

For industrial maintenance and consumer servicing professionals

May 1981 □ \$2.25

# Electronic Servicing

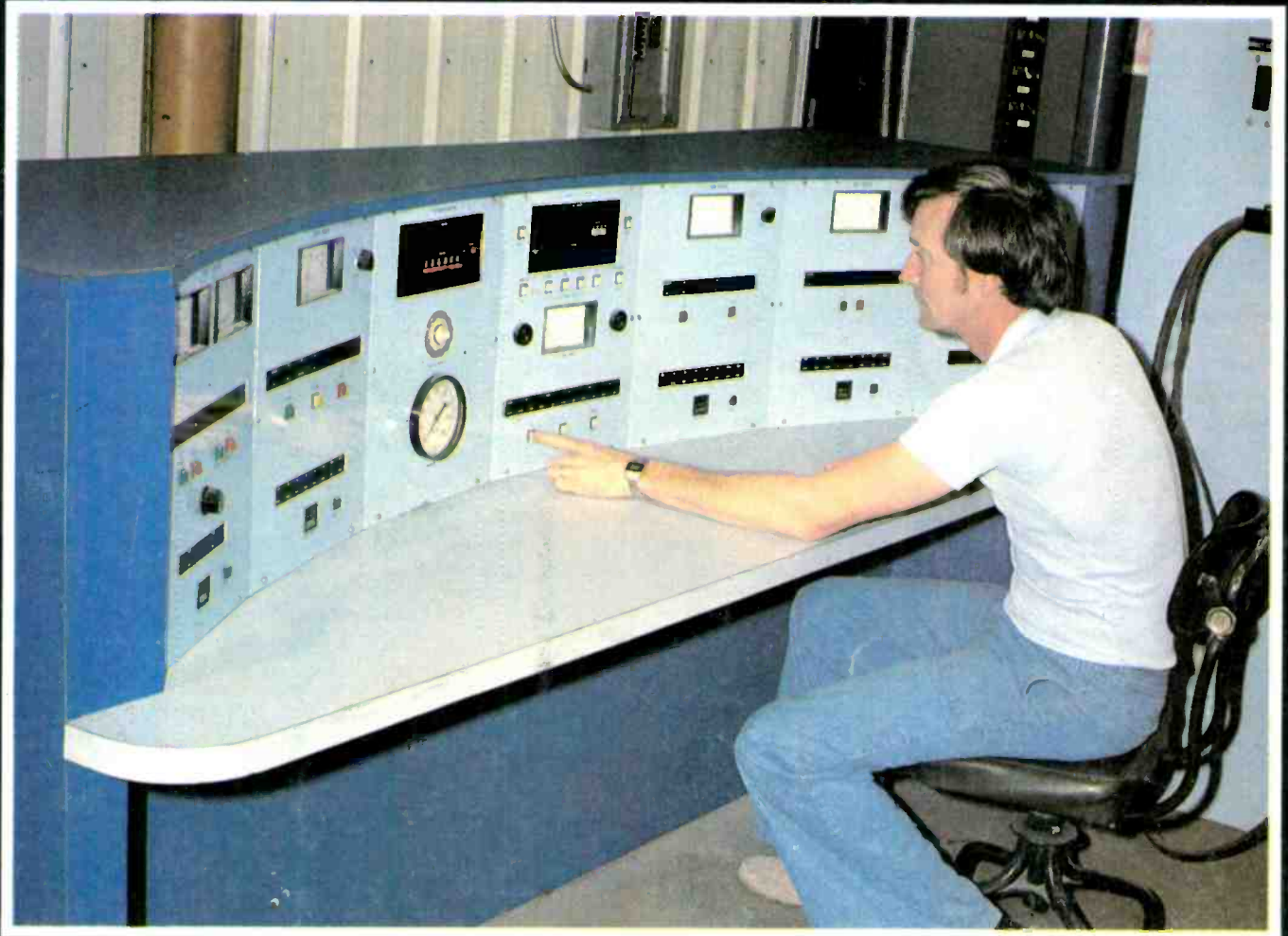

## Planning the industrial maintenance shop

## Equipping an audio test bench

SAMA3905352PE01A1 W803C883  
 A D SAMPSON 0176 11  
 6 MILL ST HANCOCKS NY 13783

**AUDIOCASSETTE REPAIRS**



Continuously variable output, 0-150 V AC  
 •  
 Input Frequencies 48-500 Hz  
 •  
 Up to 2 amp. at all voltage  
 •  
 Large taut-band panel voltmeter, 3% F.S.

**Monitor ISO-V-AC WP-29**

# REDUCE SHOCK HAZARD. NEW, VARIABLE ISOLATION TRANSFORMER, ONLY \$143.75

Here's extra safety for personnel—protection for equipment. Absolutely necessary for servicing or testing any transformerless equipment—industry, lab, school or field.

New WP-29 ISO-V-AC lets you set isolated output voltage to precise

value you need. Monitor either isolated output or direct input voltage on panel meter. It's the most versatile isolation transformer you can buy!

Two isolated outputs: polarized standard two-wire socket and banana

jacks (so isolated AC may be applied directly to circuit points). Completely portable. Thermal overload protection of transformer and output protected by 2-amp. circuit breaker. Output leads supplied.

## VIZ Isotap® isolation transformers



**WP-26A Isotap**  
 400 VA isolated, 500 VA direct. Outputs at 105, 120 and 135 V.  
**\$77.00**



**WP-27A Isotap II**  
 400 VA isolated only. Outputs 25 to 150V AC in 5V steps.  
**\$79.95**



**WP-28 Porta-Isotap**  
 150 VA isolated, 500 VA direct. Output 105-130V. TV adaptors supplied. Carrying strap.  
**\$57.00**

## AC Leakage Tester



**WT-540B**  
 For safety. Detects AC leakage in appliances and equipment. Calibrated at 0.5 and 0.75 mA.  
**\$36.75**

**VIZ RELIABILITY.**  
 VIZ is a 50 year-old company. Our instruments are fully warranted, parts and labor, for a year. All units tested to NBS standards. We offer service and parts availability for a minimum of ten years. Over 15 repair depots in U.S.A.

Want full technical details and a demonstration? Call toll-free, 1-800-523-3696, for the VIZ distributor near you.



**Look to VIZ for value, quality and availability. Over 70 instruments in the line.**  
 VIZ Mfg. Co., 335 E. Price St., Philadelphia, PA 19144

# Electronic Servicing®

Editorial, advertising and circulation correspondence should be addressed to P.O. Box 12901, Overland Park, KS 66212 (a suburb of Kansas City, MO); (913) 888-4664.

## EDITORIAL

Bill Rhodes, *Editorial Director*  
 Carl Babcoke, *Consumer Servicing Consultant*  
 Kevin Kious, *Managing Editor*  
 Marjorie Rigglin, *Editorial Assistant*

## ART

Dudley Rose, *Art Director*  
 Linda M. Pocsik, *Graphic Designer*

## CIRCULATION

John C. Arnst, *Director*  
 Evelyn Rogers, *Manager*  
 Dee Manies, *Reader Correspondent*

## ADMINISTRATION

R. J. Hancock, *President*  
 George Laughead, *Publisher*

## ADVERTISING

Greg Garrison, *National Sales Manager*  
 Mary Blinbaum, *Production Manager*

Regional advertising sales offices listed near Advertiser's Index.



Member,  
 American Business Press



Member,  
 Audit Bureau  
 of Circulation

**ELECTRONIC SERVICING** (USPS 462-050) (with which is combined PF Reporter) is published monthly by Intertec Publishing Corp., P.O. Box 12901, 9221 Quivira Road, Overland Park, KS 66212. Second Class Postage paid at Shawnee Mission, KS 66201. Send Form 3579 to P.O. Box 12901, Overland Park, KS 66212.

**ELECTRONIC SERVICING** is edited for technicians who repair home-entertainment electronic equipment (such as TV, radio, tape, stereo and record players) and for industrial technicians who repair defective production-line merchandise, test equipment, or industrial controls in factories.

Subscription prices to qualified subscribers: 1 year—\$12, 2 years—\$19, 3 years—\$24, in the USA and its possessions. Foreign countries: 1 year—\$17, 2 years—\$27, 3 years—\$35. Subscription prices to all others: 1 year—\$25, 2 years—\$50, in the USA and its possessions. Foreign countries: 1 year—\$36, 2 years—\$72. Single copy price \$2.25; back copies \$3.00. Adjustment necessitated by subscription termination to single copy rate. Allow 6 to 8 weeks delivery for change of address. Allow 6 to 8 weeks for new subscriptions.



INTERTEC PUBLISHING CORP.  
 © 1981. All rights reserved.

Next month in

# Electronic Servicing®

- TV antenna source guide
- MRO parts: how to buy them
- A computerized service operation
- Locating MRO parts and components

## QUICK CHARGE IRON- QUICK CHANGE TIPS

**ISO-TIP® Quick Charge Cordless Soldering Iron** recharges in 3-4½ hours. Uses any of Wahl's 16 snap-in tips.

Low voltage, battery powered, ground free isolated tip design.



**WAHL CLIPPER CORPORATION**  
 ORIGINATORS OF PRACTICAL CORDLESS SOLDERING.  
 Sterling, Illinois 61081 (815) 625-6525  
 "Manufacturing Excellence Since 1919"

Circle (3) on Reply Card

For industrial maintenance and consumer servicing professionals

# Electronic Servicing

May 1981 □ Volume 31, No. 5

---

## INDUSTRIAL MRO

### 8 Planning the industrial maintenance shop

*By Elwood Gilliland, technical consultant,  
Electric Service Company, Casper, WY*  
The operations of several shops are described.

### 16 Applications of digital scopes

*By Peter C. Dale, product manager,  
instruments division, Gould Inc., Cleveland, OH*

---

## CONSUMER SERVICING & INDUSTRIAL MRO

### 22 Index of 1980 articles

*Compiled by Warren G. Parker, Metairie, LA*

---

## CONSUMER SERVICING

### 25 Audio servicing with a swept-frequency generator

*By Kirk Vistain, West Chicago, IL*  
Internal actions and typical applications  
of an audio sweeper.

### 30 The well-equipped audio test bench

*By Kirk Vistain, West Chicago, IL*

### 32 Typical auto audiocassette repairs

*By Homer L. Davidson, Davidson Radio & TV,  
Fort Dodge, IA*  
Twelve case histories are discussed.

---

## Departments

4 Scanner  
6 People  
40 Test equipment

40 Reader's exchange  
41 Symcure  
42 Product Report

---

## About the cover

*Ease of operation, safety and instrumentation accuracy are  
featured in this electric motor test console designed and built  
by the Electric Service Company, Casper, WY.*

© Copyright, 1981, by Intertec Publishing Corporation. All rights reserved. Material may not  
be reproduced or photocopied in any form without written permission of publisher.

# THE METER READER'S METERS



## **A.W. SPERRY GIVES YOU A MEASURABLE ADVANTAGE IN MEASURING INSTRUMENTS**

At A.W. Sperry we're continually broadening and refining our instrument line to match your job requirements. Some of our best innovations have come from your suggestions. That's why A.W. Sperry's instruments are safety-engineered and designed with your needs in mind.

When you look at our line-up, you're looking at what you've helped us to accomplish. We appreciate the joint effort to make test

measurements easier and safer for you. For quality testing instruments, you'll find A.W. Sperry's job-matched "meter reader's meters" the preferred choice.

See the latest line-up in our Mini-Catalog. For a free copy call your distributor or A.W. Sperry Instruments Inc., 245 Marcus Blvd., Hauppauge, New York 11787, 800-645-5398 Toll-Free. (N.Y., Hawaii, Alaska call collect 516-231-7050).

**A.W. SPERRY INSTRUMENTS INC.**  
**The Measurable Advantage.**

Circle (4) on Reply Card

## NESDA/ISCET's new referral service

Three manufacturers of electronic devices have received a list of qualified servicers for their products through a new referral service of the National Electronic Service Dealers Association (NESDA) and the International Society of Certified Electronic Technicians (ISCET).

Because of occasional inquiries from manufacturers, NESDA and ISCET surveyed their members to find out which products they were presently servicing and which products they or their technicians were qualified to service. The survey also questioned if the members had the necessary test equipment to service a particular product, if they would like to add the product to their service business and if they or their technicians would be willing to attend training on the servicing of the product. Products surveyed included; color televisions, projection televisions, VCRs, videodiscs, stereos, short wave receivers, CBs, communication equipment, scanners, TV games, telephone equipment, computers and medical equipment.

The survey results have been computerized and a list of qualified servicers for any category is available from the NESDA office. Members wishing to add their service facility to the list may request copies of the survey form from NESDA, 2708 West Berry St., Fort Worth, TX 76109 (817) 921-9061.

## CPD extends regional marketing

Service dealers can now buy Sony parts direct from Consumer Products Distributing, Inc. (CPD). CPD has extended its regional direct marketing of Sony parts to include service dealers throughout the United States. National advertising by the company began in March.

For specific Sony parts price information and/or a CPD credit application contact: Dan Harp, General Manager, CPD, Inc., 3330 Pagosa Court, Indianapolis, IN 46226. Phone: (317) 897-4602.

## Perma Power appoints Skor, Inc. to cover north central states

Perma Power Electronics has appointed Skor, Inc. as manufacturer's representatives covering North Dakota, South Dakota, Minnesota, and western Wisconsin (UTP 25). According to Michael Shatz, Perma Power's sales manager, Skor will handle sales to all trade classes of all three lines of Perma Power products:

Headed by Gene Kurzweg, Skor, Inc. is located at 1821 University Avenue, St. Paul, Minnesota 55104

## First quarter sales above 1980

Total U.S. market sales to retailers of television receivers and videocassette recorders registered sharp increases over last year in the first quarter of 1981, according to statistics compiled by the Marketing Services Department, Electronic Industries Association's Consumer Electronics Group.

Videocassette recorder sales to retailers in the first three months of 1981 increased by 69.8 percent over the same period last year while the color television set sales were up 16.9 percent and monochrome TV set sales rose 16.5 percent over the first quarter of 1980.

First quarter sales to retailers of videocassette recorders amounted to 268,514, up 69.8 percent over 158,124 units sold in the comparable period last year. March 1981 sales of this product were 102,926, a gain of 64.1 percent over 62,704 units sold in the same month of 1980.

Sales of color television sets in the first quarter were 2,684,802 units, an increase of 16.9 percent over 2,297,056 units sold in the comparable period a year ago. Color TV sales in March 1981 were 992,320, up 6.2 percent over 934,414 units sold in the same month of 1980.

Monochrome television receiver sales in the first quarter of 1981 climbed to 1,483,036 units, a rise of 16.5 percent above 1,272,703 units sold in the same quarter a year ago.

## Motorola's Weisz receives EIA Medal of Honor

The Electronic Industries Association announced William J. Weisz, vice chairman and chief operating officer of Motorola, Inc., as recipient of the industry's highest award, the 1981 EIA Medal of Honor. Annually bestowed by the association, this award recognizes outstanding contributions to the advancement of the electronics industry and high personal achievement in the field of industry management.

Weisz' contributions to the electronics industry and efforts on behalf of the private enterprise system have been recognized through numerous past awards including the Freedoms Foundation of Valley Forge Award, the MIT Corporate Leadership Award, the National Electronics Conference Award of Merit and an honorary doctorate of business administration from St. Ambrose College.

## Consolidation

PTS Electronics has consolidated its Los Angeles-Paramount and San Diego operations. Since March 27, 1981, southern California service facilities have been based at the southern California district office located at 5111 University Avenue, San Diego, CA 92105; (714) 280-7070.

## Distributor bookings and shipments show strong gains

Industrial distribution's March shipments grew 4% from February while bookings gained 5%, according to the NEDA Distribution Business Index data, just released by the National Electronic Distributors Association.

The industry's book-to-bill ratio for March was 1.10 to 1.

Compared to the report's reference month of May 1980, shipments were 6% greater, while bookings were up 12%.

## **GE promotes VCR training in the South**

General Electric has launched a VCR training program that covers the 12 southeastern and western states. The two day sessions are designed to give the service dealer "hands on" experience not only in servicing the GE VCR machines, but to understand VCR service in general. Sencore, manufacturer of electronic test instruments, is assisting in the GE program. Because of Sencore's belief that training is important to the service dealer, Sencore has provided six complete set-ups of their SC60 oscilloscope, DVM56 digital volt meter, PR57 variable isolation transformer and leakage tester, CG25 color bar generator and VA48 video analyzer for the technicians to use in the GE training sessions.

The cooperative GE-Sencore effort has been well received.

## **TRW names distributors**

The fixed resistor distributor operation of TRW/IRC Resistors has named Resco/Raleigh a distributor. Effective immediately, Resco/Raleigh will distribute TRW/IRC's complete line of fixed resistors, including carbon composition, metal film, and wire wound resistors, as well as resistive networks.

Resco/Raleigh's territory includes North Carolina, South Carolina, Georgia, and eastern Tennessee.

Resco/Raleigh's contact: Bill Bagliani, president, Highway 70 West and Resco Court, Raleigh, NC 27612. Telephone: (919) 781-5700.

Also in the news and effective immediately, Peak Electronics will distribute TRW/IRC's complete line in the Philadelphia metropolitan area: eastern Pennsylvania, southern New Jersey, and Delaware.

Peak's contact: Jay Peikin, president, 354-356 West Lancaster Avenue, Wayne, PA 19087. Telephone: (215) 293-9000.

## **1980 exports show gain**

U.S. consumer electronics exports and imports experienced substantial changes in 1980, according to statistics released by the marketing services department of the Electronics Industries Association's Consumer Electronics Group.

Exports of color television receivers in 1980 increased to 787,638 units, a gain of 110.2 percent over 374,653 units exported in 1979. Customs value of color TV exports increased to \$276,982,380 in 1980. Exports of monochrome television increased by 6.7 percent to 168,857 units in 1980 and exports of TV combinations increased in 1980 to 13,425 units, up 49.2 percent over 8,997 units exported in 1979.

Audio and videotape equipment exports increased in 1980 but exports of entertainment band radios declined while auto radio shipments out of the country held about even with 1979.

## **EIA supports limited indemnification for government suppliers**

Testifying on behalf of U.S. government suppliers, the Electronic Industries Association offered its support to H.R. 1504, a bill that, if enacted, would provide for a proper and fair allocation, between user and supplier, of product liability risks which are inevitably associated with certain government procurement programs.

According to EIA's president, Peter F. McCloskey, H.R. 1504 would withhold indemnification in those cases where the accident was caused by the supplier's "primary and active or willful negligence," a provision the association believes is a well-reasoned and fair criterion for determining when and when not to shift such losses from the supplier to the government.

EIA's statement further indicated that the enactment of H.R. 1504 would result in a reduction in the government's total acquisition costs.

## **Price reductions announced by Kester**

Because of a recent drop in the price of tin, Kester Solder has reduced prices by five percent on many items in its distributor line, as announced recently by the Litton Industries division.

## **NESDA advocates Hall of Fame**

An Electronics Hall of Fame Center may become a reality due to the work of two NESDA regional vice presidents, Gene Dillingham and Bill Lawler, who are proposing the project to electronics industry associations throughout the nation.

NESDA is inviting EIA, ERA, NEDA, ITA, NARDA, NABER, NAVA, NAB, NATESA and all other national associations in the electronics industry to join together in making this Hall of Fame Center possible, through formation of a Hall of Fame foundation to administer operation of Hall of Fame and the center. Some of the noted personalities now in the Hall of Fame include are: Thomas A. Edison, inventor of the electric light, the phonograph, and the motion picture; Dr. Lee de Forest, the father of radio; Hugo Gernsback, publisher, inventor, and electronic prognosticator; and General David Sarnoff, color TV pioneer.

The Hall of Fame Center will include an electronics museum displaying electronic equipment from the past, present and future; an industry technical library, electronics archives for use by all of the industry; and exhibits displaying photos and personal histories of the famous personalities in the world of electronics. The concept of a center was endorsed by the California State Electronics Association and by participants in the Western States Conference. Dillingham and Lawler are asked for support from all allied electronics trade associations. Inquiries should be sent to NESDA, Attn.: J. W. Williams, 2708 West Berry Street, Fort Worth, TX 76109.

# Redi-Chec '81 Awards

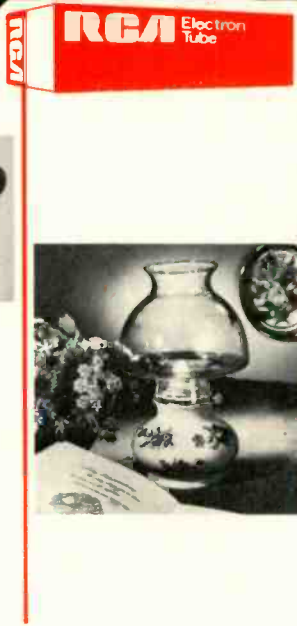

## people in the news

**W. J. (Judd) Clark**, director-national sales, has been promoted to director-marketing and business development at ITT Cannon Electric—North America. He is responsible for sales, marketing, distribution, advertising, sales promotion, customer training and program management.

Clark replaces L. Wayne Oliver who was named president in September.

Reliance Electric announced the appointment of **Robert W. Richey** as general manager of Federal Pacific Electric (F.P.E.), a subsidiary of Reliance.

In this new position, Richey will be responsible for Federal Pacific Electric operations in the United States and Mexico as well as for the international business of Cornell-Dubilier Electronics, a subsidiary of F.P.E.

Blonder-Tongue Laboratories Inc. has announced the appointment of **Charles J. Goetsch** to manager, service department. Goetsch joined the company in 1962 and has held a number of positions in the product design and engineering departments, including systems engineering manager.

**William R. Cranford**, director-market planning and development, has been named director-new product planning for ITT Cannon Electric, North America. He will be responsible for identifying new product opportunities and coordinating priorities with available talent, capital and capacity. A veteran of over 33 years with ITT Cannon, he has held numerous positions, including sales engineer, customer service manager, and manager-consumer products.

RCA has elected **James M. Alic** vice president for electronic services and VideoDisc planning. In addition to his new responsibilities, Alic will continue to be responsible for business management and controls for the RCA SelectaVision VideoDisc project.

Simultaneously, the appointments were announced of **George D. Prestwich** as president of the RCA Service Company, replacing **James J. Badaracco**, who has been appointed division vice president of special marketing programs; and of **Joseph W. Karoly**, vice president for special projects.

Named division vice president, distributor and special products division: **Edward A. Boschetti**. Progressing with RCA since 1951, Boschetti now has total responsibility for sales, merchandising, marketing services, product planning and engineering, all products of this division.





**Choose from over 700 exciting prizes -- yours free when you buy RCA Receiving Tubes.**

The all-new 1981 RCA Redi-Chec Awards program is now in full swing. Never before have there been so many terrific prizes. And never before has it been so easy to get them.

Your participating RCA Distributor will give you valuable dealer certificates when you purchase RCA Receiving Tubes. Collect these certificates to earn the prizes of your choice. The Redi-Chec Awards '81 Prize Book contains full descriptions of over 700 great prizes — including cameras, appliances and power tools. Get your free Prize Book from your participating RCA Distributor.

When you've saved the right number of certificates for the prizes you want, fill out the awards order form that's included with your Prize Book. Mail the completed form with your dealer certificates to: RCA Redi-Chec Awards '81 Headquarters, P.O. Box 154, Dayton, Ohio 45401.

Get top quality Receiving Tubes from RCA and more. Start earning your 1981 Redi-Chec Awards today.



RCA | Distributor and Special Products | Deptford, NJ 08096

**RCA Receiving Tubes**

**Gene Chaiken**, president of Almo Electronic Corporation, has been elected president of the National Electronic Distributors Association (NEDA) for the fiscal year beginning April 1. He had previously been first vice president.

Three new distributor executives joined the NEDA officers' roster for the first time: **Dan Robbin**, vice president, marketing, Time Electronics, is vice president, industrial; **Phil L. Webb**, vice president, specialty distributing, is vice president, MRO; and **Paul F. Carroll**, president, semiconductor specialists, is treasurer.

Past president **Marvin Perkel** of QAR Electronics moved to chairman of the board. Officers re-elected for a second term include: first vice president, **Richard Lindholm**, president, Melvin Electronics; vice president, consumer, **Eldon Schoedel**, vice president, Klaus Radio; vice president, general, **Jack Hinterschied**, president, Whitehead Radio; secretary, **Robert R. Daugherty**, president, Swico, Inc.

A new management team has been announced by Klein Tools. Those promoted are: **Richard T. Klein**, formerly president, to vice chairman; **Michael S. Klein**, formerly vice president, administration, to president; **Vincent Nugent**, from senior vice president, manufacturing, to senior vice president, corporate planning; **Joseph Reilly**, from vice president, finance, to senior vice president, finance; **Mathias A. Klein, III** from vice president to vice president, manufacturing; **Richard T. Klein Jr.**, to corporate quality control manager and elected corporate secretary; **Steven T. Klein**, regional sales manager, elected assistant corporate secretary; **Dan Foshee**, from regional sales manager to national sales manager.

**H. James McGill** has been appointed manager, national territorial sales, for Westinghouse Electric's Industry Products marketing, and **Charles H. Hawks** has been named to assume the position of director of distribution.

**Robert B. Lukingbeal** has been appointed senior vice president of operations including responsibility for a realigned engineering organization within the N.A.P. Consumer Electronics Corporation.

N.A.P. Consumer Electronics, a new subsidiary formed when North American Philips Corporation acquired GTE Entertainment Products, manufactures and markets under the Magnavox, Philco and Sylvania brands.

Reporting to Lukingbeal, formerly vice president of operations, Magnavox Consumer Electronics, are new vice presidents **John R. D'Aiuto** and **Eugene Lubchenko**.

D'Aiuto, named vice president of color TV engineering, previously directed engineering for GTE. Lubchenko, formerly vice president of engineering, Magnavox, is vice president of new products and systems.

Also announced: the appointment of **William A. Enser** as director of planning. Enser was formerly manager of financial planning and administration, GTE.

# Planning the industrial maintenance shop

By Elwood Gilliland, technical consultant, Electric Service Co., Casper, WY

*Planning and equipping an industrial service and repair shop can be simple or complex, depending on the market being served. The author gives points on shop planning and reviews how several companies have built successful facilities.*

A growing industrial repair market offers opportunity for the service shop to expand and diversify. But don't expect an easy path to success. There's no such thing as a tried and true method for developing an industrial electronic repair capability. Industrial controls are highly sophisticated, must work in severe environments and are applied where downtime is often computed in thousands of dollars an hour.

Servicing industrial electronic equipment can be the technician's greatest challenge. Successful service companies have learned that a "total systems approach" to troubleshooting is necessary, requiring not only a knowledge of the controls and their operation but also an understanding of the equipment or process being controlled. The final diagnosis may very well pinpoint a problem that is nonelectronic.

Many well established electrical repair companies have created an electronics department to provide their customers with more complete service and to remain viable in the marketplace as technology advances. Jim Shumberg, owner and founder of Eltron Electric in Houston, provides a good example of how a small, well-managed industrial electrical repair company can develop the capability for solid-state repair. In 1979, Shumberg attended a one-week training course in basic solid-state controls sponsored by the Electrical Apparatus Service Association.

"Until that time," he says, "I was totally unaware that such a tremendous industrial repair market ex-

isted, or even how to approach the repair of this equipment." Eltron is concentrating on the repair of small single and three phase dc motor drives that can be brought into the shop, but the company is also working toward establishing a separate electronics department with full field service capability.

There are few guidelines for expanding into the industrial electronic repair market, but an analysis of successful operations reveals several common traits. Most companies have moved into an area

closely related to their original field of expertise, and they have grown slowly and carefully, often relying on other departments to support the fledgling operation.

## Equipping the shop

The company planning to expand into the industrial repair market can expect to make a substantial investment in test equipment. George Mendell of Rainbow Electric, Franklin Park, IL, says, "The new drives are becoming more and more complex. Today it may take a

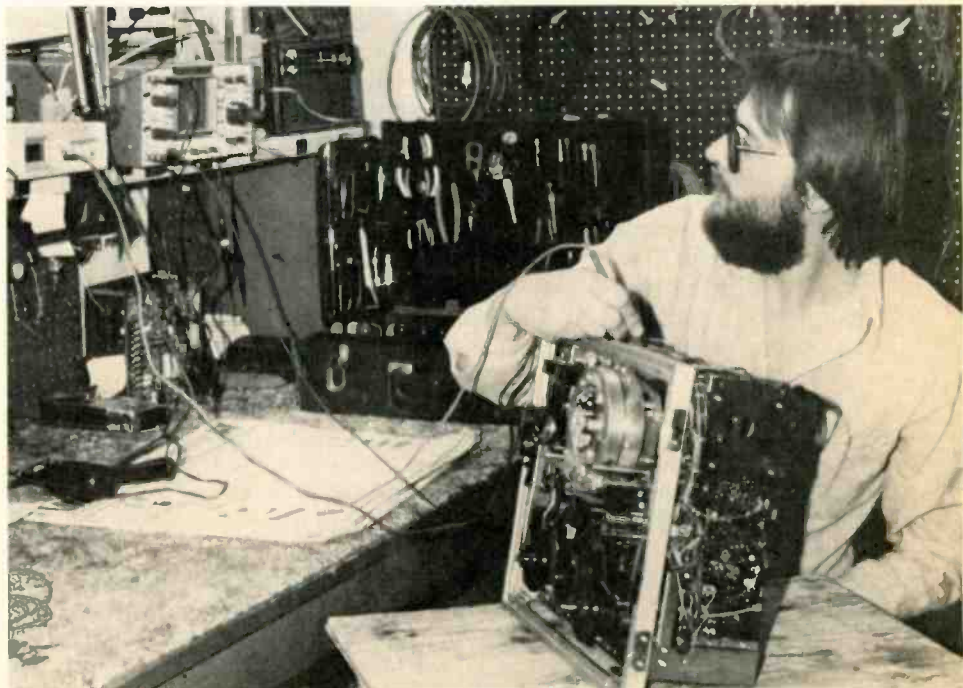

Desi Halasz, Electric Service Company technician, troubleshoots a video recorder for one of the company's many industrial customers. Mining companies are using this medium to make excavator time/motion studies.

\$10,000 oscilloscope to meet these requirements. Our portable units for field work run between \$1500 and \$3000."

Richard High of Sullivan Electric, Cincinnati, OH, makes a similar comment: "We have a much higher dollar investment in equipment in the electronics group for dollar return than in any of our other departments."

To troubleshoot printed circuit boards (where sufficient volume exists), companies such as Rainbow and Sullivan and Galco of Hazel Park, MI, have a sizeable investment in specially built test fixtures, enabling them to make repairs without the entire system.

Many smaller companies, unable to justify an extensive investment in test equipment, have purchased general purpose gear and then meet their special requirements with rented equipment. Bruno Peter of B&B Dynamo & Armature in Winnipeg, Manitoba, has obtained equipment on occasion from CAE Aircraft Ltd. in Canada. Continental Resources and Electro Rent Corporation are two US companies offering test equipment on a rental basis and can provide fast delivery either by air freight or United Parcel Service.

Test equipment requirements are as diverse as the industrial controls being serviced, and it would be difficult to make specific recommendations. Marlin Engel of Electric Service Company, Casper, WY, says, "A lot of test equipment requirements are basic to any type of electronic servicing: equipment like high impedance meters, transistor testers and capacitance bridges. When analyzing new markets, you need to see which of your other equipment will make the crossover." For field work, however, battery powered or line isolated oscilloscopes are mandatory because most industrial controls cannot be grounded. Many technicians have applied a conventional line-powered scope with disastrous results, compounding an otherwise simple repair. A dual trace scope is a must for working on three phase SCR equipment to make phase comparisons of the firing pulses.

#### Training for industrial repair

One of the major hurdles to clear in developing an industrial electronic repair capability is hiring

qualified technicians. The rule is that such a person can't be found; one has to be trained. Most industrial shops are hiring technicians with a general electronics background, such as graduates of military schools or two-year trade schools, and then providing on-the-job training covering the specifics.

High of Sullivan Electric says, "In our area there's no problem recruiting technicians. Our ads for help in this field bring a larger response than the other crafts which we employ. But none of them have much SCR experience and that component is really the heart of the dc motor drives which we service.

"For service work, we look for an individual who is accustomed to a maintenance environment as opposed to someone who has only assembly line experience."

Mendell of Rainbow describes a similar approach: "We hire technical school graduates and feel that a person's attitude and initiative are equally important to their technical training. The new man will work in the shop for a while and then accompany the senior technicians on service calls. The second

man is an expense you can't charge the customer for, and you just have to hope that they will develop enough loyalty to stay with you."

But what about the service shop situated away from the large metropolitan areas? Peter of B&B Dynamo & Armature describes a situation typical of the small shop in a remote region: "Trained technicians don't exist in our area." He says this continent could benefit from the European concept of providing specific apprenticeship type training for craftsmen at a much earlier age. The few American companies that have hired one of these highly trained individuals will readily agree.

Harold Moore of Johnson Electric in Pueblo, CO, has worked diligently to help the smaller service shop acquire a solid-state capability. As chairman of the Electrical Apparatus Service Association's (EASA) Solid State Committee, he was instrumental in the establishment of a one week traveling program in basic solid-state controls.

"This course has been highly successful in helping members to learn the basics of test equipment opera-

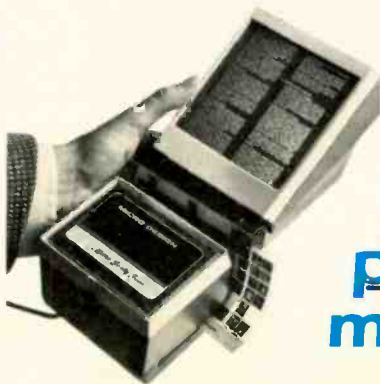

Now you've got us  
where you want us...  
right in the palm  
of your hand!

First practical,  
personal size  
microfiche reader.



**Micro Forty Four.** Puts a world of information at your fingertips—on service calls, in the field, outside office or in home. And, naturally, it comes from the leading manufacturer of micrographic readers. The design is a marvel of simplicity. Flip up viewing hood and our advanced optical system projects a bright, clear image on the full 5-1/2" diagonal screen. Operates on batteries, 110V or car lighter. Weighs less than 1-1/2 lbs. Fits a tool case.

**Micro Forty Four** is a small miracle, ideal for service personnel. Call or write now for information on the affordable new personal size **Micro Forty Four Reader** from Micro Design: the Reader Leader.

**MICRO DESIGN**

DIVISION OF BELL & HOWELL CO.

857 W. State Street  
Hartford, Wisconsin 53027  
(414) 673-3920

Circle (5) on Reply Card

## MRO shop

tion and provide component familiarization, but we are still looking for an effective method of teaching troubleshooting," he says. Moore said a lot of EASA shops are sending their employees to schools offered by the various equipment manufacturers. Although the quality of training is excellent, it is often expensive and limited to a few specific types of equipment.

He has also worked with a local

junior college. A basic course was developed, but to date the advanced program has not materialized because an instructor has not been found. "It's hard to find an individual of this caliber because they are highly sought after by the industry and can make a lot more money in that field," Moore said.

### Rainbow Electric

Rainbow Electric of Franklin Park, IL, is recognized as one of the country's leaders in servicing and

repairing of the sophisticated solid-state motor drives that keep industry rolling. Owner George Mendell has justifiable pride in his team of six crack electronic technicians that specializes exclusively in the servicing of variable speed dc and ac motor controls. It has taken Mendell 15 years to develop the Industrial Controls Department that augments Rainbow's 30 man electric motor sales and repair business.

There are many reasons for the phenomenal success of the company, but Mendell considers his location to be an important contributing factor. The Control Department headquarters is only 10 minutes from Chicago's O'Hare International Airport, which has flights to major US cities every half hour. Each of Rainbow's technicians, on call 24 hours a day, is furnished with a company car, a full complement of all major credit cards and is equipped with a small portable battery-powered oscilloscope and other test equipment that can be transported as carry-on luggage to minimize the possibility of equipment damage. A technician is never dispatched on a service call, however, until the nature of the problem has been ascertained and he is armed with the appropriate test equipment and replacement spare parts.

The company is an authorized field service center for a dozen different manufacturers including ERC, WER, Louis Allis and Fincor. The technicians are backed up by one of the country's largest inventories of motors and drives, and spare parts, including replacement PC boards, SCRs, and other discrete components.

Mendell's motto is "Don't die on the job." If the technician has a particularly tough problem and hasn't isolated the difficulty within a few hours, he is encouraged to forego his pride and consult with the drive manufacturer or one of Rainbow's other technicians for advice. Mendell insists that when his technicians are on the job there be no secrets kept from the customer. He says his people will gladly answer questions pertaining to the operation of the equipment and the nature of the repair and will assist the customer in finding ways to eliminate or minimize future downtime. Mendell's philosophy—"You may teach yourself out of an

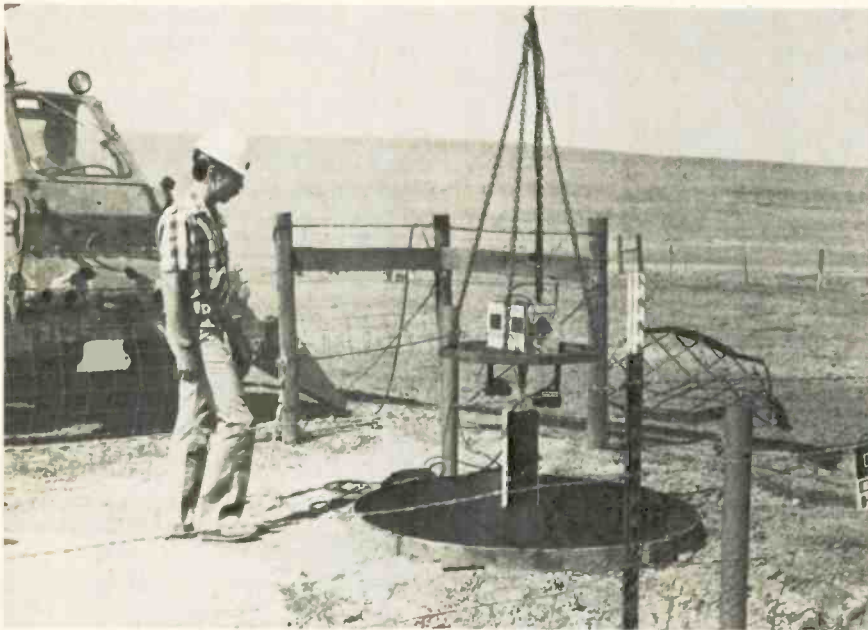

Ron Borino, Electric Service Company technician, watches as a CCTV camera and light assembly begins its 600 foot descent into a uranium mine ventilation shaft.

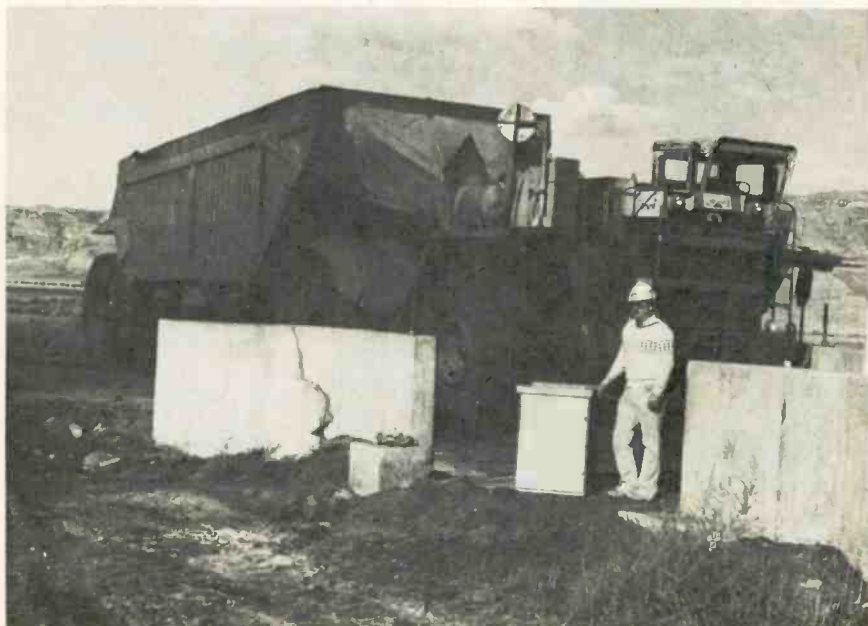

Ross Heller, mine engineer stands beside the interrogator of an automatic vehicle identification system. Each truck carries a digitally coded transponder, which is activated as the vehicle crosses over a buried 600V antenna.

occasional service call but you have gained a customer for life"—has paid big dividends in terms of satisfied customers.

Mendell says good communications is an essential ingredient in every phase of Rainbow's operations. Special work forms have been developed to ensure that every job step, from the issuing of an initial purchase order to the signature for the completed repair, has been properly authorized and documented.

The company has been closely allied with the plastics industry for years; and Mendell stresses the importance of understanding machinery and processes involved, and puts a strong emphasis on customer rapport.

#### Sullivan Electric

Sullivan Electric, one of the country's oldest electrical repair companies, began as an electrical contractor in 1898. Sullivan's president, Richard High, credits the company's longevity, in part, to its ability to "look toward the future." It was with this in mind that the company established an Electronics Depart-

ment to supplement its wiring, panel building and motor repair operations.

High says his company specializes primarily in the repair of SCR dc motor drives widely used by small manufacturers in his area. Sullivan particularly tries to promote the service of small packaged drives that range from fractional to five horsepower. These drives are generally self-contained, incorporating the regulator, SCR power package and controls in a single enclosure. The units are considered by many, because of their low cost, to be throwaway items. But the company has made a profitable business of this previously neglected area by developing rapid troubleshooting techniques and providing quick turn-around.

"This type of equipment is ideal for us because it can be brought into our shop for service," High says. "The only additional piece of equipment that we need is the motor, and we have them readily available. Furthermore, no complicated application problems are generally encountered with equipment of this size." His two technicians will also

answer field service calls within a 50 mile radius and can generally provide same-day service.

High stresses that an important aspect of the repair is final testing, and the group has built a load test station with a dynamometer to ensure every unit will perform satisfactorily under operating conditions.

Sullivan finds a ready market for its services among small manufacturers that do not have their own electrical staff; additional business comes as the result of referrals made by the various equipment manufacturers.

#### Galco

In 1975, electrical engineer Don Gallasco decided to form his own company, Galco, to specialize in the repair of solid-state adjustable speed drives and controls. Now he has a staff of 16 with an impressive background in servicing complex equipment such as numerical controls, axis and spindle drives, tape readers, tachometers and resolvers. The volume of service and repair work is divided about equally between field service calls, made nationwide, and shop repairs con-

## FAST Complete Service on All Makes of TV Tuners

Maximum time in shop—24 hours

Warranty:  
ONE  
FULL  
YEAR

WE SHIP C.O.D.  
YOU PAY SHIPPING

**\$14.95\***

BLACK & WHITE  
OR COLOR

VHF OR UHF

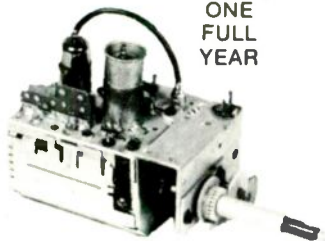

UV Combo's **\$21.95\***

\*Prices subject to change without notice

Price includes all labor and parts except Tubes, Diodes & Transistors. If combo tuner needs only one unit repaired, disassemble and ship only defective unit. Otherwise there will be a charge for a combo tuner. When sending tuners for repair, remove mounting brackets, knobs, indicator dials, remote fine tuning arrangements and remote control drive units.

**We Unconditionally Guarantee  
All Tuners for One Full Year**

**Gem City Tuner Service**

Box 6B, Dabel Station  
1621 Mardon Dr., Dayton, Ohio 45420

Circle (9) on Reply Card

## COME TO US FOR TOOL KITS THAT HELP YOU ON THE GO!

### ETK-180 ENGINEERS FIELD SERVICE TOOL KIT



See our  
catalog in  
Thomas Register  
catalog file.

Variety and great dollar value make this kit our most popular with engineers and technicians. 100, quality name brand tools for maintenance and repair of electronic, communication, radar, computer, medical and office equipment. Neatly arranged for quick selection in a distinctive attache case as professional as the services you render.

Other tool kits, tools and test equipment available. Call:

**Toll-free (800) 431-1106 • 24 Hours • 7 Days a Week**



Request catalog on company letterhead.

**ELECTRONIC TOOL CO., INC.**  
Claremont Ave. Thornwood, N.Y. 10594  
(914) 769-8070

Circle (10) on Reply Card

May 1981 *Electronic Servicing* 13

## MRO shop

ducted in Galco's facility. The company is an authorized service representative for a number of manufacturers, including Eaton Dynamic, Cutler Hammer, Electrical Regulator, Sabina Electric and Engineering, and WER Industrial.

Gallaso originally worked almost exclusively with the auto industry but he recognized early the existence of an unlimited market supporting

other repair companies around the country by providing semiconductors and replacement printed circuit boards. The diversification into component sales has been so successful that it now represents approximately 50% of the company's total dollar volume. A nationwide clientele has been developed that includes many companies in the electrical apparatus repair and electrical contracting business. Galco now maintains one of the largest inven-

ories of power semiconductors in the country. The company has done extensive research on component substitution and has the capability of cross-referencing expensive or obsolete devices to cost-effective generic replacements. Galco also inventories a large stock of new and rebuilt replacement printed circuit boards, and all rebuilt boards are tested and guaranteed.

"It's important not to get too broad," Gallasco said. "It's impossible to be proficient on the vast variety of equipment that exists, and we often have to turn down work that lies beyond our area of expertise. We can't be all things to all people."

The problem of component substitution has always plagued industrial troubleshooters having to contend with special house numbers or to buy an entire assembly when a single component would suffice. Galco's entry into this market promises to be a real help to the independent service company.



A Galco engineer works on the computer interface for a custom motor control application. The company "marries" the computer to conventional motor drives where complex sequencing is required.

## Electric Service Company

The Wyoming energy boom has touched off an unprecedented industrial expansion, resulting in numerous electronic service opportunities. Electric Service Company, a 35-year-old electrical contracting and motor repair company, has recently created a Technical Service Department to meet these needs.

Two years ago, Marlin Engel was brought in to organize and manage the new department. Engel, who has more than 20 years of communications, sound and CCTV experience, and a knack for organization, says he is glad he made the transition from consumer to commercial and industrial electronics.

"I made the change because I saw an inevitable growth in this field and was challenged by the opportunity to service equipment which is a necessity rather than a luxury," he says. He has a staff of eight that sells, designs, installs, services and repairs CCTV, sound and security systems, and industrial controls. The group also provides technical support for the company's Wiring Department personnel that perform full-time electrical and electronic maintenance for several of the state's largest refining, milling and manufacturing operations. Additionally, the company provides authorized field service for the EMICC variable frequency submer-

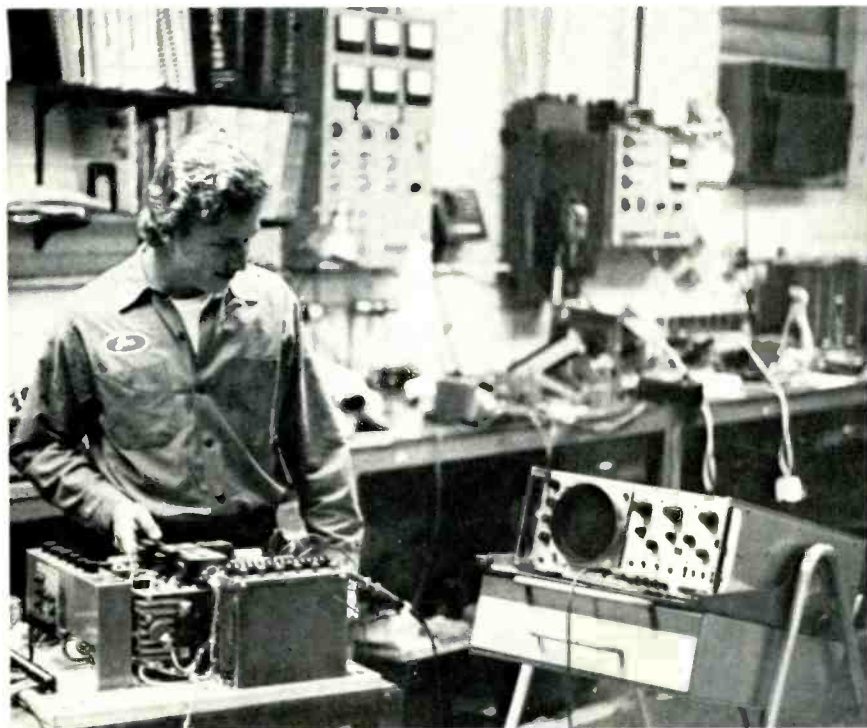

A Rainbow Electric technician services components in a dc control.

sible pump drives.

Engel, who had previously established four consumer service organizations, says that creating an entirely new industrial service operation in the widely scattered and sparsely populated Wyoming area has its own unique set of problems.

"We grew much faster than anticipated," he says, "and it was difficult to train so many new people at once. Later, as we add new individuals one or two at a time, it will be much easier."

He wants the technicians to specialize, but not to the point that they can't cross over and assist with the other disciplines in the event of an emergency.

"I guess you could say we give them a minor in General Electronics with a major in Sound, Security, CCTV, or Industrial Controls," he says. It's not uncommon for the company's technicians to travel 250 miles on a service call. "We try to group routine service calls to keep the cost down," he says, "and to minimize emergency calls, we offer scheduled preventative maintenance." The company will also train the customers' maintenance personnel to do minor repair and provides phone consultation when necessary.

The company's design philosophy is to approach every job individually and to find equipment that meets the application, not merely make the application fit what they sell. Engel says that to be competitive in the marketplace, franchises and distributorships offering significant pricing advantages are essential. However, he stresses that to be realistic the minimum inventory requirements must be adjusted to fit the smaller market area.

The group's expertise in communications has unlocked numerous jobs of a very specialized and unusual nature. For example, the company received a contract to install and maintain an Automatic Vehicle Identification system for a large surface coal mine. This equipment uses a radio frequency link to interrogate the massive 120 ton coal haulers as they enter the dump hopper. Each unit responds with its own digitally coded identification number, which is then automatically logged on a printer along with the incoming and outgoing vehicle weight.

The company prefers to design at

the system level using off-the-shelf equipment whenever possible, but its ability to do in-house circuit design has often enabled a system to be tailored exactly to the customer's needs. One project that illustrates the company's innovative capability was the design and installation of a sound system console for a local air service. The unit incorporates a solid-state priority interrupt scheme that automatically routes the customer's Unicom frequency, tower scanner, public address announcements or background music to the sound system in accordance with their importance. Chief technician Desi Halasz, who built and installed the system, said it has performed unflinchingly since its installation two years ago.

Another example of the company's design-and-build capability is the large motor test console developed for use in the company's own motor shop final test area. This state-of-the-art system uses IC logic to provide control, instrumentation and alarm functions unobtainable in conventional commercially available units.

Electric Service Company has found that once a capability and reputation for industrial servicing is developed, any project could come up. The company recently contracted to provide manpower and video equipment for an inspection of the 600 foot ventilation shaft in a large underground uranium mine. A special platform was fabricated to carry the camera, an RCA TC2000 in a Vicon housing with a 4mm lens, along with automotive batteries and headlights to provide the necessary illumination. Camera power and video signals were fed over a piggyback cable. A large air winch was used to raise and lower the assembly while the technicians checked the condition of the metal casing using an RCA TC1210 monitor on the surface.

The Electric Service Company is making an important contribution serving Wyoming's new industrial market. Engel is optimistic, and at the same time cautious, as he explains the tack he wants to take.

"We've been in a training phase, developing policies and methods," he says. "Now, as these become a matter of routine, we will begin to analyze new markets. Currently, we want to work at improving our efficiency." □

## APPLIANCE REPAIR BOOKS



Thirteen Handbooks written in easy-to-understand language by experts in the service field with illustrations and diagrams! Acclaimed by instructors and professionals alike! How to diagnose and repair air conditioners, refrigerators, washers, dryers, ranges, microwave ovens, dishwashers, vacuum cleaners, electrostatic air cleaners, RV gas appliances, hair dryers, motors, water heaters, coffeemakers, can openers, floor polishers, steam irons, food mixers, lawn care appliances, electric knives, electric and digital clocks and many others. Also fundamentals of solid state, setting up a shop, using test instruments and more. Only \$2.65 to \$4.90 ea.

SEND FOR FREE PRICE LIST

Gamit, Dept. ES

110 W. St. Charles Road,  
Lombard, Illinois 60148

Circle (6) on Reply Card

NATESA

5830 S.

Pulaski Rd

Chicago

IL 60629



### ARE YOU A PRO?

...the not for profit association championing independents' right to compete, and delivering valuable benefits continuously since 1950.

- LEADING SPOKESMAN
- TRADE INFORMATION DISPENSER
- WATCHDOG
- LOBBYIST
- YARDSTICK OF STANDARDS
- CONSUMER RELATIONS
- COUNSELOR
- PROBLEM SOLVER

We are not freeloaders. So our check for \$60.00 dues is attached. As our special premium, please ship the indicated \$15.00 Manual.

Practical Business Manual

- OR -

Service Contract Manual

# Applications of digital scopes

By Peter C. Dale, product manager, instruments division, Gould Inc., Cleveland, OH

They look like traditional scopes, and some models even double as an ordinary oscilloscope. Yet, functionally they are extensions of meters and recorders. They adapt analog monitoring and recording systems to the capture and analysis of all sorts of one-shot physical

phenomena, yet also serve as a versatile portable troubleshooting instrument.

It might seem that the addition of memory capabilities to a scope would not be very significant. This view overlooks the fact that the new digital scopes can not only freeze

time but can output it at reduced speed to conventional recorders. Data can be made to evolve just as it does on a pen recorder, yet the scope can keep only the significant events.

For example, digital scopes can be set to capture transient events occur-

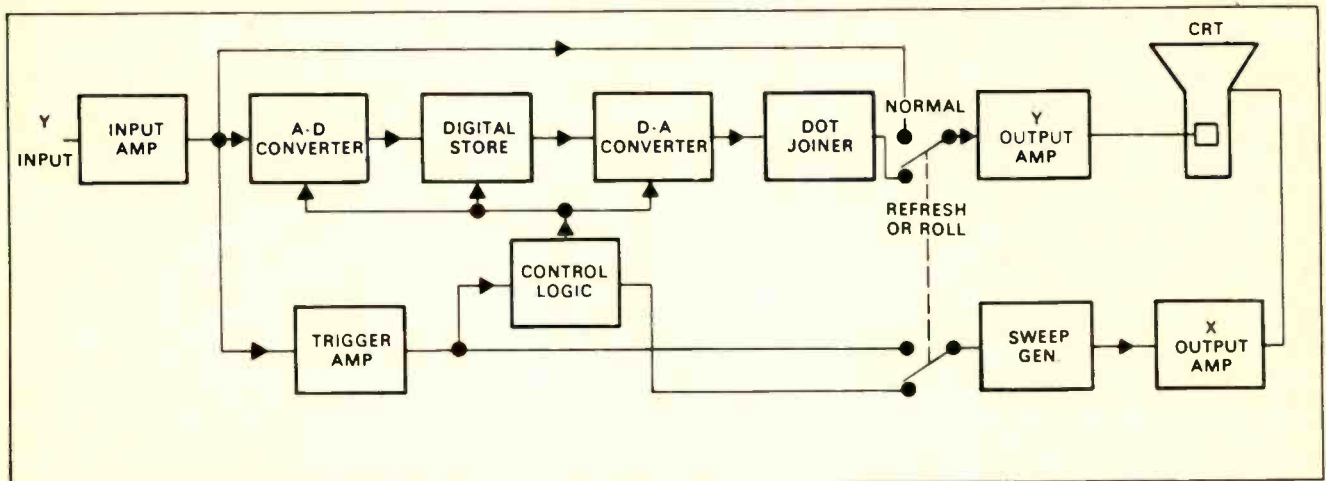

Figure 1 — Typical digital-scope block diagram for one channel. Upper bypass loop provides real-time viewing as in a conventional scope (normal mode).

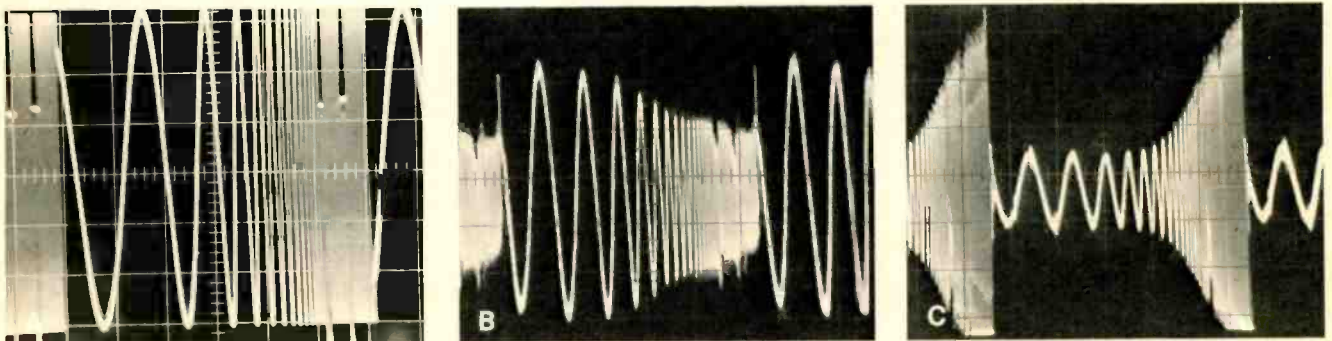

Figure 2 Challenging the process: In A, an 80kHz sine wave is displayed in real time as it would appear on a conventional scope. In B, this signal has been transformed into dots by a digital scope, and in C, the dots are joined by straight-line constructions. At this high frequency, the scope's sampling rate of 1MHz means only 12 dots are available to plot each wave repetition ( $1,000,000/80,000 = 12$ ). Because the instant of digital sampling does not occur at exactly the same point wave-to-wave, some slight variation appears between identical waveforms. Thus, some peak values may be minutely clipped as shown here, or if a superimposed megahertz transient occurred between two adjacent dots, it might be missed entirely. If such sampling errors are critical, a much higher sampling-rate instrument would be required.

Ideal for	<b>General purpose</b>	<b>Processing</b>
Field work	One-shot electromechanical phenomena	High-speed electronics analysis
Storage channels	Fully portable	Limited to laboratory use
Memory size	1 to 4	Up to 40
Frequency limits	Up to 4000 dots	Up to 24,000 dots
Price	2 Megahertz or less	Beyond 1 gigahertz (with repetitive-wave sampling)
	\$3000 and up	\$10,000 and up

Figure 3 — General purpose vs. processing scopes.



ring at anything from extremely slow to speeds in excess of 100,000Hz (less than 10 $\mu$ s), store this information indefinitely, expand it for analysis, and show what happened just before the key event or trigger point occurred. The digital scope can be used alone for monitoring and troubleshooting, or signals captured in memory can be output in analog or digital form to advanced computerized test systems.

Thus, the digital scope has become a monitoring/computing "front end" for existing measuring systems. For a modest investment, it extends system capabilities, particularly the pen sensitivity or frequency response of 1Hz for a strip-chart recorder by a factor of 10<sup>5</sup> or 100Hz for an oscillograph by a factor of 10<sup>3</sup>.

### How digitizing works

To understand what's going on inside a typical digital scope, look at a typical schematic (Figure 1). This is a simplified version of one channel of a scope that can also function as a conventional scope—displaying the amplified input signal directly on the CRT in real time by bypassing the digitizing section entirely.

To digitize, though, the analog signal must be converted, and the speed capabilities of the converter are the key to the frequency response of the digital scope. Consider the converter a shuttering window that opens typically for 1 $\mu$ s (sampling rate). In that time period, the input signal value must be matched with a digitally generated ramp or successive logic approximations with an accuracy of 1 part in 256, typically (2<sup>8</sup> or an 8-bit word). In other words, 256 decisions must be made to arrive at a value for just one dot. Because it takes 5 to 10 dots to accurately represent a waveform (for example a 100kHz sine wave), it becomes obvious why it takes 256MHz ramp speed to digitize through the 1MHz window a signal with a frequency of only 100kHz, or a 2560:1 relationship between digitizing speed and input

signal frequency. Thus, the state-of-the-art in digital circuitry must move well into the gigahertz region to make possible digital storage of megahertz waveforms. This will always be a key limiting factor.

The capacity of the digital store or memory is another key scope characteristic. Usually, a single memory serves all channels. On a 2-channel scope, for example, if both channels are storing, the finite number of memory dots is spread over two signals; half the resolution the memory would have with all dots would be devoted to a single signal. Also, the number of memory bits used for each dot (word) will limit the total dot capacity of a given memory. For example, an 8000-bit (8k) memory, used 8 bits/dot (for 1 part in 256 accuracy) has a capacity of 1000 dots, but at 10 bits/dot (1 part in 1000 accuracy) has only 800 dots to draw waveforms.

Details of the trigger amplifier are beyond the scope of this article, but, in general, it controls the input of data to the store and its release to the display CRT or an output printer. The trigger can be from an external event (contact closure) or set to capture whenever any predetermined combination of signal polarity, slope or level occurs. The scope can be armed to capture and hold the first occurrence of these trigger conditions or to continually update the displayed signal when they re-occur (refresh mode).

The D/A converter does not fully recreate the original analog signal; some information between the dots, lost during the sampling process, is gone forever. The D/A merely plots the dots stored in memory. Some digital scopes have an optional feature, dot joining (Figure 2), which constructs simple straight lines between consecutive dots that may or may not represent what actually happened between samples. Similarly, when the stored dots are output to a pen recorder, the scanning rate must be optimized to the response of the pen so that pen inertia can be used to smooth out the steps between dots. If the pen is too fast or the signal too slow, the waveform will appear as a series of steps.

### Other memory methods

Storage of oscilloscope traces did

not originate with the digital scope. Tube-type storage scopes that freeze waveforms by varying the retention rate of the phosphors on the CRT screen or by storing charge on a mesh behind the screen have been around for a long time. Unlimited by the speed of a digitizing process, they can store anything the scope can write on the screen, but for a limited period depending on the design and screen phosphors. However, they cannot output this information electronically, only photographically. They are essentially cameras, and cannot show what happened before they were triggered, or expand a waveform detailed analysis. In some tube-storage designs, the previous signal must be erased before a new signal

**IT'S NO PUZZLE** 

TO ORDER

**OELRICH SERVICE FORMS**

FOR TV-RADIO & 2 WAY RADIO SERVICE LEGAL FORMS FOR CALIF. FLA. UTAH NOW AT YOUR PARTS JOBBER OR WRITE FOR CATALOG B64

**OELRICH PUBLICATIONS**

4040 N. NASHVILLE AVE. CHICAGO, ILLINOIS 60634

Circle (7) on Reply Card

**NATIONAL ELECTRONICS SERVICE DEALERS** 

Are you standing idly by while ideas that can be money in your pocket fly away? 

Membership in NESDA is one of those ideas.

**WHAT DO YOU GET FROM NESDA?**

1. Insurance
2. Special Bancard Rates
3. ServiceShop Magazine
4. Electronic Service Industry Yearbook
5. Service Industry Information
6. Legislative Programs with State and National Government
7. Advocate for Better Warranty Practices
8. Business Information

Don't let your bucks get lost in the shuffle. 

Send in your check today.

On the bottom line it will mean extra \$\$\$ in your pocket.

**JOIN NESDA**

And Your State Association

Send for more information:  
NESDA, 2708 W. Berry St.  
Fort Worth, TX 76109



Editor's note: This general article illustrates some of the applications in which the new generation of digital scopes can be of special value in industrial servicing, R&D and manufacturing. The illustrations show applications with the new Gould series 4000 digital storage oscilloscope, but the general applications are not limited to this scope.

## Digital scopes

can be stored, which can mean missing events during the erase period. Unlike the tube-storage display, which can flicker or glow at high or low frequencies, the stored digital scope trace is constantly refreshed from the digital store and therefore uniform at all frequencies.

The field of currently available digital scopes can be divided into two primary categories: the general-purpose scope that this article is

primarily concerned with, and the processing scopes that offer full computer microprocessing. The two are compared in Figure 3.

They are clearly two entirely different classes of instruments. Just as a computer wouldn't be used when a hand-held calculator will do, a processing scope wouldn't be purchased when fast Fourier transforms, signal averaging or spectrum analysis are needed.

### Key digital functions

Here are some of the unique functions of digital scopes:

**Pre-trigger information**—At any time, a 1000-word memory contains a digitized dot indicating the instantaneous signal value plus the 999 dots that preceded it. When the scope display is triggered, 100% of pre-trigger information is displayed, but no post-trigger data; or the trigger point can be moved to half pre-trigger, half post-trigger or some other desired combination (Figure 4). In tube-type storage, only post-trigger viewing is available.

**Roll mode**—Equivalent to 100% pre-trigger in real time; in this mode the data rolls by from right to left

just as it does in a strip-chart recorder—fresh information enters right and exits left and can be stopped any time by either a predetermined trigger condition or by pushing a store button. This is useful for monitoring a slowly changing event.

**Transient comparisons**—With a stored previous signal on display, any subsequent occurrences can be visually compared and even superimposed for detailed analysis of trends. Through expansion, a trace can be magnified to examine trace portions in detail (Figure 5).

**Transient capture**—The digital scope is ideal for capturing transient phenomena even when the unit is unattended. The triggering conditions are preset—typically a triggering window or acceptable band of high and low signal values—and the unit will freeze the first occurrence of an out-of-limit condition. With a recording output option, some scopes can automatically warm up a strip-chart recorder, output the transient signal, record it, shut off the recorder, and then rearm itself to capture and record the next transient condition, all without human intervention.

**X/Y plots**—With X-with-time and Y-with-time waveforms digitized in memory, it is a simple task to compute an X-Y plot. Some digital scopes can display the plot directly, others output X/T or Y/T data to a conventional X/Y recorder. With direct viewing, many plots can be scanned and only those that require permanent recording chosen for printing.

**Function generation**—With an extremely slow sweep rate and no input signal, the basic scope beam-positioning controls can be used to generate practically any desired waveform (Figure 6). Once "hand-drawn" and captured in memory, this signal can be output singularly or repetitively for use as a signal for control, triggering or transient testing. In a lighter vein, Figure 7, the scope can be used as an "amusement generator" by deliberately overloading the scope's sampling rate with higher frequencies to create random dots that, when joined, form geometric line patterns.

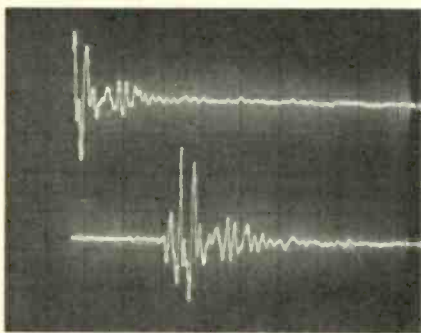

**Figure 4**—Pre-trigger options: With the same triggering criteria (signal level, slope and polarity), the upper trace shows only post-trigger data as would be seen with a tube-storage scope, but the lower trace (set for ¼ pre-trigger) captures additional information on important conditions preceding triggering.

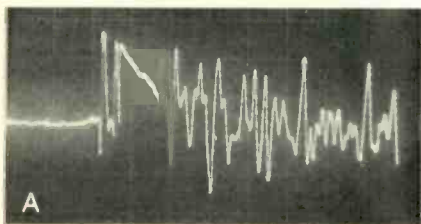

**Figure 5**—Trace expansion: The original trace as captured in A, is expanded in B to view transients that occurred immediately after triggering, left.

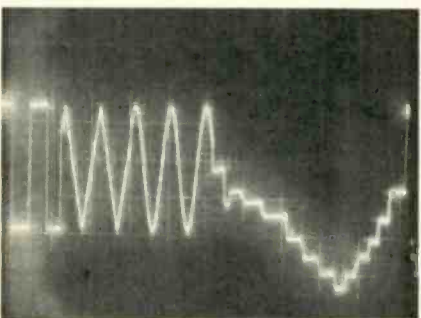

**Figure 6**—Function generation: Composite waveform was created by combining elements of a square wave, sawtooth, and sine wave produced by a signal generator with a "hand-drawn" staircase wave produced by varying the vertical deflection of a slow-moving sweep signal. This waveform can then be output as a test signal.

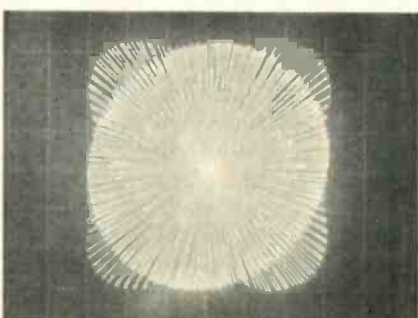

**Figure 7**—Aliasing for amusement: Deliberately inputting a high frequency signal beyond the scope's sampling rate causes it to become confused and produce random or alias dots that with dot joining and X-Y plotting become line art.

### Typical applications

With this wide range of available

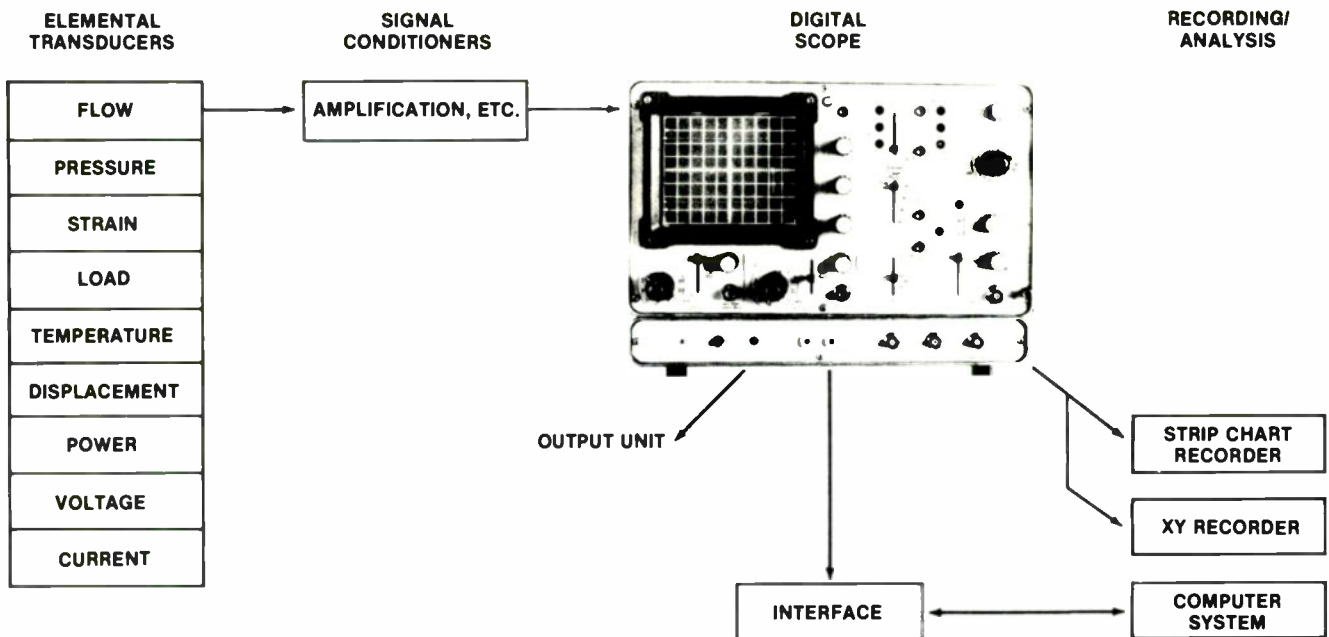

Figure 8—As the heart of an expansive monitoring, measuring and recording system, the digital scope offers many new instrumentation capabilities.

functions, the new digital scopes are finding many interesting application areas:

*Field troubleshooting*—The portability and flexibility of the digital scope make it an ideal troubleshooting tool when coupled with a suitable array of simple transducers for temperature,

pressure, strain, acceleration, displacement or basic electrical voltage and current measurement. Suitably calibrated, they enable the scope to make absolute and comparative measurements in a full time spectrum from very fast events to the very slow. Examples: checking shock, vibration, noise, monitoring

power surges or electrical transients; analyzing thermal stress or fatigue; isolating piping faults; and establishing safety limits.

*Production and quality control*—The speed of digital scopes and their X-Y modes enable 100% performance checks at production-line speeds. Permanent strain gauges on forging and punch presses can be routinely monitored for stress overloads. Electrical motors and SCR control circuits can be fine-tuned. OSHA and EPA criteria can be continuously monitored.

*R&D*—Lab applications are nearly infinite, and for detailed analysis a processing scope may be needed or a general-purpose digital scope can

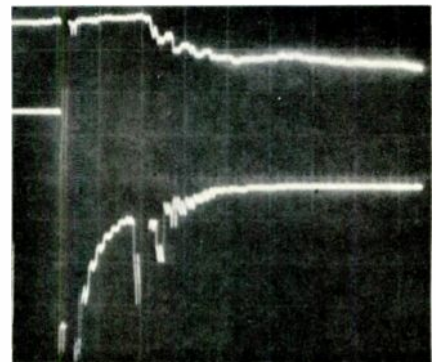
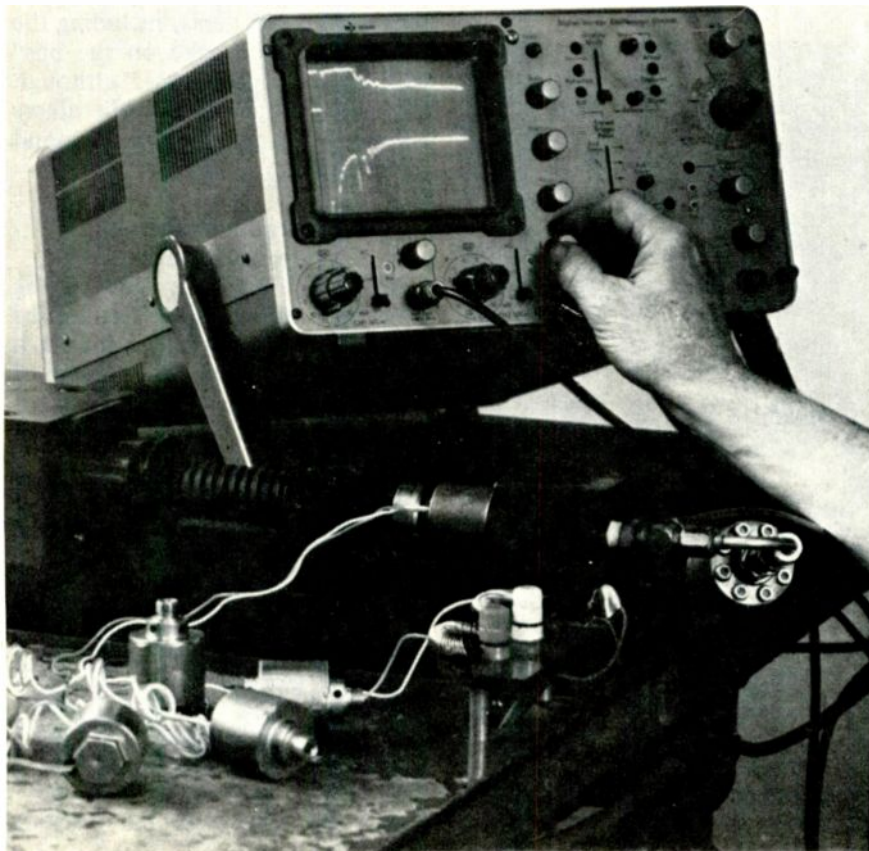

courtesy of Fluid Regulators Corp.

Figure 10—Valve test traces: upper trace is valve pressure; lower trace is coil current.

Figure 9—(Left) Testing of high-pressure gas-venting solenoid valve.

## Digital scopes

be tied into a computing system with suitable interfacing. Examples: prototype evaluation and destructive testing, IC and turbine engine effi-

ciency research, resonance-frequency checks, bearing vibration studies, establishing plastic/elastic materials criteria, telephone

switching transient checks, chemical corrosion studies and seismic research.

**Medical**—Some of the first uses for digital scopes were in heart research, particularly the vectrocardiography of heart patients under stress. Other medical examples: heart sound monitoring, ECG, brain research, neuroscience, cybernetics, respiratory exams and research, enzymatic reaction studies and speech analysis.

### The impact of digital

Thus, the immediate impact of digital scopes will be as an important new tool that greatly extends measurement and analysis of physical transients and other phenomena. Basically a monitoring device, it can output for recording only those results that need recording or further signal processing (Figure 8).

As semiconductor technology yields higher speed A/D converters and improved memories, digital scopes will replace more and more conventional storage-tube scopes in the analysis of high-speed electronic waveforms. Using currently available digital bus interfaces (IEEE-488), digital scopes are ready to contribute to highly sophisticated measurement systems, including the ability to "handshake on the bus" with data "conversations," although the digital scopes are mostly talkers (supply data), not listeners (respond to commands).

### Applications: verifying valve performance

The high-pressure gas-venting solenoid valve in Figure 9 is used for a critical trimming operation in a military application. The ability of each valve to open under 2500-psi pressure within 10ms must be

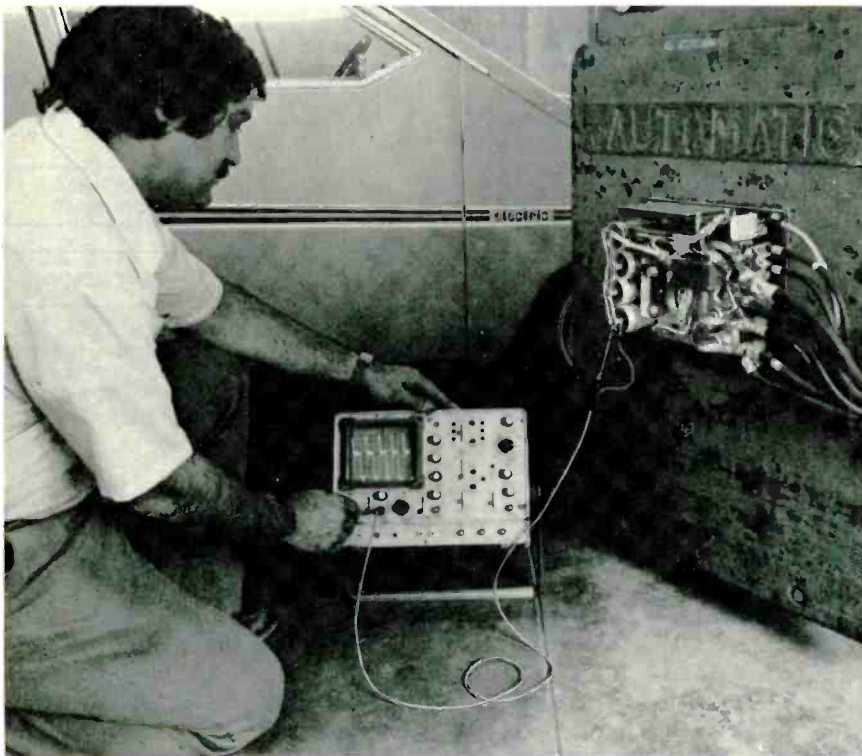

Figure 11—Technician uses digital scope to check out SCR control system on electrical lift truck converted from older resistive controls.

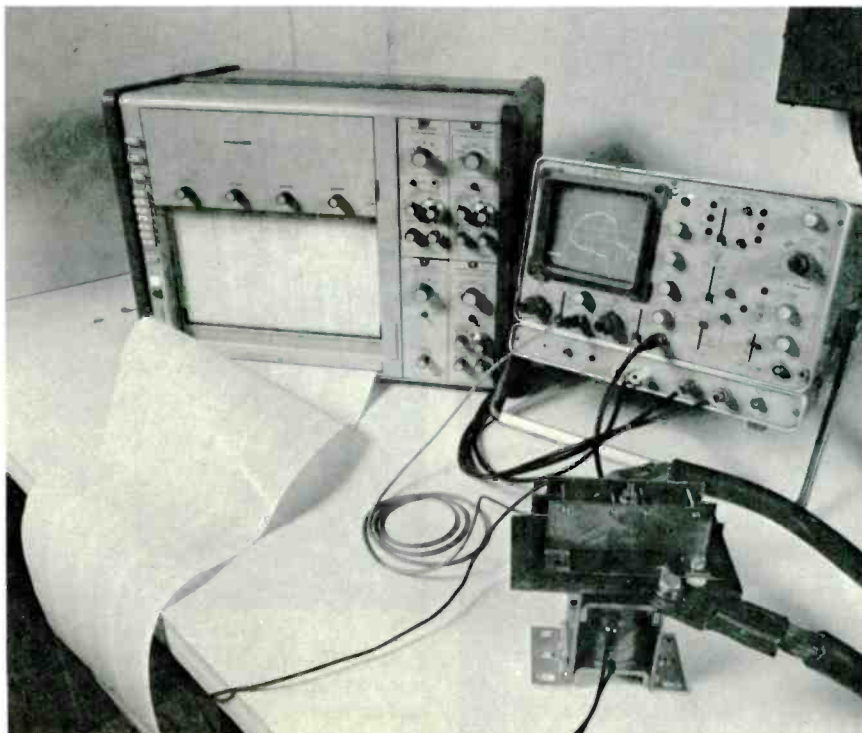
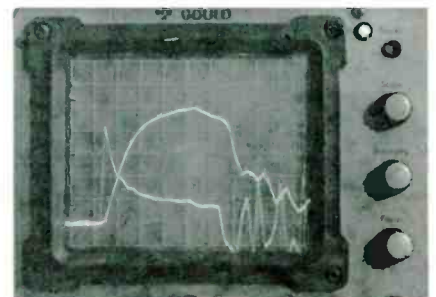

Figure 12—Lab test of contactor was performed unattended to avoid any arcing hazards. The scope captured traces for voltage and current automatically, for the transfer after viewing to the recorder.



courtesy of HB Electrical Mfg. Co.

Figure 13—Closeup of the resulting trace.

verified and recorded to qualify the lot. A test fixture holds the valve under pressure and a pressure transducer produces the upper scope trace. A digital voltmeter monitors solenoid voltage. Solenoid current, the lower trace, is used to show coil energization. The scope is set to capture 1/4 of the current pre-trigger trace to use as the demarcation point for pressure response.

When the coil is energized, Figure 10, the current trace (set to break at the first horizontal grid line) drops with inrush and then levels off at steady-state current. Meanwhile the upper pressure trace shows no change for two subsequent grid lines (5ms/division) before pressure starts to bleed off. Thus, response time is clearly 10ms, and as soon as this data and solenoid serial number are logged, the scope is reset and a new solenoid placed in the fixture to repeat the test.

The key digital features that make this an efficient and reliable production test are the ability easily to calibrate the zero current point, to capture and hold the trace in-

definitely, and the speed and simplicity of the whole operation; production people are easily trained to get consistent results.

#### Applications: developing electric-car controls

Modern electrical-vehicle control systems rely on SCRs for smooth performance and fine-tuned control at various operating speeds but still require dc contactors for switching high levels of power. This high-voltage contactor for mining equipment and electric cars, Figure 11, is used for initially arming the SCR, for bypassing it when full power is required and for interrupting the load in emergencies if the SCR should fail under closed-circuit conditions.

In the development of the contactor, the design of the unit had to be thoroughly tested and documented. Besides measuring arc time, current rise, arcking patterns and bridge temperature, the designers were particularly interested in the ability of magnetic blow-out horns to extinguish the arc in less than 5ms.

Though the contactor is rated for 400A continuous current at 250V, overloading currents of many times this had to be demonstrated and evaluated to establish rating validity.

In this test, Figure 12, a 250V bank of industrial batteries was switched into a large motor/generator load. Inrush current, Figure 13, builds to 2500A as battery voltage at the contactor drops from 250V to 50V. At this point (5ms after initial contact closure), an automatic control circuit opens the power circuit to test the contactor's interrupting ability, but also to protect the motor from overload current. Instead of a clean break, the contactor chattered several times before the arc was finally extinguished, as shown by the jagged voltage curve and decaying current curve at the right of the trace. Because of the digital scope's ability to capture and output this information to the direct-writing oscillograph alongside, this data can be permanently recorded for comparison with later tests under related conditions. □

# NOT SO FAST

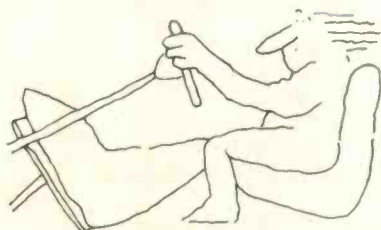

You'll get about 20 more miles from every tank of gas if you slow down from 70 to 55 mph on the highway. For a free booklet with more easy ways to save energy and money, write "Energy," Box 62, Oak Ridge, TN 37830.

**ENERGY.**  
We can't afford to waste it.

U.S. Department of Energy

## Packed with features. Priced to please.



Here's the low priced Field Strength Meter designed to meet the changing needs of the progressive TV service dealer—antenna, cable and MATV systems installer. The Mezzor Mark-12 is loaded with the features you've asked for, with specs that meet your needs for day to day service and installation jobs—all at an affordable price.

- 83 channel detent VHF and UHF.
- Two 20 db attenuation pads.
- ± 3 db video carrier accuracy.
- Portable, lightweight and durable.

**\$299.95**

See the Mark 12 at your nearest PTS Service Center or Authorized Stocking Distributor.



PTS ELECTRONICS, INC.

General Headquarters: P.O. Box 272,  
Bloomington, Indiana 47402

Circle (8) on Reply Card

# Index of 1980 articles

Compiled by Warren G. Parker, Metairie, LA

## Titles of articles

1981 Consumer electronic products	Aug	21	Typical repairs of older Zenith TVs, solid state	Jan	20
A close look at digital signals, part 1	Jan	13	Understanding CTC 99 horizontal sweep	Feb	27
A close look at digital signals, part 2	Feb	20	Unique features of DMMs	Mar	8
AGC problems in tube TV, part 1	Jun	23	Updated tube-AGC basics	Jun	28
AGC problems in tube TV, part 2	Jul	18	Verify tube defects and prevent callbacks	May	27
Antenna roundup	Jul	14			
Basic design of logic probes	Sep	13			
Calculating service labor rates	Jan	34			
Comparison of VOMs, VTVMs, and DMMs	Mar	6	<b>ANTENNAS</b>		
Digital probe roundup	Sep	14	Antenna roundup	Jul	14
Employer-employee contracts	Mar	22	Selecting TV antennas	Apr	14
Features and circuits of Sony receivers	Dec	24	Tips for installing antennas	Jul	8
Franchising the electronic service industry	Aug	8			
Index of 1979 articles	Jan	31	<b>COLOR TV</b>		
Industrial maintenance with portable scopes	Oct	11	AGC problems in tube TVs, part 1	Jun	23
Industrial product test reports	May	14	AGC problems in tube TVs, part 2	Jul	18
Locating ac leakage in industrial plants	Feb	15	More Zenith TV repairs, solid-state	Feb	38
Locating MRO parts	Jun	20	RCA chroma circuits and servicing	Jul	23
More Zenith TV repairs, solid-state	Feb	38	RCA luminance circuits	Jun	32
Multimeter roundup	Mar	12	RCA troubleshooting charts	Apr	22
New scope features	Oct	20	Servicing RCA frequency-synthesis tuning	May	18
Planning an industrial maintenance workshop	Dec	5	Typical repairs of older Zenith TVs, solid-state	Jan	20
Practical scope tips, part 1	Oct	14	Updated tube-AGC basics	Jun	20
Practical scope tips, part 2	Nov	19	Verify tube defects and prevent callbacks	May	27
Practical transient protection	Apr	8			
Preventing damage from transients	Feb	7	<b>DIGITAL</b>		
Programmable controller applications	Mar	18	A close look at digital signals, part 1	Jan	13
RCA chroma circuits and servicing	Jul	23	A close look at digital signals, part 2	Feb	20
RCA CTC 99 vertical sweep, part 1	Aug	28	Basic design of logic probes	Sep	13
RCA CTC 99 vertical sweep, part 2	Sep	22	Digital probe roundup	Sep	14
RCA luminance circuits	Jun	32	Troubleshooting digital equipment	Sep	18
RCA SCR regulator and horizontal oscillator	Jan	24			
RCA troubleshooting charts	Apr	22	<b>HORIZONTAL &amp; HV</b>		
Selecting replacement capacitors	Jun	14	Practical scope tips, part 1	Oct	14
Selecting TV antennas	Apr	14	Practical scope tips, part 2	Nov	19
Semiconductor source guide	Aug	12	RCA troubleshooting charts	Apr	22
Servicing audiocassette tape recorders, part 1	Nov	31	Troubleshooting RCA hot supply and horizontal	Mar	24
Servicing audiocassette tape recorders, part 2	Dec	14	Understanding CTC 99 horizontal sweep	Feb	27
Servicing electrocardiographs	Jul	33	Verify tube defects and prevent callbacks	May	27
Servicing RCA frequency-synthesis tuning	May	18			
Soldering and desoldering equipment	Nov	4	<b>INDUSTRIAL ELECTRONICS</b>		
Solid-state switches keep artificial hearts beating	May	11	Basic design of logic probes	Sep	13
Solving vertical problems in old TVs, vacuum tube	Apr	31	Digital probe roundup	Sep	14
Special meter and calibration services for MRO	Aug	18	Industrial maintenance with portable scopes	Oct	11
Techniques for fast, efficient soldering	Nov	7	Industrial product test reports	May	14
Testing diodes by voltage drop	Jul	30	Locating ac leakage in industrial plants	Feb	15
Testing wow and flutter	Dec	22	Locating MRO parts	Jun	20
Tips for installing TV antennas	Jul	8	Planning an industrial maintenance workshop	Dec	5
Troubleshooting digital equipment	Sep	18	Practical transient protection	Apr	8
Troubleshooting RCA hot supply and horizontal	Mar	24	Programmable controller applications	Mar	18
Typical CB radio repairs	Nov	25	Soldering and desoldering equipment	Nov	4
			Special meters and calibration services for MRO	Aug	18
			Testing diodes by voltage drop	Jul	30

## MEDICAL ELECTRONICS

Servicing electrocardiographs	Jul	33
Solid-state switches keep artificial hearts beating	May	11

## MISCELLANEOUS

1981 Consumer electronic products	Aug	21
AGC problems in tube TVs, part 1	Jun	23
AGC problems in tube TVs, part 2	Jul	18
Basic design of logic probes	Sep	13
Calculating service labor rates	Jan	34
Employer-employee contracts	Mar	22
Features and circuits of Sony receivers	Dec	24
Franchising the electronic service industry	Aug	8
Index of 1979 articles	Jan	31
Locating MRO parts	Jun	20
RCA CTC 99 vertical sweep, part 1	Aug	28
RCA CTC 99 vertical sweep, part 2	Sep	22
RCA luminance circuits	Jun	32
Selecting replacement capacitors	Jun	14
Semiconductor source guide	Aug	12
Servicing audiocassette tape recorders, part 1	Nov	31
Servicing audiocassette tape recorders, part 2	Dec	14
Soldering and desoldering equipment	Nov	4
Solving vertical problems of old TVs, vacuum tube	Apr	31
Techniques for fast, efficient soldering	Nov	7
Testing diodes by voltage drop	Jul	30
Testing wow and flutter	Dec	22
Typical CB repairs	Nov	25
Updated tube-AGC basics	Jun	28

## REPORTS FROM THE TEST LAB

B&K-Precision 1535 oscilloscope	Nov	15
Data Precision 936 DMM	Jun	12
Hickok 240 video generator	Oct	6
Keithley Instruments 130 digital multimeter	Aug	16
Sencore DVM-56 digital multimeter	Apr	18
Sencore PR-57 ac powerite	Sep	8
Sencore SC-60 oscilloscope	Dec	11
Viz WR-549A pulse generator	Jan	11

## SERVICING METHODS

Industrial maintenance with portable scopes	Oct	11
More Zenith TV repairs, solid state	Feb	38
Practical scope tips, part 1	Oct	14
Practical scope tips, part 2	Nov	19
RCA troubleshooting charts	Apr	22
Servicing audiocassette tape recorders, part 1	Nov	31
Servicing audiocassette tape recorders, part 2	Dec	14
Servicing RCA frequency-synthesis tuning	May	18
Testing diodes by voltage drop	Jul	30

Testing wow and flutter	Dec	22
Typical repairs of older Zenith TVs, solid-state	Jan	20
Verify tube defects and prevent callbacks	May	27

## SOLID-STATE SERVICING

More Zenith TV repairs, solid-state	Feb	38
Practical transient protection	Apr	8
Preventing damage from transients	Feb	7
RCA CTC 99 vertical sweep, part 1	Aug	28
RCA CTC 99 vertical sweep, part 2	Sep	22
RCA luminance circuits	Jun	32
RCA SCR regulator and horizontal oscillator	Jan	24
RCA troubleshooting charts	Apr	22
Semiconductor source guide	Aug	12
Servicing RCA frequency-synthesis tuning	May	18
Testing diodes by voltage drop	Jul	30
Typical CB repairs	Nov	25
Typical repairs of older Zenith TVs, solid-state	Jan	20
Understanding CTC 99 horizontal sweep	Feb	27

## TEST EQUIPMENT

Comparison of VOMs, VTVMs, and DMMs	Mar	6
Industrial maintenance with portable scopes	Oct	11
Multimeter roundup	Mar	12
New scope features	Oct	20
Practical scope tips, part 1	Oct	14
Practical scope tips, part 2	Nov	19
Special meters and calibration services for MRO	Aug	18
Unique features of DMMs	Mar	8

## Symcure

### ADMIRAL

M55, vertical lock is erratic	Mar	21
M55, AGC overload, might improve when warm	Mar	21
M55, no raster, sound and H V ok	Mar	21
M55, intermittent loss of red, blue, or green	Mar	21
M55, excessive brightness	Mar	21
M55, vertical instability on cable signals	Mar	21

### MAGNAVOX

T985/86, no raster, no picture, H V normal	Aug	27
T985/86, horizontal cannot be locked, vertical normal	Aug	27
T985/86, no high voltage or horizontal sweep	Aug	27
T985/86, no sound, R203 overheats when sound module is plugged in	Aug	27
T985/86, no sound, R203 overheats whether or not the sound module is plugged in	Aug	27

### RCA

CTC53, distorted video, similar to bad AGC	Apr	30
CTC85, no height	Sep	6

# Index

CTC87, short period of audio followed by shutdown	Jun	31
CTC87, no height	Nov	14
CTC87/101, no sound and no picture, shutdown condition	Nov	14
CTC87, erratic startup	Apr	30
CTC88, sound distorted	Jun	31
CTC88, short blast, sound, then shutdown	Jun	31
CTC91, no high voltage	Apr	30
CTC92, no picture or sound, fusible resistor open	Sep	6
CTC92, no sound and no picture, shutdown condition	Nov	14
CTC92, erratic tuner or station selection	Jun	31
CTC93, wrong horizontal frequency	Jun	31
CTC93, picture dark	Sep	6
CTC97, lack of regulation causes shutdown	Apr	30
CTC97, little control of brightness	Apr	30
CTC97, no height	Nov	14
CTC97HC, no height	Apr	30
CTC97, height collapses erratically	Sep	6
CTC99, shutdown giving no sound or picture	Jun	31
CTC99, compression and retrace at top of picture	Sep	6
CTC99/101, no color, but IF and oscillator signals enter IC U800	Sep	6

## SYLVANIA

D16, beat pattern in color, and interference is radiated	Feb	6
E20, no height	Feb	6
E21, no vertical or horizontal locking	Feb	6
E21, circuit breaker trips instantly	Feb	6
E21, excessive brightness with blooming	Feb	6
E21, dim picture and color smearing	Feb	6

## ZENITH

4B25C19, intermittent low sound volume	Oct	8
9JB1, excessive brightness with retrace lines	Jan	4
12FB12, width varies intermittently, center foldover	Jul	6
12HB1X, 1" lack of scan at all sides of raster	May	30
12HB1X, picture flashes bright and dark	May	30
12 JB2X, weak or intermittent audio volume	Jan	4
13HC10, right and left edges bowed	Jul	6
19GB1, intermittent loss of height	Jul	6
19GB1, vertical foldover with retrace lines	Jul	6
19GB1, bottom foldover with erratic rolling	Jul	6
19GB1Z, audio intermittent and/or CRT heater lights	Oct	8
19GC38Z, low brightness	May	30
19HC20, insufficient contrast	Dec	36
19HC45, excessive snow all channels	Jan	4
19HC50, no raster or rapid flashing in picture	Jan	4
23HC50, drive line during zoom function	Dec	36
25CC50, height about 1"	Dec	36
25DC56, no color at left edge of screen	Dec	36
25DC56, green skin hues	May	30
25DC56, excessive brightness without control	Dec	36
25EC58, no UHF reception, VHF normal	May	30

25EC58, no picture, no sound, breaker trips	Jul	6
25EC58, tripped breaker, when reset, loud, hum, retrips	Oct	8
25EC58, no luminance signal, no brightness	Oct	8
25EC58, height varies at bottom of raster	Oct	8
25EC58, weak color is missing, but strong color normal	Oct	8
SGw/remote, no remote operation, manual normal	Dec	26

## Troubleshooting tips

### ADMIRAL

2M10CA,C, shrinking picture	Jun	11
-----------------------------	-----	----

### CHANNEL MASTER

6128/29, no HV, breaker trips	May	31
-------------------------------	-----	----

### GENERAL ELECTRIC

UA, lack of raster height at bottom	Jun	8
-------------------------------------	-----	---

### HITACHI

CA568, black corner	Aug	38
---------------------	-----	----

### MAGNAVOX

T950, no vertical sweep, raster non linear	Mar	37
T936, low Bplus, without picture	Jun	8

### MOTOROLA

19TS929, vertical roll and no color	Jun	11
LC19TS-929, no picture, reset breaker, ok until receiver is turned off	Feb	40

### PACKARD BELL

98C18, intermittent video and black marks in picture	Sep	39
98C21, AGC overload	Sep	39

### PANASONIC

CT26, no HV or picture	Aug	38
CT98, picture pulling	Jun	8
CT329, buzz in sound	Dec	37

### RCA

CTC62A, no picture and no sound	Dec	37
CTC72, receiver dead, only dial lamp comes on	Apr	21
CTC72B, no sound, raster, or HV	Feb	40
CTC81A, chattering relay	Aug	37

### SANYO

CT711, drifting vertical frequency	May	31
------------------------------------	-----	----

### SYLVANIA

E10, AGC overload causes loss of HV	Mar	37
-------------------------------------	-----	----

### ZENITH

14A10C29, no color when TV is cold	Sep	40
14B36, fading contrast	Dec	37
19GC45Z1, vertical blanking bar locked in center	Jun	11



# Audio servicing with a swept-frequency generator



By Kirk Vistain, West Chicago, IL

*Swept function generators are most valuable for saving large amounts of technicians' time. Described briefly are the internal actions of an audio sweeper; the typical applications are explained thoroughly.*

Swept-frequency function generators (often called audio sweepers) are becoming indispensable instruments on many audio test benches. Although some of the tests normally made by audio sweepers can be done with far greater precision by other instruments, the audio sweepers can shorten most tests to a fraction of the time necessary with slower and more accurate generators.

A modern function generator usually has a switch that selects sine, square or triangle waveshape of the output signal over the 20Hz to 20kHz audio range plus higher frequencies up to 3MHz (depending on the model). Sine waves are made by multi-stage soft clipping of triangular waveshapes. The distortion seldom is lower than about 1%. This is satisfactory for all quick tests except measurements of total harmonic distortion (THD).

## Frequency-response graphs

It is possible to plot the frequency response of an amplifier or tone-control circuit by applying sine waves of important frequencies one at a time and comparing the input vs. the output signal voltages of the tested device. If the generator has

flat response (within 0.1dB, for example), the input voltage level can be neglected and the graph made of output voltages at key frequencies. A line is drawn between the dots representing the test frequencies. Frequency response of a stereo amplifier might be plotted at each 10Hz point between 20Hz and 100Hz, each 20Hz point between 100Hz and 200Hz, each 200Hz to 1kHz, and perhaps every 1kHz up to 20kHz. Of course, time can be saved and the accuracy improved by making the test frequencies further apart where the response has little variation, and adding more test frequencies in areas showing a larger variation of response.

Clearly, these frequency-response graphs can be very helpful (and as accurate as the test meter), but the preparation of each graph is time consuming. Audio technicians and engineers long ago found methods of speeding up routine and non-critical response tests.

## Automated graphs

Rotation of a sine wave-generator dial in synchronism with lateral movement of an ink-pen recording chart can produce a continuous and fairly accurate frequency-response

curve. Early systems had cumbersome mechanical linkages between generator and chart; more advanced systems incorporated selsyns. This mechanical method obviously requires excessive trouble, wasted time and greater expense.

When a hard copy of the response curve is not needed, it is more practical to view the curve on a scope, but the older systems could not sweep fast enough for effective scope viewing. An electronic-sweep system was needed.

## LSI integrated circuit

About 1970, the old ink-graph method was made obsolete by development of a large-scale integration (LSI) integrated circuit that provided dial-variable or electronic audio sweep, the usual three output waveforms of function generators, and required only a few components in addition to the IC (Figure 1). Central to all function generators and audio sweepers is a voltage-controlled oscillator (VCO) that varies frequency according to the applied dc voltage. This dc voltage can be varied in several ways: by dc voltage from a variable control with a calibrated dial; an external dc voltage, either fixed or

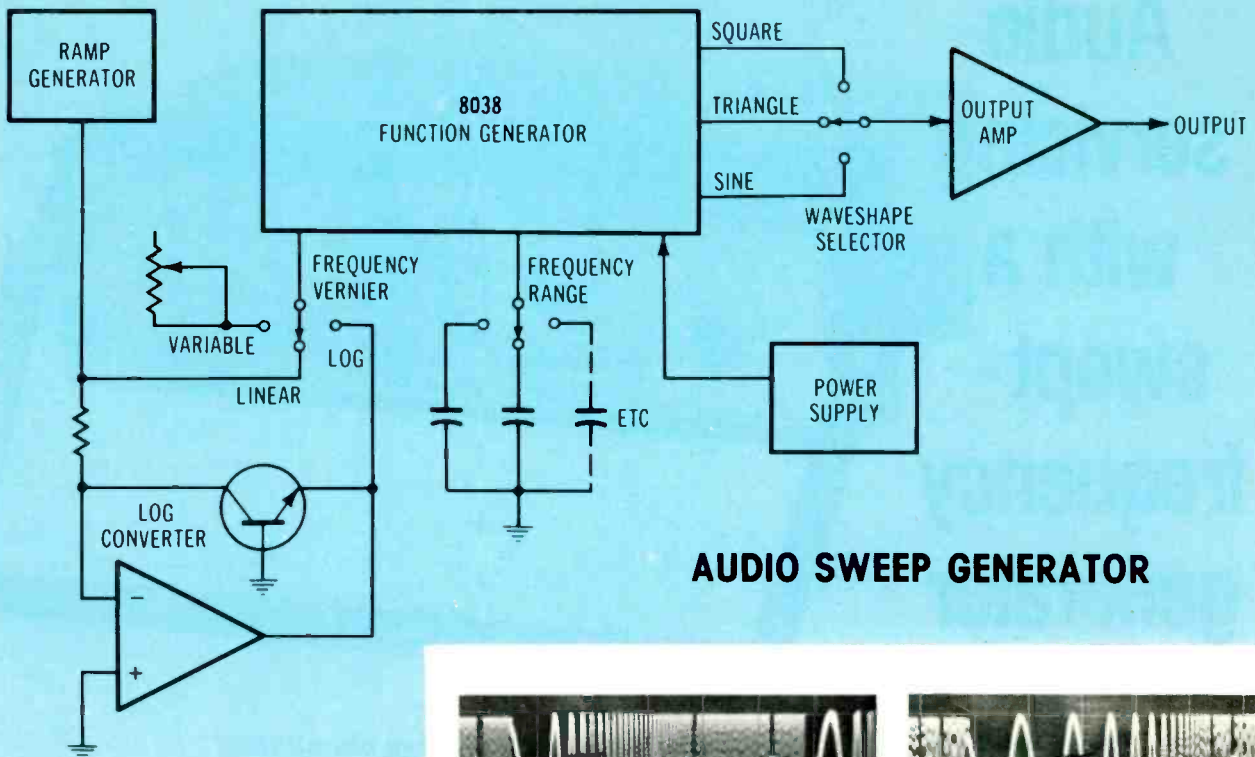

## AUDIO SWEEP GENERATOR

**Figure 1** Several types of audio-sweep function generators have been built around Intersil 8038 ICs, as shown in this block diagram. Function generators usually provide a choice of sine, square or triangle waveshapes. The dcV ramp signal sweeps the repetition frequency within the prescribed limits.

### Sweep

variable; or a repeated ramp dc voltage. A switch determines the highest sweep frequency. Added versatility is made possible by a choice of linear or log ramps.

#### Sweep linearity

Expansions of low or high frequency portions of the sweep spectrum are allowed by different ramp waveshapes (see Figure 2).

A linear ramp provides satisfactory separation of high frequencies, but it compresses the low frequencies below about 1000Hz, which might obscure narrow peaks or valleys that fall between the cycles.

When additional low-frequency cycles are needed, the ramp output can be switched through a logarithmic converter. This log sweep waveform expands the low frequencies and compresses the high frequencies (Figure 2B) to simulate hand-drawn curves on log graph paper.

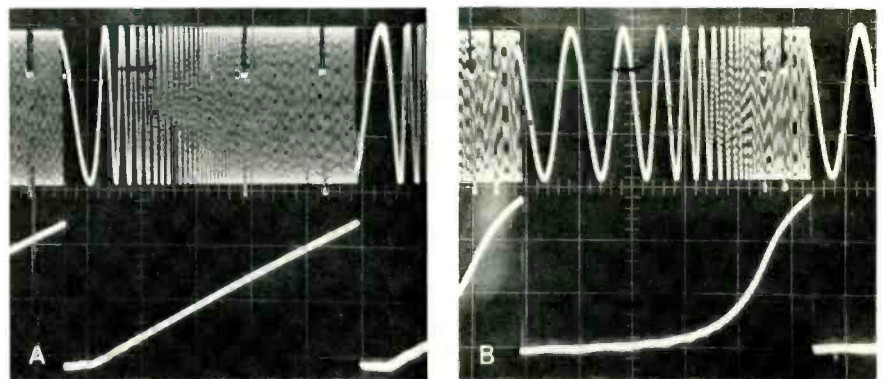

**Figure 2** Linear and logarithmic ramps provide different frequency spreads. (A) With linear sweep, the low frequencies (left end of top trace) are compressed while the high frequencies (right end of each sweep) are expanded. Lower trace shows the linear ramp waveform. (B) A log ramp waveform (lower trace) expands the low frequencies (left) and compresses the high frequencies (right part of the upper trace). Linear or log is chosen according to need.

Remember that the response curve of audio sweep follows the positive tips of the sine waves as though a line had been added between these tips.

#### Applications of audio sweepers

Measuring amplifier frequency response is the most common application of audio sweepers, as shown in Figure 3. A single stage, several stages or a complete channel of a stereo amplifier, including tone or loudness control, can be evaluated. The sweeper signal is connected to the desired input; the scope monitors the output. If the output stage is designed to drive speakers, the speaker should be disconnected and a noninductive high-wattage precision resistor (of

the same value as the speaker-impedance rating) should be connected as the amplifier's load. There are several reasons for using a dummy load (rather than a speaker) during response tests. If the test is conducted at high volume, the audible sound would be excessive. Also, the impedance of any speaker varies with frequency, so a load resistor provides the constant load required for accurate tests. Other stages usually do not require any external load, so long as the scope does not load the stage excessively.

• *Measuring frequency response.* Sine waves must be used for all frequency-response graphs, whether produced by a sweeper or drawn manually.

Frequency response of swept sine

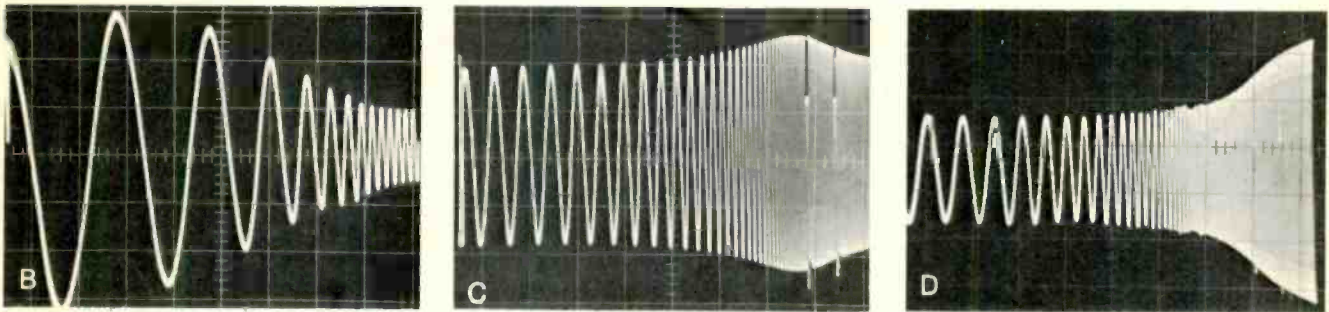
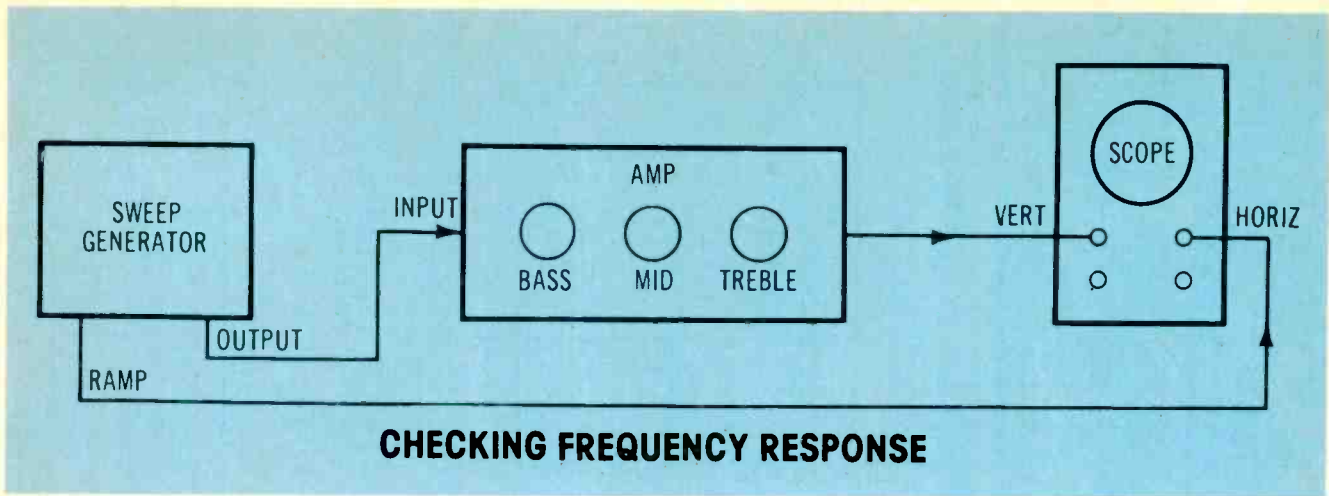

**Figure 3** Amplifier stages or complete stereo amplifiers can be checked for frequency response (including tone-control actions) by connecting the audio sweep generator signal to the amplifier input and the amplifier output to a scope (A). A power amplifier must have a high-wattage noninductive resistor connected to the output as a speaker substitute. (B) Bass boost increases the amplitude of low-frequency sinewaves at the sweep's left side. This audio sweep covered from 50Hz to about 2500Hz; the scope sweep time was 100ms/div. (C) Mid-frequency boost increases the amplitude near the 5kHz center section of the 500Hz to 25kHz generator sweep. Markers are at 10kHz and 15kHz. Scope sweep was 10ms/div. (D) Treble boost increased the amplitude of the high-frequency sinewaves above about 3kHz at the right end of the sweep. Markers and scope-sweep time are identical with the previous example. Imagine the response curve as touching the positive-peak tips of each sine wave. Ignore the negative peaks; however, they can be examined for nonsymmetrical waveshapes.

waves is measured from the ac zero-voltage point of each sine wave to the positive tip of that sine wave. With a waveform sufficiently pure to be called a sine wave, the zero-voltage point is exactly in the vertical center of the waveform. Operate the scope in the ac mode to eliminate any supply voltages or other dcV from the waveform.

An excellent procedure, when accuracy is needed, is to adjust the scope for a total waveform height of eight divisions. Move the waveform's zero-voltage point to the graticule's center horizontal line. When the scope is in the preferred ac mode, this point can be found easily by selecting the ground position of the mode switch. The resulting line represents zero voltage. Move the line to cover the center graticule line, return to ac coupling and carefully adjust the waveform height for four divisions above the line. Each of the four divisions then represents 25% of the amplitude. Of course, a response

curve with strong variations should have the **highest** amplitude point cover the four divisions.

With precise scope adjustments, the sweep response curve can be measured to about 5%, which is approximately 0.5dB. However, most measurements are not that demanding and a brief look at the display is sufficient.

Remember that scopes are calibrated in peak-to-peak, while audio readings usually are made in decibels. The voltage readings can be changed mathematically to decibels when necessary. For almost all quick response checks, it is sufficient to know only these few approximations: a reduction of about 10% is -1dB, a reduction of about 30% is -3dB and a reduction of about 50% is -6dB. Also, an increase of about 10% is +1dB, an increase of about 30% is +3dB and double amplitude (100% increase) is +6dB.

- *Scope adjustments.* One potential problem is obtaining a stable display

on the scope. Triggered scopes usually provide better stability than is possible from recurrent types. Not all audio-sweep generators have the same output signal or provide access to the ramp for locking.

The best display method for real-time applications (not tape or disc signals previously recorded) is to use the X-Y mode. Single-trace scopes usually provide a way for the sweeper-ramp signal to be amplified by the horizontal-sweep amplifier while the vertical channel supplies the height. Minor adjustments of ramp frequency and scope width should provide a rock-solid display of one sweep.

Dual-trace scopes often have X-Y capability using one channel for vertical height and the other for horizontal sweep (and width). Where available, this is preferred because of the extra calibrations.

Scopes without provision for X-Y vector displays must be locked by application of the sweeper ramp (or sync) signal to the external-sync in-

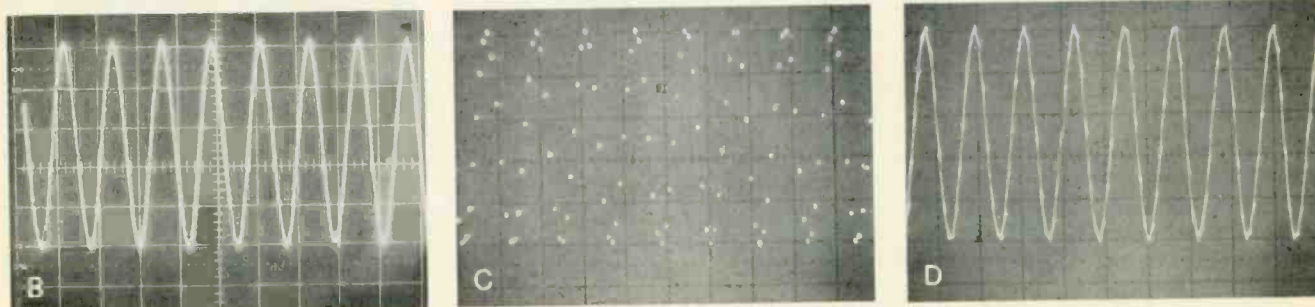
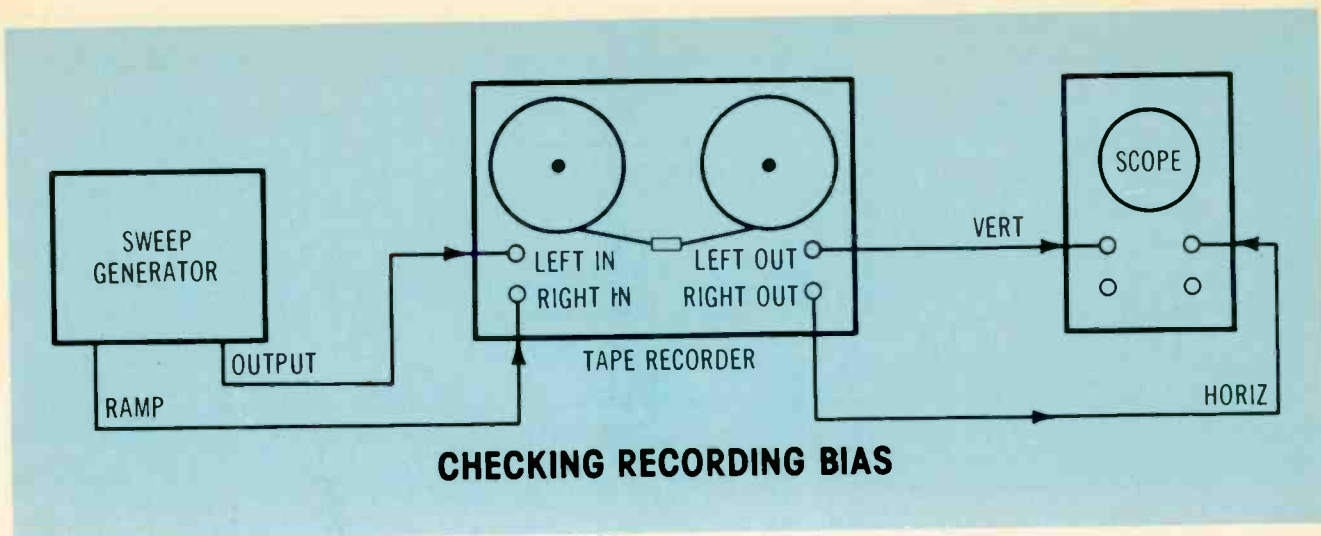

**Figure 4** Stereo tape recordings can be tested for frequency response and the effects of recording supersonic bias by connecting as shown in the (A) block diagram. Recording the ramp signal on one channel provides stable locking of the scope. The amplitude of supersonic bias affects the audio distortion and high-frequency response of the recorded signal on the tape. (B) This is the swept-audio signal from the generator, which covers the 500Hz to 25kHz range. (C) Excessive supersonic bias reduces the amplitude of the high frequencies. (D) Insufficient supersonic bias produces excessive high-frequency response while increasing the distortion.

## Audiocassette

put of the scope. Careful adjustments of scope sync level, polarity and sweep rate usually provide a stable display.

When testing tape recorders (or other non-real-time applications), the sweeper sync output cannot be used unless the recorder is a stereo type in which the sweep waveform can be recorded on one channel and the sync ramp signal on the other (see Figure 4). This works well after the optimum recording level is determined.

With monaural tape recorders, the scope locking must be done by the scope's internal sync. The stability might not be steady, but the curve can be seen well enough for most purposes.

Usually, scope locking stability is not a problem, because it is easier than with video waveforms. Most sweeper and scope combinations provide excellent stability.

Keep in mind that the lowest sweeper frequency showing one complete cycle on the scope screen is

variable, depending on sweep rate, range and the sweep-ramp waveshape (linear or log). It will not be less than about five times the reciprocal of the sweeper ramp repetition rate. For a sweeper log ramp of 10ms, the lowest complete-cycle frequency is about 500Hz. A 100ms log ramp would show a lowest signal frequency of about 50Hz. To display a complete 20Hz-20kHz audio spectrum, a ramp frequency of 4Hz (250ms) is required. Unfortunately, a storage scope is necessary to prevent flickering.

Practical experience indicates that optimum coverage is produced by a ramp rep frequency of 60Hz (16ms) which gives adequate results down to about 300Hz of sweeper-output signal. This is sufficient for tape-recorder adjustments and other applications.

It is instructive to connect the sweeper and scope to an amplifier having tone controls and watch the screen while the controls are adjusted (Figure 3). Notice that the curve (tips of sine waves) is different

from an RF or IF sweep-alignment curve demodulated to remove the carrier and thus display only the amplitude variations. Audio sweep shows the carrier sine waves, including both positive and negative peaks.

The ability to examine both sine wave peaks often is an advantage, because various kinds of distortion appear as symmetry unbalance (positive and negative peaks not identical).

### Adjusting recorder bias

Perhaps the most valuable application of an audio sweeper is adjusting recording bias and head tilt in audiotape recorders, particularly with two-head models that prevent real-time monitoring during recording.

Before swept-audio generators were available, it was necessary to perform a tedious and expensive series of spot frequency recordings and playbacks before finding the optimum amplitude of supersonic recording bias (Figure 4). For exam-

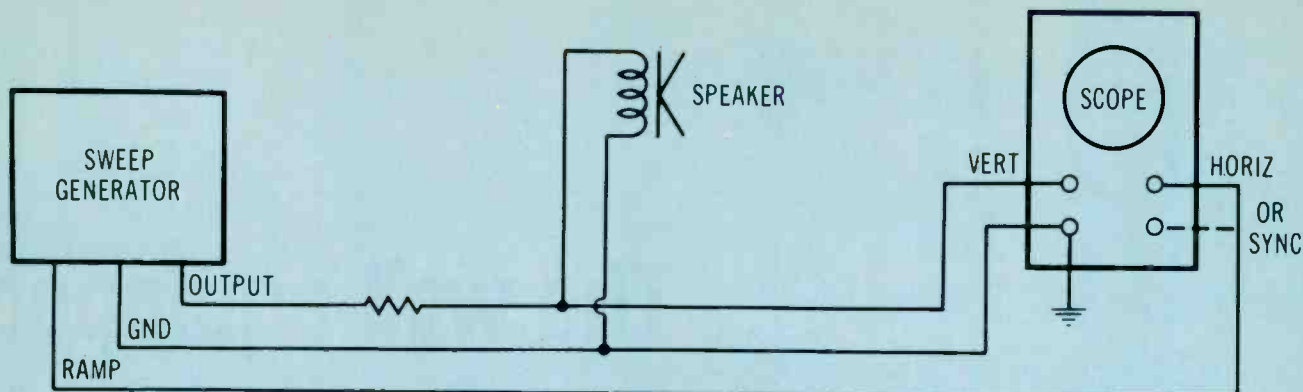

## CHECKING SPEAKER IMPEDANCE

**Figure 5** Variations of speaker impedance and identification of any resonant points can be viewed by connecting a resistor (perhaps 100Ω) between sweeper and speaker. Most speakers have a large impedance increase at the cone-resonant point, a minimum impedance at perhaps 400Hz and rising impedance to the audio limits. (Allowances must be made for horns and tweeters.) Crossovers can also be tested. If the series resistor is made equal to the speaker's rated impedance, the swept curve will trace the approximate frequency response of the speaker.

ple, it was necessary to record at 1kHz and 10kHz, rewind and check the relative levels. If they were not the same, the bias amplitude was adjusted and the recording and playback steps repeated until the optimum point was reached. With cassette machines, tape dropouts often gave false results that compounded the problem and required repeated tests.

With an audio-sweep generator, it still is necessary to record, rewind and evaluate, but the information is more complete. A low 20kHz level because of a dropout becomes visible, eliminating confusing results. Also, it can be seen if optimum biasing for 10kHz has placed a peak at 5kHz or some other frequency.

This information can be obtained by plotting many frequencies for several recordings, but the sweeper information is obtained in milliseconds vs. several minutes by separate frequency tests.

Another helpful procedure is to produce a working test tape. Few commercial test tapes have swept tones, but usually have discrete frequencies in sequence, and perhaps five minutes is required to check

playback alignment.

A sweep tape can be made using a high quality tape machine that has been calibrated carefully from a standard non-sweep test tape so it is flat over the required range. Then the sweep generator is used to record a swept-audio test tape. If care is used in calibration and recording, the tape is a good working standard test tape that permits rapid adjustments of playback equalization and azimuth.

### Checking VU meters

Specifications of professional volume-unit (VU) level meters call for identical readings of a continuous 1000Hz tone and the same tone in 300Hz bursts. A 1000Hz tone that regularly is keyed on for 0.3s and off for 0.7s should produce the same VU-meter reading as a continuous 1000Hz tone of the same amplitude produces.

If the audio-sweep generator has a tone-burst function, it can be used to determine whether the VU meter meets this standard. Adjust a frequency counter for sampling at a 1Hz or longer rate and vary the number of cycles in the burst until the counter reads 300. If the audio signal has been previously adjusted for a 1000Hz tone burst at 1 second intervals, the burst should contain 300Hz of the 1000Hz signal.

VU meters in professional-quality tape recorders probably will meet the specification, but most cassette machines will not, because the limited headroom does not permit that much damping.

### Speaker and crossover checks

Figure 5 shows how to test

speaker resonant points and impedance across the audio band. The resistor between speaker and sweeper should have a value about 10 times the speaker impedance so the change of impedance will produce a large, easily interpreted indication.

Woofer speakers have a large resonance somewhere in the 20Hz to 100Hz range that shows as a peak in the sweep waveform. Others might have resonance near their cutoff frequency, and a possibility of minor impedance peaks at higher frequencies.

Individual speakers connected by crossovers can be tested for the effects of the crossover sections and the resonances by feeding the sweep through a resistor to the crossover input and placing the scope across each woofer, midrange and tweeter in turn.

### Other applications

Because many swept function generators have repetition rates up to one or more megaHertz, they can be used to sweep-align the RF and IF stages of AM radios, to measure the locking range and capture range of PLLs, determine power-supply resonance or to test and calibrate speedometers and tachometers under dynamic conditions.

Other uses are possible in research and development work, communications and related fields. Swept-frequency function generators are versatile instruments of great usefulness in many applications. For stereo and audiotape recording servicing, these audio sweepers are indispensable. □

# The well-equipped audio test bench

By Kirk Vistain, West Chicago, IL

*Test equipment for an audio-repair bench is determined by the product specifications and the types of measurements.*

Audio performance and audio products have matured. No longer an afterthought, these new audio products have specifications equal to the complex and sophisticated circuit designs. And the repair of these complicated machines demands technicians well-trained and highly qualified.

In the same way, the test-bench instruments must match or exceed the exacting specifications of the machines tested. Test equipment is required for troubleshooting obvious defects as well as performance verification (proof of distortion, frequency response and noise specifications). General suggestions about suitable types of equipment will be given.

Audio equipment often is combined with eight-track, cassette or open-reel tape machines, phonograph turntables and changers, and combinations of AM, FM or AM/FM-multiplex radio tuners. A competent audio technician must be capable of repairing and calibrating RF, IF and multiplex radio circuits, and mechanical systems in addition to audio stages. Also, many of the cassette decks, FM digital-tuning systems and function selectors have microprocessor or other control logic.

## Test-equipment requirements

The following list shows the most essential audio test equipment:

- *oscilloscope.* For waveform information, a good scope is imperative. A high quality dual-trace triggered scope with a top response of around 30MHz is recommended. The dual-trace feature allows comparisons of amplitude and waveform between two stereo channels. Wide bandwidth is needed for accurate reproduction of fast-rise-time waveshapes and for analyzing IF waveforms in FM receivers.

- *ac millivoltmeter.* A dual-channel meter calibrated in dBmW, dBV and RMS acV is preferred. It should have frequency response from 20Hz to 1MHz and measure down to 1mV. Millivoltmeters are used for testing stereo separation, power output, signal-to-noise ratio and tape-recorder calibrations.

- *FM signal generator.* One essential is a precision and calibrated attenuator capable of providing FM-carrier frequencies at levels between 0.5 $\mu$ V and 10,000 $\mu$ V across 300 $\Omega$ . The built-in multiplex generator should have a channel separation of 50dB or more. Composite and IF outputs are helpful. And the audio total harmonic distortion (THD) should be lower than 0.1%.

- *distortion analyzer.* This instrument should have a low-distortion variable-frequency audio sine wave signal and a harmonic-distortion meter that doubles as an ac millivoltmeter. Combining these three functions in one instrument reduces the cabling and interfacing

problems while saving bench space and cost. Because the THD meter often is called on to measure less than 0.01% distortion, the distortion analyzer should read to 0.001% or better over the 10Hz to 100kHz range.

- *swept function generator.* A function generator provides a choice of sine, triangle or square waveforms. Purity of the sine waves can be around 1%, because lower distortion is needed for performance verification and not for servicing. Linear and log sweeping of frequency allows quick and approximate measurements of frequency response, tone-control action and the optimum level of tape recording ac bias. Square waves help reveal damped oscillation and slow slew rate. A frequency repetition between 3Hz and 3MHz is recommended with sine-wave THD less than 1%, output flatness better than 0.5dB across the range, and rise time of faster than 60ns. Other useful features are an output offset dcV, burst adjustments and symmetry adjustments.

- *wow-and-flutter meter.* These meters are essential for evaluating the drive-system performance of disc turntables and tape machines. A test signal of 3kHz is measured for any undesired frequency modulation by the drive system. A full-scale sensitivity of 0.1% and a choice of several weighting modes are desirable. Also, most wow-and-

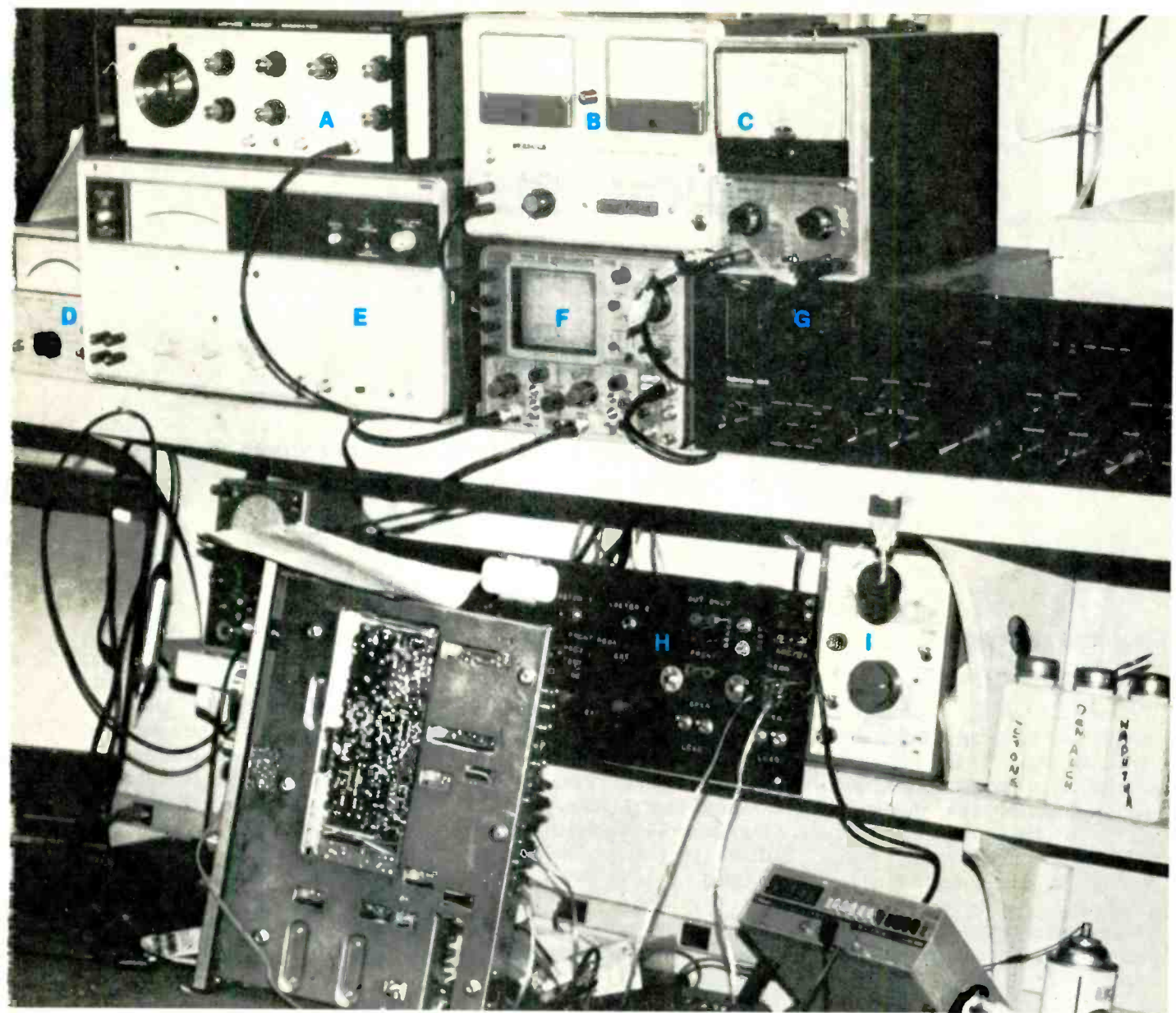

<b>A</b> Swept-function generator	<b>D</b> Millivoltmeter	<b>G</b> Stereo receiver
<b>B</b> Wow and flutter meter	<b>E</b> Distortion analyzer	<b>H</b> Test panel
<b>C</b> Dual-channel millivoltmeter	<b>F</b> Dual-trace oscilloscope	<b>I</b> Variable AC supply

flutter meters can measure drift (a long-term speed variation). More details were given on pages 22 and 23 in the December 1980 issue of **Electronic Servicing**.

• *conventional test instruments.* Additionally, a well-equipped audio bench should have basic instruments, such as a digital multimeter, variable acV transformer, VOM, transistor tester and an adjustable power supply.

Specialized devices include these: test speakers, non-inductive 8Ω high-wattage load resistors, an FM-stereo radio receiver, many test tapes and records, and gauges for measuring tension, torque and mechanical clearance. Another

necessity is a test panel that permits switch selection of the most commonly used interconnections.

Of course, soldering irons, vacuum-type solder removers, greases and chemicals, hand tools, and a stock of transistors and replacement parts are required.

#### Future needs

Probably, an AM-stereo generator will be needed in the near future, after a single standard is adopted. Few AM-radio sections are complex enough to require any sophisticated test equipment.

As microprocessors and digital logic circuits become more popular, a digital test probe will be essential.

#### Video equipment needs

Many audio and auto-sound shops now are servicing videodisc players and videocassette tape machines. This requires other test devices, such as an NTSC (or phase-locked) generator, video monitor, test tapes and discs, mechanical gauges and various test jigs.

The homes of the future will probably have integrated audio/video reproduction systems or home-entertainment centers under microprocessor control. Other technicians with a broad experience and basic knowledge of solid-state, audio, video, mechanical and digital products will find servicing these new products profitable. □

# Typical auto audiocassette repairs

*Service problems in auto versions of cassette tape machines are similar to those in portable or deck types, although unusual symptoms are encountered occasionally. Twelve typical case histories are described.*

By Homer L. Davidson, Davidson Radio & TV, Fort Dodge, IA

About 60% of all problems with cassette players in autos originate in the mechanical system; the other 40% are electronic problems. And about 85% of the mechanical failures involve complaints of slow tape speed or tape dragging.

Most people do not notice a tape-speed error up to 10% if the incorrect speed is constant. However, the slightest variation can be noticed as

a pitch change. A slow change of tape speed produces **wow**; rapid variations cause **flutter**. Many cassette machines have AM/FM radios included (Figure 1).

Details of 12 problems with auto audiocassette machines are presented.

## Wow problems

The first step in all cases of wow

is to clean all moving parts with alcohol and a cleaning stick. Remove any oil from rubber-tire drive pulleys or spindles. Use tape-head cleaner on the capstan, pressure roller and head to remove oxide. Clean the cassette-loading area using alcohol on a cloth. Check the motor drive belt for worn areas or cracks (Figure 1). Remove particles of rubber or other residue from the motor pulley. Check for a loose drive belt. It can cause wow. Hold the flywheel while the motor

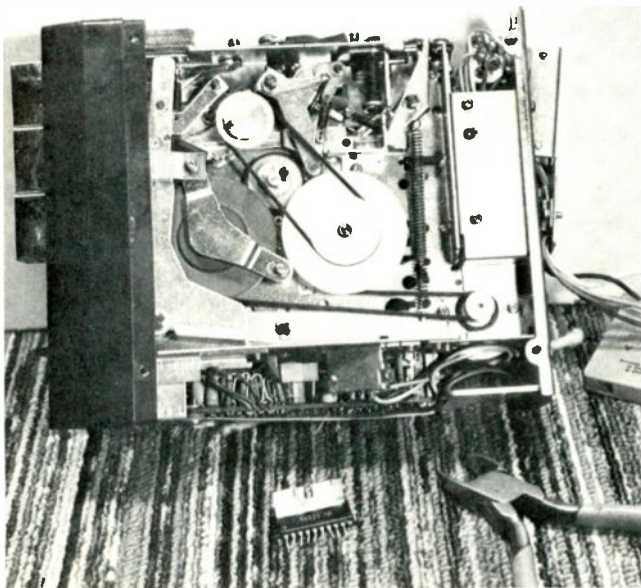

**Figure 1** Many auto cassette players (or player/recorders) are combined with AM/FM/stereo radios. One audio channel was repaired by replacement of the power-output integrated circuit.

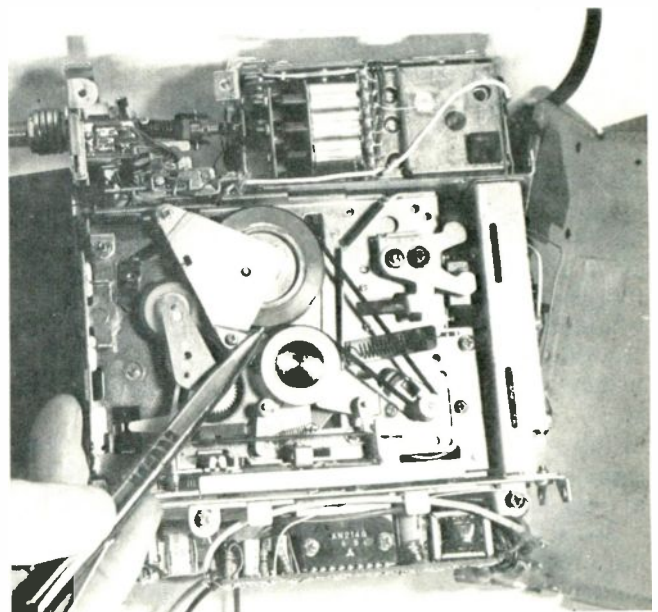

**Figure 2** Check for a motor drive belt that is broken or off the pulley. Next, examine the belt for oil or cracks. Hold the flywheel while the motor is rotating. If the motor pulley continues to turn inside the belt, replace the belt.



rotates. If the motor shaft spins easily inside the belt, a new drive belt should be installed.

### Sanyo FF453M

Even after cleaning and lubrication are completed, some speed variations were noticed. Some auto cassette players have a variable control to adjust the proper tape-travel speed. The control varies the power-supply voltage and thus the motor speed. In this case, adjustment of the control (following a thorough cleanup) solved the problem.

### Speed differences between machines

Customer complaints sometimes are caused by playing a certain tape on an auto cassette having slightly slow speed, after the tape had been recorded on a home deck which was running a bit fast. Such an extreme difference in music pitch from the two speeds can be noticed easily.

The solution is to use a test tape to measure the speed. Or, check the machines with a tape recorded on a professional-quality machine.

### Craig XA93

Intermittent mechanical opera-

tion was the complaint about the Craig. After the metal bottom cover was removed, several puddles of oil could be seen, and oil continued to drip from the mechanism. This was a clear case of the owner's using excessive oil in a futile attempt to solve a slow-speed or wow problem.

When over-oiling is found, it is best to remove most rotating components. Each rubber-tire wheel or driving surface must be cleaned thoroughly with alcohol and a brush. In extreme cases, these parts should be allowed to soak in a pan of alcohol for a time. A solution of cleaning detergent also can be used.

Although the flywheels are metal, any oil remaining on them can drip or run onto other components. Flywheels should also be cleaned of oil.

A motor-drive belt that has been saturated with oil should be replaced because it might have stretched or softened from the oil. Before the belt is removed, draw a sketch of the belt's path around the various rotating surfaces (Figure 3). The diagram eliminates much trial-and-error experimenting. Replace a drive belt with one of the original length or about 1/4-inch shorter.

### Fast tape travel

A model JS600 Met Sound machine having automatic reversing had normal tape speed in one direction but fast speed in the other. After the metal covers were removed, two separate capstans and flywheels were revealed. However, the flywheel and belt-drives appeared to be normal. The belt was removed and all surfaces were cleaned with alcohol and a cloth.

During an attempt to clean the separate pressure rollers and capstans, several turns of tape were found wrapped around one capstan shaft. This gives the effect of a larger shaft diameter, thus moving the tape faster.

The tape was cut away, revealing a large buildup of oxide residue. To prevent damage to the capstan shaft, a plastic-blade screwdriver was used to scrape away the oxide, then alcohol on a cleaning tip removed the remainder. Next checked were bearings of the pressure roller and the area between the support bracket and the pressure-roller bearing.

After these repairs, the forward and reverse tape speeds were identical.

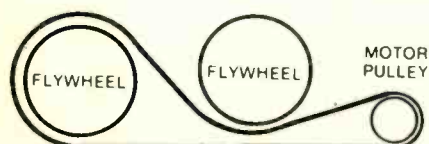
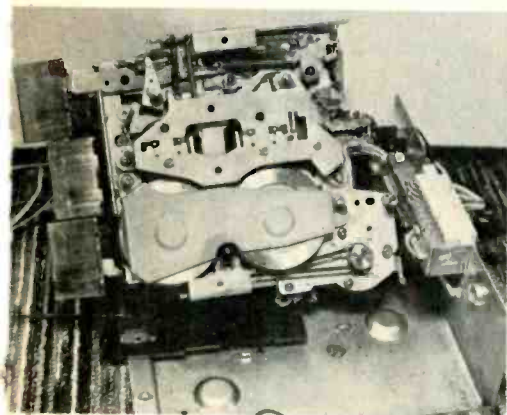

Figure 3 Before removing a belt, make a sketch, as shown at B, showing the path around pulleys and flywheels. Use the drawing to prevent mistakes during installation of a new belt.

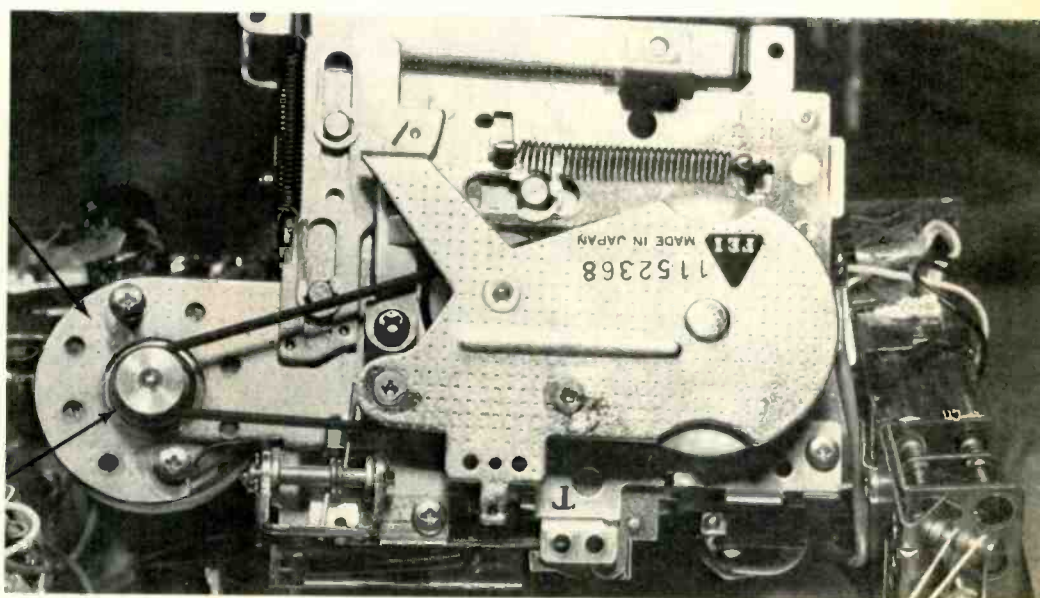

Figure 4 When tape-travel is too fast, check for tape scraps wrapped around the capstan shaft and for a motor drive belt that rides too high on the motor pulley. A defective motor also can run fast. But check for a speed control before replacing a motor. The control might be defective or misadjusted.

## Audiocassette

Defects causing fast tape travel are rare. Other possible causes (in addition to tape wrapped around the capstan shaft) are a defective motor or a defective or misadjusted speed control (Figure 4).

In another repair, the 2400-RPM motor in a Pioneer model KP4000 cassette player was found to be producing excessively fast tape speed.

### Craig model 3510 with constant reversing

Some auto cassette players have a reverse button for manual track change plus an automatic-reverse system that at the end of a tape will move the head contacts and reverse the tape movement to play the tape's other track. Such models usually have two capstan/flywheel assemblies and two heads.

In the Craig model 3510, the direction of tape travel was reversed quickly before the tape could play in the forward direction. This caused switching sounds without audio in

the speakers.

The usual cause of track-switching at the incorrect time is a problem of corroded commutator slip-ring contacts. This commutator assembly is below the capstan-pulley system.

In the Craig model 3510, the commutator is driven by a small rubber belt, which was missing. After a search, the belt was discovered in the bottom of the player. Without a belt, the commutator will not rotate, thus applying power constantly to the reverse solenoid and keeping the tape movement reversed. This rapid reversing action will force the end-of-play light to flash on and off.

Directly driven commutators usually can be repaired quickly by cleaning the commutator rings with alcohol and a cleaning stick. Also, make sure the small metal switch tongs are clean. In belt-driven models, the commutator belt must be in place and not dragging or slip-

ping. Clean it in the same way as the capstan belts. Make certain the metal screws holding the commutator contact tongs are tight and in line with the corresponding rings on the commutator shaft.

### Tape jamming without fast forward

Suspect problems with the take-up spindle assembly when symptoms of no fast forward combined with tape jamming are found. When the take-up reel is not rotating, the tape is pulled out of the cassette by the capstan and pressure roller, but it does not reel onto the take-up hub. Instead, the tape wraps around the capstan or pressure roller, causing a jam. The jamming can be erratic, of course.

A Panasonic model RS-246S had these two symptoms: When the bottom cover was removed, a small pulley was found rolling around loose inside the machine. A visual inspection proved the small drive

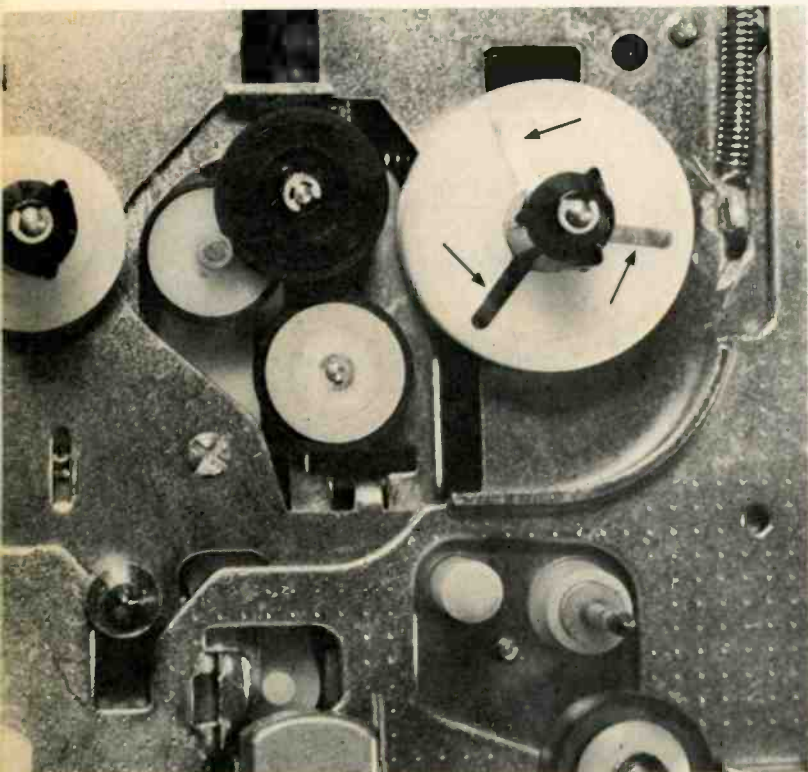

**Figure 5** Tape wound around the capstan shaft and erratic fast forward can be caused by insufficient torque of the take-up reel. Examine the take-up reel to determine whether it has a tension adjustment. The one shown has spider-type flat springs that can be lifted up and moved to the next high step in the plastic hub.

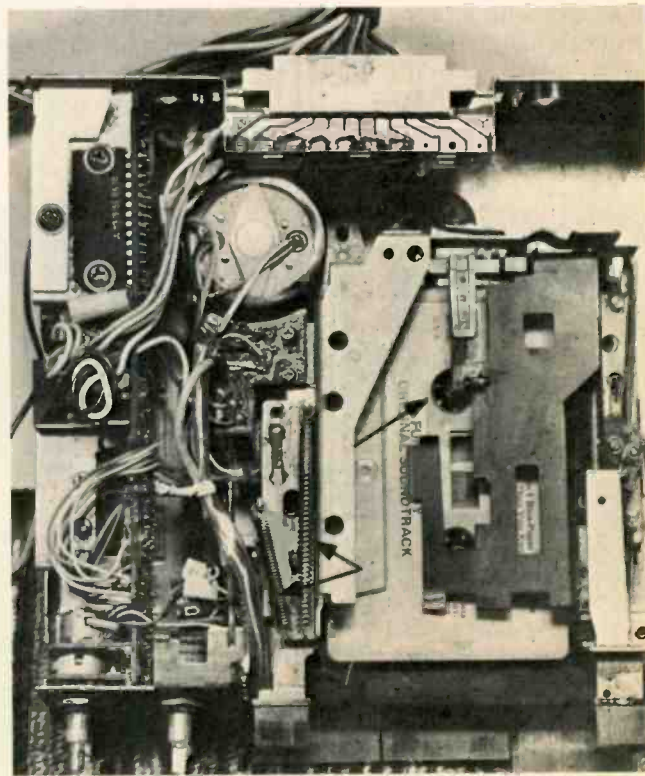

**Figure 6** Failure to load or improper loading of the cassette can be caused by missing or broken tension springs or a bent loading platform. Models with end loading (shown here) should be checked for correct clearance and set-down of the cassette. If a reel spider or shaft is bent, the cassette hubs might be prevented from sliding over the loading reels.

cam and rubber pulley had fallen from the bottom of the take-up reel assembly. Securing the same pulley with a new "C" washer cured the tape jamming and the lack of fast forward.

### Tape jamming

Tape jamming when it incorrectly

winds around the capstan can be caused also by insufficient tension of the take-up reel slip clutch. All take-up reels must slip at the correct tape tension to accommodate the difference between capstan and reel rotations as the diameter of the wound tape changes. This is a critical balance between too much

tension (perhaps breaking the tape or causing tape slippage past the capstan) and too little tension that stops proper reeling of the tape and allows the tape to build up and become caught by the capstan.

Some cassette machines allow easy adjustment of the take-up tension by moving the spider-type pressure springs on the plastic take-up spindle (Figure 5) to a higher plateau.

Other machines provide a small set screw. Rotation of the set screw changes the slip-clutch tension.

An Audio Flair model 501 had a loose "C" washer at the top of the take-up spindle which allowed the spindle to rise too high, thus lessening the tension and allowing take-up slippage. A loose plastic cap on top of the spindle also can cause the problem.

Improper tape movement in other machines can be produced by dirty or sticky capstan shafts or pressure-roller assemblies. Clean them thoroughly with alcohol. Check the capstan shaft for score marks or grooves. If the problem repeats following cleaning, install a new capstan/flywheel assembly.

Defective cassettes can also prevent smooth movement of the tape. When other individual cassettes operate normally, the one that doesn't is to blame. These cassettes should be discarded, although transfer of the tape to a repair body sometimes cures the problem.

### Gibbs model 1807 ejects cassette

Suspect a defective loading mechanism or a corroded revolving commutator if a cassette plays just a few seconds and then is ejected. This happened with a Gibbs model 1807, and a thorough cleaning of the commutator contacts solved the problem.

Other machines should have the locking levers of the mechanical-loading assembly checked. They can cause mechanical ejection. Clean all levers and lubricated bearings of the loading assembly. Improper spring tension can result in poor seating of the loading platform.

With models having a pressure-type-tension ejection system, check

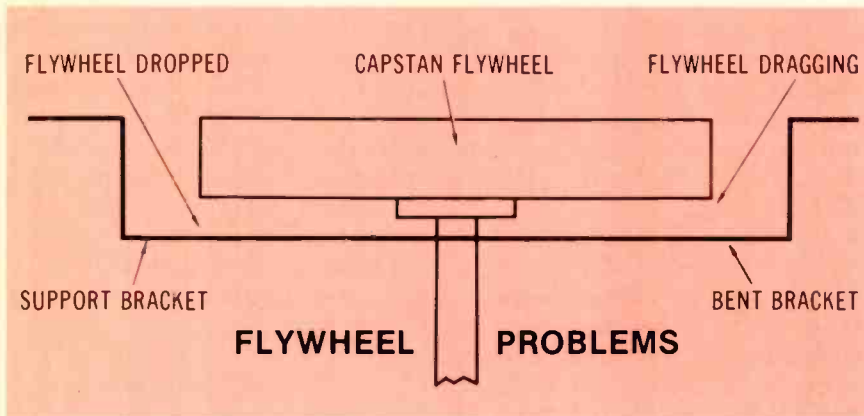

Figure 7 A continuous scraping noise can result from a loose flywheel that rides against the bracket. A bent bracket also allows contact with the flywheel.

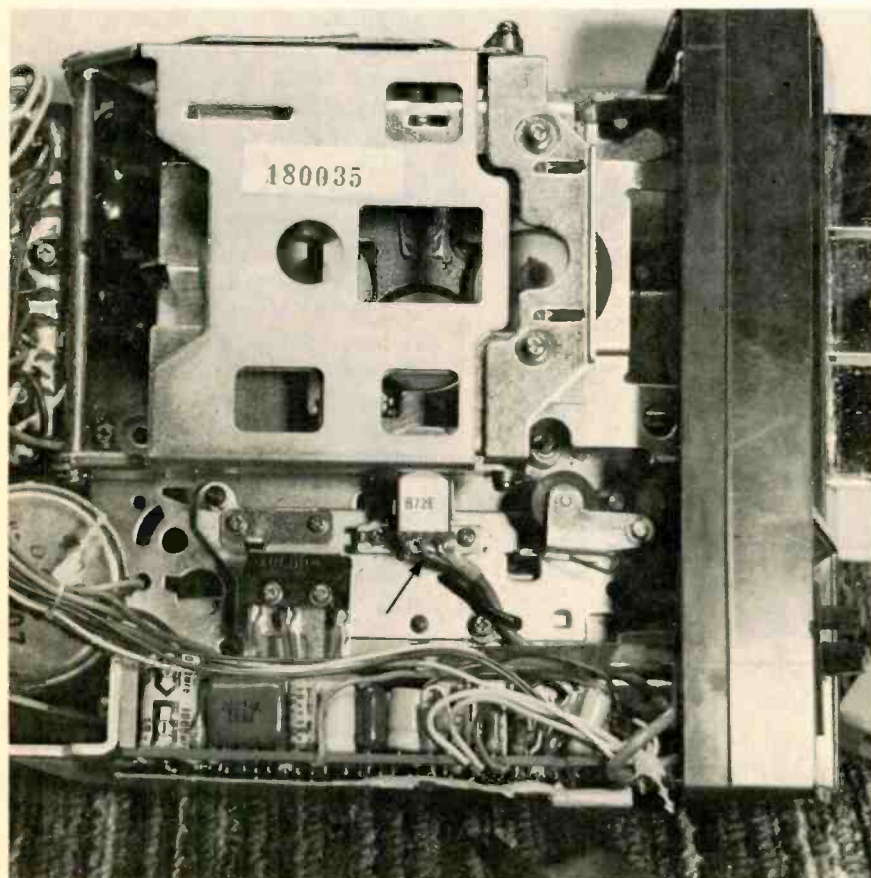

Figure 8 Broken wires at the playback head might cause intermittent volume in one or both channels or a buzzing, rushing sound. Usually these joints can be resoldered.

## Audiocassette

for dry or hard-to-rotate take-up spindles. Any increased tension can activate the end-of-tape mode, causing the ejection of the cassette (as though it is at the end of the tape). A defective cassette with its tape wound too tightly can force erratic ejection of the cassette.

### Failure to load

Some cassettes are loaded into the tape machine lengthwise (end loading). Others have front loading with the cassette's rear edge inserted first. When a cassette will not seat properly, suspect foreign objects in the loading area. Or the loading platform might be stuck in a wrong position. In mechanical-loading platforms, check for worn or bent levers and sliding areas without lubrication. Also, stretched or weak loading springs (see Figure 6) can cause incorrect tension.

Clean off all dirt and grease from the sliding areas, using a light oil. This often cures failure to load.

In a Craig model 59, the cassette

would not seat. Lubrication of bearings and sliding-cam areas using oil solved the loading problem. Tension of a weak loading spring can be increased sometimes by cutting off one or two turns and re-attaching that end.

If the machine has end loading, check for a bent spindle. After many hours of operation, the rear-most spindle can be bent enough that the cassette hub cannot be slid over the mechanism's spindle. The spindle bearing might be bent to one side. If the shaft cannot be aligned properly, a new one should be installed.

### Grinding noise in Sanyo FT642

A continuous grinding noise during operation of a Sanyo machine was caused by a bent bracket under the flywheel (Figure 7), allowing the flywheel to ride on the bracket. Usually, a bent bracket can be straightened.

The same noise can be produced

when a metal flywheel becomes loose and moves down the capstan shaft. If the flywheel is loose on the shaft, a new assembly must be installed.

### Loud continuous noise

A Pioneer model KP4000 had a loud continuous buzzing noise when a tape was played and the volume control was at maximum. Reducing the volume-control setting reduced the noise, indicating the audio stages were not the cause. One common problem (with models that move the tape heads during loading) is broken wires at the heads. Years of operation often break these delicate, shielded wires.

Locate the broken joints visually and then solder them carefully (Figure 8).

### One channel dead

A defective output transistor is the most likely suspect when no volume is obtained in one stereo speaker. Many newer models have one or two ICs for output power amplifiers of both channels.

There is no practical method of testing these ICs, but dc-voltages and signal-tracing tests should be made before a suspected IC is replaced. An audio-output IC was replaced in a Sanyo model FLT418, but unfortunately the machine still failed to operate.

While a suspected IC is removed and before a new one is installed, it is best to check all resistors and capacitors of the stage with an ohmmeter. These tests can find out-of-tolerance resistors and shorted or leaky capacitors.

In the Sanyo, the C53 100 $\mu$ F bypass capacitor was leaking (Figure 9), and this eliminated all sound from the right-channel speakers.

### Summary

The majority of problems in auto audiocassette tape player/recorders originate in the mechanism. Often, a thorough clean-up and minimum lubrication will solve most speed problems. Remember, excessive amounts of lubricant sometimes will produce other defects in the future. Do not over-oil or over-lubricate. □

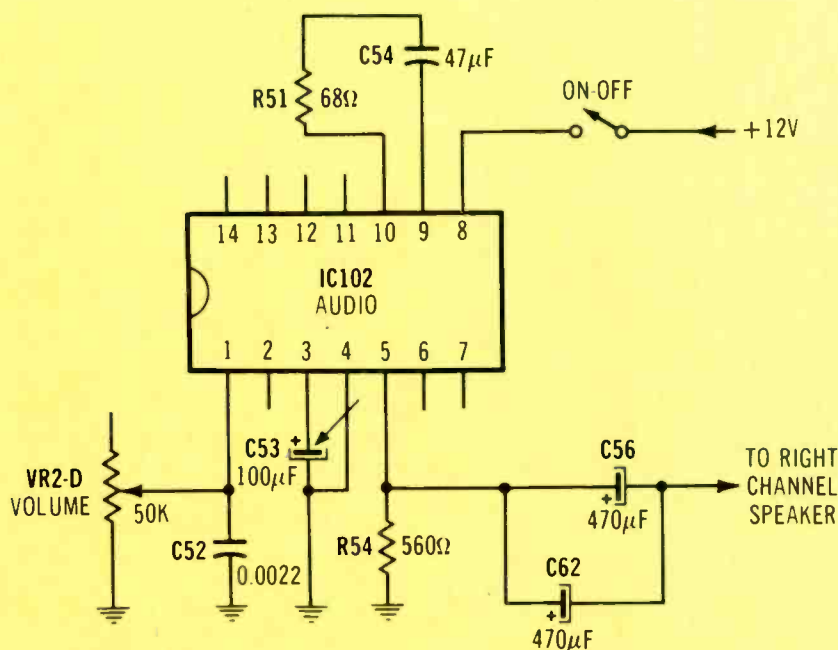

### TROUBLESOME COMPONENTS

**Figure 9** After dc-voltage and ohmmeter tests around an IC have failed to prove an integrated circuit is defective, remove the IC and use an ohmmeter to test all resistors and capacitors in the circuit. These power-output ICs sometimes produce noisy sound. C53 gave trouble in one machine.



For the man that would rather fix it himself –

# Technical Publications has service manuals designed for you!

SES-13 Small (Air Cooled) Engines Service Manual. \$9.95 (336 pages). You can service your own engines on lawnmowers, tractor sprayers and other power equipment. Special section on fundamentals, troubleshooting, preventive maintenance. Step-by-step instructions.

WLMS-1 Walking Lawnmower Service Manual \$7.95 (128 pages). The **complete** guide to the care and repair of your walk-behind, push-type lawnmower. Exploded views and diagrams.

CSS-6 Chain Saw Service Manual. \$8.95 (over 300 pages). Here's everything you need to know to tear down, repair, reassemble and adjust most popular chain saws. A truly **complete** chain saw manual.

GSM-1 Small AC Generator Service Manual \$7.95. A brand new manual that contains maintenance, service and troubleshooting procedures, as well as wiring schematics for most generator models. Covers electrical powerplants under 8kW that generate alternating current and are driven by air-cooled engines.

OS1-8 Outboard Motor Service Manual Volume 1 \$8.95 (236 pages). Covers motors below 30 hp.

OS2-8 Outboard Motor Service Manual Volume 2 \$8.95 (232 pages). Covers motors with 30 hp and above. Both Volumes 1 and 2 provide detailed fundamentals on periodic servicing.

Put these books to work on your own equipment...(Or service outside equipment for profit!)

- Small (Air Cooled) Engines Service Manual
- Walking Lawnmower Service Manual
- Chain Saw Service Manual
- Small AC Generator Service Manual
- Outboard Motor Service Manual (Vol. 1)
- Outboard Motor Service Manual (Vol. 2)

Remittance must accompany orders of less than \$25.00. Postage paid when payment accompanies order. Allow four weeks for delivery.

How to send money: The best way to send money is your own personal check, post office money order, express money order or by bank draft or check. DO NOT SEND CURRENCY OR STAMPS.

- Check Money Order Enclosed
- Ship C.O.D. (No C.O.D.s outside of U.S.)

Missouri and Kansas Residents add 4% sales tax. Tennessee Residents add 6% sales tax.

Write for a free catalog covering our entire line of service manuals and wheel-type tractor service manuals.

- VISA       MASTERCHARGE

Credit Card Number \_\_\_\_\_  
Expiration Date \_\_\_\_\_

Please Print:

Name \_\_\_\_\_

Street \_\_\_\_\_

City \_\_\_\_\_

State \_\_\_\_\_ Zip \_\_\_\_\_

Signature \_\_\_\_\_



Division  
Intertec Publishing Corp.  
P.O. Box 12901, Dept. ES  
Overland Park, KS 66212  
(913) 888-4664

# test equipment report

## Inexpensive scope

British-made, dual trace and solid state model 14D-10, from **Scopex Instruments**, is expected to sell for about \$700. The unit provides a

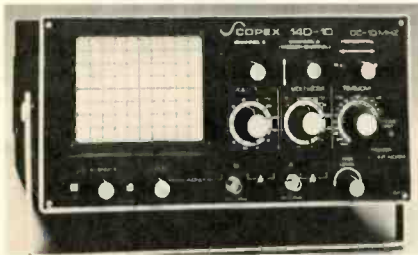

switched-mode power supply, 2mV sensitivity over its full bandwidth of 10 MHz, an add and invert facility and X-Y operation. Additional features are a display area of 3.9 x 3.1 inches (100mm x 80mm) and full probe compensation. The add and invert facility enables computer service engineers to align floppy disk drives and other peripherals.

Circle (25) on Reply Card

## DMM, true RMS

**Simpson Electric** has announced availability of model 461-2R, a new, compact, hand-portable digital multimeter that reads true RMS on ac voltage and ac current ranges. It

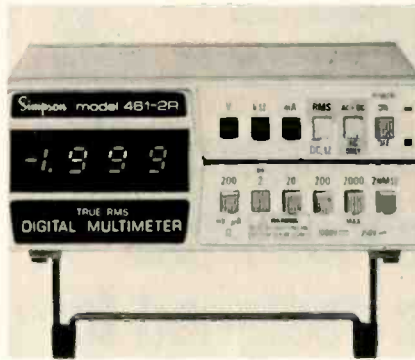

has frequency response up to 50 kHz and will respond to the RMS value of any wave shape, thus providing more accurate measurements of noisy or complex ac voltage waveforms.

Circle (26) on Reply Card

## TV sync measurement

Television sync capabilities have been added to **Hewlett-Packard's** 100 MHz models 1740A, 1741A, and 1742A oscilloscopes. This new option (005) adds the circuits and controls necessary for triggering on a composite video signal while maintaining measurement capabilities for design and troubleshooting. Scope inputs are modified to provide matching to video signals. Channel A incorporates a built-in 75 ohm input for impedance matching most video sources. Channel B has a TV clamp that stabilizes the display of video signals. This TV sync circuit locks on to one complete frame of video, with switching between fields accomplished with a pushbutton. TV line scan capability allows individual lines to be singled out for inspection and measurement. Segments of individual lines may also be examined in the triggered mode.

Circle (27) on Reply Card

# reader's exchange

**Needed:** Hickok models 539A or 539B tube tester in good condition. *Paul Capito, 637 W. 21st St., Erie, PA 16502.*

**Needed:** TV service manuals that include flow troubleshooting charts like those in RCA Technical Reference Library, Tab books, GE, Motorola, Zenith and other manufacturers. Will buy used. Also needed: Variac power supply. *P. Valer, 428 W. Roosevelt Blvd., Philadelphia, PA 19120.*

**Needed:** Any schematics manuals for radio, TV tester. Will buy or copy and return. *Monami, Box 194, Ridgefield, NJ 07657.*

**Needed:** Manual and schematic for Waterman pocketoscope model S10A. Will buy or trade test equipment for Sencore YF33 ringer, or Heathkit yoke-flyback tester, *Ken Miller, 10027 Calvin St., Pittsburgh, PA 15235.*

**Needed:** Schematic for GEC Consolidated Electrodynamics Corporation test oscillator model 20A.

Alectra division. *C. Jorgensen, 41778 Fremont Blvd., Fremont, CA 94538.*

**Needed:** Old radio tube of the 01 (or similar) type that contains an evaporated magnesium "getter," for use in X-ray generation experiments. *Pat Kelly, 2211-C S. Atlantic Blvd., Commerce, CA 90040.*

**Needed:** Will buy or borrow manuals for RCA WR64B (bar/dot generator), W969A (TV sweep generator), WA44C (audio generator), WR50B (RF generator), Hickok 615 (sweep/mark generator), Telohmike Sprague TO-6. *Ed Howell, Box 73, Folly Beach, SC 29439.*

**Needed:** B and K CB signal generator model 2040 or equivalent. *The T.V. Shop, 1461 Senter, Burlington, CO 80807.*

**Needed:** Good used or new 520KB22 and 320AWB22 picture tubes. Send cost detail to *H. Geller, 12622 N.E. 3rd St., Bellevue, WA 98005.*

### TV turn on now owner's option

To prevent unauthorized use of TV sets and other electrical equipment and to forestall "walk away" thefts of small electrical items: **New Ideas' Electric Plug Pad-lock**. New Ideas, Inc., responding to a public need recognized by Cable TV, modified the shackles of suitable padlocks so that almost any electric plug may be locked effectively.

Cost of the Electric Plug Pad-lock is \$4.95 for a package of two brass locks and six keys.



Circle (34) on Reply Card

### RFI filter

**Clifford Industries** has announced an RFI filter to prevent radio RFI from causing power supplies to shut down. Circuits in the Vista power supplies have over-voltage protection (OVP) current-limit and fold-back circuits. These circuits were being affected by voltage spikes caused by RFI transmission in close proximity to the power supply.

Vista's line of power supplies from 10 amps through 55 amps has an adjustable output voltage of 13.2 to 14.4 volts. Metered units—20RM, 30RM and 50RM—can be adjusted from 3 to 15 volts

Circle (35) on Reply Card

### Soldering aid tools in new shapes

**Desco Industries Inc.** is producing a line of soldering aids that features new designs, made from stainless steel for its non wetting and non magnetic properties. Plastic handles are designed to fit the hand for reduced fatigue and surgical control.

Circle (36) on Reply Card

### Pocket phone

An addition to their line of Freedom Phone cordless telephones has been announced by **Electra Company**, a division of Masco Corporation of Indiana. The pocket-size unit offers full capabilities of a regular phone, yet can be operated up to 600 ft. away from its connec-



Circle (37) on Reply Card

tion to the phone line. With its base unit centrally located, complete mobility, without a cord, is available over approximately a quarter-mile square area. The phone can be used to make outgoing calls as well as take calls, indoors or out.

The new Pocket Freedom Phone is an inch in depth, 2 3/4-inches wide, and 5 1/8-inches long, finished in black and grey. Although designed to be pocketable, the phone has an optional carrying case and belt loop. Suggested retail price: \$329.95.

### Solder cream Vapor phase

A solder cream formulated for use with vapor phase reflow soldering systems has been developed by **Multicore Solders**.

Conventional solder creams cause "solder balling." This occurs because of the solvation or washing effect created by the vapors which preferentially remove the flux from the soldering area before it reaches its activation temperature. These solder balls are generally indicative of poor wetting or dewetting and can create potential electrical shorts.

Multicore's vapor phase solder cream provides oxide-free solder particles homogeneously dispersed in a highly efficient non-corrosive RA, RMA or non-cleaning Xersin flux medium. The flux has been formulated to overcome the vapor washing effect problem. The system has been proved in extensive testing using commonly used vapor phase process liquids.

Vapor phase solder cream can be applied by screen or syringe and is available in 25g syringes or 500g jars.

Circle (38) on Reply Card

### Temp check display

**Micro Electronic Systems** announces the Hot Spot, a hand-held unit that displays the temperature for control in iron tip soldering. A connector permits use with standard NiCr-NiAl thermocouples.



Circle (39) on Reply Card

Advertising rates in the Classified Section are 35 cents per word, each insertion, and must be accompanied by cash to insure publication.

Each initial or abbreviation counts a full word.

Minimum classified charge \$3.00.

For ads on which replies are sent to us for forwarding (blind ads), there is an additional charge of \$3.00 per insertion to cover department number, processing of replies, and mailing costs.

Classified columns are not open to advertising of any products regularly produced by manufacturers unless used and no longer owned by the manufacturer or distributor.

## For Sale

**PICTURE TUBE REBUILDING EQUIPMENT** capable of producing four high quality tubes per day (WILL TRAIN TO OPERATE). Call or Write Atoll Television, 6425 Irving Park, Chicago, Illinois 60634, ph. 312-545-6667. 4-81-6f

**AUTOMOBILE RADIO** and tape replacement parts: Delco, Chrysler, Philco-Ford, Motorola, Panasonic and many others. Large inventory. Laran Electronics, Inc., 3768 Boston Road, Bronx, NY 10469, (212) 881-9600, out of New York State, (808) 223-8314. 5-79-tf

**TV & RADIO TUBES**, 36 cents EA! Free color catalog. Cornell, 4221 University, San Diego, California 92104. 8-76-1f

**ELECTRONIC SURPLUS: CLOSEOUTS, LIQUIDATIONS!** Parts, equipment stereo, industrial, educational. Amazing values! Fascinating items unavailable in stores or catalogs anywhere. Unusual FREE catalog. ETCO-011, Box 762, Plattsburgh, N.Y. 12901. 6-78-1f

**SCRAMBLED TELEVISION**, encoding/decoding. New book. Theory/Circuits, \$9.95 plus \$1 shipping. Workshop, Box 393ES, Dept. E, Bethpage, N.Y. 11714. 7-80-1f

**CRT REBUILDING EQUIPMENT.** Great Profits. (815) 459-0673 after 7 PM. George, 1909 Louise, Crystal Lake, IL 60014. 2-81-6f

**T.V. AND APPLIANCE**, Sales and Service—Business for sale in small South Central Montana Community. Owner retiring and will sell building, equipment, and inventory. Call MANDEVILLE AGENCY (406) 322-5361. 5-81-1f

**SENCORE CB ANALYZER.** Never used. Still in carton complete with manual, warranty card. \$475.00. Zale Radio, 302 Garden St. Roslyn Heights, N.Y. 11577. 5-81-1f

**FOR SALE: SAMS PHOTOFACTS**—#90 thru 598 Complete. \$400.00 or best offer plus shipping. Also many service and text manuals, list sent with SASE. TECH SURPLUS, 2615 Harwood Road, Baltimore, Maryland, 21234. 5-81-1f

**FOR SALE:** Well established RCA Sales and Service shop near beautiful Minnesota River, attached to country store and spacious 3 bedroom home. For details call owner, 507-925-4448. 5-81-2f

**T.V. AND 2-WAY RADIO TECHNICIANS WANTED** for immediate employment. Excellent salary, fringe benefits, good working conditions with progressive Electronic Retail-Service Corporation. Miller's Electronics, Inc.—Hwy 24—Goodland, Kansas 67735, 913-899-2386. Equal Opportunity Employer 5-81-1f

**"SUPREME** Television-Radio Diagram manuals discounted 60%. Free information. SASE. Beitman, 1760 Balsam, Highland Park, IL 60035." 5-81-1f

1—B&K 415 Sweepmarker Generator—\$250; 1—Tektronix 524AD Scope—\$250; 2—Precision UTUM EV-10 both—\$100.00; 1—RCA WO-91B Scope—\$200.00. TELE-Sonic, 164 Halstead Ave., Harrison NY 10528, 914-835-0111 5-81-2f

**WANTED: SENCORE YF33 RINGER**—Mitchell Electronics, 4 Golf Ave., Maywood, NJ. 07607. 5-81-1f

**SAMS PHOTOFACTS** 33-796 30% complete. Sell all or part. List available. R. L. Wollam, 1 Woods Ct., Huntington, NY 11743. 5-81-1f

**PRINTED CIRCUIT** boards from your sketch or artwork. Affordable prices. Also fun kit projects. Free details DANOCINTHS INC. Dept. ES, Box 261, Westland, MI 48185. 5-81-1f

Circle (11) on Reply Card

**TUBES FOR TV AND RADIO**—35¢ ea. Washington TV Service, 1330 E. Florence Ave., Los Angeles, CA 90001. 3-81-9f

**SAMS PHOTOFACTS**, 1 thru 1899 complete with cabinets \$1100.00. No delivery. Oaklandon Electronics, 7145 HAWKS HILL RD., Oaklandon, IN 46236 317/823-6338. 5-81-1f

## Wanted

**NEED GOOD USED 520KB22** and 320AWBZZ CRT's. H. Geller, 12622 NE Third, Bellevue, Washington, 98005. 5-81-1f

**MIRROR IN THE LID**, and other PRE-1946 Television sets wanted for substantial cash. Also interested in 12AP4, MW-31-3 Pre-War picture tubes, parts, literature on Pre-War Television, Arnold Chase, 9 Rushleigh Road, West Hartford, Conn. 06117 (203) 521-5280 2-81-7f

**DESPERATELY NEED:** Information on "Telcon" projection TVs from 1947, RCA "Test Lamp" for 1940's projection TVs. Arnold Chase, 9 Rushleigh Road, West Hartford, Conn. 06117 (203) 521-5280. 2-81-7f

## Business Opportunity

**TV TECHNICIAN!** Increase your income up to \$60,000 yearly. Rent-lease-sell TVs new-used, even from comfort of your home. Basic Preliminaries \$4.00. Perrys TV Systems, Hwy. 181, Box 142, R1, Bremen, KY 42325 12-80-1f

**FIX IT FAST WITH PHOTOFACT®.** Photofact® 1981 Index lists available service data for over 110,000 TV's, Radios, CB's, Auto Radios, Scanner-Monitors, and VCR's produced since 1946. Send \$2.50 plus 50 cents shipping to Howard W. Sams Co., Dept. X 0115, 4300 W. 62nd St., Indpls., IN 46268. 3-81-3f

## To get more information...

on items advertised or described in this publication, use the Reader Service Card.

As a free service for our readers, we forward your inquiry to the product's manufacturer. Reader Service Card is pre-addressed.

# advertisers' index

ETCO.....	44
Electronic Tool Co. Inc. ....	13
Gamit Enterprises .....	15
Gem City Tuner Service .....	13
Micro Design .....	11
Natesa .....	15
Nesda .....	17
Oelrich Publications .....	17
PTS Electronics .....	21
RCA Dist. & Special Products .....	6-7
A. W. Sperry .....	3
Viz Mfg. Co. ....	IFC
Wahl Clipper Corp. ....	1
Zenith Radio Corp. ....	BC

## Electronic Servicing.

Advertising Sales offices

### NATIONAL SALES MANAGER

Greg Garrison,  
P.O. Box 12901,  
Overland Park, KS 66212  
Phone: (913) 888-4664

### LONDON, ENGLAND

John Ashcraft & Co., John Ashcraft,  
12 Bear St.  
Leicester Square, London, WC2H 7AS  
England  
Phone: 930-0525  
Telex: 895-2387

### AMSTERDAM, HOLLAND

John Ashcraft & Co., John J. Lucassen,  
Akerdijk 150A, 1171 PV-Badhoevedorp  
Holland  
Phone: 0-2968-6226

### TOKYO, JAPAN

International Media Representatives, Ltd.  
2-29, Toranomon 1-chome, Minato-ku  
Tokyo 105, Japan  
Phone: 502-0656

### NORWOOD, AUSTRALIA

Williamson & Associates, John Williamson,  
No. 2 Edmund St., Norwood, S.A. 5067  
Australia  
Phone: 42-7074



# Special Inventory Clearance Offer...

Get all 5\* great books for

**\$10.00**  
(a \$25.00 value)



**Electronic Servicing** brings you 5 of its most popular reference guides for a fraction of their original value...

- Color TV Servicing
- Better Management
- Stereo FM Servicing
- Color TV Circuit Operation

plus:

\*You get "Guide to CB Servicing" FREE as an extra bonus for ordering this valuable set of reference manuals.

*For a limited time* **Electronic Servicing** is offering this complete package of 5 reference guides for one low price

**1. COLOR TV SERVICING GUIDE Volume 2**

Fourteen chapters explain many repairs of color TVs from the tuner to the deflection yoke. Included are photos of trouble symptoms from the screen of the picture tube, transistor tests, case histories of typical repairs, explanations of scan rectification, and descriptions of essential tools and techniques.

**3. BETTER MANAGEMENT GUIDES**

Practical information about bookkeeping and accounting procedures, service labor pricing, technician incentive programs, methods for increasing shop productivity, and how to get the most from your insurance dollars, plus a checklist for evaluating your own business management techniques.

**2. PROFESSIONAL TECHNICIAN'S GUIDE TO STEREO FM SERVICING**

A concise presentation of practical information essential to proficient servicing of home and auto stereo FM systems.

**4. COLOR TV CIRCUIT OPERATION GUIDE**

An in-depth analysis of existing tube and solid-state color circuitry that begins with a review of how the color signal is developed and proceeds stage by stage through each section of the color receiver.

*Order your set today for only \$10.00 by sending in this coupon:*

**5. Your FREE bonus:**

**"Guide to CB Servicing"**

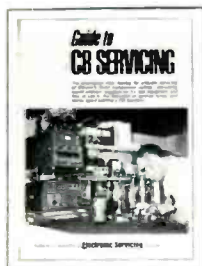

The information most needed for efficient servicing of Citizen's Band transceiver radios; including circuit analysis, suggestions for test equipment and advice about CB business.

**Electronic Servicing**

P.O. BOX 12901, DEPT. GG, OVERLAND PARK, KS 66212

Please send me Electronic Servicing's 5 reference guides at the price of only \$10.00 for the complete set.

Name \_\_\_\_\_

Company \_\_\_\_\_

Address \_\_\_\_\_

City \_\_\_\_\_ State \_\_\_\_\_ Zip \_\_\_\_\_

Signature \_\_\_\_\_

Charge to my  VISA or  MasterCard # \_\_\_\_\_  
or  I have enclosed my check for \$10.00

Make checks payable to: **Electronic Servicing**

A black and white photograph of a hand holding a telephone receiver. The receiver is tilted upwards, and the words "CALL NOW!" are printed in bold, capital letters on its side. The background is a bright yellow.

**Special limited-time  
introductory offer  
on ZIP!**

# Zenith Instant Parts Program.

Inventory control – that's the name of the game today! And Zenith's Instant Parts Program (ZIP) is the way to play it safe, sure...and money-wise. Because with ZIP, you've got Zenith's most frequently needed exact replacement parts where you want them when you want them.

Also with ZIP, slow-moving stock numbers are periodically replaced with new, more popular parts thru periodic checks by your Zenith distributor salesman. As a result, your original investment is protected and your inventory of Zenith exact replacement parts is current.

And best of all, today you can add a little ZIP or a lot of ZIP to your inventory control of Zenith parts.

For a little ZIP, you'll want ZIP-50 – the top 50 Zenith parts available with or without System 3 components. If you want more ZIP, get ZIP-100 – the most active 100 Zenith parts now available with or without System 3 components.

Call your Zenith distributor now for the ZIP program that best suits your need. Four to choose from!

ZIP – it's the easiest, least expensive, most versatile inventory control system ever devised by Zenith for TV service technicians! Call your Zenith distributor now!

**Call your Zenith distributor now for a  
special limited-time-only introductory offer  
on ZIP — Zenith's Instant Parts Program!**

*For your own reputation and in your customers' best interest,  
always service with Zenith exact replacement parts.*

**ZENITH**  
The quality goes in before the name goes on®

Zenith Radio Corporation / Service, Parts & Accessories Division / 11000 Seymour Avenue / Franklin Park, Illinois 60131  
Circle (2) on Reply Card