

Electronic Servicing



Digital probe roundup

Troubleshooting
digital equipment

RCA vertical
sweep

Logic probe
design



Digital IC Probe & Logic Pulser

PRB-1 DIGITAL LOGIC PROBE

Compatible with DTL, TTL CMOS, MOS and Microprocessors using a 4 to 15V power supply. Thresholds automatically programmed. Automatic resetting memory. No adjustment required. Visual indication of logic levels, using LED's to show high, low, bad level or open circuit logic and pulses. Highly sophisticated, shirt pocket portable (protective tip cap and removable coil cord).

Automatic threshold resetting • DE to > 60 MHz

Compatible with all logic families 4-15 VDC • 10 Nsec. pulse response

Supply O.V.P. to ± 70 VDC • 120 K Ω impedance

No switches/no calibration • Automatic pulse stretching to 60 Msec.

Open circuit detection • Automatic resetting memory

Range extended to 15-25 VDC with optional PA-1 adapter

PLS-1 LOGIC PULSER

The PLS-1 logic pulser will superimpose a dynamic pulse train (20 pps) or a single pulse onto the circuit node under test. There is no need to unsolder pins or cut printed-circuit traces even when these nodes are being clamped by digital outputs.

PLS-1 is a multi-mode, high current pulse generator packaged in a hand-held shirt pocket portable instrument. It can source or sink sufficient current to force saturated output transistors in digital circuits into the opposite logic state.

Signal injection is by means of a pushbutton switch near the probe tip. When the button is depressed, a single high-going or low-going pulse of 2 μ sec wide is delivered to the circuit node under test. Pulse polarity is automatic: high nodes are pulsed low and low nodes are pulsed high. Holding the button down delivers a series of pulses of 20 pps to the circuit under test.

High input impedance (off state) 1 meg ohm • Multi mode-single pulses or pulse trains

Low output impedance (active state) 2 ohms • Automatic polarity sensing

Output pulse width 2 μ sec nominal • Automatic current limiting; 7 amps nominal

Input over voltage protection +50 volts • Automatically programmed output level

Finger tip push button actuated • Circuit powered

Power lead reversal protector • No adjustments required

Multi-family RTL, DTL, TTL, CMOS, MOS and Microprocessors

OK Machine & Tool Corporation
3455 Conner St., Bronx, N.Y. 10475 U.S.A.
Tel. (212) 994-6600 Telex 125091

Electronic Servicing®

Industrial MRO

8 Reports from the Test Lab

By Carl Babcoke, CET

The Sencore AC Powerite model PR-57 is featured.

13 The basic design of logic probes

*By James W. Sneed, director, R&D, Kurz-Kasch,
Dayton, OH*

The author, holder of the patent for the dual-threshold logic probe, reviews his company's continued attention to logic probe development and reviews historical developments in this field.

14 Digital probe roundup

Compiled by the Electronic Servicing staff

Descriptions of digital probes are featured, and reader service numbers are supplied.

Consumer Servicing

18 Troubleshooting digital equipment

By John E. Cunningham, J. E. Cunningham Associates

Types of integrated-circuit defects and methods of testing for them are discussed.

22 RCA CTC99 vertical sweep, part 2

By Gill Grieshaber, CET

This last article of the RCA CTC99 and CTC101 series continues the circuit-operation information. Pictures from the television screen and matching scope waveforms for typical parts are provided.

Departments

6 Symcure

7 People

37 Product Report

39 Troubleshooting Tips

41 Catalogs and Literature

43 Readers Exchange

About the cover

Digital probe photograph courtesy of O.K. Machine and Tool. Graphic design by Linda Franzblau.

CASH IN ON SAMS FREE BOOK OFFER!

With your order of \$20 or more, you can select a FREE BONUS BOOK... value up to \$5.95. Take advantage of this money-saving, limited time offer on Sams Special Projects Books. Build your \$20 order from the current, popular titles listed below. Free Bonus Book selections are indicated by an asterisk (*). Mix or match the books you want... then indicate your free book selection on the order form.

AUDIO

- TAPE RECORDING FOR THE HOBBYIST—4th Edition.**
Cassettes, eight-track, open reel, and home video tape. Covers taping broadcasts, live sound, special effects and editing. #21348. \$4.95
- STEREO HIGH-FIDELITY SPEAKER SYSTEMS.**
Covers a broad range of stereo speaker systems. Includes shopping tips for equipment best suited to your needs. #21514. \$5.95.
- * **LISTEN TO RADIO ENERGY, LIGHT, AND SOUND.**
Hear fascinating, exciting new sounds through inexpensive amplifiers. #21525. \$5.95. BONUS BOOK SELECTION.

ELECTRONICS

- LED CIRCUITS AND PROJECTS.**
Covers all kinds of LED applications—from digital display and logic tester probes to communications systems and travel aids for the blind. #21006. \$5.25.
- * **ELECTRONIC CIRCUITBOOK 1: PROJECT CONSTRUCTION.**
Covers various kinds of electronic circuits and projects that can be made with them. #21241. \$3.25. BONUS BOOK SELECTION.
- * **INTRODUCTION TO RADIO ASTRONOMY.**
Explains how to construct several low-cost radio telescopes that are suitable for observation of solar phenomena, galactic noise and intergalactic signal sources. #21246. \$4.50. BONUS BOOK SELECTION.
- * **ELECTRONIC CIRCUITBOOK 5: LED PROJECTS.**
Instructions for making four-layer diode pulser, avalanche transistor pulser, high-circuit LED pulser, amplitude-modulation voice transmitter and receiver, and solid-state oscilloscope. #21311. \$3.75. BONUS BOOK SELECTION.
- BUILD-IT BOOK OF SAFETY ELECTRONICS.**
Contains ideas for building several novel projects to protect your home, family, and car. #21334. \$3.50.
- BUILD-IT BOOK OF HOME ELECTRONICS.**
Put solid-state devices and ICs to work in your home. Includes 13 interesting projects you can build. #21409. \$3.50.
- BUILDING AND INSTALLING ELECTRONIC INTRUSION ALARMS.**
Written for the novice who wants to install a security system in his home... and the technician who wants to enter the lucrative field of security electronics. #21465. \$4.95.
- UNIQUE ELECTRONIC WEATHER PROJECTS.**
You can build projects to measure temperature, wind speed, and direction, barometric pressure and construct a thermostat "with a brain" to help conserve energy. #21484. \$7.95.
- PRACTICAL LOW-COST IC PROJECTS—2nd Edition.**
Presents complete parts lists and schematic diagrams for 38 different, easy, low-cost integrated circuit projects. #21599. \$4.50.

- INTEGRATED CIRCUIT PROJECTS—2nd Edition.**
IC projects that are useful, fun to build, and educational. All projects have been tested and debugged. #21616. \$5.50.
- ELECTRONIC TELEPHONE PROJECTS.**
15 projects that can extend the capabilities of your present telephone. #21618. \$6.50.
- 99 PRACTICAL ELECTRONIC PROJECTS—2nd Edition.**
Choose from audio amplifiers, test equipment, photography projects, or automobile devices. Many can be built for less than \$10. #21635. \$4.95.
- SIMPLE IC TEST INSTRUMENTS YOU CAN BUILD.**
31 practical instruments and test accessory circuits you can inexpensively and easily build from scratch. #21683. \$4.95.
- ONE EVENING ELECTRONIC PROJECTS.**
Even beginners can build electronic projects with this book. Simple tools and readily available components can result in an evening of fun and useful projects for the house, garage, workshop, or office. #21699. \$5.95.

COMPUTERS

- GETTING ACQUAINTED WITH MICROCOMPUTERS.**
Written especially for engineers, technicians, scientists, and others who need to know about microcomputers. Self-instructional. #21486. \$8.95.
- GUIDEBOOK TO SMALL COMPUTERS.**
A must for anyone thinking about buying a small computer. Introduces small computers, software, and hardware. Surveys 21 currently popular systems. Includes a directory of small computer manufacturers. #21698. \$4.95.

ENGINES

- UNDERSTANDING YOUR CAR.**
Not a fix-it-yourself guide! Instead, this book explains problems so that they can be described to a mechanic. #21623. \$8.95.
- DIESEL ENGINE MAINTENANCE.**
Explains proper maintenance procedures for the popular, new diesel engines. #21620. \$6.95.

ENERGY

- ENERGY SAVING HOME IMPROVEMENTS.**
Outlines conservation projects, including furnace efficiency, insulation, and solar collectors. #21605. \$7.95.
- SOLAR HEATING.**
Sound facts about heat transfer and heat retention. Includes examples of use and many illustrations. #21621. \$6.95.

Sams BOOKS

SAVE 10% ON THESE BRAND NEW TITLES!

- AUTOMOTIVE TUNE-UP AND EMISSION CONTROL.**
A do-it-yourself guide for many servicing and adjustment procedures which can be performed by the average person. #21712. SAVE 10%... ONLY \$8.95.
- ELECTRONICS FOR THE BEGINNER.**
No previous electronics knowledge is needed to build exciting projects like crystal sets, transistor radios, IC amplifier, CB and aircraft tuners, hi-fi am tuner, shortwave receiver, and many more. 100 illustrations and step-by-step instructions make it fun and simple. #21737. SAVE 10%... ONLY \$6.25.
- YOU AND YOUR TELEPHONE.**
The complete telephone book. With this book, you can determine the best telephone system, accessories, and services for your needs... and determine whether you should buy and install your own equipment, or rent it from your local phone company. #21744. SAVE 10%... ONLY \$4.45.
- 101 WAYS TO USE YOUR VOM, TVM, AND DVM—3rd Edition.**
Gives both common and uncommon uses of the volt-ohm-meter and vacuum-tube voltmeter. Covers equipment checks, ac and dc voltage tests, dc current tests, ohmmeter tests, signal-tracing tests, alignment applications, and color tv tests. Includes numerous illustrations and diagrams. #21756. SAVE 10%... ONLY \$5.95.

ORDER FORM

HOWARD W. SAMS & CO., INC.
4300 West 62nd Street, P.O. Box 7092
Indianapolis, Indiana 46206
(317) 298-5400

Indicate quantity in boxes above and complete order information below. Return entire ad with order.

Sub Total _____

Add local sales tax (where applicable) _____

TOTAL AMOUNT _____

My total exceeds \$20! Please send me my FREE BOOK.

*FREE BOOK Selection:

Title _____ # _____

PAYMENT ENCLOSED

(save postage and handling costs)

CHECK MONEY ORDER

MASTER CHARGE VISA ADO27

Interbank No. (Master Charge) _____

Account Number _____

Expiration Date _____

Minimum Credit Card Purchase \$10.

Name (print) _____

Signature _____

Address _____

City _____ State _____ Zip _____

Prices subject to change without notice.

Offer expires 12/31/80



NESDA and ISCET officers: (back row, l. to r.) Bill Abernathy, NESDA treasurer; George Bluze, NESDA vice-president; Keith Knos, NESDA secretary; (front row, l. to r.) Bob Villont, immediate past president of NESDA; Larry Steckler, ISCET chairman; and Jim Rollison, NESDA president.

NESDA/ISCET 1980 Convention highlights

The combined convention of National Electronic Service Dealers Association and its subsidiary the International Society of Certified Electronic Technicians were held at the Galt House in Louisville, KY August 18-23. Total attendance was approximately 500. Tuesday activities included business-management sessions, a luncheon furnished by Sprague, and a trip to Louisville Downs race track with dinner during the evening, courtesy of Sony. After Panasonic's Wednesday breakfast, the NESDA annual meeting was held. Luncheon was supplied by PTS Electronics, and Magnavox hosted the evening banquet. Thursday began with breakfast by GTE-Sylvania, followed by the Electronics Derby trade show with exhibits by many manufacturers. NESDA officer elections and electronics instructors' conference were held in the afternoon after luncheon by General Electric. Thursday evening RCA hosted a cruise on the Ohio River aboard the riverboat *Belle of Louisville*. Sharp Electronics provided Friday breakfast. The National Service Confer-

ence and the ISCET annual meeting occupied the day, with a luncheon sponsored by Thordarson-Meissner. Zenith sponsored a banquet and dance Friday night. ISCET sponsored the Saturday breakfast and the technical-training sessions that followed. Howard W. Sams Co. provided the annual cocktail party. The NESDA Electronics Hall of Fame Banquet featured installation of NESDA and ISCET newly elected officers, with M. L. Finneburgh officiating. The NESDA officers are: Jim Rollison, president; George Bluze, vice-president; Keith Knos, secretary; and Bill Abernathy, treasurer. These officers were installed for ISCET: Larry Steckler, chairman; Frank Grabiec, vice-chairman; Robert Ocasio, secretary; and Jack Kelley, treasurer.

Two persons were inducted into the Electronics Hall of Fame. O. W. Donald was praised by LeRoy Ragsdale for his development of service forms and his assistance to the Arkansas service industry.

For more information, contact: NESDA, 2708 West Berry Street, Fort Worth, TX 76109, telephone (817) 921-9062.

1981 Winter CES plans in final stage

Space assignments for the 1981 International Winter Consumer Electronics Show have been finalized and were sent to applicants this month, according to William T. Glasgow, vice president, Consumer Electronics Shows. The ninth annual Winter event, sponsored and produced by the EIA's Consumer Electronics Group, will be held January 8-11 in Las Vegas. More than 700 manufacturers, including every major exhibitor in the 1980 Winter and Summer Shows, applied for exhibit space by August 1st. All exhibit space in the Las Vegas Convention Center, and 80% of the space at the Las Vegas Hilton and Jockey Club hotels, has been applied for. The 1981 Winter CES is expected to increase from 750 to more than 950 exhibitors. Each year the Consumer Electronics Shows have become more internationally oriented. The 1980 shows each attracted more than 5000 trade visitors from more than 50 countries.

For further information, contact: William T. Glasgow, Consumer Electronics Shows, Two Illinois Center, Suite 1607, 223 N. Michigan Ave., Chicago, IL 60601. Telephone (312) 861-1040.

EIA reports a decline in consumer electronics product imports

United States unit imports of most consumer electronics products declined in the second quarter of 1980, compared to the same period last year, according to the marketing services department of the Electronic Industries Association's consumer electronics group. Both audio and video tape recorder/player unit imports increased in the second quarter of 1980. Home radio unit imports were barely ahead of the second quarter 1979, while

imports of phonograph only units were about even with the second quarter last year. For the first six months of 1980, b&w televisions, phonographs only, and audio and video tape recorder/players showed increased unit imports over the first half of last year. Color television unit imports declined 7.3% in the second quarter, and 31.6% in the first half of 1980, compared to the same periods in 1979.



Newly elected NATESA officers: (l. to r.) Richard Ebare, treasurer; Leo E. Cloutier, president; Tom Leeny, secretary; and Ellis Hall, vice-president.

NATESA 1980 Convention highlights

The 30th annual convention of National Association of Television and Electronic Servicers of America (NATESA) was held August 7-10 at the Ramada O'Hare in Chicago with a total attendance of 320. Newly elected officers are: Leo Edmond Cloutier, president; Ellis Hall, vice-president; Tom Leeny, secretary; and Richard Ebare, treasurer. Paul F. Kelley became immediate past president, and Frank J. Moch & Associates was retained as executive director. Meals and social functions were sponsored by PTS Electronics, GTE-Sylvania, Magnavox, RCA, Sony, Zenith, GE and Howard W. Sams & Co.

Several resolutions were approved by vote. One urged the abolition of published "list prices" for components. A second resolution urged industry adoption of component and new product warranties that are limited to 90 days.

An addition to the NATESA

Code of Ethics requires members of accept all judgements made by the NATESA customer complaint-policing committee following a thorough investigation of each complaint.

Awards were presented during the annual banquet. Philip Horn was named NATESA's 1980 Friend of Service. Cooperation awards were made to Dick Wilson (Zenith), "Dutch" Meyer (General Electric), and Gene Eddy (RCA). Richard Ebare was presented a special plaque in recognition of five years of service as Treasurer. George Weiss was given the Shumavon Award. Lelia Aunspaw was presented with a desk pen set as a memento of her two years service as secretary.

The Indian Lakes Resort of Bloomingdale, IL was announced as the site of the 1981 NATESA Convention on August 19-23, 1981. For more information, contact: NATESA, 5930 South Pulaski Road, Chicago, IL 60629, telephone (312) 582-6350.

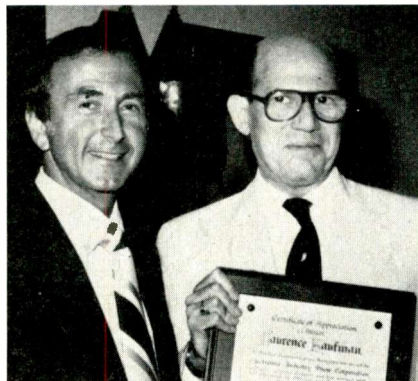

D.L. Fisher, EDS executive vice president, (left) presents a certificate of appreciation to Laurence Kaufman, Stral Advertising.

EDS Corporation honors Kaufman

The Electronic Distribution Show Corporation recently presented a Certificate of Appreciation to Laurence Kaufman, public relations counsel. David L. Fisher, EDS

executive vice president, presented the award and called attention to the more than 25 years of service to the industry provided by Kaufman and Harold Stral through Market Communications Associations, their public relation firm. The Show Corporation was MCA's first client, and for 25 years MCA and Stral Advertising have been immersed in advertising, public relations and sales promotions in the electronics industry. Their current account roster includes several EDS exhibitors, including Antenna, Inc., B&K-Precision (Dynascan), Grayhill, Perma Power Electronics and Quam-Nichols. They also have counseled and worked with distributors, sales representatives and trade associations in the industry. □

**EVERY YEAR
MILLIONS OF
UNITEDWAY
VOLUNTEERS WORK
TIME AND A HALF
SO YOU'RE NOT
BOTHERED
TIME AND AGAIN.**

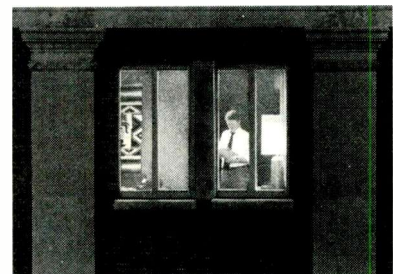

Once a year — and only once — United Way raises money to support vital human services for people in communities all across America.

United Way's continued success year after year proves a very basic point. When you ask the American people for help, they respond.



Thanks to you, it works. for all of us. United Way

Ad Council A Public Service of This Magazine & The Advertising Council

Chassis—RCA CTC93
PHOTOFACT—1810-2

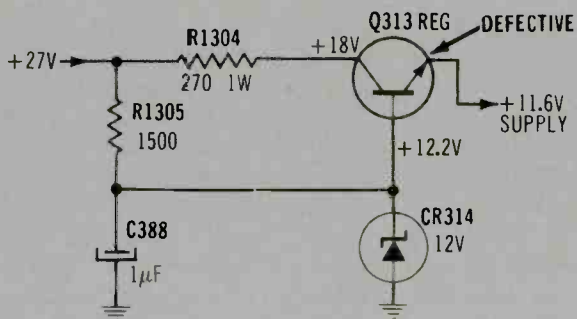

Symptom—Dark picture
Cure—Check +11.6V supply and replace Q313 (or CR314) if voltage is low

Chassis—RCA CTC97
PHOTOFACT—1862-1

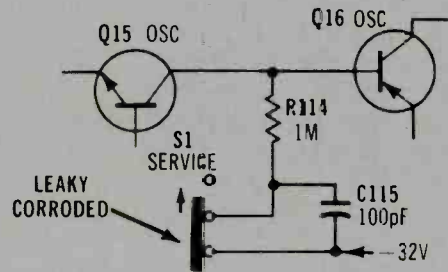

Symptom—Height collapses erratically
Cure—Check for leakage across S1 service switch (or corroded contacts)

Chassis—RCA CTC92
PHOTOFACT—1788-2

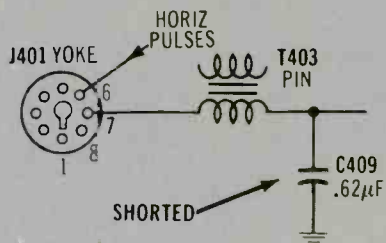

Symptom—No picture or sound; fusible resistor RF201 is open
Cure—Test yoke coupling capacitor C409, and replace it if shorted

Chassis—RCA CTC101 (also CTC99)
PHOTOFACT—1896-2

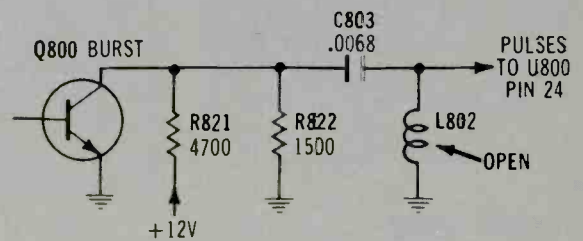

Symptom—No color, but IF and oscillator signals enter U800 IC
Cure—Check for open L802 burst-keyer coil (or defect in Q800 stage)

Chassis—RCA CTC99 (also CTC101)
PHOTOFACT—1895-1

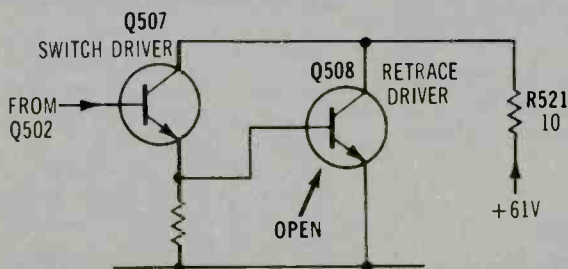

Symptom—Compression and retrace at top of picture
Cure—Check for open Q508 (or defective Q507) in retrace circuit

Chassis—RCA CTC85
PHOTOFACT—1800-1

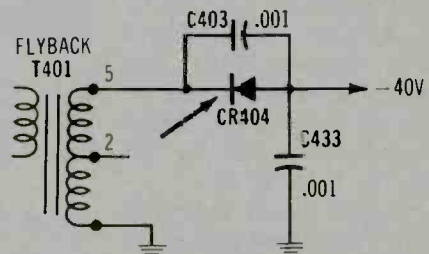

Symptom—No height
Cure—Check -40V supply, and replace CR404 if voltage is low or zero

people in the news

Martin H. Rubin has been promoted from director of industrial electronic services for RCA to division vice president, industrial electronic services. He has been with RCA for 32 years.

Shure Brothers has announced the appointment of **Robert J. Mataya** to market planning coordinator. Previously, Mataya was with C.G. Conn Ltd.

Ed Miller, president of Miller and Associates, has been elected to a newly created seat on the board of directors of the Electronic Industry Show Corporation. He will be involved in the planning of the 1981 Electronic Distribution Show scheduled for next May in Atlanta.

Margita E. White, an independent consultant and formerly a member of the FCC, has been elected to the board of directors of ITT.

The Antenna Specialists Co. has appointed **Charles E. Darrow** product marketing administrator. Prior to joining Antenna Specialists, he worked for Denton Radio.

J. Mitchell Kolesaire has been promoted from TV sales administrator to TV sales coordinator for Sharp Electronics.

Robert G. Doud has been promoted from supervisor of training to night industrial manager for ITT Cannon Electric. Doud replaces **Marvin V. Ussery** who has been named ITT Cannon area industrial relations manager.

Bernard A. Grae has been named director, industrial design for Radio Shack. He had been manager, industrial design since joining the company in 1974.

Steven T. Klein has been promoted to regional sales manager, central region at Klein Tools. Previously, he was marketing research manager.

Also at Klein Tools, **James A. Mallek** has been promoted from customer service manager to marketing services manager.



Check your IC's with a Kurz-Kasch pocket oscilloscope!

Our logic probes can check most IC functions that you may be testing now with an oscilloscope or other complex test equipment. And at a fraction of their cost. Bright logic-state LED's tell you at a glance where any input or output is — *logic 0* or *logic 1*. You can even evaluate duty cycle. And there's more. With the *Pulse* LED, you can catch pulses down to 10 nanoseconds, and you can even store a single pulse indication. We also offer the perfect probe complement. Place our Universal Pulser on any node, inject a single pulse or pulse train, then use a probe for circuit evaluation.

Special Introductory Offer

For a 10% discount, clip and attach coupon to check or purchase order. Discount prices shown are good until Dec. 31, 1980. Ohio State tax (5%) is applicable to Ohio residents/companies. Mail order to Kurz-Kasch, Inc., 2271 Arbor Blvd., Dayton, OH 45439, 513/299-0990. Be sure to check Model No. and indicate quantity on line.

- LP-710 - DTL/TTL (\$60.50) _____
- LP-750 - DTL/TTL/CMOS (\$78.50) _____
- LP-770 - DTL/TTL/CMOS/HTL (\$87.50) _____
- LP-450 - DTL/TTL/CMOS (\$56.00) _____
- HL-480 - Universal Pulser (\$56.00) _____
- Send free Probe Brochure _____

700 Series Probes, full 100-MHz operation. LP-450 Probe, full 50-MHz operation. HL-480 Pulser compatible with any probe.

Name/Title _____ Company _____
Address _____
City/State/Zip _____ Phone _____



Kurz-Kasch, Inc.

Circle (4) on Reply Card

Reports from the test lab

Each report about an item of electronic test equipment is based on examination and operation of the device in the **ELECTRONIC SERVICING** laboratory. Personal observations about the performance, and details of new and useful features are spotlighted along with tips about using the equipment for best results.

By Carl Babcoke, CET

Sencore model PR-57 AC Powerite (Figure 1) has four separate ac-power functions. First, it includes an isolation transformer. When a hot-chassis television receiver is operated from an isolated winding of a line-voltage transformer, test equipment having grounded three-prong ac plugs can be connected to the TV without danger to receiver or equipment. Without an isolation transformer, both test equipment and receiver can be damaged by certain connections that might result in unexpected shocks. The PR-57 has only one three-prong output socket. This prevents accidental defeat of the safety feature that would occur if one item of test equipment was plugged into the isolated socket (along with a hot-chassis television) and then another



Figure 1 Sencore AC Powerite model PR-57 performs four functions for ac line power. It is a variable-voltage isolation transformer with meter read-outs of voltage, current and wattage, plus a convenient and accurate safety leakage test.

line-operated meter or scope was plugged into a grounded wall outlet.

It also incorporates a separate variable-voltage transformer that provides stepless adjustment of output voltage from 0 to 140Vac RMS when the input line voltage is 120Vac RMS.

A panel-mounted analog meter has calibrations for ac voltage up to 150V (which can be switched either to incoming line voltage or isolated output voltage), two ampere current ranges, two wattage ranges, and a μA range for leakage tests.

For ac leakage tests, the PR-57 has a special probe, pushbutton switch positions and meter calibrations for performing accurate measurements.

A toggle switch on the front panel acts as the on/off switch, and is a 4A circuit breaker to protect the input power. A 4A slow-blow fuse on the rear panel protects the instrument against overloads of the isolated output power. When no load is connected to the output socket, the instrument draws an idling current of about 0.4A from the input line power.

Six pushbuttons provide a selection of these meter ranges: incoming line voltage (0-150V range); isolated output voltage at the single ac socket (0-150V range); output current to 1.5A or wattage to 175W; output current to 4A or wattage to 470W (dual calibrations for the same range); leakage current to $800\mu\text{A}$ at the low side of output voltage; leakage current to

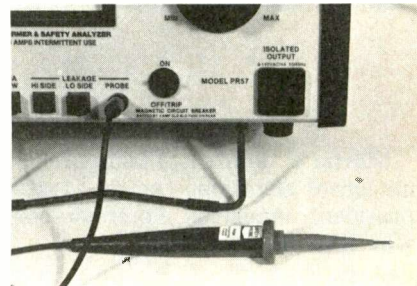

Figure 2 Two leakage pushbuttons, a probe jack, a special test lead with probe and switch and a single three-prong ac outlet are used for the current-leakage test. Current in μA is read from the meter.

$800\mu\text{A}$ at the high side of output voltage. Four LEDs indicate the range in use. The only other controls are a large knob for the output-voltage adjustment, and the on/off-trip switch.

Leakage tests

Generally, leakage tests are performed to measure the amount of leakage between the ac-line power and any metal parts (such as knobs, shafts, cabinet, antenna terminals) exposed on the outside of consumer electronic equipment. The leakage current is a measure of the shock hazard to consumers.

Leakage tests are easy to do with the PR-57. Here are the steps:

- With the PR-57 plugged into rated voltage, push the output-voltage button and adjust the *ac-volts* knob for 117V.
- Insert the power plug of the unit being tested into the three-prong *isolated-output* socket on the front panel (the test will not work if it is plugged into any other source of ac power). After the device is warmed up properly, readjust the output voltage to 117Vac.
- Plug the banana plug of the leakage-probe lead into the probe jack (Figure 2). Press in the *hi-side* button and touch the probe tip to all exposed metal parts of the equipment that's under test. If *any* reading is obtained, press the probe button and read it again. The *safety-probe* button shorts across a limiting resistor to provide an accurate reading. Write down the current reading for later reference.

SAFETY CERTIFIED

All exposed metal has been tested with a Sencore PR57 Safety Analyzer and found to have leakage below the level considered safe by Underwriter Laboratories for this type of chassis.

Max. Allowable Leakage _____ uA

Max. Measured _____ uA

Test Date _____

Tested By _____

Serial # _____

Form 66K254

Figure 3 Two banners, one ad slick, and one roll of 100 safety labels (as shown) are packed with each PR-57. These aids help educate the public to the value of safety leakage tests, and can be used as business builders. *Courtesy of Sencore.*

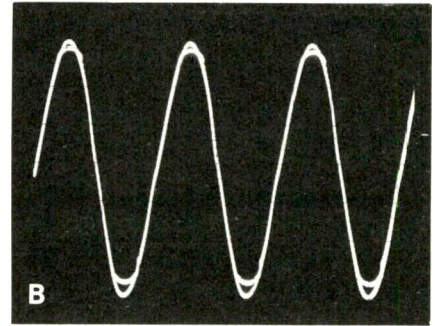
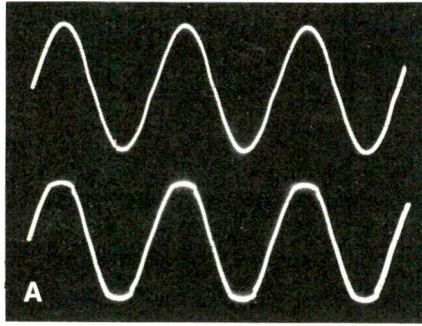

Figure 4 Operation of an RCA CTC99 from a Sencore PR-57 produced these waveforms. (A) Top trace shows the TV power voltage before the switch was turned on. The bottom trace shows the soft clipping of all peaks from the pulses of current. Scope adjustments (except centering) were not changed between photographs. (B) Both waveforms by camera double exposure prove the distortion and loss of amplitude occur only at the tips. This can result in lower B+ voltages in the TV, unless the line voltage is readjusted.

● Press in the *lo-side* pushbutton and repeat the test, writing down any readings obtained.

Current readings must be evaluated to determine whether they are

safe or dangerous. The Sencore manual gives approximate limits.

Selling safety tests

Sencore supplies with each

Powerite several items of support material for selling safety tests using the PR-57, including a roll of 100 labels (Figure 3) that can be attached to the tested device.

People
of all ages die of
heart disease
and stroke.

Put your money where
your Heart is.



American
Heart
Association
WE'RE FIGHTING FOR YOUR LIFE

32 job-matched specialty pliers for electronics workers. They feel right. They work right. Klein tools for professionals. You can buy them from authorized Klein distributors in your area... at competitive prices.

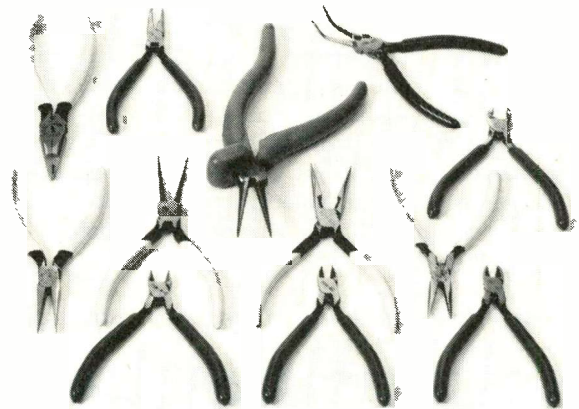

6-238

KLEIN
Hand me the Kleins
...since 1857.



Send
for
Catalog



Klein Tools, Inc. 7200 McCormick, Chicago, Ill. 60645

Circle (5) on Reply Card

Test lab

Sencore recommends making a charge for these safety tests.

Accuracy ratings

Accuracy of the 150Vac range for input and output voltages is rated at $\pm 3\%$ of full scale. All other current and wattage ranges also are rated at $\pm 3\%$ of full scale. Wattage readings are obtained by multiplication of voltage times current, and are accurate only at 117V.

Waveform distortion

Every isolation transformer tested so far in the **Electronic Servicing** laboratory has exhibited rounded sinewave peaks at the secondary winding when the sole load was a modern solid-state TV receiver. Evidently, this is a general condition, and is not a complaint against the Powerite, which also has rounded peaks (Figure 4).

Each new TV receiver has a bridge rectifier that draws current from the power line only at the positive and negative tips of the sinewaves. There is no other load on the ac-power source; maximum current flows during these short time periods, and zero current flows between the current pulses.

Because these current pulses must be averaged to obtain actual power, the ratio of peak to average current is unfavorable. For example, if the receiver requires 120W and the current flows for 25% of the time, each conduction must supply 4A, and not 1A as required for continuous current. This large peak current produces a voltage loss in the isolation transformer windings solely during the

tips of positive and negative peaks. There is no voltage drop at other times. The result is soft clipping (rounding) of all sinewave tips.

Minor power-line distortion from pulsed current would present no problems with resistive loads (such as tube heaters). They operate from the waveform's RMS value, so distortion is not important. Increasing the voltage to provide the correct RMS value would be sufficient.

Unfortunately, peak-reading diode/capacitance rectifier systems produce output voltages in direct proportion to the peak-to-peak line voltage. Of course, rounding the peaks reduces the peak-to-peak amplitude along with the dc voltage from any line-operated power supply.

Tests were conducted on an RCA CTC99 (which drew 105W, according to the PR-57) with scope and a Sencore model DVM-56, chosen because it has very accurate peak-to-peak, average and true-RMS ac measurements. Bridge rectifier (hot supply nonregulated) dc voltages in the television were measured with rounded and nonrounded power waveforms. Table 1 lists some of these measurements.

The PR-57 line-voltage meter reads the so-called average value; meter calibrations are adjusted for sine waves. Most readings will be about the same as RMS unless the waveforms are badly distorted. Therefore, slight clipping of peaks will affect the voltage readings in receivers more than it affects the PR-57 meter reading.

Calibration of the sample PR-57 line-voltage function measured about -4% at the 117V mark on the meter. (Model DVM-56 and other

digital meters read almost 122V when the PR-57 read 117V.) However, it seems likely that Sencore has deliberately provided low readings here to compensate for the drop of receiver dc voltages from the rounded sinewaves. In Table 1, notice that a PR-57 meter reading of 117V gave nearly the same receiver B+ as was obtained by a pure sinewave line power of 120.3V (measured by a DMM).

According to these findings, use of the PR-57 at the Sencore-recommended meter reading of 117V should provide correct B+ voltages for solid-state TV receivers. For those few applications requiring higher accuracy, an external DMM can be used. Keep in mind that *both* voltage and waveform affect the amount of rectified dc voltage. True-RMS readings are best for loads that draw current over the whole cycle; peak-to-peak readings are more accurate for measuring the input voltage of power supplies.

Comments

The concept of a line-voltage meter that can monitor either incoming or outgoing isolated 60Hz power is excellent, and the Sencore PR-57 performs these functions well. A large ac-voltage adjustment knob allows precise selection of desired voltages. It rotates easily and retains the setting. (Of course, line voltage varies constantly. This must be expected.)

Troubleshooting can be done faster, in many cases, by the ability to provide known (metered) high or low line voltages. Higher-than-normal line voltages help find heat-related failures and cases of borderline overload. Low line voltages in the 35V to 70V range are necessary to prevent destruction of solid-state devices (such as horizontal-output transistors) during tests for overloads that at full power would instantly ruin expensive components.

Ventilation louvers in the top and bottom of the case allow cool operation, and the unit's weight is sufficient to prevent it from sliding when a selector button is pushed.

Because the safety leakage test is simple, it is hoped that technicians will perform more such tests. □

Table 1 These are a few of the comparative tests with unclipped line voltage vs. clipped line voltage.

	PR-57 Meter	DVM-56 True RMS	DVM-56 P-To-P	CTC99 DC Supply
Sinewave ac	115V	120.3V	337V	+156.2V
Clipped ac	115V	120.3V	326V	+152.8V
Clipped ac	117V	121.8V	330V	+155.2V

The basic design of logic probes

By James W. Sneed, Jr., director, R & D, Kurz-Kasch, Dayton, OH.

Logic probes, relatively recent to the instrumentation field, provide a powerful test tool and an inexpensive alternative to using a traditional oscilloscope. The author, holder of the patent for the dual-threshold logic probe, reviews his company's continued attention to logic probe development and reviews historical developments in this field.

The *ultimate* instrument for digital testing is a wide-band scope. The scope should have a bandwidth of at least four times the highest frequency involved.

Scopes have the ability to show graphically the signals needed to be observed, often a primary requirement in test equipment. The displays of any piece of test equipment must be able to translate for the "mind's eye" just what is occurring at the test point.

Scopes are the best for this but aren't used exclusively because of portability, cost, inability to analyze and speed with which multiple observations must be made.

Logic probes were invented to overcome these four disadvantages of the scope. The probe won't do all the scope will do. However, if the probe will do the necessary test indications for digital servicing, it is an acceptable substitution.

The Kurz-Kasch logic probe, for example, is designed to approach the scope in display. Needed parameters are displayed on the Kurz-Kasch probe: low, highs, deadband, pulses (logic state transitions), pulse repetition rate and duty cycle.

In the Kurz-Kasch probe, these display parameters are achieved by three independent lights; One is for each basic parameter, low state, high state and transitions. There is no sharing of display functions.

A major consideration in any test equipment is that its display be consistent. For example, in a DVOM, the display digits should read left to right and for volts, ohms and current. The K-K probe is consistent this way in its presen-

tation. For example, the "O" LED displays all parameters of the low state, valid low, relative dwell time and off. The same is true for the "1" LED (high) and logic transition (pulse) LED.

Kurz-Kasch, as a matter of determining its competitive position, regularly evaluates these parameters:

- Clarity and readability of its indicators;
- Consistency of display;
- Speed capability—the true capture speed of a probe is determined by the *one shot mode*. This is a single pulse, both positive and negative going, of a width specified: 5ns, 10ns, etc; The speed of any probe is determined by its components. CMOS devices usually are in the 50-400ns speed range. Kurz-Kasch uses devices capable of consistent 5ns speeds;

d. Duty cycle—must show duty cycle from at least 10:1 over its operating range, DC to capture speed (usually 10ns); and

e. Construction and repairability. Continued attention to quality in components, materials, workmanship and circuitry provides users with logic probes to best serve their needs.

This probe incorporates the exclusive *dual threshold pulse circuit*, giving technicians an added dimension in troubleshooting.

A small button at the forward end of the label, in the *up* position, allows the probe to operate as a *single threshold* probe (just like previous ones). When the button is depressed, the system becomes a *dual-threshold* probe.

The following figures explain the operation of this feature.

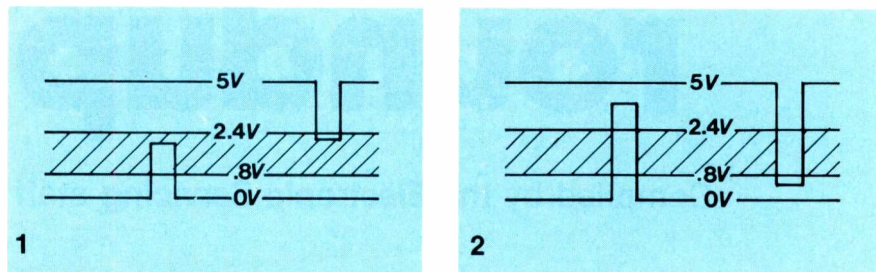

Figure 1. Earlier probes illuminate the pulse lamp if either threshold (0.8V or 2.4V) is crossed.

Figure 2. In this advanced probe, both thresholds must be crossed to cause the pulse lamp to illuminate. The obvious benefit is that the pulse must be of a *valid* logic level for the pulse lamp to illuminate.

The *dual threshold model* has another benefit: the transition across both thresholds must be accomplished within 35ns. A rise or fall time out of spec will be indicated by a lack of pulse light in the *dual threshold mode*. When there are "0" and "1" (white and red) lights and no pulse, the transition time is greater than 35ns.

Probe design

Historical notes in logic probe development

The original logic probe patent No. 3,525,939 was issued to R. L. Cartmell on August 25, 1970, and assigned to Kurz-Kasch, Inc. A new dual threshold logic probe patent No. 4,110,687 was issued to J. W. Sneed, Jr., on August 29, 1978. The notes below recapture these patents.

Dual Threshold Logic Probe

Inventor: James W. Sneed, Jr. c/o
Kurz-Kasch, Inc.,
Dayton, OH 45401

Filed: Aug. 24, 1977

ABSTRACT

A logic probe includes a first lamp for indicating an input voltage level above a first predetermined magnitude or upper threshold, a second lamp for indicating an input voltage below a second predetermined magnitude or lower threshold, and a pulse lamp for indicating the change in the input voltage level. Circuit means are provided to control the operation of the third or pulse lamp so that the lamp operates in accordance with the position of a selector switch. When the switch is in a first position, the pulse lamp will operate in response to a change in the input voltage level through either one of the thresholds, and when the switch is in the second position, the pulse lamp will operate only if the input voltage level transitions both thresholds within a predetermined time.

Aug. 25, 1970 R. L. CARTMELL 3,525,939
HAND HELD INSTRUMENT HAVING A PAIR OF INDICATOR LAMPS FOR
INDICATING VOLTAGE LEVELS IN ELECTRICAL CIRCUITS
Filed Aug. 1, 1968

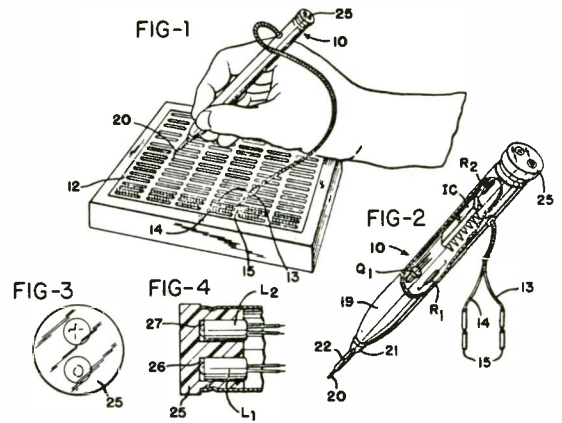

Industrial MRO

Digital probe roundup

Compiled by the **Electronic Servicing** staff

To obtain additional information and specification sheets for the digital probes featured in this roundup, circle the appropriate number on the Reader Service Information Card.

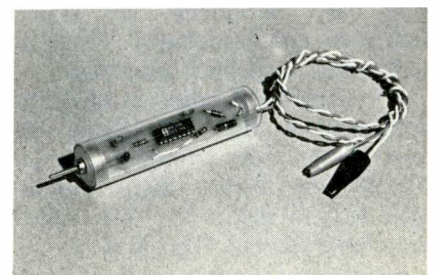

ADVA Electronics

Model LP-10 logic probe features multi-family compatibility (RTL, DTL, TTL, HTL, NiNLL and CMOS), high-input impedance (20M Ω), LED *logic 0* and *logic 1* indicators, and reverse polarity and over-voltage protection. Operating voltage range is 3V to 15V.

The LP-10 is available in kit form at \$9.95. The assembled version is \$14.95.

Circle (15) on Reply Card



Alcolite

Model 3100A logic probe performs as a level detector, pulse detector, pulse stretcher and memory probe. The unit gives instant positive indication of circuit conditions, and captures one-shot and low-rep-rate pulses. LEDs indicate *logic 1* and *logic 0* and all pulse transitions. Optional accessories include ground lead.

Circle (16) on Reply Card

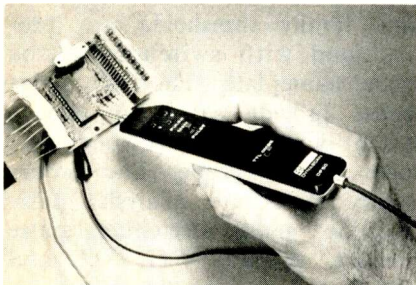

B&K-Precision

Model DP-50 digital probe is multi-family compatible with TTL, DTL, RTL, HTL, CMOS, MOS and HiNIL. The unit displays dc to 50MHz, pulse presence and logic states. Features include memory and pulse modes, 2M Ω impedance, and input overload protection.

Circle (17) on Reply Card

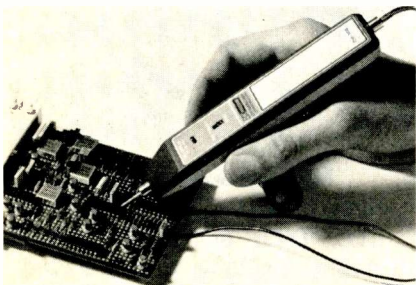

Model DP-100 digital pulse probe can be used alone, or in conjunction with a logic probe or scope. The DP-100 generates a one-shot in the single pulse mode or a continuous pulse train in the 5Hz output mode. It automatically senses logic state and changes state to its complement. The unit features overload protection and is compatible with TTL, MOS, CMOS and HiNIL logic circuits.

The price of the CP-100 is \$95.

Circle (18) on Reply Card

E&L Instruments

Model LT-2 dual-state logic probe features two LEDs to indicate logic states. A switchable *pulse stretch* mode captures pulses as narrow as 50ns. The LT-2 obtains 5Vdc for operation through attached clip leads. Two probe tips are supplied.

Circle (19) on Reply Card

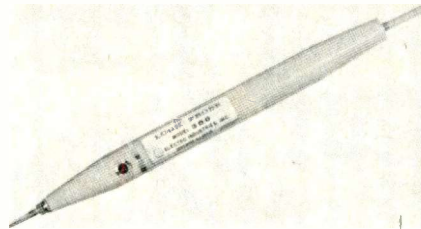

Electro Industries

Model 300 logic probe offers 12MHz frequency response, high-input impedance and polarity reversal protection. Measurement capabilities extend to TTL, and DTL systems, flip-flops, counters and decoders.

Circle (20) on Reply Card

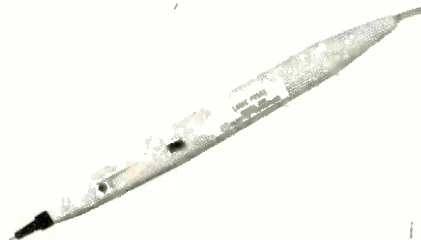

Model 330 logic probe displays logic states by red and green LED indicators. A switch-selected pulse stretch (storage) mode allows pulses as narrow as 50ns and high speed pulse trains up to 12MHz to be observed. Other features include high-input impedance, and overload

and reverse polarity protection. Two screw-on probe tips and carrying case are supplied with the unit.

Circle (21) on Reply Card



Model 340 logic pulser/probe features two modes of operation: when switched to the *on* mode, it operates as a single-shot pulser and can change logic states by injecting pulses into the circuit under test. In the *off* position the unit will detect short pulses and logic high states employing green and red LEDs as readouts. The power supply unit, pulse output and probe are protected against overvoltage, including power lead reversal.

Circle (22) on Reply Card

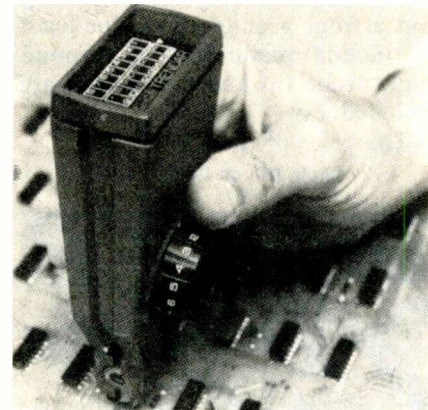

Fluke

The *200 Series* IC testclip multiple-use logic testers combine the functions of three instruments: logic probe, logic states clip and in-circuit IC comparator. Thresholds are detected automatically, and power is derived from the unit under test. DTL, TTL, CMOS and HTL compatible versions are available.

Circle (23) on Reply Card

Global Specialties

Model LP-1 logic probe combines the functions of a level detector, pulse detector, pulse stretcher and pulse memory. The unit features dual-threshold window comparators, bipolar edge detection, pulse

stretcher, front ground connector lead and switch-selected pulse memory. Instruction manual, probe tip and power cable are included.

The LP-1 is available for \$50.

Circle (24) on Reply Card

Model LP-2 identifies valid and invalid logic states, detects and stretches pulses, and permits approximation of pulse duty cycle when observing pulse trains. The unit features a front ground connector lead. Instruction manual, probe tip and power cable are included.

The price of the LP-2 is \$28.

Circle (25) on Reply Card

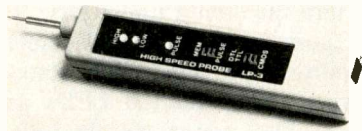

Model LP-3 logic probe is capable of capturing pulses as narrow as 6ns (typical, 100% tested at 10ns) or pulse trains to more than 70MHz. The LP-3 features pulse memory and a front ground connector lead. Instruction manual, front ground lead, probe tip and power lead are included.

The price of the LP-3 is \$77.

Circle (26) on Reply Card

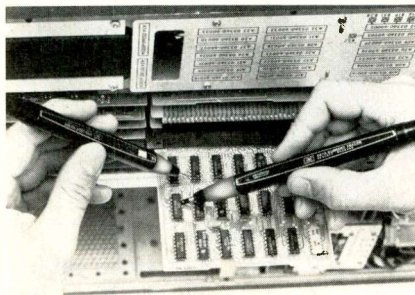

Hewlett-Packard

Model 547A current tracer senses logic current pulses as small as 1mA, up to 5mm from the conductor. The tracer operates on all logic families having current pulses from 1mA to 1A with repetition rates up to 10MHz. Self-contained in a hand-held probe, the 547A operates from 4.5 to 18Vdc; current required is less than 75mA. The indicator lamp will display single-step current transitions, single pulses greater than 50 ns wide and pulse trains to 10MHz. Current transitions with risetimes less than 200ns at 1mA are displayed.

The 547A's price is \$350.

Circle (27) on Reply Card

Model 546A logic pulser electrically stimulates integrated circuits of most positive-voltage logic families (TTL, DTL, RTL, HTL and CMOS). The unit will drive high nodes low, or low nodes high over a wide range of supply voltages. Six output pattern choices are featured that provide a single pulse, a 100Hz continuous pulse stream, 100-pulse bursts, a 10Hz continuous pulse stream, 10-pulse bursts, or a 1Hz continuous pulse stream.

Operating voltage for TTL families is $5 \pm 10\%$ Vdc and for CMOS is 3 to 18Vdc. Operating current is less than 35mA. Time base accuracy is $\pm 10\%$.

The 546A's price is \$150.

Circle (28) on Reply Card



Heath

IT-7410/ST-7410 logic probes are designed for in-circuit testing of TTL and CMOS integrated circuits. Features include switch selection of threshold levels for either TTL or CMOS circuitry and lamps that turn on when the input voltage crosses the appropriate level. A memory circuit is incorporated in the design of the unit to turn on an LED when either threshold level is crossed. Both probes provide true logic level detection at high frequencies (not ac-coupled) and will detect pulses as short as 10ns. Upper frequency limits are 100MHz and 80MHz. Power is drawn from the circuit under test. A ground lead is provided. Overload protection is 50Vdc continuous and 175Vdc for 5-seconds. The IT-7410 is the kit version and the ST-7410 is assembled.

The prices are \$39.95 for the kit and \$64.95 assembled.

Circle (29) on Reply Card

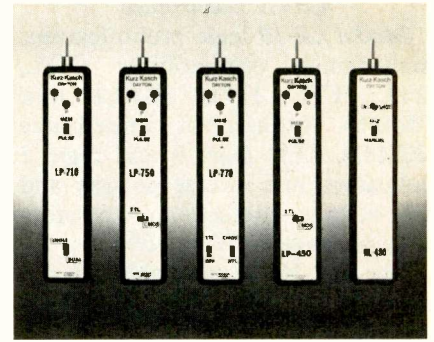

Kurz-Kasch

700 Series logic probes and **model LP-450** logic probe and the **HL-480** universal pulser have *logic 1* and *logic 0* LEDs for logic state indication and a *Pulse* LED for detecting pulse trains. The *Pulse* LED operates from a 50ms pulse-stretching circuit for clear indication of single pulses down to 10ns pulse width. A *Memory* switch allows storage of single pulse events. Operating frequency of the probes is to 100MHz. Tip and power leads have high-voltage protection with auto shutdown. The LP-750 is designed to check multiple logic families. It can be used to test TTL/DTL and CMOS families. The LP-770 can also test HTL families. The probes derive power from the circuit under test, and logic family thresholds are programmed with switches on the probe nameplate. The 700 series probes provide a special plug-in assembly that can connect two nodes to the probe. The probes feature logic-state analysis, pulse detection, pulse stretching, pulse memory, versatile TTL/DTL and CMOS testing and frequency response to 50MHz.

The 700 Series Probes are priced from \$65 to \$95. The LP-450 is priced at \$60.

Circle (30) on Reply Card

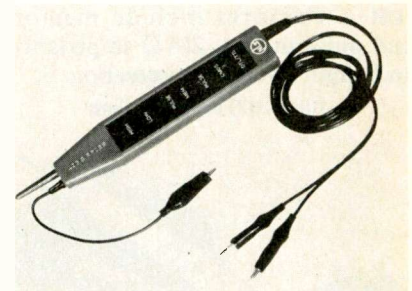

Non Linear Systems

Model MLB-1 digital logic probe is TTL, DTL or CMOS switch-selectable. Available modes include *pulse* and *memory*. The unit fea-

tures high and low LED state indicators and a flashing pulse indicator. The high and low indicators provide analytical indications in the dynamic testing of pulse trains and rectangular waveforms up to 10MHz. Minimum pulse width is 50ns.

The MLB-1 can be powered from the supply of the circuit under test, or from an external supply. Threshold voltages for each kind of logic are the go/no-go comparison limits for high and low states.

The Model MLB-1 is priced at \$41.95.

Circle (31) on Reply Card

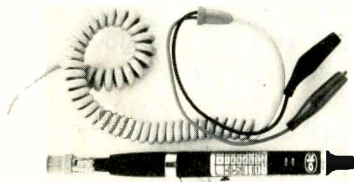

O.K. Machine and Tool

Model PRB-1 digital logic probe detects pulses as short as 10ns, has frequency response to better than 50MHz and automatic pulse stretching to 50ns (+ and -). The unit is compatible with RTL, DTL, HTL, TTL, MOS, CMOS and microprocessor logic families. It also features 120K Ω impedance, power lead reversal protection and overvoltage protection to 200V (+-V). Optional PA-1 adapter for use with supply voltages 15-25V. Includes 6-foot coiled power cord and tip protector. Troubleshooting instruction booklet and case are included.

The PRB-1 is priced at \$36.95.

Circle (32) on Reply Card

Model PLS-1 logic pulser is a multi-mode, high current pulse generator packaged in a hand-held shirt pocket portable instrument. It can source or sink sufficient current to force saturated output transistors in digital circuits into the opposite logic state. Signal injection is by means of a pushbutton switch near the probe tip. When the button is depressed, a single high-going or low-going pulse of 2 μ sec wide is delivered to the circuit node under

test. Pulse polarity is automatic. Holding the button down delivers a series of pulses at 20pps to the circuit under test.

PLS-1 is suited for use in conjunction with the PRB-1 probe and costs \$48.95.

Circle (33) on Reply Card

Sansei

Model 3300A logic probe is designed to detect and display digital logic levels of DTL/TTL, CMOS and other popular logic circuits. It provides a 1M Ω impedance, and is capable of making precise measurements without affecting circuits under test. To minimize reading errors in level detections, two LEDs are used. The unit operates at 5Vdc to 18Vdc and is protected against reverse power supply and input over voltage.

Circle (34) on Reply Card



Tektronix

Model P6401 logic probe indicates the state of logic levels in TTL, DTL or any other system with threshold between 0.7V and 2.15V. A strobe input can be used to detect the coincidence of logic signals at two points. A store mode provides an indication of whether or not a logic pulse has occurred. Power may be obtained from the unit under test or any 5V supply. The P6401 includes hook tip, two strobe leads, probe tip to 1/4-inch in square pin adapter, white plug, two alligator clips and accessory pouch.

The price of the P6401 is \$105.

Circle (35) on Reply Card

Wandel & Goltermann

Model TKL-515 digital probe permits determination of logic states in the TTL, CMOS and other related logic families. The high and low levels are displayed, but the thresholds needed for particular applications can also be individually adjusted. The unit also features a memory. The TKL-515 is protected against false polarity and overvoltage.

Circle (36) on Reply Card

APPLIANCE REPAIR BOOKS



Thirteen Handbooks written in easy-to-understand language by experts in the service field with illustrations and diagrams! Acclaimed by instructors and professionals alike! How to diagnose and repair air conditioners, refrigerators, washers, dryers, ranges, microwave ovens, dishwashers, vacuum cleaners, electrostatic air cleaners, RV gas appliances, hair dryers, motors, water heaters, coffeemakers, can openers, floor polishers, steam irons, food mixers, lawn care appliances, electric knives, electric and digital clocks and many others. Also fundamentals of solid state, setting up a shop, using test instruments and more Only \$2.65 to \$4.90 ea.

SEND FOR FREE PRICE LIST

Gamit, Dept. ES

110 W. St. Charles Road,
Lombard, Illinois 60148

Circle (6) on Reply Card

NATIONAL ELECTRONICS SERVICE DEALERS

Are you standing idly by while ideas that can be money in your pocket fly away?

Membership in NESDA is one of those ideas.



WHAT DO YOU GET FROM NESDA?

1. Insurance
2. Special Bancard Rates
3. ServiceShop Magazine
4. Electronic Service Industry Yearbook
5. Service Industry Information
6. Legislative Programs with State and National Government
7. Advocate for Better Warranty Practices
8. Business Information



Don't let your bucks get lost in the shuffle.

Send in your check today.

On the bottom line it will mean extra \$\$\$ in your pocket.

JOIN NESDA

And Your State Association
Send for more information:
NESDA, 2708 W. Berry St.
Fort Worth, TX 76109



Circle (7) on Reply Card

Troubleshooting digital equipment

Types of integrated-circuit defects and methods of testing for them are discussed.

By John E. Cunningham
J. E. Cunningham Associates

Important changes in troubleshooting methodology are necessary for any technician who was experienced with analog circuitry but now is beginning to repair troubles in digital equipment. First of all, the signals are different.

Analog signals change amplitude during each cycle. Analog ac signals often ride on dc voltage. But *digital signals are pure dc voltage*. A simple digital signal can be a positive voltage that is almost as high as the supply voltage (logic high), or it might be almost zero volts (logic low). Even digital pulses are merely slices of dc voltage with zero as reference. Digital signals might change state (high to low, or low to high) only once in several minutes (dc control voltages) or continuously at nanosecond rate when in a digital computer.

Another important difference between analog and digital involves the phase (arrival time) of two signals. Few analog signals require a phase comparison. Certain digital gates require the input signals to arrive at precisely the same time. If one gate signal arrives too soon or

too late, a false glitch signal is produced, or both signals might be ignored.

A digital-logic technician must know the characteristics of digital signals and how to analyze them, just as an analog-circuit technician is required to understand analog signals and how to test for them.

Be prepared

An industrial technician assigned to a specific item of control equipment should study the machine's functions and know how these are accomplished in the equipment. Each new piece of equipment should be examined thoroughly *before* it requires any adjustments or repairs. The service manual should be available at all times.

If the digital circuitry is part of a color-TV receiver, the technician should attend the manufacturer's seminars or study the workshop manuals until the general operation of the circuit is familiar.

Preparation can be of great value later when the machine or circuit needs troubleshooting.

Sensory preliminary tests

All troubleshooting sessions should begin with an evaluation of

any component that is overheating, a sniff test for burned odors and a thorough visual examination of all plugs, circuit boards, wiring and components.

IC general failures

Integrated circuits are black boxes with internal solid-state circuits whose type and operation are unknown to the technician. The only contact with the outside electronic world is through the IC pins. Correct signals must enter the IC case through some pins for the desired signals to exit the output pins.

Of course, ICs cannot operate without at least one power-supply dc voltage and a ground. Seldom are these supply voltages printed on a digital schematic. A manual that lists the power-supply pins and requirements of these ICs is necessary. An IC without dc power probably will ignore all input signals.

Some of the basic IC failures are these: open pins, pins shorted to ground, pins shorted to dc supply voltage, pins shorted together and pins with intermittent defects.

Open pins

A transistor-transistor-logic (TTL) gate is shown in Figure 1. Before the output (L) can change to a high state, both inputs must be driven high. A low at either input produces a low output. This is a simple AND gate.

If input A has an internal open between pin and gate, as shown, the effect at the output is the same as a permanent high at input A. Notice that this condition cannot be tested at the pin of input A. The usual highs and lows can be delivered there. Therefore, a dc-voltage test with meter or logic probe cannot test for an open input directly.

One solution is to deliver known logic highs and lows to the inputs while monitoring the output state (Figure 2). When the type of gate is known, a truth table can identify the defect.

Figure 3A shows the correct truth table for a NAND gate. The only inputs that produce a low output are two high inputs. All other

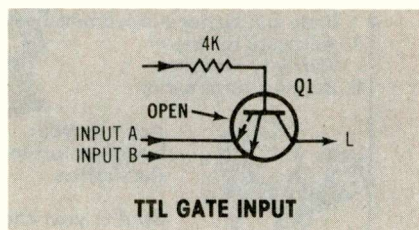

Figure 1 This double-emitter transistor is the input of a logic gate, but by itself it functions as a low-power TTL AND gate. Both inputs must be high to produce a high output; either input low produces a low output. Therefore, an internal open between the A-input pin and the emitter gives the *effect* of a permanent high at the A input.

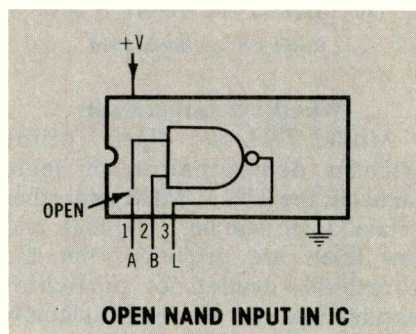

Figure 2 When the type of logic gate is known, it can be tested for opens and shorts by applying logic levels to the inputs while the output is monitored.

combinations produce a high output.

Apply the four possible input conditions in sequence and write down the truth table that results (Figure 3B). According to the four logic inputs, the second condition produces a false output. However, either input could be wrong at this point. Now the technician should use his "logic."

For a low input, this type of TTL gate requires a virtual short to ground at the proper input pin of a nondefective IC. For a high input, a high can be furnished externally, or the continuity between input and ground can be opened. During an open condition, the high is supplied internally by the IC.

According to the truth table in Figure 3B, the correct low output was obtained by the fourth test condition with both inputs high. Therefore, one input must have a permanent high. Unfortunately, the bad input is not yet known.

Next, checking the third condition with the high-low inputs for a high output, it is clear that the B-input low must be correct. Otherwise, an input-B actual internal high would have supplied two high inputs that produce a low output (not the case).

The second truth-table condition falsely has a low output, which requires two high inputs. Input B has a high from the external circuit; therefore, the A input internally must have a high from an open between the gate and the corresponding pin.

Of course, the first condition of the truth table (with two input lows) would have a high output regardless of which input had the false high.

All conditions of the truth table check perfectly when the defect is known to be a permanent high internally at input A (but not at the IC pin).

The truth table in Figure 3B also reveals another important fact. Only one of the four combinations produces an incorrect output, although half of the inputs are defective. Therefore, a digital system using this defective IC could operate correctly most of the time. It might appear to be an intermittent condition.

Another important fact can be learned from analysis of a NOR gate with an internal open at the A input pin. Figure 4A shows a correct NOR truth table, and Figure 4B shows the inputs at the pins vs. the actual internal inputs and the resulting outputs. Notice that the defective IC NOR gate has

a low output for *all* input conditions.

An output high can be obtained from a nondefective NOR gate only by a low at *each* input. A high at either or both inputs produces a low output. A study of the truth table for the NOR with an open gate shows that the table cannot

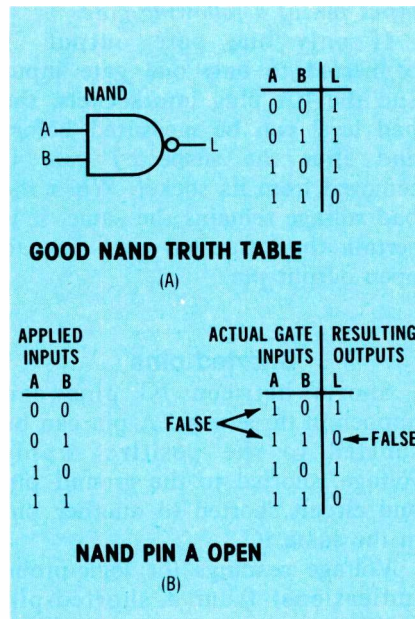

Figure 3 (A) This is the correct truth table for a nondefective NAND logic gate. (B) When there is an open at the A input pin, the truth table must be modified to show the *actual* gate inputs. The modified truth table can then be analyzed to find the defect. For TTL devices, an open input at the IC pin produces a high at the real logic input, regardless of the logic applied to the IC pin.

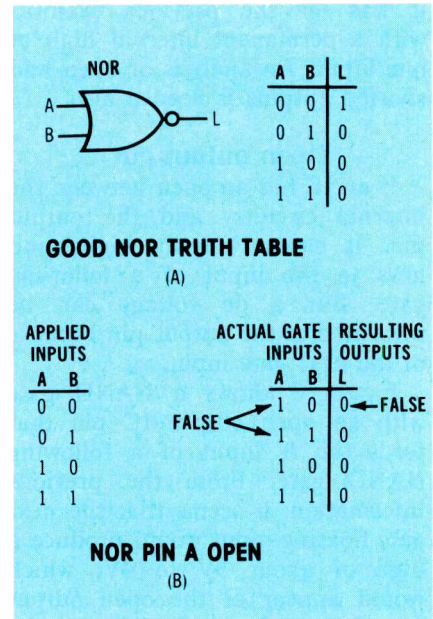

Figure 4 (A) A nondefective NOR logic gate produces a high output only when both inputs are low; all other conditions give a low output. (B) An open between the A input pin of the IC and the internal circuitry gives the effect of a constant high at the A input of the NOR gate. *None of the inputs can produce a high output.* Notice that the output level is low at all times, which is also true if the output is shorted to ground.

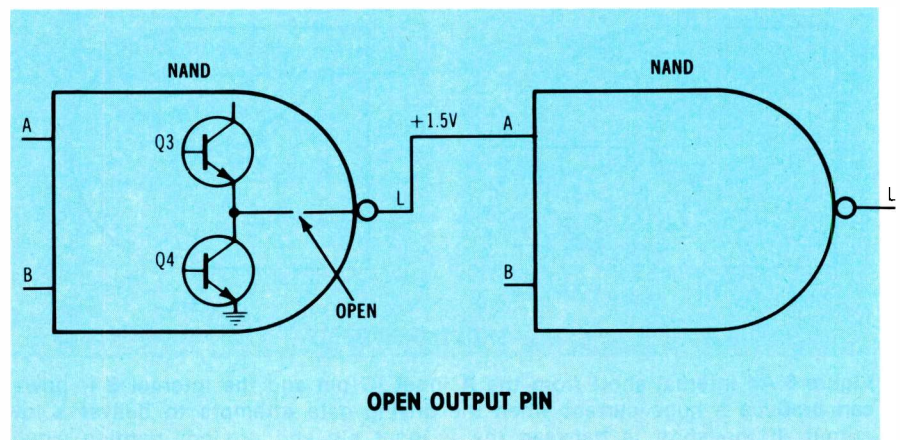

Figure 5 An open output pin in TTL logic can have a "bad" intermediate level that comes from the floating input of the *following* gate.

Troubleshooting digital

prove which input pin has the open. However, if the pin had a stuck low, it could be identified by an analysis of the truth table.

Perhaps the most important fact in Figure 4 is that the truth table of NOR inputs and outputs at the IC pins (not internally) is identical for an output pin shorted to ground as it was for the previous example with a permanent internal high at one input. An analysis of open and shorted outputs is needed also.

Open output pin

If an IC has an open between the internal circuitry and the output pin, it cannot supply highs and lows to the input of a following gate. But a dc voltage can be measured at the output pin because of the next gate input.

Figure 5 shows a NAND gate with an open output IC pin that feeds the A input of a following NAND gate. From the previous information, it seems that the next gate floating input would produce a high of about 3V to 4V, which would appear at the open output pin of the defective NAND. That is not true.

Here are two important facts about a TTL gate with an *input* that is *floating* (not connected to anything):

- The gate will function as though a high is applied to this floating input pin; and

- A TTL floating input will drift gradually from a higher voltage to a "bad level." Usually, this bad level is about +1.5V, which is higher than the +0.4V threshold for a genuine low and lower than the +2V minimum for a valid high.

Therefore, a voltmeter reading of about +1.5V at the output pin of a gate indicates this output is open, and *the voltage is coming from the input pin of a following gate.*

If only one gate output is connected to only one gate input and the ICs plug into sockets, the bad level can be measured before and after the suspected gate is removed from its socket. When the bad voltage remains the same, it is certain the suspected gate has an open output pin.

Shorted pins

Shorts between IC pins can happen in three ways: A pin can be shorted to the positive supply voltage, shorted to the ground pin and circuit shorted to another pin in the same IC.

Voltage readings (or logic-probe indications) from a shorted-pin problem are very different from those produced by an open pin. A shorted input pin changes the voltage and logic level at the preceding gate's output pin. Also, opens seldom cause any damage; shorts can ruin other ICs.

One example of damage from a pin-to-pin short is shown in Figure

6, where a following NAND has an internal short from the A-input pin to the supply voltage. When the first NAND develops a high output, the condition is correct because the short in the second gate places a permanent high at the affected input. The only symptom is the high that has a higher voltage.

A serious problem begins when the preceding NAND attempts to output a low. Q4 in the first NAND is saturation-biased into a virtual short circuit that conducts a huge current from the B+ power supply through the defective second NAND. Instantaneous and catastrophic failure of the driving gate usually results. Of course, the second gate was already bad.

When the A input pin of the second NAND is shorted to ground, the situation is similar but the effects are reversed. A low from the driving gate has no adverse effect, but when the output attempts to go high, Q3 is fully conducting to form a dead short between the first-gate B+ pin and ground. Q3 is ruined immediately.

Shorted output pins of gates might present different symptoms. A short at the pin usually ruins the output stage, exactly as though the next stage input was shorted. However, after the output stage fails, the output pin can have a permanent high or low.

It is difficult to predict the results of other pin-to-pin shorts. Sometimes the stage oscillates, and possibly damages the driving IC.

A short between two input pins of a three-input NAND is shown in

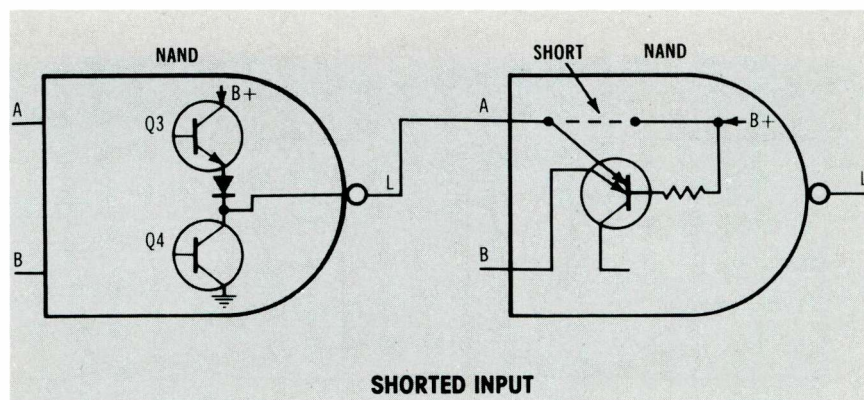

Figure 6 An internal short from the A input IC pin and the internal B+ power can produce a huge current when the driving gate attempts to deliver a low output. If the short is between the A input pin and ground, nothing would overload until the previous gate tries to deliver a high. Both defects usually ruin the driving gate.

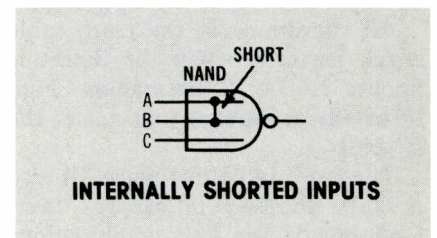

Figure 7 The result of an internal short that connects two input pins is difficult to forecast. Because each input comes from a different driving gate, a severe short occurs when the inputs attempt to receive opposite states.

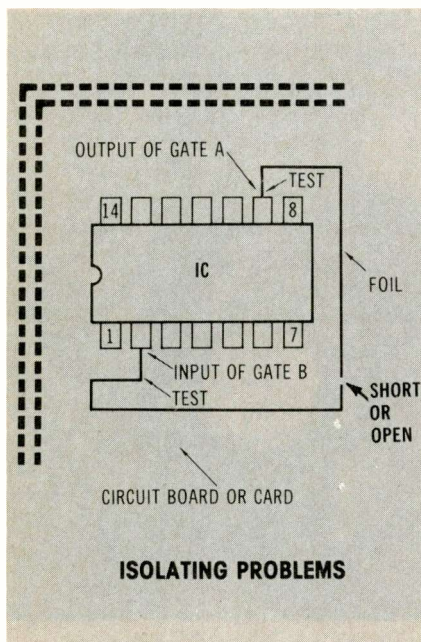

Figure 8 Circuit boards allow more accurate tests for opens and shorts than is possible with ICs, for which one end of each circuit is inaccessible. An open in the foil wire can be found by resistance tests or by comparing the logic-state voltages at each end.

Figure 7. Each input is connected to a different driver. As long as each input has the same state, there is no problem. But if one driver output goes high while the other is low, a destructive low-resistance short is placed between supply voltage and ground, resulting in damage of one or both gates.

Circuit problems

Most digital circuits are mounted on printed-circuit or wire-wrapped boards. Opens and shorts in the wiring often produce the same symptoms as do open or shorted IC pins. Sometimes board defects are easier to find because both sides of the defect are available for tests and are not hidden as in ICs.

Figure 8 illustrates an IC mounted on a circuit board. If the symptoms indicate gate B input is not correct (it is driven by gate A output), it can be tested by measuring the dc voltage at the A output and the B input pins. If the voltages are the same, the wiring between them is intact. But if the gate A output is correctly high or

low while the B input has a bad level, this is proof of an open in the circuit wiring between those points.

A strong light and magnifying glass are recommended for finding defective sections of the board wiring. Bad soldering joints, hair-line cracks across a "printed" wire, or solder that bridges one foil to another are some of the possible board defects.

Comments

Remember that these suggestions for testing digital circuits are for the TTL family of digital-logic devices. CMOS devices require different ground rules.

The troubleshooting methods described here are most appropriate for consumer or industrial circuits that have ICs with known gates inside. Computers should be tested by first running routines designed to identify the area of the defect. Sometimes hundreds or thousands of gates use the same input and output lines. Therefore, testing for individual shorted or stuck gates is not very practical in a computer. □

**Electronic Servicing.
is Available in
MICROFORM**

FOR INFORMATION
WRITE:

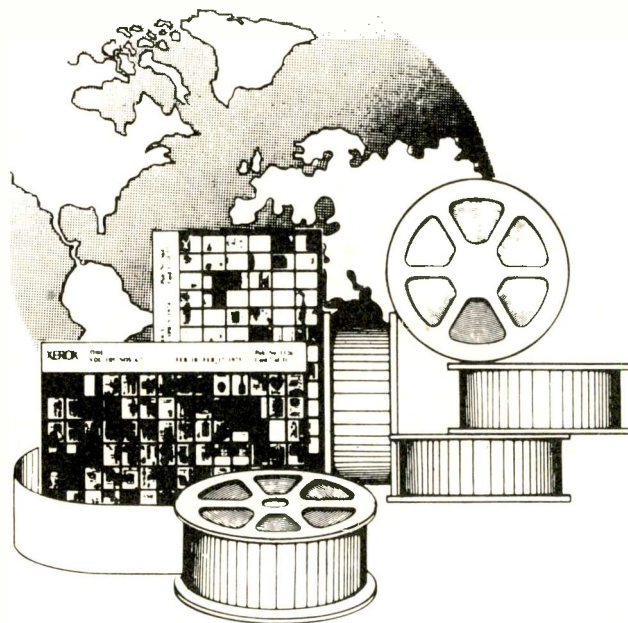

University Microfilms International

300 North Zeeb Road
Ann Arbor, Mich. 48106
U.S.A.

18 Bedford Row
London, WC1R 4EJ
England

Part 2

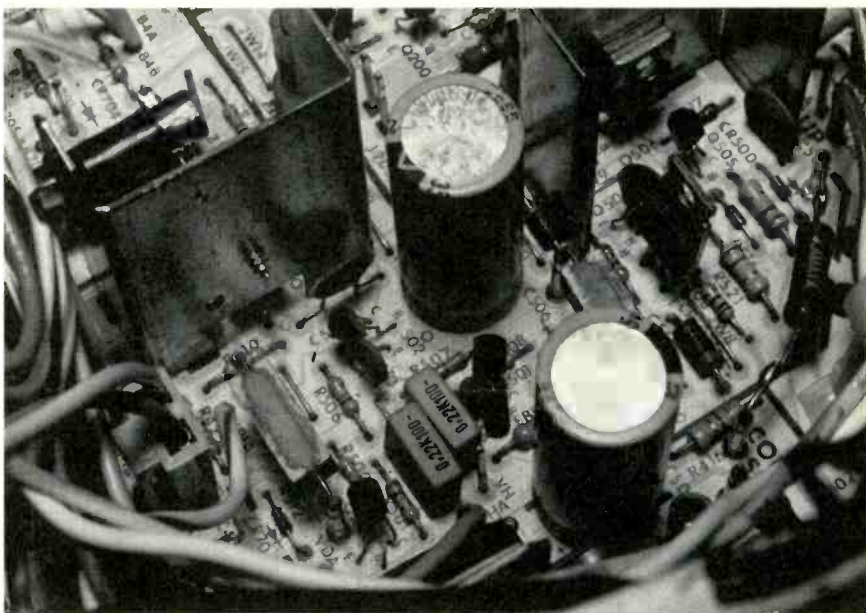

RCA CTC99 vertical sweep

This last installment of the RCA CTC99 and CTC101 series continues the circuit-operation information and provides many pictures from the TV screen and matching scope waveforms for typical parts failures.

By Gill Grieshaber, CET
Gill's Color TV

Most vertical-sweep components of the RCA CTC99 chassis are below the deflection yoke on the large circuit board. Figure 1 shows several transistors and other important components that will be discussed.

There is no vertical oscillator because it is replaced by a count-down IC, as described last month. Without the oscillator components, the vertical-sweep circuit might be expected to supply only one function: voltage and power amplification needed to drive the vertical-yoke windings. Although circuit action is complex because of the clever engineering, a feeling of simplicity is conveyed by the few components used and the lack of critical adjustments. Only a height control is required. No hold or linearity control is needed.

Vertical-frequency narrow pulses come from the count-down IC; it seems logical for these pulses to be amplified before they are fed to the yoke—not so. Yes, pulses are used to form continuous sawteeth in the Q500 stage, but these pulses are obscured in the process. Later, other pulses are constructed by amplifying the differences between two sawteeth signals, and these new pulses drive the output stage. This is part of the negative-feedback operation that eliminates all need for a manually operated linearity control.

These unusual circuits make new guidelines necessary for troubleshooting any problems of poor linearity and insufficient height. Many examples are given later.

The complete vertical-sweep schematic is shown in Figure 2. It is repeated from last month because the explanation was not finished then. The waveforms are conven-

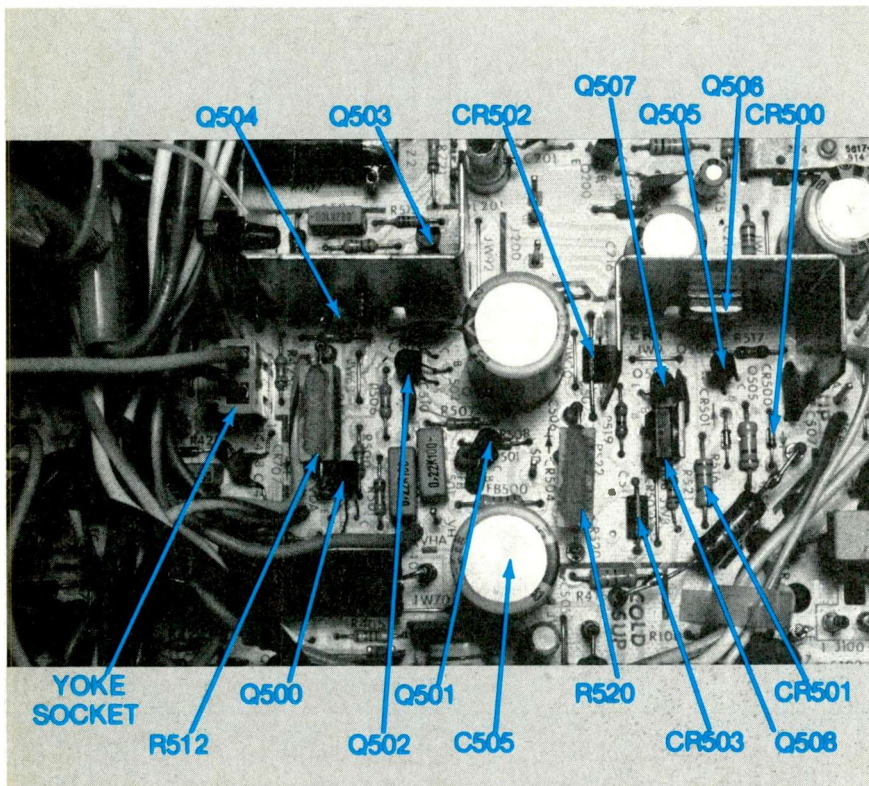

Figure 1 Locations of many vertical-sweep components are shown for the RCA CTC99 chassis (CTC101 has the same vertical circuit).

NATESA
5908 S.
Troy
Chicago
IL 60629



ARE YOU A PRO?

...the not for profit association championing independents' right to compete, and delivering valuable benefits continuously since 1950.

- LEADING SPOKESMAN
- TRADE INFORMATION DISPENSER
- WATCHDOG
- LOBBYIST
- YARDSTICK OF STANDARDS
- CONSUMER RELATIONS
- COUNSELOR
- PROBLEM SOLVER

We are not freeloaders. So our check for \$60.00 dues is attached. As our special premium, please ship the indicated \$15.00 Manual.

- Practical Business Manual
- OR -
 Service Contract Manual

Circle (8) on Reply Card

IT'S NO PUZZLE 
TO ORDER
OELRICH SERVICE FORMS
FOR TV-RADIO & 2 WAY RADIO SERVICE LEGAL FORMS FOR CALIF. FLA. UTAH NOW AT YOUR PARTS JOBBER OR WRITE FOR CATALOG B64
OELRICH PUBLICATIONS
4040 N. NASHVILLE AVE. CHICAGO, ILLINOIS 60634

Circle (9) on Reply Card

To get more information...

on items advertised or described in this publication, use the Reader Service Card.

As a free service for our readers, we forward your inquiry to the product's manufacturer. Reader Service Card is pre-addressed.

Vertical sweep

tional because all were scoped using ground as the reference point.

More Q500 operation

Before additional Q500 informa-

tion is presented, some background facts are needed. The Figure 2 schematic shows a totem-pole output stage (Q504 and Q506) with a single positive-voltage power supply, and apparently without a coupling capacitor to the yoke windings. (No

coupling capacitor is required with a complementary symmetry output stage having separate positive and negative supplies.) However, the C505 yoke-coupling capacitor has merely been moved to the cold end of the yoke.

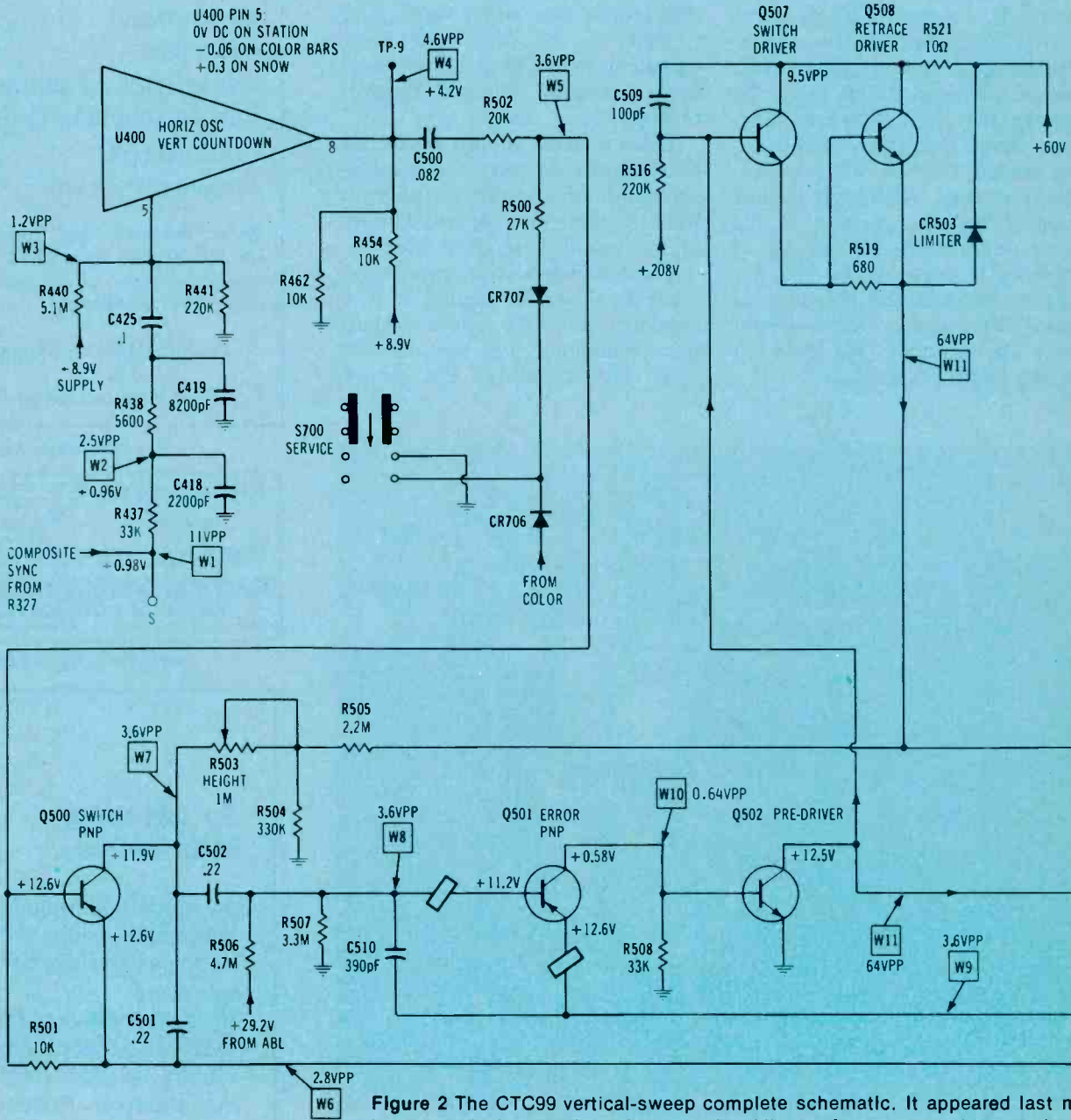

CTC99 VERTICAL

Figure 2 The CTC99 vertical-sweep complete schematic. It appeared last month, but several changes have been made. All waveforms were photographed with the scope common lead connected to chassis cold ground.

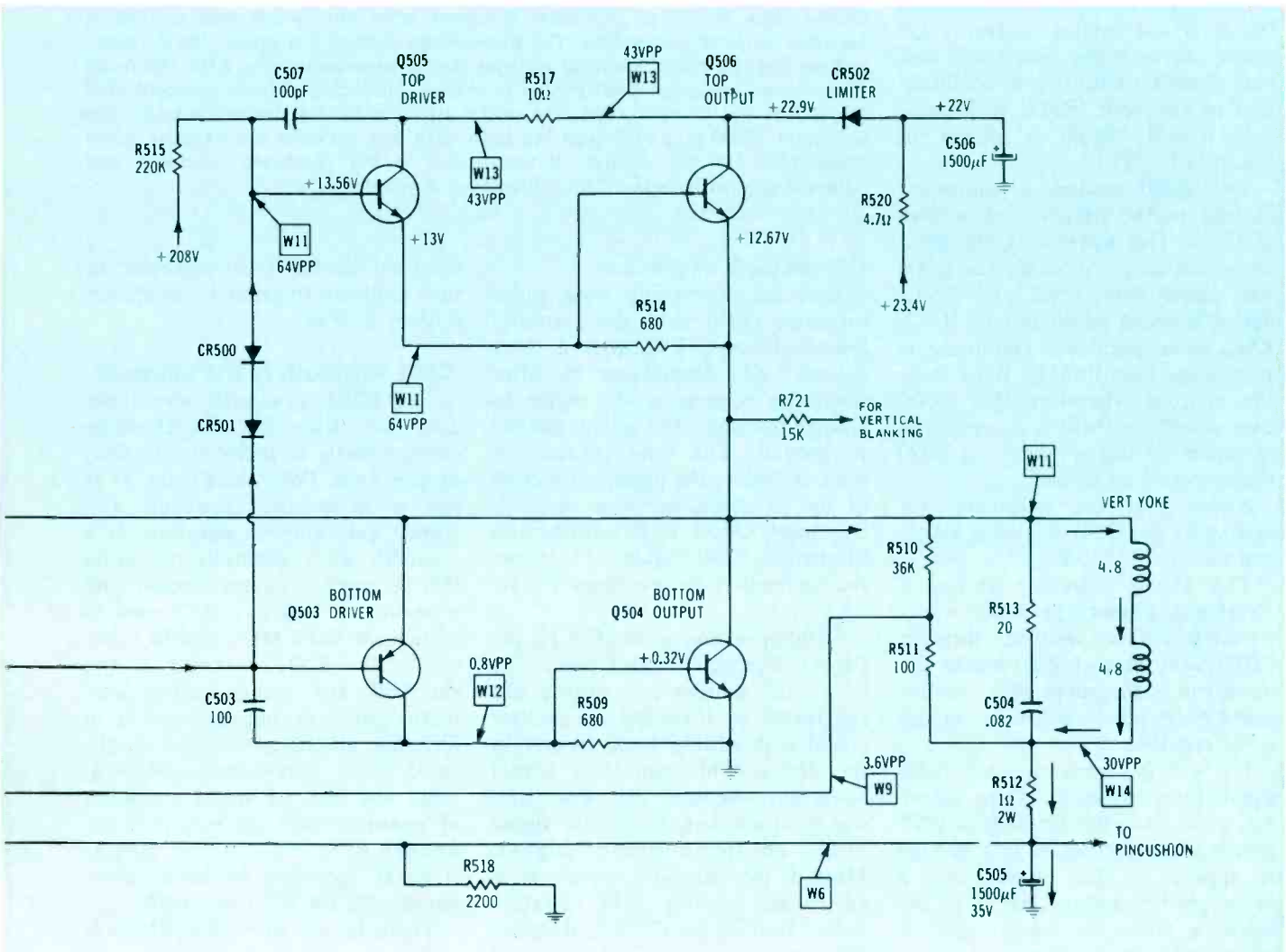
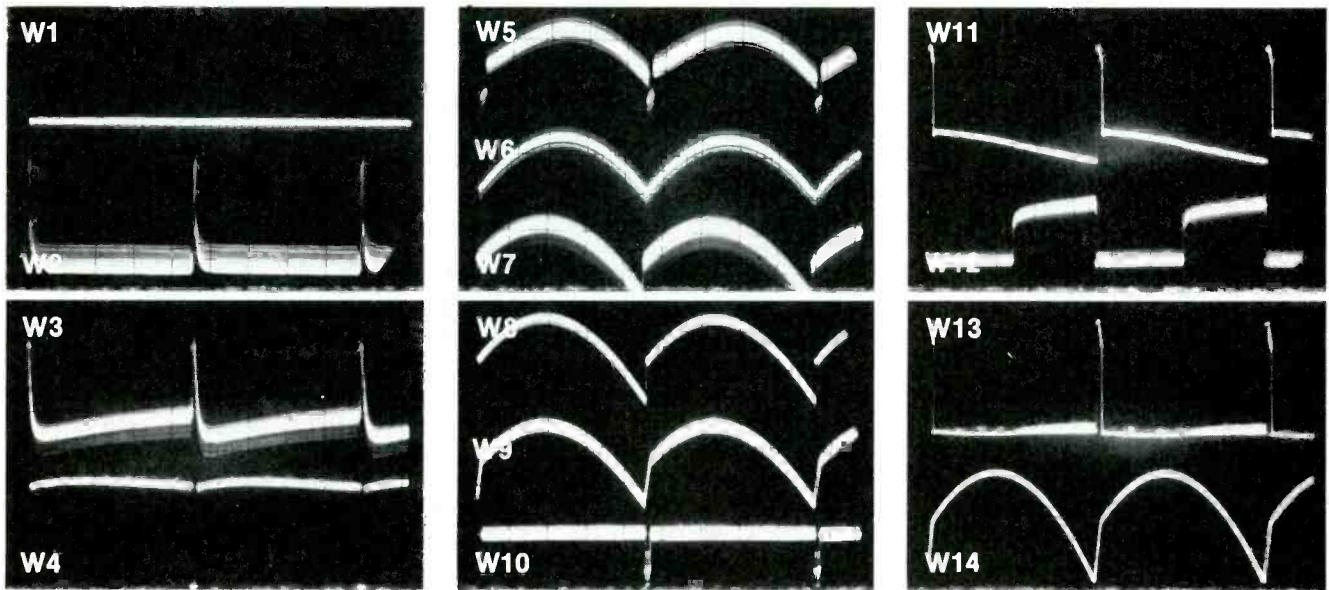

Vertical sweep

A sawtooth of yoke current flows through C505, which integrates the sawtooth into a parabolic wave-shape voltage drop across C505 (W6 in Figure 2). The positive terminal of C505 is also a source of about +12.5Vdc that has only a small ripple amplitude (Figure 2, W6); the parabola is useful for linearity corrections. (Dc voltage from the vertical output goes through the yoke and R512 to C505.)

R512 is placed between the cold end of the yoke and C505. The ac voltage drop across this 1Ω resistor is the sawtooth *voltage* waveform of the sawtooth yoke *current*, which is a vital part of the automatic linearity-correction action. Of course, between the yoke's cold end and chassis ground is a combination of sawtooth (R512) and parabola (C505), which is shown in Figure 2 by W14.

The Q500 emitter is connected directly to the parabolic waveform at C505. Two waveforms are present at the base. Pulses for the Q500 base came from C500 and R502, and referenced to ground by R462. Also, some parabolic amplitude is sent to the base through R501 from the emitter. Therefore, the Q500 base waveform (W5) is a composite of pulses (W4) and parabolas (W6) when scoped to ground.

Notice that the parabolas are needed by the Q501 following stage, and not by the Q500.

The Q500 collector shows a composite sawtooth/parabolic waveform, which is coupled through C502 to the base of Q501 where the waveform is compared with another sawtooth/parabolic waveform at the Q501 emitter.

Dc voltage from the parabolic signal furnishes most of the power for Q500. Because Q500 is a PNP polarity, the positive supply voltage is applied to the emitter and a lower positive voltage comes to the collector from the height control whose adjustment determines the

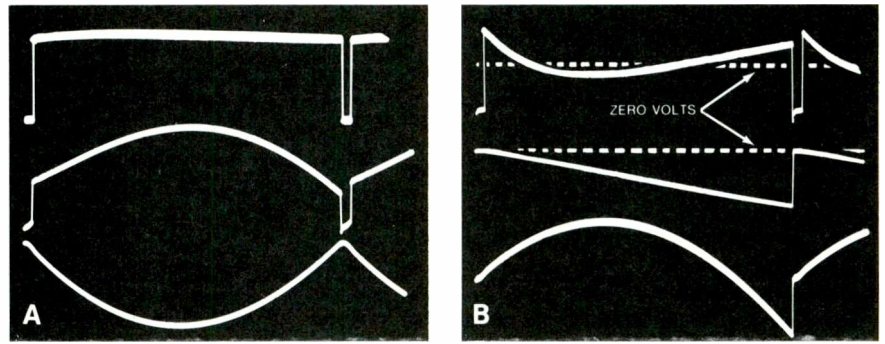

Figure 3 A parabolic waveform is required (along with drive pulses) at the Q501 base for proper correction of height and linearity errors. This parabola is added to the Q500 emitter and, therefore, changes Q500 base, emitter and collector waveforms when they are scoped to ground. (A) Top trace is the negative-pulse waveform coming from IC U400. Center trace shows the combined pulse and parabolic signal at the Q500 base, while the bottom trace is the emitter parabolic waveform. (B) The true input signal is the emitter waveform subtracted from the base signal. Top trace shows the input waveform when the scope was connected between base and emitter. The zero-voltage line was produced by the scope, then the line was changed to dashes so the waveform is not obscured. Center trace is the dc waveform obtained when the scope was connected between collector and emitter. The zero-voltage dashed line proves the collector and emitter had nearly identical voltages during base-pulse time. After the pulse time is over, capacitor C501 begins to charge, producing a linear sawtooth that is used by the following circuitry as the standard for the desired yoke-current waveform. Q500 is a PNP type, so both base and collector are negative when measured from the emitter. Bottom trace is the combined sawtooth and parabola scoped between Q500 collector and ground.

C/E sawtooth amplitude.

Each negative-going base pulse saturates Q500, and the resulting low-resistance C/E path is a short across C501, discharging it. After the pulse is gone, C501 begins to charge through the height control to ground. The time constant is long, so before the nonlinear section of the parabolic curve is reached, the next Q500 C/E conduction discharges C501 again. Therefore, the sawteeth have excellent linearity.

Q500 operation is clarified by the Figure 3 special waveforms. The base and emitter waveforms are subtracted by inverting the emitter signal and adding both signals in the scope. This simulates actual operation because the true B/E signal equals base-to-ground signal minus emitter-to-ground signal. Most of the parabolic waveform is canceled, leaving only negative pulses that cause C/E conduction. However, the emitter parabola and

the C501 sawtooth are combined in the collector-to-ground waveform (Figure 2, W7).

C501 sawtooth is the standard

The C501 sawtooth waveform does not drive the output stage either directly or indirectly. In fact, proper drive (W11 in Figure 2) is not a sawtooth. However, the correct yoke-current waveform is a sawtooth. In a normally operating CTC99 vertical-sweep circuit, the yoke-current waveform is forced to imitate the C501 sawtooth. In other words, the C501 sawtooth is the standard; any change of this sawtooth (such as nonlinearity or a different amplitude) will be duplicated in the yoke-current waveform. Also, any drift of height (variation of yoke current) or minor nonlinearity occurring in the output stage is corrected by being compared with the C501 sawtooth.

There is one exception. Deliberate reduction of high-frequency

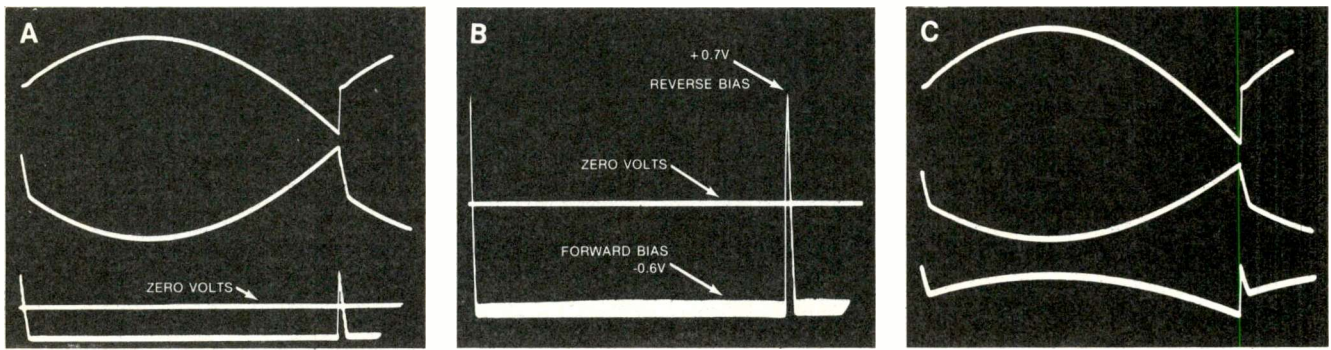

Figure 4 Correct vertical-sweep operation demands that the yoke-current sawtooth is identical (except for retrace time) to the sawtooth developed across C501 (shown in Figure 2 schematic). Therefore, the C501 standard sawtooth (plus a parabolic waveform) is applied to the Q501 base. And the yoke-current sawtooth (developed across R512) is connected to the Q501 emitter, along with an identical parabolic waveform. The two parabolas cancel out, leaving only the two sawtooth waveforms at base and emitter. Any difference between the base and emitter waveforms is the correction signal that is amplified and used to drive the output stages. (A) Top waveform is the Q501-base sawtooth and parabola signal. The center trace is the emitter yoke-current sawtooth and parabola waveform that has been inverted to simulate the actual subtraction of signals that produce the true B/E input signal. This actual B/E signal is shown by the dc waveform in the bottom trace. It appears to be positive pulses. (B) However, Q501 is a PNP that requires forward bias from a base voltage that is more negative than the emitter. Therefore, the +0.7V positive peak is reversed bias. The forward bias is the -0.6V lower (base) line that is continuous except during pulse times. This proves the Q501 transistor draws a strong C/E current except during pulse (retrace) times. (C) Correction of insufficient yoke current is simulated here by scope operation. When the Q501 base signal is normal (top trace) but the emitter yoke-current waveform has less amplitude (center trace), the true B/E signal no longer is pulses alone, but a combination of pulses and parabolas (bottom trace).

response in all three driver stages provides a desired slower retrace time.

Q501 error correction

Dc voltage for the Q501 base comes from voltage divider R506-R507, which is furnished with about +29V from the automatic brightness-limiter (ABL) circuit; the emitter has a fixed dc voltage from the yoke circuit. At extremely high brightness, the Q501 bias is decreased, thus preventing any increase of height. One of the first tests after loss of vertical sweep should be verification of the +29V. If it is low or missing, there can be no height. Incidentally, the separate base and emitter readings in Figure 2 seem to indicate a forward bias of -1.2V for PNP Q501. However, the base reading was reduced temporarily by loading of the digital meter. A later reading between base and emitter proved the forward bias actually was -0.559Vdc. Thus, without the meter loading, the base-to-ground voltage actually was about +12V. This is the only CTC9

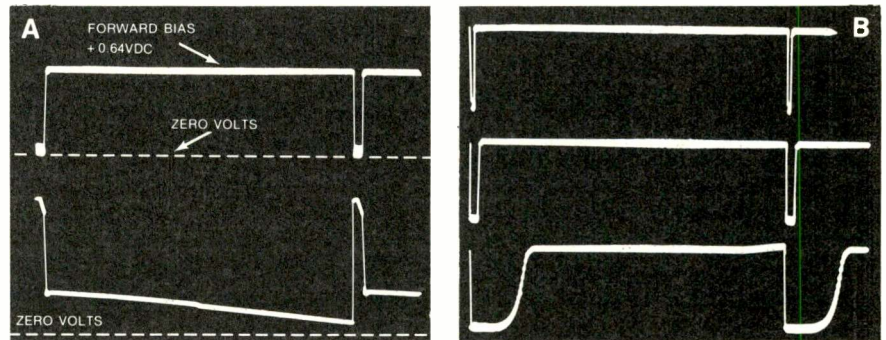

Figure 5 Q501 output at the collector is inverted and amplified pulses that are square-tipped by the saturated operation. The collector signal is direct coupled to the B502 base (A) Top trace is the Q502 base waveform. Notice, however, that the solid line at the top represents normal forward bias that gives maximum C/E conduction. Pulse tips are at zero volts. Therefore, the Q502 collector waveform *should be* only an inversion (positive-going pulses). Bottom trace shows the actual collector-to-ground waveform which has a large sawtooth for each pulse. This variation from logical operation has not been explained as yet, for no sawtooth can be found in the base waveform. (B) However, the base waveform changes with different height adjustments. Top trace shows the Q502 zero-voltage pulses are narrower than the center-trace normal pulses. When the height control was adjusted to maximum, the pulses (bottom trace) widened and some change of the top line occurred. Evidently the system was attempting to correct the distortion that was off-screen and therefore not visible in the picture. Changes to the pulses represent corrections during retrace, while distortions of the line between pulses represents corrections made during trace times.

Vertical sweep

circuit that is so susceptible to loading error.

Notice that variation of this voltage changes the height. When a $5M\ \Omega$ resistor was connected from Q501 base to chassis ground, the dc voltage at the yoke input decreased to about +10V, the height was insufficient and the sweep was erratic (nonlinearity areas moved around and the height developed an erratic motorboat). The base is sensitive to both capacitance and resistance loading.

C502 couples the combination sawtooth-and-parabola signal from the Q500 collector to the Q501 base without noticeable change (see W8 in Figure 2). Voltage divider R510 and R511 apparently is an "S" filter to improve the linearity at the bottom of deflection. The divider has a very high ratio, bringing almost all amplitude of the W14 combination sawtooth-and-parabola yoke-current waveform to the Q501 emitter.

Base (W8) and emitter (W9) have separate signals that are nearly identical. Comparison of these two signals produces an error-correction waveform. The difference between the signals is the real input to Q501, as made clear in the Figure 4 waveforms. When the circuit operation is normal, the only difference is the slope of the retrace edge; the base-to-emitter input *appears* to be narrow positive-going pulses. However, remember that Q501 is a PNP type, so the input signal is a steady -0.6V of forward bias that has narrow positive pulses in it. These positive tips are ignored by the transistor. Only 0.5V or more of negative bias produces any conduction.

Another Figure 4 waveform shows by simulation how this input signal changes when the yoke-current sawtooth decreases. The change of input signal is similar to the AGC or AFC principle; correction is in the direction necessary to reduce the output error.

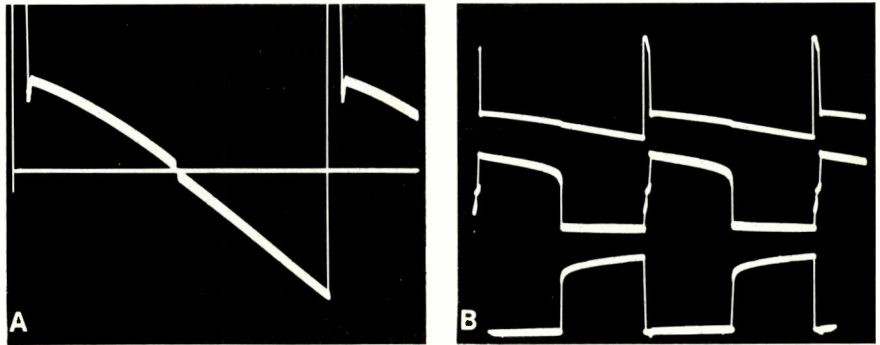

Figure 6 Waveform at the Q502 collector is identical to the output waveform (at the Q506 emitter and Q504 collector) except for the small notch in the Q502 collector waveform. (A) Excessive scope gain has driven the Q502 collector pulses off-screen. The small step near the center marks the shift from top Q505/Q506 conduction to bottom Q503/Q504 conduction. (It is the sweep equivalent of notch distortion in audio amplifiers.) The horizontal line across the step represents the dc-voltage level at the signal sent to the yoke coils. (B) Top trace shows the output-stage-driving waveform coming from the Q502 collector. It has the tiny step at the sawtooth center where switching from top deflection output transistors are NPN types. Center trace shows the B/E waveform for Q506, the top-output transistor. Maximum C/E current flows at the beginning of trace time (left edge of waveform), decreasing to zero at the center of trace (remember, a silicon transistor ignores any forward bias of less than 0.5V). This C/E current flows through the yoke and charges C505. Q504 current is the opposite. According to the Q504 B/E waveform (bottom trace), no C/E current is drawn until the center of trace. Then the current increases to the end of trace where it abruptly drops to zero. This is the current that discharges C505 through the yoke. Therefore, it deflects from the picture center to the bottom of the raster. According to these waveforms, *neither transistor draws C/E current during retrace*. Collapse of the yoke's magnetic field can bring the beam back to the center of the screen and slightly beyond. But the low impedances damp this ringing so it is insufficient to provide a linear change to the start of trace (top of picture). Therefore, the Q507/Q508 circuit adds strong pulses to supplement the ringing, as explained later.

The correction waveform that is applied to the emitter has about +12.6Vdc mixed with it. This is the positive supply voltage fed to the emitter. The collector current flows through R508 to ground, producing (by voltage drop) the Q502 base signal.

During sweep corrections, the Q501 collector waveform can change in two basic ways. Width of the zero-voltage sections varies with height adjustments or from defects that change the height. The three waveforms in the second Figure 5 photograph show the effects of minimum, normal and maximum height adjustments. Also, the top line can become crooked when strong error correction or a serious

defect is present. Remember that the space between these pulses of zero voltage represents the vertical scan time; the straightness or bending of the line is part of the linearity correction.

If the scope has no zero-voltage reference line on-screen, this collector signal appears to be vertical-rate negative pulses. But the pulse tips are at zero volts, while the waveform top line is at +0.64Vdc (see Figure 5 waveforms), which is a good value of bias. This dc waveform is the input signal for the Q502 base.

Predriver operation

Because NPN Q502 has a steady forward bias (except for vertical-

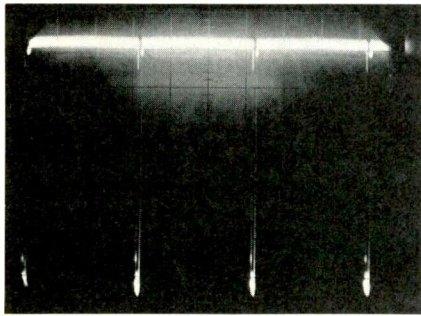

Figure 7 No sawtooth can be seen between the pulses in the Q502 base signal. Therefore, it is unlikely the sawtooth in the output signal is produced by amplification in Q502.

rate narrow segments of zero volts), the logical collector signal should be a positive voltage of about half the supply with pulses of supply voltage during the times of zero bias.

Waveform W11 in Figure 2 instead shows a large positive pulse at each retrace time and a decreasing sawtooth connecting the next positive pulse. This illogical change is difficult to explain. In fact, the operation is completely different from any other vertical circuit analyzed in depth in **Electronic Servicing's** lab. For the moment it is assumed the Q502 collector has the desired (W11) waveform.

Drivers and outputs

These vertical driver and power-output transistors have somewhat the same operation as the complementary-symmetry system that has one PNP and one NPN power transistor for driving the yoke windings. One major difference in the CTC99 is substitution of an NPN for the bottom-output transistor.

Each power transistor has a small driver transistor. NPN-type Q505 is an emitter-follower that drives top-output Q506, also an emitter follower. Neither has voltage gain. Bottom-output transistor Q504 is an NPN-type connected as a grounded-emitter amplifier. It is driven by a small PNP transistor (Q503), also wired as a grounded-emitter amplifier. Usually,

grounded-emitter stages have gain and invert the phase. The circuit resistances are so low, however, that Q503 and Q504 have unity gain. That is planned, because gain of the bottom transistors would seriously unbalance the output signal. Of course, all four transistors provide *power* gain.

Neither Q505 nor Q506 inverts the phase. Both Q503 and Q504 invert the signal phase. A double inversion brings the overall input and output back to the same phase. It is helpful to imagine Q505/Q506 as a single NPN and the Q503/Q504 team as a single PNP transistor, when a simplified overall concept of the output operation is needed.

Diodes CR500 and CR501 provide an offset drive to Q505 and Q503. They are necessary because a transistor must have about 0.5V of forward bias before C/E conduction occurs. R516 and R515 bring in dc-supply voltage to outside ends of these diodes; the voltage drop across CR500 and CR501 together is only +1.1Vdc. If both diodes are shorted, there is no center compression as is true of complementary-symmetry types. Instead, the screen shows retrace lines at the top.

Base signals of the driver and power-output transistors are shown by waveforms in Figure 6. Q506 conduction supplies yoke current for the top half; Q504 conduction produces yoke current of opposite polarity for the bottom half of the raster.

The sawtooth yoke current flows through R512 and C505 to ground. Yoke current through R512 produces a voltage-drop sawtooth signal that is sent through R511 to the Q501 emitter. Comparison of the yoke sawtooth with the C501 sawtooth to correct minor height or linearity problems has been described before.

Pulse clippers

CR503 is connected with anode at the output signal and cathode at the +62V supply. If the output-sig-

nal pulse amplitude becomes excessive, the diode is forward biased and shorts those two points together until the pulse is gone. Thus any positive pulse-tip amplitude that exceeds 62VPP (relative to ground) is removed by clipping.

At the other extreme, CR502 prevents loss of pulse tips that are more positive than the +23V supply. Assume that CR502 in Figure 2 is shorted. Any pulse tip that is more positive than the Q506 collector can travel through R514 to the Q506 base where it forward biases the base-to-collector junction, allowing the pulse tip to reach the collector. Without CR502, the collector is bypassed by C506 which eliminates the pulse tip. This path is not a dead short because R514 has 680 Ω and the B/E junction has some resistance. Even so, the low resistance eliminates most of the excessive amplitude as though it were clipped.

Of course, a pulse amplitude of about 60VPP above ground is necessary for proper retrace of the yoke. CR502 is necessary to prevent clipping of this essential pulse amplitude.

Q502 has only pulses

As stated previously, Q502 does not produce or pass the sawtooth portions of the Q502 collector waveform that appear at the driver bases. There is no evidence of any sawtooth on the line between pulses (see Figure 7), even when the scope gain was increased to drive the pulse tips off screen. Granted, only a tiny signal is needed around the 0.65V bias point. But no sawtooth could be found.

This conclusion was verified with two experiments. A replacement Q502 was wired temporarily outside the chassis with a collector resistor and a separate +12V power supply. Normal Q502 operation in the chassis was not disturbed. Then the base of the external transistor was connected to Q502's base through a 1000 Ω resistor. (When the bases were connected directly without a

Vertical sweep

resistor, the pulses became much wider.) As expected, the test-transistor collector had nothing but positive-going pulses, even when excessive scope gain was used.

Finally, the Q502 emitter circuit was opened and a $10\ \Omega$ resistor inserted between emitter and chassis ground. The waveform across the resistor revealed nothing but a steady current with zero-voltage segments that resemble negative pulses. Positively, Q502 was not amplifying and passing any sawtooth waveform.

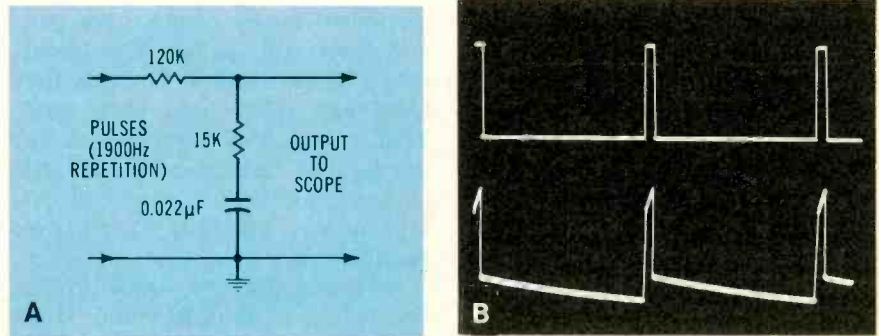

Figure 8 An R/C circuit can change pulses into pulses-plus-sawteeth. Here is one example. (A) These values produced the following waveforms. (B) Top trace is the pulse-waveform input. The combination pulse/sawtooth output waveform is shown by the lower scope trace. Vertical lines have been touched-up for clarity. Perhaps the vertical sawteeth are produced in a similar action.

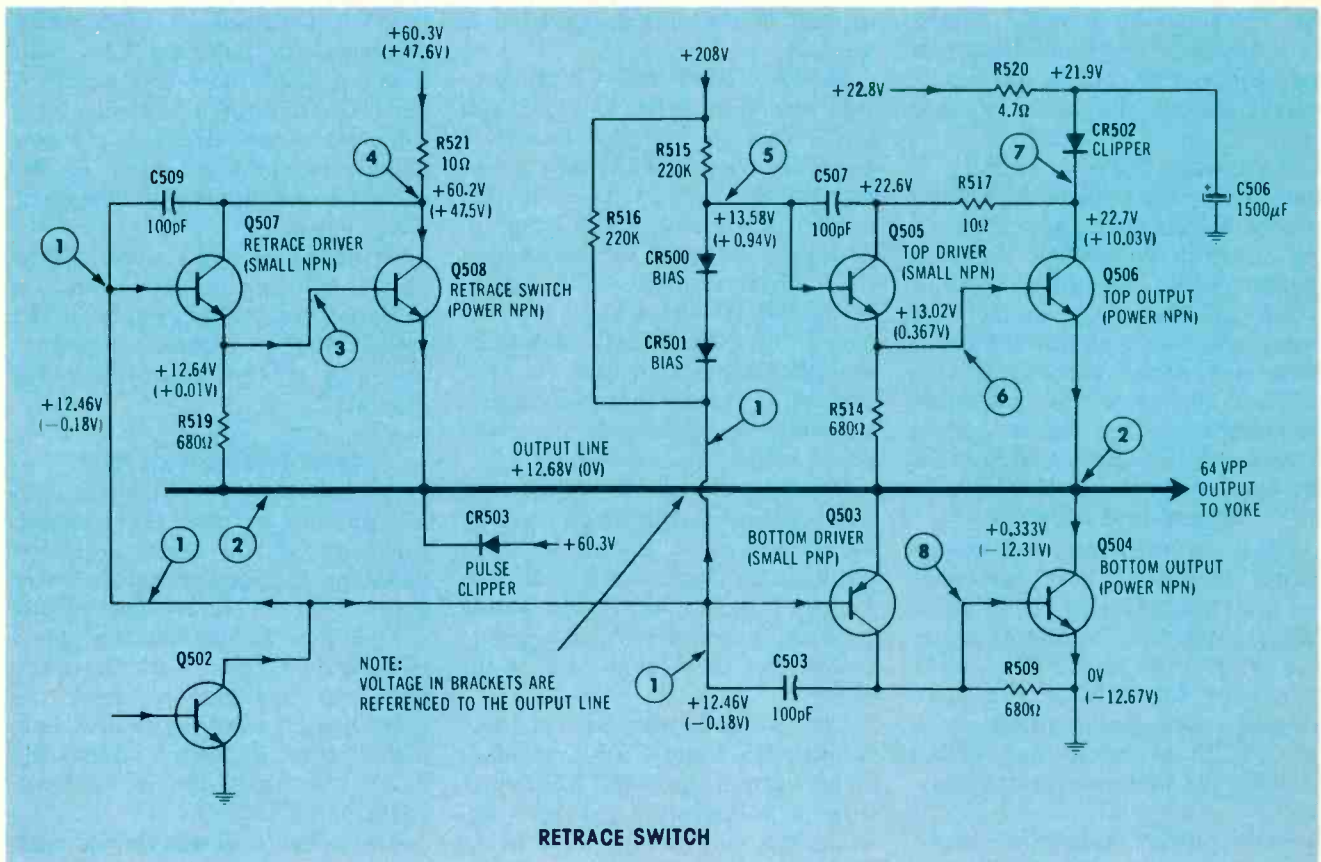

Figure 9 Q507 and Q508 function together as a Darlington transistor. The Q507 input signal is obtained direct from the Q502 collector (point 1), while the Q505 base signal comes from the other end of the CR500/CR501 bias diodes (point 5). The Q507/Q508 stage has a lower forward bias than does Q505/Q506. Therefore, it conducts only during the vertical-retrace time when triggered by Q502's collector pulses. These two stages (Q507/Q508 and Q505/Q506) operate differently, although they appear to be similar. Without the Q507/Q508 stage, the retrace slows near the need (top of picture). Notice that the Q507/Q508 stage does not amplify; it merely acts as a switch that turns on during the latter part of retrace, bringing in a brief burst of dc power from the +60V supply (point 4) to the yoke input (point 2). Arrows on the schematic show signal paths, not dc-voltage paths. One important (but unmarked) testpoint for troubleshooting is the signal line (point-2 line drawn as a wider line in the schematic) that feeds the yoke windings. Several stages use the midpoint line as reference. The circuit voltages in parenthesis were obtained with meter ground connected to point 2.

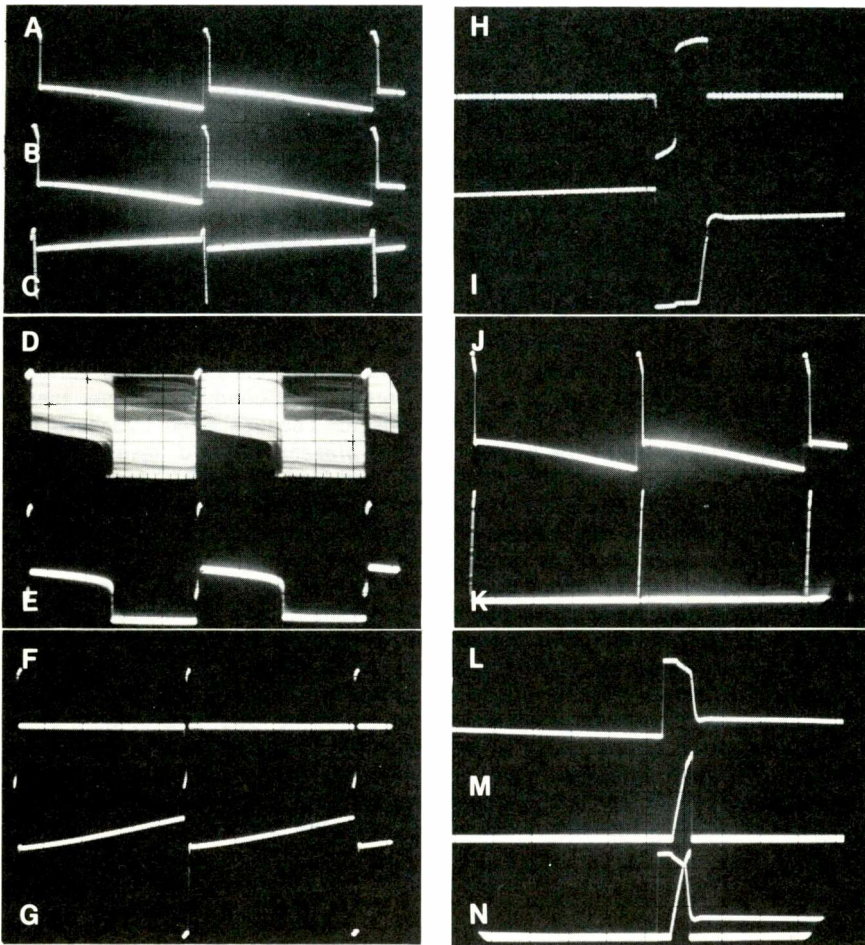

Figure 10 These waveforms help explain the Q507/Q508 operation: (A) Q507 base (point 1 in Figure 9) scoped to cold ground; (B) Q508 emitter (point 2) to ground; (C) Q508 collector (10VPP at point 4) to ground; (D) Q507 base (point 1) to emitter (point 3). Horizontal pulses blur the waveform; (E) Q507 base (point 1) to Q508 emitter (point 2). Amplitude is about +0.7V plus the positive spike. Zero voltage is at the baseline; (F) Q508 base (point 3) to emitter (point 2). This is a negative pulse followed by a positive pulse, as explained later; (G) Q508 collector (point 4) to emitter (point 2). Q508 conduction is seen as a negative pulse of voltage; (H) and (I) the previous two traces are repeated but with the pulses expanded horizontally by the scope; (J) and (K) are the output waveform and the inverted Q508 collector pulse that show the Q508 pulse begins later than the output pulse; (L) is an expanded output pulse (point 2); (M) shows an expanded Q508 pulse (inverted to show the pulse produced at the emitter by conduction from +60V); (N) both (L) and (M) are combined to show the section of the output pulse (point 2) contributed by the Q507/Q508 stage.

Sawtooth waveforms can be formed by running pulses through a resistor/capacitor or resistor/inductor low-pass filter. Or, a pulse-and-sawtooth waveform can be produced by the Figure 8 circuit. The only large capacitor in the vertical

circuit is C505, and the only inductor is the yoke.

Several theories have been proposed and discarded. None of the RCA field staff that has been questioned so far knows how the vertical-output stage operates.

HOW TO GET BETTER MILEAGE FROM YOUR CAR...

Obey the 55 mph speed limit.



Keep your engine tuned.



Avoid hot rod starts.



Drive at a steady pace.

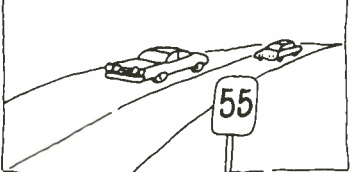

Don't let the engine idle more than 30 seconds.



And when buying, don't forget the fuel economy label is part of the price tag, too.



For a free booklet with more easy energy-saving tips, write "Energy," Box 62, Oak Ridge, TN 37830.

ENERGY.
We can't afford to waste it.

U.S. Department of Energy

Vertical sweep

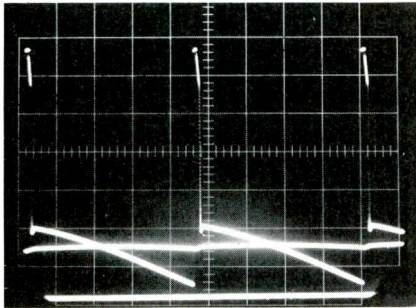

Figure 11 This dc waveform shows the location of the zero line (at bottom) relative to the vertical-output signal. The higher horizontal line is the average-voltage point of the waveform. Dc waveforms clarify operating levels that cannot be obtained by other methods.

Retrace switch operation

Transistors Q507 and Q508 in Figure 9 are part of the vertical-retrace circuit, but at first glance they seem to merely duplicate the top deflection already accomplished by Q505 and Q506. However, a closer look at the schematic shows two major differences. The signal for the Q507 base comes directly from Q502's collector (point 1 in Figure 9); the Q505 base is wired to the other end of diodes CR500 and CR501 (point 5). This means the dc line in the B/E waveform will be displaced by more than 1Vdc. Also, CR502 is between the 23V supply and the Q506 collector. But the Q508 collector has a 10 Ω resistor (R521) providing power from the +60V supply.

Therefore, retrace transistors Q505 and Q508 produce a narrow pulse of B+ that's needed to prevent what otherwise would be a sag in the yoke current at the end of retrace (top of the current sawtooth).

Q508 is biased into full saturated conduction during the second half (approximately) of the retrace time. This corresponds to the right half of the large positive-going pulse in

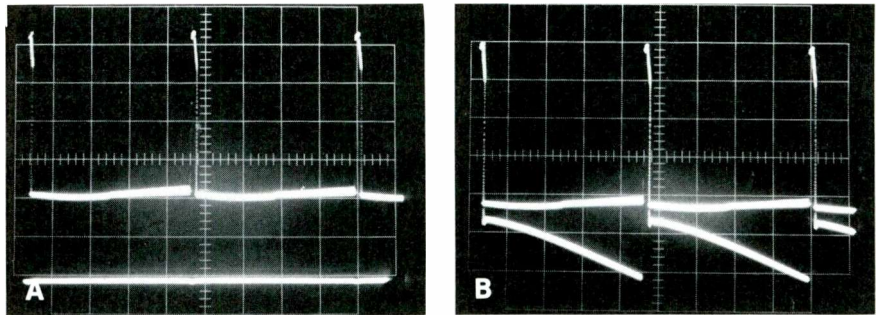

Functions of diode CR502 (Figure 9, point 7) are clarified by these waveforms. When top-output Q506 draws current, CR502 is forward biased and the current produces a dc-voltage drop of about 0.6V. During Q506 conduction time, there almost is no waveform amplitude at the collector because C506 bypasses it. When the positive pulse of the output signal is present, it *could* travel through R514 to the B/C junction of Q506. This is forward bias for the B/C junction, so it would conduct, and (if CR502 is shorted) transfer the pulse to C506 where bypassing action would remove the amplitude at the CR502 cathode (point 7) exceeds about +22V, CR502 is reverse biased and cannot conduct. Therefore, the positive pulse is not clipped above the 22V point. The top photograph shows the Q506 collector pulse along with the zero-voltage line below. With a scope gain of 10V/division, this proves the clipping occurs at about +22V. In other words, all waveform amplitude of less than +22V is removed from the Q506 collector, while higher amplitude sections remain. Combined output waveform and Q506-collector waveform are shown in the lower photograph. This shows the location of the +22V in relationship to both waveforms, and also that the pulse widths are identical (they should be—they are the same pulse at different points). Clipping by CR502 is similar to rectification, and it causes the cathode to measure a higher positive voltage than the anode.

Figure 12 Various normal and incorrect vertical-circuit conditions are shown by scope waveforms (left) and crosshatch patterns on the picture tube. Scope adjustments were not changed, so valid comparisons can be made. Some defects darkened the TV picture, and this is shown partially by the photographs on the right. (A) These are normal waveforms (output is top trace, and yoke current is the lower trace in each case) and crosshatch patterns for comparisons. (B) When CR502 is shorted, the picture is darker because the pulse amplitude is reduced, and the retrace is slower. (C) A short across both CR500 and CR501 bias diodes gave a dark picture with foldover at the top from slower retrace (D) An open R521 eliminated the Q507/Q508 pulse action and

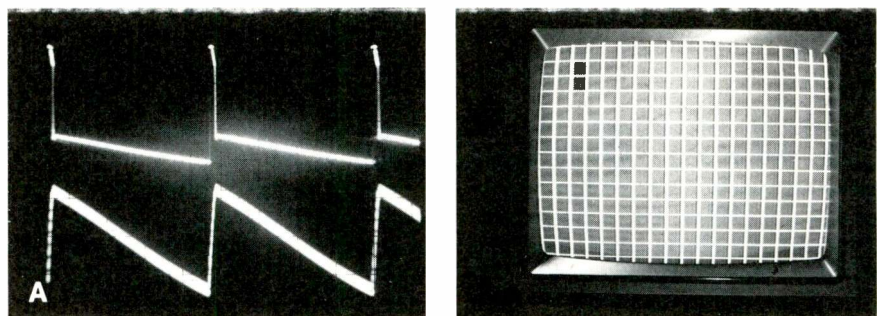

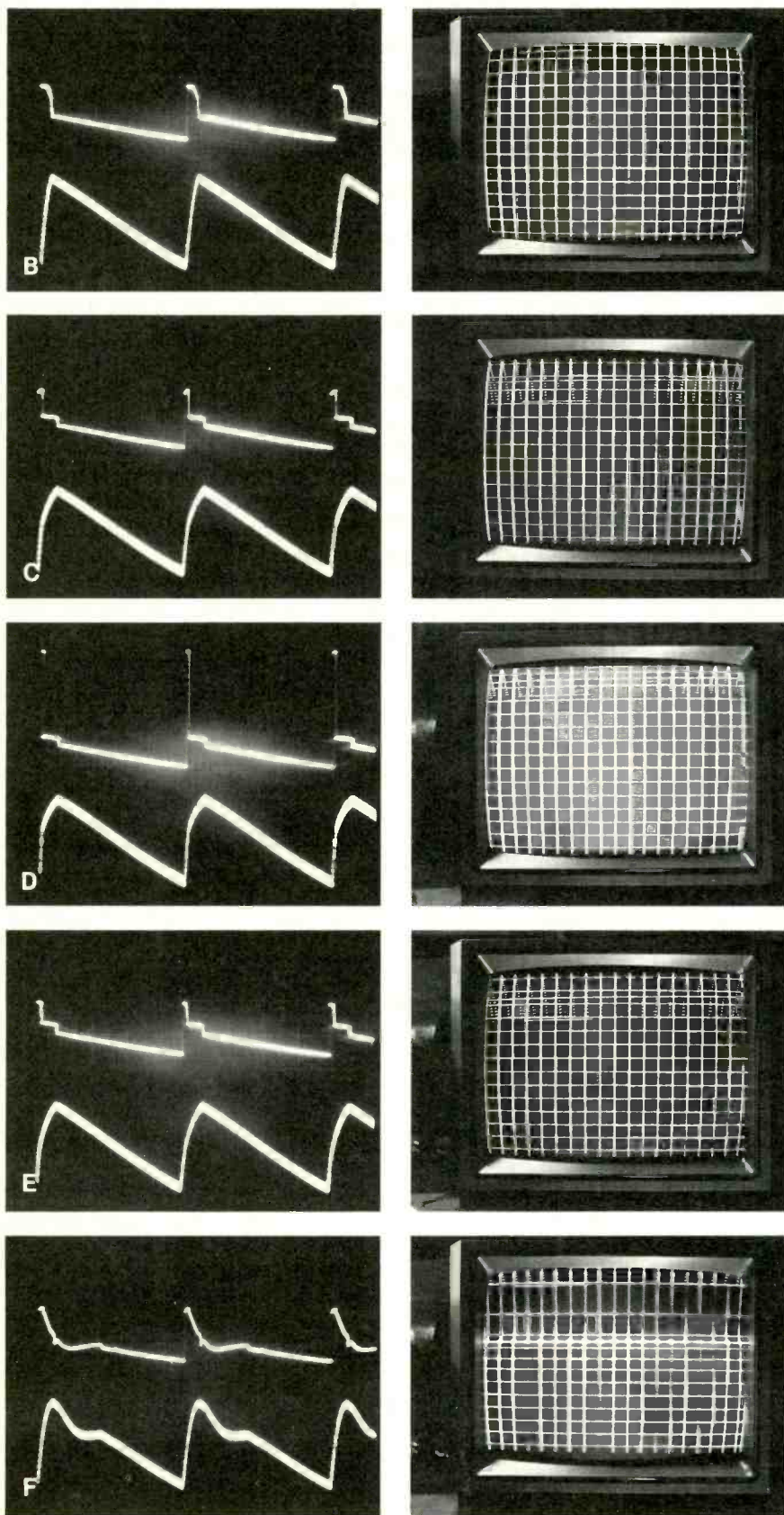

produced top foldover, but the brightness was normal (pulse amplitude was good). (E) When R521 was open and CR502 was shorted, the foldover resembled that in (E), but with a darker crosshatch. (F) A Q506 low-resistance B/E short spread the top linearity and gave a dark picture. (G) A similar near-short between base and emitter of Q504 gave normal brightness but spread the linearity just below the center. Some reduction of pincushion correction could be seen. (H) A 56Ω leakage across C505 reduced the height at the bottom and decreased the pincushion correction there. (I) A $100K \Omega$ simulated short across C501 also reduced the bottom deflection and the pincushion correction there. (J) Increasing R517 to $18K \Omega$ from the normal 10Ω gave expanded linearity and a compressed line in the upper section of the picture. (K) Maximum adjustment of the height control distorted the waveforms, but only increased the height excessively. (L) Minimum adjustment of the height control gave normal waveforms of reduced amplitude; the crosshatch was linear but with reduced height.

the output signal that is sent to the yoke, and is illustrated by the waveform photographs in Figure 10.

It is difficult to show all retrace-stage functions in waveforms. Signal amplitudes between base and emitter for Q507, Q505 and Q503 are so small that horizontal-sweep signals tend to obscure the true waveforms. Also, it is impossible to separate all pulses properly. For example, the pulse of dc voltage brought to the output line (point 2) cannot be seen separately; it can be shown indirectly. The scope ground (defeat the three-wire power ground during this test) can be connected to the 60V supply and the vertical probe touched to the Q508 collector. However, this gives a negative-going pulse unless the scope has an inverting switch. Another problem is that chassis ground seldom is the signal common-point for a certain stage.

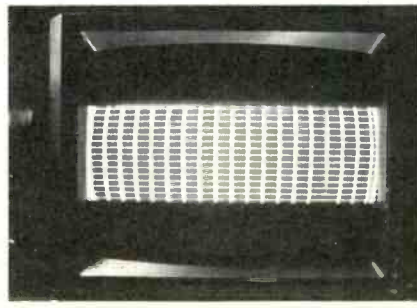
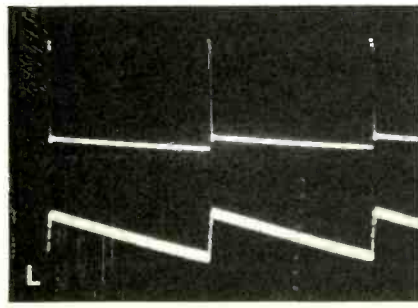
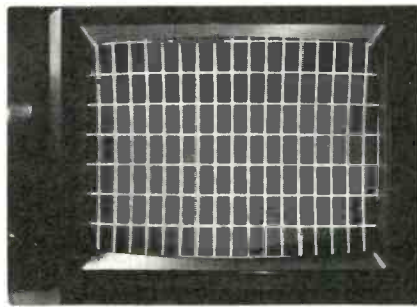
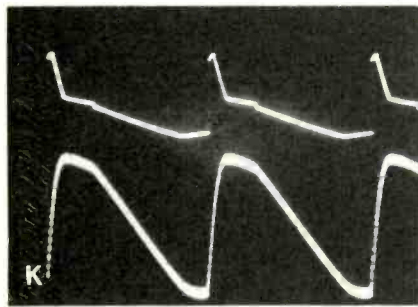
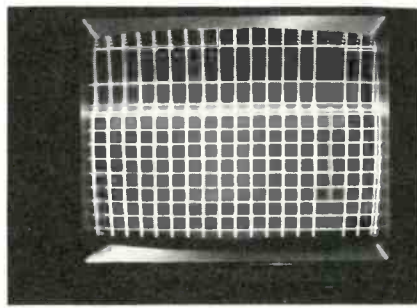
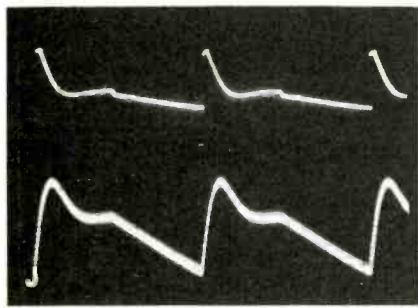
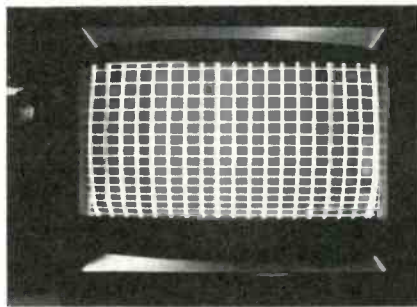
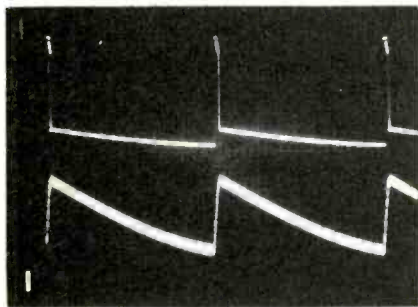
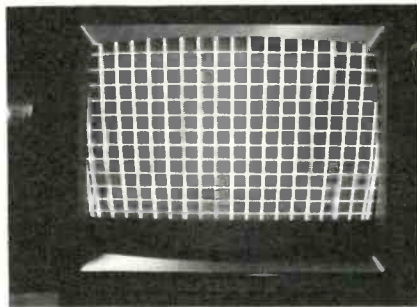
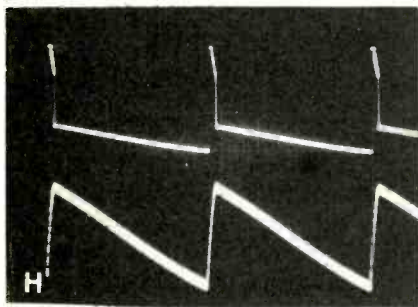
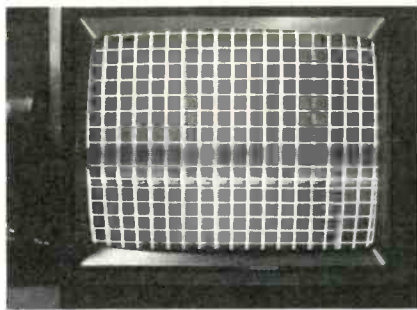
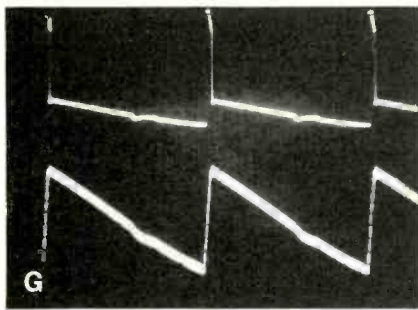

Vertical sweep

Also, some waveforms have limited value or usefulness unless they show dcV values, such as having a zero line, average-voltage line or supply-voltage line. One example is shown in Figure 11.

Troubleshooting symptoms

Obvious symptoms from failure of susceptible components are shown for the RCA CTC99 in Figure 12. One photograph of each pair shows a crosshatch pattern on the picture-tube screen. The other is a dual-trace waveform of the vertical-output signal and the yoke-current sawtooth. These examples should solve many problems.

Additionally, keep in mind these principles:

- Be certain the service/normal switch is pushed in to the *normal* position.
- Measure the dc voltage at the yoke-input signal (the heat sink of Q504 is a convenient point). In a normal circuit, the voltage should be between +12V and +13V whether or not any signal is coming from U400 or Q500. Defects after Q500 will probably change the voltage. Don't operate the receiver very long at a time if the voltage is significantly higher or lower.
- Prime suspects for no height are U400, Q504 (if output voltage is near zero), Q502 predriver, or lack of +29V at one end of R506 (at the Q501 base).
- Insufficient height usually is accompanied by severe nonlinearity; use a crosshatch to find the nonlinear area.
- Compression or lack of height at the bottom generally is produced by a defect around C501, in the height control or leakage in C505.
- Foldover at the top accompanied by retrace lines usually is caused by shorted CR500 and CR501, an open R521 or Q508, or a retrace circuit defect.
- Stretching linearity at the top might be caused by B/E leakage in Q506 or an increased resistance of R517. □

productreport

Magnet mount

The **Antenna Specialists** has introduced a magnet accessory mount, model K-350, a magnet base with pre-assembled RG-58U cable and fitting accommodate standard base loaded or low profile communications whips. The assembly will

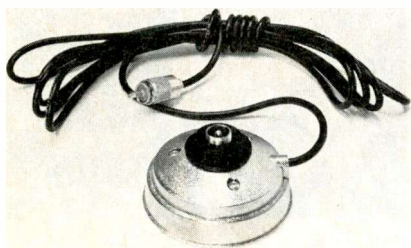

accommodate 5/8-24 thread base loads or, with a furnished adapter, the 1-1/8-18 thread low profile configuration. Cable length is 12 feet, and a pre-assembled PL-259 standard radio connector is furnished.

The price of the K-350 is \$28.75.

Circle (37) on Reply Card

Torque tools

Klein Tools has announced a line of torque wrenches and torque screwdrivers that enables the user to accurately measure the torque



applied to nuts, bolts or screws, so that they are tightened properly. These tools help avoid damaging fasteners or the parts with which the fasteners interact.

Circle (38) on Reply Card

Bench-top repair center

PACE has introduced the model PRC-151 bench-top repair center for printed circuit boards, spike-free system incorporating a full line of standard work accessories. The PRC-151 features accessories for

desoldering, soldering, precision drilling, grinding and abrasion, re-flow soldering, conformal coating removal, conductive tweezer heating, resistance tweezer heating and thermal wire stripping. Also in-



cluded is the PACE Cir-Kit, used for repair and replacement of damaged or missing pads and tracks on PC boards.

Both domestic and export versions are available. The domestic unit list price is \$1175.

Circle (39) on Reply Card

Connector presser

The CP-200 connector presser from **O.K. Machine and Tool** is designed to crimp B-type insulated wire connectors onto the ends of unstripped wires. Metal teeth within the connector penetrate the wire insulation and engage the conductor when the connector is crimped. A built-in ratchet assures that a com-

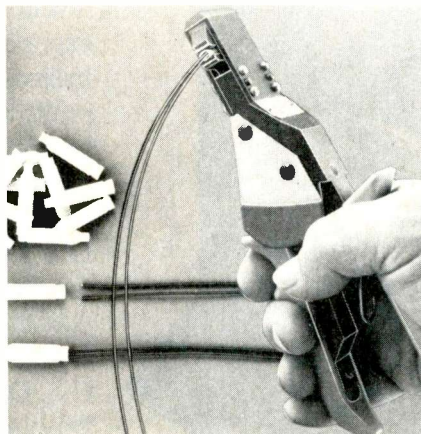

plete pressing cycle is made before the handles are released. A factory set mechanical stop prevents over-pressing. B connectors are available in plain and jelly-filled. The jelly-filled connectors feature silicon-type

grease packing. Both types are available in packages of 250, 500 and 1000 pieces.

Circle (40) on Reply Card

Header connectors

A series of insulation-displacement header connectors from **Belden** features vertical, right-angle and wire-wrapping configurations for mass-terminating 50-mil center flat ribbon cable. All three designs in the series are available in sizes from 10 to 60 pins, with optional

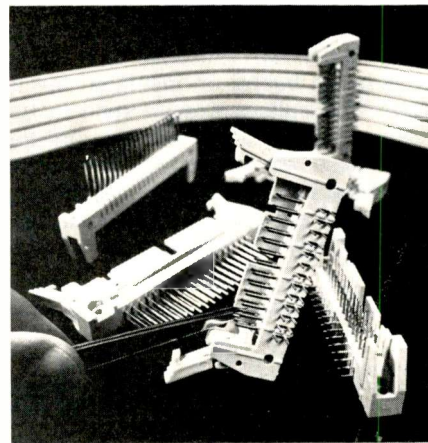

long and short snap-action lock/eject hooks. Positive connection between U-contact and 28-ga. round conductors is assured by a double-action slot design utilizing two cutting surfaces. Gold-over-nickel plated contact areas provide electrical reliability. Tin-plated terminals are said to improve solderability and prevent gold contamination of the solder bath.

Circle (41) on Reply Card

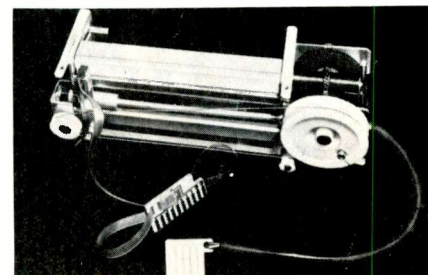

Alphanumeric printers

Two miniature alphanumeric printers are available from **Panasonic**. Model EUY-5E prints on elec-

Product report

tro-sensitive paper, and the EUY-5T prints on thermally-sensitive paper. Both versions print 32, 40, 64 or 80 characters per line, formed by a 7x5 dot matrix. Designed for OEM customers, the units come without a case, ready to be mounted into the user's equipment and be connected via their ribbon cables and pc connectors.

The EUY-5E is priced at \$145, and the EUY-5T at \$196.

Circle (42) on Reply Card

Metric hand tool

A metric hand tool, Super Champ M2 from AMP Special Industries, crimps insulated and uninsulated terminals and splices in wire sizes 0.5 - 6.0 mm². The wire barrel and insulation barrel on insulated terminals and splices are crimped in the same die. Color-coded dies in the tool nose correspond to colors on terminal insulation sleeves to ensure proper die selection. The tool features a wire cutter, bolt cutter, stud

gauge, wire stripper and universal ignition crimping notch.

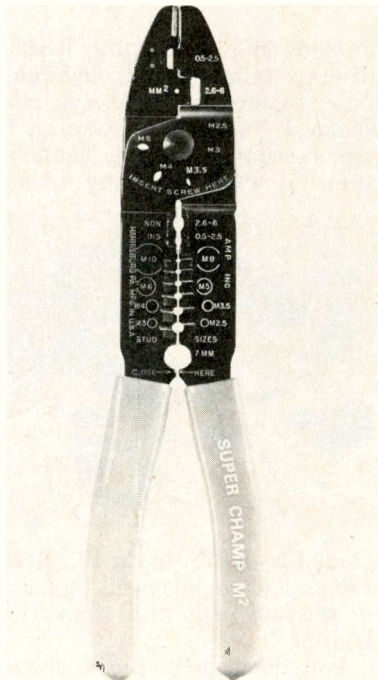

Circle (43) on Reply Card

Bonding system

Designed to cut wire tie-down costs, the Loctite Tak Pak Adhesive for Printed Circuit Board Assembly is capable of bonding electronic and electrical components quickly, in



addition to wire tie-down. The Tak Pak Adhesive has been formulated for manual bench assembly, but it can also be automated with off-the-shelf equipment such as the Bond-A-Matic 2000 Console. □

Circle (44) on Reply Card

The book that turns businessmen into best sellers.

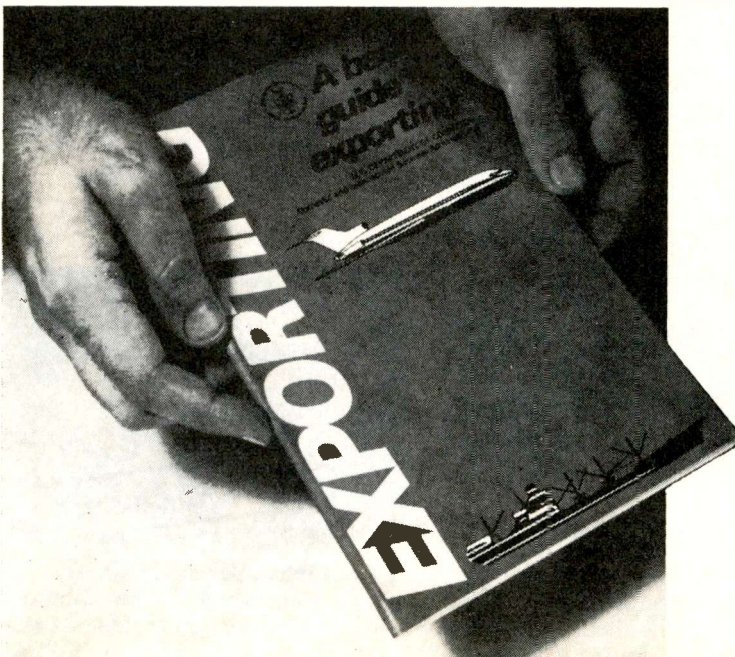

Many who've read it are now reaping the rewards. Because they've found that U.S. exports are a more than \$100 billion a year business, that exporting creates both company profits and company growth, that U.S. goods have never been more competitive in international markets. Above all, they've found that, with the help available from the U.S. Commerce Department, selling overseas is no more difficult than selling at home. And this fact-filled book can prove the same to you. Write The Secretary of Commerce, U.S. Dept. of Commerce, BED 8B, Washington, D.C. 20230.

U.S. Department of Commerce

A Public Service of This Magazine
& The Advertising Council



Intermittent video and black marks in picture Packard Bell 98C18 (Photofact 1009-2)

Symptoms of one Packard Bell 98C18 color television were intermittent video and erratic horizontal bands of snow across the picture. First tests around the Q6 AGC-keyer transistor disclosed erratic dc voltages that were causing varying AGC to IF and RF stages. I suspected the Q6 transistor of breaking down under power, and I replaced it plus the X11 pulse diode. There was no improvement.

Therefore, I went back to an old method of dealing with strange problems: where is the voltage fluctuation greatest? After several tests, the point of largest dc-voltage change was on the Q4 side of R99. This indicated that the problem was in the video and not the AGC. Video signals and dc voltage from the Q4 emitter are applied to Q6, Q7 and Q8. Replacement of the Q4 video amplifier transistor cured the problem.

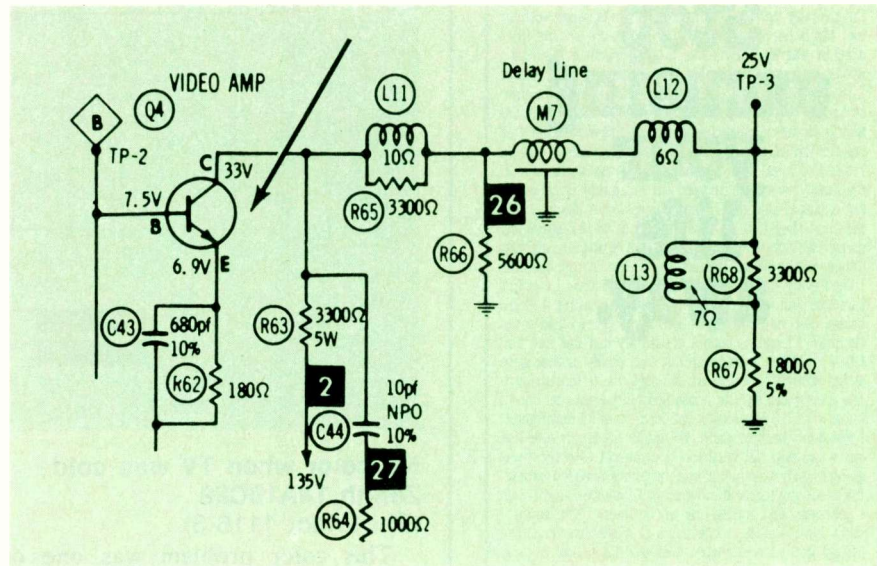

Several weeks later, another 98C18 Packard Bell had a unique black-and-white checkerboard effect following all vertical lines. This was slightly similar to IF ringing but it did not change with fine-tuning adjustments.

Remembering the previous unusual video problem, I replaced

the Q4 video transistor and found the problem was gone. Evidently the transistor is operated near the breakdown voltage, and this causes an excessive number of transistor failures.

G. Hauber
H&H TV Service
Raleigh, NC

AGC overload Packard Bell 98C21 (Photofact 1124-2)

There was no doubt about the diagnosis of AGC overload. With a strong TV carrier tuned-in, the receiver showed a fair-quality picture after the RF-amplifier tube was removed from its socket.

The first dc-voltage checks involved Q207, the AGC-keying transistor. Although all components of the Q207 stage tested normal, the collector voltage was too low.

After several unproductive tests, I replaced pulse-gate diode SR207, and was rewarded with a good picture that could be properly adjusted by the AGC control.

The picture tube had been arcing often, and apparently that damaged

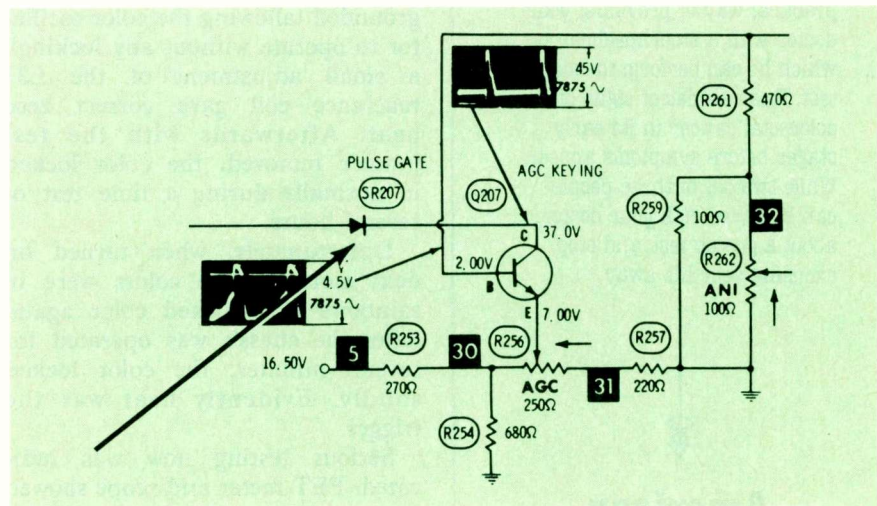

the diode, although it still had a good front-to-back resistance ratio. Sometimes replacement is the best

test.

Charles Spurgeon
Duncanville, TX

catalogs literature

A technical paper examining the effects of aluminum electrolytic capacitors on power supply filtering has been released by **Cornell-Dubilier**.

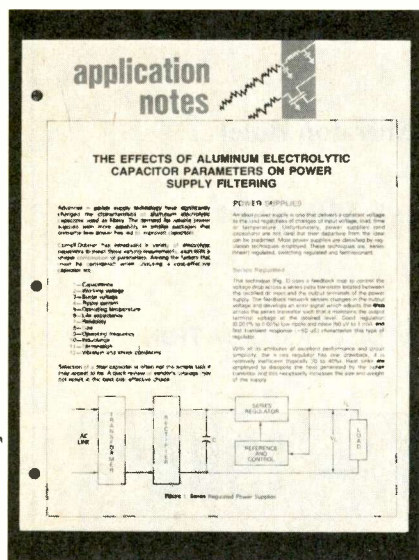

The article discusses types of power supplies and capacitor selection considerations for each type of supply. Detail is given for switching power supplies, with descriptions and recommendations for input and output capacitors.

Circle (45) on Reply Card

The **ETCO Idea Book** lists more than 4000 hard-to-find items. The 96-page book is designed for use by hobbyists, teachers, students, hams, experimenters, researchers, dealers, technicians and manufacturers.

Circle (46) on Reply Card

A 10-page color brochure, **Westinghouse Vacuum Interrupters**, describes a line of vacuum interrupters manufactured by the industrial and government tube division of **Westinghouse**.

The brochure contains brief case histories on applications of industrial and government tube division vacuum interrupters, manufactured to both US and international standards.

Circle (47) on Reply Card

ITT Schadow has published a catalog covering push buttons, key switches, rotary and slide switches. The 72-page illustrated catalog features mechanical and electrical data for all previous catalogued items as well as many new switches and front panel enhancement features. Also featured in the catalog is an option guide for quick selection, a statement of product warranty, a glossary of terms and suggestions for switch cleaning procedures.

Circle (48) on Reply Card

Heart attack or stroke could knock you down on your way up.

You're working for the challenge, the satisfaction, the success. The last thing you want is a heart attack or stroke. Yet, nearly one million Americans die of heart disease and stroke every year. And 200,000 of them die before retirement age.

The American Heart Association is fighting to reduce early death and disability from heart disease and stroke with research, professional and public education, and community service programs.

But more needs to be done.

You can help us find the answers by sending your dollars today to your local Heart Association, listed in your telephone directory.

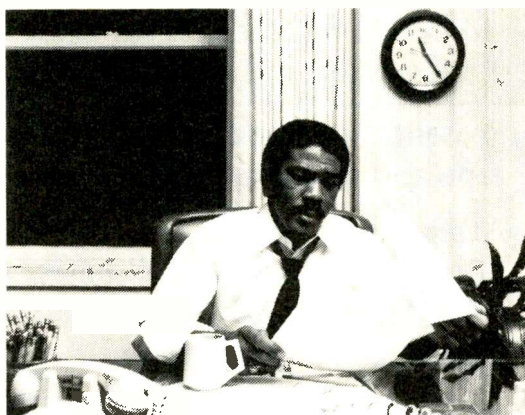

Put your money where your Heart is.



American Heart Association

WE'RE FIGHTING FOR YOUR LIFE

**Announcing Another Outstanding ITA
Industry Sponsored Seminar Devoted
to Home Video Tape & Disc Programming**

October 21-23, 1980

New York City



N.Y. Sheraton Hotel

7th Ave. & 56th Street

THE WORLD'S LARGEST INTERNATIONAL AUDIO/VIDEO TAPE & DISC ASSOCIATION
PRESENTS

"HOME VIDEO PROGRAMMING — 1980"

KEYNOTE ADDRESS • DR. ALAN GREENSPAN • WORLD RENOWNED ECONOMIST

Once again ITA presents the most prestigious and educational Seminar in our industry. An opportunity to interface and share experiences and views with key industry executives who appear on the program.

If you are contemplating, or are already involved in any area of Home Video, there is no better way to plan for the future than by attending this important conference.

Presentations and demonstrations of the latest developments in tape and disc equipment.

Attendance is limited to 200 registrations, accepted on a "first-come, first-serve" basis. At past ITA Seminars, hundreds have been turned away because of limitation in capacity so we suggest early registration.

A block of rooms and suites have been reserved at the New York Sheraton Hotel at a special reduced ITA Seminar rate. Reservations must be made on a special reservations request form which can only be obtained from ITA, and which will be mailed to you with the acknowledgement of your Seminar registration fee.

There will be no formal exhibition area, as ITA members invite you to meet them in Hospitality Suites.

For registration information, contact Diane DiMella, ITA, 10 West 66th Street,
New York, NY 10023, (212) 787-0910.

reader's exchange

There is no charge for a listing in *Readers Exchange* for items "Needed," but we reserve the right to select and edit all copy. Due to the limited amount of space for this department, "Needed" listings must contain no more than *three* items. If you can help with a request write directly to the reader, not to **Electronic Servicing**. "For Sale" listings will be charged for and included in the regular classified section of **Electronic Servicing**. Please consult that section for price and ordering instructions.

Needed: IF transformer for Zenith radio model K725, Zenith number 95-1248, Meissner 16-6682, Miller RA-117. Edward N. Carroll, 1108 Georgia Ave., Athens, TN 37303.

Needed: Operating manuals and/or schematics for the following test equipment: Precision model 910 tube tester, RCA model 150 signal generator, and Solar model CF capacitor analyzer. G. J. Kulp, 1115 Lilac Ln., West Lawn, PA 19609.

Needed: One flyback transformer for pin A30527-A for 1965 Ambassador model 4T40 portable TV. Bill Messina, 53 Railroad Ave., Norwood, MA 02012.

Needed: Power/filament transformer for Zenith model chassis 1005. Zenith part number 95-630N. Tom Modica, P.O. Box 347, Everson, WA 98247.

Needed: Schematics for Kenwood model TK-350 tuner, and an Audotron model WM-101 tape player. Will buy or copy and return. Also need a Heathkit 1G-28 color/bar generator. Steves Radio Service, P.O. Box 168, Wickes, AR 71973.

Needed: York model B/E-124 radio. FM/AM/MB/SW switch must be in good condition. L. E. Vargas, 8921 Roosevelt Blvd., Philadelphia, PA 19152.

Needed: Sencore CR31A, VA-48, LC-53, B&K-Precision 1077B and 467. Price must be below 1/2 list. Ed Tate, 8218 Jeffries Ave., Cleveland, OH 44105.

Needed: Socket adapter kit MX949/U for Supreme model 1-177-B tube tester. Also need operation manual for a Sencore TM116 tube tester modernizing panel. Larry Anderson, 3453 Balsam Ave., N.E., Grand Rapids, MI 49505.

Needed: System Electronics model 57 3-inch scope, schematic and manual, or current address of company. Ken Dolan, 286 S. Seymour St., Napa, CA 94558.

Needed: Sylvania D122000 chassis. Electronic Emergency Ward, 1603 Park Ave. So. Plainfield, NJ 07080. □

A Century in America



The Salvation Army "invades" the United States

Highlights of Salvation Army History

March 10, 1880—A group of Salvationists, seven women and one man, landed in New York City. Their first act was to kneel and pray on the cobblestones. Then they set to work, helping the needy and preaching the Gospel.

1917-18—The Salvation Army won the hearts of the doughboys serving in the trenches during World War I. General John J. Pershing praised "the Sallies" for "the degree of excellence and self-sacrifice in the work performed which has been second to none."

1930's—"No man need steal, starve, or commit suicide; come to The Salvation Army." This saying was sorely tested during the depression years when the Army fed and sheltered thousands of the unemployed. In New York City, the Army's emergency relief work increased 700 per cent in two years.

Today—There are over 1,000 Salvation Army corps community centers—in middle class suburbs, inner-city ghettos, and small-town main streets. To some, The Salvation Army is their church home. To others, a social service center which helps in times of need. To youngsters, an after-school recreation center. To all, an open door for anyone who needs its spiritual or practical ministries.



the marketplace

Advertising rates in the Classified Section are 35 cents per word, each insertion, and must be accompanied by cash to insure publication.

Each initial or abbreviation counts a full word.

Minimum classified charge \$3.00.

For ads on which replies are sent to us for forwarding (blind ads), there is an additional charge of \$3.00 per insertion to cover department number, processing of replies, and mailing costs.

Classified columns are not open to advertising of any products regularly produced by manufacturers unless used and no longer owned by the manufacturer or distributor.

For Sale

AUTOMOBILE RADIO and tape replacement parts: Delco, Chrysler, Philco-Ford, Motorola, Panasonic and many others. Large inventory. Laran EleoPronics, Inc., 3768 Boston Road, Bronx, NY 10469, (212) 881-9600, out of New York State, (800) 223-8314. 5-79-tf

TV & RADIO TUBES, 36 cents EA!! Free color catalog. Cornell, 4221 University, San Diego, California 92104. 8-78-tf

39.95
ADD \$2.50 FOR POSTAGE

ENCO ROUTE 9N,
PLATTSBURGH, N.Y. 12901
Tel.: (518) 561-8700.

FREE!
UNUSUAL 96 PAGE
ELECTRONIC PARTS
& IDEAS CATALOG!

Circle (10) on Reply Card

advertisers' index

Gamit Enterprises, Inc.....	17
Klein Tools, Inc.	11
Kurz-Kasch Inc.	7
Oelrich Publications	23
OK Machine & Tool Corp.	IFC
Phipps & Bird, Inc.	1
RCA Technical Publications.....	IBC
Howard W. Sams & Co., Inc.	3
Zenith Radio Corp.	BC

ELECTRONIC SURPLUS: CLOSEOUTS, LIQUIDATIONS! Parts, equipment stereo, industrial, educational. Amazing values! Fascinating items unavailable in stores or catalogs anywhere. Unusual FREE catalog. ETCO-011, Box 762, Plattsburgh, N.Y. 12901. 6-78-tf

TV RENTAL SYSTEMS! Complete & guaranteed. Manual or computerized. Send \$2.00 for complete details. Perry's rental systems, 133 Brenda Street, Milton, Florida 32570. 2-80-tfn

PRINTED CIRCUIT boards from your sketch or artwork. Affordable prices. Also fun kit projects. Free details DANOCINTHS INC. Dept. ES, Box 261, Westland, MI 48185. 5-80-8t

PICTURE TUBE REBUILDING EQUIPMENT capable of producing four high quality tubes per day (WILL TRAIN TO OPERATE) \$3600. Call or write Atoll Television, 6425 Irving Park, Chicago, Illinois 60634, ph. 312-545-6667. 8-80-3t

STROBE WARNING LIGHTS—PARTS, REPAIRS: R. Cecil, 805 South Penn, Roswell, New Mexico 88201. 8-80-2t

TELEPHONE CALLS recorded automatically, unattended, build yourself for less than \$10.00. Detailed plan \$2.50. Garrett Electronic, 6451-A Imperial Ave., San Diego, California 92114 8-80-6t

PICTURE TUBE REBUILDING EQUIPMENT capable of producing four high quality tubes per day (WILL TRAIN TO OPERATE) \$3600. Call or write Atoll Television, 6425 Irving Park, Chicago, Illinois 60634, ph. 312-545-6667. 9-80-3t

CAPACITOR KITS, FACTORY DIRECT! Subminiature Aluminum Electrolytics and Solid Tantalum. Send \$3 for catalog, prices and 3 samples. Beat distributor costs, keep stock up, costs low! ACT NOW! Cash or check; no C.O.D.'s. J. G. STEELE CO., Inc., Box 422, McKenzie, TN 38201, Ph. (901) 352-5109. 9-80-3t

100 TUNERS \$5.00 each plus shipping. Dan's TV, P.O. Box 42, Osakis, MN 56360, (612) 859-2851. 9-80-1t

SCRAMBLED TELEVISION, encoding/decoding. New book. Theory/circuits. \$9.95 plus \$1 shipping. Workshop, Box 393ES, Dept. C, Bethpage, N.Y. 11714. 7-80-tf

LOCKING NEEDLENOSE PLIERS! HOSPITAL QUALITY FORCEPS. 1001 USES! HEAT SINK; HOLDS TRANSISTORS WHILE SOLDERING; REACHES HARD-TO-GET-AT PARTS. GAP FOR VARIED USES. INSTRUCTIONS INCLUDED. FINGER HOLES INSURE SAFE, NON-SLIP USAGE. \$10.95 FOR THREE! (ONE WITH INSULATED HANDLES) \$1.00 SHIPPING-HANDLING. OKLAHOMANS ADD 39 cents TAX EACH SET. ELECTRONIC ENTERTAINMENT LTD., P.O. BOX 416, NICOMA PARK, OK. 73066. 9-80-1t

MODULES—ZENITH DEALERS KITS, 800-902 and 800-902A with case, new, \$225. Granzella, Wheatland, MO 65779. 9-80-1t

SYLVANIA CK3000 COLOR TEST JIG with complete adapters for Sylvania and RCA. Instructions and set-up charts, \$295. Sencore YF33 Yoke and Flyback Tester with schematic, instruction cassette and manual. \$125. Both in mint condition. M. Mc Burney, 7140 Marymount, Goleta, Calif. 93017. 9-80-1t

HELP WANTED

TELEVISION TECHNICIANS—Experience necessary, top pay, medical benefits, paid vacations. Enjoy a new "Life Style" in a beautiful, friendly, smog free, full service desert community. Send your resume to 225 E. Ridgecrest Blvd., Ridgecrest, California 93555. Telephone 714-375-1361 ask for Service Manager. 3-80-tfn

Business Opportunity

SAVE HUNDREDS: American Made quality Head-Ends, V/V, U/V Converters, Camera Modulators, Amplifiers for small CATV systems. Mid-band available. Factory prices. Send \$5.00 (or letterhead). Box 809, Boyton Beach, Fla. 33435. 8-80-tfn

TV SERVICE SHOP near SHAW AFB and Sumter, SC. Fully equipped. Warranty station for 3 major brands—\$10,000. Terms. Write Box 1164, Sumter, SC 29150. 9-80-2t

Electronic Servicing®

Advertising Sales Offices

NATIONAL SALES MANAGER
Greg Garrison, P.O. Box 12901
Overland Park, KS 66212
Phone: (913) 888-4664

NEW YORK, NEW YORK
Joe Concert, 4 West 58th St.
New York, NY 10019
Phone: (212) 888-1977

LOS ANGELES, CALIFORNIA
Herbert A. Schiff
3055 Wilshire Blvd., Suite 350
Los Angeles, CA 90010
Phone: (213) 387-0639

LONDON, ENGLAND
John Ashcraft & Co., 12 Bear St.
Leicester Square, London, WC2H 7AS
Phone: 930-0525
Telex: 895-2387

AMSTERDAM, HOLLAND
John Ashcraft & Co., John J. Lucassen
Akerdijk 150A, 1171 PV-Badhoevedorp
Phone: 2968-6226

TOKYO, JAPAN
International Media Representatives, Ltd.
2-29, Toranomon 1-chome, Minato-ku
Tokyo 105
Phone: 502-0656

C.E.T.

FOR TECHNICIANS WHO TAKE PRIDE
IN THEIR PROFESSION

CERTIFIED ELECTRONICS TECHNICIAN
Certification is available in the following areas:
AUDIO MATV
COMMUNICATIONS MEDICAL
INDUSTRIAL RADIO-TV

Write to: THE INTERNATIONAL SOCIETY
OF CERTIFIED ELECTRONICS TECHNICIANS
2708 West Berry, Fort Worth, TX 76109

Please send me:

Free booklet: CAREERS IN THE ELECTRONICS INDUSTRY (a stamped self-addressed envelope is enclosed)

Information about the CET Test.

A list of test administrators in my state/country.

I am already a CET. Send me information about IS CET membership. CET No. _____

NAME _____

ADDRESS _____

CITY _____ STATE _____

ZIP _____ PHONE () _____

RCA VIDEO CASSETTE RECORDER SELF-STUDY SERVICE COURSE

TELEVISION TECHNICIANS CAN NOW LEARN AT HOME TO SERVICE VHS FORMAT VCR'S

An ever increasing number of Video Cassette Recorders are being purchased by consumers, and many instruments sold earlier have now provided hundreds of hours of recorded entertainment. As a result, there is a growing demand for VCR service maintenance.

To meet the need of television technicians who intend to enter the field of VCR service, RCA developed this basic and in-depth home-study course. It consists of six instructional units, an appendix and two video training tapes. Each instructional unit is comprised of a study guide, reference material, workbook and quiz. Program content includes the basic concepts of video recording, mechanical and electronic system analysis and servicing considerations in addition to complete information on mechanical and electrical adjustments. The two video tapes, with a combined viewing time of one hour and forty-two minutes, visually demonstrate mechanical adjustment procedures.

SPECIAL INTRODUCTORY OFFER

This complete VCR training course with two video tapes is regularly priced at \$149.95. For a limited time only on orders received within the next 30 DAYS we will ship prepaid the entire package at the reduced price of: **\$134.95**

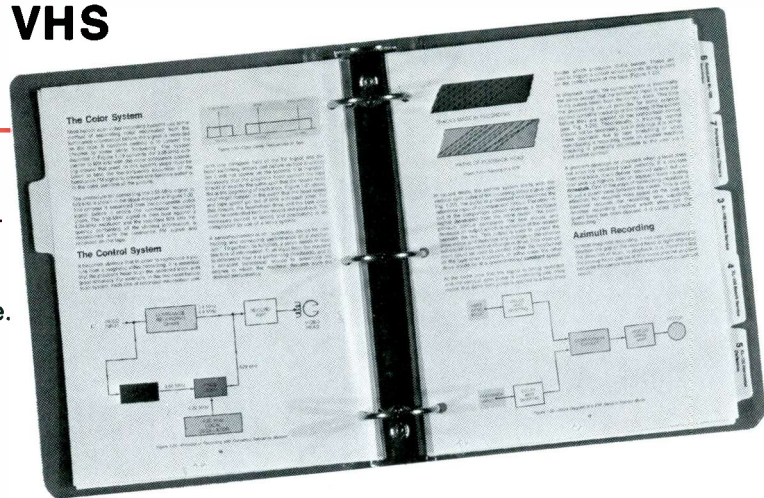

VIDEO HEAD REPLACEMENT AND INTERCHANGEABILITY ADJUSTMENTS

Specific visual instruction with audio narration on head replacement, cleaning procedures and interchangeability adjustments. Forty-five Minutes in full color, with subject matter referenced to the VCR counter number.

Available separately at: **\$49.95**



VCR TAPE TRANSPORT MECHANISM SERVICING

Clear, step-by-step sight and sound instruction on the most commonly required mechanical servicing procedures and adjustments. Fifty-seven minutes of dynamic visual demonstrations in color, with fast, easy indexing by VCR counter number.

Available separately at: **\$49.95**

YES, Send Me The Technical Training Materials Indicated Below.

QUANTITY

- _____ Complete VCR Service Course With Two Video Tapes at \$134.95
- _____ Video Training Tape Only, Titled *Video Head Replacement and Interchangeability Adjustments* at \$49.95 Each
- _____ Video Training Tape Only, Titled *VCR Tape Transport Mechanism Servicing* at \$49.95 Each
- \$ _____ TOTAL (Enclose Check With Order)

RCA

ES

THIS IS YOUR SHIPPING LABEL - PLEASE PRINT

NAME _____

STREET ADDRESS _____

CITY _____ STATE _____ ZIP _____

MAIL TO: RCA Technical Training 1-450, 600 N. Sherman Drive, Indianapolis, IN 46201



CHROMATENNA II

18 ways better to give you an antenna as strong as its name



Transmission Line Termination bleeds off static charges thru antenna system ground. Terminal stub improves front to back ratio on lower channels.



Aluminum Construction of all key metal parts works to eliminate rusting—provides long life. **Golden-Color Alodine Finish** is conductive—helps improve electrical performance!



High-Impact Plastic Insulators double-lock each element to the boom for extra bracing and durability.

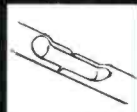

FM Block reduces FM gain up to 12dB. Remove to receive full FM gain.



Corner Reflector Bracket enlarged and re-located in most models.

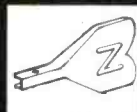

Zenith Dipole on UHF (Combination models only.)



VHF Colinear Directors provide extra signal boost on both low and high band VHF.



Loading Straps—metal plates close to first VHF element insulators provide compensation for Lo and High band by tuning the first driven element with extra capacity.



Rugged 1" Square Boom provides extra strength compared to many round-type booms.

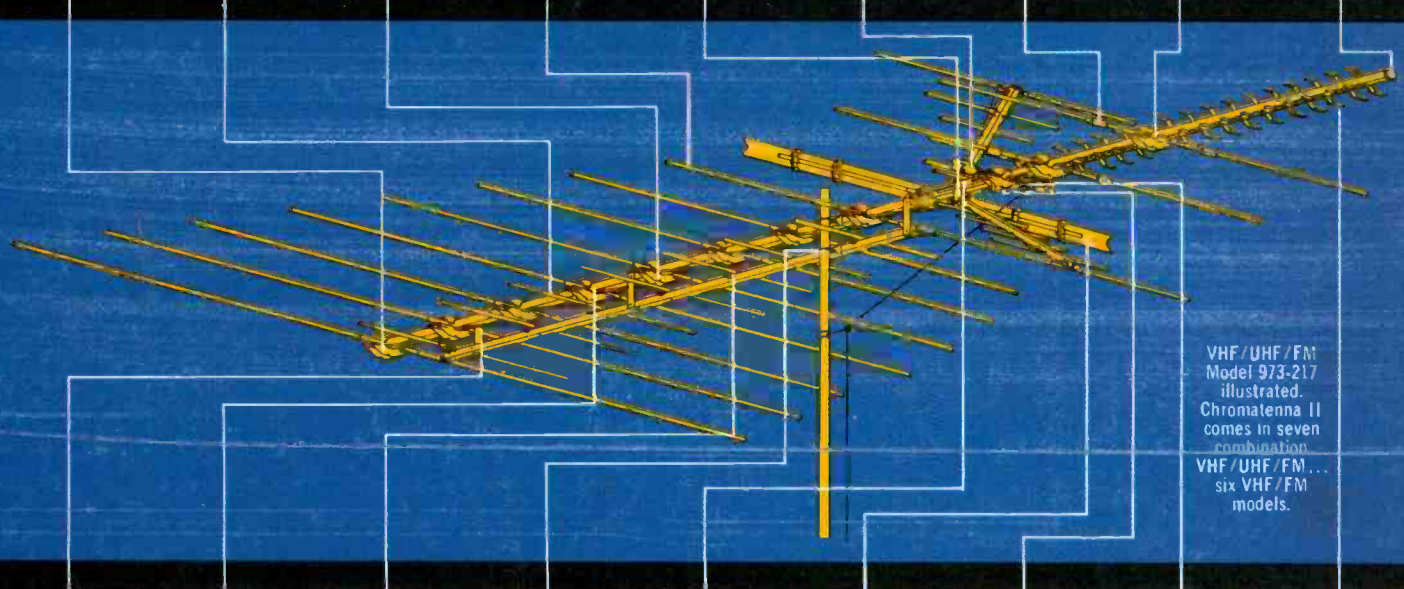

VHF/UHF/FM Model 973-217 illustrated. Chromatenna II comes in seven combination VHF/UHF/FM... six VHF/FM models.

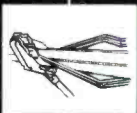

Wide-Spaced, Heavy-Duty Feed Lines help prevent shorting from heavy build-ups of snow or ice.



Sleeved Elements of heavy-duty construction afford extra bracing and protection.

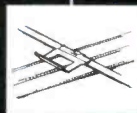

Hi-Bracket with angled ends for added strength.

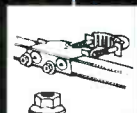

U-Bolt Mounting provides a larger clamping area; larger locking nut with teeth an integral part assures a more rugged U-BOLT arrangement.



Dual Isolator Bars insure no loss of UHF to VHF signal transfer. (Combination models only.)



Proximity Spaced Signal Balancer (Z elements) provides automatic taper control of periodic driver, improves impedance matching and signal leveling on both Lo and High band channels. Improves Channel 7 pattern.



Electrically Matched Terminals With Stainless Steel Screws eliminate mismatch... protect against rusting, and provide positive electrical contact with improved no-strip stainless steel serrated washers for the take off terminals.



Strain Relief Insulator accommodates either 300-OHM twin-lead, Foam lead or Coax downlead.



Optional Break-away UHF Wing Directors provide maximum gain of standard UHF channels with optional coverage of Hi UHF channels and translator frequencies when broken off. (Combination models only.)

Zenith has quality easy-to-install antenna kits—UHF only, VHF YAGI and Stereo FM antennas as well as a complete line of reception aid equipment.



The quality goes in before the name goes on.

Zenith Radio Corporation / Service, Parts & Accessories Division / 11000 Seymour Avenue / Franklin Park, Illinois 60131

Circle (2) on Reply Card