

May, 1980 □ \$2.25

Electronic Servicing

Biomedical maintenance

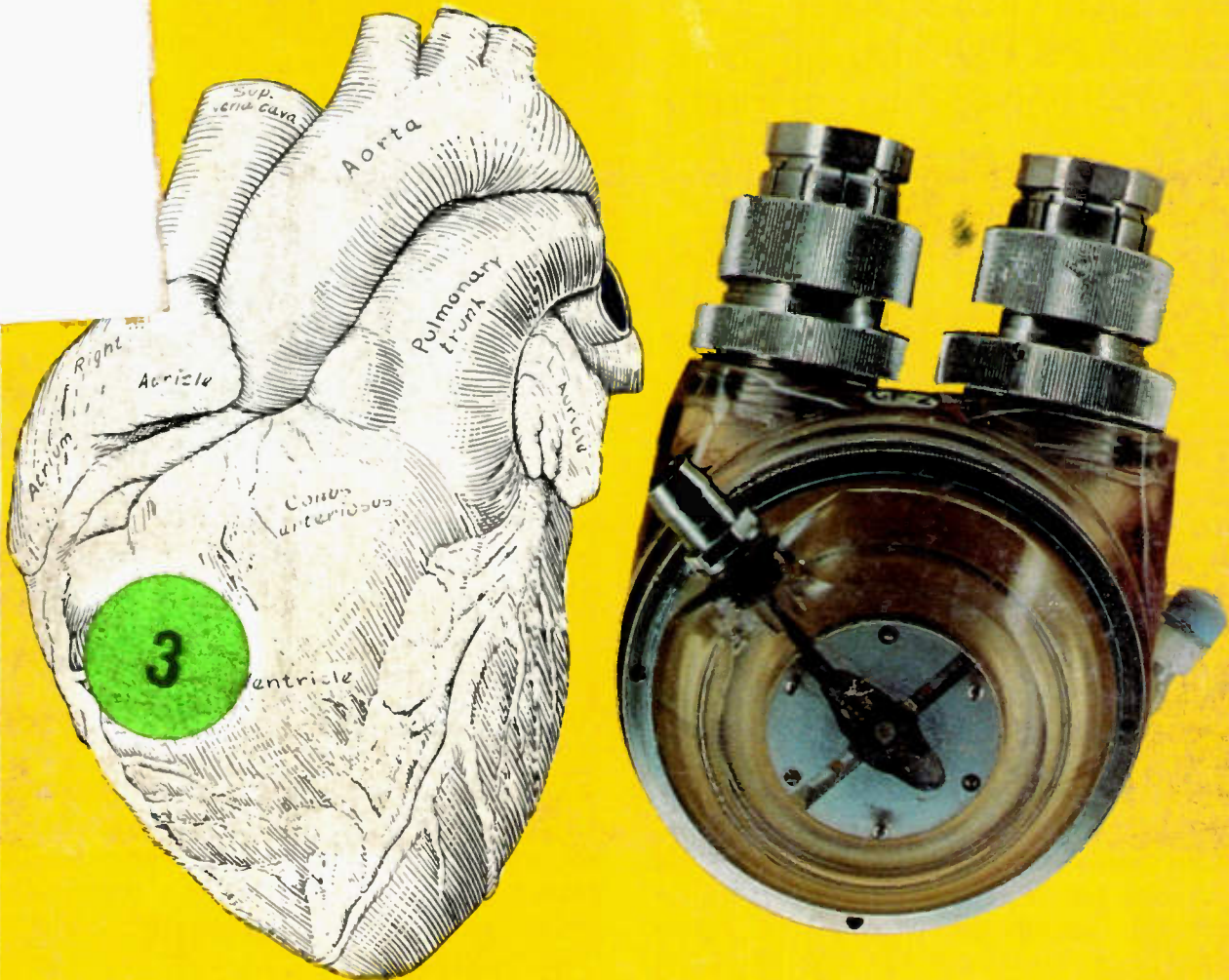

Verifying tube defects

Servicing frequency-synthesis tuners

Channel Master gives you 3 ways to insure CRT sales...

Safety

Implosion protection techniques used by Channel Master to produce All of their certified replacement tubes are recognized under the Component Program of Underwriters Laboratories Inc.



Channel Master has been meeting or exceeding industry implosion protection standards for over eighteen years by continually developing sophisticated new equipment and techniques. Local "rebuilders" just don't have these same resources and often try to cut costs by skimping on implosion protection. Tubes from these outfits are not only dangerous but can also cost you dissatisfied customers and lost sales.

Industry surveys indicate that there are some 30 million color receivers that are at least 7 years old, still in use in American homes today. Since the average life span of a color picture tube is 6 to 8 years, 30 million 7 year old sets represent an enormous continuing growth potential for CRT sales.

Superior Quality

During production, Channel Master examines every CRT by putting it through twenty separate and distinct tests. The tubes are even taken for a bumpy 65 mile ride and then tested again for focus convergence, emission and gas



ratio, high voltage leakage, inter-electrode leakage and peak cathode emission—just to make sure each tube delivered lives up to its guarantee.

Warranty

Whether it's a two year Monarch, three year Color Lux or a lifetime Opti-Chrome "LT," the warranty that comes with every Channel Master CRT is your assurance that you're giving your customers the best CRT available. They will appreciate the value you've given them, and you will appreciate their return sales!

Channel Master...We work harder to make you look better.

Channel Master

Division of Avnet, Inc.,
ES180, Ellenville, New York 12428

Electronic Servicing

Editorial, advertising and circulation correspondence should be addressed to P.O. Box 12901, Overland Park, KS 66212 (a suburb of Kansas City, MO); (913) 888-4664.

EDITORIAL

Bill Rhodes, *Editorial Director*
 Carl Babcoke, *Consumer Servicing Consultant*
 Mary Thornbrugh, *Associate Editor*

ART

Dudley Rose, *Art Director*
 Linda S. Franzblau, *Graphic Designer*

CIRCULATION

John C. Arnst, *Director*
 Evelyn Rogers, *Manager*

ADMINISTRATION

George H. Seferovitch, *President*
 George Laughead, *Publisher*

ADVERTISING

Greg Garrison, *National Sales Manager*
 Pam Morris, *Production*

Regional advertising sales offices listed near Advertiser's Index.



Member
 American Business Press



Member,
 Audit Bureau
 of Circulation

ELECTRONIC SERVICING (USPS 462-050) (with which is combined PF Reporter) is published monthly by Intertec Publishing Corp., 9221 Quivira Road, Overland Park, KS 66212. Controlled Circulation Postage paid at Shawnee Mission, KS 66201. Send Form 3579 to P.O. Box 12901, Overland Park, KS 66212.

ELECTRONIC SERVICING is edited for technicians who repair home-entertainment electronic equipment (such as TV, radio, tape, stereo and record players) and for industrial technicians who repair defective production-line merchandise, test equipment, or industrial controls in factories.

Subscription prices to qualified subscribers: 1 year—\$12, 2 years—\$19, 3 years—\$24, in the USA and its possessions. All other foreign countries: 1 year—\$15, 2 years—\$25. Subscription prices to all others: 1 year—\$25, 2 years—\$50, in the USA and its possessions. All other foreign countries: 1 year—\$34, 2 years—\$68. Single copy price \$2.25; back copies \$3.00. Adjustment necessitated by subscription termination to single copy rate. Allow 6 to 8 weeks delivery for change of address. Allow 6 to 8 weeks for new subscriptions.



INTERTEC PUBLISHING CORP.

Traditional



Wire-Wrapping

NEW

JUST WRAP



Wire-Wrapping

WHY CUT?
 WHY STRIP?
 WHY NOT...

JUST WRAP™ WIRE WRAPPING TOOL

- AWG 30 Wire
- .025" Square Posts
- Daisy Chain or Point To Point
- No Stripping or Slitting Required
- JUST WRAP.....
- Built In Cut Off
- Easy Loading of Wire
- Available Wire Colors:
- Blue, White, Red & Yellow

PATENTED U.S.A.

FOREIGN PATENTS PENDING

JUST WRAP TOOL WITH ONE 50 FT. ROLL OF WIRE		
COLOR	PART NO.	U.S. LIST PRICE
BLUE	JW 1 B	\$14.95
WHITE	JW 1 W	14.95
YELLOW	JW 1 Y	14.95
RED	JW 1 R	14.95
REPLACEMENT ROLL OF WIRE 50 FT.		
BLUE	R JW B	\$ 2.98
WHITE	R JW W	2.98
YELLOW	R JW Y	2.98
RED	R JW R	2.98
JUST WRAP-UNWRAPPING TOOL		
	JW 1	\$ 3.49

*Minimum billings \$25.00, add shipping charge \$2.00/New York State residents add applicable tax



OK Machine & Tool Corporation

3455 Conner St., Bronx, N.Y. 10475 U.S.A.
 Tel. (212) 994-6600 Telex 125091

Circle (5) on Reply Card



Maintenance

7 Reports from the Test Lab

By Carl Babcoke, CET

Hickok model LX-304 DMM features the functions and ruggedness necessary for measurements during service calls. Also, autoranging and provision for freezing the readings are two features of the Weston model 6000 digital multimeter.

11 Switches keep artificial hearts beating

By Fran Kafka, Micro Switch

Electronics has helped with development of a mechanical heart that may be used to extend human life.

14 Industrial product test reports

By Carl Babcoke, CET

This first product test report features an Autotron model RPF-303 infrared-beam self-contained photoelectric control system. It has many uses for security and industrial control.

Servicing

18 Servicing RCA frequency-synthesis tuning

By Gill Grieshaber, CET

Basic circuit operations and troubleshooting methods for the CTC99 tuners are discussed, following the final coverage of horizontal-sweep servicing.

27 Verify tube defects and prevent callbacks

By Wayne Lemons, CET

Tube tester readings and tube tests by replacement often need additional proof by dc-voltage measurements.

Departments

3 Electronic Scanner	32 Photofacts
4 Letters to the Editor	33 Catalogs & Literature
6 People in the News	34 Product Report
30 Symcure	38 Test Equipment Report
31 Troubleshooting Tips	40 Readers Exchange

About the cover

The cover shows an illustration of the human heart and a photograph of a clinical ventricular assist device that employs a Hall effect switch. Illustration reprinted with permission from *Anatomy of the Human Body*, edited by C.M. Goss, Lea & Febiger, Philadelphia, PA 1973 (Redrawn from Rauber & Kopsch). Photo courtesy of the Milton S. Hershey Medical Center, Pennsylvania State University.

AM stereo approved

The Magnavox system of AM stereo reception has been approved by the FCC. However, some legal steps remain. Widest usage of AM stereo is expected to occur in autos, since that is where FM reception is least effective. Added cost compared to a radio with FM-stereo and AM is \$2 to \$8, according to one estimate.

Another videodisc

US Pioneer Electronics plans to begin selling a \$749 (list price) laser-optical videodisc player this June in Dallas/Ft. Worth, Syracuse, NY, Madison, WI, and Minneapolis/St. Paul. Two features of the player are random access from a keyboard and an optional remote control system costing an additional \$50. This player seems to be directly competitive to the Magnavision brand by Magnavox. RCA is scheduled to market a capacitive unit next spring.

Name changes

Duracell International is the new name chosen by Dart International (the parent company) to replace P. R. Mallory & Co. The name is said to be more appropriate for the manufacturer of large quantities of alkaline, mercury, silver oxide and lithium batteries. Duracell is the trademark for the company's high-performance batteries.

Continental Specialties has changed its name to Global Specialties. The company manufactures breadboards, logic probes, frequency counters and other test instruments.

Satellite TV

Direct broadcasting from high-powered satellites to small antennas on individual homes is predicted by a FCC panel to be widespread by 1990. Reception from existing satellites is possible now, but high cost of the home antenna and down-converter prevents any serious competi-

tion with conventional TV broadcasting stations.

VCR sales rise

For the first quarter of 1980, sales of home videocassette recorders to dealers increased 59.2% compared to the same period of 1979. However, color-TV sales declined 2.7% below those of the 1979 first quarter.

Distributor closes most stores

Lafayette Radio Electronics plans to close 60 of its 68 stores in an effort to reorganize profitably under Chapter 11 proceedings.

PTS pioneers sonic cancer detector

PTS Medrix, a subsidiary of PTS Electronics, is involved in the production design, manufacturing and marketing of a new medical ultrasound system that can be used for the early detection of breast cancer. According to Roland Nobis, PTS Medrix president, sales for the system are projected to exceed \$100 million during the first seven years of full production. PTS Electronics has entered into a licensing agreement with the Indianapolis Center for Advanced Research for the production design, manufacturing, marketing and servicing of the ultrasound system. PTS Electronics' 42 company-owned and operated centers in metropolitan areas throughout the country will provide marketing and servicing for the system. Ultrasound was developed at the Indianapolis Center for Advanced Research, a research firm supported by Indiana University, Purdue University and the City of Indianapolis.

Electronic bagpipes

Keltic Pipes with electronic controls over pitch, volume and tuning now are available from Keltronics of Glasgow, Scotland. Traditional fingering has been retained, but no blowing is necessary by the musi-

cian. Optional headphones are available.

Ford selects Hickok meter

Hickok digital multimeter model LX-304 has been selected by the Ford Motor Company for inclusion in its Rotunda Parts and Service Division program. The hand-held multimeter will be in special red color as item 07-0001 in the Ford Rotunda Parts Catalog.

Dynascan introduces lighting control

Night Sentry is Dynascan's micro-processor-based lighting control for homes. It can control both inside and outside lights automatically providing both security and convenience.

TV profits decline

According to the third annual ITC survey, net profits of color-TV manufacturers have decreased each year. In 1976, the profit ratio was 3.7%, 2.8% in 1977, 1.5% in 1978, and only 1.2% in 1979. Although Japanese ownership of some American plants has risen sharply since 1976, the report does not provide individual profit ratios of Japanese ownership versus American.

Technology has no "quick fix"

No instant solution is possible for the present-day problems of energy shortage and dangers from breakdowns in high-technology operations, according to Dr. George F. Meclin, vice president of research and development for Westinghouse Electric Corporation. After a new breakthrough is discovered, about 25 years are required for development before it becomes important to society. Meclin identified seven technologies that show great promise. They are: conversion of coal into gas and liquid fuels; lasers; optics; fuel cells; solar photovoltaics; microprocessors; and robotics.

letters to the editor

Letters should be addressed to
The Editor, Electronic Servicing
P.O. Box 12901
Overland Park, KS 66212.
Please include company affiliation.

To the Editor:

In answer to your request for comments about subjects for articles, I would like a full explanation of the Magnavox Magnavision video-disc player.

Perhaps the device is too new for Photofact coverage, and Magnavox is releasing service data and test discs only in the selected marketing areas. A discussion of the circuits, alignment and repair procedures and software standards would be most welcome.

Larry Sheingorn
Conrad Enterprises
Washington, DC

Mr. Sheingorn:

If other readers agree with you, they too should write to the editor. Photofact does not cover any device until it has sales exceeding 25,000. Also, many circuit changes no doubt will be made before these players are available everywhere. A change from gas laser to solid-state is contemplated.

To the Editor:

I service the sound and light control systems for a disco, and need a schematic for Lite-Lab model L-4000 light controller. I wrote to them but they said they did not give out such information. Perhaps you could obtain a schematic from them and forward it to me. Your assistance is greatly appreciated.

Noah Sherrick, Jr.
General Electronics
Lima, Ohio

Mr. Sherrick:

A company that wants to keep their servicing information secret

probably never would send any to a publisher. Can other readers help with this request?

To the Editor:

Regarding Bob Goodman's article *Typical repairs of older Zenith TVs*, should Zenith E, F, G and H chassis be classified as older? Most of the older units I work on were manufactured before 1969. My own Zenith is a 1975 model that operates like new.

Please print Symcures for sets other than Magnavox, RCA Sylvania and Zenith. How about Symcures for Japanese and other imports, GE and audio equipment?

I would like to see an in-depth article about troubleshooting a YA GE chassis that blows the horizontal-output transistor and the 1A fuse.

Tom Seller
Tom's Radio-TV Service
Hudson, NH

Mr. Sellers:

By many standards, old includes TVs beyond the present 1981 line. Others believe that TVs more ancient than five years are old. There is no standard definition for old.

It has been difficult to obtain genuine repetitive troubles for some brands. Sony has failed to send up-to-date literature or to loan us a TV for analysis. Perhaps other readers will send us several Symcure-type tips. We pay \$5 for each one used.

The test techniques for overloaded output transistors have been discussed slightly. Perhaps in a few months we can provide more details. In general, the method involves operation of the output transistor at low power. This prevents burn-outs while tests are being made.

To the Editor:

I need to contact Radionics, the manufacturer of many 4-wire safety capacitors in horizontal-output

stages. Perhaps you know the address or can find out.

M. C. Holman
Clifton, TX

Mr. Holman:

A radionics was listed in only one of our reference books: Radionics Ltd., 195 Graveline Street, Montreal PQ, Canada H4T-1R6.

To the Editor:

Mention was made in the *Older Zenith* article that HV triplers eliminate the HV and often ruin the output transistor. How can these triplers be tested? Another question is about delay lines in color TVs. The schematics give no resistance value, and this rules out an ohmic reading. A coil can be proven good or defective by a ringing test. When I checked one for continuity, no reading was obtained. Why?

M. A. Smorowst

Mr. Smorowst:

HV triplers are difficult to test because they consist of many diode junctions in series, each one needs nearly 1V before it will conduct (even during a resistance test). Therefore, ohmmeter tests are useless, unless the tripler has a dead short. Some triplers have current-limiting resistors internally. Without such resistors, it would be possible to apply a current-limited voltage and measure the regulated voltage (diodes regulate within certain limits). We will investigate the problem and publish any good answer. *Delay lines* are more than just a coil. Most consist of a solenoid winding over a strip of metal foil that is grounded. This gives the effect of many LC low-pass filters, with each single turn and its capacitance to the foil delaying the phase a slight amount. Therefore, a delay line is a three-terminal device that should show a low resistance between two lugs (video input and output) and infinity to the third lug. Some lines have a dummy fourth lug for mounting

Editor Babcoke retires

Carl Babcoke, retired editor of *Electronic Servicing*, accepts an electronic bass guitar, a retirement gift from Intertec Publishing in appreciation of his 11 years of service.



Intertec Publishing has announced the retirement of **Carl Babcoke**, CET, editor of *Electronic Servicing*. Babcoke has been editor of the publication for 11 years. He began his career with *ES* as technical editor in 1969.

His involvement in the servicing field began in 1930, during the days of radio. By 1954, he had set up the first color TV in Kansas City and organized one of the city's earliest TV service departments.

Later, Babcoke worked for RCA Distributing Corp. as service manager. He was involved in service training and conducted technical seminars throughout the Midwest.

In addition to his hands-on work in the field, Babcoke has authored six books, including the classic standard on color TV repair, the *Color TV Servicing Made Easy* series. Other professional activities include his role as technical consultant and author for the magazines *Broadcast Engineering* and

Radio y Television. Babcoke will continue working with *ES* as consumer servicing consultant.

Bill Rhodes, editorial director of *Broadcast Engineering* and *Radio y Television*, will assume editorial directorship of *ES*.

Rhodes has an extensive background in industrial electronics, as well as broadcast electronics areas. He will accelerate *ES*'s coverage of the growing industrial electronics maintenance field.

Rhodes' background includes the position of editor of *Electro-Technology* magazine; work in electronics areas for Boeing Aircraft, Midwest Research Institute, International Rectifier, B&K Instruments and Indiana University.

His areas of experience include computers, minicomputers and microprocessors; the selection of servo-motors and servo systems; and the evolution of recorders, scopes and counters.

Noel H. Wallen has been named group sales manager in charge of technical products and export services of Wahl Clipper. **Leo T. Wahl** has been named assistant sales manager of the export department. **Ruth Heflebower** has been appointed assistant to the sales manager for technical products.

A.R. (Tony) Boyle, district manager of RCA Distributor and Special Products Division's Houston sales office, has been named the division's outstanding salesman for 1979. By winning the award, Boyle becomes president of the RCA D&SPD's Excelsior Club. Boyle has been with RCA since 1939.

Robert R. Ryder has been promoted to vice president/general manager of the newly created Switch Products Division of Digitran. Ryder was director of marketing and staff vice president.

Denis Wratten has been named president of KLH Research & Development, an Electro Audio Dynamics subsidiary. Prior to joining KLH in November 1978, as executive vice president, Wratten had been vice president of marketing for Infinity Systems, another EAD subsidiary.

Also at KLH, **Brian O'Donohue** was named vice president for finance and operations. O'Donohue previously served as KLH vice president for finance.

Quasar has announced a reorganization of its marketing department. **Jerry Hellmann**, former marketing manager, color, b&w and projection television, has been appointed group director, television products. **Tony Mirabelli**, former marketing manager, videocassette recording systems and audio products, becomes group director, audio and special products. **Gil Ravelette**, former marketing manager, microwave ovens, has been appointed group director, appliances.

Herbert J. Mayer has been appointed vice president and general manager of Belden's Cord Products Division. Mayer has been manager of planning since 1968.

Larry Puckett, PTS Nashville branch manager, has returned to the Nashville servicerenter to head up operations there. Puckett, who previously operated the Music City branch, had returned to Bloomington, IN, and held a position in the corporate headquarters tuner department. Puckett brings to Nashville his experience in TV tuner rebuilding and TV module exchange.

Michael J. LaPorte has been appointed executive vice president of Electrical Specialty Company, (ESCO), a Belden Corp. subsidiary in South San Francisco, CA. Previously, he was vice president-sales and marketing for Belden's Electronic Division, Richmond, IN. □

Reports from the test lab

Each report about an item of electronic test equipment is based on examination and operation of the device in the **ELECTRONIC SERVICING** laboratory. Personal observations about the performance, and details of new and useful features are spotlighted along with tips about using the equipment for best results.

By Carl Babcoke, CET

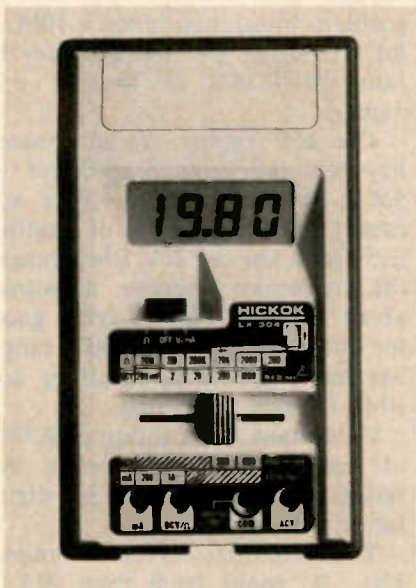

Hickok model LX-304 is a portable five-function digital multimeter measuring only 5 7/8" x 3 3/8" x 1 3/4" and weighing 12 ounces.



Model TP-20F temperature probe tests between -67F and +300F. Each millivolt at the output represents one degree F, when plugged into a DMM capable of 1mV resolution.

Portable digital multimeter

A rugged, portable DMM is model LX-304 from **Hickok**. Between 200 and 300 hours of intermittent operation can be obtained from each 9V battery. The test leads store under the removable protective lid. Accidental application of 120Vac to any voltage or resistance range does not damage the meter.

The sliding switches are arranged for convenient one-hand operation of all ranges. The readout is a 1/2-inch 3 1/2-digit LCD display with automatic-polarity indication, automatic decimal, automatic low-battery and over-range indications, and automatic zeroing. A few seldom-used functions have been deleted. These include ac current and low-voltage ac.

Specifications

Five dc-voltage ranges cover 200mV full-scale to 1000V full-scale with $\pm 0.5\%$ plus 1-digit accuracy and an input impedance of 10m Ω .

Ac-voltage ranges of 200V and 600V RMS full-scale are rated at 4.3M Ω input resistance with accuracy of $\pm 1.0\%$ plus 4-digits. Frequency response begins to roll-off above 1000Hz, reaching -1dB at about 1800Hz.

Resolution of 0.1mA is obtained on the 200mA and 1A dc-current ranges. Accuracy is rated at $\pm 1.5\%$ plus 1 digit.

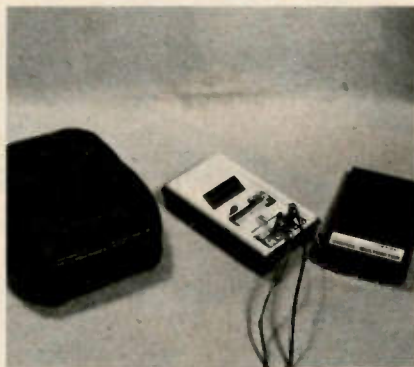

Each LX304 is equipped with a plastic cover that protects the meter and secures the test probes. An optional CC-3 zipper-opening case offers additional protection.

Six low-power resistance ranges cover 200 Ω to 20M Ω full-scale with about 0.3V across the test leads at maximum readings. In addition, the 20K range can be used to test transistor junctions and diodes, after a sliding switch near the Hickok name on the panel is moved to the up position (that exposes a red color). Although this function applies a higher dc voltage to force forward-biased solid-state junctions into partial conduction, it is *not* a high-power ohms function. The action has been tailored to show *comparative* readings of diodes and has non-linear response. Readings can be obtained on all ranges when the diode-test switch is turned on, but these readouts are not correct for resistance measurements. Therefore, be sure to turn off the diode-test sliding switch before measuring pure resistances.

Accessories

Many accessories are available for Hickok model LX-304. These include a padded carrying case, 10A current shunt, ac adapter, RF probe, 10kV probe, 40kV HV probe and a temperature probe.

Temperature probe and adapter

Model TP-20 is a probe and adapter system that can be used with any DMM (including LX-303 and LX-304) having a 200mV range. The temperature-measuring system is powered by one 9V battery and it measures -67F to +302F (or -55C to 150C for model TP-20C) at an accuracy of $\pm 2.3F$.

Comments

Hickok model LX-304 DMM has the functions and durability for either field or bench-top servicing. Accuracy is more than adequate for these applications. The sample meter showed only slightly higher readings than three other meters rated at $\pm 0.1\%$. The digital readout responded faster than most, giving about three updated readings per second. □

Circle (42) on Reply Card

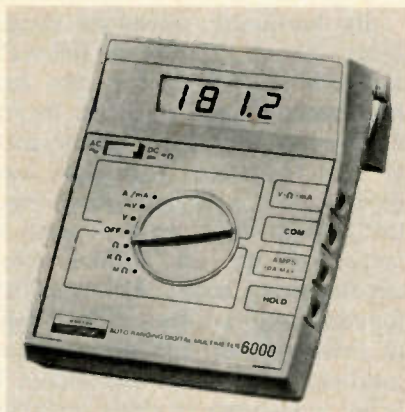

Figure 1 Weston model 6000 digital multimeter has autoranging to provide 26 ranges in nine functions. Functions and some ranges are selected by a rotary switch, while ac or dc readings are selected by the ac/dc switch.



Figure 2. The range plate can be removed by fingernail, to make accessible the two 9V batteries, the fuse and all calibration adjustments.

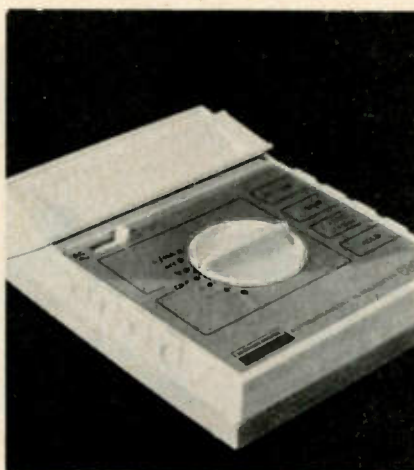
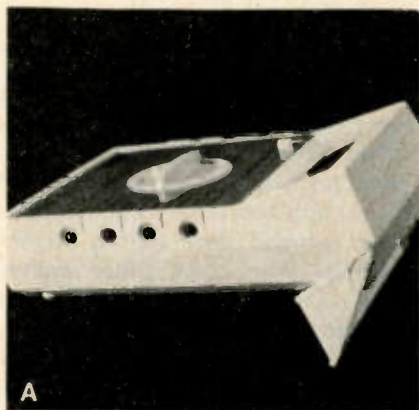

Figure 3 The carrying handle can be used as a tilt stand or a protective cover for the display. Banana plugs for the test leads are located on one side.

Autoranging DMM

Weston model 6000 is an autoranging digital-readout multimeter featuring nine functions in 26 ranges. Measurements are displayed on a 3½-digit 0.5-inch LCD readout (Figure 1). The same two input jacks are used for all measurements except 10A of current. A sliding switch provides dc or ac readings for both voltage and current. In addition, the rotary 7-position switch selects six functions and power off (Figure 1). Other ranges are selected by the autoranging.

Decimal placement, zeroing and polarity indication are all automatic.

A separate hold input jack is provided for a frozen reading. Continuity between the hold jack and the common test-lead jack prevents the reading from changing. The optional test leads have wires and hold switch ready for use.

A manual range-hold switch (that freezes the autoranging) and a backlight switch (for readings in the dark) also are optional.

Other accessories include: a 50kV HV probe; RF probes to 520MHz; a vinyl carrying case; clamp-on accurate probe for readings to 200A; and a light-meter attachment.

Two standard 9V batteries provide up to 350 hours of intermittent operation. The range plate can be removed without tools to permit

installation of the batteries (Figure 2) or for fuse replacement. This also exposes the calibration adjustments.

The carrying handle serves also as a tilt stand or a protective cover for the LCD display (Figure 3).

Accuracy ratings

Dc voltages from 00.1mV and 199.9mV are selected manually by rotating the function switch to the mV position. Four autoranged dcV ranges are selected by the V position. Input impedance is 10M Ω for all ranges and the accuracy is rated at 0.35% of reading ± 2 digits.

The acV ranges are the same; however, the input impedance is 9M Ω and the 40Hz-to-400Hz accuracy is rated at 0.5% of reading ± 5 digits. On the 20V RMS range, the frequency response measured about -1dB at 120kHz (very good for audio work). The 1000V range has less bandwidth. Readings are RMS for sine waves only.

Dc current has a rating of 0.75% of reading ± 3 digits, while the rating is 1.5% of reading ± 5 digits for ac current.

There are three resistance ranges. The Ω range reads from 00.1 Ω to 199.9 Ω with accuracy of 1% of reading ± 2 digits. The k Ω range extends from .001K Ω to 199.9K Ω with 0.5% of reading ± 1 digit accuracy. The M Ω range measures from .001M Ω to 19.99M Ω with rated accuracy of 0.5% of reading ± 1 digit.

All resistance ranges are low power, with 5V for an open circuit or less than 0.2V during measurements. Red test lead was positive for all ranges except the low Ω range, where it was negative relative to the black (common) lead. This must be remembered when testing the forward resistance of diodes.

Comments

Weston model 6000 autoranging digital multimeter performed well, giving higher accuracy than specified.

Circle (43) on Reply Card

Solid-state switches keep artificial hearts beating

By Fran Kafka
Micro Switch

A small Hall-effect solid-state switching device is one essential component of an experimental artificial heart that is under continuous development at Pennsylvania State University.

Early prototypes of the left-ventricular-assist (LVA) pump and the total artificial heart had been operated at a steady 100 beats-per-minute (BPM) or had been coordinated with an electrocardiogram. However, lack of dependability often caused early deaths of calves used as patients.

During each beat of an LVA or artificial heart, a heart-shaped polyurethane sac is filled. It is imperative that the researchers know when this sac is filled completely, because improper blood flow allows development of coagulations (thrombi) which can clog blood vessels, causing serious damage or death to the patient. Few devices can provide the perfect dependability required for signaling when the sac is full.

In 1976, a Micro Switch model 6SS solid-state switch was tried experimentally. It immediately solved several serious problems.

Hall-effect devices of this type are operated by a magnetic field. *There are no moving parts in the*

switching unit. Therefore, triggering is accomplished when a strong magnet and the switching unit are brought close together.

The model 6SS switch is epoxied into the base of the sac housing, and the triggering magnet is encapsulated in a polyurethane diaphragm at the bottom of the sac. The switch and magnet almost touch when the sac is filled completely, and this triggering starts the cycle. A simple device solved the full-sac problem.

Hall-effect switches have several advantages when used where maintenance-free long-life operation is essential. There are no moving switch contacts to oxidize or be-



Dr. William Pierce holds a total artificial heart (pneumatically operated) that was developed at Penn State's Hershey Medical Center. A model of a natural heart with the pumping chambers removed is in the foreground. Dr. Pierce is director of the interdisciplinary research team at Hershey. All photos courtesy of Micro Switch division of Honeywell.

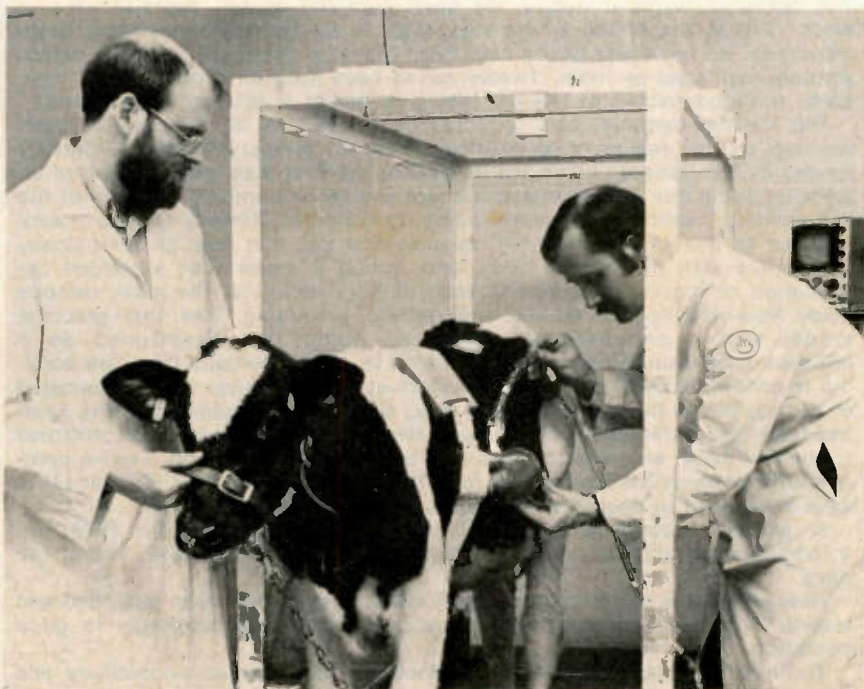

A left ventricular-assist (LVA) pump is checked by Dr. Eric Olsen (right) with assistance from Jeff McGarvey, animal-care technician. Similar LVAs are connected externally to humans after heart surgery, thus allowing the real heart to rest before the LVA is disconnected.

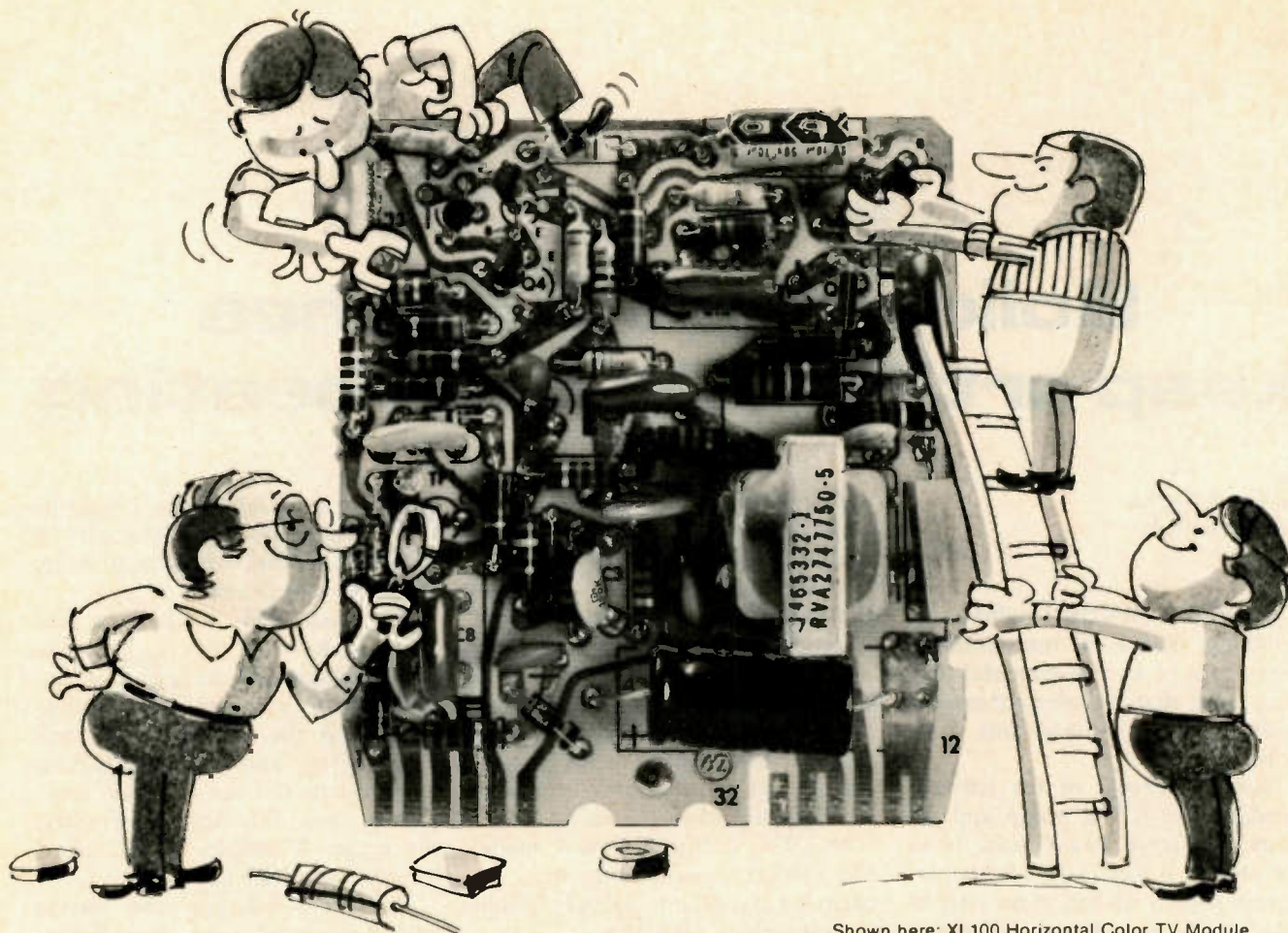

Shown here: XL100 Horizontal Color TV Module

Background of heart research

A series of artificial hearts has been pumping at 100 beats-per-minute since 1976 at the Milton S. Hershey Medical Center at Pennsylvania State University. So far, these hearts have been operated externally from the calves who are kept alive by them. Twelve calves have lived an average of 70 days each, while connected by flexible tubing to partial or total artificial hearts.

The Hershey-campus team, directed by Dr. William S. Pierce, has been working on the design of an artificial heart for almost 10 years. Primarily funded by the National Institutes of Health, the first step was creation of an artificial pump that approximated the size and blood-pumping capacity of the left ventricle, which is the main pumping chamber. Almost 10 years were required to design a segmented polyurethane sac that was physiologically compatible with the human body, and having a shape that prevented the formation of blood clots. The College of Engineering at the main campus made flow-visualization studies that proved promising. The first practical model was a pneumatically actuated pump that functioned as a left-ventricular-assist (LVA) pump. An LVA is used externally from the body, but is connected surgically to do the work of a left ventricle while a damaged or post-operative heart is allowed to rest, thus healing faster. After the heart has recovered sufficiently, the pump is removed and the aorta is reconnected to the real heart, an operation requiring only a local anesthetic. Twelve post-operative patients have benefitted from this type of LVA so far. Similar LVAs have been used in dozens of successful experiments with calves.

An angle-port pump (although still pneumatic) was developed in 1976, and it increased the survival rate of the calves to about 70 days, with one of 140 days.

Now an *electric* motor-powered total artificial heart has been designed and tested. One was connected in February. The calf was reportedly in good condition.

The new artificial heart weighs 2½-pounds and operates on ordinary 116 power. In the future, a 15-watt battery pack should permit about six hours of mobile operation.

It is predicted that electrically operated artificial hearts should be available for permanent implant in humans within about 10 years.

Artificial hearts

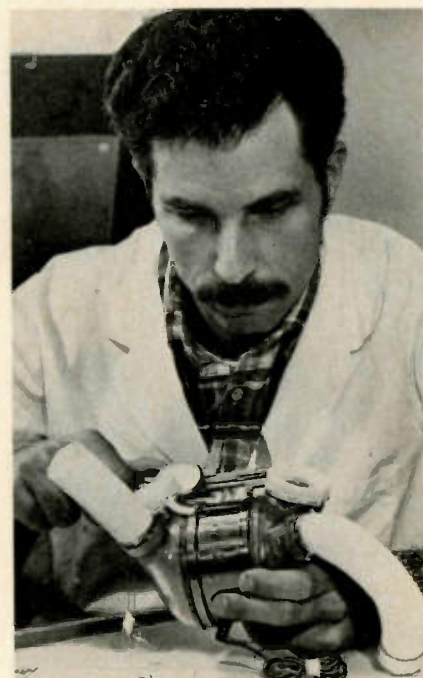

The latest artificial total heart from the Hershey Medical Center is the 2¼-pound electrical motor-driven heart being tested by Dr. Gerson Rosenberg. This is the type undergoing pre-implant experiments now. The first full implant is scheduled for 1981.

RCA remanufactured modules are as good as new, or even better.

You can be sure you're using a product of the highest quality when you install RCA remanufactured modules.

Each dud module returned to RCA is critically inspected. Those that don't meet factory standards for remanufacturing are scrapped. Accepted units are then cleaned and repaired. If any engineering improvements have been made in the module design, they are incorporated, where feasible, to make sure the module meets or exceeds original specifications for performance and reliability.

Included in RCA's rigid remanufacturing process are all IF and chroma sweep alignment adjustments, and setting of all circuitboard pots. Other tests include extreme temperature cycling of all modules, and vibration testing of selected types to disclose intermittent problems.

Finally, the modules are sample-tested by RCA Quality Control Engineering. If only a single module

fails to meet the original manufacturing specifications for performance, the entire lot is rejected.

In many cases, an RCA module can replace one or more earlier versions because it is designed to be compatible in older applications. This RCA design-improvement policy minimizes the number of types you need for servicing, reduces the amount of your investment, and improves instrument performance. The remanufactured module shown here, for example, can be used in place of five different modules.

RCA's remanufacturing process assures you of the most dependable replacement modules you can buy. You can be sure they are as good as new — or even better.

RCA Distributor and Special Products Division

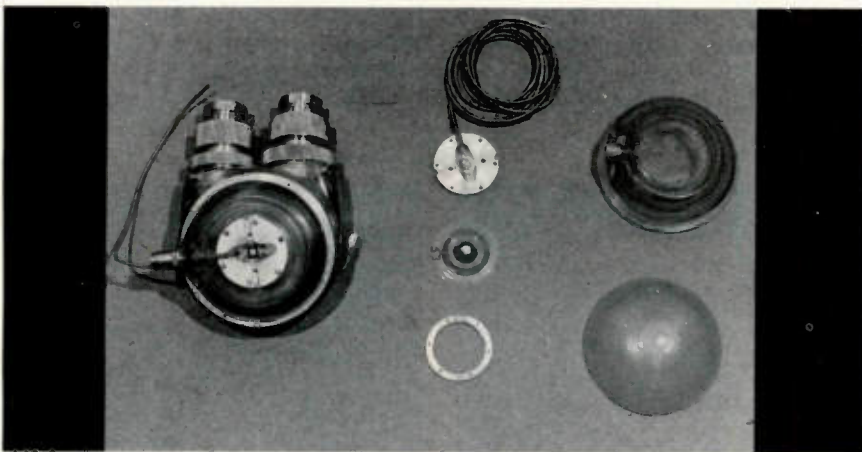

A complete LVA is shown at the left. The epoxy-mounted 6SS switch is at top-center, the magnet and diaphragm is at the center, with a clamping ring below it. At the top-right is the pump cap, and the diaphragm is at bottom-right. When actuated by nearness of the magnet, the solid-state switch starts a series of operations that allow the LVA to pump the proper amount of blood.

come intermittent. Conventional switches often are rated for 500,000 operations. But a human heart beats that many times in just five days, so ordinary switches are almost useless. Hall-effect devices are made from semiconductor materials and, therefore, have almost infinite lifespans.

The model 6SS switch does not deteriorate from dirt or body fluids, so it should never need to be replaced. There is little chance of an external magnetic field triggering the switch accidentally, because a comparatively strong magnetic field is required to trigger the device. Neither is the solid-state switch sen-

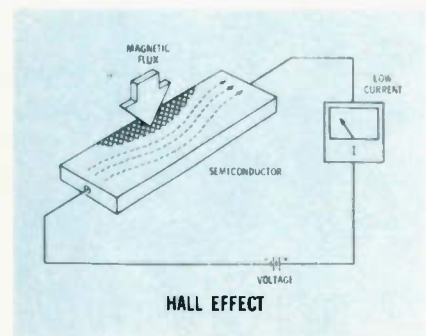

One characteristic of the Hall effect is a decrease of current through semiconductor material when a magnet is moved near the material, as shown. Commercial versions have Schmitt Triggers and other circuitry to improve the operation. Many are compatible with transistor-transistor-logic (TTL) digital circuits.

sitive to radio signals or other RF fields.

Hall-effect switches now are used in calculator and digital-terminal keyboards, position sensors and other products requiring maximum reliability. Some models have internal Schmitt Triggers for precisely timed output pulses. □

Industrial product test reports

By Carl Babcoke, CET

These reports describe an industrial type of component, control system, or specialized testing equipment. Some information was obtained from the manufacturer's instruction book and specifications sheet. The comments are based on personal inspection and operation of the device. Suggestions are given for both typical and unusual applications.

Infrared photoelectric control

Autotron model RPF-303 photoelectric control system performs on/off switching of controlled-equipment power according to whether or not the light beam is unbroken between transmitter and receiver.

Infrared light cannot be seen by unaided human eyes, so it is the choice when the light beam must be invisible. It also reduces problems from indoor ambient lighting, since fluorescent and incandescent bulbs do not radiate much infrared.

Additional immunity from ambient lighting is provided by modulating (chopping) the light source and limiting the receiver response to rapidly varying light levels only. Therefore, the receiver ignores all steady or slowly varying light levels.

For maximum immunity to ambient lighting, model RPF-303 operates with a *chopped infrared* light beam.

Reflected light—For most applications, the light beam is emitted and received through the same lens. This requires some kind of reflector at the far end to bounce the light back along the same route.

A retro-reflective disc has many 6-sided optical cells that reflect their outgoing beams closely parallel to the incoming beam. With retro-reflective paint, chalk and plastic tapes, the reflecting elements are a multitude of tiny transparent spheres. These materials reflect the light satisfactorily, even when the reflector is being vibrated or the disc is not tilted perfectly.

Many useful functions can be

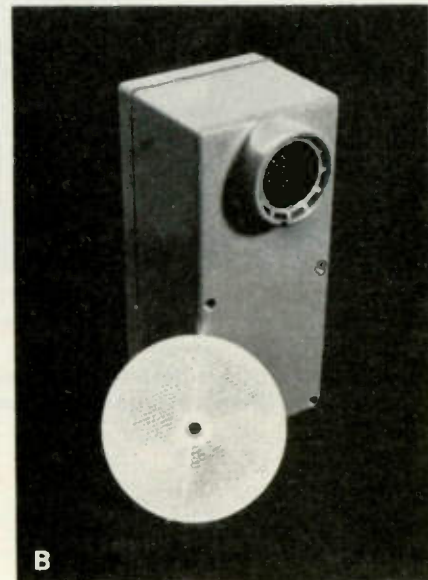
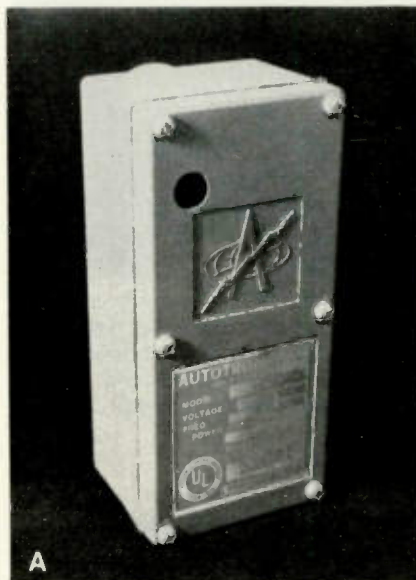

Autotron photoelectric system model RPF-303 is self-contained, except for the reflector. (A) The focusing lens for outgoing and incoming infrared beams is on the front of the metal enclosure which contains the electronics. Also shown is the retro-reflective disc that bounces the beam back to the lens. (B) The removable back has model number and electrical ratings. At the upper-left corner is the filter that covers a red LED used to indicate relative beam strength during alignment of the light path.

done when the alignment of light beams with the objects being monitored has been properly performed. For example, the position of reflective tape on a carton can activate a mechanism that diverts the carton

to the desired moving belt.

Basic description

Model RPF-303 has a die-cast aluminum box with dimensions of approximately 6 3/4- x 3 1/8- x 2 5/8-inches plus a 5/8-inch protrusion that protects the glass lens on the front. The removable back cover is secured by six captive screws, and a lip between box and cover prevents blow-in or deformation of the sealing gasket during high-pressure cleaning.

Six tapped holes in the bottom and four in the front of the case allow various kinds of mounting. A large 5/8-inch tapped hole is provided in the bottom for electric wiring. If the conduit is thick-wall type, the unit could be mounted by this wiring hole. A swivel bracket for tilting the unit to almost any angle is optional.

One 3-inch reflector disc is included with the basic unit. The disc can be mounted in many different ways.

Electronic operation

An IC oscillator generates square waves which are amplified by one transistor. The transistor collector current lights a GaAs infrared LED. This is the transmitter signal.

Light from the LED travels *straight* through the 45° mounted

half-silvered mirror, and is focused into a beam by passing through the glass lens on its way to the reflective disc. The disc reflects the beam back through the same lens. However, the angle-mounted mirror diverts the beam, causing it to strike the phototransistor. Output of the phototransistor has a dc level from the ambient lighting and square waves from the light beam. The dc is removed by high-pass filters, while the square waves are amplified and rectified to become a dc signal voltage that varies with the strength of the chopped infrared signal.

A sample of the rectified dc voltage controls the brightness of a red LED that can be seen through a red filter on the back of the housing. Stronger signals increase the red LED brightness. This varying brightness is used as an indication of relative signal strength during adjustments of the reflector (for maximum signal level).

Another sample of the dc signal operates a Schmitt trigger which provides dependable snap action of

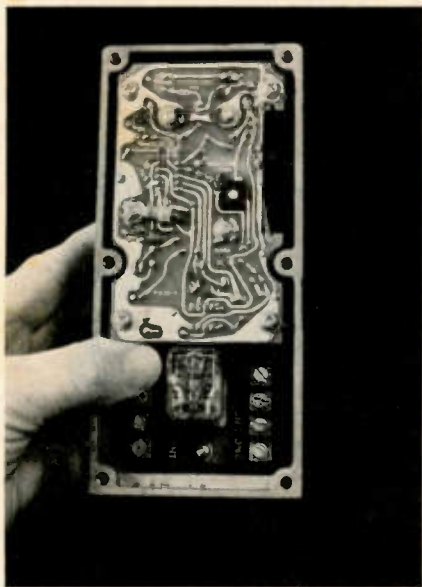

Removing the back exposes the circuit board's wiring side. Below the board are the ac wiring terminals and the plug-in power relay. The notch in the board is for insertion of any optional timing module. Without a module, the unit performs on/off switching in synchronism with breaking and closing of the beam.

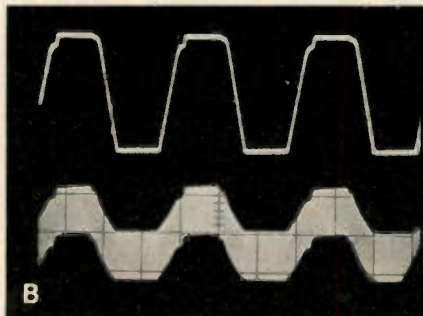
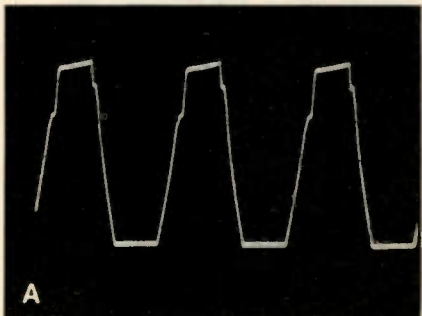

(A) These 0.5VPP 5000Hz almost-square waves were scoped across the infrared transmitter LED. Notches near the top mark the start and finish of LED current. (B) Similar waveforms were found at both base and emitter of the driver transistor (top trace). The collector waveform (lower trace) showed a large amplitude of 120Hz power-supply ripple when scoped to ground. On the sample, base measured +3.63V, emitter +3.01V, and collector +14.21V.

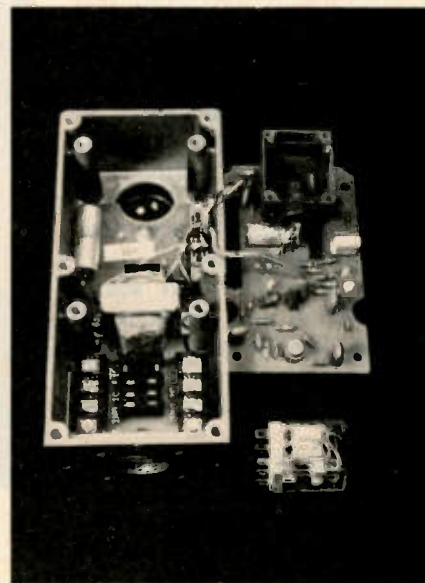

Removal of four screws allows the circuit board to be removed and turned over for good accessibility. Power-supply components and the module socket are exposed.

Industrial reports

the relay-driver transistor and ac-power relay.

A wire with spade lug is connected to either the screw terminal marked *light* or the one marked *dark*. This determines whether the relay is energized when the beam is unimpeded (light) or when the beam is blocked (dark).

Sensitivity can be adjusted by rotation of the *sens* control.

The power relay has double-pole double-throw contacts rated at 10A for a resistive load. The relay plugs into a socket for easy replacement, and it is sealed to keep out dirt and moisture. Terminals are provided near the relay for line voltage and relay wiring.

Timing modules

As it comes from the factory, the RPF-303 performs dependable on/off operations. However, a slot at the right of the sensitivity control allows installation of a function card (module or panel) in the edge-connector socket.

These function cards permit the timing of either light or dark cycles. They have variable time-delay controls.

Other options include these:

- Solid-state switch (opto-isolated triac) output that gives longer life and handles faster repetition rates.
- Logic output that is supplied by a transistor sinking up to 100mA. This allows interface with electronic controllers and computers.
- A visible red LED light source for easier testing and alignment of the beam in difficult installations.
- Inputs for 230Vac, 12Vdc, or 12Vac power. The unit draws only 5W.
- Universal swivel mounting bracket.
- A separate transmitter unit for operation up to 200-feet. Standard dual-purpose units operate with up to 35-feet of beam distance. Of course, smoke, steam or dirty windows in the beam path reduce the maximum distance for dependable operation.

- A special system is available with a 6-digit manual-reset counter mounted on the housing.

Applications

Counting operations, end of roll indicator, blockage indicator, one-shot action (filling pie shells, for example), and burglar alarm are a few applications. Autotron literature illustrates many uses.

Troubleshooting

The RPF-303 manual devotes one full page to servicing these units. Many typical possible problems and remedies are illustrated. Most components are readily accessible. Technicians who are experienced with solid-state analysis on circuit boards should have no unusual difficulties when servicing these control systems. □

Circle (15) on Reply Card

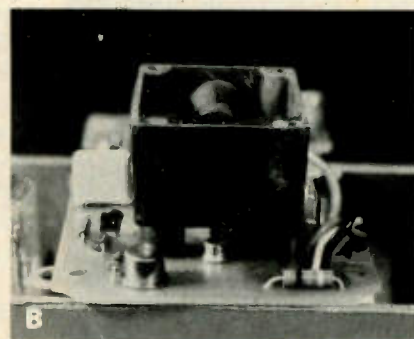
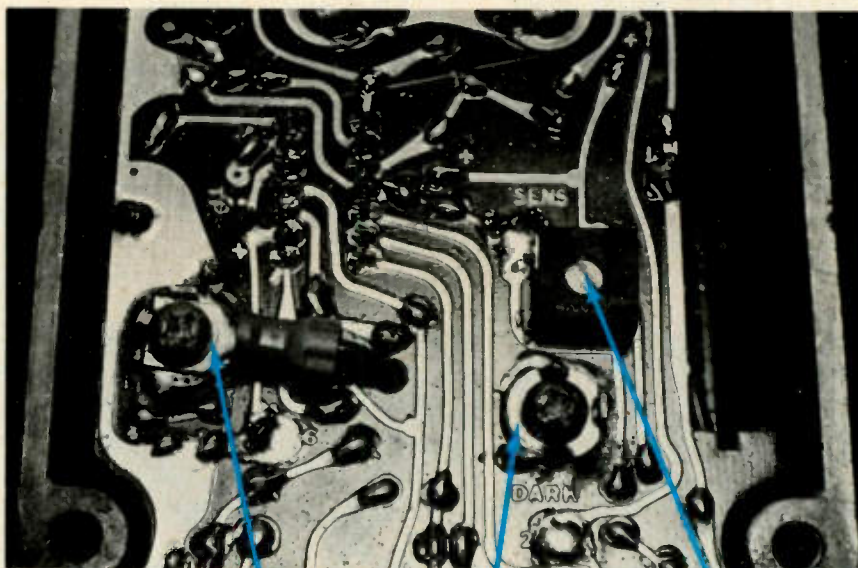

Photo (A) shows the phototransistor end of the beam-splitting mirror. (B) The infrared LED is on the chassis below the mirror assembly.



Light switching Dark switching Sensitivity

Arrows point to the *light* terminal with wire (this causes the relay to close and remain closed while the beam path is complete), the dark terminal (when the wire is moved to it, the relay closes and remains closed so long as the beam path is open), and the sensitivity control. These are the only adjustments, although each plug-in timer module has a time control.

VCR SERVICING PROBLEMS?

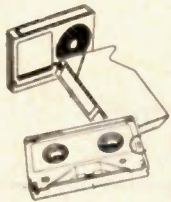

Get Answers From Expert Troubleshooting Writer

FOREST BELT during a 3-day

Home Video Recorder Seminar

Grab this opportunity
to gain VITAL
VCR servicing know-how

1980 Locations

Los Angeles

June 30-July 2

Chicago

July 17-19

Philadelphia

August 18-20

Day 1-General electronics of Beta & VHS formats. Emphasis on practical troubleshooting.

Day 2-Mechanics and digital electronics of threading and unthreading cassette-type VCR's, how to clear jammed cassettes. Live VCR's and test instruments assure you of experience you can apply realistically to troubleshooting.

Day 3-Intimate details of the electronics and mechanics involved in driving and synchronizing the helical-scan head cylinder and capstan, especially VHS and Beta servos.

Get Hands-On Solutions to puzzling VCR troubles

- ✓ QUICKLY
- ✓ EFFICIENTLY
- ✓ EFFECTIVELY

Package Fees Include:

- Timely training
- Best teachers
- Carry-home manual
- Hands-on experience
- Certificate of training
- All workshop materials and functions
- Hotel room (double-occupancy)
- Meals

Seminar-Only Fee

Includes:

- Timely training
- Best teachers
- Carry-home manual
- Hands-on experience
- Certificate of training

**BE THERE,
ENROLL NOW!**

ENROLL ME in the 3-Day VCR Seminar at: Los Angeles Chicago Philadelphia

3-Day Package \$950

3-Day Seminar Only \$735

Total Enclosed \$ _____ Check # _____ MD \$200 Deposit, Balance Due 30 Days Before Seminar

Charge my Master Charge # _____ Expires _____ Signature _____

(A minimum \$50 Processing Fee will be charged on all cancelled enrollments.)

NAME _____ AGE _____ PHONE () _____

ADDRESS _____ COMPANY _____ TITLE _____

CITY _____ STATE _____ ZIP _____

Class Size Limited

We Honor
Master Charge



Liaison Electronics Seminars

(317) 253-7774

P. O. Box 40821

Indianapolis IN 46240

Servicing RCA frequency-synthesis tuning

After the final horizontal-sweep tests are completed, the RCA CTC99 frequency-synthesis tuner system is explained, along with troubleshooting suggestions.

By Gill Grieshaber, CET
Gill's Color TV Service

Additional facts needed for fast, efficient troubleshooting of RCA CTC99 horizontal sweep can be (and should be) obtained from any symptoms viewed on the TV screen during operation, and from the interpretation of more scope waveforms.

TV pictures show defects

If any sort of picture can be obtained on a malfunctioning TV, a dot-bar generator should be connected to the receiver while the crosshatch and color bars are examined for substandard conditions. Analyze the stability, sharpness, focus, width, height, linearity and brightness. Clues obtained at this step often can shorten the troubleshooting time substantially.

A normal CTC99 crosshatch pattern for comparison with other conditions is shown in Figure 1A. Expanded horizontal linearity at the left in Figure 1B results from a shorted L106 linearity coil. A nar-

row and hum-modulated horizontal sweep (Figure 1C) was seen after the line voltage was reduced to 90Vac (to prevent shutdown). A shorted SCR100 was the defect.

In addition to the knowledge of chroma conditions that's made possible by color bars, the 10 visible color bars also can reveal pincushion and width problems. Figure 2A shows normal color bars (printed here in black-and-white), while the Figure 2B picture shows narrow width and pincushioned color bars. Both defects were caused by an open Q400 in the pincushion circuit. (In addition to eliminating the side pincushioning, this circuit also has a large effect on the width. Defects can widen the picture excessively or narrow it.) Figure 2C shows only eight color bars, proving excessive width which is the symptom of T103 shorted windings. Of course, a shorted Q401, C404 or CR402 produces the same symptom.

Scope waveforms indicate defects

Waveforms at the collector of Q100 horizontal-output transistor

probably are the most helpful for quick tests. This is true for full-line voltage or 35Vac test voltage. In addition, many defects also change the SCR100 anode waveform in significant ways. Therefore, many of the following examples involve those two testpoints.

Yoke problems—An open circuit to the two parallel-connected horizontal-yoke windings produces two sensory symptoms: an erratic high-frequency whine, and a single low-brightness vertical line without a raster. These symptoms are unmistakable, as are the accompanying waveforms.

Figure 3A shows the Q100 collector signal instability that generates the whistle. After the oscillator-driver stages were operated from external dc voltage and the line voltage reduced to 35Vac, the waveform became almost steady (Figure 3B). Notice the broad pulses that are typical of any open horizontal yoke.

If only one of the horizontal-yoke coils opens, the picture will have a trapezoidal shape. A serious case of



Figure 1 Crosshatch patterns reveal many horizontal defects. (A) This is the normal crosshatch for comparison. (B) A shorted L106 linearity coil expanded the linearity at the left. (C) When SCR100 regulator was shorted, shut-down occurred at normal line voltage. After the line voltage was reduced to about 90V, a small raster with 120Hz hum could be seen.

The one tool that pays for itself first time out.

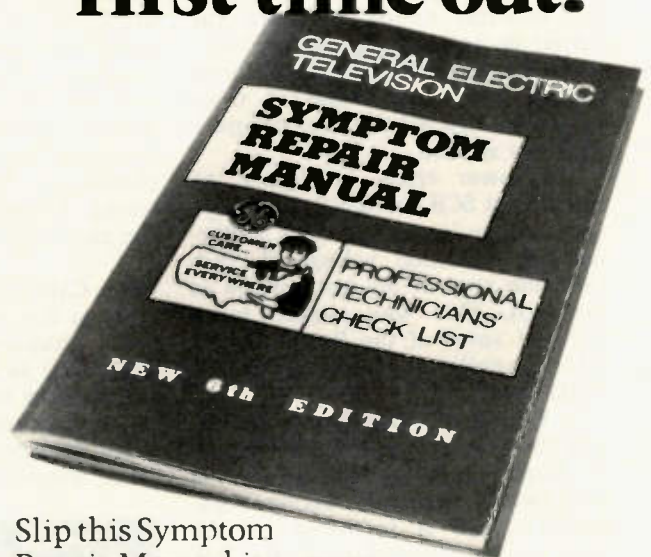

Slip this Symptom Repair Manual into your tool caddy. It lists all sorts of symptoms for individual GE TV chassis and tells you what to check and in what order. You can save hours of frustrating (and unprofitable) diagnostic time.

The new Sixth Edition manual packs the combined experience of hundreds of service technicians into a 5½" by 8½", 104 page package. It's free to subscribers of GE Technical Data, but non-subscribing technicians may obtain a copy by paying a \$2.00 handling fee. You can make that back in the first few minutes it saves.

"DUTCH" MEYER
 GENERAL ELECTRIC COMPANY ES
 PORTSMOUTH, VA 23704

Please check items desired:

One Symptom Repair Manual (\$2.00 Enclosed)
 Two Symptom Repair Manuals (\$3.00 Enclosed)

Enclosed is Check Cash or
 Money Order (No C.O.D. Please)

Name _____

Service Company _____

Address _____

City _____ State _____ Zip _____

IT'S OUR BUSINESS TO MAKE YOUR BUSINESS EASIER.

GENERAL ELECTRIC

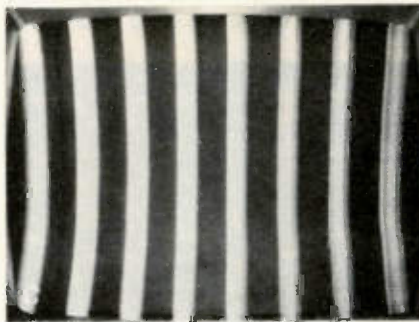
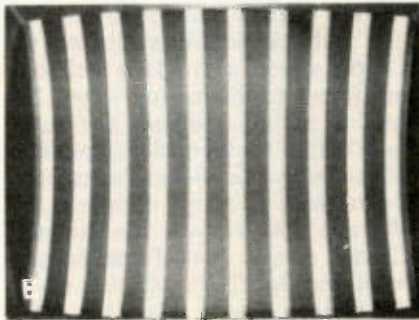
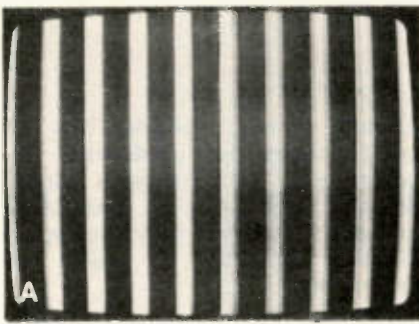
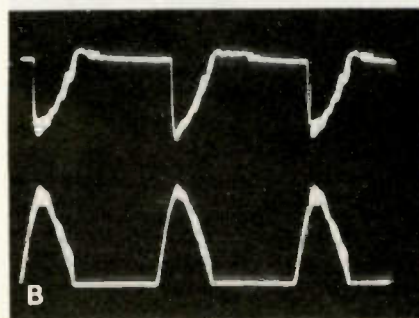
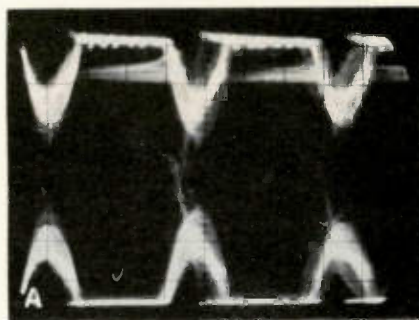

Figure 2 Width and pincushion problems are shown clearly by color bars. (A) Normal width displays eight complete and two partial color bars. (B) An open Q400 pincushion transistor narrowed the width and gave severe pincushioning. (C) An excessive width of only eight bars and pincushioning were visible when the T103 transformer had shorted turns (or any pincushion transistor was shorted).

Figure 3 (A) At 120V line voltage, an open horizontal yoke gave a dim single vertical line, a singing noise from the flyback, and unstable patterns at the SCR anode (top trace) and the Q100 collector (lower trace). High voltage was 28kV. (B) After the line voltage was reduced to 35V and the oscillator powered from an external supply, the waveforms were stable and the HV was 7kV. Notice the broad pulses that are typical of open yoke waveforms.



RCA tuner

shorted turns in either winding overloads the horizontal-output transistor and probably will ruin it.

Regulator problems—Waveforms at the SCR100 anode indicate the output dc voltage and other conditions. Each upper waveform shows normal regulation. Some of these variations are subtle, and comparisons are needed.

The lower trace in Figure 4A shows that SCR current flowed for a shorter time (narrower step), reducing the regulated voltage (farther from the step to the hot voltage at the top). This was caused by a reduced value of the R113-through-R116 paralleled resistors at the Q102 base.

In Figure 4B, a reduced value of R117 increased the regulated voltage by lengthening the SCR conduction time (wider step). The higher regulated voltage is indicated by the step moving upward near the hot supply at the waveform's top.

Safe operation at low voltages

Many defects in the horizontal-sweep and high-voltage circuits can overload and destroy the horizontal-output transistor. If a new transistor is installed, but the overload is not eliminated, the replacement also shorts or otherwise fails. The solution is to operate the Q100 output transistor at about +45V, where these overloads can be tolerated without additional failures. This method buys time to make voltage tests and waveform analyses.

The steps were given last month: reduce the input line voltage to 35Vac RMS (sine waveform), connect the positive wire of an external 23V supply to TP-13 (CR422 cathode), and ground the negative wire to the cold-chassis metal rail (this connection was not made clear previously). No picture or sound can be obtained by the low-voltage operation, but voltages and waveforms can be measured.

Shorted L103—One defect that sends a CTC99—when operated with full power—into instant shutdown is shorted turns in L103, the coil in series with the SCR100 anode. Low-voltage operation prevents damage and shutdown during scope tests.

Figure 5 shows the SCR100 anode voltage waveform versus its current waveform when L103 is shorted and when it is not. When L103 was

shorted by a test lead during these measurements, the Q100 collector pulse amplitude increased almost 30% without much waveform change. At the SCR100 anode, the amplitude changed little, but the waveform was noticeably different. However, the most drastic change was in the SCR current. During normal operation, the current increased gradually to maximum (forming a kind of rounded sawtooth), but a shorted coil allowed the current to flow in abrupt pulses.

Open C117—Another defect that increases the high voltage and activates shutdown (during full-power operation) is an open C117 (Figure 6), which is the main tuning capacitor for retrace. Therefore, the C117 value determines the Q100 collector-pulse amplitude and, in turn, the

amount of high voltage. The TV must not be operated with full power and the shutdown circuit defeated when C117 is open. Arcs and overload could cause extensive damage, since the HV would approach 50kV.

Waveforms of flyback overloads—Shorted turns or overloads on the T102 flyback windings distort the SCR100 anode and Q100 collector waveforms in distinctive ways. Notice that not all overloads decreased the HV that's obtained during low-voltage operation. Some shorts actually increase the high voltage.

Figure 7A shows the normal SCR100 anode waveform (upper trace) and the Q100 collector waveform (lower trace) when the 123V supply is about +45V during these tests. The corresponding traces of

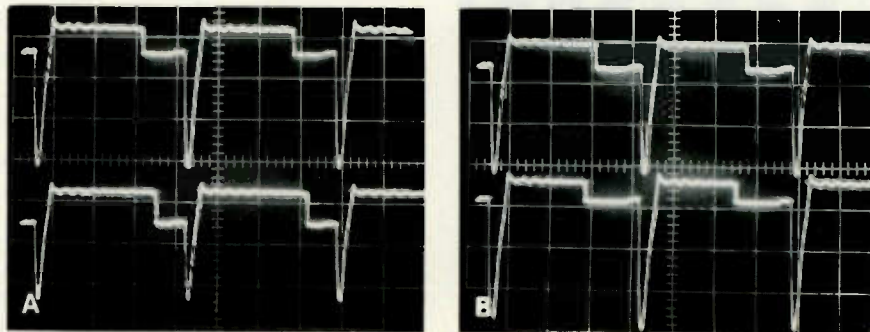

Figure 4 Conduction of SCR100 regulator affects the regulated B+ voltage, the amount of HV, and the SCR anode waveform. (A) Upper waveform is the normal 480VPP SCR anode signal. A reduced value of R113 produced a narrow and dark picture, HV of only 22kV, and a 340VPP anode waveform (lower trace) with shorter conduction (horizontal section of the step) and a regulated voltage of +95V (vertical section of the step). (B) Again, the top trace is normal, while the 540VPP lower trace shows the longer conduction time (horizontal part of the step) and less distance between step and top of waveform (+132V) along with a wider picture and a HV of 33kV. A higher value of R113 produced these changes.

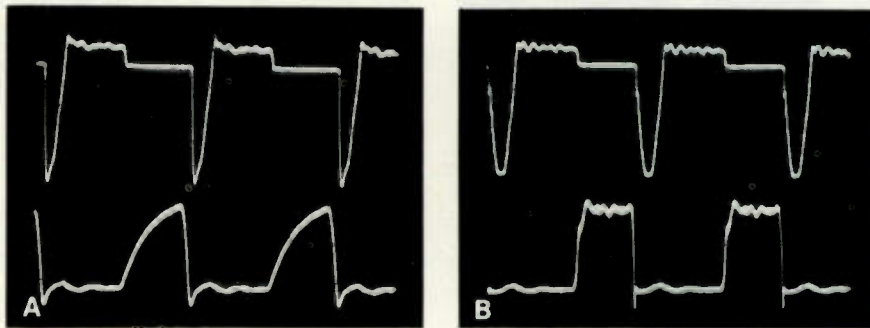

Figure 5 With normal 120V line voltage, shorted turns in L103 produces shutdown from higher regulated voltages. These waveforms show normal versus shorted L103 waveforms during low-voltage operation. (A) Normal operation has an SCR100 anode signal of 170VPP (top trace) and a sawtooth waveform of current (lower trace). (B) When L103 was shorted, the anode amplitude rose slightly to 180VPP while the average current increased about 25% because of the square-tipped dc pulses. This current waveform is positive proof that L103 is shorted (or has shorted turns).

VA-VA-VA-VOMS!

Figure 7B reveal the effects of a 30 short from flyback pin 10 to cold ground. This short reduced the normal 11.8kV of HV to 9.5kV.

CR420 decouples sections of the 23V supply during start-up, and it is a reverse-biased open circuit during these low-voltage tests. Therefore, a short in that part of the 23V supply does not eliminate the external +23V. One method of finding shorted C405, CR401 or CR402 was given in Figure 11 last month. These shorts reduce the HV from 11.8kV to about 9.8kV. The Figure 7C waveforms show some instability, probably because the regulator is working outside the normal range of operation.

When both CR402 and CR401 were shorted to ground, the HV increased to about 14kV, the SCR anode waveform almost disappeared (Figure 7D), and the Q100 collector waveform loses some amplitude while becoming thinner and having extra pulses following the main retrace pulses.

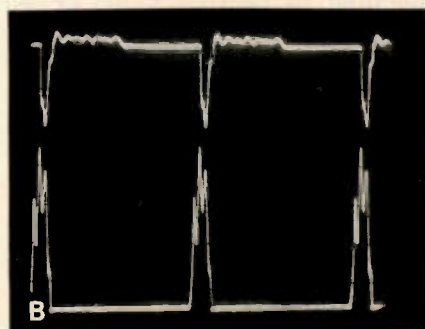
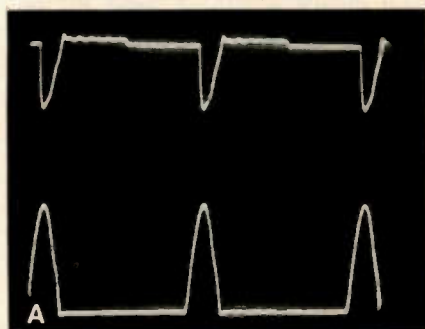

Figure 6 C117 is the main tuning capacitor during retrace, so its value largely determines the amount of HV. (A) These are the SCR100 anode (upper waveform) and Q100 collector waveform (lower waveform) during low-power operation of a normal TV. HV was 11.8kV, which increased to 13kV when the SCR was shorted. (B) An open C117 added ringing to the waveforms and increased both amplitudes. HV was 17kV, increasing to 19kV when the SCR was shorted.

MONEY-SAVING TEST EQUIPMENT

The excitement in VOMs and testers today is coming only from MURA. With a full line of test equipment that provides high performance and solid construction at surprisingly low prices.

There's a Techlite® meter, for example, with a sensitivity of 50,000 ohms/volt DC and 12,500 ohms/volt AC. Another in which the lowest DC range is .125 volt full scale. And another that measures DC current on any one of ten ranges and resistance on any one of five ranges.

Then there's a Clamprober® that can accurately measure AC current and voltage without even breaking into the line. And a battery tester with non-polar leads that you can safely connect to either battery terminal for quick and easy measurements.

So the next time you need troubleshooting equipment, don't shoot your budget. Get in on the excitement from MURA.



MORE FOR YOUR MONEY

MURA

CORPORATION

177 Cantlague Rock Road
Westbury, N.Y. 11590

Circle (6) on Reply Card

QUICK CHARGE IRON-QUICK CHANGE TIPS

ISO-TIP® Quick Charge Cordless Soldering Iron recharges in 3-4½ hours. Uses any of Wahl's 16 snap-in tips.

Low voltage, battery powered, ground free isolated tip design.

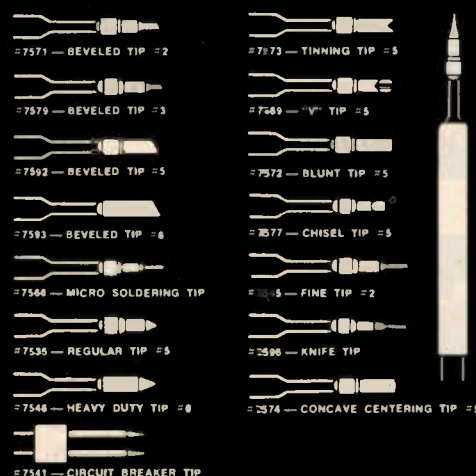

WAHL CLIPPER CORPORATION
ORIGINATORS OF PRACTICAL CORDLESS SOLDERING
Sterling, Illinois 61081 (815) 625-6525
"Manufacturing Excellence Since 1919"

Circle (7) on Reply Card

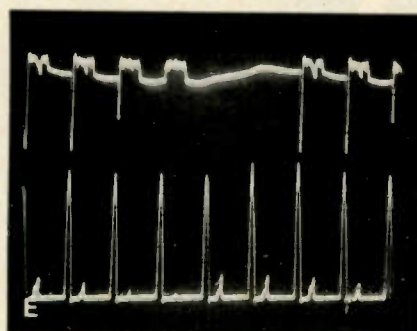
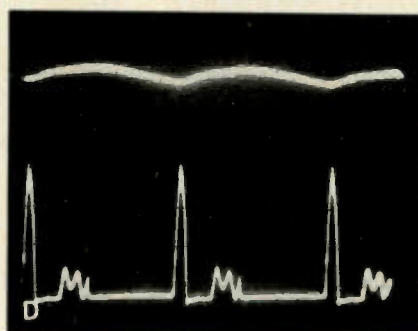
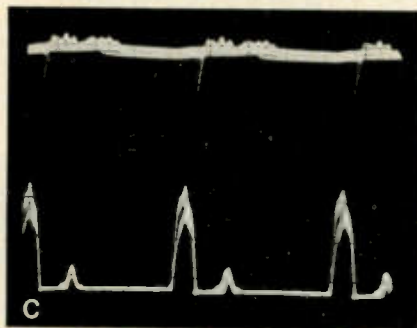
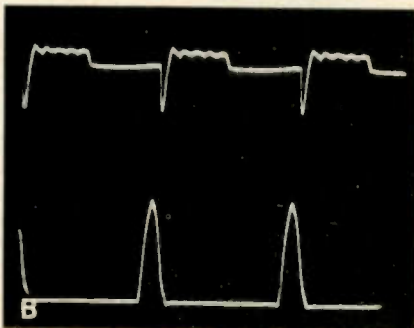
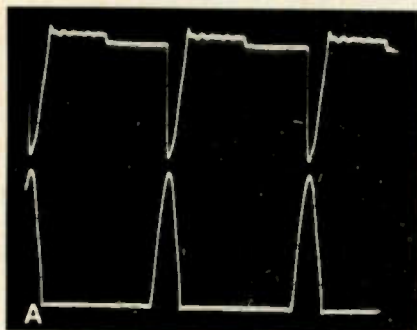

Figure 7 Abnormal loads on the flyback also distort the SCR and Q100 waveforms. Most of these overloads would ruin the output transistor if occurring during full-power operation. (A) These are normal waveforms for low-voltage operation. (B) A 30 Ω short between flyback pin 10 and cold ground reduced the amplitudes and gave only 9.5kV of HV. (C) Shorting the CR420 anode to cold ground distorted the waveforms and produced 9.8kV. (D) When CR401 and CR402 were shorted to cold ground, the SCR waveform was integrated and extra pulses appeared in the Q100 collector waveform. However, the HV increased to 14kV. (E) A short between flyback pin 14 and cold ground produced these varying waveforms (sweep time was increased to show more cycles) and HV of 12.5kV.

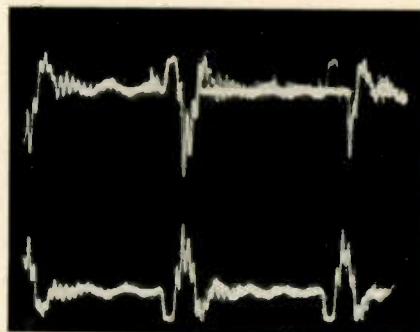

Figure 8 These abnormal waveforms were obtained when the oscillator and driver were powered from an external supply. C117 was open and shut-down was produced by about 56Vac line voltage. Such operation is not recommended, since the driver Q407 was overloaded severely. SCR waveform was 125VPP, Q100 collector waveform (bottom trace) was about 300VPP, and the Q407 bias was almost 0.2V higher than the usual +0.65V.

There is no ready explanation for the phenomena shown in Figure 7E. When flyback pin 14 was grounded, the amplitude of SCR100 anode pulses varied in a regular pattern (sweep time was increased to show additional cycles), and the HV increased slightly. At the Q100 collector, the retrace pulses did not vary in amplitude much, but unwanted pulses varied more.

Unusual operation—During these low-voltage tests while C117 was open, the line voltage was increased slowly to determine the minimum line voltage that produced shut-down (the external +23V continued to supply the oscillator and drivers). The shutdown circuit operated at 56Vac, but the sweep circuit continued to work at reduced amplitude. This was not conventional shut-down, although the Q407 base bias had been raised from the usual +0.65V to an excessive +0.83V. The Q407 gain was reduced to almost zero by the saturation caused by the high bias, then Q407 began to overheat and the test was discontinued immediately before Q407 failed.

Waveforms produced during the false shutdown are shown in Figure 8. The lesson taught by this accident is that the shutdown circuit never should be activated during oscillator-driver operation from an external supply.

Miscellaneous tips

Power-supply and horizontal-

sweep operating currents can produce almost a volt of hash in the wiring of circuit boards. Figure 9 shows an 0.8VPP waveform scoped between the Z7B circuit ground and the cold-rail ground at the rear.

Some signal waveforms in solid-state TVs are about that amplitude or slightly stronger. A correct 2VPP signal with this 0.8VPP added to it by improper grounding would emerge as a false and distorted waveshape.

Therefore, choose the ground specified in service data, or a ground of the circuit being scoped. Usually, this will minimize common-ground hash and prevent distortion of the desired waveforms.

Figure 10 shows an easy way to detect sweep pulses at the Q100 collector. Even the reduced-amplitude pulses during low-voltage operation are sufficient to make the neon lamp glow. At 120V line power, the field around the flyback is strong enough to light a neon when it is held very near the windings. This tip, along with the adapters described last month, make possible many in-home tests by using only a VOM.

Ringling tests

These ringling tests were performed with a Sencore YF-33 Ring-er. It is essential that the red lead is connected to the Q100 collector and the black lead is clipped to hot ground. Otherwise, solid-state junc-

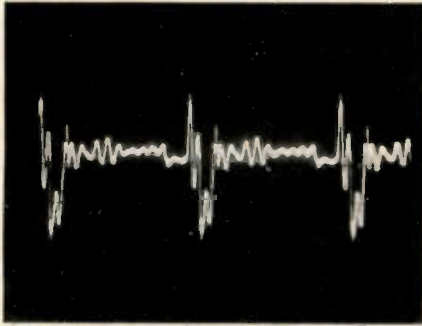

Figure 9 Using the wrong cold ground can distort many low-amplitude waveforms. This 0.8VPP waveform was scoped between Z7B ground and the rear rail (cold ground).

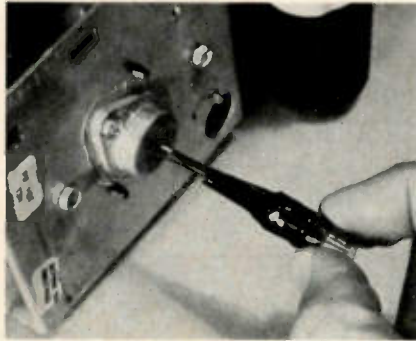

Figure 10 A neon bulb can be lit brightly by touching one lead to the Q100 collector when pulses are present there. The bulb glows even during low-voltage operation when pulses are normal.

tions of the circuit eliminate all ringing.

Unplug the TV line power before attempting any ringing tests.

These were the ringing-test results:

- With no sweep defects, the reading was 12 rings on Button 5.
- When the HV lead was shorted to cold ground, one ring was measured.
- A reading of five rings was obtained with the SCR shorted from anode to cathode.
- The same five rings was obtained with TP-12 (+123V supply) shorted to the hot ground.
- Shorting CR401 cathode to ground gave 11 rings on Button 1.
- CR402 cathode shorted to ground showed 8 rings on Button 1.
- When CR403 cathode was shorted to ground, the reading was seven rings on Button 5, but shorting anode to cathode of CR403 reduced the rings to one.
- A short across C118 (series yoke coupling) gave only one ring.
- When terminal XD (pulses for X-ray circuit) was grounded, the ringing dropped to only 10 because of the internal resistor in the flyback.
- A short across the picture-tube heater made no change.
- When the horizontal yoke was unplugged, Button 3 gave nine rings.

The horizontal yoke was tested along while it was disconnected. It produced 14 rings on Button 5. Readings above 10 are considered good.

Neither the HV secondary of the flyback nor the T101 driver transformer would give any reading.

In general, a short across any in-circuit flyback winding (except

the CRT heater winding) reduced the ringing almost to zero. Therefore, these ringing tests are recommended as being helpful and accurate. (But, remember to ground the black wire as instructed.)

RCA frequency-synthesis tuners

All RCA CTC99 and CTC101 models have some form of frequency-synthesis generation of tuner-oscillator frequencies. Two types are the keyboard-operated version and the scan-plus-remote operation. The sample CTC99 was equipped with up-scan and down-scan without remote. All unprogrammed channels are skipped during scanning. Therefore, that type will be described, after a preliminary explanation of phase-locked loops.

Basic PLLs

Phase-locked loops (PLLs) produce a signal frequency that is locked solidly to the phase (but not necessarily the same frequency) of a stable reference signal. A TV horizontal-phase detector locks an oscillator to the same frequency and phase as the station sync. A chroma phase detector locks a color oscillator to the same phase and frequency as the station's color burst.

However, PLLs can produce stable signals having many different ratios to the standard frequency. Figure 11 is the block diagram of a typical simple PLL. Except for the frequency divider, it has the same block diagram as a diode horizontal-phase detector. Frequency dividers can be placed between the standard source and the phase comparator to obtain additional frequencies.

APPLIANCE REPAIR BOOKS



Thirteen Handbooks written in easy-to-understand language by experts in the service field with illustrations and diagrams! Acclaimed by Instructors and professionals alike! How to diagnose and repair air conditioners, refrigerators, washers, dryers, ranges, microwave ovens, dishwashers, vacuum cleaners, electrostatic air cleaners, RV gas appliances, hair dryers, motors, water heaters, coffeemakers, can openers, floor polishers, steam irons, food mixers, lawn care appliances, electric knives, electric and digital clocks and many others. Also fundamentals of solid state, setting up a shop, using test instruments and more **Only \$2.65 to \$4.90 ea.**

SEND FOR FREE PRICE LIST

Gamit, Dept. ES

110 W. St. Charles Road,
Lombard, Illinois 60148

Circle (8) on Reply Card



SOLID STATE DEVICES

AVAILABLE FOR IMMEDIATE SHIPMENT AT PROFIT SAVING PRICES!

WE FEATURE A QUALITY LINE OF SEMI-CONDUCTOR REPLACEMENTS FROM PROJECTOR BELT & RAYTHEON.

- ✓ Guaranteed Quality
- ✓ Same Day Shipment
- ✓ Toll Free Ordering

CALL TOLL FREE

1-800-558-9572

Ask for our Dealer Proven Catalog today!



PROJECTOR RECORDER
Belt Corporation

200 Clay Street, P.O. Box 176
Whitewater, WI 53190

Circle (9) on Reply Card

RCA tuner

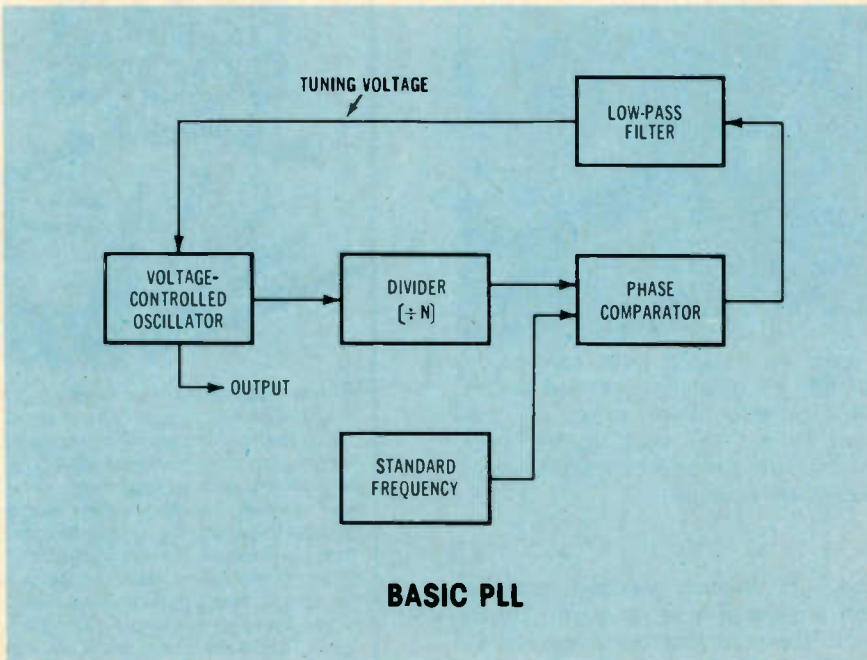

Figure 11 A phase-locked loop can produce output frequencies higher than the standard frequency when a divider is added between the VCO and the phase comparator. A PLL changes the VCO frequency to whatever is required to produce the same frequency at both phase comparator inputs.

These are the basic rules for a PLL:

- A frequency divider between the voltage-controlled oscillator (VCO) and the phase comparator produces an output frequency from the VCO that is higher in frequency than that of the standard. A $\div 1$ provides the same frequency as the standard; a $\div 2$ raises the output frequency to double the standard, and a $\div 6$ multiplies the output frequency by six.
- A frequency divider between the standard frequency and the phase comparator produces a VCO output frequency that is N times lower in frequency than the standard signal. A divide-by-one gives an output of the same frequency as the standard. A $\div 3$ gives an output of one-third the standard frequency, or a $\div 11$ furnishes an output of 1/11 the standard frequency.
- Dividers can be added to both inputs of the phase comparator to produce output frequencies either higher or lower than the standard.
- Programmable frequency dividers

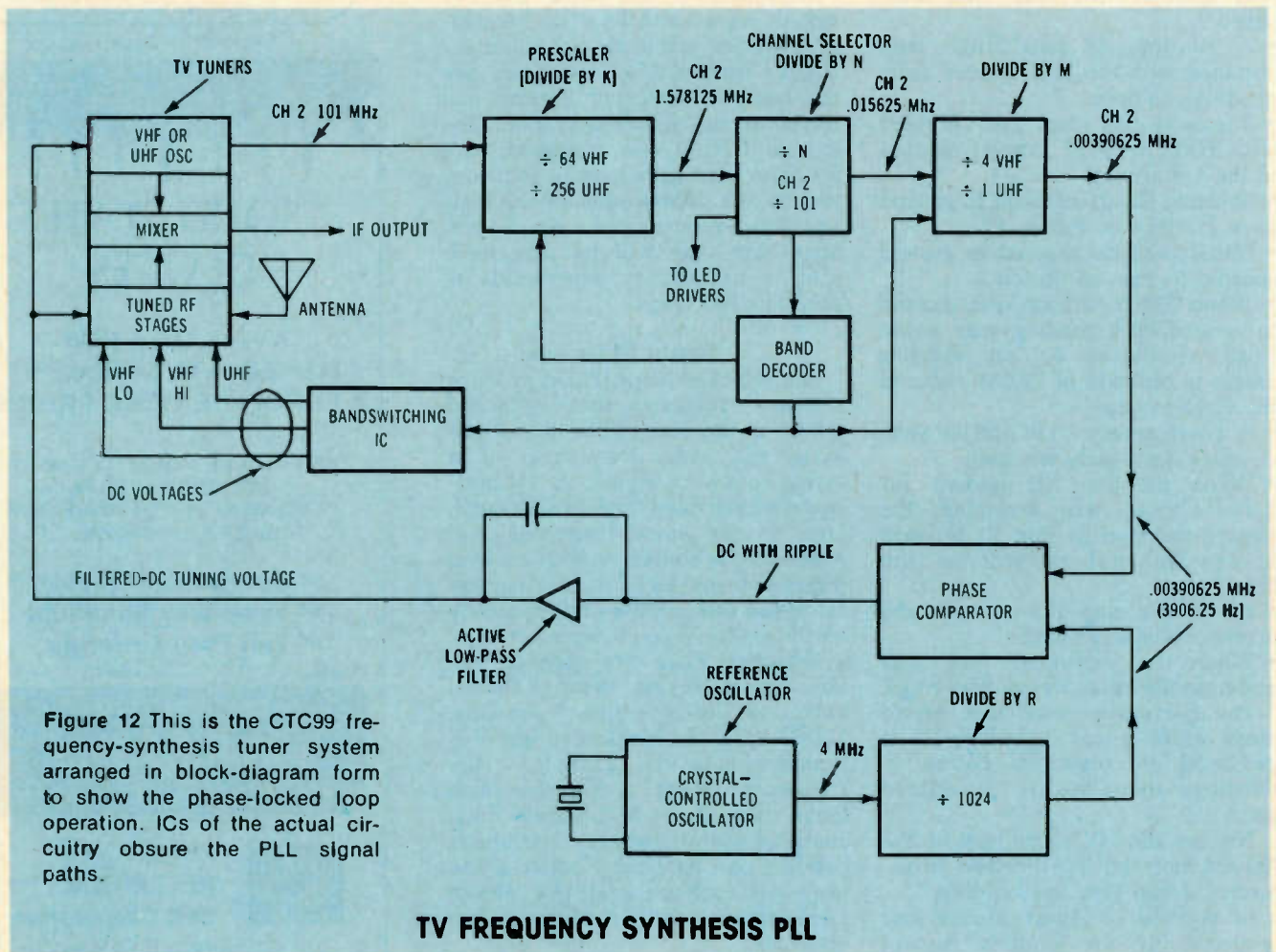

Figure 12 This is the CTC99 frequency-synthesis tuner system arranged in block-diagram form to show the phase-locked loop operation. ICs of the actual circuitry obscure the PLL signal paths.

can be changed to different degrees of division by the proper logic states applied to their control lines.

• Therefore, the correct choice of dividers and standard frequency can produce almost any desired frequency.

Phase comparator inputs—Most conventional explanations show a PLL at rest after it achieves stability. But this tends to obscure the previous action. Comparator inputs do not always have identical frequencies. Immediately following a change of divider programming (which initiates the generation of a new VCO output frequency), the oscillator frequency remains for a brief time at the previous value. Momentarily, different frequencies are present at the comparator inputs. This frequency difference forces the comparator output to change, becoming either positive-going or negative-going as required to reach the new frequency. Following filtering, this error-correction dc output voltage is applied to the VCO where it gradually shifts the frequency near the one demanded by the dividers and the standard frequency.

Finally, the output dc voltage reaches the level required for the correct oscillator frequency, and now the two comparator inputs have the same frequency and phase. Notice, however, that the dc correction voltage does not go to zero. It must remain near the same voltage level. If the oscillator frequency drifts, the correction voltage changes just enough to restore the correct frequency (which provides identical frequencies at the comparator inputs). Therefore, the control voltage is not required to be any certain measured dc voltage, but only whatever is needed to achieve solid frequency lock. The next time another frequency is selected, the loop acts to balance the comparator inputs by producing a different correction-voltage from the comparator.

RCA frequency synthesis

Figure 12 illustrates the RCA frequency-synthesis system in the style of the previous PLL. Four dividers are employed. The prescaler divider is included on the tuner board along with VHF and UHF tuner components. The prescaler divides by 64 for VHF channels or by 256 for UHF.

Inside the tuner-control box, the

first programmable divider ($\div N$) is operated by the channel-selector system. Its division equals the oscillator frequency in megaHertz for each channel selected. For example, the Channel-2 oscillator frequency is 101MHz, so the $\div N$ circuit divides by 101. The same circuit also operates the band decoder that feeds the bandswitching IC, and it controls the division of the $\div M$ stage that follows.

A non-programmable $\div 1024$ divider follows the 4MHz reference crystal-controlled oscillator. Therefore, the reference-signal input at the comparator has a 3906.25Hz frequency. The output of the phase comparator (after filtering) is the dc tuning voltage for the varactor-type tuners. It tunes both the oscillator and the RF stages. Dc voltages from U2502 bandswitching IC select VHF-low (channels 2-6), VHF-high (channels 7-13), or UHF channels.

In the CTC99 tuner system, these basic sections of the PLL are not easy to recognize (Figure 13). The channel memory is not part of the PLL, but it supplies the information otherwise obtained from a pushbutton keyboard. This allows scanning up-channel or down-channel, and the skipping over of inactive channels. LED drivers and LED digits are necessary to display the channel selected.

One additional feature is not illustrated here. It is the search for off-frequency carriers (video games or cable offset carriers) which must be locked by a special form of AFT.

Servicing the FS system

The tuner board and the tuner-control board are enclosed individually in shielded boxes (Figure 14) with a common mounting. These boxes and the front-panel components can be mounted on the chassis for transportation, when needed.

Between the metal boxes is an 8-pin connector that provides short signal paths between the circuit boards. A multiple-wire cable extends from the front-panel controls to the control board, and a 7-pin socket at the control-assembly rear panel has wires that connect to the main TV chassis.

Either the MST-001 tuner circuit board or the MSC-002 control board can be removed without any unsoldering. At this time, exchange of any defective board usually is made, and few repairs are attempted on the boards.

HOW TO GET BETTER MILEAGE FROM YOUR CAR...

Obey the 55 mph speed limit.



Keep your engine tuned.

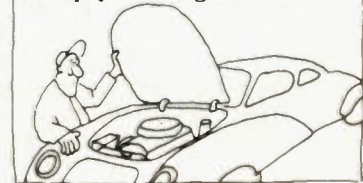

Avoid hot rod starts.



Drive at a steady pace.

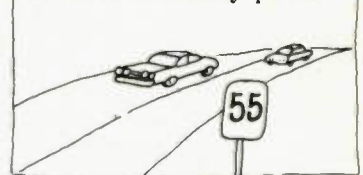

Don't let the engine idle more than 30 seconds.

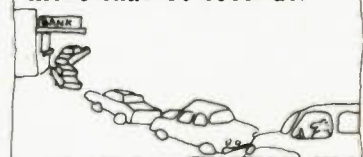

And when buying, don't forget the fuel economy label is part of the price tag, too.



For a free booklet with more easy energy-saving tips, write "Energy," Box 62, Oak Ridge, TN 37830.

ENERGY.
We can't afford to waste it.

U.S. Department of Energy

RCA tuner

However, it is necessary for the faulty board to be identified. These are the essential steps:

- Check all connecting wiring and connector plugs. Move them gently and notice any operation changes. Repair or replace any defective components.
- Flip the channel select/lock switch to the select position and try all VHF channels plus UHF channels that begin with numbers other than one. Notice if any segments of the LED digits fail to light. Any problems indicate a defect in the LED digits or the U2503 IC. Look for pictures or snow on each of these channels. Excessive or insufficient snow on unused channels indicates a tuner defect or a wrong tuning voltage from the control module. Compare the actual tuning voltages with the list of nominal voltages.
- If difficulties are experienced with either up-scan or down-scan,

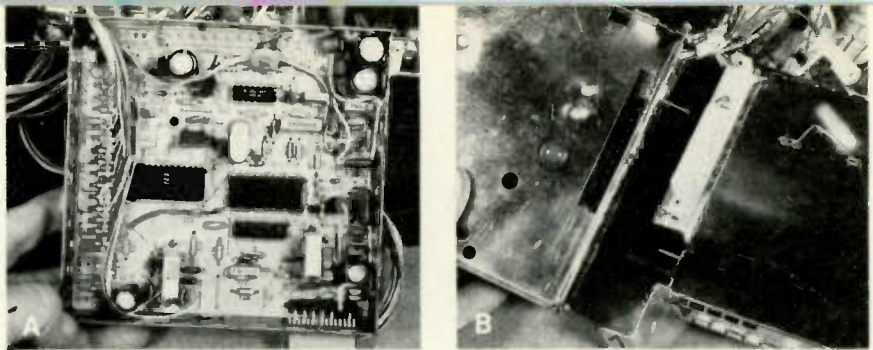

Figure 14 The CTC99 tuner system has four ICs in the control section plus a prescaler divider located with the VHF and UHF tuners in the other shielded box. (A) This is the component side of the tuner-control board. (B) Control and tuner boards are connected by a plug and eight-pin socket with guide pin.

check for the proper logic levels (+5V high for no action, or a low for operation) at U2501 pins 16 (down-scan) and 17 (up-scan). Test for a good ground between terminal S (on the row along the control board's top side) and the up-down scan switch assembly. Bad grounds prevent low logic levels.

- Try the add and erase of channels. If either function does not work, check for logic lows (when

the add or erase button is pressed) at control board terminals T and U.

- If normal operation is obtained with one or more of the VHF-low, VHF-high or UHF functions, the tuning voltage probably is correct. Check the bandswitching voltages at pins 7, 6 and 3. If they are correct, but either UHF or both VHF operations are dead, it is likely the defect is in the tuner section that does not operate. □

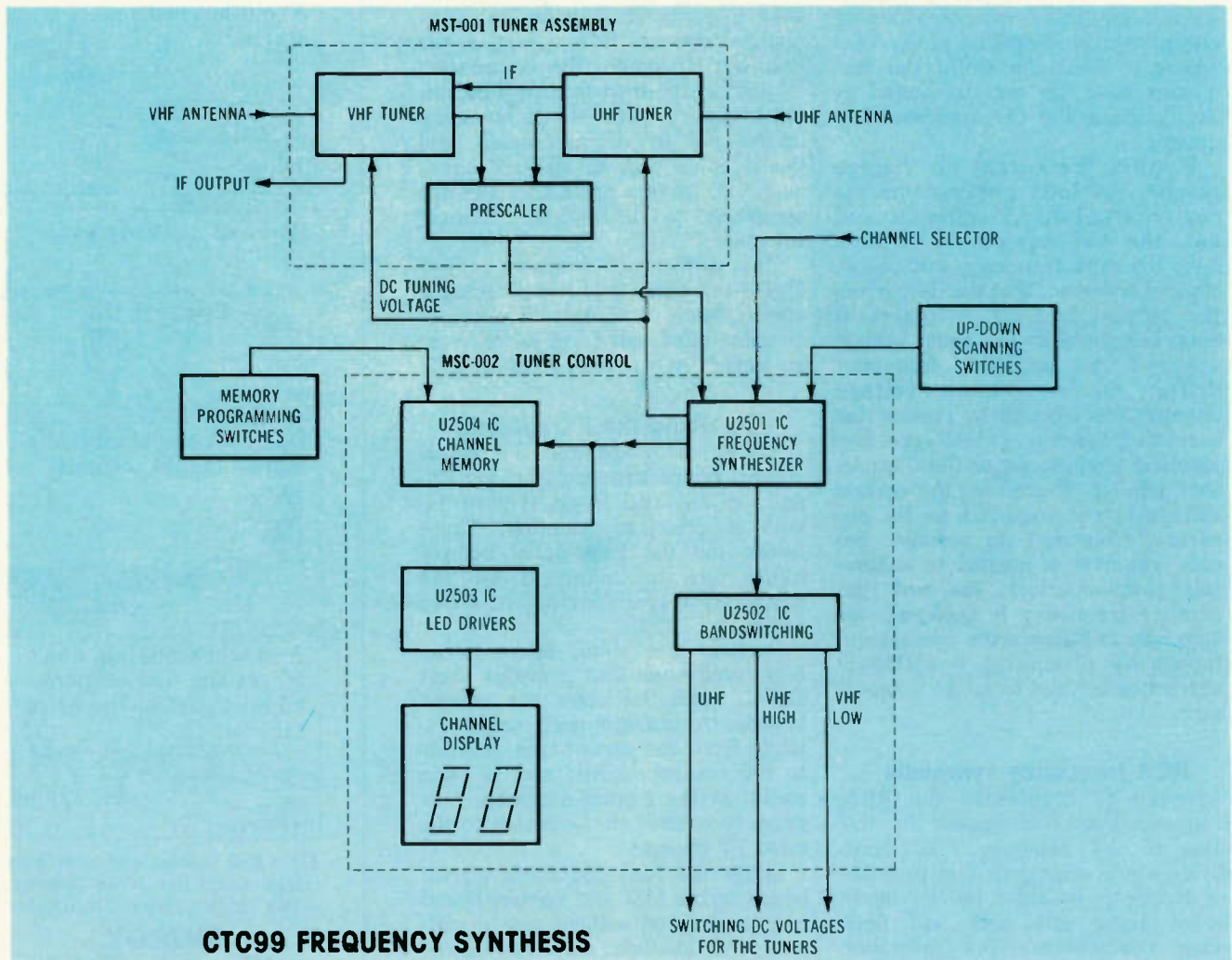

Figure 13 In the CTC99, most of the phase-locked loop is hidden inside these ICs. The up-down scanning switches change the division factor. U2504 IC and the memory-programming switches are not part of a basic PLL.

Verify tube defects and prevent callbacks

If the usual tests in tube checkers or by replacement have not been conclusive, these additional voltage measurements can prove the need for a new tube.

By Wayne Lemons, CET

Technicians often disagree about the best method of identifying weak or defective tubes. Some accept tube-tester readings as final authority, and they are pleased with the results. Other believe—just as firmly—that testing tubes merely wastes time. They advocate replacing all suspected tubes with new ones. Any improvement of performance is viewed as proof the new tubes were needed.

No doubt, each group can point to a multitude of successes with its chosen method. However, many technicians recommend a combination of *both* methods.

When a *third* method is added, the total sequence allows dependable tube evaluations of almost perfect accuracy. This can be accomplished without requiring much additional time.

Strong and weak points of tube tests

Serious tube defects (shorts, open heaters and low emission) can be located easily by tube testers. These testers are less reliable for finding intermittent tubes or those that drift from warmer ambient temperatures. Defects that occur when tubes are operated near maximum voltage and current usually can't be found at all.

For example, it is almost useless to test a vertical-output tube when the symptom is a *slight* reduction of height. Neither can a tube tester dependably evaluate horizontal-output or damper tubes that cause a slight width or horizontal-linearity problem. Some audio tubes can check "in the green" but still distort the sound.

Although tube testers accurately can measure relative gain and cathode current (emission), they never apply the large amounts of power that are typically encountered in TVs. A damper tube, for example, often has momentary currents of 1A at peak voltages up to 5kV. These powerful tubes cannot be checked adequately in a tester using 25V at 1mA.

A tube tester that supplied sufficient power for accurate tests would be extremely expensive, difficult to adjust, and probably dangerous to the operator. Better testers are not the solution.

Tests by replacement

A time-honored method used by most technicians is the replacement of all tubes in any circuit suspected of having a defect. However, many questions can remain after a new tube is installed. To prevent callbacks and for protection against critics, these questions must have definite answers.

Perhaps a new video-output tube is installed. The contrast seems to be higher. But is the new tube responsible for the improvement? Or, during the time required for the tube installation, has the TV program changed to a scene having higher contrast? (One method of achieving consistency with the video contrast is to use a generator with four quadrants or stairsteps of different levels. Observe the same pattern before and after the tube replacement. However, a constant video level does not solve all problems of contrast that are evaluated only by looking. Meter or scope measurements should be added for best accuracy.)

Symptoms such as loose vertical locking or slow changes from the

effects of heat can inspire similar questions. New tubes do not always solve the TV problem.

At the other extreme are cases involving weak tubes where the danger is not to the weak one but to another tube downstream. A weak horizontal-oscillator tube is the most likely example. Insufficient drive to the output-tube grid can force the output tube to draw more than typical plate current, which causes it to fail within a few days or weeks. A good test method should be able to locate these potential failures before a total breakdown occurs.

The third test: dc voltages

Measurement of important dc voltages at and around the suspected tube can provide additional proof that verifies tube-tester readings or any improvements from tube replacements.

Tubes operated as class-A amplifiers can be evaluated best by dc voltage readings taken across the cathode resistor before and after the tube is replaced. (Measurements of plate or screen voltages are less accurate because the readings do not always indicate directly any change of tube current.)

When the socket pins are not accessible, use a lifting-type tube-socket adapter. Figure 1 shows part of a video-amplifier circuit, although it is typical of many others.

There are a few limitations and precautions to observe if these tests

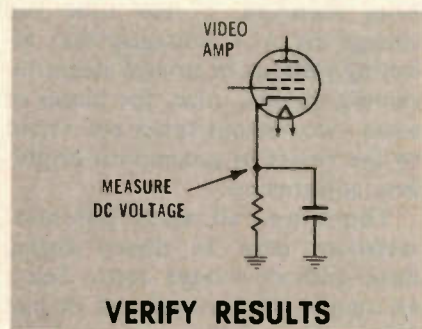

VERIFY RESULTS

Figure 1 With class-A amplifiers, measure the cathode-to-ground voltage before and after a new tube is installed. An increase of 10% or more indicates the old tube was weak. In one example, a +1.4V reading increased to +2.1V, and the contrast appeared to be higher. **Caution:** Gassy tubes usually show an increasing cathode current with continued operation. And the higher current can ruin the accuracy and value of this test. Therefore, use a tube checker *first* to locate any gassy condition.

Tube tests

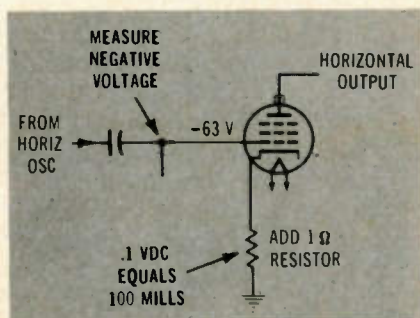

Figure 2 Excessive negative grid voltage can cause a narrow picture and reduced HV. Insufficient negative voltage forces the tube to draw excessive current and perhaps fail quickly. A 1 Ω resistor added as shown can allow cathode-current measurements without breaking the circuit.

are to be accurate. A tube that is controlled by a closed-loop circuit often shows little cathode-current change between good or weak tubes. The closed-loop opposes any change.

AGC-controlled IF tubes are in this category. Therefore, defeat the AGC temporarily by tuning to an unused TV channel before making the old-versus-new-tube readings. This also allows another visual test of gain by observing the intensity of snow in the picture.

The bias and cathode current of many video tubes is varied according to the video-detector signal level. First-video-amplifier tubes often are included in the AGC loop; therefore, a new tube can change the AGC voltages, thus affecting voltages in several stages including its own. Also, the biases of some video-output tubes are varied by the viewer to accomplish brightness adjustments.

Therefore, all such potential variations must be frozen during these cathode-voltage tests. Select an unused TV channel and do not adjust the brightness control (or any others) between the cathode voltage measurements with the old and new tubes.

Other ways of freezing the conditions during these tests are possible. But a schematic should be used as a guide. The no-signal approach is simple and it works properly with all circuits.

Vertical and horizontal outputs—Most vertical-output tubes have

cathode resistors, and therefore cathode voltages easily can be tested. An increase of 10% or more is significant when the problem is a slight lack of sufficient height. Bias is critical for proper linearity. Therefore, tube failure from insufficient bias is rare. The wrong bias or insufficient cathode current immediately is shown by linearity and height symptoms.

Horizontal-output tubes are susceptible to being ruined by insufficient bias or from low ac loads in the plate circuit. Diagnosis is much easier when grid and screen dc voltages are known and when cathode current can be measured.

Figure 2 has a reminder to always test the negative grid voltage. This negative voltage is formed by clamping of the oscillator sawtooth signal by the output tube grid-cathode current. Grid current and clamping occurs at the positive tip, and the amount of negative voltage depends on the amplitude of the sawtooth waveform. Any reduction of oscillator output signal is shown by an equal reduction of negative voltage.

Two general conditions can modify this negative voltage. One is any leakage of positive voltage (perhaps through the coupling capacitor) into the grid circuit, or tube gas that produces positive voltage which reduces the negative voltage. The other possibility is additional negative voltage fed to the grid from a grid-bias HV regulator or a blanker circuit. Any excess or insufficient voltage applied to the grid from either of these sources can increase or decrease the measured negative grid voltage, and these possibilities must be included in any total diagnosis.

Test the oscillator tube condition by measuring the output grid voltage before and after a new oscillator tube is installed. A difference of more than 2V proves the new tube was needed.

Measuring output current—A 1 Ω $\frac{1}{2}$ W resistor added between cathode and ground (Figure 2) allows easy measurements of cathode current. A reading of 0.1Vdc indicates current of 100mA. Many tubes are rated between 170mA

(0.17Vdc) and 300mA (0.30Vdc), and this low voltage can be measured easily and accurately by a digital multimeter. **Caution:** Be certain the resistor is not added to any other grounds. Some heaters are grounded to the same circuit point. Do not allow the heater current to flow through the resistor.

The added resistor does not affect the performance of the output stage in any way, and it does not need a bypass capacitor. If measurements from behind the chassis are desired, an insulated wire can be added between the cathode and a tie lug mounted on the chassis.

Testing the cathode current against the schematic value is only one of the advantages of the added resistor. Proper adjustments of the high-voltage regulator and the efficiency coil can be monitored by their effects on the cathode current. Low cathode current gives better performance and longer tube life.

Another important measurement is the output-tube screen dc voltage (Figure 3). Of course, an open or leaky screen bypass capacitor or an open or changed-resistance screen-supply resistor will change the screen voltage. However, *this screen voltage also depends on the amount of plate current.* Increased plate current causes decreased screen current, which in turn increases the screen voltage. When a heavier load in the plate circuit increases the plate current, the higher screen voltage forces even more plate cur-

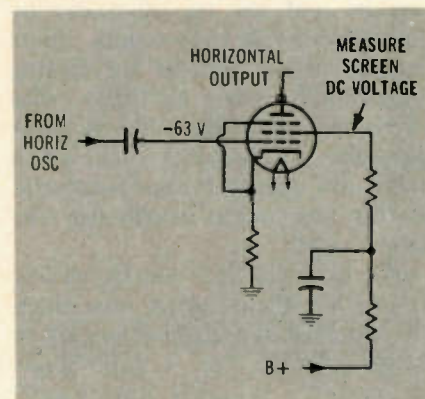

Figure 3 Screen-grid dc voltages also indicate output-tube conditions. A weak tube raises the screen voltage. Decreased grid drive reduces the screen voltage.

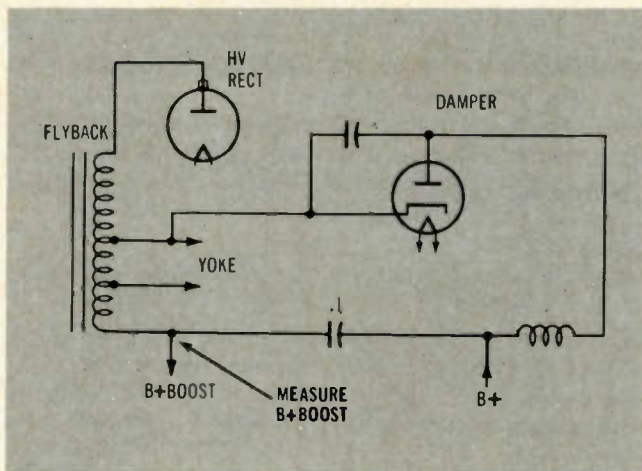

Figure 4 The amount of B+ boost voltage is a sensitive indicator of damper-tube condition. Measure the boost voltage before and after each damper replacement.

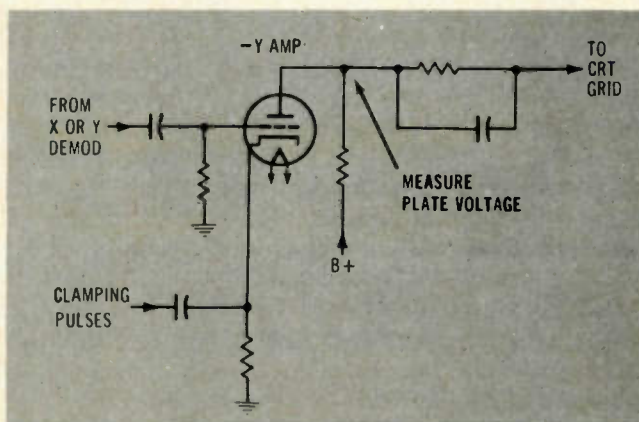

Figure 5 Measure -Y amplifier plate voltage before and after the tube is replaced. A decrease of 10V or more proves the old tube was weak. These three -Y tubes drive the CRT grids, so wrong voltages can cause excessive brightness or wrong b&w screen color.

rent to flow. This increases the regulation of plate power so it can accommodate greater demands for power, but it also hastens the total failure of these tubes when serious overloads occur. That's why operation without an oscillator signal or with a shorted HV rectifier ruins output tubes rapidly.

Variations of the screen voltage, therefore, can be used to diagnose many different conditions in the output stage. A total loss of dc plate voltage increases the screen current, thus reducing the dc voltage to about 60% of the usual value. A weak output tube will have an abnormally high screen voltage, even when the screen resistor and bypass are normal.

Measure the screen voltage before replacing the output tube and then again with the new tube. A lower screen voltage usually indicates a stronger tube, and voltage differences of 10V or more are significant.

Testing damper tubes—A quick and easy way to compare damper tubes is to measure the B+ boost voltage (Figure 4). If the boost source is not accessible, then measure one of the picture-tube screen-grid voltages during a comparison of the readings with the old versus the new tube. More than 5V increase indicates the new tube is needed.

Load changes in the flyback circuit (that affect the high voltage)

also vary the boost voltage. Tune in a TV channel that does not have a signal, or operate the service/normal switch in the service position. That way the video level variations cannot affect the boost voltages.

In those older TVs that operate the vertical oscillator from the boost supply, it is possible to check the damper tube condition by the affect on height. With the older damper tube in place, adjust the height and linearity until about 1/2-inch of black shows at the bottom of the screen. Install a new damper tube and notice if the height has increased (less black border at the bottom). Increased height proves the new damper tube was needed.

Incidentally, the trick of reducing the height is very useful for testing vertical tubes. Adjust height and linearity controls for about 1/2-inch at top and bottom of the picture, and then replace the tube. Any increase of height indicates the new tube should be left in the socket. The height and linearity should be adjusted properly after these tests.

Testing -Y amplifiers—Excessive brightness with blooming can ruin horizontal-output tubes. Defects in -Y amplifiers (Figure 5) can produce this extreme blooming (with output-tube damage) in addition to affecting amplitude and balance of the color signals.

A good testpoint is the plate of each -Y amplifier tube. Pulses at

the common cathode resistor for the three tubes are supposed to clamp the plate voltages to specific voltages that do not drift. Therefore, excessive amplitude of pulses increases the plate voltages (brighter picture) while decreased pulse amplitudes decrease the plate voltages (darker picture). When all three -Y tubes change the same, the brightness changes. If only one changes, the gray-scale tracking (raster color) is disturbed.

The grid resistor and capacitor both affect the plate voltage, because they are part of the clamping action.

Remember that picture-tube grid and screen-grid voltages affect the picture brightness and b&w raster color as much as a similar change of CRT-cathode voltages (which are supplied by the video circuit). Dc voltage measurements are recommended highly for tests in these circuits.

Comments

Tube testers are quite valuable for locating many tube defects. They also help convince customers that tube replacements are necessary. However, larger tubes often need additional testing by the improvement noticed after a new one is installed.

Both testing methods are valid. But they should be supplemented by voltage tests or scope-waveform analysis to determine the extent of any improvement from the new tube. □

Chassis—Zenith 12HB1X
PHOTOFACT—1641-2

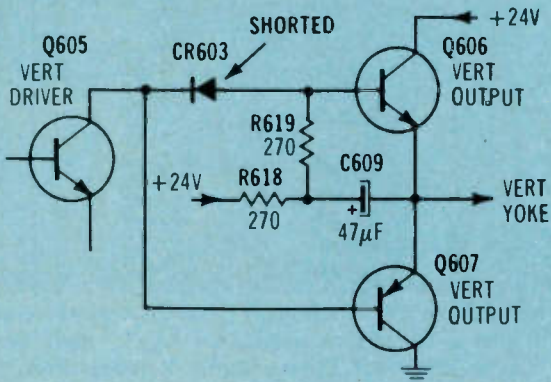

Symptom—1" lack of scan at all sides of raster
Cure—Check diode CR603, and replace it if shorted

Chassis—Zenith 12HB1X
PHOTOFACT—1641-2

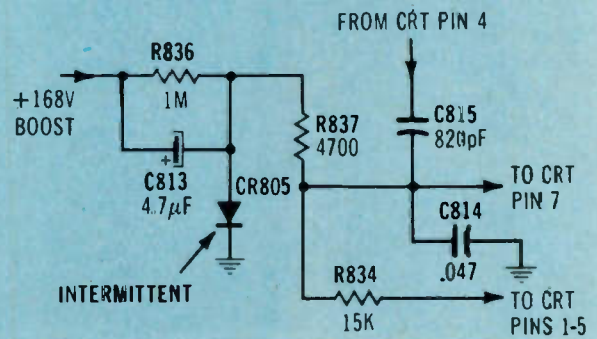

Symptom—Picture flashes bright and dark
Cure—Replace diode CR805 as a test for intermittent operation

Chassis—Zenith 19GB1Z
PHOTOFACT—1692-2

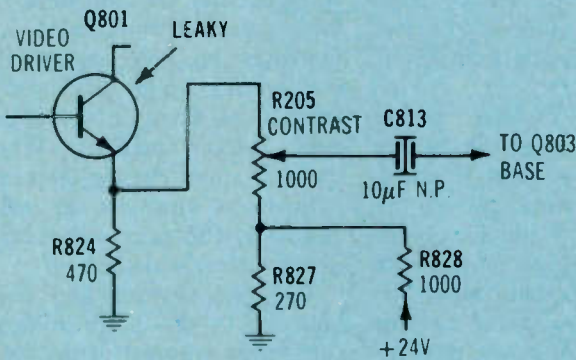

Symptom—Loss of vert and horiz sync, as though AGC problem
Cure—Replace transistor Q801 as a test for internal leakage

Chassis—Zenith 25EC58
PHOTOFACT—1370-2

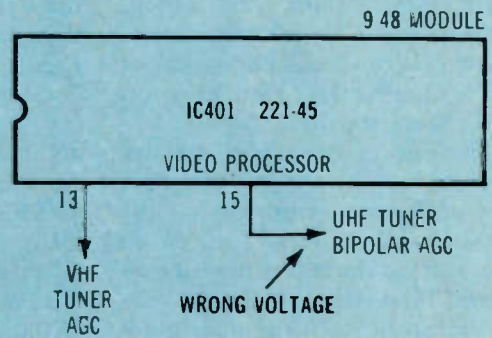

Symptom—No UHF reception (VHF operates normally)
Cure—Replace IC401 as a test

Chassis—Zenith 25DC56
PHOTOFACT—1312-3

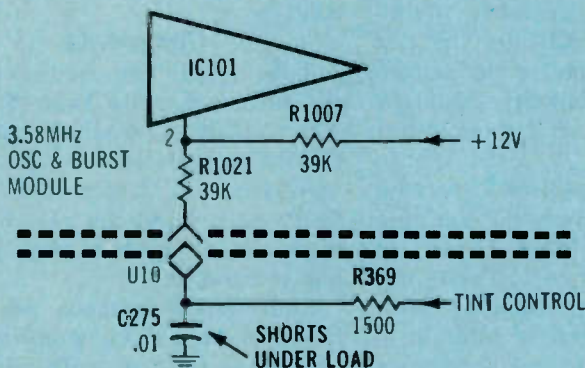

Symptom—Green skin hues
Cure—Check C275, and replace it if shorted

Chassis—Zenith 19GC38Z
PHOTOFACT—1562-2

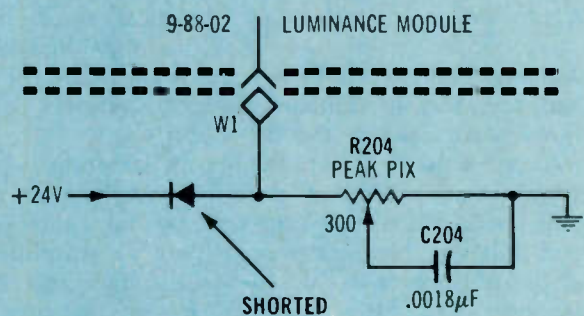

Symptom—Low brightness
Cure—Check diode at W1 terminal, and replace it if shorted

troubleshootingtips

Tripping breaker Channel Master 6128 & 6129 (Photofact 1410-1)

No HV was produced and no raster appeared when the TV was turned on. After about a moment of operation, the breaker opened. These were the only symptoms. First, I removed the 6GK6 (horizontal-output tube) plate cap to prevent breaker tripping during tests of the horizontal-oscillator stage.

Pin 3 of the 6GH8 oscillator tube tested zero volts, but an ohmmeter reading indicated C503 was not shorted. Other resistance tests in the B+ circuit showed the R903 value was correct. But between R903 and pin 3 (where R921 was supposed to be), the circuit was open. Further, the circuit board had no markings for R921, and no unidentified resistors could be found on the board.

Photofact 1410-1 provided a solution for the mystery of R921. The photograph showed insulated wire connected from R903 (and the 6GK6 suppressor grid) to resistor R921 at the wire's other end near the 6GH8 oscillator tube. R921 was not visible

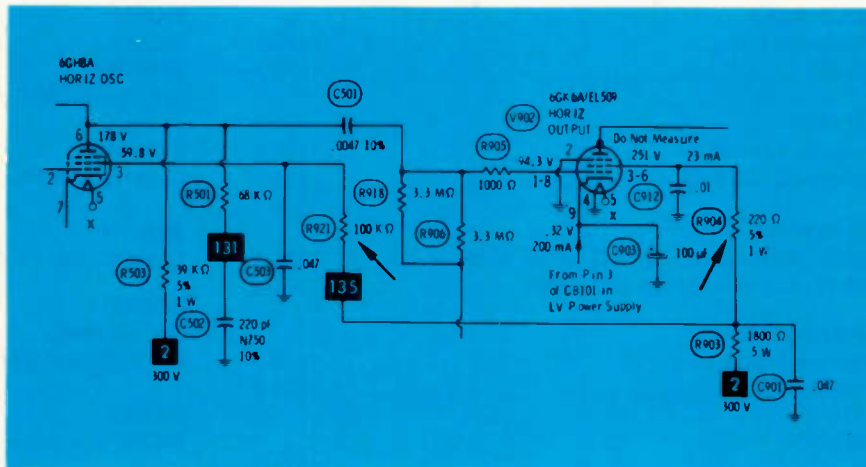

because a length of spaghetti enclosed it.

R921 was replaced and the TV performance was very good. During the tests, R904 (220 Ω) had overheated and smoked, so it was replaced as a precaution.

Charlie Jackson

Buckner, Illinois

Editor's Note: Overheating of R904 during operation with the horizon-

tal-output plate cap removed points out a danger. Zero plate current forces the screen current to almost double, which can ruin the tube or harm other components. Instead of removing the plate cap when there is no drive, a technician should apply a bias-pack voltage of -40V or higher to the control grid. Of course, remove the bias after the oscillator is repaired.

Drifting vertical frequency Milovac (Sanyo) CT711 (Photofact 1159-1)

Vertical locking was normal at first. But as the TV warmed up, the picture would begin to roll slowly downward. A slight rotation of the vertical-hold control restored locking, but the rolling and adjustments continued time after time.

Vertical tubes were substituted, voltages were tested and components were checked or changed. Nothing helped.

Finally the technician noticed that the heater of the 21LU8 vertical-output tube appeared to be brighter than usual. The heater voltage measured about 30V, an excessive voltage. Other voltage and resistance tests made along the heater string proved that X6 heater rectifier was shorted, thus applying too much voltage to all tubes. Of course, vertical multivibrators are very sensitive to the extra heat produced by wrong voltages. Therefore, the defect affected the vertical more than the others.

Frank Dickinson

Stony Point, New York □

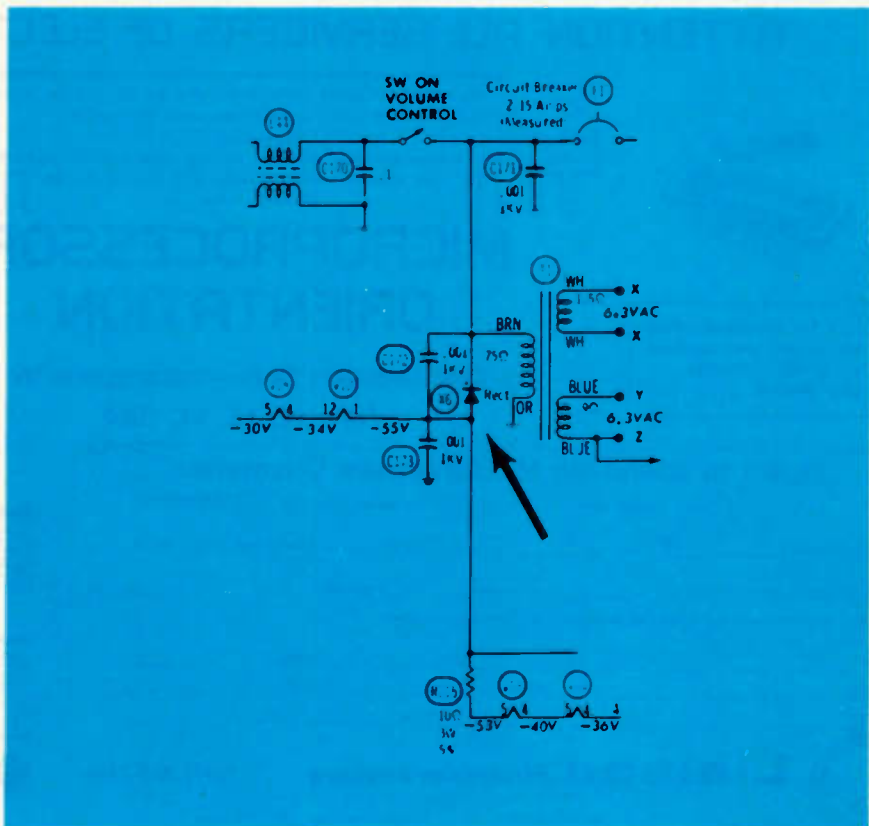

GOLD STAR

Chassis NT6X 1873-1
 VR-230 1875-1

HITACHI

Chassis SJS-A4 1876-1
 Chassis CQ3DX-S 1878-1

JC PENNEY

2006D, 2007, 2015D, 2020D, 2038, 2125 1874-1
 685-1014D, 685-101400 (855-0667) 1878-2

PANASONIC

Chassis T508A 1872-1
 Chassis T505-A 1875-2

PHILCO

Chassis E24-16 1873-2

QUASAR

Chassis AEDTS-972N, DTS-972N, EDTS-972N 1877-1
 Chassis STS-970N, TS-970N 1878-3

RCA

Chassis KCS203AA, AB, AC 1873-3
 Chassis CTC91E 1875-3

SEARS

562.40320800 1872-2

SHARP

13C33A 1872-3
 SKB1210A 1874-2
 SKC1910B, SKC1920B, 19C67, 19C68 1877-2

SYLVANIA

Chassis A19-10/-11 1874-3

ZENITH

L1310C, C9, L1330W, W9, L3310C, SL1325W, W9 1876-2

SEARS

564.40610800 1898-1
 564.40360800/01/02 1899-1

SHARP

3W-99 1895-2

SONY

Chassis SCC-204C-A 1894-2

TOSHIBA

Chassis TAC800/05/10 1894-3
 Chassis TAC892, TAC897 1898-2
 Chassis TAC840/41/45 1899-2

ZENITH

L1970P9, SL1961W9, X9/71P9 1897-2

ATTENTION ALL SERVICERS OF ELECTRONIC GEAR

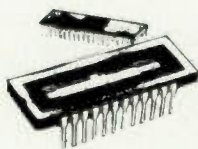

Tips for troubleshooting equipment and systems using this versatile new device

The MICROPROCESSOR INVASION isn't off in the future. It's here, now, in almost every type of equipment you service and maintain.

Gain first-hand familiarization from electronics servicing author, instructor, expert, FOREST BELT, and microprocessor/digital expert, BOB MANERY, through LIAISON's 3-Day

MICROPROCESSOR ORIENTATION

One Location Only—Indianapolis IN

Nov. 12, 13, 14, 1980



CLASS SIZE LIMITED TO 30 MAXIMUM ENROLL NOW!

Hands-on understanding of microprocessor operation

Experience in testing microprocessors practically

I want to attend the Microprocessor Orientation.

3-Day Package \$950 3-Day Seminar Only \$735 Pay me on LIAISON's Billing Plan

Total Enclosed \$ _____ Check # _____ MO \$200 Deposit. Balance Due 30 Days Before Seminar

Charge by Master Charge # _____ Expires _____ Signature _____

(A minimum \$50 Processing Fee will be charged on all cancelled enrollments.)

NAME _____ AGE _____ PHONE (_____) _____

ADDRESS _____ COMPANY _____ TITLE _____

CITY _____ STATE _____ ZIP _____

Package Fees Include:

- Timely training
- Best teachers
- Carry home manual
- Hands-on experience
- Certificate of training
- All work shop materials and functions
- Hotel room (double occupancy)
- Meals

Seminar-Only Fees Include:

- Timely training
- Best teachers
- Carry home manual
- Hands-on experience
- Certificate of training

We Honor



Vital To Services Of

- CONSUMER ELECTRONICS
- HOME APPLIANCES
- INDUSTRIAL SYSTEMS
- MEDICAL EQUIPMENT
- BROADCAST & COMMUNICATIONS GEAR



Liaison Electronics Seminars

(317) 253-7774

P. O. Box 40821 Indianapolis IN 46240

catalogs literature

A catalog of hard-to-find tools for electronic assembly and precision mechanics is offered by **Jensen Tools**. The catalog includes more than 2000 tools of interest to field engineers, technicians, instrument mechanics, locksmiths, watchmak-



ers and electronic hobbyists. Major categories include micro-tools, test equipment, soldering equipment, tweezers, screwdrivers, cutters, drafting supplies, power tools and a complete line of tool kits and tool cases.

Circle (16) on Reply Card

Speco offers a new supplemental catalog. This supplement has information on three new FM wireless intercoms and four new crossover networks.

Circle (17) on Reply Card

A new 8-page catalog describing their low-cost radio-frequency interference shielded cases, RF transfer switches and accessories is available from **COMPAC**. The illustrated catalog contains descriptions of a variety of blank cases, standard size cases and a custom series. It also describes the COMPAC RFT-series that offers shielding effectiveness through closer spacing of 0-80 screws tapped directly into the side-walls. Accessories are also described, including circuit boards, feedthroughs, RF connectors, test cables, adapters, coaxial termina-

tions, attenuators and a line of RF transfer switches.

Circle (18) on Reply Card

Extex has issued a 20-page catalog that features a wide variety of low-cost temperature, pH, mV, and conductivity meters and sensing probes. Also included are digital colorimeters, RH meters and recorders, memory timers viscometers, tachometers, anemometers, multimeters, and other electronic test and measuring instruments. Specifications, features, pricing and ordering information given for each product.

Circle (19) on Reply Card

The 1980 edition of the 96-page **Klein Tools & Occupational Protective Equipment Catalog 123** contains descriptions of more than 1000 products available from **Klein Tools**. The products are presented in seven basic sections. The catalog also includes descriptions of various hand tools with respect to finishes, usage, construction and nomenclature. The catalog is indexed numerically and alphabetically for easy reference.

Circle (20) on Reply Card

Two product line groupings of the new Variac autotransformers and voltage regulators, manufactured by **Technipower**, are detailed in separate catalogs made available for electronic and electrical industry use.

The 28-page adjustable autotransformer catalog contains applications, features, specifications and other data for the more than 700 Variac units in this group. It also provides details on the more than 1000 possible product variations manufactured to custom order.

Circle (21) on Reply Card

Many new scopes, function generators, and professional video generators are among the featured products in a new 40-page full-line catalog issued by **Leader Instruments**. The catalog details complete features, specifications and applications of more than 50 test instruments in addition to a large selection of probes and other test accessories.

Circle (22) on Reply Card

NATESA
5908 S.
Troy
Chicago
IL 60629



ARE YOU A PRO?

...the not for profit association championing independents' right to compete, and delivering valuable benefits continuously since 1950.

- LEADING SPOKESMAN
- TRADE INFORMATION DISPENSER
- WATCHDOG
- LOBBYIST
- YARDSTICK OF STANDARDS
- CONSUMER RELATIONS
- COUNSELOR
- PROBLEM SOLVER

We are not freeloaders. So our check for \$60.00 dues is attached. As our special premium, please ship the indicated \$15.00 Manual.

- Practical Business Manual
- OR -
 Service Contract Manual

NATIONAL ELECTRONICS SERVICE DEALERS

Are you standing idly by while ideas that can be money in your pocket fly away? Membership in NESDA is one of those ideas.



WHAT DO YOU GET FROM NESDA?

1. Insurance
2. Special Bancard Rates
3. ServiceShop Magazine
4. Electronic Service Industry Yearbook
5. Service Industry Information
6. Legislative Programs with State and National Government
7. Advocate for Better Warranty Practices
8. Business Information



Don't let your bucks get lost in the shuffle.

Send in your check today.

On the bottom line it will mean extra \$\$\$ in your pocket.

JOIN NESDA
And Your State Association
Send for more information:
NESDA, 2708 W. Berry St.
Fort Worth, TX 76109



Wire-wrapping kit

The WK-3B wire wrapping kit from **O.K. Machine and Tool** includes new wire wrapping tool, wire-wrapping wire, two 14-pin DIP Sockets, two 16-pin DIP sockets and PC board model H-PCB-1.

The kit features the model WSU-30 tool that wraps and unwraps 30

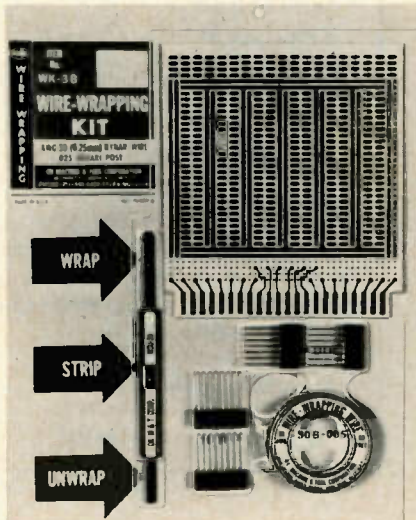

AWG wire on .025 square pins, plus strips 30 AWG wire using built-in stripper. The wire is Kynar insulated silver-plated copper. The DIP sockets feature gold-plated 3-level wire wrapping pins, phosphor bronze leaf spring contacts, and glass-filled thermoplastic bodies.

The kit is priced at \$16.95.

Circle (23) on Reply Card

Digital thermometer

Extech's model 1112 digital thermometer features F-C switching along with large 1/2-inch LCD displays and a wide temperature range. F or C readings are selectable by a switch, eliminating the need for conversion tables. Temperatures from -60 to 41F or -50 to

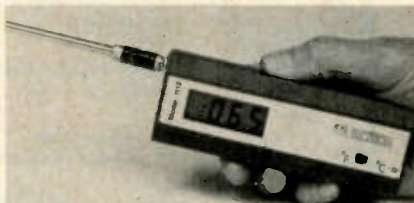

215C are covered with 0.5 accuracy and 1F (0.1C) resolution. A wide selection of probes is available, including air, surface and immersion

probes that can be stored within the meter housing.

The 1112 digital thermometer is priced at \$135.

Circle (24) on Reply Card

Portable soldering iron

The **Antex MLX12** portable soldering iron that connects to any 12V source has been introduced by **M.M. Newman**. Consuming minimal power, the lightweight iron heats up to 800F in less than two minutes. The unit features 15-foot leads with



alligator clips, replaceable iron-plated tips that slide directly over the heating element, an 8-inch plastic handle that remains cool at maximum temperatures, and carrying case.

The Antex MLX 12V soldering iron with leads is priced at \$19.95.

Circle (25) on Reply Card

Minigrabber

ITT Pomona Electronics has designed a new Minigrabber with a banana jack built into the plunger. Model 4723's banana jack is a standard 4.22 mm (.166 in.) diameter and is engineered for attaching the grabber directly to the end of a banana plug patch cord. The grabber has a gold-flashed beryllium copper hook for attachment of the test point. The banana jack is nickel-plated brass. The unit is insulated with glass-filled nylon that withstands temperatures to +100C (+216F).

The Minigrabber 4723 is priced at \$2.95.

Circle (26) on Reply Card

TV caddy

RCA has announced a system to help TV technicians tailor their parts inventory to the types of chassis being serviced. The heart of the new system is a carrying case called the **RCA Sidekick**. With this

case, it is not necessary for technicians to carry a separate kit for each new chassis. When a new chassis comes out, they buy only those parts they don't already have. An RCA chart helps to cross reference parts by chassis usage. The Sidekick contains five drawers. Four of these drawers, each 1 1/2-inches deep, hold 164 standard RCA parts boxes—the fifth drawer is 3 1/2-inches deep with room for tools, meters, handbook, dropcloth, etc. The Sidekick is made of ABS plastic. The case measures 19"x9 1/2"x13 5/8" and weighs 12 pounds.

Circle (27) on Reply Card

Electronic components

Beckman Instruments is introducing a line of individually packaged passive electronic components. The bubble-package products will be available for sale in retail electronic markets throughout the US. Two starter kits are offered to retailers at prices in the area of \$500 to \$1000. The product line will consist

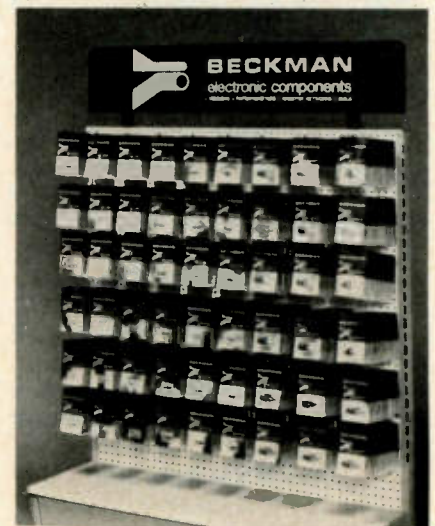

of five cermet trimmer models, four resistor network models, two precision potentiometer models and tow dial models. The 14 product lines will be available in various resistance values to total more than 60 different line items.

Circle (28) on Reply Card

Triple output supplies

The **TPM 15/200-5/500** and **TPM 12/200-5/500** are new entries in the line of **Datel-Intersil** triple output supplies. They offer advantages in performance and design features in

a compact, PC board-mountable encapsulated module measuring only 3.5"x2.5"x1.56". The models operate from 115Vac $\pm 10\%$ at 60 to 440Hz. Full-rated output is provided over an ambient temperature range of -25°C to +71°C with no derating. The TPM series includes output current limiting protection, .05% line regulation for 5V output and .02% for 15V or 12V output with impedance of 0.1 for analog outputs (12V/15V) and .05 for logic outputs (5V). The power modules are specially designed for operation with data conversion and other circuits where both a dual analog supply and a 5V logic supply are required.

Pricing in quantities of one to nine is: \$83 each.

Circle (29) on Reply Card

Multiple outlet box

Heath has introduced a new 6-socket multiple outlet box kit. The

kit features six 3-hole outlets; five switched for killing power to equipment not in use, and one unswitched for clock or computer memory save.

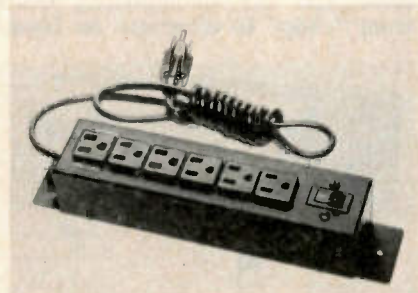

The kit includes fuse, fuse holder and 6-foot cord. Mail order priced at \$12.95, the multiple outlet box is designed to handle a 10A maximum load on 120Vac lines.

Circle (30) on Reply Card

Mini-State TV antennas

RCA has introduced a Mini-State TV antenna system. A saucer-shaped 21-inch diameter polyethylene

radome protects a unidirectional UHF/VHF antenna, solid-state amplifier and rotator from weather and dust. The antenna rotates inside the radome. A lighted, hand-held rotator remote-control unit is provided to search out the strongest TV signal. Also included are a VHF/UHF band separator, power supply, coaxial cable with attached connectors combined with rotator cable, outdoor mast mounting bracket with hardware, legs for optional indoor mounting, and a complete instruction manual. Two Mini-State models are available. The model 5MS550 connects to either 120Vac or 12Vdc, and model 5MS440 connects to 120Vac only. Both models can be installed outdoors or indoors, and bring in top reception as far as 35 miles from the TV transmitter.

Optional list prices are \$115.50 for the 5MS550 and \$103.95 for the 5MS440.

Circle (31) on Reply Card



Electronic Servicing. is Available in MICROFORM

FOR INFORMATION
WRITE:

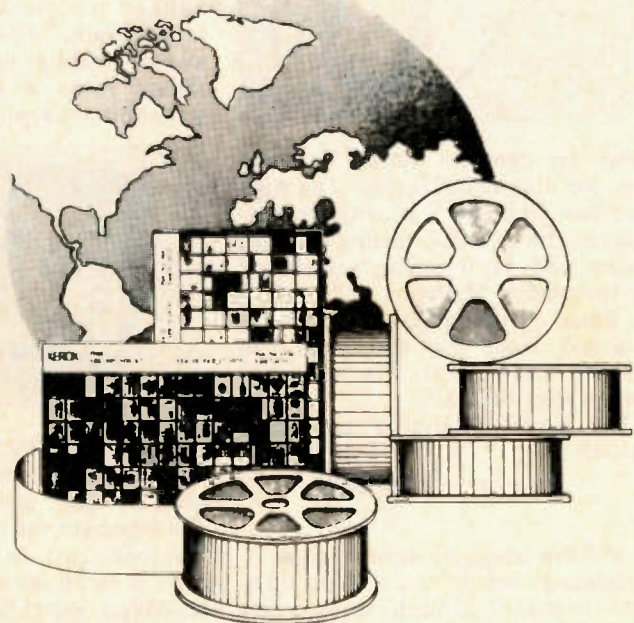

University Microfilms International

300 North Zeeb Road
Ann Arbor, Mich. 48106
U.S.A.

18 Bedford Row
London, WC1R 4EJ
England

test equipment report

Logic probe

The Non Linear Systems' model MLB-1 digital logic probe is a small electronic probe that measures logic states and levels both statically and dynamically and detects spurious random pulses. Its indicators are grouped closely so the user can focus attention on the circuits under consideration. The TTL, DTL or CMOS type of logic is switch selected. Other models include

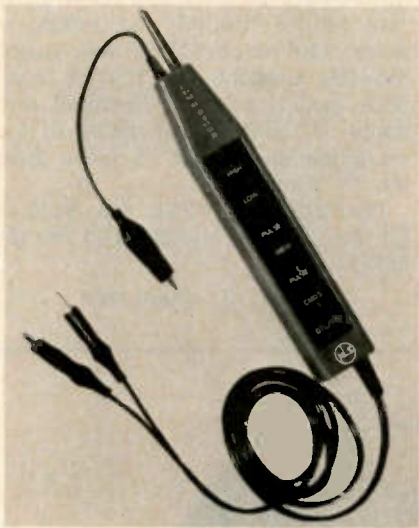

pulse, for dynamic testing, or memory, for stored indication. The high and low indicators provide indications in the dynamic testing of pulse trains and rectangular waveforms up to 10MHz. Minimum pulse width is 50ns. The MLB-1 is usually powered from the supply of the circuit under test. An external supply may be used.

The model MLB-1 is priced at \$41.96.

Circle (32) on Reply Card

15 MHz triggered-sweep scope

Simpson Electric has introduced a new compact 3-inch dual-trace scope, model 454.

The 454 features triggered sweep and 15 MHz bandwidth plus all solid-state and IC components (except CRT). Differential vertical amplifier stages provide wide bandwidth (dc coupled, dc to 15MHz) with smooth roll-off through 30MHz. Triggering is external or internal from Ch A or Ch B with sync position for TV. Sensitivity is 5

mV/division and rise time is 24 nsec. The 454 automatically shifts from "chop" to alternate on faster

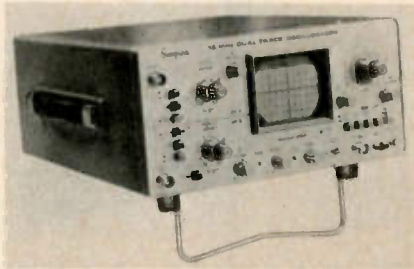

sweeps. A folding convenience stand and two low capacitance probes are provided.

The 454 is priced at \$675.

Circle (33) on Reply Card

Function/sweep generator

Leader's first function generator, model LFG-1300S provides a wide range of signal generator capabilities. The LFG-1300S covers frequencies of 0.002 to 2MHz in eight ranges and includes linear and logarithmic sweep modes with sweep widths up to 1000:1 and sweep rates of 0.5 to 50Hz. The generator output frequency may



also be varied by an external 0-10V signal. Waveform outputs include sine, triangle, sawtooth and pulses. The symmetry of the pulse output is variable from 9:1 to 1:9. Output level is continuously variable from 0 to 20Vpp (50 Ω load) and a push button attenuator provides up to 70 dB attenuation in 10 dB steps.

The manufacturer's suggested price for the LFG-1300S function/sweep generator is \$495.

Circle (34) on Reply Card

Pocket-sized multimeter

The M15 multimeter by Universal Enterprises has been restyled to

include easy to read numerals on the scale plate and a more compact design. The unit features three color coded scale plate and front panel, impedance protected Ohm circuit, diode protected movement, and a 1-year warranty. The tester has

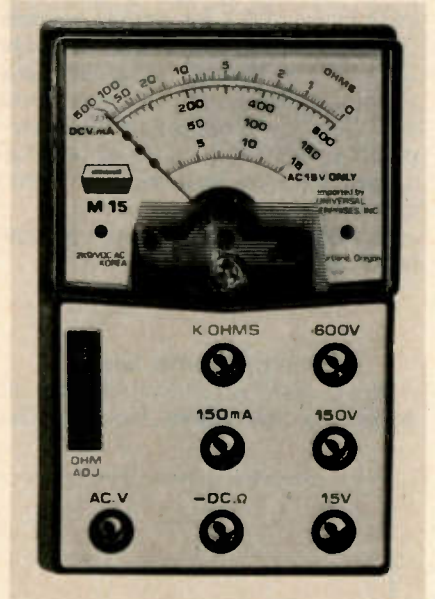

eight electrical test ranges: ac and dc volts, 0-15-150-600; dc mA, 0-150; and Ohms, 0-500K. Test leads, battery and instruction manual are included. Accessories available include insulated alligator clips and a soft vinyl carrying case. The suggested price of the M-15 is \$11.95.

Circle (35) on Reply Card

Function generator

The model 420 function generator, by Simpson Electric, provides sine, triangle and square wave output, plus dc and TTL logic output over a frequency range of 0.1Hz to 1MHz in seven ranges. Signal amplitude is 10Vpp into a 600 Ω load, and is continuously variable more than 30dB. In addition, a fixed attenuator selects 0 to -30dB attenuation. The 420 also has continuously variable dc offset with a convenient off position. Frequency accuracy is $\pm 3\%$ of full scale from 1Hz to 100KHz. Sine wave distortion is less than 1% over a frequency range of 1Hz to 100KHz. A VCG input permits external voltage control of generator

output frequency over a 300-to-1 ratio. The 420A is designed for ac line operation only, and the 420D is designed for ac line and battery



operation using four C size, rechargeable, nickel cadmium cells.

The 420A is priced at \$175, and the 420D is \$210.

Circle (36) on Reply Card

Safety test leads

The newly-developed **Herman H. Smith** "Total Safety" test lead system limits any danger of personal contact with live metallic conductors during test procedures and provides full protection against accidental disengagement of cable assembly, test prod, input accessories or meter inputs. The system consists of a universally applicable safety test prod, a separate plug-in cable assembly that can double as a separate jumper, and input adapter accessories that plug into the prod nose and cable assembly. The plug-in cable assembly, equipped with safety connectors on each end, is designed to mate with the prod on one end and meter inputs on the other, making it both versatile and modular. The safety prod nose is designed to mate with any of seven input adapter accessories.

Circle (37) on Reply Card

Snap-around VOM

A snap-around VOM, featuring a 1.5A scale, and designed for low current measurements, has been introduced by **A.W. Sperry Instruments**. The model SPR-311 snap-around accurately measures current below 3A, offers $\pm 3\%$ of full-scale accuracy at 60Hz, and with the optional E-1 energizer, can accurately measure 1/10A. The unit offers five current ranges up to

150A ac; gives measurements for three voltage scales up to 600ac and has a continuity tester with 25 Ω midscale.



The SPR-311 snap-around includes test leads, 1-piece ohmprobe attachment, case, battery, fuse and instructions.

Circle (38) on Reply Card

Digital thermometers

Non-Linear Systems has introduced two hand-held digital temperature meters; models LT-3 and LT-31. The LT-3 features a 3½-digit LED readout, rechargeable batteries and charger. The LT-31 features an LCD readout and operates from a replaceable 9V battery.



The LT series digital temperature meters can be supplied with any of eight thermistor or RTD temperature sensors to read temperatures within the range of 0 to 199°C or 32 to

199°F, with a resolution of 0.1 degrees. Prices are \$85.55 for the Model LT-3 and \$79.95 for the Model LT-31.

Circle (39) on Reply Card

Instrument probe

A high-performance wideband instrument probe has been announced by **B&K-Precision**. The model PR-40 is designed for use with scopes and frequency counters in applications through 100MHz. The PR-40 is a slim-body probe with a three-position switch which selects either a 10:1, a direct mode, or a reference position that grounds the tip through a 9M resistor. Accessories supplied with the PR-40 include a spring-loaded retractable tip-cover, insulating tip, a snap-on ground clip, BNC tip adapter and an IC tip.

The PR-40, complete with accessories, is priced at \$34.

Circle (40) on Reply Card

CRT restorer/analyzer

The **B&K-Precision** model 467 CRT restorer/analyzer provides definite yes or no answers to tube conditions. The unit features a built-in restoring capability to restore ex-



tended life to faulty tubes. The 467 is designed for fast operation and will remove shorts and leakage from faulty tubes. Automatic restoration timing governs restoration duration.

Circle (41) on Reply Card

reader's exchange

There is no charge for a listing in *Readers Exchange* for items "Needed," but we reserve the right to select and edit all copy. Due to the limited amount of space for this department, "Needed" listings must contain no more than three items. If you can help with a request write directly

For Sale: DSI 3550 frequency counter, original cost \$150, used once, \$125; Heathkit used SM-105A, original cost \$375. Make offer. Scheider Radio & TV, 2381 Hamms Rd., Burlington, WI 53105.

For Sale: Make best offer for the three Philco console radios of '40s, four 10-inch TVs, GE and Motorola. John Lang, RD 3 Box 87 B, Hudson, NY 12534.

For Sale: Model 650-C Hickok universal video generator, very good condition, \$75. Homer Schulz, 524 N. Cherry, Valentine, NE 69201.

For Sale: EICO 460 scope, new in box with manual, turned on once, \$75; Sencore TF-166 transistor checker, excellent condition, \$100. TV Radio Hospital, 462 Main, Torrington, CT 06790.

For Sale: Hickok model 799 dynamic mutual-conductance tube tester, \$60; 332 TV tubes, \$330; 180 **Electronic Servicing**, **PF Reporter** and other publications, 1963-77, \$45. Send SASE for lists of other test equipment. Al Larsen, 26 Amboy Ln., Schaumburg, IL 60194.

For Sale: More than 250 tubes of different types, new and used, \$75; send SASE for list and make offer. Don Hicke, 11380 Bootes, San Diego, CA 92126.

For Sale or Trade: conar single-trace 6-MHz triggered-sweep scope with probe kit, \$150; tubes, switches, other parts. Send for list. Also will trade for a good frequency counter, yoke/flyback tester, Variac or good VHF/UHF scanner. Leonard Elgart, 3510 Avenue H, Brooklyn, NY 11210.

For Sale: Hewlett-Packard 182C scope with 1802A timebase and 1801A dual-channel, 50MHz vertical amplifier, \$1250; Hewlett-Packard 5300B counter with TCXO and 5302Z 50MHz plug-in \$500; B&K-Precision E-310B sine/square generator, \$150; Heath IM-102 DMM with HV and RF probes, \$225; and several CB Photofacts. M. Murrel, Rt. 3, Box 714, Cut Off, LA 70345.

For Sale: Measurement lab model 78B signal generator, 20-32MHz and 190-230MHz, \$20; Rider's TV manuals volumes 5 through 26, \$75; Rider's radio manuals volumes 16 and 17, \$8 each; Pilot model AA-405 monaural amplifier, push-pull 6L6 output, \$30; and Sylvania model 500 TV sweep generator, new in original carton, \$50. M. Seligsohn, 1455 55th St., Brooklyn, NY 11219.

For Sale: Sencore model TF151 transistor FET tester with manuals, good condition, \$75 plus shipping; B&K-Precision model 1076 television analyst, with manuals, good condition, \$200 plus shipping. Wilburn W. Crain, Rt. 3, Box 384, Murphysboro, IL 62966.

to the reader, not to **Electronic Servicing**. "For Sale" listings received after May 1, 1980 will be charged for and included in the regular classified section of **Electronic Servicing**. Please consult that section for price and ordering instructions.

For Sale: Good used test equipment and supplies such as B&K-Precision model 415 sweep generator; Sencore FET 20 multimeter; Beltron picture-tube restorer; and several older Photofacts and magazines. Best offer for any or all; write for list. Lewis Radio & TV, RR1, Central City, NE 68826.

For Sale: Heath IG-18 sine/square audio gen., exc, \$75; Heath IG-37 stereo gen., etc., \$60; continental Specialities R/C bridge, DM-3 exc., \$65; EICO model 214 VTVM, collectors item, works good, \$40. Electronic Service Company, 1412 Mayfield Ave., Morgantown, WV 26505.

Needed: Schematic for an Aircastle solid-state AM/FM stereo receiver model TCM-800oB. E. Sutherland, 1391 Sturdevant Rd., Smiths Creek, MI 48074.

For Sale: Many early radio and TV schematics (some from the 1920s) in hard covers. Must sell. Mrs. Frank Michuda, Rt. 3, Box 345, Paris, TN 38242.

For Sale: EICO flyback-yoke tester, \$20; Sencore CG-22 dot-bar generator, \$30; EICO signal tracer, \$20. Home TV, 2945 Norvus, Sarasota, FL 33577.

For Sale: RCA color test jigs 10S102 and 10J104, complete with meeters and 60 adaptors, \$400 for both, B&K-Precision 1077 Analyst, \$200; Sencore ringer and flyback checker, 100; Sencore Super Cricket transistor checker, \$120. Hazel Kuhn, RR 2 Box 109, Louisburg, KS 66053.

For Sale: B&K-Precision model 1077B TV Analyst, good condition, \$350; Conar model 255 triggered-sweep scope, excellent condition, \$250. You pay shipping. The Electronic Image, 133 N. 1st St., Seneca, SC 29678.

For Sale: CB radio repair course (from CB magazine), \$275; Leader LSG-227 CB signal generator, \$300; Hickok 388 CB in-line tester, \$175. All items in boxes. CB Discount Supply, 305 Natchitoches, W. Monroe, LA 71291.

Needed: Oscillator coil for Zenith model Royal-500 (chassis 7XT40) portable radio. Zenith part number is 95-1461. Pay good price for operable coil, or will buy radio (any condition) for the coil. Art's Radio Repair, 2861 Rimrock Rd., Madison, WI 53713.

For Sale: B&K-Precision 415 sweep generator, \$300; B&K-Precision CRT tester, \$100; RCA 10J103 test jig, \$200; Photofacts 19-800, not complete, \$1 each. Other information and tubes. L.E. Stokes, 2316 Fontaine Dr., Alton, IL 62002.

For Sale: B&K-Precision scope model 1465, 10MHz, with probe, in original carton, like new \$300. Also Photofacts from 1-700, \$300. Channel Electronics, Rt. 206, Andover, NJ 07821.

Needed: Schematic for model 6424 (ID 1011510-1) Sears Silverstone old radio. Weaver's TV & Electronics, Mount Zion, WV 26151.

For Sale: Many 74367 ICs, .69 each. E.F. Duggan, 416 Roberts St., Reno, NV 89502.

For Sale: Sylvania model 500 TV sweep generator, new in original carton, \$50; measurement lab model 78B signal generator 20-32MC and 190-230MC, \$15; Pilot model AA905 mono amplifier, push-pull 6L6 output, perfect condition, \$25; Rider's TV Manuals, volumes 5-26, \$65; Rider's Radio Manuals volumes 16 and 17, \$7 each. All items plus shipping. Send for list of additional parts. M. Seligshon, 1455 55th, Brooklyn, NY 11219.

For Sale: Photofacts 1-800 and some extras. Best offer. Wm. Barrick, Box 14, Lebanon Church, VA 22641.

For Sale: Slightly used B&K-Precision 1801 frequency counter, 2040 CB generator, and 1040 CB service master for \$625, and a 415 sweep/marker generator, \$400. Like new, with manuals. Julian Haskins, 1425 E. Jackson, Thomasville, GA 31792.

For Sale: Leader model LB0520 dual-trace 30MHz scope, like new, \$800. Raymond Mack, 728 Bismark Ave., Ventura, CA 93003.

For Sale: ACA wow and flutter meter with built-in 3000Hz test signal 7-inch meter, \$150 prepaid. H.E. Friedman, 16-40-163 St., Whitestone, NY 11357.

Needed: Schematic for Eldorado Electro Data Corp. calculator model (Director Two). National Electronics digital display panel NDP-1252-B. A. Edison, 2738 McLaughlin Ave., San Jose, CA 95121.

Needed: Schematic and service data for model H3046T Philco TV. This is in Photofact 484-2, which is out of print. Will buy, or copy and return. Joe Banche, 763 Breezedale Pl., Columbus, OH 43213.

Needed: Used digital techniques courses, also reasonably priced digital trainer ET200. All postage paid. K. Ramjee, 41 Agapalithus Rd., Malabar, Port Elizabeth 6001, South Africa.

Needed: Schematic and/or other information about Boonton FM signal generator model 202C. L.A. Goodman, 2130 Chandler Ave., Fort Myers, FL 33907.

Needed: Manual for Simpson 260 Series 5 VOM. James Humphrey, 1006 E. 28th St., Los Angeles, CA 90011.

Needed: Operating instructions and schematics for a DuMont scope, type 403. Joe Tokarz, 4054 Sheffield Ave., Hammond, IN 46327.

Needed: Schematic and service data for Candle model MT-510A 5-inch b&w TV. Will buy or copy and return, James Hudson, 1826 Elmwood Ln., Bettendorf, IA 52722.

Needed: Heathkit IG-57 post-marker/sweep generator;

Heathkit CRT tester/rejuvenator model IT-5230; Heathkit resistor substitution box IN-3137; and Heathkit capacitor substitution box IN-3147. Need complete manuals. James L. Young, Box 2297, APO NY 09021.

For Sale: Contents of TV service shop, including test equipment, parts, tubes, modules and older service literature. Send self-addressed stamped business envelope for details. Mr. TV, P.O. Box 533, East Dennis, MA 02641.

For Sale: Heathkit IG-18 audio generator, \$50; Heathkit IG-28 color/bar generator, \$65; Heathkit IO-18 lab oscillator, \$50; Sencore TC-162 tube tester, \$70; and Telematic test jig, \$50. Good condition and with probes. Shipping extra. Edward Andryscyk, 100 Compton Ave., West Keansburg, NJ 07734.

Needed: Sylvania CK-3000 test jig with any adapters. Ken Ausperk, RR 4 Box 13, Logansport, IN 46947.

For Sale: Twenty-seven new GE modules for Y and M lines at one-half GE net plus shipping. Write for list. Carroll Seats, 682 Fescue, Portage, MI 49081.

Needed: Service information, theory of operation, specifications or any other information for a West Bend Radar Gun model DHH 6000. Navcom Electronics, PO Box 1568, Blaine, WA 98230.

For Sale: Sony/JVC color-type RF modulators, crystal-controlled single-channel units, FCC approved, available for channels 3, 4 and 6. Need power supply, limited supply. List \$100, will sacrifice. Send stamped addressed envelope for details. Petroff Electronics, 1219 McDonald Ave., Hastings, NE 68901.

Needed: Service Manual and schematic for a sig gen TS-413AU model 359. Will buy or copy and return. CB Service Tech., Alert Base, Willis O'Bryan, 409 S. High St., Sible, IL 61773.

Needed: One good 12KP4A kine scope. Lee Johnson, 8617 Piney Branch Rd., Silver Spring, MD 20901.

Needed: A transformer, Zenith part 95-630. Tom Modica, The Electronic Shoppe, 102 W. Main, Everson, WA 98247.

Needed: Socket adapter model CA-4 for Hickok tube tester. Kermit Shetley, 2031 Woodland Hills Dr., Cape Girardeau, MO 63701.

For Sale: Approved AM signal generator, like new, \$30; Astatic model BT-1 UHF/FM booster, \$20 or best offer. Irv Goodman, 516 S. Kenmore Ave., Los Angeles, CA.

For Sale: Model SA84T Polorad spectrum analyzer; Sensitive Research Instrument model B laboratory standard antique milliammeter, in excellent condition. Best offer for each. Andrew Kulick, 88 Standiford Ave., Sayreville, NJ 08872.

Needed: Schematic and power transformer for Crosley radio model 1019M. Quote price delivered. Fred Palm, 318 Swallow Ave., Sebring, FL 33870.

Readers exchange

Needed: Service data for Empire model MB-880 AM/FM 8-track tape combination, also need source for parts. Herman Walton, 59 Hoffman Dr., Hampton, VA 23669.

Needed: Used, in good condition, MTI course about FM radio servicing. State price. Paul Vida, 300 Lorraine Dr., Weirton, WV 26062.

For Sale: Telequipment DG7, 30MHz dual-trace scope, excellent cond., \$490; Lamba 20V at 6A variable voltage/current dc lab supply, excellent cond., \$175; Hewlett-Packard 3469B DMM, 90% operational, \$125.
Needed: Hickok electronic Volt-Ohm-Capacitance

For Sale: Six RCA Victor service notes and manuals, 1929-1936, best offer. Thos. Ferzaco, 57 Colburn St., Leominster, MA 04153.

Needed: Simpson Series 5 VOM. Will trade Rider's Radio or TV manuals or buy. Also, need tuner substituter. Troch's TV, 290 Main St., Spotswood, NJ 08884.

Needed: Used B&K-Precision test equipment in good working order, at a fair price. Analyst model 1077B; mobile power supply model 1640; and transistor tester model 520B. State prices, age, and how units can be shipped. Bob Howe, 4361 McDowell Ln., Baltimore, MD 21227.

For Sale: Telematic transverter, \$29.95; Hickok 610 sweep generator and manual, \$50; and Micro-fiche 4x6 literature cards, \$3 each. Samar TV, 8 Dusk Dr., Centereach, NY 11720.

For Sale: New and used test equipment, parts and supplies. Send stamped addressed envelope for list and prices. Helton's TV, 7472 Memorial Dr., Hitchcock, TX 77563.

For Sale: American antique radio diagrams pre-1950, \$5.00 + 75 cents postage and handling; send make, model, serial and chassis numbers and sketch of tube layout. Dan Steele, Box 1643, San Luis Obispo, CA 93406.

Needed: Hickok electronic Volt-Ohm-Capacitance milliammeter model 209-A, with or without probes. John's Speakers Service, 318 Poplar Rd., Riegelsville, PA 18077.

For Sale: All of part of Supreme Publications service manuals, Photofacts, Rider's Radio manuals and other antique radio material. Lawrence Beitman, 1760 Balsam Rd., Highland Park, IL 60035.

For Sale: More than 1900 unused tubes with 7 tube caddies, \$500 or best offer. Some Photofacts, send for complete list. Scott Eisenberg, 301 W. Jackson, Chicago, IL 60606.

Needed: Operation manual and related information for RCA scope type 155-C, MI-30155-C. Martin Augustine, 26 Star Rt., Downsville, NY 13755.

Needed: 3KP1 or 3KP4 cathode ray tube; early radios, battery and electric; and WD11 and 201A tubes. Joe Santomas, 14 Railroad Ave., Hammonton, NJ 08037.

For Sale: TIC UHF sweep generator with crystal marker on every channel, \$100. Ted Foster, Texas Tuner Service, 4210 NE 28th St., Fort Worth, TX 76117.

Needed: Good used 9WP4 b&w picture tube, and Y105 yoke. M. Danish, Mike's Repair Service, Box 2176, Aberdeen Proving Ground, MD 21005.

Needed: Schematic and power transformer for a Denon MX-990 AM/FM receiver; also schematic for Sharp FX-28A portable car radio. R.C. Schmick, 909 Knepper Dr., Mechanicsburg, PA 17055.

For Sale: Reel-to-reel stereo tape deck Dokorder model 8010, good condition, microphones and manuals, \$275 plus freight; Sencore Super Cricket TF-30 transistor tester, good condition, reference book, manual and touch test PC board probe, \$200 plus freight. Geo. Wolovick, 215 Tottenham Rd., Lynbrook, NY 11563.

For Sale: R.L. Drake R-48 receiver, like new, \$350; and Sonar model G CB transciever, like new, \$75. P.O. Smith, Rt. 4 Box 793, Mooresville, NC 28115.

Needed: New or used audio output transformer for KU45A Knight Kit part no. 102-217; high-voltage transformer for Broadmoor color set model 6911C part no. VZ12017 alternate part 36VZ1216; Power transformer for Saba AM/FM radio model 200-10T. Tony Schumacher, 3338 E. Grange Ave., Cudahy, WI 53110.

For Sale: Sencore "Big Mac" CRT tester, \$150; Sencore CG-169 color generator, \$150; Sencore 139 transistor checker, \$30; and Berkley-Beckman ac voltmeter, \$25. Orville Dreyer, 116 N. Regency Pl., Tucson, AZ 85711.

For Sale: B&K-Precision scope model 1465 with probe. Tony Schumaker, 3338 E. Grange Ave., Cudahy. WI 53110.

For Sale: Sylvania 3000 Check-A-Color test-jig with four adapter sets—GE, Zen., Mag., RCA, \$235; B&K-Precision 1077B TV Analyst, \$275; B&K-Precision 415 sweep generagor, \$225; Sencore PS-29 pushbutton scope, \$300; B&K-Precision 467 CRT analyzer with adapters, \$185. All items in new condition with cables and manuals. W.H. Hammons, 1315 N. Liberty St., Morris, IL 60450.

For Sale: Tektronix 535A dual-trace scope, type 202-2, dust cover, two low-capacity probes and two manuals, excellent condition, \$850 plus shipping; Fluke 8000A DMM, ac and battery operation, with carrying case, HV probe and test leads, excellent condition, \$200 plus shipping. Benes Rachiele, 867 Throggs Neck Exp., Bronx, NY 10465.

For Sale: Lafayette 3B-8 ac-powered scanner. Made in US by Bearcat/Electra. Takes up to eight Bearcat crystals. Clean, 100% original. Set has never been peaked up or repaired. J. DeLasse, 17 Seldin Ave., Richmond, NY 10314.

Needed: Lectrotech TO-50 scope and Sencore PS-120 portable scope. Kenneth Miller, 10027 Calvin St., Pittsburgh, PA 15235.

For Sale: Heathkit capacitance tester, \$25; Simpson 311 VTVM, \$25; Precision tube checker, \$25; all excellent condition, with manuals. Ed Abrams, 42 Daniel Rd., West Haven, CT 06516.

For Sale: B&K-Precision 520 transistor tester, \$125; Heath kit VTVM IM-28, \$40; Heathkit high-voltage probe (30,000V) \$15. All items with manuals and cables, plus shipping. Gunter Seuring, Rt. 2 Box 338, Hidden Lakes, Mukwonago, WI 53149.

For Sale: Hickok 539B tube tester; Golden hour clock, complete and clean, would trade on small metal cutting lathe. George Robinson, 7155 Walden Rd., Newburgh, IN 47630.

Needed: Schematic for a Candle model MT510A b&w TV by Tokyo Television. Ed Hanker, 236 Winding Way Rd., Stratford, NJ 08084.

For Sale: Sencore CR31 Super Mack CRT tester/restorer with accessories, \$30; Sencore SM152 sweep/marker generator with cables and manual, \$195; Weston 666 FET-VOM, \$60; Sencore TF26 Cricket transistor tester, \$90. Other equipment available. All items in perfect working condition. Shipping additional. Mario Rosignulo, 368 S. Hill Blvd., Daly City, CA 94014.

Needed: B&K-Precision 1248 color generator/analyzer with instructions. Please state condition and price. John Caputo, 271 Cadman Plaza East, GPO Record Rm: 606, Brooklyn, NY 11201.

Needed: Panasonic power transformer part no. TLP-5213 for TV also need modulation transformer for General CB radio, part no. Ensign 6561. Commercial TV Electronics, 1828 Peyton Dr., Las Vegas, NV 89104.

For Sale: B&K-Precision 415 sweep generator, \$300; B&K-Precision 1077B Analyst, \$300; Sencore YF33 with HV probe, \$125. William Quirk, Box 760, Robin Rd., Furlong, PA 18925.

Needed: B&K-Precision tube tester model 700. Send price. Vergin's TV, Box 220, Rockford, MN 55373.

For Sale: Forty different yoke adapters (Telematic type), \$5 each plus shipping; PF Reporter and Electronic Servicing from Nov. 1965-Dec. 1978 (Nov '75 missing) 50¢ each plus shipping. Benes Rachiele, 867 Throggs Neck Exp., Bronx, NY 10465.

For Sale: Heathkit model IO-12 5" 5MHz scope with coil ringing jack and demodulation probe, \$60; Mallory capacitance/inductance tester model CRT-1, \$35; EICO model 315 RF signal generator, \$35; Sencore probes model FP201 and 39G89, new, \$25; 180 Photofacts below 400, \$75. All testers in good condition with manuals and schematics. Long's TV, 720 Goshen St., Salt Lake City, UT 84104.

For Sale: Rider's Radio manuals with complete index, Volumes 1-22 (No. 3 missing). Sold as complete set only. Also, Rider Phono Recorder manual. Please make offer. Harold Hanson, Box 28, Almelund, MN 55002.

Needed: Schematic for ERC stereo radio #8625. Will pay all cost for copy and mailing. George Cambell, 44445 13th St. E., Lancaster, CA 93534.

Needed: Schematic for a model 7-11 RCA Victrola Radiola (circa 1928). Henry Schamdling, 1250 Saunders Dr., Elizabeth Cy, NC 27909.

Needed: Motorola solder pot. Will buy or swap. Loyal Heights TV, 7735-24th NW, Seattle, WA 98117.

For Sale: 16-inch b&w Emerson portable TV, with new CRT; b&w GE console TV, good shape. Either set for \$50 plus shipping. Zenith VHF-color Video-Guard tuner, Part no. 175-503, \$10 plus shipping. William M. Suhy, 456 Burrirt Ave., Stratford, CT 06497.

Needed: Sencore Power Monitor model PM-157 and Sencore Big Mack picture tube tester. Kenneth Miller, 10027 Calvin St., Pittsburgh, PA 15235.

For Sale: Complete set Rider's Radio Manuals, volumes 1-22; Rider's TV manual, volumes 1-27 with indexes; one 1953 Motorola TV and radio manual; six volumes (1-6) Rider's TV Manufacturer's Trouble Cures (1953-54). All in good condition. Sold only as a complete unit, \$1000 plus shipping costs. John Szucs, Box 74, Middlefield, OH 44062.

For Sale: EICO model 685 transistor analyzer. Incorporates dc voltmeter, \$95; EICO model 242 FET-TVOM with multi-probe and probe, \$75. Both in good condition with manuals. P. Eodice, 5056 Lincrest Pl., Dayton, OH 45424.

Needed: Good VTVM wide-band scope, B&K-Precision 1077 TV Analyst and older Photofacts. Please state your low price and condition. Al D'Angelo, 280 Dark Hollow Rd., Oakmont, PA 15139.

Needed: Used B&K-Precision test equipment. State condition, model and price. All offers will be answered. Don Mol, Audio Sound, 0-932 Chicago Dr., Jenison, MI 49428.

Needed: Telematic yoke adapter, No. 17 or 18. Also Telematic yoke adapter no. 15. Joe Mehalko, 324 4th St., Blakely, PA 18447.

For Sale: Complete Bell & Howell schools' correspondence course, Television and Radio Servicing. Includes all tests, exams answer sheets, projector lessons and supplements, \$200 or best offer. William Suhy, 456 Burrirt Ave., Stratford, CT 06497.

For Sale: B&K-Precision TV Analyst 1077B with manual, cables, transparencies and accessories. Unit looks and works like new. \$450 plus shipping. Streeters TV & Audio Service, Box 275, Springfield, VT 05156.

For Sale: Dual-trace 15MHz Heathkit scope, excellent condition, \$375. Heinz TV, 68 North Hill Ave., Pasadena, CA 91106.

Needed: Sencore SM-152 sweep generator with manuals and cables. In good condition, State price. Dennis Cordeiro, 3373 Kii Pl., Makawao, HI 96768. □

IT'S NO PUZZLE

TO ORDER

OELRICH SERVICE FORMS

FOR TV-RADIO & 2 WAY RADIO SERVICE LEGAL FORMS FOR CALIF. FLA. UTAH NOW AT YOUR PARTS JOURNAL OR WRITE FOR CATALOG B64
OELRICH PUBLICATIONS

4040 N. NASHVILLE AVE. CHICAGO, ILLINOIS 60634

Circle (10) on Reply Card

themarketplace

Advertising rates in the Classified Section are 35 cents per word, each insertion, and must be accompanied by cash to insure publication.

Each initial or abbreviation counts a full word.

Minimum classified charge \$3.00.

For ads on which replies are sent to us for forwarding (blind ads), there is an additional charge of \$3.00 per insertion to cover department number, processing of replies, and mailing costs.

Classified columns are not open to advertising of any products regularly produced by manufacturers unless used and no longer owned by the manufacturer or distributor.

For Sale

REPLACEMENT COLOR YOKES—DEALER ONLY. Zenith 95-2501-2532-2638-2667-S-89633 etc. \$19.94. Magnavox 361380-1 \$21.95, Sylvania, GE etc. \$17.95 to \$22.95. Request for price list on your letterhead. David Sims Enterprises, Inc., 665 Jericho Turnpike, Huntington Station, N.Y. 11746, (516) 549-3925. 5-79-tf

AUTOMOBILE RADIO and tape replacement parts: Delco, Chrysler, Philco-Ford, Motorola, Panasonic and many others. Large inventory. Laran Electronics, Inc., 3768 Boston Road, Bronx, NY 10469, (212) 881-9600, out of New York State, (800) 223-8314. 5-79-tf

TV & RADIO TUBES, 36 cents EA!! Free color catalog. Cornell, 4221 University, San Diego, California 92104. 8-76-tf

ELECTRONIC SURPLUS: CLOSEOUTS, LIQUIDATIONS! Parts, equipment stereo, industrial, educational. Amazing values! Fascinating items unavailable in stores or catalogs anywhere. Unusual FREE catalog. ETCO-011, Box 762, Plattsburgh, N.Y. 12901. 6-78-tf

TV RENTAL SYSTEMS! Complete & guaranteed. Manual or computerized. Send \$2.00 for complete details. Perry's rental systems, 133 Brenda Street, Milton, Florida 32570. 2-80-tfn

BUY FACTORY DIRECT: TV parts, semiconductors, antennas, chemicals. Prices below wholesale. Write: Midwest Semiconductor, 4411 W. North Ave., Milwaukee, WI 53208. 2-80-4t

FOR SALE: T.V. ANTENNA INSTALLATIONS + MATV SYSTEMS + SATELLITE/PAY T.V. INCLUDED! SACRAMENTO, CAL. BASED. LARGEST COMPANY HERE. ASKING \$700K + INVENTORY. WRITE VAG78B BOX 1010, WOODLAND HILLS, CA. 91365. 3-80-2t

HEWLETT-PACKARD SCOPES: 22 mhz Dual Trace—\$350 50 mhz Dual Trace—\$650. Calibrated & Guaranteed. Free Catalog. 1445 N.W. 9th St., Homestead, Fla. 33030, (305) 247-6349. 3-80-2t

TIME AND LABOR-SAVING DEVICES, previously unmarketed. Can increase service profits substantially. Plans range from efficient shop and van layouts to specialty tools, such as telescoping mastjacks and turntable cradles. For plans send \$12.50 to Devices, P.O. Box 204, Rock Port, Mo. 64482. 3-80-3t

NEED A NEW ONE? Write me. I can make or remake most meter or instrument faces. Rapid service, professionally executed work. Free Info. FRASGA TECHNICAL ARTWORKS, 422 Metropolitan Ave., Waukegan, Ill. 60085. 5-80-1t

TUBE CADDY complete with tubes. Approx. \$800 worth for \$600. Rt 1, Box 250, Grottoes, Va. 24441. (703) 249-5544. 5-80-1t

PRINTED CIRCUIT boards from your sketch or artwork. Affordable prices. Also fun kit projects. Free details DANOCINTHS INC. Dept. ES, Box 261, Westland, MI 48185. 5-80-1t

FOR SALE: 1 B&K Model 1471 Dual trace 10 Meg. Scope—\$300.00; 1 Sencore SM152 SWEEP-Marker generator—\$90.00; 1 Sencore FE160 Meter—\$50.00. All like new with instruction manuals. R. McLaughlin, 51 Lyon St., Valley Stream, N.Y. 11580. 5-80-1t

PICTURE TUBE REBUILDING EQUIPMENT capable of producing four high quality tubes per day (WILL TRAIN TO OPERATE) \$4200. Call or write Atoll Television, 6425 Irving Park, Chicago, Illinois 60634. PH: 312-545-6667. 5-80-2t

Business Opportunity

TV SALES AND SERVICE in sunny Florida. Same location over 20 years. \$20,000 firm. Interested apply only. Send letter to shop owner, 1516 South Jefferson Avenue, Clearwater, Fla. 33516 3-80-5t

ESTABLISHED TELEVISION REPAIR. Good income. Friendly people. Enjoyable living. Available after June 1st. Owner retiring to Caribbean. Greg Bolton, Box 1221, Shawnee, OK 74801. Phone: Day (405) 273-1990; Evening (405) 273-8270. No Friday evening or Saturday calls, please. 5-80

TV SALES & SERVICE BUSINESS established 25 years plus. Located in St. Petersburg Florida on Gulf of Mexico & Tampa Bay. Spacious shop area & showroom. Good net. Address inquiries to Box 01585, St. Petersburg, FL 33710. 5-80-1t

FOR SALE: TV sale & service shop. Established business in beautiful Wyoming—a fast growing energy-impact area—Includes real estate, equipment, & inventory. Call 307-672-9415. 5-80-1t

EXTRA INCOME! NO SELLING! Distribute VIDEO GAMES ad cards from your shop or on service calls and earn easy commissions! Write: Video, Box 27348, Dept. ES1, Mpls., MN 55427. 5-80-1t

FOUR THOUSAND DOLLARS takes over inventory and equipment and puts you in the service business. Low overhead and unlimited possibilities. Saline T.V. Center, P.O. Box 233, Saline, Michigan 48176. Phone: 313-429-7930 5-80-1t

Wanted

WANTED: Sams folders 1400 up. Heath color generator IG-5240/SG-5240. Herbert, 410 N. Third, Minersville, PA 17954. 3-80-2t

WANTED: Used picture tube rebuilding equipment. Modern Electronics, 260 Davis St, Sarnia, Ontario, N7T 1B5, Canada. Ph: 519-336-7633. 5-80-1t

HELP WANTED

TELEVISION TECHNICIANS—Experience necessary, top pay, medical benefits, paid vacations. Enjoy a new "Life Style" in a beautiful, friendly, smog free, full service desert community. Send your resume to 225 E. Ridgecrest Blvd., Ridgecrest, California 93555. Telephone 714-375-1361 ask for Service Manager. 3-80-tfn

To get more information...

on items advertised or described in this publication, use the Reader Service Card

advertisers' index

Channel Master	IFC
Fuji Svea Enterprises	5
Liaison	17,32
Gamit Enterprises Inc.	23
General Electric Co., Television	19
General Electric Co. Tube Div	IBC
Klein Tools Inc	5
Mura Corp.	21
NATESA	33
NESDA	33
OK Machine & Tool Corp.	1
Oelrich Publications	44
Projector Recorder Belt Corp	23
RCA Distributor & Special Products Div.	12, 13
Wahl Clipper Corp.	21
Zenith Radio Corp.	BC

Electronic Servicing

Advertising Sales Offices

NATIONAL SALES MANAGER
Greg Garrison, P.O. Box 12901,
Overland Park, KS 66212;
Phone: (913) 888-4664

NEW YORK, NEW YORK
Joe Concert, 4 West 58th St.,
New York, NY 10019;
Phone: (212) 888-1977

LOS ANGELES, CALIFORNIA
Herbert A. Schiff
3055 Wilshire Blvd., Suite 350
Los Angeles, CA 90010
Phone (213) 387-0639

LONDON, ENGLAND
John Ashcraft & Co., 12 Bear St.,
Leicester Square, London, WC2H 7AS,
England;
Phone: 930-0525
Telex: 895-2387

AMSTERDAM, HOLLAND
John Ashcraft & Co., John J. Lucassen,
Akerdijk 150A, 1171 PV-Badhoevedorp
Holland;
Phone: 2968-6226

TOKYO, JAPAN
International Media Representatives, Ltd.,
2-29, Toranomon 1-chome, Minato-ku,
Tokyo 105, Japan;
Phone: 502-0656

Get valuable premiums with General Electric Tradin' Time Dollars!

Your General Electric distributor has been authorized to make the kind of deal that turns you on during our seven-month TRADIN' TIME Program: May 1 through November 30, 1980.

All you do to make the kind of swap you'd like is save and mail all your GE receiving tube and tripler flaps and semiconductor bags to Tradin' Time Headquarters. (GE Tradin' Time Program HQ, 5999 Butterfield Rd., Hillside, IL 60162.) Your distributor can give you pre-addressed labels to make flap and bag mailing quick and easy.

Program HQ will send you Tradin' Time Dol-

lars—10¢ for each tube or semi flap or bag, 50¢ for each tripler flap. Then, simply take your Tradin' Time Dollars to any participating GE distributor for on-the-spot redemption. Ask him about the premiums or electronic merchandise your TTDs will buy.

S&H Stamp Option: In the event your GE distributor is not a Tradin' Time participant—or, if you prefer—you may redeem your TTDs for S&H Green Stamps... and you know what they're worth! See your General Electric distributor today for complete details.

Offer limited to U.S.A. and its territories, except where prohibited by law.

Tube Products Department—Owensboro, Kentucky 42301

GENERAL  ELECTRIC



Switch to **ZENITH UNIVERSAL TRIPLERS** and get more than just a tripler... get a complete package.



A95-5314	977-29500-A	32-33057-3	977-29500-A	66F-159-1	977-29522	1464607-8	977-29532
ECG 500A	977-29500-A	32-33057-4	977-29500-A	66F-159-2	977-29522	1464607-7	977-29531
ECG 521	800-791	32-33057-5	977-29500-A	66F-159-3	977-29530	1464607-8	977-29531
ECG 522	977-29522	32-33094-1	977-29522	66X0060-1	977-29530	1464607-9	977-29533
ECG 523	977-36	32-33094-2	977-29522	66X0060-2	977-36	1464607-10	977-29533
ECG 526A	977-29526-A	32-33094-3	977-29522	76-14327-1	977-29522	1464984-1	977-29532
ECG 528	977-41	32-33094-4	977-29522	76-14327-2	977-29522	1464984-2	977-29532
ECG 529	977-29529	32-33094-5	977-29522	76-14327-3	977-29522	1466860-1	977-29532
ECG 530	977-29530	32-33094-6	977-29522	76-14327-4	977-29522	1466860-2	977-29537
ECG 531	977-29531	32-35894-1	977-29522	76-14327-5	977-29522	1466865-1	977-29532
ECG 532	977-29532	32-35894-2	977-29522	76-14327-6	977-29522	1826065-1	977-29532
ECG 533	977-29533	32-35894-3	977-29522	76-14327-7	977-29522	1826065-2	977-29532
ECG 534	977-29534	32-35894-4	977-29522	76-14327-8	977-29522	1826065-3	977-29531
ECG 535	977-29535	32-35894-5	977-29522	76-14327-9	977-29522	S-88569	800-791
ECG 536A	977-29536-A	32-35894-6	977-29522	76-14327-10	977-29522	S-88593	800-791
ECG 537	977-29537	32-35894-7	977-29522	76-14327-11	977-29522	S-91731	800-791
ECG 538	977-29538	32-35894-8	977-29522	76-14327-12	977-29522	212-102	800-791
ECG 539	977-29539	32-35894-9	977-29522	76-14327-13	977-29522	212-103	800-791
GE 521	977-29526-A	32-39091-1	977-36	76-14327-14	977-29522	212-104	800-791
GE 522	977-29536-A	32-39091-2	977-36	76-14327-15	977-29522	212-105	800-791
GE 523	977-29522	32-39091-3	977-36	76-14327-16	977-29522	212-106	800-791
GE 524	977-29531	32-39091-4	977-36	76-14327-17	977-29522	212-108	800-791
GE 525	977-29532	32-39091-5	977-36	76-14327-18	977-29522	212-109	800-791
GE 526	977-29533	32-39091-6	977-36	76-14327-19	977-29522	212-110	800-791
GE 527	977-29500-A	32-39091-7	977-36	76-14327-20	977-29522	212-128	800-791
GE 528	977-36	32-39091-8	977-36	76-14327-21	977-29522	212-129	800-791
GE 529	977-29529	32-39091-9	977-36	76-14327-22	977-29522	212-130	800-791
GE 534	977-29534	32-39091-10	977-36	76-14327-23	977-29522	212-131	800-791
GE 535	977-29535	32-39091-11	977-36	76-14327-24	977-29522	212-132	800-791
GE 536	977-29536	32-39091-12	977-36	76-14327-25	977-29522	212-133	800-791
GE 537	977-29537	32-39091-13	977-36	76-14327-26	977-29522	212-134	800-791
GE 538	977-29538	32-39091-14	977-36	76-14327-27	977-29522	212-135	800-791
GE 539	800-791	32-39091-15	977-36	76-14327-28	977-29522	212-136	800-791
GE 540	977-29530	32-39091-16	977-36	76-14327-29	977-29522	212-137	800-791
N2A	977-29529	32-39091-17	977-36	76-14327-30	977-29522	212-138	800-791
N2A-1	977-29529	32-39091-18	977-36	76-14327-31	977-29522	212-140	800-791
N2A-2	977-29529	32-39091-19	977-36	76-14327-32	977-29522	212-140-01	800-791
SK 3301	977-29531	32-39091-20	977-36	76-14327-33	977-29522	212-141	977-36
SK 3302	977-29533	32-39091-21	977-36	76-14327-34	977-29522	212-141-01	977-36
SK 3303	977-29522	32-39091-22	977-36	76-14327-35	977-29522	212-141-01	977-35
SK 3304	977-29500-A	32-39091-23	977-36	76-14327-36	977-29522	212-141-01	977-36
SK 3305	977-29534	32-39091-24	977-36	76-14327-37	977-29522	212-141-01	977-36
SK 3306	977-36	32-39091-25	977-36	76-14327-38	977-29522	212-141-02	977-36
SK 3307	977-29529	32-39091-26	977-36	76-14327-39	977-29522	212-141-02	977-36
SK 3308	977-29526-A	32-39091-27	977-36	76-14327-40	977-29522	212-141-03	977-37
148348-1	977-36	32-39091-28	977-36	76-14327-41	977-29522	212-142	977-46
148348-2	977-36	32-39091-29	977-36	76-14327-42	977-29522	212-142	977-38
148348-3	977-36	32-39091-30	977-36	76-14327-43	977-29522	212-142-02	977-46
148348-4	977-36	32-39091-31	977-36	76-14327-44	977-29522	212-143	977-40
148348-5	977-36	32-39091-32	977-36	76-14327-45	977-29522	212-145	977-41
28-32-0X	977-29500-A	32-39091-33	977-36	76-14327-46	977-29522	212-145-01	977-41
28-35-01	977-46	32-39091-34	977-36	76-14327-47	977-29522	212-145-01	977-42
32-29778-2	977-29500-A	32-39091-35	977-36	76-14327-48	977-29522	212-146	977-41
32-29778-3	977-29500-A	32-39091-36	977-36	76-14327-49	977-29522	212-146-01	977-41
32-33057-2	977-29522	32-39091-37	977-36	76-14327-50	977-29522	212-146-01	977-42
57-90	977-29530	32-39091-38	977-36	76-14327-51	977-29522	212-147	977-43
57-98	977-29530	32-39091-39	977-36	76-14327-52	977-29522	212-149	977-45
66F-054-3	977-29500-A	32-39091-40	977-36	76-14327-53	977-29522	977-42	977-41
66F-054-4	977-29500-A	32-39091-41	977-36	76-14327-54	977-29522	93D96-2	977-29500-A
66F-112-1	977-29522	32-39091-42	977-36	76-14327-55	977-29522	93D96-3	977-29500-A
66F-112-2	977-29522	32-39091-43	977-36	76-14327-56	977-29522	93D99-2	977-29538
66F-181-1	977-29522	32-39091-44	977-36	76-14327-57	977-29522	93D99-3	977-29538
800-000-025	977-29500-A	32-39091-45	977-36	76-14327-58	977-29522	93D99-4	977-29538
		32-39091-46	977-36	76-14327-59	977-29522	93D99-5	977-29538
		32-39091-47	977-36	76-14327-60	977-29522	93D99-6	977-29538
		32-39091-48	977-36	76-14327-61	977-29522	93D99-7	977-29538
		32-39091-49	977-36	76-14327-62	977-29522	72180	977-36
		32-39091-50	977-36	76-14327-63	977-29522	146364-1	977-29536-A
		32-39091-51	977-36	76-14327-64	977-29522	1464607-1	977-29532
		32-39091-52	977-36	76-14327-65	977-29522	1464807-2	977-29532
		32-39091-53	977-36	76-14327-66	977-29522	1464607-3	977-29532
		32-39091-54	977-36	76-14327-67	977-29522	1464607-4	977-29532
		32-39091-55	977-36	76-14327-68	977-29522	1464607-5	977-A9532

Now in stock at your Zenith distributor's — a full line of universal triplers.

Packaged with each Zenith tripler is a cross-reference guide with a no-nonsense numbering system that relates ECG®, GE, and RCA Universal lines and 22 other manufacturers to Zenith part numbers...plus detailed installation and safety instructions...and a wire tie and sealart at no extra cost.

That's why you get more than just a tripler when you switch to Zenith Universal Triplers.

See your distributor for Zenith's Universal Tripler Cross Reference Guide (#902-2011)...and Zenith's Universal Semiconductor Guide with over 150,000 cross-references!

ECG is a registered trademark of GTE SYLVANIA



The quality goes in before the name goes on®

Zenith Radio Corporation / Service, Parts & Accessories Division
11000 Seymour Avenue / Franklin Park, Illinois 60131