

January, 1979 □ \$2.25

Electronic Servicing



A HOWARD W. SAMS PUBLICATION

Selecting Capacitors
GE IF and AGC



**SPECIAL
CAPACITOR
ISSUE**





Carl Meyer
President, A to Z TV Service
Clinton & Harlem Streets
Buffalo, New York 14224

**“I buy from the source—GE.
They’re the world’s largest supplier
of receiving tubes.”**

Your reputation is our reputation
Tube Products Department • Owensboro, Kentucky 42301

GENERAL  ELECTRIC

Electronic Servicing®

Contents

- 8 Capacitors: Components of many faces**—Neither ac nor dc actually *passes through* a capacitor. These explanations show how a capacitor can function as a filter, a tone control, a bypass or a coupling for ac—*Gill Grieshaber*.
- 22 Capacitor manufacturers and products**—These firms supplied information about their products. Use the circle number on the Reader's Service Card to request data sheets from them—*Staff*.
- 23 Selecting replacement capacitors**—Obsolete paper capacitors have been superseded by half a dozen types using plastic films. The advantages and limitations of these various types are part of the information you need to choose the proper capacitor for each circuit—*Carl Babcock, editor*.
- 31 Index of 1978 articles**—All 1978 Electronic Servicing articles are listed alphabetically and according to subject matter. Troubleshooting Tips and Symcures are indexed by brand and chassis number—*Staff*.
- 34 Sam Wilson's technical notebook**—Sam discusses a light bulb with water inside, a cheap voltage regulator, and other miscellaneous topics—*J. A. "Sam" Wilson*.
- 39 Servicing GE 13" color TV, part 5**—Circuit operation and troubleshooting of the IF and AGC circuits are the topics this month—*Gill Grieshaber*.

About the cover—Graphic rendition of various capacitor models—design by *Linda Franzblau, graphic designer*.

DEPARTMENTS

3 Electronic Scanner	46 Test Equipment
4 Reader's Exchange	48 Product Report
7 Symcure	51 Catalogs & Literature
29 Quick Quiz	52 The Marketplace
38 Puzzle	52 Advertiser's Index
45 Troubleshooting Tips	

Application to Mail at Controlled Circulation Postage is pending at Shawnee Mission, KS, and at additional offices. Published monthly at 9221 Quivira Road, Overland Park, Kansas 66212 by Intertec Publishing Corp., 9221 Quivira Road, Overland Park, Kansas 66212. Send Form 3579 to 9221 Quivira Road, P.O. Box 12901, Overland Park, Kansas 66212.

© Copyright, 1979, Howard W. Sams & Co., Inc. All rights reserved. Material may not be reproduced or photocopied in any form without written permission of publisher.

How much better off would you be if you had your 1st Class FCC License ?

Think about it. An FCC License is required for certain jobs in Broadcasting and communications. And, even when a 1st Class FCC "ticket" is not a legal requirement for a job, it is Government certification of specific skills and knowledge. That's bound to impress any employer of electronics personnel! That's why Cleveland Institute of Electronics offers you a choice of professional career courses designed to help you pass the government-administered FCC License exam.

Learn from the specialists.

We know what the government examiners require. We aim to make sure you get it. In fact, close to 4 out of 5 CIE graduates who took the FCC exam got their licenses, according to our continuing surveys. Not surprising. CIE is the largest independent home-study school in the world specializing exclusively in electronics.

Send for your FREE CIE Catalog

Get all the details on earning your FCC License. Fast! Mail the coupon right now for CIE's FREE school catalog—plus a complete package of independent home-study information. For your convenience, we'll try to have a CIE representative contact you to answer any questions you may have. All CIE career courses are approved for educational benefits under the G.I. Bill.

Print Name _____
 Home Address _____ Apt. _____
 City _____ State _____ Zip _____
 Phone (Area Code) _____ / _____

Check here for G.I. Bill information:
 Active Duty Veteran PF-80

CIE Cleveland Institute of Electronics, Inc.
 1776 East 17th Street, Cleveland, Ohio 44114
Accredited Member National Home Study Council

Circle (3) on Reply Card
 January 1979 *Electronic Servicing* 1

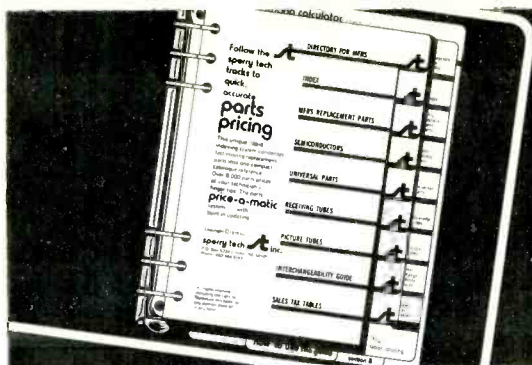

NOW ONE PARTS BOOK FOR ALL BRANDS

The Sperry Tech pricing book places, right at your fingertips:

- over 8,000 most used parts
- over 3,000 direct factory replacement parts, including 17 major MFR's, both domestic and off shore
- over 1,100 receiving tube prices
- 750 picture tube prices
- 2,250 semiconductors
- plus a complete universal parts listing.

Now, for the first time, an authority that backs you up. That means protection for you and your customers. No guesswork. You're ready to make the right impression.

All parts have a built-in, automatic updating so you'll always have current prices.

But, that's not all. As part of our subscription service, parts usage is ranked by popularity and is updated

each year—a vital factor in controlling obsolescence.

At the same time, you can adjust prices in a manner that will compensate for the slow turn and high obsolescence risk of stocking solid state parts.

**CALL, TOLL-FREE:
1-800-228-4338**

between 8:00 A.M. and 5:00 P.M., C.S.T. and we'll send you a complete parts book with the markup percentage you feel is correct for your shop, for only \$24.50. You'll have the opportunity to examine the contents and make any markup adjustments **before** you decide to accept our parts pricing service.

Sperry Tech, Inc.
P.O. Box 5234
Lincoln, NE 68505

Circle (12) on Reply Card

WHERE WOULD THE CAMERA HAVE BEEN, WITHOUT A COLLEGE EDUCATION?

Still making Daguerreotypes, probably.

Instead, photography is a billion-dollar business today. Because inquiring minds, trained and honed on college campuses, started looking into chemicals and film and lens.

Life-saving pharmaceuticals. Hunger-fighting new rice and new wheat. Petrochemicals. Radio. Television. The list of billion dollar industries that got their start in college-trained minds is startling.

You don't want the flow of college-bred new ideas, improvements, inventions to stop. Ever. Not if you're a good businessman.

So perhaps you'd better take a good

hard look at how much your company is giving to higher education. Because inflation has hit colleges and universities even harder than most.

Freedom to experiment is the first casualty of tight budgets.

For the sake of the future, "Give to the college of your choice. Now." Who knows what billion-dollar business of tomorrow is germinating on some college campus today.

CF Council for Financial Aid to Education, Inc.
680 Fifth Avenue, New York, N.Y. 10019

AE A Public Service of This Magazine & The Advertising Council



Electronic Servicing

Editorial, advertising and circulation correspondence should be addressed to: 9221 Quivira Road, P.O. Box 12901, Overland Park, KS 66212 (a suburb of Kansas City, MO)—(913) 888-4664.

EDITORIAL

Bill Rhodes, Editorial Director
Carl Babcoke, Editor
Cindy Nelson, Managing Editor
Beth Brugman, Editorial Assistant
JoAnn Vella, Editorial Assistant
Dudley Rose, Art Director
Linda Franzblau, Graphic Designer

EDITORIAL ADVISORY BOARD

Les Nelson, Chairman
Howard W. Sams & Co., Indianapolis
Joe A. Groves, Technical Consultant
Howard W. Sams & Co., Indianapolis

CIRCULATION

John C. Arnst, Director
Evelyn Rogers, Manager

ADMINISTRATION

George H. Seferovich, President
George Laughead, Publisher

ADVERTISING SALES

Marilyn Carroll, Production
Regional and Advertising Sales Offices
near Advertising Index

ELECTRONIC SERVICING (ISSN 0013-497X) (with which is combined PF Reporter) is published monthly by Intertec Publishing Corp., 9221 Quivira Road, Overland Park, KS 66212.

ELECTRONIC SERVICING is edited for technicians who repair home-entertainment electronic equipment (such as TV, radio, tape, stereo and record players) and for industrial technicians who repair defective production-line merchandise, test equipment, or industrial controls in factories.

Subscription prices to qualified subscribers: 1 year—\$10, 2 years—\$16, 3 years—\$20, in the USA and its possessions. All other foreign countries: 1 year—\$13, 2 years—\$22. Subscription prices to all others: 1 year—\$25, 2 years—\$50, in the USA and its possessions. All other foreign countries: 1 year—\$34, 2 years—\$68. Single copy price \$2.25; back copies \$3.00. Adjustment necessitated by subscription termination to single copy rate. Allow 6 to 8 weeks delivery for change of address. Allow 6 to 8 weeks for new subscriptions.



INTERTEC PUBLISHING CORP.
Subsidiary of HOWARD W. SAM'S & CO., INC.

electronicscanner

news of the industry

Sales of color TVs to dealers increased 6% in November compared to last year, while EIA figures show an increase of 13.1% for the year to date, totalling 9,135,970 units. Radio sales were considerably reduced. Home VTRs to dealers number 49,980 for November and 349,114 for the first 11 months of 1978. VTR figures are not available for 1977.

The proposed joint venture of GE and Hitachi to form General Television of America has been opposed by the Justice Department on grounds that the venture would eliminate competition between GE and Hitachi. It's doubtful these companies will fight the ruling. At about the same time, GE revealed it will supply the majority of the Montgomery Ward private-label TVs, replacing Admiral which has withdrawn from TV production.

A translator with a vocabulary of 1,500 words is announced by Craig. A user of the M100 translator types a word in his language, presses one of the four language buttons, and the machine reads-out with the corresponding word or phrase of the selected foreign language. Each unit is said to be available for four languages selected from French, English, German, Spanish, Japanese, and Italian. Additional modules can be plugged in to add 1,500 words each.

Sony has established a new independent-service division for its audio products. Seven representatives of the Hi-Fi Technical Support Group will be available by phone to help the 500 Sony dealers and 300 authorized service stations and will also visit all dealers and servicers periodically. Training seminars are planned.

Sharp Electronics has announced plans to build a large manufacturing plant in the Memphis, Tennessee area. The plant is scheduled to produce 30,000 microwave ovens and 10,000 color TV sets per month during the first year of operation. Audio products also will be manufactured there.

Far less snow, streaks and flashes will be broadcast when a new noise reduction digital circuit is adopted by all TV stations. Heart of DNR system developed by the CBS Technology Center is a recursive circuit that includes a comb filter, according to an article in *Electronic Design*. (Recursive concerns recurring signals.) Although there are slight similarities to the comb filters used in VTRs and some TV receivers, the differences are important. Instead of a one-horizontal-line time delay, this comb filter gives a delay of one vertical frame or 1/30 second. A comparison is made between the previous vertical frame (which is stored) and the one in progress. When a large difference is detected between the two frames, the comb filter signal is switched in to furnish the stored signal for the remainder of that frame. This minimizes large disturbances such as flashes. When no large differences are detected, the circuit averages several frames together, which minimizes snow. Of course, motion in the picture scene must not be averaged or cancelled, so picture motion is sensed and the filter action is reduced. This works well because noise elimination is needed more when the action is slow.

Miniature toroid transformers now can be included in hybrid ICs, according to *Electronic Design*. In addition to providing the lowest-cost toroids the method should allow internal noise filters for ICs, D/A converters with deglitched output, and sample-and-hold circuits that operate at high speed.

reader's exchange

There is no charge for a listing in *Reader's Exchange*, but we reserve the right to edit all copy. If you can help with

a request, write directly to the reader, not to **Electronic Servicing**.

Needed: Schematic or information about Bohsel-M7505 in-line frequency counter. Will buy, or copy and return. E. McKenzie, 5721 Rolston, Norwood, OH 45212.

For Sale: Used test equipment. EICO model 460 scope, \$25, needs transformer; Heathkit RF signal generator, \$3; EMC model 81 in-circuit capacitor checker, \$10; Sencore color generator (battery), \$25; high-voltage probe, \$2; EICO model 667 tube tester, \$25; Accurate model 257 tube tester, \$25. Will sell all for \$100 plus COD shipping charges. Frank Phaneuf, 605 Brittany Court, Casselberry, FL 32707.

For Sale: B&K-Precision 415 sweep/marker generator \$315; B&K-1076 Analyst, \$150; Sencore YF33 flyback and yoke Ringer, \$115; Heathkit IM-12 harmonic-distortion meter, \$35; all items include manuals and cables; 181 Photofacts below 400 for \$90. Long's TV Service, 720 Goshen, Salt Lake City, UT 84104.

For Sale: B&K-Precision TV Analyst model 1077B, 1 year old, \$250. Electronic Emergency Ward, 1315 Park Avenue, Plainfield, NJ 07060.

Needed: A complete exact replacement for tubular tone arm and pick-up shell for Garrard model SL-55 record changer, and/or the address and name of the supplier of Garrard replacement parts. C.R. Iseminger, 14251 Lawndale, Havertown, PA 19083.

For Sale: Heathkit IO-104, 15 MHz, triggered scope, lab calibrated, with X10 probe, like new, \$295; Heathkit IG-57A post-marker/sweep-generator, never used, with cables and attenuator calibrated, \$145; Heathkit IT-28 capacitor checker, new, \$45. All prices plus shipping. Gunter Seuring, Route 2, Box 338, Hidden Lakes, Mukwonago, WI 53149.

Needed: Output transformer part T991-116-2C for a Fisher FM receiver model 500C. Also, service manual for a Tandberg reel-to-reel tape recorder model 74. Lou's Electronics Service, 823 S.E. 47th Terrace, Cape Coral, FL 33904.

For Sale: One new Panasonic flyback transformer part number TLF5007-1SF, \$40, or best offer; one new Thordarson vertical-output transformer part number 26583, exact replacement for RCA 113096, 113293, 113422, \$20 or best offer. One vertical-output transformer, RCA part number 130092, used but like new, \$15, or best offer. Wayne Stevens, 3903 Leila, Tampa, FL 33616.

Needed: Any information for Superior Genometer, model TV-50; military equipment electronic switch, TS-433 B/V; also any conversion or update information for Jackson tube tester model 648. Ron Wiedman, 1225 NE 73rd, Port, OR 97213.

Needed: Instruction books and schematics for National TX-601P TV; CV-1758/URR SSB Converter; Hickok 288X signal generator; and UHER 4000 Report-L tape recorder. Roderick P. Allen, 1511 Nyuanu Avenue, #65, Honolulu, HI 96817.

Needed: Service manual or schematic for Rock-O-La jukebox model 1428 and amplifier model "P", manufactured in 1948. Will buy, or copy and return. Tops Electronic Service, 213 Main, North Reading, MA.

For Sale: Heath IT-3120 FET/transistor tester, \$35; Heath IG-102 RF signal generator, \$40; Heath CO-1015 ignition analyzer, with 12-volt inverter, \$125; and Spartronics 2000 digital multimeter, \$45. All nearly new; fully assembled, with cables and manuals. Sell all as a package for \$200. M. Hoffman, 150-38A Union Turnpike, Flushing, NY 11367.

For Sale: New 5EKPSC Sylvania CRT (SC4006PSC/BUC97707-1F industrial/military type), used in Tektronix model 545 scopes, \$30 including shipping. Mike Murphy, 40512 Regency Drive, Sterling Heights, MI 48078.

Needed: RCA KRK124U VHF tuner (used in CTC25 color chassis). Advise price and condition. Jay's TV-Radio Clinic, 945 Clay Avenue, Stroudsburg, PA 18360.

For Sale: Approximately 90 issues of **Electronic Servicing** dating back to January of 1969. Best offer, F.O.B. G. Epstein, 200-27 46th Avenue, Bayside, NY 11361.

For Sale: Bell & Howell (International Video Corp.) model IVC-800 color video recorder, with complete manual, \$500 plug shipping. Ted Dust, 343 North Butterfield Lane, Libertyville, IL 60048.

For Sale: Bell & Howell (Heathkit) 5-MHz scope and DVM, both in excellent condition for \$180; Sencore SM152 sweep marker, like new with box and manuals \$200. Glenn Watkins, 3035 Ford Road, Bristol, PA 19007.

Needed: To correspond with someone who is studying electronics by correspondence. M. Gonzalez, 911 Urbahn, Laredo, TX 78040.

Needed: Heath IG57A or B&K-Precision 445 or other similar type sweep/marker generator with manual, cables and accessories. Also need a color-bar generator. Must be in good test condition and very reasonably priced. Frank Batkay, 52 Lucerne Drive, West Babylon, NY 11704.

For Sale or Trade: Extra Rider's radio and TV manuals in trade for factory manuals of 1930-1950

Haven't you wanted and waited long enough for your Sencore VA48 TV-Video Analyzer?

"I'm dead serious about wanting to help you increase your service by isolating trouble to specific TV stages in minutes."

Rich Brockway, Technical Customer Service Director

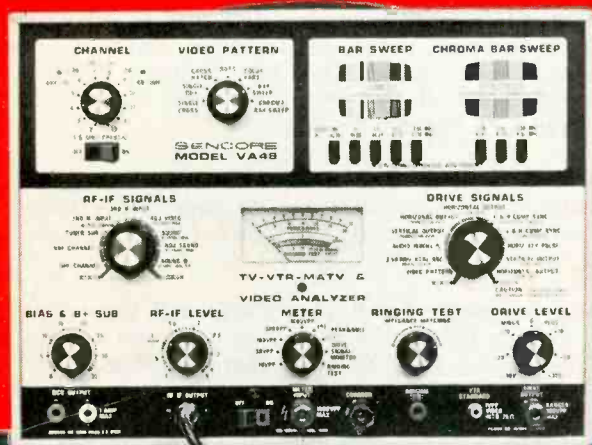
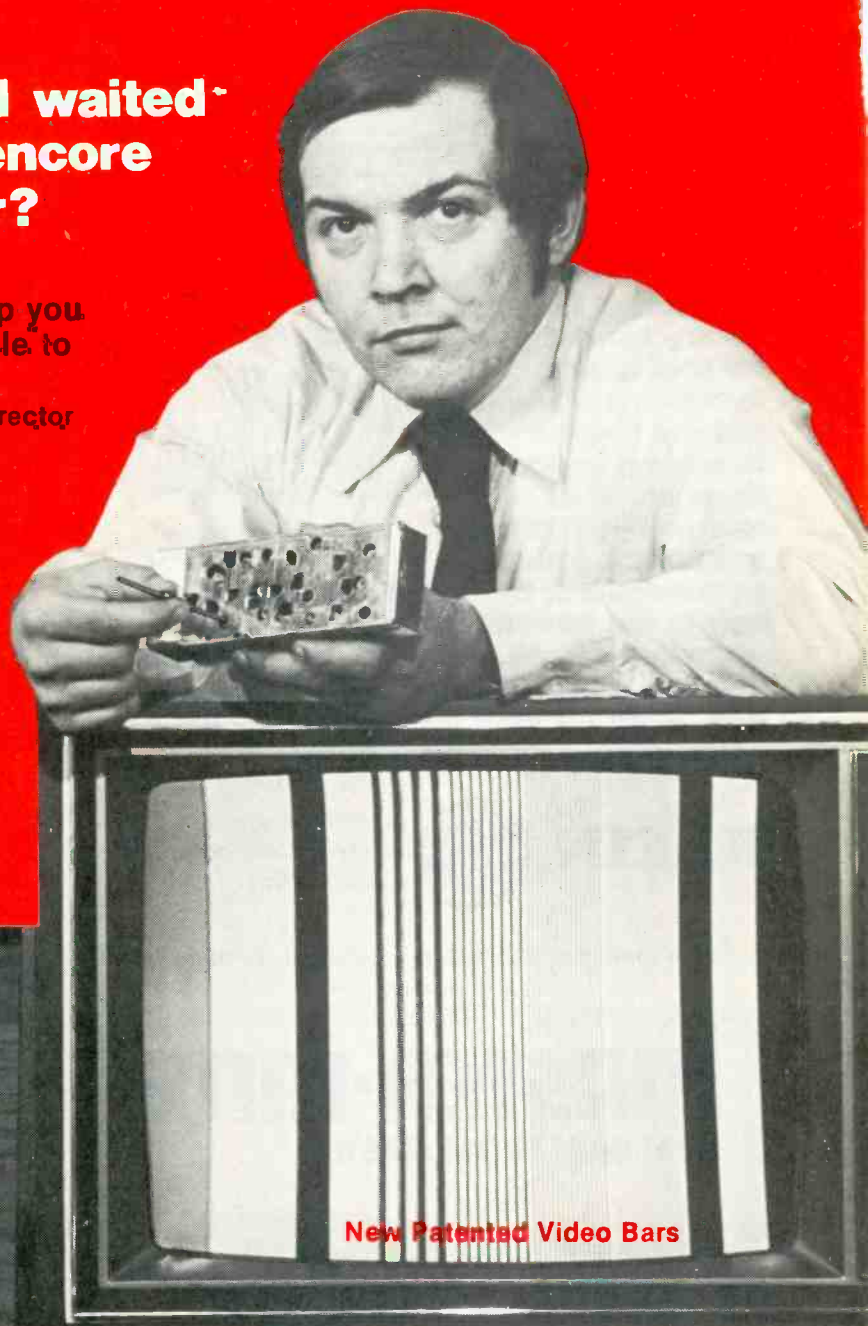

Your VA48 is practically jumpin' out of the box in the Sencore stockroom, anxious to help you increase your color TV, black and white TV, VTR, or closed circuit TV service by as much as 50 percent. The VA48 will help you double your shop income next year and build a service reputation that will never go away.

How can I help you and your VA48 get together? Just drop a note to the Sencore Customer Service Department or call our toll-free WATS number 800-843-3338 today and ask for Rich Brockway. I will see that your VA48 is delivered to you immediately, on a 30-day money-back guarantee that it will do just what we say it will do. How can you lose? The only way you can lose is by not picking up the phone right now. Need financing? Perhaps I can help you there.

The VA48 TV-Video Analyzer is like having a miniature TV station at your fingertips for troubleshooting.

The VA48 provides all phase-locked signals for fast signal injection troubleshooting into every single stage of every TV, video tape recorder, MATV, CATV, or closed circuit TV. Makes all TV systems look alike for simplified IC troubleshooting.

- **Patented Bar Sweep patterns** enable you to align all RF, IF, and Chroma stages from top of chassis. Cuts aligning and troubleshooting time in these sections to less than one half.
- **Crystal-controlled trap frequency markers** equip you to set all traps from top of chassis without removing a single nut or bolt. What a time-saver!
- **Phase-locked color bars, crosshatch, and dots** speeds up your convergence, troubleshooting, or alignment of any color circuit. No more running color patterns and no more guesswork as the entire TV stays locked in. Scope waveforms stay in sync for comparison of any stage to another stage, anywhere in the TV.
- **Only TV analyzer that provides all variable drive signals** for tube, transistor, and SCR TV sets as well. All drive signals are monitored on peak-to-peak meter for accuracy and to help determine defective stages.

- **Provides highly filtered 0 to 35 Volt power supply** for bias, troubleshooting automatic circuits, powering circuits with horizontal sweep derived voltages, and SCR checks.
- **One-third the cost of equivalent instruments** that have up to 60 separate test leads and non-synchronized signals. The VA48 is all phase-locked and all signals delivered from three circuit-matched test leads for only \$975.



SENCORE

3200 SENCORE DRIVE, SIOUX FALLS, S.D. 57107
(605) 339-0100



FREE

More than a catalog, Klein's 88-page guide to tools and safety equipment is packed with tips for tool users, facts on pertinent federal regulations and inside dope on what makes Klein pliers, wrenches, knives, screwdrivers, belts and pouches, and safety equipment the best you'll find anywhere. In all, detailed descriptions of more than 1000 items in 44 categories. Send for your free Klein catalog or contact your local distributor.

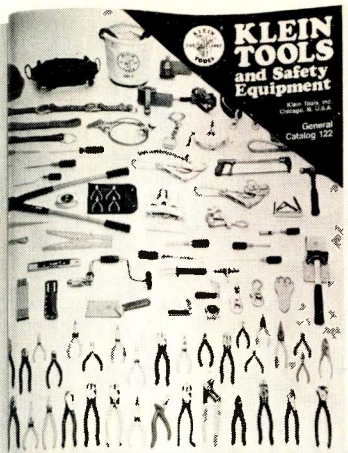

KLEIN



An independent, family-owned company ...since 1857.

Klein Tools, Inc. 7200 McCormick, Chicago, Ill. 60645

Circle (5) on Reply Card

MASTER-MITETM

HEAT GUN FROM MASTER



Rugged, Anodized, Air Cooled Barrel

Convenient Hanging Loop

Safety Light—Easy to see... Indicates unit is "on"

One Hand Control—Three-way switch operated with simple finger movement

U.L. listed

Now bring a new dimension to heat shrinking as well as countless other industrial applications. Easier to handle... only two pounds with nozzle... perfectly balanced.

Three easily interchangeable color-coded nozzles to speed specific jobs. Silver (standard)... used for most shrinkables (475° F.). Blue nozzle for Mylar* (500° F.)... and Black for Teflon* (800° F.) both optional equipment. Nozzles can be changed in seconds.

Draws only 5.4 amps. High impact housing withstands hard knocks of shop use. For information on the MASTER-MITE Heat Gun or the full line of Master Heat tools, contact your distributor or write:

MASTER appliance corporation

2420 18th Street, Racine Wis. 53404 (414) 633-7791

In Canada, contact Martin Industrial Sales Ltd. 4445 Harvester Road, C-1 Burlington, Ontario.

Circle (6) on Reply Card

Reader's exchange

sets, old textbooks about radio repair or sell for cash. Lawrence Beitman, P.O. Box 46, Highland Park, IL 60035.

Needed: Sencore MX II stereo-multiplex generator for parts source or possible repair (if practical). Also, a Realistic QA-622 4-channel stereo amplifier. State price and condition, including recent photograph if available. Phil Williams TV, 2733 B Niles Street, Bakersfield, CA 93306.

For Sale: REM cathode-recovery unit and CRT checker, \$185; Leader color-bar generator model LCG-388, \$160; B&K-Precision DVM model 280 with DR-21 direct/100-K probe, \$80; Sencore model TC-28, \$195; and Mura analog VOM, \$20. Shipping charges are extra. Ray Duffy, 1821 N.E. 65 Street, Ft. Lauderdale, FL 33308.

Needed: Schematic for a B&K-Precision color-bar generator model 1240. Will buy, or copy and return. William Mayer, 5722 S.W. 1st Court, Cape Coral, FL 33904.

Needed: Schematic for Skyfon 23-channel CB radio, serial number 014293. Will buy, or copy and return. P. Theodoulou, 3045 Godwin Terrace, Bronx, NY 10463.

Needed: A schematic and service manual for a Packard Bell Telecaster, model 900. Will buy, or copy and return. Martin Winkler, 6618 St. Clair Avenue, North Hollywood, CA 91606.

Needed: Manual or schematic for Hammarlund HQ-180 radio receiver. Also, need source of parts for JVC TV. Charlie J. Ezell, Route 3, Box 479-A, Decatur, AL 35602.

Needed: Vertical-output grid varistor (RV 301) Westinghouse part 259V015H03; and horizontal varistor (RV 401) Westinghouse part 259V015H01 for Westinghouse V-2655 color chassis. (Workman FS-308 and FS-106, Oneida GB-308 and GB-106 not available locally.) William M. Suhy, 456 Burritt Avenue, Stratford, CT 06497.

For Sale: Ademco 1003 alarm system with bell and cylindrical key switch. Also, some door and window switches. Used only one year; will sell for \$90 complete. Mintzer's Electronics, 1134 R. Washington Boulevard, Williamsport, PA 17701.

Needed: New or good-used IF transformer for Zenith radio model H-725. Part is no longer available from Zenith. Will pay reasonable price plus shipping; either COD or pre-paid. Hall's TV & Appliances, 328 East Main, Havelock, NC 28532.

For Sale: Two Heathkit WA-P2 preamplifiers. Make reasonable offer. J. Markiewicz, Vans Terrace, Lake Katrine, NY 12449.

Needed: One 19A3 tube, state price. James N. Thompson, 3026 14th N.W., Canton, OH 44708.

For Sale: B&K-Precision 1040 and 2040 CB service equipment, new in box. J.V. Brown, 7117 E. Mercer Lane, Scottsdale, AZ 85254. □

Chassis—Zenith 23EC15
PHOTOFACT—1423-3

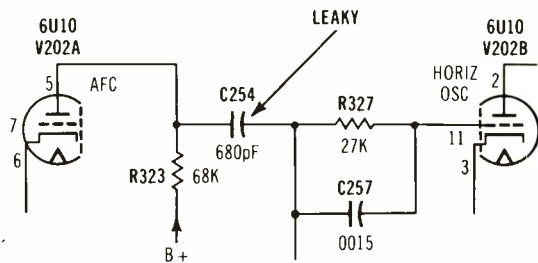

Symptom—Intermittent horizontal jitter; good sync
Cure—Check capacitor C254, and replace it if leaky or erratic

Chassis—Zenith 25DC56
PHOTOFACT—1312-3

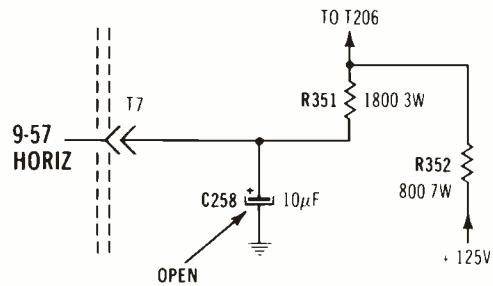

Symptom—Improper drive to horizontal output transistor
Cure—Check capacitor C258, and replace it if open

Chassis—Zenith 25DC58
PHOTOFACT—1370-2

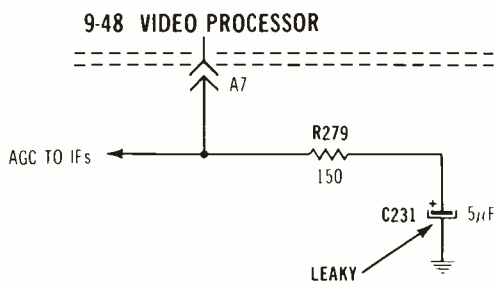

Symptom—White horizontal streaks in picture
Cure—Check capacitor C231, and replace it if defective

Chassis—Zenith 19EC45
PHOTOFACT—1377-3

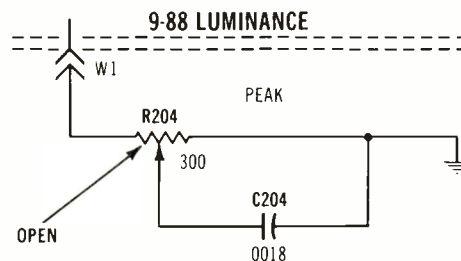

Symptom—Low brightness or no raster
Cure—Check the picture peaking control, and replace it if open

Chassis—Zenith 19FC45
PHOTOFACT—1466-3

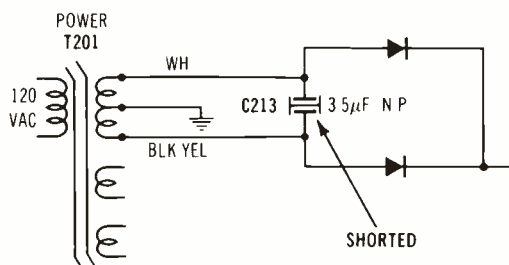

Symptom—No picture, sound, or CRT heater voltage; breaker trips after 20 seconds
Cure—Check regulating capacitor C213, and replace it if shorted

Chassis—Zenith 19EC45
PHOTOFACT—1377-3

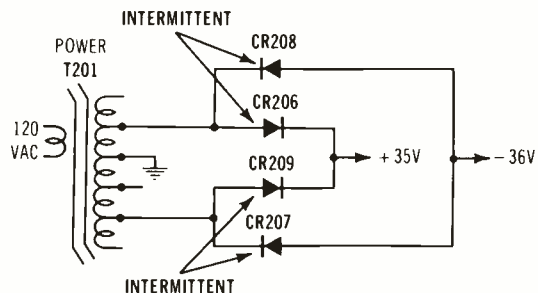

Symptom—Intermittent horizontal lines move up through the picture
Cure—Check supply diodes CR206, CR207, CR208 and CR209. Replace any that are intermittently open

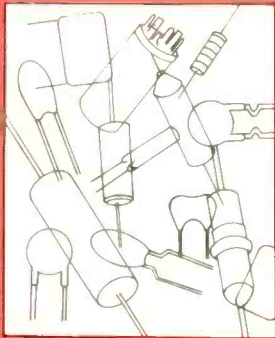

Capacitors: Components of many faces

By Gill Grieshaber, CET

Contrary to popular belief, ac does not pass *through* a capacitor. Instead, the capacitor produces current that re-creates the ac at the output. Capacitors do "pass" dc (for a time),

because the charging and discharging of a capacitor always is done with dc. You don't believe these statements? Then read on.

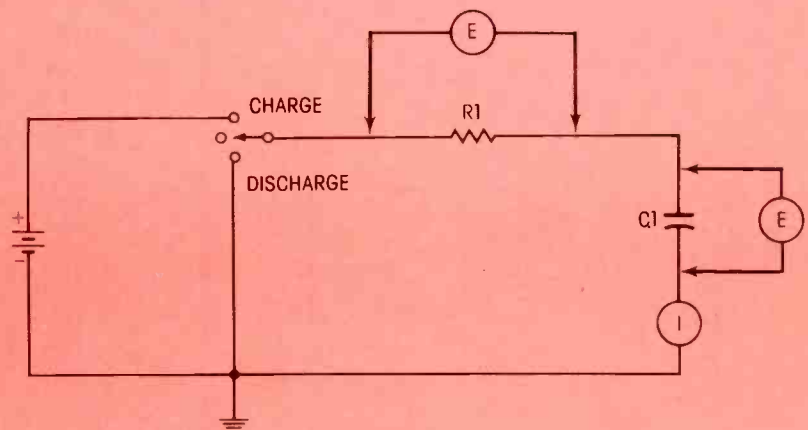

Figure 1 A three-position switch allows fast selection of charging or discharging for the R1/C1 time-constant network. The time-constant is the same for both charging and discharging. Resistance in megohms multiplied by capacitance in microfarads gives the time in seconds for the rising capacitor voltage to reach 63.2% of the supply voltage.

**CIRCUIT FOR TIME-CONSTANT
CURVES**

READER SERVICE INFORMATION CARD 1-79

This card is usable until April 1, 1979. Please apply appropriate postage before mailing.

For more information on products or services mentioned in this issue, simply circle the appropriate numbers below, check one box in each column, type or print your name and address and mail.

1	2	3	4	5	6	7	8	9	10
11	12	13	14	15	16	17	18	19	20
21	22	23	24	25	26	27	28	29	30
31	32	33	34	35	36	37	38	39	40
41	42	43	44	45	46	47	48	49	50
51	52	53	54	55	56	57	58	59	60
61	62	63	64	65	66	67	68	69	70
71	72	73	74	75	76	77	78	79	80
81	82	83	84	85	86	87	88	89	90
91	92	93	94	95	96	97	98	99	100

IMPORTANT! Please check your business classification:

Type of Business

Check One:

- A. Independent Electronic Service Organization
B. Retailer with Electronic Service Department
C. Independent or Self-Employed Service Technician
D. Electronics, Radio, TV Manufacturer
E. Industrial Electronic Service
F. Wholesaler, Jobber, Distributor
G. Other (Specify

Position

Check One:

- H. Owner, Manager
I. Ser. Manager
J. Technician
K. Other

Please print plainly:

NAME _____ FIRM _____

FIRM ADDRESS _____

CITY _____ STATE _____ ZIP CODE _____

TELEPHONE: Include area code _____

Be sure you have checked ONE box in each column above!

Want more information? Circle the numbers of those items of interest to you

GET MORE FACTS

PLACE FIRST CLASS POSTAGE HERE

Electronic Servicing

P.O. Box 17253

Denver, Colorado 80217

PLACE
FIRST CLASS
POSTAGE
HERE

Electronic Servicing

P.O. Box 17253

Denver, Colorado 80217

GET
MORE
FACTS

READER SERVICE INFORMATION CARD 1-79

This card is usable until April 1, 1979. Please apply appropriate postage before mailing.

For more information on products or services mentioned in this issue, simply circle the appropriate numbers below, check one box in each column, type or print your name and address and mail.

1 2 3 4 5 6 7 8 9 10
11 12 13 14 15 16 17 18 19 20
21 22 23 24 25 26 27 28 29 30
31 32 33 34 35 36 37 38 39 40
41 42 43 44 45 46 47 48 49 50
51 52 53 54 55 56 57 58 59 60
61 62 63 64 65 66 67 68 69 70
71 72 73 74 75 76 77 78 79 80
81 82 83 84 85 86 87 88 89 90
91 92 93 94 95 96 97 98 99 100

IMPORTANT! Please check your business classification:

Type of Business

Check One:

- A. Independent Electronic Service Organization
B. Retailer with Electronic Service Department
C. Independent or Self-Employed Service Technician
D. Electronics, Radio, TV Manufacturer
E. Industrial Electronic Service
F. Wholesaler, Jobber, Distributor
G. Other (Specify

Position

Check One:

- H. Owner, Manager
I. Ser. Manager
J. Technician
K. Other

Be sure you have checked ONE box in each column above!

Please print plainly:

NAME _____ FIRM _____

FIRM ADDRESS _____

CITY _____ STATE _____ ZIP CODE _____

TELEPHONE: Include area code _____

Want
more
information?
Circle the
numbers
of those
items of
interest
to you

Capacitor operation

Capacitors: simple and complex

Capacitors are mysterious little devices. Not because of their physical construction, for they are relatively simple. According to the capacitor symbol, they are two pieces of metal that are separated by a non-conductor. That's certainly not complicated. Neither are they mysterious because they rarely are seen in circuits. Capacitors are second only to resistors as commonly-used components.

No, the misunderstanding and confusion arises from the illogical things they do in actual operation. Capacitors appear to do different things in different circuits.

Many half-truths are taught and believed about capacitors.

Incomplete models

One concept of capacitors is that they are only reservoirs for storing electrical power. They are compared to an electric bucket which alter-

nately is filled and emptied of power. When used as filter capacitors in power supplies, they are called *storage* capacitors.

In school, most technicians are brainwashed into believing that a capacitor passes ac but not dc. This partial truth is reinforced by calling them "blocking" capacitors when they couple an ac signal. However, it's easy to prove that capacitors will "pass" direct current (at least for a time) under certain circumstances.

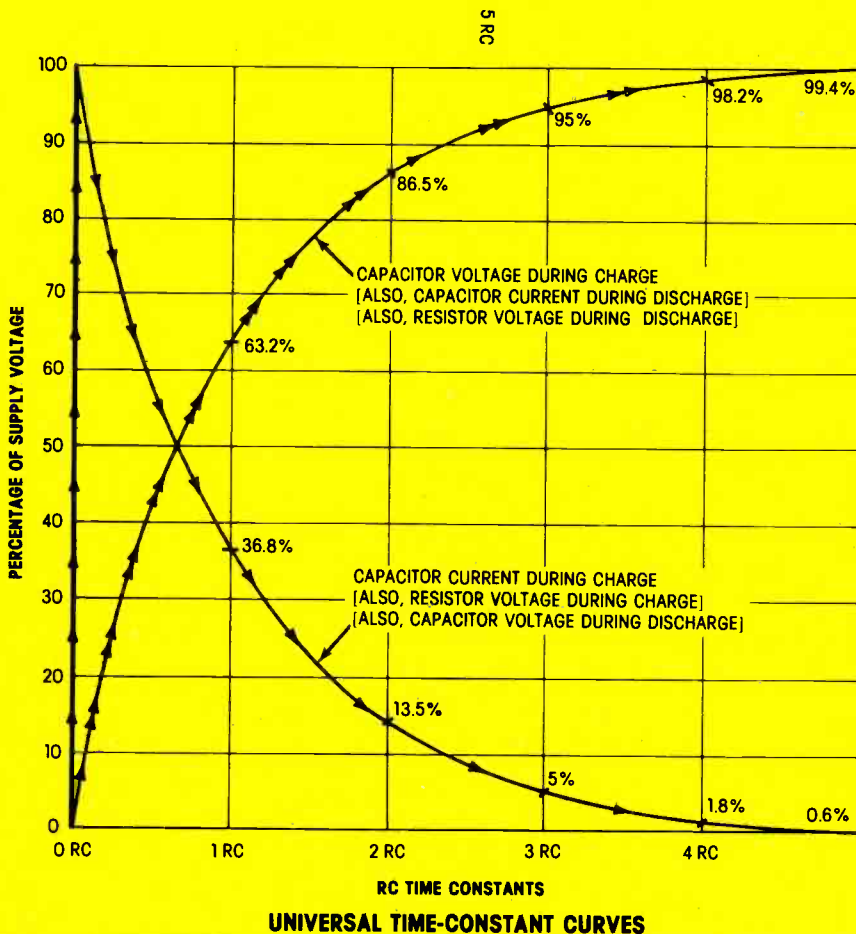

Figure 2 These two basic time-constant curves are produced by the circuit of Figure 1. At turn-on, the current is maximum (the amount is determined by the R_1 resistance versus the supply voltage), but the capacitor voltage is zero. As the capacitor accepts current, the voltage increases. However, the capacitor voltage subtracts (in effect) from the supply voltage and this reduces the current. In turn, the increase of capacitor voltage is slowed by the decreased current. Both actions decrease each other. Therefore, the curves begin as linear ones and then level off to become parabolic. They are inverted images of each other. Notice that capacitor current was maximum at the beginning of charge; so C_1 was equivalent to a low value resistor. At the end of charge, no current was flowing; therefore, C_1 was an open circuit. What's more, the charge is merely stored in the capacitor. No current passes through the capacitor.



costly call- backs...

Capacitor operation

Figure 4 Six parabolic curves are formed by capacitor voltage, capacitor current and resistor voltage during charging and discharging. The capacitor-current and resistor-voltage curves are identical; a point to

remember for future use. Notice that four have positive voltage or current, but the other two start at zero, instantly go to a maximum NEGATIVE value, and then trace the usual parabola.

Figure 3 As shown here, LEDs can be substituted for the Figure 1 meters thus providing instantaneous visual proof of both voltage and current during charging and discharging. LED3 is prevented from loading the capacitor by the Q1 isolation stage. LED1 lights brightly and dims rapidly during charge while LED2 does the same during discharge.

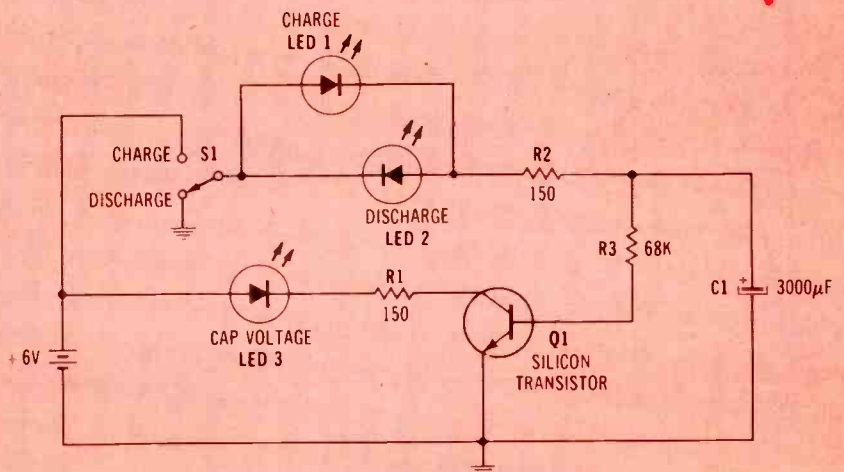

make more money with RCA SKs...

... and your customers will really appreciate your reliable service.

You eliminate costly call backs because: with RCA SKs you know you're using the best. RCA guarantees it. We'll replace any defective SK within one year of purchase by the dealer. We can afford to make this offer because our malfunction rate is one of the lowest in the industry — less than one percent.

With RCA SKs you know your customer is getting the right semiconductor. Our SK line includes over 900 replacement transistors, rectifiers, thyristors, integrated circuits and high voltage triplers that meet or exceed the OEM standards for the 150,000 domestic or foreign semiconductors our SKs can replace.

You save time because you'll identify the exact SK you need quickly in RCA's easy-to-use Replacement Guide with complete installation data. And on every SK package you'll find all the necessary technical specifications, physical characteristics and terminal diagrams.

All hardware, when needed, is also included right in the SK package which saves you extra trips back to the truck or back to the shop.

You make more money because: you can work faster, more efficiently with RCA SKs. And you virtually end costly call-backs which means a lot more satisfied customers as well.

For details on how to order, see your RCA SK Distributor. Or contact RCA Distributor and Special

Products Division, Deptford, N.J. 08096, Attention: Sales Promotion Services.



RCA

SK Solid State Replacement

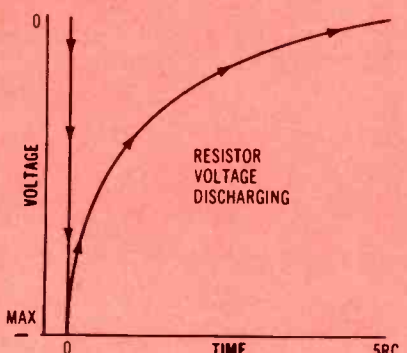
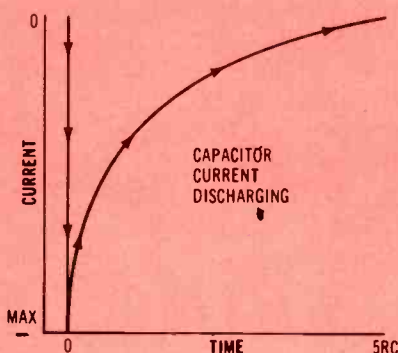
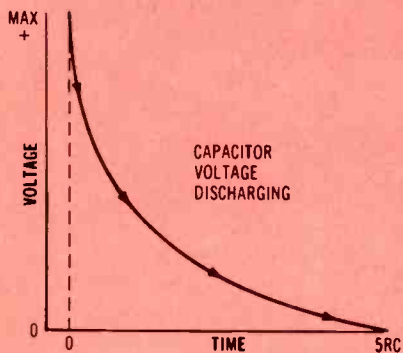
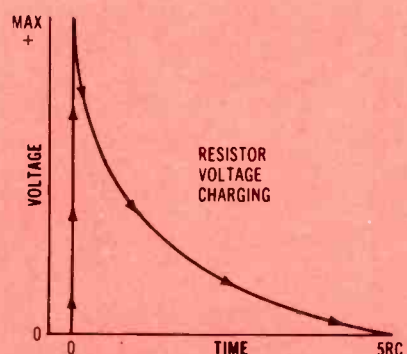
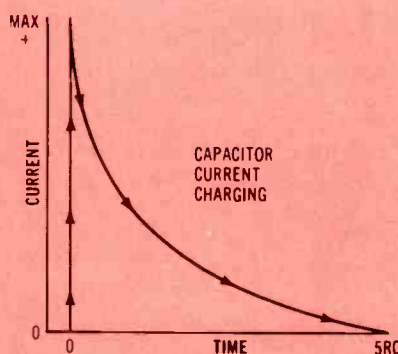
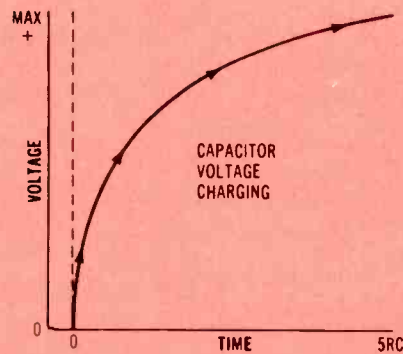

Capacitor operation

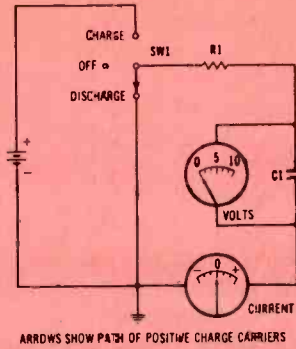

SW1 has been set to discharge for some time. Therefore, C1 has no voltage or current. (C1 is uncharged, and is prepared for maximum current of either polarity. The system is at rest.

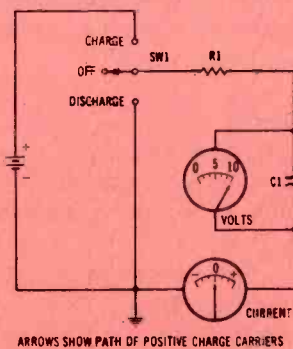

After the voltage has risen to maximum and the current has decreased to zero, SW1 is rotated to the off position. No current can flow because of the open circuit, the voltage can't go down without current, and the dielectric can't charge unless the voltage does. Therefore, these conditions remain as they are. Orbits of electrons in the dielectric atoms were forced sideways by the charging process, and they now hold their positions. This is the end of the charging cycle.

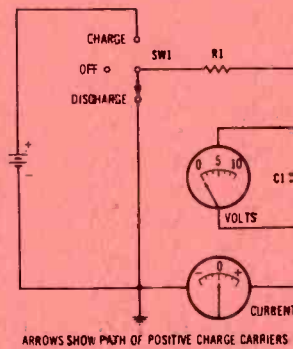

At the end of the discharge period, the voltage and current both are zero. As the voltage went down, the dielectric electrons were allowed to resume their normal circular orbits. The dielectric now is discharged (uncharged), and the system is at rest.

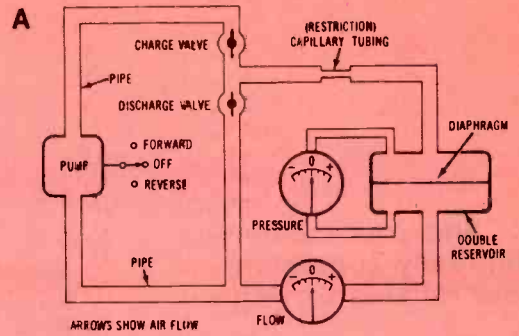

The pump is turned off, therefore the reservoir has no air pressure or flow. (The reservoir is uncharged, and is prepared for maximum flow from either direction.) The system is at rest.

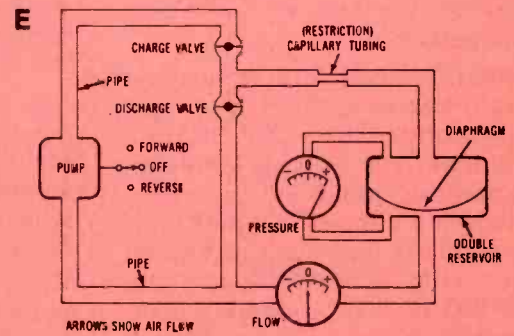

After the pressure has risen to maximum, and the flow has subsided to zero, the pump is turned off and the charging valve closed. Therefore, the reservoir pressure is trapped, and it remains as it was. The diaphragm was bulged by the pressure, and it remains that way. Power was expended to raise the pressure and bend the diaphragm; it remains as possible (potential) power. This is the end of the charging cycle.

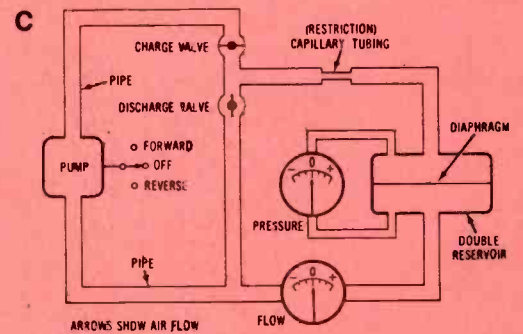

At the end of the discharge period, both the pressure and flow are zero. As the pressure went down, the diaphragm was allowed to resume its flat original shape. The system now is discharged and is at rest.

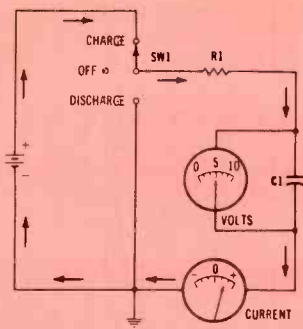

ARROWS SHOW PATH OF POSITIVE CHARGE CARRIERS

SW1 is rotated to the charge position. C1 accepts maximum current (determined by R1) which decreases as the C1 voltage builds up to oppose it. Because of R1, the C1 voltage begins at zero and increases as the current tapers off. This is the active part of the charging cycle which ends when the C1 voltage equals the supply voltage.

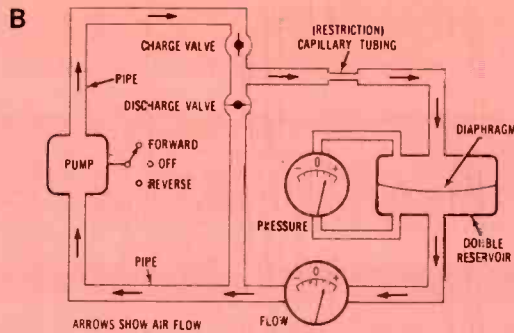

ARROWS SHOW AIR FLOW

The pump is powered for forward pressure, the charge valve is open, and the discharge valve is closed. The reservoir accepts maximum air flow which decreases as the reservoir pressure builds up to oppose it. Because of the restriction, the reservoir pressure begins at zero and increases as the flow tapers off. This is the active part of the charging cycle.

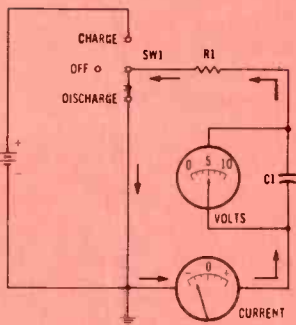

ARROWS SHOW PATH OF POSITIVE CHARGE CARRIERS

SW1 is rotated to the discharge position. The voltage is at maximum, so maximum current flows through R1. Notice that it flows opposite to the previous direction during charging. As the current flows it reduces the voltage, and the lower voltage in turn reduces the current. This is the active part of the discharging cycle.

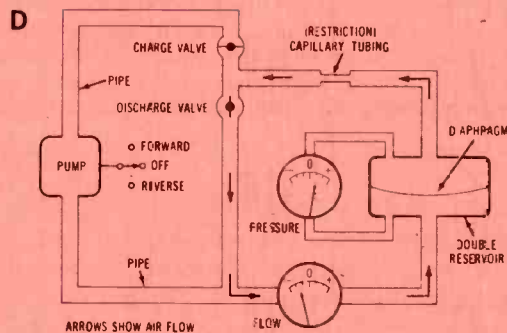

ARROWS SHOW AIR FLOW

The charge valve is closed, and the discharge valve is opened. Air flows through the bypass pipe, raising the pressure at the other end. Notice that the flow is opposite to the charging flow. The pressure and the flow both decrease. This is the active part of the discharging cycle.

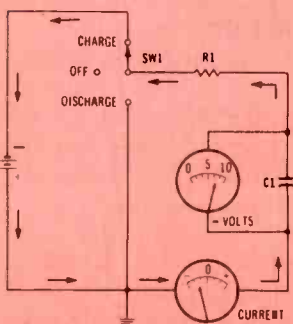

ARROWS SHOW PATH OF POSITIVE CHARGE CARRIERS

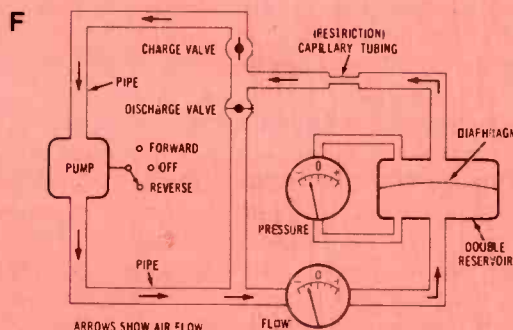

ARROWS SHOW AIR FLOW

Figure 5 Time-constant current and voltage are compared with flow and pressure in a "model" that operates by compressed air. Illustrations labeled (A) show both systems in the inactive discharged condition. The (B) drawings show beginnings of the charging mode. (C) gives the end of charge, and (D) details the beginning of discharge (notice the reversed current and flow). The (E) drawings show end conditions of discharge, with both voltage and current measuring zero. Next, the (F) figures change to charging with reversed polarity voltage and opposite flow. Both systems operate equally well with either polarity.

Capacitor operation

Even the statement that "capacitors pass alternating current" is wrong. If sinusoidal ac voltage is applied to a capacitor, a wattmeter will read zero power. Therefore, capacitors can't pass ac the way resistors do.

In fact, *no electrical power of any kind ever physically passes through a capacitor*. Between the plates is a dielectric, which *must* be an insulator. No electrical charges of any kind actually pass through the dielectric from one plate to another.

Perhaps you disagree with that statement by saying, "But my scope shows the same ac waveform at each end of a coupling capacitor. It *must* be coming *through* the capacitor." Not so! The ac voltages at the input cause charging and discharging current there. However, the same currents also appear at the other end of the capacitor, and they cause identical voltages at the output by voltage drop across the resistors. In other words, **the ac voltages are changed to currents which in turn re-create other identical ac voltages**. But no charge carriers or voltages actually pass through the capacitor dielectric.

Capacitors also are said to clip transient peaks by *absorbing them*. That's an incorrect way of stating another capacitor characteristic. When used in R/C or L/C filters, capacitors integrate (average) the peaks, which rounds them and reduces the amplitude. A similar half-truth is that capacitors work to stabilize the voltage across them.

In these distortions of truth, no explanation is found for the effect called *capacitive reactance*. This is a term describing the way a capacitor can respond to ac voltages as if it is a resistor whose resistance changes according to the applied frequency. (More about capacitive reactance will be given later.)

These half-truths can be clarified and many questions answered by a proper analysis of the one (and only) capacitor action. Otherwise, confusion continues, for the situation is similar to the blind men who gave conflicting reports after each examined just one area of an elephant. What to them appeared to be several vastly different animals was found to be merely the

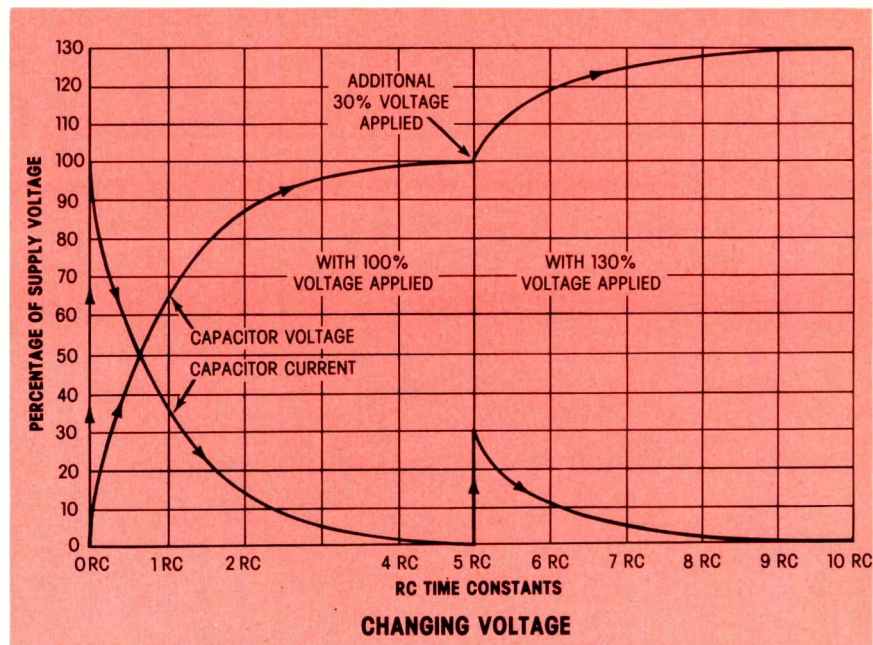

Figure 6 This illustration shows what happens to the capacitor voltage and current when it first is charged and then the supply voltage is increased by 30%. A new 30% charge occurs with the same parabolic curves, and the charge is complete after another five time-constants. Operation with an ac input signal is similar to this. Each peak of the signal produces a new charge with the current following the time-constant curves (if allowed to complete them).

various parts of one elephant. So is with our capacitor "elephant." Capacitors are capable of doing only one action, but these various symptoms appear to indicate many functions.

Just "black boxes"

For this article, we'll not discuss in detail how capacitors work on the inside. Instead, we'll show how capacitors operate in actual circuits, according to measurements made by standard test equipment.

An old solution

Surprisingly, new and different extrapolations of the old textbook time-constant curves (of capacitor charging and discharging) provide answers to all the questions.

This material should be both interesting and informative.

Charge and discharge curves

The schematic in Figure 1 shows how to measure capacitor voltage and current during both charging and discharging modes.

Best voltage accuracy is obtained when the dc voltmeters are electro-

static types that draw no current from the tested circuit. However, if the time is lengthened and the current is increased by the choice of a large-value capacitor, the readings can be taken by two VTVM or FET meters and one current meter. Most digital meters can't follow fast enough. Later, we'll show how to use a scope for faster analysis.

Just watching the meters follow the voltages and currents will give you a *feeling* for capacitor actions that you won't soon forget. I recommend you measure these voltages and currents, although the accuracy of the Figure 2 curves have been proven many times.

Defining time-constant

The time-constant curves of Figure 2 were plotted for the Figure 1 circuit, and the operation of the circuit is described fully in the illustration. However, a definition of time-constant is needed.

For capacitor charging, one time-constant is the time required to charge a capacitor with 63.2% of the supply voltage, and for decreasing the capacitor-charging current

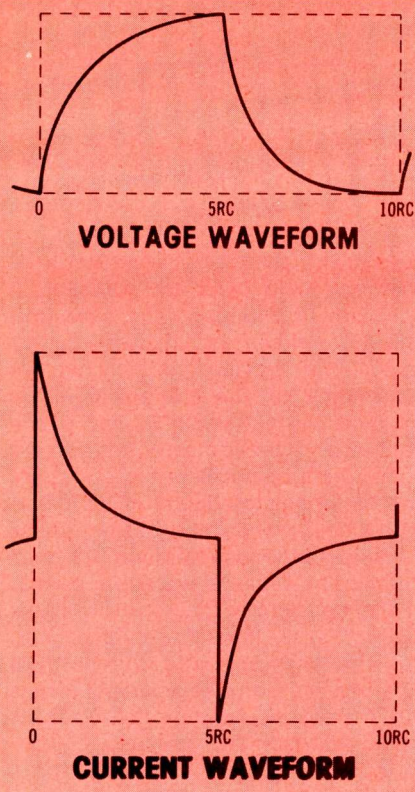

Figure 7 In actual operation, charges and discharges usually occur in succession. (A) shows the voltage waveform produced by charging and immediate discharge. (B) is similar, but it shows the current charge and discharge curves joined together. These two completed waveforms are part of square-wave analysis.

to 36.8% of the turn-on maximum value. For discharge, it is the time required for the capacitor voltage to drop to 36.8% of the supply voltage, and for the opposite-polarity capacitor current to drop to 36.8% of the maximum discharge value.

This is the time-constant formula:

$$T = RC$$

where time (T) is expressed seconds, resistance (R) is in ohms, and capacitance (C) is in farads. Since farads are too large for practical use, the formula can be changed to:

$$\text{Time in seconds} = \text{megohms times microfarads}$$

Remember that each successive

time-constant increases the capacitor voltage by 63.2% of the *remaining* supply voltage. In other words, at one time-constant, 36.8% of the supply voltage remains for future charging, so 63.2% of 36.8 V (Figure 2) is the increase during the second time-constant. And so on, as long as the charging continues.

A capacitor is considered to be fully charged after five time-constants (when the capacitor voltage is 99.4% of the supply voltage, and the current is only 0.6% of its maximum value).

Of course, all non-electrolytic capacitors charge just as readily and completely from a negative supply voltage as for the positive one shown.

Learn from the LEDs

The previous information has been verified theoretically and experimentally. But you can check the basic operation for yourself by constructing the simple circuit of Figure 3, and watching the lighting of the LEDs as you flip the charge/discharge switch.

Two LEDs of opposite polarity are used to show that the capacitor current for discharge is the reverse of the charge current. One lights for charge and the other for discharge.

An impedance-matching transistor is added to drive the capacitor-voltage LED. (If the LED is wired direct to the capacitor, the current would discharge the capacitor too quickly, thus upsetting the timing.)

Only one LED is required to show the capacitor voltage, for in this circuit the voltage never can become negative.

Two curves or six?

A point seldom mentioned or clarified is that the two curves of Figure 2 (with only minor alterations) serve also for the discharge capacitor voltage, the discharge capacitor current, plus the charge and discharge voltage drops across R1 (caused by capacitor currents).

Figure 4 shows all six curves in their general forms. Notice that two curves begin at turn-on with zero, go instantly to a maximum, and then resume the parabola. Two others begin at zero, but go

instantly to a maximum negative value before tracing the parabola. In fact, if (B) and (E) were placed properly, (E) should be moved down until the zero points are in horizontal alignment. The same applies to (C) and (F). Later, we'll show a practical example of (B) and (E).

Electric bucket with diaphragm dielectric

I want to propose a new model for capacitors. Of course, all model/examples fall short of reality when carried beyond basic similarities, but this one is more exact than most. A capacitor is represented by a reservoir divided through the middle by a special diaphragm which bends from the pressure against it, but doesn't allow any gas or fluid to pass through it.

Refer to Figure 5 for a comparison of the capacitor and reservoir for five stages of charge and discharge.

Can ac pass through a charged capacitor?

According to the previous facts, a fully-charged capacitor has *no* current (either internal or external). Any capacitor that couples two audio stages always has dc voltage applied to it for much longer than five time-constants. It **must** be completely charged, and therefore *is an open circuit*. If it is open, then how can the ac audio signal pass through? There must be a valid explanation, since we know the audio does reach the second stage.

More than one charging and discharging

The compound curves of Figure 6 provide most of the answers to the preceding question. **When the supply voltage of a capacitor is changed, the capacitor goes through another charge or discharge process** (according to whether the voltage was increased or decreased) **until it assumes a new charge** (that is, with no current, but with full voltage across it).

Therefore, the charged condition is not permanent, but it changes from any voltage variation. In the same way, audio ac signals also produce new charge and discharge

Capacitor operation

currents in a charged capacitor.

Next, an illustration is needed to make clear how the currents from charging and discharging (around, but not through) the capacitor can be changed into ac audio at the output of the capacitor.

Addition of two curves

The various curves of Figures 2 and 4 were isolated from each other. In actual operations, however, the charging and discharging often go on consecutively without any breaks in between.

For example, each waveform in Figure 7 was made by joining together two separate charge or discharge curves. The (A) waveform is a voltage capacitor-charging curve of five time-constants that's followed by five time-constants of a voltage capacitor-discharging curve. (If the whole waveform looks familiar to you, it should. It's part of square-wave analysis, which will be discussed later.)

The (B) waveform is a bit more tricky, since the half waveforms can't be placed on the same level. A current capacitor-charging curve is the left half of (B), while the right half is a current capacitor-discharging curve. These are the same as (B) and (E) in Figure 4. Notice that (B) ends at zero current, then (E) begins also at zero current but instantly drops to maximum *negative* current before it traces the prescribed parabola. When the ending zero of the first curve is lined up horizontally with the beginning zero of the second curve, the complete Figure 7B waveform is produced. (This waveform also should be familiar to you.)

Important points

Two important lessons can be learned from these combinations of time-constant curves.

First, square-wave analysis (which provides fast frequency-response information) is based on time-constant curves.

Second, capacitor current from charging and discharging can cause voltage drops across resistors. In those cases, **the voltage waveform is an accurate rendition of the current waveform that produced it.** Incidentally, the current-measuring func-

tion of a VOM uses the same principle. Current is sent through a low-value resistor, and the resulting voltage drop is measured by the meter.

A resistor (which is included to change varying current into a varying voltage drop) can be placed in series with either end of the capacitor.

Previous schematics showed a time-constant resistor (which is the equivalent of a plate or collector load resistor) at the capacitor input. However, the capacitor charging and discharging currents also can produce voltage drops across a resistor that's in series with the capacitor output (grid or base resistor in audio stages). The *same* capacitor currents flow through both resistors; **therefore, the waveforms will be identical.**

At the capacitor output, these charging and discharging currents produce half waves of positive and negative current (see Figure 7B for square waves) which combine at the capacitor output to produce a complete current waveform. Voltage drop across the output resistor changes the current waveform into a voltage waveform that drives the tube or transistor. Figure 8 shows a typical audio-coupling circuit.

This is proof that the ac signal itself did *not* pass through the capacitor.

For most frequencies of ac, the *effect* is the same as the old cliché, "passing the ac and blocking the dc." However, with some time-constants, the amount of ac that passes is attenuated by an effect similar to resistance. Yes, it's another masquerade; one effect that seems to be another.

The name of this capacitor characteristic is capacitive reactance, and it explains how a small coupling capacitor can attenuate low frequencies more than it does high frequencies. However, we will discover that **capacitive reactance is just one more effect produced by the time-constant charging and discharging.**

Capacitive reactance

In many ac circuits, a capacitor acts as though it is a resistor whose resistance value varies according to

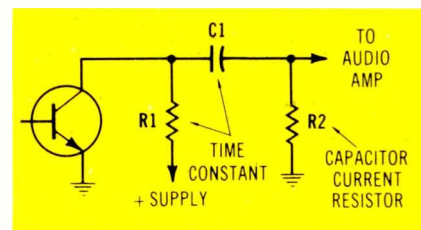

Figure 8 Identical current flows at each end of a capacitor, although it does not flow *through* the capacitor. The C1 voltage is changed by R1 versus the varying collector/emitter resistance of the transistor. This produces current at the R2 end of the capacitor. One polarity of current comes from one peak of the ac signal, and the opposite polarity of current is produced by the other peak. These currents both pass through R2 thus forming the same ac waveform as that at the transistor collector. The signal did *not* pass through the capacitor, but the charging and discharging currents caused voltage drops across R2, thereby re-creating the collector signal that is at R2.

the frequency of the signal. This capacitor characteristic is called capacitive reactance. It can cause a capacitor to function as if it is almost an open circuit at low-frequency ac, or as almost a short circuit at high frequencies.

Capacitive reactance has a formula which is supposed to be memorized by students and engineers. However, our purpose here is to show how it operates, and not how to calculate it. Capacitive reactance is most important in tone-control circuits, coupling capacitors, and bypasses.

Keep in mind that transferring all of the input signal indirectly to the output first requires the capacitor to be uncharged. (A charged capacitor is an open circuit.)

Therefore, to (apparently) pass an ac signal through a capacitor without attenuation requires the capacitor to be uncharged (or discharged, which is the same thing) for most of each half cycle.

We all know that a very low-frequency sine wave becomes an attenuated sine wave with leading phase at the output of a coupling capacitor. Therefore, square waves will be used to show the reason for the loss.

Here's how to become as good a businessman as you are a service technician.

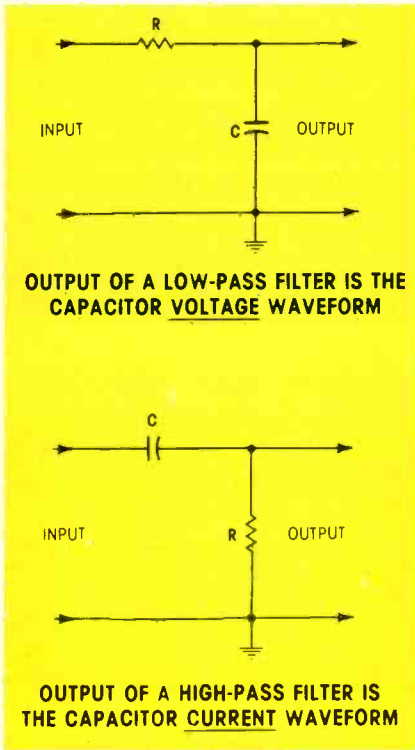

Figure 9 These are two variations of the time-constant circuit. When the voltage or signal is taken from the capacitor, the output is the capacitor voltage. This (A) circuit also is called a low-pass filter. The (B) circuit is a high-pass (or low-frequency attenuation) circuit because the output is taken from the time-constant resistor.

Square waves versus time-constant

Remember that *any* voltage across a coupling capacitor produces a loss of ac signal at the output, and only an uncharged capacitor has no voltage drop across it. Also, the voltage at a capacitor's output is generated by current. (The capacitor charging is powered by the supply voltage and capacitor current is produced. But the output voltage is developed by the capacitor current producing a voltage drop across a resistance.)

A time-constant filter can be inverted. Figure 9A shows the usual circuit for illustrating time-constant curves. It also is a low-pass filter (which produces lagging phase), and the output signal is the voltage curve of the capacitor for charging or discharging.

Figure 9B is just the reverse. The capacitor charging is exactly the



Business management course for service technicians—proved in classroom use for over 3 years—now available on audio cassettes with 48-page workbook!

Whether you work for yourself or not, it's important for you to know the dollars-and-cents side of the electronics business.

How and why rates are set and revised periodically, for example. How to organize and maintain customers' records. Different techniques, too, for speeding up collections.

These are just some of the business management subjects—originally tested and proved in actual classroom use by Zenith—now available to you on audio cassettes with a 48-page workbook.

There's simply no easier, faster, more convenient way for you to become as good a businessman as you are a service technician!

You listen and learn at your own pace... at your own convenience. And then you review and refresh yourself on any one or all of the subjects whenever you choose.

You'll learn about inventory control of parts, about budgets, about how to prepare a balance sheet, a profit and loss statement.

Such subjects as site selection are covered, too. Accounts receivable and payable. Insurance. Purchasing. Taxes. Telephone usage. Analyzing income and expenses. Equipment depreciation.

All in all, the 19 essentials of management—as they apply in today's inflationary economy—are discussed thoroughly and clearly as they relate directly to your profitable performance as a service technician.

There's even a "case study"—patterned after the teaching method of the graduate schools of business management—to prove dramatically how much you've learned so easily, so quickly, so well.

Order your *Business Management I* self-training program now by completing and mailing the coupon below!

Your livelihood may depend on it.

ZENITH
The quality goes in before the name goes on®

Please send one set of four audio cassettes and the 48-page workbook of the Service Technicians' *Business Management I* self-training program. Enclosed is a check for \$39.95 to cover the cost of the complete program plus shipping and handling expenses.

Name _____

Company Name _____

Address _____

City _____ State _____ Zip _____

Please complete and mail this coupon with a check or money order to: Zenith Radio Corporation, Business Management Services, Dept. 10, 11000 Seymour Avenue, Franklin Park, Illinois 60131.

Circle (8) on Reply Card

January 1979 *Electronic Servicing* 19

Capacitor operation

same. However, the output is taken from the time-constant resistor, and the waveform is a voltage replica of the current waveform.

Since coupling capacitors operate with current, the circuit of Figure 9B will be used along with a scope and square-wave generator.

Current waveforms

The current waveforms of Figure 10 will prove that capacitive reactance is a function of time-constant charging and discharging. These are genuine scope waveforms with some parts of the curves outlined to make them easier to follow. The current charging curves are in the upper right corner of the scope graticule, with four squares of height (each square representing 25% amplitude) and five squares of width (for the five time-constants).

A sine/square wave generator provided the input signal and a scope furnished the current time-constant curves.

In the Figure 9B schematic, C was .01 and R was 20K, for a time constant of 0.0002 seconds. But one complete waveform requires 10 time-constants, so the waveform must require 0.002 seconds, which is 500 Hz. When a 500-Hz square wave was fed to the time-constant network, the result was the classic current capacitor-charging waveform.

The sequence of waveforms in Figure 10 shows that the 60-Hz curve had current for a very short time (all current was ended after a half time-constant). Then, each curve from 120 Hz on up to 4000 Hz had progressively more current. In fact, at 4000 Hz the current flowed for most of the half cycle, representing nearly zero attenuation.

At 60 Hz, therefore, the capacitor output had very little current, a small voltage was developed across the resistor, and the attenuation was very high. Each higher frequency in turn produced more current, a

higher voltage was at the output, and the attenuation was reduced.

This test was performed with square waves, but frequency response curves of the *same* filter using sine waves gave these results:

60 Hz	-22 dB
120 Hz	-16 dB
250 Hz	-10 dB
500 Hz	-6 dB
1000 Hz	-2 dB
2000 Hz	-1 dB
4000 Hz	0 dB
8000 Hz	0 dB

Not only did the actual frequency response curve verify the prediction, but it told us that a -6 dB response at the 10-time-constant frequency produced the classic current capacitor-charging curve! As mentioned before, when a low-frequency sine wave entered the time-constant high-pass filter, the output waveform *always* was a sine wave (although the amplitude was reduced and the phase was leading). The time-constant theory explains the operation with sine waves as easily as it does the square-wave operation. The current reaches a reduced maximum early and it also decreases ahead of the input wave because the actual time constant is too short for that low frequency (which would have required a longer one for a more-extended current time). If this is not clear, we'll discuss it thoroughly in a later article.

Capacitance with VTVM

By using your knowledge of time-constant curves and a VTVM, you can test capacitors from about .05 microfarad to the largest filters.

Examine the schematic of Figure 11. Neglecting the voltmeter part of the VTVM (which without a range switch is extremely high impedance and will not affect the results), the range-switch resistors and the unknown capacitor that's to be tested form a conventional time-constant

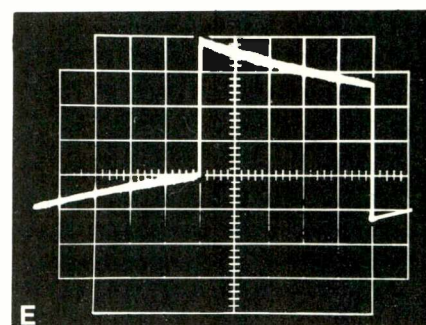
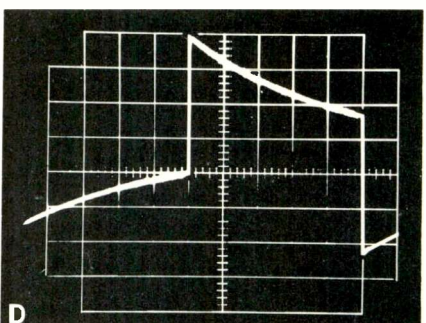
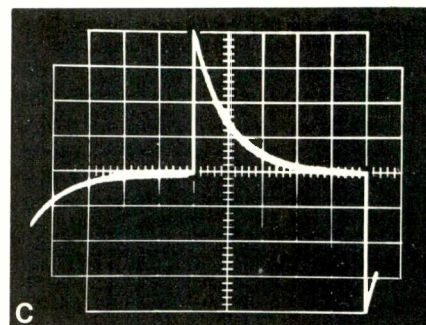
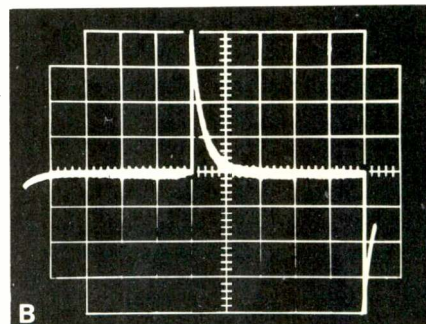
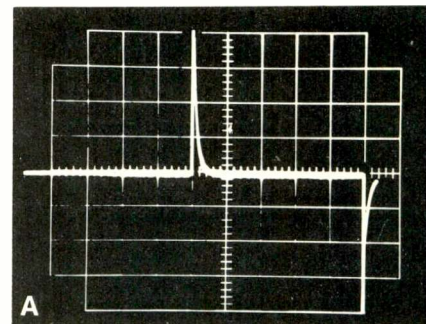

Figure 10 Current waveforms of square waves show how much of each half cycle of ac has capacitor current. Current that flows for most of each half cycle indicates the capacitor will pass ac of that frequency with little attenuation, while a short pulse of current proves sine waves of that frequency will be greatly attenuated.

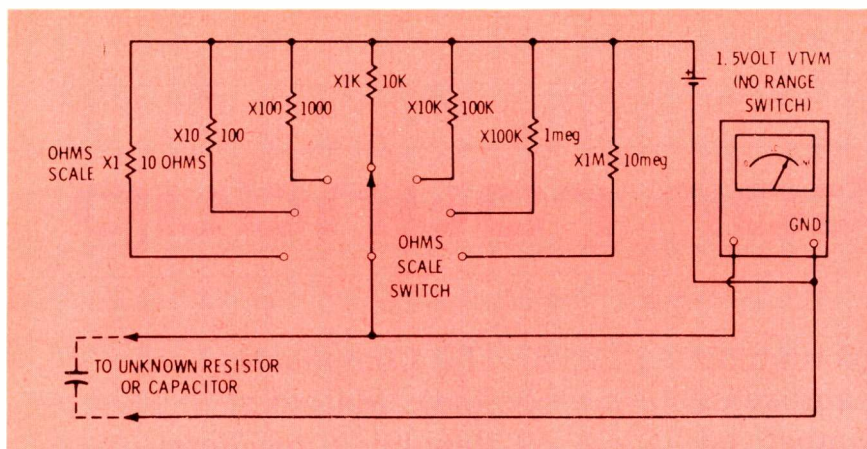

Figure 11 The ohmmeter function of a VTVM becomes a time-constant circuit when a capacitor is tested. All of the components (except the capacitor being tested) are inside the VTVM. Capacitance can be measured by the seconds required to reach 0.95 volts or 17 on the ohms calibration.

network fed by the 1.5-V battery. (Of course, the battery, switch and range resistors are all inside the VTVM. Only the test capacitor is outside.)

According to theory, the capacitor voltage should rise to 63.2% of the 1.5-V battery voltage in one time-constant. Therefore, on the X100K range (the only direct-reading capacitor test), the capacitor voltage should rise to 0.95 V in the first time-constant. For a 1- μ F capacitor, the time-constant is 1 second. For a 100- μ F capacitor, the time-constant is 100 seconds and the pointer should reach 0.95 V in 100 seconds.

The +0.95 V can be read on the 1.5 VTVM scale, or it corresponds to the 17 mark on the ohmmeter scale.

There are only two precautions. The capacitor must have the leads shorted together for several seconds before the test, and the capacitor must not be too leaky. If the reading *never* goes above the 17 (or 0.95 V) mark, the capacitor is leaky and the measurement is not valid.

Here are the four multipliers:

- Using the X1K range, multiply the seconds by 100 to give the capacitance in microfarads.
- Using the X10K range, multiply the seconds by 10 to give the capacitance in microfarads.
- Using the X100K range, the reading in seconds is the capacitance in microfarads.
- Using the X1M range, divide the seconds by 10 to give the capacitance in microfarads.

Summary

Regardless of what a capacitor *appears* to be doing in a circuit, the **one and only capacitor action is to accept an electric charge, store it and then discharge it into a load.** Current meters connected to the external circuit will show current into and out of a capacitor during the charging and discharging modes. However, this current is not continuous because **no current actually travels through the capacitor dielectric.**

When properly interpreted, the charging and discharging of electrical power explains those actions that appear to be distinctly different and separate. Each newly applied voltage causes another charge or discharge which flows through the circuit outside of the capacitor.

Therefore, the electrical storage in B+ capacitors, the capacitive reactance of bypasses and RC frequency equalizers, and the apparent passing of ac through a coupling capacitor all are produced by the capacitor charging and discharging. Also, the changes of waveshape when square waves are sent through high-pass and low-pass filters are caused by capacitor charging and discharging in the shape of time-constant curves.

So remember, neither ac nor dc actually goes through the capacitor, but the charging and discharging currents can re-create an ac waveform at the capacitor output. Each separate flow of dc current into or out of a capacitor continues for no more than five time-constants. □

The
cost effective
way to
**MEASURE
CAPACITANCE**



The
**B&K-PRECISION
MODEL 820**
Only \$130

For about one-third the cost of the most popular digital capacitance meter, you can own five times more measurement capability. The new B&K-PRECISION 820 reads all the way to 1 Farad, in ten ranges. With 0.5% accuracy, the 820 resolves to 0.1pF for a maximum count of 9999.

The battery operated 820 stays on the job over a wide range of temperatures, making it ideal for field use. The bright LED display is easily readable under all lighting conditions.

The 820 has almost unlimited applications in engineering, production line work, QC, education and field service. For example, you can measure unmarked capacitors... Verify capacitor tolerance... Measure cable capacitance... Select and match capacitors for critical circuit applications... Sample production components for quality assurance... Measure capacitance of complex series-parallel capacitor networks... Set trimmer capacitors to specific capacity... Check capacitance in switches and other components.

**Available for immediate delivery
at your local electronic distributor**

B&K PRECISION DYNASCAN
CORPORATION
6460 W. Cortland Street - Chicago, IL 60635
312/889-9087

In Canada: Atlas Electronics, Ontario
Int'l. Sls: Empire Exp., 270 Newtown Rd. Plainview, LI, NY 11803

Circle (9) on Reply Card
January 1979 *Electronic Servicing* 21

Capacitor roundup

If you want capacitor information from any of these manufacturers, circle the corresponding number on the Reader Service Card, stamp it and mail the card.

- | | |
|--------------------------------|--------------------------------|
| 50 Allied Electronics | 57 ITT Components |
| 51 American Technical Ceramics | 58 Radio Materials |
| 52 Arco Electronics | 59 Republic Capacitors |
| 53 Capacitor Specialists | 60 San Fernando Electric |
| 54 Capon, Incorporated | 61 Seacor, Incorporated |
| 55 Dielectric Laboratories | 62 Speco Components |
| 56 Film Capacitors | 63 Sprague Electric |
| | 64 Sprague-Goodman Electronics |
| | 65 Temtron, Limited |
| | 66 Tran Spectra |
| | 67 Varadyne Industries |
| | 68 Wesco Electric |

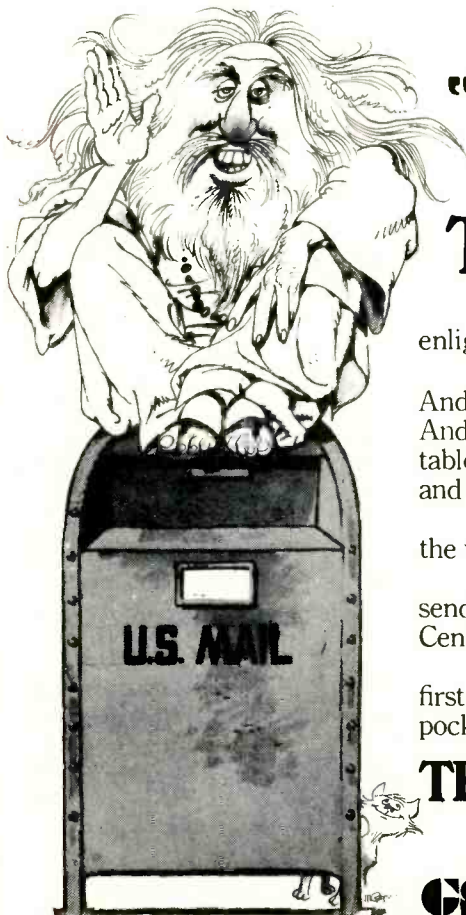

"YOU DON'T HAVE TO CLIMB A MOUNTAIN TO GAIN ENLIGHTENMENT."

Just send away for the Consumer Information Catalog and a key to enlightenment will appear in your mailbox.

The Consumer Information Catalog is put out by the Federal Government. And it lists over 200 of their booklets that you can send away for. Most are free. And they can help you with things like how to buy a home, how to grow vegetables, how to deal with headaches, simple plumbing repairs and many other everyday and not-so-everyday problems.

So if you wish to learn about the mystic sensibilities of the wayward ancients, put on your climbing gear.

But, if you wish to know about how to fix a leaky faucet, send for the catalog. Write: Consumer Information Center, Dept. A, Pueblo, Colorado 81009.

Remember, it's free. Which is only right. After all, the first step towards enlightenment shouldn't enlighten your pocketbook.

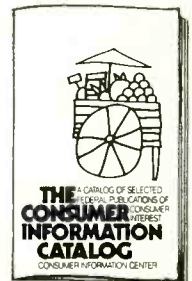

THE CONSUMER INFORMATION CATALOG

A catalog of over 200 helpful publications.

 General Services Administration • Consumer Information Center

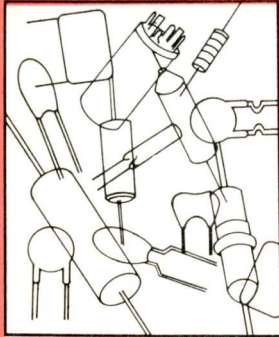

Selecting replacement capacitors

By Carl Babcoke, CET

Technicians today are offered a broad range of capacitor types for replacement uses. In fact, so many kinds are available that selecting the

best type can be a serious puzzle. The information you need about capacitors is compiled here.

Unusual Information About Capacitors

Some types gradually increase in capacitance over the years. Others have decreased capacitance with age. Do you know examples of each?

A capacitor can operate too warm and then short, although it is subjected to less than the rated voltage. What conditions can cause such failures?

Some capacitors repair their own shorts. Can you name the type?

Many capacitors can regain as much as 8% of the original voltage after they are discharged. What is this called, and how can it be a problem?

Which type of capacitor undergoes a change of capacitance from the applied voltage or the signal frequency?

Which kind of capacitor **never** should be used as a replacement? Why?

No single type of capacitor is best for all uses. None is perfect. Therefore, for each replacement, you should select the **one** type that provides the characteristics most needed, but without serious drawbacks. This is not a depressing situation. Instead, it gives you the **opportunity of reducing call-backs and providing superior operation of the products you service.**

Capacitance

Few capacitors have the exact rated capacitance when first manufactured. All are rated in percentage of error. What's more, their capacitances are subject to drift or variation from aging effects, temperature changes and the amount of applied voltage or frequency.

The amount of change from these conditions depends on the construction of the capacitor and on the materials used (particularly the dielectric). Therefore, we need to know the effects of the various kinds of dielectric materials, plus

the other specifications that determine the suitability of replacement capacitors.

Paper dielectric

Paper-dielectric wound capacitors are constructed by rolling long layers of material into a tubular shape. There are four layers. One is thin metal for one plate, next is a layer of waxed or oiled paper for a dielectric, another plate of thin metal and finally a second layer of paper. The plates are offset so they can have wire leads attached to them. Finally, a sealing coat of plastic is placed over the body.

Paper is not used anymore as a dielectric because it invariably had defects and pinholes, and two layers (minimum) of paper were required to cover the imperfections. Paper-dielectric capacitors increased in capacitance over several years. Sometimes the increase measured up to 10%. This probably was the reason so many of the horizontal stabilizing circuits in old RCA TV

Replacement capacitors

receivers caused double-triggering. Plastic film has replaced paper in capacitors.

Plastic-dielectric capacitors

All of the newer plastics used in wound capacitors now are superior to paper. However, the various characteristics vary considerably between these different plastics. Some of these important differences will be discussed.

Polyester

Polyester probably is the most common dielectric for present-day capacitors. Polyester can withstand relatively high voltages without shorting (has high dielectric strength), and can be used in most circuits up to an ambient temperature of 150 C (302 F) with only nominal drift of characteristics. Mylar is one brand of polyester.

Polycarbonate

Polycarbonate film retains the good physical properties of polyester while offering improved dielectric absorption, dissipation factor, temperature coefficient and insulation resistance. Polycarbonate approaches the desirable specs of polystyrene, but allows smaller packages and operation at higher temperatures. In short, it's an excellent compromise.

Polystyrene

Polystyrene has very low dielectric absorption and a moderate linear temperature coefficient. The only drawback is the low melting point of 90 C (194 F) which permits operation only up to 185 F.

Polypropylene

One of the newest capacitor films is polypropylene, which has excellent specs that are second only to polystyrene, but without the low-temperature limitation. Polypropylene is rated for use up to 105 C.

Others

Two new capacitor films are polysulfone for temperatures up to 150 C and Kapton (trademark of Dupont) for operation up to 200 C. These are found rarely on the replacement market, although they have good specs.

Metallized dielectrics

A metallic layer is deposited by an evaporative process on a dielectric film to form the capacitor plates, replacing the usual metal foil. This technique has been used on polycarbonate, polyester, polystyrene, polypropylene and perhaps others.

In other words, *any of the plastic films can be metallized.*

All electrical specs are nearly the same as for the non-metallized films, but the metallized versions can be made smaller, lighter and self-healing.

Probably the benefits from self-healing are the most important to technicians. When the dielectric of a *paper* capacitor is ruptured by excessive voltage, the paper chars, becomes carbon, and shorts the capacitor. However, in a metallized capacitor, the current from a short circuit burns away the metal film faster than the paper can char. Thus, the short is repaired.

There are a couple of limitations. The metallized layers are very thin. Therefore, this might present a limitation where huge currents are required. Also, the self-healing action probably could not happen in low-voltage or current-limited circuits. Power of the stored field and the external power together must be sufficient to burn away the metallized layer at the puncture, otherwise the short continues.

Mica dielectrics

Ruby mica is an excellent dielectric. It has very low loss, moderate "K" factor, and has a temperature coefficient similar to NPO (little change from temperature variations). However, mica breaks when folded, which causes them to be larger than ceramic types and limits the possible shapes. "Silver" mica capacitors contain mica that is treated with silver which acts as the metal plate. Both types of mica capacitors are suitable where a replacement needs low loss, high Q and little frequency drift. Many of the older TV receivers used mica coupling capacitors in sweep oscillators and the oscillators often drifted after unsuitable replacements were installed.

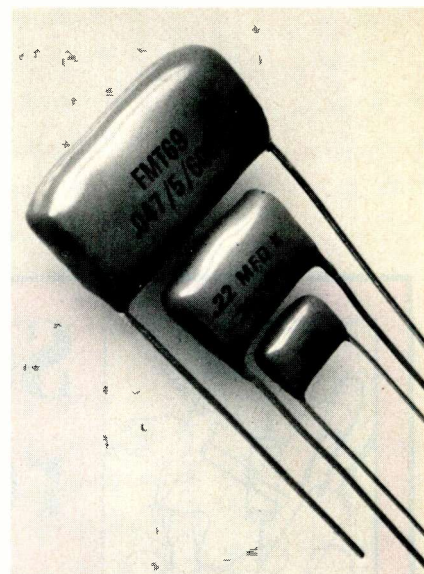

Wound plastic-film types of capacitors have the wire leads at the center of both ends or from one side (as shown). (Courtesy of Seacor.)

Ceramic capacitors

Selecting the proper type of ceramic capacitor for a precise application must be made with more care than for other capacitors. An *enormous* spread of characteristics is found with ceramics. Ceramic capacitors are extremely useful, but you must select them with discrimination.

There are only four general types of ceramic capacitors, although probably hundreds of minor variations exist. A higher dielectric constant (K) enables a capacitor to store more power in the same space. Or the same power can be stored in a smaller capacitor. However, the higher K types are much more unstable to temperature, frequency, voltage and rate of aging.

COG/NPO type BP

For stability below 10 MHz, the COG/NPO type BP is recognized as an industry standard. There are no aging effects, and the temperature coefficient is around 30 PPM per degree centigrade. Usually this type has leads. NPO stands for *negative-positive-zero*, which means the capacitance drift from temperature is almost zero.

COG/NPO type BN

This type is similar to type BP,

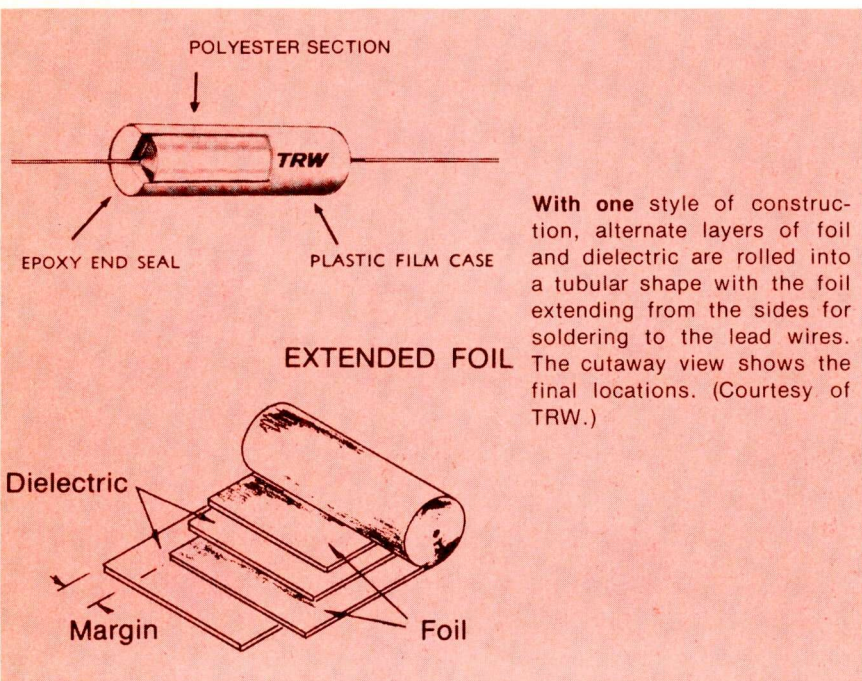

With one style of construction, alternate layers of foil and dielectric are rolled into a tubular shape with the foil extending from the sides for soldering to the lead wires. The cutaway view shows the final locations. (Courtesy of TRW.)

but comes in chip form only (without leads) and is recommended for use above 10 MHz.

X7R type BR

Probably more of this type is used than any other. Capacitor physical sizes are much smaller than for those with equal NPO values. These are general application (GA) types having an approximate temperature coefficient of $\pm 5\%$ between -40 C to $+100\text{ C}$, a decrease of 10% in capacitance at 50% of rated voltage, and an increase of capacitance with AC voltages. Aging is about -4% after 10,000 hours, and the dissipation factor is between 2% and 3%.

Z5U type GU

This type has about four times the storage capacity of X7R type BR, but it's much more unstable. For example, the temperature coefficient is about $\pm 15\%$ between $+10\text{ C}$ and $+40\text{ C}$, but it drops rapidly above $+40\text{ C}$ to -60% at about $+85\text{ C}$. A dissipation factor of 3.5%, aging rate of 5% per hour decade, and a 40% capacitance loss at 50% of rated voltage are all higher than other types.

However, these Z5U type GU capacitors are intended for non-critical uses such as bypasses or

decouplers. Often the capacitance spec is -20% to +80%. Some are specified at a guaranteed minimum value (GMV) so they will not have less than the rated capacitance at room temperature, although the capacitance can be 100% greater than the rating.

If you have ever tried to use this type in oscillators or tuned circuits, probably the results were drifting frequency and low amplitude. However, these capacitors are economical and very small, and thus are extremely useful when you know their limitations.

Temperature-compensating ceramics

Most RF and IF transformers and coils have a positive temperature coefficient. That is, an increase of temperature increases the inductance which in tuned circuits decreases the frequency. One solution for this kind of drift is a tuning capacitor having a negative coefficient that slopes gradually without peaks or valleys.

These temperature-compensating ceramic capacitors are available in many different ratings from N030 to N5600. A popular value is N750, which means the capacitor will decrease 750 parts-per-million (PPM) for each degree centigrade of temperature rise. This translates to

APPLIANCE REPAIR BOOKS



Thirteen Handbooks written in easy-to-understand language by experts in the service field with illustrations and diagrams! Acclaimed by instructors and professionals alike! How to diagnose and repair air conditioners, refrigerators, washers, dryers, ranges, microwave ovens, dishwashers, vacuum cleaners, electrostatic air cleaners, RV gas appliances, hair dryers, motors, water heaters, coffeemakers, can openers, floor polishers, steam irons, food mixers, lawn care appliances, electric knives, electric and digital clocks and many others. Also fundamentals of solid state, setting up a shop, using test instruments and more. Only \$2.65 to \$4.90 ea.

SEND FOR FREE PRICE LIST

Gamit, Dept. ES

110 W. St. Charles Road,
Lombard, Illinois 60148

Circle (20) on Reply Card

SERIOUS ABOUT YOUR FUTURE IN HOME ELECTRONIC SERVICE?



The Sign of Professional Service

...a not for profit association championing independents' right to compete, and delivering valuable benefits continuously since 1950.

NATESA offers low cost group insurance, discounts on everything from eyeglasses to motor vehicles, individual consultation on particular problems, representation to government and industry at all levels and a place to unite to protect each individual member with the strength of all.

Send this ad with your card or letterhead to:

NATESA, Dept. ES
5908 S. Troy St.
Chicago, Il. 60629

- Membership. \$60.00 enclosed. As our member premium, please send free . . .
- Practical Business Manual - OR -
- Service Contract Manual

Replacement capacitors

-1.5% change for an increase of 20 C.

Filter capacitors

Filter capacitors are available not only in the old favorite aluminum oxide, but now also in tantalum. The dielectric constant of tantalum is higher than for aluminum; therefore, tantalum filters are smaller for the same capacitance. Tantalum does not deform when idle, so the shelf life is longer, and the capacitors don't change characteristics as much as aluminum electrolytics do.

Capacitor specifications

Several performance characteristics are important when determining the suitability of a capacitor. These will be described briefly.

Capacity

The basic unit of capacitance is the farad, but this is too large for use in conventional electronic circuits. Our basic unit is the microfarad (one millionth of a farad), which is divided further into nanofarads (one thousandth of a microfarad) and a picofarad (one millionth of a microfarad). Nanofarads are not used often in service literature, but they are used often by engineers.

Here are the most common conversions from one unit to another:

- To change microfarads to nanofarads, move the decimal 3 places to the right.
- To change microfarads to picofarads, move the decimal 6 places to the right.
- To change nanofarads to picofarads, move the decimal 3 places to the right.
- To change nanofarads to microfarads, move the decimal 3 places to the left.
- To change picofarads to nanofarads, move the decimal 3 places to the left.
- To change picofarads to microfarads, move the decimal 6 places to the left.

Of course, you must add zeros to fill any spaces left by moving the decimal. For example, .001 microfarads equals 1000 picofarads, and 47 picofarads equals .047 nanofarads or .000047 microfarads.

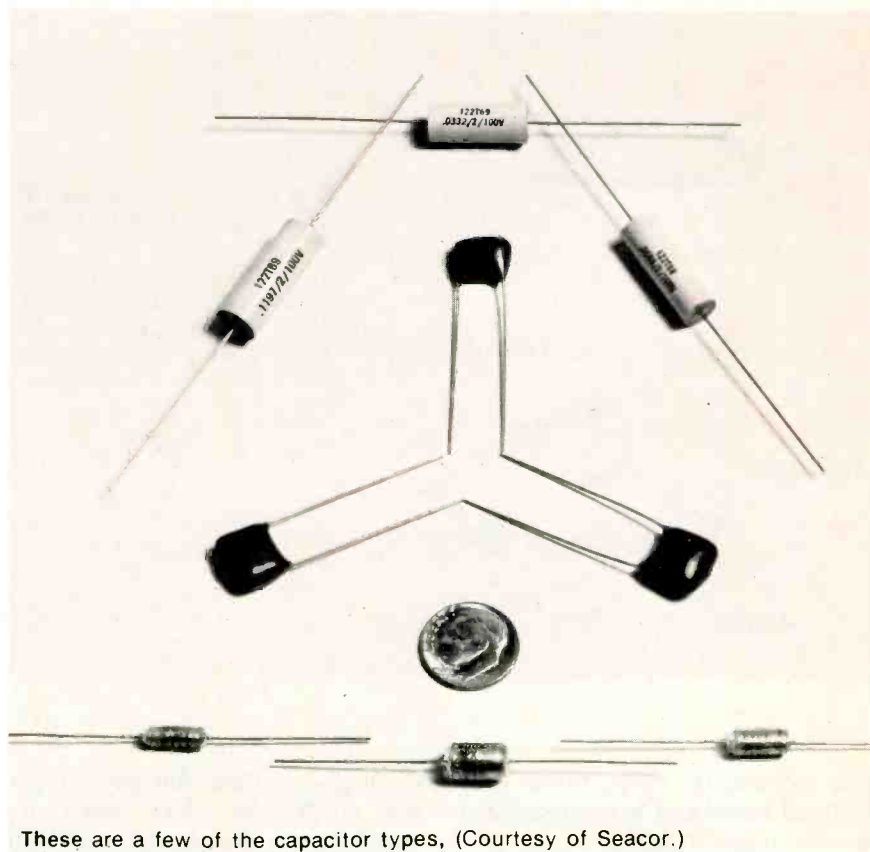

These are a few of the capacitor types, (Courtesy of Seacor.)

Many capacitors are color coded with the capacitance; however, stripes or dots for tolerance and voltage are added in so many ways that the situation is confusing. Perhaps you should ask your local distributor about a code sheet for the brand he sells to you.

Tolerance

Usually, the permissible deviation from marked values is expressed as a \pm percentage. However, this is for 20 to 25 C, and you will have to apply any change because of other temperatures.

In some circuits, the capacitance is critical. The schematic should indicate that indirectly by stating the percentage required.

Insulation resistance

As the name implies, insulation resistance (dielectric strength) is the ohmmeter reading after the capacitor has stopped charging. Some tests are made at 500 V that's applied for two minutes. Except possibly for some inexpensive ceramic capacitors, insulation resis-

tance is no problem with new capacitors. Film capacitors, for example, often are rated at 25,000 M Ω .

Capacitive reactance

Capacitive reactance is the ability of a capacitor to function as though it is a resistor whose resistance changes with the frequency. It is expressed in ohms, and the "resistance" decreases as the frequency increases. The other capacitor article in this issue gives an explanation of capacitive reactance.

Equivalent series resistance

All capacitor losses (which degrade the performance as though a fixed resistor is placed in series with a perfect capacitor) are lumped under the term *equivalent series resistance* (ESR).

Some of these losses include dielectric current leakage, corona and dielectric absorption; or resistances in capacitor plates, leads and joints. Formerly, ESR and the dissipation factor were included in the obsolete term *power factor*.

Dissipation factor and "Q"

Capacitor "Q" is defined as the ratio of capacitive reactance to the equivalent series resistance. Higher "Q" ratings are desirable.

Dissipation factor (DF) is the mathematical reciprocal of "Q". Therefore, it should be as low as possible. Polypropylene has the lowest DF of the films, followed in order by polystyrene, polysulfone, polycarbonate and polyester.

Total schematic

Practical capacitors are diagrammed as a perfect capacitor in series with an inductance and a low-value resistor. In addition, another higher-value resistor is connected in parallel with the series components. This is illustrated in one of the figures.

Dielectric absorption

If you ever have discharged a large picture tube, and then later received a severe shock from the anode button, you have had practical experience with *dielectric absorption* (DA).

The effect occurs in *all* capacitors having a solid dielectric, although it varies considerably according to the material. Non-polar materials do not permit instantaneous rotation and alignment of the atomic electrons. There is a time lag during both charge and discharge modes. Contaminants or impregnants in

the dielectric material also vary the intensity of the effect.

At the factory level, DA is measured by giving the capacitor the rated charge, discharging it through a 5-ohm resistor for 10 seconds, waiting for 60 seconds, and then measuring the voltage by using an electrometer.

These are typical dielectric absorption percentages of some materials:

Tantalum pentoxide	8%
Polyester (Mylar)	0.30%
Polysulfone	0.15%
Polycarbonate	0.15%
Polystyrene	0.05%
Polypropylene	0.02%

Dielectric constant

Dielectric constant (K) is a measure of the additional charge a capacitor can handle when other dielectrics are substituted for a vacuum. (Actually, dielectric constant is misleading, since there is some variability. Authorities use the term *permittivity* instead.)

Here are the approximate K values of a few substances:

Vacuum	1.0000
Air	1.0006
Paper	2.1—6.0
Glass	4.8—8.0
Mica	5.4—8.7
Polyester	2.8—3.1
Kraft paper	about 4

Volksmeter + A Little Extra For Less



LM-3.5A \$155
0.5% Accuracy

- Measures VDC, VAC, Ohms, DCmA & ACmA.
- Auto zero & Polarity.
- Battery powered with charger unit included.
- 1.9"H x 2.7"W x 4.0"D.
- Large 0.3" LED display.



Non-Linear Systems, Inc.
Originator of the digital voltmeter.
Box N, Del Mar, California 92014
Telephone (714) 755-1134 TWX 910-322-1132

Circle (21) on Reply Card

INFLATION. IT HURTS US ALL.

This booklet helps explain why.

The coupon will bring you a free copy of "Inflation in the American Economic System and your part in it..."

Once you read it, we hope you'll want to order bulk copies for your company's employees, shareholders, plant communities, schools, libraries, and other groups

The price will be as non-inflationary as we can possibly make it.

The American Economic System.
We should all learn more about it.



A public service message
of this Magazine and
The Advertising Council

PO Box 2157, New York, N Y 10001
Please send me a free copy of
your inflation booklet.

Name _____
Address _____
City _____
State _____ Zip _____

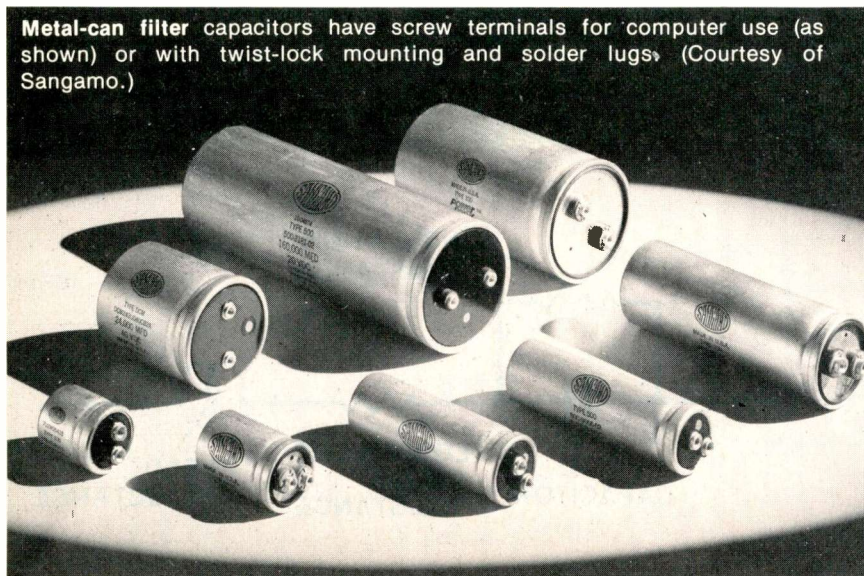

Metal-can filter capacitors have screw terminals for computer use (as shown) or with twist-lock mounting and solder lugs. (Courtesy of Sangamo.)

Replacement capacitors

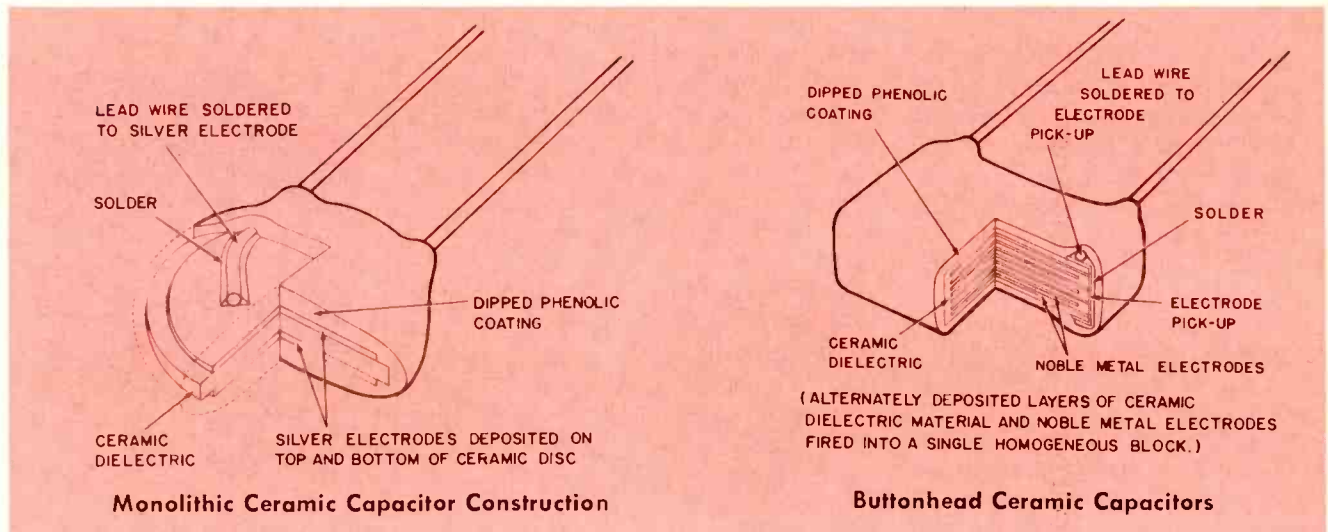

Most ceramic capacitors are manufactured in these two kinds of construction. Some resemble resistors (not shown). (Courtesy of Sprague.)

Aluminum oxide	about 7
Tantalum oxide	about 11
Ceramic NPO	25—100
Ceramic X7R	300—1800
Ceramic Z5U	2500—15,000

(Other sources give slightly different figures.)

For example, a capacitor using aluminum oxide can store an electrical charge seven times greater than can a similar capacitor with a vacuum dielectric.

Probably the most important reason why materials of higher "K" are not used for all dielectrics (thus reducing the physical size for the same capacitance) is that the lower "K" dielectrics are more stable. However, don't compare polyester against a NPO ceramic; they are in different categories.

Temperature coefficient

Temperature coefficient describes the changes of capacitance that occur at different capacitor temperatures. It is expressed either as a percentage change or in the number of parts-per-million (PPM).

None of the plastic films drifts tremendously, but none is without drift.

Polysulfone probably has the least change from temperatures between 32 F and 212 F (however, hermetical sealing is recommended to keep out moisture), followed in descending order by polycarbonate, polystyrene, polypropylene and polyester.

It is difficult to be precise in these ratings, because metallizing makes some change and different

physical features also have an effect on the TC.

Capacitance changes from applied voltage

Some capacitors increase capacitance when supplied with ac voltages, and decrease capacitance with dc voltages. This appears to be serious only with certain "high K" (low "Q") ceramic capacitors.

Therefore, you need not be concerned when using other types. Remember, the "high K" types should not be used where capacitance is critical.

Ordering by specification

These capacitor facts should have explained why a ceramic capacitor of correct marked value (but unknown type) worked so poorly when

Real-world capacitors have several kinds of loss problems. Insulation resistance decreases with temperature, causing additional leakage. The equivalent series resistance is the sum of all losses that affect the capacitor operation as though a resistor is added in series. A small amount of inductance always is present. This is one reason every capacitor has a self-resonant frequency where the impedance is minimum.

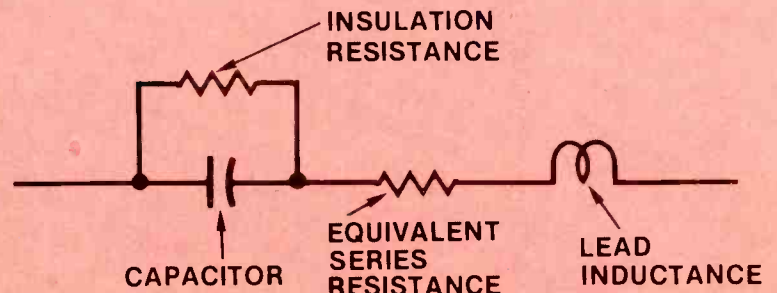

used in a vertical multivibrator, for example. Best results can be achieved only when the replacement capacitor has proper specs for the circuit.

Capacitors used in multivibrator or other time-constant oscillators and sample-and-hold circuits should be a type with low dielectric absorption. All oscillator capacitors must be stable with temperature changes, while some need the negative-temperature types to cancel drift introduced by other components.

Pulse circuits

Quite often, you will see manufacturer's admonitions to use only their replacement capacitor. One of those critical areas is the SCR-sweep circuits. We have heard the horror stories about ordinary capacitors that heated and then shorted, although they were operated well within their rated voltages.

There are two warnings here. One is that the capacitor must be designed for high-current operation (low dissipation), low dielectric absorption and freedom from internal corona.

Metallized capacitors might not carry the extreme currents. From the listings we have made here, polypropylene and polycarbonate should be first and second choices because of the low dielectrical absorption and low dissipation.

Curie point

Ceramic capacitors are made from a powder which is subjected to heat and pressure in a mold. At first, the capacitance drops severely over several days or weeks. After this initial variation (which decreases the capacitance only to the rated value), the capacitance slowly decreases over a period of years.

However, heating a X7R or Z5U type capacitor to the Curie temperature (of 125 C or above) restarts the capacitor at the original excessive capacitance, which is followed by fast aging before stability is restored.

Therefore, avoid excessive heat when you solder these two types of capacitors. Use cooling spray on the capacitor body immediately before

QUICK-QUIZ

#4

By Wayne Lemons

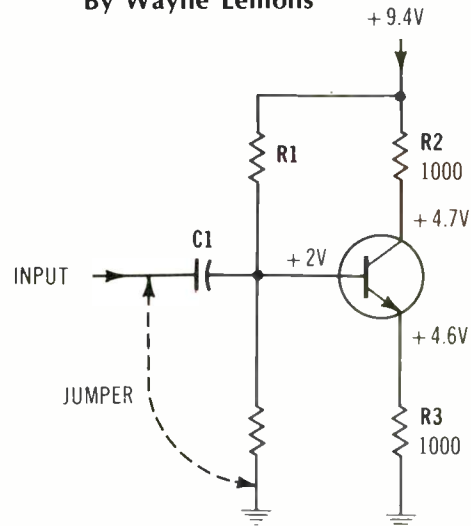

WHICH PART IS BAD?

ANSWER ON PAGE 50

A Public Service of This Magazine & The Advertising Council



Your Business can be one, too.

Red Cross needs individual volunteers, and donors of blood and money, by the millions.

But we need even more help. We need the solid support of American Business. And we never needed it more.

If your business is already helping, by organizing blood drives, and by supporting payroll deductions—either directly for the Red Cross, or through the local combined fund drive—the whole community owes you thanks. And we thank you, too.

Last year, with help from our friends, we offered major aid at over 30,000

disasters—from typhoons, to local (but just as devastating) house fires.

We were able to help the elderly with practical programs, we helped veterans by the hundreds of thousands, we taught people by the millions to swim or swim better. And that's just the tip of the iceberg.

Think of America without The American Red Cross.

And you'll know why we need your business as a Red Cross Volunteer. In your community. And all across America. Contact your local Red Cross Chapter to see how your company can become a volunteer.

Red Cross is counting on you.

Replacement capacitors

A typical temperature characteristic curve for polyester dielectric is shown. Other plastic film capacitors have a flatter curve. (Courtesy of TRW.)

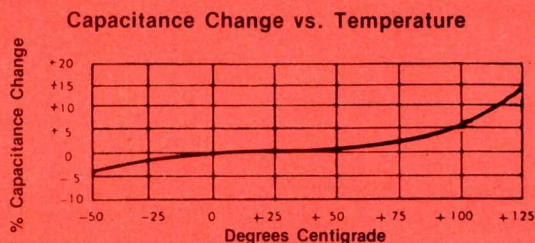

soldering to prevent the capacitor from becoming too hot.

Beware of unknowns

Do you have a large quantity of ceramic and wound capacitors that you have kept for 10 to 20 years? Chances are good that you don't know what type they are. To avoid call-backs and other penalties of using inferior components, *perhaps you should throw them all out and*

stock new types that are best for replacements.

Substitute a higher rating

A helpful general rule is to install a replacement capacitor of higher ratings than those of the original that failed.

For example, a wound tubular 200-V capacitor could be replaced by a 400-V or 600-V type. Some of

the new ones are smaller physically than are the old paper versions. If you must substitute for a mica, use *only* a NPO ceramic.

Also, a polycarbonate can be substituted for a paper or polyester.

Don't knowingly stock any Z5U ceramics. Use the better X7R instead. The smaller total stock will be more valuable than the lower prices on those few Z5U ceramics that are really needed. □

Freebies!

Free publications from the Internal Revenue Service on just about every tax subject. Send for them by mail using the order form in your tax package.

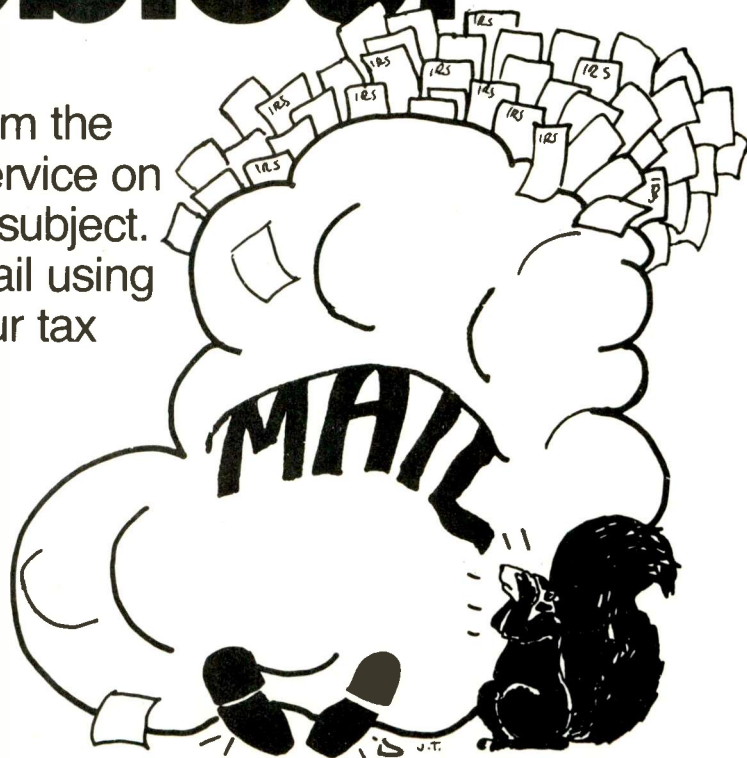

Prepared as a public service by the Internal Revenue Service.

INDEX OF 1978 ARTICLES

TITLES OF ARTICLES

Auto-Audio Update Jan. 28
Auto Radio Tips Mar. 14
Betamax Videotape, Part 1, videotape basics Apr. 22
Betamax Videotape, Part 2A, recording B & W May 61
Betamax Videotape, Part 2B, Betamax B & W Jun. 32
Betamax Videotape, Part 3, chroma recording Jul. 45
Betamax Videotape, Part 4, comb filters Aug. 41
Betamax Videotape, Part 5, servo systems Sep. 29
Betamax Videotape, Part 6, servo circuits Oct. 54
Betamax Videotape, Part 7, mechanical Nov. 36
Betamax Videotape, Part 8, servicing tips Dec. 18
Curing Horiz Drift, Part 1, ringing coils Jul. 14
Curing Horiz Drift, Part 2, RC oscillator Aug. 28
Curing Horiz Drift, Part 3, methods & tips Oct. 38
GE Color Portable, Part 1, power supplies Sep. 14
GE Color Portable, Part 2, horiz and HV Oct. 23
GE Color Portable, Part 3, vertical Nov. 18
GE Color Portable, Part 4, vertical & sync tips Dec. 38
GE Projection TV Jun. 14

Industrial Electronics, Part 7, gates & truth tables Jan. 36
Industrial Electronics, Part 8, logic probe Feb. 48
Industrial Electronics, Part 9, NOT gates Mar. 24
Industrial Electronics, Part 10, clocks Apr. 59
Industrial Electronics, Part 11, DeMorgan's Law May 52
Industrial Electronics, Part 12, Schmitt triggers Jun. 24
Industrial Electronics, Part 13, timers & flip flops Jul. 20
Industrial Electronics, Part 14, toggles to counter Aug. 37
Industrial Electronics, Part 15, 7-count flip flop Sep. 21
Industrial Electronics, Part 16, ripple counters Oct. 31
Industrial Electronics, Part 17, counting circuits Nov. 32
LED Tests Feb. 54
Magnavox Color TV, Part 8, touch-tune repairs Jan. 18
National Service Conventions Oct. 19
Quasar's Compu-Matic Tuning, digital tuners Dec. 24
Service Management, Part 1, improved income Jan. 14
Service Management, Part 2, low productivity Feb. 28
Service Management, Part 3, P&L statements Mar. 20
Service Management, Part 4, balance sheets Apr. 54
Service Management, Part 5, profitable rates May 32
Service Management, Part 6, calculating rates Jun. 18
Service Management, Part 7, pricing plans Jul. 26
Service Management, Part 8, ratio analysis Aug. 25

Service Management, Part 9, fair rates	Sep. 35
Service Management, Part 10, service vs sales	Oct. 44
Service Management, Part 11, parts profit	Nov. 13
Service Management, Part 12, analyzing costs	Dec. 34
Signal-Seeking Radios	Feb. 40
Sylvania Color TV, Part 1, tuners & power	Feb. 18
Sylvania Color TV, Part 2, horiz & HV	Mar. 32
Sylvania Color TV, part 3, vertical sweep	Apr. 34
Sylvania Color TV, Part 4, AGC circuits	May 42
Sylvania Color TV, Part 5, video	Jun. 41
Sylvania Color TV, Part 6, chroma circuits	Jul. 30
Sylvania Color TV, Part 7, sound & audio	Aug. 19
Technical Notebook, Part 1, test questions	Feb. 34
Technical Notebook, Part 2, resistance tests	Mar. 41
Technical Notebook, Part 3, magnetic domains	Apr. 49
Technical Notebook, Part 4, capacitor questions	May 37
Technical Notebook, Part 5, magnetic strength	Jun. 38
Technical Notebook, Part 6, diode protection	Jul. 38
Technical Notebook, Part 7, magnetic memories	Aug. 47
Technical Notebook, Part 8, uncharged capacitors	Sep. 39
Technical Notebook, Part 9, magnet core, in-situ	Oct. 47
Technical Notebook, Part 10, dielectric effects	Nov. 42
Technical Notebook, Part 11, dielectric changes	Dec. 46
TV Brightness Problems	May 16

AUDIO

Auto-Audio Update	Jan. 28
Auto Radio Tips	Mar. 14
Signal-Seeking Radios	Feb. 40
Sylvania Color TV, Part 7, sound IF & audio	Aug. 19

BUSINESS

Analyzing True Costs	Dec. 34
Balance Sheets	Apr. 54
Calculating Labor Rates	June 18
Improving Income	Jan. 14
Increasing Parts Profits	Nov. 13
Low Productivity Cures	Feb. 28
Pricing Philosophy	Jul. 26
Profitable Service Rates	May 32
Profit and Loss Statements	Mar. 20
Proving Rates Are Fair	Sep. 35
Ratio Analysis	Aug. 25
Separate Profits of Sales & Service	Oct. 44

COLOR TV

GE Horizontal & HV	Oct. 23
GE Power Supplies	Sep. 14
GE Projection TV	June 14
GE Vertical Sweep	Nov. 18
GE Vertical & Sync Tips	Dec. 38
Horizontal Drift, Part 1	Jul. 14
Horizontal Drift, Part 2	Aug. 28
Horizontal Drift, Part 3	Oct. 38
Magnavox Touch-Tune Servicing	Jan. 18
Quasar's Compu-Matic Tuning	Dec. 24
Sylvania AGC	May 42
Sylvania Sound IF & Audio	Aug. 19
Sylvania Tuners & Power Supplies	Feb. 18
Sylvania Horizontal & HV	Mar. 32
Sylvania Vertical Sweep	Apr. 34
Sylvania Video	Jun. 41
TV Brightness Problems	May 16

HORIZONTAL SWEEP & HV

GE Horizontal & HV	Oct. 23
Sylvania Horizontal & HV	Mar. 32

INDUSTRIAL ELECTRONICS

Clock Oscillators	Apr. 59
Clock and Flip Flops	Jul. 20
Counting Circuits	Nov. 32
DeMorgan's Law	May 52
Digital Gates and Truth Tables	Jan. 36
Flip Flops Count To 7	Sep. 21
Logic Probes & Tests	Feb. 48
NOT Gates	Mar. 24
Ripple Counters	Oct. 31
Schmitt Triggers	Jun. 24
Toggles Can Count	Aug. 37

MISCELLANEOUS

Capacitor Questions	May 37
Dielectric Changes When Charged	Dec. 46
Diode Protection	Jul. 38
Effects Of Dielectrics	Nov. 42
LED Practical Tests	Feb. 54
Magnetic Cores & In-Situ	Oct. 47
Magnetic Domains	Apr. 49
Magnetic Memories	Aug. 47
Magnetic Strength	Jun. 38
National Service Conventions	Oct. 19
Resistance Tests	Mar. 41
Test Questions	Feb. 34
Uncharged Capacitors	Sep. 39

REPORTS FROM THE TEST LAB

Leader LBO-515 dual-trace delayed-trigger scope	Feb. 58
---	---------

VERTICAL SWEEP

GE AA Chassis Vertical Sweep	Nov. 18
GE Vertical Tips	Dec. 38
Sylvania Vertical Sweep	Apr. 34

VIDEO

Betamax Comb Filter Stops Crosstalk	Aug. 41
Betamax Chroma Recording	Jul. 45
Betamax Luminance Recording	May 61
Betamax Mechanical Systems	Nov. 36
Betamax Monochrome Playback	Jun. 32
Betamax Servicing Tips	Dec. 18
Betamax Servo Circuits	Oct. 54
Betamax Servo Operation	Sep. 29
Videotape Fundamentals	Apr. 22

SYMCURE

ADMIRAL

9M50, no high voltage	Jul. 6
-----------------------	--------

GENERAL ELECTRIC

19JA, dark picture, screen controls don't work	Jul. 6
--	--------

MAGNAVOX

T995, intermittent loss of tuner signal	Feb. 8
T995, CRT arcs damaged chroma IC	Feb. 8
T995, defective M114 PS module	Feb. 8
T995, retrace lines and poor linearity	Feb. 8
T995, excessive HV, HV adjust has no effect	Feb. 8
T995, no channel readout with STAR	Feb. 8
T952, dark picture, screen controls operate	Jul. 6

RCA

CTC38, picture is too bright	Jul. 6
------------------------------	--------

CTC40, no high voltage, hot odor Jul. 6
 CTC71, blanking bar at right Jan. 8
 CTC71, horizontal won't lock, & regulated DC
 is high Nov. 11
 CTC71, repeated failure of horiz-output transistor Dec. 11
 CTC71AB, foldover near center of vertical Apr. 21
 CTC72, intermittent CRT heater Jan. 8
 CTC72, brightness causes video pulling at top Apr. 21
 CTC72, Intermittent picture & sound, then none, Nov. 11
 CTC74, narrow picture Jan. 8
 CTC74, at high brightness, power relay chatters Apr. 21
 CTC74, intermittent height or vertical locking Apr. 21
 CTC74, R510 & R508 overheat, & RF401 is open Nov. 11
 CTC76, excessive brightness with retrace lines Apr. 21
 CTC78, insufficient height with retrace lines Dec. 11
 CTC81, poor focus, dim raster Jan. 8
 CTC81, channel motor runs constantly Jun. 8
 CTC81, RF401 is open, and picture is dim Nov. 11
 CTC81H, channel motor runs continuously Apr. 21
 CTC85, no video or audio Jan. 8
 CTC85, insufficient width Aug. 8
 CTC85, retrace lines, raster shrinks, & shut-down
 stops sound and raster Aug. 8
 CTC86, locks with horiz-blanking bar about 2"
 from left Dec. 11
 CTC86, no sound or raster Aug. 8
 CTC86A, sound begins, then shut-down stops
 sound & HV Aug. 8
 CTC90, horizontal pulling moves through picture Nov. 11
 CTC90, no power to TV; remote has power Nov. 11
 CTC90, intermittent loss of horiz lock Dec. 11
 CTC90, hum bars move up through picture Dec. 11
 CTC90, stationary horizontal bend in picture Dec. 11
 CTC90D, channel frequencies drift Aug. 8
 CTC90B, no raster, HV okay Aug. 8

SYLVANIA

D14, no picture, like bad AGC Oct. 61
 D14, weave in picture, like bad filter Oct. 61
 E01, horizontal bending Oct. 61
 E03, low brightness, looks like bad CRT Oct. 61
 E04, snow only at right edge of picture Oct. 61
 E04, on UHF, a bar of interference at top Oct. 61
 E44, no raster, HV okay Jun. 12
 E44, non-linear at top, no sweep at bottom Jun. 12
 E44, delayed failures of horiz output Jun. 12
 E44, intermittent vertical roll Jun. 12
 E44, low contrast, no snow off channel Jun. 12
 E44, good sound, but no picture or snow Jun. 12

ZENITH

12FB12X (B&W) hold control can't lock vertical Mar. 5
 14DC15, narrow picture, too bright, no horiz locking Jul. 6
 19GC45, hum bars, insufficient height Mar. 5
 19GC45, intermittent brightness Mar. 5
 19GC45, circuit breaker trips Mar. 5
 19GC45, squeal, no HV, breaker trips May 8
 19GC45, no setup line, dark picture with green
 streaks May 8
 19GC45, no picture or sound; dim raster May 8
 19GC45, picture flashes, loses locking May 8
 19HC48, no brightness, but HV is okay Sep. 11
 23DC14, flutter on high-band VHF stations Mar. 5
 23DC14, picture 2" narrow at each side May 8
 23DC14, no height May 8
 23HC45, can't adjust gray scale Sep. 11
 23HC45, picture smears at high brightness Sep. 11
 23HC50, left third of picture is darker Sep. 11

25EC58, color smeared and color locking is loose Sep. 11
 25EC58, poor color locking Sep. 11
 25GC50, no height, or intermittent Mar. 5

TROUBLESHOOTING TIPS

ANY BRAND

Transformerless TV, no picture or sound Aug. 8

BALLY

Fireball, pinball resetting Feb. 16

GE

UA, sound but no raster Apr. 8
 19Qb, lightning damage Jul. 7
 UA (B&W), poor vertical line Aug. 8

MAGNAVOX

T960 (B&W) vertical won't lock Mar. 13

MOTOROLA

CL337-BM, no sound, breaker trips Jan. 13
 STS-934, vertical flickering May 11
 23TS-918A, circuit breaker trips Jan. 12
 TS929, breaker trips, TV is dead Sep. 12

PANASONIC

AN-49, part of raster blacked out Aug. 8
 CT-26, vertical flip or poor locking Mar. 13
 T125-A, T126-A, raster without video Apr. 11

RCA

CTC51/52, black area moves up Mar. 12
 CTC71AB, circuit breaker trips Oct. 16
 KCS169B, B&W, blackout after warmup Mar. 11

REALISTIC

TRC-57 CB radio, no reception, has noise Feb. 16

SANYO

21VG5, vertical stretch and roll May 11

SEARS SILVERTONE

562.10390, double troubles Jun. 13
 562.10110 (B&W), blanking bar at center Jun. 13

SONY

KV1710, weak color, color too red Jan. 2
 VO-1600 VTR, frozen tape Sep. 12

SYLVANIA

D19, pincushion parts run hot Mar. 11
 E01-17, double troubles Aug. 8

SYLVANIA & PHILCO

E20, E21, E22, weak color Nov. 12

WINDSOR

am/fm model 2136, hum, distortion & intermittent
 volume Feb. 15

ZENITH

14B38/Z (B&W), unstable horizontal Apr. 8
 14CC16Z, rapid vertical roll Feb. 15
 14Z8C50, no top convergence Jul. 7
 20Y1C48, no color Jan. 12
 25ED58, loss of locking Sep. 12

Sam Wilson's Technical Notebook

By J.A. "Sam" Wilson, CET

Your comments or questions are welcome. Please give us permission to quote from your letters. Write to Sam at:

J.A. "Sam" Wilson
c/o Electronic Servicing
P.O. Box 12901
Overland Park, Kansas 66212

The old watered-lightbulb trick

Lecturers can be classified into two broad categories:

- stand-up lecturers who are very formal, use lecture notes and tolerate no nonsense; and
- conversational lecturers who talk about the subject in a conversational style and rarely (if ever) use notes.

If you have attended my workshops or seminars you'll recognize that I'm in the second category. My style has been described as casual, loose, and (sometimes) sloppy.

But, it wasn't always that way. About 20 years ago, I took a teaching job in a small California college. Although I had been teaching for several years, the new job and the type of school combined to

give me the idea I should operate as a stand-up lecturer.

I made course outlines, gave quizzes every Friday, and lectured in a monotone for full-hour periods. In my mind, I thought I was doing fine.

The students, of course, regarded the whole thing as a crashing bore. They began to look for any kind of relief from *what seemed to them* an endless chain of dull facts.

At first they tried the usual pranks, such as drawing caricatures of the teacher on the blackboard, setting the room thermostat to 90° and placing a mouse in my desk drawer. But, I gave no hint that I noticed.

On and on I droned, day after day. Nothing but facts, facts, facts.

Then one day I entered the classroom, walked up to the chalkboard and turned on a small 60-watt bulb that hung over the board.

I stopped cold. In the bottom of the lightbulb was about ¼-inch of water. And the bulb was glowing normally!

While I was standing there, just staring in disbelief, a front-row student said, "Hey, look! There's water in the lightbulb." That remark triggered comments and questions from all around the room.

"How did water get into the lightbulb, Mr. Wilson?" Not only

did I fail to give an answer, but I couldn't even speak.

After about two minutes the bulb flickered and burned out. I unscrewed it from the socket and examined it carefully. There was not a clue. I left the room and showed the bulb to several other instructors. Each looked appropriately amazed, but none could explain it.

Needless to say, there was no stand-up lecture that day.

Later, one of the students came to my table in the cafeteria and explained. "It was a joke, you know. We ruined about 20 bulbs before we got one to work. We held the bulb under water and worked a needle between the glass and the metal base. After water seeped into the bulb, we sealed it with wax, and then glued over the wax."

Epilog

Last week, one of my students at Colorado State University stopped at my desk after class. "I was home over the weekend, and my dad showed me something that's really weird."

"What was that?" I asked.

"It was a lightbulb with water in it. He says it probably came in through the wires. He's pretty smart about electronics. He studied at a small college in Los Angeles. I'd like to have you meet him sometime."

“Well,” I said, “it wouldn’t surprise me to find that I *have* met him already.”

An 18-cent voltage regulator

An old slogan stated that “What this country needs is a good 10-cent cigar.” After all the talk about smoking and cancer, that saying isn’t heard often anymore. Anyway, inflation would change it to “a good \$1.00 cigar.” So, I have a substitute. What this country needs is a good 18-cent voltage regulator. I have a solution for that need.

Textbooks often list two purposes for the bleeder resistor in a power supply. One obvious purpose is to discharge the filter capacitors after the supply is shut off.

Secondly, a bleeder resistor improves the voltage regulation of a supply. This is not needed for supplies that have amplified closed-loop regulation. It’s very useful for unregulated supplies where the current drain varies widely.

How much regulation?

Using the basic circuit of Figure 1, the voltage regulation will be calculated for no bleeder and two values of bleeder resistance as the load resistance is varied between 40 Ω and 140 Ω.

Regulation of a power supply is judged by how much the output

voltage changes for different values of load current or resistance. It can be expressed either as a percentage or by the voltage change.

For purposes of calculation, the dc voltage source is considered to be a perfectly-regulated voltage in series with the internal resistance of the supply. In a typical brute-force power supply, the internal resistance is the sum of the rectifier’s forward resistance, the value of any surge-limiting resistors, wiring resistances, and the dc resistance of the transformer winding.

Formula

If you like your technical discussions laced with a little math, then you can follow the calculations. Otherwise, just skim over the figures and examine the results of each example.

Here is the basic formula for proportional voltages:

(Equation 1)

$$V_L = V_S \left(\frac{R_L}{R_I + R_L} \right)$$

where: V_S is the supply voltage
 V_L is the load voltage
 R_L is the load resistance
 R_I is the internal resistance

Without a bleeder

After substituting 100 for the supply voltage and 40 Ω for the internal resistance, the equation becomes:

$$V_L = 100 \left(\frac{R_L}{40 + R_L} \right)$$

This is the equation when the load resistance is 40 Ω:

$$V_L = 100 \left(\frac{40}{40 + 40} \right)$$

$$V_L = 50 \text{ V}$$

And when the load resistance is changed to 140 Ω, the equation becomes:

$$V_L = 100 \left(\frac{140}{40 + 140} \right)$$

$$V_L = 77.7 \text{ V}$$

In other words, the output vol-

Figure 1 Use this circuit to check the effects of bleeders on power-supply regulation. The *internal resistance* is the sum of all resistances in the voltage source. For the third calculation of regulation, the source voltage is changed to 150 V. Thus the average output voltage is approximately the same as for the previous tests with 100 V.

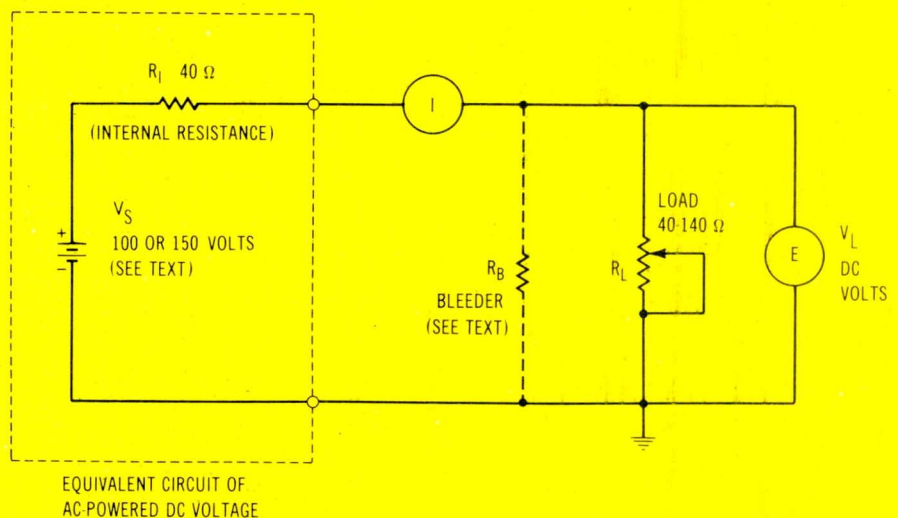

CIRCUIT FOR BLEEDER REGULATION

Technical notebook

tage increased by 27.7 V when the load was changed from 40 Ω to 140 Ω. This is poor regulation, probably because of the high internal resistance.

400-Ω bleeder

A general method for finding the value of a bleeder resistor is to select one that draws 10% of the amount of load current. In this case, the value is 400 Ω when the load is 40 Ω. (Of course, the bleeder current is more than 10% when the load is adjusted to 140 Ω.)

The load on the supply (R_O) is the value of R_L and R_B in parallel.

$$\text{thus } R_O = \frac{R_B \times R_L}{R_B + R_L}$$

When the values are substituted, the equation becomes:

$$400 \times 40$$

$$R_O = \frac{400 \times 40}{400 + 40}$$

$$R_O = 36.36 \Omega$$

$$R_O = \frac{400 \times 140}{400 + 140}$$

$$R_O = 103.7 \Omega$$

Substitute these two resistances in Equation 1 (given before), and these two output voltages are obtained:

$$V_L = 100 \left(\frac{36.36}{40 + 36.36} \right)$$

$$V_L = 49.56 \text{ V}$$

$$V_L = 100 \left(\frac{103.7}{40 + 103.7} \right)$$

$$V_L = 72.2 \text{ V}$$

Without a bleeder, the voltage changed 27.7 V, and with a 10% bleeder, the change is 22.66 V. Therefore, an 18-cent bleeder resistor does improve the regulation.

This improvement, however, is disappointing. Perhaps an increased bleeder current will help.

40-Ω bleeder

A 40-Ω bleeder resistor paralleled with a 40-Ω load resistance presents a 20-Ω load at the output. (No formula is needed for that one.) When the 40-Ω bleeder is added to the 140-Ω load, the parallel resistance formula is worked this way:

$$R_O = \frac{40 \times 140}{40 + 140}$$

$$R_O = 31.1 \Omega$$

Such low values will reduce the output voltage below the previous average level. To compensate, the supply voltage is changed to 150 V. The output voltage under both loads are calculated this way:

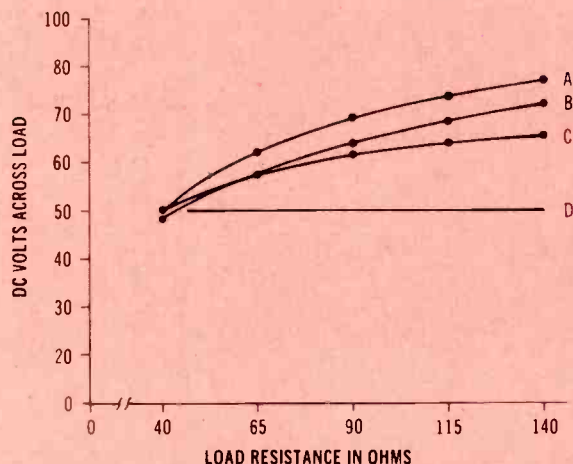

Figure 2 These are curves of the regulation calculations. Curve A shows the curves obtained from five different load resistances without a bleeder. Curve B is the same except a fixed 400-Ω bleeder is connected in parallel with the variable load. For curve C, the supply voltage is increased to 150 V and a 40-Ω bleeder is added. Perfect regulation is represented by the straight line of Curve D.

$$V_L = 150 \left(\frac{20}{40+20} \right)$$

$$V_L = 50 \text{ V}$$

$$V_L = 150 \left(\frac{31.1}{40+31.1} \right)$$

$$V_L = 65.6 \text{ V}$$

The variation of output voltage now is only 15.6 V, which is improved regulation. However, the efficiency is worse. Whenever the load resistance is higher than 40Ω , more current flows in the bleeder than in the load.

Summary

Power-supply regulation is improved by adding a stable bleeder current. And higher bleeder current improves the regulation, but at the expense of inefficiency.

Figure 2 shows a graph of the three ranges of output voltage versus the various load resistances. The bottom line represents perfect regulation.

In actual equipment, few "brute-force" power supplies have such a high internal resistance, but the regulation principle is the same.

With power supplies that use a bleeder, the output voltage will increase if it opens. This must be considered when you troubleshoot.

Delayed mail

Because I made many trips this year, my mail has not all reached me. I'll reply as soon as possible.

Here are a couple of questions that some of you might be able to answer. If so, write to me in care of **Electronic Servicing**.

Ignition scope

F. J. Pisano of Girard, Ohio wants to know how to convert his scope for use in analyzing auto

ignition systems. The commercial scopes all have some kind of triggered sweep, but I have no information about converting a service scope. My impression is that such a conversion would require an excessive amount of trouble and expense.

If you can advise this reader, please write to me.

Upgrading

Glen Trotten of Sacramento, CA asked if my monographs would help him obtain a WG10 grade. The answer is "No."

Monographs are specialized publications about just one subject. They are useful for increasing your knowledge and skill in one segment of the electronics field.

For upgrading tests, it's usually better to study a broad range of subjects. Books are the best source of general knowledge, and I recommend that you check the *Howard W. Sams Book Catalog*.

Our American Economic System is good bad.

(check one)

Most Americans (about 80%) believe that our economic system—with its individual freedom—is the best in the world, yet some changes are needed. To help give you a clearer picture of our system on which to base decisions, a special booklet has been prepared.

For a free copy, write: "Booklets," P.O. Box 1887, New York, N.Y. 10001.

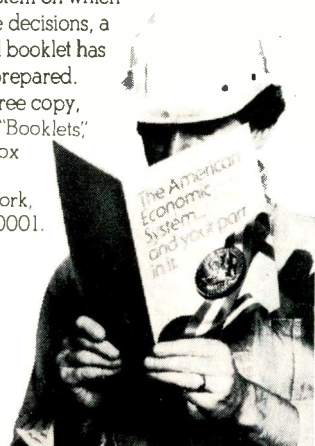

A public service of The Advertising Council & U.S. Department of Commerce presented by this Magazine.



TUNERS • MODULES

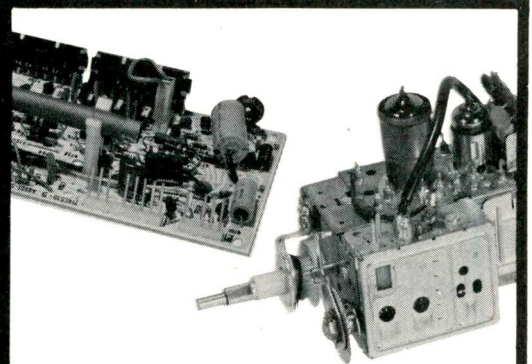

The next time you need a tuner repaired or module rebuilt:

Remember **FAST SERVICE**

Remember **PROFESSIONAL QUALITY**

Remember **ONE-YEAR LIMITED WARRANTY**

Remember **PTS ELECTRONICS**

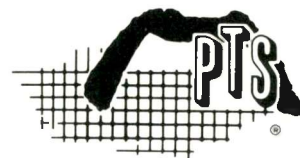

PTS ELECTRONICS, INC.

SEE THE YELLOW PAGES FOR THE PTS SERVICENTER LOCATION NEAREST YOU

Circle (13) on Reply Card

Hi, Tension!

by Edmund A. Braun

There are no downs to this Just-across-word Puzzle based on Electronics. Each word connected to the word above and below by one or more letters but only one is shown as a clue. Each correct answer is worth 4 points; a perfect score is 100. It should prove fairly easy to get a high rating except perhaps for someone who thinks "hypotenuse" refers to wearing a girdle, or that "flycutter" is a specialized tailor in a pants factory! So put on your thinking cap, pick up a pencil, and GO!

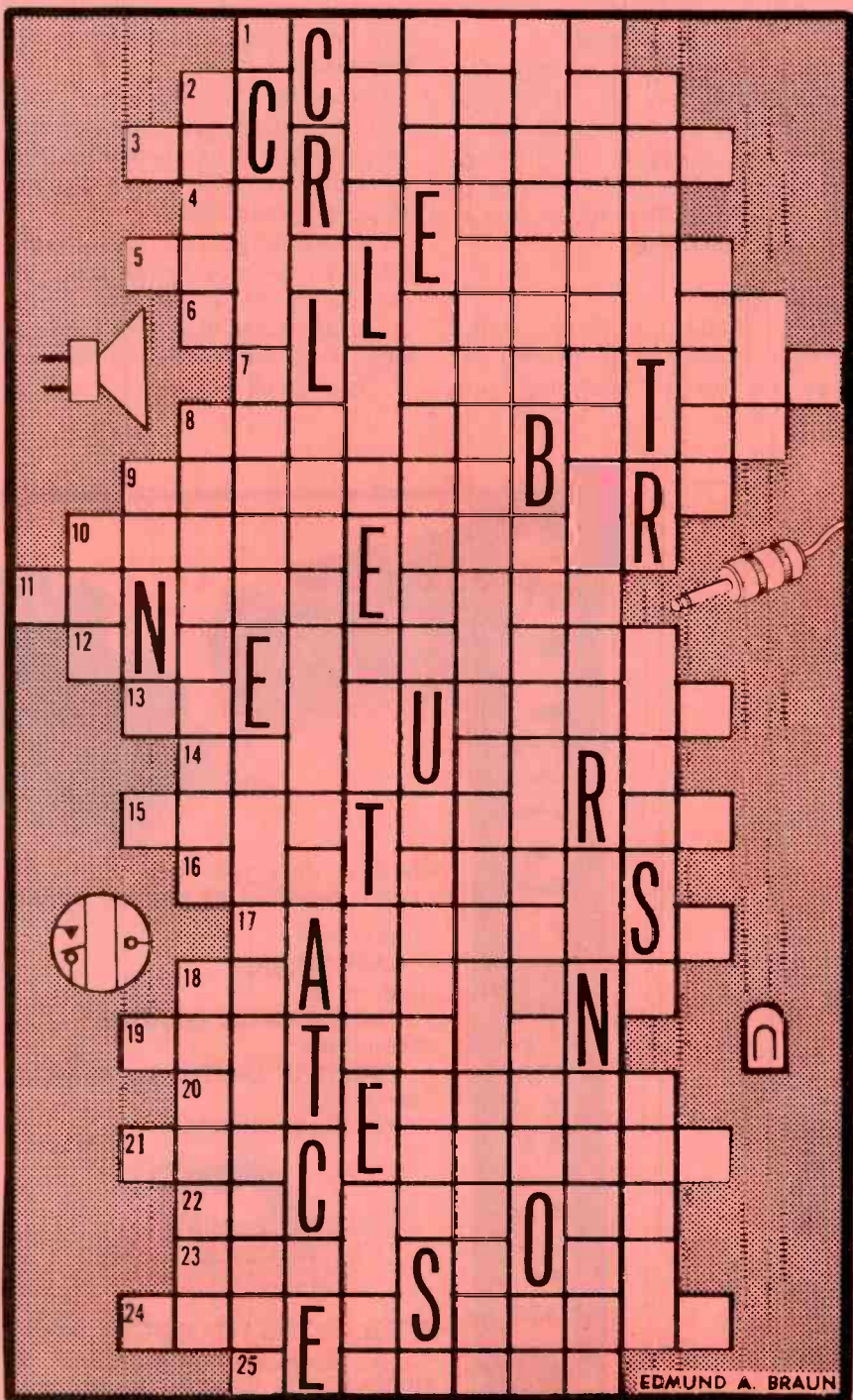

- 1 Pertaining to imaginary line on a magnetic map which connects points of equal magnetic inclination or dip.
- 2 A type of contact used in some printed circuit connectors.
- 3 One-millionth of a unit of electrical current.
- 4 A style of permanent magnet.
- 5 Having the same electric potential.
- 6 Process of adjusting an instrument so that its reference axis is aligned in a desired direction within a determined tolerance.
- 7 Pertaining to a current that reverses direction at regular intervals.
- 8 An agent or agency for marketing a manufacturer's product.
- 9 A unit of luminance.
- 10 Unit for expressing luminous intensity.
- 11 Basic; primary; elementary.
- 12 Effects parts or components have on one another while each is functioning.
- 13 Electricity in a circuit which will cause excessive temperatures in conductors or their insulators.
- 14 Paths of current connecting within or between systems.
- 15 Term used principally in industrial electronics to mean a hot cathode tube.
- 16 Devices for producing or storing electricity.
- 17 Result of leakage from outside a tube or by evolution from inside.
- 18 Physical quantity, force, property, or condition determined by an instrument.
- 19 A five-electrode vacuum tube that provides push-pull amplification with a single tube.
- 20 The brilliance of an image on the screen of a CRT.
- 21 Reciprocal of reactance.
- 22 Centimeter-gram-second electromagnetic unit of electrical quantity.
- 23 Also called a phasmajector.
- 24 Any articles or devices that add to the convenience or effectiveness of something else.
- 25 Type of electromechanical switch.

Now switch to page 50 for the solution.

EDMUND A. BRAUN

IF circuits and operations

Servicing GE 13" color TV, part 5

By Gill Grieshaber, CET

IF features

In the General Electric AA chassis, a single integrated circuit (IC) provides all functions of IF amplification, RF and IF AGC, AFT and synchronous demodulation. The AGC circuit has one additional tuner-mounted transistor, but it only serves as a switch to prevent "AGC lockout" during channel changes.

IF tuning versus amplification

Most IF systems have an amplifying device (tube, transistor or IC) between each pair of tuned coils. For example, one set of coils and traps is followed by a transistor. The amplified signal from the transistor is tuned by a coil which supplies its signal to a second transistor. Next, another tuned coil feeds a third transistor and this output goes through a final coil and trap before it arrives at the video-detector diode.

However, the arrangement is different in the GE AA chassis. *All* of the IF coils and traps are grouped together physically and electrically and **they shape the bandwidth before any IF signal reaches the IC** which alone supplies all IF amplification.

Figure 1 shows the locations of these coils, other important IF components and several testpoints. The two shielded coils (located at the camera side of the IC) are used for synchronous demodulation and AFT.

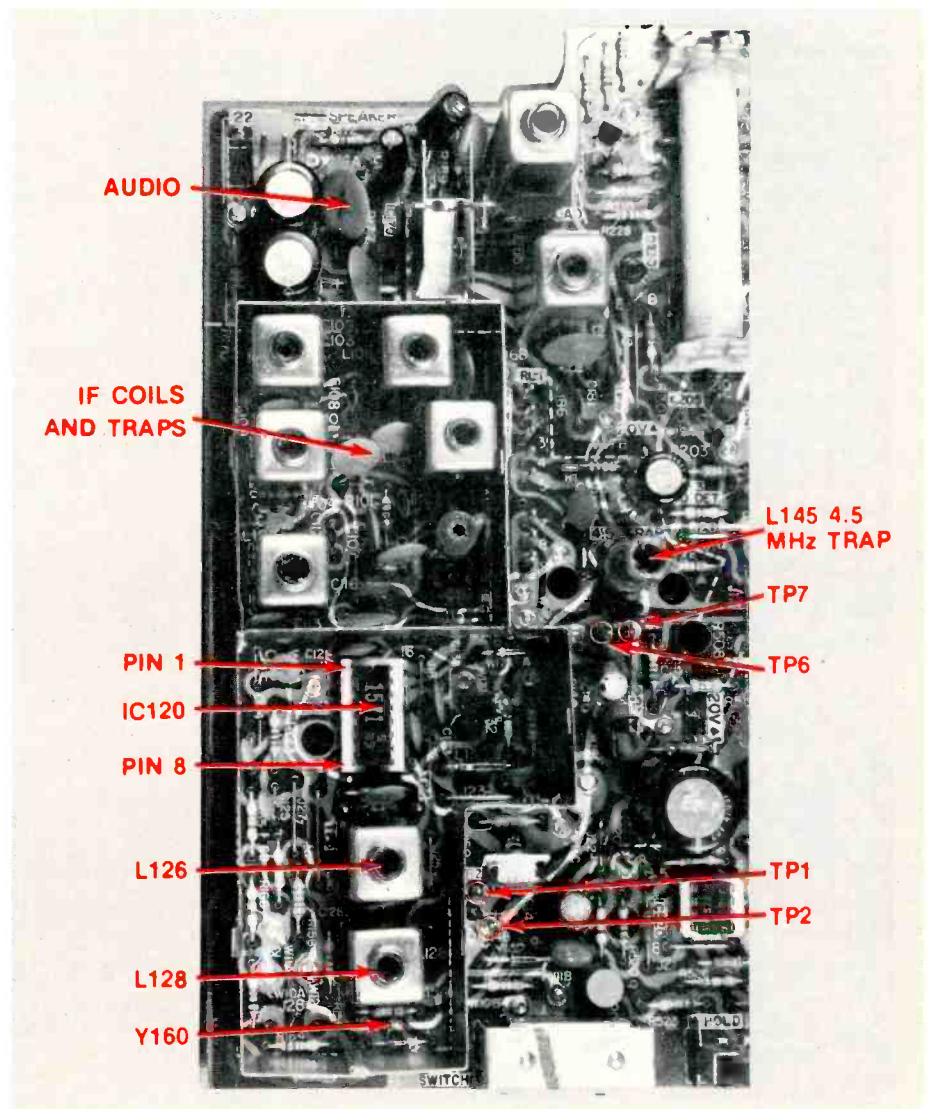

Figure 1 Arrows point out the locations of major components in the GE AA chassis IF circuit. The top IF-circuit shield was removed for the picture.

General Electric

The IF top shield (shown removed in Figure 1) can be taken off easily, thus exposing the IC and other components when tests are required. This is fortunate, since the bottom shield is soldered to the circuit board (see Figure 2).

IC functions

A complete schematic of the components and wiring inside an IC seldom is provided, since this would be more confusing than helpful. However, troubleshooting is easier when the internal functions and pin numbers are known. Therefore, the Figure 3 IF schematic shows an approximate interconnection of the various stages inside IC120.

IF amplification

The IF signal from the tuner first goes through six tuned coils and traps that provide the desired IF bandwidth, then this IF signal is applied to pins 1 and 16 of IC120. High amplification of the IF signal, AGC correction of the gain, synchronous demodulation that produces video, and preamplification all take place inside IC120 before the video signal emerges at pin 12. (Synchronous demodulation is said to reduce the waveform distortion that otherwise occurs with highly modulated signals.)

AGC

No horizontal pulses enter IC120. Therefore, the AGC is not a keyed type. Troubleshooting is more simple without these pulses.

One AGC adjustment control (R150) is provided. Although it is designated as "RF AGC," it directly controls the IF gain and indirectly determines the RF gain, as is true in most solid-state TV receivers.

The dc voltage at IC120 pin 3 determines the amount of IF gain reduction, and it's adjustable by R150. If the R150 voltage is adjusted for a lower positive voltage at pin 3, the IF gain is reduced. However, the AGC circuit compensates by increasing the gain of the RF FET. The video level remains about the same, but the receiver is more susceptible to overload from strong TV signals.

On the other hand, if the pin 3 dc voltage is increased, the IF gain increases, but the AGC system compensates again by decreasing the RF gain. Overload is not likely; however, more snow can be seen on signals of moderate strength. Within limits, the video level is the same as it was before the first R150 adjustment.

RF AGC

A varying dc voltage that provides AGC for the dual-gate FET RF amplifier is obtained from IC120 pin 4. R154 increases this positive voltage and reduces the amount of variation from signal levels. R156 and C68 remove the ripple. As shown on the schematic, the voltage measured about +8 V without an input signal, and about +2 V with a dot/bar generator attached to the antenna terminals.

Switch SW60A is mounted on the rear of the VHF tuner, and is rotated by the channel-selector shaft. It closes only between channels, and is open after each channel is reached. When closed, SW60A applies about +6 V to R68, which then furnishes about +0.6 V to the Q60 base. The +0.6 V bias causes Q60 to saturate and thus ground out the RF AGC voltage.

Therefore, when the tuner is temporarily between channels, the RF AGC voltage is only about +0.1 V. The low voltage reduces the gain of the RF FET to almost zero, and this prevents "AGC lockout" when the tuner reaches a channel having a strong signal.

Synchronous demodulation

Except for L126, R126 and C126,

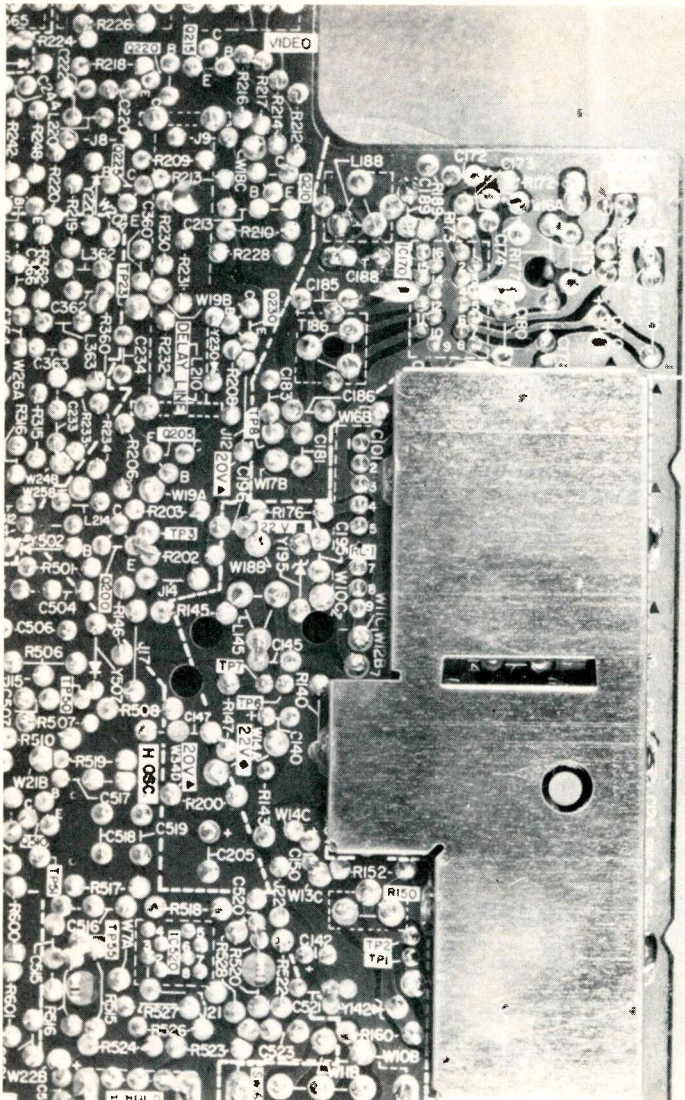

Figure 2 The bottom shield is similar to the top one, but it's soldered in place. Locations of most components are marked on the chassis, along with the major testpoints.

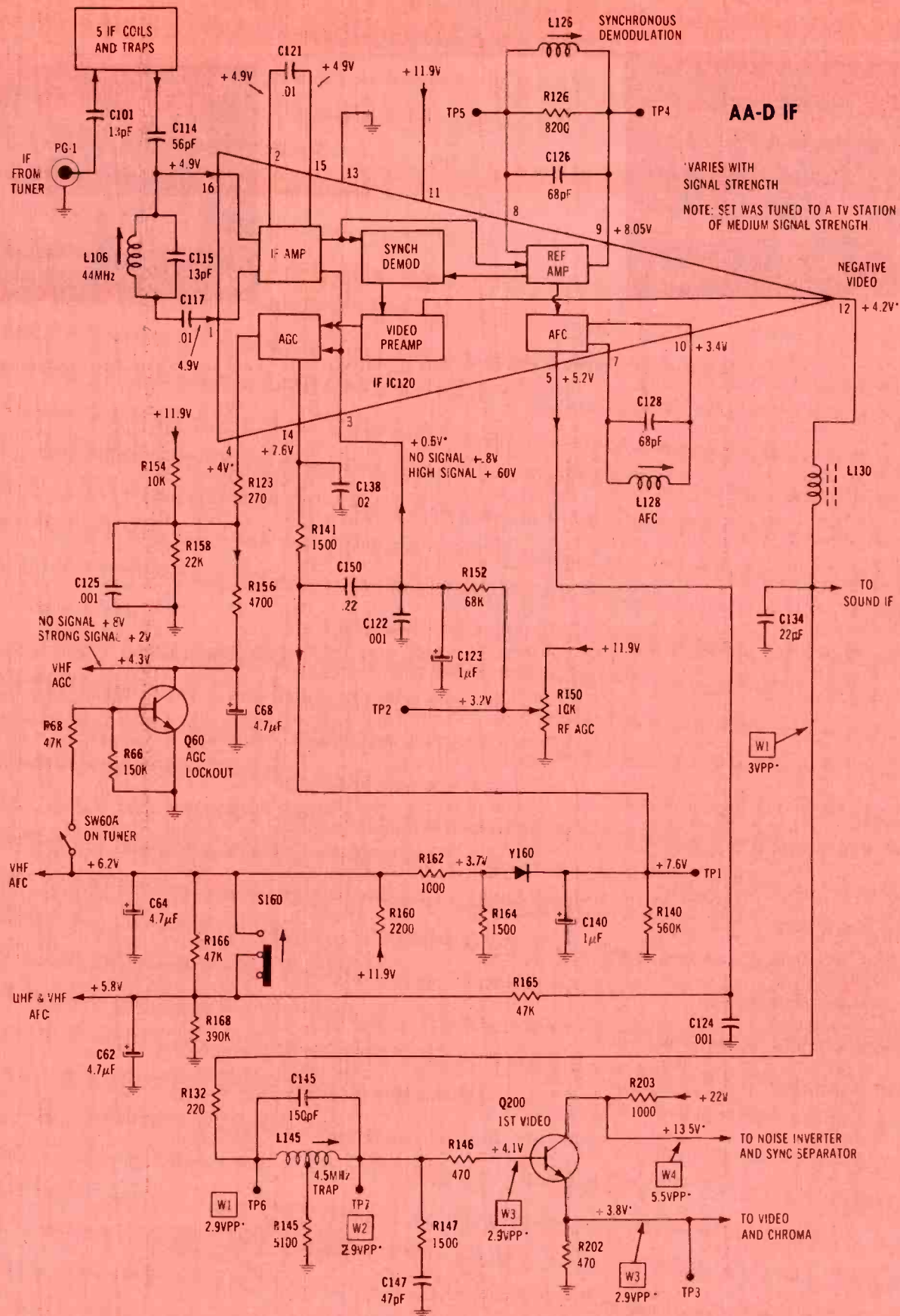

Figure 3 IC120 handles the IF amplification, RF and IF AGC, synchronous demodulation, AFC and video preamplification in the AA-chassis General Electric color TV.

Q60 is mounted on the rear of VHF tuner, and Q200 is near the center of the large module.

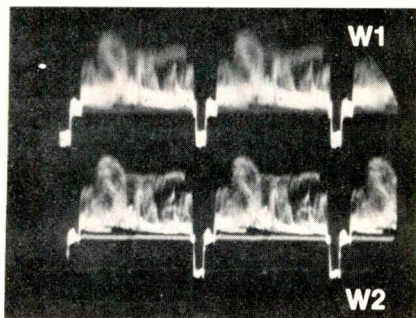
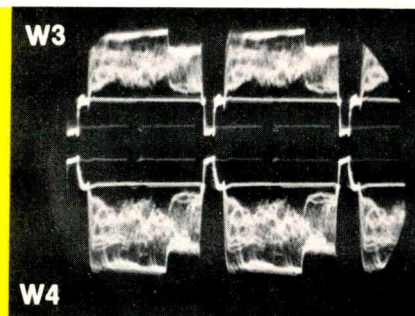

Figure 4 These are video waveforms found at the "W" testpoints of the Figure 3 schematic. All were scoped at the horizontal rate.



all components and circuit operation of the synchronous demodulation (detection) are inside IC120 where they are not available for tests. This type of detection has been described as being similar to chroma demodulation. A 45.75 MHz reference carrier is generated and then is compared against the IF signal.

Adjustment of L126 is described in Photofact 1765-2. I would advise you *not* to change the L126 setting unless you are set up for sweep alignment of the IFs.

AFC

In the AFC circuit, only L128 (at pins 7 and 10) is variable. Probably L128 and C128 operate as a tuned circuit which removes all of the IF signal except those frequencies around 45.75 MHz. Therefore, it is not likely to require adjusting in the field.

The dc reference voltage for AFC operation is found at C64. During normal operation, the reference voltage measures about +6 V, which is produced by the R160/R162/R164 voltage divider. Y160 had a reverse bias (causing it to be an open circuit) for all of the signal levels tested. Under conditions of extreme pull-in, the pin 14 voltage might drop below the Y160 anode voltage, thus reducing the dc reference voltage.

Pin 5 of IC120 produces the variable AFC voltage which corrects any wrong tuner-oscillator frequency. This voltage changes with adjustment of the fine tuning (when switch S160 is open). For AFC defeat, the reference voltage at C64 is shorted to the varying voltage at C62.

Remember this for servicing: an

open Y160 diode has no effect; but a shorted one eliminates the VHF channels.

Video

Demodulated video emerges from IC120 at pin 12. L130 and C134 remove most of the hash, but considerable amplitude of 4.5 MHz (sound carrier) remains. As shown by the waveforms of Figure 4, the video waveform is "cleaner" at the output of the 4.5 MHz trap (L145).

Transistor Q200 is a direct-coupled amplifier, producing from the emitter a non-inverted video signal that supplies both the video amplifiers and the chroma IFs.

Also, inverted video from the collector is sent to the noise-cancellation and sync-separation circuits that were described last month.

As is typical of all direct-coupled video amplifiers, the ac waveform amplitudes and the measured dc voltages at all pins of Q200 vary as much as 50% in step with changes in the picture.

At the Q200 base and emitter, the video is negative-going. Therefore, increased station strength produces lower dc voltages at both base and emitter. However, the AGC minimizes these changes. A stronger video level reduces the dc voltages in direct proportion to the increase.

Servicing the IFs

Only a limited amount of testing can be done around ICs. First, the important dc voltages should be measured. If those are within tolerance, the input and output signal levels are checked. Then, after all else fails to spot any obvious defects, the IC itself should be replaced. This general method

has some limitations when it's applied to IF circuits.

With service-type instruments, measurement of the IF input signal level is almost impossible. A tuner substitute is one good way of being certain the IF input signal is adequate. However, in this one TV, the tuner input and output plugs were spot-soldered, thus requiring more work to make the test.

Dc voltage and waveform tests at the emitter of Q200 (TP3) often will indicate the source of trouble. For example, TP3 measured +3.8 V with a strong signal, and +3.9 V with slight snow in the picture. However, the reading with no signal at the antenna terminals was only +2.2 V! According to the video voltage, the snow was stronger than the stations. This phenomena is common with solid-state sets.

IC120 is mounted in a socket. If replacement is needed, little work will be required.

Other components enclosed by the shield are not likely to fail, unless a resistor or two might be burned if IC120 shorted. These other components are soldered to the circuit board, but the joints can be reached after the bottom shield is removed.

Neither the IC nor the coils or components were especially sensitive to oscillation or other disturbances when meter and scope probes were attached to the terminals. Therefore, no extreme precautions need be taken during servicing, except to avoid slips that might short together different dc voltage levels.

Next month

Details and waveforms of the video stages will be the subjects of the next article. □

Improve your business
and sharpen your skills
as a technician for
less than 16 cents a week...

Every single issue of **Electronic Servicing** brings you a wealth of time-saving—and money-making—tips and ideas on servicing and selling all kinds of electronic products, from color TV to CB radio. No “skimming over the top” here! In-depth lab reports, prepared by the nation's leading experts, **dig right in** to the servicing problems you face most, complete with photos and step-by-step guidance in trouble-shooting even the toughest symptoms!



Don't miss
a single
issue!
Mail this
postage-paid
card today!

IMPORTANT!

Please
check your
business
classification.

Type of Business

Check One

- Independent Electronic Service Organization
- Retailer with Electronic Service Department
- Independent or Self-Employed Service Technician
- Electronics, Radio, TV Manufacturer
- Industrial Electronic Service
- Wholesale, Jobber, Distributor
- Other (Specify) _____

Position

- Owner, Manager
- Service Manager
- Technician
- Other _____

Be sure you have checked
one box under each arrow!

yes! Enter my
subscription to
Electronic Servicing

I PREFER:

- 2 years at \$16.00 (You save \$4 off regular price)
- 1 year at \$10.00

Above rates apply only in U.S.A. and its possessions.
Other countries please add \$3.00 per year.

I ENCLOSE PAYMENT OF \$ _____ PLEASE BILL ME

PLEASE PRINT

NAME _____

ADDRESS _____

CITY _____ STATE _____ ZIP _____

Your signature, please _____

Writing to Electronic Servicing?

PREVENT DELAY BY USING THESE ADDRESSES:

ABOUT YOUR SUBSCRIPTION

Changes of address or any questions about your subscription should be sent to the address at right. Please advise us of a change of address at least 6-8 weeks in advance of your move, if possible. Also allow 6-8 weeks for new subscriptions.



Evelyn Rogers, Circulation Manager
ELECTRONIC SERVICING
P.O. Box 12901
Overland Park, Ks. 66212

TO THE EDITOR

If you have a comment or question about an article, an opinion about industry conditions, a Troubleshooting Tip, an item for Reader's Exchange, or a suggestion for a future article, write to:



Carl Babcoke, Managing Editor
ELECTRONIC SERVICING
P.O. Box 12901
Overland Park, Ks. 66212

PHOTOFACTS, BOOKS, OR SCHEMATICS

Electronic Servicing does not have parts, books, or schematics for sale. Questions or orders for Photofact schematics of Sams technical books should be sent to:



Howard W. Sams & Co., Inc.
4300 West 62nd Street
Indianapolis, Ind. 46268

First Class
PERMIT
No. 1810
Overland Park, Ks.

BUSINESS REPLY MAIL

No Postage Necessary If Mailed in the United States

Postage Will Be Paid By

Electronic Servicing

P.O. Box 12901
Overland Park, Kansas
66212

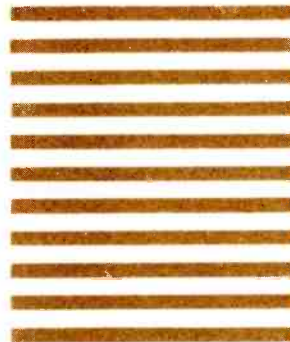

Your ticket
to learn
more and
earn more.
**MAIL
TODAY!**

3 YEARS WARRANTY!

EXACT Replacements For **SYLVANIA ECG**



TRANSISTORS-DIODES-I.C.'s

ECG#	ECG#	ECG#	ECG#	ECG#			
100	94	163	5.95	220	1.72	289	.88
101	98	164	5.75	221	1.90	290	.98
102	96	165	6.95	222	1.99	291	1.99
102A	98	171	1.37	223	2.79	292	2.26
103	1.05	172A	.72	224	5.06	293	1.08
103A	1.11	175	1.62	225	4.34	294	1.14
104	1.06	176	2.06	226	1.67	295	2.02
105	2.27	177	.49	228	1.36	297	1.13
106	.80	179	5.69	229	3.60	298	1.13
107	.79	180	5.88	230	3.60	299	2.02
108	.89	181	4.65	231	3.96	300	2.02
121	2.15	182	3.35	232	.70	302	2.80
122	.69	183	3.63	233	.74	306	2.80
122A	.73	184	1.37	234	.72	307	2.57
124	1.53	185	1.70	235	2.45	308	7.65
126	1.16	186A	1.46	236	5.75	309K	3.27
127	4.60	187A	1.46	237	5.07	310	7.65
128	1.37	188	1.59	238	7.95	311	2.13
129	1.56	189	1.59	239	3.02	312	1.13
130	1.95	190	1.85	241	1.71	313	1.00
131	1.98	191	2.07	242	1.90	314	7.85
132	1.01	192	.98	276	6.72	315	2.01
133	1.14	193	1.04	278	2.36	316	2.74
134	1.43	194	.82	279	5.65	317	24.20
153	1.85	195A	2.67	280	5.06	318	20.60
154	1.85	196	1.98	281	6.35	319	1.11
155	2.02	197	1.89	282	4.24	320	26.00
157	1.43	198	1.89	283	6.32	321	7.65
158	1.08	199	.59	284	7.35	322	1.80
159	.86	210	.37	285	7.99	323	3.53
160	1.43	211	1.56	286	5.75	324	3.53
161	.98	218	3.08	287	.69	325	27.50
162	5.75	219	4.36	288	.74	326	.96

- R-U-S-H, All orders shipped-Same Day Received!**
- FREE Freight on all prepaid orders
 - EXCLUSIVE 3 YEAR CONDITIONAL WARRANTY!
 - NO Min. Order-Quantity Discounts Available
- EXACT I.C.'s & DIODES-IN STOCK!**
- Longer Hours-Mon-Sat. 9a-10p, Sun. 1-7p.
- UPS C.O.D. Orders Accepted
- Call or Write TODAY...TO PLACE YOUR ORDER:
(518) 465-3367

Communications & T.V. Unlimited
17 Washington St., Rensselaer, N.Y. 12144

DISTRIBUTOR INQUIRIES INVITED

T.V.—C.B.—AMATEUR RADIO—STEREO—MONITORS—ELECTRONIC PARTS

Circle (14) on Reply Card

You Are Not ALONE!

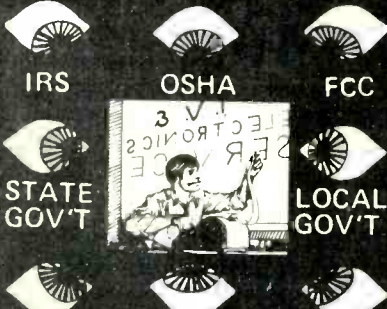

EEOC CONSUMER FTC ADVOCATES

If you think that being in business makes you INDEPENDENT, think again! Consumerists and government agencies are your silent - but greedy - partners; AND THEIR SHARE COMES FIRST; even if you don't make a profit.

WELL, YOU DON'T HAVE TO FACE THEM BY YOURSELF

JOIN NESDA

AND YOUR LOCAL & STATE ASSOCIATIONS

Send for more information to:

NESDA, 1715 Expo Lane
Indianapolis, IN 46224



test equipment

Portable DMM

Model ME-521DX multimeter is a 3½-digit battery-powered unit from **Soar Electronics**. It features a high-low ohm switch for all resistance ranges, five function modes, automatic zero adjustment, automatic polarity and overload protection. Typical accuracy is 0.5% and low current drain provides long battery life.

Price is \$115.



Circle (25) on Reply Card

Modular scope probe

VIZ Instruments makes available model WG-478 universal probe for scopes and frequency counters. Compatible with most scopes, the probe consists of screw-together elements that can be assembled for direct, X10 (low capacitance), or optional demodulator operation.



The coaxial cable has a BNC connector and a direct probe. A spring-loaded hook-on tip and ground clip assembly complete the direct probe. Isolation boots are provided to insulate the probe tip.

When a low-capacitance probe is needed, the user screws on the X10 module and connects frequency-compensation module to the scope end of the cable.

Price of the universal probe is \$39.

Circle (26) on Reply Card

Frequency counter

A large 8-digit fluorescent display is the readout for the model LDC-823 250-MHz frequency counter from **Leader Instruments**. Maximum sensitivity for stable counting is 20 mV and pushbutton-controlled attenuation minimizes false triggering from noise. Both 50 Ω and 1 MΩ inputs are provided. Three gate times allow maximum resolution. Either frequency or time-period measurements can be made. Also, a choice of three different time bases allows a choice of temperature stability.



Circle (27) on Reply Card

Temperature probe

Model TP-28 solid-state temperature probe from **B&K-Precision** is designed to be used with either analog or digital voltmeters to measure temperatures between -50 C (-58 F) and +150 C (302 F). For immersion in liquids, the probe requires only 10 seconds of settling time to allow reading accuracy within 1.7 C. Temperatures of any gas, liquid or solid can be measured; including transistors, ICs, resistors, transformers and motors.



A conventional 9-V battery is said to provide up to 120 hours of operation. The circuit has an automatic low-battery indicator.

Price of model TP-28 is \$75.

Circle (28) on Reply Card

Digital capacitance meter

Dynascan Corporation announces the B&K-Precision model 820 portable digital capacitance meter. It is a compact instrument capable of measurement over the wide capacitance range of 0.1 pF to 1 F. The unit features a 4-digit LED display.

The B&K-Precision model 820



comes with a 26-page detailed manual at a price of \$130.

Circle (29) on Reply Card

Dual-trace scope

A new 12-MHz dual-trace scope (model OS253) is offered by Gould. It is said to have the features of more-expensive models, including 2 mV maximum vertical sensitivity, ac and dc coupling, 18 ranges of horizontal sweep from 0.2 s/cm to 0.5 us/cm (to 0.1 us with X5 expander), Z-modulation input, X-Y display, addition of both channels, inversion of channel 2, external-triggering input and automatic selection of chopped or alternate dual-trace operation.

Model OS253 sells for \$695.

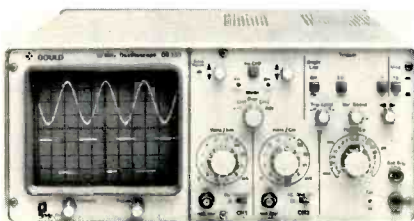

Circle (30) on Reply Card

Capacitance Meter

The Poly Paks Digital Capacitance Meter measures capacitance values between 100 pF and 9999 μF with a rated accuracy of ±5%. Values are read-out on a 4-digit LED display. Five ranges measure 0-1, 0-10, 1-100, 1-1000, and 0-10,000 μF.

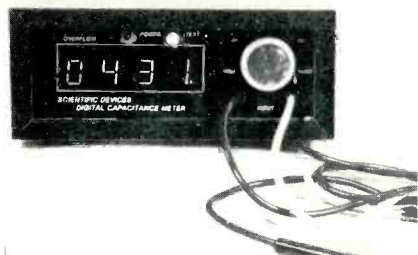

The instrument has a built-in power supply and comes equipped with test probes.

Price of the kit is \$69.95 or \$90 for the wired version.

Circle (31) on Reply Card

Original Japanese Replacement Parts for TV, Stereo and CB

25-UP 10-24 1-9			25-UP 10-24 1-9			25-UP 10-24 1-9			25-UP 10-24 1-9			25-UP 10-24 1-9			25-UP 10-24 1-9								
2SA102	29	.34	.39	2SC460	45	.50	.55	2SC1114	3.40	3.60	3.80	2SC2072	3.55	3.75	3.95	AN247P	2.40	2.60	2.90	TA7089P	1.95	2.15	2.45
2SA473	45	.55	.60	2SC481	1.25	1.35	1.45	2SC1116A	3.20	3.45	3.80	2SC2076	45	.60	.65	AN274	1.50	1.70	1.90	TA7092	4.40	4.90	5.40
2SA484	1.85	2.05	2.35	2SC482	1.25	1.35	1.45	2SC1124	.80	.85	.95	2SC2091	85	1.05	1.15	AN313	4.20	4.40	4.60	TA7120P	1.45	1.65	1.85
2SA485	25	.30	.35	2SC485	1.25	1.35	1.45	2SC1127	.80	.85	.95	2SC2092	1.75	1.95	2.20	AN315	1.75	1.95	2.20	TA7139P	1.55	1.75	1.95
2SA497	90	1.15	1.25	2SC485	45	.55	.60	2SC1162	.70	.75	.85	2SC2098	3.00	3.20	3.45	BA511A	1.70	1.90	2.15	TA7153P	5.70	5.90	6.10
2SA509	30	.35	.40	2SC509	30	.40	.45	2SC1166	.25	.35	.40	2SD72	50	.60	.65	BA521	1.85	2.05	2.35	TA7203P	2.45	2.60	2.85
2SA562	25	.30	.35	2SC517	2.90	3.10	3.25	2SC1172B	3.10	3.50	3.85	2SD91	1.30	1.40	1.55	HA1151	1.4E	1.70	1.85	TA7204P	1.95	2.10	2.45
2SA564A	29	.34	.39	2SC535	.30	.35	.40	2SC1173	.50	.65	.70	2SD92	1.40	1.55	1.75	HA1156	1.60	1.75	1.95	TA7205P	1.55	1.75	1.95
2SA634	35	.40	.45	2SC620	45	.50	.55	2SC1177	10.90	12.40	13.80	2SD180	1.55	1.75	1.95	HA1306W	1.90	2.10	2.40	TA7214P	3.90	4.20	4.50
2SA636	80	.85	.90	2SC632A	35	.40	.45	2SC1209	.25	.35	.40	2SD187	.30	.40	.45	HA1322	2.40	2.60	2.90	TA7310P	1.25	1.40	1.55
2SA643	30	.35	.40	2SC634A	40	.45	.50	2SC1228	50	60	70	2SD218	2.95	3.20	3.45	HA1339	2.45	2.65	2.95	TA7607P	5.80	6.00	6.20
2SA673	30	.40	.45	2SC697A	3.20	3.50	3.90	2SC1226A	.50	.60	.70	2SD234	.60	.70	.80	HA1339A	2.45	2.65	2.95	TA7609P	4.40	4.60	4.80
2SA678	40	.50	.55	2SC710	20	.27	.30	2SC1237	1.70	1.90	2.15	2SD235	.60	.70	.80	LA1222	2.10	2.30	2.50	TBA8105H	1.85	2.05	2.35
2SA683	40	.50	.55	2SC711	20	.27	.30	2SC1239	2.10	2.65	2.85	2SD261	.30	.35	.40	LA3101	3.45	3.60	3.75	TC5080P	4.80	5.00	5.60
2SA684	40	.50	.55	2SC712	20	.27	.30	2SC1306	1.25	1.65	1.85	2SD287	2.50	2.65	2.85	LA4031P	1.75	1.95	2.20	TC5081P	2.90	3.10	3.30
2SA695	40	.50	.55	2SC717	35	.40	.45	2SC1307	2.15	2.65	2.85	2SD291	2.05	2.45	2.75	LA4032P	1.75	1.95	2.20	TC5082P	3.30	3.45	3.80
2SA699A	50	.60	.65	2SC730	2.95	3.15	3.35	2SC1318	.30	.40	.45	2SD313	.60	.65	.70	LA4220	2.25	2.40	2.55	UHC001	4.80	5.10	5.60
2SA706	85	.95	1.05	2SC732	20	.25	.30	2SC1364	.30	.40	.45	2SD315	.60	.70	.80	LA4400	1.85	2.05	2.35	UHC002	4.90	5.10	5.60
2SA720	30	.35	.40	2SC733	20	.25	.30	2SC1383	.30	.40	.45	2SD325	.60	.65	.75	LD3141	1.70	1.80	1.90	UHC003	4.90	5.10	5.60
2SA733	25	.27	.30	2SC734	20	.25	.30	2SC1384	.30	.40	.45	2SD330	69	.79	.89	M5115P	4.85	4.90	4.95	UHC004	4.90	5.10	5.60
2SA747	4.15	4.35	4.55	2SC735	20	.25	.30	2SC1424	2.75	2.85	2.95	2SD356	70	.85	.80	MS1513L	1.85	2.15	2.45	UHC005	4.90	5.10	5.60
2SB22	45	.50	.55	2SC756	1.45	1.75	1.95	2SC1448A	1.00	1.10	1.20	2SD358	70	.80	.90	MN3001	13.20	14.85	16.50	UPC006	4.90	5.10	5.60
2SB54	30	.35	.40	2SC756A	2.00	2.10	2.20	2SC1475	.65	.85	.95	2SD359	75	.85	.95	MN3002	9.25	10.40	11.55	UPC20C	2.00	2.40	2.70
2SB77	30	.40	.45	2SC778	2.80	3.10	3.30	2SC1509	.55	.60	.65	2SD427	1.75	1.95	2.20	MN3003	5.64	6.34	7.04	UPC141C	2.30	2.40	2.50
2SB175	35	.40	.45	2SC781	1.95	2.15	2.45	2SC1567A	.60	.65	.75	2SD525	70	1.05	1.15	PL101A	4.90	4.15	4.55	UPC157A	3.25	3.45	3.65
2SB186	30	.35	.40	2SC784	30	.35	.40	2SC1675	.25	.30	.35	2SD526	60	.70	.80	PL102A	4.95	5.20	5.80	UPC554C	1.60	1.70	1.80
2SB187	20	.27	.30	2SC789	.75	.85	.95	2SC1678	1.25	1.40	1.55	2SK19	45	.50	.55	PL103A	7.50	7.90	8.70	UPC555H	1.60	1.70	1.80
2SB324	25	.35	.40	2SC793	1.95	2.15	2.45	2SC1687	.40	.45	.50	2SK23	80	.95	1.05	SG264A	7.00	7.40	7.80	UPC572C	3.70	4.10	3.69
2SB367	1.10	1.20	1.35	2SC799	1.95	2.15	2.45	2SC1727	1.20	1.25	1.30	2SK30	40	.45	.50	SG609	4.10	4.30	4.50	UPC574C	9.0	1.08	1.20
2SB405	25	.30	.35	2SC828	20	.27	.30	2SC1728	.90	.95	1.00	2SK33	60	.65	.75	SG613	5.05	5.45	5.85	UPC575C2	1.25	1.40	1.55
2SB407	70	.85	.95	2SC829	20	.27	.30	2SC1760	.85	1.00	1.10	2SK34	50	.55	.60	SMS104	7.90	8.40	8.90	UPC576	1.85	2.05	2.35
2SB463	1.00	1.05	1.15	2SC839	.30	.35	.40	2SC1775	.30	.35	.40	2SK41	50	.55	.60	STK011	3.55	3.95	4.35	UPC582H2	.75	.85	.95
2SB474	70	.80	.90	2SC867A	4.00	4.25	4.50	2SC1816	1.45	1.70	1.95	2SK45	60	.65	.75	STK013	8.90	10.00	11.10	UPC1001H21	.85	2.05	2.35
2SB507	70	.80	.90	2SC900	20	.27	.30	2SC1908	.25	.35	.40	3SK22Y	1.60	1.70	1.80	STK015	4.10	4.30	4.80	UPC1008C	4.85	5.15	5.75
2SB511	70	.75	.85	2SC930	20	.27	.30	2SC1909	2.00	2.55	2.75	3SK35	1.20	1.35	1.50	STK050	23.10	25.98	28.86	UPC1020H	1.85	2.05	2.35
2SB557	2.05	2.45	2.75	2SC945	20	.27	.30	2SC1945	4.40	4.90	5.50	3SK37	1.70	2.00	2.30	STK415	7.10	7.60	8.10	UPC1025	1.85	2.05	2.35
2SC183	40	.50	.55	2SC1000BL	35	.40	.45	2SC1957	.60	.70	.80	3SK40	1.25	1.40	1.55	STK435	4.45	4.95	5.55	UPC1028	1.40	1.52	1.80
2SC184	40	.50	.55	2SC1013	.45	.60	.65	2SC1969	3.50	3.90	4.30	3SK41	1.25	1.40	1.55	STK439	8.00	9.00	10.00	UPC1031H	2.52	2.74	2.98
2SC372	20	.27	.30	2SC1014	.50	.60	.65	2SC1973	.60	.65	.70	3SK45	1.25	1.40	1.55	TA7045M	1.95	2.15	2.45	UPC1032H	1.70	1.85	2.10
2SC373	20	.27	.30	2SC1018	.70	.75	.85	2SC1974	1.25	1.65	1.85	3SK48	3.30	3.40	3.70	TA7055P	1.95	2.15	2.45	UPC1152H	2.90	3.10	3.30
2SC380	20	.27	.30	2SC1030	1.90	2.05	2.35	2SC1975	1.25	1.65	1.85	3SK49	1.25	1.40	1.55	TA7060P	85	1.05	1.15	UPC1156	1.85	2.05	2.35
2SC382	30	.40	.45	2SC1056	4.50	4.70	4.90	2SC2009	.75	.80	.85	AN115	2.00	2.15	2.25	TA7061P	85	1.05	1.15	UPD277C	8.70	8.90	9.10
2SC387A	30	.40	.45	2SC1060	.65	.75	.85	2SC2021	.55	.60	.65	AN214Q	1.55	1.65	1.85	TA7062P	1.05	1.20	1.35	UPD857C	7.90	8.30	9.40
2SC394	25	.30	.35	2SC1061	.70	.80	.90	2SC2028	.50	.60	.65	AN228	4.10	4.30	4.50	TA7063P	1.25	1.35	1.50	UPD858C	7.00	7.10	7.20
2SC458	20	.27	.30	2SC1096	.45	.50	.55	2SC2029	1.45	1.75	1.95	AN239	4.10	4.30	4.80	TA7074P	3.70	3.85	4.00	UPD861C	8.70	8.90	9.10

PRICES MAY CHANGE WITHOUT NOTICE COD ORDERS WELCOMED

Minimum order \$10.00 - N.J. Residents add 5% Sales Tax.
We pay postage for prepaid orders of \$50.00 or more.
Under \$50.00, add \$1.00, Canada \$1.50.
Quantity Discount Prices - Ask for our complete price list.
Manufacturer inquiries welcome - All parts guaranteed.

TOLL FREE TELEPHONE
Nationwide 800/631-1250 Local 201/748-5089
New York 212/732-1376
HOURS: Mon. - Fri. 8 to 5.30 Sat. 8 to 1



NEW-TONE ELECTRONICS INTERNATIONAL
P. O. Box 1738, Bloomfield, N. J. 07003
New Jersey Phone: 201/748-5089

Circle (15) on Reply Card

NEW TUNERS

NOT universal or customized. NOT seconds, culls, dogs, or oddballs. Only \$29.95 for ANY new tuner. Over 5,000 in stock including Philco TT192.

Call Toll Free 1-800-433-7124

TEXAS TUNER SUPPLY

4210 N.E. 28th St., Ft. Worth, TX 76117

Circle (16) on Reply Card

IT'S NO PUZZLE

TO ORDER

OELRICH SERVICE FORMS

FOR TV-RADIO & 2 WAY RADIO SERVICE LEGAL FORMS FOR CALIF. FLA. UTAH NOW AT YOUR PARTS JOBBER OR WRITE FOR CATALOG B64

OELRICH PUBLICATIONS

4040 N. NASHVILLE AVE. CHICAGO, ILLINOIS 60634

Circle (17) on Reply Card

TUNER SERVICE

All overhauls guaranteed two full years

Give us a try - you'll like the way we do business.

Call TOLL FREE 800-433-7124

In Texas call 817-834-8201

TEXAS TUNER SERVICE

4210 N.E. 28th St., Ft. Worth, TX 76117

Circle (18) on Reply Card

FREE CATALOG

HARD-TO-FIND PRECISION TOOLS

Lists more than 3000 items: pliers, tweezers, wire strippers, vacuum systems, relay tools, optical equipment, tool kits and cases. Also includes ten pages of useful "Tool Tips" to aid in tool selection.



JENSEN TOOLS & ALLOYS
1230 SOUTH PRIEST DRIVE - TEMPE, AZ 85281

Circle (19) on Reply Card

Electronic Servicing

Advertising Sales Offices

NATIONAL SALES MANAGER/CHICAGO

Jim Reilly, 1011 E. Touhy Ave., Suite 245, Des Plaines, IL 60018; Phone: (312) 299-2601

KANSAS CITY, MISSOURI

Helen Hull, P.O. Box 12901, Overland Park, KS 66212; Phone: (913) 888-4664

NEW YORK, NEW YORK

Joe Concert, One Penn Plaza, Suite 2532, New York, NY 10001; Phone: (212) 564-8454

FT. LAUDERDALE, FLORIDA

Brinker and Brinker
2240 N.E. 53 Street
Ft. Lauderdale, FL 33308
Phone: (305) 771-0064

SAN FRANCISCO, CALIFORNIA

John MacKay, 703 Market St., Room 1109, San Francisco, CA 94103
Phone: (415) 546-1040

LONDON, ENGLAND

John Ashcraft & Co., 12 Bear St., Leicester Square, London W.C.2, England; Phone: 930-0525

AMSTERDAM, HOLLAND

John Ashcraft & Co., John J. Lucassen, Sloteweg 303, 1171 VC-Badhoevedorp, Holland; Phone: 2968-6226

TOKYO, JAPAN

International Media Representatives, Ltd., 2-29, Toranomon 1-chome, Minato-ku, Tokyo 105, Japan; Phone: 502-0656

productreport

Miniature replacement bulbs

Oneida recently added miniature replacement lamps to its accessory line. These tiny lamps are available in either 6-V or 12-V ratings and are assembled to lead wires. They are needed often in stereo tuners, CB radios, digital clocks, and many imported products (where they are exact replacements).



Circle (32) on Reply Card

Metric wrenches

ORA Electronics tool set model OT-W27 has three wrenches for six different metric sizes. Each wrench is shaped like a double-ended socket, but no shaft or handle is needed because a metal loop is attached.

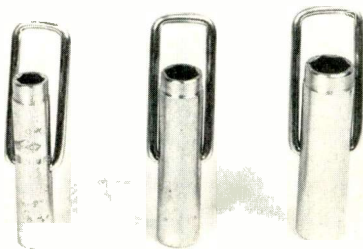

These wrenches increase installation or removal speed and minimize damage to auto dashes during work with CB radios and car-stereo systems.

OT-W27 has a list price of \$11.95.

Circle (33) on Reply Card

Ultrasonic alarm

A silent sound burglar alarm offered by Master Lock requires no installation. Internal circuits can identify random room disturbances versus noises of an intrusion. A built-in alarm sounds when motion is detected. Model 2606 Ultrason-2 also sends a signal over the power wiring to an optional FM-coded

satellite alarm which sounds at a nearby building or in another room.

Automatic delay is provided for 15 seconds to allow authorized persons to leave or enter the protected area. Outlets are provided for additional external sirens or lights.

Circle (34) on Reply Card

Swiveling CB antenna

Three Quick-Swivel model CB antennas are offered by AVAI. Model 702 has a roof mount, model 712 has a trunk lip mount and model 752 has a groove mount. All models have a swivel and spring that allows adjustment of the angle without the necessity of tools.

Suggested list price of each is \$33.95

Circle (35) on Reply Card

Coax Tool

AMP Special Industries' coax hand-tool line now includes a crimper for Belden 8281 cable, a popular 75-ohm video cable. Designed to crimp UHF and BNC connectors on Belden 8281 cable, this "Super Champ" hand tool is lightweight and economical. It fea-

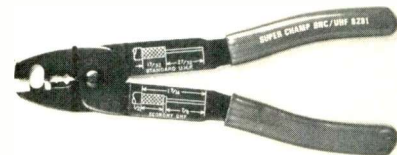

tures a guide on the tool body for strip dimensions of all coax series—standard, economy, single or dual crimp. The handles are cushioned.

Circle (36) on Reply Card

Desoldering Tool

Mohawk Wholesale Equipment is offering a hand-held desoldering tool which utilizes a head-resistant plastic dispenser. The Tech-Wick, constructed of pure copper treated with rosin flux, contains more voids than the braided flat copper wick and absorbs the molten solder faster.

Available in two styles, model S-16 contains about ten feet of number 16 gauge wick 0.64 O.D.; it is priced at \$2.75 each. Model R-20

QUICK-QUIZ

ANSWER:

#4

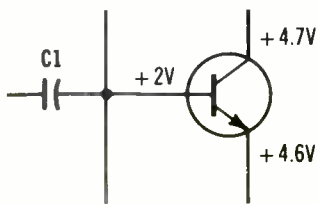

According to the voltages, the transistor has 2.6 volts of reversed bias; so it should have no C/E current. C/E has about 0.1 volt. The ground at C1 prevents signal bias. Either the forward bias is excessive (disproved by voltages), or the transistor is shorted.

Defect: transistor has a C/E short.

REFER TO PAGE 29

Solution to:

HI, TENSION!

- | | |
|----------------|----------------|
| 1 acclinic | 14 circuitry |
| 2 accordion | 15 phantastron |
| 3 microampere | 16 batteries |
| 4 horseshoe | 17 gassiness |
| 5 isoelectric | 18 measurand |
| 6 collimation | 19 pentatron |
| 7 alternating | 20 intensity |
| 8 distributor | 21 susceptance |
| 9 footlambert | 22 abcoulomb |
| 10 candlepower | 23 monoscope |
| 11 fundamental | 24 accessories |
| 12 interaction | 25 feereeed |
| 13 overcurrent | |

Start with 100 points and deduct 4 points for any part you may not have answered correctly.

Your rating:

- 60 - 64 Could be better.
- 68 - 72 Pretty good.
- 76 - 84 Very good.
- 88 - 96 Excellent.
- 100 PERFECT!
(And that's the truth!)

audio systems report

Solid-state amplifiers

Perma Power has added three portable solid-state amplifiers to its line. Model S-302 (pictured) is rated at 32 W for 5% distortion into 8Ω . It plugs into a cigarette lighter and weighs about eight pounds. Model S-302 has a tone control with on/off switch, auxiliary volume control, master volume control and two output plugs. Either a ceramic or dynamic mic can be used. An optional battery pack permits operation with 10 D size alkaline batteries for about 100 hours.



Model S-402 is rated at 18 W and has separate mic and phono volume controls plus a tone control. It operates from either 120 vac or battery power.

Portable cordless model S-702 operates for about 200 hours with each set of 10 alkaline batteries. It's rated at 12 W of continuous power.

Circle (42) on Reply Card

Background music amplifiers

The TU series of public-address amplifiers from **Bogen** feature two internal 600-ohm matching transformers for connecting to telephone lines. There are three additional inputs. An internal precedence circuit reduces the volume of other sound sources when the designated input is activated.

All connections are made to built-in terminal strips, and the controls are adjusted with a screwdriver. These features are included to discourage unauthorized adjustment changes. The amplifier can be mounted on a wall or in a standard 19-inch rack, if desired.

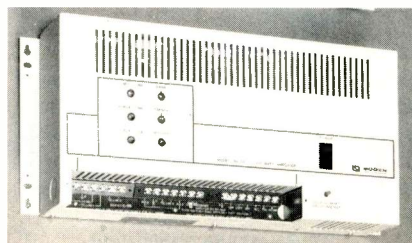

Available are models TU-35, TU-60 and TU-100 (the number indicates output wattage). At flat positions of the tone controls the frequency response is rated at ± 2 dB between 70 Hz and 12 KHz.

Circle (43) on Reply Card

Bass-reciprocator speakers

Mesa Electronics is marketing improved versions of its bass reciprocator loudspeaker line. Each of the four models features the new prismadome tweeter, an active woofer, a passive bass reciprocator cone, midrange drivers in sealed enclosures and tweeter-level controls. All models have an internal circuit breaker to protect against damage from overloads.

Suggested list prices range from \$119 to \$279.

Circle (44) on Reply Card

Speaker Sets

Sparkomatic has introduced two Triple Play three-way stereo speaker sets. Both feature three speakers mounted triaxially to reproduce sound similar to home stereo speakers.

Model SK-6922T is a 6"x9" oval designed for rear-deck installation; model SK-622, a round unit, is designed for indoor use.



Each model has two air-suspension high-compliance woofers, two direct-radiating midrange speakers, and two dome horn-loaded tweeters with individual crossover networks.

Circle (45) on Reply Card

73. Mura—Mura Corporation offers an updated 8-page audio products catalog. Many microphones, stereo headphones, accessories and the Muradapter are featured in the new literature.

75. Thordarson-Meissner—announces extensive additions of universal replacement semiconductors to their Tech-Mate product line. Simultaneously, the company released their new Tech-Mate Semiconductor Cross Reference Guide, which contains over 161,000 listings.

76. Leader Instruments—Application features and complete specifications for 8 new single-trace and dual-trace scopes are featured in a full-color 16-page catalog from Leader Instruments.

80. Projector Recorder Belt—Projector Recorder Belt has introduced an update to their 1977 comprehensive audio/video belt catalog and cross-reference chart which details over 500 new reference listings, and includes corrections to the 1977 audio/video belt catalog.

81. B&K-Precision—The entire line of test instruments has been condensed into a compact catalog, BK-9. The 52-page catalog describes specifications, features and applications of scopes, semi-conductor testers, multimeters, frequency counters and specialized test instruments for CB, radio and TV maintenance and repair. Several new products are included.

82. Motorola—Portable communications equipment and accessories, including Motorola's newest handy-talky radios, batteries, antennas and mobile accessories are described in a brochure.

83. Quam-Nichols—Catalog sheet AR-79 describes the line of five speakers intended for the demanding environment of aircraft radios and sound systems.

84. Radio Shack—A 20-page, full color TRS-80 microcomputer catalog, RSC-2, includes complete, current information on the TRS-80 microcomputer, its peripherals and accessories, with plain-language de-

scriptions, application ideas and detailed specifications.

85. ETCO—A 48-page *Electronic Things & Ideas Book* includes a 16-page insert of wholesale offerings for those who make quantity purchases.

86. Columbia Electronic Cables—Catalog details complete product line of audio, CATV, intercom, microphone, power and television cables. The 96-page catalog includes all recently introduced products.

87. Mura—A 2-color brochure includes Mura's line of audio equipment, in eight pages of illustrations and detailed specifications. A variety of microphones, stereo headphones, accessories and the Muradapter is featured.

88. Perma Power—Descriptive literature about the Perma Power modular lectern is available.















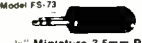

89. Tektronix—A 34-page information package about Tektronix's portable scopes. Comprehensive data sheets with large photographs, selection information, and latest specifications are included.

90. Non-Linear Systems—1979 test instrument catalog features digital multimeters, scopes and frequency meters. All test instruments are portable, battery operated units. These include multimeters with LED and LCD readouts, single-trace and dual-trace scopes, frequency meters that count up to 512 MHz and carrying cases.

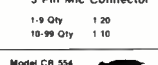
91. Continental Specialties Corporation—Catalog includes solderless breadboard products, modular solderless breadboards; solderless breadboard elements; "Proto-Board" solderless breadboard arrays (some including regulated power supplies); IC-test clips, (both with and without connected ribbon cable); and the "Logical Force" family of digital troubleshooting equipment.

92. Klein Tools—An 84-page, 2-color catalog covering the Klein line of pliers, screwdrivers, hacksaws, and many other tools plus gloves, tool pouches and cable cutters. □

Complete Line of Replacement Parts for CB - STEREO - TV

<p>Model UG-175 Adapta PL-259 for use with RG58U Cable</p> <p>1-9 Qty 25 10-99 Qty 22</p> 	<p>MODEL FS-72</p>  <p>Heavy Duty Clip Leads Two each of 5 different colors 22" long tip to tip</p> <p>1-9 Qty. 1.80 10-99 Qty. 1.50</p>
<p>Model UG-176/U Adaptor for RG-58/U Cable</p> <p>1-9 Qty 20 10-99 Qty 18</p> 	<p>Matching Transformer 75-300 ohm</p>  <p>VHF/UHF/FM 75-300 ohm matching unit Input accepts "F" type fittings. 300 ohm thin lead output. Features low insertion loss, ac/dc blocking w/excellent match</p> <p>1-9 Qty 80 10-99 Qty 55</p>
<p>Model FS-71</p>  <p>RCA Shielded Plug</p> <p>1-9 Qty 30 10-99 Qty 27</p>	<p>Axial Lead Capacitors 80 MFD x 450 volts</p> <p>1-9 Qty 1.30 10-99 Qty 1.20</p> <p>100 MFD x 450 volts</p> <p>1-9 Qty 1.40 10-99 Qty 1.25</p>
<p>Model FS-68</p>  <p>Standard Stereo Phone Plug with 1/4" phone plug, screw terminal</p> <p>1-9 Qty 45 10-99 Qty 40</p>	<p>Emitter Resistors 0.5 ohm</p> <p>2W 1-9 Qty 20 10-99 Qty 18</p> <p>3W 1-9 Qty 23 10-99 Qty 20</p> <p>5W 1-9 Qty 29 10-99 Qty 26</p>
<p>Model FS-73</p>  <p>1/4" Miniature 3.5mm Plug</p> <p>1-9 Qty .25 10-99 Qty .22</p>	<p>Focus Rectifier 8 KV 6.5 KV</p> <p>1-9 Qty 80 1-9 Qty 1.00 10-99 Qty 70 10-99 Qty 90</p>
<p>PL-259 for RG8U Cable</p>  <p>1-9 Qty 50 10-99 Qty 45</p>	<p>Lighter Plug</p>  <p>1-9 Qty 70 10-99 Qty 64</p>
<p>4 Pin Mic Connector</p> <p>1-9 Qty 90 10-99 Qty 80</p> 	<p>Fuse Holder Model FH-1</p>  <p>Fuse holder with 18 wire for all standard 1/4" fuses W/2 amp fuse.</p> <p>1-9 Qty 45 10-99 Qty 40</p>
<p>3 Pin Mic Connector</p> <p>1-9 Qty 1.20 10-99 Qty 1.10</p> 	<p>Fuse Holder Model FS-50</p>  <p>Holds 1/4" x 1" fuses. Can be used on panels up to 5/16" thick. Has bayonet knob. No screw driver required.</p> <p>1-9 Qty 60 10-99 Qty 55</p>
<p>Model CB 554</p>  <p>Adapta PL-259 to Motorola plug or RCA type phone jack.</p> <p>1-9 Qty 90 10-99 Qty 80</p>	<p>3AG Fuses 1A, 2A, 3A, 4A, 5A, 6A</p>  <p>1-9 Qty 13 10-99 Qty 11</p>
<p>Model FS-187</p>  <p>3-Conductor open circuit phone jack</p> <p>1-9 Qty 45 10-99 Qty 40</p>	<p>UHF/VHF Splitter with Matching Transformer</p>  <p>Separate F-59 and ring included</p> <p>Model SP 802 1-9 Qty 1.50 UHF/VHF 10-99 Qty 1.40</p> <p>Model SP 803 1-9 Qty 1.60 UHF/VHF/FM 10-99 Qty 1.50</p>

IMMEDIATE DELIVERY WITHIN 48 HOURS
Minimum order \$10.00 Add \$1.00 postage
Quantity discount prices M/Gr. inquiries Welcome

Ask For Our Complete Price List

FUJI - SVEA ENTERPRISE
a Division of Fuji-Svea Incorporated

P.O. Box 40325 Cincinnati, Ohio 45240

TOLL FREE Nationwide 800/543-1607
TELEPHONE Ohio 800/582-1630

Hours: Mon.-Fri. 10-7; Sat. 11-5

themarketplace

Advertising rates in the Classified Section are 35 cents per word, each insertion, and must be accompanied by cash to insure publication.

Each initial or abbreviation counts a full word.

Minimum classified charge \$3.00.

For ads on which replies are sent to us for forwarding (blind ads), there is an additional charge of \$3.00 per insertion to cover department number, processing of replies, and mailing costs.

Classified columns are not open to advertising of any products regularly produced by manufacturers unless used and no longer owned by the manufacturer or a distributor.

For Sale

REPLACEMENT COLOR YOKES-DEALERS ONLY. Zenith 95-2501-2532-2638-2667-S-89633 etc. 16.95, Magnavox 361380-1 18.95, Sylvania, GE etc. 14.95 to 19.95. Request for price list on your Letterhead. David Sims Enterprises, Inc., 665 Jericho Turnpike, Huntington Station, N.Y. 11746. 12-76-tf

TV & RADIO TUBES 36c EA!! Free color catalog. Cornell, 4221 University, San Diego, California 92105. 8-76-tf

ELECTRONIC SURPLUS, CLOSEOUTS, LIQUIDATIONS! Parts, equipment stereo, industrial, educational. Amazing values! Fascinating items unavailable in stores or catalogs anywhere. Unusual FREE catalog. ETCO-011, Box 762, Plattsburgh, N.Y. 12901. 6-78-tf

MOVING TO FLORIDA? TV SERVICE AND RENTAL BUSINESS FOR SALE ON FLORIDA'S WEST COAST. DOING \$40,000-\$50,000 PER YEAR. ALL REASONABLE OFFERS CONSIDERED, ALSO BUILDING AVAILABLE. CONTACT: MR. SOTHERN, 1-813-535-2026 AFTER 7 PM OR WRITE: 1834 SUNRISE BLVD., CLEARWATER, FLORIDA 33520. 9-78-tf

TV SALES & SERVICE, business established 23 years. Building available. 109 W. Center St., Bellevue, Ohio 44811. 1-79-2t

T.V. TECHNICIAN AND DEALERS, "INCREASE YOUR INCOME" Thousands of dollars yearly! "Rent-Lease-Sell TV's." Easy to start or add to your present operation. "Guaranteed complete basic plan and starter kit" \$15.00, or stamped envelope will get you free details. Perrys' TV Leasing Systems Box 1407 Santa Maria, Calif. 93456 11-78-3t

T.V. SALES & SERVICE Business. Same location 19 years. Building available. 1039 E. Marjorie Avenue, Punta Gorda, FL 33950. 813-639-1919 PM 11-78-3t

SAMS PHOTOFACTS—1 thru 1309 and 1443 thru 1528. All but first 100 in filing cabinets, \$900. Robert C. Knapp, Box 145, Lyndhurst, VA. 22952. 1-79-1t

APPROX. 1500—Photofacts (1-1500), 147-TSM (24-147), 130-AR (18-182), 20 File Cabinets all for \$1,750.00. Canton Radio & TV Center, 118 Pisgah Dr., Canton, NC 28716. Phone: (704) 648-3068. 1-79-1t

Perform a death-defying act.

Have regular medical check-ups.

Give Heart Fund
American Heart Association 

For Sale (Cont.)

TUBES-RECEIVING, Industrial and Semiconductors Factory Boxed. Free price sheet including TV, Radio and audio parts list. Low, low prices. Transletronic, Inc., 1365 39th St., Brooklyn, New York 11218. Telephone: (212) 633-2800. Toll free: 800-221-5802. 5-78-12t

Business Opportunity

MECHANICALLY INCLINED INDIVIDUALS—BUILD ELECTRONIC DEVICES IN YOUR HOME. GET STARTED IN YOUR SPARE TIME. \$300 TO \$600/WK POSSIBLE. EXPERIENCE NOT NECESSARY. WRITE FOR FREE LITERATURE. ELECTRONIC DEVELOPMENT LAB., BOX 1560A, PINELLAS PARK, FLA., 33565.

8-78-tf

WANTED FOR CASH! We buy scrap electronic parts containing gold, silver, platinum! Immediate top dollar cash offer by return mail. Ship to: American Metals Co., P.O. Box 30009, Dept. ES, St. Andrews Branch, Charleston, SC 29407

11-78-tf

MEN/WOMEN FOR FUN! Shaklee Wholesale Distributors earn \$200-\$5,000 monthly. Bonus, New Car, Etc. Details, Golden, RT2, Box 392ES, Fair Grove, MO 65648. 12-78-3t

SAVE HUNDREDS: American Made (AGC Optional) quality Head-Ends, V/V, U/V Converters, Camera Modulators. Factory prices. Send \$5.00 (or letterhead). Box 809, Boyton Beach, FL 33435. 11-78-EOM

Education-Instruction

REPAIR TV TUNERS—High Earnings. Complete Course Details, 12 Repair Tricks, Many Plans, Two Lessons, all for \$2. Refundable. Frank Bocek, Box 3236 Enterprise, Redding, Calif. 96001. 8-76-tf

Help Wanted

"SUNNY FLORIDA NEAR DISNEY WORLD: once in a lifetime opportunity. Need additional television and stereo technicians immediately for our growing service business. Experienced only. Opportunities for men and women alike. Live and work in Americas Vacation Wonderland. Leave the snow and high taxes behind forever! Non-smokers preferred. Call or write today. CHRISTIAN TELEVISION AND AUDIO, 6916 Silver Star Road, Orlando, Florida 32808. Telephone (305) 293-7288." 1-79-1t

TELEVISION TECHNICIANS—Experience necessary, top pay, medical benefits, paid vacations. Enjoy a new "Life Style" in a beautiful, friendly, smog free, full service desert community. Send your resume to 225 E. Ridgecrest Blvd., Ridgecrest, California 93555. Telephone 714-375-1361, ask for Service manager. 1-79-3t

EARNINGS OVER \$20,000 YEARLY to top outside technicians. Qualifications: 15 years experience, absolute honesty, non-drinker, non-smoker. Benefits: group hospital plan, paid vacations, reimbursement for moving, excellent area to raise families, outdoor sports paradise. Send resume to American Television, 1032 South State, Orem, Utah 84057. 10-78-4t

Advertising Services

TERRIFIC SWAP OFFERS NATIONWIDE! Next 5 issues \$2. "Electronics Trader," Box 73-ES, Folly Beach, SC 29439. 1-79-TF

Professionals Accredited

PROFESSIONAL DEGREES (Bachelor, Master, Doctor) earned with Professional Experience in Electronic Business Management, Sales, or Servicing. **WORLDWIDE SERVICE.** Free Details. **EBERT PROFESSIONALS INSTITUTE**, Box 1651, Dept. R, Columbia, Missouri 65201. 1-79-4t

advertisers'index

B & K Precision,	
Dynascan Corp.	21
Cleveland Institute of	
Electronics, Inc.	1
Communications & TV	
Unlimited	46
Dynascan Corp.,	
B & K Precision	21
Fuji-Svea Enterprise	49, 51
Gamit Enterprises, Inc.	25
General Electric Co.,	
Tube Products	
Dept. Inside Front Cover	
Jensen Tools and	
Alloys	48
Klein Tools, Inc.	6
Master Appliance	
Corp.	6
NATESA	25
NESDA	46
New-Tone Electronics	
Int'l.	47
Non-Linear	
Systems	27
Oelrich Publications	48
PTS Electronics,	
Inc.	37
RCA Distributor	
and Special	
Products	12-13
Sencore, Inc.	5
Sperry Tech Inc.	2
GTE	
Sylvania... Inside Back Cover	
Texas Tuner	
Service	48
Texas Tuner	
Supply	48
Zenith Radio	
Corp.	19, Back Cover

**Here's a new tool
repair shops can really use.**

**5yr.
warranty**

ON REPLACEMENT TV PICTURE TUBES.

Aside from your fine work, what are you doing to make your customers return to you with more repairs? A nice smile and "thank you, please call again" may not be enough.

Well, Sylvania has come up with a new tool that's sure to help you turn every customer into a steady customer. It's a 5-year warranty* that you can now offer on replacement picture tubes.

So now not only can you offer the best in replacement tubes, but also have a 5-year backing from GTE Sylvania—one of the largest electronics corporations in the world.

For more information on how we can help your repair shop business just contact your nearest Sylvania distributor or GTE Sylvania, Distributor and Special Markets Division, Seneca Falls, N.Y. 13148

SYLVANIA

GTE

*LIMITED WARRANTY. LABOR NOT INCLUDED.

Circle (1) on Reply Card

Take a tip from a man whose replacements are as good as his starters!

A receiving tube replacement must be as good as the original.

That's why you should stock your caddy with Zenith receiving tubes.



Zenith, after all, is the one TV brand name that for years has won the endorsement of top service technicians just like you.

With anything less than a genuine Zenith receiving tube replacement, you risk your reputation and your relationship with your customers.

Sneak in an off-brand replacement and you're laying yourself open to problems in a day and age when customers are as well aware of Zenith quality as you are.

Call your Zenith distributor now for replacements as good as our starters!

*For your own reputation and in your customers' best interest,
always specify Zenith exact replacement parts and accessories.*



ZENITH

The quality goes in before the name goes on®

Zenith Radio Corporation / Service, Parts & Accessories Division / 11000 Seymour Avenue / Franklin Park, Illinois 60131

Circle (2) on Reply Card