

EST-3070 N 1C 1272 4
NORMAN C RIEDEL
911 SHEA AVE
GREEN BAY WISC 54303



Electronic Servicing®

**NEA
and
NATESA
to
merge!**
page 14



JUNG HOTEL

Horizontal Phase Detector page 26

Save On Depreciation page 46

A Look At 4-Channel Sound page 20

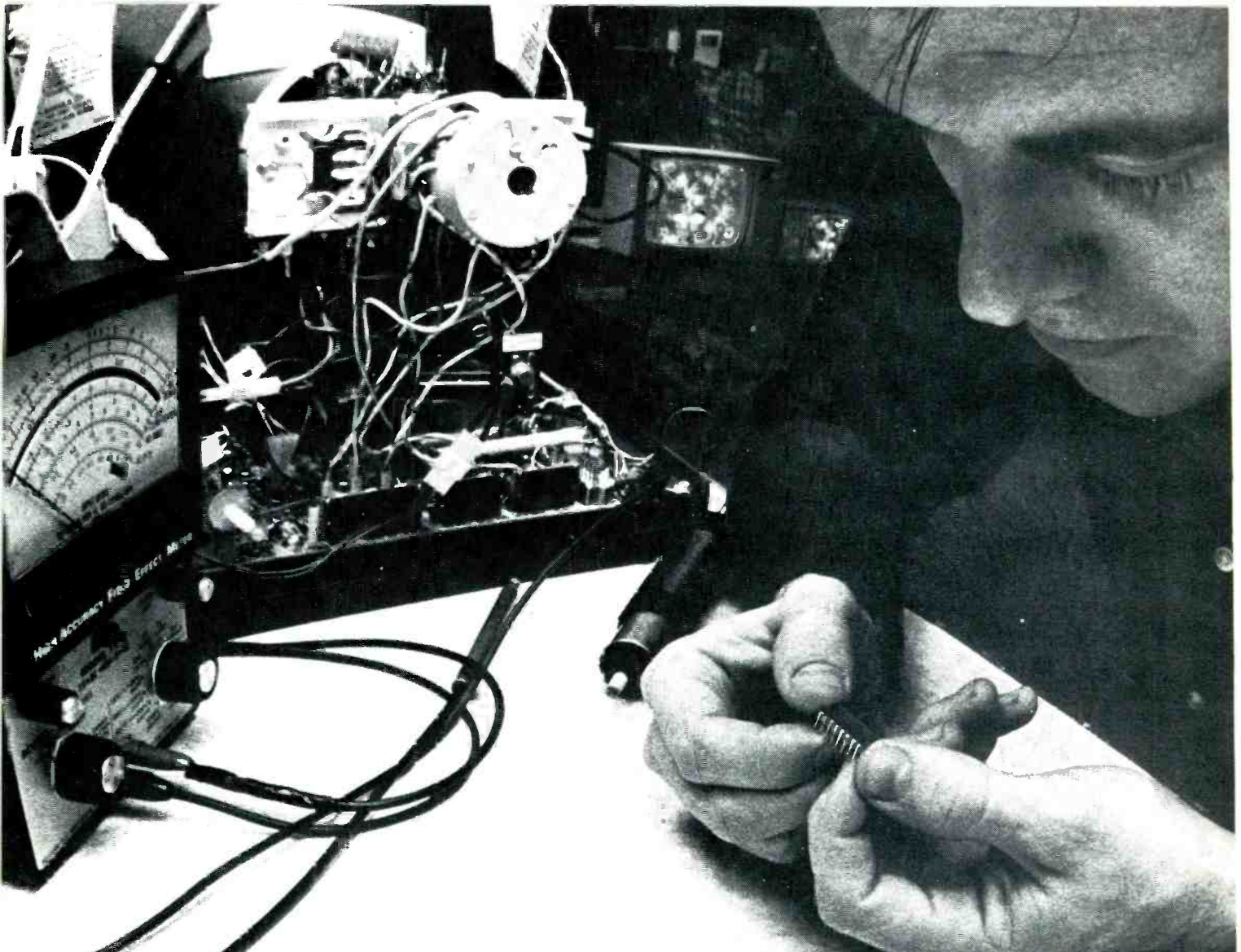

We're in this business together.

Semiconductors
you can depend on
for customers
who depend on you.

Tube Products Department, Owensboro, Kentucky 42301



GENERAL  ELECTRIC

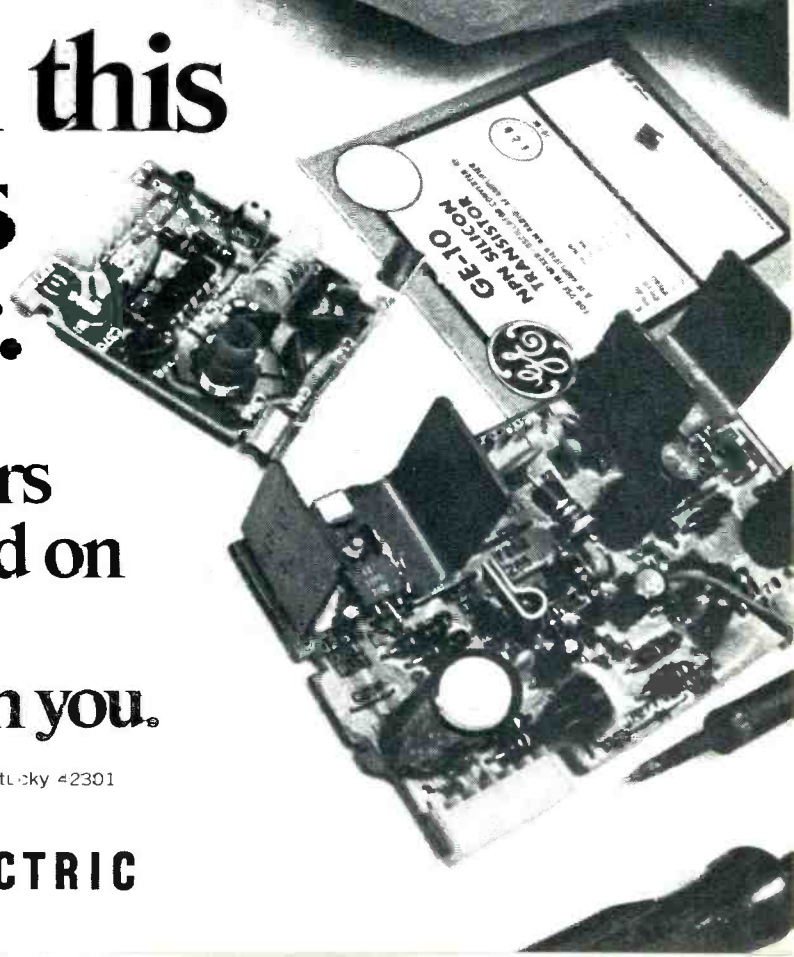

What you see is what you get



Solid State
DIGITAL
MULTIMETER
\$299.95

The LDM 850. No compromise. No ifs, no buts. Here is precision and accuracy, never before possible in a DVM... with non-blinking digital readout that eliminates any possibility for error or parallax. Scale accuracy is $\pm 1.0\%$ or greater with $3\frac{1}{2}$ digit identification up to 1,999. You can measure AC or DC voltage, current and ohms in 25 ranges and the 115/230V power supply gives you in-shop or in-the-field flexibility. We've even developed an exclusive dual slope operating mode with an instant response, manual range switch. Max. input is 1,000VDC and 350VAC; 10 M Ω input impeded. Sensitivity ranges from 100 μ V to 1V; current from 0.2mA to 1,000mA; resistance from 0.2K Ω to 2,000K Ω ; plus automatic polarity reversal. Size? Just $3\frac{1}{4}$ "x $7\frac{3}{4}$ "d. What you see is what you get from Leader - outstanding quality.

The more you see... the more you believe... the more you save

LEADER INSTRUMENTS CORP. 37-27 TWENTY-SEVENTH ST. LONG ISLAND CITY, N.Y. 11101 (212) 729-7411

Circle 4 on literature card

October, 1972/ELECTRONIC SERVICING 1

Electronic Servicing®

in this issue...

- 14 **At The Convention . . . NEA-NATESA Announce Historic Merger**—Details and pictures of the August convention in New Orleans—Carl Babcoke.
- 20 **4-Channel Sound . . . A Profusion Of Confusion**—4-channel sound is great, but is it ready?—Wayne Lemons.
- 26 **The Inside Story Of Horizontal Phase Detectors**—Theory and troubleshooting of phase detectors for beginners or experienced technicians alike—Carl Babcoke.
- 34 **The Most Common Car-Radio Defects**—Typical troubles plaguing recent models of car radios—Joseph J. Carr.
- 40 **Serv-A-Set Builds Success On Planning And Promotion**—Ideas and principles that have worked well for one shop—John Stapp.
- 46 **Cut Your Depreciation Losses**—Depreciation is inevitable, but keep it within reason—Robert G. Amick.
- 51 **Test Your Skill At Troubleshooting Solid-State, Part 2**—Direct-coupled stages make analysis more difficult—Wayne Lemons.
- 68 **Supplement to 1972 Sams PHOTOFAC Annual Index**—A complete listing of new models of home entertainment electronic products covered in PHOTOFAC. Use with the PHOTOFAC 1972 Annual Index.

DEPARTMENTS

Electronic Scanner 4	Antenna Systems Report . . . 59
Symcure 8	Audio Systems Report 60
Readers Exchange 10	Book Review 61
Service Bulletin 12	Product Report 63
Photo-Tip 54	Test Equipment Report 65
Catalog & Literature 55	The Marketplace 67
Advertiser's Index 67	

Second class postage paid at Kansas City, Mo. and additional mailing offices. Published monthly by INTERTEC PUBLISHING CORP., 1014 Wyandotte St., Kansas City, Mo. 64105. Vol. 22, No. 10. Subscription rate \$6 per year in U.S., its possessions and Canada; other countries \$7 per year.

Copyright, 1972, Howard W. Sams & Co., Inc. All rights Reserved. Material may not be reproduced or photocopied in any form without written permission of publisher.

EDITORIAL
 RONALD N. MERRELL, Director
 CARL H. BABCOKE, Managing Editor
 BARBARA L. BORDERS, Editorial Assistant
 WEBB G. STREIT, Graphic Designer

CONTRIBUTING AUTHORS
 Bruce Anderson
 Joseph J. Carr
 Wayne Lemons
 Robert G. Amick

TECHNICAL CONSULTANT
 JOE A. GROVES

EDITORIAL ADVISORY BOARD
 LES NELSON, Chairman
 Howard W. Sams & Co., Indianapolis

CIRCULATION
 EVELYN ROGERS, Manager

ADVERTISING SALES
 Kansas City, Missouri 64105
 Tele: 913/888 4664
 E. P. LANGAN, Director
 R. JACK HANCOCK, Manager
 JAKE STOCKWELL
 MIKE KREITER
 TERRY TEMPLE, Production

REGIONAL ADVERTISING SALES OFFICES
 Indianapolis, Indiana 46280
 ROY HENRY
 2469 E. 98th St.
 Tele: 317/846-7026

New York, New York 10017
 George W. Fleck
 Room 1227
 60 E. 42nd St.
 Tele: 212/687-7240

Los Angeles, California 90005
 RICHARD BOHEN
 3600 Wilshire Blvd., Suite 1510
 Tele: 213/383-1552

London W. C. 2, England
 JOHN ASHCRAFT & CO.
 12 Bear Street
 Leicester Square
 Tele: 930-0525

Amsterdam C. Holland
 JOHN ASHCRAFT & CO.
 W.J.M. Sanders, Mgr.
 for Benelux & Germany
 Herengracht 365
 Tele: 020-240908

Tokyo, Japan
 INTERNATIONAL MEDIA REPRESENTATIVES LTD.
 1, Shiba-Kotohiracho, Minatoku
 Tele: 502-0656



ELECTRONIC SERVICING (with which is combined PF Reporter) is published monthly by Intertec Publishing Corp., 1014 Wyandotte Street, Kansas City, Missouri 64105.

Subscription Prices: 1 year—\$6.00, 2 years—\$10.00, 3 years—\$13.00, in the U.S.A., its possessions and Canada.

All other foreign countries: 1 year—\$7.00, 2 years—\$12.00, 3 years—\$16.00. Single copy 75c; back copies \$1.

Adjustment necessitated by subscription termination at single copy rate.



Robert E. Hertel, Publisher

Intertec Publishing Corp.
Subsidiary of Howard W. Sams & Co., Inc.



MEET YOUR NEW RIGHT HAND MAN

the Sprague Model TO-6 TEL-OHMIKE® Capacitor Analyzer

MEASURES ALL FOUR!			
1 CAPACITANCE	2 POWER FACTOR	3 LEAKAGE CURRENT	4 INSULATION RESISTANCE
Measures up to 2000 μF in five overlapping ranges . . . including a special 1 to 100 pF range, exclusive with Sprague. Low ac voltage . . . Capacitors rated at 3V can now be tested without damage.	Power factor of electrolytic capacitors is measured by the highly accurate Wien Bridge method. Reads up to 50% in three ranges for convenience in power factor measurement.	Leakage current of electrolytics is measured directly on easy-to-read meter, with exact rated voltage up to 600V applied from continuously adjustable power supply. 4 ranges: .06, .6, 6, 60 mA.	Insulation resistance of paper, ceramic, and mica capacitors is read directly on meter. Dual range—to 10KM Ω @ 30V for low voltage capacitors, to 50KM Ω @ 150V for higher voltage units.

A must for checking all capacitors, the TO-6 is moderately priced, yet offers laboratory quality and accuracy.

See the TO-6-TEL-OHMIKE in action at your Sprague Distributor Today...or, for more information, write to Sprague Products Company, 105 Marshall Street, North Adams, Mass. 01247.

THE BROAD-LINE PRODUCER OF ELECTRONIC PARTS



Circle 5 on literature card

electronic scanner

news of the industry

The FCC approves subscription-TV broadcasting by the Blonder-Tongue Broadcasting Company. Mr. Isaac S. Blonder, president of the company, recently announced that a construction permit for their UHF TV station on Channel 68 in the New York/New Jersey area has been issued by the FCC. This is the first subscription-TV station licensed by the FCC.

The BTVision system, designed by Blonder-Tongue Laboratories, Inc., alters the vertical-sync pulses during broadcasts which causes the picture on a non-subscriber's TV to roll uncontrollably. Subscribers to the service will have a rented decoder unit attached to their TV receivers. This decoder changes the STV signal to restore the vertical locking, records (for billing purposes) which programs were selected for viewing, and also provides "barker" audio so the station can give details about the programming.

No wiring change to the receiver is necessary. The regular antenna is connected to the STV decoder unit which, in turn, is connected to the antenna terminals of the receiver. Two separate antennas can be used. Or, a single antenna plus either a signal-splitter or an antenna-switch supplies both the decoder and the TV receiver.

Not all programs from this station will be of the STV type (for which a charge is to be made). One of the FCC rules specifies that 28 hours a week must be "free" programming.

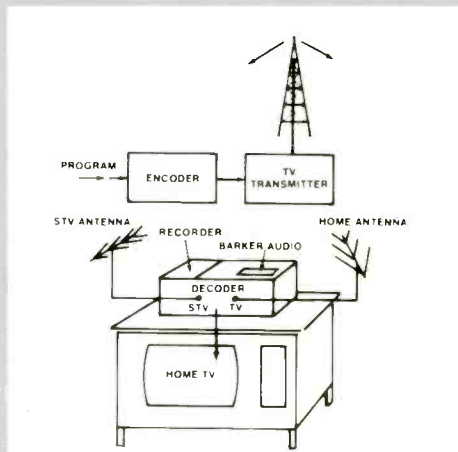

Courtesy of Blonder-Tongue Laboratories, Inc.

A spokesman for the Blonder-Tongue Laboratories speculates that **broadcast** subscription TV of the BTVision type will prove profitable to independent TV technicians. Because the system doesn't require modifications or special adjustments of the receivers, and doesn't interfere with normal reception of other stations, there will be no reason for the BTVision organization to infringe on any servicing activities. In addition, the set owners will be *paying* for superior TV programs, and probably will want their receivers maintained in top-notch condition.

NATESA and NEA members vote to merge their organizations. Elsewhere in this issue is the story of the joint convention in New Orleans, and the details of the monumental merger decision. The editors and staff of ELECTRONIC SERVICING heartily applaud this important step, and we believe it eventually will prove of immense value to all electronic technicians everywhere.

(Continued on page 6)

TO A PRO, TIME IS MONEY

So take time to read about the BUSS® Kolor Kit of replacement fuses

The mark of a professional Certified Electronic Technician is efficiency. He's got the ability to locate a problem quickly, repair it quickly, and get on to the next job.

One of his secrets is that he always has the part he needs when he needs it. That's where the BUSS Kolor Kit of replacement fuses for domestic and foreign TVs comes in.

The Kolor Kit comes in two sizes, the No. 140 Kolor Kit containing 120 fuses, and the No. 240 Deluxe Kolor Kit containing 240 fuses plus four sets of twin clips. With a BUSS Kolor Kit in your tube caddy, you'll always have the fuse you need when you need it. Ideal for servicing both color and black and white TV's.

BUSS Kolor Kits are available from your local BUSS Distributor.



Bussmann Mfg. Division, McGraw-Edison Co., St. Louis, Mo. 63107

SUPPLIED THE ECONOMICAL WAY
... THRU DISTRIBUTORS
BUSS QUALITY
FUSES

Officials of Cartrivision video-tape recorders revealed at the NEA/NATESA convention details of the world's first video tape service school. More than 300 television technicians from 25 organizations, they stated, have completed a training school for the maintenance of home-type video-tape recorders. According to S. Carl Huber, director of parts and service for Cartrivision, this seven-day course is the first consumer-oriented video-tape recorder service course ever offered in the United States. According to Huber, "The school uses a hands-on approach, accompanied by training aids and makes extensive use of the abilities of the video-tape recorder as a training tool. One aid is a training tape which serves as a lesson in the course." The school directed by Mark Sheldon, takes seven working days, and is held in the San Francisco area.

The Star Sighter, used to navigate NASA spacecraft, is shown being tested by ITT Gilfillan, a division of IT&T Corporation. The test chamber, at Van Nuys, California, simulates the vacuum and temperature conditions of outer space. □



Courtesy of IT&T



Who said B & K couldn't improve the only complete Television Analyst?

Now there is a new model... the 1077-B, with solid state sweep drive.

The B & K Television Analyst has become standard equipment in repair shops everywhere. And for good reason. It's the quickest, simplest way to test every stage of any TV.

But even classic instruments have to keep up with the times.

That's why we've added a solid state sweep drive in our latest model. It can check any new transistorized color set on the market today.

It's so easy, too. Because the unique B & K signal substitution technique eliminates the need for external scopes or wave-form interpretation.

Whether it's tubes or transistors, VHF or UHF, simply inject the appropriate test pattern or any other known signal. The new Model 1077-B, with its exclusive flying spot scanner, checks everything from the antenna terminals to the input of the picture tube.

Ask your distributor about the new Television Analyst. Only B & K makes it. And now B & K makes it even better.

Model 1077-B \$399.95



Product of DYNASCAN CORPORATION
1801 W. Belle Plaine, Chicago, Illinois 60613

Circle 7 on literature card

Chassis—Zenith 12A12C52, 12A13C52
PHOTOFACT—1120-3

IF AGC TRANSISTOR

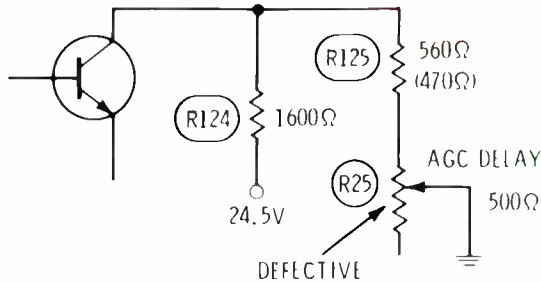

Symptom—Brightness increases intermittently; might exhibit vertical lines during this condition
Cure—Replace defective AGC delay control, R25

Chassis—Admiral 1K2084-2
PHOTOFACT—Not yet available

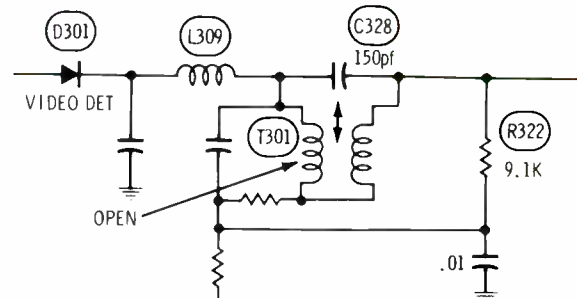

Symptom—Ghostly, faint "negative" appearing picture. Sound normal
Cure—Check for open winding in T301

Chassis—Zenith 12A12C52, 12A13C52
PHOTOFACT—1120-3

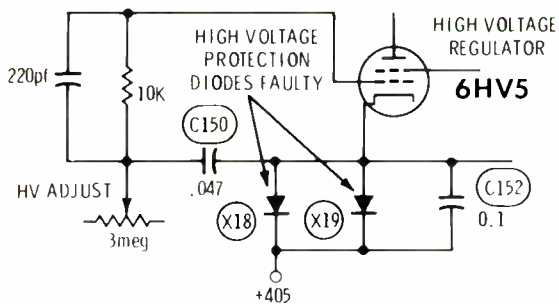

Symptom—Picture gets narrow at bottom when brightness control is turned down to produce low level. High-voltage adjustment does not change high voltage, or does so erratically
Cure—Replace both high-voltage protection diodes, X18 and X19

Chassis—Admiral 1K2084-2
PHOTOFACT—Not yet available

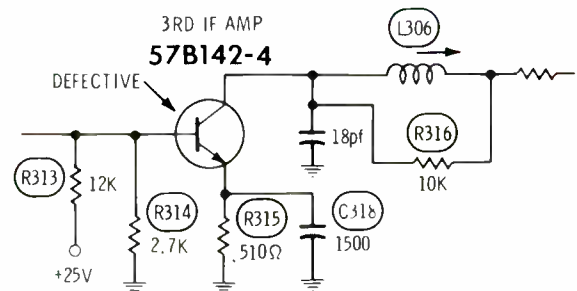

Symptom—Intermittent loss of picture and sound; raster okay. Might become a steady condition after set operates for several minutes
Cure—Check 3rd IF transistor, 57B142-4, and replace, if defective

Chassis—Zenith 14A10C19
PHOTOFACT—1108-3

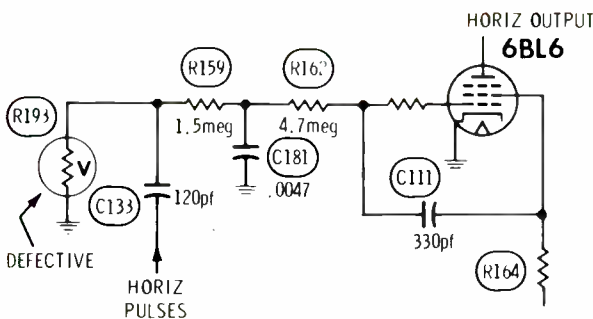

Symptom—"Cog wheel" or "Pie crust" effect in vertical lines of picture. Also picture "shimmy".
Cure—Replace defective VDR (R193), in horizontal-output circuit (Also check for defective 1K resistor, between Pin 3 or 6HV5 HV regulator tube and ground)

Chassis—Admiral 11H12 and similar chassis
PHOTOFACT—1116

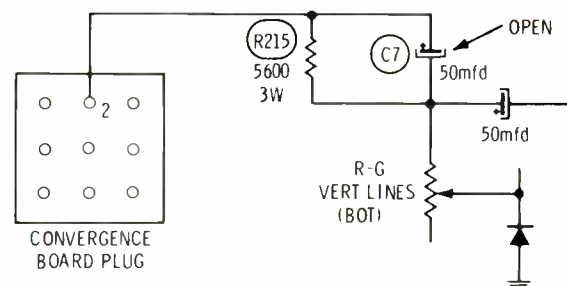

Symptom—Insufficient height; raster pulled up at bottom; no foldover
Cure—Replace 50-mfd, 150-volt (100 volt in some chassis) capacitor, C7, mounted on convergence board

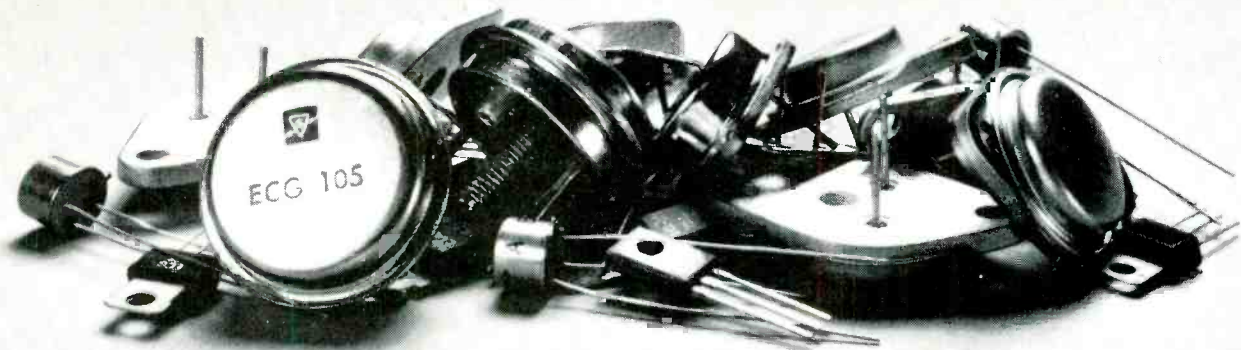

Our 39 audio power transistors replace...

To Be Replaced	ECG Replacement	To Be Replaced	ECG Replacement
AD138	121	QP-1A	179
AD138/50	121	QP-2	179
AD139	104	QP-3	179
AD140	121	QP-4	179
AD142	179	QP-5	179
AD143	179	QP-6	179
AD143B	179	QP-7	179
AD148	131	QP-8	130
AD149	104	QP-8-1	130
AD149-01	121	QP-8-P	130
AD149-02	121	QP-10	179
AD149B	121	QP-11	130
AD150	121	QP-12	130
AD152	131	QP-13	185
AD155	131	QP-14	184
AD156	131	QP8-6623N	105
AD157	131	QP-13	153
AD159	121	QP-14	152
AD16C	175	QQC61209	158
AD161	155	QQC61210	102A

and thousands more.

There are a lot of identical transistors around hiding under different manufacturers' part numbers.

But we've boiled power transistors down to just 39 types that will handle almost all of your replacement problems.

And we've also put together a cross-reference guide that tells you which one replaces which.

Our cross-reference guide also tells you about the rest of our ECG replacement semiconductor line. Altogether they can substitute for 53,000 others.

Practically everything from diodes to integrated circuits.

And we don't stop there.

The ECG semiconductor line includes a variety of heat sinks, heat-sink compounds, transistor mounting kits, and sockets.

In short, carrying Sylvania's ECG replacement semiconductor line can take a big load off your back.

And you can still give power to the people.

Sylvania Electronic Components,
Waltham, Mass. 02154.

GTE SYLVANIA

readers'exchange

Need a not-available schematic? Need an obsolete part? Have an unusual service problem and want help? Send information and full mailing address to ELECTRONIC SERVICING. Other ES readers should send replies with their offer of help direct to the writer. We reserve the right to edit and print all letters sent to this column. Let us help one another.

Needed: Schematic and operating instructions for an RCA scope, type WO-79A (3-inch CRT).

Gerard Kersting
2463 Tiebout Ave.
Bronx, New York 10458

Needed: Schematic, voltage readings, etc., for a Lincoln transistor tape recorder, Model L-4320.

S.R. Creacey
308 Bond St.
Redlands, California 92373

Needed: Schematic and service data for a CANDLE (Valiant) Micro TV, Model MT-510.

Jerry Malewicz
361 92nd St.
Brooklyn, New York 11209

Needed: Schematic and operating instructions for Atwater Kent, Model 286 radio. Restoring, may need parts.

R.E. Shaver
218 Kolbe St.
Napoleon, Ohio 43545

Needed: Schematic and service data for a PACO, Model S-55 scope.

J. Bautista
J-B Radio-TV Servicing
140 W. Orangethorpe No. 76
Placentia, California 92670

Needed: Schematic and service data for a Webcor, Model TV208. This is a solid-state type and has no chassis number.

S. Comeaux
1616 Thomas Ave.
San Francisco, California 94124

Wanted: The schematic for a Curtis Mathes color TV, Model FF500W.

Forrest Wilkinson
5817 No. Kauffman Ave.
Temple City, California 91780

Wanted: The U.S. distributor for Monacor. The home manufacturing center is in Japan.

Belford A. Belles
117 Andover Dr.
Exton, Pennsylvania 19341

Editor's Note: The address of the U.S. distributor for Monacor products is: Monarch Electronics Corp., 7035 Laurel Canyon Blvd., N. Hollywood, California 91605.

Wanted: We are looking for a repair capability for Touch Tone generators such as the ones used in Touch Tone telephones. One rumor has it that one of the TV tuner firms who repair or supply replacement tuners also repair the Touch Tone single transistor pads that are so common now in telephones.

R. E. Hightower
9224 Woodland Dr.
Silver Spring, Maryland 20910

Wanted: Information about the new Panaplex read-out system.

Jimmy Whitley
Route 1
Marshville, North Carolina 28103

Weller® Model WP25 Soldering Tool

- Ideal 25 watt pencil-type iron for general purpose soldering
- Small, handy-only 7 $\frac{7}{8}$ " long for easy use and storage
- Works with a variety of easy-change Wellercote tips to perform many jobs without freezing
- Useful in crowded work areas
- Use from tool box in the field or with custom stand (Model PH60) as complete bench station

COMPLETE INFORMATION AVAILABLE at your local WELLER Distributor... or Write WELLER, The Cooper Group, P.O. Box 728, Apex, North Carolina 27502.



The Cooper Group

CRESCENT · LUFKIN · WELLER

Circle 9 on literature card



15678

"We get a great number of service calls from people who saw our ad in the Yellow Pages."



"We don't just sell our products, we service them as well," says Mr. James Godwin, Godwin Radio Company, Birmingham, Alabama. "Our Yellow Pages ad has kept our phones ringing with people who want service on their radios, stereos, and televisions. We advertise under several headings, because we sell a number of different types of home entertainment equipment. So the

Yellow Pages is helpful in the area of sales as well as service. I think the Yellow Pages is a kind of final reference for people. Your ad or commercial will interest them, but they may need your phone number or address or some other piece of information. Then they head straight for the Yellow Pages."

Let the Yellow Pages do your talking. People will listen.

**3 out of 4 prospects
let their
fingers do the walking.**



service bulletin

a digest of info from manufacturers

Failure of oscillator capacitor

Magnavox T958 and T962 color TV chassis

Loss of high voltage in these models has been traced in some cases to a shorted C529 in the horizontal oscillator circuit.

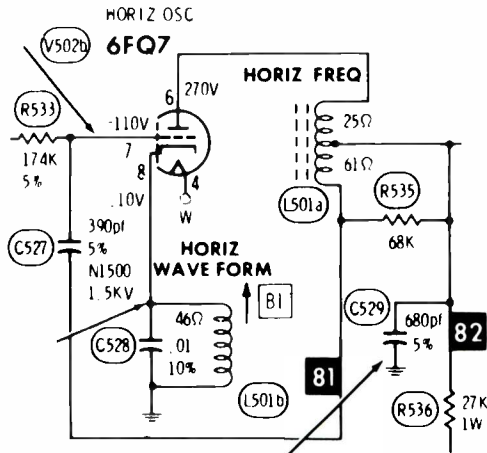

The Magnavox part number is 250364-350 for this 680-Pf 500-volt silver-mica capacitor. Use **only** a silver-mica type for replacement.

Vertical bars in picture

General Electric C2/L2 color TV chassis

Four or five vertical bars in the picture of 18", 19" or 20" receivers might be caused by an open in R270 (3300 ohms) which is a damping resistor in parallel with L260. (These are GE numbers.)

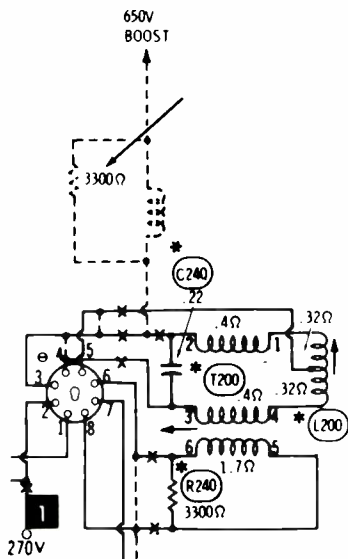

These components are mounted on a terminal strip in front of the 26HU5 horizontal-output tube. Replace the resistor only with a flame-proof type, such as GE EP14X38.

C529 was erroneously listed as a 200-volt type on the Magnavox schematic.

New location for yoke capacitors

Magnavox T958 and T974 color TV chassis

Deflection yokes used in the new T974 and the late-production T958 chassis have been designed and manufactured without the capacitors which usually are included inside the cover of the yoke.

On those chassis, the capacitors are mounted on a terminal board at the top rear of the high-voltage cage.

When you connect one of these chassis to a test jig containing capacitors inside the yoke, the width will be overscanned and the high voltage will be slightly reduced.

Tip for horizontal centering

Admiral G11 color TV chassis

After you have installed an Admiral number 79A148-1 high-voltage transformer in a G11 chassis, you might find that horizontal centering is needed.

Wire a 5-ohm 3-watt resistor and a power-supply diode in parallel, and connect this assembly between the blue yoke wire and terminal #3 of the HV transformer.

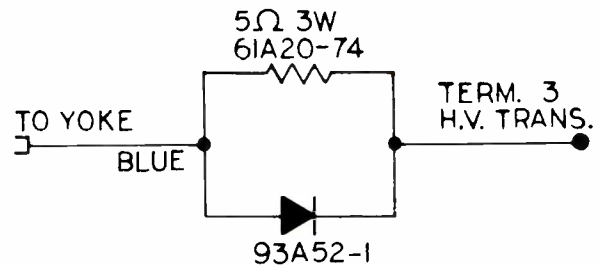

Courtesy of Admiral Corporation

Polarity of the diode determines the direction of centering. Diode polarity, as shown, shifts the picture to the left about one inch. Reverse the polarity, if centering to the right is needed.

Loss of sound

Admiral K20 color TV chassis

If you check one of these chassis for a complaint of "no sound" and find the audio IC is defective, check the grounding point of the .022-mfd tone control capacitor, C134. This capacitor **must** be grounded to the shield braid at the volume control. If it is connected to the tuner-cluster bracket, change this ground before you install a new IC.

One Color Missing

General Electric C2/L2 color TV chassis

When one color is missing from the raster and also from the color picture, remove the picture-tube socket and measure the DC voltages there.

Measure the control-grid voltages at pins 3, 7 and 12, and the screen-grid voltages at pins 4, 5 and 13. If one voltage is appreciably lower than the other two, suspect leakage of the spark gap inside the socket. Measure the resistance to pin 8 (ground), and replace the socket if leakage is indicated. □

Don't forget...the training, the discipline, the experience, the leadership, the teamwork, the loyalty, the determination.

Don't forget all the assets veterans have. Attitudes that make them highly-motivated, productive individuals. Skills adaptable to a variety of industries and positions. Proven trainability and self-discipline. Don't forget. Don't forget all they learned . . . sometimes the hard way.

For help in hiring veterans, contact your local office of the State Employment Service;
for on-the-job training information, see your local Veterans Administration office.

Don't forget. Hire the vet.





Fig. 1 The registration and information booths on the sixth floor of the Jung Hotel were the center of activity.

At the convention

NEA-NATESA announce historic merger

by Carl Babcoke

Highlights of the recent NATESA, NEA, ETA of Louisiana and ISCET conventions held August 9-13 in New Orleans.

PEACE, IT'S WONDERFUL! This well might have been the theme recently of the combined convention in New Orleans of NATESA, NEA, ETA of Louisiana (host organization) and ISCET. Not only was there peace between the National Alliance of Television & Electronic Service Associations (NATESA) and the National Electronics Associations (NEA), whose memberships voted to merge, but good feeling also was evident between the assembled technicians and the visiting manufacturer's representatives who made speeches, conducted seminars, and presented displays in the Trade Show.

A full crew of reporters would have been required to cover all the action in the Jung Hotel; often several important meetings or seminars were scheduled simultaneously. Any omissions in our coverage are strictly accidental, and do

not reflect our opinion of their importance.

The registration and information booths on the sixth floor of the Jung Hotel were a beehive of activity as latecomers registered. Some conventioners wanted to know the room number of a friend or a hospitality suite, and others asked about the correct meeting room, often changed at the last minute.

After a welcome by Roger Drost, of the host organization ETA of Louisiana, the convention was officially opened with keynote speeches by presidents Leo Shumavon of NATESA and Norris Browne of NEA.

Shortly afterwards, Morris L. Finneburgh made an impassioned plea for merger of the two organizations and retention of the leaders, including both Dick Glass (NEA) and Frank Moch (NATESA). Mr. Finneburgh offered to take a year's leave of absence from his company and help if the merger was approved. The thunderous applause and the joking reference by one of the speakers that Mrs. Finneburgh (often affectionately called "Babe") should be renamed

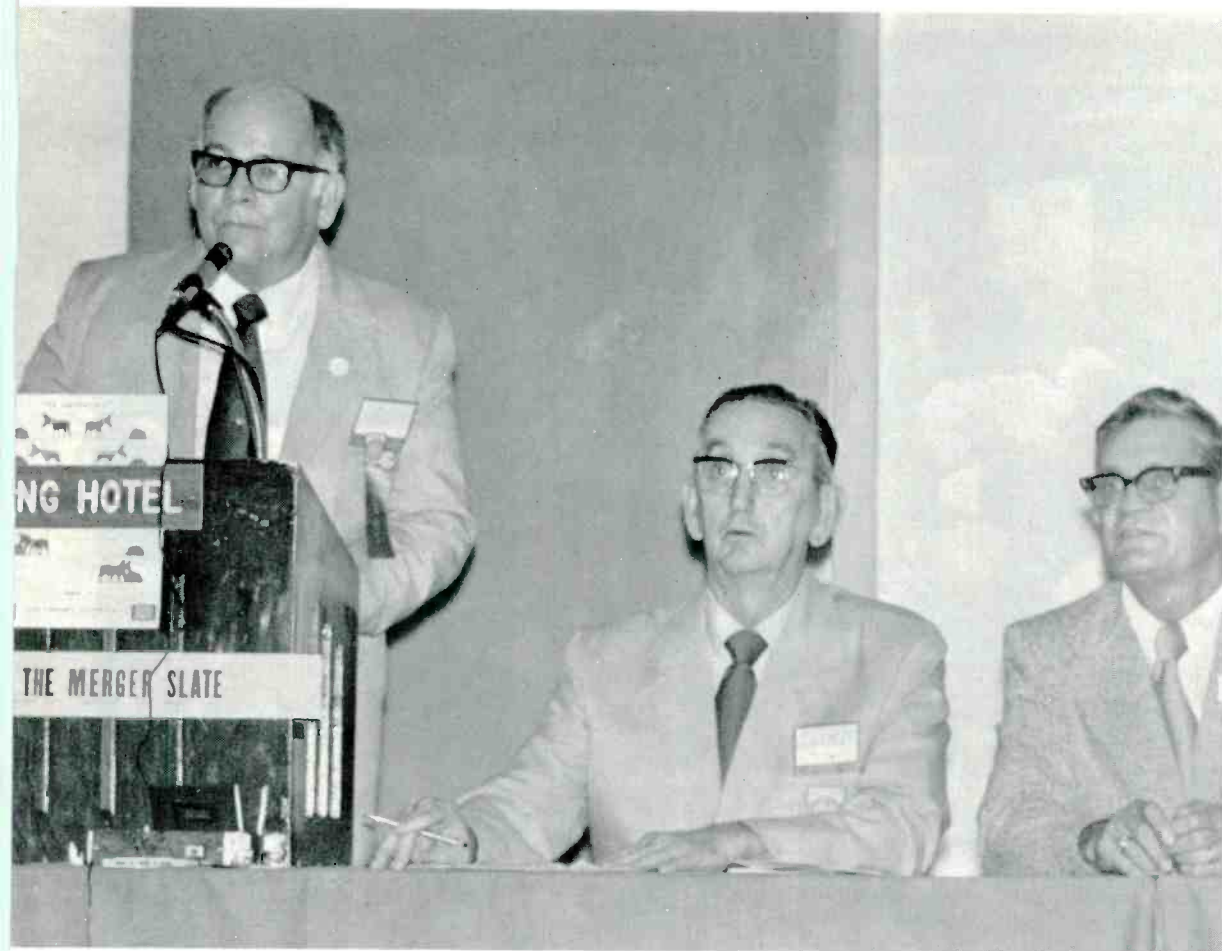

Fig. 2 Henry Smith, ETA of Louisiana President, welcomes those attending the convention, while Roger Drost, of ETA of Louisiana, and Norris R. Browne, President of NATESA, wait their turn at the podium.

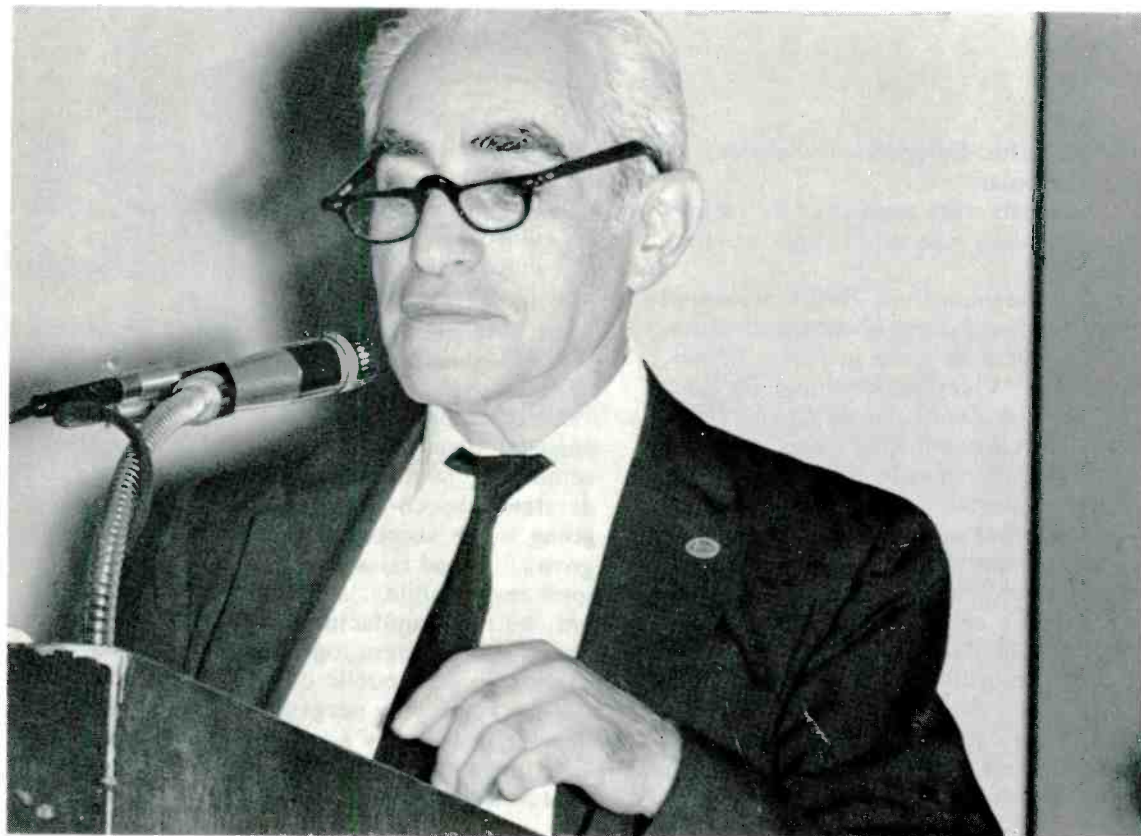

Fig. 3 Lee Shumavon, NATESA President, at the microphone making one of the keynote addresses.

Fig. 4 A full house was the rule at every Business Management School session. Bob Bond lectured at this one.



Fig. 5 Lew Edwards presents a Serviceability Design Award (SDA) to John Kelly, vice-president of Magnavox.

“SIS” (for Superior Independent Service) all testified to his popularity.

Many of the meals were sponsored by various electronics companies who often supplied after-dinner speakers.

An official spokesman from Zenith presented some interesting speculations about the electronic devices that might be used in future homes. Dr. Robert Adler, Vice-President and Director of Research for the Zenith Radio Corporation, prophesized that television would gain in importance during the next decade with applications far beyond mere entertainment.

Dr. Adler said that color TV would continue to be the most important consumer electronic product even in 1985 because vision is the most important of man's senses. Also, he predicted the development of flat-panel TV screens and low-cost video recording and playback equipment.

“By 1985,” Dr. Adler said, “a component failure of any part of a color television set, or a consumer device of similar complexity, should be a rare event, indeed. On the other hand, the

addition of new devices such as those for video recording and playback, and various automatic features to replace manual adjustments, will increase complexity. Highly-trained service people will clearly be needed to maintain such sophisticated equipment.”

At another banquet, Ed Stehle, Vice-President of General Electric, also spoke about the future of the electronic servicing business. “By 1985, three-out-of-four in the work force will be engaged in supply and services,” he told the assembled conventioners. “And those who understand the consumer are the ones who are going to be successful as the service business grows.” Good reliable service, he declared, is a joint responsibility, and “good, bad or indifferent, we the manufacturer, and you the servicer, are in this business together.” Continued cooperation to gain public confidence, according to Stehle, is not only necessary for success, but for survival. “In today's consumerism market, public confidence is granted only if the service is the best attainable,” and he termed this the joint goal

(Continued on page 18)

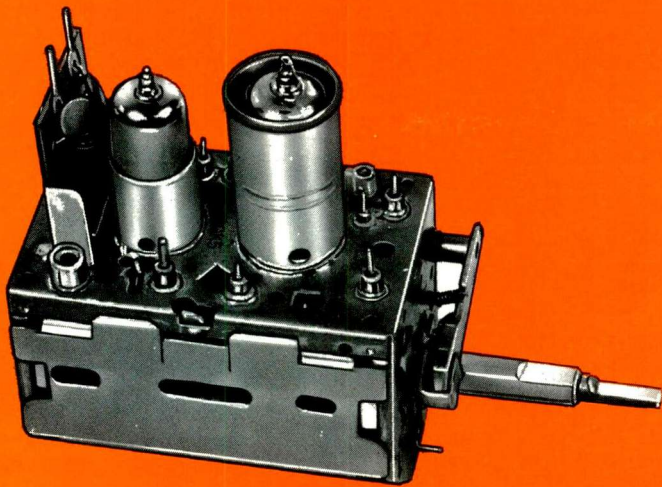

\$975

ALL PARTS INCLUDED

ONE YEAR GUARANTEE

TUNER SERVICE CORPORATION

PROVIDES YOU WITH A COMPLETE SERVICE FOR ALL YOUR TELEVISION TUNER REQUIREMENTS.

REPAIR

VHF Or UHF Any Type \$9.75.
UHF/VHF Combo \$15.00.

In this price all parts are included, tubes, transistors, diodes, and nuvistors are charged at cost.

Fast efficient service at our 5 conveniently located service centers.

All tuners are cleaned inside and out, repaired, realigned and air tested.

REPLACE

Replacement Tuner \$9.75.

This price buys you a complete new tuner built specifically by SARKES TARZIAN INC. for this purpose.

All shafts have a maximum length of 12" which can be cut to 1 1/2".

Specify heater type parallel and series 450mA or 600mA.

CUSTOMIZE

Customized tuners are available at a cost of only \$15.95.

Send in your original tuner for comparison purposes to:



TUNER SERVICE CORPORATION

FACTORY

TUNER SERVICE

Backed by the largest tuner manufacturer in the U.S.—

Sarkes Tarzian, Inc.

- INDIANA** 537 S. WALNUT, Bloomington, Indiana 47401 TEL: 812-332-7251
(Headquarters)
- 817 N. PENNSYLVANIA ST., Indianapolis, Indiana 46204 ... TEL: 317-632-3493
- NEW JERSEY** .. 547-49 TONNELE AVE., Jersey City, New Jersey 07307 TEL: 201-792-3730
- VIRGINIA** 4538 PRINCESS ANNE RD., Norfolk, Va. 23502 TEL: 703-855-2518
- GEORGIA** 938 GORDON ST., S.W., Atlanta, Georgia 30310 TEL: 404-758-2232
- KENTUCKY** 2920 TAYLOR BLVD., Louisville, Kentucky 40208 TEL: 502-634-3334
- FLORIDA** 1505 C PRESS St., Tampa, Florida 33606 TEL: 813-253-0324
- CALIFORNIA** .. SARKES TARZIAN, Inc. TUNER SERVICE DIVISION
10654 MAGNOLIA BLVD., North Hollywood, Calif. 91601 TEL: 213-769-2720

WATCH US GROW

Circle 12 on literature card

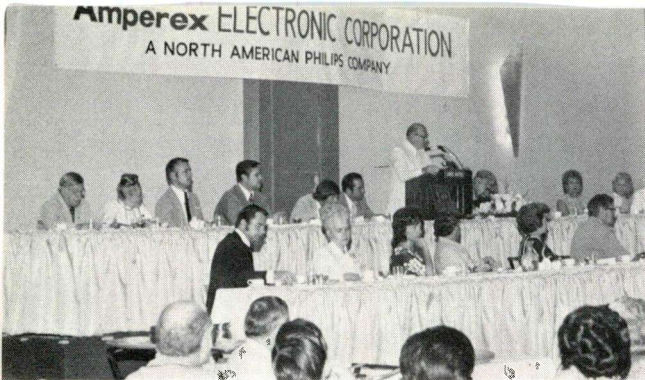

Fig. 6 An overflow crowd listens intently as John F. Rider tells of his experiences in the electronics field. Mr. Rider had just been inducted into the Electronics Hall of Fame.



Fig. 7 Emmett Mefford presents the plaque of the Electronics Hall of Fame to John F. Rider.



Fig. 9 Dick Glass and Frank Moch are inspired by Morris Finneburgh to show the enthusiasm felt by most members when the merger was official.



Fig. 8 For the first time, the new NEA and NATESA officers were installed together. Back row, left to right: J. Leach; E. Pershing; C. Cave; A. Powers; W. Carden; W. Cooke and M. L. Finneburgh (installer). Front row, left to right: J. Rollison; T. Cooper; V. Gaither; C. Couch; Leo Shumavon, C. Barvle, E. Gove and Phil Holt.

and challenge in the new era of solid-state TV.

Commenting on the serviceability ratings given GE receivers by the independent servicer panel, Stehle said GE was pleased by this, because it verified that GE had taken steps to design products so they are easy to service. As an example, he stated that GE is using the same signal-processing board in the company's 10-inch, 16-inch and 19-inch solid-state color TV's. This approach eliminates the need for technicians to become familiar with three different layouts, and it also minimizes the parts procurement problems.

Magnavox received a Serviceability Design Award plaque, which was presented by Lew Edwards and received by John Kelly, Vice-President of Magnavox. Zenith also received a similar award for their Model C4030 color receiver. This award was presented by John MacPherson (President of the Virginia Electronics Association) and accepted by Brian Marohnic, national service manager for Zenith.

Another highlight was the installation of John F. Rider into the Electronics Hall of Fame. Mr. Rider is a veteran of the electronics field, including a hitch in the Army Signal Corps, from which he retired in 1945 with the rank of Lt. Colonel. But, perhaps he is best remembered by oldtimers as publisher of the well-known Rider's Manuals.

Business-Management and technical seminars were well attended, as was the Trade Show, which consisted of several dozen attractive booths by various manufacturers.

Extra-curricular activities weren't overlooked either. Many conventioners also entered the golfing and bowling tournaments, or played hooky long enough to investigate (and photograph) the interesting and historic old French Section of New Orleans.

Business meetings and elections by both major organizations concluded the convention.

The new officers of NEA are: president, Charles Couch; executive vice-president, Dick Glass; treasurer, Tom Cooper; and secretary, Virgil Gaither.

New NATESA officers are: president, Leo Shumavon; vice-president, Charles Barvle; secretary-general, Earl Gove, Jr.; and treasurer, Phil Holt.

The International Society of Certified Electronic Technicians (ISCET) also elected these new officers: chairman, Phillip Dahlen; vice-chairman, Jim Boyd; secretary, Valerie Miller; and treasurer, Bob Cook.

Last, and most important was the decision of both NEA and NATESA to merge. One meeting about implementing the merger was held in New Orleans before the participants left the city. A second meeting was held in Memphis, Tennessee this last September.

The editor and staff of ELECTRONIC SERVICING sincerely wish both organizations the best of luck and a minimum of problems as they undertake this historic merger. And we believe that all electronic technicians should join and support the new organization that will result. □

Why RCA XL-100's can be a quick fix:

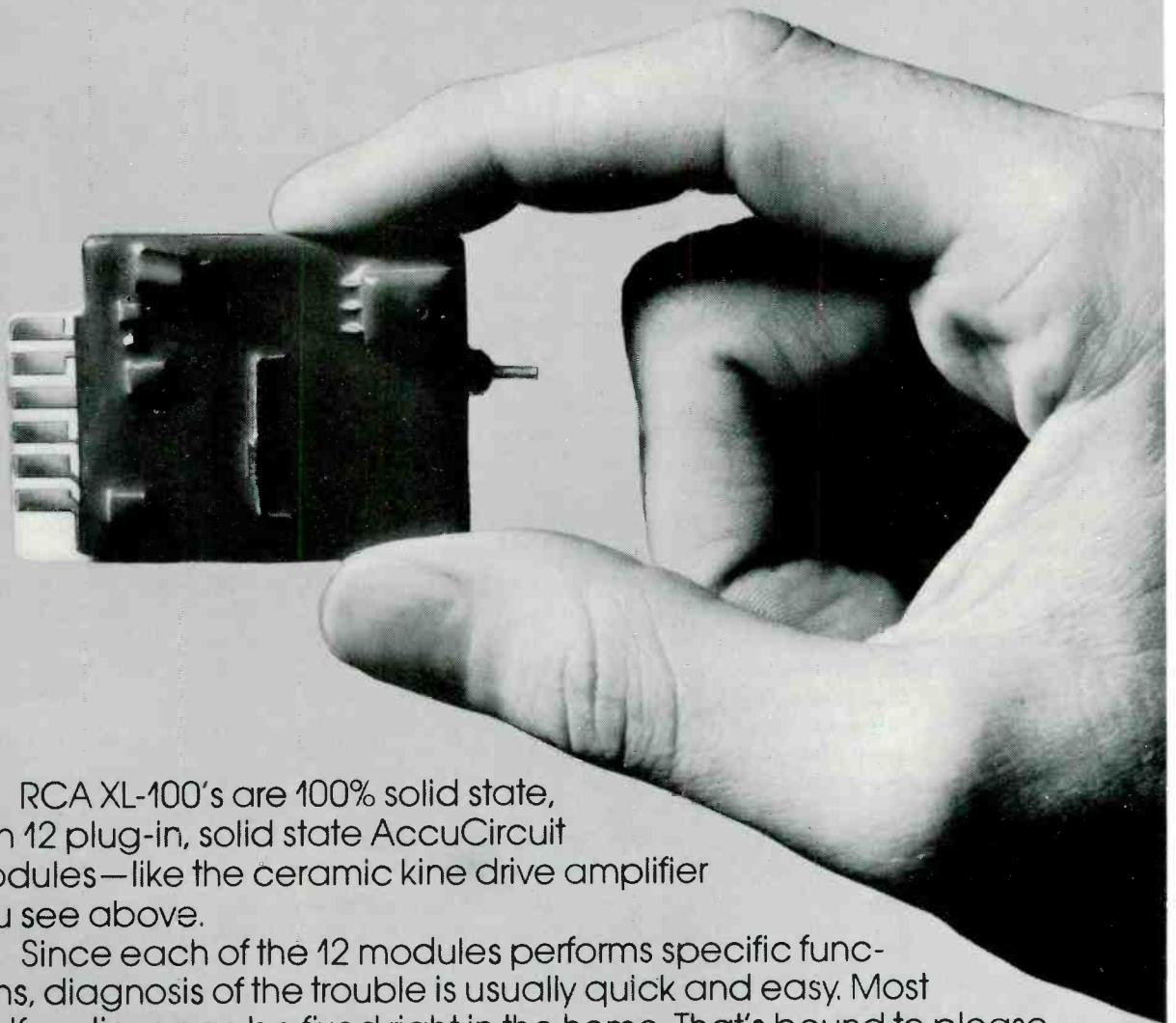

RCA XL-100's are 100% solid state, with 12 plug-in, solid state AccuCircuit modules—like the ceramic kine drive amplifier you see above.

Since each of the 12 modules performs specific functions, diagnosis of the trouble is usually quick and easy. Most malfunctions can be fixed right in the home. That's bound to please your customer.

So when it comes to servicing RCA solid state color, XL-100's let you make more house calls—in a lot less time!

And you won't waste so much time hauling sets back and forth to the shop.

Something else: Whether you're servicing an XL-100 console, table model or portable, most modules are interchangeable, function for function. That will make your life easier, and you won't have to worry about stocking a large parts inventory.

RCA XL-100. It's already got a great reputation. It could even add to yours.

RCA **XL-100** 
100% Solid State AccuColor

4-CHANNEL SOUND...A Profusion Of

By Wayne Lemons

Confusion, claims and counter-claims of the rival systems often obscure the basic issues of the new 4-channel sound. This interim report should answer most of the questions occurring either to you or your customers. After the situation has stabilized, we will cover the circuitry and servicing techniques for 4-channel equipment.

Some wit has said that if Nature had intended for people to listen to 4-channel stereo sound, she would have provided us with four ears! Perhaps this jibe isn't screamingly funny. But it does illustrate the feeling shared by many that 4-channel sound is not very practical. At least, not at this time.

To place the problems in perspective, we'll review briefly what 4-channel sound is, and why it is desirable.

4-Channel Sound Adds Depth To The Width

Conventional 2-channel stereo gives the illusion of directivity.

Often, we can hear the locations of the instruments that are playing the music. However, the instruments seem to be arranged in a straight line from side to side in front of us.

This same lateral directional effect also is reproduced by 4-channel stereo, but with added reverberation and auditorium noises, or the sounds of unconventionally-located musical instruments, coming from the sides or from behind the listener. When you listen, the sounds surround you.

At its best, such spacious musical reproduction closely approaches the beauty of "live" sound.

Which System Of 4-Channel Sound Is Best?

Unfortunately, into this paradise of aural perfection intrudes the noise of a huge technological and merchandising war. Both major methods of reproducing 4-channel sound are championed by companies who have been antagonists in

similar battles for many decades. These giants are RCA and CBS. We all know of the bitter fights over 45-RPM and 33-RPM records, and electronic-scanning of color television versus mechanical scanning. Luckily, our industry was spared such costly fights over 2-channel stereo records.

But now the same battlers, and their allies, are marshalling their strongest arguments to prove their system of 4-channel sound is best. Neither side wants such a battle, but both want the other to give in.

Discrete 4-Channel Sound

Most experts agree that the ideal method for reproducing natural-sounding 4-channel music is to have four separate (discrete) channels all the way from the recording studio to four separate speaker systems in the listening room.

However, this is not always possible. FM stations cannot broadcast discrete 4-channel sound until

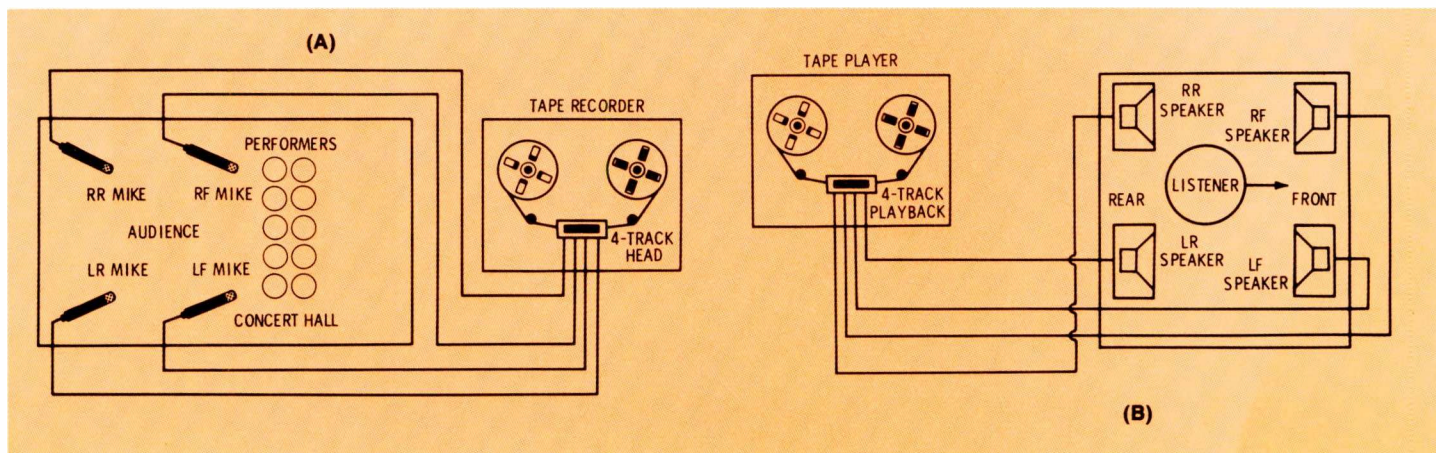

Fig. 1 This arrangement of microphones and playback speakers gives natural sound from symphony orchestras playing in large auditoriums.

Confusion

the FCC rules are changed. Discs with 4 discrete channels are promised, but are not generally available as yet.

Audio tape is the easiest source of four discrete channels. Cassette 4-channel tapes should be available shortly. And, 4-channel stereo-8 tapes are here now in limited quantities for those having a tape machine capable of playing them.

One method of arranging the microphones and playback speakers for discrete 4-channel stereo on tape is shown in Fig. 1. Other placements also can be used, but this one is very effective for reproducing the music of symphony orchestras.

But the tape method, although ideal from the electronic standpoint, suffers from economic problems. Twice the number of separate tracks are required for 4-channel compared to conventional stereo. This cuts in half the number of minutes of music from each tape of the same length. Also, tapes cost more than discs which play the same amount of music.

Discrete 4-Channel Records

Disc records playing four discrete channels appear to be the most practical answer to the needs of the mass market. Especially if the records would produce conventional 2-channel stereo when played on present stereo machines. Such compatibility is highly desirable.

The Japan Victor Company (JVC) has announced their new version of an old idea (once proposed for the original stereo records). In this system, a frequency-modulated supersonic carrier is

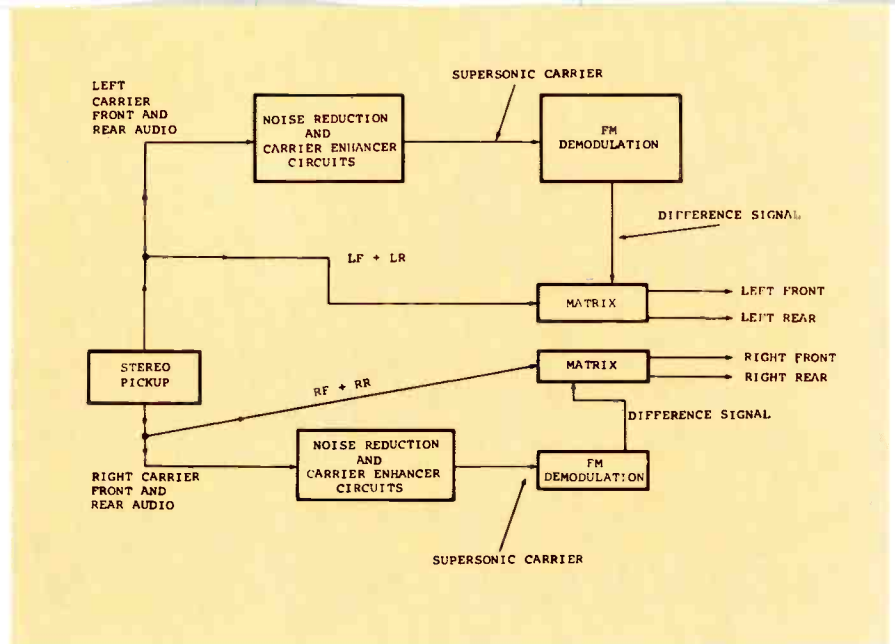

Fig. 2 A simplified diagram of the circuits used in playing JVC-system 4-channel discrete-stereo records made by RCA. Each channel during recording has an added 30-KHz carrier that is frequency-modulated by the stereo-difference signal. During playback, audio signals of the two normal stereo channels are mixed with the signals recovered from the carriers to provide four discrete stereo signals which are amplified and supplied to four speaker systems.

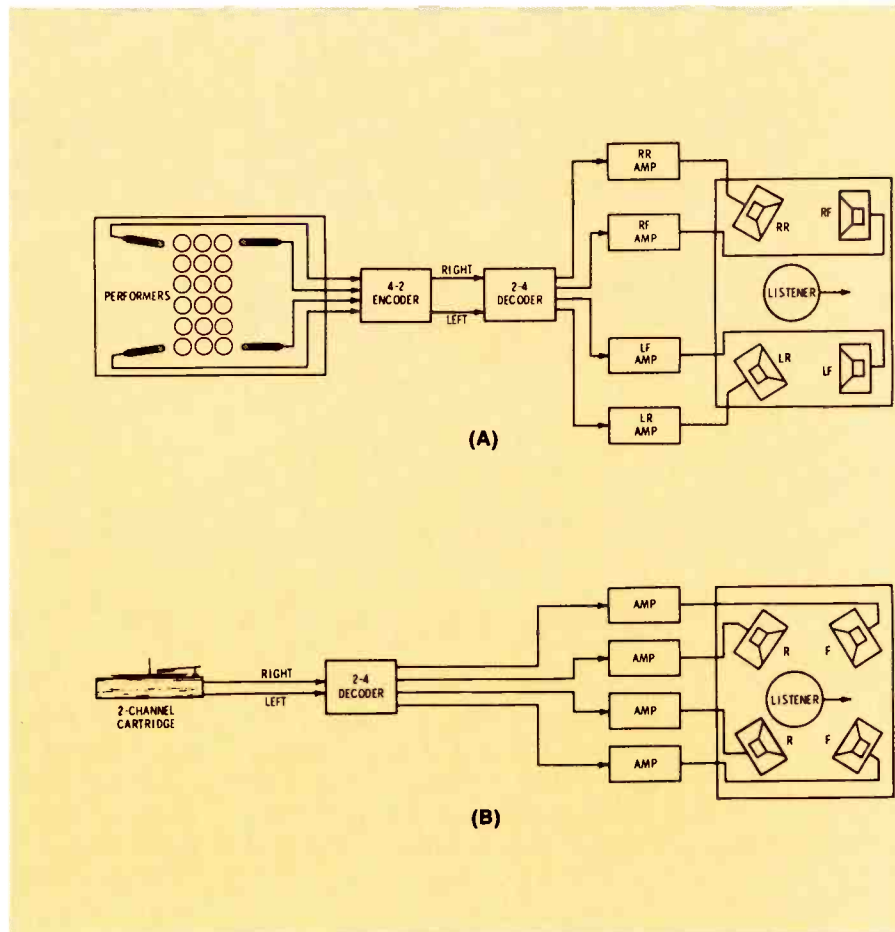

Fig. 3 Encoders and decoders are used in matrixing systems to permit transmission of 4-channel information with 2-channel equipment. **(A)** This arrangement is used in 4-2-4 systems for stereo FM or stereo tapes. **(B)** Matrix-encoded records require a complementary decoder during playback to provide the four channels.

RCA antennas- your answer for the 2 toughest questions you get.

1. "How do I get a better picture?"
2. "What does it cost?"

With RCA in your inventory, you'll never have to turn down a sale because you don't have the right image-improver. RCA has everything for every reception problem—a complete line of outdoor antennas, rotators, reception aids and hardware. Each RCA product is a precision engineered, top quality performer in its class. All carry the RCA name that your customers know they

can depend on. And the complete array of models gives you a full range of prices to bargain from, too.

Next time you get a tough question from a customer, make sure you have RCA on hand to answer it for you.

See your RCA Parts and Accessories distributor today, or contact RCA Parts and Accessories, Deptford, N.J. **RCA**

Circle 14 on literature card

added to each channel of the conventional 45°/45° stereo record. The normal left/right stereo channels carry the "sum" of the front and rear sounds, and they reproduce the usual stereo effect when played on present-day machines. The carriers are modulated by the "difference" signals which, after demodulation and mixing with the right and left channel signals, produce four separate discrete channels of stereo sound.

Although the basic idea of such a system is simple and straightforward, two severe problems must be solved. Because each FM carrier has a center frequency of about 30 KHz, separation of the channels during both recording and playback must be very good up to nearly 50 KHz. That's very difficult! Also the durability of the record material and the compliance of the playback stylus must permit many playings without shearing off the tiny undulations of the carriers.

For their contribution to the new disc system, RCA has produced a record material mix which they claim is about five times more resistant to wear than is the conventional vinyl, and should allow more than 100 playings without loss of the carriers.

Figure 2 shows the routing of the signals from the special stereo cartridge through the carrier-enhancer and noise-reduction circuits, the FM demodulators, and the matrixing circuits.

The JVC playback system (called CD4) also features the Shibata stylus, which has an elliptical tip plus a special shape of the rear side designed to improve contact with the record groove, and also to reduce wear of the record.

Records cut for use with this type of playback equipment give four discrete channels when used with JVC or Panasonic machines. When played on conventional machines, these records produce 2-channel stereo, because the cartridges and amplifiers ignore the carriers.

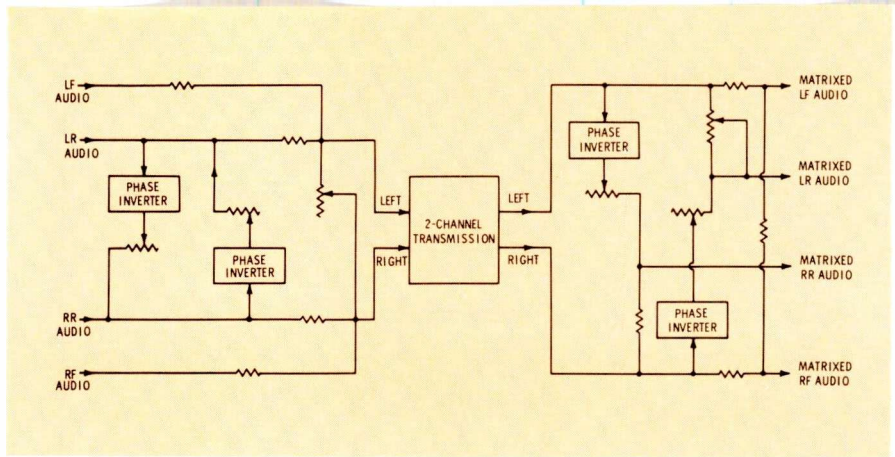

Fig. 4 Some encoder/decoder systems are based on this diagram which uses 180° phase shifts. One drawback is the cancellation in certain listening areas of some portions of the music.

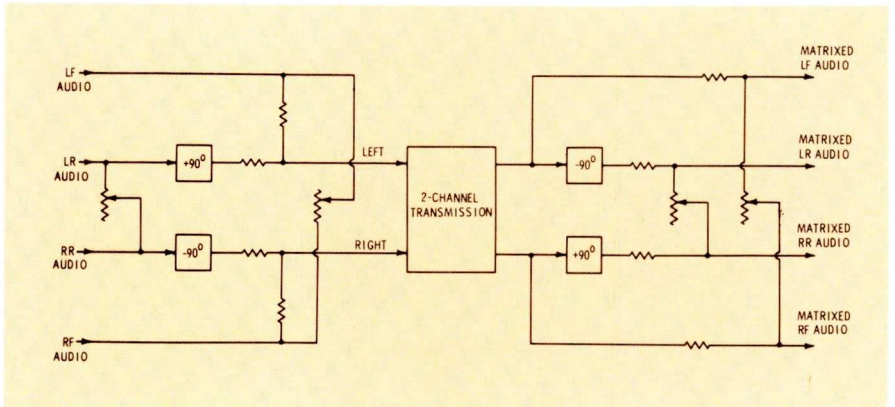

Fig. 5 The Sansui QS system avoids any complete cancellation by shifting the phases by +90° and -90°.

Only time and extensive field-testing will reveal whether or not this system is satisfactory for adoption industrywide.

Matrixed 4-Channel Sound

The sky is the limit in this wild and unpredictable field of matrixed 4-channel sound. For one thing, there are several basic ways of matrixing.

Some pioneers couldn't wait for the encoded records and they tried conventional stereo through three- or four-speaker arrays with various electrical phasings of the voice coils, and experimental locations of the speakers in the rooms. Many such hookups used only one 2-channel amplifier. Page 37 of the October, 1971 *ELECTRONIC SERVICING* gave some information about one such method. Some recordings were reported to give a beautiful effect when played over these far-out systems, while others gave some weird sounds.

A more scientific approach is the use of encoders during recording, and complementary decoders during playback. One such system is illustrated in Fig. 3.

The schematic of many encoder/decoder circuits are similar to those of Fig. 4, which require 180° phase shifts. However, this 180° phase sometimes results in cancellation of portions of the music.

Another method, said to eliminate the unwanted phase-cancellations, is the Sansui QS system which uses plus and minus 90° phases (Fig. 5).

Other matrixing circuits are recommended by Electro-Voice and Columbia Records who recently agreed to an exchange of patent rights covering 4-channel sound.

The situation is changing so rapidly that it is useless to list any more variations of the matrixing principle.

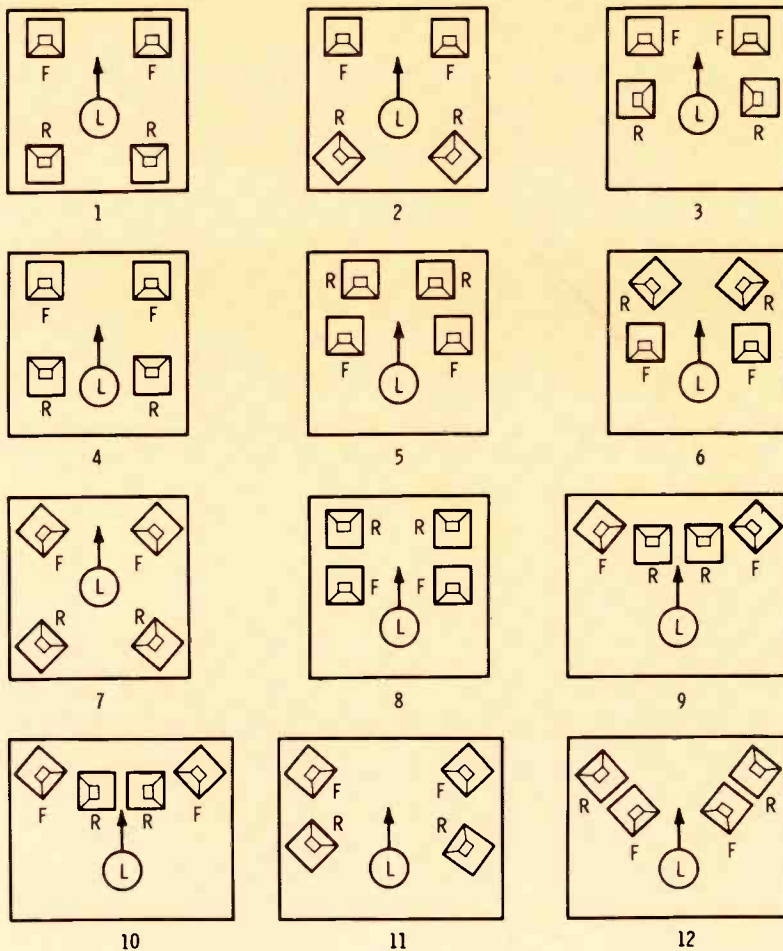

Fig. 6 Here are some of the speaker arrangements you can try either with matrixed-stereo records, or with simulated-4-channel hookups made by the phasing of speakers.

The Debate Rages On

Adherents of the discrete systems insist that only their method can give the excellent channel separation necessary for life-like sound.

Partisans of the matrixing methods reply that the early "ping-pong" type of exaggerated stereo effect was unsatisfactory and later was replaced by mixed (matrixed) sound which gave more blend and less separation. They accuse the discrete boosters of insisting on "ping-pong-pang-pung" 4-channel effects.

The matrix system does have several good talking points. One is compatibility; that is, 4-channel matrixed records play okay on 2-channel stereo machines. However, the discrete reply is that the musical sound is not very natural.

Also, when played through a 4-

channel matrixed system, 2-channel records produce a synthetic diffused-stereo effect which many people find quite pleasant. On the other hand, critics say the sound is not natural.

Speaker Locations

Speaker placements for 4-channel matrixed sound give results ranging from a "It seats you right in the center of the orchestra" effect to "I want to listen from the 20th row center."

There are no right or wrong ways of connecting or locating the four speaker systems; only your ear can be the judge. Some possible speaker locations are diagrammed in Fig. 6. Try them for yourself; some of the results will be very pleasant.

Selling Methods For 4-Channel Sound

While researching for this arti-

cle, I visited a number of "big name" hi-fi stores in a city of about 125,000 people. I wanted to hear different brands and systems, and to find out how a salesman would try to "sell" a potential customer.

When I asked a salesman whether or not I should buy 4-channel equipment now, invariably the answer was, "Sure, it's great! It's the coming thing, just like being at the performance", and so on.

"But", I said, "I have heard there is now no standardization. If I buy today, will my equipment be obsolete right away?" The best answer I got was, "Oh, it won't become obsolete; they've got all that worked out." But, when I innocently asked who "they" were and what they were doing about it, the salesman handed me a brochure and escaped to wait on someone else.

Such ignorance of the product certainly doesn't help to sell 4-channel merchandise.

And none of the demonstration setups were adequate. Connections were haywired, with speakers placed just anywhere, or perhaps stacked among other components. Not once did I hear a demonstration of the "overwhelming difference" between "old-fashioned" stereo and the new 4-channel sound.

If you sell 4-channel equipment, this is my advice:

- Learn enough about 4-channel systems to be able to explain or defend the brand and type you sell; and
- provide a realistic demonstration of good sound quality by having the equipment placed for optimum listening.

Or, if you are thinking about buying a 4-channel stereo system for your own use, try to listen to a demonstration which does justice to the music. If it pleases you, buy it; there is never a time when progress ceases and it is "safe" to purchase anything. □

TV TUNER SERVICE

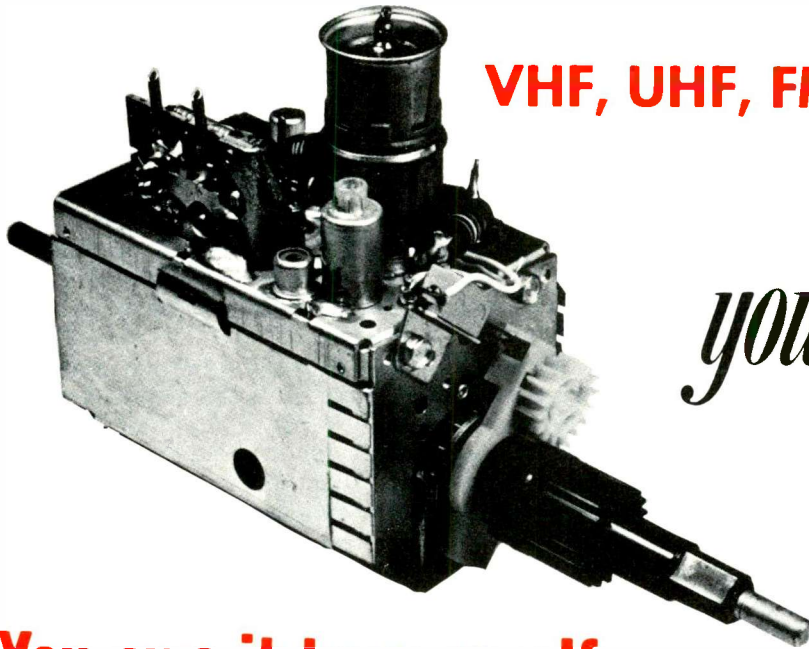

VHF, UHF, FM or IF-Subchassis. . .
 . . . All Makes

you get...

Fast 8 hr. Service!

You owe it to yourself

1 YEAR GUARANTEE

to try P.T.S. We are the fastest growing, oldest and now the largest tuner service company in the world. Here is what you get:

1. Fastest Service — 8 hr. — in and out the same day. Overnight transit to one of our six plants, for parts, tuners or IF-modules.
2. All tuners cleaned inside and out, repaired, realigned and air tested.
3. On IF-modules all stages checked, all traps set with high calibre test equipment.
4. Fine Quality! Your customers are satisfied and you are not bothered with returning your units for rework!
5. Lower Cost! Up to \$5.50 less than other tuner companies!
6. Friendly, helpful personalized service!

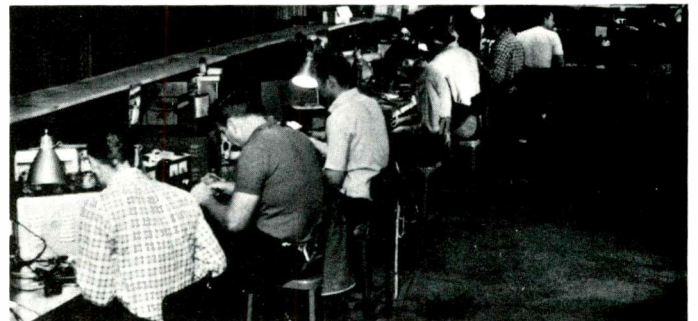

FIRST TO OFFER 365-DAY GUARANTEE!
 COLOR—BLACK & WHITE—TRANSISTOR TUNERS—ALL MAKES
 GUARANTEED COLOR ALIGNMENT—NO ADDITIONAL CHARGE

We offer you finer, faster...

VHF-UHF-FM	\$ 9.95
UV-COMBO	\$16.95
IF-MODULE	\$12.50

Major Parts charged at Net Price

CUSTOMIZED REPLACEMENTS AVAILABLE
 FOR \$12.95 UP (NEW OR REBUILT)

**Precision
 Tuner Service**



LIKE TO DO IT YOURSELF?

PTS makes all tuner parts available to you.

Send one dollar (redeemable) for our
TUNER REPLACEMENT GUIDE AND PARTS CATALOG

- 60 pages of top information
- Blow-up of all tuners
- Largest exact tuner replacement guide
- Antenna Coil Replacement Guide
- Multi-fit Replacement Tuner Shaft Guide

For fastest service, send faulty unit with tubes, shields and all broken parts to:

PTS ELECTRONICS, INC.

HOME OFFICE—P. O. Box 272—Bloomington, Ind. 47401 Tel. 812/824-9331
 EAST— P. O. Box 3189—Springfield, Mass. 01103 Tel. 413/734-2737
 WEST COAST— P. O. Box 41354—Sacramento, Calif. 95841 Tel. 916/482-6220
 MOUNTAIN— P. O. Box 4145—Denver, Colo. 80204 Tel. 303/244-2819
 SOUTHWEST— P. O. Box 7332—Longview, Tex. 75601 Tel. 214/753-4334
 SOUTHEAST— P. O. Box 6771—Jacksonville, Fla. 32205 Tel. 904/389-9952

Circle 15 on literature card

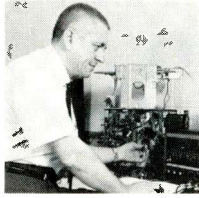

By Carl Babcoke

The inside story of horizontal phase detectors

Continuing our series of in-depth analysis of the basic television circuits, we take a searching look at duo-diode horizontal phase detectors and give troubleshooting tips for better servicing.

Any horizontal phase detector using a duo-diode appears to be very simple. The one we're using as an example has only 12 components. And yet, some of the electronic actions in these circuits are so complex that we often take the theory on faith without really understanding it.

Because we believe that all technicians can service more accurately and more rapidly when they understand the operation of the circuit in question, we are combining the theory of horizontal phase detectors with troubleshooting tips.

Further, we are attempting to explain all horizontal phase detectors by analyzing thoroughly just one specific example.

The schematic in Fig. 1 includes the normal DC voltages and waveforms of the horizontal phase detector in an Admiral 25D6 color chassis, which is covered in PHOTOFACT 540-1. This chassis is nearly identical with the RCA CTC10, and others.

Requirements Of Phase Detectors

For any horizontal phase detector to give the best results, it must fulfill these conditions:

- A DC error-correcting voltage must be produced by leading or lagging phases between the horizontal sync and the reference signal from the sweep circuit. This control voltage is used to maintain horizontal locking and also the desired phase.

- Reasonable variations in the amplitude of the sync should not cause locking problems, or bending of the picture.
- The frequency of the horizontal oscillator, which is determined by the action of the phase detector, should be nearly the same either with or without a sync signal. This helps eliminate "hooking" at the top of the picture. Also, the high voltage and the width of the picture are the same whether or not a station is tuned in.
- Correction of wrong phase should be very rapid, but without "hunting" or "piecrusting".

A Preview Of Operation

Many phase detectors, such as those for color locking, or horizontal phase detectors in older TV receivers, compare the phases of a push-pull sync signal to a single-ended sweep waveform. These are simple circuits that are easy to analyze.

Not so with the duo-diode type of horizontal phase detector. Although it's true the action of the circuit has the same effect as a push-pull sweep signal and single-ended sync pulses. It's interesting to see how this unlikely situation occurs.

Two Peak-Reading Series Rectifiers

Both diodes simultaneously rectify (Fig. 1) the sweep and sync signals. But a different type of rectification is used for each signal.

When they rectify the sweep waveform (W4 waveform, nearly a sawtooth), both diodes act as series-type peak-reading rectifiers. Now someone is sure to question that statement, because the signal enters through C72 and C71. Shunt-rectifier circuits normally

bring the AC in through a capacitor, while series circuits usually have a DC path through an input transformer. This circuit is an exception to those general rules.

The simplified schematics in Fig. 2 show the electron current flow during both the positive and negative peaks of the sweep sawtooth. Notice this: either diode **alone** (the other diode removed) rectifies in the shunt mode, and the DC voltages obtained are opposite in polarity from those shown in Fig. 2. But when the actions of Figs. 2A and 2B proceed alternately, C72 (and also C71, less importantly) discharges each time either diode conducts. This prevents C72 from becoming the peak-reading input capacitor of a shunt-type rectifier circuit. The action is the same for AC as though the input waveform entered via the secondary winding of a transformer connected where C73 is now.

To make the rectifier action clear, we have shown the sync-coupling capacitor, C69 returning to ground. In the actual circuit (Fig. 1), the resistance of the sync circuit is between C69 and ground.

However, proof that this method of illustration is valid is found in the DC voltages obtained from the actual chassis. Without a sync signal (off-channel operation), rectifications by X1 and X2 of the sweep sawtooth produce nearly equal DC voltages which combined at the output measure within a few tenths of a volt of zero.

Also, peak rectification is proven by the narrow pulses of diode current shown in Fig. 3.

Looking at the separate paths of rectification in Figs. 2A and 2B, it is easy to see that R102 is the load resistor, and C69 is the peak-reading filter capacitor for X1, which supplies the positive part of the

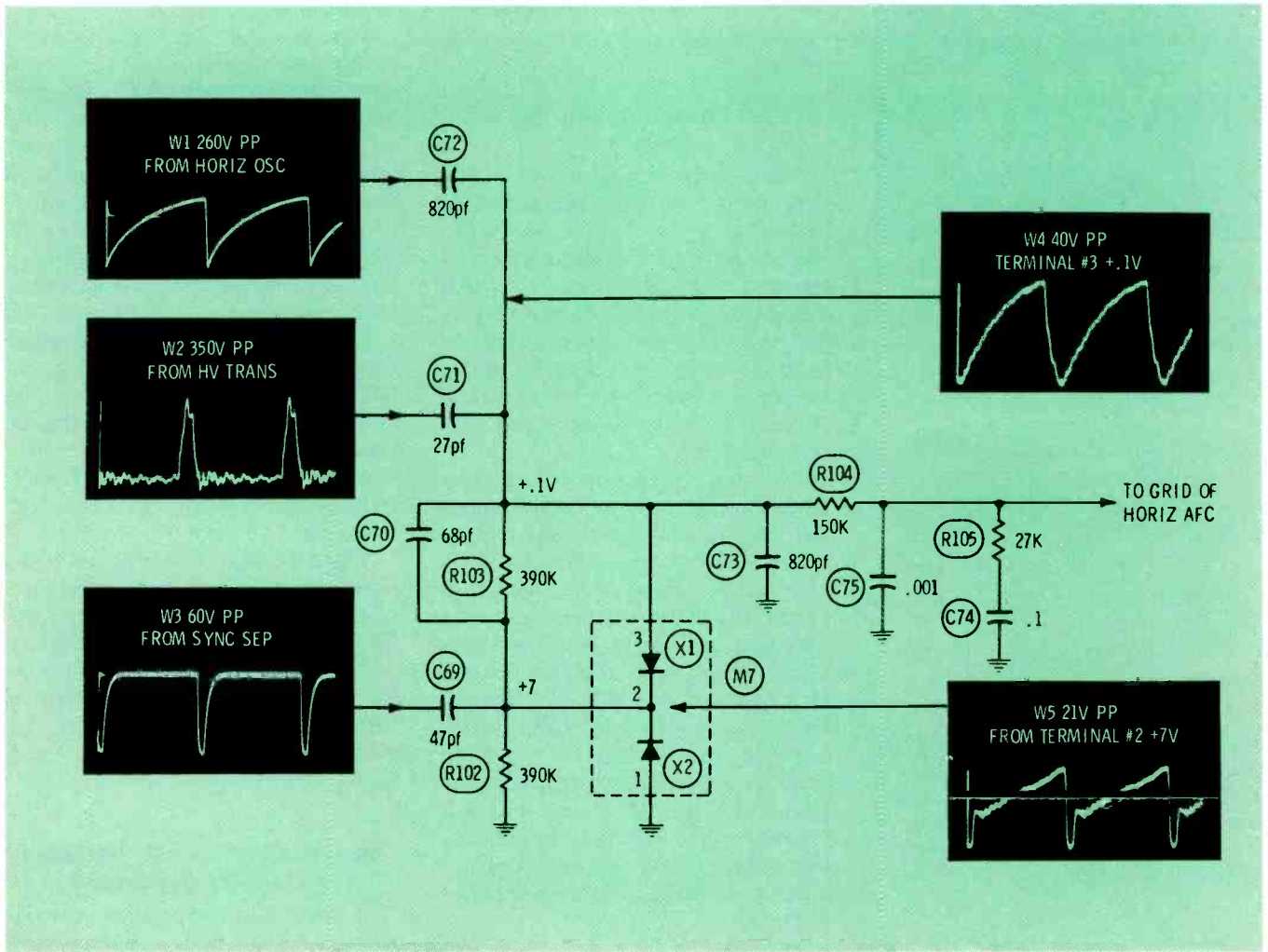

Fig. 1 Complete schematic of the horizontal phase detector circuit in an Admiral 25D6 color chassis. DC voltages and wave-

forms shown are those obtained from this one chassis, but they are nearly typical of many similar circuits.

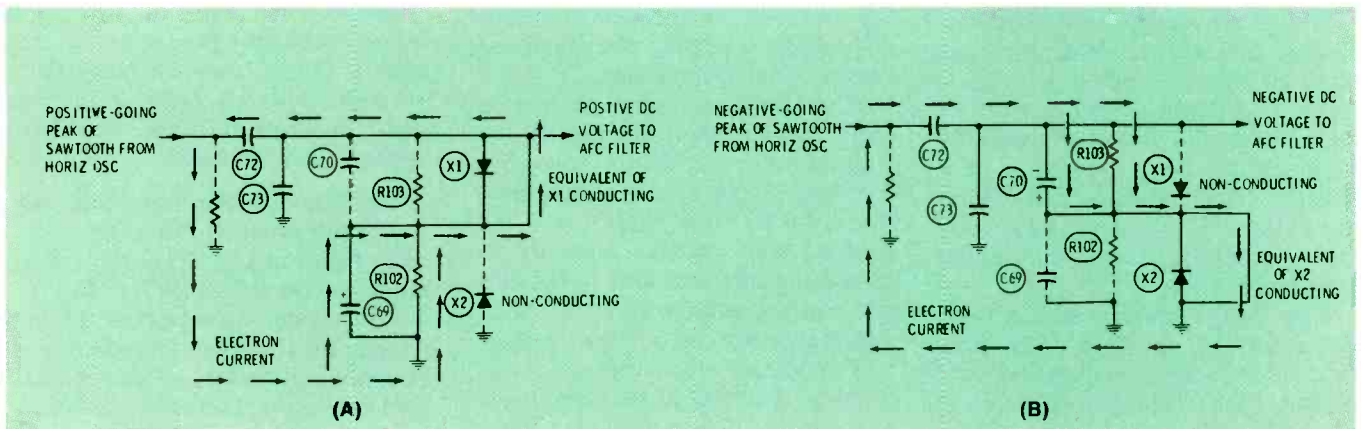

Fig. 2 The diodes alternately rectify the positive and negative peaks of the sawteeth coming from the sweep circuit. There is no sync. at this time. **(A)** Paths of the electron flow show that rectification is in a series-type peak-reading circuit, which produces a positive voltage at the output from rectification of the

positive peaks of the sawteeth. **(B)** Paths of the electron flow during rectification of the negative peaks of the sawteeth also show that the circuit is a series-type of peak-reading circuit. Negative voltage is produced.

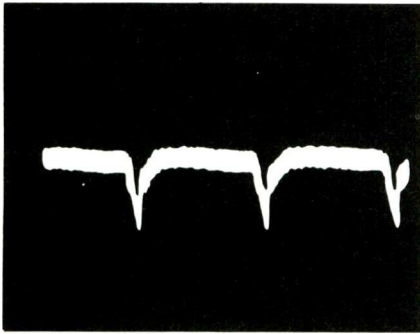

Fig. 3 Narrow, negative-going pulses of X2 diode current prove the rectification is peak reading, and that rectification occurs during the negative peak.

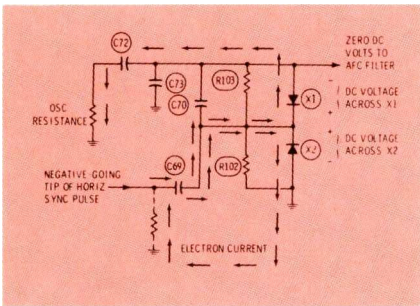

Fig. 4 Rectification of the negative-going sync signal is by shunt-type peak-reading action. This back-to-back series connection produces both positive and negative voltages which cancel to give an output voltage of nearly zero.

error-correcting voltage. Also, R103 is the load resistor, and C70 is the peak-reading filter capacitor for X2, and it supplies the negative part of the control voltage.

When these components, and the diodes, are all matched, the two rectified voltages are equal to each other, and opposite in polarity, so the output voltage is nearly zero. If a capacitor is open or leaking, or a resistor value too high or too low, the balance between the two voltages is upset and the output voltage is no longer zero.

This makes possible a very fast, yet accurate, method of testing those four components and the two diodes. Tune the receiver to a channel without any signal, and measure the DC voltage at the anode of X1 (output voltage). If the voltage is zero, or within a few tenths of a volt of zero, and the voltage at the common-cathode

connection is between +6 and +9 volts (showing rectification of the sawtooth of sweep), it is virtually a certainty that all those components are normal.

Two Peak-Reading Shunt Rectifiers

The negative-going pulses of the sync signal are shunt rectified also by the same two diodes. Arrows in Fig. 4 show the resulting electron current. Rectification by both diodes occurs simultaneously at the tip of the sync pulses. This is opposite to the rectification of the sweep sawtooth, which occurred alternately on the positive and negative peaks.

Although operation of the two shunt-rectifiers with sync pulses but without sweep sawteeth produces a DC output voltage that is only about .6 positive, the two shunt rectifier circuits are not identical, and the positive and negative voltages are not quite equal. In a practical way this is of no consequence, because operation without the sweep signal, but with sync, is nearly impossible in practice. The slight unbalance makes it impractical to use the shunt-rectifier mode to test the components, as was urged for the series-rectifier circuits.

Combining The Four Rectifying Actions

In actual operation, all four rectifying actions occur together. Perhaps it is more accurate to say that the mode of rectification is determined by whether the sync or sweep signal is dominant.

When the phase between the two input signals is correct and all the components are within tolerance for values, the sync voltage adds the same to both diodes, and the positive and negative voltages increase the same amount so the output control voltage is zero. Also, you remember, zero output voltage was obtained when the sync was missing. This fulfills the third basic requirement for duo-diode phase detectors, that the control voltage should be the same both on and off channel.

This situation also gives us another fast test. Suppose the hori-

zontal oscillator is off frequency. Is the trouble in the oscillator, or in the phase detector?

Just ground the error-control voltage at the output of the phase detector (the anode of X1 is a good spot), and attempt to bring the oscillator to frequency by using the hold control. If the phase detector is at fault, you will be able to adjust to the frequency (the picture upright), and also to obtain the diagonal bars with adjustments to either side.

If you can't obtain the normal frequency, the defect is in the oscillator circuit.

Of course, there are a few similar circuits designed so the error-correction voltage is always positive. Naturally, this quick test will not work with those few circuits.

When both the sweep and sync signals are present, any difference of phase between them causes the DC output voltage to swing slightly positive or negative, and this control voltage forces the oscillator to run slower or faster to bring the sweep signal to the phase of the sync.

How The Positive Or Negative Voltage Is Developed

It is difficult to visualize how the phase difference between the sweep sawteeth and the sync pulses can upset the balance of the two rectifier systems and produce the required positive or negative error-correction voltage. One problem is that the vital waveform across X1 can't be seen with any clarity. Our solution to this difficulty will be given later. First, we need to know how the waveform across X2 is produced.

The top waveform of Fig. 5A shows the sawteeth from the sweep circuit (W4 in Fig. 1), in the center are the sync pulses (W3 in Fig. 1), and the lower waveform is a composite of the two found at the common cathodes of the diodes (W5 in Fig. 1). The sync pulses are coupled through C69 to the common cathodes, and the sawteeth arrive through R103 and C70. This triple exposure was arranged to show the correct phase between the waveforms. The lower wave-

form here is the same as the lower one in Fig. 5B.

From the complete schematic, there doesn't appear to be any way for the sync pulse to affect X1. However, it is the voltage across X1 (not measured to ground) that is important. And the voltage across X1 is the waveform at the common cathode minus the waveform at the anode of X1. To obtain this waveform, it should only be necessary to connect the ground wire of the scope to the anode, and the low-capacitance probe to the common cathode. Unfortunately, the floating case and ground wiring of the scope applied to this ungrounded point introduces more hum than waveform. But, enough of the waveform could be seen so we could be certain of the shape, and then simulate a good waveform

photographically, as shown in the top waveform of Fig. 5B. Figure 5 shows the waveforms across both X1 and X2; they are mirror views of each other.

When the horizontal oscillator starts running too slow so the sweep waveform moves to the left of the sync pulse, the pulse protrudes less from the X1 (top) waveform. At the same time, the pulse of the X2 waveform protrudes more from the X2 (bottom) waveform. Therefore, X2 is supplied with more voltage, and produces more positive voltage. (This rectification is in the shunt mode, because the pulse has more amplitude than the sawtooth.) On the other hand, X1 has less voltage, and by shunt rectification produces less negative voltage. The two voltage supplies are no longer in balance,

and the output voltage is positive, which speeds up the oscillator until the phase error is nearly eliminated.

Of course, if the oscillator begins to run too fast, and the sweep sawtooth moves to the right relative to the sync pulses, opposite reactions take place, and the output voltage becomes negative to decrease the frequency of the oscillator.

Limits Of Locking

Once locked, the oscillator often remains locked, even though the phase (which affects the centering and the possible loss of burst) might be slightly wrong. At such times, the control voltage from the phase detector will **not** be zero. To learn more about horizontal locking, follow the adjustments and the normal results given next.

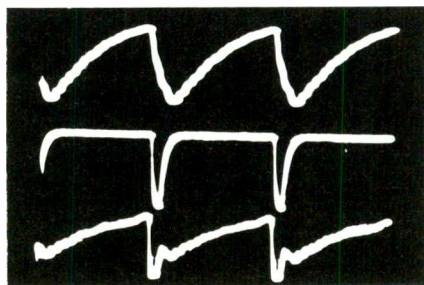

(A)

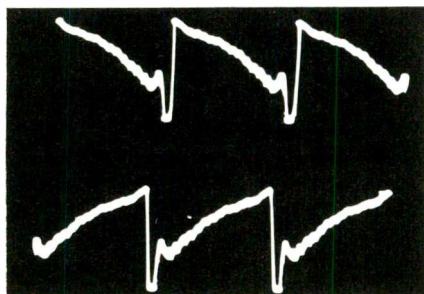
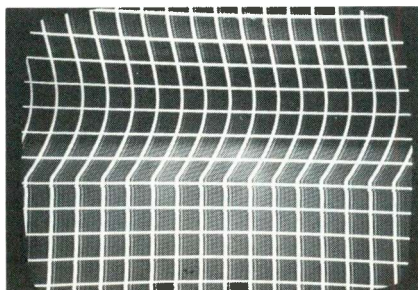

Fig. 5 Both sweep and sync waveforms are found at both diodes.

(A) Sweep sawteeth (top) added to sync pulses (center) produce the composite waveform (bottom) which is across X2 diode.

(B) The X2 waveform is shown at the bottom. At the top is the simulated X1 waveform, which is a mirror image of that at X2. When a phase change moves the sawteeth right or left, the pulses retract or protrude and this moves the zero-voltage point up on one waveform and down on the other. This action represents a voltage change to the diodes.



PICTURE MOVES TO RIGHT —LOSES COLOR



STRIPES SLANT DOWN TO THE RIGHT (LOWER FREQUENCY)

THEN

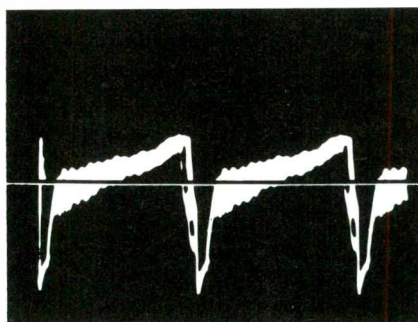

SWEEP LAGS THE SYNC AT COMMON CATHODE

ANODE OF X1 +2V
COMMON CATHODES +9V

(A)

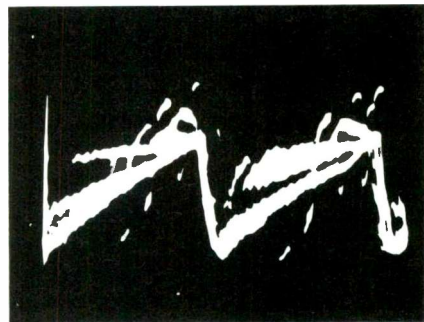

OUT OF LOCK AT COMMON CATHODE

ANODE OF X1 0V
COMMON CATHODES +7

(B)

Fig. 6 These pictures, waveforms and DC voltages were obtained when the horizontal locking was almost lost; and after the oscillator was forced out of lock.

(A) The horizontal hold control has been adjusted to move the picture to the right as far as possible without loss of locking.

(B) An additional adjustment of the hold control has forced the oscillator out of lock. Notice that the DC voltages are nearly the same as those measured when the oscillator was locked correctly.

Starting with locking that gives zero output voltage from the phase detector:

- Adjust the horizontal hold control so the picture moves slightly to the right. Go as far as possible without losing the locking.
- Voltages and waveforms of our test chassis are shown in Fig. 6A.

- Adjust the hold control more in the same direction until locking is lost.
- The new voltages and waveforms are in Fig. 6B.

Now, repeat the same adjustments, but move the picture to the left. Those results are given in Fig. 7. Notice that when the oscillator is

not locked, the DC voltages are the same as for correct locking; but the waveform at the common cathode tells the story.

Waveforms At The Common Cathode

The composite waveform at the common cathode connection of the duo-diode will be, in many cases, the only one you need to analyze. Samples of both the sync and sweep waveforms appear there, and the waveform is given in many schematics. For this reason, the common-cathode waveform is often the only one given in the following section of theory and troubleshooting tips.

C72

C72 brings the sawteeth from the horizontal oscillator to the diodes of the phase detector. An open C72 removed most of the sweep portion of the waveform at the anode of X1 and inverted (Fig. 8) the sawtooth there. The small remaining sweep was brought in by C71; therefore, the locking was touchy and the color tint sometimes was wrong.

Even a slight leakage of C72 effects the horizontal frequency. For example, leakage of only 5.6M forced the oscillator far out of frequency and caused a reading of +6.5 volts at the anode of X1.

C71

Apparently C71 brings in a small amount of pulse from the horizontal sweep system to make the oscillator lock at the point giving best centering of the picture on the raster, and also best burst keyer action. An open C71 removed the wrinkles from the waveform at the common cathode of the diodes (Fig. 9), and moved the picture about one-half inch to the left. Locking was not affected.

Leakage was not a critical factor, but leakage of 100K or less in ohms narrowed the range of locking.

C73

C73 reduces the oscillator sawtooth at the anode of X1. When C73 was open, horizontal locking became critical, and often the color was lost. AC voltages increased to 86 volts p-p at the anode of X1 and 37 volts p-p at the common cathode (Fig. 10).

(Continued on page 32)

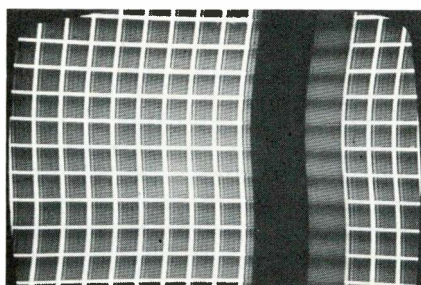

PICTURE MOVES TO LEFT—LOSES COLOR

THEN



STRIPES SLANT DOWN TO LEFT (HIGHER FREQUENCY)

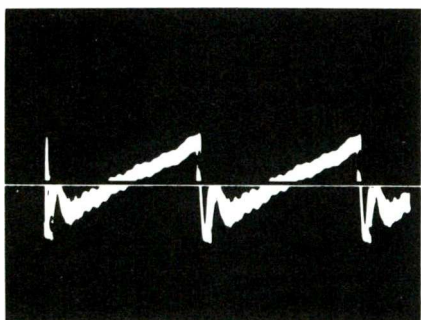

SWEEP LEADS THE SYNC AT COMMON CATHODE

ANODE OF X1 -5V
COMMON CATHODES +3

(A)



OUT OF LOCK AT COMMON CATHODE

ANODE OF X1 0V
COMMON CATHODES +7V

(B)

Fig. 7 These pictures, waveforms and DC voltages were obtained when the horizontal locking was nearly lost; and after the oscillator was forced out of lock.

(A) The horizontal hold control had been adjusted to move the picture to the left as far as possible without loss of locking.

(B) An additional adjustment of the hold control now has forced the oscillator out of lock. The DC voltages are the same as when locked.

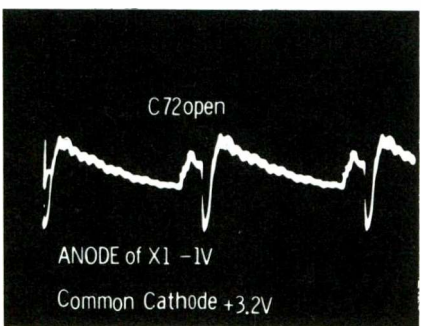

Fig. 8 An open C72 inverted and weakened the sawtooth at the common cathode terminal, and decreased the positive voltage supply. Slight leakage of C72 forced the horizontal oscillator far out of frequency.

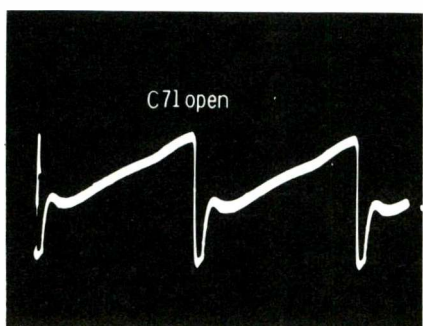
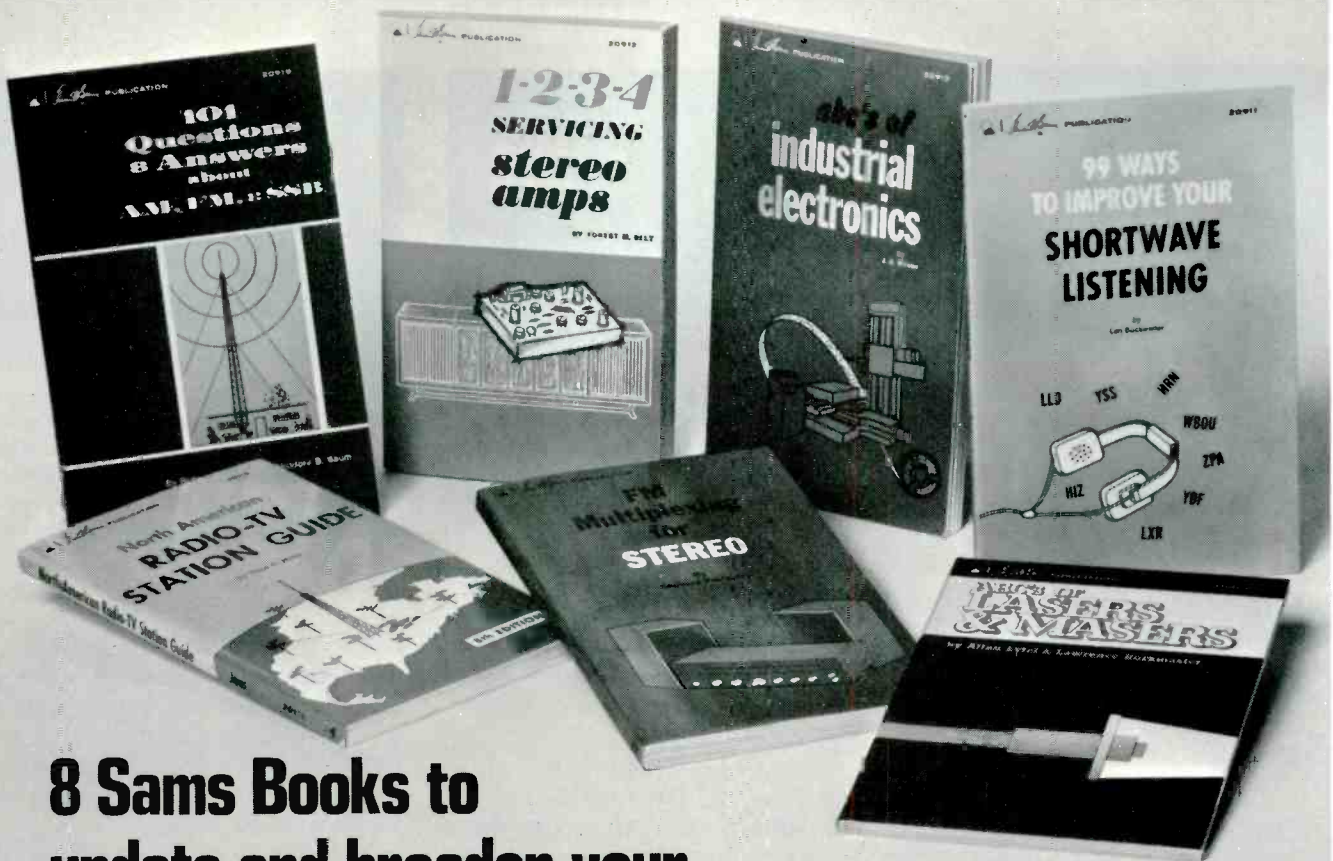

Fig. 9 When C71 was open, the picture moved about 1/2 inch to the left; but the locking and DC voltages were unchanged. The waveform at the common cathode lost the ringing that came from the flyback transformer.



8 Sams Books to update and broaden your Electronics Skills

Three are newly revised editions . . . 5 are brand new this fall . . . all will be valuable additions to your library.

ABC'S OF LASERS AND MASERS (3rd Edition)

By Allan Lytel and Lawrence Buckmaster
The completely updated explanation and review of the development and applications of lasers and masers in measurements, communications, medical surgery, and industrial usages; 128 pages; 5½" x 8½"; softbound.
No. 20863 \$3.50

99 WAYS TO IMPROVE YOUR SHORTWAVE LISTENING (NEW)

By Len Buckwalter
A valuable source of information for both hobbyist and experienced technician. Includes: antennas and installation, receiver improvements, accessories, interference sources, troubleshooting tips, listening techniques. 144 pages; 5½" x 8½"; softbound.
No. 20911 \$3.95

101 QUESTIONS AND ANSWERS ABOUT AM, FM, & SSB (NEW)

By Leo G. Sands
Easy-to-understand information about the three basic modulation techniques and the various types of transmission. Describes best uses, technical aspects and limitations of each in a Q&A format. 96 pages; 5½" x 8½"; softbound.
No. 20919 \$3.95

1-2-3-4 SERVICING STEREO AMPS (NEW)

By Forest H. Belt
Details the "divide and conquer" method of troubleshooting and servicing stereo equipment and shows how to apply the method for best results. Many illustrations and schematics in this clear, easy-to-read manual. 240 pages; 5½" x 8½"; softbound.
No. 20912 \$4.95

NORTH AMERICAN RADIO-TV STATION GUIDE (8th Edition)

by Vane A. Jones
Lists nearly 10,000 a-m, fm and television stations in the U.S., Canada, Mexico, and the West Indies. Includes: power (day and night), antenna height, and time sharing. Arranged by geographical location, frequency (or channel), and call letters. 160 pages; 5½" x 8½"; softbound.
No. 20915 \$3.95

ABC'S OF INDUSTRIAL ELECTRONICS (NEW)

By J. A. Willson
Covers the circuits and applications of electronics used in manufacturing, together with all types of electronics systems that are not designed for home entertainment. Tells and shows how electronics have improved on old-time methods of machine and process controls. 96 pages; 5½" x 8½"; softbound.
No. 20913 \$3.95

FM MULTIPLEXING FOR STEREO (3rd Edition)

By Leonard Feldman
Analyzes the fm stereo signal; gives requirements for fm stereo receiver; covers multiplex decoder circuit variety and servicing, stereo indicator lights and automatic stereo switching; test equipment and alignment procedures. 176 pages; 5½" x 8½"; softbound.
No. 20910 \$4.95

MARINE SINGLE SIDEBAND (NEW, NOT SHOWN)

By Donald M. Stoner and Pierre B. Goral
Fills a void in published literature on the subject of Marine Single Sideband, the method by which all marine electronic voice communications must soon be carried out. Covers all facets of Single Sideband in marine communications. 192 pages; 5½" x 8½"; softbound.
No. 24029 \$5.95

 **HOWARD W. SAMS & CO., INC.**
4300 West 62nd Street, Indianapolis, Indiana 46268

Order from your Electronics Parts Distributor, or mail to Howard W. Sams & Co., Inc. 20863 20915

Send books checked at right. \$_____ enclosed. 20911 20913

Please include sales tax where applicable. 20919 20910

Canadian prices slightly higher. 20912 24029

Send Free 1972 Sams Book Catalog.

Name _____

Address _____

City _____ State _____ Zip _____

ES-102

Circle 16 on literature card

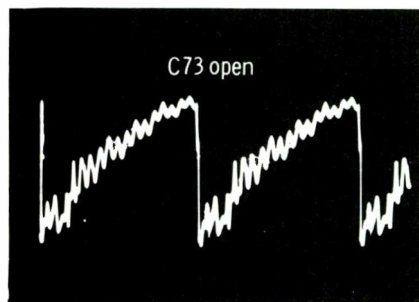

Fig. 10 An open C73 greatly increased the amplitude of the sawteeth at the anode of X1, and gave poor locking. Also, this permitted more ringing to come through C71 from the flyback transformer.

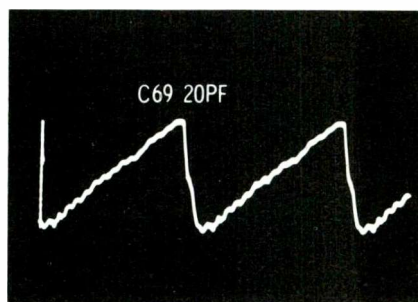

Fig. 11 Weak, critical locking was the symptom when C69 was reduced to 20 Pf. When it was open, no locking was possible. Slight leakage forced the oscillator far off frequency.

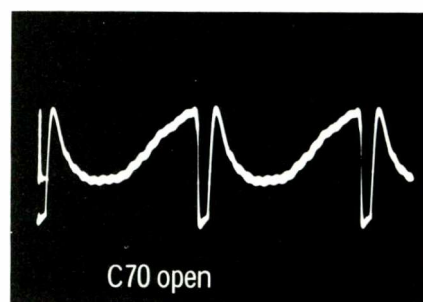

Fig. 12 More amplitude of sync pulses and less of sawteeth were obtained at the common cathodes when C70 was open. Locking range was unbalanced, with better locking in one direction and poor locking in the other rotation of the hold control.

Larger values than the normal 820 Pf reduced the amplitude of the sawtooth waveform and made the locking very critical.

Leakages of 100K or less in ohms caused touchy locking.

C69

C69 couples the sync to the common cathode of the diodes, and also acts as the input filter capacitor for X1. Therefore, defects of C69 affect the DC voltages at the diodes even when there is no sync.

An open C69 prevented all horizontal locking. A DC voltage of +4.6 was measured at the common cathode. A value of only 9 Pf barely permitted locking. Notice the waveform in Fig. 11.

Even a slight leakage of C69 affects the horizontal frequency. For example, a 1M resistor paralleled across C69 forced the oscillator far out of frequency. At that time, the common cathode connection measured +14 volts DC, and the anode of X1 was +4 volts.

C70

C70 is the peak-reading filter capacitor for X2. The exact value determines, to a large degree, the equal balancing of the two voltages.

An open C70 (waveform shown in Fig. 12) caused tighter locking in one direction of the hold control, and poorer locking in the other rotation. The anode of X1 measured -1.5 volts, and +4.8 volts was measured at the common cathode connection. As you can see, the positive voltage supply was decreased.

Moderate leakage didn't change

the locking, although leakages worse than 180K reduced the positive voltage at the common cathodes.

R103

R103 is the DC load for the series voltage from X2 or the shunt voltage from X1, therefore the exact value affected the DC voltages both on and off station.

When R103 was open, there was no horizontal locking, and the DC voltage at the common cathodes increased to +9 volts. Lower values of R103 moved the point of locking, and decreased the positive voltage at the common cathodes.

R102

Because R102 is the DC load for the shunt voltage from X1, and the series voltage from X2, we might expect its values to give results just the reverse of that of R103. Not quite true. An open R102 moved the point of best locking to one side of the hold control, and also increased the positive voltage at the common cathodes to +8 volts. Lower values of R102 caused ineffective, critical locking.

R104

R104 is a filter resistor which, in conjunction with C75 and C74, slows down the speed with which the oscillator frequency is changed. It helps prevent "piecrust".

Values below 51K ohms made the locking more critical, and less than 4.7K ohms caused bending of the picture. Values above 680K caused large bends of the picture.

C75

C75 acts with R104 to slow down the change of oscillator frequency. An open C75 made tighter locking on one side of the adjustment, but the oscillator had a parasitic oscillation when locking was lost on the high-frequency side.

Slight leakage has no noticeable effect, but leakage more serious than 100K should be avoided.

C74 and R105

These two components wired in series are a storage device to prevent the DC control voltage to the oscillator-control tube from changing too rapidly. When either was open, there was "piecrusting" of the vertical lines of the picture, as shown in Fig. 13.

Slight leakage of C74 made no difference in the locking.

A value of less than 10K ohms for R105 produced some bowing of the vertical lines in the picture. When the value was zero, the picture bending was tremendous, sometimes moving nearly the width of the screen.

Loss of Sync

Loss of sync pulses from the sync separator made locking impossible. As shown in Fig. 14, no sync pulses appeared at the common cathode connection of the diodes, but the DC voltages were nearly normal.

Defects Of The Diodes

Defects of the duo-diode are likely to cause most of the trouble



Fig. 13 This "piecrusting" was caused by an open in either C74 or R105.

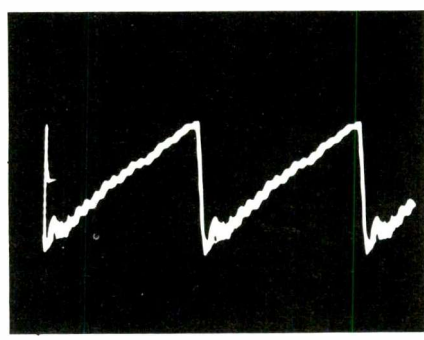

Fig. 14 When the sync separator stage was dead, no sync pulses were present at the common cathode.

in this circuit. Many of these diodes are selenium type, and they are difficult to test accurately with an ohmmeter. For example, even with new units, forward or reverse readings of the two sections seldom are matched.

When X1 is open, X2 functions as a shunt rectifier, and the output measures several volts positive. And when X2 is open, X1 functions as a shunt rectifier, and the output is several volts negative.

Horizontal locking is not possible if either diode is open or has serious leakage.

Summary

Because some defects affect the DC voltages but change the waveforms very little, and others operate just the opposite, it is recommended that you check both DC voltages and waveforms. Then analyze the defect using the method which is most useful in that particular case.

You should find it much easier to troubleshoot duo-diode horizontal phase detectors after you know the function of all components in the circuit. □

NEW AUTORANGING DIGITAL MULTIMETER... IN-PROBE DISPLAY, HIGH-SPEED READOUT, BATTERY OPERATION...

\$325.



For AC or DC voltage, resistance and even current, our Model 167 with unique in-probe readout lets you make time-saving measurements directly at the point of measurement. With up to 3-month battery life. The Model 167's combination probe/readout, with 3½ digit LED display, automatically indicates decimal point, polarity, range and function. Front panel terminals and probe receptacle allow alternative use as a bench instrument. The neat, sweet-to-hold 167 Auto-Probe DMM is only \$325 (less in quantity). Check it out and get our latest "How Sweet" button.

- Measures easily ...** 1 mV to 1000 VDC • 1 mV to 500 VAC RMS • 1 ohm to 20 megohms
- with the convenience of ...** 55 megohms input resistance • 2-sec. reading time to rated accuracy • 1200 volts overload protection • Complete choice of accessories.



KEITHLEY INSTRUMENTS
 U.S.A.: 28775 AURORA ROAD, CLEVELAND, OHIO 44139
 EUROPE: 14, AVENUE VILLARDIN, 1009 PULLY, SUISSE



The Model 167... another how-sweet-it-is Keithley Multimeter
 Buy now using BankAmericard or Master Charge

Circle 17 on literature card

The most common car radiodefects

By Joseph J. Carr

Use this checklist to save time when you repair recurrent defects in late-model car radios. For the beginner, it can be a guide to typical problems. If you are an old-timer, use it as a reminder.

Don't be surprised if my list of the most common defects doesn't agree with your experience. Local climatic conditions change the types of failures. For example, most of my work has been in humid areas near the Atlantic Ocean where leaking and noisy trimmer capacitors are a constant problem. But, a tech in Arizona might never find one.

Weak Volume

When the 1000-mfd 4-volt electrolytic capacitor of Fig. 1 opens, audio degeneration causes weak volume in Bendix radios.

Because the open capacitor doesn't change the DC voltages, you must use other tests to locate it. Perhaps the easiest and most positive check is to parallel the suspected one with a new capacitor of the same rating. A sudden return to full volume proves that the old capacitor is open.

A defective output transistor produces similar audible symptoms; both defects cause weak volume. However, the sound will be weak and undistorted with an open capacitor, but weak and distorted when the transistor is bad. After experiencing both troubles, you should begin to develop a "feeling" for the subtle differences of sound quality that will enable you to diagnose by listening.

In some instances, the Bendix distributor might fill your order with a capacitor having a different suffix number. Usually this substitution is satisfactory. Except for use in the radios from some imported cars. When working with these few types, use a replacement which is no larger than the original. Otherwise, you will find it impossible to replace the back cover.

No Sound, And Low Current

No audio and abnormally-low "A" current are the first symptoms you are likely to notice when the silicon NPN output transistor (Fig. 2) is defective in Bendix radios manufactured after 1967.

Typically, the base-emitter junction opens. When you measure the DC voltages, the base-to-ground voltage (normally about 2 volts) probably is higher than 8 volts. Such a high base voltage applied to a non-defective transistor would saturate it. Because the collector current actually is less than normal, this indicates an open base circuit. Verify the defect by using

an ohmmeter or an in-circuit transistor tester.

Early-production transistors were made on an exposed metal base of the TO-3 type. The transistor was molded into a pellet of blue epoxy, and welded to the base plate. Later versions were in P-66 style plastic cases similar to some RCA's. This type was mounted with a metal end-tab to the heat sink. Plastic transistors of the Motorola style were mounted to the heat sink by a machine screw through a hole in the plastic body of the transistor.

After you have determined that the transistor is bad, there are three ways of handling the repair. One is merely to replace the transistor with a Bendix of the same part number.

Or you might want to increase the safety factor by reducing the current and heat of the replacement transistor. A change recommended by Bendix for certain models used in Fords is to add a 150K 1/4-watt resistor in parallel with the 68K base-bias resistor in the first audio-preamp circuit.

Probably the best solution is to replace the output transistor (or both, if the unit is stereo) with one having a larger wattage rating. One suitable replacement is the type 2N3055, which is popular in home-type hi-fi machines. Because the power requirements of car radios are low, the selection of a higher-rated replacement is not critical.

You can buy at the local distributor of Bendix car-radio parts a modification kit containing two TO-3 silicon NPN power transistors and all the hardware needed for mounting them.

Also available are TO-66 NPN silicon transistors for use in any radios having holes in the chassis for this style. Some Bendix radios, such as those made for Chryslers, used this type as original equipment. And Philco-Ford radios have mounting holes pre-cut for the TO-66 type. Mounting is easier, however, if you use a socket from some pre-69 Philco model.

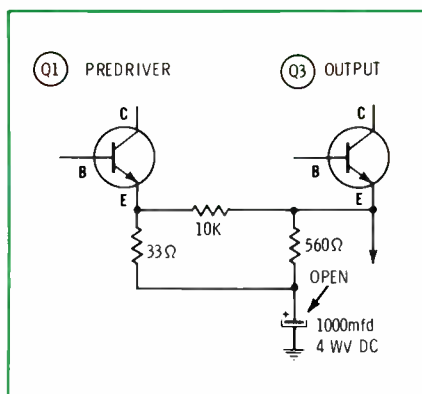

Fig. 1 Low volume without distortion often is caused by an open 1000 mfd capacitor which allows audio degeneration in Bendix car radios.

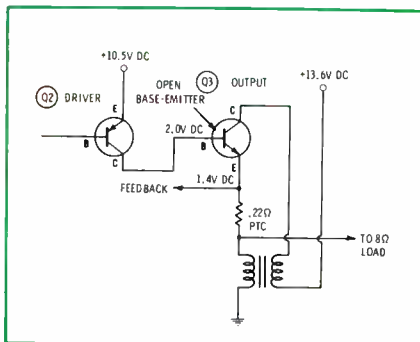

Fig. 2 No audio and insufficient "A" current often are produced by an open base-emitter junction in the output transistor in Bendix radios supplied after 1967. Excessive voltage at the base of the transistor Q3 is a good clue.

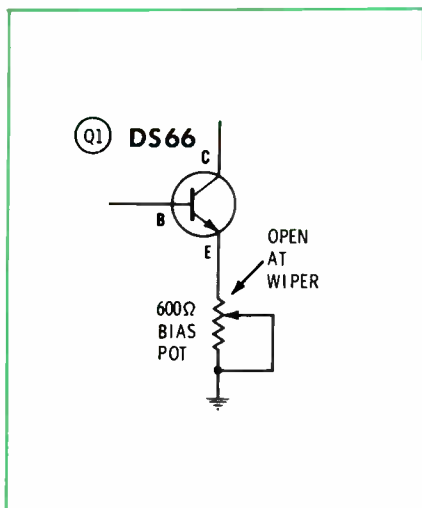

Fig. 3 In cases of intermittent volume or distortion in Delco radios built since 1966, look for an open bias potentiometer in the emitter circuit of Q1.

Many Bendix radios which already use the P-66 type transistors are pre-cut for one or two TO-3 types. In most cases, the cut-outs are on the front section of the radio on each side of the dial bezel. Unfortunately, in the '69 and '70 Galaxy/LTD series, you must drill the four holes needed for each transistor.

A molded socket is preferred whenever the holes are drilled, because the wafer type might permit the collector to touch ground. Also, covers for TO-3 type transistors are available, if you want to be extra certain there will be no shorts.

No Sound, But Transistor Is Normal

Not all dead audio channels in post-'67 Bendix radios are the result of open output transistors. Open windings of the audio-output transformer can also kill the audio.

In many Ford radios, the output transformer is soldered to the circuit board. Vibration can loosen a soldered joint, or a wire of the winding might break where it is soldered to the lug of the transformer. Give that area a good visual inspection to save time. Most of these defects can be repaired by careful soldering.

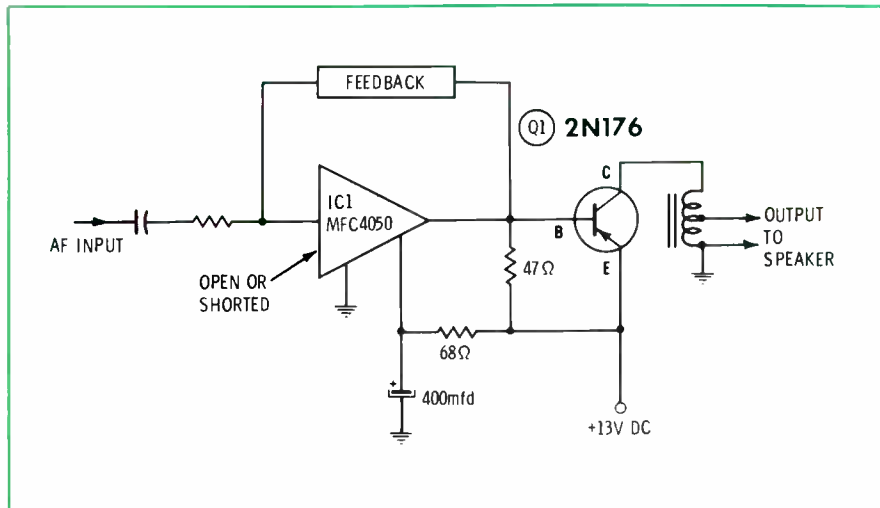

Fig. 4 No audio, and excessive collector current which makes the output autoformer smoke or burn might be caused by a defective IC used as audio driver in Motorola radios built for Chrysler and Volkswagen.

Intermittent Distortion

Intermittent volume or distortion often can be traced in post-'66 Delco radios to the bias potentiometer (Fig. 3). Older types of pots tend to open at the wiper contacts.

Opening the emitter circuit of the pre-driver causes the output transistor to saturate and draw excessive current. One tell-tale sign is discoloration of the fuse-resistor protecting the emitter circuit of the output transistor.

Check the pot this way: Lightly tap the lugs of the bias pot while you monitor the current drawn by the entire radio, or the collector voltage of the power transistor. Any radical change of meter reading indicates a defective pot. Replacement is the best and most permanent cure.

No Sound, Might Smoke

When there is no volume, late-model Motorola radios made for Chrysler and Volkswagen might have a defective Integrated Circuit (IC) which is used as audio pre-amp and driver. This IC is number MFC4050, and has only four terminals.

Because the IC is direct-coupled to the 2N176 output transistor, bias voltage and collector current of the output transistor are affected drastically by conditions in the IC.

These IC's either open or short (as do most solid-state components) when they fail.

A shorted IC reduces the base voltage of the PNP-polarity 2N176. This increases the forward bias, and the collector current approaches saturation. In fact, the choke which serves as output transformer can be cooked and ruined by the excessive current, if the radio is operated too long in this condition. The burned choke is the source of the smoke which arises in some cases.

Test for the possibility of excessive forward bias by connecting together the base and emitter terminals of the 2N176. If the collector voltage drops to zero, or if the drain of the receiver decreases sharply, we must assume the IC is shorted and increasing the bias. But if the excessive current continues, the 2N176 probably is shorted. Conversely, an open IC biases the 2N176 to cutoff, eliminating the collector current.

To test for an open IC, connect a 100-ohm resistor from the base of the 2N176 to ground. If this causes a collector voltage, or if the "A" current to the receiver increases, it is a good bet the IC is open. However, if these results are not obtained, the output transistor probably is open.

Next, test the IC by connecting

Fig. 5 Weak sensitivity on FM or loss of stereo in Motorola car radios often is caused by a defective IC used as the IF amplifier.

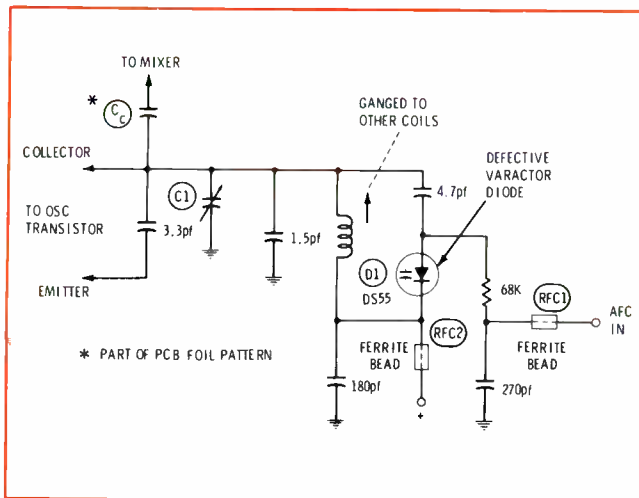
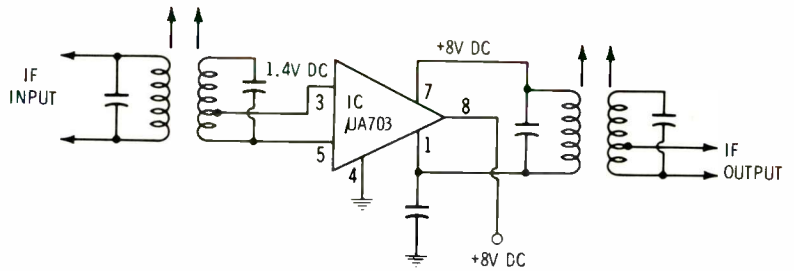

Fig. 6 Sudden shifts of tuning are most likely to be produced by defective varactor diodes used in the AFC circuit of almost any car radio with FM.

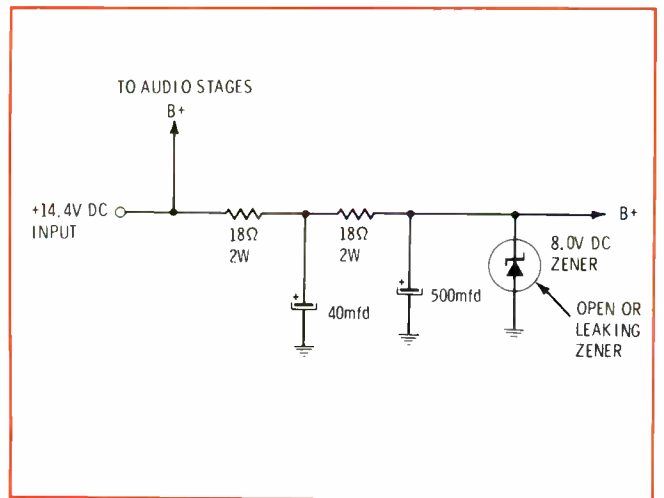

Fig. 7 Leakage in the zener voltage-regulator diode gives the same symptoms as a dead IF stage. A shorted zener kills all reception, and an open zener causes erratic tuning which varies with the motor speed.

a high-value resistor (around 470K) between the +12 volt supply and the input terminal of the IC. If the IC is good, this should increase the forward bias of the output transistor so it draws more collector current. No change output current indicates an open IC.

It is advisable to use a Motorola Semiconductor Products MFC 4050, or the equivalent in the Motorola HEP line for replacement.

Weak FM Reception

Loss of stereo effect and weak sensitivity of the FM band often are caused in Motorola receivers by a bad IC used as the IF amplifier on FM (see Fig. 5).

This IC, a version of the popular Fairchild μ A703, is basically a differential amplifier, internally stabi-

lized by diodes. Some newer replacements are packaged in a metal housing similar to the TO-5 transistor. These are regarded generally as being more reliable than the older plastic ones. Replacements are available from MAPI or Motorola Consumer Products distributors, and other sources. Carefully check the HEP substitute, because it's different mechanically.

Most defective IC's change the DC voltages at the terminals. But, other failures leave the DC voltages undisturbed, and such cases require signal tracing to locate the dead stage.

Drift Or Shift Of Tuning

Defective AFC varactor diodes, such as the one shown in Fig. 6, can cause a slow drift or a fast shift in tuning. Or certain defects might

stop all FM reception. A shorted or open diode can stop the oscillation, or change the frequency so much that no stations can be tuned in.

Drift is caused by heat changing the junction capacitance of the AFC diode or the oscillator transistor. In either case, any slight normal drift should be cancelled by the AFC action. On the other hand, loss of the error-correcting DC voltage at the diode permits the normal drift to become noticeable. Cases of drift originating in the oscillator circuit are quite rare.

The varactor diode is the prime suspect in a radio that has sudden large frequency shifts. Replacement of the diode is the only sure cure. Because most diode frequency shifts are triggered by heat cycles, spraying the diode with coolant often causes the shift to occur

(Continued on page 38)

FROM WINEGARD...THE GREATEST BROADBAND AMPLIFIER VALUE EVER!

Winegard
Ultrplex
Modular
Broadband
Amplifiers
with
Highest
Input
and
Output
Capability.



- * 5 models with unlimited flexibility
- * VHF, UHF or any combination
- * sub-channel and closed circuit optional
- * electronically regulated and filtered power supply with heavy duty transformer
- * choice of single or separate band antennas, plus switch-selectable FM trap on 3 largest models
- * modular boosters available for 15 db additional gain in weak signal areas

Now you can install a higher-performance system for sharper - much sharper - MATV pictures! Check your distributor or write Winegard.



WINEGARD
TELEVISION SYSTEMS

Winegard Co., 3000 Kirkwood Street, Burlington, Iowa 52601

Circle 18 on literature card

DESIGNS OF THE NEW SHAPE OF SOUND[®] TOMORROW

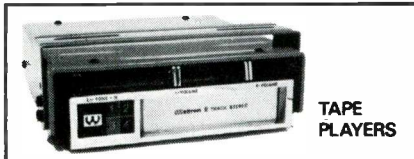

COMPLETE CATALOG AVAILABLE.
CALL YOUR WELTRON DISTRIBUTOR TODAY!
or write or call direct:



Circle 19 on literature card

(Continued from page 36)

for defective AFC diodes.

Weak Reception, Or Drifting Tuning

Weak reception without noise between stations, or a drift of tuning which changes with speed of the car engine, can be caused by opposite defects of the zener diode which regulates the voltage to some stages (Fig. 7).

When leakage of the zener drops the voltage as low as 2 to 4 volts, the effect is similar to that of a dead IF stage: strong signals come through okay, but the sensitivity to distant stations is low. Test for this possibility by disconnecting the zener. If the supply voltage shoots up above normal and the sensitivity returns, the zener definitely is bad. A shorted zener kills reception.

When the stations are tuned out by accelerating the car, and drift back when the engine idles, suspect an open zener diode. This effect is more noticeable when the car battery is weak or nearly discharged.

amplifiers in the multiplex section, as shown in Fig. 8.

A light touch on the terminals of the pot usually triggers the intermittent. If you are tempted to take the easy way out and merely reset the pot, remember that this gives only a temporary "cure" which decreases the stereo separation. Replacement of the pot is recommended.

Loss Of Stereo, Or Loss Of Sound

A loss of stereo effect (both channels playing the same audio) occurs when the sub-carrier is killed by a defect in the IC used as a stereo-decoder (Fig. 9) in Motorola radios. Test for the sub-carrier by using your scope at the 19-KHz coils which are outside the IC.

Other defects inside the IC can kill both channels of audio. Use DC voltage analysis and signal tracing to find where the signal is lost.

Three different IC's, MC1304, MC1305 and MC1307, have been used in various models of Motorola radios. Check the service data before replacing an IC.

Usually, these IC's are lower in price when purchased from the distributors of Motorola Semiconductor Products than when bought from most other sources. □

One Stereo Channel Intermittent

under controlled conditions which helps prove the diode is defective.

Be careful to check for other causes of shift. Loose or cracked trimmer capacitors, cracked circuit boards, and loose screws holding the boards all have been mistaken

Intermittent operation of one stereo channel in Bendix FM car radios often can be traced to the separation control. This control is in the emitter circuit of the buffer

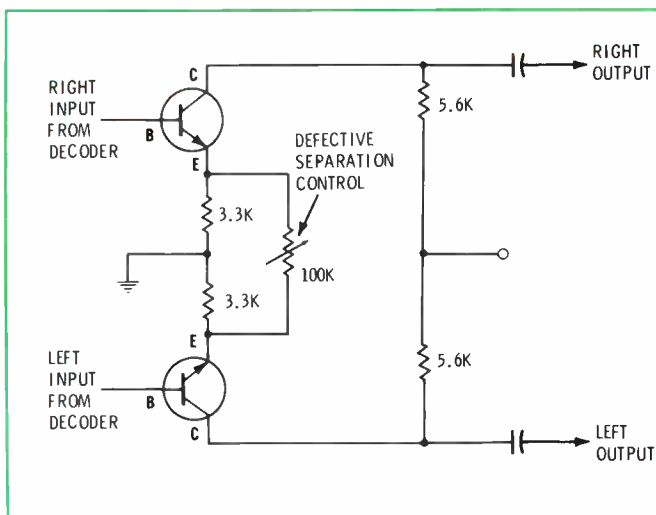

Fig. 8 A defective separation control often causes intermittent operation of one stereo channel in Bendix FM-stereo car radios.

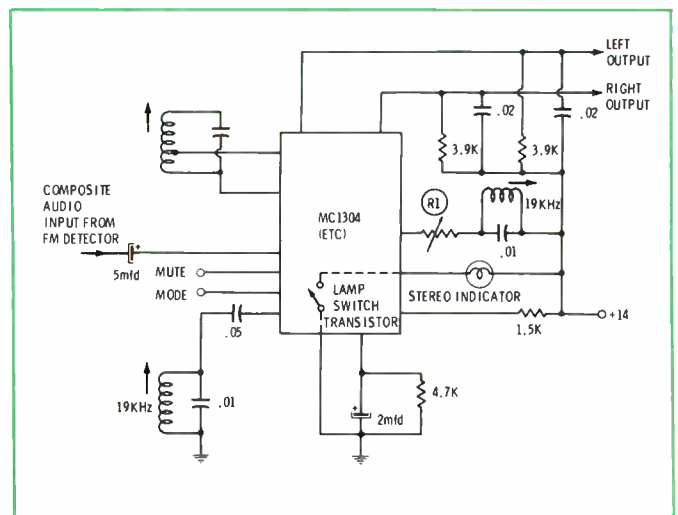

Fig. 9 Loss of the stereo effect is produced by defects of the IC used as the stereo-decoder in Motorola FM-stereo radios. Usually this is caused by loss of the 19-KHz carrier, and can be verified by use of a scope.

Still another benefit for new Photofact®-of-the-Month Club members...

The best reason for subscribing to Photofact®-of-the-Month is, of course, that every month you'll receive six new Photofact sets containing detailed circuit information on at least 50 of the newest model TVs, radios, stereos, record changers, etc.

And you get them at the special Club price that saves you \$54 a year. In addition, Photofact sends you, **every month**, bonuses of "advance" color schematics, preliminary data on the latest equipment to fill your immediate servicing needs . . . a file folder for each set . . . a Photofact Servicer with helpful service hints, and coupons toward permanent, metal Photofact set files.

And now this . . . **you will also receive this 10-piece PS-120 Nutdriver set (a \$6.15 value) FREE for enrolling now!**

Sign up today and get it all! Just use the coupon.

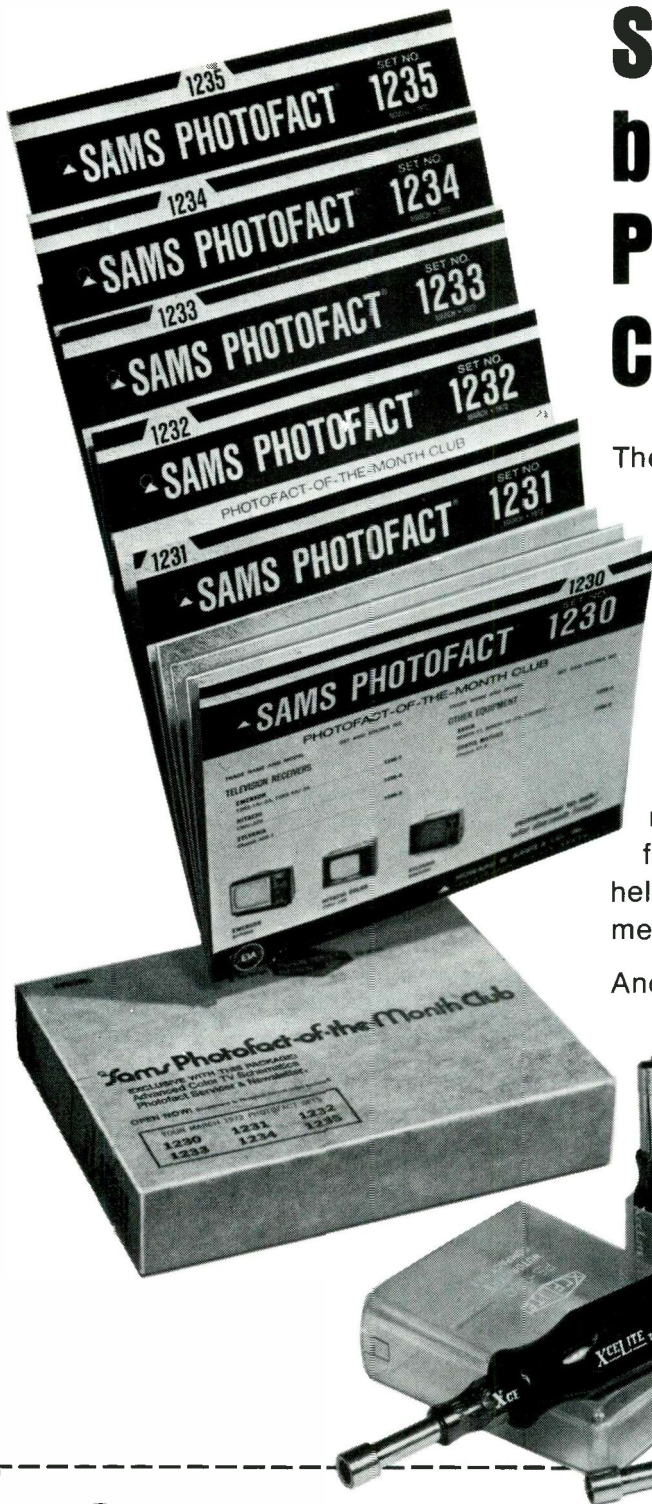

ES102



HOWARD W. SAMS & CO., INC.

4300 WEST 62nd ST. • INDIANAPOLIS, INDIANA 46268

Please enroll me as a new member of the Photofact-of-the-Month Club. I agree to pay \$13.50 per month for my subscription, which will begin _____, and I agree to maintain this subscription for at least 9 months.

Name

Company Name

Address

City State Zip

My Photofact Distributor is _____

Address

City State Zip

Circle 20 on literature card



Both Serv-A-Set shops are in attractive shopping centers. This provides adequate parking and encourages carry-in service.

Serv-A-Set builds success on planning and promotion

"We have to search constantly for new ideas, break old habits that are no longer useful, and keep upgrading our business."

by John Stapp

Only three years ago, Jim Ballard opened the first branch of Serv-A-Set, Inc. Today this San Francisco area company is the fastest growing television service business on the West Coast, and Ballard, the firm's president, sees continued rapid growth ahead. A second shop has been opened, and two others are planned. In one year, the two shops serviced over 7,000 TV sets.

This phenomenal growth didn't happen by accident, but resulted from long and thorough planning of every aspect of the business.

Jim explains it this way: "Before opening Serv-A-Set, I traveled the country for three months, looking at service shops and gathering information on what procedures they used and what their problems were. The service order form seemed to be a major problem. Consequently, I worked with a marketing company in designing a service order that overcomes the problems of misunderstandings between the shop and its customers."

Service Order Forms

It seems strange for a shop manager to be so concerned about service orders. They usually get a low priority. "Our complaints are nearly zero, and this is largely because we use our service order form to establish the first line of communication with the customer. Our service orders are complete in every detail. There's no room for misunderstandings. Basically, we consider the service order the prime tool for re-educating the public on honesty in service. Everything pertinent to the repair goes on our service order—what needs to be done, what is done, and what the work is

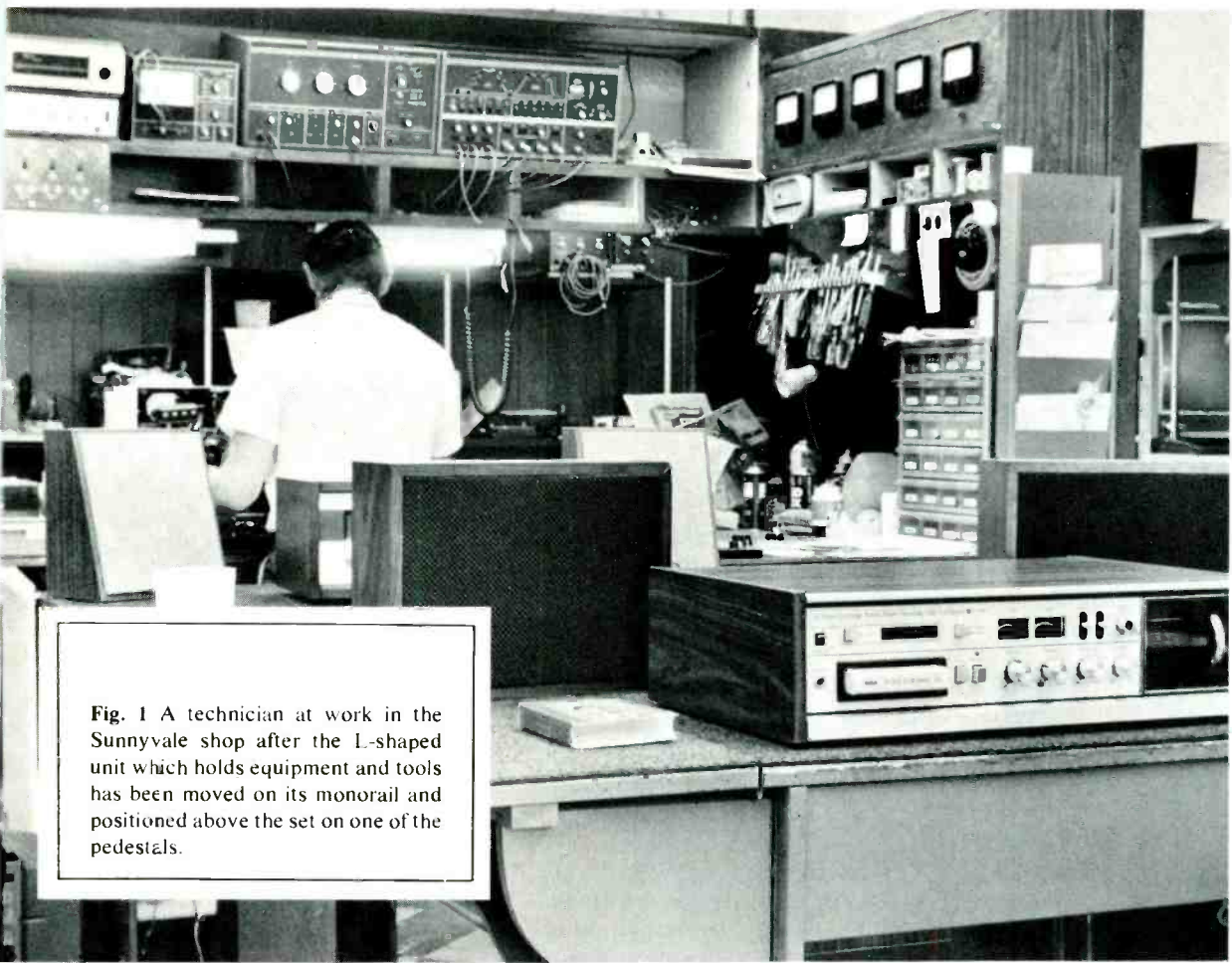

Fig. 1 A technician at work in the Sunnyvale shop after the L-shaped unit which holds equipment and tools has been moved on its monorail and positioned above the set on one of the pedestals.

going to cost—and it's signed by the customer who gets a copy for his own records."

Ballard goes on to say that some TV servicemen resort to near-fraudulent practices in order to make ends meet. He believes they do this because they charge 1949 prices in 1972. "Our service order tells it like it is, so the customer knows just what he's paying for, and knows he's not getting jabbed by the service technician."

After the serviceman inspects the set, usually in the presence of the customer, he places a check mark in front of the items or circuits that **should** be repaired for

optimum performance. If the customer decides to have only a part of this work done, this also is marked on the service order.

All parts are individually itemized and priced, separate charges are listed for technical shop labor, field service, and removal-and-reinstallation.

Unique Shop Layouts

Following this nationwide inspection of service shops, Ballard designed his own unique shop layout.

Serv-A-Set's shop layout is unusual, in that it eliminates the bench-type operation, substituting a

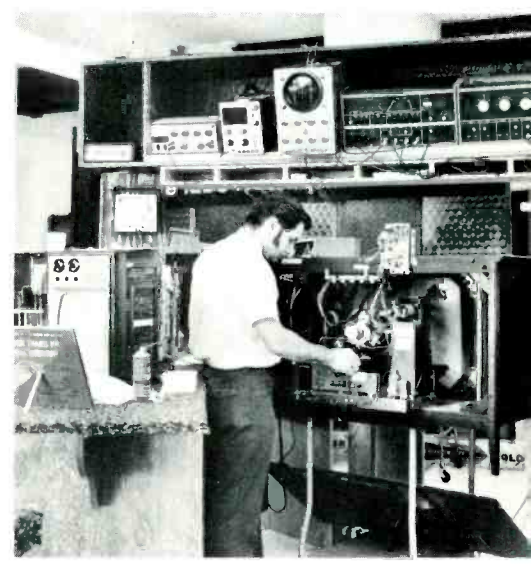

Fig. 2 In the Campbell shop, a "carousel" holding the test equipment circles above the work pedestals, which are arranged in a semi-circle. This system was designed for use in a shop that's wider than it is long.



Fig. 3 A carry-in service counter has all the equipment necessary for most repairs. Minor repairs are made as the customer waits. Notice the low lift-through section of the counter which is carpeted to avoid scratching portable television sets.

“continuous flow” system which moves the shop service man and his equipment to the set, rather than moving the set to the bench.

Ballard declares this continuous-flow system, which makes use of all the latest test equipment, is seven times more efficient than the usual bench-type shop system. His statistics show that a single shop man can repair as many as 140 TV sets a month.

While the two Serv-A-Set shops are both organized on the continuous-flow system, there is some variation in design and layout.

At the Sunnyvale shop, which is long and narrow, five pedestals were built instead of benches (Fig. 1). These extend in a straight line from front to rear of the narrow shop.

Test equipment and tools are carried on an L-shaped cabinet which moves on a monorail alongside the pedestals, with the top of the “L” extending out over the pedestals (Fig. 1).

With this monorail system, the service man can have five sets in various stages of repair or cooking without having to remove the sets from the pedestals. He easily pushes the L-shaped unit holding his equipment and tools along the monorail until it is centered at the pedestal where he plans to work next.

At the Campbell shop (Fig. 2), which is wider than long, the same system is used, except that the pedestals are built in a semi-circle, and the equipment and tools ride on a “carousel” which turns in a circle.

Both systems are equally efficient, Ballard emphasizes, making possible the application of “assembly line” procedures in the shop operation. Normally, one service man and an apprentice handle the shop work at Sunnyvale, and one service man handles the Campbell shop.

“Of course, we’re also constant-

ly buying the latest equipment, when it proves out,” Ballard continues. “Cost of equipment is a small factor in overall costs, and it certainly makes a big difference in the time a man spends on the job.”

Coping With Changing Technology

While Ballard is optimistic about the service business, predicting an increase of more than \$1 million a year in his TV service operations during the next five years, he believes the small owner-operated service shops will have to develop more efficient operations or an increasing number will fail.

“Too many shop owners do not have time to keep up with changing technology while also handling the management aspects of their businesses,” Ballard points out.

“Just three weeks ago, for example, we bought the business of a service shop at an IRS sale. In the three weeks since buying this business, we’ve done four thousand dollars in work for this shop’s customer accounts. What was the matter? Why did a shop with a volume of more than \$1,000 a week go broke? The answer is lack of efficiency.”

Making The Work Profitable

Shop design and up-to-the-minute procedures are only part of Ballard’s program for developing the highest possible efficiency.

Concentration on work that is definitely profitable plays a part. Serv-A-Set services 17 makes of TV sets, but politely declines the oddballs. The main problem with the latter is not isolating the trouble, but finding the replacement parts.

To maintain profitability at all times, Ballard periodically analyzes every shop ticket.

“We can’t lose money on one service job and hope to make it up on the next one,” Ballard declares. “Every six months, I find the time to sit down and go through all the



Fig. 4 Jim Ballard demonstrates how the large wall-map helps in locating a technician who is making a home call.

tickets to see if we have to tighten up anywhere along the line. I add up, by brands, the total labor time spent on each repair. Therefore, we know what it costs us to service each brand. **And believe me, there are significant differences which, if not taken into consideration, eventually will lead to losing money on certain brands.**"

All Labor Is Listed By Time

All labor time is recorded on the service orders in one-tenth of an hour segments (six minutes per tenth).

Ballard explains, "If, for example, I see .4 of an hour on several tickets covering a repair of a particular make, but the price we're getting covers only .3 of an hour, then we have to raise our price on that repair.

"The only alternative would be to cut down on the components or on the quality of the work, and that would mean a loss of customer satisfaction. On the other hand, we've found there is absolutely no complaint when we have to raise prices."

All antenna work is subbed out.

It's a different ball game that doesn't fit into the operation. For the same reason, there are no retail sales except for a small traffic-building display of items for easy-to-fix, do-it-yourself repairs. This is self-selection. Shop men don't "wait on trade."

Carry-In Service Is Encouraged

Serv-A-Set's business is now 60 percent in-home service and 40 percent carry-in, but a program is under way to increase carry-in service to 50 percent of the dollar volume by the end of 1972.

Anyone telephoning for in-home service is told he can save money by bringing the set into the shop: at least \$18.50 (the charge for a house call) and possibly an additional \$15.00 for pickup and delivery, in the event the set must be brought into the shop for service.

The campaign is getting results and more people are now bringing in sets, including even a few consoles. Ballard considers it well worth the effort, because shop service is more profitable than in-home service.

Customers Watch The Repairs

The customer-service area at the front of the shop is designed to encourage carry-in service.

Test equipment is built into the counter (Fig. 3) and the customer is encouraged to stay and watch the service man make a thorough checkout to pinpoint any malfunction of the set. This check-out procedure is called "preventative service"—and it's **not** free. A \$9.50 charge is made if the repair is refused.

Carry-in repair service (b-w or color) is \$15.50 minimum plus parts. The average time required for carry-in repairs is approximately 22 minutes. Approximately 70 percent of the sets are repaired while customers wait.

"We have very, very few objections to our policy of not giving free estimates," Ballard says. "Less than one person out of a hundred picks up his set and walks out when we explain we charge \$9.50 for checking out the set, if he decides not to get it repaired."

Outside Service Improves The Image

The Serv-A-Set technician making house calls has to be more than a skilled service man; he must be pleasant and diplomatic as well. He wears a navy-blue tie with the CSEA emblem on it, a blazer with coordinated dress slacks, and a white shirt. He carries his tools in an attache case.

"Look like a pro and you feel like a pro," Ballard says. "If you look efficient, you feel efficient, and you are efficient. Yes, to many consumers, service costs seem high. But, they recognize that the man who looks like a pro and acts like a pro is probably worth the money they have to pay for service."

It costs Serv-A-Set \$14.07 to ring a door bell when the service man averages eight calls a day. Serv-A-Set charges \$18.50 for a house call in a trading area where quite a few others are getting only \$10.95—and, Ballard adds grimly, probably facing bankruptcy, or being forced to cut corners to make up the difference.

Technicians Get Top Pay

Serv-A-Set pays the top dollar in technicians' wages and fringe benefits, puts the right man on the right job, then expects a lot.

There are now four outside technicians, and Ballard plans to add three more by the end of the year. He prefers graduates of the Philco-Ford technical schools.

Procedures For Outside Calls

A new outside man is given a standard truck inventory and has one day to check it out before going on a route. He signs the itemized list of his truck inventory which then becomes a perpetual inventory, checked every six months by management for possible shortages.

The truck inventory was set up after a study was made of the components most needed for in-home repair service. An 89 percent completed-in-home record is now being achieved.

Daily route sheets are made up by an "early man" who lines up

house calls on each route in order, and lines up the sets in the order of return. He also sets out the parts and components to bring the truck inventory up to the perpetual inventory list.

Stops for the day then are flagged on a large wall map which is covered with plastic (Fig. 4). Grease crayons are used to make a black mark for a service call, yellow for a pickup, and red for a delivery. Everything is ready to go by 9 a.m., so there's no reason why outside men can't start rolling at 9:10 a.m.

Route areas are closely plotted for efficient operation and the service charges are based on the same one-tenth of an hour system that prevails in the shop.

Checking Performance Of Outside Techs

Outside service technicians are completely aware that management is not only going to check out their work orders for accuracy, but also is going to spot-check their in-home performance. Once a week, Ballard or the shop foreman selects three calls at random from each route. There is no set day for this and service men never know the day when the spot-check is to be made.

"We follow right up behind the technicians before the calls get cold," Ballard explains. "We have a checkout list for each set—the same as that appearing on the service order. After checking over the set to verify that it's working properly, we'll ask the customer a few questions: What time did our service technician get here? What time did he leave? Was he neatly in uniform? Do you have any complaints about him?"

"After thanking the customer, we give him or her a certificate entitling the customer to a dinner for two at one of our better restaurants. This makes quite a hit and gets us talked about favorably in the neighborhood—along the line of 'Look how careful they are. They came back and went over the set again and then gave us two dinners just for telling them what the man had done.' This pays off tre-

mendously for us, we find."

The "Gig Sheet"

A monthly "gig sheet" is prepared from information collected on these random surveys, and from any other customer complaints. At the regular monthly meeting, the technician who drew the fewest complaints is awarded at least \$20, and sometimes as high as \$50, the exact amount being determined by throwing darts.

During the course of the monthly meeting, Ballard discusses any necessary changes in procedures. This information also is posted on a bulletin board. In addition, each technician gets a Xerox copy of the service problems discussed.

"All our service men carry a monthly 'burden,' based on office and overhead expenses," Ballard says. "The burden is set as a quota and expressed in dollars. What we shoot for is three times wages, although we average two-and-one-half times. It's important not to put the burden too high because we might lose control over quality."

Any repeats because of unsatisfactory in-home repair work are added at retail price to the outside technician's next month's burden. Technicians understand, according to Ballard, that this is essential to running a profitable operation, and he's had no beefs about the policy.

Parts Inventory Control

Parts inventory control admittedly is something of a thorn in the side for Serv-A-Set. With a \$10,000-\$15,000 inventory, Ballard aims for a 90-day turn but is not getting it.

The main problem, he adds, is model changes. Serv-A-Set is now in the process of setting up a model stock in an effort to establish better turnover.

"Our practice, at this point, is not to keep anything in stock over three years," Ballard says. "When it gets that old, we donate it to the schools. We'd have to sell it at two-hundred percent more than list price to come out on it, so we're better off getting rid of it."

Advertising

Serv-A-Set's advertising program is directed, first, to holding old customers and, second, to winning new ones. Every service customer costs \$11 to find, Ballard declares, but the problem is: how to hang onto them?

"Here's a good test of your standing with your customers," he says. "Go through your file and pick out at random the names of ten customers. Telephone each one and ask them what service company they call when they need service. I did this about a year after starting and found out that three out of ten of my customers didn't know the name Serv-A-Set. That really gave me something to think about!"

Thinking about it, Ballard decided it was necessary to remind customers about Serv-A-Set at least twice yearly.

Therefore, during the Christmas season, Serv-A-Set sends out a small gift—a potholder or perhaps a calendar, always with the shop name, address, phone number, and an advertising message imprinted on it—and always something the customer will keep and use. Then during the summer, a pre-Fall check-up special is offered at \$3.00 off (this is the only special Serv-A-Set ever offers).

Two means are used to reach new customers. Everyone moving into the suburban communities covered by Serv-A-Set receives a welcoming letter and a sticker to go on the set. Newcomers are likely prospects since they'll sooner or later be looking for a service shop.

To reach the general trading area, advertising folders are placed under windshield wipers of automobiles parked at nearby shopping centers. Their present folder, printed on a good grade of heavy paper, costs nine cents each in lots of 10,000.

"We learned our lesson early about not wasting money on cheap-looking fliers," Ballard says. "Aft-

er we put out one such flier, we got calls from two shopping centers to come out and pick up our trash off their property. This taught us that unless it's quality, it's money thrown away. Now we put out a good-looking folder and it gets results."

New Ideas

Ballard is always devising new ways to sell service. Three months ago, he introduced a 6-year warranty on color TV tubes. The warranty runs from \$20 minimum to \$27.75 maximum, depending on the make. This is getting lots of attention.

He has also introduced, with good results, a maximum labor charge of \$56.50 for in-shop service. Logging shop-service costs over a six-month period, Ballard found the labor charge on any repair job seldom exceeded that amount. He is widely advertising the \$56.50 maximum labor charge and finds it creates a favorable identity for the progressive young company.

"We have to search constantly for new ideas, break old habits that are no longer useful, and keep upgrading our business," Ballard concludes.

"As we see it, there's going to be a wide-open future for electronic servicing—such things as video tapes, computerized TV sets, instant replays that will record a program when you're out of the house and play it back to you when you get home.

"At the same time, there will be changes that seem to be for the worse. The modular portable is one example. The man who's now changing his own tubes is just going to start changing boards. We're already planning for this new situation, and we're setting up test-board jigs and a module exchange system to take care of this new development when it hits.

"The service business is a very good business—if we stay on top of it." □

SUIT YOUR SELF

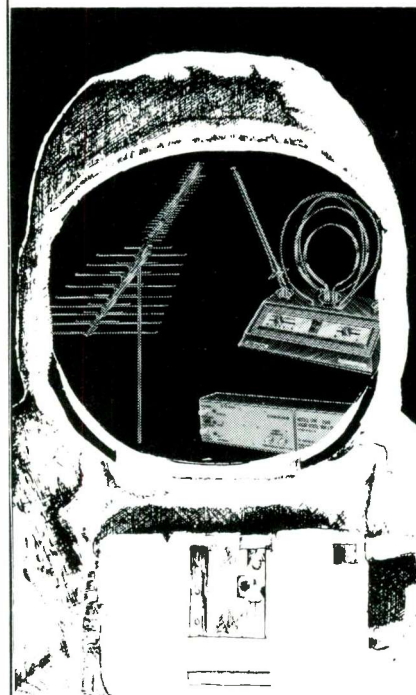

FROM ANTENNAS TO AMPLIFIERS!

Ride the Antennacraft rocket. . . land space-age sales. With new CDX color antennas, super-swept Colorfinder series. Custom Area Specials. . . boosted by Gavin selling power! New space-age indoor and outdoor antennas, MATV, hardware and accessories, UHF-TV converters. Get with Project Profits. Get on the M.A.P.* with Antennacraft and Gavin!

*Write for top secret M.A.P. facts

ANTENNACRAFT
P.O. BOX 1005 Burlington, Iowa
AC (319) 754-7575 TWX 910-525-1133

Gavin
Gavin Electronics
1450 U.S. Route 22
Somerville N.J. 08876
(201) 356-3500

One-Source Specialists . . .

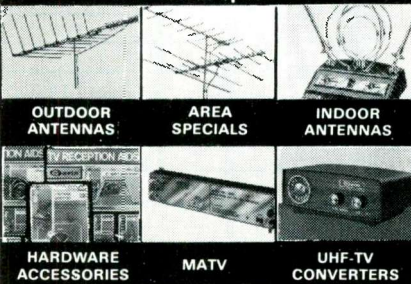

Circle 21 on literature card

Cut your depreciation losses



Losses by depreciation are inevitable. Use these suggestions to minimize this part of your expense.

by Robert G. Amick

Depreciation Is Normal

There's a bit of doggerel that goes: "Use it up, wear it out, make it do, or do without."

The pressure of modern-day business doesn't often allow us to follow that suggestion. But the little verse does point up a natural aspect of owning something. Through the action of time—either as wear, erosion, corrosion, consumption or obsolescence—almost everything you own loses value.

This loss is called **depreciation**.

In your business, this loss of value is an expense. It's part of your cost of doing business. (Remember, from our earlier discussions, we defined an expense as an outlay that reduces capital.)

The furniture, equipment, tools and trucks you use in your business begin a constant march from the dealer's shelves to the junkyard the minute you acquire them. When you bought them, their value was what they cost; a month later, a part of this value already is lost. Your truck is "like new", but it's still a used truck, and you couldn't get your purchase price out of it if you were forced to liquidate. Ten years after you bought it, it might have practically no value at all, except as junk.

So, over ten years, that truck depreciates from a

\$3,000 item to one worth \$100. The difference between what it cost and its salvage value is \$2,900, and that's its depreciation. If you figure it over ten years, that averages \$290 per year.

Depreciation and Bookkeeping

Accounting for depreciation in your bookkeeping system is essential. If you remember our early discussions of the Balance Sheet, or Financial Statement, you'll see why. The Balance Sheet shows the value of your business at the close of an accounting period. If your Balance Sheet still carries your equipment at its new value, it **overstates** the value of your business.

Likewise, if your system doesn't account for depreciation, then your Operating Statement (or Income and Expense Summary) will **understate** your expenses, making your profit picture look better than it really is.

Your Income and Expense Summary thereby fails to show the true cost of operating your business.

There's another strong reason for maintaining an accurate depreciation system: Taxes. Income taxes, obviously, but probably for property taxes on the personal property of your business as well.

Depreciation is handled much the same on your tax return as it is on your books. The reasoning is the same; it's an expense of the business. Methods do vary, however.

On your books, depreciation begins with a card form like the one shown in Fig. 1. All essential data about the item is listed, and the record of period-by-

Date			Remarks	Asset Account			Depreciation Allow.			Book Value					
Mo.	Day	Yr.		DR	CR	BAL	DR	CR	BAL						
			ITEM <u>SIGNAL GENERATOR</u> GEN. LEDGER ACCOUNT <u>EQUIPMENT</u> SER. NO. <u>6-811060</u> DESCRIPTION <u>MAJESTIC MODEL SG-10</u> FROM WHOM PURCHASED <u>MAJESTIC MFG. CO., PASSAIC, SO. VA.</u> ESTIMATED LIFE <u>7 YEARS</u> DEPRECIATION PER YEAR <u>14%</u>												
7	2	69	← INITIAL PURCHASE →	200	00		200	00			200	00			
12	31	69	← CLOSE OF BOOKS FOR '69						(1)	14	00	14	00	186	00
12	31	70								28	00	42	00	158	00
12	31	71								28	00	70	00	130	00
									(2)		(3)		(4)		

period depreciation is kept, so that the card is a complete record of the item. It records essential data—brand, model number, and serial number—which are helpful for many purposes. It's an inventory, it's an identification record in case of theft or other loss, and it's a definition of the item's depreciation status. Also, in my own office, I use the reverse side of each card to record important data on maintenance, repair or modification of the equipment.

The initial purchase is entered on the first line, as noted. The second line deserves an explanation. Only half a year's depreciation is charged off, since the signal generator was bought on July 1. Thereafter each year's entry is for the full annual amount.

For that group of items called Fixed Assets (those having a fairly extended useful life, and a fairly substantial value), the card system forms a permanent inventory record, as well as a running record of depreciation claimed and value remaining.

Incidentally, we might clear up one point of theory: Only fixed assets depreciate, those which are consumed rapidly don't. Likewise, land doesn't depreciate, although the building standing on it does.

That card system, and its depreciation accounting takes care of things like your truck, furniture, test equipment and the like. But, take a three-dollar waste basket, or a five-dollar pair of pliers. It's foolish to set up a card and keep a running record of 25 or 30 cents in depreciation a year. And yet, you might have a large number of small items around the shop. Ordinarily, these are set up on a card labeled "Miscellaneous Small Tools." Their value is totaled, and a fairly long average life is established. Then the total value is depreciated as in the case of a single item. (Again, I list the items covered on the back of the card, just by way of having a record. I started this when I found that the number of small items came to a value greater than that of my typewriter when new.)

Depreciation And Taxes

As a tax matter, depreciation depends on the book-keeping you've done. As you know, the Internal Revenue Service does call on taxpayers from time to time to prove their claims. It's comforting to face an IRS audit with the records to back up whatever your return has claimed. And, you'll never win that argument without them. I'm all for shouldering my fair load, but I hate the idea of paying too much as a penalty for not keeping records.

When it comes to depreciation guidelines for taxpayers, the IRS is less generous than your accountant. That is, useful life definitions for certain classes of equipment, as suggested by the tax people are a bit longer than you and your accountant might agree to. Recent efforts to encourage businessmen to invest in modernization and expansion have improved this situation a little. But, you might have to settle for a ten-year life on some test equipment you know you'll junk, or sell for salvage value in six or seven.

The reason for this is **obsolescence**. It's hard to de-

(Continued on page 48)

Sharper, brilliant Jitter-Free intensity or pulse markers!



SMG-39 LECTROTECH sweeper marker generator

A precision sweeper with quality and features found only in high priced laboratory instruments. The SMG-39 utilizes post injection markers for fast, accurate alignment of any television receiver when used with any standard oscilloscope. The SMG-39 provides all needed bias' and linear sweeping signals for accurate alignment. Unique marker display enables accurate marker positioning for superior receiver alignment. VFO facility provides any additional marker from 39 MHz to 49 MHz for protection from future obsolescence, may also be used for spot alignment.

Exclusives

- Jitter-Free Intensity or Pulse Markers • VFO Variable Marker
- 4 Bias Supplies including — 67 Volts

Marker Options

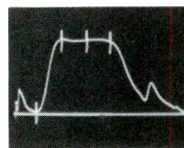

Pulse Vertical
(Overall Chroma).

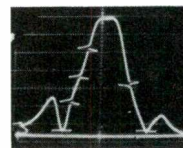

Pulse Horizontal
(Typical I.F.
response).

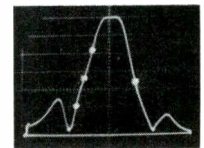

Intensity
(Typical I.F.
response).

Benefits

- Clean, bright Jitter-Free pulse markers
- All markers of equal amplitude regardless of position on response curve.
- Adjustable marker amplitude
- Marker location accurately determined with brilliant pulse or intensity markers (a must in AFT alignment)
- All signals have blanking included for zero base line

FULL TWO YEAR PARTS WARRANTY

SMG-39

Solid state, glass epoxy circuit boards.
Complete with all cables.

NET **33950**



See your distributor or write Dept. ES-10

LECTROTECH, INC.

5810 N. Western Ave., Chicago, Illinois 60659
(312) 769-6262

Circle 22 on literature card

fine for tax purposes. Technical advances make a three-year-old item inefficient, although it's still usable. How much value has it lost? The tax collector doesn't know, you don't know, nobody else can say. The only way you can settle that question is to sell the item. That will establish its value fairly quickly, if there's a market for it at all.

So, the tax guidelines hold the line against over-rapid depreciation, simply to keep it from becoming another loophole.

Methods Of Depreciation

There are three main methods of depreciating equipment which are recognized by the IRS. There's the straight-line method; in which the unit is depreciated by a fixed percentage each year of its useful life. There's the declining-balance method which speeds up the depreciation during early years. And there's the "sum-of-the-year-digits" method which helps with the middle- and late-years depreciation.

A comparison of the rates of all three methods is shown in Fig. 2. The straight-line method depreciates a constant amount each year. The declining balance gives a fast start, with higher depreciation in the early years, and slows down in the middle and late years. The sum-of-the-year-digits method gives you almost as fast a start, but a better break in the middle and late years.

The graphs are based on an example of a \$1,000 item of equipment with a useful life of 10 years. The table in Fig. 3 shows the amount of depreciation by each of the three methods for each of the ten years.

If you plan to keep the equipment until the end of its useful life, and can afford to yield a little of the early-year break, the straight-line method will give you the best late-year deduction. It's also useful when the tax rates are not expected to change, and are not particularly high at the beginning of the equipment's life span.

In a high-tax year, one of the other two methods

probably would be more advantageous. It also depends on how long you plan to keep the equipment being depreciated. A truck you plan to keep for only four years might best be depreciated by one of these methods.

Selecting a method involves those factors and several others. If you're having a better-than-average year, and need to do all you can to cut your taxes, you'll want the high-early-years methods. If business is off, but you expect it to improve, you may want the mid- and late-year protection of straight-line. A small item—say \$150—doesn't matter much. A few dollars in depreciation, and less in taxes, is all that's at stake. But, a piece of equipment that costs \$1,500 or \$2,000 does make a difference. There's substantial money riding on your choice.

Understand, if your truck cost \$3,000 and you use it until it's junked, you'll depreciate it all the way by any of the three methods. You can only depreciate it by \$2,900 or so (new cost minus salvage value), in any event. The three methods only help you by giving you a choice of when you'll take it. With taxes fairly high now, not expected to drop much, and technological obsolescence a problem in your field, the early break might generally be most favorable.

Figuring depreciation isn't really difficult. What is tough is making sure that the method you choose is acceptable to IRS—and boning up on the data in their applicable publications is necessary. But, understand one thing: IRS likes consistency, and dislikes changes in methods. So, you should go on depreciating old equipment by whatever method you started with, even though you choose a different method for newly-acquired equipment.

Straight-Line Depreciation

Figuring straight-line depreciation is just a matter of fixing the useful life in years, dividing that life-span into 100 (percent) to get the yearly percentage rate.

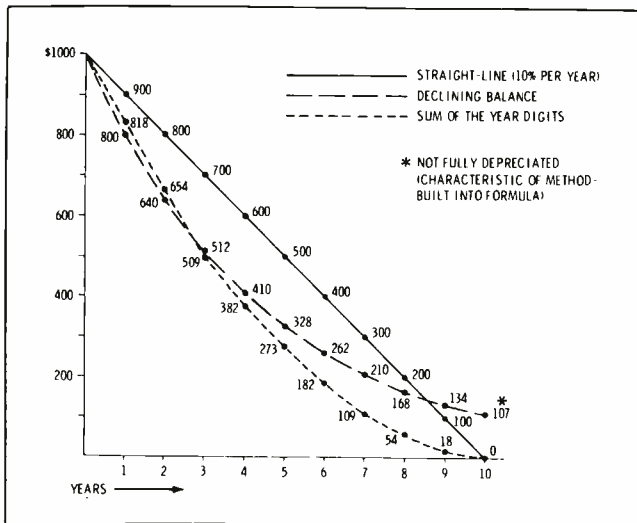

Fig. 2 Comparison of the rate of depreciation obtained by the three common methods. The figures beside each curve shows the remaining balance to be depreciated.

Year	Straight Line	Declining Balance	Sum-of-year-digits
1st	\$100	\$200	\$182
2nd	100	160	164
3rd	100	128	145
4th	100	102	127
5th	100	82	109
6th	100	66	91
7th	100	52	73
8th	100	42	55
9th	100	34	36
10th	100	27	18

Fig. 3 This table shows the comparative depreciation on an item costing \$1000 taken by three methods for calculating losses of value for tax purposes.

Help college help you.

Businesses like yours gave over \$340,000,000 to higher education last year.

It was good business to do so. Half of all college graduates who seek work go into business. The more graduates there are, and the better educated they are, the more college serves the business community.

Your money was vital to colleges. It relieved financial pressures, made planning more flexible, and contributed to the kind of basic and applied research that puts new knowledge and technology at the service of industry.

So that colleges can continue to help you, give to the college of your choice now. For information on ways to do it, please fill in and mail the coupon.

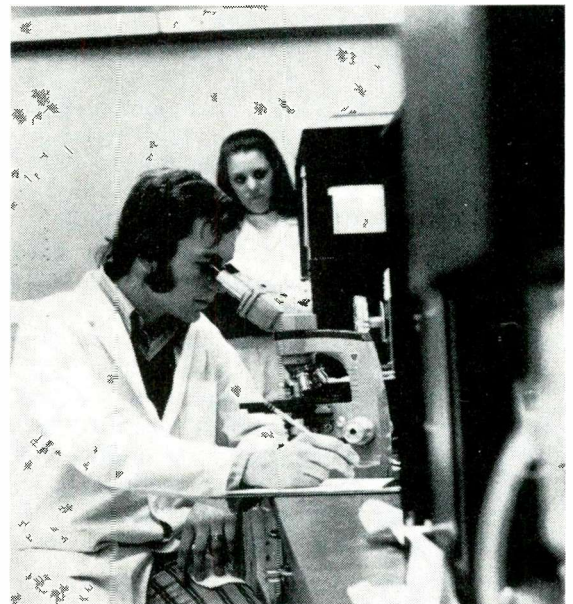

Council for Financial Aid to Education, Inc.
6 East 45th Street, New York, N.Y. 10017

Please send me your free booklet, "How Corporations Can Aid Colleges and Universities."

Name _____

Company _____

Address _____

City _____ State _____ Zip _____



Council for Financial Aid to Education, Inc.

Advertising contributed for the public good.



Council for Financial Aid to Education, Inc., 6 E. 45th St., N.Y.C., N.Y. 10017

Then, every year, depreciate the item by that amount.

Declining-Balance Depreciation

Figuring declining balance isn't much harder. Some assets may be depreciated at twice the straight-line rate; for certain others it's limited to 1 1/2 or even 1 1/4 times the straight-line rate. Let's assume it's twice the straight-line rate. In the previous example, we used 10 percent as the straight line depreciation per year. By the declining balance method it becomes 20 percent, but now it's applied against the preceding year's balance instead of the initial price.

The first year you deduct 20 percent of the purchase price. The second, 20 percent of the remaining balance (book value).

Digit-Sum Depreciation

The digit-sum method is more complicated yet, but not so much so that you can't grasp it and figure depreciation with it. The "year-digits" referred to, mean the total of the number of years—10 in our example. So, you develop a series of fractions based on this 10-year useful life. To get the denominator of the fraction, you add 10 + 9 + 8 + 7 + 6 + and so on, down through 1. That's the sum of the year-digits. It totals 55. The fractions are formed with the same digits, thus:

1st year (10 years to go) 10/55 18.1%

2nd year (9 years to go) 9/55 16.4%

3rd year (8 years to go) 8/55 14.5%

and so on.

As mentioned earlier, most bookkeeping systems use straight-line depreciation. The other two methods are primarily tax-figuring methods.

The Reality Of Depreciation

Up to now, we've been talking about bookkeeping and taxpaying situations. Both place about as much emphasis on consistency as on logic. Reality enters the picture when your theoretical value—on the books or on your tax return—is put to the test by disposal or conversion of the asset in question. You've used up the equipment, or it's outmoded, or broken down and not worth the cost of repair. So you sell it. Perhaps for junk, or to a young fellow just starting out, who's glad to find a bargain even if he does have to fix it. Or, you trade it in on a newer model.

Outright sale will show you what the item's real value is. If it's above book value, that's a gain. If below, you have a loss. You can take the loss on this conversion, both on the books and in your tax return. You also must show a gain in both places, if that turns out to be the case.

But, if you trade in the item, you have neither a gain nor a loss, either on the books, or for the tax return. Remember that truck we were talking about? It cost \$3,000, you kept it four years and depreciated it to \$1,640 (book value) by the declining-balance method. At trade-in, you pay \$1,800 cash along with your old one for a new truck. Your new truck shows a cost on the books of \$1,800 + \$1,640 or \$3,440. You begin depreciating the new one on the basis of that cost. The apparent loss can't be taken off your tax return, but

you get to make it up in depreciating the new truck.

Notice what has happened. Knowing that you'd trade in early, you took your depreciation in the early years. Looking at the table of Fig. 3, you can see the relative value of each method in this example. Using straight-line you'd have a truck with \$1,200 in depreciation deductions. This would be a certain loss at trade-in time; a loss you couldn't use. There is an advantage at four years under the sum-of-the-year-digits method: you'd have claimed \$1,850 in depreciation. Selecting a method, in the light of your plans and your own circumstances, as well as the tax situation, is very important, as you can see.

Depreciation Of Buildings

Earlier, I mentioned buildings depreciating. Useful life on these is standardized by the tax guidelines: 30 years on dwellings, and as much as 50 years on factories. Usually, these are depreciated by straight-line. If you own the building your shop occupies, and you remodel, the gain in value added by remodeling becomes part of the building's value for depreciation. Repairs can be fully deductible in the year they're made (and paid for), or they might become depreciation items because they extend the building's useful life. Which claim you make depends on IRS regulations. Replacing a roof is depreciated. Repairing one that has burned might be a deductible repair. A major criterion is whether the change is an improvement or a restoration of the normal condition of the property.

Tax Advice

As an early scholar once remarked, "The art of plucking a goose is to get the most feathers with the least hissing." Well, the art of being a taxpayer is to yield gracefully to your fate (being plucked) but to keep all the feathers you can (legitimately). □

DEMODULATOR OMISSION

Chart 1 referred to on page 27 of the September, 1972 issue of ELECTRONIC SERVICING accidentally was omitted. It is printed here for your convenience.

CHART 1

Relative phase of "C" and "E"	3.58M-Hz at "A" and "B"	Chroma at "C"	PP volts at "D" and "E"	DC volts at "D"	DC volts at "E"	DC volts at "F"
no chroma	12 V PP	0 V PP	10.4 V PP	-4.1	+4.1	+0.1
in-phase	12 V PP	4 V PP	10.7 10.4 V PP	-5.9	+3.3	-1.4
in-phase	12 V PP	6 V PP	11.9 11.4 V PP	-7.0	+1.4	-2.3
out-of-phase	12 V PP	4 V PP	10.9 10.3 V PP	-2.5	+6.0	+1.4
out-of-phase	12 V PP	6 V PP	11.0 10.6 V PP	-1.5	+7.0	+2.3
no 3.58M-Hz	0 V PP	6 V PP	1.4 V PP	-2.0	+2.1	+0.7
90 degrees	12 V PP	6 V PP	13 & 10 V PP	-5.0	+5.0	+0.1

Chart 1 These DC and p-p voltages were recorded in a simulated diode demodulator circuit under the conditions stated. Parts tolerances were ± 10 percent. The measurements were made with scope and VTVM calibrated and read only to the accuracy necessary for good troubleshooting standards; therefore, they should be representative of actual conditions.



by Wayne Lemons

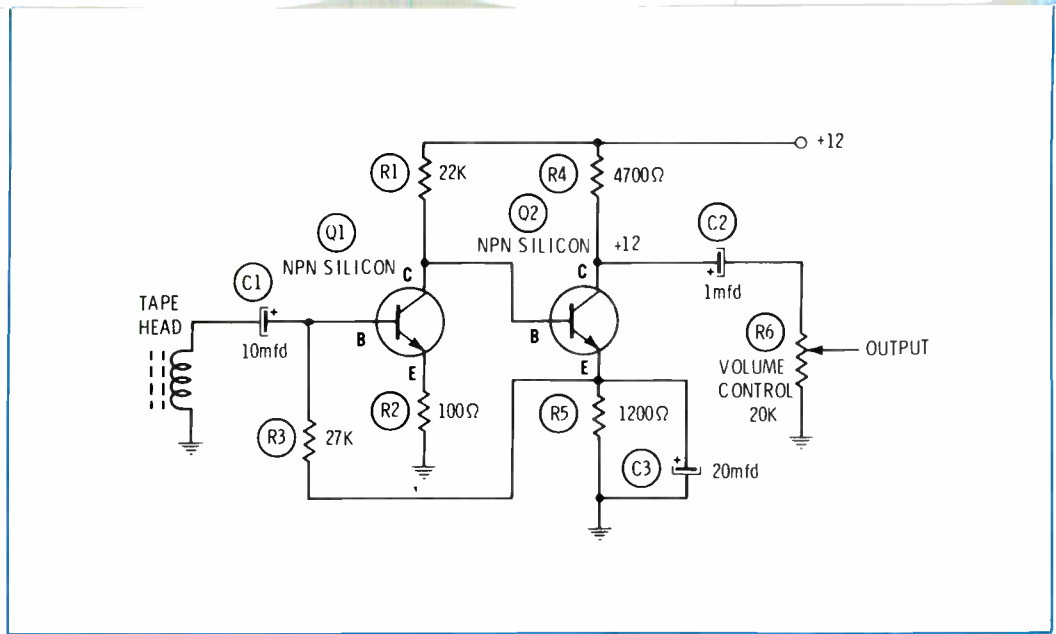

Test your skill at troubleshooting solid state Part 2

Answer this quiz to test and improve your skill at analyzing solid-state defects.

A two-stage direct-coupled preamplifier that amplifies the tiny signal voltage from a tape head is the subject of our solid-state quiz this month.

Tips About Circuit Actions

Two kinds of direct-coupling are designed into this simple circuit. The collector of Q1 is connected to the base of Q2, and the emitter of Q2 through R3 supplies the base-bias voltage for Q1. Therefore, defects which change the DC voltage at any element of either transistor tend to change the DC voltages at all the other elements. The voltage through R3 is DC negative feedback, which attempts to keep the voltage at the emitter of Q2 from changing.

In addition, both transistors have emitter resistors which also stabilize against temperature and voltage changes. Consequently, small changes in the values of the components don't critically change the gain or operation.

Figure 1 shows the circuit and

two of the DC voltages, the collector voltage of Q2 and the supply voltage. Both voltages are the same: +12 volts.

Solid-State Quiz

Take the quiz now, filling in a mark for either "yes" or "no", then go to my explanation of the answers which follow.

1. Is the tape head open? Yes___No___
2. Is C1 shorted or leaking? Yes___No___
3. Does Q1 have an open junction? Yes___No___
4. Is Q1 shorted between collector and emitter? Yes___No___
5. Does Q1 have near-zero current? Yes___No___
6. Is R1 open? Yes___No___
7. Is R2 open? Yes___No___
8. Is R3 open? Yes___No___
9. Is Q2 shorted between collector and emitter? Yes___No___
10. Is Q2 open? Yes___No___
11. Is it likely that R4 is shorted? Yes___No___
12. Is C2 either open or shorted? Yes___No___
13. Is R5 open? Yes___No___

14. Is C3 open or shorted? Yes___No___

Quiz Answers

Check your answers against these:

1. No. No defect of the tape head could possibly have any effect on the collector voltage.
2. No. If C1 were shorted or leaky, this would reduce the base bias of Q1. In turn, the collector of Q1 (and the base of Q2) would become more positive, and this would increase the collector current of Q2 and lower the collector voltage.
3. No. An open in any element of Q1 would increase its collector voltage and decrease the collector voltage of Q2, as given in No.2.
4. Yes, it's possible. The collector voltage of Q1 would decrease to nearly zero, thus driving the base of Q2 to cutoff, and Q2 collector voltage would rise to the supply voltage.
5. Yes, it's possible. But only if R1 opened completely. Then Q1 would have no collector voltage, Q2 would have no

base voltage and the collector of Q2 would rise to the supply voltage.

6. Yes. Refer to No. 5.
7. No. This would stop all collector-emitter current of Q1 causing the collector voltage to rise. Therefore, the collector voltage of Q2 would decrease.
8. No. Without R3, Q1 would not conduct, the base of Q2 would become very positive, Q2 would saturate and Q2's collector voltage would be near zero.
9. No. A collector-to-emitter short in Q2 would give about 2.5 volts at both the collector and emitter (according to ohms law).
10. Yes, it's possible. An open in any element of Q2 would cause the collector to rise to the supply voltage.
11. No. Although this defect would give the +12 volts at the collector, resistors of this type almost never short unless severely overloaded. And even if Q2 shorted, only about 25 milliwatts would be applied to R4; certainly not enough to burn it.
12. No. An open C2 would not change the voltage at R6, which should be zero when C2 is either normal or open. A shorted C2 would add R6 as a voltage divider from collector to ground, and reduce the collector voltage slightly.
13. Yes, it's possible. The only path to ground would be through R3 and the base-emitter circuit of Q1; certainly enough to cutoff Q2 and give a collector voltage equal to the supply voltage.
14. No. If C3 shorted, Q2 would be without emitter voltage. In turn, there would be no base voltage of Q1, so its collector and Q2's base voltage would increase. Decrease of emitter voltage and an increase of base voltage to Q2 would saturate it and cause nearly zero volts at the collector. An open C3 would reduce greatly the gain of Q2 (also Q1 by negative feedback), but have no effect on the DC voltages.

CHART 1

		Normal DC Voltages Of Fig. 1				
Q1	base +.74	emitter +.04	collector +1.75	B/E bias +.7		
Q2	base +1.75	emitter +1.18	collector +7.3	B/E bias +.6		
		DC Voltages With R5 Open				
Q1	base +.75	emitter +.05	collector +1.6	B/E bias +.7		
Q2	base +1.6	emitter +1.19	collector +12	B/E bias +.48		
		DC Voltages With R4 Open				
Q1	base +.58	emitter 0.0	collector +1.25	B/E bias +.58		
Q2	base +1.25	emitter +.59	collector +.63	B/E bias +.65		
		DC Voltages With Q2 Collector Open				
Q1	base +.58	emitter 0.0	collector +1.25	B/E bias +.58		
Q2	base +1.25	emitter +.59	collector +12	B/E bias +.65		

What Have We Proved?

Looking at the "no" answers shows that by using only two voltage readings we have eliminated the tape head, C1, R2, R3, R4 and C3 as possible sources of the trouble. Also, we are sure Q1 is not open, and Q2 is not shorted.

Possible defects still remaining are: a shorted Q1, an open Q2, open R1, or an open R5.

Next, suppose we measure the base-to-ground voltage of Q2 and find that it is +1.6 volts. Mark which of the following (perhaps more than one) components might be defective:

open R1 () open R5 () shorted Q1 () open Q2 ().

You should have indicated both R5 and Q2 because they can reduce the current through R4 to zero. A collector-to-emitter short in Q1 would have reduced the Q1 collector voltage (and Q2 base voltage) to about .5 volt. An open R1 would have provided zero volts to the base of Q2, cutting off the emitter current.

Therefore, an open R5 and an open Q2 are still suspects. R5 can be measured in-circuit with an ohmmeter; the interaction of other components should not seriously change the reading.

Q2 also can be measured for "diode" action between base-and-emitter and base-and-collector. Remember that it is possible to have a collector-to-emitter short which does not affect the diode readings from base to both emitter and collector. However, it isn't possible to have an open from collector to emitter that doesn't show on the diode test.

The diode effect of Q2 checked okay; therefore, Q2 is not open.

R5 Is Open

The only component not cleared of suspicion is R5. When checked by an ohmmeter, it measured nearly open in-circuit and completely open out-of-circuit.

Because it had been some time since we located this particular defect in the course of normal servicing, we reconstructed the problem in a breadboarded circuit (Fig. 1) and measured all the transistor voltages. Chart 1 shows those voltages, both with and without R5.

Do you notice anything strange about those voltages? With the exception of the collector voltage of Q2, they are all within the conventional ± 10 percent tolerance. If we had shown you all the voltages before you began the quiz, they wouldn't have helped your diagnosis! In this case, logical reasoning and the measurement of the parts values were more effective in troubleshooting than any analysis of the DC voltages could ever be.

Symptoms Of An Open Emitter Circuit

When the base voltage of a transistor is not changed, increasing the value of an emitter resistor (such as R5) increases the emitter voltage, decreases the forward bias, and permits less collector-emitter current. As the value is increased at a linear rate, the rate of voltage increase from emitter-to-ground levels off. The decreasing emitter current accounts for this action.

Each new value of emitter resistance finds two opposing forces at work. The larger resistance decreases the forward bias, which decreases the emitter current. On

the other hand, the decrease of emitter current reduces the voltage from emitter to ground, and this increases the forward bias which increases the emitter current. After a short period of time, a point of equilibrium is reached, and the voltage and current become stable.

As the value of the emitter resistor is increased, a point is reached where no apparent changes occur. At this point, the collector-emitter current is virtually zero. However, the emitter voltage can never rise above the voltage which (relative to the base voltage) results in a practical cutoff of current.

An alternate high-resistance path remains through R3, the base-emitter junction of Q1, and R1 to ground. The emitter voltage rises, but only a few millivolts. But that increased emitter voltage is the source of the base bias for Q1. Therefore, Q1 draws a tiny bit more collector current which reduces the voltage at Q1's collector and Q2's base.

The reduction of base voltage and the increase of emitter voltage to Q2 is just enough to bias it near enough to cutoff so there is no measurable drop across the collector resistor.

The point is this: those millivolts are important when they contribute to the bias of transistors.

Now you know why most technicians think troubleshooting direct-coupled stages is difficult!

Opens In The Collector Circuit of Q2

Here's an interesting question: How does an open in the collector circuit of Q2 affect the DC voltages in both stages? Of course, the same closed loop which causes the interdependent voltages remains. But the importance of the two basic actions previously described is reversed. In a non-defective circuit, the DC voltage at the base of Q2 is determined mainly by the conduction of Q1. This is no longer the case when Q2's collector circuit is open.

First, an open in the collector

circuit of Q2 naturally stops all collector-emitter current; so the emitter voltage **must** decrease. Then, if the base current is not increased, the emitter voltage will be nearly zero. However, the base current does increase.

Because the emitter voltage of Q2 is the source of the bias for Q1, it follows that Q1 will have insufficient bias, thus increasing the collector voltage. This action **would** occur except for another which now becomes important: The base-emitter circuit of Q2 remains intact, and current flows through R1, the base-emitter junction of Q2, and R5 to ground. With less reduction of base-emitter voltage because of the lower emitter voltage, the base-emitter current increases. The "diode" effect prevents the base-emitter voltage from exceeding about .7 volt.

Therefore, assuming no current in Q1, and +.7 volt across base and emitter of Q2, calculations for the base and emitter voltages (measured to ground) go like this:

- From the supply voltage of +12 volts, subtract the +.7 volt bias.
- The remainder of +11.3 volts is applied to R1 and R5 in series.
- By ohm's law, the drop across R5 should be +.61 volts. Therefore, the base of Q2 should measure about +1.31 volts.

The \$64 question is: How accurate were the voltages obtained by calculation compared to the actual voltages measured in the bread-board circuit? The answer is found in Chart 1, where the base of Q2 is listed as +1.25 volts, and the emitter is +.59 volts, thus making a bias of about +.65 volt. The results were well within useful limits, and prove that the analysis was correct.

Still Stumped By Solid State?

If you have questions about the actions of solid-state components, write to the editor about them. Perhaps we can answer them in future quiz features. □

Your
Centralab
distributor has
just the right one,

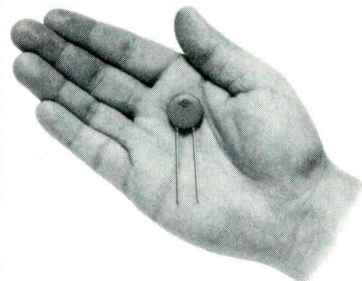

or all of them

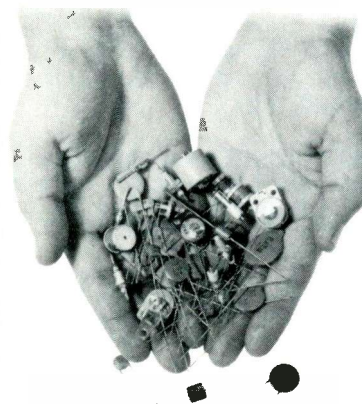

Your Centralab distributor has the most complete line of ceramic capacitors available. He's your best supplier of just the right capacitor for fast, reliable replacement service.

Choose from low voltage, transistor circuit, general purpose, high voltage and Gap-Kap™ Ceramic disc capacitors. Available with voltage ratings from 3 V to 6000 V, in values from .75 pF to 2.2 mF.

Your Centralab distributor stocks other highly reliable, special purpose ceramic capacitors including feed-thru, variable trimmer and transmitting types. He's also your source for a wide range of polystyrene capacitors and miniature electrolytics in both axial and PC lead styles. Check your parts stock, then call your Centralab distributor. He has just the capacitors you need.

DISTRIBUTOR PRODUCTS



CENTRALAB
Electronics Division
GLOBE-UNION INC.

Circle 23 on literature card

Put the first team on the bench

Heathkit "Profit-Makers" pay-off in price and performance

NEW IB-1102 120 MHz FREQUENCY COUNTER; Another Heathkit first! An eight-digit counter with illuminated overrange, gating, kHz and MHz indicators. Preassembled temperature compensated clock assures overall accuracy. High-impedance, low-capacitance (FET) input circuit presents minimum loading. Automatic triggering level permits "hands-off" operation. Sensitivity is 50 mV to 100 MHz, 125 mV above 100 MHz. The 1102 will accept inputs up to 120 V rms from 1 Hz to 150 Hz, 50 V at 4 MHz, and 3 V at 120 MHz. Stability is ± 1 ppm from $+10^\circ$ to $+40^\circ$ C, and aging rate is less than ± 1 ppm per year. Other features include ECL circuitry, 1 Hz resolution without switching time base, 120/240 VAC operation, portable case with bail handle and detachable line cord. Assemble yours in an easy 15 hours.

Kit IB-1102, 12 lbs. 349.95*

349.95*



IM-102 DIGITAL MULTIMETER; Measures AC and DC voltage, current, and resistance, with automatic switching for DC polarity. Five overlapping ranges show voltage from 100uV to 1000V on DC; 5 ranges cover 100uV to 500V on AC; 10 ranges measure 100nA to 2A, AC or DC; 6 resistance ranges cover 0.1 ohm to 20 megohms. Input impedance is 1,000 megohms on the 2V range, 10 megohms on higher ranges, with overload protection on all. $3\frac{1}{2}$ digits for 100uV resolution on 200mV range, 1V on 1000V. Automatic decimal point. Panel light indicates over-range. DC calibrator, furnished assembled, and unique transfer method allow calibration to 0.2%. Unit can be lab calibrated to 0.1%. Kit includes standard banana jack connectors complete with test leads. Assembles in approximately 15 hours. For lab spec performance on a budget...order your IM-102 today!

Kit IM-102, 9 lbs. 229.95*

Kit ID-1041, high-voltage probe accessory, 1 lb. ... 6.95*

229.95*



IO-103 5" TRIGGERED SWEEP SCOPE; Maximum flexibility in a general purpose scope, at a price to fit any budget... the new Heathkit IO-103 is a tech's dream come true! Big 6x10 cm screen with lighted graticule for easy, accurate measurements. DC-10 MHz ± 3 dB response with less than 50 ns rise time on vertical channel. Horizontal expansion gives x2 magnification $\pm 5\%$ for a 50 ns/cm sweep rate. Triggered sweep, too, with selection of either normal or automatic modes. Other features are switch controlled AC-DC coupling; provision for external triggering signals and horizontal deflection signal; front-mounted connectors for vertical inputs and 1V peak-to-peak signal for checking calibration; 120/240 VAC operation. Put this budget-minder to work for you now.

Kit IO-103, 37 lbs. 229.95*

229.95*



Free — Your 1973 Heathkit Catalog with the world's largest selection of instrument kits.

HEATH COMPANY, Dept. 25-10
Benton Harbor, Michigan 49022

Enclosed is \$ _____, plus shipping.

Please send model(s) _____

Please send FREE Heathkit Catalog.

Name _____

Address _____

City _____

State _____

Zip _____

Prices & specifications subject to change without notice.

*Mail order prices; F.O.B. factory.

TE-260R

phototip

Exchange

by A. E. Plavcan

Shrinkable plastic tubing can be used as an emergency or inexpensive shaft extender, as pictured. Apply a layer of tape with adhesive on both sides to the shaft, then heat the tubing with a match or heat gun and slip the hot end over the shaft of the control. Allow the tubing to cool before use.

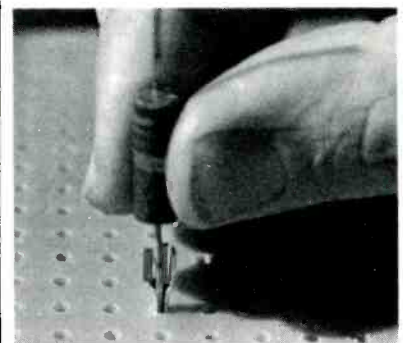
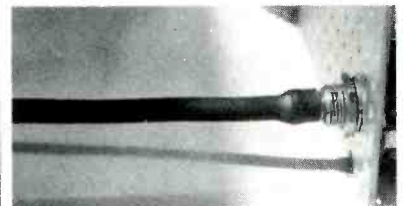

Push-in type terminals, used in experimental breadboards or in strengthening circuit-board connections, can be installed easily by using the wire lead of a 1-watt resistor as an insertion tool. □



Circle 24 on literature card

Circle appropriate number on Reader Service Card.

ANTENNAS

100. Antenna Specialists Co.—announces a new amateur radio catalog with an expanded line of two meter, six meter, and three-quarter meter amateur base and mobile antennas.

101. Blonder-Tongue, Inc.—announces a booklet presenting the basic facts necessary to understand MATV systems. A Glossary of Terms is included for further understanding.

102. Jerrold Electronics Corp.—has introduced a new 10-page guide to installing TV and FM antennas covering antenna selection, masts, mounts, lead-in wire, lightning protection and multi-set systems. Tips on how and where to take lead-in wire into the house, how to run coaxial cable and twinlead indoors and out, and how to drill through exterior walls are included.

AUDIO

103. Atlas Sound—introduces an 8-page color brochure of loudspeakers, paging and intercom speakers, projector horns and drivers, mobile and industrial communications units, hi-fi and sound columns. Included are 100 individual models of loudspeakers and accessories.

104. Mellotone, Inc.—introduces a new catalog featuring CHANGE-A-GRILLE self-stick acoustic fabric for speaker grilles. Swatches of six basic patterns are attached to the catalog showing fabric styles and colors.

105. Switchcraft, Inc.—introduces a 28-page catalog listing its line of phone jacks and plugs, switches, connectors, adapters, and molded cable assemblies. Each part is listed by number and the page on which it is found.

CCTV

106. GBC Closed Circuit TV Corp.—announces a new 20-page

catalog, which illustrates and describes all of the components necessary to a complete video communications system. The catalog illustrates monitors ranging from 5-inch units to a 20-inch solid-state unit.

FUSES

107. Littelfuse, Inc.—announces a new four-page catalog featuring its product line of exact replacement fuse and circuit breaker caddy assortments designed for domestic and foreign electronic equipment service requirements in the field.

KITS

108. Heath Co.—announces their 1972 Heathkit catalog, reportedly featuring over 350 kit projects. Projects for the home, the car, and workshop included.

MARINE ELECTRONICS

109. Raytheon Co.—introduces the Webster antennas and seven new antennas designed for use with standard and single sideband marine radio-telephone and citizens band radios. The Webster antennas for VHF/FM radio are offered in 3 dB, 6 dB, and 9 dB models.

Pioneering again.....Castle presents a sensational NEW Timesaver for the Professional TV Service Technician..... Speed Testing by signal substitution. A new, simplified approach to signal circuit analyzing.....

TV TUNER SUBBER™



Transistorized Test Unit substitutes the tuner in defective TV Receiver to prove whether original tuner is good or bad. Performs tests normally made using elaborate and expensive signal generating equipment and oscilloscopes . . . but much more simply, with easily understood results. Tests that are, in fact, so simple that they can be made right in the home, in most cases without removing the tuner or chassis from cabinet.

Use with any 40MHz receiver . . . black and white or color . . . tube or transistor.

Completely self contained and battery operated; Mk. II, all solid state, improved version of original "subber." Uses L.E.D. indicator, has higher gain with wide range control affording more than 40db of gain reduction. Use on the bench or in the home . . . anywhere.

Substitutes the VHF tuner and tests the UHF tuner. Provides signal to simplify testing of tuner, i.f. system and AGC system. Comes complete with extension cables and instructions.

Unsolicited praise bestowed this revolutionary device includes:

"... works good. I know it will save hours in my TV Service ... you are to be commended ..."

"... in one month ... TV Tuner Subber ... already paid for itself — twice! Thanks much!"

TV TUNER SUBBER MK. II net \$31.95

Contact your distributor.

Include \$1.50 shipping and handling on prepaid mail orders: we will ship C.O.D.



CASTLE TV TUNER SERVICE, INC.

5701 N. Western Ave., Chicago, Illinois 60645 • Phone: (312) - 561-6354

Circle 25 on literature card

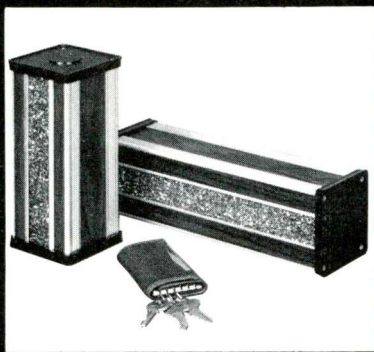

Find Out How Selling the DeltAlert Home Alarm System Makes a Secure P & L Statement

Make money in the expanding home alarm market by selling DeltAlert, the reliable, sophisticated ultrasonic system that assures customer satisfaction. Priced right so you can forget about call-backs, it carries the kind of margin that makes it all worth while. No big cash tie-up in inventory... you order as necessary (experience shows consistent, fast reorders from dealers).

Find out how the DeltAlert and DeltaHorn accessories are your sure boost to profits.

Send for complete information now.
"Delta Products, One Of America's
Finest Names In Electronics"



Circle 26 on literature card

SEMICONDUCTORS

110. GTE Sylvania—has published a 12-page supplement, designated ECG 212D-2, cross referenced with more than 7,100 industrial part numbers with the Sylvania types which replace them.

111. North American Electronics—announces a new catalog supplement (N-72) describing 70 new products. Included are miscellaneous accessories as a universal AC adapter and a low-cost auto burglar alarm, audio cables and adapters, DIN cables, speakers and accessories, and a selection of 13 semiconductors.

SERVICE AIDS

112. Castle Television Tuner Service, Inc.—literature describing the Castle TV Tuner Subber—solid-state, portable unit for field service of color or black and white TV receivers.

SHOP EQUIPMENT

113. Kole Enterprises, Inc.—announces a 36-page color catalog which includes 31 sizes of corrugated stock/parts bins, flat and vertical storage bins, transfer and magazine files and shipping cartons.

TECHNICAL PUBLICATIONS

114. Howard W. Sams & Co., Inc.—announces publication of a new 96-page 1972 Technical and Scientific Book Catalog. Described are over 800 hardbound and softbound books which cover "do-it-yourself" titles from the Audel Division, amateur radio publications, audio visual materials, instructor's guides and student workbooks. Titles range from "ABC's of Air Conditioning" to Writer's and Editor's Technical Stylebook."

115. Sencore, Inc.—Speed Aligner Workshop Manual, Form No. 576P, provides 20 pages of detailed, step-by-step procedures for operation and application for Sencore Model SM 158 Speed Aligner sweep marker generator.

116. Sylvania Electronic Components Div.—has published the 14th edition of their technical manual, which includes mechanical and electrical ratings for receiving tubes, television picture tubes and solid-state devices.

TEST EQUIPMENT

117. Leader Instruments Corp.—announces the 1972 Catalog of Leader Test Equipment. Test equipment included is the LBO-301 portable triggered-sweep oscilloscope, LSW-300 new solid-state post injection sweep/marker generator, and the LCG-384 miniportable, solid-state battery operated color-bar generator.

118. Lectrotech, Inc.—announces the 1972 catalog. "Precision Test Instruments for the Professional Technician". It contains specifications and prices on sweep marker generator, oscilloscopes, vectorscopes, color bar generators and other test equipment.

119. Speco Components Specialists, Inc.—announces their 43-page, 1972 catalog of VOM multimeters and meters for TV technicians. Individual features and specifications for each instrument are included.

TOOLS

120. Jensen Tools and Alloys—has announced a new catalog No. 470, "Tools for Electronic Assembly and Precision Mechanics." The 72-page handbook-size catalog contains over 1,700 individually available items.

121. Plato Products, Inc.—introduces a 28-page, 2-color soldering tip catalog, No. 0372. Illustrated with dimensioned drawings to facilitate accurate selection, the new catalog features tips to fit leading brands and models of soldering irons.

TRANSFORMERS/COILS

122. Essex Controls Division—new Stancor Transformer Catalog No. 207 lists over 1,900 standard transformers for design engineers. Full technical data, mounting dimensions, photographs and other specifications on the line of audio transformers, power transformers, chokes and inductors are included. A complete listing of all Stancor sales offices and stocking warehouses is included.

123. J.W. Miller Co.—announces a new 92-page radio and TV replacement coil cross reference guide for known domestic and foreign color and black and white TV sets, home and car radios. Over 22,000 replacement coils for 327 manufacturers names reportedly are listed. □

antenna systems report

Features and/or specifications listed are obtained from manufacturers' reports. For more information about any product listed, circle the associated number on the reader service card in this issue.

Antenna Installers Meter

Product: Model FS-733 by Sadelco, Inc.

Features: Model FS-733 is solid-state and portable, is battery operated and housed in a rugged case with an accessory compartment. Meter reads in dBmV (and microvolts) to show signal levels, and provides continuous coverage 54-216 MHz for VHF TVFM. Additional features include: taut-band suspension meter gold plated attenuator switches, safety switch turns off power when cover is closed and audio output jacks with crystal earphone provided.

Weight: 4 lbs. 6 oz.

Price: The Model FS-733 sells for \$215.00.



Circle 50 on literature card

Stick-on Indoor Antenna

Product: M-100 VHF-UHF-FM indoor antenna by Gavin Electronics

Features: The antenna has a stick adhesive that attaches to the back of any model TV set. Called the "Retractable Receptor", the telescoping body of the antenna slides down behind the set when not in use. A rotating scanner head allows the receptors dipoles to be

moved for best possible positioning. Installation takes 12 seconds and separate color coded VHF-UHF lead wires are then connected.

Price: Model M-100 sells for \$7.95.

Circle 51 on literature card

Antenna Amplifier

Product: Model TA-82 Colorcaster II by Jerrold Electronics

Features: Model TA-82 is a two set antenna signal amplifier which amplifies UHF and VHF TV channels, plus FM stations. The Colorcaster II is solid-state and encased in cyclac housing that mounts behind a TV set, in the basement, attic or any place else that is convenient. Mounting screws are supplied.

Specifications: Gain at each output is 8 dB at VHF and FM; 5 dB at UHF. Input and output impedances are 300 ohms, matched to twinlead. Response is flat within 1/2 dB per channel and isolation between outputs is at least 15 dB.

Price: Model TA-82 Colorcaster II sells for \$21.50. □

Circle 52 on literature card

When is an exact replacement not an exact replacement?

When it's an **improved** exact replacement flyback or yoke from **STANCOR**.

Here's why:

- Not designed with every mil of cost reduction in mind.
- Performance and reliability are of prime importance. If more insulation or better materials are indicated, Stancor uses them regardless of cost.
- Exact replacements mechanically.
- No modifications required to install.
- Check Stancor's prices — you'll be glad you did.
- You get more for your money with Stancor.

For your improved replacement flybacks and yokes see your independent electronic parts distributor.

ESSEX transformers **STANCOR**



ESSEX INTERNATIONAL, INC., CONTROLS DIVISION 3501 W. Addison Street, Chicago, Illinois 60618

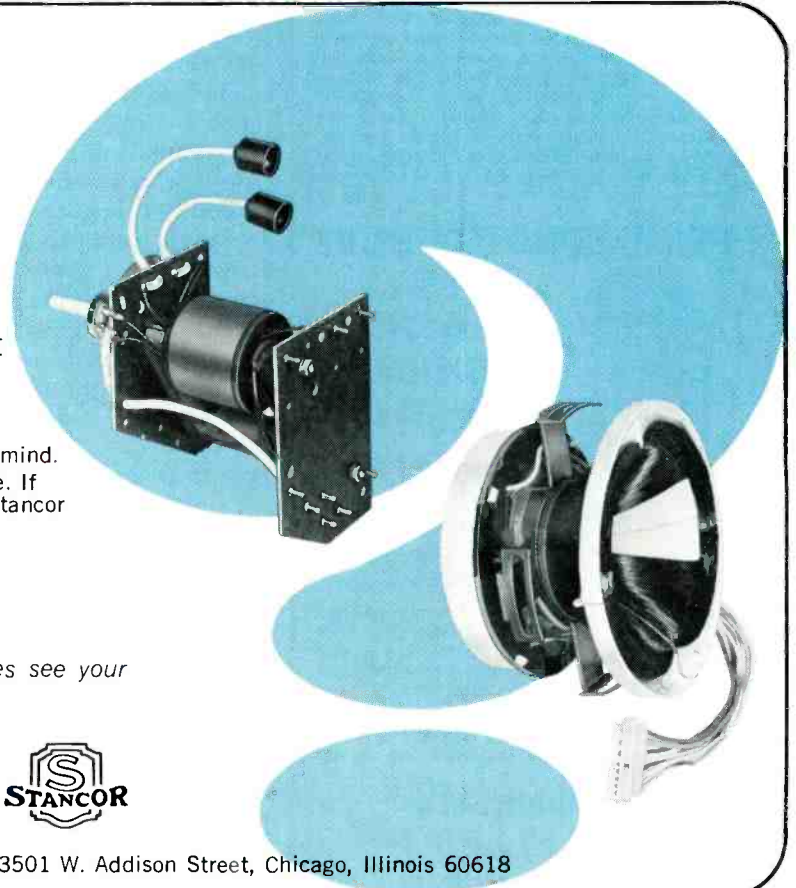

Circle 27 on literature card

SOLVE YOUR DRIVE BELT PROBLEMS IN MINUTES

with ONEIDA'S all new DRIVE BELT KITS

- Eliminates "Down Time" on special and foreign belts.
- No need to stock replacement belts; makes any size in minutes.
- No molds or complicated vulcanizing processes to follow.
- No special skill required, cutting guide, cutting tools and adhesive all included.
- Special Insta-Weld® adhesive makes replacement belts as strong as or stronger than originals for lasting repairs.



ORK-1 Round Rubber Drive Belt Kit\$19.95

ORK-2 Flat and Square Rubber Drive Belt Kit ...\$19.95

ORK-3 "O" Ring Kit\$19.95

Get up to five times your investment back in belt sales. Each of these kits will make from 80-100 dollars or more in rubber drive belts. Included with the kit is the special cutting guide, razor blade, Special Insta-Weld® adhesive, a large quantity of rubber stock and easy-to-follow directions. Nothing has been left out. Packed in an attractive, handy, plastic box that fits into the tube caddy or on the bench. Now, you can replace over 90% of the belts found on tape recorders, phonographs and cassette recorders, both foreign and domestic, right on the spot. Check with your distributor now. If he doesn't stock them, ask him to order them for you today.

PERMABOND ADHESIVE POWER WITH ONEIDA'S Insta-Weld®



Makes Space Age Bonds

Great for: Rubber • Plastic • Metal • Ceramics • Glass • Etc.

Insta-Weld® is new, not epoxy, nothing you have heard of before. There is no mixing, just apply and hold parts together. Just seconds are all that is required for a bond stronger than anything you could ever get before. One drop supports 2,000 pounds per square inch.

Now make economical repairs that were never before possible. Extremely economical, up to 132 bonds per tube.

NEW INSTA-WELD®
only \$2.00 per 2-gram tube



ONEIDA ELECTRONIC MFG., INC.
MEADVILLE, PENNA. 16335

Circle 28 on literature card

audio systems report

Features and/or specifications listed are obtained from manufacturers reports. For more information about any product listed, circle the associated number on the reader service card in this issue.

Four-Channel Quadrafones

Product: Model K-6LCQ by Koss Corp.

Features: The K-6LCQ is designed with slide volume-and-balance controls and foam earcup cushions. It also features a self-adjusting headband and a 10-foot long coil cord with two three-circuit plugs. The new model features a stereo/four-channel switch, making it compatible with both modes of sound reproduction. It is available in regent bronze with brown trim.

Price: Model K-6LCQ sells for \$39.95.



Circle 61 on literature card

Linear Suspension Speaker System

Product: Model 15 by Onkyo Sales Section

Features: The three-way speaker system features a 10-inch woofer, a 1 3/8 inch hemispheric dome mid-range and a 1 inch hemispheric dome tweeter. The woofer has a ported cone cap, said to help eliminate nonlinear distortion for full-bodied bass response. A three-way crossover network provides clean transitions at 1,000 Hz and 7,000 Hz. In addition, the Model 15 features a rear mounted crossover control panel with individual 5-position, mid-range and tweeter control switches, variable in ±2 dB steps.

Specifications: Frequency range is 30-20,000 Hz; maximum power capacity is 40 watts; minimum amplifier power is 10 watts RMS/Channel; impedance is 8 ohms; level controls; high and mid-

range in 5 steps, each ±2 dB; and crossover frequency is 1,000 Hz, 7,000 Hz.

Size and Weight: 22 3/8 inches x 12 5/8 inches x 11 3/8 inches and weighs 11 pounds.

Price: Model 15 sells for \$149.95.



Circle 62 on literature card

Five-Mixer Audio Control Console

Product: Model B-503 by McMartin Industries, Inc.

Features: The B-503 features dual program channel capability at a nominal +8 dBm, 600 ohm balanced output. Input flexibility with plug-in modules to accommodate

microphone or high-level input requirements for each of the five input mixing channels is provided. Two inputs per channel are available through interlocked pushbutton preswitching.

Specifications: Each program channel delivers frequency response characteristics of ±0.5 dB, 30-

bookreview

ABC's Of Industrial Electronics

Author: J. A. Wilson

Publisher: Howard W. Sams & Co., Inc., Indianapolis, Indiana

Size: 5½ inches x 8½ inches, 96 pages

Price: Softcover, \$3.95.

Chapter 1 of this new volume discusses the three basic control system elements: a transducer, a switching component, and an amplifier. Chapter 2 covers the power supply systems: Power sources, power factor, rectifiers, and filters are a few of the various areas covered. The electronic technician is also exposed to the numerical control systems and methods of programming machine operations with punched or magnetic tape.

Contents: Components For Industrial Electronic Circuits—Power Supply Systems—Amplifiers For Control Systems—Introduction To Switching And Logic Circuits—Logic Circuits In Industrial Control Systems—Numerical Control Systems.

How To Interpret TV Waveforms (TAB Book No. 616)

Author: Forest H. Belt

Publisher: TAB Books, Blue Ridge Summit, Pennsylvania

Size: 8¾ inches x 5½ inches, 256 pages

Price: Softcover, \$4.95; hardcover, \$7.95.

The waveform photos, over 250, appearing in this new book have been collected through studying television circuit breakdowns; everyone is authentic, taken from a set troubled by the fault described. The book shows what the normal waveforms should look like at key test points—in addition to showing what happens to each key waveform under various component fault conditions.

Contents: The Nature Of Waveforms—Setting The Scope For TV Waveforms—Sweep Alignment Curves For Troubleshooting—A TV Set's Own Waveforms—Waveforms Created By Station Signals—Signals For Testing Color Stages.

Change of Address

To receive Electronic Servicing at your new address, send an address label from a recent issue and your new address to:

Electronic Servicing, Circulation Dept.
1014 Wyandotte St., Kansas City, Mo. 64105

UPDATE WITH SOLID-STATE!



5 TM
SOLID-TUBES
replace **25**
vacuum tubes



Pull out those troublesome vacuum tubes. Plug in the new SOLID-TUBES from EDI, pioneers in high voltage, solid-state devices for the TV industry.

PART NO. EDI	REPLACE VACUUM TUBE TYPES
SOLID-TUBE TM R-3A3	3A3, 3AW3, 3B2, 3CA3, 3CN3, 3CU3, 3CZ3, 2CN3, 1B3, 1G3, 1K3, 1J3
SOLID-TUBE TM R-3AT2	3AT2, 3AW2, 3BL2, 3BM2, 3BN2
SOLID-TUBE TM R-3DB3	3DB3, 3DJ3
SOLID-TUBE TM R-2AV2	2AV2, 1V2
SOLID-TUBE TM R-DW4	6DW4, 6CK3, 6CL3, 6BA3

CONSIDER THESE BENEFITS . . .

- consistent output
- more reliable — longer life
- no filament winding repairs
- reduces inventories
- real cool
- instant starting
- saves call backs
- no x-radiation

Order EDI SOLID-TUBES from your parts distributor. Or call us collect. Write today for FREE new solid-state replacement parts guide.



ELECTRONIC DEVICES, INC.

21 GRAY CAKS AVE. ■ YONKERS, N.Y. 10710
TELEPHONE 514-965-4400 ■ TELETYPE 710-560-0021

Circle 37 on literature card

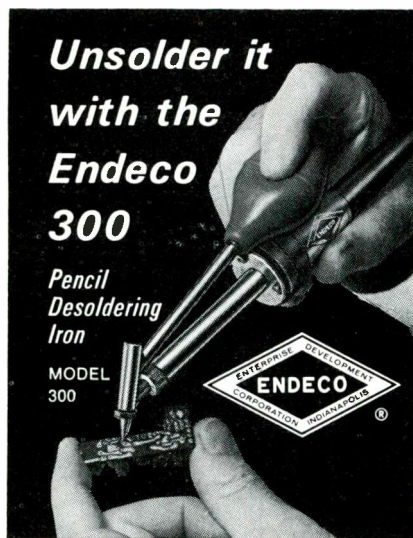

**Unsolder it
with the
Endeco
300**

**Pencil
Desoldering
Iron**

MODEL
300

Removes miniature soldered components in seconds—without damage

Hollow tip fits over connection; vacuums all solder for easy removal of component. Leaves terminals and mounting holes clean. Then, with 360° contact, it resolders faster, better than regular irons. Handles miniature and standard components in PC boards and conventional wiring. Self-cleaning. All parts replaceable. 40 watts, 120-v. Standard tip supplied, 5 other tip sizes available. Pays for itself. \$11.95 net East of the Rockies.

Larger model available. See your distributor or write:

ENTERPRISE DEVELOPMENT CORPORATION
5127 E. 65th St. • Indianapolis, Ind. 46220

Circle 29 on literature card

15,000 Hz with THD of 0.5 percent or less at ±18 dBm output level. The self-contained unit includes 4-watt RMS monitor amplifier output and complete cue facilities.

Price: The Model B-503 sells for \$950.00.

Circle 63 on literature card



Quad-Synthesizer

Product: Four-channel system adapter by Robins Industries Corp.

Features: The adapter derives two additional channels from existing two-channel stereo material by making use of differential phase relationships of the two signals. The adapter is added between the amplifiers and the speakers, two additional speakers are required to gain the quadrasonic sound. The adapter is a synthesizer that enables two-channel stereo to produce a four-channel effect.

Price: The quad-synthesizer sells for \$6.95, with volume and balance controls added the unit sells for \$9.95.

Circle 64 on literature card

Speaker System

Product: Fifteen inch, three-way floor speaker by Utah Electronics.

Features: The new 4-speaker, three-way speaker system has a high compliance 15-inch woofer and a 2-inch diameter voice coil with a 6¾ pound magnetic structure. Cloth edge rolls smooth the response of the acoustically isolated 5-inch midrange. Two dome-radiator tweeters, with horn amplification, assure reproduction of the

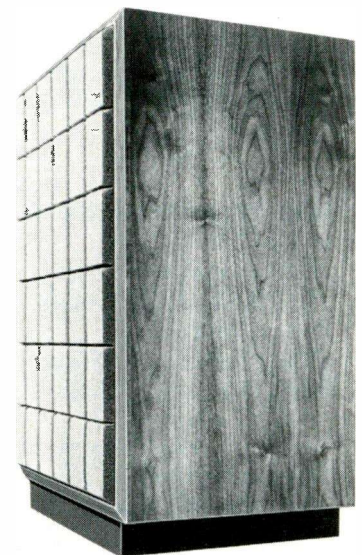

high frequencies throughout a wide dispersion angle. Separate controls for the midrange and tweeters permit the owner to reshape the overall system response.

Size: 27 inches x 20½ inches by 14 inches.

Price: The MP 3000 sells for \$199.95.

Circle 65 on literature card

from



**ANOTHER
QUALITY
INSTRUMENT**



MORE THAN 500,000 sold (in use) **\$1650 net**

MULTITESTER THL-33

Designed to provide maximum service flexibility for many applications. Compact type with a very wide range and can conduct the measurements easily and simply by operation of the Rotary Switch. Portable; has many features that comparative high-priced units do not.

- . 2% Accuracy
- . 1% Precision Resistors
- . Complete with test leads & batteries
- . Meter Fuse Protection
- . Metal Case
- . leather case avail.

SPECIFICATIONS
AC DC V: 0-10-50-250-500-1000 (-2000 /V)
DC A: 0-500uA - 10 - 250mA (-2000 /V)
OHMS: 0-10,100K, 1Mohms (3 ranges)
D B: -20+22 +20 -36DB
Size: 5" x 3½" x 2"

**SEE YOUR LOCAL DISTRIBUTOR OR
SEND FOR SPECO'S FULL LINE CATALOGUE**

Immediate Delivery Means:
• No back orders!
• No waiting!
• Maximum profits!
Send for 1972 Sound Catalog.

**Components
Specialties Inc**
39 St. Mary's Place, Freeport, Long Island, NY 11520

**TO GET
MORE
INFOR-
MATION**

...on items
advertised or
described in
this
publication,
use the
Reader
Service Card.

**Send Your Own
Photo-Tip
To The Editor
Yes— We Pay**

Circle 30 on literature card

productreport

for further information on any of the following items, circle the associated number on the reader service card.

Microwave Intrusion Detector

Product: A5-001 Space Switch by Mountain West Alarm Supply Co.

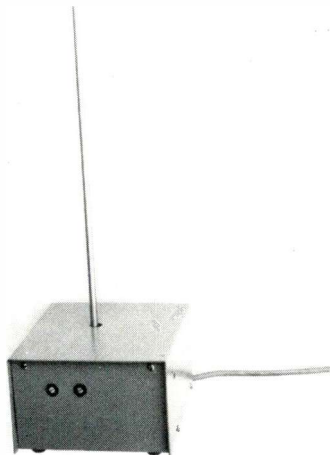

Features: The Space Switch is an all solid-state Microwave (UHF) Doppler Radar System. Microwave transmissions penetrate most non-metallic structures like, plaster, wood and concrete and are reflected by metal. Movements from an intruder set off the alarm circuits while a digital filter rejects movements of small animals and other false alarms.

Specifications: Wall to wall and floor to ceiling protection is provided over as much as 3500 square feet or a 30 foot radius. The A5-001 is powered by 110 VAC or optional 12 VDC battery.

Size and Weight: The Space Switch measures 3¾ inches x 6 inches x 7 inches and weighs 4 pounds.

Price: The A5-001 sells for \$185.00.

Circle 70 on literature card

Marking And Etching Instrument

Product: Mark VII by Electro Stylus.

Features: The Mark VII is streamlined like a pen or pencil with no overhanging bulge. It operates by

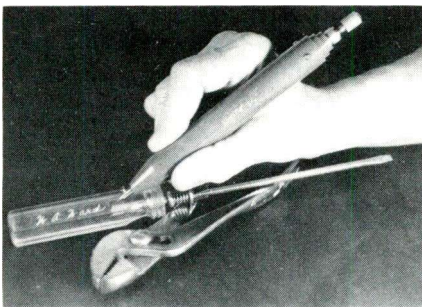

plugging it directly into house current. Noise level of this instrument is very low. Points are interchangeable for ease in engraving on many materials. The Mark VII has many uses in the home, business and industry.

Size and Weight: The Mark VII is ¾ inch in diameter and weighs 7 ounces.

Price: The Mark VII, with standard steel points sells for \$19.95; carbide point, \$2.95; diamond point, \$7.95. A booster box for additional power is \$7.95.

Circle 71 on literature card

Replacement Picture Tubes

Product: Mark II electron gun by General Electric Tube Products.

Features: The Mark II utilizes 20 percent smaller aperture holes to concentrate electron beams on the screen's phosphor spots. The tubes are tested for all electrical characteristics, each is given a 30-KV test to detect any tendency toward arcing. Samples are life-tested for 2,000 hours without significant degradation of electrical or screen performance characteristics.

Circle 72 on literature card

Chemical Spray Valve

Product: ADJUSTA-SPRAY by Chemtronics, Inc.

Features: The new valve can be used with variable spray intensity and a special spray nozzle that may be used with or without extender tubes. ADJUSTA-SPRAY is available on 8-ounce cans of TUN-O-FOAM tuner cleaner/lubricant and TUN-O-BRITE tuner cleaner/polisher/lubricant.

Price: ADJUSTA-SPRAY is available on TUN-O-FOAM and TUN-O-BRITE at \$2.39.

Circle 73 on literature card

(Continued on page 64)

how often could you have used...

a Seizer?

two-position snap-lock

Handy as an extra hand or helper. Clamps lightly or tightly... for moments or minutes.

A remarkably versatile tool with unusual holding qualities. Clamps tightly. Holds wires for soldering, acts as a heat sink, retrieves small parts from hard-to-reach places. Two-position snap-lock. Box joint construction. Precision machined from perfectly tempered stainless steel.

4 MODELS: 6" (serrated jaws) Nos. 42H straight and 43H curved nose; 5" Jr. (smooth, slim jaws) Nos. 32H straight and 33H curved nose.

XCELITE

XCELITE, INC., 18 Bank St., Orchard Park, N. Y. 14127
In Canada contact Charles W. Pointon, Ltd.

Circle 31 on literature card

Guides for All Areas of TV-Radio Servicing
Available on 10-day FREE Trial

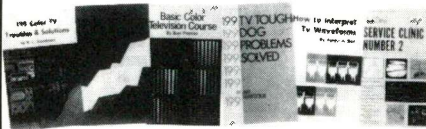

- HOW TO SOLVE SOLID-STATE CIRCUIT TROUBLES—304 pps., 161 illus. No. 624; \$5.95
- TROUBLESHOOTING SOLID-STATE ELECTRONIC POWER SUPPLIES—240 pps., 85 illus. No. 619; \$4.95
- HOW TO INTERPRET TV WAVEFORMS—256 pps., 270 illus. No. 618; \$4.95
- KWIK-FIX TV SERVICE MANUAL—384 pps., schematic diagrams & charts. No. 611; \$5.95
- SOLID-STATE CIRCUIT TROUBLESHOOTING GUIDE—224 pps., 150 illus. No. 607; \$4.95
- BASIC COLOR TELEVISION COURSE—420 pps., over 300 illus. No. 601; \$6.95
- 199 COLOR TV TROUBLES & SOLUTIONS—224 pps., over 180 illus. No. 595; \$4.95
- 199 ELECTRONIC TEST & ALIGNMENT TECHNIQUES—224 pps., 130 illus. No. 593; \$4.95
- CITIZENS BANO RADIO SERVICE MANUAL—228 pps., including 36-page foldout, 83 illus. No. 581; \$4.95
- MODERN RADIO REPAIR TECHNIQUES—260 pps., including 36 page foldout, over 170 illus. No. 580; \$4.95
- HOW TO USE COLOR TV TEST INSTRUMENTS—256 pps., over 230 illus. No. 577; \$4.95
- JACK DARR'S SERVICE CLINIC No. 2—176 pps., 165 illus. No. 566; \$3.95
- JACK DARR'S SERVICE CLINIC No. 1—192 pps., 125 illus. No. 133; \$3.95
- TV, RADIO, HI-FI HINTS & KINKS—256 pps., over 160 illus. No. 561; \$4.95
- 199 TV TOUGH-006 PROBLEMS SOLVED—256 pps., 199 illus. No. 559; \$4.95
- HOW TO USE VECTORSCOPE-OSCILLOSCOPES & SWEEP-MARKER GENERATORS—256 pps., 22 illus. No. 556; \$4.95
- PRACTICAL ELECTRONIC SERVICING TECHNIQUES—256 pps., 138 illus. No. 547; \$4.95
- TV TROUBLE DIAGNOSIS MADE EASY—256 pps., 132 illus. No. 544; \$4.95
- SERVICING MODERN HI-FI STEREO SYSTEMS—248 pps., 250 illus. No. 534; \$4.95
- HOW TO REPAIR SOLID-STATE IMPORTS—184 pps., 8 1/2 x 11. No. 532; \$4.95
- TV TROUBLESHOOTER'S HANDBOOK: 2nd Edition—288 pps., 250 illus. No. 521; \$2.95
- COLOR TV TROUBLE FACTBOOK—176 pps., 150 illus. No. 519; \$2.95
- HOME-CALL TV REPAIR GUIDE—144 pps., 14 quick-reference charts. No. 517; \$2.95
- 101 TV TROUBLES: FROM SYMPTOM TO REPAIR—224 pps., 170 illus. No. 507; \$4.95
- ELECTRONIC TEST & MEASUREMENT HANDBOOK—224 pps., 100 illus. No. 506; \$4.95
- INSTALLING & SERVICING HOME AUDIO SYSTEMS—256 pps., 150 illus. No. 505; \$4.95
- HOW TO FIX TRANSISTOR RADIOS & PRINTED CIRCUITS—256 pps., 150 illus. No. 504; \$4.95
- SERVICING THE SOLID-STATE CHASSIS—256 pps., 221 illus. No. 495; \$4.95
- ON THE COLOR TV SERVICE BENCH—192 pps., 69 illus. No. 489; \$4.95
- HOW TO USE TEST INSTRUMENTS IN ELECTRONIC SERVICING—256 pps., 200 illus. No. 485; \$4.95
- TV SERVICING GUIDEBOOK: PROBLEMS & SOLUTIONS—176 pps., 100 illus. No. 484; \$3.95
- 99 WAYS TO USE YOUR OSCILLOSCOPE—192 pps., 327 illus. No. 483; \$4.95
- PRACTICAL COLOR TV SERVICING TECHNIQUES—2nd Ed. 404 pps., 325 illus. No. 436; \$5.95
- PINPOINT TV TROUBLES IN 10 MINUTES—372 pps., 394 illus. No. 428; \$5.95
- NEW WAYS TO DIAGNOSE ELECTRONIC TROUBLES—288 pps., 146 illus. No. 427; \$4.95
- TEN-MINUTE TEST TECHNIQUES FOR ELECTRONIC SERVICING—176 pps., 125 illus. No. 424; \$2.95
- NEW WAY TO SERVICE COLOR TV—192 pps. No. 136; \$3.95
- COLOR TV REPAIR—160 pps., 131 illus. No. 123; \$2.95
- RAPID RADIO REPAIR—224 pps., 102 illus. No. 78; \$3.95
- SERVICING TRANSISTOR RADIOS—224 pps., 282 illus. No. 76; \$4.95
- RAPID TV REPAIR—224 pps., 107 illus. No. 60; \$4.95

NO-RISK COUPON—MAIL TODAY

TAB BOOKS, Blue Ridge Summit, Pa. 17214

Please send me the following books:

- I have enclosed \$_____. Send postpaid.
- Please invoice me on 10-day FREE trial.

Name _____

Address _____

City _____ State _____ Zip _____

Foreign add 10%. Pa. residents add 6% sales tax. ES-102

Circle 32 on literature card

(Continued from page 63)

Miniature Screwdriver Sets

Product: Mini-Driver Set M-50 and M-60 by Xcelite, Inc.
Features: Set M-50 contains five drivers for slotted head screws, with tips ranging from .040 inches to .100 inches in width. With an overall length of 2 1/8 inches, each driver has a blade length of 7/8 inch and a handle measuring 3/8 inch by 1 1/4 inch. The set is housed in a snap-close, flexible, plastic, see-thru pouch. Set M-60 consists of the same five flat-tip drivers plus one size 00 Phillips type driver and a piggyback torque-amplifier handle which fits over the handles of any of the mini-drivers. All handles are of clear, durable, color-coded



plastic for instant identification.
Price: Set M-50 sells for \$2.50; Set M-60 sells for \$3.50.

Circle 74 on literature card

Speaker Guard

Product: Speaker Guard by Workman Electronic Products, Inc.
Features: The Speaker Guard consists of a resistor and a circuit breaker. An overload in wattage of the amplifier output activates the circuit breaker and prevents damage.
Specifications: Eighteen different models are available with varying combinations of wattage and speaker ohmic values.

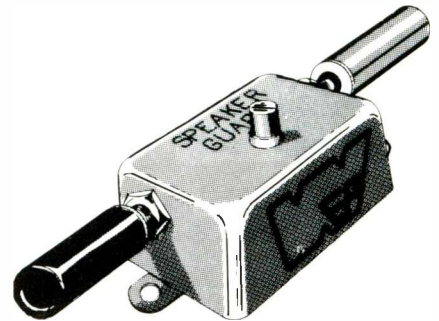

Circle 75 on literature card

Fuse Clips

Product: TRON fuse clips by Bussmann Mfg.
Features: There are TRON fuse clips with two mounting tabs for alignment; the tabs are bowed in such a way that the fuse clip can be snapped into the circuit board. This holds the clip firmly in place while being wane soldered, eliminating the need for riveting. For stringent requirements clips can be furnished in Beryllium Copper, a high quality metal that has the ability to retain spring pressure under adverse conditions, thus preventing heating due to loose contacts. Clips are also available in Spring Bronze metal.

Circle 76 on literature card

Prince, or any other type of L-key within its dimensional capability. The key is slipped into one of nine different bushings, the bushing is slid into the handle, and the tool is ready for use. There are no set screws to tighten and no broached holes or plastic to strip or break.
Specifications: A 20-piece set is offered which includes the basic GLA tool, nine bushings, a nine-piece hex-key set including all sizes from 0.050 to 3/16 inch, and a wooden box with thumb cover screws. The GLA tool is 5 inches long by 3/4 inches hex and is made of hard aluminum.
Price: The GLA tool sells for \$14.25. □

Circle 77 on literature card

Universal Key Driver

Product: GLA key driver by Jensen Tools and Alloys.
Features: It accomodates hex (Allen type), spline (Bristol type), clutch-head, Scrulox, cross recessed (Phillips type), Reed and



test equipment report

Features and/or specifications listed are obtained from manufacturers' reports. For more information about any product listed, circle the associated number on the reader service card in this issue.

Color TV Test Unit

Product: Chek-A-Color, Model CK1500X by GTE Sylvania.

Features: The CK1500X is designed to test solid-state, hybrid, or tube-type receivers. The picture tube provides 14-inches of view-

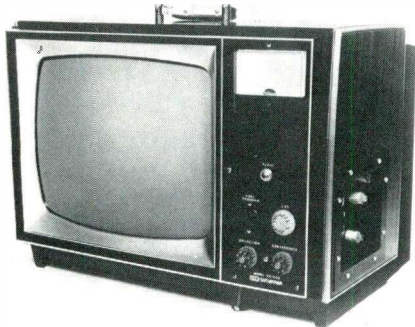

able screen area and is equipped with dual circuits for the testing of high and low focus-voltage receivers. Sixty-one adapters and exten-

sions allow the testing of more than 5,000 chassis sold under 42 brand names. The accessories sold as standard equipment are: solid-state yoke programmer which provides a range of impedances with front-panel switching to match deflection systems in both solid-state and tube-type receivers; a 3.4 inch high voltage meter for monitoring anode voltage from zero to 34KV; a 4-inch speaker to provide audio signals for chassis being monitored; a setup manual, referencing adapters and extensions for servicing different brands and models.

Size and Weight: 15 inches x 20 inches x 16 inches and weighs 34 lbs.

Price: Model CK1500X sells for \$239.15, Model CK1500 with no accessories included, but offered as options sells for \$172.50.

Circle 80 on literature card

Digital Multimeter

Product: Model LDM-850 by Leader Instruments Corp.

Features: Scale accuracy is as good as 1.0 percent or greater and provides a 3 1/2 digit non-blinking dis-



play up to 1,999. A dual-slope operating mode is offered with a maximum input voltage of 1,000VDC and 350VAC with 10 megohms of input impedance. Sensitivity ranges are from 100 μ V to 1V with current from 0.2mA to 1,000mA, AC or DC. Resistance is reported at 200 ohms to 2 megohms. Other features include: automatic polarity reversal and overrange lamp indication; sampling frequency is 200m/sec with instant response. The unit has a dual power supply for field or in-shop testing.

Size and Weight: 10 inches x 7 3/4 inches x 3 1/4 inches and weighs 10 lbs.

Price: Model LDM-850 sells for \$299.50.

Circle 81 on literature card

Dual Trace Oscilloscope

Product: Model PM3110 by Test & Measuring Instruments

Features: Three selector switches control trigger source (inputs A or B or external), trigger polarity, and

trigger mode (high frequency, TV and line). No DC balance knobs are needed because two independent vertical amplifiers are internally corrected for drift. The unit displays either A or B or both depend-

WORKMAN Electronic
Subsidiary of IPM TECHNOLOGY, INC.
BOX 3828 SARASOTA, FLA. 33578
PRODUCTS, INC.

SOCKETS

for TV and RADIOS

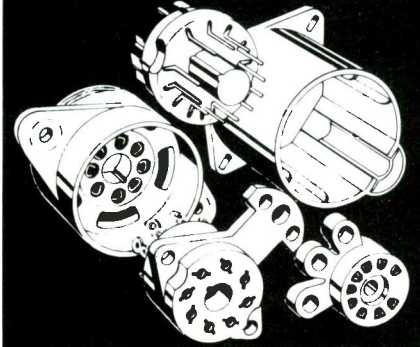

OCTAL • NOVAR • PRINTED
CIRCUIT • TUBE and MINIATURE
SOCKETS. SEVEN, NINE, TWELVE
PIN PLUG SOCKETS with NUVIS-
TOR, TRANSISTOR, SILICON
RECTIFIER, CRYSTAL AND
GENERAL PURPOSE SOCKETS.

Individually packaged for pegboard display

Ask For CROSS REFERENCE X68.

Circle 33 on literature card



**WANT TO KEEP
THINGS QUIET?
AND
CLEAN
TOO?**

Then use Quietrol... the choice of better servicemen everywhere for cleaning and lubricating all T.V. moving parts.

Spray Pack guarantees silent, smooth operation, with absolutely no harmful aftereffects for both color, and black and white sets.

Also available in bottles if you prefer.



Product of
QUIETROLE
COMPANY
Spartanburg, South Carolina

Circle 34 on literature card

ing on the setting of the input control switches, selection of A and B is automatic.

Specifications: Sensitivity can be multiplied by 10 times to 5mV/cm by means of the input control switches; in the high sensitivity model, bandwidth is 5 MHz. Horizontal sweep can be expanded up to 50 cm. The graticule is 8 by 10



cm instead of the usual 6 by 10, permitting the use of the entire 8 by 10 cm CRT face for measurements. Protection against input overloads of up to 1,000 volts DC or AC peak for up to 30 seconds is provided by the cathode follower input. Inputs of 500 volts DC or AC peak can be accepted indefinitely.

MERCURY TUNER SERVICE offers a new money- and time-saving approach to tuner repair . . .

- All major parts replaced AT COST!
- 1N82 UHF diode replaced AT NO COST!
- Return POSTAGE PAID!
- Extra-fast service!

All tuners completely overhauled and aligned to manufacturers' specifications . . . then "air checked" on Mercury's VISION-VIEW MONITOR.

VHF . . . only \$9.50 | B-W or COLOR
 UHF . . . only \$8.50 | Tube or
 VHF/UHF . . . only \$14.50 | Transistor
 Save an additional \$1.00
 by sending this ad with tuner NOW!

MERCURY TUNER SERVICE

DEPT. "C", 49 McClellan St.
 Bronx, N.Y. 10452,
 Phone (212) 293-9060

Inquire about our tuner analyzer. (2 yr. warranty)

Circle 38 on literature card

Weight: The PM3110 weighs 19 pounds.

Price: The PM3110 sells for \$550.00. Optional accessories include probes and viewing hood.

Circle 82 on literature card

Solid-State Circuit Tester

Product: Model 666 by Weston Instruments.

Features: Twelve ranges for current measurements are offered with a lowest full scale range of 1 microamp, eighteen voltage ranges, from 100 mV full scale through

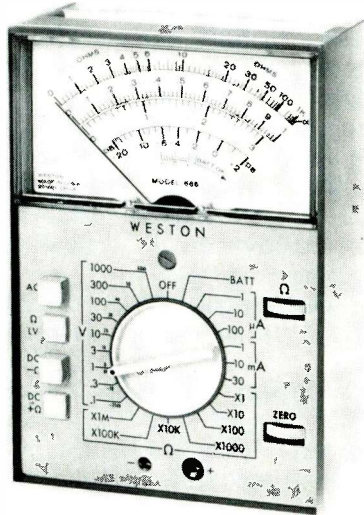

1000 volts, and fourteen ohms ranges, featuring seven low power ohms ranges for "in circuit" measurements of semiconductors. A special differential-FET input circuit provides 10 megohms impedance. Diode protection on the meter movement as well as protection with an externally replaceable fuse, input-reversal switch, temperature and frequency compensation and a self-shielded taut band mechanism are all included in the design of the Model 666. The tester is warranted to withstand a five foot drop.

Price: The Model 666 circuit tester sells for \$132.50.

Circle 83 on literature card

Resistance Decades

Product: Model 1122 and 1124 by Special Instruments & Machinery Co.

Features: There are ten wire-wound, low inductance, manganin resistors, operated by ratchet type, rotary switches for each dial. The unit comes with switches and binding posts mounted on the top panel.

Specifications Accuracy is 0.05 percent with a long-time stability. Each single resistor can carry up to 0.5 watt. Design of the unit allows a high insulation resistance.

Price: Model 1122 sells for \$415.00 and the Model 1124 sells for \$495.00



Circle 84 on literature card

Digital Multimeter

Product: Model 8100B by John Fluke Mfg. Co., Inc.

Features: AC and DC volts are measured in four ranges to 1200 volts and ohms in five ranges to 12 megohms. Readout is four full digits plus "1" for 20 percent over-ranging. Also included is an active 2-pole switchable filter and automatic polarity indicator. All functions are push-button selectable. Options available are: rechargeable battery pack, RF and high voltage,

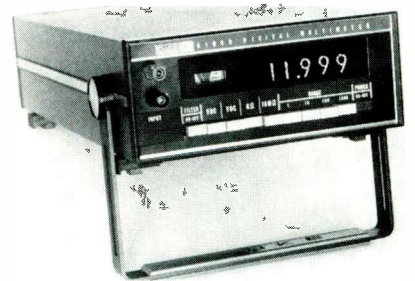

probes, switches AC-DC current shunts, a ruggedized case and data output.

Price: The Model 8100B sells for \$595.00. □

Circle 85 on literature card

Got A Troubleshooting Tip?

If you've recently run across an unusual trouble symptom, send a thorough description of it and the solution to:

Troubleshooting Tip,
 Electronic Servicing
 1014 Wyandotte St.
 Kansas City, Mo. 64105

YEATS dollies

FURNITURE PADS

ROLLS UP & DOWN STAIRS

TRUCK DEVELOPED!

MOST VERSATILE Color Television TRUCK DEVELOPED!

Yeats Platform Dolly \$22.95 ea

FREE-illustrated brochures

Yeats Appliance Dolly Sales Inc.
1307 W. Fond du Lac Ave.
Milwaukee, Wisconsin 53205

YEATS Model No. 5 \$66.50

Circle 35 on literature card

FREE CATALOG

HARD-TO-FIND PRECISION TOOLS

Lists more than 1700 items—pliers, tweezers, wire strippers, vacuum systems, relay tools, optical equipment, tool kits and cases. Also includes four pages of useful "Tool Tips" to aid in tool selection.

JENSEN TOOLS
4117 N. 44th Street, Phoenix, Ariz. 85018

Circle 36 on literature card

GET COMPLETE DETAILS

about the products advertised or described in this issue.

Use Free Reader Service Card.

Be sure to include your name and address

Send Your Own Photo-Tip To The Editor Yes— We Pay



The MARKETPLACE

This classified section is available to electronic technicians and owners or managers of service shops who have for sale surplus supplies and equipment or who are seeking employment or recruiting employees.

Advertising Rates in the Classified Section are:

- 25 cents per word (minimum \$3.00)
- "Blind" ads \$2.00 additional
- All letters capitalized—35 cents per word

Each ad insertion must be accompanied by a check for the full cost of the ad.

Deadline for acceptance is 30 days prior to the date of the issue in which the ad is to be published.

This classified section is not open to the regular paid product advertising of manufacturers.

Use your Scope (any model, no rewiring) to Test Transistors Incircuit. Simple instructions \$1.00. Schek Technical Services, 8101 Schrider St Silver Spring, Maryland 20910. 9-72-6t

FOR SALE

EVERYTHING MUST GO—Test equipment, Tubes, Transistors, Tools, etc. Send for list and prices. Bob Greher, 10144 Dunbarton Dr., El Paso, Texas 79925. 10-72-2t

Antique tubes, Riders manuals, Hickok, Model 600A tester, reasonable price. Goodwin Radio Shop, Rankin, Illinois 60960. 10-72-1t

For Sale: Tubes, Transistors, Meters, Misc. Also plastic bread boards with plug-in plastic encapsulated resistors, caps, etc. Some military equipment. Send stamped self-addressed envelope for list. Jim Dorrell, 2627 Ablene St., Aurora, Colorado 80010. 10-72-1t

FOR SALE, Sencore CR143 CRT tester, \$65. Heathkit IG-28 Dot Bar generator, \$55. Jerrold AIM-718 VHF-UHF field strength meter, \$85. All in perfect condition. Don Masters, P.O. Box 16 North Sandwich, N.H. 03259 (603) 284-6400. 10-72-1t

TV & RADIO TUBES 36c EA.!! Free color catalog. Cornell, 4221 University, San Diego, California 92105 9-72-6t

NEEDED

Cash for good used single or double oven CRT rebuilding machine and supplies. State best price, itemized list, polaroid picture, and condition in first letter. All inquiries answered, write Dept. 501, Electronic Servicing, 1014 Wyandotte, Kansas City, Mo. 64105 10-72-1t

Send in your true anecdote or short, amusing troubleshooting story to share with our readers. We reserve the right to edit and print all contributions to this column.

advertisers' index

American Telephone & Telegraph Co.,	11
Antennacraft	45
B & K Mfg. Co. Div of Dynascan Corp.	7
Bussmann Mfg. Div McGraw Edison Co.	5
Castle Television Tuner Service	55
Centralab Globe Union Inc.	53
Components Specialties—SPECO	61
The Cooper Group	10
Delta Products, Inc.	56
Eico Electronic Instrument Co., Inc.	12-13
Electronic Devices, Inc.	61
Enterprise Development Corp.	62
Essex International— Stancor Div.	59
General Electric Co.— Tube Div.	Cover 2
Heath Company	54
Jensen Tools and Alloys	67
Keithley Instruments, Inc.	33
Leader Instruments Corp.	1
Lectrotech, Inc.	47
Littelfuse, Inc.	Cover 4
Mercury Tuner Service	66
Oneida Electronic Mfg., Inc.	60
Precision Tuner Service	25
Quietrole Company	65
RCA Consumer Electronics	19
RCA Electronic Components ..	49, Cover 3
RCA Parts & Accessories	22
Howard W. Sams & Company	31, 39
Sprague Products Company	3
GTE Sylvania Elec. Components— Consumer Renewal	8
Tab Books	64
Tuner Service Corporation	17
Weltron Company, Inc.	38
Winegard Company	37
Workman Electronic Products, Inc.	65
Xcelite, Inc.	63
Yeats Appliance Dolly Sales	67

Set No.	Folde No.	RC-A-Cont.	Set No.	Folde No.	RC-A-Cont.	Set No.	Folde No.	SEARS-SILVERTONE	Set No.	Folde No.	SETCHELL-CARLSON	Set No.	Folde No.	SYLVANIA-Cont.	Set No.	Folde No.	SYLVANIA-Cont.																																																																																																																																																																																																																																																																																																																																																																																																																																																																																																																																																																																																																																																																																																																																																																																																																																																																																																		
*G0719D.S (Ch. CT464H)	1243-2	*G0719D.SR (Ch. CT464A, CT20A,CRK14C)	1254-2	*G0723W (Ch. CT464H)	1243-2	*G0723W (Ch. CT464H)	1243-2	*G0729P (Ch. CT464H)	1243-2	*G0729P (Ch. CT464H)	1243-2	*G0737L/739D,S,O,Y (Ch. CT464H)	1243-2	*G0745W (Ch. CT464H)	1243-2	*G0745W (Ch. CT464H)	1243-2	*G0749W (Ch. CT464H)	1243-2	*G0759L (Ch. CT464H)	1243-2	*G0769D.S (Ch. CT464H)	1243-2	*G0819W (Ch. CT464H)	1243-2	*G0819W (Ch. CT464H)	1243-2	*G0839L (Ch. CT464H)	1243-2	*G0841L (Ch. CT464H)	1243-2	*G0841L (Ch. CT464H)	1243-2	*G0849F (Ch. CT464H)	1243-2	*G0859D.S (Ch. CT464H)	1243-2	*G0861D.SR (Ch. CT464A, CT20A,CRK14C)	1254-2	*G0879W (Ch. CT464H)	1243-2	*G0881W (Ch. CT464H)	1243-2	*G0893D.S (Ch. CT464H)	1243-2	*GR-530W (Ch. CT464A)	1242-POM	*GR-534A (Ch. CT464A)	1242-POM	*GR-538D,S,X (Ch. CT464A)	1242-POM	*GR-544A,LX (Ch. CT464A)	1242-POM	*GR-548D,X,GX,5X (Ch. CT464A)	1242-POM	*GR612W (Ch. CT39XAJ,XAB)	1254-POM	*GR657L (Ch. CT39XAJ,XAB)	1254-POM	*GR661D.S (Ch. CT39XAJ,XAB)	1254-POM	*GX72AW (Ch. CT464H)	1243-2	*HP0801/910D,S (Ch. CT39XFP, RC-1239D, RS-253F)	1126-3	*HO01A,W (TV Ch. Only CT464P)	1243-2	*HO07W (TV Ch. Only CT464P)	1243-2	*HO0919W (TV Ch. Only CT464P)	1243-2	*HO0923L (TV Ch. Only CT464P)	1243-2	*HO0927D,S (TV Ch. Only CT464P)	1243-2	*HO335R (TV & Remote Ch. Only CT35AP, CT20A, CRK14C)	1254-2	*HO4915R/9435R,DR (TV & Remote Ch. Only CT35AH, CT20A, CRK14C)	1254-2	*JP192W (Ch. KCS171J,T,AC)	1061-1	*JP195W (Ch. CT35XAD)	1271-1	*KF185E,J (Ch. KF1842R)	728-3	*KR29E	MHF-27	*RLM50A (Similar to Page 75)	TSM-136	*RVM685E	TSM-134	*RVM694E	TSM-130	*RVS856R	1238-5	*RVS881W	1238-5	*RVS884L	1238-5	*RVC288	MHF-29	*RZC941W-K	MHF-24	*RZM152E	TSM-136	*RZS454T	1238-5	*RZS470W	1217-5	*VFP50E (Ch. RC-3003A, RS-243A)	1242-5	*VPP62R (Ch. RC-3004A, RS-265B)	1262-5	*VPT26W (Ch. RC-3005)	1250-4	*VQP62B (Ch. RC-3004A, RS-265F)	1262-5	*VQ110W/111/125 (Ch. RC-3005B)	1250-4	*VQ118W/191 (Ch. RC-3005B)	1250-4	*VQ120W/211 (Ch. RC-3005A,B)	1250-4	*VQ122S (Ch. RC-3005A)	1250-4	*VRE08W/09L (Amp Ch. Only RS-265D)	1207-4	*VRP48S (Ch. RS-271B)	1208-4	*VRP56W (Ch. RS-265D)	1207-4	*VRP42R (Ch. RC-3004A, RS-265F)	1262-5	*VRT20W/211/225 (Radio Ch. Only RC3005B)	1250-4	*VS1001W (Ch. RS-265D)	1207-4	*VS1002W (Ch. RS-265D)	1207-4	*VS1200W (See Page 75)	MHF-20	*VS1300WV	MHF-28	*VS1400Y	MHF-29	*VS3001W	MHF-27	*VS4000	MHF-26	*VZP30C (Ch. RS-270B)	1208-4	*VZP38J (Ch. RS-270B)	1208-4	*VZP38B (Ch. RS-270B)	1208-4	*193K019MV (Similar to PCB 655.4)	553-2	*Ch. CRK13A (TV Remote Control Unit)	1243-2	*Ch. CRK14C (TV Remote Control Unit)	1254-2A	*Ch. CT39XAJ,XAB,XAR,XAT,XF	1246-2	*Ch. CT39XAJ,XBJ (1973 Prod.)	1254-POM	*Ch. CT464A (1972 Prod.)	1243-2	*Ch. CT464B (1973 Prod.)	1243-2	*Ch. CT464H,P	1243-2	*Ch. CT465XR	1226-2	*Ch. CT651B (Similar to Chassis)	1209-3	*Ch. CT651X,U	1242-POM	*Ch. CT652XAB,XAE	1242-POM	*Ch. CT653AD	1271-1	*Ch. CT653XU	1271-1	*Ch. CT654A,H,P	1254-2	*Ch. CT655XAB	1271-1	*Ch. CT655XAH	1271-1	*Ch. CT655XT (Similar to Chassis)	1203-2	*Ch. CT659X,XB	1212-POM	*Ch. CT659XD,XE	1248-POM	*Ch. CT663XA,XC	1242-POM	*Ch. CT69A (TV Remote Control Unit)	1254-2A	*Ch. KCS148R (Similar to Chassis)	728-3	*Ch. KCS168XA	1268-3	*Ch. KCS168XB	1251-1	*Ch. KCS168XD,XE	1248-POM	*Ch. KCS171AA,AB,AC,E,F	1061-1	*Ch. KCS172L,M	1262-POM	*Ch. KCS173K,L,N,P	1061-1	*Ch. KCS174H,L,M	1115-2	*Ch. KCS176X (PCB 1232-4)	1224-1	*Ch. KCS176XH	1254-POM	*Ch. KCS179XA,XY,XK	1093-1	*Ch. KCS179XM	1254-POM	*Ch. KCS183D	1236-3	*Ch. KCS183F	1254-POM	*Ch. KCS186B	1254-POM	*Ch. KCS187A	1242-POM	*Ch. KCS188A (1973 Prod.)	1261-2	*Ch. KCS188B	1261-2	*Ch. KR75A (TV Remote Control Unit)	1251-1A	*Ch. KR75B (TV Remote Control Unit)	1271-1	*Ch. RC-3003A	1242-5	*Ch. RC-3004A	1262-5	*Ch. RC-3005A,B	1250-4	*Ch. RC-3006	1224-1A	*Ch. RS-243A	1242-5	*Ch. RS-265B,F	1262-5	*Ch. RS-265C	1263-3	*Ch. RS-265D	1263-3	*Ch. RS-265E	1263-3	*Ch. RS-265F	1263-3	*Ch. RS-265G	1263-3	*Ch. RS-265H	1263-3	*Ch. RS-265I	1263-3	*Ch. RS-265J	1263-3	*Ch. RS-265K	1263-3	*Ch. RS-265L	1263-3	*Ch. RS-265M	1263-3	*Ch. RS-265N	1263-3	*Ch. RS-265O	1263-3	*Ch. RS-265P	1263-3	*Ch. RS-265Q	1263-3	*Ch. RS-265R	1263-3	*Ch. RS-265S	1263-3	*Ch. RS-265T	1263-3	*Ch. RS-265U	1263-3	*Ch. RS-265V	1263-3	*Ch. RS-265W	1263-3	*Ch. RS-265X	1263-3	*Ch. RS-265Y	1263-3	*Ch. RS-265Z	1263-3	*Ch. RS-265AA	1263-3	*Ch. RS-265AB	1263-3	*Ch. RS-265AC	1263-3	*Ch. RS-265AD	1263-3	*Ch. RS-265AE	1263-3	*Ch. RS-265AF	1263-3	*Ch. RS-265AG	1263-3	*Ch. RS-265AH	1263-3	*Ch. RS-265AI	1263-3	*Ch. RS-265AJ	1263-3	*Ch. RS-265AK	1263-3	*Ch. RS-265AL	1263-3	*Ch. RS-265AM	1263-3	*Ch. RS-265AN	1263-3	*Ch. RS-265AO	1263-3	*Ch. RS-265AP	1263-3	*Ch. RS-265AQ	1263-3	*Ch. RS-265AR	1263-3	*Ch. RS-265AS	1263-3	*Ch. RS-265AT	1263-3	*Ch. RS-265AU	1263-3	*Ch. RS-265AV	1263-3	*Ch. RS-265AW	1263-3	*Ch. RS-265AX	1263-3	*Ch. RS-265AY	1263-3	*Ch. RS-265AZ	1263-3	*Ch. RS-265BA	1263-3	*Ch. RS-265BB	1263-3	*Ch. RS-265BC	1263-3	*Ch. RS-265BD	1263-3	*Ch. RS-265BE	1263-3	*Ch. RS-265BF	1263-3	*Ch. RS-265BG	1263-3	*Ch. RS-265BH	1263-3	*Ch. RS-265BI	1263-3	*Ch. RS-265BJ	1263-3	*Ch. RS-265BK	1263-3	*Ch. RS-265BL	1263-3	*Ch. RS-265BM	1263-3	*Ch. RS-265BN	1263-3	*Ch. RS-265BO	1263-3	*Ch. RS-265BP	1263-3	*Ch. RS-265BQ	1263-3	*Ch. RS-265BR	1263-3	*Ch. RS-265BS	1263-3	*Ch. RS-265BT	1263-3	*Ch. RS-265BU	1263-3	*Ch. RS-265BV	1263-3	*Ch. RS-265BW	1263-3	*Ch. RS-265BX	1263-3	*Ch. RS-265BY	1263-3	*Ch. RS-265BZ	1263-3	*Ch. RS-265CA	1263-3	*Ch. RS-265CB	1263-3	*Ch. RS-265CC	1263-3	*Ch. RS-265CD	1263-3	*Ch. RS-265CE	1263-3	*Ch. RS-265CF	1263-3	*Ch. RS-265CG	1263-3	*Ch. RS-265CH	1263-3	*Ch. RS-265CI	1263-3	*Ch. RS-265CJ	1263-3	*Ch. RS-265CK	1263-3	*Ch. RS-265CL	1263-3	*Ch. RS-265CM	1263-3	*Ch. RS-265CN	1263-3	*Ch. RS-265CO	1263-3	*Ch. RS-265CP	1263-3	*Ch. RS-265CQ	1263-3	*Ch. RS-265CR	1263-3	*Ch. RS-265CS	1263-3	*Ch. RS-265CT	1263-3	*Ch. RS-265CU	1263-3	*Ch. RS-265CV	1263-3	*Ch. RS-265CW	1263-3	*Ch. RS-265CX	1263-3	*Ch. RS-265CY	1263-3	*Ch. RS-265CZ	1263-3	*Ch. RS-265DA	1263-3	*Ch. RS-265DB	1263-3	*Ch. RS-265DC	1263-3	*Ch. RS-265DD	1263-3	*Ch. RS-265DE	1263-3	*Ch. RS-265DF	1263-3	*Ch. RS-265DG	1263-3	*Ch. RS-265DH	1263-3	*Ch. RS-265DI	1263-3	*Ch. RS-265DJ	1263-3	*Ch. RS-265DK	1263-3	*Ch. RS-265DL	1263-3	*Ch. RS-265DM	1263-3	*Ch. RS-265DN	1263-3	*Ch. RS-265DO	1263-3	*Ch. RS-265DP	1263-3	*Ch. RS-265DQ	1263-3	*Ch. RS-265DR	1263-3	*Ch. RS-265DS	1263-3	*Ch. RS-265DT	1263-3	*Ch. RS-265DU	1263-3	*Ch. RS-265DV	1263-3	*Ch. RS-265DW	1263-3	*Ch. RS-265DX	1263-3	*Ch. RS-265DY	1263-3	*Ch. RS-265DZ	1263-3	*Ch. RS-265EA	1263-3	*Ch. RS-265EB	1263-3	*Ch. RS-265EC	1263-3	*Ch. RS-265ED	1263-3	*Ch. RS-265EE	1263-3	*Ch. RS-265EF	1263-3	*Ch. RS-265EG	1263-3	*Ch. RS-265EH	1263-3	*Ch. RS-265EI	1263-3	*Ch. RS-265EJ	1263-3	*Ch. RS-265EK	1263-3	*Ch. RS-265EL	1263-3	*Ch. RS-265EM	1263-3	*Ch. RS-265EN	1263-3	*Ch. RS-265EO	1263-3	*Ch. RS-265EP	1263-3	*Ch. RS-265EQ	1263-3	*Ch. RS-265ER	1263-3	*Ch. RS-265ES	1263-3	*Ch. RS-265ET	1263-3	*Ch. RS-265EU	1263-3	*Ch. RS-265EV	1263-3	*Ch. RS-265EW	1263-3	*Ch. RS-265EX	1263-3	*Ch. RS-265EY	1263-3	*Ch. RS-265EZ	1263-3	*Ch. RS-265FA	1263-3	*Ch. RS-265FB	1263-3	*Ch. RS-265FC	1263-3	*Ch. RS-265FD	1263-3	*Ch. RS-265FE	1263-3	*Ch. RS-265FF	1263-3	*Ch. RS-265FG	1263-3	*Ch. RS-265FH	1263-3	*Ch. RS-265FI	1263-3	*Ch. RS-265FJ	1263-3	*Ch. RS-265FK	1263-3	*Ch. RS-265FL	1263-3	*Ch. RS-265FM	1263-3	*Ch. RS-265FN	1263-3	*Ch. RS-265FO	1263-3	*Ch. RS-265FP	1263-3	*Ch. RS-265FQ	1263-3	*Ch. RS-265FR	1263-3	*Ch. RS-265FS	1263-3	*Ch. RS-265FT	1263-3	*Ch. RS-265FU	1263-3	*Ch. RS-265FV	1263-3	*Ch. RS-265FW	1263-3	*Ch. RS-265FX	1263-3	*Ch. RS-265FY	1263-3	*Ch. RS-265FZ	1263-3	*Ch. RS-265GA	1263-3	*Ch. RS-265GB	1263-3	*Ch. RS-265GC	1263-3	*Ch. RS-265GD	1263-3	*Ch. RS-265GE	1263-3	*Ch. RS-265GF	1263-3	*Ch. RS-265GG	1263-3	*Ch. RS-265GH	1263-3	*Ch. RS-265GI	1263-3	*Ch. RS-265GJ	1263-3	*Ch. RS-265GK	1263-3	*Ch. RS-265GL	1263-3	*Ch. RS-265GM	1263-3	*Ch. RS-265GN	1263-3	*Ch. RS-265GO	1263-3	*Ch. RS-265GP	1263-3	*Ch. RS-265GQ	1263-3	*Ch. RS-265GR	1263-3	*Ch. RS-265GS	1263-3	*Ch. RS-265GT	1263-3	*Ch. RS-265GU	1263-3	*Ch. RS-265GV	1263-3	*Ch. RS-265GW	1263-3	*Ch. RS-265GX	1263-3	*Ch. RS-265GY	1263-3	*Ch. RS-265GZ	1263-3	*Ch. RS-265HA	1263-3	*Ch. RS-265HB	1263-3	*Ch. RS-265HC	1263-3	*Ch. RS-265HD	1263-3	*Ch. RS-265HE	1263-3	*Ch. RS-265HF	1263-3	*Ch. RS-265HG	1263-3	*Ch. RS-265HH	1263-3	*Ch. RS-265HI	1263-3	*Ch. RS-265HJ	1263-3	*Ch. RS-265HK	1263-3	*Ch. RS-265HL	1263-3	*Ch. RS-265HM	1263-3	*Ch. RS-265HN	1263-3	*Ch. RS-265HO	1263-3	*Ch. RS-265HP	1263-3	*Ch. RS-265HQ	1263-3	*Ch. RS-265HR	1263-3	*Ch. RS-265HS	1263-3	*Ch. RS-265HT	1263-3	*Ch. RS-265HU	1263-3	*Ch. RS-265HV	1263-3	*Ch. RS-265HW	1263-3	*Ch. RS-265HX	1263-3	*Ch. RS-265HY	1263-3	*Ch. RS-265HZ	1263-3	*Ch. RS-265IA	1263-3	*Ch. RS-265IB	1263-3	*Ch. RS-265IC	1263-3	*Ch. RS-265ID	1263-3	*Ch. RS-265IE	1263-3	*Ch. RS-265IF	1263-3	*Ch. RS-265IG	1263-3	*Ch. RS-265IH	1263-3	*Ch. RS-265II	1263-3	*Ch. RS-265IJ	1263-3	*Ch. RS-265IK	1263-3	*Ch. RS-265IL	1263-3	*Ch. RS-265IM	1263-3	*Ch. RS-265IN	1263-3	*Ch. RS-265IO	1263-3	*Ch. RS-265IP	1263-3	*Ch. RS-265IQ	1263-3	*Ch. RS-265IR	1263-3	*Ch. RS-265IS	1263-3	*Ch. RS-265IT	1263-3	*Ch. RS-265IU	1263-3	*Ch. RS-265IV	1263-3	*Ch. RS-265IW	1263-3	*Ch. RS-265IX	1263-3	*Ch. RS-265IY	1263-3	*Ch. RS-265IZ	1263-3	*Ch. RS-265JA	1263-3	*Ch. RS-265JB	1263-3	*Ch. RS-265JC	1263-3	*Ch. RS-265JD	1263-3	*Ch. RS-265JE	1263-3	*Ch. RS-265JF	1263-3	*Ch. RS-265JG	1263-3	*Ch. RS-265JH	1263-3	*Ch. RS-265JI	1263-3	*Ch. RS-265JJ	1263-3	*Ch. RS-265JK	1263-3	*Ch. RS-265JL	1263-3	*Ch. RS-265JM	1263-3	*Ch. RS-265JN	1263-3	*Ch. RS-265JO	1263-3	*Ch. RS-265JP	1263-3	*Ch. RS-265JQ	1263-3	*Ch. RS-265JR	1263-3	*Ch. RS-265JS	1263-3	*Ch. RS-265JT	1263-3	*Ch. RS-265JU	1263-3	*Ch. RS-265JV	1263-3	*Ch. RS-265JW	1263-3	*Ch. RS-265JX	1263-3	*Ch. RS-265JY	1263-3	*Ch. RS-265JZ	1263-3	*Ch. RS-265KA	1263-3	*Ch. RS-265KB	1263-3	*Ch. RS-265KC	1263-3	*Ch. RS-265KD	1263-3	*Ch. RS-265KE	1263-3	*Ch. RS-265KF	1263-3	*Ch. RS-265KG	1263-3	*Ch. RS-265KH	1263-3	*Ch. RS-265KI	1263-3	*Ch. RS-265KJ	1263-3	*Ch. RS-265KK	1263-3	*Ch. RS-265KL	1263-3	*Ch. RS-265KM	1263-3	*Ch. RS-265KN	1263-3	*Ch. RS-265KO	1263-3	*Ch. RS-265KP	1263-3	*Ch. RS-265KQ	1263-3	*Ch. RS-265KR	1263-3	*Ch. RS-265KS	1263-3	*Ch. RS-265KT	1263-3	*Ch. RS-265KU	1263-3	*Ch. RS-265KV	1263-3	*Ch. RS-265KW	1263-3	*Ch. RS-265KX	1263-3	*Ch. RS-265KY	1263-3	*Ch. RS-265KZ	1263-3	*Ch. RS-265LA	1263-3	*Ch. RS-265LB	1263-3	*Ch. RS-265LC	1263-3	*Ch. RS-265LD	1263-3	*Ch. RS-265LE	1263-3	*Ch. RS-265LF	1263-3

Set No.	Folder No.	Set No.	Folder No.
I			
INLAND-DYNATRONICS			
Inland Dynatronics, Inc.			
10 Horizon Blvd.			
South Hackensack, N. J. 07606			
AF-604	AR-124		
FM-400	AR-125		
MPX-2000	AR-128		
S-75	AR-121		
S-85	AR-119		
S-900	AR-119		
WV-209A	AR-124		
WV-509	AR-122		
X-204	AR-122		
X-204	AR-124		
INTERNATIONAL			
International Harvester Co.			
180 N. Michigan Avenue			
Chicago, Illinois 60601			
F95MH1	AR-124		
18T1H	AR-110		
1HA1914 (244793-R91)	AR-120		
1HA1918 (244766-R91)	AR-125		
244766-R91	AR-125		
244793-R91	AR-120		

Set No.	Folder No.	Set No.	Folder No.
NGA			
Mitsubishi International Corp.			
7045 North Ridgeway Ave.			
Lincolnwood, Illinois 60465			
AR-6155G-BL-L	AR-117		
AR-101, W	AR-117		
MGB (See British Leyland)			
MOTOROLA			
Motorola, Inc.			
9401 West Grand Ave.			
Franklin Park, Ill. 60131			
CMX501	AR-127		
F8PM (200)	AR-125		
P7185	AR-116		
TM7185	AR-116		
2MP2031	AR-127		
75MFT	AR-109		
OP3598	AR-109		
1Ch. 1D138J	AR-116		

Set No.	Folder No.	Set No.	Folder No.
PONTIAC—Cont.			
228FF1	AR-109		
228P2 (See Page 99)	AR-109		
228FK1	AR-109		
228FPK2 (See Page 99)	AR-109		
228PB1	AR-118		
228PB2	AR-118		
228PB3 (Similar to page 93)	AR-118		
228PBK1	AR-115		
228PBK2	AR-122		
228PB11	AR-117		
228PB12	AR-127		
228T411	AR-112		
228T412	AR-114		
228T413	AR-114		
228T414	AR-113		
228T415	AR-113		
228T416	AR-113		
228T417	AR-113		
228T418	AR-113		
228T419	AR-113		
228T420	AR-113		
228T421	AR-113		
228T422	AR-113		
228T423	AR-113		
228T424	AR-113		
228T425	AR-113		
228T426	AR-113		
228T427	AR-113		
228T428	AR-113		
228T429	AR-113		
228T430	AR-113		
228T431	AR-113		
228T432	AR-113		
228T433	AR-113		
228T434	AR-113		
228T435	AR-113		
228T436	AR-113		
228T437	AR-113		
228T438	AR-113		
228T439	AR-113		
228T440	AR-113		
228T441	AR-113		
228T442	AR-113		
228T443	AR-113		
228T444	AR-113		
228T445	AR-113		
228T446	AR-113		
228T447	AR-113		
228T448	AR-113		
228T449	AR-113		
228T450	AR-113		
228T451	AR-113		
228T452	AR-113		
228T453	AR-113		
228T454	AR-113		
228T455	AR-113		
228T456	AR-113		
228T457	AR-113		
228T458	AR-113		
228T459	AR-113		
228T460	AR-113		
228T461	AR-113		
228T462	AR-113		
228T463	AR-113		
228T464	AR-113		
228T465	AR-113		
228T466	AR-113		
228T467	AR-113		
228T468	AR-113		
228T469	AR-113		
228T470	AR-113		
228T471	AR-113		
228T472	AR-113		
228T473	AR-113		
228T474	AR-113		
228T475	AR-113		
228T476	AR-113		
228T477	AR-113		
228T478	AR-113		
228T479	AR-113		
228T480	AR-113		
228T481	AR-113		
228T482	AR-113		
228T483	AR-113		
228T484	AR-113		
228T485	AR-113		
228T486	AR-113		
228T487	AR-113		
228T488	AR-113		
228T489	AR-113		
228T490	AR-113		
228T491	AR-113		
228T492	AR-113		
228T493	AR-113		
228T494	AR-113		
228T495	AR-113		
228T496	AR-113		
228T497	AR-113		
228T498	AR-113		
228T499	AR-113		
228T500	AR-113		

Set No.	Folder No.	Set No.	Folder No.
TENNA			
Tenna Corporation			
19201 Cranwood Parkway			
Wentzville Heights, Ohio			
44128			
TC-80-T	AR-116		
TC-82-T	AR-111		
TOYOTA			
Toyota Motors			
Distributors, Inc.			
2055 W. 190th St.			
P.O. Box 2991			
Torrance, Calif. 90509			
CR-122F1	AR-114		
CR-122F1, K2, K3	AR-120		
22FPB1	AR-114		
22FPB2, 22FPBK2	AR-126		
22FT411	AR-112		
22GFM1	AR-113		
22GFP1, P2	AR-120		
22GFP3 (See Page 89)	AR-120		
22GFPK1, K2, K3	AR-120		
22GPB1	AR-114		
22GPB2	AR-126		
22GPBK2	AR-126		
22XT411	AR-112		
7307302	AR-114		
7307302 (1972 1/2 Prod.)	AR-126		
7307332	AR-126		
7307332 (1972 1/2 Prod.)	AR-126		
7307402 (1971 1/2 and 1972 Prod.)	AR-120		
7307432 (1971 1/2 and 1972 Prod.)	AR-120		
7307702	AR-112		
7312332	AR-113		
7312892 (1972 1/2 Prod.)	AR-126		
7312912	AR-114		
7312912 (1972 1/2 Prod.)	AR-126		
7312922 (1971 1/2 and 1972 Prod.)	AR-120		
7312942 (1971 1/2 and 1972 Prod.)	AR-120		
7313522 (1971 1/2 and 1972 Prod.)	AR-120		
7313522 (1972 1/2 Prod.)	AR-126		
7313532 (1971 1/2 and 1972 Prod.)	AR-120		
7313542	AR-113		
7313552	AR-114		
7313552 (1972 1/2 Prod.)	AR-126		
7313562 (1971 1/2 and 1972 Prod.)	AR-120		
7330012 (1972 Prod.)	AR-118		
7330012 (1972 1/2 Prod.)	AR-122		
7330022	AR-109		
7330032	AR-112		
7330022 (1972 Prod.)	AR-118		
7330022 (1972 1/2 Prod.)	AR-122		
7330212	AR-109		
7330242	AR-117		
7330242 (1972 1/2 Prod.)	AR-122		
7330252	AR-115		
7330492	AR-112		
7330542	AR-113		
7332324 (1972 1/2 Prod.)	AR-126		
7332324 (1972 1/2 Prod.)	AR-126		
7333251	AR-120		
7333261	AR-113		
7333501	AR-114		
7333501 (1972 1/2 Prod.)	AR-126		
7333511	AR-120		
7334782	AR-112		
7336181	AR-117		
7336191	AR-115		
7336232	AR-112		

Set No.	Folder No.	Set No.	Folder No.
TENNA			
Tenna Corporation			
19201 Cranwood Parkway			
Wentzville Heights, Ohio			
44128			
TC-80-T	AR-116		
TC-82-T	AR-111		
TOYOTA			
Toyota Motors			
Distributors, Inc.			
2055 W. 190th St.			
P.O. Box 2991			
Torrance, Calif. 90509			
CR-122F1	AR-114		
CR-122F1, K2, K3	AR-120		
22FPB1	AR-114		
22FPB2, 22FPBK2	AR-126		
22FT411	AR-112		
22GFM1	AR-113		
22GFP1, P2	AR-120		
22GFP3 (See Page 89)	AR-120		
22GFPK1, K2, K3	AR-120		
22GPB1	AR-114		
22GPB2	AR-126		
22GPBK2	AR-126		
22XT411	AR-112		
7307302	AR-114		
7307302 (1972 1/2 Prod.)	AR-126		
7307332	AR-126		
7307332 (1972 1/2 Prod.)	AR-126		
7307402 (1971 1/2 and 1972 Prod.)	AR-120		
7307432 (1971 1/2 and 1972 Prod.)	AR-120		
7307702	AR-112		
7312332	AR-113		
7312892 (1972 1/2 Prod.)	AR-126		
7312912	AR-114		
7312912 (1972 1/2 Prod.)	AR-126		
7312922 (1971 1/2 and 1972 Prod.)	AR-120		
7312942 (1971 1/2 and 1972 Prod.)	AR-120		
7313522 (1971 1/2 and 1972 Prod.)	AR-120		
7313522 (1972 1/2 Prod.)	AR-126		
7313532 (1971 1/2 and 1972 Prod.)	AR-120		
7313542	AR-113		
7313552	AR-114		
7313552 (1972 1/2 Prod.)	AR-126		
7313562 (1971 1/2 and 1972 Prod.)	AR-120		
7330012 (1972 Prod.)	AR-118		
7330012 (1972 1/2 Prod.)	AR-122		
7330022	AR-109		
7330032	AR-112		
7330022 (1972 Prod.)	AR-118		
7330022 (1972 1/2 Prod.)	AR-122		
7330212	AR-109		
7330242	AR-117		
7330242 (1972 1/2 Prod.)	AR-122		
7330252	AR-115		
7330492	AR-112		
7330542	AR-113		
7332324 (1972 1/2 Prod.)	AR-126		
7332324 (1972 1/2 Prod.)	AR-126		
7333251	AR-120		
7333261	AR-113		
7333501	AR-114		
7333501 (1972 1/2 Prod.)	AR-126		
7333511	AR-120		
7334782	AR-112		
7336181	AR-117		
7336191	AR-115		
7336232	AR-112		

Set No.	Folder No.	Set No.	Folder No.
BRADFORD			
W. T. Grant Company			
1515 Broadway, Times Square			
New York, New York 10036			
WTC-52506	TR-102		
WTC-60939	TSM-132		
205030	TSM-132		
2104541	TR-102		

F		L		M		N		O		P		R		S		T		Y															
Set No.	Folde No.	Set No.	Folde No.	Set No.	Folde No.	Set No.	Folde No.	Set No.	Folde No.	Set No.	Folde No.	Set No.	Folde No.	Set No.	Folde No.	Set No.	Folde No.	Set No.	Folde No.														
FANON-MASCO Fanon/Courier Corporation 990 South Fair Oaks Avenue Pasadena, California 91105 Address Change		LINCOLN Ford Motor Company Dearborn, Michigan D1LA-19A242AAR-104 2M1A108 (D1LA-19A242A)AR-104		MAGNAVOX The Magnavox Company Buster Road Fort Wayne, Indiana 46803 1Y9002TR-90 1Y9029TR-106 1Y9033TR-105 2V9030TR-102		NORELCO Norelco Service, Inc. 30-30 Review Avenue Long Island City, New York 11101 RR25TR-101 1320TR-96 1440TR-90 1530TR-94 1570TR-105 2400,PTR-92		OLDSMOBILE United Delco Distributors 138FM72AR-117 138PB72AR-118 23A7411AR-117 238FM71AR-117 238PB71AR-118 238PB72AR-126 7930053AR-118 7930063AR-117 7930093AR-117 7935063AR-118 7935063 (1972 1/2 Prod.)AR-126 7937413AR-112		PACKARD BELL Teledyne Packard Bell Electronics 12333 West Olympic Blvd. Los Angeles, Calif. 90064 TRD-120 (Similar to Page 34)TR-73		RANGER Ranger Radio 19201 Cranwood Parkway Warrensview Heights, Ohio 44128 R-71-TAR-111		SANYO Sanyo Electric, Inc. 1200 West Walnut Street Compton, California 90220 FT-863AR-127 FT-883AR-121		SEARS-SILVERTONE Sears, Roebuck & Company 303 East Ohio Street Chicago, Illinois 60611 174.34940000TR-97 400.34171100 (Similar to page 97)TR-89 564.21180200 (Similar to page 83)TR-72 564.34300000TR-100 564.34401700 (Similar to page 93)TR-62		SHARP Sharp Electronics Corp. 10 Keystone Place Paramus, N. J. 07652 RD-416UTR-100 RD-425UTR-99 RD-426UTR-92 RD-428UTR-104		SUNNY Sunnyside, Inc. 8150 Vineland Ave. Sun Valley, Calif. 91353 TC-8WTR-96 TC-60TR-98 TC-90TR-106 TC-95,ATR-104 TC-100 (Serial #258, 171 and later (USA) #309, 101 and later (Canada)TR-90 TC-110ATR-102 TC-125TR-100 TC-160TR-93 TC-180/AVTR-99 TC-330TR-101 TC-352DTR-97 TC-640TR-103 TC-65TR-94 TC-651 (Similar to Page 65)TR-94 TC-707C (Similar to Page 65)TR-94 TC-1150TR-99 TC-210TR-100 TC-2200TR-93 TC-6350TR-97 TC-9400TR-103		TOYOTA Toyota Motor Sales U.S.A., Inc. 2055 West 190th Street Torrance, Calif. 90501 CX-161FTBAR-114 CX-165FTBAR-114 86260-14010 (CX-165FTB)AR-114 86260-20011 (CX-161FTB)AR-114		TRUETONE Western Auto Supply Co. 2107 Grand Avenue Kansas City, Mo. 64108 1TC7004A-07AR-111 1TC7003A-17AR-116 4DC7003AR-116 4DC7004AR-111		WARDS (AIRLINE-RIVERSIDE) Montgomery Ward & Co. 619 Chicago Avenue Chicago, Illinois 60607 GEN-3930ATR-95 GEN-3960ATR-105 GEN-6211ATSM-129 7CX-16753A,B,C,DAR-116 61-16753AR-116 62-6211TSM-129 62-3930TR-95		WELTRON Weltron Company, Inc. 514 East Peabody Street Durham, North Carolina 27702 WFMX-104TSM-129 717,718AR-111 2001TSM-131		WESTINGHOUSE Westinghouse Electric Corp. Consumer Electronics Div. Route 27 Vineard Road Edison, New Jersey 08817 TSC4030A, BTR-102 TSC8020ATR-102		WOLLENSAK 3M Company Revere-Mincom Div. 2501 Hudson Rd. St. Paul, Minnesota 55119 4400TR-98 4410TR-98 4500TR-97 4510TR-97 6150 (Lots A,B)TR-93 6154 (Lots A,B)TR-93 6250TR-91 6350TR-91 6360TR-91 6364TR-91	

NOTE: ● Denotes Television Receiver. ★ Denotes Color Television Receiver. AOR Denotes Available On Request. AR Denotes Auto Radio Series Volume. CB Denotes CB Radio Series Volume. HTP Denotes Home Tape Player Series Volume. MHF Denotes Modular Hi-Fi Series Volume. PCB Denotes Production Change Bulletin. POM Denotes Bonus Schematic in Photocast-of-the-Month Package—Unavailable After Month Of Issue. SED Denotes Special Equipment Data. TR Denotes Tape Recorder Series Volume. TSM Denotes Transistor Radio Series Volume.



NEW SAMS COVERAGE CONCEPT Provides Better Service for the Dealer or Technician

Subscribers to the Sams Modular Hi-Fi Specialized Series manuals will notice several changes in the latest issues. Although this series has a new cover design, the big change is inside—there's twice the coverage as before. Now each manual contains schematics and pertinent servicing information on up to 13 different modular hi-fi and compact stereo units, and best of all, it doesn't cost a penny more—the price is still \$3.95 per volume. All of this is possible through greater utilization of manufac-

turer's service data. It's a tremendous opportunity for anyone who needs to repair popular late model modular hi-fi and stereo components. Here's a quick and easy way to establish an extensive file of the necessary servicing information, for all the recently produced modular hi-fi and compact stereo equipment. Contact your distributor, and order the new Sams Modular Hi-Fi Series manuals today.

sk

The Solid-State System ... for better servicing

It all works together to help you meet today's tough demands of solid-state servicing. See your RCA Distributor now and put SK, The RCA Solid-State Replacement System, to work in your business. You'll see why you can't beat it for better servicing and profits. It's the system built from your point of view.

RCA/Electronic Components
Harrison, N.J. 07029

RCA
Electronic
Components

RCA Quality Product

- Top-of-the-line premium devices
- Meet or exceed specs for professional servicing
- 146 RCA SKs replace over 50,000 devices

RCA Solid-State Hardware

- 10 sockets for transistors and ICs
- 15 heat sinks from TO-18 to TO-3 package styles



RCA Information Support

- Replacement Guide (SPG-202M) cross-references over 50,000 domestic and foreign devices and supplies specific application information to assure correct replacement
- SK Quick Selection Wall Chart (1L1367A) . . . saves you time making the right choice
- Three slide-film/cassette tape presentations on Transistor Servicing cover Basic Techniques for Transistor Checking (1L1337), Identifying The Defective Stage (1L1377), Identifying & Replacing The Defective Component (1L1378), plus the Transistor Servicing Booklet (1L1379). Available through your RCA Distributor

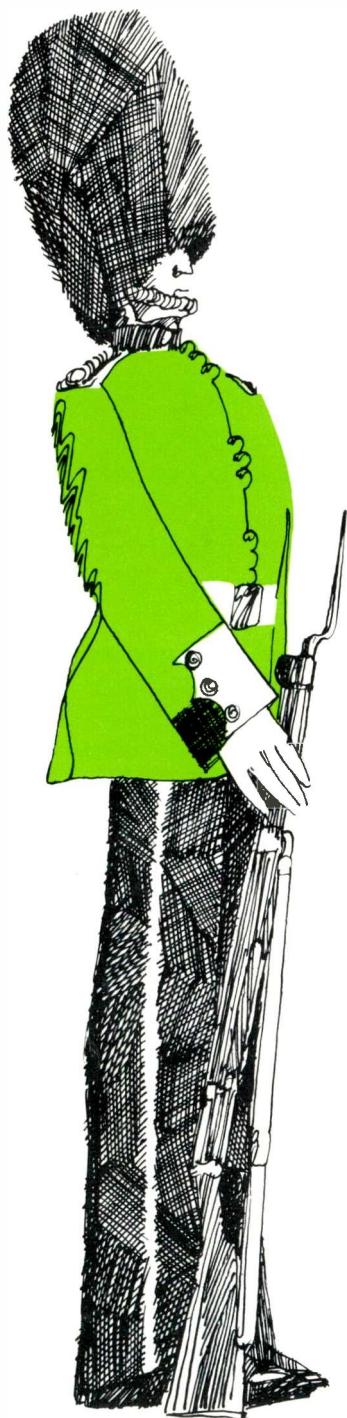

24 hour watch



Everyday. All over the world. On millions of television sets, our sentry stands. The new Littelfuse Circuit Breaker. Meeting industry's new safety requirements of SE-O insulating materials, our breaker is demanded by virtually all set manufacturers. It's the perfect replacement part too!

Contact your nearest Littelfuse source. He'll show you the 19 available models with a variety of packaging choices.

24 hour watch. All over the world. It's a big assignment. But the Littelfuse Sentry is one of television's brightest stars.

Recognized under the components program of Underwriters' Laboratories, Inc.

LITTELFUSE

Littelfuse, Inc. Subsidiary of Tracor, Inc.
800 E. Northwest Highway, Des Plaines, Ill. 60016

Circle 3 on literature card