

Electronic Servicing

The Curve Tracer:
Another Approach
to Testing Transistors



Independent Business '70 and '71:

Analysis by members of the National
Federation of Independent Business

FROM THE COMPANY WHO GIVES YOU
THE STRONGEST GUARANTEE IN THE BUSINESS

BUY AN INSTRUMENT. GET AN INSTRUMENT FREE.*

SIGNAL TRACER PROBE



Gain 3000 at 2 KHz. Bandwidth 50 Hz to 200 MHz. Z 3500 Ω to 350 K Ω . Output 0.3 p-p volts. Noise -45db. Supplied with anti-overload probe tips: Eico PST-2, Kit \$19.95, Wired \$29.95.

NEW TRANSISTOR ANALYZER



Tests trans-conductance and Beta in and out of circuit. Measures FETs, bipolars, diodes, rectifiers, SCRs, UJTs. Built-in voltmeter, ohmmeter. 50 μ a taut band meter movement. Eico 685, Kit \$99.95, Wired \$149.95.

NEW CURVE TRACER



New professional transistor/diode curve tracer enables any general-purpose oscilloscope to display direct readouts of the most meaningful data. Eico 443, Kit \$99.95, Wired \$149.95.

SOLID STATE COLOR GENERATOR



Standard offset carrier type stable 10-bar display plus precision dots, crosshatch, individual series of V & H lines; gun killers. Feeds to ant. terminals. Portable, battery/AC. Eico 385, Kit \$79.95, Wired \$109.95.

*FREE EICO TRUVOHM™ MULTIMETERS (with purchases as described)



Model 1A1
1 K Ω /V

Model 4A3
4 K Ω /V

NEW OSCILLOSCOPE/VECTORSCOPE



DC-8MHz (usable to 10 MHz). 5" flat-face CRT. Sensitivity 12 MV RMS/CM. Negligible relative H & V phase shift. Excellent curve tracer with Eico 443 (below). Eico 465, Kit \$179.95, Wired \$249.95.

CRT TESTER AND REJUVENATOR

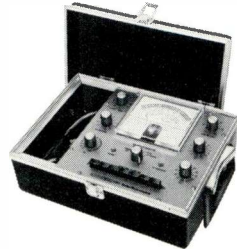

For all B-W & Color Picture Tubes. Each gun of Color Tube measured individually and numerically, provides required gray scale tracking information. Eico 633, Kit \$79.95, Wired \$109.95.

NEW SOLID STATE SINE/SQUARE WAVE GENERATOR



Provides simultaneous sine and square wave outputs. Covers 20 Hz-2MHz, 5 bands. Max. distortion 0.25%. Rise time at 20 KHz <0.1 μ sec. Eico 379, Kit \$69.95, Wired \$99.95.

NEW SOLID STATE FET-TVM'S



AC RMS/DCV: 0-1, 3, 10, 30, 100, 300, 1000V. P-P ACV: 0-2.8, 8.5, 28, 85, 280, 850, 2800V. DC Input Z 11 M Ω . Ohmmeter 0.2 Ω to 1000 M Ω . 4 1/2" 200 μ A meter. Eico 240, Kit \$59.95, Wired \$79.95. With 6 1/2" meter & AC/DC Current readings.

Eico 242 FET-TVOM, Kit \$69.95, Wired \$94.50.

TUBE TESTER



Tests all standard tubes plus decals, magnovals, 7-pin nuvistors, popular TV picture tubes. Professional, compact, lightweight, and modest price. Eico 635, Kit \$44.95, Wired \$69.95.

NEW SOLID STATE SIGNAL TRACER



Output 400mw. Inputs: 1mv RF; 63 mv AF; Hum >60 db below 400 mv. 200 μ a meter. Provides substitution output Xfmr & spkr. Eico 150, Kit \$59.95, Wired \$79.95.

THE TECHNICIAN'S CAUSE EICO helps it. With . . .

1. The first and only instruments with the MOST capability-per-dollar. They do more, faster - save you more time, effort, money.
2. The first and only solid state instruments guaranteed for 5 years.
3. Now, in the teeth of inflation, EICO makes your dollars buy even more TOTAL VALUE than ever before.

OUR 25th YEAR. LABORATORY PRECISION AT LOWEST COST.

After purchasing any instrument on this page from your local EICO Distributor, mail EICO the sales slip, Registration Card and coupon at right. We'll ship you prepaid an EICO Truvohm Multimeter as follows: For each purchase up to \$100, the Model 1A1; for each purchase over \$100, the Model 4A3. Offer expires Mar. 31, 1971. Void where prohibited or taxed.

For latest catalog on EICO Test Instruments, Stereo, EICOCRAFT Projects, Environmental Lighting, and name of nearest EICO Distributor, check Reader Service Card or use coupon.

Circle 1 on literature card

ES-2 Offer expires March 31, 1971
Name _____
Address _____
City _____ State _____ Zip _____

EICO

EICO • 283 Malta Street • Brooklyn, N.Y. 11207

35,000 parts for a dollar.

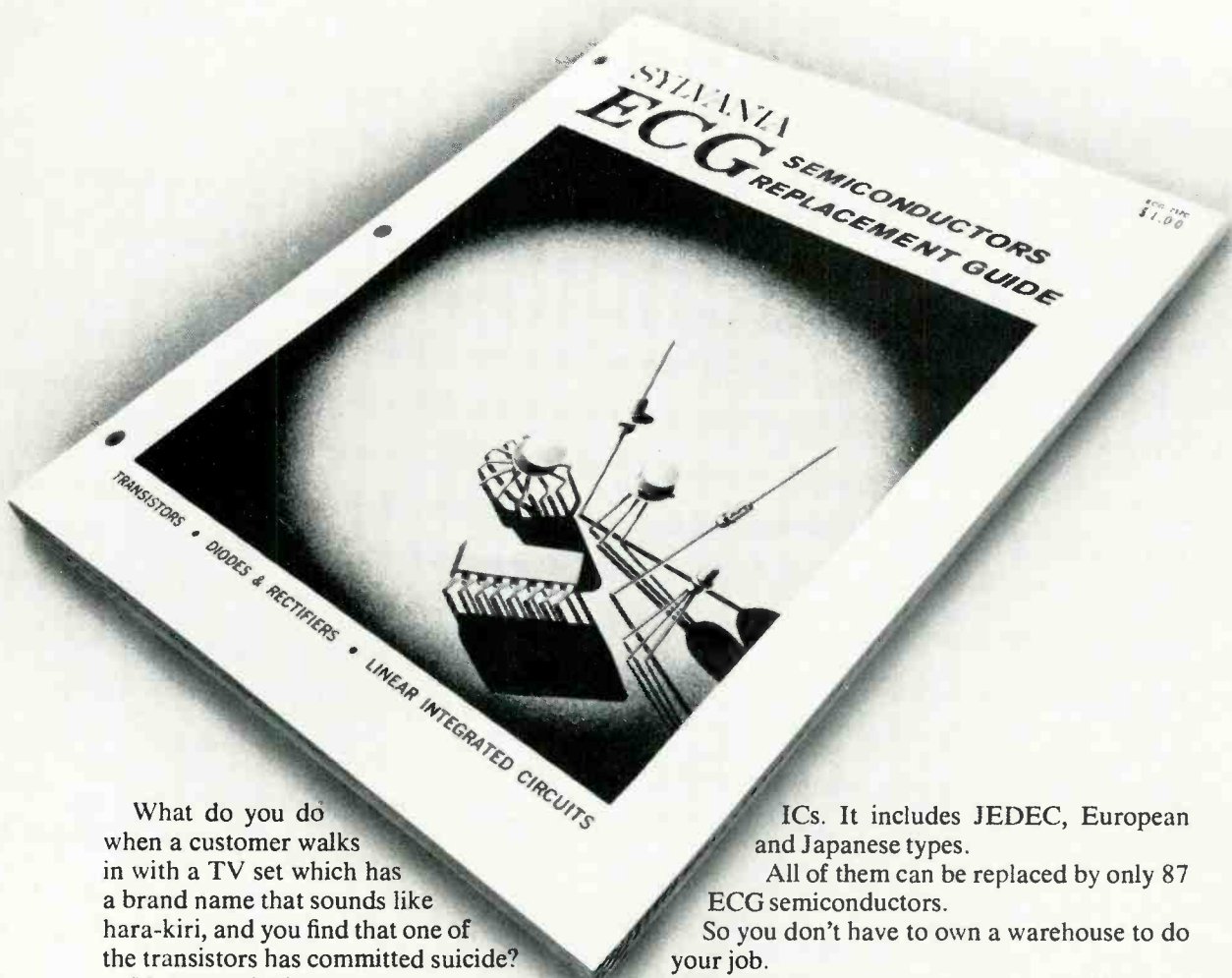

What do you do when a customer walks in with a TV set which has a brand name that sounds like hara-kiri, and you find that one of the transistors has committed suicide?

You can tell him to throw the set away.

Or, if the transistor has a number, you can look it up in Sylvania's ECG Semiconductor Replacement Guide and pop in an ECG replacement.

The Guide lists over 35,000 transistors, FETs, diodes, rectifiers, Zener diodes and linear

ICs. It includes JEDEC, European and Japanese types.

All of them can be replaced by only 87 ECG semiconductors.

So you don't have to own a warehouse to do your job.

You just need a few drawers of ECG parts. And one buck...

for which your Sylvania Distributor will gladly sell you the Guide. He also has the entire ECG replacement line. Remember: Sylvania supplies you; we don't compete with you.

SYLVANIA
GENERAL TELEPHONE & ELECTRONICS

Circle 4 on literature card

Electronic Servicing

Formerly PF Reporter

in this issue...

18 IC's in TV. How integrated circuits are constructed, what functions they now perform in television, and how to test them. **by Bruce Anderson.**

26 Dale's Service Bench—Dynamic Convergence: Troubleshooting and Touchup. Veteran servicer Dale explains his practical approach to tracking down trouble in convergence boards. **by Allan Dale.**

30 Small Independent Business, 1970 and 1971—An NFIB Synopsis. What members of the National Federation of Independent Business, Inc., had to say about the health of their businesses in 1970 and what they expect in 1971. **by J. W. Phipps.**

36 The Lighter Side of Service Pricing. Subtle humor about the serious subjects of pricing, billing and credit. **(Cartoons by Marvin Townsend, Gene Lyons and Paul Swan.)**

38 The Curve Tracer: Another Method of Testing Transistors, Part 1. ELECTRONIC SERVICINGS technical editor explains the operation of the curve tracer, a newly revived concept of testing transistors in and out of circuit, and compares the effectiveness of it, the beta tester and conventional ohmmeter tests. **by Carl Babcoke.**

48 "Use It Before You Buy It": Another Approach to Selecting Test Equipment. A first-hand, practical evaluation of each instrument before you buy is the ideal way to select test equipment. Some manufacturers will even teach you how to use their model before you buy. **by J. W. Phipps.**

60 Shop Talk—New and Changed Circuitry in '71 Color TV, Part 3. Serviceability and product safety features and pinchion correction, degaussing and chroma circuits are the major items analyzed in this final installment of a series written to acquaint you with the new color TV chassis. **by Carl Babcoke.**

DEPARTMENTS

Letters to the Editor	4	Audio Systems Report	50
Troubleshooter	8	Test Equipment Report	52
Electronic Scanner	10	Antenna Systems Report	58
Readers' Exchange	14	Advertisers' Index	59
Book Review	46	Product Report	70
Catalog and Literature		71	

Second class postage paid at Kansas City, Mo. and additional mailing offices. Published monthly by INTERTEC PUBLISHING CORP., 1014 Wyandotte St., Kansas City, Mo. 64105. Vol. 21, No. 2. Subscription rates \$5 per year in U.S., its possessions and Canada; other countries \$6 per year.

Copyright, 1971, Howard W. Sams & Co., Inc. All rights Reserved. Material may not be reproduced or photocopied in any form without written permission of publisher.

EDITORIAL

GEO. H. SEFEROVICH, Director
J. W. PHIPPS, Managing Editor
CARL BABCOKE, Technical Editor
BARBARA L. BORDERS, Editorial Assistant
DUDLEY ROSE, Art Director

CONTRIBUTING AUTHORS

Bruce Anderson
Joseph J. Carr
Allan Dale
Robert G. Middleton

TECHNICAL CONSULTANT

JOE A. GROVES

EDITORIAL ADVISORY BOARD

LES NELSON, Chairman
Howard W. Sams & Co., Indianapolis

CIRCULATION

EVELYN ROGERS, Manager

ADVERTISING SALES

Kansas City, Missouri 64105
Tele: 913/888-4664
E. P. LANGAN, Director
R. JACK HANCOCK, Manager
JAKE STOCKWELL
S. F. WILSON, Production

REGIONAL ADVERTISING SALES OFFICES

Indianapolis, Indiana 46280
ROY HENRY
2469 E. 98th St.
Tele: 317/846-7026

New York, New York 10019
CHARLES C. HORNER
3 W. 57th St.
Tele: 212/688-6350

Los Angeles, California 90005
JOHN D. GILLIES
3600 Wilshire Blvd., Suite 1510
Tele: 213/383-1552

London W. C. 2, England
JOHN ASHCRAFT & CO.
12 Bear Street
Leicester Square
Tele: 930-0525

Amsterdam C. Holland
JOHN ASHCRAFT & CO.
W.J.M. Sanders, Mgr.
for Benelux & Germany
Herengracht 365
Tele: 020-240908

Tokyo, Japan
INTERNATIONAL MEDIA
REPRESENTATIVES LTD.
1, Shiba-Kotohiracho, Minatoku
Tele: 502-0656



ELECTRONIC SERVICING (with which is combined PF Reporter) is published monthly by Intertec Publishing Corp., 1014 Wyandotte Street, Kansas City, Missouri 64105.

Subscription Prices: 1 year—\$5.00, 2 years—\$8.00, 3 years—\$10.00, in the U. S. A., its possessions and Canada.

All other foreign countries: 1 year—\$6.00, 2 years—\$10.00, 3 years—\$13.00. Single copy 75¢; back copies \$1.



Robert E. Hertel, Publisher
Intertec Publishing Corp.
Subsidiary of Howard W. Sams & Co., Inc.

When you need
 a Sprague component "yesterday"
 and our distributor
 doesn't have it in stock...

PRINTED BY THE STANBROOK REPRODUCING COMPANY, U.S.A. ZIPSET 8

REMOVE COPIES 1 AND 2 FROM BOOK AND FORWARD TO SPRAGUE PRODUCTS

SPRAGUE
 THE MARK OF RELIABILITY

Distributor's Supply Subsidiary of the Sprague Electric Company
SPRAGUE PRODUCTS COMPANY
 NORTH ADAMS, MASSACHUSETTS 01247

BILL TO _____

SHIP TO _____

CUSTOMER ORDER NO. _____

SP. PRODUCTS ORDER NO. _____

PRICE _____

QUANTITY _____ ITEM _____

RUSH ORDER SERVICE

ORIGINAL ORDER

...ask him to use this form!

Upon arriving at our factory, the order will bypass normal order entry procedures, assuring same-day shipment by air, UPS, or first-class mail, as distance dictates.

Now there's no need to waste time "shopping" for an exact replacement. Any Sprague distributor can get any factory stock item on its way in 24 hours!

THE BROAD-LINE PRODUCER OF ELECTRONIC PARTS



'Sprague' and '®' are registered trademarks of the Sprague Electric Co.

Circle 5 on literature card

FREE CATALOG

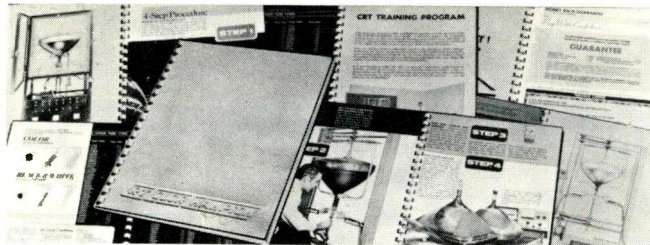

RT COLOR CHAMPION

TV PICTURE TUBE REBUILDING EQUIPMENT

C.R.T. Equipment Company, Inc.
2740 Old Lebanon Road
Nashville, Tennessee 37214

Telephone (615) 883-0215

Mail Coupon Today

(Please Print)

Name _____

Firm Name _____

Address _____

City _____ State _____ Zip _____

Clip Me Out

Circle 6 on literature card

You need both! VECTORSCOPE / COLOR BAR GENERATOR



Made in U.S.A.

One Year Warranty

MODEL V-7

Unique all-in-one unit

- Checks, aligns demodulators to any angle
- Checks, aligns bandpass-amplifier circuit
- Pinpoints troubles to a specific color circuit
- Portable for field or shop.

Exclusive Features: Self-Calibrating—adjust timing circuit without external test equipment. Plus: All Crosshatch, Dots, and Color Patterns; Voltage Regulated. Free copy, Wayne Lemon's "Color TV Servicing Simplified with Vectorscope".

\$ 199⁵⁰ NET



See your distributor or write Dept. ES-2
LECTROTECH, INC.
4529 N. Kedzie Ave., Chicago, Illinois 60625

Circle 7 on literature card

letters to the editor

Parts Distribution System

Each of us servicing electronic products can produce a list of parts backorders which was more lengthy in 1970 than we've previously experienced for a similar quantity of business being performed.

I would like to pass on to fellow technicians and manufacturers the basics of our system (John Deere dealerships) in hopes the TV industry may adopt a similar operation. To date I have heard of only one company headed in this direction.

Basically the system is composed of one central parts warehouse in the midwest and five parts depots located strategically around the country. We dealers do not funnel through a distributor, where more hands in the soup allows for more possible human errors. Instead, we phone or write our orders directly to the parts depot nearest us. Parts orders can be called into a recorder 24 hours a day, 7 days a week. Orders indicated by phrase "machine down" are given priority and processed immediately through the computer, filled, and arrive at our business usually within 24 hours from a distance of 280 miles. Orders which cannot be filled at the depot are transferred to the central warehouse, and we receive them usually within 6 days of our phone call from a distance up to 1100 miles.

We realize the cost of a computerized parts depots would be a tremendous expense. The part which now costs us \$2.00 might increase to \$2.85. However, more important than the additional part cost is the fact that the customer would have his TV back in operation perhaps within 4 days rather than a month or more. This system would enable technicians to provide the prompt, professional service they are obliged to provide, but which they are finding more difficult to achieve.

Roger J. Companion
Essex Junction, Vt.

Response To TV Commercial

How about that television commercial where the TV repairman tells the lady of the house he will have to take the set to the shop to repair it—she offers him a piece of cake she has just baked and in order to get another he says he will fix the set there. One can take this several ways, but it smacks of the same old abuse the industry has suffered since the inception of television. If this is the image projected by the television servicing industry nationally, we need wonder no more about the state of servicing today. Miles Sterling recent characterization of the television servicing industry as "sick and most downgraded" finds a degree of corroboration in the episode above. The incredible thing about it is that the industry at large has earned the contempt of its customers because it

(Continued on page 6)

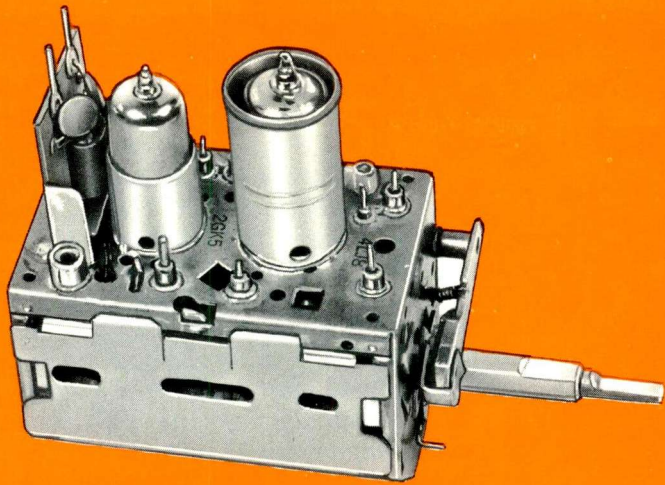

\$975

TUNER SERVICE CORPORATION

PROVIDES YOU WITH A COMPLETE SERVICE FOR ALL YOUR TELEVISION TUNER REQUIREMENTS AT ONE PRICE.

TUNER REPAIR

VHF Or UHF Any Type \$9.75.
UHF/VHF Combo \$15.00.

In this price all parts are included. Tubes, transistors, diodes, and nuvistors are charged at cost.

Fast efficient service at our 4 conveniently located service centers.

1 year guarantee backed up by the largest tuner manufacturer in the U.S.—SARKES TARZIAN INC.

All tuners are cleaned inside and out, repaired, realigned and air tested.

TUNER REPLACEMENT

Replacement Tuner \$9.75.

This price buys you a complete new tuner built specifically by SARKES TARZIAN INC. for this purpose.

The price is the same for every type of universal replacement tuner.

Specify heater type

Parallel 6.3V
Series 450 mA
Series 600 mA

All shafts have the same length of 12".

Characteristics are:

Memory Fine Tuning
UHF Plug In
Universal Mounting
Hi-Gain Lo-Noise

If you prefer we'll customize this tuner for you. The price will be \$18.25. Send in original tuner for comparison purposes to our office in INDIANAPOLIS, INDIANA.



TUNER SERVICE CORPORATION

FACTORY-SUPERVISED TUNER SERVICE

MIDWEST 817 N. PENNSYLVANIA ST., Indianapolis, Indiana TEL: 317-632-3493
(Home Office)
EAST 547-49 TONNELE AVE., Jersey City, New Jersey TEL: 201-792-3730
SOUTH-EAST 938 GORDON ST., S. W., Atlanta, Georgia TEL: 404-758-2232
WEST SARKES TARZIAN, Inc. TUNER SERVICE DIVISION
10654 MAGNOLIA BLVD., North Hollywood, California TEL: 213-769-2720

Circle 8 on literature card

(Continued from page 4)

has been coerced into the impossible state of affairs presently characterizing television servicing. Clearly, we in the industry are culpable simply because we should have refused long ago to render service at a full run, especially with the inception of color, absolutely with solid state.

Television servicing is in the crucible of change. The swing may be towards consolidation if major companies, such as RCA's ServiceAmerica, become the trend. But how sad for most of us this will be if RCA succeeds in the very thing we independents obviously are unwilling to do for ourselves. You can be sure these companies will refuse to accede to the ridiculous demands under which the industry at large now labors, and absolutely positive the rate structure will reflect the cost of doing business (computers even), with the profit factor holding final position. There definitely will be no cake eating. Color service calls will be substantially higher than the norm of most shops too timid and unrealistic to come to terms with economic reality. The option will be eliminated by unionized personnel.

Mr. Collier's letter (ELECTRONIC SERVICING, August 1970) depicting the impending demise of the servicing industry due to the unitized chassis or module is ill founded. The shops are being killed by low labor pricing and working hours better suited for coolies—this is in fact what has driven the industry to the wall.

Vincent L. Irvan
P.O. Box 247
De Queen, Ark. 71832

NEA VP REACTS TO TV COMMERCIAL

This letter was sent to the Sales Manager of the Proctor & Gamble Company, Cincinnati, Ohio, by C. R. Couch, Jr., Vice President of the National Electronics Association, Inc.—Ed.

I am quite amazed and surprised at your Duncan Hines television commercial involving a television technician. We have had a number of our fine customers call this ad to our attention in our defense and were quite surprised that a company of your size with its fine reputation would do such a thing. The ad certainly downgrades the television technician and this hurts.

There are many fine national, state, and local organizations who are doing everything they can to upgrade the image of the television technician and then to have some national advertisers slap us across the face is a blow below the belt. If it were not for the lowly paid and overworked television technicians, in all likelihood your advertisement would not be seen or appreciated by most television viewers because their sets would not be working properly.

May I ask you what appliance or piece of equipment do you personally own that is as highly engineered and technically developed as your television set?

The home entertainment field is one of continual changes and improvements partially due to the intense world-wide competition that exists in the field and the rest to the glamour and interest that the field generates in engineers, supporting technicians, and scientists.

It is a known fact the service field is critically short of good technicians as new developments have left many of the present technicians behind. What we need instead of derogatory criticism is help and support to interest the above-average, young person to enter this interesting and ever-changing field. It offers us a new challenge each day with its technology. Those in the field must study each and every day in order to just partially keep up with the every day changes and improvements.

A program that has been entered by the National Electronics Association is the C.E.T. or Certified Electronics Technician Program. In this program one has to take and pass a very comprehensive examination in both basic theory as well as to his "know how" in applying this theory in practical applications. Your help and the help of others to actively support and push this type of program on a national basis would help to upgrade the television technician and get new people into the field.

Would you please think this over and see how you and other national advertisers might help upgrade a field that is now critically short of technicians and trainees.

C. R. Couch, Jr. C.E.T.
Vice President
The National Electronics
Association, Inc.

Ground Connections

It looks to me like illustration (B), Fig. 1, on page 32 of the August issue has the common ground return rather than (A).

Irving E. Miner
Cornell, Ill.

The caption for Fig. 1 on page 32 of the August, 1970 issue is correct. However, Fig. 1B is not drawn properly to indicate that the ground connections are physically separate on the chassis. —Ed. ▲

New Service Literature

TV TECH AID, Edward G. Gorman, Kings Park, L.I., New York 11754; printed monthly; yearly subscription \$7.95.

A monthly summary of actual color and b-w TV trouble symptoms, their possible causes and the cure for each. Where needed, a schematic of the circuitry involved is included.

The troubles and cures are grouped according to manufacturers, which, in turn, are listed alphabetically. The format of the publication is designed to facilitate filing the troubles and cures according to manufacturer and chassis number—a definite aid to quicker servicing.



Model 5410
30db Gain
VHF Amplifier

Model 5416
45/30db Gain
UHF/VHF Amplifier

Model 5415
30db Gain
UHF/VHF Amplifier

Model 5414
45db Gain
UHF Amplifier

Model 5411
45db Gain
VHF Amplifier

Model 5413
30db Gain
UHF Amplifier

Model 5412
55db Gain
1 Volt
VHF Amplifier

vikoa CUSTOMIZED MATV POWER

Custom design without pilot engineering costs. Vikoa has the widest range of options available in the industry, fit the amplifier to your system, rather than fitting your system to an amplifier. 30 to 55db gain available, VHF and/or UHF, and

+47dbmv to +60dbmv (one full volt) output capability. These completely modular amplifiers feature low noise figure, flat response, and the dependability of silicon solid-state devices

mounted on military grade glass substrates. With attractive aluminum housing and cast end bells for rail type mounting, these low profile units can be mounted in the most inaccessible locations. For your next project get the best.

vikoa
technically the one.



COMMUNICATIONS DIVISION: New York, N. Y. (212) 943-5793 • Hoboken, N. J. (201) 656-2020 • Dallas, Tex. (214) 276-1181 • Vikoa of Canada, Limited (514) 341-7440
Circle 9 on literature card

Green Screen Color

The picture on the screen of the color TV receiver suddenly became greenish. You turned up the red and blue screen controls, but then found the red and blue areas of the color picture to be weak and blurred. In which circuit do you troubleshoot? The cause of this trouble might be nothing but a broken wire, if the color chassis is a RCA CTC15, CTC16X, CTC17 or CTC17X.

An insulated wire lying on top of the chroma board conducts the +400-volt supply from one 2-watt resistor to another, as shown in the picture adapted from PHOTOFACT. Heat from these resistors combined with moisture from the air often causes the copper wire to become brittle and corroded. Final breakage of the wire is likely to occur when the chassis is moved, such as in normal servicing of another problem.

The broken wire disconnects the main source of voltage from the plates of the R-Y and B-Y amplifier tubes, although a plate voltage of approximately +50 can be measured at both plates, because of voltage supplied from the plate circuits of the demodulators through the matrix-trimming resistors. This secondary source of plate voltage can mislead us into following a wrong trail, if we do not understand the interconnection.

Replace the wire, routing it away from the hot resistors. Or better yet, install a new wire underneath the circuit board where the temperature is cooler.

Several readers have written to remind us of this recurring problem. Our thanks go to Gill Grieshaber, St. Joseph, Missouri; Ronald Zimmerman, Franksville, Wisconsin; and Charles Jackson, Buckner, Illinois.

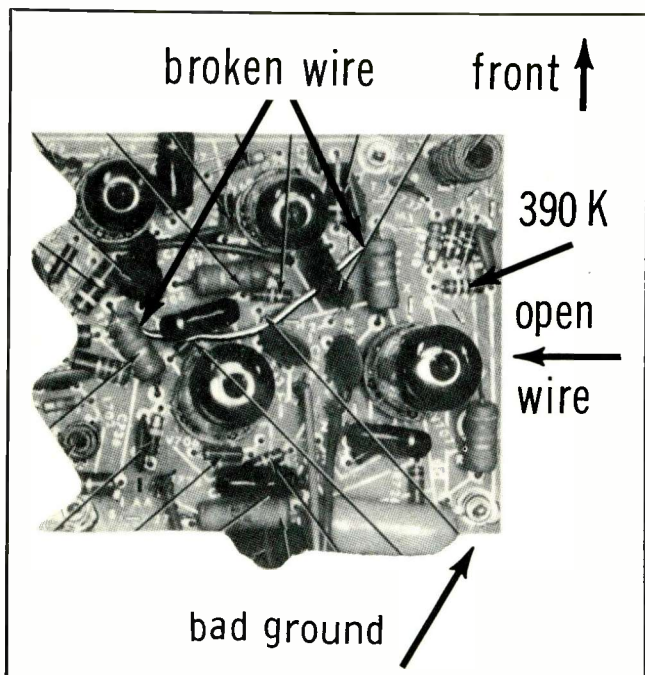

A Brightness Or Blooming Problem

Another persistent problem in this same series of RCA chassis is a defective ground at the corner of the chroma board near the G-Y/blanker tube. Heaters of both the -Y amplifier/blanker tubes return to chassis through this connection. The entire corner of the board can be moved up and down, if the soldering around the ground point has deteriorated badly enough.

If the open circuit is intermittent, variable brightness is likely to be the most noticeable symptom. Serious blooming or loss of raster might result from a permanent open.

An open can occur between the rivet and the copper wiring. A tiny, nearly invisible crack that goes completely around the rivet is enough to cause an open circuit. A magnifier is recommended for positive visual identification.

Another fast method for detecting such a defective connection is to connect an AC meter between the side of the heater which is normally grounded and chassis ground. An open ground return will cause a reading of the full 6.3-volt heater supply.

A large amount of heat is necessary to correctly solder this ground, because a lance of the chassis is inserted up into a rivet which is a part of the board. However, the same rivet is also soldered to the copper wiring of the board. Excessive heat applied for too long a period of time might unglue the copper wiring around the rivet. Use care.

Narrow Width

Would you believe an open wire can cause a picture to be too narrow by about 1 inch? This symptom can result from a crack that opens the etched-copper wire on the right side (near the horizontal output tube) of the chroma board shown here. This wire is the ground return for the 390K-ohm resistor which is connected to the grid of the blanker tube. Opening this resistive circuit increases the negative voltage at the grid of the blanker tube, which, in turn, slightly increases the negative voltage at the grid of the horizontal output tube. The increase in negative voltage on the grid of the horizontal output tube will be less than 10 percent, but it is enough to narrow the width of the picture.

Temporarily grounding the right end (as you face the rear of the chassis) of the 390K-ohm resistor is a good method of checking for such an open ground. An increase in picture width is proof of an open between the resistor and ground.

Repair Tip: Connect a piece of insulated wire from the right end of the 390K-ohm resistor and the ground at the corner of the board, for a fast, permanent repair of this open ground wire without the necessity of removing the chassis. ▲

Change of Address

To receive Electronic Servicing at your new address, send an address label from a recent issue and your new address to:

Electronic Servicing, Circulation Dept.
1014 Wyandotte St., Kansas City, Mo. 64105

THE FIRST IN-CIRCUIT TEST TO TELL A GOOD TRANSISTOR FROM A BAD ONE. WITH NO IFS, ANDS OR BUTS.



MODEL A

Inside every transistor is a message you want to get at: whether the transistor is good or bad.

We've come up with a way to let the transistor tell you. For dead-certain, without ever taking the transistor out of the circuit. (In fact the circuit isn't even on.)

Our way is the transistor curve tracer you see above. It sweeps a transistor with pulses of DC voltage. And presto, the transistor starts talking.

You get the message on an oscilloscope. If the transistor is good you see a family

of curves; if it's kerflooey, a single vertical or drooping line appears; and if the transistor is open, the scope will show you a single horizontal line.

Another thing.

Transistor manufacturers make lots of essentially identical transistors. But each manufacturer uses different numbers, so you don't know the transistors are identical.

Our transistor curve tracer can tell you that too. So you don't have to buy all those identical transistors; instead you can build up an inventory of universal replacement types.

It's all so simple, we don't know why somebody didn't think of it before. All we know is, nobody did.

The dynamic transistor curve tracer.

\$135 at your local distributor's.

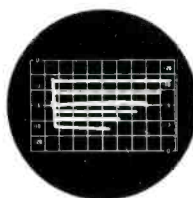

Good transistor.

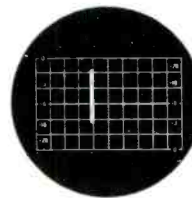

Shorted transistor.

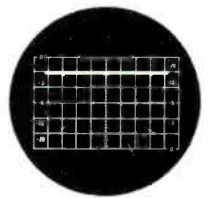

Open transistor.

JUD WILLIAMS

Box 335, Long Valley, N.J. 07853. (201) 852-7373

Circle 10 on literature card

Responsees to Survey Say Finding Service is Problem With Japanese-Made Home Entertainment Electronic Products

Fifty-nine percent of respondents to a recent **News-week** survey agreed that "finding servicing agencies" is a "problem" with Japanese-made home entertainment electronic products, according to a report in **Home Furnishings Daily**.

Over fifty percent of the respondents to the survey reportedly also feel that domestically produced color TV sets are superior to those produced in Japan.

A majority of the 1,877 individuals who responded to the survey reportedly have a "great amount of confidence" in U.S.-made products. (675 of the 1,877 responsees have annual incomes of \$15,000 and more.)

Zenith Research Director Cited For Outstanding Contributions To Consumer Electronics

Dr. Robert Adler (right), Zenith Radio Corporation vice president and director of research, received the 1970 Consumer Electronics Outstanding Achievement Award during the National Electronics Conference meeting December 7, 8, and 9.

The award cited Adler for his "outstanding contributions to the consumer electronics industry."

The award, made annually to an engineer who has contributed significantly towards the advancement of consumer electronics through engineering achievements, is given by the Consumer Electronics Symposium, which is held annually in conjunction with the National Electronics Conference. The Symposium is sponsored by

the Institute of Electrical and Electronics Engineers (IEEE), of which Adler is a Fellow. The presentation was made by Larry Poel (left), awards chairman.

Among Adler's innovative developments is an ultrasonic remote control for TV receivers, for which he received the 1958 Outstanding Technical Achievement Award of the Institute of Radio Engineers, predecessor to the IEEE. He was also instrumental in originating and developing a synchronizing circuit which reportedly permits demonstrably greater stability even in fringe areas of television reception. This invention is now in wide use.

N.Y. Attorney General Tells Servicemen to Police Their Industry

"Police your own field" was the advice given by New York State Attorney General Louis J. Lefkowitz to servicemen gathered at a meeting between the Service Managers Association, Inc., and the Attorney General, in New York City.

"Today, anyone can put out a sign and become a TV repairman," said Lefkowitz. "You're all affected by it. Police your own field."

The Attorney General stated that he believes in letting most industries police themselves. "But," he added, "It seems to me that this (the TV service industry) is one particular field that needs to clean house quite a bit."

Philco-Ford Reduces Number of Shops "Franchised" to Service Their Products

The number of shops franchised to service Philco-Ford home entertainment electronic products has been cut from 50,000 to 15,000, according to a recent report in **Home Furnishings Daily**.

The cut reportedly is part of a complete reorganization of Philco-Fords national service system.

John Miller, general parts and service manager, stated that the reorganization was made for two primary reasons: 1) Philco-Fords service organization previously was too large and too unwieldy and 2) the increasing emphasis on consumer protection laws makes it mandatory that a manufacturer offer efficient, quick and reasonable service to customers.

According to Miller, 80 percent of service on Philco-Ford consumer electronic products previously had been performed by about 1,000 "key" service firms located in major market areas. Reducing the number of franchised shops, he reportedly said, will enable the remaining shops to receive a larger share of the service business in their area.

Miller also said, according to the report, that business and technical training for service agents is being stepped up by Philco-Ford. The company reportedly now has 125 service representatives calling on Philco "franchised" service shops located throughout the entire country, which Philco-Ford has divided into 26 zones of operation.



(Continued on page 12)

2500 Hertz Truck Rental Agents are conveniently located right under your nose.

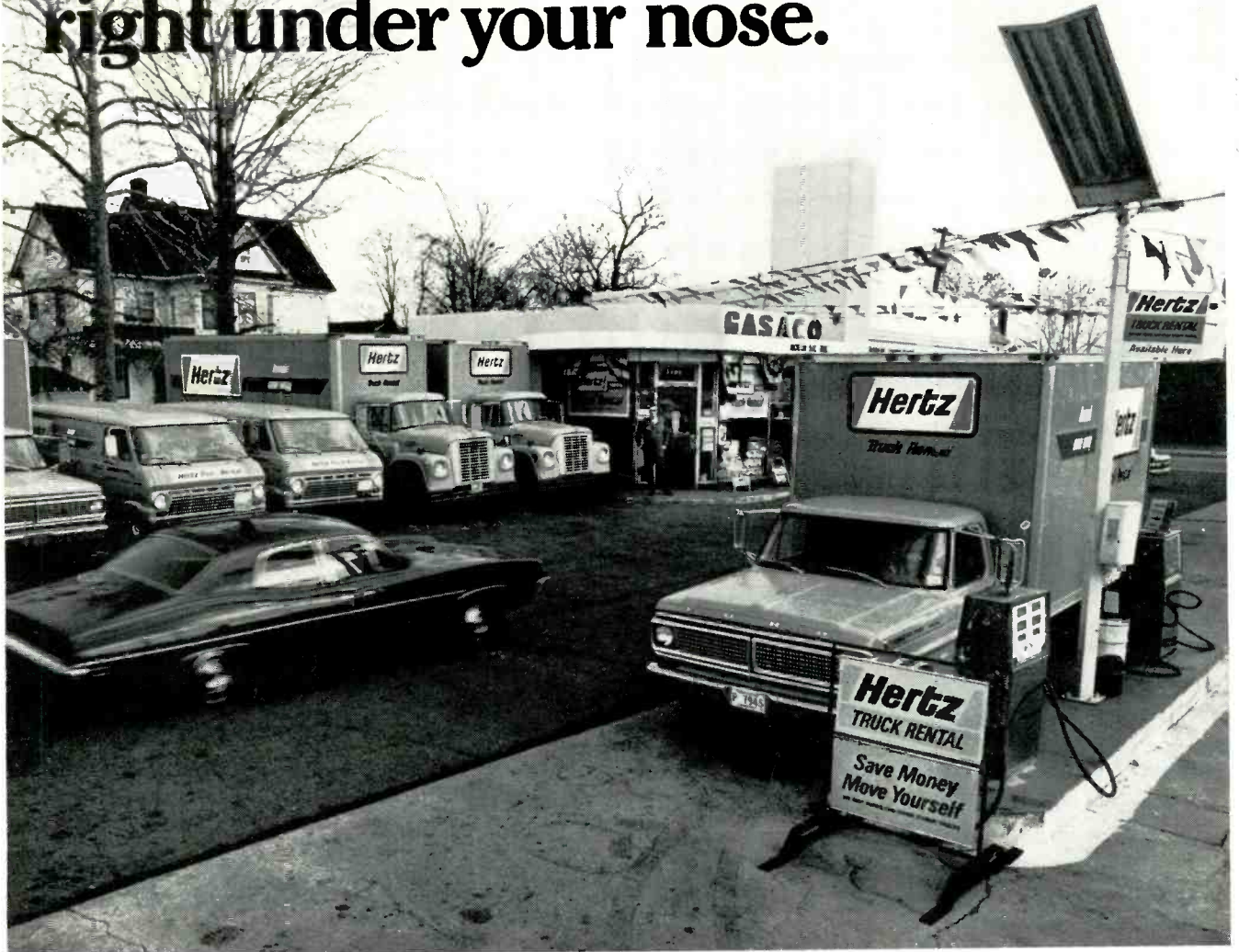

No doubt you've noticed Hertz trucks parked in many gas stations, but you may not have realized these trucks are for rent.

The next time you need an extra truck for business peaks, or should one of your own trucks temporarily break down, call us.

We rent over 30 different sizes and types of Fords and other sturdy trucks. Anything from Econolines and walk-ins, to vans and tractors. And they're available at low rates.

To reserve a Hertz truck call our central reservation number listed in the Yellow Pages.



Circle 11 on literature card

Tron Rectifier Fuses



Available in sizes from 1/2 to 1000 amps for voltages up to 1500, TRON Rectifier Fuses are ideal for protecting variable speed drives, inverters, battery chargers, plating power supplies, power controls, and any other application where fast opening and great current limitation are required.



Write for BUSS Form TRFS

Bussmann Mfg. Division, McGraw-Edison Co., St. Louis, Mo. 63107

comply with the applicable U.S. standards of permissible levels of X radiation.

Philip's Service Manager Elected VP of NY Chapter of NASM

Rudolph G. Kroupa, general manager for service of the Home Entertainment Products Division of North American Philips Corporation, has been elected vice president of the New York Chapter of the National Association of Service Managers (NASM).

A veteran of 25 years in the service industry, Mr. Kroupa has been involved with a wide range of Norelco and Philips home entertainment, appliance and professional products during his 11 years with the company. He is a member of the Institute of Electrical and Electronics Engineers.

NASM is a professional group for executives involved in the service aspects of the electronic, appliance and capital equipment industries.

New GE Process Reportedly Will Make IC's Cheaper

Lower prices and insertion of integrated circuits (IC's) into products completely by automation reportedly are the primary benefits of a new automated pro-

BUSS: The Complete Line of Fuses and . . .

Teledyne Packard Bell Appoints New Midwest Field Engineer

David Appleby has been appointed Teledyne Packard Bell Field Engineer for the Midwest, according to Paul Pekarsky, Director of Field Engineering.

Based in Chicago, Appleby replaces Bill Mondik who moves to the television and stereo maker's headquarters in Los Angeles.

Basically "troubleshooters", field engineers help train independent dealers and their salesmen in the care and maintenance of Packard Bell home entertainment electronic products.

X radiation of Imported TV to be "Sample" Tested by Customs Bureau

Testing of imported color television receivers for excessive amounts of X radiation will be performed on a "sampling" basis by the U.S. Bureau of Customs, according to spokesmen for the Product Testing and Evaluation Branch of the Public Health Service, a division of the U.S. Department of Health, Education and Welfare.

Walter E. Gundaker and Thomas M. Smith, spokesmen for the Public Health Service, speaking before the National Electronics Conference, held in Chicago Dec. 7-9, said that arrangements are being completed with the U.S. Bureau of Customs to sample color TV receivers imported into this country to insure that they

FUSES

for protection of Electronic Devices



There is a complete line of BUSS Quality fuses in 1/4 x 1 inch, 1/4 x 1 1/4 inch, and miniature sizes, with standard and pigtail types available in quick-acting or dual-element slow blowing varieties.



Write for BUSS Form SFB

Bussmann Mfg. Division, McGraw-Edison Co., St. Louis, Mo. 63107

FUSEHOLDERS

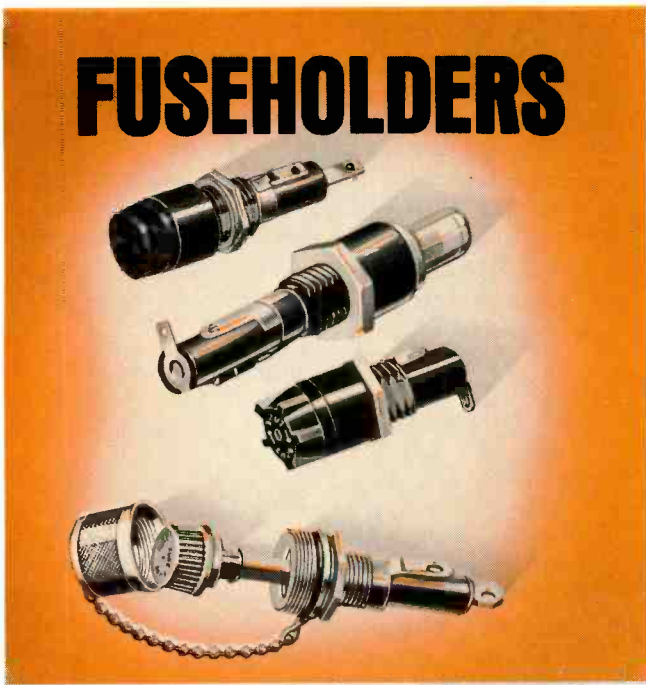

BUSS has a complete line of fuseholders to cover every application. It includes lamp indicating and alarm activating types, space-saving panel mounted types, in-line holders, RFI-shielded types, and a full line of military types. Most are available with quick-connect terminals.

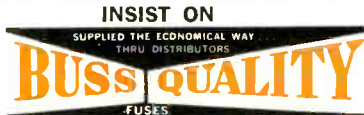

Write for BUSS Form SFB

Bussmann Mfg. Division, McGraw-Edison Co., St. Louis, Mo. 63107

For CATV, OCLs eliminate the need for certain cable runs, thus reducing the costs for both the CATV company and the user, and will avoid the need for tearing up streets to plant the cables, Rikelman stated. Range of up to six miles can be achieved with currently available systems, and repeaters can extend this to any distance desired, he said.

In a related application, one CATV company is using a University Instruments OCL to feed a microwave antenna atop a mountain. Use of the unit eliminates the need for stringing wires up the side of the mountain, or establishing microwave stations to relay the signal. No FCC licensing is required because—unlike microwave links—the OCL does not operate in the electro-magnetic (RF) spectrum.

Optical links reportedly can operate under most weather conditions except a very dense snow storm in which visibility is obscured. A prototype of the University Instruments OCL reportedly has been in operation for 1½ years at the University of Colorado, through some exceptionally heavy snow storms, and has lost communication only when there was no line-of-sight transmission path. University Instruments has made plots based on weather extremes for a number of major cities around the country, and concluded that availability of 99.9% or greater can be achieved in all of the cities, Rikelman said. ▲

Fuseholders of Unquestioned High Quality

cess for manufacturing IC's recently introduced by General Electric.

In the new process, IC's are grown on a 35-millimeter film strip. The film strips, each containing about 800 individual IC's, then are sent directly to the manufacturer.

In previous systems, individual IC's have been delivered to the manufacturer, a method which required considerably more labor to insert the IC's into the end product.

Light Beams Proposed as Method of Distributing TV Signals Within Cities

A system that uses light beams to distribute television signals to homes within a city has been proposed to the Federal Communications Commission (FCC) by University Instruments Corporation, Boulder, Colorado, according to Herbert Rikelman, president of the University.

The system, called an optical communications link (OCL), is comprised of a transmitter equipped with a light-emitting diode which converts the TV signal to incoherent infra-red light (unlike a laser, which produces coherent light), and a receiver in which a photo-detector converts variations in light intensity back into electronic signals. Receiver output is maintained constant by AGC. Nominal bandwidth of the analog OCL is from 60 Hz to either 4.5 or 7.5 MHz.

FUSEBLOCKS



There is a full line of BUSS Quality fuseblocks in bakelite, phenolic, and porcelain, with solder, screw-type, or quick-connect terminals.

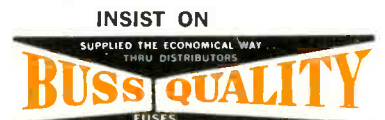

Write for BUSS Form SFB

Bussmann Mfg. Division, McGraw-Edison Co., St. Louis, Mo. 63107

Circle 13 on literature card

■ Electronic technicians and owners or managers of electronic service shops who need assistance obtaining a part, service literature or any other item related to the servicing of electronic equipment, or who have for sale such an item, are invited to use this column to inform other readers of their need or offer. Requests or offers submitted for publication in this column should be sent to: Readers' Exchange, ELECTRONIC SERVICING, 1014 Wyandotte St., Kansas City, Mo. 64105. Include a brief but complete description of the item(s) you need or are offering for sale, your complete mailing address and how much you are willing to pay or want for the item(s). Individuals responding to a request or sale offer in this column should write **direct** to the requestee or seller.

Tubes For Sale

I have a large quantity of Victoreen 1B85 Geiger-Mueller tubes as called for in the x-ray detection instruments in the December issue of *Electronic Servicing*.

These tubes are brand new, unused, recently manufactured and fully guaranteed. Price, including postage and packing is \$15.00 each, or 2 for \$25.00.

David B. Kerslake
16 Surrey Lane
East Brunswick, N.J. 00816

Source of "Old" Tubes

In answer to Mr. Wiersma's letter (Dec. '70) in regard to the 12FR8 tubes; these tubes may be purchased from United Radio Company, 56 Ferry St., Newark, N.J., 07105. The price of these tubes is \$10.00 each. This company also carries other old and out-of-use tubes.

I hope this information will be helpful to Mr. Wiersma and others needing the older tubes.

J. Robert Davis
Liberty St.
P.O. Box 356
Pontotoc, Miss.

Organ Schematics Needed

I need the schematic for an organ manufactured by Minshall Estey Organ, Inc., Battleboro, Vermont, organ Model H.

I mailed a letter to them but my letter was returned by the post office indicating they had moved to a new location.

I would also like information on where I can purchase organ schematics.

George Olsen
13519 Westwind Dr.
Silver Spring, Md. 20904

Radio Spectrum Handbook

I need help locating a schematic for the following:

- 1) Hallicrafters S140 4-band receiver
- 2) Scott LC21 stereo control center
- 3) Music Associated Sub-carrier adapter circuit
- 4) Sony ST80W stereo tuner, AM/FM/AM.

I also need a chart of frequencies. What is their use from 0 cycles to 470 MHz. I would appreciate any information that is available about multiplex adapters, in kit or wired form.

Dagoberto E. Saer
P.O. Box 181
Valencia, Venezuela

Howard W. Sams & Co., Inc., recently has published a book titled "Radio Spectrum Handbook (Catalog No. 20772)" which provides detailed information about the assignment and use of all frequencies controlled by the FCC. In my opinion it is the most complete publication written to date about this subject. The author, James M. Moore, is a former editor of *Broadcast Engineering* magazine. Price of the hardbound edition is \$7.95—Ed.

Schematic Needed For Old Radio

I have recently acquired an old Buckingham radio which looks like it could be from the late 20's or early 30's. The workings look to be intact for the most part, although several tubes are missing and some wiring is disconnected. The Utah speaker seems to be okay. I would like to obtain some specs or a schematic on the chassis and a tube layout, so I can begin to recondition this radio.

Charles Eberhart
5127 S. Parkside Ave.
Chicago, Ill. 60638

Thanks For Reader Assistance

I would like to thank those readers of *ELECTRONIC SERVICING* who recently offered their assistance in locating a 12FR8 tube.

Stephen Colquett
Auburn, Ala.

Test Equipment For Sale

I would like to sell the following test equipment:

- 1) B&K Model 1076 Television Analyst. This is the late model with the rainbow color circuit.
- 2) Eico Model 710, grid dip meter
- 3) Eico Model 632, CRT tester and rejuvenator
- 4) Hickok Model 532, Dynamic Mutual Conductance tube tester, with Hickok CRT-1 Adapter
- 5) Sencore Model VB2 Vibra-Dapter, complete with instruction manual, and roll-chart, good second checker.

All of these are in excellent condition with instructions.
(Continued on page 16)



**professional
hands require
years of training**

**professional TV
service dealers insist on
GE ULTRACOLOR picture tubes
(made by professionals for professionals)**

GENERAL  ELECTRIC

**TUBE DEPARTMENT
OWENSBORO, KENTUCKY 42301**



(Continued from page 14)

tion manuals, test leads, and other original accessories. I would like to sell this test equipment for about 60% of the original cost.

Bert E. Zeilesch
Route 5
P.O. Box 43
Wausau, Wisc. 54401

I have for sale a new Philco Model S8208, five-inch High Gain Oscilloscope. I purchased this scope new from Philco approximately 5 years ago and have not used it. It is still in its original box, with direct probe and instructions. I will sell it for \$50.00 cash.

George Otto
1045 Magnolia Ave.
Beaumont, Tex. 77701

I have for sale a Precision Sweep Signal Generator, Model E400, in excellent condition. Bandwidth 0 to 1 MHz and 0 to 15 MHz. Frequency coverage is 392 on fundamentals and 900 MHz on harmonics. It comes with instruction book, 4.5 MHz plug-in crystal and all necessary probes. Anyone who is interested please write.

Anthony J. Alaimo
1664-81 Street
Brooklyn, N.Y. 11214

I have the following test equipment for sale:

- 1) RCA Marker Generator WR89A
- 2) RCA Adder WR70A
- 3) RCA Sweep Generator 59C
- 4) High Voltage Probe WG289
- 5) Hickok Sweep and Marker 288X
- 6) Hickok Oscilloscope 640
- 7) Precision Sweep Generator E-400
- 8) Precision Marker E-200-C
- 9) Precision Tube Tester 640
- 10) B&K Color Bar Generator 1240
- 11) B&K Picture Tube Tester.

The above test equipment is in excellent condition and we have all service manuals to equipment.

Owen E. Reiney, Jr.
4733 Lewis Dr.
Port Arthur, Tex. 77640

Help Needed (General)

I am wanting to build a 117VAC/12VDC power supply w/dial light (#47) for a Raytheon Fathometer, DE732. I would appreciate any help offered.

Arthur J. Jones
4612 E. Broadway
Tampa, Fla. 33605

I need the schematic diagram for a Radiola 18 radio.

Edward Isotalo
1818 E. Melrose Ave.
Appleton, Wisc.

I need service information on an old Zenith table model radio, serial number R426F15, manufactured in the late '20's.

Michael Maich
628 16th
Boulder, Colo. 80302

I need a schematic for a Bendix car radio, Sapphire V, 7BVX (148363). I also would appreciate any help you can give me in obtaining a schematic for an old RCA radio, No. 002547.

Joe Banche
763 Breezedale Pl.
Columbus, Ohio 43213

I am in need of the manuals and schematics for the following:

- 1) Solar Capacitor Analyzer, Model CC-1-60 (Serial No. 31659)
- 2) Silver "VOMAX", Model 900 (McMurdo Silver Co., Hartford Conn.)
- 3) Capacitor Bridge, Model BN (Serial No. 15781, Cornell Dubilier Elect. Co.)
- 4) Signal Generator, Model 705A (Radio City Products Co., Inc.)
- 5) Tube Tester, TC-3A (General Electric).

Michael Wargo
22 Kyle Drive
Dover, N.J.

**save up to
2/3rds on
flameless
heat**



Only MASTER offers so much in heat blowers, priced as much as 2/3rds less than others! Adjustable orifice controls temperature up to 800°. Heavy-duty motor for continuous service. Removable sturdy base. Mounts in any position, adjusts to any angle. Easy portability. Twelve basic models to meet any application ... blister pack, parts assembly, spot drying, shrink tubing, auxiliary space heater, or fan. Write for FREE 12-page catalog on flameless blowers, torches, guns.

MASTER >> HEAT BLOWERS
Racine, WI 53403

Circle 15 on literature card



SM152 . . . Only Complete Sweep and Marker Generator

Here is why:

- Sweeps all VHF channels
- Sweeps all UHF channels
- Sweeps Chroma Bandpass through IF amplifiers or direct.
- Sweeps FM, IF and complete band of RF
- Covers 20 MHz older sets . . . also includes new imports.
- Eight crystal controlled markers for accurate IF and chroma marking with the push of a button.
- VHF channel markers on both video and sound carriers on four VHF channels.
- Base line zero reference as shown on all manufacturers alignment instructions.

IN STOCK AT YOUR
LOCAL PARTS DISTRIBUTOR
ONLY \$450.00

USERS SAY YES TO SENCORE

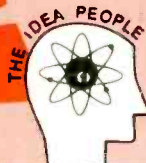

YOU, too, will say YES if you will just try the SM152

SENCORE

3200 SENCORE DRIVE, SIOUX FALLS, SOUTH DAKOTA 57107

Circle 16 on literature card

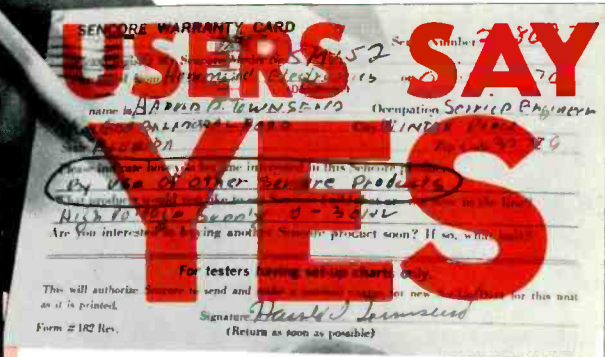

TO THE SM152

Yes, yes, yes . . . they all say yes after using the marvelous SM152 sweep and marker generator.

See how the typical user says yes on his warranty card after he has had a chance to use the SM152.

Arthur F. Powers
Arts TV Service
Covington, Ky.

Can't be beat

Roger Hatcher
Electrical Engineer
Columbus, Georgia

Well built equipment

Walker Electronics
Radio TV Repair
Windsor, Colorado

Our shop is now almost all Sencore equipment

Robert Gibson
TV and Radio Repair
Lubbock, Texas

Because Sencore is the best always

David Zeinert
TV Repair
Wittenber, Wisc.

All my equipment is Sencore

IC's in TV

by Bruce Anderson

Construction, applications and testing of integrated circuitry in today's and tomorrow's television receivers.

Although the home entertainment electronics industry is still in the process of changing from vacuum-tube circuitry to the use of transistors, another revolution also is in the making. The new gadget causing all the stir is the integrated circuit (IC), sometimes simply called a "chip."

Incorporating this new device into a television receiver might appear as just another way for the manufacturers to make life miserable for servicing technicians, but in reality there are some pretty sound reasons why we are going to see more and more IC's in today's and tomorrow's TV.

One of the advantages of using IC's is that they require so little space. This equates into smaller instruments, for consumer appeal, and also smaller chassis frames, less circuit board area, less weight, etc. Along with this goes the saving in assembly costs. Obviously, it is cheaper to mount a single unit on a board than it is to mount the dozen or more components which an IC replaces. Whether or not the IC itself is cheaper than the separate components which it replaces would be hard for us "outsiders" to know at the moment; but it is probable that improved manufacturing techniques will bring down the cost of IC's as their use becomes more general.

The IC retains most of the good characteristics of the transistor—low power consumption and the attending coolness of operation, no consumption of the material of which it is made (as contrasted with a tube filament and cathode), resistance to physical shock, etc.

The IC also has about the same poor qualities as the transistor, in-

cluding wide variations in characteristics as the ambient temperature is changed, susceptibility to damage from electrical overloads and arc transients, and susceptibility to damage from excessive heat when it is installed or removed from soldered circuits.

There are some limitations which are peculiar to IC's, but more on that later.

Construction of an Integrated Circuit

The construction of IC's has become literally a science, and certainly no complete description of the processes involved could fit into this magazine. But a few simple drawings can, at least, provide an understanding of the basic construction technique.

Suppose that we take a slab of P-type silicon material and diffuse into it some N-type impurities, as shown in Fig. 1. The depth of the diffusion will depend on the length of time the slab is exposed to the N impurities and the temperature at which it is diffused. The area of diffusion will depend on the amount of surface which is exposed and the amount which is covered with a protective mask, which can be removed later. If leads are welded to the slab and to the N region, a useful diode has been produced.

The next step is to mask all but a portion of the N surface and subject the device to another diffusion, but this time with P material. As illustrated in Fig. 2, a transistor is produced as a result of this second process. Obviously, if one transistor can be made in this manner, it is simply a matter of repetition to form a number of transistors on the same slab and then cut them apart. (As

a point of interest, transistors produced simultaneously on the same slab will be quite uniform in characteristics, for reasons which should be obvious.)

Just as two or more vacuum tubes often share the same glass envelope, there are many times when it is desirable to form several transistors in a single package. If the transistors produced in the manner just described were not cut apart, we would have such a "packaged" device. But there is one problem: All the collectors would be connected together. Consequently, the device would not be very useful.

To provide a means of isolating the transistors from one another, and also to provide an inactive mounting for them, one more process of masking and diffusion is employed, the end product of which is shown in Fig. 3.

Note that in Fig. 3 the original slab is no longer used as one of the elements of the transistors but, instead, forms a mounting base called the substrate. Because the substrate is made of P material, the junctions of the substrate and the collectors of the NPN transistors are reverse biased and, consequently, no conduction can take place between the substrate and collectors of the transistors. There is capacitance between these elements;

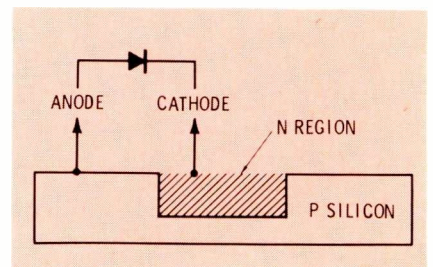

Fig. 1 The first step in construction of an integrated circuit is the formation of "N pockets."

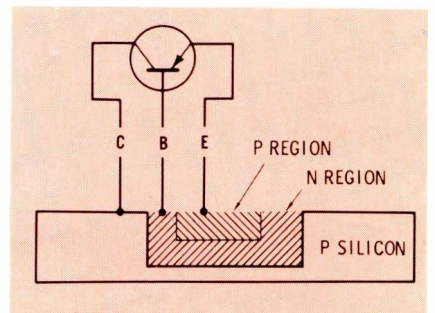
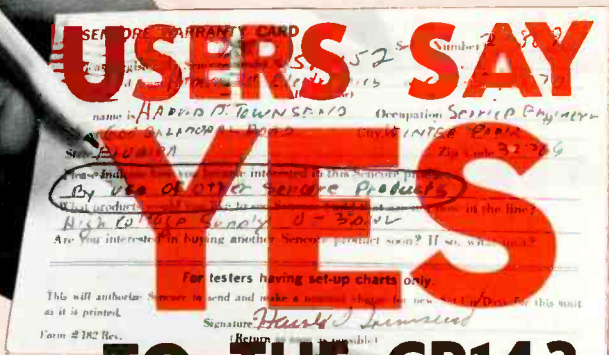

Fig. 2 By diffusing P material into the N region, the elements, or junctions, of a transistor are formed.



USERS SAY YES TO THE CR143 CRT CHAMPION

The industry's most recommended CRT Tester. Here is what users say: they say YES after using the CR143 Champion, they say YES to their friends and they are saying YES to you. They say YES, go ahead and buy the CR143 . . . it can't be beat. See these excerpts from users' warranty cards and judge for yourself.

BEST EQUIPMENT MADE TO DATE

CR143 User Says YES

Richard E. Sanderferd , Radio & TV Repair
Raleigh, No. Carolina

I SAW IT AND I LIKED IT RIGHT AWAY

CR143 User Says YES

Anthony Pieczkowski , TV Service
Cicero, Illinois

A FINE PRODUCT

CR143 User Says YES

Howard Delaughter , TV & Electronics
Moultrie, Georgia

SPEC'S UP AGAINST OTHER COMPANIES . . . LOVE SENCORE'S STEEL CABINETS

CR143 User Says YES

Charles Marchese , TV Technician
Mechanicville, New York

IT'S QUALITY AND AMERICAN MADE

CR143 User Says YES

W. L. Baker , P. T. Technician
Sandia Base, New Mexico

NEEDED A NEW CRT TESTER . . . THIS HAD THE BEST FEATURES

CR143 User Says YES

Frank Cwynar , Pharmacist
Randallstown, Maryland

A GOOD PRODUCT AT A FAIR PRICE

CR143 User Says YES

Leo Coy , Inspector
Bettendorf, Iowa

HIGHLY RECOMMENDED

CR143 User Says YES

Roy W. Grau , Technician
Lancaster, New York

USERS SAY YES TO SENCORE

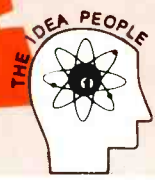

YOU, too, will say YES if you will just try the CR143 at your local Sencore parts distributor only \$119.50.

SENCORE
3200 SENCORE DRIVE, SIOUX FALLS, SOUTH DAKOTA 57107

Circle 17 on literature card

however, it can be compensated for in much the same way that the stray capacitance of a vacuum-tube is either used to advantage or compensated for by the external circuitry.

Although an array of closely similar transistors is sometimes useful, it is more often desirable to interconnect a pair of transistors within the unit, as in the Darlington pair configuration, for example. This can be accomplished by the following additional manufacturing processes.

After the transistors are formed, the points which are to be used for connections are masked. The unmasked surface then is exposed to an oxygen atmosphere and baked. This forms a layer of silicon dioxide, better known as glass, which is an excellent insulator.

Next, another masking operation covers all the surface except those points at which connections are desired, and some type of metal, perhaps gold, then is deposited on the unmasked areas.

Finally, leads are welded to the metal-covered points, for external connections. The completed circuit is shown in Fig. 4. (The interconnection between the two collectors cannot be shown in the same cross-section with the emitter-to-base connection, because it must take some other path across the surface of the chip.)

Forming resistors and capacitors in the integrated circuit is somewhat simpler in concept, although not necessarily in actual practice. Fig. 5 shows diagrammatically how it can be done.

On the left of the chip in Fig. 5 a resistor is formed by utilizing the resistance of a block of P material, which is isolated from the substrate by an intervening layer of N material. The size and shape of the P material determines the resistance; a long, narrow strip has higher resistance than a short, wide one.

The capacitance between the deposited metal and the N material beneath the insulation forms the capacitor at the right. As with any capacitor, the value can be increased by increasing the area of the plates.

In manufacturing integrated circuits, a great number of them, perhaps a hundred or more, each having the equivalent of many transistors, diodes, resistors, and capaci-

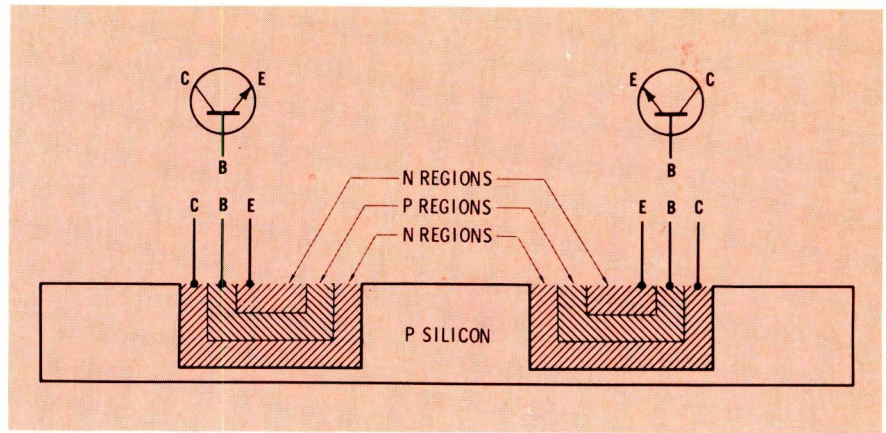

Fig 3 Formation of NPN transistors on a P substrate. The substrate can be cut to yield individual transistors, or additional processing can be performed to make an IC.

tors, are formed simultaneously on a single wafer, or substrate, a couple of inches in diameter. Obviously, the more IC's produced on the wafer, the lower the price per IC. As a rule of thumb, a 1000-ohm resistor requires about twice the area of a transistor and a 10-pf capacitor requires about three times as much area as a transistor. For this reason, integrated circuits are designed to use as many transistors and as few passive components (resistors, capacitors and coils) as possible. This is just the opposite of conventional circuitry, in which the transistors usually are the most expensive of the four devices.

Also because of cost, the values of resistance and capacitance are kept as low as possible, and often external components are used, if space permits. A common trick used to reduce the values of resistors is to stack diodes and use their junction potentials to drop voltage. For example, if 3000 ohms is required to drop 2 volts in a certain bias circuit, an area of the chip which could accommodate six transistors is required. But, by using three diode junctions in series, approximately the same voltage drop can be obtained using only the area of three transistors. Possibly a zener will be used, reducing the required area to that of a single transistor (see Fig. 6).

At the present state of the art, the tolerance of resistors and capacitors in IC's are very broad, although the ratio of two resistances or capacitances can be held to relatively close specifications. Consequently, circuits are normally designed so that absolute values of R and C are not critical. In practice,

this equates, more or less, to "lots of gain and lots of negative feedback."

Integrated circuits are packaged in about the same fashion as transistors, except, of course, there are many more leads coming out of the device. A common package is similar to the TO-5 transistor, but with eight to a dozen leads. They also are packaged in flat, rectangular enclosures made of plastic or ceramic with conductors extending from both long edges. The conductors are either flat or round, and sockets are available for either type.

Applications in Television

The IC first appeared in television about five years ago. That first IC functioned as a combined 4.5-MHz amplifier, FM detector, and audio preamplifier.

At present, we know of the following applications, which illustrate the design sophistication already achieved:

- 1) 4.5-MHz amplifier/FM detector/audio preamplifier with voltage-operated variable gain and an audio output of more than 1 volt P-P.
- 2) Video IF amplifier/discriminator/differential DC amplifier, with integral voltage regulator. This type is used for automatic fine tuning.
- 3) Chroma demodulator and color-difference amplifiers, with voltage-operated phase shift of the 3.85-MHz reference signal, to allow tint control.
- 4) Chroma-bandpass amplifier/reference oscillator/burst amplifier/color killer/ACC/burst blanking, with voltage-operated gain control.
- 5) Complete IF amplifier with in-

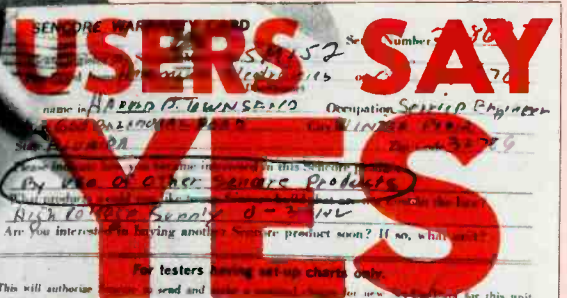

TO THE SENCORE TC154 MIGHTY MITE TUBE TESTER

Here is why over 60,000
Mighty Mite tube testers are now
being used daily. Here is how users say YES
on their warranty cards after using the Mighty Mite.

COMPARED SENCORE TO OTHER MANUFACTURERS

**They
Say
YES**

Ralph Jones Electronic Student
San Diego, California

HAD EARLIER MODEL

**They
Say
YES**

H. R. Schultz Electronic Technician
Phoenix, Arizona

REASONABLE PRICE AND EXCELLENT QUALITY

**They
Say
YES**

George Anthony Master TV Technician
Vineyard Haven, Mass.

IT'S COMPACTNESS, TRUE INDICATOR AND LOW PRICE

**They
Say
YES**

Wallace S. Waniya Electronic Technician
Honolulu, Hawaii

SHARP EYE FOR FINE EQUIPMENT

**They
Say
YES**

Arnold F. Walter Technician
Buffalo, New York

IT HAD THE FEATURES I WANTED

**They
Say
YES**

Karl L. Radke Student
Pittsfield, Massachusetts

USING THEM— SENCORE IS THE BEST

**They
Say
YES**

Richard Sanderford Radio & TV Service
Raleigh, No. Carolina

RECOMMENDED BY MORE EXPERIENCED T.V. REPAIRMEN

**They
Say
YES**

E. A. Kirvan Elec. Technician Specialist
Minneapolis, Minnesota

JUST CHECKED AN OLD FAMILIAR NAME

**They
Say
YES**

Philip D. Walters Electronic Technician
Dayton, Ohio

AS FAR AS I AM CONCERNED, SENCORE IS THE BEST

**They
Say
YES**

Ira Reeves Test Engineer
Augusta, Georgia

**USERS SAY YES
TO SENCORE**

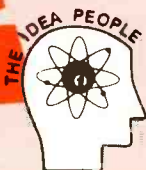

*YOU, too, will say YES if you will just try the TC154
at your local Sencore parts distributor only \$99.50.*

SENCORE

3200 SENCORE DRIVE, SIOUX FALLS, SOUTH DAKOTA 57107

Circle 18 on literature card

tegral AGC, sound and video detectors, and video amplifier with a 6-volt output.

Naturally, some of the IC's in current usage might not perform all of the functions listed above; or different combinations of functions may be performed by a certain IC. For example, a circuit designer might choose to include the reference oscillator in the same IC with the chroma demodulators. (The IC's used in the electronic tuner control of RCA's CTC 47 are simple logic devices which do not reflect the present state of the art.) Fig. 7 shows an early model IC used as a 4.5-MHz amplifier, FM detector, and audio preamplifier. It, too, is relatively simple by today's standards.

As technology advances, it is likely that more integrated circuits will be developed for use in television. On the other hand, there are three limitations of the IC which make the all-IC receiver seem unlikely for quite some time.

First, it is difficult to build an IC which will operate with much more than 10 volts of supply, and this limits the usable output amplitude of an IC to about this peak-to-peak amplitude.

Secondly, heat dissipation becomes a problem in IC's, and so they are essentially low-power devices.

Third, large values of capacitance (in excess of perhaps 20 pf) are undesirable in an IC because of the size requirement and additional cost.

These limitations pretty well exclude IC's from the deflection systems and the audio and video output circuits of TV receivers.

Troubleshooting

As most technicians who are servicing solid-state television have discovered, there are fewer failures in them than in vacuum-tube receivers. Of course, a transistor failure might require more time to replace than a tube failure, because so many transistors are soldered in, and also because there are so few standard-type transistors. Still, transistors are the most frequent cause of failure; but not because transistors are bad.

For most applications, $\frac{1}{2}$ -watt resistors are used in circuits, even though the actual dissipation might be only a fraction of this rating. Smaller resistors are no cheaper,

and much of the equipment (or people, for that matter) which inserts components into circuit boards can handle the $\frac{1}{2}$ -watt resistors more easily than smaller ones. Because of this oversizing, burned-out and off-tolerance resistors (usually caused by overheating) occur less often in solid-state circuits, particularly circuits using IC's.

Capacitor failures also are rare because capacitors in low-power, solid-state circuits often are operated far below their voltage ratings. Also, there has been a lot of improvement of capacitors in recent years.

Because of these factors, the incidence of failure in solid-state equipment has been reduced to a level below the failure rate of comparable tube-type circuits. However, most of the failures in solid-state equipment result from faulty transistors. There haven't been enough integrated circuits used in television receivers to permit definite conclusions, but it appears that we

are faced with the same situation that has prevailed in tube-type equipment—many failures will be caused directly or indirectly by the active component, the IC.

Transistors are relatively cheap, simple to test, relatively easy to change, and often can be substituted.

IC's are more expensive, practically impossible to test, and cannot normally be replaced by some substitute type. Also, unless they are plugged in, which is rare, it is possible that the original will be destroyed when it is removed from the board. (Incidentally, plug-in IC's function normally in a computer operating in an air-conditioned environment; but contact contamination definitely has been experienced in television receivers employing plug-in IC's).

Before you decide to replace an IC, several checks should be made. Just how extensive these checks are will depend on your equipment, your knowledge of the circuit in which the IC is located, and the

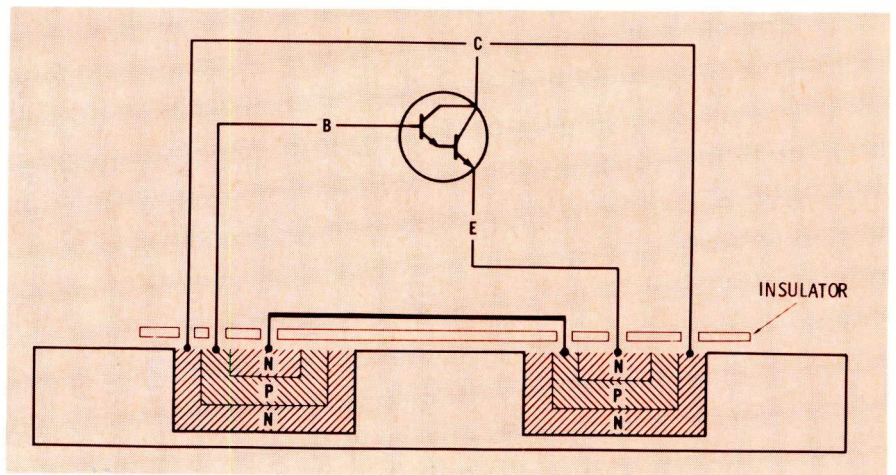

Fig. 4 The interconnections are made by covering the devices with an insulating layer having apertures in the desired locations and then depositing metallic conductors on top.

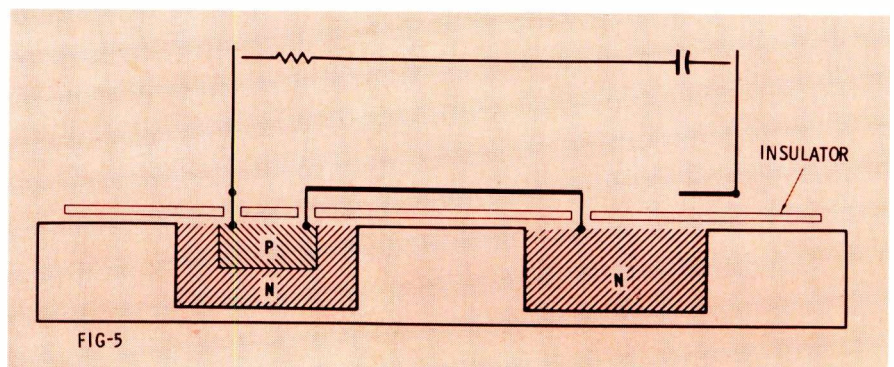
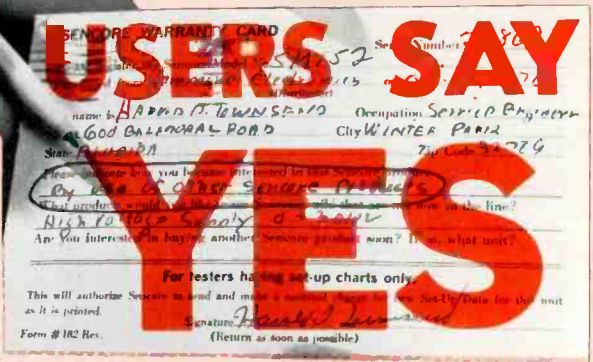

FIG-5

Fig. 5 Capacitors and resistors are formed in this manner.



TO THE SENCORE COLOR GENERATOR

Read how Sencore users say YES, YES, YES after they own a Sencore CG153 Color King. These are excerpts from warranty cards of Color King owners.

COMPACT SIZE AND PRICE

Yes! Thomas G. Stone, TV Service
Dansville, New York

BECAUSE OF GOOD DESIGN, ENGINEERING & PRICE

Yes! Urban M. Krier
4461 No. Prospect Ave., Shorewood, Wisc.

LIKED THE SINGLE LINE AND DOT FEATURE

Yes! M. L. Sakraida, TV Service
Edgewood, Pennsylvania

HAVE LONG KNOWN SENCORE'S QUALITY

Yes! James Feroben, TV Repair
Jackson, Mississippi

HAVE OTHER SENCORE EQUIPMENT

Yes! George R. Hiley, Section Foreman
Stanton, California

I HAVE NINE SENCORE UNITS NOW

Yes! Rogers Electronics, TV Service
Flag Staff, Arizona

IN MY OPINION, BEST ON THE MARKET

Yes! Upson Tutt, TV Repair
Springfield, Massachusetts

EXCLUSIVE FEATURES

Yes! Herman Schmidt, Electronic Technician
Satellite Beach, Florida

GOOD SERVICE FROM SENCORE

Yes! Frank Yingling, TV Service
Temple Hills, Maryland

ALL MY INSTRUMENTS ARE SENCORE

Yes! Peter Wiwel, Technician
Napa, California

USERS SAY YES TO SENCORE

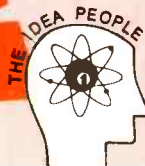

YOU, too, will say YES if you will just try the CG153 at your local Sencore parts distributor only \$169.95.

SENCORE

3200 SENCORE DRIVE, SIOUX FALLS, SOUTH DAKOTA 57107

Circle 19 on literature card

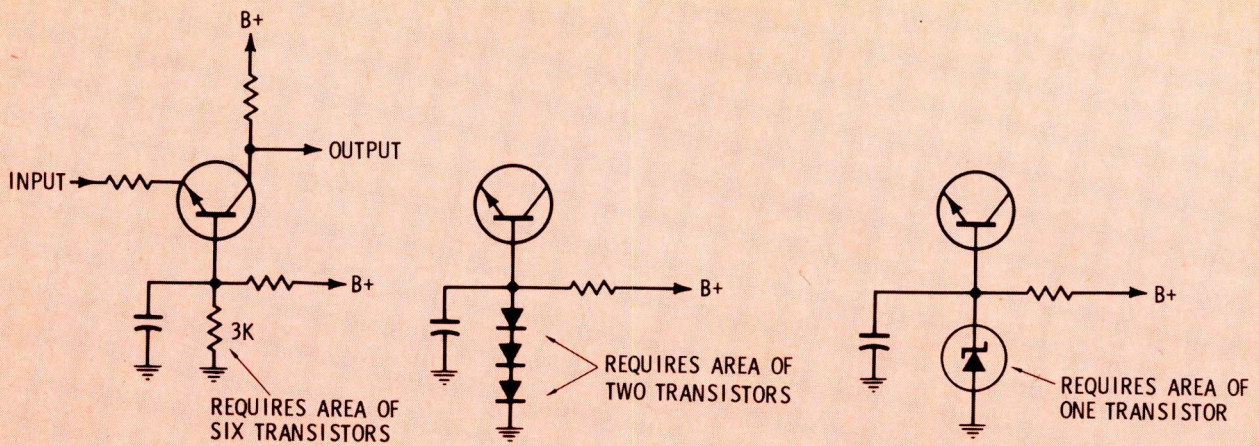

Fig. 6 A voltage drop can be obtained by forming a resistor, a series of diodes, or a zener. Cost is a major consideration in determining which method is used.

trade-off between your labor cost and the cost of the IC.

First of all, be sure that the IC actually is receiving the supply voltage it is supposed to receive. A shorted zener diode used as a regulator, or an off-tolerance power-supply bleeder, might be supplying insufficient voltage; IC's are rather critical in this respect. Also, an open zener or some other fault external to the IC might increase the supply voltage to a level that will destroy the new IC as soon as it is installed.

The next item on the pre-replacement check list seems obvious, but it is too important to be ignored. Be sure that the input signal actually is getting to the input terminal of the IC. It is possible that a coupling capacitor has opened, or that there is a defective solder connection or a cracked board. Defective solder connections have been known to turn up months, or even years, after manufacture. Plated-through holes in circuit boards are still a bit new, and it is not uncommon for the through plating to be open.

Usually there will be several terminals of the IC which are connected to ground via a resistor and bypass capacitor. It is fairly certain that a transistor emitter inside the IC is connected to this terminal. If either of these components is open or shorted, the transistor to which they are connected will develop little or no gain.

Another item to be checked is the circuit which the IC is driving. If it uses a transistor, perhaps it is the one which has failed. Inject a

signal at a convenient point near the output of the IC; if the test signal doesn't pass through the rest of the system, it is a safe bet that the output of the IC cannot either.

IC Replacement

If the IC is mounted in a socket, replacement is simple, but there are a few tips which might save you time and money:

- First, don't plug in another IC until you are certain that the supply voltage is correct. Excessive supply voltage seldom ruins a tube immediately, but it is likely to "zap" a transistor or IC before you know what happened.

- Don't forget that the trouble might be socket and pin corrosion. It is possible that a new IC will fix the trouble, but the old one might too, if it is reinserted. If you do not have a replacement, try removing and inserting the suspected IC a couple of times before ordering a new one. Since IC's have come along, we have added another subject to our "do-not-argue-about-these-things" list. How to get an IC off the board is almost as inflammatory as discussions of religion and politics. Everybody has a pet method which he is prepared to defend against all others. Here are some of the leading contenders:

One approach is simply to cut off all the leads and then remove the ends which are soldered through the board, one at a time. This works rather well with IC's which have long leads, but not so well with the plastic, in-line types which are mounted tightly to the board. As a rule, the IC is destroyed; but this

is unimportant unless the IC was actually good, or if it is a warranty item and the manufacturer wants it back. (As a point of interest, I have always maintained that the customer rightfully should pay for any parts which are destroyed through no fault of the technician, or as a calculated risk—but it does run up the repair bill.)

Another popular method of IC removal involves using braided ground strapping as a wick to draw off molten solder from around the terminals of the IC. Braid designed specifically for this purpose also is available. However, extreme caution is needed, because it requires a lot of heat to melt the solder and also get the braid hot enough to carry the solder away. It is easy to get the printed wiring on the board so hot that the bonding between the copper and the board melts and the two separate. Nevertheless, some technicians become very adept and can perform a very neat job with this method.

The flat-surface soldering iron, which is designed to heat all the contacts simultaneously, works well for removing AFC-diode packs having three leads. But this method sometimes gets difficult with IC's having up to 14 leads. Either the iron is too large or not large enough. Of course, if all integrated circuits had the same lead configuration there wouldn't be any problem with this method.

Another approach uses a soldering iron with a tube and squeeze bulb attached. The idea is to get the terminal hot and then pump the bulb to blow away the solder. The

one we tried didn't seem to work too well, but maybe with more practice we could have mastered the trick.

One tool that seems to be relatively effective consists of a spring-loaded piston inside a small cylinder which has a teflon nozzle on one end. The piston is pushed down and the nozzle is held as near as possible to the connection to be unsoldered. When the solder melts, the piston is released and, hopefully it draws up the solder. If there is room to operate, it works fairly well, but usually one has to repeat the process on some of the IC terminals.

An uncle of mine has had a small air compressor in his shop for the past twenty years. He uses it to blow the dust out of cabinets, clean off the bench, etc. Now he uses it to blow the solder out of holes in boards. To prevent spraying solder all over the chassis, he wads a paper towel around and

beneath the reverse side of the area where he is working.

Summary

In the next few years, it can be assumed that the IC will be applied to many more circuits in television receivers. The reasons for this assumption are: simplified assembly, smaller and lighter chassis, reduced cost and performance equal to, or better than, tube and transistor circuits.

At the moment, the production of the types of IC's suitable for most TV applications is, relatively speaking, in its infancy. The techniques for manufacturing IC's are being constantly revised; however, basic construction techniques probably will remain similar to those described in this article.

From the servicing angle, it isn't really necessary to know precisely how an IC is made, or for that matter, precisely how it functions. It is important, however, to know

thoroughly what each IC in a receiver **does**. Equally important, the technician must know the purpose of each component connected to an IC. If he does not, he will make a lot of wrong guesses, replacing good IC's needlessly and damaging new ones by installing them in defective circuits.

Good soldering techniques must be employed when you are removing IC's. Whether or not an IC found to be good should be reinstalled is questionable—putting it back might be more costly than leaving the new one in place. But ruining the circuit board while removing it is another matter! A patched up board can lead to future failures, and the alternative—replacing the board—is too costly even to consider in most cases. A sign we noticed in a shop not too long ago sums it up. "If you're too busy to do it right the first time, how will you find time to do it over?" ▲

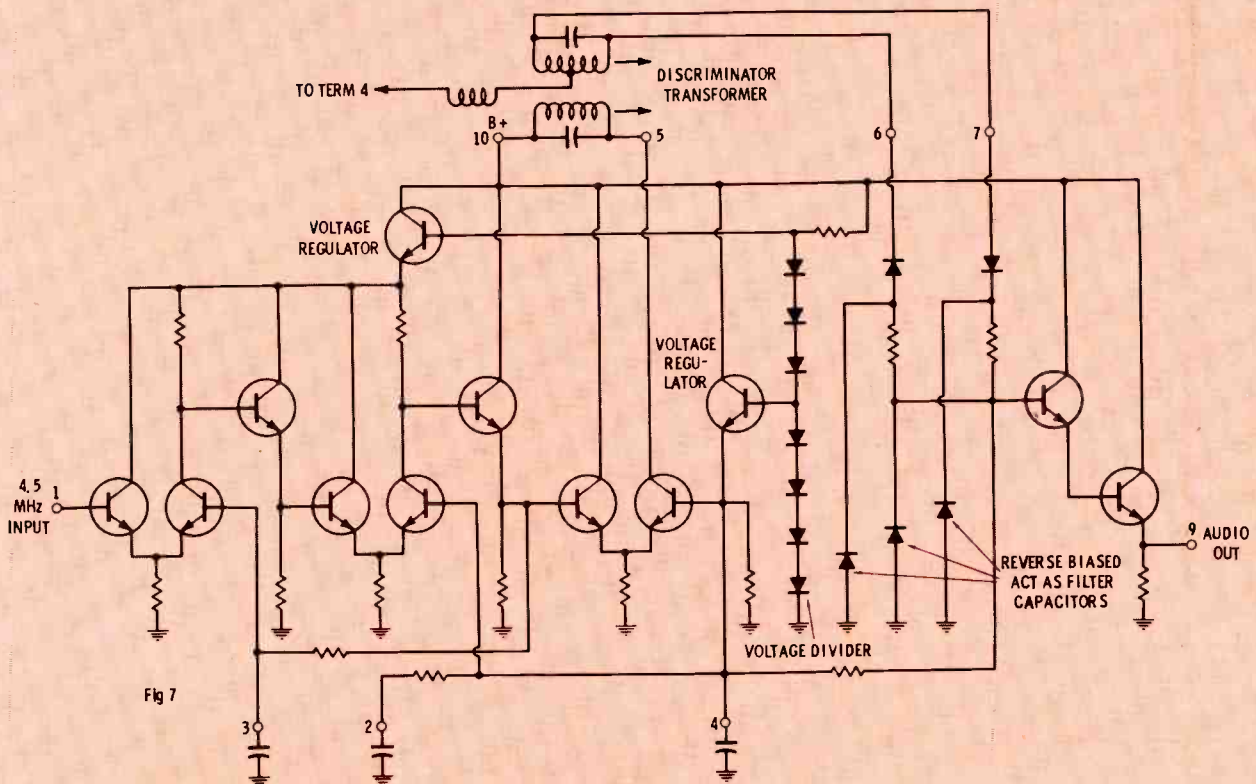

Fig. 7 The RCA type CA 3013 amplifier and discriminator, with typical external circuitry.

by Allan Dale

Dynamic Convergence: Troubleshooting and Touchup

Recognize the Trouble and Do Something About It

Some technicians shy away from servicing convergence boards. There they are, in the middle of a dynamic convergence procedure, and one of the adjustments won't respond. I've watched guys go through the whole first part of the procedure five times rather than dig into what's wrong on the board.

Maybe it's because there are so many wires and connections. It does look like a veritable rat's nest. Yet, there are some quick ways to figure out what's wrong. Some are ridiculously simple.

For example, suppose you're going through the steps—1, 2, 3, and so on—just like the directions say. Suddenly, step 9 says, "Make the middle blue line straight". Not only does the line stay crooked, but you can't see it move at all when you turn the associated control. It stands to reason, the control or some associated component must be bad. To overlook it and continue to try to work around and past it is a waste of time.

There are a few circumstances when you might want to go ahead with another step or two in the sequence. Sometimes, if an amplitude control is down, the associated tilt control doesn't seem to operate. Repeating the steps just before and just after the one that doesn't work might be a good idea. But one attempt should settle your mind about it. If the adjustments before and after the inoperative adjustment are working and the one you're turning isn't, stop and cure the fault. More twiddling will just take more time, and you still won't get the set converged.

Quick Component Checks

If you like a little clip-and-test now and then, the convergence panel is one place in which it's

occasionally worthwhile. You can use deduction to narrow down the possibilities and then go ahead and "clip-and-test" a few parts.

For example, a set delivered to me not long ago exhibited bad mis-

convergence. Fortunately, the outside technician brought the convergence panel along. Hooked up to the bench test jig, the chassis couldn't be adjusted to make red and green converge in the lower left quarter

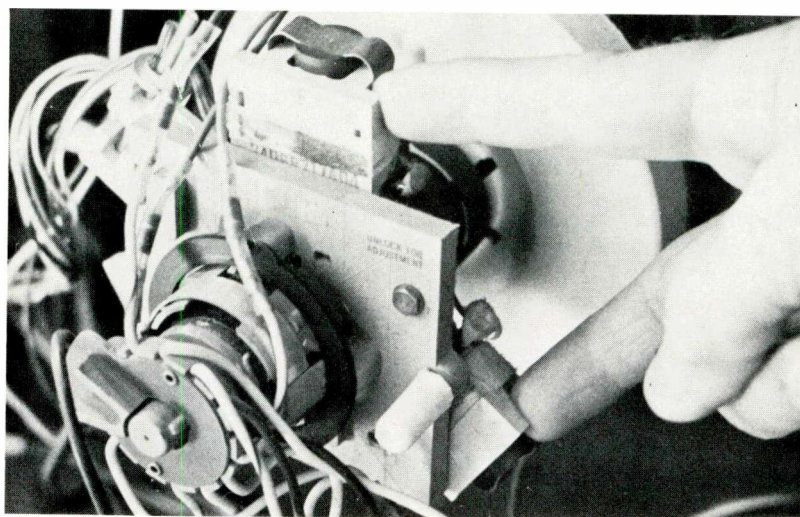

Fig. 1 The cloverleaf-shaped assembly clamped on the neck of a color CRT holds the coils which shape the color beams to produce proper convergence.

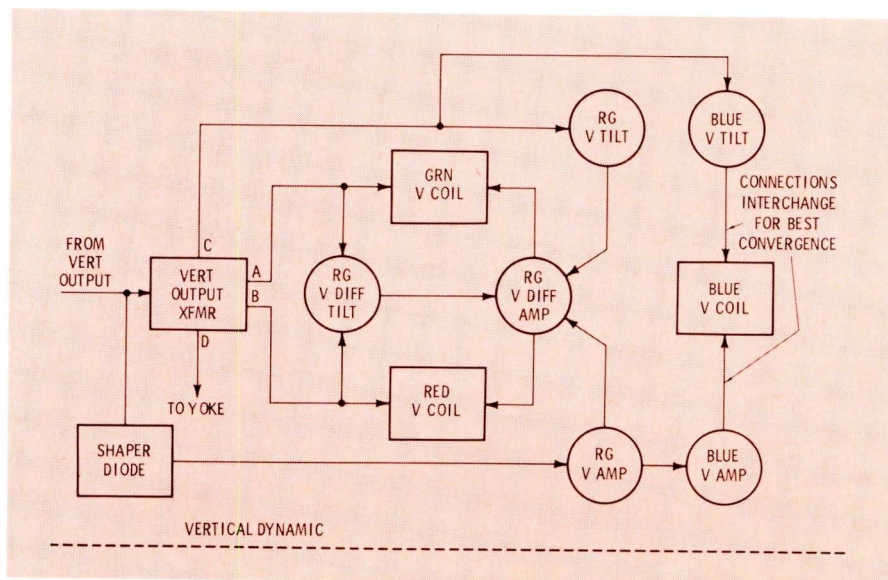

Fig. 2 Vertical dynamic convergence function diagram, showing how the signal currents flow through the various controls and shaping circuits on their way to their respective coils.

of the screen. The outside technician said he got the same result at home, only it had been bad all over the screen before he tried setting it up.

Several tries in the shop produced almost no improvement. It soon became obvious that almost none of the R-G controls were having any effect on the vertical crosshatch lines on the left side of the screen. Time for a quick clip-and-test.

I turned the set off, picked up the ohmmeter, and stuck it across the red coil and then the green coil leads. One of the green coils was open. Unsoldering and measuring each coil winding separately pinpointed which one.

Replacing the coil was quick and easy. Fact was, if he'd wanted to, the outside man could have found that bad coil and replaced it in the home. (Of course, some shop managers prefer that all soldering be accomplished in the shop.)

Neck Coils

Few technicians have ever been taught just what sequence signals take through a convergence panel. It's not too easy to tell from the schematic. You can draw a block function diagram of other sections in a color receiver and analyze how the signals travel from stage to stage; why not do it for a convergence panel?

You can. Once you dope out how the signals move, the function blocks help you remember. Most brands use virtually the same convergence arrangement except Sony, who has developed a simplified system for the Triniton picture tube.

First thing to consider is how the neck coils are put together. Fig. 1 shows the CRT neck of one recent-model color receiver. Fingers point out two of the convergence-coil housings. The third coil housing is out of sight on the other side of the CRT neck. Inside each of these housings is a pair of coils. One is for vertical dynamic convergence, the other is for horizontal.

In the red-coil housing, for example, is a red horizontal dynamic convergence coil (I'll call it Red H, for short) and a red vertical dynamic

mic convergence coil (Red V). Inside the green-coil housing are green horizontal and vertical dynamic convergence coils (Green H and Green V). The blue housing, of course, contains the Blue H and Blue V coils.

The coils inside each housing have a common core. In other words, Red V and Red H are wound not far from each other on one core. Green V and Green H have their common core, and so do Blue V and Blue H.

This explains why you find interaction among the adjustments that shape the currents that feed these coils. You twist a control or inductance that affects current through the Red H coil and it also affects the Red V to a small extent. The same also is true of the green and blue.

These effects can sometimes fool you when you're analyzing how the controls function. Suppose the Red H controls operates okay, but Red V controls produce only mild effect. Since both work, you might naturally assume the red coil is okay. But, knowing there are two separate red coils in the housing, you're more likely to recognize the symptoms for what they really mean—a Red V coil is bad.

Tracing Currents Through A Panel

Each of the six coils is fed a carefully shaped set of voltages and

currents. Because waveforms become so intermingled, a scope is not much help in identifying what's wrong with waveshapes. That isn't really necessary anyway, because you can watch what the combination of currents in each coil does to the beams of the color picture-tube. That's the most dependable way to troubleshoot the panel.

The diagram in Fig. 2 shows which way signals flow in the vertical dynamics section of a typical convergence board. The round blocks are potentiometer controls, all of which you turn with a screwdriver. The squares represent components—the three vertical (V) coils, a shaper diode, and the vertical output transformer.

Keep in mind, as I explain them to you, that the signals here are **currents**. Their voltage amplitudes or shapes are not an accurate indication of the currents present. That's why the scope isn't much real help. The effect of these currents on the lines of a crosshatch pattern is the important thing. From those effects you'll be able to tell whenever one of the paths is broken. I'll give you an example of this, but first let's trace the signal paths in this vertical dynamic convergence board.

The vertical section gets four signals: One comes directly from the vertical output tube; three are from windings on the vertical output transformer.

One vertical output winding sup-

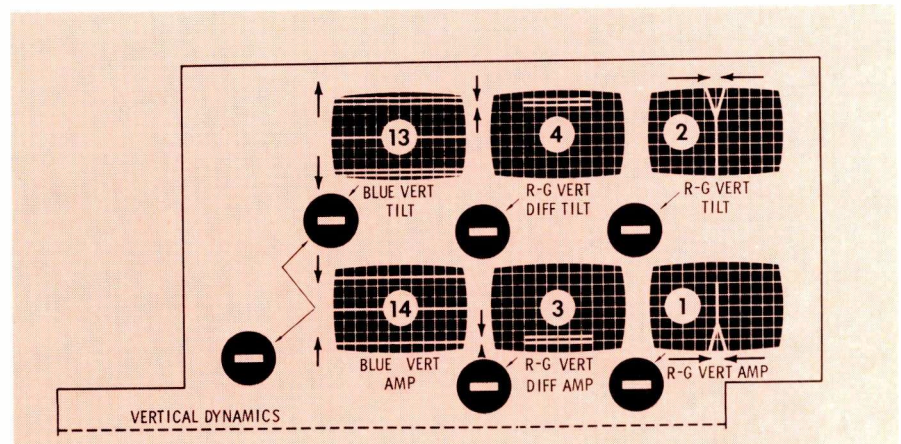

Fig. 3 Position of adjustments on convergence panel often is illustrated in this manner. Crosshatch patterns tell you which part of screen is affected by each control.

plies signals A and B. These two outputs are from opposite ends of the same winding and, consequently, are 180 degrees out of phase with each other.

The A signal goes directly to one end of the Green V coil; the B goes directly to one end of the Red V coil. The total A-B signal is applied across the potentiometer labeled **RG V Diff Tilt**, which is an abbreviation for Red/Green Vertical Differential Tilt.

Moving the slider of that pot shifts the phase of signal fed to the **RG V Diff Amp** (Red/Green Vertical Differential Amplitude) control. The RG V Diff Amp is a mixing potentiometer; two other signals are fed into it. Its output goes to the other ends of the Red V and Green V coils. But first look at those other two signals.

Another winding of the vertical output transformer supplies signal C to the **RG V Tilt** (Red/Green Vertical Tilt) potentiometer. Also, a signal direct from the vertical output tube (usually a sawtooth from

the cathode circuit) passes through a shaper diode and is applied to the **RG V Amp** (Red/Green Vertical Amplitude) pot.

The RG V Amp control determines **how much** of the shaped output-stage signal is applied to the mixing potentiometer (RG V Diff Amp). The RG V Tilt does somewhat the same thing to the C signal from the vertical output transformer, but the effect is to **shift the net phase** of the C signal applied to the mixing pot.

Now the mixing pot (RG V Diff Amp) has three signals on it. One comes from the RG V Diff Tilt pot, another from the RG V Amp pot, and one from the RG V Tilt pot. The RG V Diff Amp pot picks off the right amplitude and phase of all three signals and applies the mixture to the other ends of the Red V and Green V coils.

Analyzing Function Sequence

Now, what does all this mean in relation to troubleshooting? It gives you clues to where in the

signal flow path a fault might be.

For example, suppose a convergence instruction tells you to adjust the RG V Diff Amp. This control, when it's functioning properly, has its greatest effect on horizontal red and green crosshatch lines near the bottom of the screen. You can determine this from the diagram of the convergence board, which in most cases will be like the one in Fig 3; most color sets have one pasted on or near the convergence panel.

Suppose that when you try it, the control doesn't seem to have much effect. You check the other pots that supply signals to the RG V Diff Amp control. The RG V Tilt operates okay. The RG V Amp does, too. However, the RG V Diff Tilt pot doesn't have much effect. Chances are it's the culprit, rather than the RG V Diff Amp, even though both are inoperative. This logic is based on the sequence in which signal currents are applied to the controls, not by which control you first noticed was not operating properly (determined by the sequence in which the controls are adjusted during the convergence procedure).

In another case, suppose RG V Diff Amp, the mixing pot, doesn't have the proper effect on green lines, although it seems to effect red lines properly. You try the other vertical dynamic pots and get little response, although there is more when you turn the RG V Diff Tilt pot.

You can verify that it's the red lines which are moving. Just blank out the green one (blue lines are usually blanked anyway during RG adjustments).

From what you've already learned, you've probably concluded—and rightly—that the most likely culprit is the Green V coil. You get some response from turning the Diff Tilt pot because it changes the shape and amplitude of the voltage applied to the coil wires, even though current can't flow. The chief clue in this case is that red is okay.

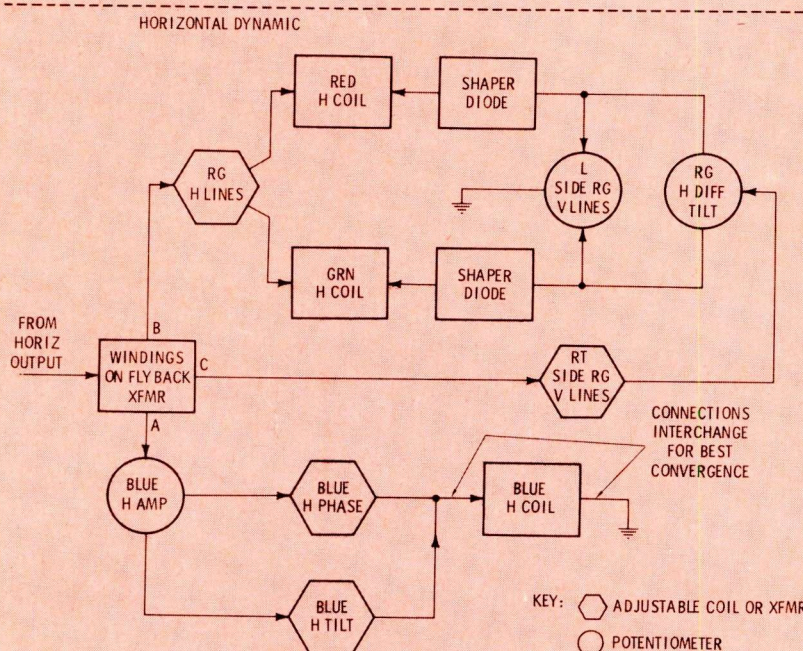

Fig. 4 Function diagram for horizontal dynamic convergence. Hex blocks are variable inductances.

Horizontal Dynamics

The operation of the blue portion of the vertical dynamics section is

the easiest to understand. From the function sequence it can be seen that the RG V Amp pot can have a slight effect on blue. Consequently be sure to make adjustments in the order suggested by the set maker.

The block diagram in Fig. 4 is of the horizontal dynamics section of the same convergence board discussed previously. The sequence of currents is probably clear, since you've now been through the vertical dynamics. But let's take a brief look at them.

The source of all three signals is the horizontal output transformer. From it the three signals are processed through various shaping and mixing stages and then to the H coils. Here's the sequence.

The A signal from the horizontal output transformer goes through a **Blu H Amp** control to two coil-type adjustments (hex-shaped blocks in Fig. 4). The **Blu H Phase** and **Blu H Tilt** inductances adjust the phase of the currents and apply them to the one end of the Blu H coil. The other end of the coil is grounded.

To understand what these controls are supposed to be doing to the CRT beams, look at the dia-

grams in Fig. 5. The Blu H Tilt inductance centers any bow in the blue line across the middle of the color CRT. To see if it's adjusted right, you may have to misadjust slightly the Blu H Amp control (that's what the instructions usually say to do). The Blu H Phase inductance pushes the deep part of any bow upward, shallowing out the bow. Then the Blu H Amp pot makes the line straight across.

Signals B and C from the horizontal output transformer feed the red/green branch of the horizontal dynamics board. They are in opposite phase. The "B" portion is fed through a phase-adjusting coil, the RG H Lines inductance. The current is split there and fed to one end of the Red H and Green H coils.

The "A" portion goes through a phase inductance called **L Side RG Lines**. It's then fed to the **RG H Diff Tilt** control, which splits the A signal so it can be sent to the other end of both H coils. An **L Side RG V Lines** pot, with its slider grounded, balances the A signals between the two coils. A shaper diode clips each A signal, and the

signals are then applied to the Red H and Green H coils.

Again, as you did in the vertical section, you can analyze difficulties by tracing out the path the currents follow to reach the coils.

Convergence Touchups

It's an aggravation to have to go through a whole convergence setup procedure when only one corner of the crosshatch is misconverged. Yet, that's the surest way. However, if you understand the signal paths in convergence boards, you might occasionally save some time by trying a touchup.

Suppose, for example, the set has poor convergence in the lower right corner of the screen. You can study the crosshatch diagrams in Figs. 3 and 5 and get a pretty good idea which controls to use for a touchup. If it's red and green that don't quite fit, the likely control is 5, RG Rt Side V Lines. Maybe 3 and 13 will need touching up too (RG V Diff Amp and Blu Vert Tilt, respectively).

The preceding would be clear-cut if it weren't for interaction. Look again at Fig. 4. Signals which are altered by turning the RG Rt Side V Lines inductance also are fed to the RG H Diff Tilt and RG L Side V Lines controls. Consequently, these two controls might need readjustment, too. If you turn the Blu V Tilt control, you might get away with not touching up Blu V Amp, but don't be surprised if you have to. The RG V Diff Amp is the last in its chain (Fig. 2); when you adjust it, you might not have to touch up any of the other controls.

Conclusion

That's how you can use the function diagram for troubleshooting and touchup of convergence. The diagram I've used here applies to a lot of modern color chassis. If you find it doesn't suit one you're servicing, draw a revision. You can figure it out from the schematic diagram, now that you know what to look for. Once you have it, file it with the PHOTOFACT for the set. It'll come in handy anytime you have a convergence problem. ▲

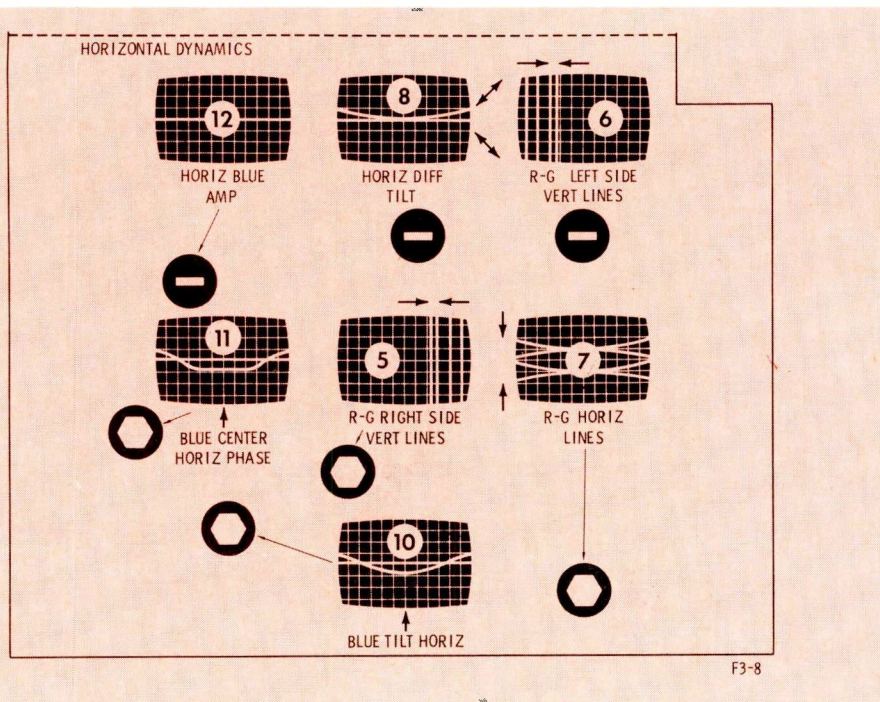

Fig. 5 Numbers on layout diagram (this one for horizontal dynamic adjustments) tell the sequence in which the set-maker suggests convergence adjustments be made.

SMALL INDEPENDENT BUSINESS, 1970 & 1971

An NFIB Synopsis

by J. W. Phipps

How members of the National Federation of Independent Business, Inc., (NFIB) viewed 1970 and what they anticipate this year. (Data and opinions reported in this article are from a year-end summation by the NFIB, and reportedly are based on more than 120,000 responses to NFIB membership surveys conducted throughout 1970.)

The Year That Was

Throughout 1970, the National Federation of Independent Business (NFIB) has been asking its 287,000 members, "How's business?" Responses to this question have reflected the hardships imposed on small independent businesses by inflation, recession and tight money in 1970.

"The Year of Higher Everything, Except Profit"

What was the business climate in 1970? According to the NFIB, most small independent businesses experienced higher overhead and higher taxes, and some reported higher volume. Replying to the NFIB, a Minneapolis food locker proprietor described 1970 as "the year of higher everything, except profit."

Of those responding to the NFIB's request to compare 1970 with 1969:

- 88 percent said the price of goods they purchase (wholesale) has risen
- 73 percent said their average labor costs are higher
- 71 percent said their selling prices (or professional fees) are higher
- But only 48 percent said their business volume has increased . . . and 22 percent said it has declined.

Higher Costs and Consumer Resistance Have Put the Squeeze on Profit

The preceding figures, according to the NFIB, support its contention that "small independent business not only finds it difficult to raise prices, but when it does, often experiences diminishing returns from consumer resistance." In other words, when increased operating and labor costs force small businessmen to increase selling prices to maintain their profit margin, the higher selling prices often reduce volume, which, in

turn, reduces net profit. Thus, the small independent businessman has found himself seemingly trapped between the results of higher costs and consumer resistance to higher selling prices.

While the Federation did not ask about profits, per se, many members volunteered comments on declining profits and the need for working capital. A small New Jersey retailer reported, "Gross take is up about \$2,000 this year, but my net is down . . . unable to change prices as easily as the wholesaler passes them on to me."

"High taxes and interest rates make great inroads on my profits," a Nebraska stationery store owner wrote, adding that even more profit is lost by not being able to pay cash.

Economic Downturn Has Increased Price Competition From "Big" Businesses

The combined effects of inflation and recession also have been felt by even the largest chain and corporate firms. However, unlike the small independent—who has no corporate "fat" to trim off to reduce costs, and no corporate reserve to carry him over the crisis—"big" business is able to maintain relatively lower prices than the independent and/or can sacrifice some profit margin to maintain volume. Thus, as NFIB members have reported, "the economic downturn has resulted in much tougher price competition from chains and major corporate firms seeking to maintain volume. And some who are primarily in service lines note more competition from firms primarily in sales and manufacturing."

Independents Cannot Cut Back More, Have Maintained Employment Level

One surprising aspect of the Federation's findings is that, so far, independents apparently have held the line on employment. Whereas big businesses have made large payroll cuts, on balance the independents still show a small net gain; only 25 percent changed employment levels, and these averaged a net gain of .4 employee, compared to a year earlier. The Federation believes that many small firms cannot cut back any further—after years of economizing—without liquidating.

If employment by independents tumbles, it could have devastating effects on unemployment and the economy, the Federation contends, because independents account for about 60 percent of the nation's private employment. Higher Social Security taxes—on employee and employer—effective January 1, could aggravate the employment picture quickly, the Federation warns.

Slower Collection of Receivables Aggravated Tight Money Situation For Independents

Faced with tight money and a recession, reportedly many business owners saw their accounts receivable become a problem. Federation statistics reportedly show a 7:2 ratio between those reporting a higher amount of receivables and those with lower receivables, but an adverse 8:1 ratio on collections, with 32 percent reporting slower collections than a year earlier and only four percent reporting faster collections.

Investment By Independents Slumped

In three years the number of businesses reporting added investment has slumped from 60 percent, to 55, to 50, according to the NFIB. Most of this limited re-investment (60 percent) goes into equipment, and repeal of the 7-percent investment tax credit is believed to have been a factor in this decline. In Federation polls, the businessmen reportedly have supported several Congressional moves to restore the tax credit in limited form.

Limited Bank Funds and Record High Interest Rates Reduced Number of Loans to Independents, Although Need is Believed High

Only 30 percent of the proprietors responding to the NFIB surveys said they obtained a loan in the previous six months, reportedly the lowest figure since the Federation began asking about borrowing four years ago. The NFIB believes that the demand is very high, but that many have been denied loans (as banks channeled limited funds to larger customers) or have been unwilling to pay such high rates.

The business loan picture shows record interest rates. Even the most recent NFIB data shows the average business bank loan at 8.6 percent, with rates below that average in the Midwest but much higher in the West. Although the banks' prime rate has been cut to 7 percent, no major change has shown up in the independents' survey responses.

News that the Small Business Administration (SBA) had exhausted its lending capacity by November added to the fiscal problems of small business. Federation leaders, meeting with the Chairman of the President's Council of Economic Advisers on December 15, reportedly stressed that unless there is more cooperation by banks in the SBA lending program to provide needed funds to credit-worthy, established firms, the Administration should ask Congress to appropriate more funds so SBA can resume making direct loans.

One legislative hope for the future is a Small Busi-

ness Tax Reform and Simplification Bill, introduced by Senators Alan Bible of Nevada and Quentin Burdick of North Dakota, both of whom are on the Senate Small Business Committee. It remains to be seen whether the new Congress will support this bill.

The Wage/Price Spiral—Who's To Blame?

Many independents blame union wage demands, "fantastic raises to construction workers" and "unreasonable wages" for the continuing wage-price spiral, according to the NFIB report.

"I strongly feel that the labor movement is on a self-defeating course, which is contrary to our country's interest," said a smalltown California grocer.

An Illinois manufacturer who employs 13 persons said, "Our labor force demands higher wages each year, and we do not blame them . . . yet there will be a limit on how much a small employer can pay out and continue in business."

The Year That Is

Pessimistic Hopefulness is Present Attitude of The Small Independent Says the NFIB

At the end of 1969, independent businessmen reportedly seemed to be saying to the NFIB, "Things can't go on like this." At the end of 1970, they seem to be saying, "We were right, things got worse."

While economists generally predict 1971 will be a year of recovery, many independents are skeptical. To the most disillusioned, says the NFIB, small business is in a tail spin and only immediate drastic action can avoid a crash.

Now that Washington has indicated a change of gears—less brake on inflation and more fuel to the economy—many independents fear a runaway wage/price spiral that will decimate small business, according to the NFIB report.

One Cincinnati businessman told the NFIB, "I have been in business 40 years and have never been so discouraged."

An industrial designer in Wisconsin, blaming the recession, reports he's been ". . . on the verge of bankruptcy for the last six months. While big business can 'trim the fat' and survive, we are struggling. . ."

NFIB Says Three Major Reasons Have Raised the Hopes of Small Independents

However, as 1971 dawns, independents reportedly also see signs that the Seventh Cavalry is coming over the horizon. The present mood seems to be a paradoxical one of pessimistic hopefulness, says the NFIB.

Three major events in the closing days of 1970 raised their hopes, despite the pessimism generated by general business conditions:

- **Tax Relief**

One event, according to the NFIB, was the introduction by Senator Alan Bible (Nevada), chairman of the Senate Small Business Committee, and Senator Quentin Burdick (North Dakota) of a comprehensive eight-part "Small Business Tax Reform Bill." Although no action was expected until the new Congress, it was introduced late in the now-expired Congress to promote discussion of what is hailed as the "most comprehensive tax reform ever undertaken for the preservation and expansion of small and independent business."

- **More Attention to Small Business By Economic Policy Makers**

The second event, says the NFIB, was the decision of President Nixon, at a meeting held with small business leaders in Washington in September, to arrange quarterly meetings with Dr. Paul McCracken, Chairman of the Council of Economic Advisers. This decision, reportedly prompted by a request for closer liaison between the administrative branch of government and small business by Wilson Johnson, president of the National Federation of Independent Business, marks the first time in national history that a dialogue has been established between the small business sector of the economy and the prestigious economic policy makers.

In the first meeting at year's end, Dr. McCracken was asked to adopt a policy of "Stop-Look-Listen." In other words, he reportedly was asked that research be conducted into the impact that any proposed new program will have on the welfare of small business, on the basis that what big business can live with is often harmful for small business.

- **Increased Recognition of Important Role of Small Business in National Economy**

A third important development late in the year just ended was the increased attention being paid to the plight of small business by the news media. As inflation mounted, as the nation's largest railroad and the sixth biggest corporation went under financially, as more automation was undertaken by big industry to offset the costs piled up by large union demands, more attention was being focused on where jobs would be created. This attention to jobs, says the NFIB, was made more prominent when supposedly blue chip employers in the airplane, space, and defense industries were forced to lay off thousands as the result of spending cutbacks.

The role of independent business, which reportedly currently supplies 60 percent of all jobs in private employment, is assuming greater news importance, according to the NFIB. ▲

"My shop's been loaded since I got my FCC License...and I could kick myself for not getting it sooner. I'm pulling in all kinds of mobile, marine and CB business that I couldn't touch before; have even had some calls to work on closed-circuit television. I've hired two new men to help out and even with them, I'm two weeks behind."

And so it goes. Once you have that FCC ticket, you open the door to all kinds of new business. And that's not all. The knowledge you need to pass the FCC exam gives you a fundamental understanding of *all* electronics. You'll find you can do more work in less time...work on almost *any* kind of electronics gear.

What's the best way to get a Commercial FCC License...and still keep up with your work? Thousands of men will tell you, "Cleveland Institute of Electronics."

Men like August E. Gibbemeyer, for example. He was in radio-TV repair work before studying with CIE and getting his 1st Class FCC License. Now, he writes, "We are very happily in the marine and two-way radio business...servicing police and fire departments in three communities, as well as cab

companies...and our trade has grown by leaps and bounds."

Ed Dulaney is another example. He started his own part-time service business after training with CIE and passing the FCC License exam. This worked out so well that he then opened a full-time business. Today, he reports, "I manufacture my own two-way radio equipment, with dealers who sell it in seven states, and have seven full-time employees."

CIE has been preparing men like these for FCC License exams since 1934. What's more, CIE backs its Home-Study Licensing Programs with this remarkable money-back offer:

A CIE home-study FCC License course will quickly prepare you for a Commercial FCC License. If you fail to pass the FCC examination after completing your course, CIE will refund all your tuition. You get an FCC License...or your money back!

And only CIE offers you new, up-to-the-minute lessons in all these subjects: Advanced Troubleshooting Techniques, How To Work With Transistors, Microminiaturization, Pulse Theory and Application, and many more.

Send bound-in postpaid card today for CIE's FREE informative book "HOW TO GET A COMMERCIAL FCC LICENSE." With it, we'll include a second FREE book, "HOW TO SUCCEED IN ELECTRONICS." If card is missing, use the coupon below. Cleveland Institute of Electronics, 1776 East 17th Street, Cleveland, Ohio 44114.

NEWS FOR VETERANS: New G.I. Bill may entitle you to Government-paid tuition for CIE courses if you had active duty in the Armed Forces after Jan. 31, 1955. Check box in coupon for complete information.

CIE
Cleveland Institute of Electronics
1776 East 17th Street, Cleveland, Ohio 44114

Please send FREE book, "How To Get A Commercial FCC License." Also include your second FREE book, "How To Succeed In Electronics."

Name _____ Age _____
(Please Print)

Address _____

City _____

State _____ Zip _____

Veterans check here for GI Bill information

Accredited Member National Home Study Council
A Leader in Electronic Training... Since 1934

PF65



"My shop's
been loaded...
since
I got my
FCC
License."

Circle 20 on literature card

The lighter side of Service Pricing

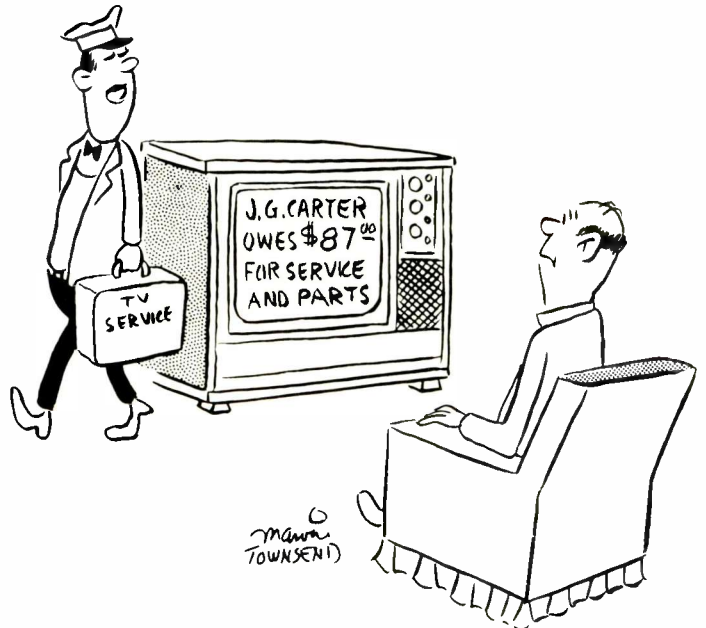

"You now have closed-circuit TV to our credit office until your bill is paid."

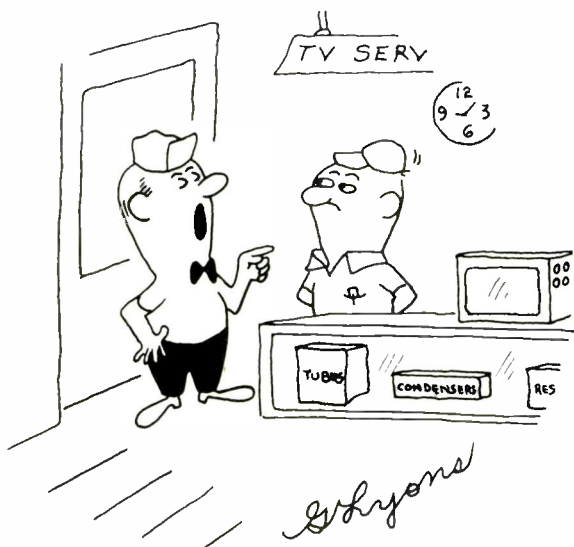

"We have a new credit policy. From now on, the only thing we charge here are capacitors—and we do that very carefully."



"I'm sorry, ladies, but I'm not allowed to accept home-made jams and jellies as payment."



"I see someone stole your TV. I hope you realize you'll still have to pay for this service call."



"Of course, that's only an estimate."

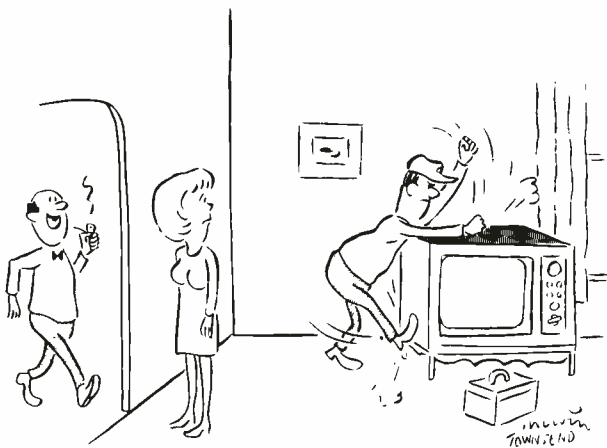

"What's this I hear about you finding a TV service technician who charges only 2 dollars an hour?"

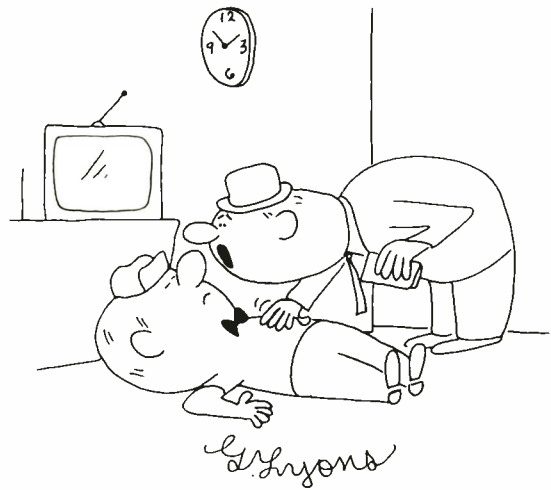

"Gee whiz! All I said was, 'Would you like me to pay the repair bill in advance?'"

The Curve Tracer:

Another Method of Testing Transistors, Part 1

by Carl Babcoke

Transistor Characteristics Which Can Be Tested

Characteristics of transistors which can be measured include DC beta, AC beta, shorts, leakage, opens, bandwidth, linearity, polarity (PNP or NPN), internal capacitance, noise level, and maximum permissible operating currents and voltages. Only a few of these characteristics can be tested in an electronic service shop, because of practical limits of test equipment and technicians' time.

Several simple methods of testing some characteristics of transistors were given in an article titled "Quick Testing of Transistors", in the No-

vember '70 issue of ELECTRONIC SERVICING.

Testing of shorts, leakage and opens is understood best by thinking of the transistor as three interconnected diodes, as shown in Fig. 2. Forward and reverse resistance of the three junctions can be measured with an ohmmeter by testing one junction, then reversing the polarity of the leads and measuring again. This method demands some experience in interpretation, and, unfortunately, when applied to non-defective silicon types, infinite resistance is indicated by most of these tests. However, some opens, shorts and most leakage can be detected using this method.

Each diode junction of a transistor also can be dynamically tested

for its ability to rectify, by use of the circuit shown in Fig. 3. The ideal waveform for a good junction is a right angle. A short produces a vertical line, and an open produces a horizontal line. These tests can be made on in-circuit transistors; however, the accuracy will depend upon the circuit characteristics. Also, collector-emitter tests are not as definite as we might desire, and leakage indications are not very sensitive.

Turn-on and turn-off tests in which the collector-emitter junction is measured with an ohmmeter are true measures of transistor actions. Of course, no accurate calibration is possible. The basic circuit for such tests is shown in Fig. 4.

DC beta testers accurately measure the DC, or static, gain of a transistor by adjusting the base current to achieve a known collector current; the base current then is measured on a meter whose scale is calibrated in DC beta. The smaller the base current required, the higher the beta. A simplified schematic of



Fig. 1 Jud Williams Model A transistor curve tracer, one of at least three commercially produced curve tracers now available. Unit shown here simultaneously applies one step of a staircase waveform of current to the base of a transistor and a parabolic voltage to its collector. Emitter-collector current (voltage dropped across emitter resistor) is used to drive the vertical deflection of a scope and the collector voltage provides horizontal deflection. The resultant waveform is a "family of curves" which reveals the degree of control the base exercises over emitter-collector current, levels of leakage between junctions and AC gain, or beta (ratio of base and collector currents). Two three-prong sockets on top of unit are for out-of-circuit testing of transistors. Three-prong probe which is plugged into PROBE socket on front panel of unit is used for in-circuit testing. Connections to scope are located at rear of unit.

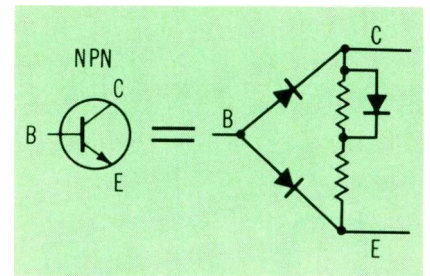

Fig. 2 Equivalent circuit of an NPN transistor shows three interconnected diodes which represent the relationships of the three elements of a transistor—emitter, base and collector. Resistance testing of these "equivalent diodes" reveals positive information about the diode action of the junctions (front-to-back ratios) and the junction-to-junction leakages (reduced resistance). The equivalent circuit of a PNP transistor is the same as that shown here, except the polarity of the diodes is reversed.

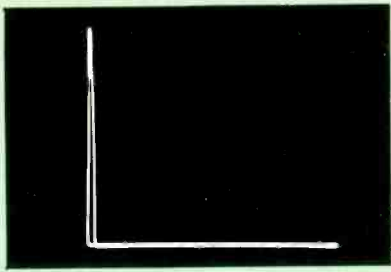

Fig. 3 Schematic of a simple method which permits testing of the diode junctions in a transistor using a scope as the readout. A right angle is the ideal waveform for base-emitter and base-collector junctions.

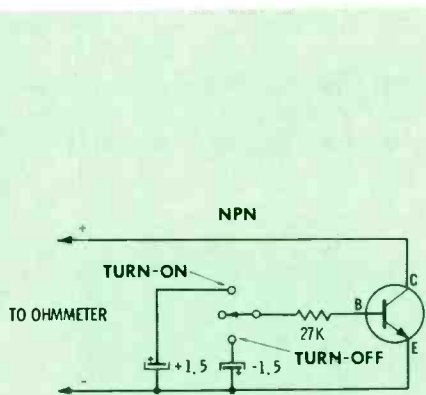
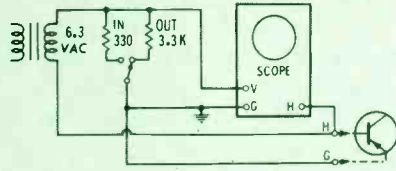

Fig. 4 The ability of the base to control the resistance of the collector-emitter circuit can be tested by this simple test unit, which is connected to an ohmmeter.

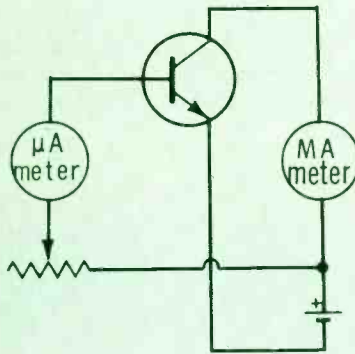

Fig. 5 DC beta is the ratio of static base current to static collector current.

this method is shown in Fig. 5. In actual commercial instruments, only one meter is used, with switching for the various shunts. Other switch functions are used for polarity reversal, leakage, calibration, etc. Also, provision usually is made for the beta tests to be made at various amounts of collector current. This is desirable because transistors provide different betas at different collector currents. For example, one transistor measured a beta of 180 at 1 milliamp and a beta of 240 at 10 milliamps. Many commercial transistor testers have provision for measuring beta in-circuit. I will not comment on this because to date I have not had an occasion to perform these tests.

Testing Transistors With Curve Tracer And Scope

Dynamic transistor curve tracers are beginning to be heralded as the best solution to some of the shortcomings of the preceding tests. Follow with us as we thoroughly check out the performance of the Jud Williams Transistor Curve Tracer, Model A (photo in Fig. 1).

The curve tracer applies a "staircase" waveform of base current to the base of the transistor, and during each step of the staircase a DC voltage that varies from zero to maximum and back to zero again is applied to the collector of the transistor. Collector current vertically deflects the scope beam, and collector voltage provides horizontal deflection.

Fig. 6 shows the relationships between the waveforms applied to the transistor and the resultant "family of curves" produced by a normal

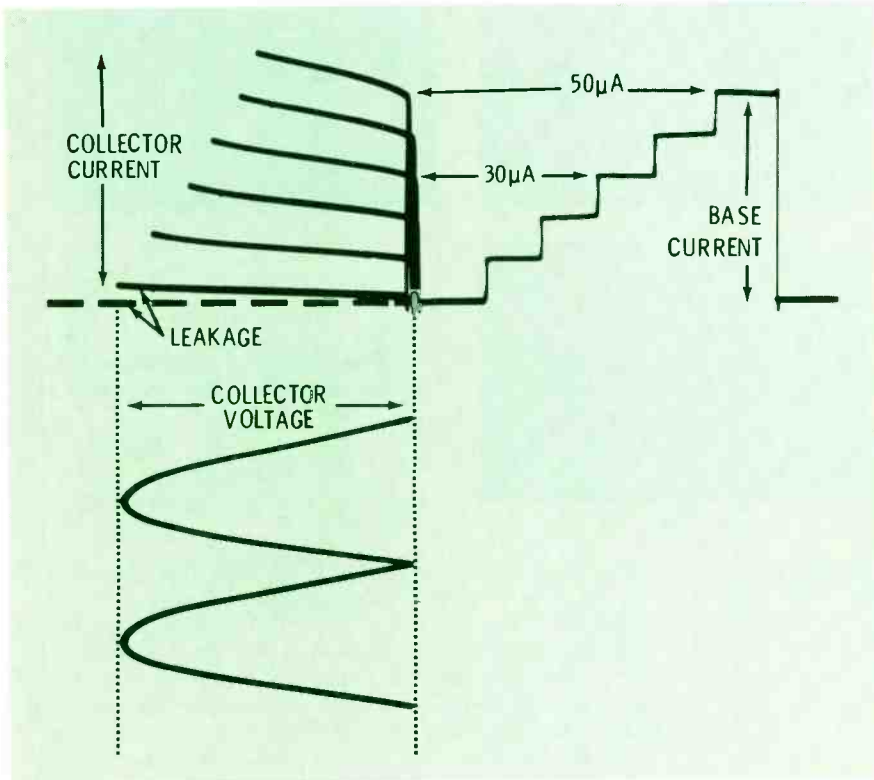
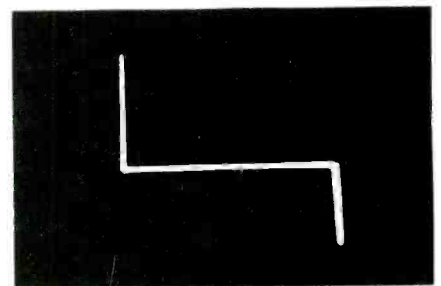

Fig. 6 A typical family of transistor curves showing the relationship between the DC "staircase" base current and the DC parabolic collector voltage. The collector voltage varies from zero volts to maximum and back to zero again during the duration of each step of the staircase. Collector-emitter leakage can be read by the tilt of the zero base current curve compared to the true zero line on the scope graticule.

Fig. 7 Curve produced on a solid-state scope as a result of protective zener action in the horizontal sweep circuit of the scope. Many scopes will overload when the COLLECTOR VOLTAGE control is set to produce higher voltages. False curves are the result. See the text for ways of eliminating such horizontal sweep overload.

transistor. The family of curves shows collector voltage and current at zero base current and at five steps of increasing base current. Tilt of the "zero base current" curve (the longest one) is an indication of collector-to-emitter current not controlled by the base. This uncontrolled current is a direct indication of collector-to-emitter leakage.

How To Connect The Scope And Obtain A Curve

Three wires extend from the rear of the curve tracer cabinet. The black lead connects to the ground post of the scope, the white lead to the horizontal input terminal or binding post, and the red lead to

the vertical input. Usually, it is more convenient to use the regular scope probe. If the probe has direct and low-capacitance functions, use the direct position, to avoid unnecessary mathematics when measuring transistor beta.

Rotate the horizontal selector knob on the scope panel to the position marked "EXT", "H INPUT" or "HORIZONTAL INPUT". With both the curve tracer and scope turned on and the VOLTAGE control of the tracer turned up partially, a horizontal line should be seen on the screen of the scope. The horizontal width of this line should vary when both the VOLTAGE control

on the tracer and the horizontal gain control on the scope are adjusted. Scope intensity, focus and centering should be adjusted normally.

No locking adjustments are necessary, because the scope receives both horizontal and vertical deflection voltages from the curve tracer.

Preset the BASE CURRENT switch to $10 \mu\text{A}$, the SELECTOR switch to LEFT position and the VOLTAGE control to about 20 volts. Plug into the left socket on top of the tracer a small three-lead transistor which is known to be good. Be certain the leads are inserted in the correct socket holes.

Between two and six curves, de-

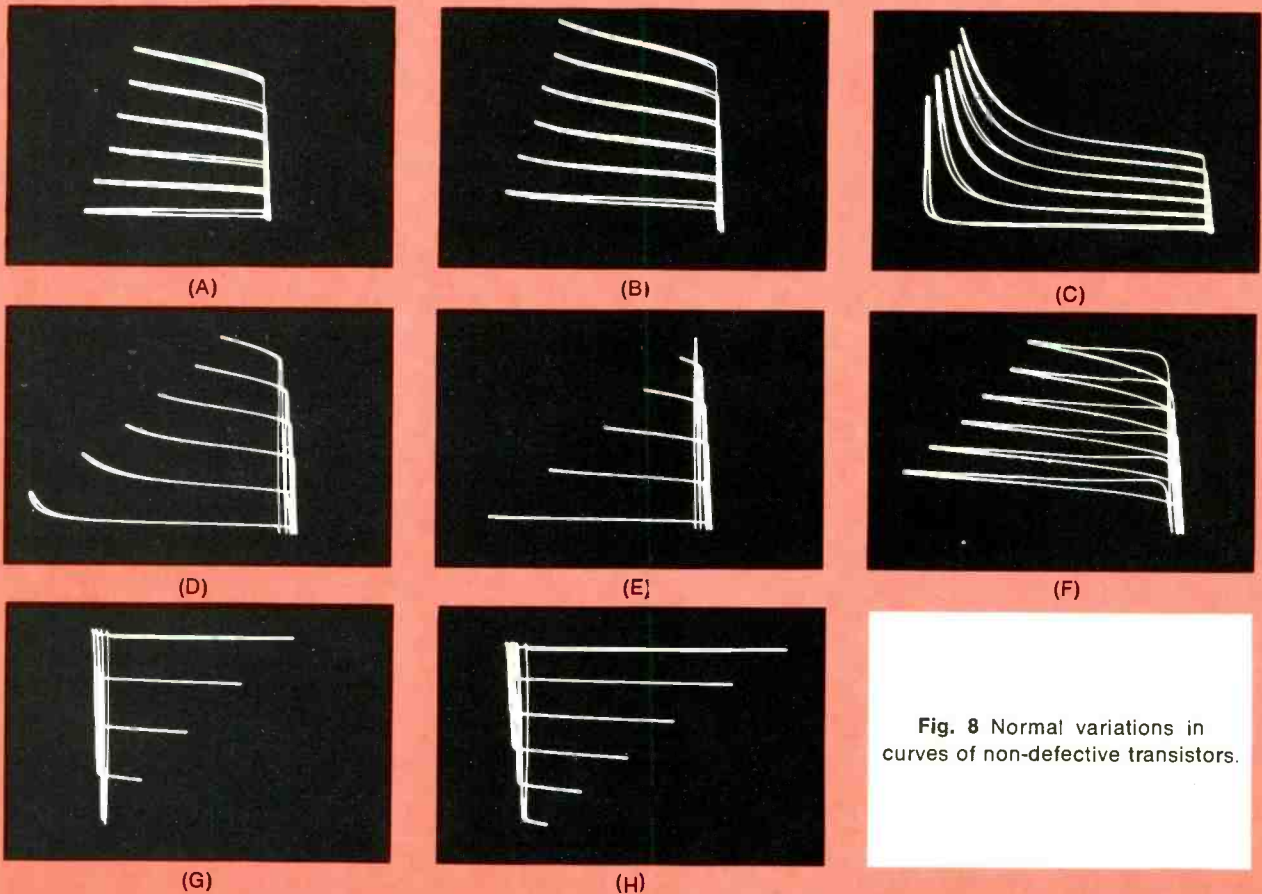

Fig. 8 Normal variations in curves of non-defective transistors.

(A) Family of curves for a 2N411 PNP germanium transistor. BASE CURRENT control set for $10 \mu\text{A}$ per step of the staircase, and VOLTAGE control set at 20 volts PP.

(B) Curves produced by same transistor, but with BIAS switch erroneously set for silicon instead of germanium.

(C) Curves produced by same transistor, but with VOLTAGE control set at 70. Avalanche leakage occurs at about 50 volts.

(D) Curves produced by same transistor, but with BASE CURRENT control set at $50 \mu\text{A}$, VOLTAGE set at 30, and scope vertical gain reduced.

(E) Curves produced by same transistor and conditions

as in (D), but, because COLLECTOR VOLTAGE is set at only 20, only 5 curves are produced on scope.

(F) Curves of an old type 2N301A PNP germanium power transistor. Notice how leakage tilts the "zero base current" curve. Also note the loops in each curve, which indicate poor frequency response and internal heating.

(G) Family of curves of a small NPN silicon transistor with EASE control set at $10 \mu\text{A}$ and COLLECTOR set at 15 volts. This transistor produces about 50 percent more gain than the one in (A).

(H) Curves produced by same silicon transistor, but with VOLTAGE control increased to 25, to produce all 6 curves.

Important New SAMS Books

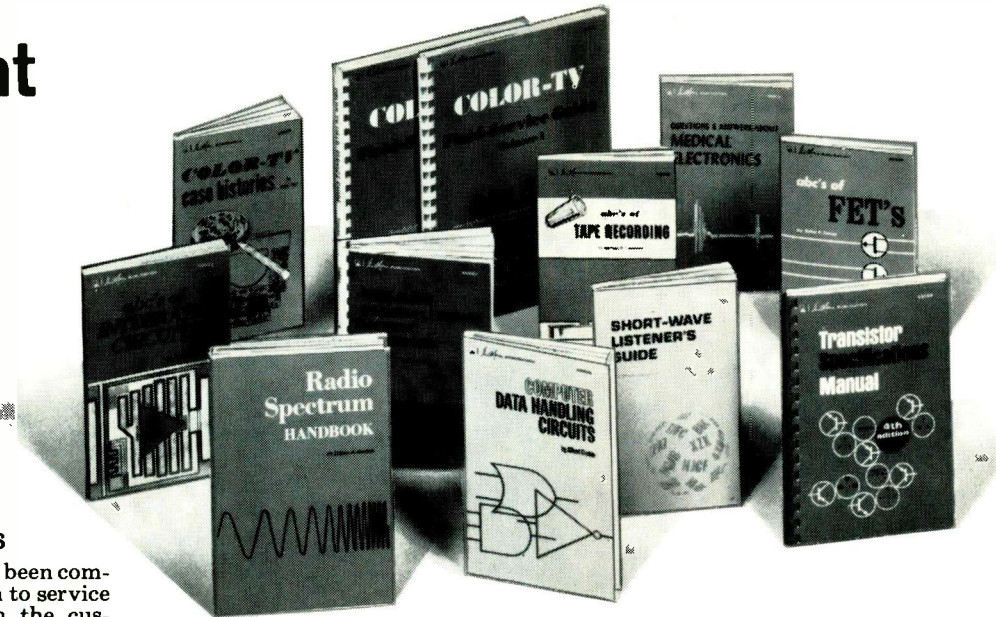

Color-TV Field-Service Guides

These invaluable guides have been compiled to enable the technician to service color-TV more efficiently in the customer's home. Charts provide chassis layouts showing type, function, and location of all tubes and/or transistors used in a particular chassis, ratings and locations of fuses and circuit breakers, location of service controls and adjustments, etc. Specific field-adjustment procedures are shown on page opposite chassis layout. Index provides instant reference to the proper chart for any particular TV chassis. Each volume contains 80 diagrams covering over 3,000 chassis.

Volume 1. Order 20796, only . . . \$4.95
Volume 2. Order 20807, only . . . \$4.95

Questions and Answers About Medical Electronics

by EDWARD J. BUKSTEIN Anyone familiar with basic electronic circuits will find this a fascinating and readily understandable book emphasizing the applications of electronic equipment in clinical and research medicine, general principles of equipment operation, special features of the equipment, and the related medical terminology.

Order 20816, only . . . \$2.95

ABC's of Integrated Circuits

by RUFUS P. TURNER. This basic introduction to the integrated circuit (IC) will be welcomed by hobbyists, experimenters, and students who have some familiarity with semiconductors. Describes the fundamentals of the IC, and its applications in amplifiers, oscillators, control circuits, communications, test equipment, and computers.

Order 20823, only . . . \$2.95

Transistor Specifications Manual. 4th Ed.

by THE HOWARD W. SAMS ENGINEERING STAFF. Lists the electrical and physical parameters (along with the manufacturers) of virtually all of the transistor types now in use. Also includes frequency, gain, and leakage parameters, as well as a special section on rf power transistors. Comb-bound.

Order 20788, only . . . \$4.50

ABC's of FET's

by RUFUS P. TURNER. Clearly explains the theory and describes the operating principles of FET's (field-effect transistors), special semiconductor devices with unique qualities. Describes FET circuit design and typical applications in a number of practical circuits.

Order 20789, only . . . \$2.95

Computer Data Handling Circuits

by ALFRED CORBIN. This book offers the beginner a valuable introductory course in practical digital data circuit analysis. Makes understandable the semiconductors and circuitry used in digital equipment. Explains digital data logic and the associated mathematics. Analyzes the basic logic circuits and their functional blocks, as well as digital display devices. Invaluable for anyone desiring to be conversant in the operational theory of data handling circuits.

Order 20808, only . . . \$4.50

Color-TV Case Histories

by JACK DARR. Case histories not only provide the TV technician with solutions to troubles he is likely to encounter, but enable him to compare his troubleshooting methods with those of others. Each of these case histories of troubles actually happened. The symptoms are given for each trouble, along with the method used to locate it.

Order 20809, only . . . \$3.50

Radio Spectrum Handbook

by JAMES M. MOORE. This book fills the "information gap" about the many types of radiocommunication which exist apart from radio and TV. Each chapter covers a given frequency-allocation range; a table provides an overall summary of the uses of all frequencies in that range, followed by text describing the individual radio services available. Includes information on receivers available for the various frequency bands described. Hardbound.

Order 20772, only . . . \$7.95

First-Class Radiotelephone License Handbook. Third Edition

by EDWARD M. NOLL. Completely updated to cover all the new material included in the recently revised FCC Study Guide. Book sections include: Theory and discussion of all phases of broadcasting; all the questions (and the answers) included in the FCC Study Guide; three simulated FCC examinations; appendices containing the most relevant FCC Rules and Regulations. This book will not only help you acquire your license, but will also serve as a textbook for broadcast engineering training.

Order 20804, only . . . \$6.50

Short-Wave Listener's Guide. 4th Ed.

by H. CHARLES WOODRUFF. Completely revised and enlarged to include the most recent changes in SW broadcasting schedules. Lists world-wide short-wave stations by country, city, call letters, frequency, power, and transmission time. Includes Voice of America and Radio Free Europe stations, and stations operating behind the Iron Curtain. With conversion chart and handy log.

Order 20798, only . . . \$2.95

ABC's of Tape Recording. 3rd Ed.

by NORMAN CROWHURST. Newly revised and updated edition of this popular handbook. Explains how tape recorders work (transport mechanisms, heads, controls, etc.), how to choose the best recorder for your needs, and how to use it most effectively for both entertainment and practical purposes. Includes tips on recording quality and recorder care.

Order 20805, only . . . \$2.95

HOWARD W. SAMS & CO., INC.

Order from your Electronic Parts Distributor, or mail to Howard W. Sams & Co., Inc., Dept. ES-021
 4300 W. 62nd St., Indianapolis, Ind. 46268

Send books checked at right. \$_____ enclosed (please include sales tax where applicable).

Send FREE 1971 Sams Book Catalog

Name _____
PLEASE PRINT

Address _____

City _____ State _____ Zip _____

- | | |
|--------------------------------|--------------------------------|
| <input type="checkbox"/> 20796 | <input type="checkbox"/> 20808 |
| <input type="checkbox"/> 20807 | <input type="checkbox"/> 20809 |
| <input type="checkbox"/> 20772 | <input type="checkbox"/> 20789 |
| <input type="checkbox"/> 20816 | <input type="checkbox"/> 20804 |
| <input type="checkbox"/> 20823 | <input type="checkbox"/> 20798 |
| <input type="checkbox"/> 20788 | <input type="checkbox"/> 20805 |

Circle 21 on literature card

pending on the transistor, should appear on the scope. Wrong setting of the POLARITY switch will cause an "L" or "J" waveform or a vertical line. Select the position of the POLARITY switch which produces a normal curve; the polarity of the transistor then can be read directly from the position of the switch.

Adjust the vertical and horizontal gain controls and the centering controls for a waveform of sufficient size to be seen easily. Fewer changes in centering will be produced by adjustment of the various controls if the scope vertical circuit is set for the AC function.

Overload of the horizontal deflection circuit in the scope is relatively common when the VOLTAGE control is positioned to high settings. Fig. 7 shows the bent ends of the waveform produced by overload in one brand of solid-state scope (caused by zener protection of the FET used as horizontal amplifier). To test your scope for this possibility: 1) Operate the tracer and scope as usual, except do not plug in a transistor; 2) Progressively increase the setting of the VOLTAGE control on the tracer while reducing the scope width with the horizontal gain control; 3) A vertical corner or a brighter area at either end of the horizontal line indicates scope overload. Such overload cannot be considered a transistor or scope defect, because more input is applied to the horizontal amplifier of the scope than is necessary for full horizontal deflection.

Elimination of scope overload is very simple. The manual for the Jud Williams curve tracer says to insert a 1 meg-ohm (or higher, if needed) resistor between the white wire from the tracer and the horizontal input of the scope. If you are plagued by pickup of a powerful local broadcast station which rides on top of the waveform, as we are in our locality, a 5-to-1 or 10-to-1 fixed voltage divider might minimize the interference. Values of 470K/47K-ohm perform well with the solid-state scope.

Normal Variations Of The Curves

Gain, leakage, avalanche voltages, linearity and many other characteristics of transistors vary widely. Consequently, many variations in the waveshape of curves obtained from individual transistors of the same

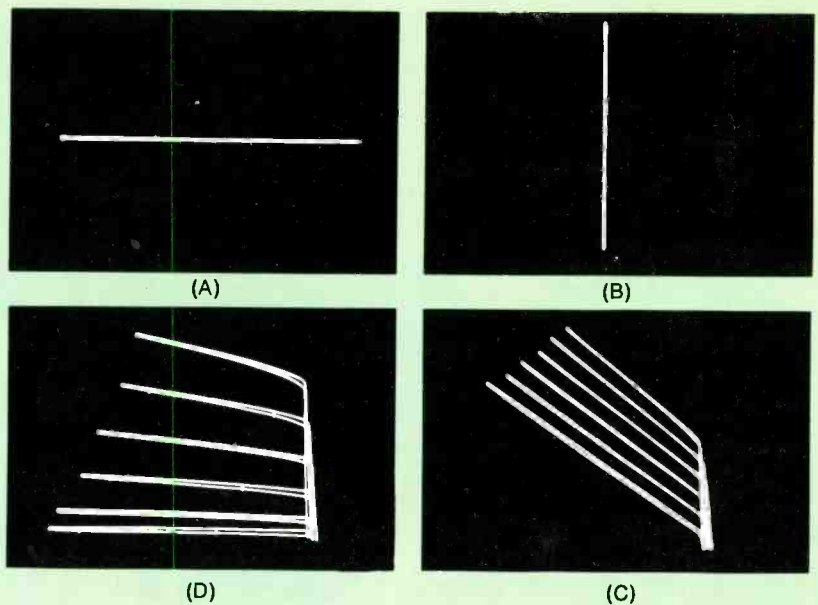

Fig. 9 Curves produced by defective transistors.

- (A) A single horizontal line is caused by a base-emitter short or an open element.
- (B) A single vertical line is caused by a base-collector or collector-emitter short.
- (C) Curves of a 2N408 PNP germanium transistor with a 1.8K-ohm short between collector and emitter, or a 180K-ohm short between base and collector. Notice the tilt of all the curves.
- (D) Non-linearity near the "zero base current" curve of a 2N408 caused by a base-emitter short of 10K ohms.

nomenclature and brand can be expected, in addition to the larger variations obtained from transistors of different types and/or brands.

However, the mere production of a family of curves, regardless of minute variations and/or abnormalities, in most instances can be considered absolute proof that the base of the transistor is controlling the collector current and, consequently, the transistor probably is functioning relatively normally. In other words, presence or absence of the family of curves is, for all practical considerations, a valid "go/no-go" indication.

Many of the normal out-of-circuit curves are shown in Fig. 8. Notice carefully the settings of the curve tracer controls, which are listed for your guidance.

Open Circuits and Leakages

An open in any element, a base-emitter short, or no transistor plugged into the curve tracer will produce a straight horizontal line on the scope, as shown in Fig. 9. A vertical line is caused by a collector-emitter or a base-collector short.

Leakage tilts the horizontal lines of the curves. Fig. 9 shows the

curves produced by transistors with various values of leakage.

Mistakes Cause Wrong Curves

Improper curves can be caused by mistakes in plugging in or connecting the transistors or improper adjustment of the curve tracer controls. Some of the resultant snares possible are shown in Fig. 10.

Comparison of Tests Of Defective Transistors

For comparison, I tested several defective transistors with 1) the curve tracer, 2) with a good commercial beta tester and 3) by use of the standard series of ohmmeter tests. The results then were compared for accuracy and speed. The findings are included in the following paragraphs.

Fig. 11 shows the curve tracer waveform and the results of the other two methods. The beta tester disclosed that the DC beta was slightly low, but the transistor was otherwise okay. Analysis of the ohmmeter readings indicated collector-to-emitter leakage, while the curve tracer revealed low gain and poor linearity. All three methods indicated that the transistor was not

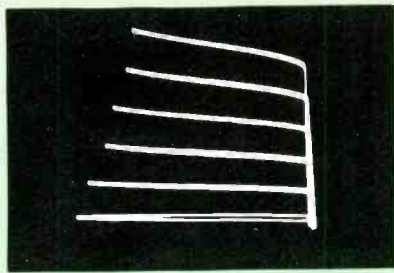

(A)

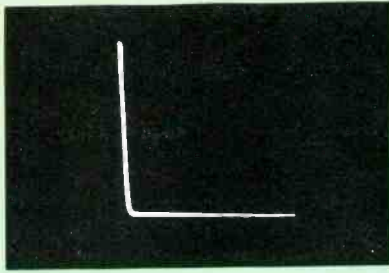

(B)

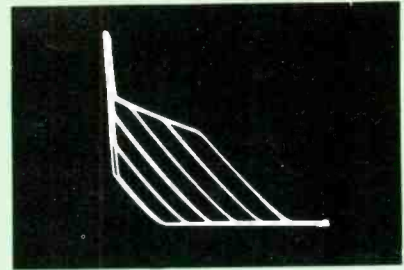

(C)

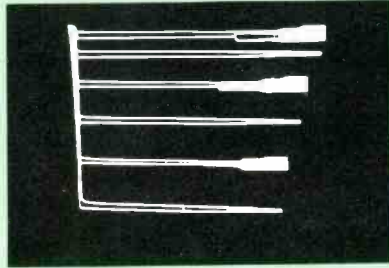

(D)

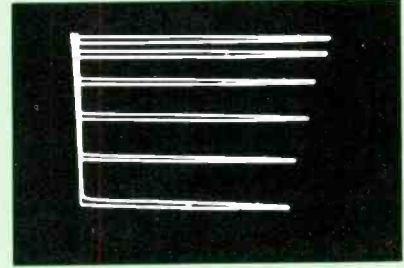

(E)

Fig. 10 Abnormal curves caused by improper connections and/or adjustments. (A) At first analysis, this is a normal-appearing curve; however, the collector and emitter of the transistor were interchanged. A large base current of $100 \mu\text{A}$ was required to produce the curve, indicating very low transistor gain. (B) Some variation of a right angle is obtained when the POLARITY switch is reversed. (C) A right angle and false curves caused by operation of a PNP silicon power transistor with the polarity switch set for PNP and the base current increased to $500 \mu\text{A}$. (D) The same NPN silicon power transistor operated correctly with BASE CURRENT of $10 \mu\text{A}$, but with the SILICON BIAS control turned to one end, causing a "gremlin" on alternate lines. This is a factory adjustment which can be touched up, if needed. Slight adjustment of the bias control eliminated the spurious response. (E) Curves produced by same transistor reveals non-linearity, also caused by a wrong setting of the SILICON BIAS control.

completely normal, but the results from the curve tracer were obtained quicker and were more absolute.

The curves in Fig. 12 indicate high transistor beta, or gain; however, the slope of the "zero collector voltage" side of the curves was excessive. Base-emitter forward resistance measured normal (110 ohms) on an ohmmeter, but the base-collector forward resistance was 1.2K ohms, nearly ten times the normal value. The beta tester indicated that the beta was 170 at 1 milliamperes, and that the leakage was normal. Both the ohmmeter and the curve tracer revealed a defect in the transistor, but the curve tracer revealed it quicker.

It's possible to try too hard to obtain a curve; in such cases the result usually is a false curve, as shown in Fig. 13. Ohmmeter measurements indicated that the transistor had an open emitter. The beta tester indicated "no collector current." The two curves produced by the curve tracer are false ones obtained by increasing the setting of the COLLECTOR VOLTAGE control which, in turn, increased the height of the waveforms.

All three test methods correctly indicated high leakage in another transistor, whose family of curves is shown in Fig. 14. However, tests

with the curve tracer required less time.

A "zero base current" curve of a 2N1303 germanium transistor is shown in Fig. 15. This curve indicates leakage with a few volts of collector voltage, no leakage with a relatively higher level of collector voltage, followed by normal avalanche leakage. (Another transistor of the identical type did not produce the unexpected dip in the base line.) The beta reading was a high 300,

and leakage was normal. Ohmmeter readings seemed normal. Only the curve tracer found this defect.

Two extreme avalanche conditions are shown in Fig. 16. The curve at (A) shows low-gain avalanche leakage on all of the curves except the "zero base current" curve, which usually is the first to bend when the COLLECTOR VOLTAGE control is advanced. A beta of only 37 and normal leakages were indicated by the beta-type

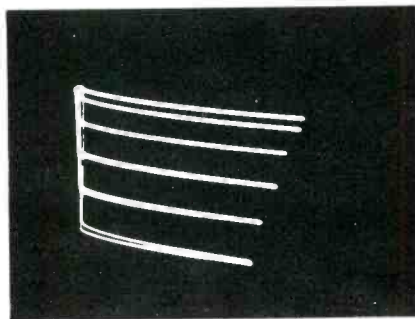

Fig. 11 These curves are nearly normal for a NPN silicon type except for some non-linearity, but low gain was indicated when the base current had to be increased to $20 \mu\text{A}$ to obtain a waveform of the usual height. Beta measured 42 at 10 milliamperes, with no noticeable leakage. The collector-emitter forward reading was 20K ohms and the reversed reading only 24K ohms.

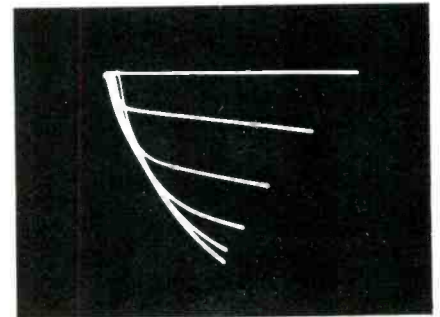

Fig. 12 Excessive slope of the left side of the curve. Beta was 170, with normal leakage. The forward resistance of base-emitter junction was a normal 110 ohms, but the base-collector measured 1.2K ohms.

tester, while an ohmmeter test indicated excessive collector-base leakage.

The family of curves shown in Fig. 16B reveals a sharp avalanche leakage at only 10 volts PP. Many circuits use more DC voltage than this, and under such conditions the transistor would act as if it had a collector-emitter short. Normal ohmmeter readings and a very high beta reading of 400 at 10 milliamperes with normal leakage would seem to indicate that the transistor was entirely normal. Only the curve tracer revealed the true defect, a voltage limitation.

Another transistor with lower gain exhibited similar avalanche symptoms. Fig. 16C shows how the avalanche corner extended down to meet the "maximum base current" curve when the collector voltage was increased to 20 volts.

In Part Two

The second part of this two-part article about curve tracers will discuss in-circuit testing of transistors with the curve tracer, step-by-step operation of the curve tracer, how the curve tracer functions, and general tips about testing of transistors. Also, two other makes of curve tracers will be presented and briefly analyzed. ▲

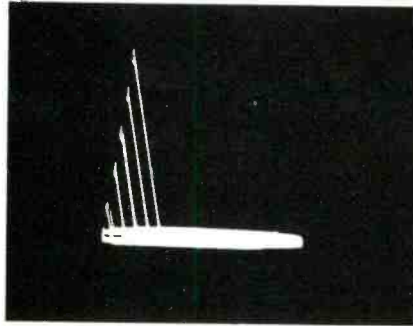

(A)

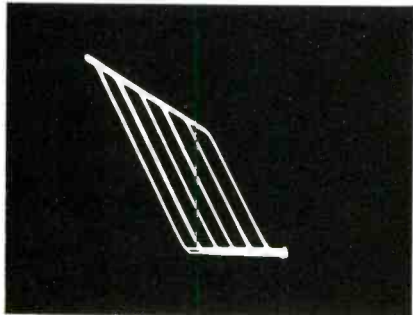

(B)

Fig. 13 Two false curves produced by an NPN transistor with an open emitter. Base-collector was 80 ohms; base-emitter indicated infinity on ohmmeter tests.

(A) Tested as an NPN, with base current of 100 μA .

(B) Tested as a PNP, with the base current at 500 μA .

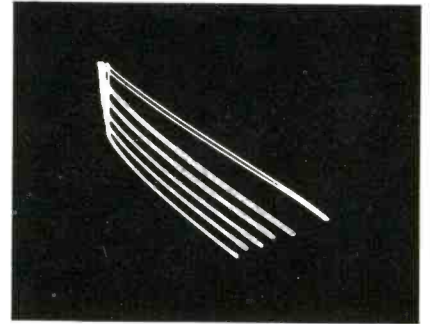

Fig. 14 Curve here shows low gain (base 20 μA) and severe leakage. Beta was 67 with collector-emitter leakage. Ohmmeter tests indicated collector-emitter forward resistance of 1300 ohms; the reverse resistance was 3000 ohms. All three test methods produced accurate indications in this case.

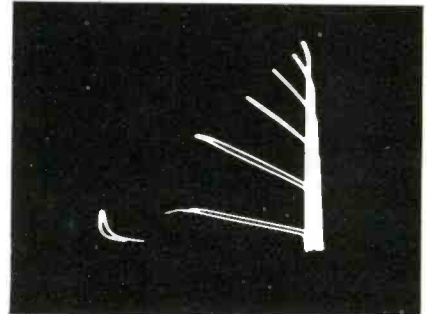
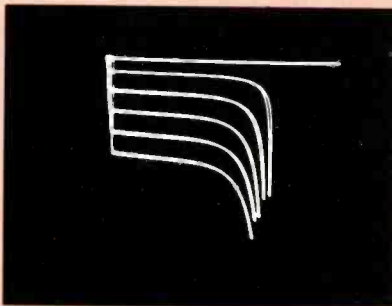
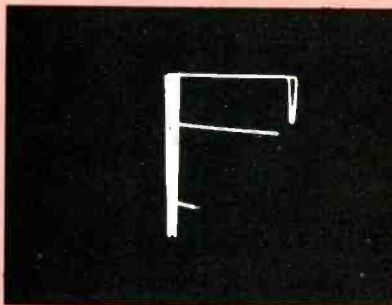

Fig. 15 Except for the peculiar leakage pattern on the "zero base current" curve, these curves indicate a normal PNP germanium transistor. Ohmmeter tests were good, and beta measured a high 300.



(A) Base current of 50 μA was necessary to produce this normal-size waveform, indicating low gain in this NPN silicon transistor. Ohmmeter tests were normal, except for excessive base-collector leakage. Beta was 37, with normal leakage indicated.



(B) Curves of this NPN silicon transistor indicate very high gain (base current 10 μA) and a sharp avalanche at 10 volts. Ohmmeter readings were normal. Beta was a very high 400 at 10 milliamperes. Only the curve tracer showed any sign of a defect in this instance.

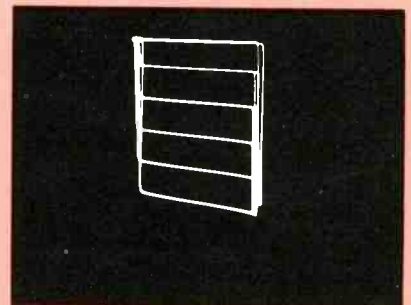

(C) A NPN silicon transistor with an indicated beta of 140 and normal leakages and ohmmeter readings. The transistor had so much avalanche the corner of the curve moved down and touched the bottom curve when the collector voltage was increased to 20 volts.

Fig. 16 Three different kinds or degrees of avalanche leakage.

THE WORKHORSE

The industry's top replacement tube, 6GH8A, is used in so many makes of TV and in so many different applications that it will be a high volume replacement type for years to come.

RCA's versatile 6GH8A is designed to satisfy the demands of all these applications:

Multi-vibrator type horizontal-deflection-oscillator circuits, sound if-amplifier, agc-amplifier, burst-amplifier, chroma-amplifier, 3.58 MHz-oscillator demodulator circuits, video-amplifier, sync-separator, noise inverter, color killer control, matrix-amplifier and blanker applications.

Three good reasons to replace with the RCA-6GH8A:

1. Stringent performance tests eliminate shorts. Special processes and tests minimize inter-element leakage.
2. Low heater-cathode leakage.
3. Optimum gm for efficient operation in all applications.

Stock up on the industry's workhorse 6GH8A and specify RCA! See your RCA tube distributor for all your tube requirements.

RCA | Electronic Components, | Harrison, N.J.



RCA

HELP WANTED

Nationwide organization committed to promoting development of minority businesses seeks assistance of like-minded corporations and organizations.

Companies with capital can, in partnership with affiliate of ours, make available as much as \$15 in loans to minority enterprises for every \$1 they put up. Minimum investment by you: \$150,000.

Size no obstacle: General Motors Corporation, I.T.T., Environmental Development Corporation of Bishopville, South Carolina, local and regional Chambers of Commerce already participating.

Talent needed, too. Iowa accountants are counseling minority businessmen on bookkeeping systems and debt management. Stanford University Business School students are studying toward becoming managers of fledgling minority firms on graduation. What can you offer?

Inquiries invited from corporations, organizations, professional associations which can provide such managerial and technical services.

Details on all programs first letter. Reply in confidence to: A. S. Venable, Director, Office of Minority Business Enterprise, United States Department of Commerce, Washington, D.C. 20230.

Space contributed in cooperation with The Advertising Council.

bookreview

Color-TV Field-Service Guide, Volumes 1 and 2 (Book No.'s 20796 and 20807)

Author: Howard W. Sams Editorial Staff

Publisher: Howard W. Sams & Co., Inc.

Size: 8 $\frac{5}{8}$ inches x 11 inches, 160 two-page charts plus Indexes

Price: Softcover, \$9.90 (\$4.95 per volume).

Compiled to help TV technicians service color TV more efficiently in the customer's home, this much-needed two-volume guide provides, on facing pages, detailed diagrams of the chassis layouts and step-by-step procedures for field adjustments of all color TV receivers produced between 1960 and 1967, plus many of the most popular models produced between 1968 and 1970. Coverage of models produced after 1967 but not included in these two volumes will be covered in subsequent volumes to be published soon.

Contents: Included in each of the chassis-layout diagrams are: type, function, and location of all tubes; ratings and location of fuses and circuit breakers; type and location of horizontal AFC diodes, when used; and the location of all service controls, including the quadrature or ratio detector transformer and color AFC adjustments.

Field-adjustment procedures provided include horizontal sweep, AGC, color AFC, purity, gray scale, and color killer, if used. Numbers positioned to the left of the adjustment procedures identify partial schematics, on the same page,

which show the exact electrical locations of test points.

Chassis and/or models of specific makes are identified by chart numbers. An index at the back of each volume alphabetically lists brand names. Under each brand name, the related models are listed numerically according to both model and chassis numbers. Charts 1 through 80 are included in Volume 1, and Charts 81 through 160 are included in Volume 2.

Tube Substitution Handbook, 14th Edition (Book No. 20829)

Author: Howard W. Sams Engineering Staff

Publisher: Howard W. Sams & Co., Inc.

Size: 96 pages, 5 $\frac{3}{8}$ inches x 8 $\frac{1}{2}$ inches

Price: Softcover, \$1.75 (including a 3 $\frac{1}{2}$ -inch x 5 $\frac{1}{2}$ -inch miniature copy for carrying in pocket or caddy)

An up-to-date cross reference of substitutes for nearly all receiving and picture tubes which have been or are used in home entertainment electronic products and communications equipment, including the latest tube types registered with EIA but not yet in production.

Contents: Cross Reference of American Receiving Tubes—Picture-Tube Substitutes—Cross Reference of Subminiature Tubes—Industrial Substitutes for Receiving Tubes—Communications and Special-Purpose Tubes—Foreign Substitutes for American Types—American Substitutes for Foreign Types. ▲

How Can You Make A Good Product Better --- Without Changing It?

Simple - - - Just take a winner like **BLUE SHOWER** that comes in a bench size can for bench jobs and put it in a caddy size can for house calls.

Many of our technician friends that use **BLUE SHOWER** in the shop have wanted a smaller package to carry in a caddy for use on house calls - - - not only to clean contaminated tuners but also to clean dust from high voltage cages and other components that need to be spotless in order to function best.

So now BLUE SHOWER

comes in two sizes -

No. 1657-12S, 12 ozs. for \$1.99

No. 1657-24S, 24 ozs. for \$3.25



**Either way its the best way to flush out tuners
and restore them to like new condition.**

**TECH
SPRAY**

makers of better chemical tools for technicians

P. O. Box 949 Amarillo, Texas • Canada: Wm. Cohen, Montreal • Export: Empire Exporters, N.Y.C.

Circle 24 on literature card

February, 1971/ELECTRONIC SERVICING 47

“Use It Before You Buy It”:

Another Approach to Selecting Test Equipment

by J. W. Phipps

Sencore's “learn to use it before you buy it” workshop provides participating technicians a working knowledge of how to properly align a color television receiver. Learning is by actually doing, as shown here. The workshops are conducted by Sencore field representatives through local Sencore distributors, who are given the opportunity to select twenty technicians to attend each workshop.



Some manufacturers will let you perform a first-hand practical evaluation of a test instrument before you buy it—and some will even teach you how to use it.

Evaluation of a test instrument involves two primary considerations: 1) will the instrument accurately provide the diagnostic data you require, and 2) can you operate the instrument with reasonable ease and efficiency? These two merits usually should be considered first, and then weighed against such considerations as size, weight, adaptability and price.

The relative merits of meter-type test instruments—whose operation and interpretation is relatively simple—such as VTVM's, VOM's, FET meters, transistor testers, tube testers, etc., can be evaluated reasonably accurately on the basis of published electrical specifications and operating characteristics, if you are thoroughly familiar with the specifications and characteristics required for the applications to which you will be applying the instrument.

However, test instruments such as oscilloscopes and sweep alignment equipment, whose accuracy and effi-

ciency of operation are more dependent on the operational and interpretive skills of the technician, often require “hands-on” evaluation. Buying such a test instrument without first having used it to perform the function(s) for which it is designed, or at least, having witnessed a practical demonstration of such application(s), can be like buying “a pig in a poke.”

Some test equipment manufacturers—including Sencore, Leader and Jud Williams—now are offering technicians the opportunity to not only try out some of their equipment before purchasing it but also to learn how to operate it.

ELECTRONIC SERVICING encourages technicians to take advantage of all such “use it before you buy it” opportunities. Sure, you'll get a sales pitch, but it'll be one you can evaluate based on first-hand experiences—and if you do buy, you'll have, at least, a working knowledge of how to operate and apply the instrument.

Sencore's “learn to use it before you buy it” workshop is described here, as an example of the “hands-on teaching” approach to presenting test instruments to technicians.

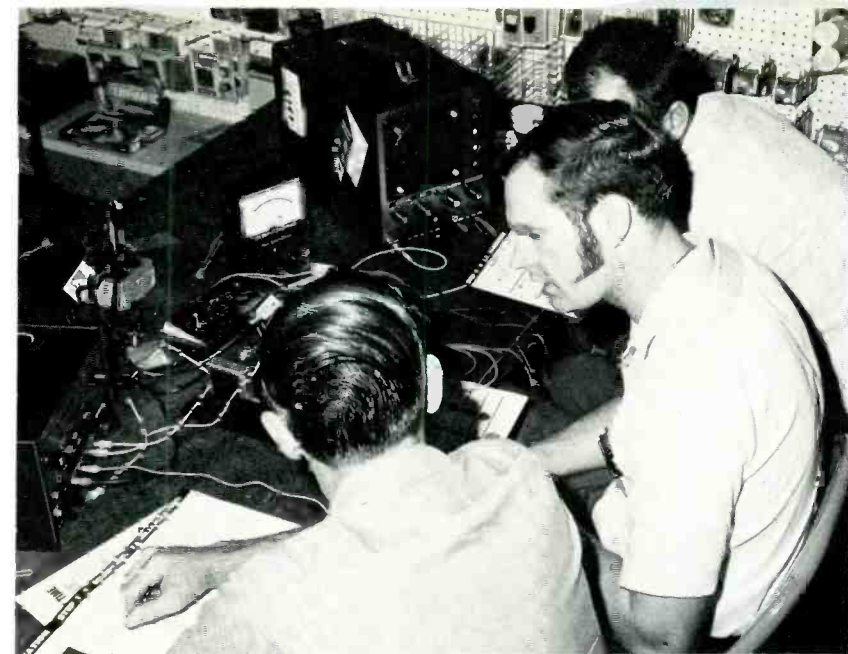

The twenty participating technicians are divided into four 5-man groups. One man in each group is assigned the function of "table captain," to coordinate the learning efforts of the group. Each group is provided with a complete alignment setup, which includes a specially designed test jig of the actual solid-state video IF/chroma circuit board out of an Admiral K-10 color TV chassis. Sencore test instruments provided each group include the Model SM158 "Speed Aligner" sweep/marker generator, the Model PS148A oscilloscope/vectorscope, the Model BE165 bias box and a Model FE14 field-effect multimeter.

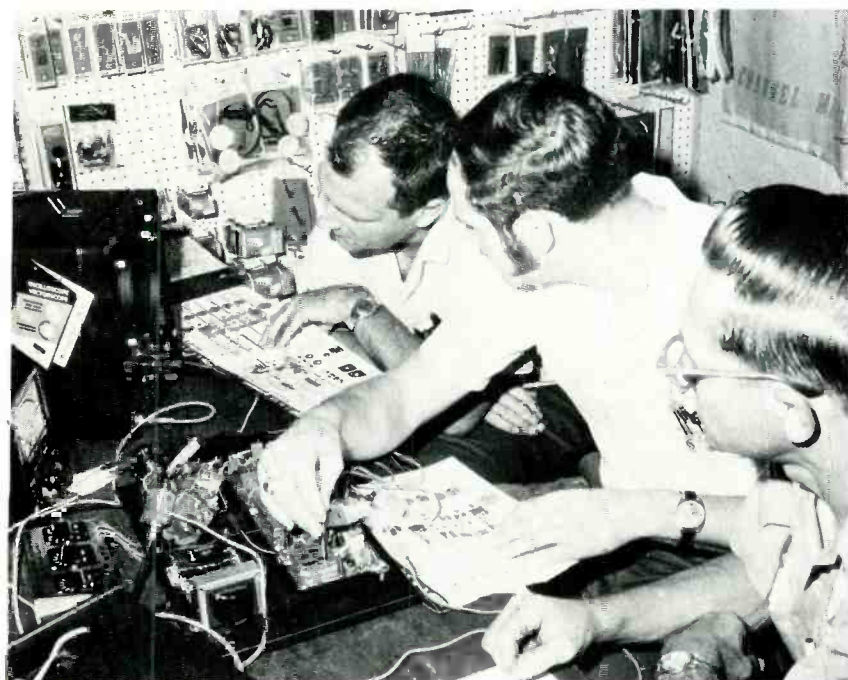

Each technician also is provided, without charge, a 20-page workshop manual, which he can keep for future reference. The manual provides graphic, easy-to-follow, step-by-step procedures for complete video IF and chroma alignment, as well as equipment operating instructions and schematic and pictorial diagrams of the Admiral circuitry being aligned. (Similar manuals now are being prepared for alignment of Zenith and Motorola Quasar video IF and chroma circuitry.)



The captain of each group, with the assistance of the other group members, connects the test instruments and performs the preliminary procedures. Each of the team then performs a portion of the alignment in accordance with the procedure outlined in the workshop manual. The instructor periodically visits each table to check on the progress of the group, answer any questions and assist, if requested. At the conclusion of the workshop, participants are invited to take home the "Speed Aligner" and use it to align any TV chassis they desire, after which they may return it without charge, if they are not satisfied with its performance. ▲

new 19-piece midget reversible ratchet offset screwdriver set

3-3/4" heavy duty, stainless steel reversible 20-tooth ratchet with short turning radius for close work.

Unique 6" spinner/extension has drive socket insert in handle for ratchet. Use also as regular screwdriver with bits.

1/4" hex to 1/4" square adapter bit permits use of ratchet or spinner/extension with Xcelite Series 1000 or other 1/4" sq. drive sockets.

16 precision made, alloy steel bits with knurled spinner tops . . . 12 Allen hex type, 2 slotted screw bits, 2 Phillips bits.

FREE STICK-ON INITIALS personalize the sturdy plastic case and help prevent loss or mix-up.

No. XL-70 Set

Made in U. S. A.

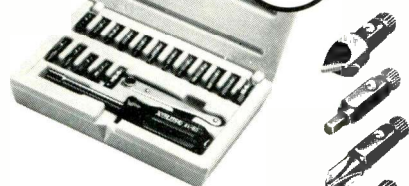

Also 5-Piece Kit (No. XL-75)
Reversible ratchet with 3/16" and 1/4" slotted screw bits, #1 and #2 Phillips bits, all in a durable plastic, pocket size, snap fastener case.

nationwide availability through local distributors
REQUEST BULLETIN N770



XCELITE, INC., 18 Bank St., Orchard Park, N. Y. 14127
In Canada contact Charles W. Poynton, Ltd.

Circle 25 on literature card

audio systems report

CB Accessory Speaker

E. F. Johnson Co. announces an accessory mobile speaker, for CB operators, that is similar in type to those used by many police and fire departments.



The mobile speaker reportedly has specially designed audio responses that increase clarity and intelligibility by de-emphasizing noise frequencies. Additional features include a power handling capability of 5 watts, which permits higher volume without distortion and allows the operator to hear clearly in noisy traffic or while standing outside his car, according to the manufacturer.

The speaker has charcoal gray styling, and comes with its own mounting plug for connection to the transceiver's external speaker jack.

The mobile speaker sells for \$13.00.

Circle 60 on literature card

Intercommunications Systems

Atlas Sound has developed the CJ-Series molded fiberglass and HU-Series aluminum talk-back speakers for industrial and commercial intercommunications systems and paging facilities.

Each of the four reflex-type talk-back speakers reportedly can be applied as a microphone or a reproducer, and features driver units with sensitivity and frequency response specially designed for maximum efficiency in the voice range.

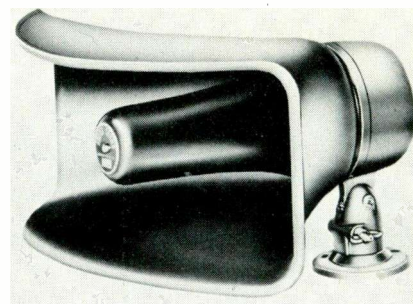

An omni-directional mounting bracket reportedly allows adjustment on either a vertical or horizontal plane, with a single locking pin; to facilitate installation on columns or beams, the mounting brackets of the speakers include provisions for strapping or banding.

The Model CJ-30N, pictured here, sells for \$51.00.

Circle 61 on literature card

Pre-Record Test Cartridge

Robins Industries Corp. announces a special pre-record test cartridge.



Model TBT-8 reportedly permits a rapid, last-minute check of recording level, tone balance and track switching before recording begins.

The unit consists of a special length of test tape in a standard, 8-track cartridge.

The price of the unit is \$3.65.

Circle 62 on literature card

Outdoor Extension Speakers

Argos Products Company introduces a new outdoor stereo speaker system which reportedly is weather-proof and can be left outside the year round.

The manufacturer reports a built-in volume control, which permits convenient adjustment without going indoors, and a special dual-

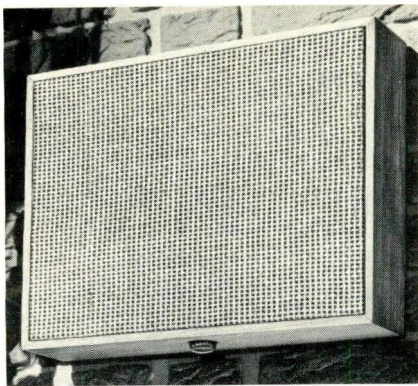

cone design, which produces a full-range, full-fidelity sound.

The outdoor extension speaker sells for \$15.95.

Circle 63 on literature card

Tape-Head Demagnetizer

A tape-head demagnetizer built into a standard cartridge case is available from Robins Industries Corp.

Model TD-12 is designed for use with home equipment, and operates on ordinary house current.

Model TD-15 is a DC powered model for use with 12-volt auto units, plugging into the cigarette lighter. A pilot light indicates operation.



The demagnetizer slips into a cartridge player, as the cartridge itself does, and is withdrawn after a few seconds. The unit reportedly should be used every 15 to 20 hours of operation to eliminate magnetic loss.

The home version, Model TD-12, lists at \$13.35, and Model TD-15 sells for \$16.65.

Circle 64 on literature card



Magna-See

Magna-See, a product of Sound-

craft, reportedly makes magnetic sound tracks visible, to simplify editing and to facilitate equipment check-out.

The manufacturer reports that improper alignment and balance and head wear are among the possible equipment failures it enables the user to spot.

Magna-See sells for \$12.00. ▲

Circle 65 on literature card

**For more information
about above products
use reader service card**

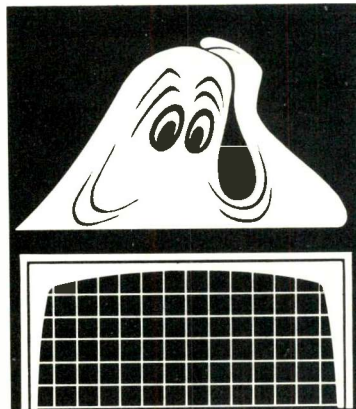

Two new B&K digitals that don't stand a chance of a ghost.

Ghosts, blurs, wiggles, jitters . . . whatever you call them, you won't get them with our two new digital color generators. You can converge, install or trouble-shoot color TV's quickly and accurately. Because these two units employ totally new concepts that take the trouble out of trouble-shooting.

Integrated circuit flip-flops perform all binary counting functions. Just no way they can jump a count. Result: Crisp, clean, stable test patterns.

And all IC's (nine of them) and transistors are silicon devices, which means they can withstand severe weather changes with no effect on performance.

The 1243 is a basic 6 pattern color generator. The deluxe 1246 has nine patterns, three more than the 1243, and

also features a 4½ MHz sound carrier, crystal controlled RF for channels 3 and 4, gun killers, and comes with its own instant-use case.

All the accuracy and reliability of a computer in these compact units, and they're guaranteed to be maintenance free, making your job a lot easier.

So don't get a CBG that may come back to haunt you. Get one of B&K's new digital generators: They don't have a chance of a ghost.



The new standard of stability

(Ask your distributor or write us for complete catalog)

1. B&K Model 1246 Color Generator \$149.95

2. B&K Model 1243 Color Generator \$99.95



Circle 26 on literature card

ARROW AUTOMATIC STAPLE GUNS

CUT WIRE & CABLE INSTALLATION COSTS

... without cutting into insulation!

SAFE! Grooved Guide positions wire for proper staple envelopment! Grooved Driving Blade stops staple at right depth of penetration to prevent cutting into wire or cable insulation!

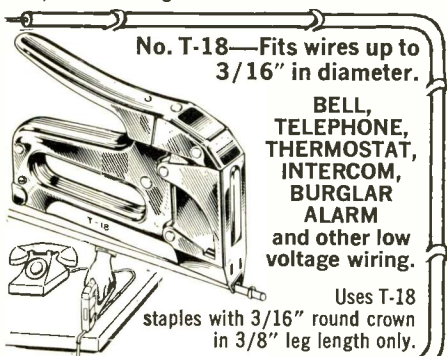

No. T-18—Fits wires up to 3/16" in diameter.

BELL, TELEPHONE, THERMOSTAT, INTERCOM, BURGLAR ALARM and other low voltage wiring.

Uses T-18 staples with 3/16" round crown in 3/8" leg length only.

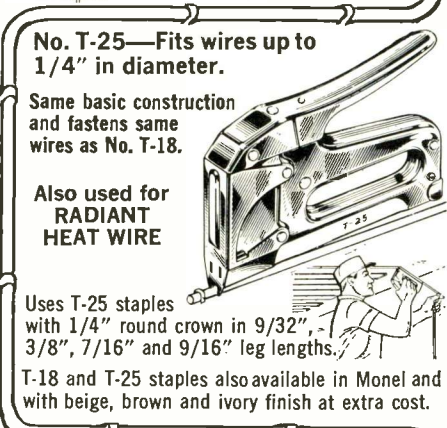

No. T-25—Fits wires up to 1/4" in diameter.

Same basic construction and fastens same wires as No. T-18.

Also used for RADIANT HEAT WIRE

Uses T-25 staples with 1/4" round crown in 9/32", 3/8", 7/16" and 9/16" leg lengths.

T-18 and T-25 staples also available in Monel and with beige, brown and ivory finish at extra cost.

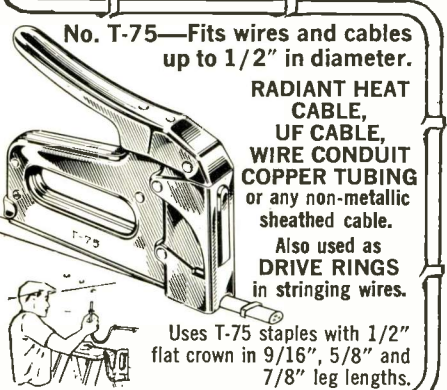

No. T-75—Fits wires and cables up to 1/2" in diameter.

RADIANT HEAT CABLE, UF CABLE, WIRE CONDUIT COPPER TUBING or any non-metallic sheathed cable.

Also used as DRIVE RINGS in stringing wires.

Uses T-75 staples with 1/2" flat crown in 9/16", 5/8" and 7/8" leg lengths.

Arrow Automatic Staple Guns save 70% in time and effort on every type of wire or cable fastening job. Arrow staples are specially designed with divergent-pointed legs for easier driving and rosin-coated for greater holding power! All-steel construction and high-carbon hardened steel working parts are your assurance of maximum long-life service and trouble-free performance.

Ask your Electrical Supply Dealer or write for further details.

ARROW FASTENER COMPANY INC
Saddle Brook, New Jersey 07863
"Pioneers and Pacesetters
For Almost A Half Century"

Circle 27 on literature card

test equipment

notes on analysis of test instruments, their operation and applications

Current/Power Monitor

A power monitor, Model PM157, designed to help detect TV's or appliances that are drawing excessive current or dissipating excessive power, has been announced by Sen-core.

The new instrument checks AC current up to 10 amperes, to determine whether the circuit is itself at fault.

Because some appliances do not show maximum current, such as TV sets, but are required to show maximum wattage, the PM157 is designed to measure wattage and current simultaneously with the same setting of the control switches.

Because the PM157 uses a bridge circuit, DC current up to 10 amperes also can be measured, to check circuits that might be drawing excess current, such as a TV horizontal output tube.



The bridge circuit also will read a combination of AC and DC current, such as is found in fuse resistors in power supply sections. A separate scale is shown for each fuse resistor used in radio and TV and a red and green section to show if it is safe to replace the resistor or whether a higher value is required.

To complete the many applications of the power monitor, AC line voltage is read directly with the simple flick of a switch. As with

current checks, the power is fed through the monitor so that measurements are made under actual load. All checks can be made either with test leads or with the associated line cord; a separate test lead/line cord switch provides complete isolation to prevent shock to the user.

Because short circuits are often encountered by the technician when troubleshooting for excessive power consumption, the PM157 is protected by a 10-ampere circuit breaker.

Price of the PM157 is \$69.95.

Circle 50 on literature card

Pocket-Size Megohmmeter

A new compact megohmmeter which indicates resistance to 100 megohms at 500 volts DC is now available from Associated Research, Inc.



Insulation resistance tests of motors, wiring, appliances and other electrical equipment can be performed with Model 2001 Meg-Chek, which also is suited for testing high-voltage rectifiers for opens and shorts.

The megohmmeter is powered by penlight cells and employs transistors, printed circuitry and a taut-band meter for stability and long life, according to the manufacturer.

Model 2001 measures 5 3/4 inches x 3 1/2 inches x 2 7/8 inches, and weighs 17 ounces. It is housed in a leatherette carrying case which provides space for two 5-foot test leads and an illustrated instruction manual. The price is \$99.00.

Circle 51 on literature card

(Continued on page 54)

The replacement picture tube no other color tube can replace!



Simulated TV picture

ZENITH
CHROMACOLOR[®]

Now you can install the revolutionary Chromacolor picture tube in almost any brand of 23" (diag.) color TV. And let your customer see the difference: a new, sharper Chromacolor picture with greater brilliance, contrast and color definition.

Zenith pioneered, developed and patented (U.S. Patent No. 3146368) the Chromacolor picture tube. And only Zenith has Chromacolor.

Chromacolor is an easy sale because people already know of Chromacolor's superiority. (Last year, after the revolutionary new Chromacolor system was

introduced, Zenith giant-screen color TV sets became the No. 1 best-seller!)

Full two-year warranty.

Here's your sales clincher: Chromacolor replacement color tubes are warranted for two full years. Exactly double the warranty period for most other replacement color picture tubes.

Give your customers the best — Chromacolor replacement color tubes. Only your Zenith Distributor has them.

TWO-YEAR WARRANTY

Zenith Radio Corporation warrants the replacement CHROMACOLOR picture tube to be free from defects in material arising from normal usage for two years from date of original consumer purchase. Warranty covers replacement or repair of picture tube, through any authorized Zenith dealer; transportation, labor and service charges are the obligation of the owner.



Zenith Chromacolor picture tube pinpoints the color dots on a jet black background and for the first time fully illuminates every dot.

ZENITH
The quality goes in
before the name goes on

Circle 28 on literature card

NEW DYNAMIC UHF/ VHF PERFORMANCE...

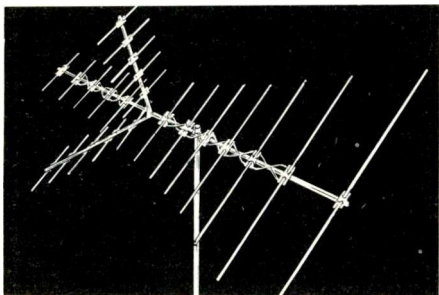

#CB-22

the RMS COLOR-BOOSTER COLOR ANTENNAS WITH SINGLE DOWN-LEAD

#CB-22: 22 elements, #CB-28, 28 elements, #CB-34: 34 elements. All designed to add mileage to UHF and VHF TV reception. Each antenna is actually two antennas in one—the front section for UHF—the rear section for VHF—plus a corner array reflector to amplify desired signals from the front and to screen out all undesired signals from the rear. Brings in clearest reception on Channels 2 to 83 free of co-channel interference and ghosts. Model SP-332 UHF/VHF quality Splitter is included with each antenna to facilitate simple single-line installation. The CB series antennas feature Reynolds Aluminum weather-proof COLORWELD Gold finish! Write for complete specs—

RMS ELECTRONICS, INC.

50 Antin Place, Bronx, N.Y. 10462
• Tel. (212) 892-6700

Circle 29 on literature card

NEW!

from TV TECH AID

Over 400 Causes and Cures of Recurring Troubles in major-brand Black-and-White TV

All in one large, easy-to-use issue

All for only \$5.95 . . . Less than 1½¢ per tip . . . each of which can save you hours of valuable troubleshooting time!

TV TECH AID
P. O. Box 603
Kings Park, N.Y. 11754

Enclosed is a check or money order for \$5.95. Please send the TV TECH AID issue of over 400 b-w TV troubleshooting tips to:

NAME

ADDRESS

CITY

STATE ZIP.....

Circle 30 on literature card

Semiconductor Checker

Ames Electronics, Inc., announces a curve tracer type semiconductor checker designed to operate with any oscilloscope as a read-out device.

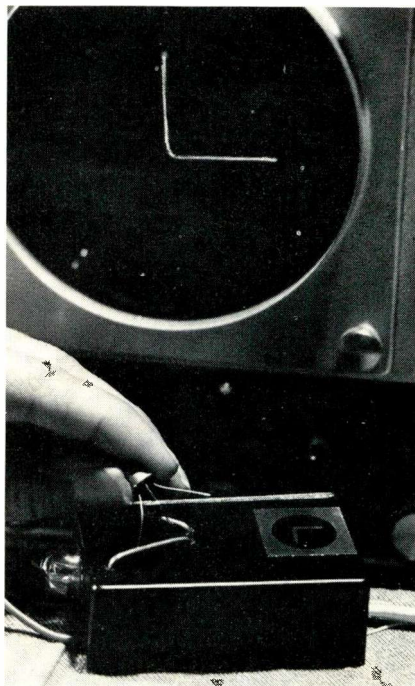

Model 170 features controlled voltage and currents (15 volts p-p and 10 milliamps p-p), test leads for in-current use and test bars on the instrument itself for out-of-circuit checks.

The Model 170 reportedly is compact, lightweight and sells for \$14.95.

Circle 52 on literature card

Directional RF Wattmeter

A new coaxial ThruLine® wattmeter which measures forward and reflected CW power in 7/8" EIA and RF cable transmission lines has been announced by Bird Electronic Corp.

The portable wattmeter provides the mating of three components: 1)

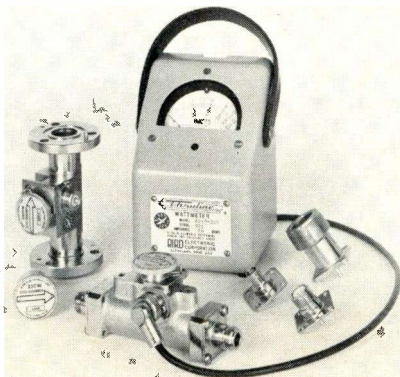

2) triple-scale, case-mounted meter; 2) a section of reference transmission line; and 3) reversible plug-in elements for power- and frequency-range selection. The wattmeter also reportedly provides full-scale power ranges from 1 watt to 10,000 watts in frequency bands from 0.45 MHz to 2.3 GHz.

The price of the wattmeter package, including a coax line with two female "N" connectors and one element, starts at \$119.00.

Circle 53 on literature card

Solid-State Component Checker

A new tester for checking solid-state components, semi-conductors, transistors, diodes and for testing circuit continuity, is being distributed by the Electronic Tools Division of C. H. Mitchell Co.

CONSCAN, according to the manufacturer, indicates a change in circuit condition by an audible tone. A change in resistance produces a change in pitch; defective components, shorts, open circuits, leaks, poor connections, incomplete welds and bad solder joints can be detected in this manner.

CONSCAN reportedly can be used anywhere that in-circuit component testing or circuit continuity can be a problem.

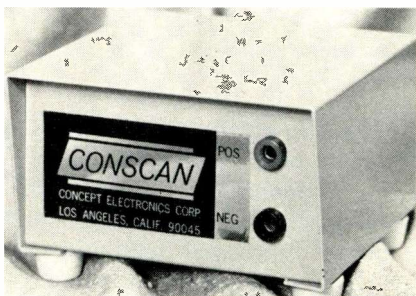

CONSCAN is housed in an all-metal enclosure, weighs 12 ounces, and measures 5 x 4½ x 3½ inches. The price, without leads or battery, is \$19.75.

Circle 54 on literature card

CATV/MATV Systems Analyst

A new method of checking CATV and MATV systems has been introduced by JFD Electronics Corp./Systems Division.

The Model 7500 Systems Analyst reportedly can be used for a wide variety of CATV and MATV testing applications, including: sweeping cables for return loss and fre-

quency response; troubleshooting trunklines; checking amplifiers for gain; checking splitters, directionals and taps for loss and VSWR; measuring bandpass of filters and single-channel amplifiers; and calibrating field-strength meters.



Specifications for the Model 7500 include: a continuous, flat signal from 50 to 220 MHz, with an accuracy of ± 1 dB; a narrow-band, crystal-controlled 73.5-MHz reference signal which can be accurately monitored on a panel meter and calibrated to within ± 0.5 dB.

Model 7500 weighs 6 pounds, including a rechargeable battery with which it is equipped. The price is \$495.00.

Circle 55 on literature card

Diode and Rectifier Tester

A diode and rectifier tester, Model TE-244, has been announced by Olson Electronics.

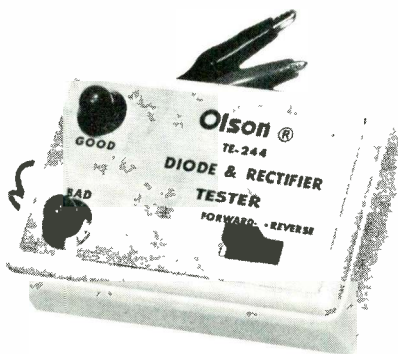

Model TE-244 checks for open and shorted diodes and rectifiers, indicates diode polarity, plus checks low-voltage electrolytics.

Model TE-244 measures $3\frac{1}{4}$ inches x $2\frac{1}{8}$ inches x $1\frac{3}{8}$ inches and costs \$2.98.

Circle 56 on literature card

Direct-Reading RLC Meter

Radiometer has introduced a new RLC meter which measures a wide range of capacitance, resistance and inductance values.

Resistance measurements are performed in 12 linear ranges, from a virtual short circuit at 0.1 ohm to 1 megohm. Inductances are measured in 16 linear ranges from $3\mu\text{h}$ to 100 Henrys full scale.

The basic capacitor test voltage is 316 mV at appropriate decade frequencies from 1.6 MHz for small capacitor values to 160 Hz for large capacitances.

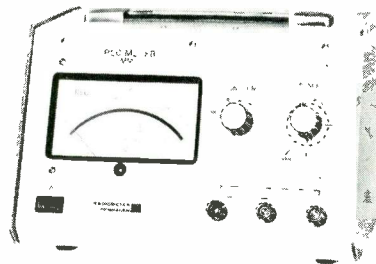

The RLC meter provides input terminals for DC biasing at levels to $\pm 60\text{V}$, for voltage sensitive devices, and a recorder output for environmental or extended performance tests. The price is \$493.00.

Circle 57 on literature card

Clamp-Around Ammeter

A new tong-type clamp-around Ammeter, Model 705A, which reportedly offers accurate DC/AC readings, has been introduced by Pacer Industries, Inc.

Model 705A offers four linear scales with 2% full-scale accuracy and extended ranges for DC and AC measurements (0-400A), according to the manufacturer.



Model 705A is portable, with a 6 foot retractable cable. The price is \$120.00. ▲

Circle 58 on literature card

SKINNY, YES.

undernourished?

HARDLY!

This QUAM speaker is thinner and lighter than most, but there's nothing scrawny about its sound or emaciated about its performance.

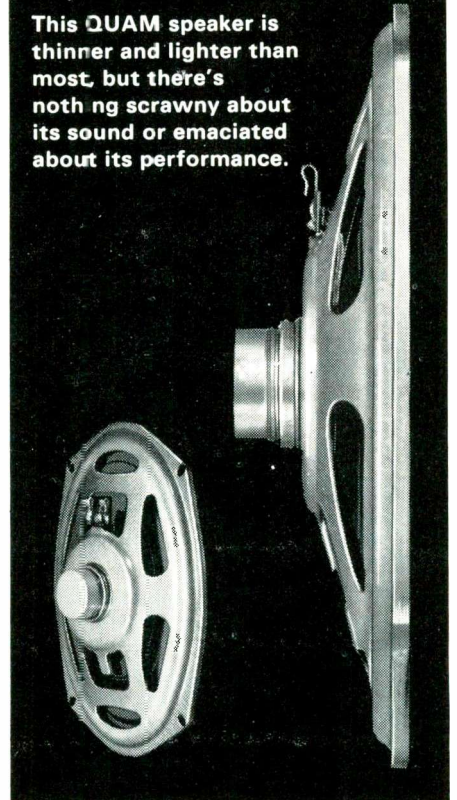

It's one of 25 models in the Quam line that's being fed a special diet . . . an exclusive new high energy magnet material we call Q/8.

Q/8 provides more gap energy for less weight, so a .65 ounce magnet gives you the same performance as a full ounce of Alnico V. Ideally suited to Quam's high density cup-pot structure, Q/8 slims the speaker down in contour as well as weight—while delivering full, robust sound.

Q/8 magnets are exclusively available today on Quam speakers—part of our ongoing program of nourishing our customers first with the finest.

QUAM —always the Quality Line, for every speaker need.

QUAM-NICHOLS COMPANY
234 East Marquette Road
Chicago, Illinois 60637

Circle 31 on literature card

NEW ENDECO Desoldering Kits

MODEL
300-K
KIT
SHOWN



All you need to handle almost any desoldering and resoldering job!



Kit 300K includes the famous Endeco pencil desoldering iron Model 300, six different size tips (.038 to .090) for any job, tip cleaning tool, and metal stand for iron . . . all in a handy lifetime steel storage box. \$19.90 net. Model 300K-3 with a 3-wire cord \$20.90. Also a similar kit for military users. Kit 100K with large Endeco iron (Model 100A) is \$27.40, and 3-wire Kit 100AD-3 \$28.40.

SEE YOUR DISTRIBUTOR OR WRITE



**ENTERPRISE
DEVELOPMENT
CORPORATION**

5127 E. 65th St., Indianapolis, Ind. 46220

Circle 32 on literature card

Division of Lorac Corporation



Fix it. Forget it.

We wind our tv-replacement capacitors with computer-grade aluminum foil for your protection. They last longer in your customer's set and they won't deteriorate even at high tv operating temperatures. Yet, they're priced for tv service.

Elmenco & Arcolytic Capacitors—mica, Mylar, electrolytic, ceramic.

Free: Replacement Guide, Cross Reference, Catalog. Call or write today.

LORAL DISTRIBUTOR PRODUCTS
Pondhill Industrial Park
Great Neck, New York 11022
516 466-5500

Circle 33 on literature card

antenna systems report

Corner Reflector Antenna

A corner reflector antenna, Model ASPB603, is now available from The Antenna Specialists Company.

The ASPB603 is reportedly built from high-strength, welded aluminum alloy and covers the 148- to 160-MHz band without tuning. The manufacturer states the advantages of simple installation, with no critical on-sight tuning adjustments, and rugged non-corrosive construction effectively reduces servicing prob-

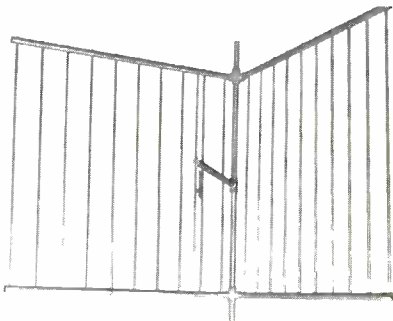

lems. The antenna is fed with a 50-ohm gamma-match, according to the manufacturer, and is grounded to reduce static build up and lightning problems.

Designed for point-to-point communications installations, the antenna reportedly produces a directional gain of 8 dB over a 1/2-wave-length dipole reference.

Model ASPB603 sells for \$159.00.

Circle 80 on literature card

All-Channel Preamplifier

A new outdoor, all-channel preamplifier, reportedly designed to improve color and black-and-white pictures in deeper fringe areas is now available from Jerrold Electronics Corporation.

Model 4287-S features a 75-ohm output device connected to a shielded cable that eliminates power-line and ignition interference. High gain and low noise reportedly improves picture quality from 300-ohm antennas in locations of normally poor TV reception. The preamplifier also features lightning protection and a tuneable FM trap.



Model 4287-S measures about 8 inches x 2 1/2 inches x 4 inches and sells for \$47.25.

Circle 81 on literature card

All-Channel Gibraltar Amplifier

Jerrold Electronics Corp., introduces all-channel Model 4330, a new member to the Gibraltar family of solid-state amplifiers for color and black-and-white TV.

Model 4330 reportedly includes a switch-selected input that allows either a single all-channel input, or separate VHF and UHF inputs, with duodiode lightning protection, tuneable FM trap, and a flat response at ± 1.5 dB on all 82 channels. Input impedance is 75-ohms.

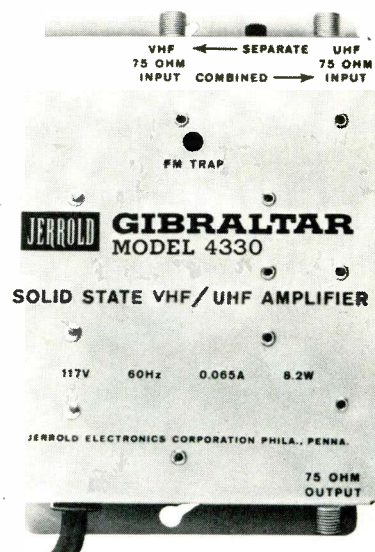

The self-contained power supply supplied with the unit operates on 117-volts, 60-Hz power.

The list price for the Model 4330 Gibraltar amplifier is \$120.00.

Circle 82 on literature card

Mobile Antenna

A new series of UHF mobile antennas which reportedly are

equipped with completely water-proof base connections has been introduced by The Antenna Specialists Company.

Model ASP 660, a 5-dB gain, 450-MHz antenna, reportedly is designed "to permit quick removal of the entire spring, phasing coil and whip assembly, leaving the loading coil and mount that can be fully immersed in water without shorting". The phasing coil also is an integrated, molded unit, impervious to weather and abrasion.

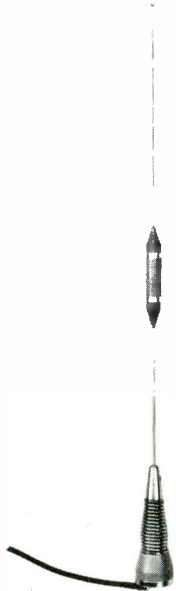

The Model ASP 660 is available in 6 different mounting configurations including Quick Grip (trunk lip mount); cowl mount; magnetic mount; and conversion models for Motorola, GE, RCA, and other standard base mounts.

Prices range from \$14.95 to \$19.95, depending on the mounting option.

Circle 83 on literature card

ELECTRONIC SERVICING

is your magazine!

If you would like to see an article about a particular subject directly related to servicing consumer or communications electronic products, send us your suggestion.

We value your comments and criticism.—Ed.

advertisers' index

Arrow Fastener Co. Inc.	52
B & K Manufacturing Co.	51
Bussmann Mfg. Div. McGraw Edison Co.	12-13
C. R. T. Equipment Co., Inc.	4
Cleveland Institute of Electronics	33-35
Eico Electronic Instrument Co.	Cover 2
Enterprise Development Corp. ..	58
General Electric Company	15
Heath Company	69
Hertz Systems, Inc.	11
Lectrotech, Inc.	4
Littelfuse, Inc.	Cover 4
Loral Corporation	58
Master Appliance, Corporation	16
Quam-Nichols Co.	57
RCA Electronic Components	Cover 3, 45
RMS Electronics, Inc.	54
Howard W. Sams & Co., Inc. ...	41
Sencore Inc.	17, 19, 21, 23
Sprague Products Co.	3
Sylvania Electric Products Inc.	1
Tab Books	72
TV Tech Aid	46, 54
Tech Spray	47
Telematic, Div. of UXL Corp.	59
Tuner Service Corporation	5
Vikoa Inc.	7
Jud Williams	9
Workman Electronic Products, Inc.	59
Xcelite, Inc.	50
Zenith Radio Corporation	53

TeleMatic

SERVICE
any color set
on your present
color test jig
with Telematic's
Color Test Adapter
Program...

Over 2500 sets listed
in Free Cross Reference

Ask Your Distributor

TELEMATIC, BKLYN, N.Y. 11207

Circle 34 on literature card

WORKMAN *Electronic*
P.O. BOX 3828 SARASOTA FLORIDA 33578 PRODUCTS, INC.

OEM and REPLACEMENT
MANUFACTURERS OF

FAIL SAFE **CIRCUIT**
IN **BREAKERS**
MOLDED
BLACK
PHENOLIC
CASE

14 Models
FA1 to
FA7

FREE BUTTON EXTENSION
IN PACKAGE

FREE VEST POCKET
CROSS REFERENCE

ASK FOR BOOKLET # X53

RECOGNIZED UNDER THE
COMPONENT PROGRAM OF
UNDERWRITERS' LABORATORIES, INC.

Circle 35 on literature card

New and changed circuitry in '71 color TV Part 3

Improved Serviceability and Product Safety

Product serviceability, or the lack of it is a subject near to both the mind and pocketbook of TV technicians. Solid-state circuits, with more complex designs housed in smaller spaces, make this subject even more important. It is only fair and right for us to commend any constructive actions taken by manufacturers to improve serviceability. Although space does not permit us to list every such action, we would like to spotlight a few.

Motorola Quasar

The new Motorola TS934 color chassis (Fig. 1) is constructed with plug-in panels mounted in a roll-out drawer, in the distinctive Quasar tradition. But in addition, the entire front panel swivels, after a few screws are removed, to permit tuner repairs or contact cleaning without removal of the tuner.

Zenith

Zenith color TV receivers which feature the 4B25C19 chassis do not require a shielded high-voltage compartment because no high-voltage rectifier, regulator or focus rectifier tubes are employed. Instead, a solid-state, high-voltage tripler, housed in

a sealed assembly (behind the high-voltage transformer in Fig. 2), furnishes both high voltage and focus voltage. Both the transformer and tripler are readily accessible for testing or replacement.

Clips and brackets prevent accidental removal of the medium- and large-size transistors during transport, as shown in Fig. 3.

General Electric

Symbols of components important to the prevention of fire and X radiation are printed over a gray background on General Electric's schematics, as shown in Fig. 4. GE recommends that their cataloged parts be used as replacements for those in the gray-shaded areas. Resistors which act as fuses when overloaded, power supply parts and high-voltage components are the ones usually marked for such attention.

DC voltage sources and their destinations are marked with large symbols, also shown in Fig. 4. Each voltage source is indicated by the outline of a symbol, while each circuit which draws power from that source is indicated by a black overlay of the same shape. Obviously, this system is designed to save the

technician time when he is tracing circuits.

GE's use of their unique in-line-guns color picture tube has been expanded to include larger screen sizes. Fig. 5 shows the relatively few convergence components necessary with this system, which permits simpler purity and convergence adjustments.

RCA

Vertical output transistors and horizontal sweep SCR's are readily accessible on the large heat sinks of the RCA CTC49 chassis (Fig. 6).

High voltage and focus voltage in the new RCA chassis are obtained from a solid-state quadrupler assembly (Fig. 7).

Plug-in modules are used extensively in the CTC49, as described in the December '70 issue. The larger modules employ more than one heavy-duty plug and socket, in addition to the spring clips found at the ends of the modules, to prevent accidental removal of the modules.

Pincushion Correction

Many pincushion correction cir-

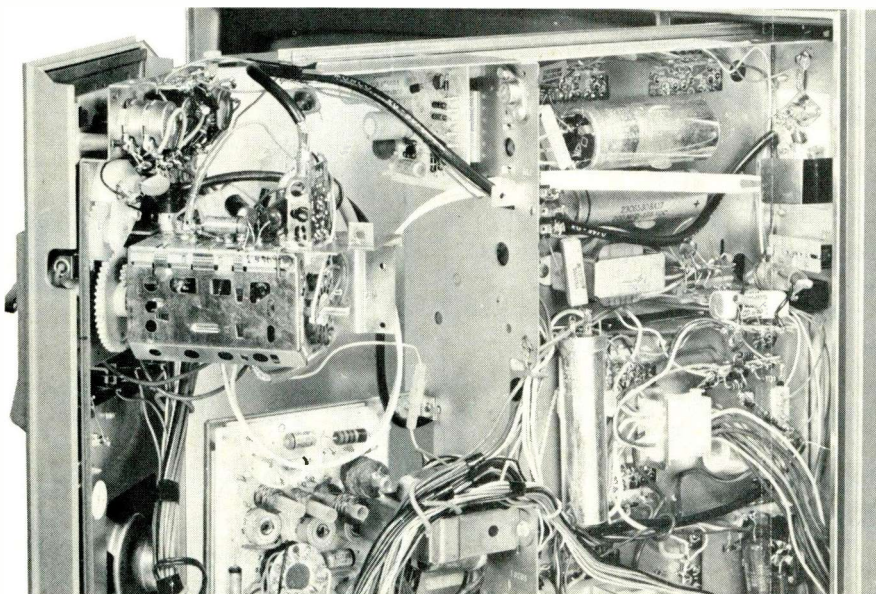

Fig. 1 The entire front panel of the Motorola TS934 swivels to permit access to the tuners.

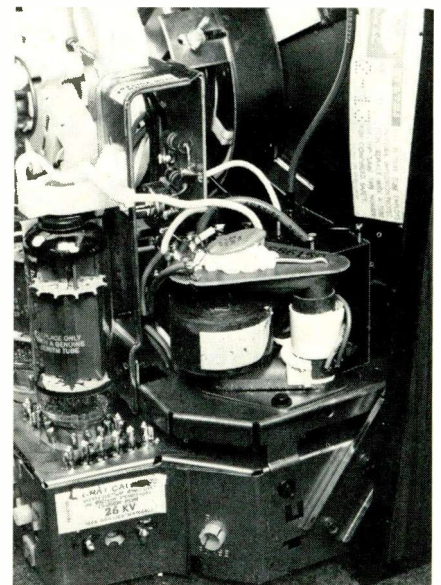

Fig. 2 No high-voltage compartment is needed in the Zenith 4B25C19 chassis; consequently, the high-voltage transformer and the tripler assembly are easily accessible.

cuits have been changed. The trend is toward the use of special transformers and saturable reactors in circuits without tubes, transistors or diodes.

Packard Bell

The Packard Bell 98C32 color chassis employs the circuit shown in Fig. 8 to correct both vertical and horizontal pincushioning. The amplitude of horizontal pulses induced through pincushion modulator transformer T508 are corrected by the adjustment of R525. Resonant action of C513 and L502 shapes the horizontal pulses into near-sine waves, which are inserted in series with the vertical yoke coils. L502 also functions as a phase, or tilt, adjustment. Simultaneously, the sawtooth waveform of vertical yoke current changes the inductance of modulator transformer T508, reducing the width of the picture at the top and bottom (the primary winding of T508 is in series with the horizontal yoke deflection coils).

Zenith

The pincushion correction circuit of the Zenith 4B25C19 color chassis is similar in basic concept to that of the Packard Bell circuit just described. As shown in Fig. 9, horizontal pulses from the yoke circuit are routed through the two outside-leg windings of T203, thus inducing horizontal pulses into the center-leg winding. These pulses are

changed into near-sine waves by the resonant circuit, comprised of L208 and C224/C246. L208 also functions as a phase, or tilt, adjustment. The sawtooth vertical yoke current flowing through the center-leg winding of T203 also changes the inductances of the two series-connected outside-leg windings. Because the outside-leg windings are in series with the horizontal yoke coils, the horizontal sweep width is reduced at the top and bottom of the picture.

Pincushion correction for the Zenith 40BC50 and 12B14C50 chassis is divided into separate top/bottom and side correction circuits. At first glance, the circuit in Fig. 10 appears to be nearly the same as that used by RCA for so many years. However, T208 is a toroidal type, whose ferrite core is doughnut shaped. The two toroidal windings in series with the vertical yoke coils are wound around the circular core in true toroidal fashion. The winding marked "outside" is wound around the entire core in the way a solenoid coil is wound. However, because the magnetic fields of the coils are at right angles, no AC signal would be induced from one type of coil into the other if two ceramic magnets were not added.

The two ceramic magnets are included with the toroidal core. Their magnetic flux is enough to nearly

saturate the ferrite core. Current flowing through the outside winding also will saturate the core, and thus permit horizontal pulses to be transferred to the toroidal windings. However, the vertical sawtooth current in the toroidal windings is not induced into the outside winding.

The horizontal pulses obtained from the toroidal windings are filtered into a near-sine wave by the resonant action of C261 and T202, which also functions as the tilt adjustment.

Side pincushion correction in the Zenith 40BC50 chassis is accomplished by the circuit shown in Fig. 11. Vertical pulses from the vertical sweep circuit are filtered into a parabolic waveform and reduced in amplitude by the actions of CR212, R-313, C233, R312 (side pincushion control), R311 and C233 before they are applied to the base of transistor Q211. The amplified vertical parabolic waveform at the collector of Q211 is applied to the voltage regulator of the 128-volt supply, which furnishes the voltage for the horizontal-output stage.

Because the 128 volts applied to

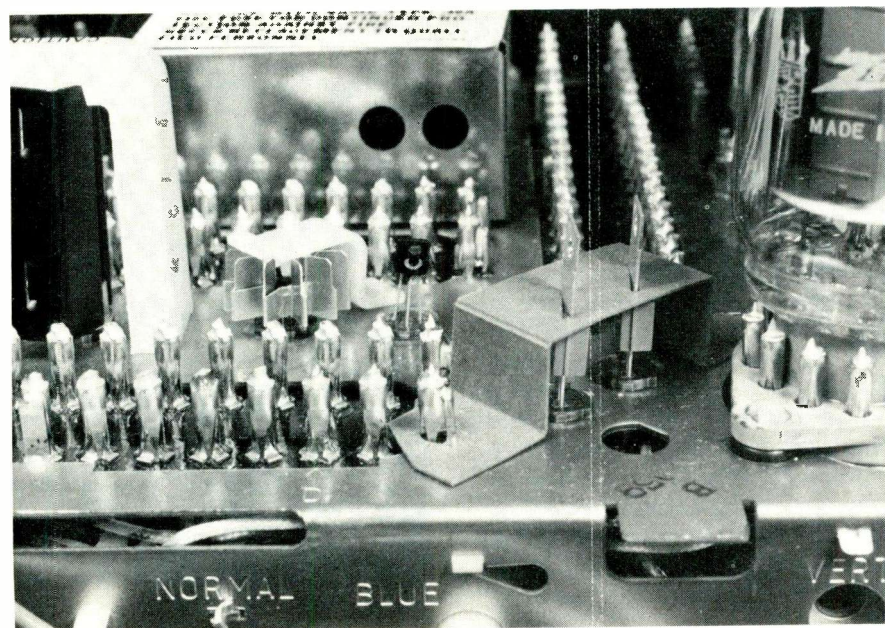

Fig. 3 Zenith provides clips and brackets to hold medium and large transistors in their sockets during shipping.

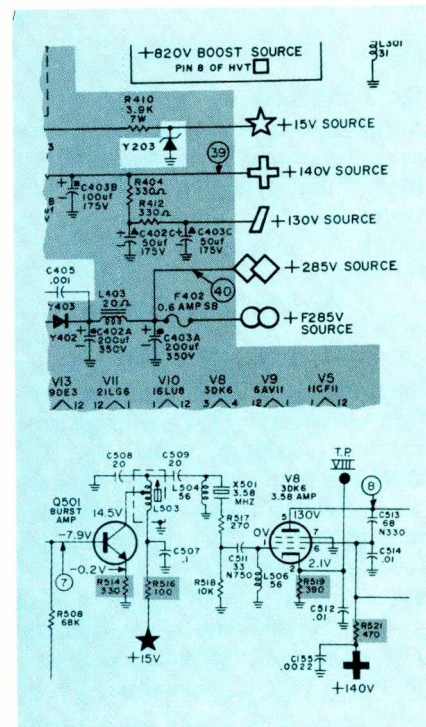

Fig. 4 Gray-shaded areas on GE schematics indicate parts that are important to product safety or the prevention of x-radiation. Each DC voltage source is shown by an outline of a distinctive symbol, and each connecting circuit is indicated by a filled-in black symbol of the same shape.

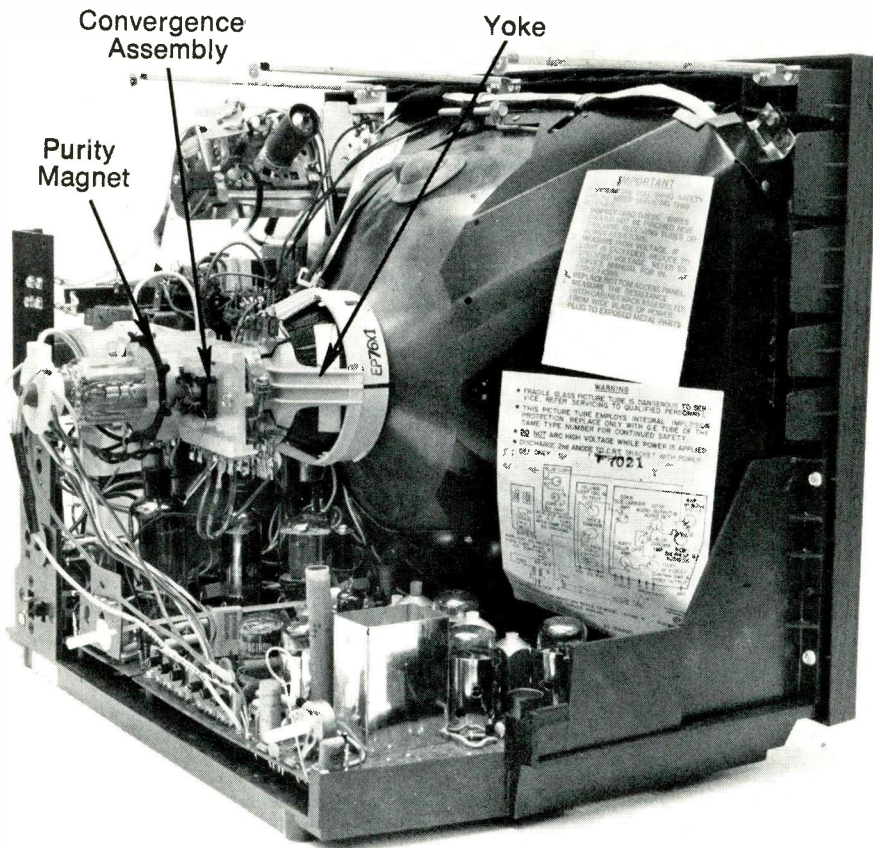

Fig. 5 There is no separate board for convergence controls in GE receivers employing the in-line-guns CRT; all adjustments are performed by changing connector taps and rotating magnets on the convergence assembly mounted on the neck of the CRT.

the horizontal output stage is reduced during the time the vertical sweep is scanning the top and bottom of the screen, the width of the raster at these points also is reduced.

Degaussing Circuits

Several of the new degaussing circuits use a bridge which becomes balanced when the positive-temperature coefficient resistor (posistor) reaches maximum resistance. This double action reduces the degaussing current to a very low value during normal receiver operation following degaussing.

JVC

The degaussing circuit of the JVC 7438 and 7408 color chassis, shown in Fig. 12, includes a double positive-temperature-coefficient thermistor, a tapped power transformer and a fixed resistor (which balances the bridge). Because both sections of R710 are cold and offer low resistance when the receiver is first turned on, almost the full 100 volts AC is applied to the degaussing coil. The resulting current

through the coil heats both sections of R710, and the increased temperature causes the resistance of this unit to increase.

When the resistance of R710 reaches its maximum value the current through the degaussing coil will be minimum, but not quite zero. To completely stop the current through the coil, a voltage from the 110-volt tap of the power transformer is routed to the degaussing coil through R809 and thermistor R-710A, so that both ends of the degaussing coil are at 100 volts. With no voltage applied across the coil, its current stops completely, and the degaussing cycle is finished. However, current through R709 heats R710B as long as the receiver is turned on. The heat of R710B is physically transferred to R710A, to prevent R710A from cooling excessively during normal receiver operation, when no voltage is applied across R710A and the degaussing coil. When the receiver is turned off and the thermistor is allowed to cool, the degaussing cycle repeats.

Circuit actions of the degaussing

circuit employed in the RCA CTC49 chassis (Fig. 13) are similar to those of the previously-described JVC design, except that a single positive-temperature-coefficient thermistor (posistor) is used. After the thermistor is stabilized at a high resistance, voltage from the power transformer, applied through R4, lowers the voltage at the R4/RT1 end of the degaussing coil until it is equal to that at the transformer end. Sufficient current flows through R4 and RT1 to keep RT1 hot enough to maintain a high value of resistance.

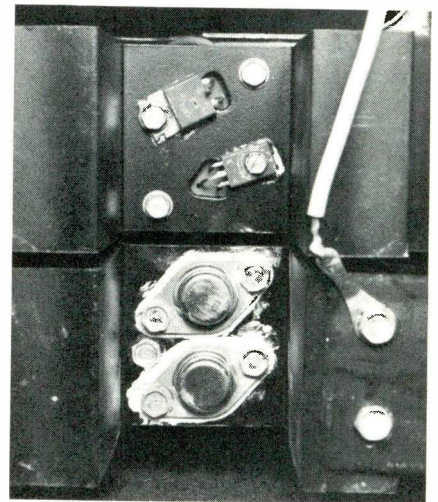

Fig. 6 The RCA CTC49 has the vertical output transistors and the horizontal sweep SCR's mounted on conveniently-located heat sinks.

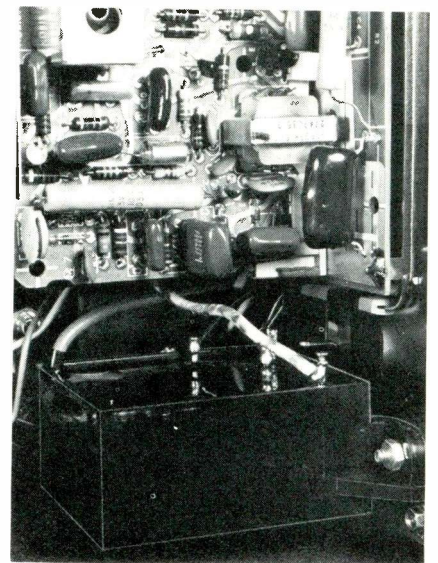

Fig. 7 Both high voltage and focus voltage in the RCA CTC49 are obtained from the solid-state quadrupler assembly.

Packard Bell

Degaussing of the CRT is not automatic in the Packard Bell 98C32 chassis, but is manually switched on by the TV viewer. This system is called "Instant Color Purity" (ICP). The advantage of this system is that the set operator can degauss the picture tube at any time while the set is operating, without waiting for thermistors to cool before the degaussing will re-cycle.

As shown in Fig. 14, the degaussing coils are in series with the AC supply to a bridge rectifier circuit which is used only for degaussing. The ICP pushbutton switches in C509, causing a large sine wave of 120-Hz current to pass through the degaussing coil. This current rapidly decays (like a damped wave train) as electrolytic capacitor C509 accepts a charge. Because the degaussing action is so quick, it is completed before the set operator can withdraw a finger from the push-button. A moving, swirling color display, when the button is activated, is proof of degaussing.

Chroma Circuits

Motorola

An integrated circuit (IC) in the Motorola TS929 chassis is employed as three demodulators, three color pre-amplifiers and three pre-CRT matrix circuits, as shown in Fig. 15.

The outputs of the matrix circuits are not -Y signals, but, instead, are pure color signals consisting of a pre-CRT mixture of video and -Y signals which, after more amplification, are ready for direct application to the appropriate cathodes of the picture tube.

Varactor diodes (varicaps) function as variable tuning capacitors in the Motorola TT651 UHF tuner (see Fig. 16). Positive DC voltage used to control the capacitance of the varactors is selected by the channel-selector switch from one of 13 potentiometers. This design enables all four of the varactors to be controlled by one voltage. The action is the same as a four-section variable capacitor which is activated by a common shaft.

Zenith

Varactor-controlled VHF and UHF tuners plus a unique system of pre-tuning and automatic switching are combined in Zenith's new "Varactor TV Tuning System" to enable viewers to select, with a single knob and without fine tuning,

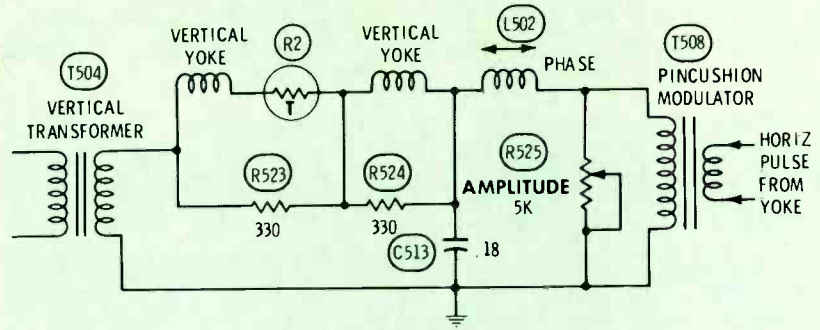

Fig. 8 The Packard Bell 98C32 color chassis uses this one circuit to correct both vertical and horizontal pincushioning.

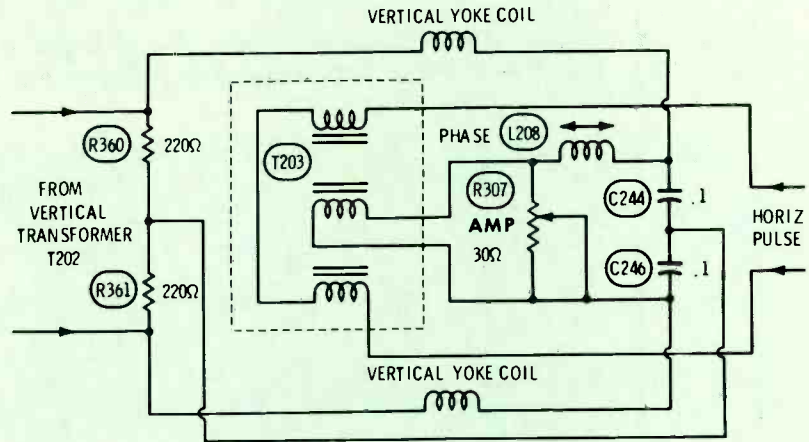

Fig. 9 Both vertical and horizontal pincushioning in the Zenith 4B25C19 chassis are corrected by this circuit.

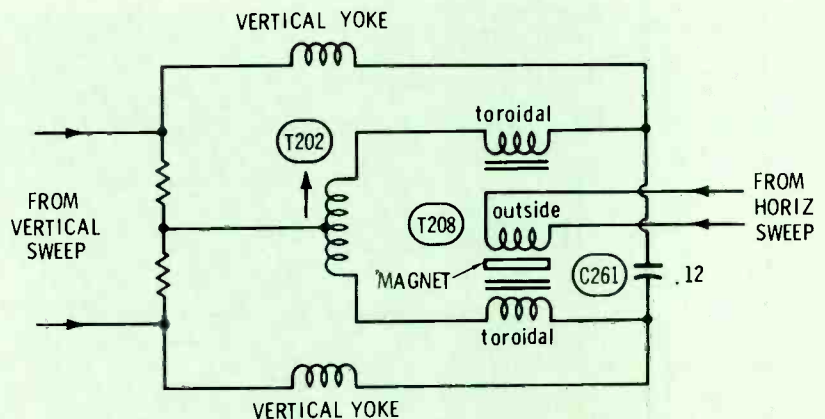

Fig. 10 New in the Zenith 40BC50 all-solid-state chassis is T208, which has a toroidal core, two ceramic magnets, two toroidal windings and one conventional winding. This combination provides a one-way signal transference. C261 and T202 filter the horizontal pulse into a near-sine wave for top/bottom pincushion correction.

any one of 14 pre-set VHF or UHF channels, or combination of VHF and UHF channels.

The new all-solid-state tuning system, a diagram of which is shown in Fig. 17, consists of:

- A channel-selector unit, in which all mechanical switching is accomplished;
- An all-electronic, FET-equipped VHF tuner whose frequency is changed by 1) changing

the reverse bias applied across varicap diodes employed in its four tuned circuits and 2) triggering on and off five switching diodes which effectively insert or remove inductances from the tuned circuits so that the tuner can be tuned across both the low and high VHF bands with about the same amount of varicap control voltage.

- An all-electronic UHF tuner equipped with four varicap-tuned circuits, one of which is a transistor RF amplifier stage (itself, a radical departure from previous UHF tuner designs).
- A "nerve center" unit which is constructed on a Duramodule plug-in circuit board and which, in conjunction with the channel selector unit, controls the voltages necessary for proper operation of the system.

The channel selector unit, which, as mentioned previously, performs all mechanical switching, is equipped with a drum-type, detent channel-selector mechanism similar to that employed in some conventional VHF tuners. However, instead of coil strips, the Zenith channel selector mechanism is equipped with 14 vernier-type potentiometers, each of which corresponds to a desired channel.

When the channel selector is rotated to one of the 14 available positions, the full resistance of the potentiometer associated with that position is placed between a regulated +33 volts source and ground. At the same time, the slider of the potentiometer is connected to a line which is common to all varactors in either the VHF or UHF tuner. Consequently, depending upon the position of the slider, a portion of the varactor control voltage (+5 to +28 volts) is applied as reverse bias across the varactors, changing the resonant frequency of the tuned circuits in which the varactors are used. (Changing the level of reverse bias applied across a varactor produces a corresponding change in its internal capacitance. Consequently, when the varactor is used as part of a tuned circuit, the resonant frequency of the circuit will be changed when the reverse bias applied to the varactor is changed.)

A bandswitch which effectively functions as a five-section, three-

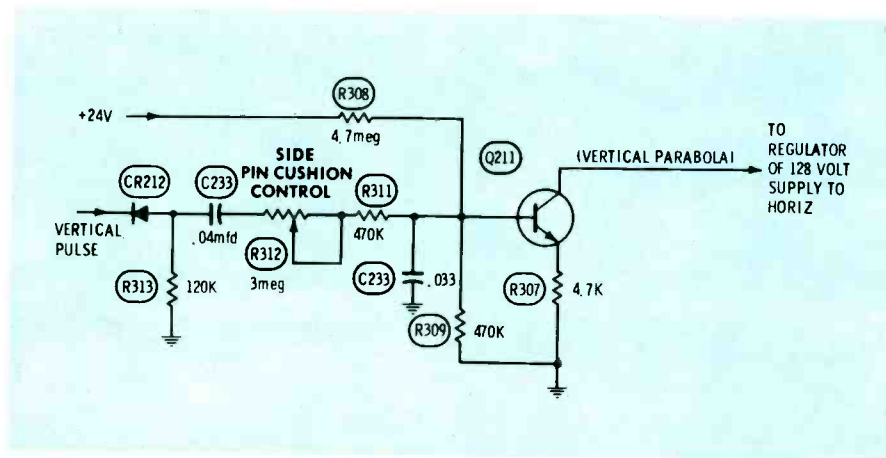

Fig. 11 Side pincushion correction in the Zenith 40BC50 chassis is accomplished by reducing the +128 volts supplied to the horizontal output stage during the time the sweep is at the top and bottom of the picture.

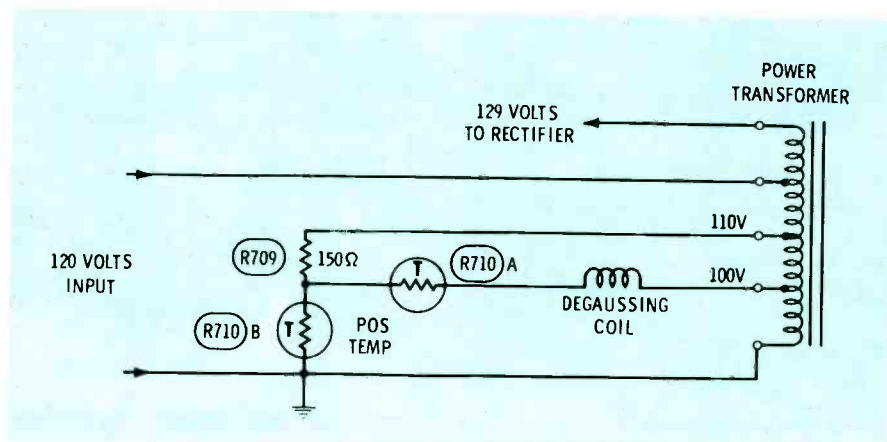

Fig. 12 The JVC 7438 and 7408 chassis employs a double thermistor plus a fixed resistor in a bridge circuit, to more completely shut off degaussing.

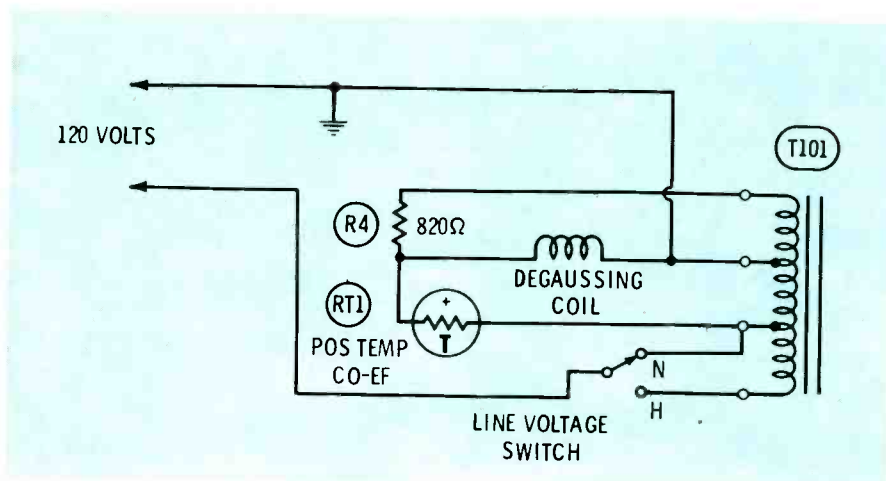

Fig. 13 A different bridge circuit is used in the degaussing circuit of the RCA CTC-49 chassis; a resistor and one posistor balance out the current flow through the degaussing coil.

position switch, and which is actuated by the tuning drum mechanism after initial setup, performs the circuit changes required for switching between low-band VHF (2-6), high-band VHF (7-13) and UHF (14-83)

Fig. 14 "Instant Color Purity" in the Packard Bell 98C32 chassis is initiated by a manually operated control. Current through the degaussing coil decreases rapidly as capacitor C509 becomes charged.

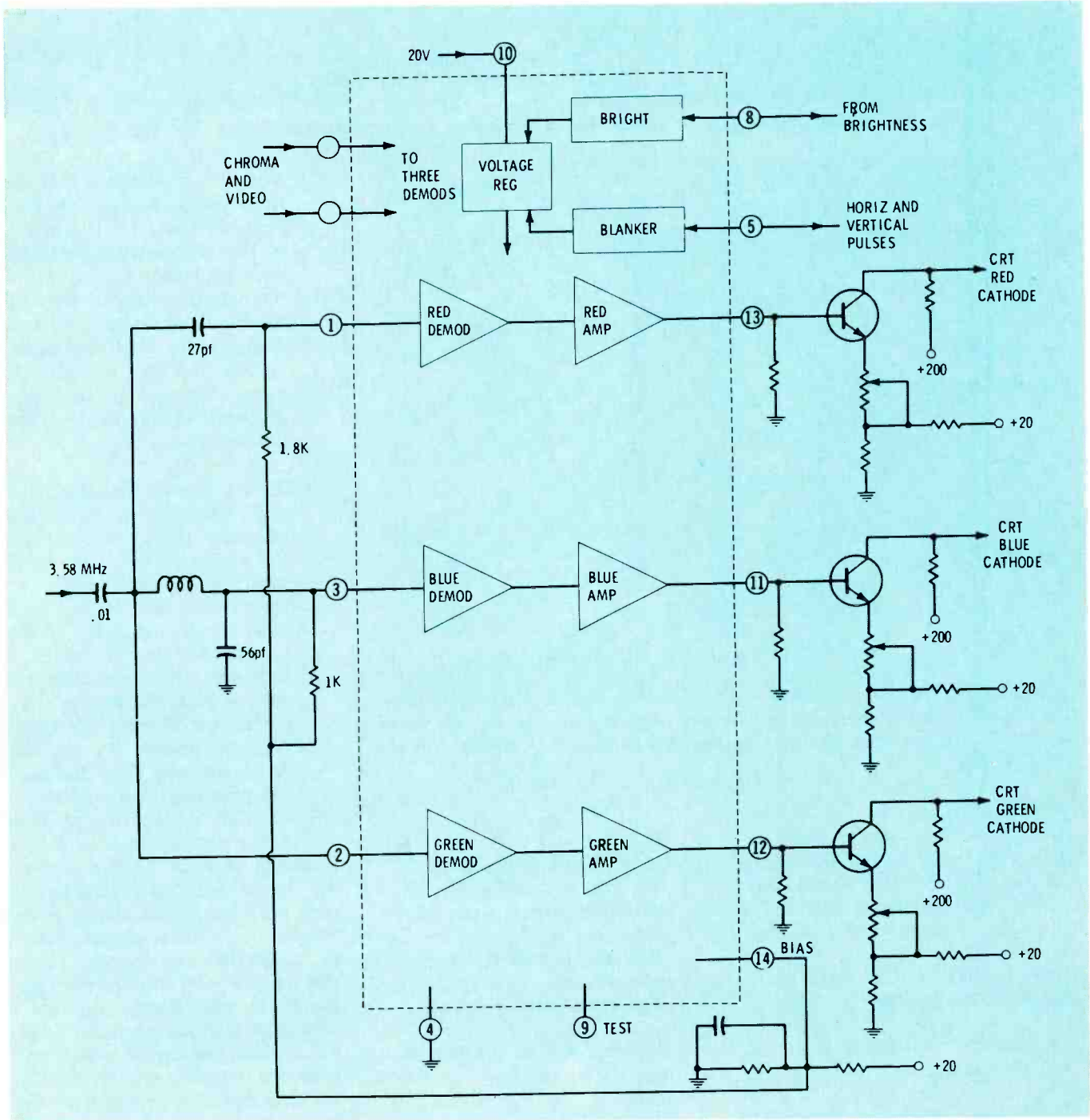
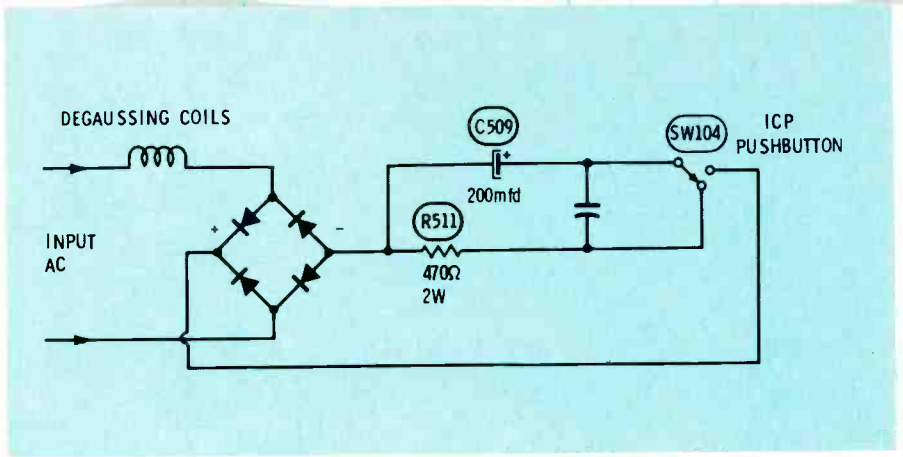

Fig. 15 The Motorola TS929 chassis employs an IC to perform demodulation, amplification and pre-CRT matrixing.

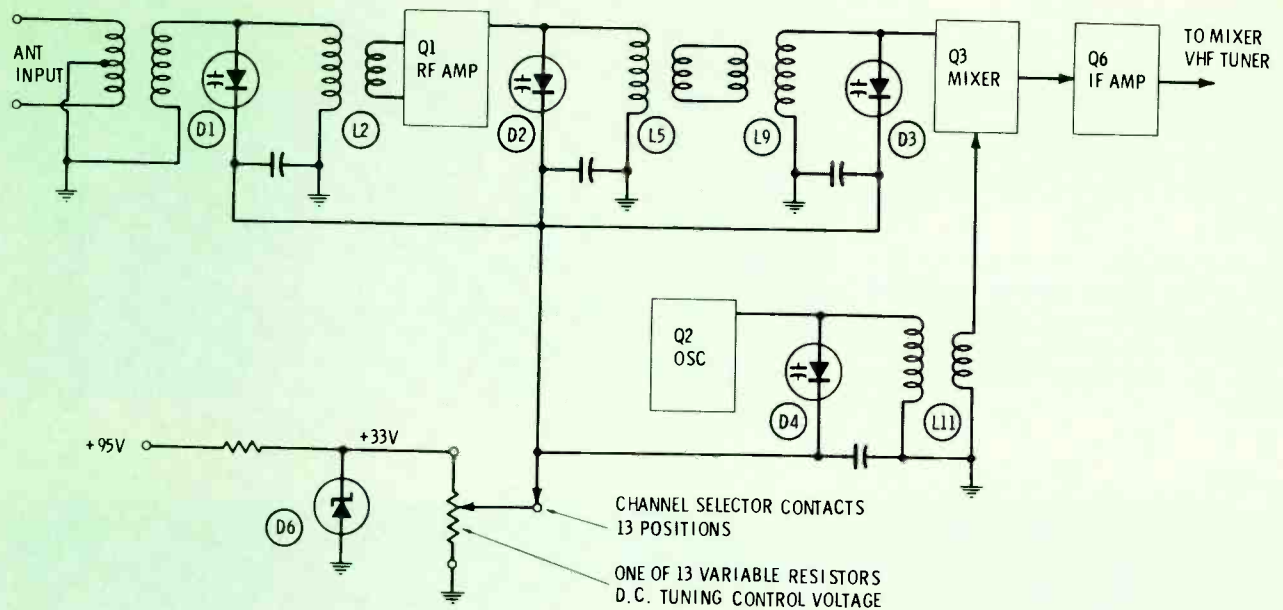

Fig. 16 Varactor diodes replace variable-tuning capacitors in the Motorola TT651 UHF tuner.

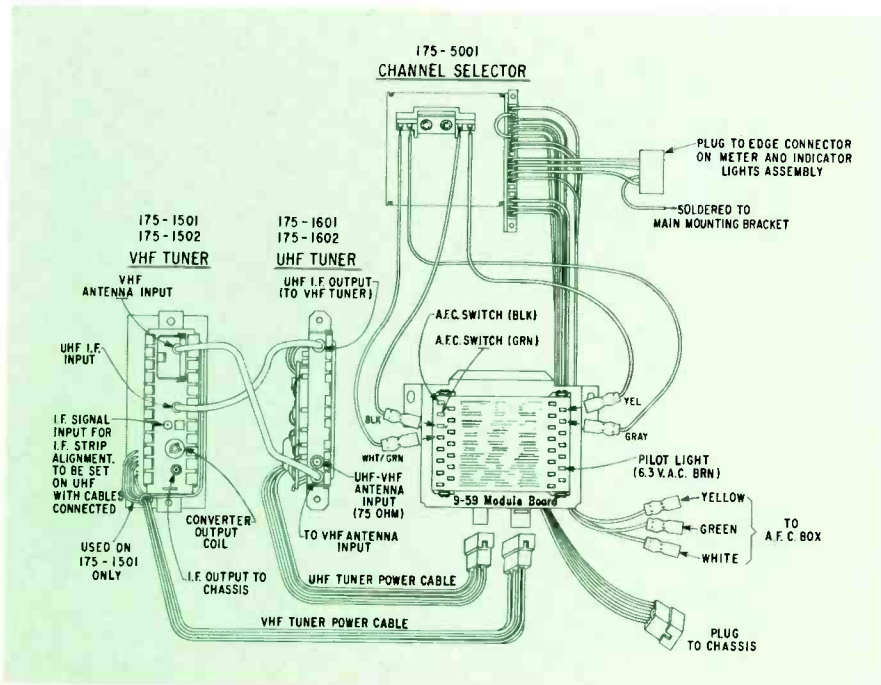

Fig. 17 Varactor-controlled tuning in both VHF and UHF tuners of the new Zenith Varactor Tuning system makes possible one-knob tuning of 14 pre-set VHF and UHF channels.

operation, each of which relates to one of the three switch positions. The five sections of the switch control $B+$, bandswitching, band-indicator lights, varactor and AFC tuning, and AGC switching. For example, in the low-band VHF position of the bandswitch:

- Section 1 switches $B+$ to the VHF tuner,
- Section 2 applies a reverse bias (negative) voltage to the five

switch diodes in the VHF tuner. These diodes—X1, X2, X5, X6, and X10 in Fig. 18—effectively switch more inductance into their respective circuits for low-band VHF, operation and less inductance for high-band VHF operation.

- Section 3 applies filament voltage to the low-band indicator lamp.
- Section 4 performs no function

when the bandswitch is in the low-band position. (In the high-band and UHF positions of the bandswitch more resistance is placed in parallel with the output resistor of the AFC discriminator, to limit the variation of the AFC correction voltage and thus maintain the same frequency pull-in range as provided on the low-band position.)

- Section 5 provides appropriate AGC voltage to the field-effect transistor (FET) employed as the RF amplifier in the VHF tuner. A conventional (bipolar) transistor is used for the same function in the UHF tuner. Consequently, because the techniques for controlling the gain of FET and bipolar transistors are different, the receiver must provide two separate AGC voltages. Thus the need for switching AGC voltages.

The design of the system also has permitted the inclusion of automatic frequency control (AFC) without the use of additional varactor diodes. AFC correction voltage is developed in the conventional manner by a discriminator circuit, except that the new AFC discriminator employed in this chassis provides a dual output, which is applied across a 6.8K-ohm resistor. When no correction is required or when the AFC circuit is manually defeated, the differential between the two outputs in zero and no voltage is dropped

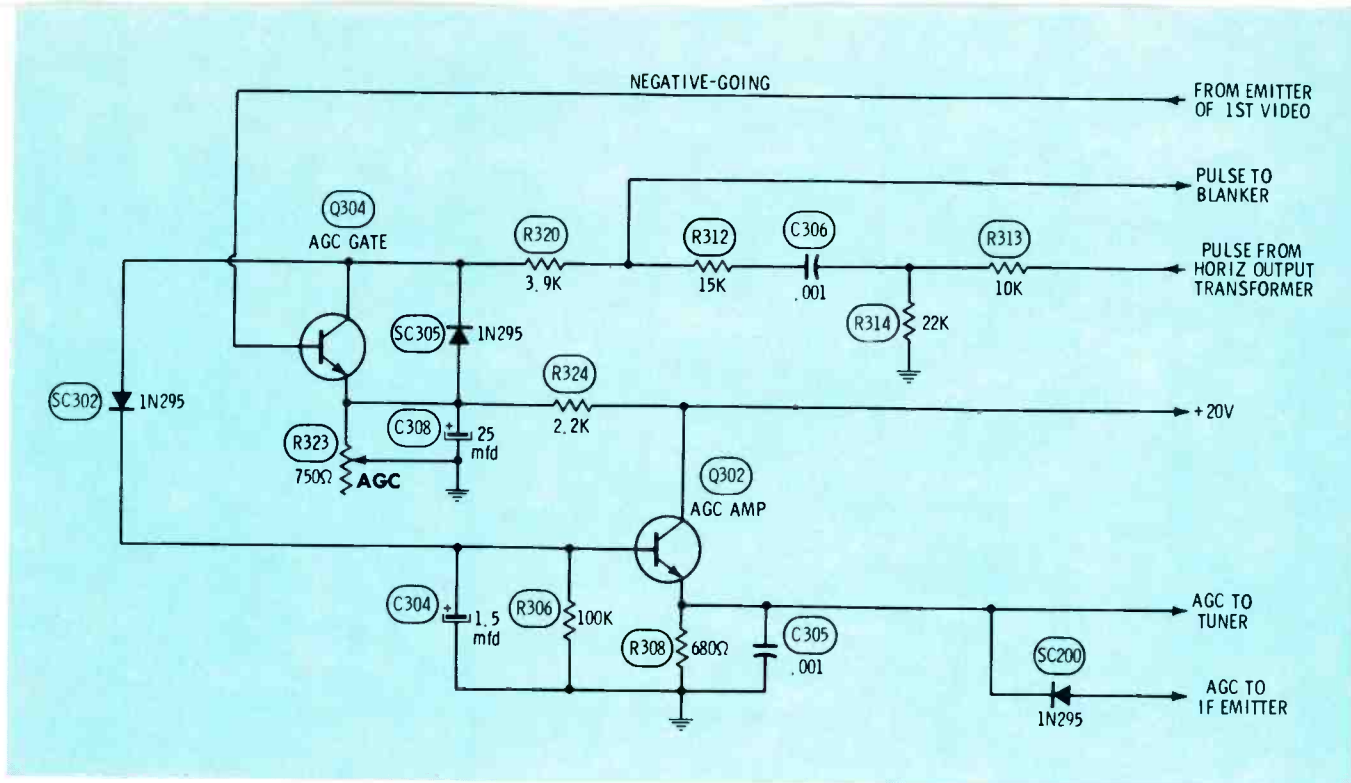

Fig. 20 The Sylvania D-16 color chassis AGC circuit employs a transistor (Q304) as a shunt resistor to vary the amplitude of the horizontal pulse, which is then rectified by diode SC302

Zenith's new "Varactor TV Tuning System" will appear in a near-future issue of ELECTRONIC SERVICING.

Miscellaneous Circuit Features

Sylvania AGC

Most AGC circuits, both tube and transistor, have a stage labelled "AGC gate" or "AGC keyer" which rectifies (with different efficiencies for different signal strengths) a horizontal pulse. The variable DC produced by this rectification is used as an AGC control voltage, or it varies the bias of a transistor whose output voltage supplies an AGC control voltage.

The AGC circuit of the Sylvania D-16 color chassis, shown in Fig. 20, is a departure from this traditional AGC system. Q304, although called the AGC gate, is actually the lower branch of a variable voltage divider that changes the amplitude of the pulse supplied to SC302, which performs the actual rectification. Positive DC voltage developed by the rectification is filtered by C304 and is applied to Q302 as forward bias. Because of the polarities involved, an increase in signal strength increases the forward bias on Q302, which in turn, increases (for saturation reduction of gain) the forward bias of the RF and IF amplifier transistors.

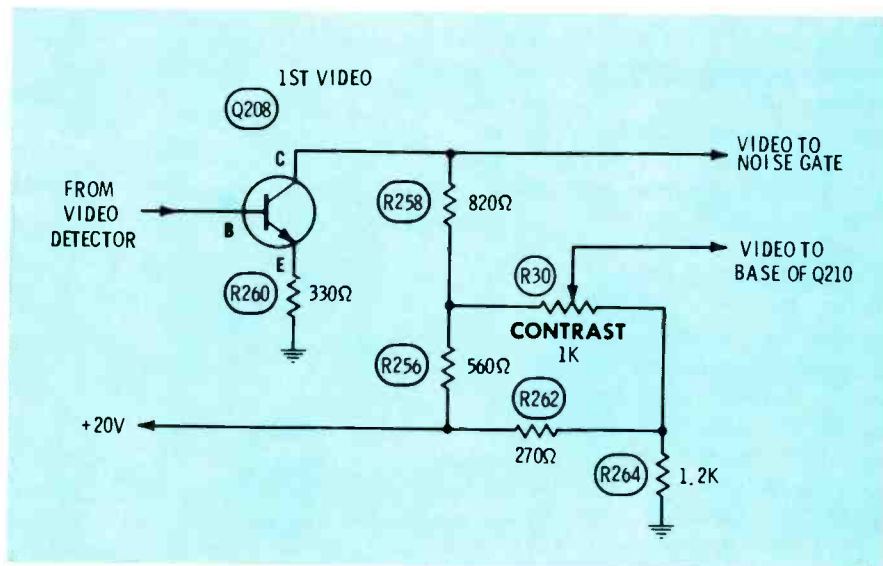

Fig. 21 DC voltages at each end of the contrast control in the Sylvania E01 chassis are nearly the same to prevent normal contrast adjustments from changing the DC voltages in the directly coupled video stages.

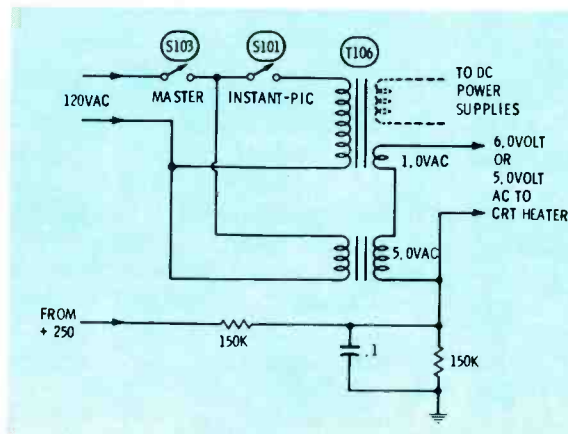

Fig. 22 Any receiver incorporating a fast-warmup picture circuit must operate the tubes at reduced heater voltage during periods when the set is turned off. The RCA CTC44 chassis obtains the 6 volts AC necessary for the CRT heater from two separate power transformers. When the receiver is turned off by the "Instant-Pic" switch, T107 continues to supply 5 volts to the heaters of the CRT.

The first action of the AGC is to lower the gain of the IF transistor, because of the voltage channeled through diode SC200. But when the voltage from the emitter of Q302 exceeds the positive bias on the IF transistor, diode SC200 is cut off. Further increases of the voltage at the emitter of Q302 are applied only to the RF transistor. Thus, application of AGC to the RF stage is delayed until a certain signal strength is exceeded. This prevents overload of the mixer stage in the tuner, and also establishes a good signal-to-noise ratio.

Sylvania Contrast

A different approach to contrast circuits is used in the Sylvania E01 color chassis (see Fig. 21). Part of the voltage from the collector of Q208 appears at the high side of R30, the contrast control, while the voltage divider consisting of R262 and R264 supplies a fixed DC voltage to the low end of the contrast control. Because both ends of the contrast control have approximately the same DC voltages, contrast changes, resulting from adjustment of the contrast control, have no effect on the bias of Q210, the following video amplifier transistor.

RCA Instant-Pic

The "Instant-Pic" circuit of the RCA CTC44 chassis (Fig. 22) utilizes two separate transformers to supply the heater voltage of the picture tube, the only tube used in receivers equipped with this chassis. With master switch S103 in the ON position, T107 supplies 5 volts AC to the heater of the CRT. Although the 1-volt winding of T106 is in series with this heater supply path, the primary of T106 is not energized, so the 1-volt winding functions as a very-low-value resistor.

When the "Instant-Pic" switch is in the ON position, T106 is energized, the output of the 1-volt winding is added in series with the 5 volts from T107, and the heater of the CRT has 6 volts applied.

A DC voltage from the voltage divider consisting of two 150K-ohm resistors is supplied to minimize the possibility of heater-to-cathode shorts inside the CRT. ▲



**Put the Heathkit® IO-101 & IG-57A
on your service bench...
and the \$600 savings in your pocket.**

\$259.95* . . . that's all the Heathkit IO-101 & IG-57A cost together . . . compared to well over \$800 for the competitive equipment you'd need to do the same job (vectorscope, color generator and sweep/marker). Compare features, capability & price . . . Heath always comes out ahead . . . and so do you.

Heathkit IO-101 Vectorscope/Color Generator . . . only \$124.95*

Gives you the means to accurately, quickly perform all these adjustments: raster, static & dynamic convergence, purity, gray scale, 3.58 oscillator, reactance coil, phase detector transformer, demodulator angle check and chroma bandpass touchup. Vector pattern shows you at a glance missing or weak colors, misadjustment of burst phase transformer, reactance & oscillator coils, bandpass transformer. Pattern lets you diagnose any color problem quickly, easily, without guesswork or a bench full of extra instruments. IC circuitry produces 12 patterns plus clear raster, in either 9x9 or exclusive Heath 3x3 display. Rear panel switch keeps vector pattern in same position regardless of whether CRT is grid or cathode driven. Variable front panel tuning, channels 2 thru 6. Front panel sync output. Switchable 4.5 MHz crystal oscillator. Gun shorting switches & grid jacks built-in. 12 lbs.

Heathkit IG-57A sweep/marker generator . . . only \$135.00*

Provides 15 crystal-controlled markers for color bandpass, TV sound, IF, picture & sound carriers for channels 4 & 10, FM IF . . . new Video Sweep Modulation allows injection of chroma-sweep directly into IF amplifiers or through antenna terminals . . . two built-in variable bias supplies . . . 400 Hz modulated or CW output of any individual marker . . . exclusive Heathkit external attenuator provides up to 70 dB attenuation, eliminates guessing 6 dB points . . . stable, linear sweep signals for the five most used frequency ranges . . . complete scope matching controls . . . quick disconnect BNC connectors . . . complete with all necessary probes, test leads & terminated cables. Famous Heath manual includes a comprehensive treatment of TV alignment. 14 lbs.

Assembled IGW-57A, 11 lbs. **\$199.00***

	FREE '71 CATALOG Describes these and over 300 other Heathkits. Save up to 50% by building them yourself. Use coupon and send for your FREE copy!	HEATHKIT a Schlumberger company HEATH COMPANY, Dept. 25-2 Benton Harbor, Michigan 49022 <input type="checkbox"/> Enclosed is \$ _____, plus shipping. <input type="checkbox"/> Please send model (s). <input type="checkbox"/> Please send FREE Heathkit Catalog. Name _____ Address _____ City _____ State _____ Zip _____ <small>Prices & specifications subject to change without notice. *Mail order prices: F.O.B. factory.</small>
	<small>TE-235</small>	

Circle 36 on literature card

productreport

for further information on any of the following items, circle the associated number on the reader service card.

L2000 Soldering Gun

A new one-handed soldering gun, which allows freedom of the other hand for holding and manipulating workpieces, has been introduced by Klaus Schlitt.

L2000 features automatic feed of soldering wire to the tip of the soldering gun plus an adjustable rate of feeding solder wire. According to the manufacturer, different accessories allow the use of the one-handed soldering gun with nearly all soldering tasks. A special attachment permits the use of larger solder reels. A built-in lamp illuminates the working area.



L2000 weighs 8 ozs., is housed in an impact-resisting plastic case, and sells for about \$12.00.

Circle 70 on literature card

Replacement TV Tuners

Castle Television Tuner Service, Inc. manufactures a large range of replacement tuners designed to replace the original tuner of many models of the most popular color and b-w television receivers.

The manufacturer states that these units are designed to meet the mechanical and electrical requirements

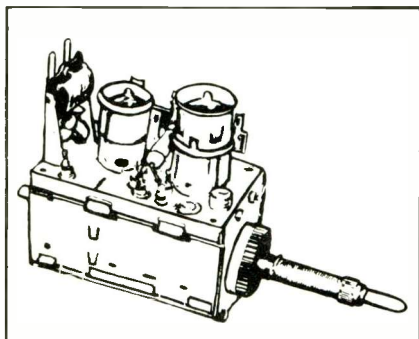

of the original factory tuner.

The price of the tuners is \$15.95.

Circle 71 on literature card

"Magic Vista" Tuner Cleaner

GC Electronics introduces, "Magic Vista", a foam tuner cleaner reportedly formulated for difficult TV tuner problems.



The aerosol can features a new, "any-angle" discharge valve that lets the technician use the spray regardless of the can's position. The manufacturer states that the special foam formulation cleans, polishes and lubricates TV tuner contacts without running off or evaporating, and that the chemical is safe for plastics.

The 8-ounce aerosol can sells for \$3.85.

Circle 72 on literature card

Precision Decade Boxes

Ohmite Mfg. Co. introduces a new line of ± 0.1 -percent precision decade boxes, with a choice of three, four-decade and one, six-decade models to cover the resistance range from one ohm through one megohm.

Features of the new Determ-Ohm include resistance values "dialed" easily by operation of rotation rocker-type thumbwheel switches, resistance setting indications in direct in-line numeric readout, and a metal panel housing case equipped with five-way binding circuits.

Pictured here is the Determ-Ohm Model 3407, four-decade box with resistances from zero through 999.9K ohms in 100-ohm steps. Model 3410, six decade box reportedly covers the complete zero through 999.999K range in steps of



one ohm each.

Model 3407 and 3410 sell for \$90.00 and \$125.00, respectively.

Circle 73 on literature card

Low-Voltage Transformers

Two new compact transformers for ringing bells and chimes, or operating other low-voltage devices, are available from the Edwards Company.

Model 592, with three taps, is reportedly three transformers in one. Output is rated at 8 volts, 10 V/A for ringing small bells; 16 volts, 10 V/A for chimes; or 24 volts, 20 V/A for operating low-voltage electrical devices, such as door openers, annunciators and 24-volt bells or horns.

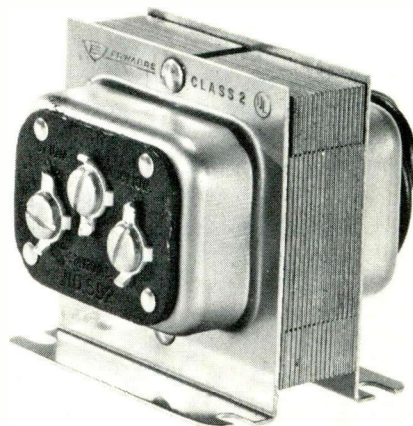

Model 590 is rated at 10 volts, 5 V/A for ringing door bells and residential chimes.

The manufacturer recommends these transformers for apartment houses and other large buildings requiring long wire runs, elevator signaling, oil burner controls, and as components in electrical equipment assemblies.

Model 592 sells for \$3.00, and Model 590 for \$3.70. ▲

Circle 74 on literature card

ANTENNAS

100. *Vikoa, Inc.*—is making available a 64-page, illustrated catalog covering their line of wire and cables and IDS/MATV equipment. Hardware, accessories, connectors, fittings and an index also are included.*

AUDIO

101. *Bell P/A Products Corp.*—a new 6-page catalog gives detailed specifications and descriptions of the company's broad line of commercial sound components and special purpose sound system products.

102. *Jensen Manufacturing Div.*—has issued an 8-page, catalog, No. 1090-E, which describes applications of 167 individual speaker models. Special automotive, communications, intercom and weathermaster speakers, plus a complete line of electronic musical instrument loudspeakers are featured.

103. *Shure Brother, Inc.*—has published a 4-page brochure, "Professional Sound Systems in High Schools, Colleges, and Universities," No. AL 398, describes the company's Vocal Master Sound System and how it helps solve public-address problems.

COMMUNICATIONS

104. *Sonar Radio Corp.*—Catalog titled "Sonar Business Radio, FM Monitor Receivers and CB Equipment" lists specifications and prices of this manufacturer's line of transceivers, receivers and communications accessories.

COMPONENTS

105. *Loral Distributor Products*—has made available a 24-page electrolytic capacitor replacement guide. The catalog features replacement products listed by original manufacturers' part numbers.*

106. *General Electric Tube Department*—has released a new 52-page Entertainment Semiconductor Almanac, No. ETRM-4311F. The almanac contains approximately 20,000 cross references from JEDEC, or OEM part numbers to GE part numbers for universal replacement semiconductors, selenium rectifiers for color TV, dual diodes, and quartz crystals.*

107. *Motorola, Inc.*—has made available a HEP cross reference guide catalog No. HMA07 which lists replacements for over 27,000 different semiconductor device type numbers available through authorized HEP suppliers.

108. *RCA Commercial Engineering*—has made available a 23-page booklet PTD-1878, describing the RCA power transistor product line, which is composed of more than 200 device types. Product matrices include up-to-date information on the latest commercial devices, as well as preliminary data on developmental units. An expanded index lists all of the newer type numbers, the older germanium types, and the developmental devices.

109. *Semitronics Corp.*—has a new, revised "Transistor Rectifier, and Diode Interchangeability Guide" containing a list of over 100 basic types of semiconductors that can be used as substitutes for over 12,000 types. Include 25 cents to cover handling and postage.

110. *Stancor Products*—pocket-size, 108-page "Stancor Color and Monochrome Television Parts Replacement Guide" provides the TV technician with transformer and deflection component part-to-part cross reference replacement data for over 14,000 original parts.

111. *Sylvania Electric Products, Inc.*—a 73-page guide which provides replacement considerations, specifications and drawings of Sylvania semiconductor devices plus a listing of over 35,000 JEDEC types and manufacturers' part numbers. Copies are \$1.00.

112. *General Electric*—a 12-page, 4-color, illustrated "Picture Tube Guidebook", brochure No. ETRO-5372, provides a reference source for information about GE color picture tube replacements and tube interchangeability.*

113. *Workman Electronic Products, Inc.*—has released a 32-page, pocket-size cross reference listing for color TV controls. 105 Workman part numbers are listed in numerical order with specifications and illustrations of the part.*

SPECIAL EQUIPMENT

114. *The Denson Electronics Corp.*—has released their new 25th Anniversary Catalog featuring the largest selection of new and used TV cameras and associated equipment.

TECHNICAL PUBLICATIONS

115. *Howard W. Sams & Co., Inc.*—literature describes popular and informative publications on radio and television servicing, communications, audio, hi-fi and industrial electronics, including their 1970 catalog of technical books about every phase of electronics.*

116. *Sencore, Inc.*—Speed Aligner Workshop Manual, Form No. 576P, provides 20 pages of detailed, step-by-step procedures for operation and application of Sencore Model SM158 Speed Aligner sweep/marker generator.*

117. *Sylvania Electric Products, Inc., Sylvania Electronic Components Div.*—has published the 14th edition of their technical manual, which includes mechanical and electrical ratings for receiving tubes, television picture tubes and solid-state devices. Price of this manual is \$1.90.*

TEST EQUIPMENT

118. *B&K Mfg. Div., Dynascan Corp.*—is making available an illustrated, 24-page, two-color Catalog, BK-71, featuring B&K test equipment, with charts, patterns and full descriptive details and specifications included.*

NEW from TAB

ALL-IN-ONE COLOR TV SCHEMATIC/SERVICING MANUALS



Each Manual contains **EVERYTHING** you need to service all models of the brand covered. Now, in one convenient manual, you can have immediate access to all the pertinent information you need to service brand-name Color TV receivers. Each manual contains descriptions of unusual circuits, field-service change data, causes and cures for repetitive and unusual troubles, alignment instruction, setup and convergence procedures, and other helpful servicing data. Also included are full-size schematic foldout sections with complete schematic diagrams for virtually all models produced by each manufacturer. Choose from 8 large 8½ x 11" manuals now available in either paperback or long-life leatherette cover.

RCA COLOR TV SERVICE MANUAL

Covers 23 different chassis designations, from CTC-12 to all solid-state CTC40. 176 pages, plus 36-page foldout containing 12 schematic diagrams. No. 496 Leatherette cover \$7.95; paper \$4.95

ZENITH COLOR TV SERVICE MANUAL

Covers all chassis designations from 27KC20 to 1428C50. 160 pages, plus 36-page foldout containing 12 complete schematic diagrams. No. 502 Leatherette cover \$7.95; paper \$4.95

MOTOROLA COLOR TV SERVICE MANUAL

Covers all models using chassis designation TS-907 through TS-924. 160 pages, plus 18-page foldout containing 6 complete schematic diagrams. No. 509 Leatherette cover \$7.95; paper \$4.95

PHILCO COLOR TV SERVICE MANUAL

Covers all chassis designations from 15M90-91 through hybrid 20QT88. 160 pages, plus 36-page foldout containing 12 complete schematic diagrams. No. 522 Leatherette cover \$7.95; paper \$4.95

MAGNAVOX COLOR TV SERVICE MANUAL

Covers all chassis designations from Series 37 through T940. 160 pages, plus 36-page foldout containing 12 complete schematic diagrams. No. 526 Leatherette cover \$7.95; paper \$4.95

G. E. COLOR TV SERVICE MANUAL

Covers all chassis designations from CT through KE. 160 pages, plus 36-page foldout containing 12 complete schematic diagrams. No. 536 Leatherette cover \$7.95; paper \$4.95

SYLVANIA COLOR TV SERVICE MANUAL

Covers all chassis designations from 576 through E01. 160 pages, plus 36-page foldout containing 12 complete schematic diagrams. No. 539 Leatherette cover \$7.95; paper \$4.95

ADMIRAL COLOR TV SERVICE MANUAL

Covers all chassis designations from the D11 to the K10 hybrid. 160 pages, plus 36-page foldout containing 12 complete schematic diagrams. No. 545 Leatherette cover \$7.95; paper \$4.95

OTHER TERRIFIC SERVICE AIDS

RCA MONOCHROME TV SERVICE MANUAL

Covers 33 B & W models, from KCS136 to KCS-178. 176 pages, plus 36-page foldout containing 16 complete schematic diagrams. No. 549 Leatherette cover \$7.95; paper \$4.95

ZENITH MONOCHROME TV SERVICE MANUAL

Covers 54 B & W chassis designations from 13A16 to 22AB55. 160 pages, plus 36-page foldout containing 19 complete schematic diagrams. No. 552 Leatherette cover \$7.95; paper \$4.95

1970 POPULAR TUBE/TRANSISTOR SUBSTITUTION GUIDE

All-in-one guide lists only readily-available and popularly-price substitutes—no need for you to search through lists of tubes and transistors you'll rarely see in use. 224 pps. No. 525 Leatherette cover \$4.95; paper \$2.95

HOW TO REPAIR SOLID-STATE IMPORTS

A large, diversified collection of schematics and service data for nearly 100 of the most popular foreign-made radios, tape recorders, and TV sets. Includes extensive list of suppliers. Also tells you what to do when a schematic isn't available. 160 pages, 8½ x 11½", plus 32-page schematic foldout section. No. 532 Leatherette cover \$7.95; paper \$4.95

Use Handy Coupon Below to Order Manuals on 10-DAY FREE TRIAL!

TAB BOOKS, Blue Ridge Summit, Pa. 17214

Please send me the manuals checked:
 496 502 509 522 526 536
 539 549 552 525 532

I have enclosed \$..... Send post-paid.

Please invoice me on 10-day free trial.

Name

Address

City State Zip

If paying in foreign currency, add 10%. Pa. residents add 6% sales tax. ES21

Circle 37 on literature card

119. *Eico*—has released a 32-page, 1970 catalog which features 12 new products in their test equipment line, plus a 7-page listing of authorized Eico dealers.*

120. *Mercury Electronics Corp.*—14-page catalog provides technical specifications and prices of this manufacturer's line of Mercury and Jackson test equipment, self-service tube testers, test equipment kits and indoor TV antennas.

121. *Sencore, Inc.*—Catalog No. 579P (1971) describes this company's complete line of test equipment. Sixteen pages of photographs, specifications, prices and other important data.*

122. *Signal Analysis Industries Corp.*—introduces a 4-page bulletin describing their real time spectrum analyzers and combined spectrum analyzer/digital integrators. The company designs and builds signal processing equipment including spectrum analyzers, digital integrators, and correlation and probability analyzers.

123. *Triplet Corp.*—has released a new, 2-color Test Equipment catalog (No. 57-T) featuring digital VOM's, FET accessories, sales and service data plus a VOM selection chart.

TOOLS

124. *Brookstone Co.*—introduces a new, expanded 32-page catalog offering hundreds of unusual and extremely useful hard-to-find tools. Among the new tools are: glass pliers, hand vises, glass drills, jewelers' screwdrivers, watchmakers' loupes and many other hand tools and small power tools.

125. *General Electric*—has issued a 2-page brochure No. GE-8927, describing the features of GE's new soldering iron.*

126. *Xcelite, Inc.*—has published a 2-page illustrated Bulletin N670, which introduces two new reversible ratcheting handles for use with more than 60 of the company's available Series "99" nutdriver, screwdriver and special purpose blades.*

*Check "Index to Advertisers" for additional information. ▲



Advertising contributed for the public good.

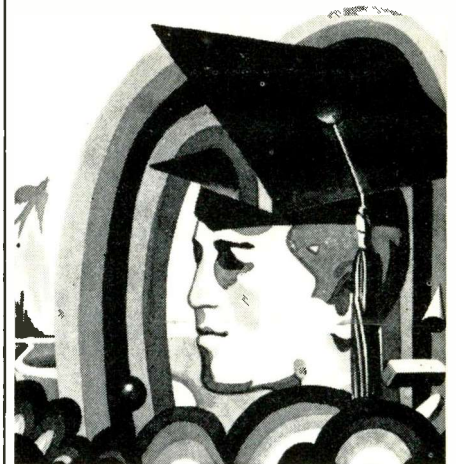

The real explosion on campus today is a knowledge explosion.

Every second of every day, 30,000 words of scientific information are added to the libraries of the world.

Every day, 1000 books are published.

Every year, 60,000,000 pages of new scientific and technical data are released.

This means that most of man's scientific knowledge is new knowledge, requiring new equipment, techniques, trained teachers. It means more classrooms for more college students than ever before—if they are to learn more than ever before.

College is where this new knowledge is being shaped for our use, as individuals, as business managers. But colleges and universities need money to do this. Shouldn't your business help? Write for "How To Aid Education," Council for Financial Aid to Education, 6 East 45th St., New York, N. Y. 10017.

The "college of your choice" is in financial trouble. Send money.

Please send me the free booklet, "How To Aid Education."

Name

Address

City State Zip code

Mail this coupon to "HOW TO AID EDUCATION," Council for Financial Aid to Education, 6 East 45th St., New York, N. Y. 10017.

10 million reasons why it pays to promote matrix, the brightest, sharpest color picture tube in RCA history!

Reasons 1 to 10,000,000. Large-screen MATRIX can upgrade the performance of at least 10 million color TV sets now in use. The RCA MATRIX 23VALP22 is a direct replacement for the 23VANP22, 23VARP22, 25AP22A, 25BAP22 (Chromacolor), 25BCP22, 25BGP22, 25XP22, and 45 other industry types! Giant-screen sales potential for the RCA MATRIX—practically unlimited!

More RCA Color Picture Tubes are stocked and sold by

distributors than any other color picture tubes in the industry. So, MATRIX is more readily available to you no matter where you are, to give your customers faster service and ring up more profitable sales.

MATRIX is the brightest and sharpest color picture tube in RCA history!

Here's why:

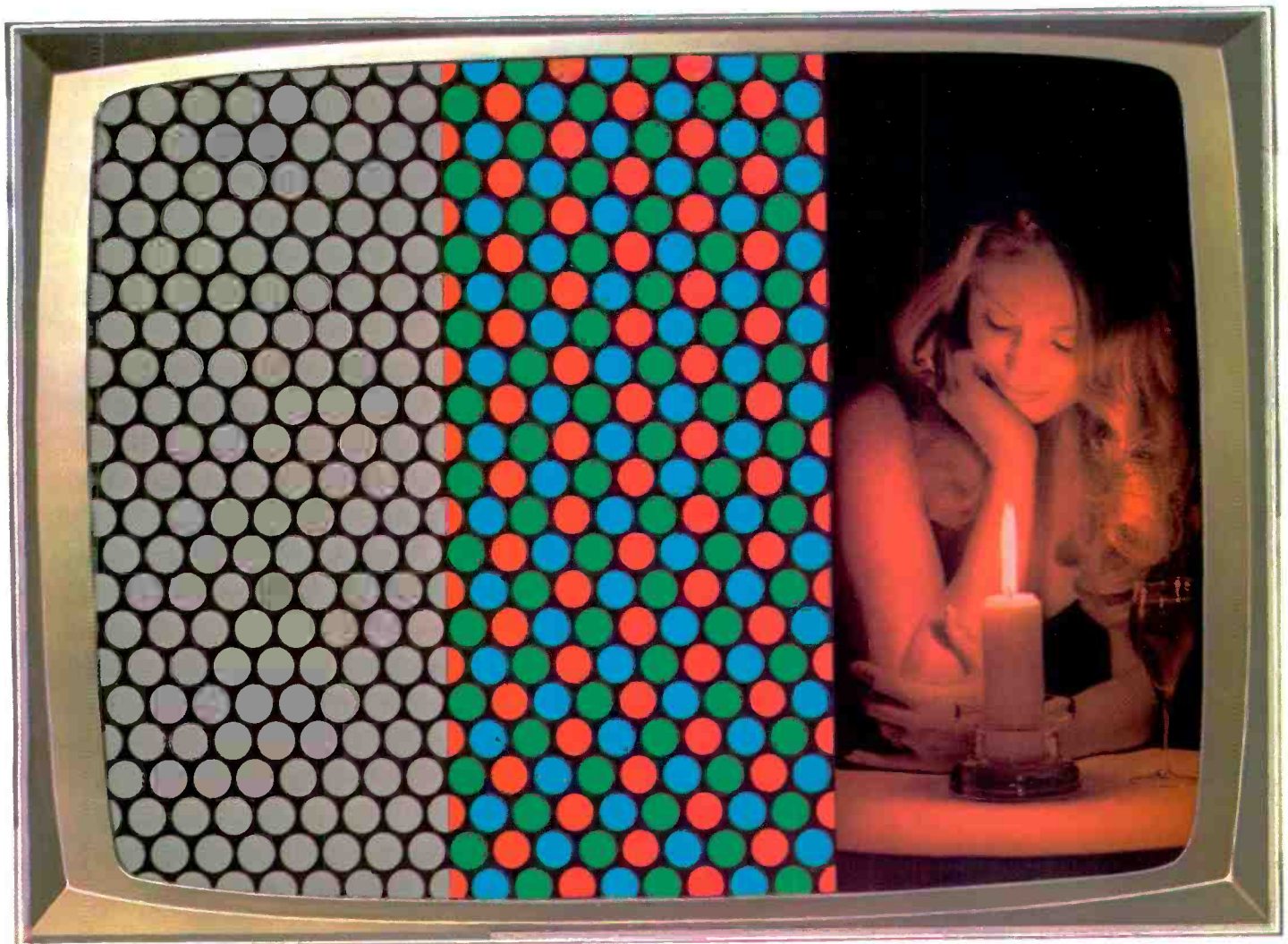

The RCA Jet-black matrix*

It soaks up room-light normally reflected back at the viewer from the face of the tube. Result: brighter pictures because now there's no need to "filter out" brightness to maintain contrast under strong room-light conditions.

The RCA MATRIX phosphor-dot process*

First, we developed brilliant new phosphors and a unique screening process incorporating a jet-black matrix. Then we deposited the 1,200,000 red, green, and blue high-intensity phosphor dots precisely within the black matrix. Result: brightness doubled with dramatic improvement in contrast and clarity.

The RCA MATRIX picture**

Spectacular! In operation, a new, unique high-resolution gun "shoots" the phosphors with more energy than any other gun previously available. Result: black matrix + phosphors + high-resolution gun = maximum sharpness over the entire brightness range, truer colors under all viewing conditions.



New 4-color consumer flyer on MATRIX is available from your RCA Distributor.
RCA | Electronic Components | Harrison, N. J. 07029

*Magnified drawing **Simulated

THE SAFEST SETS YOU'LL EVER SERVICE HAVE LITTELFUSE CIRCUIT BREAKERS.

LITTELFUSE INC. 1111 SHEPHERD AVE. GREEN BAY WISCONSIN 54303



Standard Catalog Part No.	Hold Rating (Amps.)	Standard Catalog Part No.	Hold Rating (Amps.)
815.650	.490	8152.75	1.92
815.800	.600	815003	2.1
815001	.650	8153.25	2.2
8151.25	.930	815004	2.5
81501.5	1	81504.5	3
8151.75	1.2	815005	3.25
815002	1.4	815006	3.9
8152.25	1.5	815007	4.14
81502.5	1.65		

Littelfuse TV set circuit breakers are the safe, reliable, money saving short-circuit-problem-solvers . . . 17 available models—exact replacements—cover the entire range of domestic television sets.

Littelfuse circuit breakers are available from your distributor—singly or in bulk.

Super-simple in operation—the sensitive breaker flips open under current overloads protecting the circuitry. Reset by merely pressing the red reset plunger. A built-in “trip free” feature of Littelfuse breakers prevents forced closing when dangerous overload currents are present.

Nothing's more reliable than a Littelfuse circuit breaker. Thermal-responsive Littelfuse breakers are dual operated bi-metallic devices providing temperature compensation over a wide range of ambient temperature variation. Molded phenolic construction eliminates warping and distortion of the base, maintaining exact factory set calibrations. The unit is completely enclosed to protect critical moving parts from dirt and other foreign matter.

Any TV set you're likely to service will take Littelfuse circuit breakers.

They'll flip for safety.

You'll flip for satisfaction.

LITTELFUSE

DES PLAINES, ILLINOIS 60016
SUBSIDIARY OF TRACOR, INC.
Circle 3 on literature card