



# Electronic Servicing



## RCA Answers Questions

about the new challenge to independents, page 48

## CES Wrapup

New designs you'll service in the future, page 14

# The first and only solid-state test equipment guaranteed for 5 years.

Now EICO, because of its emphasis on *reliability* in engineering and manufacture, offers the industry this breakthrough.

EICO's new line of solid-state test equipment comes with an unprecedented 5-year guarantee of performance and workmanship. (Send

for full details of this EICO 5-year GUARANTEE on factory-assembled instruments.)

Additional advanced features include: new functional design, new color-coordinated esthetics, new PC construction, new easier-to-build kit designs.

## New EICO Solid-State Test Equipment



### EICO 240 Solid-State FET-VOM \$59.95 kit, \$79.95 wired.

One all-purpose DC/AC OHMS Uniprobe®. Reads 0.01V to 1 KV (to 30 KV with optional HVP probe). 7 non-skip ranges, in 10 dB steps. AC or battery operated. RMS & DCV: 0-1, 3, 10, 30, 100, 300, 1000V P-P ACV: 0-2.8, 8.5, 28, 85, 280, 850, 2800V. Input Z: DC, 11 M; AC, 1 MΩ. Response 25 Hz to 2 MHz (to 250 MHz with optional RF probe). Ohmmeter reads 0.2 to 1 MΩ in 7 ranges. 4½" 200 μA movement. HWD: 8½", 5¾", 5", 6 lbs.

### EICO 242 Solid-State FET-TVOM \$69.95 kit, \$94.50 wired.

All the versatility of the EICO 240 plus: AC/DC Milliammeter, 1 ma to 1000 ma in 7 non-skip ranges; single all-purpose DC/AC-Ohms — MA Uniprobe®; and large 6½" 200 μA meter movement.

### EICO 150 Solid-State Signal Tracer \$49.95 kit, \$69.95 wired.

Multi-purpose troubleshooter for TV/FM/AM & Audio Equipment. Independent RF Audio inputs. Speaker and meter output indicators. 400 mW continuous power output. Substitution amplifier, output transformer, speaker. Input for rated output: 1 mV RF, 63 mV audio.

Hum 60 dB below 400 mW, 105-132 VAC, 50/60 Hz, 5VA. HWD: 7½", 8½", 5", 6 lbs.

### EICO 330 Solid-State RF Signal Generator. \$59.95 kit, \$84.50 wired.

5 fundamental bands 100 kHz to 54 MHz. Vernier control 0-100%. Output 300,000 μV into 50-Ohm load. External signal modulation or internal 400 Hz, 0 to 100%. 105-132 VAC, 50/60 Hz, 1.7 VA. HWD: 7½", 8½", 5", 5 lbs.

### EICO 379 Solid-State Sine/Square Wave Generator. \$69.95 kit, \$94.50 wired.

5 sine wave and 4 square wave bands. Low distortion Sultzer feedback FET circuit. Sine: 20 Hz to 2 MHz; 0-7.5V rms into hi-Z, 0-6.5V into 600 ohms Max. distortion 0.25%. Square: 20 Hz to 200 kHz; 0-10V p-p into hi-Z, pos. direction, zero ground. Rise time at 20 kHz less than 0.1 μ sec. 105-132 VAC, 50/60 Hz, 10VA. HWD: 7½", 8½", 8½", 9 lbs.

## New EICO High Performance Instruments



- EICO 385 — Solid-State Portable Color Generator \$79.95 Kit, \$109.95 Wired.
- EICO 465 — Wideband Vectorscope/Oscilloscope \$179.95 Kit, \$249.95 Wired.
- EICO 1025 — Solid-State Power Supply \$79.95 Kit, \$119.95 Wired.
- EICO 443 — Semiconductor Curve Tracer \$69.95 Kit, \$99.95 Wired.
- EICO 633 — CRT Tester & Rejuvenator \$69.95 Kit, \$99.95 Wired.
- EICO 635 — Portable Tube Tester \$44.95 Kit, \$69.95 Wired.

## New EICO Probes for the Pros

### Hi-Voltage Probe HVP-5, Wired \$19.95.

Convenient built-in voltmeter. Barrier sections isolate HV tip from handle and meter. Measures up to 30 KV. Lightweight, compact.

### Solid-State Signal Injector Probe PSI-1, Kit \$5.95, Wired \$9.95.

Pen-size, 1-ounce, self-powered signal generator. Frequency range from 1kHz to 30MHz, with harmonics. Clip it to your pocket — ideal for signal tracing in the field.

### Solid-State Signal Tracer Probe PST-2, Kit \$19.95, Wired \$29.95.

Flashlight-size, 2.2oz, self-powered, Hi-gain amplifier. 50Hz to 200MHz with demod tip. Input Z: 3500Ω, 35KΩ, 350KΩ; Output: 0.3 p-p volts. Noise —45dB. Distortion <5%. Complete with earphone, all probe tips, AA battery, pocket clip.



Circle 1 on literature card

SEND FREE 1970 CATALOG

Name \_\_\_\_\_  
Address \_\_\_\_\_  
City \_\_\_\_\_ State \_\_\_\_\_ Zip \_\_\_\_\_



EICO Electronic Instrument Co., Inc.  
283 Malta Street, Brooklyn, N.Y. 11207  
EICO Canada Ltd.  
20 Millwick Drive, Weston, Ontario

# Don't sell a color picture tube unless its been on a test ride.

Down at the bottom of the page, you have a major advance in space-age homeliness.

And a major advance in color tube testing as well.

That machine squatting down there is our beloved Iron Horse, the fully-automated, revolving carousel we use to test our color bright 85® tubes for emission, gas leakage, shorts, arcing and screen uniformity prior to shipment.

Now we don't intend to go into a song and dance on how total automation reduces testing error.

But we will tell you one thing.

Our Iron Horse test ride, combined with our life testing and 100% set testing, makes it almost impossible for you to get a defective color tube from us.

Which in turn makes it almost impossible for you to get chewed out by a customer.

Next time you need a color replacement tube, remember the great thing about the color bright 85. We don't send it to you till it's been around.

**SYLVANIA**  
GENERAL TELEPHONE & ELECTRONICS

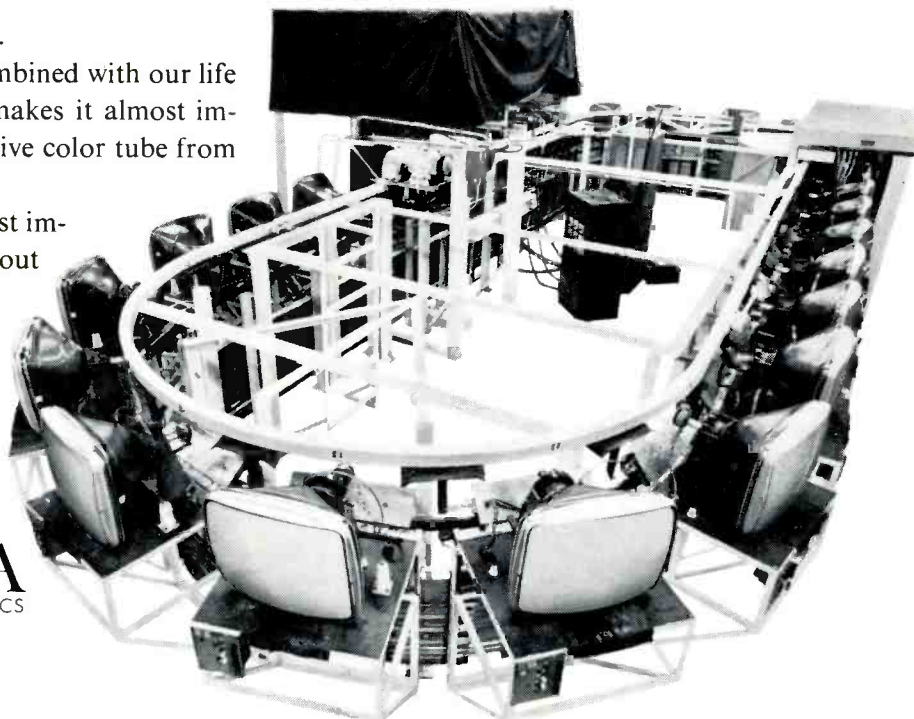

*Circle 4 on literature card*

# Electronic Servicing

Formerly PF Reporter

*in this issue...*

- 14 CES Wrapup.** Home video player/recorders, reel- and cartridge-type quadrasonic player/recorders, multi-cassette players, large-scale integrated circuits (LSI), and monochrome TV with increased numbers of integrated circuits are just a few of the new types and designs of home entertainment electronic products exhibited at the Consumer Electronics Show in June.
- 22 How to Troubleshoot "No High Voltage", Part 1.** Step-by-step techniques for isolating troubles that cause loss of high voltage in TV receivers that employ tube-type horizontal output and high-voltage sections. **by Bruce Anderson.**
- 30 Dale's Service Bench—Modulation Limiting in CB.** How the modulation-limiting circuits used in various Citizens Band transmitters operate, plus simplified procedures for adjusting and troubleshooting them. **by Allan Dale.**
- 39 Tube Substitution Supplement.** Characteristics, basing diagrams and recommended substitutes of recently introduced tubes.
- 42 Vertical Foldover and Other Linearity Problems—Causes and Cures.** Abnormal shift of the operating point of a tube or transistor can produce vertical compression, vertical expansion and other vertical sweep distortion of a TV raster. **by Robert G. Middleton.**
- 48 Factory All-Brand Servicing—The New Challenge to Independents.** Earlier this year, RCA announced that it would establish all-brand servicing centers in the major metropolitan areas of the U.S. In July, the first of these centers began operation. Presented in this article are independent servicers' reactions to RCA's new all-brand servicing centers, plus RCA's answers to some of the many questions that independents have been asking. **by J. W. Phipps.**
- 56 Shop Talk/Rectifier Circuits—Operation and Testing.** ELECTRONIC SERVICING's technical editor discusses all aspects of power supplies, including both the operation of associated components and circuitry and practical troubleshooting techniques. **by Carl Babcoke.**

## DEPARTMENTS

Letters to the Editor . . . . .	4	Audio Systems Report . . .	53
Electronic Scanner . . . . .	9	Product Report . . . . .	68
PHOTOFACT Bulletin . . . . .	20	Advertisers' Index . . . . .	71
Troubleshooter . . . . .	36	Catalog and Literature . . . .	72
Test Equipment Report . . . . .	46		

Second class postage paid at Kansas City, Mo. and additional mailing offices. Published monthly by INTERTEC PUBLISHING CORP., 1014 Wyandotte St., Kansas City, Mo. 64105. Vol. 20, No. 9. Subscription rates \$5 per year in U.S., its possessions and Canada; other countries \$6 per year.

Copyright, 1970, Howard W. Sams & Co., Inc. All rights Reserved. Material may not be reproduced or photocopied in any form without written permission of publisher.

**EDITORIAL**  
 GEO. H. SEFEROVICH, Director  
 J. W. PHIPPS, Managing Editor  
 CARL BABCOKE, Technical Editor  
 MARY M. SYMON, Editorial Assistant  
 DUDLEY ROSE, Art Director

**CONTRIBUTING AUTHORS**  
 Bruce Anderson  
 Allan Dale  
 Robert G. Middleton

**TECHNICAL CONSULTANT**  
 JOE A. GROVES

**EDITORIAL ADVISORY BOARD**  
 LES NELSON, Chairman  
 Howard W. Sams & Co., Indianapolis

**CIRCULATION**  
 ROBERT M. CURRY, Director  
 EVELYN ROGERS, Manager

**ADVERTISING SALES**  
 Kansas City, Missouri 64105  
 Tele: 913/888-4664  
 E. P. LANGAN, Director  
 R. JACK HANCOCK, Manager  
 JAKE STOCKWELL  
 S. F. WILSON, Production

**REGIONAL ADVERTISING SALES OFFICES**  
 Indianapolis, Indiana 46280  
 ROY HENRY  
 2469 E. 98th St.  
 Tele: 317/846-7026

**New York, New York 10019**  
 CHARLES C. HORNER  
 3 W. 57th St.  
 Tele: 212/688-6350

**Los Angeles, California 90005**  
 JOHN D. GILLIES  
 3600 Wilshire Blvd., Suite 1510  
 Tele: 213/383-1552

**London W. C. 2, England**  
 JOHN ASHCRAFT & CO.  
 12 Bear Street  
 Leicester Square  
 Tele: 930-0525

**Amsterdam C. HoBand**  
 JOHN ASHCRAFT & CO.  
 W.J.M. Sanders, Mgr.  
 for Benelux & Germany  
 Herengracht 365  
 Tele: 020-240900

**Tokyo, Japan**  
 INTERNATIONAL MEDIA  
 REPRESENTATIVES LTD.  
 1, Shiba-Kotohiracho, Minatoku  
 Tele: 502-0656



ELECTRONIC SERVICING (with which is combined PF Reporter) is published monthly by Intertec Publishing Corp., 1014 Wyandotte Street, Kansas City, Missouri 64105.

Subscription Prices: 1 year—\$5.00, 2 years—\$8.00, 3 years—\$10.00, in the U. S. A., its possessions and Canada.

All other foreign countries: 1 year—\$6.00, 2 years—\$10.00, 3 years—\$13.00. Single copy 75¢; back copies \$1.



Robert E. Hertel, Publisher  
 Intertec Publishing Corp.  
 Subsidiary of Howard W. Sams & Co., Inc.

## The big difference in TV Alignment instruments: Ours Works.

The B & K Model 415 Sweep/Marker Generator not only works, but it makes alignment jobs faster and more accurate.

Why? Because it eliminates the need for a separate marker generator, sweep generator, marker adder, and bias supply. You get it all in one compact instrument.

And it's so easy to use. The IF and chroma bandpasses are simulated on the front panel for constant reference. Lights tell you which of the crystal-controlled markers are in use and where they should be located. And the exclusive marker tilt feature lets you place the markers either horizontally or vertically, so you can always identify their exact positions.

Put the B & K Model 415 Sweep/Marker Generator to work for you.

Ask your distributor for complete details.



Product of  
DYNASCAN CORPORATION  
1801 W. Belle Plaine  
Chicago, Illinois 60613



Model 415:  
\$399.95

Circle 5 on literature card

## Licensing Promotes Professionalism

I read with deep interest Mr. Sgarlat's letter printed in the Letters to the Editor column in the June 1970 issue of ELECTRONIC SERVICING.

Apparently Mr. Sgarlat is years behind on the stand that has been taken by the independent service industry concerning licensing. His thinking in this relation is 180 degrees out of phase with the real reason for licensing: Consumer electronic servicing has for years been classified in the skilled-labor category; however, with the introduction of sophisticated electronic circuits, along with the need for sophisticated test equipment to service them, the skilled-labor category no longer applies to service technicians (proper terminology). Those technicians who have upgraded their knowledge to the level of proficiency that enables them to use the required test equipment and test procedures have expressed a desire to be known as professional servicers. Therefore, legislative licensing measures were taken to reflect the true category of the electronics repair technician. Licensing also takes into consideration the need for apprenticeship training, which ultimately produces technicians with a high degree of competence.

As a matter of information, most of the licensing laws pertinent to the radio and television repair industry in this country were prepared by local television service associations and submitted by them to their state legislatures for adoption and enactment.

In regards to Mr. Sgarlat's statement on the printing of brochures for the public, the National Electronics Association makes available to its members a variety of public relations pamphlets, not only in those areas he mentioned, but also in many others.

I strongly believe that Mr. Sgarlat would greatly benefit from the results of belonging to a local, as well as a national, association of professional service technicians.

Guillermo L. Russell  
Philadelphia, Pa.

## "Licensing Does Not Improve The Integrity of The Servicer"

I'd like to take a minute of your readers' time to express my views on licensing technicians.

When I started servicing televisions from my home, I probably couldn't have passed any kind of a test. I did turn out some very satisfactory work, however, mainly because of my persistence and integrity. I often worked many hours on a set to find the solution to what would be a simple problem for me today, and I must add that I did not charge the customer for the excess time (and sometimes parts), in order to get some good experience.

Recently in our area a man with 20 or 25 years experience in TV servicing opened a repair shop (and

I don't doubt the 25 years because all of his equipment is at least that old). My point here is that the real issue is not one of testing the man, but one of personal integrity. Because this man turns out some terrible workmanship, much of it comes to me after he has returned it to the customer as being serviced. I could go into a long discourse about his charges and inferior diagnoses and service procedures, but my point here is that licensing does not improve the integrity of the servicer.

To me, licensing is a move on the part of established shops to eliminate competition that might be coming up and to discourage young men starting out. You will note most shops that advertise for help specify "experienced technicians wanted". How is a young man to get that experience if no one will hire him, and he cannot get a license.

I also feel that licensing would be another form of government intervention in and taxation of the free enterprise system that has made our country so great.

I still insist that integrity is the answer, because my service business has grown to where I simply cannot keep up with it.

Also, I charge a rate that is realistic and in tune with the times. As a result, few of my customers have gone elsewhere for service, but those that have usually end up with poorer quality work at a higher charge.

I must readily admit that I don't know it all by a long shot and I must continually study to keep up (or should I say catch up) with the career I love so well. In spite of this, if the right test were prepared, I bet even I would fail it. But when it comes to being as honest as I know how to be, that test I could pass.

Glenn Fessenden  
Ozark, Mo.

## Technicians Should Speak Out About Parts Problems

(Enclosed is a copy of a letter that I recently sent to the National Electronics Association. It tells about the problem we had trying to secure a replacement part from a manufacturer who produces CB radio.

I hope you will print this in your Letters to the Editor column to encourage others to speak up and inform you of the many problems we individual shops can do nothing about.)

"I feel it is time service technicians stand up and be counted, and do something about the way manufacturers completely ignore explicit orders for replacement parts. Many of these parts are specialized, and no general replacement parts can be substituted for them. (I enclosed copies of three letters to illustrate my point.)

"I wrote a letter to the manufacturer of CB equipment on March 7 to order a microphone for a CB radio, which is part of their AM/CB radio for tractors.



# \$975

## TUNER SERVICE CORPORATION

**PROVIDES YOU WITH A COMPLETE SERVICE FOR ALL YOUR TELEVISION TUNER REQUIREMENTS AT ONE PRICE.**

### TUNER REPAIR

VHF Or UHF Any Type \$9.75.  
UHF/VHF Combo \$15.00.

In this price all parts are included. Tubes, transistors, diodes, and nuvistors are charged at cost.

Fast efficient service at our 4 conveniently located service centers.

1 year guarantee backed up by the largest tuner manufacturer in the U.S.—SARKES TARZIAN INC.

All tuners are cleaned inside and out, repaired, realigned and air tested.

### TUNER REPLACEMENT

Replacement Tuner \$9.75.

This price buys you a complete new tuner built specifically by SARKES TARZIAN INC. for this purpose.

The price is the same for every type of universal replacement tuner.

#### Specify heater type

Parallel 6.3V  
Series 450 mA  
Series 600 mA

All shafts have the same length of 12".

Characteristics are:

Memory Fine Tuning  
UHF Plug In  
Universal Mounting  
Hi-Gain Lo-Noise

If you prefer we'll customize this tuner for you. The price will be \$18.25. Send in original tuner for comparison purposes to our office in INDIANAPOLIS, INDIANA.



## TUNER SERVICE CORPORATION

**FACTORY-SUPERVISED TUNER SERVICE**

<b>MIDWEST</b> . . . . .	817 N. PENNSYLVANIA ST., Indianapolis, Indiana . . . . .	TEL: 317-632-3493
	(Home Office)	
<b>EAST</b> . . . . .	547-49 TONNELE AVE., Jersey City, New Jersey . . . . .	TEL: 201-792-3730
<b>SOUTH-EAST</b> . . . . .	938 GORDON ST., S. W., Atlanta, Georgia . . . . .	TEL: 404-758-2232
<b>WEST</b> . . . . .	SARKES TARZIAN, Inc. TUNER SERVICE DIVISION 10654 MAGNOLIA BLVD., North Hollywood, California . . . . .	TEL: 213-769-2720

*Circle 6 on literature card*

## FAST IN TIGHT PLACES



HANDLE ONLY 3¼" LONG –  
18° Working Arc.

Stainless steel Midget Ratchet handle, 17 Drivers, 3-5/8" extension, two slotted and two Phillips bits, 12 hexagonal bits from 0.050 to 5/16", one square adapter for ¼" wrench sockets—all in pocket-sized plastic covered steel case with molded foam interior.

Kit No. 1320

Complete \$11.00

You may purchase from your local Industrial Supply House or direct from  
**THE CHAPMAN MANUFACTURING CO.**  
Manufacturers of Midget Ratchet Offset Screwdrivers for over 25 Years.

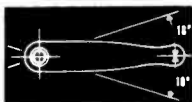

10 SAW MILL ROAD, DURHAM, CONN. 06422  
Circle 7 on literature card



"Yes, I do have a small fortune in this business . . . trouble is, I started with a large one."

The farmer became impatient, so on March 23 I wrote a second letter. Finally, on April 24, I received the first response to my 'special order'.

"Now they request that we send them the money first to expedite the order. Needless to say, I sure don't plan to send money for a part that might take one or two months to get here. The customer was very dissatisfied, to say the least, and said he wouldn't wait to see if they might send the part.

"So now we have nothing to show for all the time and trouble we went to. The customer, even knowing it wasn't our fault, still feels cheated because his equipment couldn't be repaired in a reasonable length of time.

"This situation has happened before. I feel that the companies who cause delays like this should be exposed time and time again."

George Savage  
Grand Island, Nebr.

### Sales and Service Operation For Sale

I have a radio and TV sales and service shop that I have operated since the 1940's. I now would like to sell out and retire. The business is in a good location with good equipment and stock. If anyone is interested, please write:

R. J. Langhofer  
Grand Avenue, Box 248  
Plains, Kansas 67869

### Oscilloscope For Sale

I have an almost-new Model ES 550B oscilloscope with a complete set of probes made by Precision Instruments Co. If anyone is interested in purchasing this scope, please write:

M. Jeffrey  
601 W. 115th Street  
New York, N.Y. 10025

### Agrees That Licensing Will Not Solve Problems

I must say "Hooray" for the letter from Mr. Sgarlat, which appeared on page 8 in the June 1970 issue of *ELECTRONIC SERVICING*. He voiced my ideas on licensing perfectly.

Now for a question: Where do the TV and radio manufacturers get their design engineers who design sets that defy servicing because of inaccessible parts? I suppose they all have degrees in electronics, but I certainly wouldn't give them a kindergarten diploma.

Lester N. Stephans  
Minneiska, Minn.

### Help Needed

I need schematics and tubes for two 1928 radios. One is an RCA Model AR804 Radiola 24. I need two C-299 tubes for it. The second is an Orpheus Grand, manufactured by the Wiley B. Allen Co., and I need a UV-199 tube for it.

Any help with these parts and/or the schematics will be greatly appreciated.

Jim Hartt  
12143 S. Paramount Blvd.  
Downey, Calif. 90242





# COMPLETE TUNER SERVICE

Castle, the pioneer of television tuner overhauling, now offers the following services to solve ALL your television tuner problems.

## OVERHAUL SERVICE — All makes and models.

VHF or UHF tuner (1960 or later)	\$9.95
TRANSISTOR tuner	\$9.95
COLOR tuner (Guaranteed color alignment . . . no additional charge)	\$9.95

Overhaul includes parts, except tubes and transistors.

Simply send us the defective tuner complete; include tubes, shield cover and any damaged parts with model number and complaint. Your tuner will be expertly overhauled and returned promptly, performance restored, aligned to original standards and warranted for 90 days.

Dismantle tandem UHF and VHF tuners and send in defective unit only.

Remove all accessories . . . or dismantling charge may apply.

## EXCHANGE REPLACEMENTS

When our inspection reveals that original tuner is unfit for overhaul, we offer an exact replacement (new or rebuilt) as low as \$12.95 exchange, depending on type. If exact replacement is not available in our stock we custom rebuild the original at the exchange price.

## PROFESSIONAL "CONTACT OVERHAUL" KIT

Do your own minor tuner overhauling by using this professional kit of chemicals. Enables you to recondition the switching contacts with the same advanced cleaning, polishing and lubricating materials used by Castle. Attain the same professional results we do . . . in most cases you can do this right in the customer's home.

Safe for all types of tuners, one kit will process several.

Order Now . . . or write for more information.



Dealer Net \$5.50

## UNIVERSAL REPLACEMENTS Prefer to do it yourself?

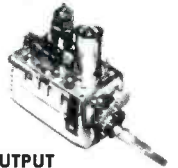

STOCK No.	HEATERS	SHAFT		I.F. OUTPUT		PRICE
		Min.*	Max.*	Snd.	Pic.	
CR6P	Parallel 6.3v	1¾"	3"	41.25	45.75	8.95
CR7S	Series 600mA	1¾"	3"	41.25	45.75	9.50
CR9S	Series 450mA	1¾"	3"	41.25	45.75	9.50
CR6XL	Parallel 6.3v	2½"	12"	41.25	45.75	10.45
CR7XL	Series 600mA	2½"	12"	41.25	45.75	11.00
CR9XL	Series 450mA	2½"	12"	41.25	45.75	11.00

\*Supplied with max. length selector shaft (measured from tuner front apron to tip) . . . you cut to suit.

These Castle replacement tuners are all equipped with memory fine tuning and UHF position with plug input for UHF tuner. They come complete with hardware and component kit to adapt for use in thousands of popular TV receivers.

## EXACT REPLACEMENTS

Purchase outright . . . no exchange needed. \$15.95 ea.

Castle replacements made to fit exactly in place of original tuner. Available in the following popular numbers.

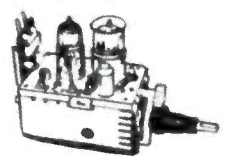
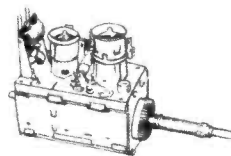

### ZENITH

175-168	175-740	175-1104	175-1156
175-204A	175-750	175-1105	175-1157
175-264	175-752	175-1106	175-1160
175-268	175-754	175-1118	175-1161
175-711	175-755	175-1121	175-1162
175-716	175-756	175-1122	175-1163
175-718	175-758	175-1131	175-1164
175-719	175-759	175-1132	175-1165
175-721	175-761	175-1134	175-1168
175-722	175-762	175-1151	
175-738	175-763	175-1154	
175-739	175-764	175-1155	

### RCA

KRK 103A	KRK 123D
KRK 103C	KRK 127AB
KRK 103F	KRK 127BA
KRK 107A*	
KRK 107B*	
KRK 107C*	
KRK 107D*	
KRK 107E*	
KRK 108A*	
KRK 108B*	
KRK 108D*	
KRK 108E*	

\*Supplied with new channel indicator skirt knob, original illuminated dial is not used.

Order EXACT REPLACEMENTS, UNIVERSAL REPLACEMENTS and "CONTACT OVERHAUL" KITS out of Main Plant (Chicago) only. Overhaul Service, Exchange Replacements and Custom Rebuilding available from New York or Chicago.



## CASTLE TV TUNER SERVICE, INC.

MAIN PLANT: 5701 N. Western Ave., Chicago, Illinois 60645

EAST: 130-07 89th Road, Richmond Hill, N.Y. 11418

Circle 9 on literature card

I would appreciate it if a reader could tell me where I can get a 5BTP1 CRT for a Jackson Model 600 scope.

M. Walsh  
649 Crawford  
Toledo, Ohio 43612

I need a service manual for a Goodyear 4-Band Transistor Radio Model GP6803. The company that made the radio has sold out, and the new company cannot supply any information on it.

William N. Morris  
R.F.D. 4, Box 38  
Lisbon, Ohio 44432

We have a Hickok Model 810 Transistor Radio Tester and need the operating instructions for it. Can anyone help?

O. V. Howell  
Route 1, Box 98B  
Mars Hill, N.C. 28754

We are in need of a schematic for a Transis-Tronic Model TEC S-25 all-transistor stereo amplifier. The brand name is Transis-Tronic, Inc. of Santa Monica, Calif., a company which is no longer in business.

We will appreciate a schematic for this amplifier and will gladly pay for it or a copy of same.

Orion TV  
4059 Adams Avenue  
San Diego, Calif. 92116

I have a General Electronics Model 200 signal generator and need the specifications for it. Could someone tell me if this New York (state) company still exists, or where I can get the specifications for this unit? Any help will be greatly appreciated.

Jim Gamez  
832 E. Camille  
Santa Ana, Calif. 92701

I have a Webcor Portable tape recorder, Model No. EP-2714-1. I have written to the company; however, my letter was returned marked "out of business". Could someone help me locate a schematic for this tape recorder? Thank you.

James J. McAllister  
6308 E. 152d Street  
Grandview, Mo. 64030

Does anyone know of an electronic parts distribution chain similar to Lafayette where one might inquire about a franchise?

Also, I would like to find a company that will copy a broken dial glass.

Leroy T. Noga  
288 Wellsian Way  
Richland, Wash. 99352

I need service information on Jackson's Model TVG2 sweep and marker generator.

Ray Gorzen  
2577 Parkside Drive  
Jackson, Mich. 49203



## COLOR TV CONTROLS

- Audio Controls
- Convergence Controls
- A.G.C. Delay Controls
- Vertical Linearity Controls
- Horizontal Linearity Controls

**EXACT REPLACEMENTS FOR**

**RCA • SILVERTONE  
ADMIRAL • ZENITH  
GENERAL ELECTRIC**

COLOR CODED KNOBS SAME AS  
MANUFACTURER'S SPECS.

AVAILABLE FROM  
YOUR FAVORITE  
DISTRIBUTOR

**WORKMAN** *Electronic*  
PRODUCTS, INC.  
P.O. BOX 3628 SARASOTA, FLORIDA 33578

Circle 10 on literature card

## Who Needs a Tuner Wash?

Use  
**QUIETROLE**  
Mark II Spray Pack

The product that cleans and lubricates better than any product you can buy and has been used for more years than any product of its kind.

The Choice of "Better Servicemen" Everywhere



manufactured by  
**QUIETROLE** COMPANY  
Spartanburg, South Carolina

Circle 11 on literature card

## Sylvania Names Benton Harbor Distributor

Sylvania Electronic Components, an operating group of Sylvania Electric Products Inc., has named Stolz-Wicks, Inc. a franchised distributor for the Benton Harbor, Mich., area.

Luke C. Henrichs, Sylvania Distributor Marketing Manager, said Stolz-Wicks will market the group's complete line of receiving tubes, television picture tubes, semiconductor devices and special products.

The Benton Harbor branch of Stolz-Wicks, Inc. is located at 1220 Milton Street.

## Gaiden Appointed Motorola Parts and Service Manager

Edward J. Gaiden has been promoted to national parts and service manager for the consumer products division of Motorola Inc.

The new position has been created to maximize and consolidate opportunities to perform total parts and



service support for the consumer, according to Art Schnipper, Jr., Motorola manager of marketing.

Gaiden formerly held the title of national service manager for the division.

Reporting to Gaiden under the new organizational set-up are Robert D. Wheeler, service manager, and Harold F. Diegel, parts manager. Peter Fantino reports to Diegel as assistant parts manager. Stephen Boll, parts material manager, and Sig Metz, parts administration manager, report to Fantino.

## New MGA Line Inboards Warranty Labor

The cost of warranty labor reportedly is inboarded in the price of each product in the new MGA consumer

electronics line, which includes color and b-w TV, radios, tape recorders and audio components.

MGA, formerly called Electric Sales Division, is part of Mitsubishi International Corporation, which itself is owned and operated by a large Japanese complex which manufactures a line of consumer electronic and home appliances.

## EIA Says 1968 Radiation From TV About 1/10 of Permissible

Total radiation from TV in 1968 was less than .5% of average annual dose from natural background sources, according to the findings of an Electronic Industries Association (EIA) Ad Hoc Committee, which used the results of the U.S. Public Health Service in-home color TV radiation tests in the Washington, D.C. area as the basis for the projection.

The projected figure of .5% is about 1/10 of the average annual permissible dosage from TV recommended by the National Council on Radiation Protection and Measurement.

## Electronic Store Primary Tape Equipment Source, Says Time Survey

More people purchase tape equipment from electronic stores than from any other single source, according to the results of a survey recently conducted by Time magazine and reported on in Home Furnishings Daily.

Questionnaires reportedly were sent by an independent research firm to 2,580 individuals who recently purchased tape equipment. The individuals were selected at random from the warranty cards of four leading manufacturers of tape equipment.

	Total 100.0%	Monaural Cassette 100.0%	Stereo Cassette/ Stereo 8 Track 100.0%	Reel to Reel 100.0%
Electronic Store	35.8	27.4	35.9	45.9
Department Store	18.2	20.4	20.9	11.7
Discount				
Department Store	11.3	15.6	9.2	8.5
Camera Store	7.0	7.5	5.6	7.8
Appliance Store	4.0	4.7	4.5	2.8
Miscellaneous				
Other Stores	20.1	20.7	19.2	20.2
No Answer	3.6	3.6	4.7	3.7

Base: 995 respondents

## Land Mobile Communication Wins New UHF Channels

UHF television channels 14 through (and including) 20 not already assigned a TV station will be assigned to land mobile communications users in ten of the largest metropolitan areas, according to a recent vote of the Federal Communications Commission (FCC).

The FCC also have voted to make available on a permanent basis to land mobile radio users UHF channels throughout the country.

Users of land mobile radio include police and fire departments, taxicabs and other businesses who have

# Quick-connect Fuseholders and Fuseblocks

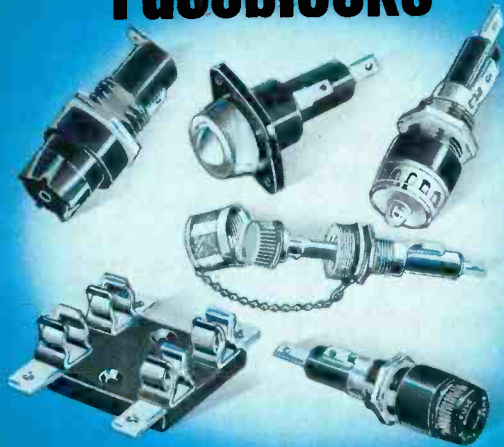

The complete line of BUSS fuseholders and fuseblocks is available with quick-connect terminals to save assembly time and cut costs.

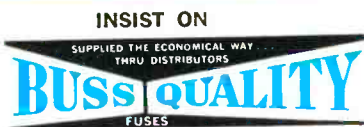

Write for BUSS Form SFB

Bussmann Mfg. Division, McGraw-Edison Co., St. Louis, Mo. 63107

tronic experts reportedly determined that the charred TV set was an RCA color set equipped with a CTC15 chassis.

Last February, RCA issued a service bulletin advising service technicians to replace the plastic on/off switch in the CTC15 chassis with a metal one which would not melt if the set became "overheated". Earlier, this particular chassis had been cited by the National Commission on Product Safety as being defective.)

The National Electronic Association, in a report by that association's product safety committee at the NEA convention in St. Louis in July, has stated that reports received from independent servicers during the period January 1 to March 30 indicate that TV fires and smoke do not occur as often as estimated by the commission on Product Safety.

According to the NEA committee, there annually are about 4000 TV failures which produce indications of combustion. Of these, only 800 (20 percent) actually catch fire to the back cover, cabinet or a large component and are a potential source of a serious fire.

Areas of specific defects and their relative contributions to reported fires in TV are estimated by NEA as: On/off switch area, 38 percent; high-voltage/horizontal-output transformer area, 33 percent; shorts that cause power supply overheating, 13 percent; and miscellaneous, 16 percent.

## BUSS: The Complete Line of Fuses and . . .

the need for radio dispatching and control of vehicles.

There now are about three million land mobile broadcasting stations in use in this country. Industry sources estimate that the total will increase to over seven million by 1980.

### Sylvania Appoints Jackson, Miss., Distributor

Tristate Electronics has been appointed Sylvania franchised distributor in the Jackson, Mississippi, area.

The principal location of Tristate Electronics is 124 West Smith Street, Jackson.

### Color TV Safety Record

#### Unacceptable, Says Government Commission; NEA Says Government Wrong

Color TV sets were included in a list of 17 products which the Commission on Product Safety singled out in its final report as containing risks often enough to be rated "unacceptable".

The commission report estimates that color TV caused 10,000 fires last year. Details in the report about some of these fires even includes the names of those killed in the blaze.

(In July, three children, ages 5 to 11, were killed in a fire which swept through their home in Hamilton Township, New Jersey. Local fire officials stated that the fire was caused by an "overheated" TV set, according to a report in *Home Furnishings Daily*. Elec-

# Tron Rectifier Fuses



Available in sizes from 1/2 to 1000 amps for voltages up to 1500, TRON Rectifier Fuses are ideal for protecting variable speed drives, inverters, battery chargers, plating power supplies, power controls, and any other application where fast opening and great current limitation are required.

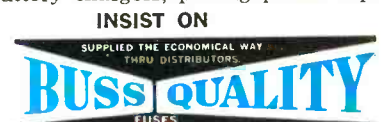

Write for BUSS Form TRFS

Bussmann Mfg. Division, McGraw-Edison Co., St. Louis, Mo. 63107

Circle 12 on literature card

# FUSES

for protection of Electronic Devices



There is a complete line of BUSS Quality fuses in 1/4 x 1 inch, 1/4 x 1 1/4 inch, and miniature sizes, with standard and pigtail types available in quick-acting or dual-element slow blowing varieties.

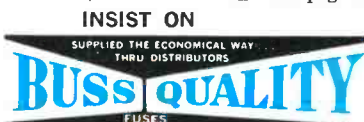

Write for BUSS Form SFB

Bussmann Mfg. Division, McGraw-Edison Co., St. Louis, Mo. 63107

veys had indicated were capable of emitting excessive radiation.

BRH's report says the tests indicated that "in all cases, if the voltage had been held down to within the manufacturers' suggested minimum operating value, no set would have violated the standard. Future sets will have to . . . employ circuitry designed to perform this function of voltage hold-down."

The report also stated that, based on preliminary data, Japanese-made color tubes "might be more poorly shielded than are their American counterparts."

Paperback copies of the full report, titled "Laboratory Testing and Evaluation of Color TV Receivers Acquired During the In-Plant Survey (BRH/DEP 70-6)", is available for \$3.00 from Clearinghouse for Federal Scientific and Technical Information, Springfield, Va. 22151. Microfiche copies are available for 65 cents.

## RCA Introduces Plug-In, Throwaway Ceramic Modules and 110-Degree Color CRT

Plug-in, throwaway ceramic modules and a 110-degree picture tube are employed in a radically new 18-inch all-solid-state color TV recently introduced by RCA.

The new "Argosy" color receiver, which is 4 inches slimmer than sets equipped with the more conventional

## Fuseholders of Unquestioned High Quality

### FCC Extends Deadlines For Comparable Tuning

The Federal Communications Commission (FCC), in response to petitions, has given U.S. TV manufacturers more time to make UHF tuning mechanisms comparable to those for VHF.

The FCC previously had ruled that after May 1, 1971, all television receivers manufactured with screens larger than 9 inches must be equipped with comparable tuners for UHF and VHF channels, and receivers with screens smaller than 9 inches must be so equipped by May 1, 1973.

The commission recently issued new compliance dates in the form of a step-by-step timetable requiring comparable UHF and VHF tuning on 10 percent of models produced after July 1, 1971, on 40 percent of models produced after July 1, 1972, on 70 percent made after July 1, 1973 and on all sets produced after July 1, 1974, regardless of screen sizes.

### Excessive High Voltage Major Cause of Color TV X-Radiation

The predominant cause of X-radiation in color TV receivers is excessive high voltage on the picture tube.

This reportedly is the conclusion reached by the Bureau of Radiological Health (BRH), U. S. Department of Health, Education and Welfare, after laboratory tests of 22 color receivers which previous in-plant sur-

## Subminiature Fuses and Fuseholders



BUSS has the fuses and fuseholders for space-tight applications, in a wide range of ampere ratings from 1/100 to 15. Allow visual inspection of element. Tiny but tough, they're built to withstand severe environments.



Write for BUSS Form SFB

Bussmann Mfg. Division, McGraw-Edison Co., St. Louis, Mo. 63107  
Circle 13 on literature card

90-degree CRT, reportedly has 75 percent of circuitry contained in 11 small plug-in circuit boards. Initially, only 3 of the 11 plug-in modules will be thick-film ceramic types, which combine printed and encapsulated discrete components; however, ceramic equivalents reportedly are being developed for the remaining 8 discrete-component modules and will be phased into the new chassis as they become available—and even used as direct replacement.

The 3 ceramic modules ready for use now measure about 1 $\frac{3}{8}$  inches by 1 $\frac{5}{8}$  inches and are nearly flat. Each module is pre-adjusted; the service technician merely snaps out the defective module and plugs in the new one, without performing any circuit adjustments. Different sizes of plug-in sockets are used for each module, to prevent insertion of the wrong module.

Standardization of module design for specific functions reportedly will permit the use of the same modules in a number of different receivers without adjustment, thus reducing the number of replacement modules required.

Present RCA modules employing discrete components are repairable, but new ceramic units that will replace them will be designed to be discarded. Smaller ceramic modules reportedly might cost as little as \$3 each.

Five integrated circuits are included in the new design. Two of these contain all chroma processing circuits, including a gain-controlled chroma amplifier, band-pass amplifier, injection-lock type oscillator ACC detector/amplifier, killer detector/amplifier, DC chroma gain control, two zener diode voltage regulators, synchronous detector with color difference matrix, tint control, oscillator injection limiter, and the color difference amplifiers.

The new ceramic modules are being manufactured by RCA Consumer Electronics in a new automated facility in Indianapolis. Ceramic circuitry used previously in RCA FM stereo tuners was purchased from outside sources, including Centralab and Sprague.

Designated RCA 18VANP22, the new 110-degree, 18-inch color CRT has been designed with a small (29 millimeter) neck diameter to reduce the deflection power required to scan the wide-angle tube, and to reduce the beam landing and convergence corrections required. Installation and set-up procedures for the new picture tube are similar to those for presently used 90-degree tubes.

### 1969 Sales of Consumer Electronic Products Reach \$5.3 Million

Total U.S. sales of consumer electronic products in 1969 reached an all-time high, \$5.3 million, including phonograph records and magnetic tape.

Consumer electronic products accounted for nearly 20 percent of the electronic industries \$25.8 billion total annual sales, which itself is up 5.3 percent from the previous year.

These and other statistics about major electronic markets are included in the **Electronic Market Data Book**, recently published by the Electronic Industries Association (EIA). Copies of the 98-page publication can be obtained for \$15 each from the EIA Public Relations Department, 2001 Eye Street, N.W., Washington, D.C. 20006.

### Color TV "X-Radiation Monitor"

A new device that reportedly warns color television owners of the potential of dangerous X-radiation from their sets is being produced by Audio Equipment Co.

Called "Rayguard", the unit monitors the high voltage providing a warning to the set owner on a small meter when the voltage exceeds levels set by the manufacturer of the television. Excessive high voltage, most often related to faulty components or incorrect adjustments, reportedly can produce potentially dangerous levels of X-radiation.

The device consists of a sensor unit, which must be installed inside the set by an electronic technician, and

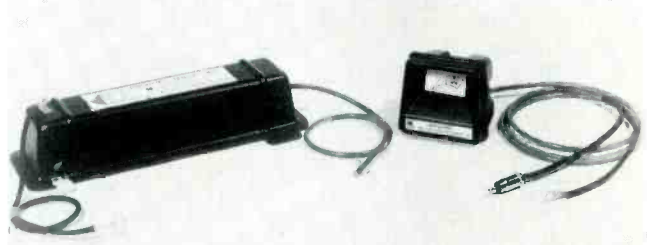

a meter, which is set in a bracket at the rear of the set. A needle on the meter enters a clearly marked yellow danger area when voltage in the receiver exceeds prescribed limits.

The set owner is instructed, upon noting a reading that indicates excessive high voltage in his set, to turn the receiver off and contact a service shop for replacement of defective parts or proper adjustment of the high voltage.

"Rayguard" reportedly will be distributed through television service shops.

### Servicing Dealers Fare Better Than Non-Servicers

The 1969 dollar sales of non-servicing appliance/radio/TV retailers decreased 2.75 percent from 1968 sales and after-tax profits dropped to 1.7 percent of volume from 2.0 percent in 1968, while the dollar sales of servicing dealers increased 5.1 percent over 1968 figures, and after-tax profits were 3.0 percent of volume, according to a preliminary report of 1969 cost-of-doing-business statistics compiled by the National Appliance and Radio-TV Dealers Association (NARDA) through their 24th annual cost-of-doing-business survey. The preliminary report appeared recently in **Merchandising Week**.

Copies of the completed computerized survey reportedly are available without charge to participating NARDA members, \$10 to non-participating NARDA members and \$25 to all others. Requests should be sent to: NARDA, 318 W. Randolph St., Chicago, Ill. 60606.

### Zenith Chroma Circuitry On Three IC Chips

The color demodulator, chroma amplifier and sub-carriers reference oscillator sections in Zenith's new series of 19-inch color TV receivers are each contained on a single integrated circuit (IC) chip that is less than one-sixteenth of an inch square.

The three IC chips, mounted on Zenith's new Dura-Module plug-in circuit boards, reportedly in combination are the equivalent of 58 transistors, 15 diodes and 88 resistors. ▲

# Now a Heathkit®

## Solid State **Vectorscope/Color Generator**

### Only \$124.95\*



#### Accurately Performs All Of These Adjustments:

- Raster
- Static & Dynamic Convergence
- Purity
- Gray Scale

- 3.58 MHz Oscillator
- Reactance Coil
- Phase Detector Transformer
- Demodulator Angle Check
- Chroma Bandpass Touch-Up

Kit IO-101, 12 lbs. . . . . \$124.95\*

#### Fast switch selection of standard 9 x 9 display . . . or exclusive Heath "3 x 3" display

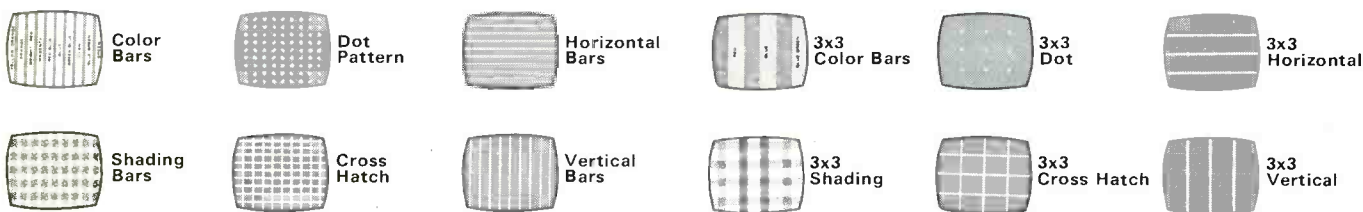

**IO-101 SPECIFICATIONS — PATTERNS — Purity:** Produces a snow-free raster for purity adjustments. **Dots\***: 9 x 9 produces a display of 110 small dots. 3 x 3 produces a display of nine dots for convergence adjustments. **Crosshatch\***: 9 x 9 produces a display of 11 vertical and 10 horizontal lines. 3 x 3 produces a display of three vertical and three horizontal lines for convergence and linearity adjustments. **Horizontal Lines\***: 9 x 9 produces a display of 10 horizontal lines. 3 x 3 produces a display of three horizontal lines for vertical linearity and pin-cushion adjustments. **Vertical Lines\***: 9 x 9 produces 11 vertical lines. 3 x 3 produces a display of 3 vertical lines for horizontal linearity and convergence adjustments. **Color Bars\***: 9 x 9 produces a display of ten standard color bars. 3 x 3 produces a display of three standard color bars. A visual fingerprint (voltage pattern) of all ten color bars in the form of a petal pattern is displayed for color circuit servicing. **Gray Scale:** Provides a wide bar crosshatch pattern with six shades of brightness for color gun level adjustments. **OUTPUT SIGNALS — Video:** Greater than  $\pm 1$  volt peak-to-peak composite signal for composite signal injection beyond the video detector. **RF:** Variable to approximately 25,000 uV output, channels 2 through 6, for composite signal injection into the TV receiver antenna input terminals. **Sync:** Greater than 3.5 volts peak-to-peak signal for servicing sync circuits without video, or sets having separate video and sync demodulator phase adjustments. **GENERAL — Power Requirements:** 105-125 or 210-250 VAC, 50/60 Hz, 20 Watts. **Cabinet Dimensions:** 6 $\frac{3}{4}$ " W x 9 $\frac{1}{4}$ " H x 14 $\frac{1}{2}$ " D. **Net Weight:** 9 $\frac{1}{2}$  lbs.

\*The number of dots, lines, and bars indicated for a 9 x 9 display is the number displayed if the receiver under test has no overscan.

**HEATH COMPANY, Dept. 25-9**  
Benton Harbor, Michigan 49022  
*a Schlumberger company*

Please send FREE Heathkit Catalog  
 Please send IO-101 Specification Sheet

Enclosed is \$ \_\_\_\_\_ plus shipping.  
Please send Model IO-101

Name \_\_\_\_\_

Address \_\_\_\_\_

City \_\_\_\_\_ State \_\_\_\_\_ Zip \_\_\_\_\_

Prices and specifications subject to change without notice.  
\*Mail Order Prices; F.O.B. Factory

TE-222

Circle 14 on literature card

# CES wrapup

Some of the new equipment you'll be servicing next year was displayed this June at the Consumer Electronics Show in New York.

---

Well over 31,000 dealers and reps drifted through 210 exhibits in the Americana and New York Hilton hotels during the CES. What they saw was an extravaganza of new selling ideas, new kinds of equipment, and new shapes and appearances in familiar equipment. If you missed the big CES, it may be several months before you find out what the manufacturers have in store for you. So you wouldn't miss out altogether, ELECTRONIC SERVICING had a reporter there. Here is his report.

---

Domestic TV manufacturers were pointedly absent from the Show. Many had hospitality suites in nearby hotels, but few displayed anything. A few have permanent showrooms in midtown Manhattan, and showed new lines there. But the majority of CES-goers didn't see them.

Everybody came to the CES worried about business. Action was plenty after they got there. Interest in new lines was high, and showgoers and exhibitors alike decided the 1971 selling season is going to be a good one.

One sour note was the new record-keeping requirement. The U.S. Department of Health, Education and Welfare (HEW) has decided dealers have to fill out reports of who buys any kind of TV set. The rule went into effect June 27, the day before the Show. The "official"

magazine surveyed dealers at the Show and reported that less than a tenth of them were complying; less than 20 percent even knew what the new rule was all about. What's being done about that by HEW isn't known.

A wide selection of new electronic gadgetry for the home was evident in a few categories: "Quadrasonic" is the big word in stereo for now. Digital clocks in radios made a strong splash. There also was a rash of odd-looking, mod-looking little radios—some AM-only, some AM/FM, although AM/FM dominated ordinary table radios. The electronic video player developed by CBS Laboratories and manufactured by Motorola was there, but it was overshadowed by a cartridge-tape video recorder/playback made by Cartridge Television, Inc., a division of Avco. It's being built and marketed by Admiral.

### Four-Channel Stereo

You've undoubtedly heard about the new kind of stereo called quadrasonic. You have the regular two speakers in front of you on the left and right. Then you have two more speakers behind you. They carry left and right rear-channel sound.

When quadrasonic tapes are made, four mikes are used—the regular two and two more at the rear of the "hall". The two extra mikes pick up reflected and reverberated

sound, the same sounds you'd hear if you were actually seated out in the hall or auditorium. The result is more realism, imparting a quality called "ambiance."

Several companies at the CES brought reel-type tape recorders and players for quad sound. Among them were Crown, Teac, Telex/Viking, and 3M/Wollensak. You can see typical units in Fig. 1. The Teac has its electronics with it—two regular stereo bias-and-pre-amplifier systems. Servicing them is no different than servicing other stereo tape machines, except alignment of the four-channel heads is more critical.

Prerecorded cartridge tapes are more popular for quad sound than reel types. Vanguard Records produced the first. Others have already followed: RCA Victor, Columbia Records, Ampex, and some specialist companies. More will come shortly.

Cartridge machines for quadrasonic tapes are based on the eight-track models pioneered by Lear-Jet. Special heads, most made by Nortronics and Michigan Magnetics, simply handle four channels at once instead of two. The Vanguard system looks like the standard: track 1, left front; track 2, left rear; track 3, right front; track 4, right rear. A second program is played on the remaining four tracks. Again, head alignment is the only way servicing



**Fig. 1** Four-channel reel tape decks for quadrasonic recording and playback. There are few pre-recorded four-channel reel tapes, but quality is claimed to be better than with cartridge formats.



it differs from eight-track stereo—except of course there are four amplifiers and four (or more) speakers.

A home-type recorder/player for cartridge quadrasonics is pictured in Fig. 2. It's from Telex/Viking. A couple of Japanese companies demonstrated auto units for four-channel. Some U.S. companies have them, but they weren't at the Show. Even cassette quad units will be available by the end of the year.

Quadrasonic sound is no longer imaginary; the CES proved that. A system of putting four channels on a stereo FM station was demonstrated, though results were not as good as anticipated. That might be a year or two away, but it's sure to happen. Even a four-channel stereo disc is in the works, but tape and FM probably will be the chief program source for quadrasonic music.

### Cartridge Tape Changers

Hi-fi dealers at the CES got some other surprises. One was changer mechanisms for playing cartridges.

Panasonic grabbed attention with a deck (Fig. 3) that plays 20 cassettes. It's a carousel, and can be programmed to play cassettes in sequence or random group selection. Also, any three can be set to play in whatever order a listener wants. The deck automatically plays the reverse track of each cassette before going to the next.

Benjamin/Lenco also had a carousel changer at the Show that handles 24 cassettes—that's 24 hours of monophonic playing time.

A company called Qatron has a changer for eight-track cartridges. The rotating magazine holds twelve, for at least 6 hours of stereo playing. Fig. 4 shows the Qatron changer mounted in an AM/FM stereo console.

A close examination of mechanisms in these changers reveals what you might expect: They combine some characteristics of a tape machine with some of a record changer. The turntable or "magazine" that holds the cartridges or cassettes is detented to hold the active tape accurately against the head. When a cassette tape plays through, a metallic strip at the end reverses the transport. With an eight-track changer, the strip moves the head to the next set of tracks. When either kind of cartridge has played to the end, the strip activates the



**Fig. 2** Quadrasonic cartridge player / recorder includes the electronics for all four channels. This is actually a whole four-channel home tape system.

changer and it moves the next cartridge into position for playing.

The only added consideration is the extra cleaning needed for the heads. Tape heads **do** wear out. When they get noisy and cleaning and demagnetizing don't help, be sure to install new ones. Cassette stereo heads are particularly vulnerable. Not that they're especially prone to wear, but the slow speed makes stereo fidelity open to question anyway; a little too much wear or oxide on the head can make noise intolerable to the critical listener.

### Modular Construction

Something new and unique in FM stereo receiver design was shown at the CES. H. H. Scott displayed a "state of the art" FM stereo receiver that scan-tunes electronically across the entire FM broadcast band. It can be set to stop at any station strong enough to listen to, or at any station broadcasting stereo, or at whatever station is programmed on a small card that fits into a front-panel slot. The listener can also push a bar to keep the tuner scanning.

The Model 433 Scott tuner, shown in Fig. 5, uses a crystal-based frequency synthesizer. It tunes extremely accurately any of the 100 FM channels in the band. There's no dial or mechanical tuning—just var-

actor tuning. The station frequency appears on cold-cathode, luminescent digital indicators.

Servicing? You mainly have to understand the "synthesis" method of making many frequencies from a few fixed ones. (**Editor's note:** Allan Dale covers that very subject in next month's **Service Bench** department). Otherwise, the 433 is much like any FM stereo tuner. It uses some integrated circuits (IC's), as do several other hi-fi tuners at the CES. But in Scott units they're easier than usual to service: Modular construction does it (Fig. 5A). Sections of the unit are on plug-in circuit boards. When one section has a fault in it, just install a replacement module.

Scott isn't the only one with search tuning. Kenwood, a Japanese importer, has an AM/FM/stereo receiver equipped with automatic tuning. However, the Kenwood tuner is mechanical, similar in some respects to car-radio search tuners. (**Editor's note:** Search tuning was covered in the April and May 1970



**Fig. 3** Cassette changer deck handles twenty cartridges at a time.



**Fig. 4** Changer deck for eight-track cartridges operates vertically, as it is mounted here, or horizontally. The unit plays twelve cartridges.



**Fig. 5** FM stereo receiver with digital station indicators uses electronic tuning by frequency synthesis to pick out FM stations. Electronic scanning lets tuner hunt active stations within listening range. Modular design (B) drastically improves serviceability.

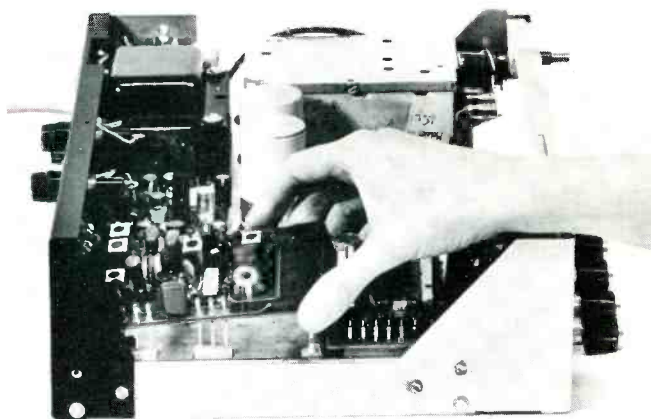

**Fig. 6** Home electronics industry's first product to use large-scale integrated circuits (LSI), which is part of logic circuitry that operates digital clock. Radio is conventional AM/FM.



issues, on pages 26 and 36, respectively.) The Kenwood Model KR-7070 has several IC's and FET's, crystal IF filters for FM, and a mechanical IF filter for AM. Except for critical front-end alignment, and the search-tuner arrangement, servicing the unit is little different than servicing any other stereo receiver.

### Digital Clocks

When you mention digital indicators, you can't ignore another trend: digital-reading clocks in radios. They show up in both simple AM jobs and fancy AM/FM table radios. Prize for the fanciest one at the CES should go to General Electric. The G.E. Model C4390 radio in Fig. 6 has a completely all-electronic clock. (Usual digital-reading clocks are electromechanical, with number wheels.)

The all-electronic clock uses extensive logic circuitry. This might

have made the whole idea prohibitively expensive, except that large-scale integration (LSI) is used. More than 800 logic-type transistor elements are contained on a single chip of silicon only a fraction of an inch square. The numerals are electroluminescent, and the timer is as accurate as any power-line controlled clock. If power goes off, an internal battery takes over for up to thirty minutes.

Yet, you won't have to be a computer expert to service one of these clock radios. The radio is ordinary AM/FM—no problem there. If the logic section of the clock goes bad, you replace the whole clock module. As more home electronics units appear with computer-IC sections like these, you don't have to worry—servicing almost invariably will be modular.

But you do have to do one thing. Before you get bogged down in ser-

vic-ing unique equipment like this, make sure the manufacturer has set up sensible and speedy supply lines for oddball components and modules. Without that, you are just asking for problems with customers. Plan ahead; find out whether you can get parts before you get involved. If not, you might want to turn down the repair of that brand or model.

A couple of other digital clock radios we saw at the Show also typify the modernistic look of radios. One is the Motorola Model TC70, at the top in Fig. 7. The clock numerals are on wheels, but they're lighted. The radio is AM/FM.

The other is the sleek Model 1736 from Magnavox, pictured at the bottom of Fig. 7. The clock is different in this one. The numerals flip down somewhat like the pages of a desk calendar.

Neither of these radios offers any special servicing problem; just be sure you know where to send the clocks for repair or where to get replacement clocks.

### Speakers Shaping Up

One of the housewife's regular complaints about component stereo—or even compacts—is the drab



Fig. 7 Digital clock radios take on sleek "mcd" appearance, which showed up throughout the entire line of radios at CES. Both have clock indicators slightly different from usual numbers-on-wheel systems.

plainness of stereo speakers. "Wooden boxes," they call them.

Not every speaker-maker has gotten the message yet, but some who make medium-priced compact systems have. A few we saw at the Show are pictured in Fig. 8.

Prize for the most versatile goes to JBL (James B. Lansing Sound, Inc.). Its Aquarius series of "environmental loudspeaker systems" offers unequalled aesthetic possibilities to homemakers or interior decorators. They are Portion A of the speaker grouping in Fig. 8.

The trend to omnidirectional speakers was strengthened at the Show by compact systems like those in B and C of the speaker grouping. The one in B is Panasonic; the one in C is Electrophonic. And the Grenadier model from Empire Scientific is another (D in Fig. 8). It's designed as an end or corner table,



and comes with marble top, if you want it.

There were a dozen or more others, but these in particular we noticed and obtained pictures for you.

### More Solid-State TV

Take a look at Fig. 9 if you want to see a solid-state TV chassis that is typical of those you might be asked to service before this year is ended. This Panasonic monochrome set has five integrated cir-

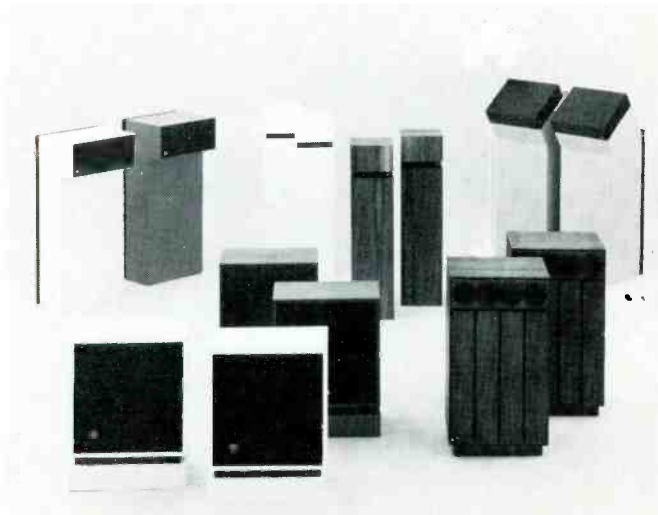

Fig. 8 Shown here are several kinds of stereo speaker designs that manufacturers are coming up with to combat image of "boxes" that prevails among most housewives. Maybe husbands in future can have component stereo without so much hassling over its appearance.



cuits. Notice the heavy shielding around the flyback transformer; that heavy aluminum also makes a heat sink for the power transistors mounted on the chassis.

Something you can't see in the photo, but will soon be concerned with, is the 10-position detented UHF tuner. Because of the new tuner-equality rule the FCC passed just before Showtime, all sets will soon have one form or another of UHF tuning that matches the tuning convenience of VHF. For you, it means more adjustments to make—usually critical ones at UHF frequencies—and more mechanical tuner contacts to keep clean and tight.

The only manufacturer we saw at the Show with an electronic tuner to meet the "equality" demand was Electrohome. Other makers have them, but they didn't display at the CES. The Electrohome tuner was shown for the first time last year—probably the first all-electronic UHF/VHF tuner in the field. It uses 18 metallic touchbuttons and a bar; a channel is activated by body conductivity as the viewer touches

a finger simultaneously to the bar and a button.

### Home TV Recorder

Next to quad stereo, the most talked-about event at the Show was "Cartrivision." That's a new cartridge-loaded, magnetic-tape recorder and playback unit for video programs. Take a look at Fig. 10. We saw a demonstration (the thing does work) and we talked to some engineers from Cartridge Television,

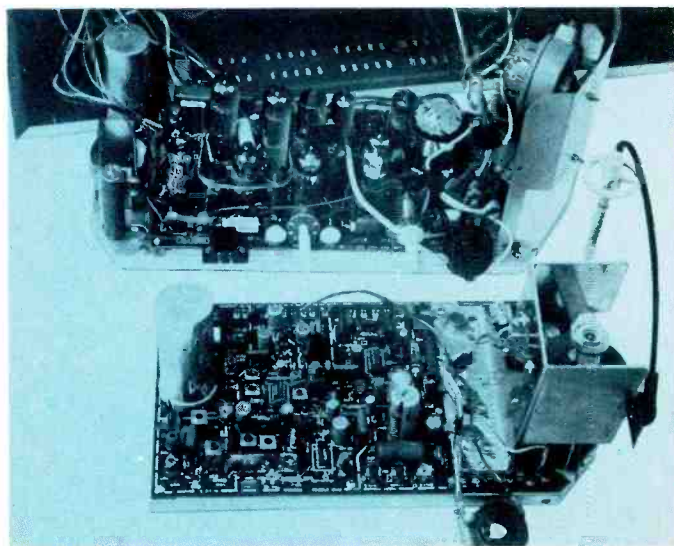

Fig. 9 Solid-state imported monochrome TV has five integrated circuits (IC's)—typical of increased use of IC's in all home electronics equipment. Significant use of IC's seems highly unlikely for at least a few years.

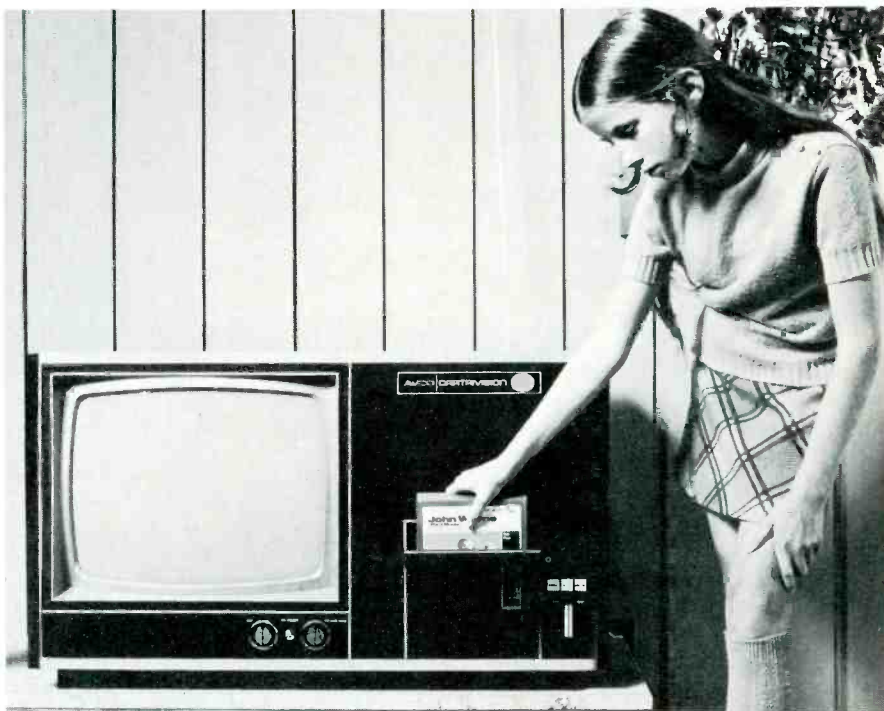

Fig. 10 Consumer Show's star product was this home video player/recorder. Only one available so far that does both, at price under \$1000 including large-screen receiver. Home movies are easy to make with accessory camera. Magnetic-tape cartridges fit into slot for playing.

Inc., the company that developed the machinery.

The Cartrivision unit we saw is part of a large-screen Admiral color television set. (Admiral is to make and market the unit.) A cartridge about the size of a book fits into a trapdoor on the front of the receiver. You close it, turn the switch, and the unit records, in color, whatever program is playing on the TV set. Rewind the tape and turn the switch to "Play", give it a few seconds to stabilize, and the same color program is played back on the TV screen. The quality we saw wasn't equal to that of the original broadcast, but it was viewable.

The cartridges are filled with up to an hour's worth of half-inch magnetic tape. It is drawn at 3.8 ips past three heads which scan it helically; the heads spin at 1200 rpm. The unit shows only every other frame, but that didn't seem to bother what we saw.

Big thing is the library of pre-recorded tapes being made to sell or rent to owners of Cartrivision sets. Some are pretty old: "The Maltese Falcon" with Humphrey Bogart and "Little Caesar" with Edward G. Robinson; but a few are newer: "Exodus" and "Zulu". Rentals for pre-recorded tapes start at \$3 per showing; some for sale will retail as high as \$25.

The receiver/recorder/playback machine sells for under \$1000. A small camera for making your own "home tapes" will be about \$200 (black-and-white, of course). Empty tapes run from \$10 for 15 minutes to \$25 for 2 hours.

A deck is to be available in the future for attaching to any TV set, priced at \$400 or \$500. One engineer said the deck would be simple and cheap to add to a set. Don't bet on that. It requires quite a bit of under-chassis wiring and work, and will be costly to a customer. Adding the camera is simple, though; jacks are provided for it and the microphone.

We were told consumer electronic technicians will be expected to service Cartrivision sets. They're nothing to be worried about, yet you'll have to be sure you can get service data and parts. Heads will likely need to be cleaned periodically, and they won't last much beyond 1000 hours of playing. This could mean replacement every 2 or 3 years, or

even yearly. Installing and aligning them is a job you should get prepared to tackle.

All in all, the Cartrivision scheme seems to have a long jump on the CBS/Motorola EVR system and the RCA SelectaVision system. Neither of those is a recorder, and neither company expects to have hardware for the home market before late 1971. If Cartrivision keeps to schedule, you'll probably be servicing them by early next year.

### More Next Time

The Show this year was the biggest ever, despite the fact that the "big" TV manufacturers were missing. Overall, the CES looked almost like a hi-fi show.

There were several companies new to consumer electronics and to the Show. Here are some of them.

Altec Lansing, long known for commercial sound, introduced stereo components and speakers for its first foray into home electronics. The BIC/LUX division of British Industries Corp. showed stereo components. Castagna Electronics Corp. had compacts and tape equipment at the Show. Chiyoda Electronics Co. displayed various kinds of audio equipment. Mitsubishi of Japan displayed color and monochrome TV and radio under the "MGA" brand. Nikko Electric Corp. showed audio accessories. Telusa, Inc. had TV, tape machines, radios and speakers. Toyo Radio had stereo component units, radios, and recorders. The Vivitar division of Ponder & Best, Inc. displayed a line of tape recorders and receivers. Zodiac Sound Inc. showed speaker systems.

Those are new names you can start watching for in the consumer electronics industry. Always, though, when you're asked to service one of these new brands, you'd best make sure you can get service information and parts for them. It's only trouble for you when neither is available.

Next year, the 1971 Consumer Electronics Show promises to be even larger. It will be held in Chicago, at the new McCormick Place, which has lots more room than the two hotels in New York. More exhibitors are expected, including the return of several big-name TV manufacturers. It'll be held June 27-30. Maybe we'll see you there. ▲

## NEW from TAB

### ALL-IN-ONE COLOR TV SCHEMATIC/SERVICING MANUALS

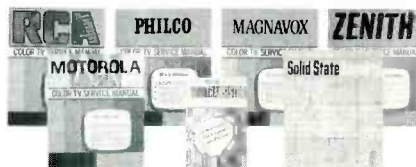

Each Manual contains EVERYTHING you need to service all models of the brand covered

Now, in one convenient manual, you can have immediate access to all the pertinent information you need to service brand-name Color TV receivers. Each manual contains descriptions of unusual circuits, field-service change data, causes and cures for repetitive and unusual troubles, alignment instructions, setup and convergence procedures, and other helpful servicing data. Also included are full-size schematic foldout sections with complete schematic diagrams for virtually all models produced by each manufacturer. Choose from 7 large 8 1/2 x 11" manuals now available for immediate shipment in either paperback or long-life leatherette cover.

#### RCA COLOR TV SERVICE MANUAL

Covers 23 different chassis designations, from CTC-12 to all solid-state CTC40, 176 pages, plus 36-page foldout containing 12 complete schematic diagrams.

No. 496 Leatherette cover \$7.95; paper \$4.95

#### ZENITH COLOR TV SERVICE MANUAL

Covers all chassis designations from 27KC20 through hybrid models up to and including 14Z-8C50, 160 pages, plus 36-page foldout containing 12 complete schematic diagrams.

No. 502 Leatherette cover \$7.95; paper \$4.95

#### MOTOROLA COLOR TV SERVICE MANUAL

Covers all models using chassis designation TS-907 through TS-924, including the all-transistor TS-915/919, 160 pages, plus 18-page foldout containing 6 complete schematic diagrams.

No. 509 Leatherette cover \$7.95; paper \$4.95

#### PHILCO COLOR TV SERVICE MANUAL

Covers all chassis designations from 15M90-91 through the hybrid 20QT88, including small-screen portable model T5062WA, 160 pages, plus 36-page foldout containing 12 complete schematic diagrams.

No. 522 Leatherette cover \$7.95; paper \$4.95

#### MAGNAVOX COLOR TV SERVICE MANUAL

Covers all chassis designations from Series 37 through T940, including hybrid chassis T936, 160 pages, plus 36-page foldout containing 12 complete schematic diagrams.

No. 526 Leatherette cover \$7.95; paper \$4.95

#### G. E. COLOR TV SERVICE MANUAL

Covers all chassis designations from CA through KE, including HB and HC Porta-Color models, 160 pages, plus 36-page foldout containing 12 complete schematic diagrams.

No. 536 Leatherette cover \$7.95; paper \$4.95

#### SYLVANIA COLOR TV SERVICE MANUAL

Covers all chassis designations from 576 through E01, the newest solid-state models just introduced, 160 pages, plus 36-page foldout containing 12 complete schematic diagrams.

No. 539 Leatherette cover \$7.95; paper \$4.95

#### OTHER TERRIFIC SERVICE AIDS

##### 1970 POPULAR TUBE/TRANSISTOR

##### SUBSTITUTION GUIDE

All-in-one guide lists only readily-available and popularly-priced substitutes—no need for you to search through lists of tubes and transistors you'll rarely see in use. Covers popular receiving tubes, industrial tubes, American-foreign substitutes, popular transistor substitutes, foreign transistors, general purpose transistors, 224 pps.

No. 525 Leatherette cover \$4.95; paper \$2.95

##### HOW TO REPAIR SOLID-STATE IMPORTS

A large, diversified collection of schematics and service data for nearly 100 of the most popular foreign-made radios, tape recorders, and TV sets. And to help you find replacement parts, there is a list of importers and distributors. Also tells you what to do when a schematic isn't available. 160 pages, 8 1/2 x 11 1/2", plus 32-page schematic foldout section.

No. 532 Leatherette cover \$7.95; paper \$4.95

Use Handy Coupon Below to Order Manuals on 10-DAY FREE TRIAL!

TAB BOOKS, Blue Ridge Summit, Pa. 17214

Please send me the manuals checked:

496  502  509  522  526  536  
 539  525  532

I have enclosed \$..... Send post-paid.

Please invoice me on 10-day free trial.

Name .....

Address .....

City ..... State ..... Zip .....

If paying in foreign currency, add 10% exchange fee. Pa. residents must add 6% sales tax. ES97

Circle 15 on literature card

# photofact<sup>TM</sup>bulletin

PHOTOFACT BULLETIN lists new PHOTOFACT coverage issued during the past two months for new TV chassis. This is another way ELECTRONIC SERVICING brings you the very latest facts you need to keep fully informed between regular issues of PHOTOFACT Index Supplements issued in March, June and September. PHOTOFACT folders are available through your local parts distributor.

## ADMIRAL

Chassis 6H1063-1/-2/-7/-22/ -25, 6H1065-5, 6H1066-1 .....	1113-1
Chassis 4H1273-9/-13/ -17/-19, 4H1297-6, 11H1273-9/-13 .....	1116-1
Remote Control Receiver 11A9N, Transmitter S376AN .....	1116-1A

## ARVIN

Model 60K34-12 (Ch. 1.48201) .....	1112-1
---------------------------------------	--------

## BROADMOOR

6911C, 6911CA .....	1113-2
---------------------	--------

## CORONADO

TV21-7113A .....	1116-2
TV22-7104 .....	1120-1

## CRAIG

6302 .....	1122-1
6303, 6304 .....	1124-1

## CURTIS MATHES

52M594 .....	1118-1
--------------	--------

## DUMONT

Chassis 120926A, 120928A, 120957A, 120958A ....	1114-1
--	--------

## EMERSON

MODELS 18P48/50, 19P87/ 88/89W (Ch. 120959A/ 69A/70B) .....	1112-2
Chassis 120962A/963A/ 963B/964A/964B .....	1123-1

## GENERAL ELECTRIC

M132VEB-2, M138VVY-2 (Ch. V-2) .....	1114-2
---	--------

## HITACHI

CNA-25T .....	1117-1
---------------	--------

## MAGNAVOX

Chassis T934-01-AA .....	1117-2
Chassis T936-01-AA, T936- 02-AA/EA .....	1119-1

## MOTOROLA

Chassis AC23TS-915, AG23TS-915, AH23TS-915,	
--	--

C23TS-915, D23TS-915, E23TS-915, F23TS-915, G23TS-915, H23TS-915, C20TS-919 .....	1121-1
Remote Control Receiver TRR-7, Transmitter TRT-6 .....	1121-1A

## PACKARD BELL

Chassis 98C21/22/32/33	1124-2
Remote Control Mark 73/93 (WRT11, WRR19) ...	1124-2A

## PANASONIC

CT-94T, CT-95D, CT-95DC .....	1115-1
----------------------------------	--------

## PENNCREST

1315-89 .....	1117-3
2851 .....	1123-2

## PHILCO-FORD

B780TWA (Ch. 20T33)	1113-3
B820TWA, B830TWA (Ch. 20V35) .....	1118-2
Chassis 20QT87B/BX, 20QT88 .....	1119-2
Chassis 20KT40B, 20KT41B .....	1122-2

## RCA

Chassis CTC41A/XP, CTC42A/XP/XR .....	1112-3
Remote Control Receiver, Transmitter CRK13A ..	1112-3A
AP223WEN, AP225WEN (Ch. KCS174K) .....	1115-2

## SEARS

Chassis 564.10220 .....	1119-3
Chassis 562.10530/531 ...	1120-2
4033 (Ch. 562.10510, 562.10511) .....	1123-3
5029, 5030 (Ch. 562.10700/701) ..	1124-3
AM-FM Radio used in Models 5029, 5030 ....	1124-3A

## SONY

KV-1210U .....	1115-3
----------------	--------

## TRUETONE

EIS2065A-96 (2DC2065), EIS2067A-96 (2DC2067) EIS4020A-07 (2DC4020)	1118-3
WEG2063A-17 (2DC2063)	1122-3

## WARDS AIRLINE

GEN-12200A .....	1114-3
------------------	--------

## ZENITH

Chassis 14A9C29, 14A10C29 .....	1116-3
Remote Control Receiver S-80373 .....	1116-3A
Chassis 12A12C52, 12A13C52 .....	1120-3
Remote Control Receiver S-77536, Transmitter S83596 .....	1120-3A
A2050C, A2055W (Ch. 22AB55) .....	1121-2

# NOW you can measure resistors accurately

# IN CIRCUIT!

## in solid state devices



**FE20 HI-LO**  
with hi-voltage probe and large  
six-inch meter **\$129.50**



**FE21 HI-LO**  
with 4 1/2-inch  
meter **\$99.50**

## WITH THE NEW HI-LO FIELD EFFECT MULTIMETERS

**USES ONLY .08 VOLTS TO POWER OHMMETER TO PREVENT TRANSISTORS FROM CONDUCTING AND UPSETTING READINGS**

Look at these extra features to see why the Hi-Lo meter belongs on your want list:

- Unbelievable specifications of 15 megohm input impedance on DC and 12 megohms on AC
- Laboratory accuracy of 1.5 percent on DC and 3 percent on AC
- 9 DC voltage ranges from as low as .1 volts full scale to 1000 volts
- 3 hi-voltage ranges of 3 KV, 10 KV and 30 KV
- 9 DC zero center ranges from .05 volts to 500 volts . . . a must for delicate transistor bias measurements
- 7 resistance ranges from 1000 ohms full scale to 1000 megohms
- 9 DC current ranges from 100 microamps to 1 amp
- Automatic built-in battery test . . . never a worry about rundown batteries, just push the switches under the meter and read.
- Standard .6 amp fuse to protect the ohms and milliamps scales if voltage or overload is accidentally applied. No more need to return the meter to factory for repair . . . just replace the fuse.
- Special probe with 100K isolation resistor in probe to prevent AC pickup or to prevent loading oscillator circuits. Leave in normal position for most tests.

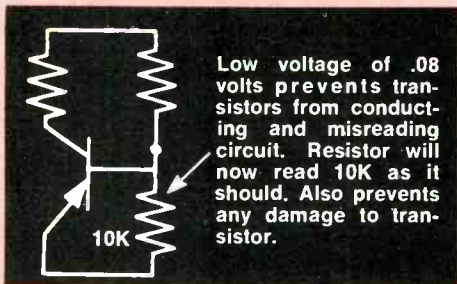

Here is why you should have both Hi and Lo battery voltages for correct in-circuit resistance measurements in solid state circuits:

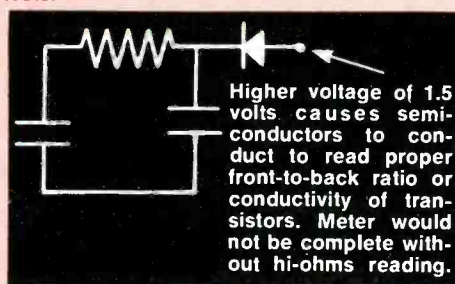

**SENCORE** INC. 3200 Sencore Drive • Sioux Falls, South Dakota 57107

Circle 16 on literature card

# How to Troubleshoot "No Raster"

## Part 1

Procedures and tips that simplify trouble isolation in one of the most confusing TV sections—by Bruce Anderson

One of the most frequent causes of customer complaint is loss of the raster. In many cases, if not most, the fix is fairly easy: replace the high-voltage rectifier, the damper, the regulator or the horizontal-output tube. In this article and the one to follow, the troubles which are not so simple to correct will be considered.

Sometimes, replacement of the tubes named above does not correct the trouble because the trouble is not loss of high voltage in the first place. It hardly seems necessary to point this out, but it is so easy to assume that loss of raster and

loss of high voltage are synonymous, when actually they are not.

First, how about the picture tube itself? Because picture tubes seldom fail suddenly, you can almost always assure your customer, even before you have seen the receiver, that the trouble is not the picture tube, unless the failure is the end result of several months of gradual loss of brightness. But hedge a little, because filaments do burn out. Also, some of the older, large-based tubes sometimes develop opens between the socket pins and the filament leads themselves. These may be resoldered.

Along those same lines, it has been a long time since we personally observed a picture tube (black-and-white) with an open between the high-voltage button and the aquadag, but we heard a report of this happening in a color tube; the raster remained, but it was out of focus, the purity was terrible, and there was blooming.

The presence of high voltage and a good picture tube are only two of the requirements which must be fulfilled before a raster can exist. The cathode-to-grid voltage must be out of cutoff, screen voltage must be present, and in most cases focus voltage also must be supplied to the focus grids, although not so in many monochrome tubes.

Before looking for other defects, it is good policy to make sure that all these voltages are present. You should carry a high-voltage meter with you on service calls, and check the high voltage of color receivers as a matter of policy. By making a habit of this, you might occasionally avoid pulling a chassis for a high-voltage problem when the trouble is elsewhere and can be fixed on the spot.

As an example, suppose the receiver has no raster but plenty of sound. You check the high voltage with a meter before pulling the chassis and find that it is right on the button—25 kv. The filaments of the picture tube light, and the customer tells you that the picture was normal the last time the set was on before it failed. At this stage of the game you get smart and check the cathode voltage of the picture

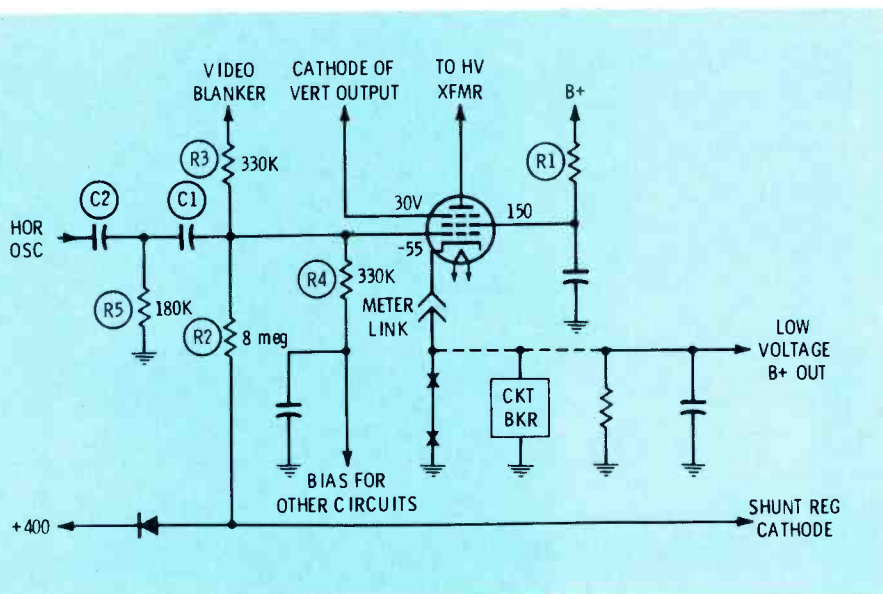

Fig. 1 Schematic of a "composite" horizontal-output circuit employing most of the features a technician will encounter. No horizontal-output circuit employs all of the features shown here.



# High Voltage”

tube. Behold, the voltage stays at about 400 volts, regardless of the setting of the brightness control. You change the video output tube and nothing happens, but at least you have a good idea of the trouble when you get to the shop. Just as important, you can tell your customer, with some feeling of certainty, what is wrong, and roughly what it will cost for the repairs.

Direct coupling between the last two or three stages of the video chain is common, and in transistorized receivers there can be as many as five direct-coupled video amplifiers. Remember, whenever stages are direct coupled, changes in bias will be amplified just as a signal, and a very minor change in the bias of one stage may turn into a cutoff voltage by the time it reaches the cathode of the CRT. But, enough of the extraneous problems; let's get on with the true no-high-voltage troubles.

## Horizontal Oscillator

In tube-type systems, failure of the horizontal oscillator not only causes loss of high voltage, but it also can lead to destruction of the horizontal-output tube as well. Unless the cathode return of the output tube is circuit-breaker protected, this is usually the case, although the line fuse or circuit breaker might open before the output tube becomes damaged.

In addition to complete failure of the oscillator, there is the possibility that the amount of drive from it to the horizontal output stage is insufficient. This, by itself, is not likely

to cause complete loss of high voltage, at least not right away. But a reduction of drive voltage might cause a decrease in picture width, with a reduction in high voltage and a tendency towards blooming. Also, the horizontal-output tube will not develop enough grid-leak bias voltage, which leads to heating and premature failure. Obviously, it is impractical to check the output amplitude of the oscillator each time a horizontal-oscillator tube is replaced. On the other hand, a receiver which has repeated failures of the horizontal output tube might very well be suffering from a case of weak “oscillator-itis”.

Possible, although not very likely, is the case where the oscillator is operating at some frequency which is very different from the normal 15,750 Hz. Since the operation of the horizontal-output transformer depends, at least to a degree, on resonance effects, off-frequency op-

eration is very inefficient and the high voltage may drop to the point where the raster is extinguished. Damage to the horizontal-output tube can follow if the receiver is allowed to operate under this condition for more than a few minutes.

Any large change in the value of a horizontal-oscillator component might affect the frequency. In many cases the frequency will decrease enough to be detected by the sound which is emitted. In other instances the frequency might increase and cannot be heard at all. If you have been in this profession long enough, your ears might be well calibrated at the horizontal frequency—don't be afraid to use this bit of knowledge; otherwise, use a scope to determine if the frequency is correct.

To check oscillator frequency with a scope, adjust the horizontal sweep rate to the point which is approximately correct and connect the vertical input of the scope to the

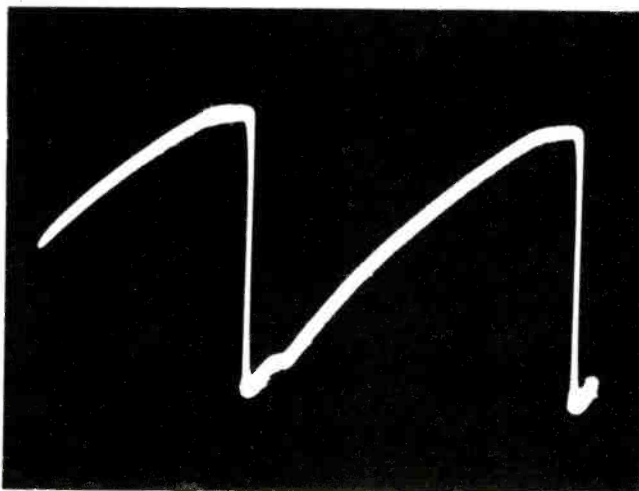

**Fig. 2** Typical horizontal grid drive pulse. Key feature is near-linear rise of forward slope.



# The RCA rotator has many features your customers won't understand. It has one that everyone recognizes: the name, RCA.

RCA engineers have produced the best in rotators. Beautiful, easy to operate control cabinets. Rugged, durable drive units. And they're tested. Continuous operation life-tested, under conditions no rotator would ever encounter in normal use.

The "extra feature" in every RCA rotator is the name . . . RCA. It's the feature your customers recognize, rely upon. It's taken over fifty years to build this kind of acceptance . . . acceptance that means more sales for you.

**RCA**  
Rotators

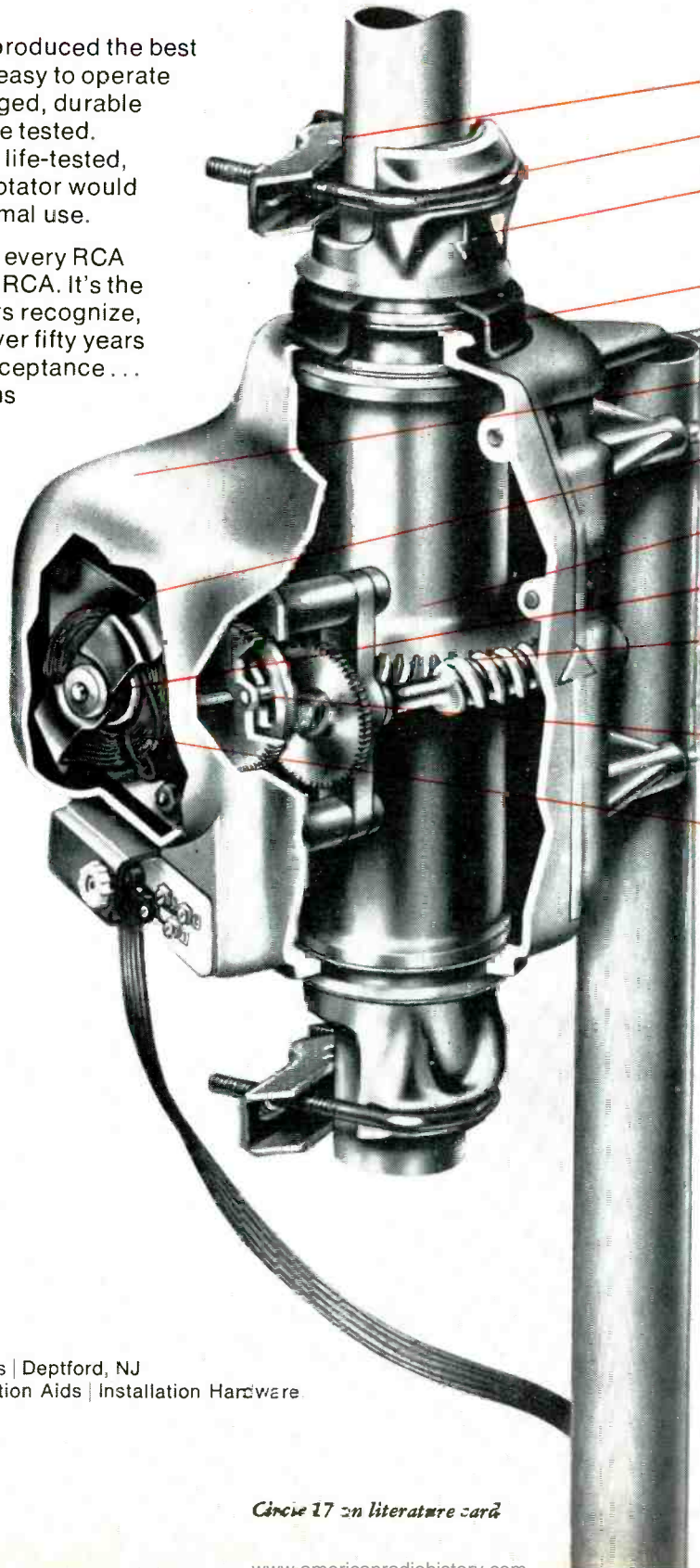

V-block serrated clamping system locks mast securely.

Reinforced shaft has nested "U" bolt.

Center-position alignment markers speed installation.

Stainless steel bearings are permanently lubricated. No external thrust bearings required.

High-tensile aluminum housing is rugged, lightweight for less inertial loading on mast.

High-temperature insulation on motor allows continuous operation.

Main drive gear is cast integral to main shaft; can't loosen.

Positive disc brake on motor prevents "overshoot."

Positive worm drive prevents windmilling.

Overtravel clutch permits motor to run before load is engaged—for pre-turning momentum.

High-efficiency motor consumes less power; less voltage drop over long cable runs.

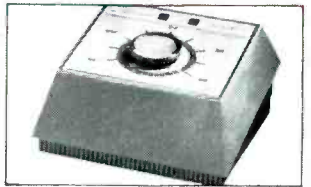

Model 10W707

The RCA fully automatic Rotator has solid state circuitry for positive synchronization. Positive directional indicator lights. Silent operation.



Model 10W505

The RCA positive push-button fingertip control Rotator with 360° indicator dial. Unique design assures precise control with few moving parts. RCA performance and quality at a modest price!

RCA | Parts and Accessories | Deptford, NJ  
Rotators | Antennas | Reception Aids | Installation Hardware.

Circle 17 on literature card

quickly, so it is a good idea to watch the new tube carefully for a few minutes after it is installed, to be sure the plate does not get red hot. If there is a metering link in the cathode circuit of the horizontal-output tube, meter the cathode current **every** time you replace an output tube. Typical cathode current is around 225 ma; if it is more than 235 ma, it probably is too great.

Often there will be some bias, and near-normal high voltage, for a few days at least, until the new tube goes bad. On the call-back, you will discover that the cathode current is way above the ratings. Referring to Fig. 1, here are some of the things to check:

1. If C1 is leaking, the bias developed by the grid will be loaded by R5 and will be decreased. It also is possible, but not very likely, that both C1 and C2 are leaking slightly, in which case some of the B+ from the oscillator plate circuit

will be coupled over to the grid of the output tube. This can be checked easily by removing the output tube and then measuring the grid socket voltage. If any positive potential exists, you have a leaking capacitor.

2. Many horizontal-output grid circuits have a high-resistance return path to the positive supply voltage, as shown by R2. This is done to increase slightly the output, but if the resistance of R2 decreases significantly, there won't be enough bias to protect the tube. Early tube failure is the usual result.

3. Some receivers use the negative bias developed by the horizontal-output grid for other purposes, such as bias for automatic color-level control (ACC). If there is a short or a leakage path to ground or B+ in one of these loads, it will reduce the bias on the horizontal-output grid.

4. Sometimes, signal is taken from the control grid of the tube and

used to operate a retrace blanker, or the high-voltage pulse regulator. There are two possible ways that this can cause trouble. The usual problem is that something shorts in the blanker or regulator input and loads that circuit so much that some of the horizontal-output self-bias is shunted to ground. It is possible, although not very likely, that the opposite condition could develop. That is, a malfunction of the blanker might cause its grid-leak bias to increase, thereby increasing the bias on the horizontal-output tube. This, of course, would tend to reduce both scan and high voltage.

In addition to these various troubles which might decrease the horizontal-output bias, there are a few faults which can cause the bias to increase. It is doubtful if any of these will cause the high voltage to drop to zero, but they can decrease it enough to cause blooming and loss of brightness. One of these possible troubles was just mentioned; there are more:

Referring once more to Fig. 1, a drastic increase in the resistance of R2, R3 or R4 would tend to increase the bias. The same would be true of any resistance from the grid to ground or B+. (Remember, not all of the circuits shown in Fig. 1 are to be found in a single receiver.)

Since the X-radiation incidents of a couple of years ago, fail-safe circuits are being incorporated in the design of high-voltage systems. Without them, if the emission of the shunt regulator drops, the high voltage will increase, perhaps to as high as 30 to 35 kv. A circuit addition similar to R2 and the diode of Fig. 1 will prevent this. During normal operation, the shunt regulator conducts and keeps the diode forward biased. This clamps the lower end of R2 to 400 volts, and the small current through R2 sets the bias of the horizontal-output tube at its design value. If the regulator stops conducting, the anode of the diode becomes more negative than the cathode, isolating the grid of the horizontal-output tube from B+ and allowing the bias to increase. This causes a loss of width and high voltage. As a result, the receiver cannot be operated satisfactorily with a defective shunt regulator. (If the

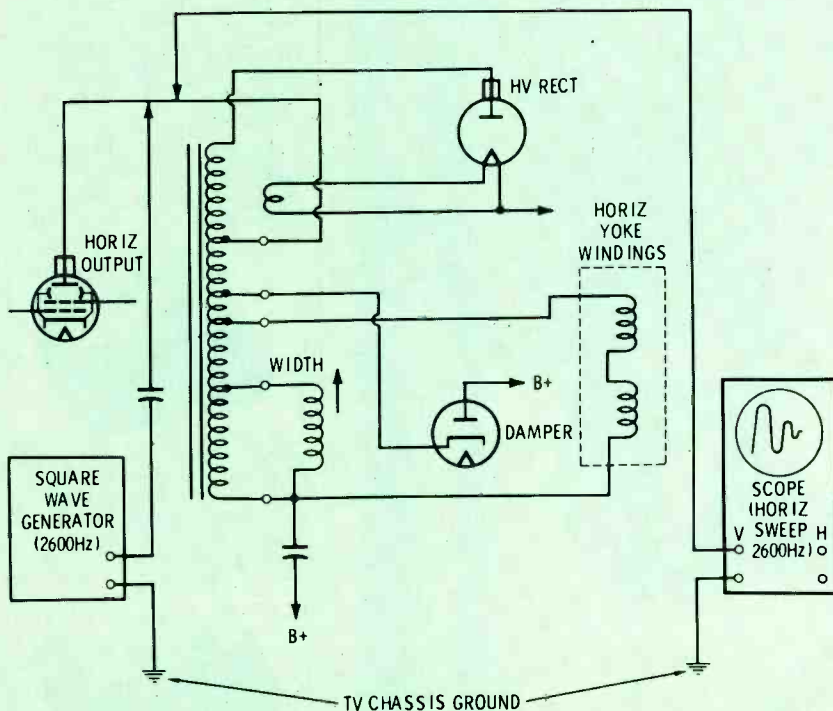

**Fig. 4** Test setup for ringing test of a horizontal-output circuit. Set pulse generator and scope sweep rate to about 2600 Hz, to produce about 6 to 9 distinct sine waves. Normal and abnormal scope patterns are shown in Fig. 5. To individually test fly-back, connect pulse generator and scope across primary of transformer (ground bottom terminal of autotransformers).

# Important New SAMS Books



New 10th Edition of the Sams

## Transistor Substitution Handbook

by the HOWARD W. SAMS ENGINEERING STAFF. Fully updated to include tens of thousands of substitutions. Covers all manufacturers and gives proper substitutions for all types of bipolar transistors: U.S. and foreign, home-entertainment and industrial. Computer-compiled for accuracy. Also includes manufacturers' recommendations for general-replacement transistor substitutions. Order 20773 only..... \$1.95

## Color-TV Training Manual, 3rd Edition

by the HOWARD W. SAMS ENGINEERING STAFF. The completely revised third edition of this famous training guide covers all the latest developments in the field. Written for the technician preparing to service color TV receivers. Describes the science of color, requirements and make-up of the color signal, latest color circuits, and practical setup and servicing procedures. Includes full-color picture tube photos. Order 20736, only... \$6.95

## ABC's of Air Conditioning

by ERNEST TRICOMI. This book presents a non-technical explanation of the laws of physics which relate to air conditioning and shows how these laws are applied practically in the design and manufacture of all types of air conditioning units and their components. Covers components common to all systems, electrical systems, estimating capacity and installation methods, and air conditioning repairs. Order 20725, only..... \$2.95

## 1-2-3-4 Servicing Transistor Color TV

by FOREST H. BELT. The "1-2-3-4 Method" is a simple, logical, step-by-step process which helps do the service job the right way and the easy way. In this book, the fundamentals of transistor color TV are covered, followed by a detailed explanation of how to apply the method for quick troubleshooting and easy repairs. Supported by a wealth of illustrations, charts, and block and schematic diagrams to make understanding easy. Order 20777, only..... \$4.95

## Tape Recorder Servicing Guide

by ROBERT G. MIDDLETON. Thoroughly explains the principles and characteristics of magnetic recorder circuitry, describing the various components and systems. Provides comprehensive instructions on preventative maintenance, adjustments and minor repairs, and solving tape transport, recording, and reproduction troubles. Order 20748, only..... \$3.95

## 1-2-3-4 Servicing Automobile Stereo

by FOREST H. BELT. This book first applies the ingenious "1-2-3-4" repair method to both mechanical and electrical equipment and then proceeds to cover the electronic and mechanical principles of automobile stereo, fm multiplex and tape cartridge systems. Finally, the book shows how to apply the method to auto stereo systems. Includes many schematics, charts and illustrations. Order 20737, only..... \$3.95

## Workshop in Solid State

by HAROLD E. ENNES. Presents the technology of transistor operation in terms familiar to those educated in tube technology. Provides an orientation in solid state principles, and a detailed analysis of the diode; covers transistor parameters, linear switching and pulse circuits, a wide variety of practical design problems and applications and basic testing and servicing techniques. Order 20735, only..... \$9.95



## Hi-Fi Stereo Servicing Guide

by ROBERT G. MIDDLETON. This book is a complete guide to effective hi-fi and stereo servicing. The author provides the basis for a full understanding of hi-fi tuner and amplifier circuitry and procedures for proper servicing of this type of equipment. The proper use of audio test and measurement equipment and the basic principles of acoustics are also given. Covers all components of the system (except record players and tape recorders). Order 20785, only..... \$3.95

## ABC's of Avionics

by LEX PARRISH. This book provides a basic understanding of avionics—the electronic equipment used to insure the safety of crew and passengers. The type of equipment and the techniques employed in private aircraft operations are featured. The requirements for basic communications, navigation aids, instrument flight aids, weather guidance equipment, and special flight control safety devices are discussed. Explains the terminology of avionics. Order 20764, only..... \$3.50

## North American Radio-TV Station Guide, 6th Edition

by VANE A. JONES. Lists all the radio and television stations in the United States, Canada, Mexico, and the West Indies. Includes a-m, fm, and television stations presently in operation, as well as those that are about to start operating, or are temporarily off the air. Separate listings arranged by geographical location, frequency (or channel), and call letters make this guide the most useful one available. Also includes data on power and antenna height. Order 20779, only..... \$2.95

### HOWARD W. SAMS & CO., INC.

Order from your Electronic Parts Distributor, or mail to Howard W. Sams & Co., Inc., Dept. ES-090  
4300 W. 62nd St., Indianapolis, Ind. 46268

Send books checked at right. \$\_\_\_\_\_ enclosed

Send FREE 1970 Sams Book Catalog

Name \_\_\_\_\_

Address \_\_\_\_\_

City \_\_\_\_\_ State \_\_\_\_\_ Zip \_\_\_\_\_

- |                                |                                |
|--------------------------------|--------------------------------|
| <input type="checkbox"/> 20773 | <input type="checkbox"/> 20737 |
| <input type="checkbox"/> 20736 | <input type="checkbox"/> 20735 |
| <input type="checkbox"/> 20725 | <input type="checkbox"/> 20785 |
| <input type="checkbox"/> 20777 | <input type="checkbox"/> 20764 |
| <input type="checkbox"/> 20748 | <input type="checkbox"/> 20779 |

Circle 18 on literature card

owner attempts to continue using it, there is no danger of X-radiation, which is caused by excessive high voltage.)

### B Boost and Boosted Boost

Maybe the "good old days" weren't really so good at that! We can remember that at one time we knew the exact location of the B Boost filter in about every receiver around, but now this type of information isn't nearly so useful. Either capacitors are getting better, or the manufacturers are getting wiser; at any rate, this trouble is a lot less frequent. Nevertheless, a shorted or leaking filter capacitor for the boosted supply voltage still turns up on occasion. As a general rule, these filters return to the highest B+ supply in the receiver, rather than ground, because this reduces the operating voltage of the capacitor.

If one of these capacitors shorts, it places a heavy load on the horizontal-output transformer, reducing the high voltage to a very low value, and causing a black raster. If it is only leaky, there will be some additional loading of the transformer and a reduction of high voltage and width. Of greater importance, this can cause overheating of the high-voltage transformer and possible failure, or the horizontal-output tube might fail before the transformer. Therefore, B boost filters should be checked or replaced whenever a high-voltage transformer is replaced, or if there are repeated failures of the horizontal-output tube.

In receivers using vacuum-tube high-voltage regulators, two basic systems are popular: One, the shunt regulator, hasn't changed very much over the years and resembles the circuit shown in Fig. 3. Because the high voltage and the boosted B+ voltage track each other, as high voltage increases the regulator current also increases, which loads the high-voltage power supply and pulls the voltage back down again. In earlier receivers, the resistance network between boosted B+ and the regulator grid included a potentiometer, which was used for adjustment of high voltage. In some recent receivers, fixed precision resistors are used, and no adjustment is possible.

A shorted shunt regulator shorts the high voltage to ground, and this happens often enough to warrant checking it early in the servicing routine. In cases of low high voltage, it is possible that one of the grid biasing resistors has changed value. This condition normally will not last very long, because overcurrent through the regulator normally will destroy the tube after a short time. Once this has happened, the high voltage increases to maximum and cannot be adjusted. When installing a new regulator tube, always readjust the high voltage; metering the regulator current also is a good practice.

To meter the regulator current, connect a voltmeter across the cathode resistor (R1 of Fig. 3). Since

this is almost universally a 1000-ohm resistor, 1 volt indicates 1 ma of regulator current. A new regulator should conduct about 1.2 ma with the high voltage properly set and the brightness control set to minimum. This will give a meter reading of 1.2 volt; however, any reading over approximately .95 volt is acceptable, if the high voltage is normal.

Pulse type regulators are less likely to short, because the plate voltage is much lower. If it should short, it will eliminate the high voltage. A pulse regulator which has low emission often will cause the high-voltage to increase. As with the shunt regulator tubes, a tube tester is of no practical value; substitution is the only positive test.

### High-Voltage Transformer

Just because the flyback transformer has dripped a little wax, do not assume that it has failed. It is very possible that the loss of high voltage which you are troubleshooting developed over a period of time, and that the transformer was merely operating with an overload for awhile before the complete loss of high voltage. Sometimes it is possible to find a fault in the transformer by checking it with an ohmmeter, but this is not very reliable. A few shorted turns will change the resistance very little, but will completely stop the generation of high voltage.

A better check is the ringing test: Connect a scope and a squarewave

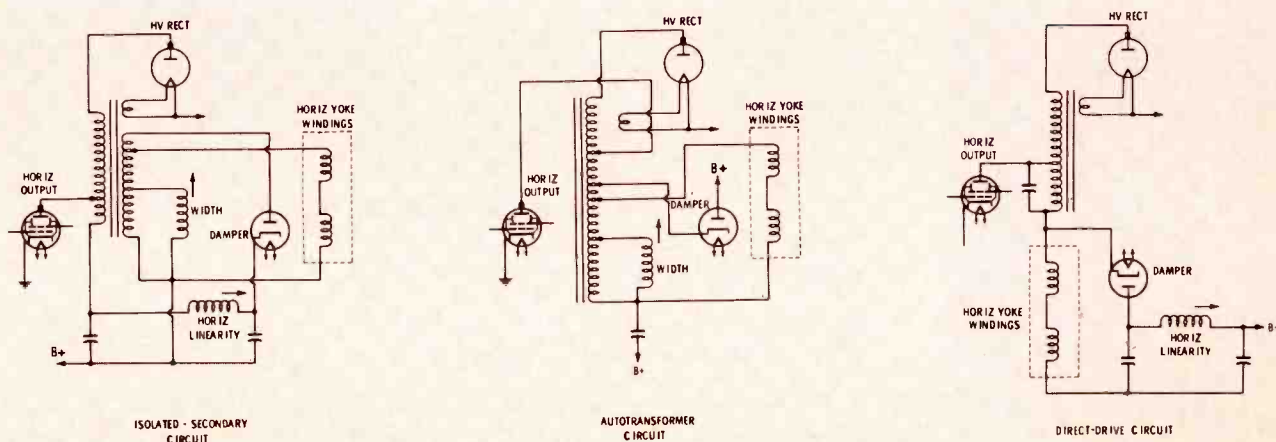

Fig. 5 Results of ringing test of three basic types of horizontal-output circuits.

generator to the transformer, as shown in Fig. 4, and observe the waveform. If the transformer is good, ringing will be observed on the waveform; if it is not good, no ringing or only a couple of cycles will be observed, as shown in Fig. 5. Like a lot of tests, this one is not always accurate, but this is mostly a matter of observer error. To improve your technique, try this test a few times on sets which are known to be working, and you will know what to expect when you are testing for trouble.

When making a ringing test, don't forget that a short across the transformer also will damp out the ringing, as shown in photos B, C and D of Fig. 5. Check the external circuit before replacing the transformer, if damped ringing is evident.

The yoke also may be checked with a ringing test, and here again external components may be the cause of damped ringing. Included in this category are the capacitors and resistors which are inside the yoke housing.

(For detailed information about ringing tests, see the article titled "Ringing Checks For Sweep Coils" in the March 1963 issue of PF Reporter.)

### Efficiency Coils

From an engineering point of view, the efficiency coil tunes the horizontal-output circuit for maximum output with minimum dissipation in the horizontal-output tube. In servicing terms, it stops callbacks

for dead horizontal-output tubes. Use it.

The procedure is similar on most sets: Connect a current meter in series with the cathode of the horizontal-output tube and also connect a meter to the high voltage. Adjust the high voltage to the proper value, if an adjustment is provided, and then adjust the efficiency coil for **minimum** cathode current of the output tube. After you reach minimum, allow the cathode current to increase a couple of ma by turning the core of the efficiency coil in the direction which increases the high voltage. As mentioned before, the cathode current is usually specified at about 225 ma, and if the minimum is above 235 ma, a defect exists.

### Summary

The first step in troubleshooting loss of high voltage is to make sure that this is really the problem. There are a lot of other causes for loss of raster. If you don't carry a high-voltage meter with you on service calls, you are just making life difficult for yourself—and for your customers.

Naturally, you first should substitute tubes; while you are substituting them keep an eye open for signs of excessive current in the horizontal-output tube. It doesn't take long to damage a new one if there is no bias. Whenever you can do it without making a major project of it, meter the cathode current of the output tube to see if it is within

limits—less than 235 ma in most cases. This will help prevent a lot of callbacks.

While you are metering the cathode current, it is good insurance to check the adjustment of the efficiency coil. You may feel that all this is a little more than you want to attempt in the home, and this is your business. Nevertheless, it is easier to take a little time to do a job right for pay than to find a lot of time to do it over—for free.

If you have to take the chassis to the shop, use a step-by-step sequence to find the trouble. Start by checking the horizontal-output tube voltages and the grid waveform. This way, you are not so apt to damage the horizontal-output tube while troubleshooting. Next, check for shorted loads on the flyback transformer; these include the focus power supply, side pincushion transformer, the boosted B+ and boosted boost supplies and their filters and loads.

Finally, focus your attention on the transformer and the yoke, unless, of course, your nose told you to check out these first. A ringing test will turn up shorted turns in most yokes and high-voltage transformers.

### In Part 2

Part 1 of this two-part series has covered tube-type horizontal-output and high-voltage sections. Part 2 will analyze the circuit operation and troubleshooting of solid-state circuitry. ▲

CHART OF RESULTS

CONDITION	PATTERN FOR:		
	ISOLATED - SECONDARY	AUTO TRANSFORMER	DIRECT-DRIVE
FLYBACK, YOKE, AND WIDTH COIL NORMAL	A	A	A(1)
SHORT IN FLYBACK	B	B	B(1)
YOKE SHORT (MILD)	C(3)	B OR D (3) (5)	A(3)
YOKE SHORT (SEVERE)	D(4)	B(5)	A(6)
SHORT IN WIDTH COIL	B(2)	B	

#### REFERENCE NOTES

- (1) YOKE MUST BE CONNECTED IN CIRCUIT.
- (2) AS LITTLE AS ONE SHORTED TURN.
- (3) KEYSTONE - SHAPED RASTER.
- (4) NO RASTER OR HIGH VOLTAGE.
- (5) MIGHT KILL RASTER, OR SHRINK RASTER WITHOUT KEYSTONING.
- (6) WILL NOT KILL HIGH VOLTAGE; RASTER WILL BE THIN VERTICAL LINE.

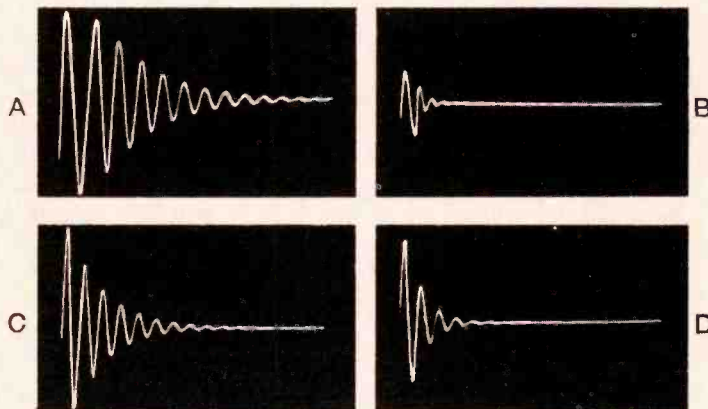

# Modulation limiting in CB

Dale's service bench

by Allan Dale



If you're a Citizens-Band (CB) or Business Radio user, you'll know right away if modulation drops off. Your other stations won't hear you as well. Your distance won't be as good, either.

However, overmodulation may come to your attention more rudely. You might get a pink slip from the FCC.

Even if you only repair CB, you'd better know about modulation. Your FCC ticket can be lifted if many of your customers get overmodulation citations. You'd lose customers, too—the word gets around.

So, have a good way to measure amplitude modulation. Measure it every time you have a unit on the bench, even if you haven't repaired a part of the transmitter that affects modulation.

## Putting the Lid On

Any CB transmitter type-accepted for class D has some form of modulation limiting. It may be as simple as diodes wired for clipping, or it may be an elaborate compression device.

In higher-priced transceivers, the

technician can adjust a control. In others, modulation level is fixed by a divider network. Either device determines how much voice signal reaches the modulator stage. The fixed network requires circuit change if overmodulation persists—but first be sure no defect is causing it.

A simple modulation limiter is shown in Fig. 1. It's from the B & K Cobra series of CB transceivers. Two zener diodes are connected in the primary of the modulation transformer (which is the audio output transformer during reception). If peaks of the modulating voltage in the output stage exceed the zener voltage, the diodes conduct and clip them off. Naturally, with high modulation this introduces some distortion, but slight inverse feedback tends to smooth out the distortion that does occur.

Another simple peak-clipping modulation leveler is part of the earlier tube-type Cobra models. One is diagrammed in Fig. 2.

A capacitor connects a neon lamp, with its series resistor, across the primary section of audio trans-

former T1. For modulation, T1 is an autotransformer. The tube drives the lower portion of the primary winding. The other portion of that winding connects to the screen and plate of the output amplifier—producing Heising modulation. The secondary winding drives the speaker or phones during reception.

The neon clipper is a handy modulation monitor, too. If you talk loud enough into the mike, the lamp lights on modulation peaks. If it stays lit too much, you're too loud; the lamp will clip the peaks, which avoids overmodulation, but your transmission won't be clear.

Troubleshooting either of these simple systems primarily consists of 1) being sure there is enough gain that a loud "a-a-h-h-h" into the mike causes clipping, and 2) making sure clipping really does take place.

You can judge modulation somewhat from the RF output meter, if the unit has one (or if you have hooked an in-line RF meter in series with your antenna lead). Key the transmitter on without any modulation from the mike. Note the RF



reading. Then say "a-a-h-h-h" strongly into the mike. The RF reading should increase slightly. If there's no change, modulation isn't sufficient. If the meter reading moves downward, you're overmodulating.

### Closed-Loop Control

Another system that is used to limit modulation in more elaborate transceivers develops a control voltage from the audio output signal. Several imported units are equipped with this modulation control system.

The example in Fig. 3 is taken from the Pearce-Simpson "Tiger 23" transceiver. It uses the closed-loop concept of modulation limiting. The system also is sometimes called **automatic limiting control** or merely **ALC**.

An extra winding on the audio output/modulator transformer supplies the sensing signal. When the R/T relay is in the transmit position, a contact pair connects the extra winding to a resistive divider. From there, the audio signal goes to a diode, which rectifies it.

A pi-type filter network eliminates any remaining audio fluctuations. That leaves only a DC output voltage proportional to the amount of signal fed to the ALC diode. The DC control voltage is coupled by another contact pair to the base of the first audio preamplifier (which serves also as the microphone preamplifier). The control voltage changes the forward bias on this stage.

If the voice into the microphone is too loud, excessive signal reaches the extra winding of the transformer. The diode and filter network build up a high DC voltage. The highly negative control voltage overrides most of the normally positive base voltage in the preamplifier stage. Because the transistor in Fig. 3 is NPN, this lowers the forward bias, and gain is reduced.

If the voice in the mike is moderate, less signal is fed from the extra winding to the diode, and less

negative DC control voltage reaches the transistor base. Regular bias takes over and the preamplifier stage amplifies normally.

If normal bias for the 1st transistor amplifier is chosen properly, a weak voice is amplified more than normal. This operates the transmitter speech section in an expansion-type mode; voice signals are amplified strongly when weak, but compressed when too strong. Overmodulation is thus avoided.

Troubleshooting a system like this is done best with a clamp voltage in place. Connect an external bias supply **through a 10K resistor** to the relay end of the input choke. The resistor is necessary to keep the supply from bypassing input voice signals. Adjust the clamp voltage for normal operation with audio signals fed to the receiver.

Then switch to transmit. With a scope and a DC voltmeter, trace the ALC voltage through the divider

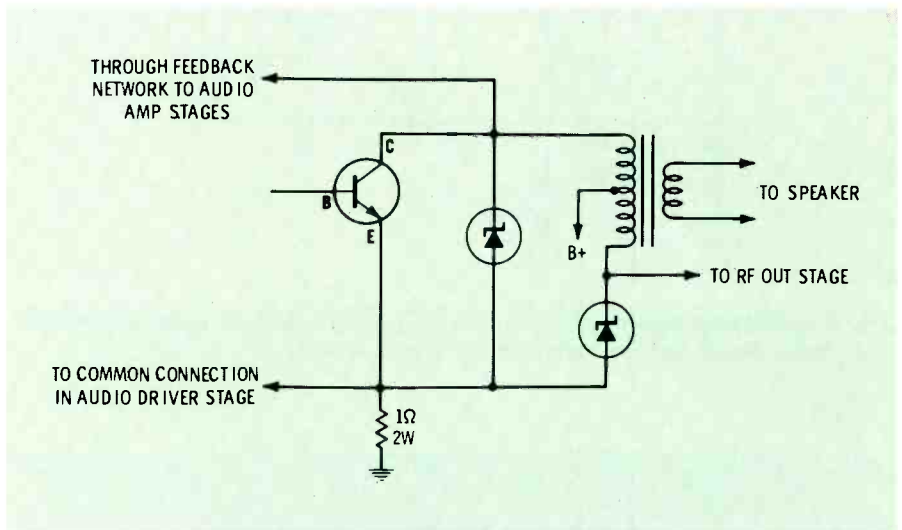

Fig. 1 Modulation limiter uses zener diodes in clipper-type stage. Distortion is higher than with some more complex systems.

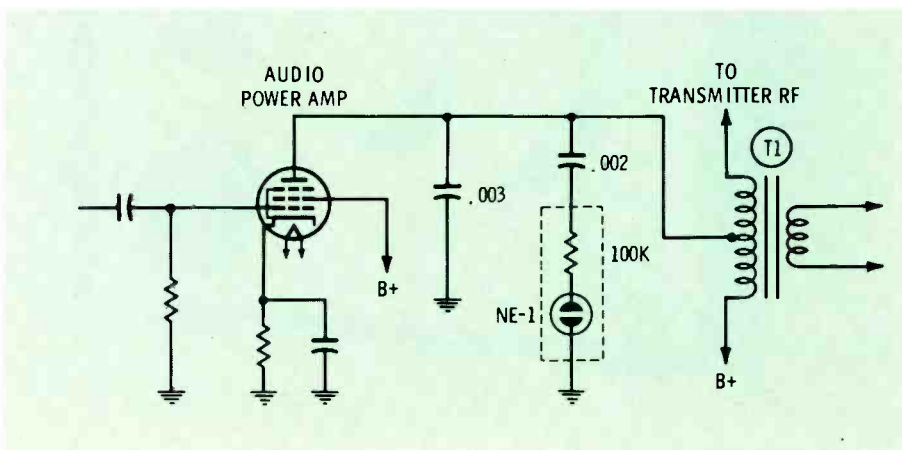

Fig. 2 Tube-type transceiver uses very simple neon-lamp for clipping modulation peaks from voice signals in output stage.

and filter network.

With a scope at the diode input, see if the signal gets stronger and weaker when you make the clamp voltage less negative and more negative, respectively. If it does, the audio section is okay, and so are the transformer winding and resis-

tive divider. If it doesn't, trace back to see what keeps the DC bias from increasing and decreasing the signal level in the amplifier stages.

If the scope shows everything up to the diode is okay, trace through the output filter network with your DC voltmeter. As you adjust the

clamp voltage more and less negative, the opposite should happen to the voltage developed by the ALC network. If not, the diode might be bad, or one of the capacitors faulty.

A slightly more elaborate system is used in the Sideband Engineers Model SB-35. The takeoff point is in the modulated RF stage. But the operation is essentially the same. A diode develops a DC control voltage. This is applied to the emitter of the 1st mike amplifier and controls its gain. A **Mike Limiter** control is part of a divider in the DC output line.

Troubleshooting this closed-loop ALC system is little different from the one just described, except that you should confine use of the scope to the mike amplifier section itself. But use the clamp voltage at the base of the 1st mike amplifier stage. Check the results of varying the clamp voltage. Trace those results through the diode and filter network with a DC voltmeter.

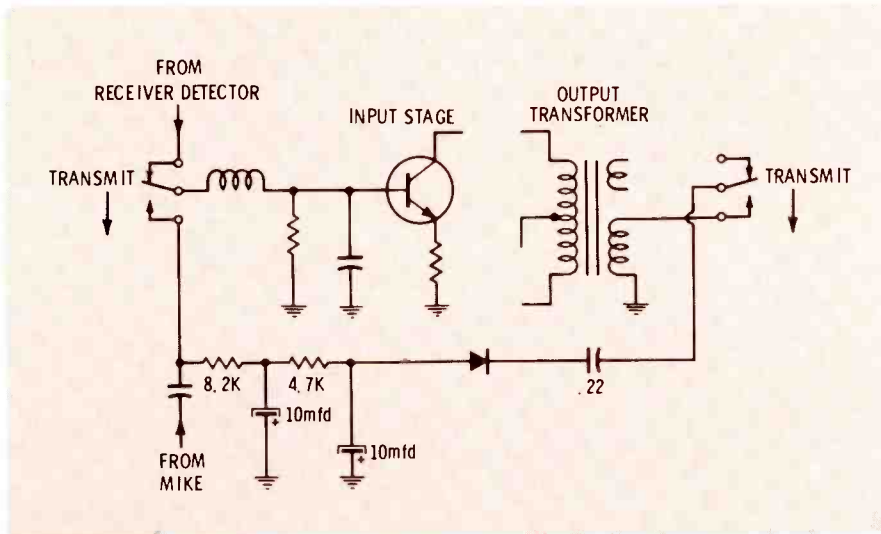

Fig. 3 Closed-loop form of modulation limiting, often called automatic limiting control (ALC). Signal strength develops DC control voltage.



Fig. 4 Two knobs on this compressor/expander type of modulation controller can be turned by operator—not a good idea, because scope and modulation monitor are needed for optimum adjustment.

### External Compressor/Amps

Some CB manufacturers are offering the advantages of compression/expansion to owners of less-expensive units. The means is an external compressor amplifier. It's beginning to catch on in the CB market.

Some compressor amplifiers must be wired into the transceiver. The one shown in Fig. 4 plugs into the transmitter's microphone jack and has its own jack to accept the microphone. The schematic for the unit is in Fig. 5.

The mainstay of this unit is a logarithmic amplifier. The effective output of this kind of amplifier is logarithmically related to its input. This gives the stage an expansion/compression operating characteristic. Weak signals are amplified more than the "design center" value; strong signals are amplified less. Output is relatively constant.

The unit shown in Figs. 4 and 5 contains further assurance that voice-signal levels don't exceed the value that produces 100 percent modulation of the transmitted signal. A back-to-back diode pair con-

# The replacement picture tube no other color tube can replace!

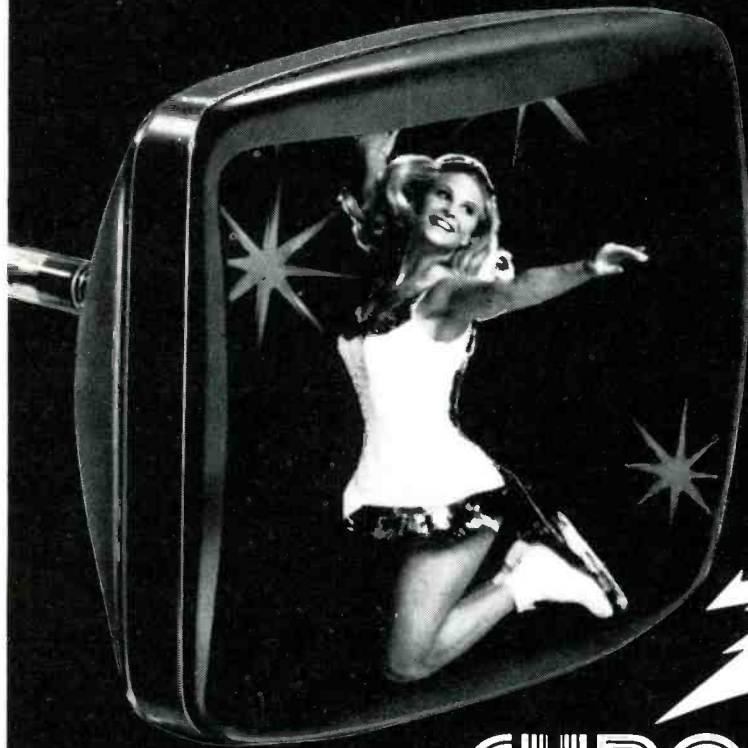

Simulated TV picture

**ZENITH**  
**CHROMACOLOR**

Now you can install the revolutionary Chromacolor picture tube in almost any brand of 23" (diag.) color TV. And let your customer see the difference: a new, sharper Chromacolor picture with greater brilliance, contrast and color definition.

Zenith pioneered, developed and patented (U.S. Patent No. 3146368) the Chromacolor picture tube. And only Zenith has Chromacolor.

Chromacolor is an easy sale because people already know of Chromacolor's superiority. (Last year, after the revolutionary new Chromacolor system was

introduced, Zenith giant-screen color TV sets became the No. 1 best-seller!)

### Full two-year warranty.

Here's your sales clincher: Chromacolor replacement color tubes are warranted for two full years. Exactly double the warranty period for most other replacement color picture tubes.

Give your customers the best — Chromacolor replacement color tubes. Only your Zenith Distributor has them.

## TWO-YEAR WARRANTY

Zenith Radio Corporation warrants the replacement CHROMACOLOR picture tube to be free from defects in material arising from normal usage for two years from date of original consumer purchase. Warranty covers replacement or repair of picture tube, through any authorized Zenith dealer; transportation, labor and service charges are the obligation of the owner.



Zenith Chromacolor picture tube pinpoints the color dots on a jet black background and for the first time fully illuminates every dot.

**ZENITH**  
The quality goes in  
before the name goes on

Circle 19 on literature card

nected across the output prevents signal-cycle excursions too far in either direction.

Two controls, **compressor** and **level**, are provided on the compressor amplifier in Fig. 5. Unfortunately, both are accessible to the operator. Unless the output is monitored with a modulation meter or modulation scope, it is all too easy to leave the level set too high. If the transmitter overmodulation protection is less than perfect, distorted transmission and spurious radiations are possible.

However, properly set, these controls prevent any possibility of overmodulation, while assuring nearly 100 percent modulation most of the time. Set the Compressor control so that the signal level at the output, viewed on a scope, is held constant over wide loudness variations. Then,

watching a modulation meter connected to the transmitter, set the Level control for about 95 percent modulation. (The compressor/expander action makes the transmitter so effective, you won't miss that 5 percent safety factor.)

A scope is the best tool for hunting out most troubles in one of these units. You might want to check the transistors first, merely as a matter of procedure. Be sure the forward resistances of the two diodes are well matched, and that both have very high reverse values.

If you're using an audio generator to run down modulation troubles in any kind of system, use a sine wave around 1000 Hz. Remember that the frequency response of communications audio stages is deliberately limited—seldom does it go below 200 Hz or above 3000

Hz. Don't use a square wave to check distortion; the amplifiers tilt it radically when they're functioning normally.

### What's Up Next

From letter's I've gotten, it seems a good many technicians have trouble really understanding convergence panels. They look like a complicated mess of wiring and parts. Yet, they have a rather simple, straightforward mode of operation—if you know what it is.

Next in **Service Bench** I'll make a stab at explaining it to you. Once you know the functions of those different controls (and the occasional diodes), you'll have a lot less trouble chasing down a defect in a convergence panel. Even making convergence adjustments will be easier. ▲

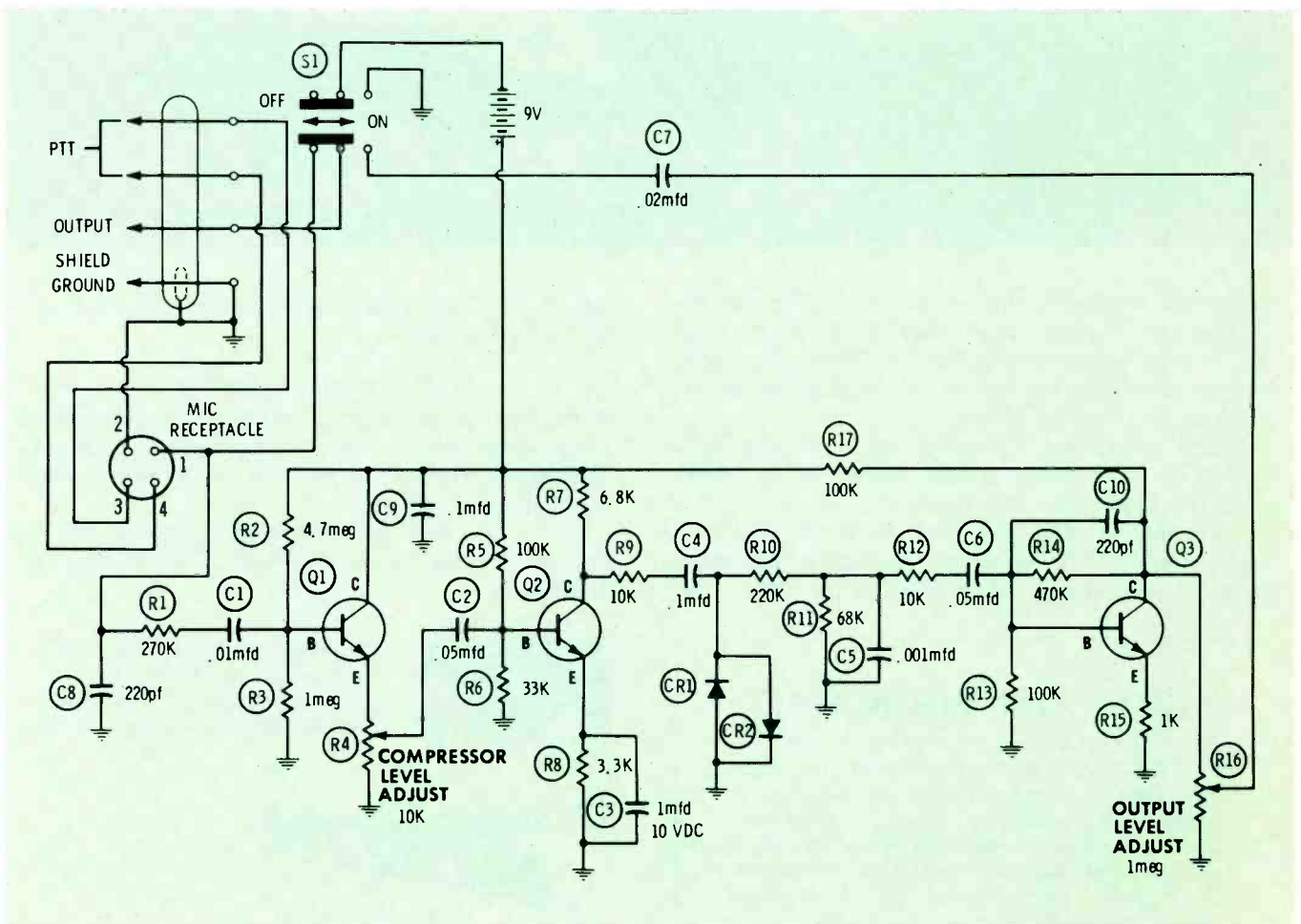

**Fig. 5** Logarithmic amplifier, with two transistors, feeds signal past additional clipping to linear amplifier and Level potentiometer.



**NO CAMPING  
NO SWIMMING  
NO HIKING  
NO RELAXING  
NO FISHING  
NO HUNTING  
NO RIDING  
NO SIGHTSEEING**



Only you can prevent forest fires.

# troubleshooter

## Overheating Horizontal Output Transformer

An RCA CTC15 color chassis (PHOTOFACT 673-2) had no raster, and visual inspection indicated the horizontal output transformer had been overheated.

The damper and horizontal output tubes were tested and found to be bad. New ones were installed and the set turned on. Operation was normal for about 30 minutes, then the horizontal output transformer started arcing and caught fire.

After the transformer was replaced, the high voltage read above the scale on a 0-30 kv meter. The high-voltage adjust control had no effect on this reading, yet the 6BK4 high-voltage regulator was good.

Further testing showed R145, the 1.5-megohm resistor wired from B-boost to the 6BK4 grid, measured about 3 megohms. This resistor and its mate (they are a matched pair) were replaced, and high-voltage regulation was restored.

The horizontal efficiency coil has been adjusted for minimum current (200 ma) in the horizontal output tube (6JE6) cathode circuit, and the high voltage set for 23 kv. After approximately an hour, the horizontal output transformer is hot to the touch. The waveform

at the grid of the (6JE6) is correct and measures 200 volts p-p; DC bias on the grid is -52 volts, and the screen voltage is normal.

The horizontal output screen dropping resistor has been changed to 16K ohms, and a coat of silicone heat compound has been applied between the horizontal output transformer and chassis; however, the transformer continues to run hot.

Overall performance of the set is good, except for this overheating transformer, which has been replaced at least once before. I fear the new transformer will not last long. What causes it to overheat?

J. B. Adkins  
Albany, Ga.

You seem to have accomplished most of the repairs correctly and efficiently, but I do have a few suggestions: Most RCA horizontal output transformers drip what appears to be an excessive amount of wax. This symptom, by itself, seems to mean nothing. The transformer that failed during testing might have done so because of the overload of the defective output and damper tubes. On the other hand, one of the most likely causes of transformer failure in these (and similar) models is a failure of the high-voltage regulator to draw any current. The high voltage increases to a high level that produces internal arcs.

There is a danger that arbitrarily setting the high voltage to 23 kv might be overloading the sweep circuit and contributing to the extra transformer heating. I have encountered many of these sets in which a black-raster regulator current of around 2 milliamps is necessary to drag the high voltage that low. This is more than the tube and the set are designed to take. I am a great believer in setting the 6BK4 cathode current, and measuring the high voltage almost as an afterthought. Actually, both measurements are necessary to give the answer to high-voltage problems.

Efficiency coil and high-voltage adjustments affect each other very much. In border-line cases, such as this one, I recommend the following sequence of adjustments:

- A 0-200 ma current meter should be connected in the 6JE6 cathode return, and a 0- to +1.5-volt meter connected across the 6BK4 1K cathode resistor (which should be checked for tolerance).
- With a b-w program tuned in normally, advance the brightness control until the voltage across the 1K resistor is nearly zero, or about .1 or .2 volt (not possible if the CRT is weak).
- Adjust the efficiency coil for minimum horizontal output cathode current; then turn the core ¼ turn in the direction that gives higher regulator current or B-boost voltage.
- Turn the brightness down to a black raster, adjust the high-voltage control for 1.4 volts across the 6BK4 cathode resistor.

## FREE CATALOG

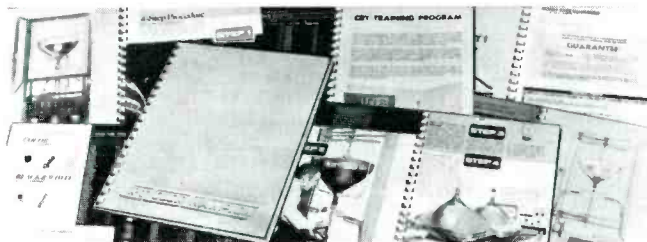

# CRT COLOR CHAMPION

### TV PICTURE TUBE REBUILDING EQUIPMENT

C.R.T. Equipment Company, Inc.  
2740 Old Lebanon Road  
Nashville, Tennessee 37214

Telephone (615) 883-0215

Mail Coupon Today

(Please Print)

Name \_\_\_\_\_

Firm Name \_\_\_\_\_

Address \_\_\_\_\_

City \_\_\_\_\_ State \_\_\_\_\_ Zip \_\_\_\_\_

Clip Me Out

Circle 20 on literature card

# CUT TV ALIGNMENT TIME

# IN HALF!

with the all new  
SENCORE SM158

# SPEED ALIGNER

and at \$120.00 less  
than competition!  
only \$275.00

## Here are 7 Reasons why we call the SM158 the Speed Aligner

**AUTOMATIC ALL CRYSTAL CONTROLLED MARKERS:** You will never spend any more time looking up marker frequencies or interpreting them when you own an SM158; they are automatic. For example, want the chroma carrier on any RF curve, IF curve, or chroma curve, simply push the chroma carrier marker button. Want the sound, video, adjacent carrier markers or any other marker on any curve, just push the button as directed on the panel. The SM158 is fast and saves you time . . . that's why we call it the speed aligner.

**UNLIMITED MARKER AMPLITUDE:** The marker height control is like a powerhouse; crank it up as far as you want, even to the point where the markers are larger than the scope screen, without upsetting the response curve. Each marker is crystal controlled on fundamental frequencies and post-injected so that you may place all markers on the curve at unbelievable heights without affecting the curve in the least. That's why we call the SM158 the speed aligner.

**EASY TO CONNECT:** Just four connecting cables clearly marked TO TV and TO SCOPE. It takes just seconds to connect . . . that's why we call the SM158 the speed aligner.



**TWO EXTRA VHF CHANNELS:** Competition has only two VHF channels; the SM158 has an extra high channel and an extra low frequency channel to prevent any co-channel interference. The SM158 is interference-free . . . that's why we call it the speed aligner.

**PLENTY OF SWEEP WIDTH:** A full 15 megahertz sweep signal, constant on all IF, chroma and RF curves, provides adequate sweep width to cover new solid state IF amplifiers. Competition covers only 12 megahertz. The SM158 gives you the full picture the first time . . . that's why we call it the speed aligner.

**GENERATES A ZERO REFERENCE BASE LINE:** You know where zero is with the SM158. All alignment instructions show a base line, yet some competitors do not generate a base line. You can follow TV manufacturers' instructions to the "T", easier and faster with the SM158 . . . that's why we call it the speed aligner.

**SWITCHABLE HORIZONTAL OR VERTICAL MARKERS:** want to tilt markers 90 degrees so you can view markers better in traps or for leveling? Merely pull the MARKER HEIGHT control out and markers appear horizontally — a real plus feature.

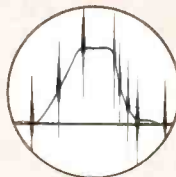

# SENCORE

3200 Sencore Drive  
Sioux Falls, South Dakota 57107

Circle 21 on literature card

• Recheck the efficiency coil adjustment. If either adjustment requires changing very much, the other should be checked again until both are right at the same time.

Remember that the efficiency coil adjustment should be done at high brightness (just under blooming), while the regulator current must be set with the brightness turned down for a black raster.

If the 6JE6 cathode current is less than the maximum specified, and high voltage is between 24 kv and 26 kv after these adjustments, the tubes and transformers should have a long life. But if the high voltage is too high, don't reduce it by increasing the regulator current; increase the screen resistor on the horizontal output tube instead until the right amount of high voltage is obtained with not over 1.4 volts across the 6BK4 cathode resistor during a black raster.

### Heater-to-Cathode Shorts in Color CRT's

*Please analyze for me the following trouble in an RCA CTC25 chassis: Every few minutes the color picture becomes dim, blurred and defocused. This intermittent defect makes a b-w picture look like a dim color picture with wrong colors.*

*Both demodulators and the three -Y amplifiers have been thoroughly checked for defects, but none were found. On the attached page are some puzzling voltage readings taken before and during the time the defect was present.*

*If I lower the CRT heater voltage to about five volts, the intermittent trouble is gone, but the picture is too dim. Do these symptoms indicate a defective CRT?*

*Robert P. Lee  
Fort Lee, New Jersey*

The symptoms strongly indicate an intermittent heater-to-cathode short in the picture tube. Such a defect has been common with tubes of certain production runs.

One of the confusing factors in analyzing this kind of trouble is that the visual symptoms from the screen of the CRT will vary radically according to the number

b-w picture (because the video is missing from all three CRT cathodes, color is not affected except that it will be dim and blurred because the b-w is not present to give contrast and sharpness).

If the blue video drive control is turned about half-way and the same heater to blue cathode short occurs, the symptoms will be very different: b-w pictures will be dim, smeared and have very poor gray scale tracking. The highlights will be white but the lowlights will be a definite blue. If you examine the red, blue or green pictures separately, the CRT screen (or scope at the cathodes) will show video at the green and red cathodes but none at the blue. Of course, shorts can occur at any cathode.

Loss of video during such a short is caused by the heater supply bypass capacitor, C150. The approximately 180 volts on the heaters, which minimizes the

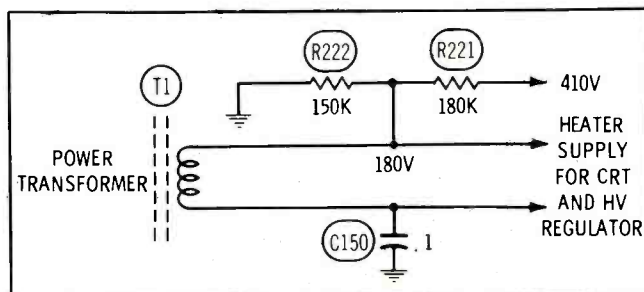

possibility of cathode shorts, prevents the drive control from being destroyed when the CRT short occurs.

The drive controls provide us with a fast, accurate cathode-short test without use of test equipment: Turn all the video drive controls completely clockwise. Wait until the video disappears, then rapidly turn down the drive controls one at a time. When you turn down the one connected to the shorted cathode, the video will come back to the other two cathodes. Turn it back up and the video should disappear again. In receivers with only two drive controls, a red-green switch might be provided, as shown in the CTC25 schematic. Slide the red-green switch, then try the red-green drive control in order to identify the short.

Most of these heater-to-cathode shorts are thermally caused: Metals expand when heated. This explains why a CRT heater voltage of 5 volts stopped the intermittent short. ▲

### NATESA Annual Convention Delayed

The annual convention of the National Alliance of Television and Electronic Service Associations (NATESA) has been postponed, according to Frank J. Moch, executive director of NATESA.

No reason was given for the postponement. It is expected to be rescheduled for mid-October.

### Change of Address?

To receive *Electronic Servicing* at your new address, send an address label from a recent issue and your new address to:

**Electronic, Servicing**, Circulation Dept.  
1014 Wyandotte St., Kansas City, Mo. 64105

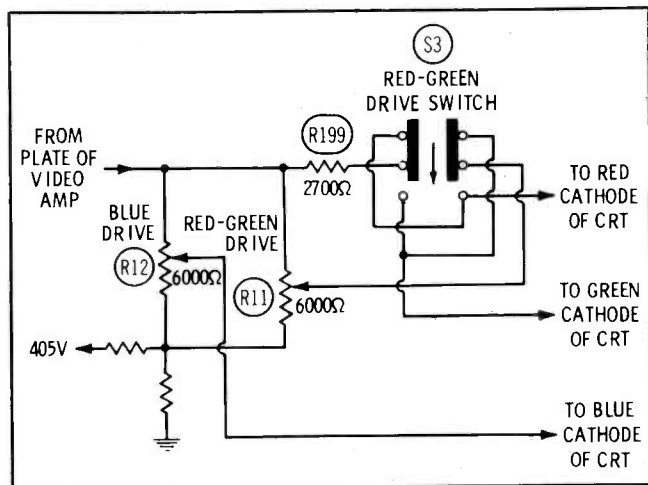

of video drive controls and where they happen to be adjusted at the time. The partial schematic should help make clear how so many symptoms are possible.

If the blue drive control is turned up completely, and then the heater shorts to the blue cathode of the CRT, the following symptoms will be produced: no



Protection—None  
 Deflection—90°  
 Filament—6.3V @ .9A  
 Grid 2—400V

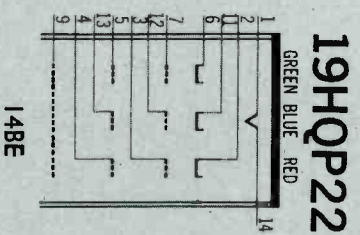

Protection—Banded  
 Deflection—90°  
 Filament—6.3V @ .9A  
 Grid 2—200V

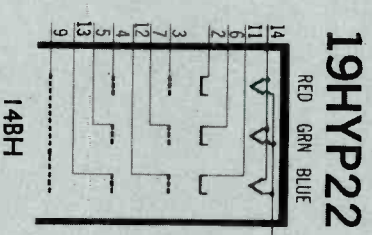

Protection—Banded  
 Deflection—90°  
 Filament—6.3V @ 1.35A  
 Grid 2—400V

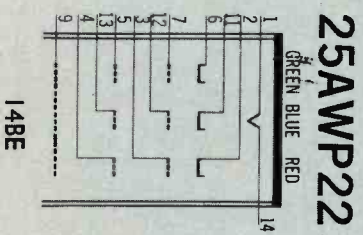

# Electronic Servicing Tube Substitution Supplement

This Supplement has been designed to provide you with the latest up-to-date information on new tubes. The format allows maximum use during a house call or at the bench.

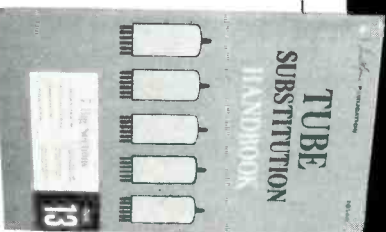

REMOVE THIS  
 SUPPLEMENT FROM

**Electronic Servicing**  
 and put it in  
 the back of your

**TUBE  
 SUBSTITUTION  
 HANDBOOK**

## direct substitutes

Included are the older tubes that will substitute directly for the new tubes. This information supplements the sections in the Tube Substitution Handbook for American Receiving Tubes and Picture Tubes.

## basing diagrams

The basing diagram for each new tube will help you in the servicing of new receivers when service literature is not available.

## typical characteristics

The typical, or average, characteristics of each new tube can be of great help when troubleshooting new circuits.

## easy reference

The direct substitution list will be cumulative each month. Thus, only the latest edition need be carried in the Tube Substitution Handbook.

# Direct Substitutions

To Replace	Use	To Replace	Use
2AS2A	*	16LU8A	16LU8
3AT2A	*	17ESP4	*
3BN2A	*	17EVP22	*
4LU6	*	17FCP4	*
5MQ8	*	17KV6	*
6AG9	6AL9	18AJ10	*
6AK10	6AG9	19DE3	*
6AL9	*	19HQP22	*
6BW3	*	19HXP22	*
6KV6A	*	19HYP22	*
6MQ8	*	20ADP4	*
8AL9	*	20AHP4	*
8KR8	*	22AHP22	*
8LS6	*	25AWP22	*
9AK10	*	25CK3	*
9YP4	*	25GP22A	*
10ASP4	*	26HU5	*
10LY8	*	31AL10	*
11CF11	*	32HQ7	*
11MS8	*	33HE7	*
12DGP4	*	12DEP4	*
12DKP4	*	12DHP4	*
15ACP22	*	19GEP4	*
15WP22	*	19HNP22	*
16BX11	*	22TP4	*
16DCP4	*	22ZP4	*
16LU8	16LU8A	25ALP22	*

\*No substitution at present time.  
Thirteenth edition of Tube Substitution Handbook now available at your distributor.

## 9YP4

Protection—Banded  
Deflection—85°  
Filament—12.6V @ .080A  
Neck diam—0.788 inches  
Grid 2—100V

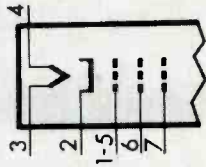

7GR

## 15WP22

Protection—Banded  
Deflection—90°  
Filament—6.3V & .9A  
Grid 2—200V

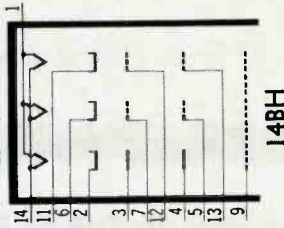

# General Specifications

Diode—H.V. Rect.  
Filament—3.15V @ 220mA  
PIV—30KV @ 1.7mA

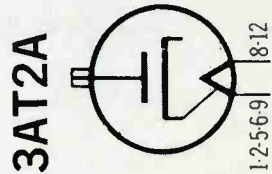

12FV

## 17KV6

Filament—16.8V @ .6A—11 sec warmup

EP = 140  
E<sub>SG</sub> = 140  
E<sub>G</sub> = 24.5  
I<sub>P</sub> = 40  
I<sub>SG</sub> = 2.4  
G<sub>m</sub> = 6000

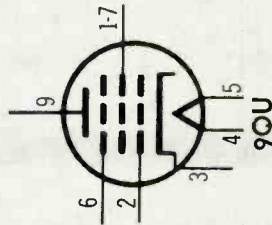



# WHAT DO YOU DO FOR AN ENCORE . . . ?

**after you have sold your customers  
the best home TV towers.**

That's one of the big advantages when you stock and sell Spaulding AX Series Home TV Towers. You're offering a tower in which they'll not only see the quality, which is apparent, but they'll also see the trouble-free performance they are looking for.

The Spaulding AX Home TV Tower is designed for quick economical installation . . . and is all-steel, galvanized and all riveted construction with no welds to rust.

The AX 48' Home TV Tower package only requires 2 sq. ft. of floor space . . . the AX series packages are available in heights up to 64'. Package includes base stubs, hardware, mast and mast kit.

The Spaulding AX Series Tower is a self-supporting tower and is extremely rigid under most erection situations. The higher the tower goes, the greater the strength at the base. The wind resistance at the top decreases with height. The "tapering" effect adds to the attractiveness of the tower.

Get specifications on this complete tower package, and profit in two ways—bigger sales and greater goodwill from your customers.

## **ROHN<sup>®</sup>-SPAULDING, INC.**

Peoria, Illinois • Birmingham, Alabama • Frankfort, Indiana

*Circle 32 on literature card*

# Vertical foldover and other linearity problems—causes and cures

**Pinpointing component defects that produce vertical compression, expansion and other vertical distortion of the raster.**

by Robert G. Middleton

The term "vertical foldover" means, in the strict sense of the word, that part of the image on the screen of a TV which vertically overlaps another part of the image, as shown in Fig. 1. In this example, the vertical deflection is produced by a sine waveform. This picture symptom commonly is caused by heater-cathode leakage in a vertical-oscillator tube, or by an open coupling capacitor such as C47 in Fig. 2. Note that when the coupling capacitor opens up, the grid-input impedance becomes very high (3.3 megohms). In turn, the grid lead picks up stray 60-Hz hum voltage, and a 60-Hz sine-wave current

flows through the vertical-deflection coils.

True vertical foldover differs from vertical compression. For example, Fig. 3A shows severe compression at the bottom of the

picture—the missing portion of the picture is concentrated in the form of a bright horizontal line at the bottom of the image. There is no foldover present in the strict sense of the term. This picture symptom

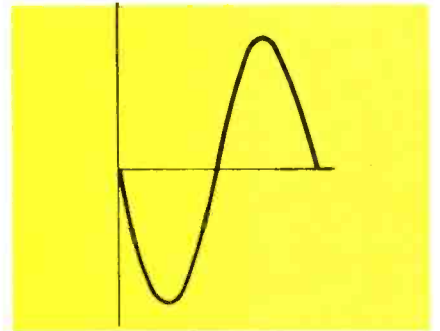
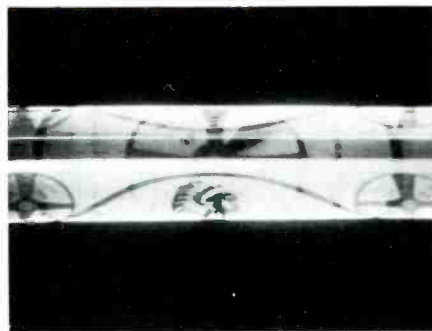

**Fig. 1** Basic example of foldover. (A) Picture symptom. (B) Voltage across and current through yoke.

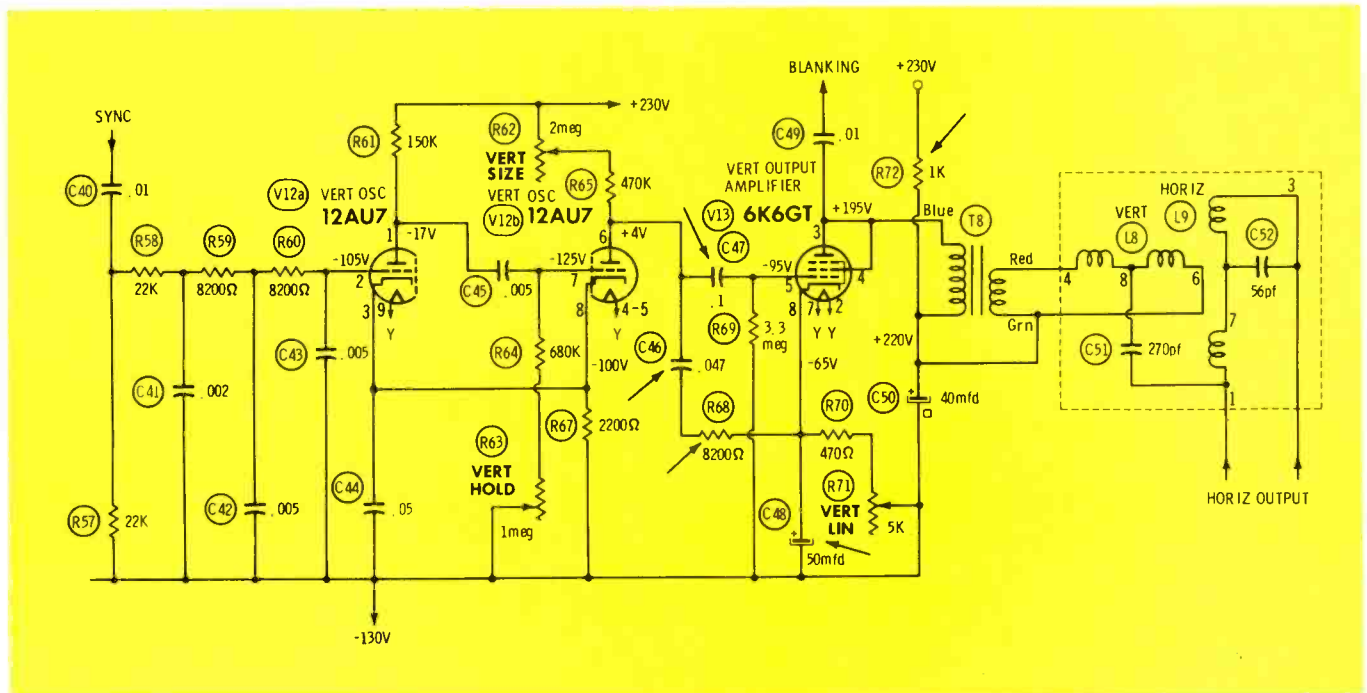

**Fig. 2** An older vertical-deflection system.

is caused by peak clipping of the voltage waveform across the vertical-deflection coils, as illustrated in Fig. 3B. Any component defect that causes a large reduction of vertical output plate voltage will become evident as peak clipping. An example typical of peak clipping is shown in Fig. 4. The peak clipping was caused by an increase in the value of the plate-decoupling resistor in the vertical output stage (R72 in Fig. 2).

In the foregoing situation, measurement of the DC voltage at the plate of the vertical output tube confirmed the suspicion of low plate voltage. In such a case, checking the grid-drive waveform could be very misleading, because the cathode-bias resistor causes interaction between the plate and grid circuits in this configuration. Since the grid-drive waveform also becomes clipped, the unwary technician could jump to the conclusion that the trouble is in the grid circuit, or in the preceding oscillator circuit. Note in Fig. 2 that the cathode-bias resistor (and linearity control) are partially bypassed by C48; that is, the cathode circuit functions as a waveshaping network, as well as a bias source. Since the cathode is coupled to the grid via R68, C46 and C47, abnormalities in the plate-cathode circuit will be reflected into the grid circuit.

Typical symptoms of vertical nonlinearity caused by waveform compression, as distinguished from waveform clipping, are shown in Fig. 5. Fig. 5A depicts normal vertical linearity, as would be displayed by a crosshatch pattern. As the plate-decoupling resistor in Fig. 2, R72, increases in value, the picture becomes progressively non-linear. The defect causes compression near the top of the screen, followed by progressive expansion toward the bottom of the picture, as shown in Fig. 5B. With a large increase in resistance, peak clipping of the deflection waveform results, and the last portion of the picture becomes concentrated suddenly into a bright horizontal line at the bottom of the screen.

The same general picture symptom shown in Fig. 5B can be caused by other component defects, and

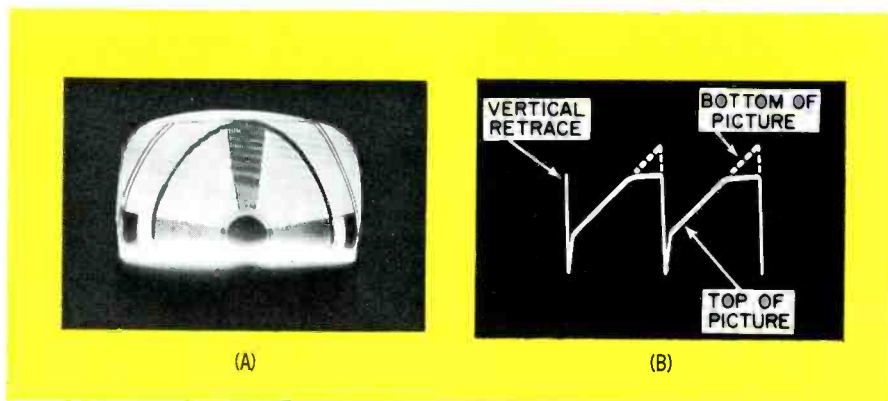

Fig. 3 Example of vertical compression. (A) Picture symptom. (B) Associated waveform distortion.

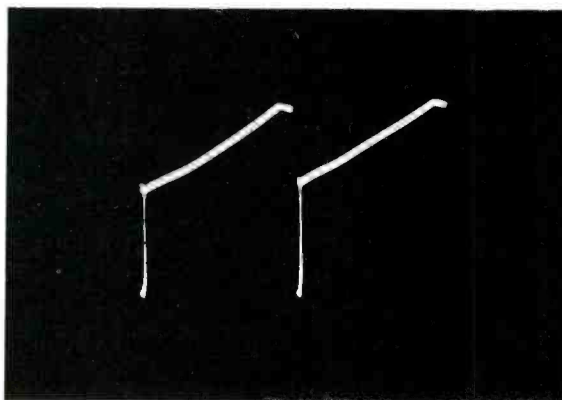

Fig. 4 Vertical-output waveform is clipped when plate voltage is reduced to one-half of normal value.

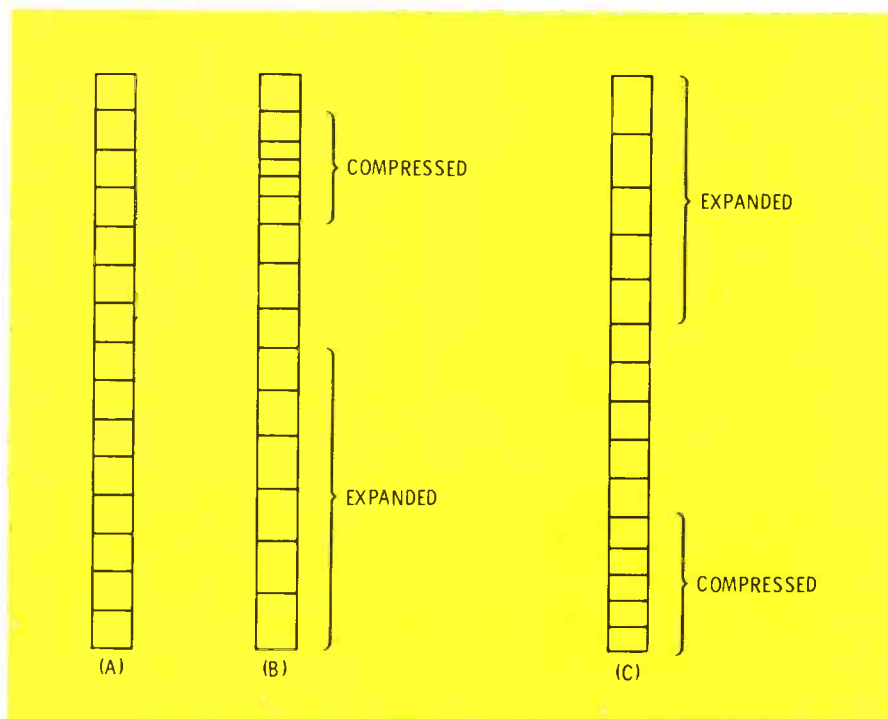

Fig. 5 Illustrations showing normal and abnormal vertical linearity. (A) Normal vertical linearity. (B) Nonlinearity caused by increase in plate-dropping resistance of vertical output stage. (C) Nonlinearity caused by leakage in coupling capacitor of vertical output stage.

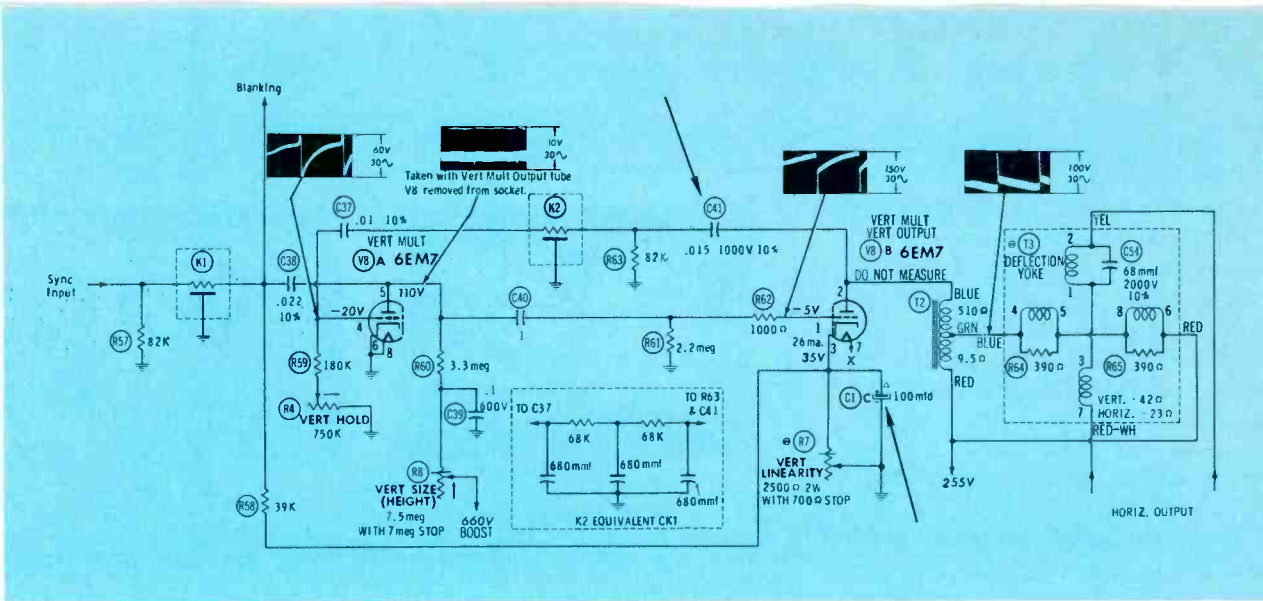

Fig. 6 Typical tube-type multivibrator vertical oscillator/output configuration.

suitable tests must be made to distinguish among the various possibilities. For example, the foregoing picture symptom can be caused by an open cathode-bypass capacitor (C48 in Fig. 2), or by an open plate-decoupling capacitor (C50 in Fig. 2). If it is suspected that a capacitor is open, a quick check can be made by bridging the suspect with a good capacitor, to see if the picture symptom disappears.

The picture symptom shown in Fig. 5B also can be caused by leakage in the cathode-bypass capacitor (C48 in Fig. 2). This defect is accompanied by an increase of the vertical output cathode current, and adjustment of the vertical-linearity control will not correct the trouble symptom.

Leakage in the vertical output coupling capacitor (C47 in Fig. 2), is a common cause of vertical non-linearity. In this situation, the pic-

ture appears expanded at the top and progressively compressed toward the bottom, as shown in Fig. 5C. Measurement of the DC voltage at the grid of the vertical output tube will reveal reduced bias. Curvature also will be introduced into the output waveform, although this symptom is not very conclusive because the curvature could be caused by defects other than a leaky coupling capacitor.

Apprentice technicians occasionally get into difficulties because of incorrect replacement parts. The service data for the receiver is the reliable authority in this regard. A vertical-output transformer must be used with the correct yoke; otherwise, vertical non-linearity will be produced.

### Multivibrator Vertical Oscillator/Output

Two triodes often are used in a

configuration similar to the multivibrator vertical oscillator/output arrangement shown in Fig. 6. When it is compared to the older circuit configuration in Fig. 2, basic similarities are evident. For example, in both circuits the drive waveform is generated by a multivibrator. However, in Fig. 6 the output function (V13 in Fig. 2) is combined with the oscillator function of V8B. Although an output autotransformer is utilized in Fig. 6, its essential similarity to transformer T8 in Fig. 2 is apparent. Because of the similarity of the two designs in Figs. 2 and 6, trouble symptoms and related component defects also are similar.

When cathode capacitor C1 in Fig. 6 is leaky, vertical non-linearity appears in the picture, as shown in Fig. 5C; the same general effect is produced if C1 loses capacitance, or if it has a poor power factor.

If C1 opens up completely, there will be foldover at the bottom of the picture similar to that shown in Fig. 7. (This symptom also is caused by severe leakage in the coupling capacitor (C47) to the vertical output tube in the circuit in Fig. 2.) When C1 in Fig. 6 is open, the amount of non-linearity is affected by the settings of the height and linearity controls, as would be expected. It will be impossible to fill the screen vertically when C1 is open, because of the large amount of cathode degeneration and loss of stage gain that occurs.

If C41 in Fig. 6 becomes leaky, the picture symptom will be similar to that shown in Fig. 5B; also, the

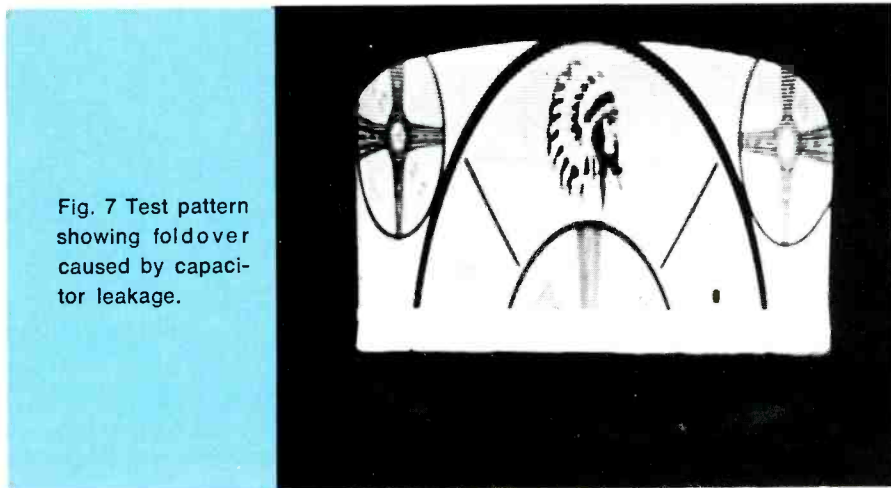

Fig. 7 Test pattern showing foldover caused by capacitor leakage.

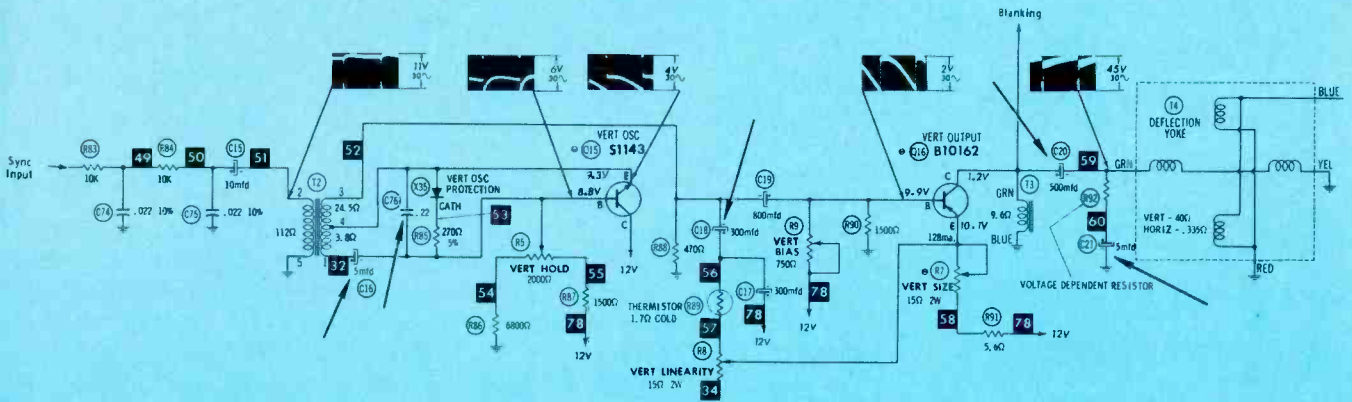

Fig. 8 Transistor blocking-oscillator and output stage configuration.

defective feedback loop will cause "motorboating", which tends to "shake" the picture vertically.

### Blocking Oscillator and Output Stage (Solid State)

Another type of vertical-system design is shown in Fig. 8. This arrangement employs a blocking oscillator driving an output stage. The most likely cause of vertical non-linearity and/or foldover in this cir-

cuit is a defective capacitor in the oscillator or output section. For example, if C76 becomes leaky, the picture folds over from the top, as illustrated in Fig. 9. The trouble can be confirmed by measuring the base-emitter voltage of Q15; this voltage drops from 0.5 volt to about 0.25 volt when the foregoing picture symptom appears.

The same general symptoms are observed when C16 is leaky; however, the picture symptom will be like those shown in Fig. 9 or Fig. 10, depending on the setting of the vertical-hold control. Also, the base and emitter voltages of Q15 will increase somewhat when C16 is leaky.

If C18 in Fig. 8 becomes leaky, the picture will become compressed at the top and expanded at the bottom. If the leakage resistance becomes less than 150 ohms, both the vertical height and hold controls will be at the ends of their range, and the picture will be more or less folded over at the top, as shown in Fig. 9. The leakage can be confirmed by measuring the emitter bias on Q16; the emitter voltage will be less than the normal 10.1 volts.

If C19 is leaky, the vertical-bias control can be reset to restore the normal base voltage on Q16, up to a point. When the leakage becomes excessive, the vertical-height control will not have sufficient range to restore the base voltage to normal.

Capacitor C20 in Fig. 8 is simply a blocking capacitor. It prevents flow of DC current through the vertical-deflection coils. If C20 becomes shorted, the picture will be decentered downward. One indica-

tion of leakage or a short in C20 is the fact that the collector voltage on Q16 will appear on the right-hand terminal of C20.

Although C21 has a small effect on linearity, its action is not very prominent. If C21 becomes shorted, the picture will be expanded slightly at the bottom. The chief purpose of C21 is to assist voltage-dependent resistor R92 in stabilizing the vertical height as the vertical-deflection coils heat up. If C21 is open, the height of the raster will tend to shrink after the receiver has been in operation for some time.

### Conclusion

Although various configurations are used in the vertical-deflection sections of different TV receivers, there are general principles that are common to all designs. Most picture symptoms of vertical non-linearity and/or foldover are due to shift in the quiescent, or operating, point of a tube or transistor, and often is caused by capacitor leakage. In turn, the tube or transistor is driven into its cutoff or saturation region, with resultant waveform compression or clipping.

Although leaky capacitors are the most common culprits, open capacitors also can cause vertical linearity and foldover problems. Picture analysis usually must be followed up by DC voltage measurements. Open capacitors can be localized with DC voltage measurements only if they normally have signal-developed bias voltage at one terminal; they can be pinpointed quicker by bridging with a good capacitor, or by a scope waveform check. ▲

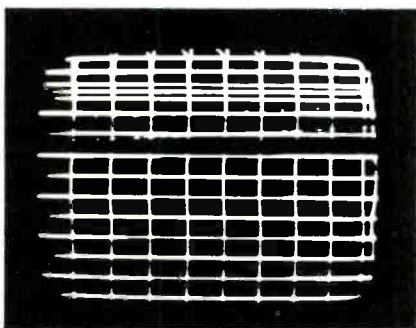

Fig. 9 Foldover at top of picture caused by leaky vertical-oscillator capacitor.

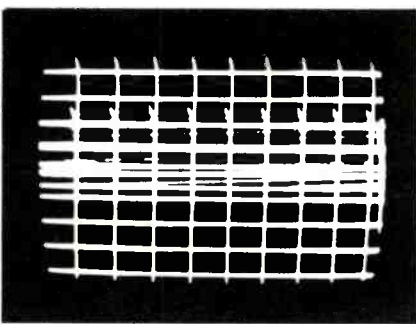
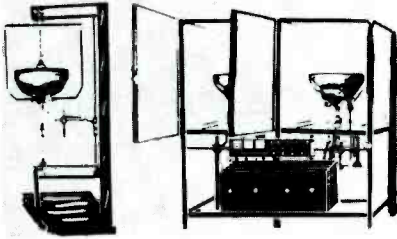

Fig. 10 Foldover in the center-screen area caused by capacitor leakage.

## REBUILD YOUR OWN PICTURE TUBES?



With Lakeside Industries precision equipment, you can rebuild any picture tube!

### EASY TO OPERATE!

Requires only 4x8 ft. of space.  
Your cost to rebuild black and white—  
\$1.50

Your cost to rebuild Color—\$5.80

For complete details, mail coupon.

#### Lakeside Industries

5234 N. Clark St.  
Chicago, Ill. 60640

Phone: 312-271-3399

- Free demonstration appointment  
 Send me more information

Name .....

Address .....

City ..... State .....

Circle 22 on literature card

## IF YOU ARE A TV REPAIR MAN YOU NEED TV TECH AID!

TV TECH AID is the best trouble shooting guide available today. It takes all the guesswork out of TV repair and is designed to help you solve your problems quickly and economically.

Each month you receive updated information on up to 40 different troubleshooting cases. This important information is supplied to us by technicians, field reps and all the leading TV manufacturers. You will find every symptom pictured with a clearly marked schematic of the particular faulty stage. The faulty components and corrections will also be listed to aid in repair. You go right to the source of the trouble without guesswork. In addition you get valuable information on current models as well as older models along with circuit changes and modifications as they occur.

TV TECH AID is the best investment you can make in your own business. The cost to you is only \$7.95 for a full years subscription. Send for it now . . . You'll be glad you did!

#### TV TECH AID

P.O. BOX 603  
KINGS PARK, L. I.  
NEW YORK 11754

ENCLOSED IS A CHECK OR M.O. FOR \$7.95. PLEASE SEND 12 ISSUES OF TV TECH AID

TO:

NAME .....

ADDRESS .....

CITY .....

STATE ..... ZIP .....

Circle 23 on literature card

## test equipment report

### FET Tester

A new tester for checking field-effect transistors (FET's), Model FT155, has recently been announced by SENCORE.

The new FET tester is designed to check leakage and gain (GM) of



both N- and P-channel JFET's and single- and dual-gate MOSFET's.

The unit is intended as a companion unit to SENCORE's Model TR139 transistor tester, or any other tester than can be used for testing only conventional, or bipolar, transistors.

Price is \$94.50.

Circle 50 on literature card

### 3-Inch Oscilloscope

A 3-inch oscilloscope, designed for field use as well as multi-channel monitoring applications, has been introduced by Leader Instruments Corp.

Model LBO-31M has a band-



width of 1 MHz and requires a power supply of 105 to 125 volts AC at 50/60 Hz. Vertical axis sensitivity is 80  $\mu$ V p-p/cm at 1 KHz and the response is within -3dB from 3 Hz to 1 MHz. The sensitivity on the horizontal axis is 2.5 volts p-p/cm and the response is within -3 dB from 3 Hz to 400 KHz. The sweep frequency ranges from 10 Hz to 100 KHz.

The unit is 7 inches X 4 inches X 12 inches, weighs 11 lbs. and lists at \$99.00.

Circle 51 on literature card

### 20,000 Ohms-Per-Volt VOM

A portable, 20,000 ohms-per-volt volt-ohmmeter (VOM) is now available from Lafayette Radio Electronics.

The unit, stock No. 99-50585, has 1 percent multiplier resistors and built-in overload protective circuitry. It is equipped with an expanded 6-inch mirror scale. The



50- $\mu$ A meter provides 20,000 ohms per volt DC and 5,000 ohms per volt AC sensitivity. The stated accuracy is  $\pm 3$  percent DC,  $\pm 4$  percent AC and  $\pm 3$  percent resistance. DC ranges are 0-0.25, 1, 2.5, 10, 50, 250, 1000 and 5000 volts; AC ranges are 0-2.5, 10, 50, 250, 1000 and 5000 volts. DC current ranges are 0-50  $\mu$ A, 1 ma, 10 ma, 100 ma, 500 ma, 1 amp and 10 amp. Resistance ranges are 0-2K, 200K and



20 megohms (12, 1200, 120K center scale). The range of dB is from -20 to +50.

Enclosed in a steel case with high-impact plastic panel, the unit operates on self-contained batteries. It is priced at \$29.95, complete with test leads, batteries and carrying handle.

Circle 52 on literature card

### RF Attenuators

Bird Electronics Corp. has introduced a new 100-watt RF attenuator, with 30 db attenuation and a range from DC to 500 MHz.

The Model 8323's applications include making high-power RF



measurements with low-level power meters while reportedly dissipating 99.9 percent of the input to the attenuator, and performing RFI analyses on high-power transmitters.

In the lower-frequency bands, each unit replaces four or more directional couplers of one octave each and adds DC verification. Bird states that the attenuator curve is flat compared to that obtainable with four individual couplers, and VSWR is low for both input and output.

Maximum frequency deviation is  $\pm 0.5$  dB from DC to 500 MHz, which can be corrected to within 0.2 dB at six calibration frequencies and at DC by use of a table. The attenuator is unidirectional. It also can be used as an RF coaxial load resistor with a maximum VSWR of 1.10.

The price is \$165.00. ▲

Circle 53 on literature card

Now - from GC Electronics

# a Foam Tuner Cleaner good enough to be called MAGIC VISTA ...it's gold



- Features the new, any-angle/constant discharge 360° valve.
- No need to pan for gold today. We make it easy for you. We sell it in a can.
- Cleans, polishes and lubricates tuner contacts.
- Will not rub off or evaporate.
- Safe for plastics.



Golden Foam Tuner Cleaner is just one of about 12,000 items from GC Electronics — your best single source for all your service needs! Buy the golden 6-Pak today. See your dealer.



## GC ELECTRONICS

400 SO. WYMAN ST., ROCKFORD, ILL. 61101  
A DIVISION OF HYDROMETALS, INC

Circle 24 on literature card



# The new challenge to independents

by J. W. Phipps

■ ServiceAmerica, RCA's new all-brand servicing arm, is a fact. It is here **now**, and it **is** competition to **some** independent servicers of consumer electronic products.

The big questions uppermost in the minds of independents are:

- Why has RCA established an all-brand servicing arm?
- Why didn't RCA give RCA Service Company the task of all-brand servicing?
- How much and what kind of competition will ServiceAmerica be?
- Will independents be able to successfully compete against the financial and prestigious might of a large corporation?

Lawrence G. Borgeson, vice president of RCA's Consumer Products Division, in a speech before independents attending the National Electronic Associations' annual convention in St. Louis, provided the following answers to these and other questions posed by independent servicers:

### Why ServiceAmerica?

"As we all know, TV servicing has been expanding at a fantastic rate. The total TV servicing dollar is expected to pass new set sales for the first time this year. And the dollar volume will grow by 600 million over the next four years. We think there's room for an operation like ServiceAmerica to fit into a business that's expanding that enormously—and do it without upsetting the other guy's apple cart."

### Is RCA entering all-brands servicing because they think the independents can't handle it—that they have been "botching" it up?

"That, quite obviously, is ridiculous. Of course the independents can handle TV service, and handle it well. Except for a few strays that we'd all be better off without, the business has been handled with a high degree of honesty and efficiency."

### Why not delegate all-brand servicing to RCA Service Company, or operate both out of the same facilities?

"Certainly, on the surface, this would seem to be the ideal way to run our operation. The saving in overhead alone would be tremendous. Scratching below the

surface, however, we find that such an arrangement simply could not work.

"One immediately obvious thing is that we would find ourselves trading on the RCA name, an action . . . we have pledged ourselves to avoid.

"Also, as a matter of hard fact, there is no way that our Service Company branches could absorb ServiceAmerica. Our branches are already at total capacity, as yours probably are. There is no physical space at the branch facilities to accommodate the additional people, equipment, inventory, trucks, or customer parking that would be needed."

### How much and what kind of competition will ServiceAmerica be?

"I'm **not** going to tell you that ServiceAmerica won't be in competition with the independents. Obviously, in the cities where we're operating, we will be—in the same way you're in competition with each other, if your shops are in the same coverage area.

"Sure, we'll be competing. But I can guarantee you we'll be doing it on a scrupulously honest basis, with no side benefits that stack the odds in our favor."

### The name RCA is well known by consumers. Isn't that an advantage?

"First off, let's start with our new name—ServiceAmerica. You'll note that there's no 'RCA' in front of it. It's not RCA ServiceAmerica—simply ServiceAmerica. If you visited one of our Philadelphia centers you'd see no RCA identification. Our trucks say only ServiceAmerica, and so does our advertising copy. In other words, we have no intention of capitalizing on the drawing power of the RCA name to attract customers. Everyone in the **business** knows that ServiceAmerica is an RCA operation. But, unless she reads the trade magazines, your average **housewife** isn't going to know it.

"We'll get parts the same way you do. Tubes, kinescopes, and parts required in connection with the operation of ServiceAmerica will be purchased from independent distributors in the areas of operation. There will be **no** nationwide purchasing plan. We'll pay the going rate the same as anyone else. This even carries over to test equipment. Equipment used in our centers will be purchased in the same fashion."

### What will be the sources of technicians for ServiceAmerica?

"Manpower has also proved to be something of a bugaboo. There has been some concern—and understandably so—that ServiceAmerica would be raiding the independents. I can assure you that this is not our intention.

"Okay, then, how are we staffing our centers?

## What RCA and the independent servicing industry have to say about ServiceAmerica.

Basically, we are leaning on three sources: RCA internal transfers, trainees with some background in electronics, and former TV technicians who are interested in returning to the field. These sources will provide the bulk of our manpower needs.

"Now I'm not going to . . . tell you that never under any circumstances will we hire a man employed by an independent. Some technicians will, of course, be attracted to our operation. If a man comes to us, and if we have an opening, and if he is well-qualified, we'll probably hire him. We could hardly do anything else. Obviously, we can't blackball a man simply because he works for someone else. But we **will not be actively** recruiting in the shops of our competitors.

"We have an extensive training program that was designed specifically for ServiceAmerica employees. In the short time the course has been in operation, we've had excellent results. Our rate of training will increase as ServiceAmerica expands, and we will be building a gradually widening base of highly trained technicians. If past performance can be depended upon as an accurate guide, some of those we train will some day work for some of you (independent shop owners) and others will start their own repair service. And I see nothing wrong in that. We can't expect to retain everyone we train. Actually, keeping them in the TV servicing field is the principal concern.

"In recent years, all of us have been losing good men to the more glamorous jobs in the electronics field, particularly computers and related equipment. We hope through our training to instill once more a sense of pride and importance in a career of TV servicing. Too many

"Sure, we'll be competing. But I can guarantee you we'll be doing it on a scrupulously honest basis, with no side benefits that stack the odds in our favor."

"We have no intention of capitalizing on the growing power of the RCA name to attract customers."

"We'll get parts the same way you do."

"If a man comes to us, and if we have an opening, and if he is well-qualified, we'll probably hire him."

"Of course, the independents can handle TV



service and handle it well."

"You can be sure that every ServiceAmerica employee will have it pounded into him that he will never—but never—suggest a brand name to a customer, be it RCA or any other."

**Lawrence G. Borgeson,**  
RCA Division Vice President/Consumer Products.

technicians have a poor image of themselves and their work. Until we can dispel this negativism, we will never attract and retain the kind of men we want in the numbers needed.

### Expansion—how quickly and where?

"When will ServiceAmerica be truly national in scope? Our best guess is four to five years, if you are willing to accept a rather loose interpretation of the word 'national'. We should be in a representative number of the major market areas throughout the United States within that time span.

"We will, of course, be concentrating solely on the larger metropolitan areas. As has been already announced, we'll be opening next (Philadelphia operation began in July) in the San Francisco area shortly after Labor Day. Our third market area will be the Miami area, scheduled for early next year. From that point on, various markets are under study, with final determinations still to be made."

### Will ServiceAmerica be channeling business to the RCA Service Company branches?

"Purposely, to avoid just such charges, we decided back in the beginning that ServiceAmerica would service RCA products the same as any other. So, in a sense, we'll be competing with ourselves. But we think it will be a healthy competition—not really different than what's been happening in the automobile industry for a good many years."

### Won't ServiceAmerica be in a position to influence its customers to switch to RCA products?

"Again, on the surface, that seems logical enough. But let's consider that thought in a cold, clear light.

"Suppose we tried it. How long do you think it would take for the other manufacturers to hear about it? The few dollars we could make for another RCA division (sales) would never begin to compensate for the tremendous loss of trust and good will.

"You can be sure that every ServiceAmerica employee will have it pounded into him that he will never—but never—suggests a brand name to a customer, be it RCA or any other.

"We're not entering this business with a death wish. We hope and expect to see it build into something meaningful. And we know full well that can't possibly happen without total honesty and fair play in every phase of the business."

### Will ServiceAmerica centers eventually become retail outlets for RCA products?

"Such a move would be directly against the entire

concept of ServiceAmerica. You can be sure it will not happen."

### **What percentage of the TV service market is ServiceAmerica shooting for?**

"If anybody gets 2 percent of this market, they're doing an outstanding job. I don't think anyone can get 2 percent."

---

## **Industry Reaction to ServiceAmerica**

---

The reaction of the independent consumer electronic servicing industry to ServiceAmerica has ranged from indignant shock and panic to open skepticism of the success of RCA's new all-brand servicing arm.

### **Legal Objections**

Some independent servicers feel that establishment of ServiceAmerica is "unfair", both morally and legally.

The Texas Electronics Association early adopted a resolution stating that "the entry by RCA Corporation into retail servicing of all brands of television sets is detrimental to the interests of, and a threat to the survival of, present retail service dealers, and we also believe it is an unfair trade practice, which we pledge to oppose by every legal means available to us."

An editorial in the NESAs News, the official publication of the Nebraska Electronic Service Association, stated: "We would be the last to deny anyone the right to enter the electronic service business on a free and equal basis. We do not believe it is a field sacred only to those who have been in it for some time, and that others should be excluded. But we do question the propriety of any manufacturer going into the service business in competition with the very people who have for years made it possible for him to sell his product. We believe his advantages, whether he uses them or not, constitute unfair competition and could be construed as restraint of trade."

Late in April of this year, Casper W. Weinberger, chairman of the Federal Trade Commission, in a report to the Tri-State Council of TV Service Associations, Inc., which represents a number of service firms in Delaware, Pennsylvania and New Jersey, and which, in a petition to the FTC, charged RCA with restraint of trade, advised that its Bureau of Restraint of Trade had conducted a number of inquiries into the matter and would continue to investigate complaints.

According to a report in **Home Furnishings Daily**,

Mr. Weinberger stated: "From present indications, it would appear RCA will, no doubt, engage in the practice of dual distribution in selling its repair parts both to independent servicemen and its own service companies.

"It is quite possible the latter may compete with independent servicemen . . . (but) the practice of dual distribution does not, in and of itself, violate any of the laws presently administered by the (Federal Trade) Commission."

### **NEA Creates Fund to Combat ServiceAmerica**

The National Electronic Association (NEA), representing about 1500 independent servicers, has adopted the Texas Electronic Association resolution (stated earlier in this article). NEA also is sponsoring a fundraising campaign to combat ServiceAmerica through advertisement and other promotion of independent television servicing. The campaign, called S.I.S., an acronym for "Save Independent Service", was announced at the Association's sixth annual convention in St. Louis in July. Funds from the campaign are to be used to promote independent servicing in Philadelphia and San Francisco, the sites of the first ServiceAmerica operations.

### **Ohio organization encourages "write to RCA" campaign**

An editorial in the ARTSD News, official publication of the Associated Radio and Television Service Dealers of Columbus, Ohio, encouraged its members to send their objections about ServiceAmerica to the head of the RCA Corporation, Robert Sarnoff, Jr., 30 Rockefeller Plaza, New York.

### **NATESA head and others are skeptical of ServiceAmerica's future**

Frank Moch, executive director of the National Alliance of Television and Electronic Service Associations (NATESA), believes RCA's venture into all-brand servicing is doomed to failure within two years, but cautions that "by that time independent businesses would be destroyed".

Mr. Moch gives four primary reasons for his skepticism of ServiceAmerica's success: "First, to expect other set marketers to complacently sit by and allow a super-giant and greedy competitor to enter the homes of their customers at a time when they are unhappy, to say the least, because their set needs service, is very unrealistic. No sane businessman would give a competitor such a propaganda opportunity. The result, at best, would be encouragement of universal captive service by all manufacturers.

"Second, the quality, speed and cost of service presently available from RCA Service Company in no way meets the high standards of independents. This being so with one brand, what reason is there to believe that improvement would result (from) handling all brands.

"Third, it is one thing to use men trained . . . in a few weeks who may or may not be capable of fixing even one chassis . . . (and another) to find men capable of servicing hundreds of chassis of dozens of brands. This could only result in technician pirating."

"Fourth, is the problem of parts availability. It is a matter of record that each day this becomes more serious due to proliferation of models. This being so, the planned RCA universal operation would, of necessity, have to have multiple complete inventories at each location. Under existing thinking, investment in adequate parts inventories is opposed because of slow turnover. The problem for the RCA operation (ServiceAmerica) would be multiplied by 20 or more."

Other veteran independent servicers and retailers also are skeptical of ServiceAmerica's future. Ken Crane, president of a chain of Magnavox home entertainment centers in the Los Angeles area, recently stated this view: "I can't imagine any of our customers wanting RCA to service their Magnavox sets. Actually, it might be a good thing for Magnavox dealers by making them more conscious of good service.

"The way we see it, they're another potential competitor, and that's all," observes Jerry Canter, president of Universal Television Company, a large firm which does servicing for many retailers in California. "I don't expect them to come into a community with very low prices to attract customers away from other firms."

#### **Other independents believe factory all-brand servicing will drain customers away from independents via service contracts at the time of set sale.**

Pete Fabbri, independent servicer and editor of TSA News, the official publication of the Michigan Television Service Association, in a recent editorial said: "It's hard to believe that any smart service dealer may think the FATS (factory all-brand TV service companies) people are going to fight him on the open service market, customer by individual customer.

"FATS is too smart for that; it would be too costly, too strenuous and too slow. But some FATS operations might go this route as a smoke screen to cover the real action: That's the point of sale of the TV set, by using the time-proven strategy of locking up customers indefinitely via the service policy (contract).

"Here's the way it works: Packard Bell reportedly has taken over the service contracts on all of the numerous brands of TV carried by a large Los Angeles

## **ServiceAmerica Now Operating in Philadelphia Area**

ServiceAmerica reportedly on July 14 began operations in the Philadelphia area. According to a spokesman for RCA, five service centers have been opened in the area, and will cover a 25-mile radius extending out from the center of greater Philadelphia.

Each of the service centers is staffed initially with a manager, five technicians, two clerical employees, and five service vehicles.

The new ServiceAmerica operations reportedly are limiting servicing to home entertainment electronic products, and are not servicing major appliances, although spokesmen for RCA stated earlier that appliance servicing was being considered.

Pre-opening promotion of ServiceAmerica in Philadelphia and suburban papers, according to a recent report in *Home Furnishings Daily*, included the following statements:

"Introducing a new idea in TV repair service: ServiceAmerica.

"It is not our intention that you come down with a broken TV set. However, if you should be so unlucky, we think you should know about us. On July 14, 1970, ServiceAmerica opens in Philadelphia with five locations, a new idea on how a TV repair service should be run, and four solemn promises to back it up . . .

"When we say we'll be out Thursday, we'll be out Thursday, or the cost of the labor's on us . . ." "We'll charge you fairly for the work we do . . ." "We not only give you a warranty on parts, we give you a warranty on us . . ." "In the age of specialization, we'll fix virtually any TV set ever made . . ."

## RCA Service Company Added Nine Centers in 1969

RCA Service Company in 1969 added nine new service centers in eight states to its nationwide network of branches, according to RCA's 1969 Annual Report.

Commercial sales of the RCA Service Company reportedly were up 45 percent.

chain discounter, thereby beating . . . RCA to the punch. From now on, if this discounter sells a lot of sets, Packard Bell will lock up thousands of future service-needing customers via the 'service policy strategy' for at least 90 days, but more likely for one or more years, thus freezing out the independent TV servicers."

### **NARDA staffer believes ServiceAmerica will cut sales of independent dealers who service.**

Mickey Walther, assistant to the executive vice president of the National Appliance & Radio-TV Dealers Association (NARDA), in an interview published in **Home Furnishings Daily**, stated he believes RCA's all-brand service operations will hurt the independent by reducing the "we-service-what-we-sell" advantage of retailers who service.

"We have always contended," said Mr. Walther, "that factory service takes away some business from the independent appliance retailer, and RCA's plan to offer central service for all brands is going to further minimize the reasons for buying from an independent."

---

### Conclusion

RCA acknowledges that its all-brand servicing arm, ServiceAmerica, is in direct competition with independent servicers of consumer electronic products, but states that it will play the ballgame by the same rules practiced by independents, without moving into the lineup such obvious advantages as the drawing power

of the RCA name and the financial weight of the RCA Corporation.

RCA also has stated that it will not permit the employees of ServiceAmerica to "push" RCA products during home service calls on other makes of home entertainment products.

RCA contends that a continuing rapid increase of the need for servicing—an increase which they say exceeds the present volume capabilities of the independent service business—is the reason they have established all-brand servicing facilities in the major metropolitan areas of the U.S. According to spokesmen for RCA, there is enough business for everyone—the independents and ServiceAmerica.

RCA also contends that they will not actively solicit technicians for ServiceAmerica from among those employed by independent shops; however, RCA has qualified this statement by adding that they will not turn away skilled technicians who knock on their door. Consequently, if RCA offers technicians better pay, more fringe benefits or better working conditions than those available in independent shops, the natural desire for self-improvement will lead skilled technicians to ServiceAmerica's door.

RCA also has stated that they intend to offer "Cadillac" service, at prices \$2 or \$3 above the norm in some localities.

While it is difficult to predict just how much competition ServiceAmerica eventually will become, independents must realize that the "war" will be an economic one. When the battle lines form, the only effective weapons will be:

- 
- Competitive but realistic service labor pricing
  - Realistic compensation of skilled technicians, including both wages and fringe benefits
  - Effective customer relations—prompt and personalized service
  - Proficient servicing—quick diagnosis and cure of troubles, fixes that stay fixed
- 

To insure that these weapons are available when needed, independent shop owners must begin now to develop effective cost accounting and efficient shop operations—two essential elements that today seem to be weak spots in the management of many independent shops, particularly the small- and medium-size shops. ▲

## PA Microphones

A series of public-address (PA) dispatcher-type dynamic microphones has been introduced by the Turner Company.

Model 751 is a 150-ohm impedance unit having 300- to 3500-Hz frequency response, which is essentially voice range, and this reportedly cancels out many unwanted background noises that fall outside the unit's tailored frequency range. Finely adjusted leaf-type switches are wired for relay operation. The microphone comes with a 20-foot cable and complete specification sheet.



Models 750 and 758 are similar to Model 751 with the exception that the former is a high-impedance unit and switches are wired normally open. Model 758's switches are wired line-shortening.

These three units incorporate a new "forward-voice" design to efficiently capture and reproduce the human voice, according to Turner. Housed in a rugged die-cast metal case, the microphones include a front touch-to-talk switch bar and locking on/off switch. The cartridge, front screen and switches reportedly can be easily replaced.

Model 754C is a new conventional ceramic base-station microphone, for citizens-band application. The high-output ceramic interior provides a frequency response

# If you're not using these tools of the trade, YOU'RE LOSING MONEY!

That's right. The combination of TUN-O-WASH and TUN-O-BRITE for tuners increases customer satisfaction and eliminates costly callbacks. Super Frost Aid is far superior to other circuit coolers in tracking down thermal intermittents. Without these professional chemical tools of the trade, you're wasting hours of labor and a lot of referral business from satisfied customers.

## TUN-O-WASH

GETS TUNERS  
REALLY CLEAN!



NO. 2400

TUN-O-WASH is completely unlike any other tuner spray on the market. TUN-O-WASH contains no lubricants. All of the power of its high pressure spray is designed to do just one job superlatively well—to melt away grease, oil, dust, dirt, corrosion and any other foreign material that may be on the tuner contacts. No other spray can even approach TUN-O-WASH in pure cleaning power. TUN-O-WASH restores the tuner to its original condition, leaving parts and contacts like new. Especially good for removing old, encrusted tuner sprays.

## SUPER FROST AID

TAMES THERMAL  
INTERMITTENTS FAST!

LEAVES NO LIQUID RESIDUE



NO. 1550

Just let the chassis "cook" for an hour or so and then spray each component in the suspected circuit until you see a dramatic change on the TV screen or hear it on the speaker. The last component you have sprayed is usually the defective one.

Some component coolers don't work fast enough to enable you to be sure, but with Super Frost Aid, the reaction is fast and definite—as though you had clicked a switch.

## TUN-O-BRITE

THE HEAVY DUTY TUNER  
SPRAY WITH BUILT-IN  
CONTACT BRIGHTENERS!



NO. BT-8

Polishes tuner contacts, removing all dirt and corrosion. Can't damage precious metal platings because polishing particles are hollow—disintegrate after initial wiping action. Leaves film of thick, protective lubricant with more body and staying power than any other aerosol lubricant on the market.

CHEMTRONICS

**CHEMTRONICS** 1260 RALPH AVENUE  
BROOKLYN, N. Y. 11236

Circle 25 on literature card

of 300 to 3000 Hz, and has an output level of -52 dB. The unit is equipped with a black PVC-coiled, three-conductor cable (one shielded), with an extended length of five feet and a retracted length of 11 inches. It is available with either touch-to-talk or lock on/off switching and may be used for either relay or electronic switching by movement of the slide switch located at the base of the unit.

Models 750, 751 and 758 each sell for \$75.00 and Model 754C is list priced at \$35.00.

*Circle 55 on literature card*

### Flat Speakers

The Magitran Company, Division of ERA Acoustics Corp., announces the addition of a new series of flat, plastic speakers to their Poly-Planar line of units.

Designated as the "Roly-Poly" series, the new speakers feature a thin, round silhouette constructed to permit exact RETMA replacement of the cone speaker equivalent. Constructed entirely of weather-proof polystyrene material, the new speakers reportedly offer the ad-

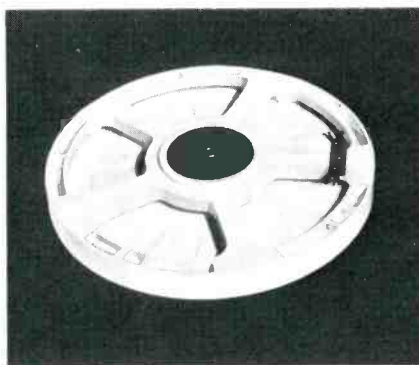

vantages of wide-range, hi-fi reproduction; low distortion; bi-directional, wide-angle dispersion; and high sensitivity.

A typical unit in the series is the Model RP8, which has a diameter of 8 inches, an overall depth of 1 inch and weighs 11 oz. Frequency response is 40 Hz to 20,000 Hz, and power handling capability is 10 watts rms, 20 watts peak. Sensitivity is 90 dB/m for one watt electrical input. Directional characteristics are essentially cardiodal with bi-directional dispersion, according to Magitran. The unit uses an electromagnetic movement and standard impedance is 8 ohms, although other impedances are avail-

able on order. The speaker reportedly can operate at full ratings over the temperature range of -20 degrees F to +175 degrees F.

The price of Model RP8 is \$9.95.

*Circle 56 on literature card*

### Background Music and Paging Amplifier

A 15-watt, solid-state amplifier for background music and paging applications has been made available by Bell P/A Products Corp.

Model T-15 is a compact, all-silicon, solid-state amplifier featuring: one high-impedance microphone; one program input with a



wide-range tone control (15 dB cut at 10,000 Hz); and 4-ohm, 25- and 70-volt line outputs. The unit is available with balanced low-impedance microphone input and/or balanced 600-ohm input.

The unit measures 2 7/8 inches X 9 1/4 inches X 8 7/8 inches, weighs 6 lbs. and is priced at \$107.50.

*Circle 57 on literature card*

### Cassette Tension Winders

Tape tension winders, engineered to mate with all standard cassette hubs, is being offered by Robins Industries.

Especially useful in editing or splicing, the manufacturer calls the



winders "an ingeniously simple necessity." The main function is to take up slack in the cassette that can lead to jamming and damaged tape.

The winders list for \$1.50 per pair in a blister package. ▲

*Circle 58 on literature card*

## When one gun fades restore color balance with a Perma-Power single-brite COLOR GUN CONTROL

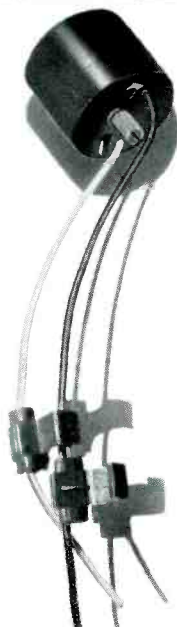

MODEL

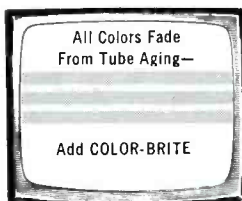

# B-150

\$800 Suggested List Price

Here's a unique new product that lets you restore color picture balance when a single gun weakens. You just adjust the bias between the G1 and G2 grid leads of the weakened gun, permitting color intensity variation as needed for a balanced picture. Installation is easy . . . just two simple connections, no soldering. Now available at your parts distributor.

**CHAMBERLAIN MANUFACTURING CORPORATION**  
845 Larch Avenue • Elmhurst, Illinois 60126 • Phone: (312) 279-3600

*Circle 26 on literature card*



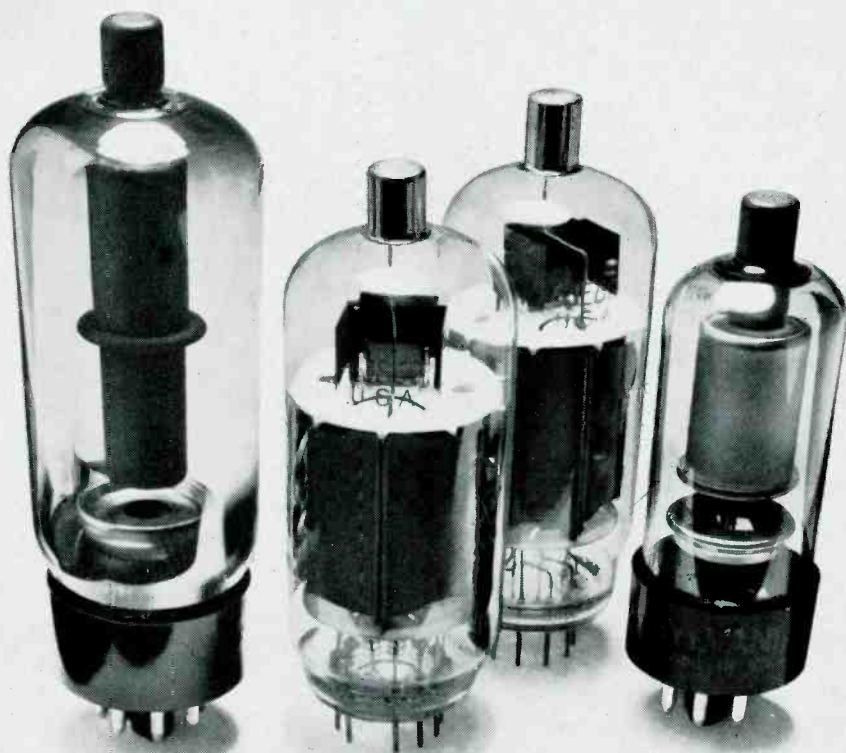

## Our hot ones are the last to go.

The last thing you need is to be called back a day or two after you've replaced the sweep or high voltage tubes in somebody's color TV.

But, they're usually the first to go. Because they get so hot.

So we figured out how to cool them. Now, they last a lot longer.

Take our 6JE6C/6LQ6, for example. It's the horizontal deflection tube that takes such a beating when the set gets hot.

Well, we've given it special patented radiator fins that first absorb the heat and then radiate it out of the tube.

Now it runs cooler and lasts longer. Same for our 6JS6C.

Or take our 6BK4C/6EL4A. That's the shunt regulator that eliminates runaway high voltage. We gave this one a whole new anode and shield design to improve heat transfer and stability.

Now it also runs cooler and lasts longer.

Or take our 3A3B high voltage rectifier. This one's got leaded glass for added protection. And it lasts longer too.

So next time you have to replace any of the hot ones, just cool it. You'll both last longer.

**SYLVANIA**  
GENERAL TELEPHONE & ELECTRONICS

*Circle 27 on literature card*



## Rectifier circuits - - - operation and testing

Facts all technicians need to know about series and shunt rectifier circuits. Explains how and why the shunt rectifier is the basis of most oscillators, sync separators and horizontal drive circuits. Practical methods of using a scope to diagnose rectifier circuit defects also are included.

### Understanding Diodes

Only two things are necessary for rectification: a source of AC and a diode. All other parts are refinements—even a filter capacitor can be replaced by a battery in some circuits. Diodes can be vacuum-tube or solid-state types made of such materials as copper-sulfide, selenium, germanium or silicon. Assorted types of solid-state rectifiers are shown in Fig. 1. Later, we will see that the grids of tubes and the bases or collectors of transistors can function similarly to the anode of a diode.

Any diode is actually a voltage-controlled switch, regardless of its type of construction or efficiency. When the anode is positive, relative to the cathode, a near-perfect diode will have almost zero resistance, as shown in Fig. 2. Or, to say the same thing another way, when the diode is forward biased, the forward resistance is nearly a short-circuit. When the anode is negative, relative to the cathode, the diode is reverse biased, and a near-perfect diode will have infinite resistance. These statements are true even when the diode is used as a DC clamp, an AM detector, a power supply rectifier or a damper.

The efficiency of any diode is measured by the power (wattage) dissipated across it as the result of both forward-bias voltage drop and reverse-bias leakage current. Let's again analyze the action of a near-perfect diode: Current produced by forward bias can be very large,

but the voltage drop across the diode will be nearly zero, because the internal resistance also will be nearly zero. The formula is:  $\text{Wattage} = I^2 \times R$ , but if  $R$  is zero, the answer also will be zero. When the diode is reverse biased, the voltage across the diode will be very high, but the leakage current will be nearly zero. Again, almost no power will be dissipated across the diode.

Perfect diodes do not exist. A tube diode can have zero reverse current, but the forward resistance is relatively high. A silicon diode might have very low forward resistance but measurable reverse current. At this time, silicon diodes have the highest efficiency of any used commercially.

All such diode losses produce heat; the less heat, the higher the efficiency. The heat generated by a diode depends, in part, on the length of time it takes to switch from a completely "on" state to a completely "off" state, or visa versa. Between these two operating states, internal resistance is relatively high. The quicker this switching action, the less heat generated. The ultimate in efficient switching is the conventional on-off switch. These facts explain how SCR's and triacs can switch large amounts of power and remain relatively cool. They are either completely on or completely off—the two conditions where heat dissipation is minimum.

### Evolution of Rectifier Circuits

The most simple rectifier circuit, consisting of a source of voltage, a diode and a load resistor, is shown in Fig. 3A. The output waveform is produced by the positive half of the incoming sine wave, as pictured in the double-trace scope waveform in Fig. 3B. Diode conduction occurs only when the anode is positive, and because there is a pulse of positive voltage for each positive side of the sine wave, the frequency of the rectified output is 60 Hz. If you don't have a dual-trace scope, check the frequency by connecting the vertical input probe of your scope to the positive end

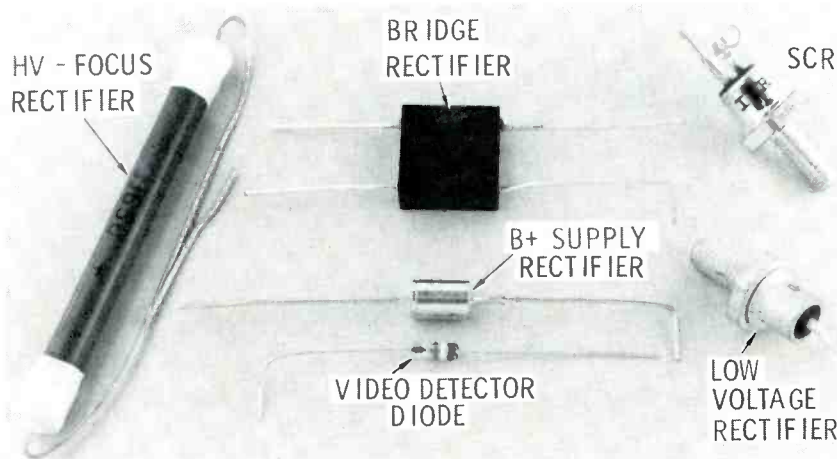
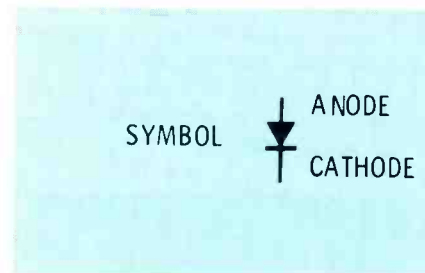

Fig. 1 An assortment of typical solid-state diode rectifiers.

of the load resistor, and the scope ground lead to the power supply ground. Reset the scope controls for internal 60-Hz horizontal (sine-wave) sweep. Adjust the vertical and horizontal gain controls for equal height and width; the waveform should look like that of Fig. 3C, if the output of the power supply is a positive-going pulse. If your scope does not have internal 60-Hz horizontal sweep, change the controls for external horizontal sweep, then attach the horizontal input probe to the anode of the diode, X1. Adjust width as needed. This kind of rectification is often called "half-wave", because only half of the sine wave is used. The DC voltage produced will be low because VOM's and VTVM's **average** any rapid variation in voltage, and this half-wave voltage is present only part of the time, thus making the average very low.

"Full-wave" rectification is illustrated in the schematic of Fig. 4A. The center-tapped transformer provides 180-degree, out-of-phase voltages to X1 and X2, which causes them to conduct alternately when their anodes become positive. Comparison of the full-wave output with the sine-wave input in Fig. 4B verifies that the output pulses of the full-wave voltage are 120 Hz. Or, use the 60-Hz horizontal sine-wave deflection on your scope, as detailed before, and the "V" wave-shape (like that in Fig. 4C) will prove the output pulses (if they are positive) to be 120 Hz.

Rectifier circuits without capacitors are not typical in the power supplies of consumer electronic equipment. A half-wave rectifier with an input filter capacitor of 20 mfd is shown in Fig. 5A. The output waveform (hum or ripple) is a 60-Hz sawtooth, as shown in Fig. 5B. It is important for us to know, and remember, that the output is actually 95 percent pure DC with about 5 percent of sawtooth riding on top. The frequency of the saw-



(A) Schematic symbol of a diode.

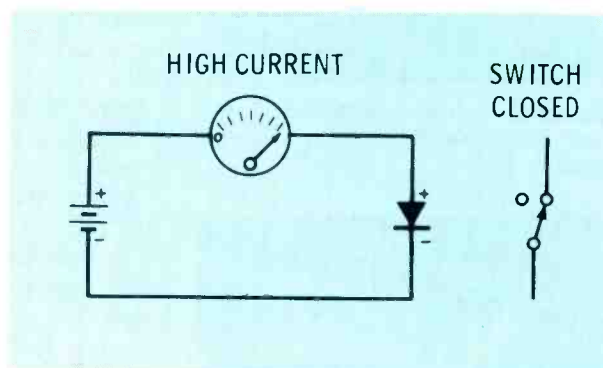

(B) A diode is switched "on" when the anode is positive relative to the cathode.

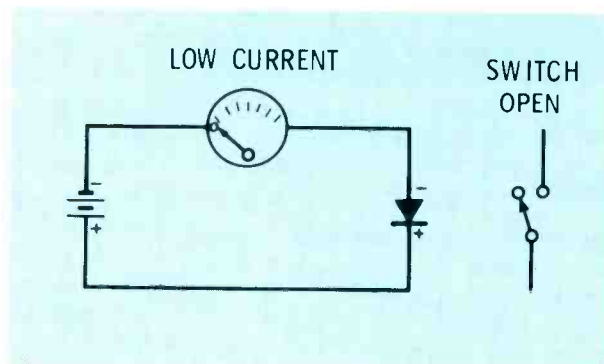

(C) A diode is switched "off" when the anode is negative relative to the cathode.

Fig. 2 A diode is a voltage-controlled switch.

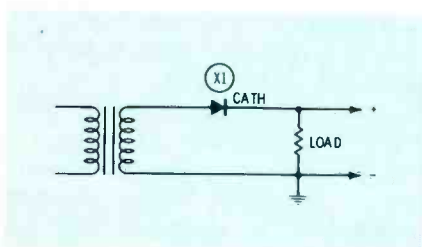

(A) Schematic of the half-wave circuit. Input voltage is 150 volts rms, DC output is +67 volts, AC output is 205 volts p-p and the load is 4.7K ohms.

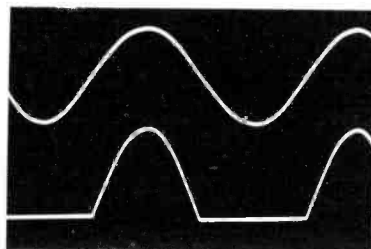

(B) Double-trace scope waveform of the input sine wave and the output rectified pulse; both are 60 Hz.

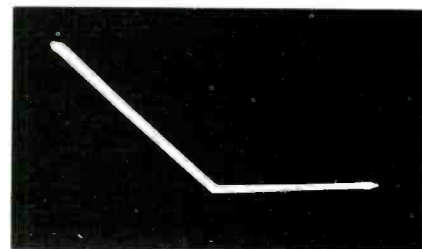

(C) Scope waveform with the output pulse applied to the vertical amplifier of the scope and a 60-Hz sine wave used for horizontal deflection.

Fig. 3 Simple, unfiltered, half-wave rectifier circuit.

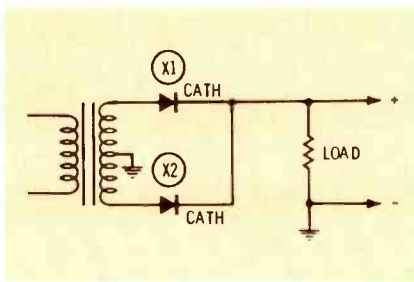

(A) Schematic of the full-wave rectifier circuit. Input voltage is 150 volts rms on each side of the center-tap, load resistance is 4.7K ohms, DC output is +135 volts and the AC output (hum) is 210 volts p-p.

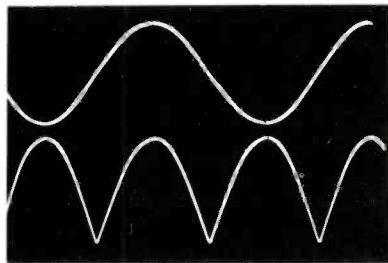

(B) Scope waveform of the 60-Hz input sine wave and the 120-Hz full-wave pulse.

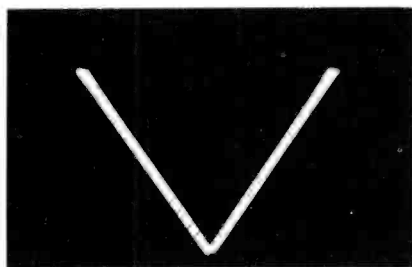

(C) The 120-Hz output pulse applied to the vertical amplifier of the scope and a 60-Hz sine wave applied to the horizontal amplifier.

Fig. 4 A full-wave unfiltered rectifier circuit, using a center-tapped transformer.

tooth can be determined with a scope by the method given previously; the correct waveform is shown in Fig. 5C.

Compared to the basic circuit voltages in Fig. 3, the voltages of Fig. 5 show a substantial increase in DC voltage, and an equally substantial decrease in p-p AC (hum). These differences are produced by the capacitor.

### An Input Capacitor Causes "Peak-Reading" DC Voltages

Fig. 6 shows the relationships of p-p, peak and rms voltages. Since rectification uses no more than one peak for one diode, the peak volt-

age is the one of interest to us. Peak voltage equals the rms voltage multiplied by 1.414.

In the rectifier circuits of Figs. 3A and 4A, each diode conducts current and voltage for a complete half cycle, because this is the time the anode is positive relative to the cathode. Adding a capacitor in parallel with the load resistance (Fig. 5A) causes the diode to supply power to the load, and charge the capacitor, during the time of conduction. In between diode conduction pulses, the capacitor partially discharges, to furnish power to the load. This partial discharge results in a sawtooth ripple, or hum, across the capacitor, as shown in Fig. 7B.

Diode conduction cannot occur until the anode becomes more positive than the cathode. With the cathode connected to the positive end of the storage capacitor, only the tip of the input sine wave is more positive than the cathode/capacitor voltage; therefore, diode conduction occurs for a short period of time, as shown in the waveform of Fig. 7A. The dotted lines in Fig. 7B were added to show the part of the sine wave during which the diode current flows, while Fig. 7C shows the relationship between the rising edge of the sawtooth and the diode current (the scope width was expanded for better visibility).

The voltage at the top of the sawtooth is the peak voltage (rms times 1.414) of the applied AC sine wave, less any losses. The amplitude of the sawtooth depends principally on the capacitance and the load. If the load is very light and the capacitance large, the output DC voltage will measure almost exactly the peak of the input AC voltage. This is the meaning of the old phrase "peak-reading".

A 20-mfd capacitor added to the full-wave circuit, as shown in Fig. 8A, produces more DC and less AC (hum) at the output, and the hum is 120 Hz (see Fig. 8B). Frequency of the hum is verified on single-trace scopes by using 60-Hz, sine-wave horizontal sweep and applying the sawtooth to the vertical input. A "bow tie" waveform, as shown in Fig. 8C, indicates the frequency is 120 Hz.

If negative voltage is desired from any of these four types of rectifier circuits, merely reverse the di-

ode(s) and the polarity of the filter capacitor.

Many variations of these basic circuits are possible. For example, Fig. 9A shows a rectifier circuit which supplies a positive output voltage, yet one side of the rectifier is grounded. This circuit was used to produce the waveforms of the capacitor current and diode current (Fig. 9B) by adding small resistors in series between anode and ground, and the negative plate of the capacitor and ground. The common ground necessary for operation of a dual-trace scope inverted the polarity of the pulse of the diode current.

Any rectifier circuit is a closed loop, and the basic operation is not changed by repositioning the ground connection. The ground is there only for the external circuits that constitute the load. Take the schematic of Fig. 9C as an example. It is the same as that of Fig. 5A, except for the grounding point.

Some power supplies have negative output, others have positive output, and some equipment (particularly solid-state types) might have both positive and negative voltage outputs. One model of solid-state TV receiver stacks one power supply on top of another. To determine what the polarity of a power supply should be, follow this helpful rule:

**When rectified DC is obtained from a diode, the polarity of the voltage will be negative if it is taken from the anode, and positive if it is taken from the cathode.** In Figs. 3A, 4A, 5A and 8A, the output voltage is obviously obtained from the cathode of the diode, and consequently is positive. The output voltage of Fig. 9A is from the cathode, through the transformer winding, and is also positive.

A rectifier circuit with both positive and negative voltages is diagrammed in Fig. 10A; the associated waveforms are shown in Fig. 10B. To change this circuit to one that produces twice the normal amount of positive voltage (voltage doubler), it is necessary only to switch the ground to the -output terminal, as shown in Fig. 10C. The same circuit is redrawn in a more familiar configuration in Fig. 10D. It is very odd to see a diode connected from one side of the trans-

# THE GREAT ANTENNA DEBATE



**T**he current heated debate over the greatness of our Color Crossfire versus our Color Vector was not our intent when we engineered them. We merely wanted to see that you have more than one way to provide outstanding color and black and white reception.

That's why we didn't stop with the Color Crossfire...the antenna that pushed the fringe farther back than anyone ever thought possible. We went ahead with the Color Vector for extra-

ordinary performance from a compact. And we build them both so you're not going to be called for repairs after every windstorm or smog inversion.

But since both sides stand firm for the finest color and black and white TV reception there is, and the debate rages on, may we say:

Gentlemen, please don't fight! There are still plenty of roofs left in this country for two great antennas...

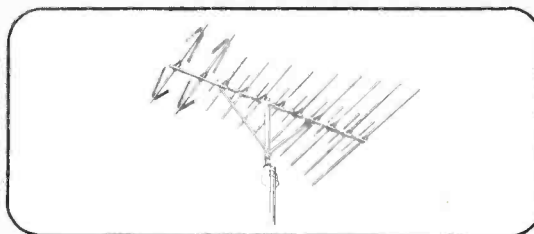
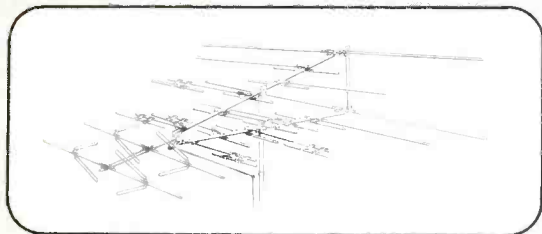

The **COLOR VECTOR** or the **COLOR CROSSFIRE** from

**CHANNEL MASTER**

DIVISION OF AVNET, INC. ELLENVILLE, N.Y. 12428

Circle 33 on literature card

former winding to ground and a filter capacitor connected from the other side of the winding to ground, but Fig. 10C shows that the double voltage is obtained by connecting the negative and positive supplies in series. This is verified when the full-wave, 120-Hz output waveform in Fig. 10E is compared to the two 60-Hz, half-wave, alternate-conduction waveforms in Fig. 10B.

### Shunt Rectifiers

All of the rectifier circuits described previously were "series" types; which, incidentally, function just as well if the transformer shown

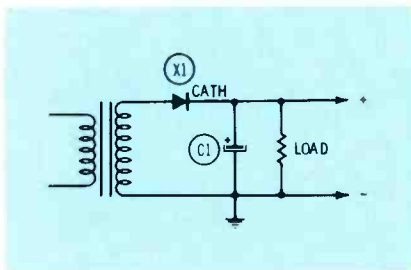

(A) Schematic of the half-wave rectifier with capacitor circuit. Input AC voltage is 150 volts rms, C1 is 20 mfd, load is 4.7K ohms, DC output is +175 volts and AC output is 17 volts p-p.

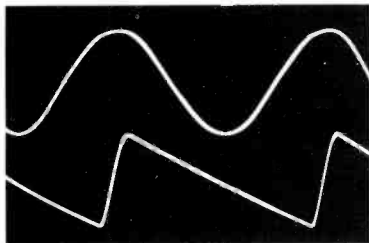

(B) Input sine wave and the output sawtooth AC; both are 60 Hz.

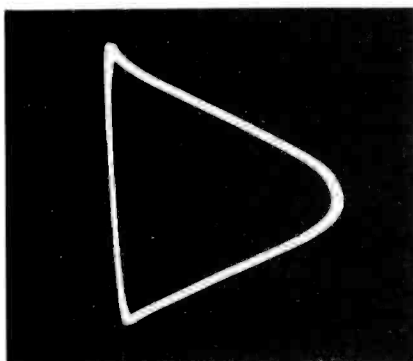

(C) Scope waveform with the output sawtooth applied to the vertical amplifier and a 60-Hz sine wave applied to the horizontal amplifier.

**Fig. 5** An input electrolytic capacitor is added to the half-wave circuit to make it "peak reading".

is actually the one on the power company pole.

The other basic rectifier circuit is the shunt, or parallel, type. Although it requires a resistive path somewhere across the input terminals, the rectifier diode and load are separated from the source voltage by the input filter (storage) capacitance. The other distinctive characteristic is that the entire input AC voltage also appears across the output, as shown in Fig. 11A.

Fig. 11B illustrates an unsuccessful attempt to filter out the huge amount of hum from the output. Even when fed through a strong filter system consisting of a 680-ohm resistor and a 40-mfd capacitor with no DC load on the output, the hum measured 45 volts p-p. Because of the inherent hum, this circuit is useless for powering radios or TV receivers.

One very successful adaptation is to combine the shunt with a following series rectifier, as shown in Fig. 12. DC and nearly full line voltage are the output of the shunt rectifier. The series rectifier rectifies the AC sine-wave output of the shunt rectifier and adds the DC on top of the DC from the shunt stage to produce voltage doubling.

The output hum of this circuit is 60 Hz. Notice the polarity of diodes X1 and X2 in Fig. 12. X1 conducts on the negative side of the sine wave, and X2 conducts on the positive peak. In many doubler circuits such operation would double

the frequency, but not in this case. Because the large sine-wave output from the shunt rectifier circuit completely swamps any small amount of ripple that might be present, the hum output of X2 is 60 Hz.

The voltage charts in Table 1 provide the values of the DC and hum voltages obtained from the circuit of Fig. 12 when the size of the two input capacitors and the value of the load resistor were changed. I have known for many years that the capacitance of C1 and C2 would radically change the output DC voltage and hum. Even so, two items in the table surprised me: One was the reduced output hum voltage as the capacitance of C1 was decreased. The explanation is simple: Hum voltage is dependent on the series rectifier circuit—and it is supplied with less input DC and AC when the capacitance is decreased.

The other surprise was the result when the capacitance of C2 was changed. When C3 is 0 mfd, and C2 is changed to 0 mfd, the resultant output is +165 DC and 325 volts p-p 60-Hz sine wave, exactly the same as the output of the shunt rectifier. The only explanation is that the anode of X2 is positive relative to its cathode at all times; the peak DC and AC from the X1 circuit are the same.

Other applications of the shunt/series type of voltage doubler are shown in Fig. 13. The load and quadrupler circuit is used during alignment of single- or over-coupled

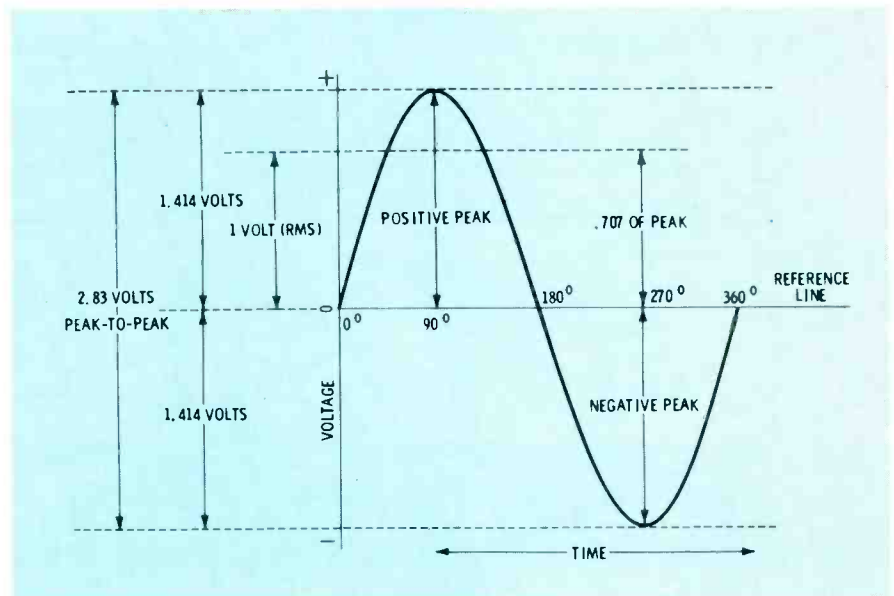

**Fig. 6** Peak and rms voltages are enough to evaluate sine-wave AC voltages; p-p voltages are necessary to measure correctly square waves or non-symmetrical waveforms.

pairs of IF transformers in TV receivers, and it consists of two shunt/series doublers with the DC output voltages connected in series for increased output.

Fig. 13B shows the p-p rectifier circuit of the RCA WV98C VTVM. Other VTVM's and FET meters use solid-state diodes instead of the 6AL5, but the principle is the same. A p-p rectifier circuit must rectify both the positive and negative peaks, regardless of wave-shape, and add the two voltages together for the complete reading.

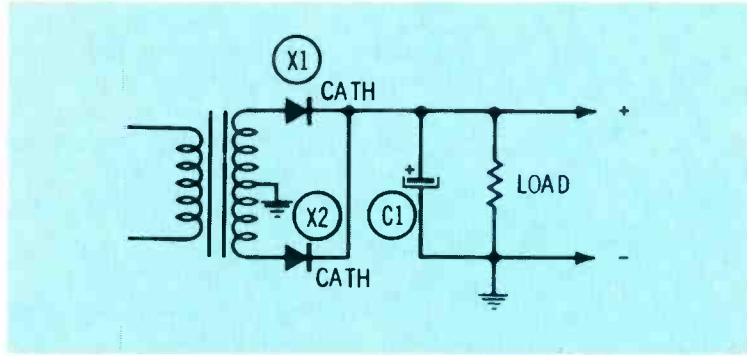

(A) Schematic of the full-wave circuit using two diodes, a center-tapped transformer secondary and a peak-reading input capacitor. AC input voltage is 150 volts rms each side of center-tap, C1 is 20 mfd, load is 4.7K ohms, the output DC voltage is +195 and the output AC hum is 8 volts p-p.

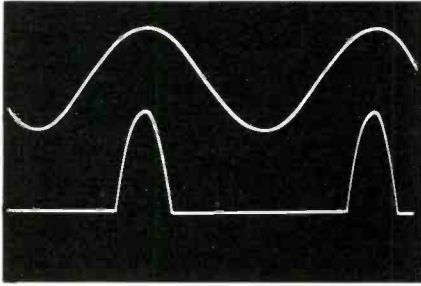

(A) Top waveform is the 60-Hz input sine wave and the bottom waveform is the diode current (slightly broadened by the resistances in the circuit).

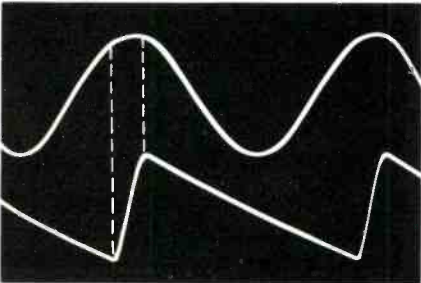

(B) The relationship of the input sine wave to the output sawtooth hum. The dotted lines were added to show the part of the sine wave during which diode current flows.

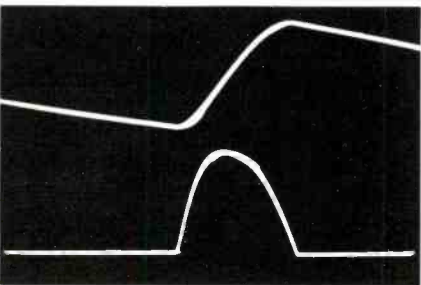

(C) Horizontal sweep width of the scope is increased to make the relationship between the sawtooth hum (at top) and the diode current more clear.

Fig. 7 Dual-trace scope waveforms of current and voltages in the schematic of Fig. 5A.

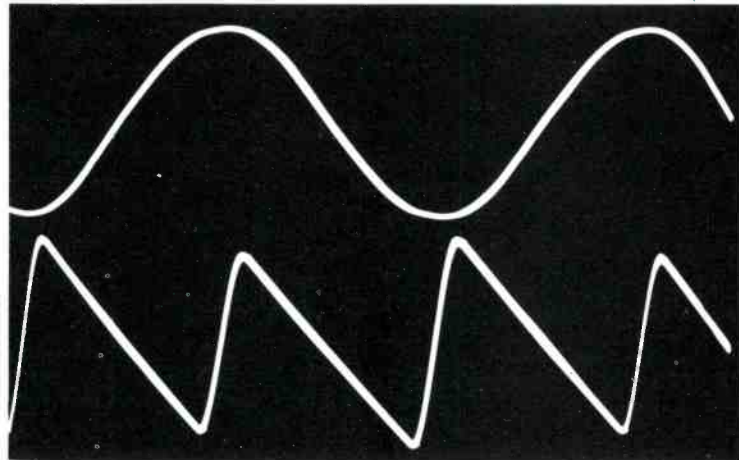

(B) Waveforms of the 60-Hz input sine wave and the 120-Hz output sawtooth hum.

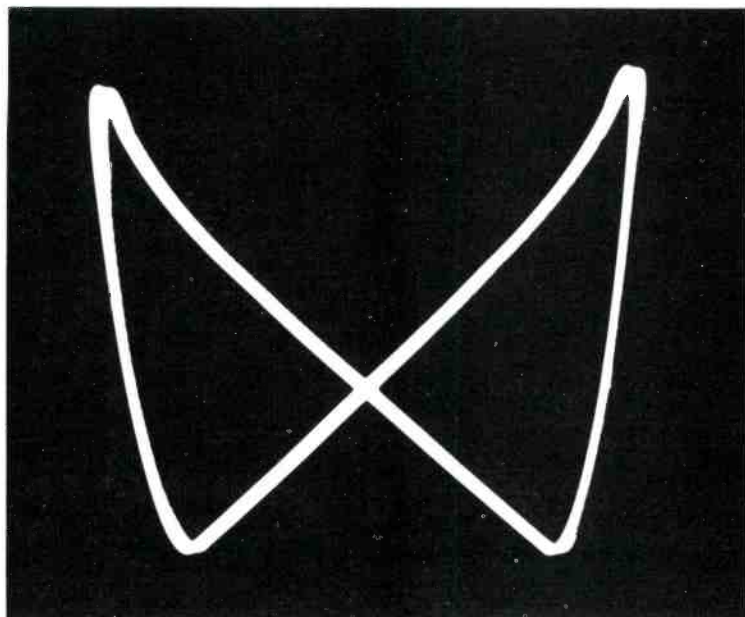

(C) "Bowtie" waveform obtained with the sawtooth hum applied to the vertical input of the scope and a 60-Hz sine-wave horizontal sweep.

Fig. 8 A frequently used full-wave rectifier with capacitor input filter.

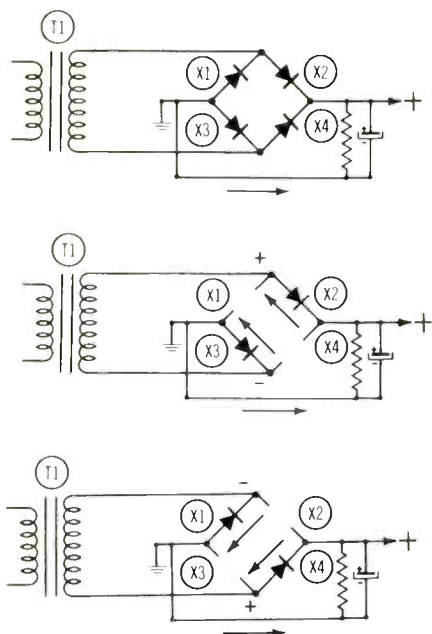

**Fig. 8 (D)** Schematic of a full-wave bridge rectifier circuit with peak-reading input capacitor. Circuit action is similar to the fullwave circuit in Fig. 8A, except that the diodes switch at both ends of the transformer winding, and the single non-tapped winding supplies power for both positive and negative peak rectification.

Someone might question the practicality of this circuit, because it was previously stated that the output hum is the same frequency as the input voltage. However, it also was explained that one of the diodes conducted on the positive peak and the other diode conducted on the negative peak. Thus, the requirements for p-p measurements are fulfilled.

### Examples of Grids Used as Anodes

Three examples in which the grids of tubes act as the anodes of diodes in shunt rectifier circuits (in addition to their normal functions as controllers of plate current) are shown in Fig. 14. Example (A) shows the grid circuit of a sync separator stage in a television receiver. The composite video input to the grid of the sync separator must be positive-going (remember, the grid acts as an anode). Grid current flows only for the duration of the sync pulse, then the negative voltage resulting from the rectification biases the grid to cutoff. Plate-current conduction occurs only during grid-current time (when the grid is slightly positive), and the output sync pulse is negative-going.

Fig. 14B shows the grid circuit of a horizontal output stage in a color TV receiver. I am certain you now recognize that this is a shunt rectifier circuit with the grid functioning as the anode of a diode. Rectification of the sawtooth output from the horizontal oscillator is the sole source of grid bias in this circuit.

Many of the shortcuts we use in troubleshooting the grid drive (sawtooth and DC) are valid and help-

ful. But notice that **no** negative voltage will be produced if the tube is out of the socket, or the grid or cathode circuits open. These defects can include open tube socket pins or bad grounds. Leakage or a short circuit in C65 might cause a positive voltage on the grid, or it might kill the horizontal oscillator. Also, the correct negative voltage on the grid does not prove that the oscillator is operating on the

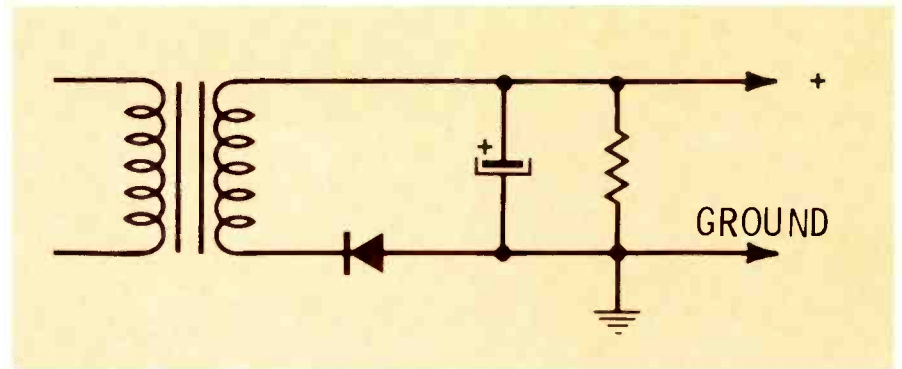

**(A)** Schematic of a rectifier circuit with the rectifier grounded. The output voltage is positive in polarity.

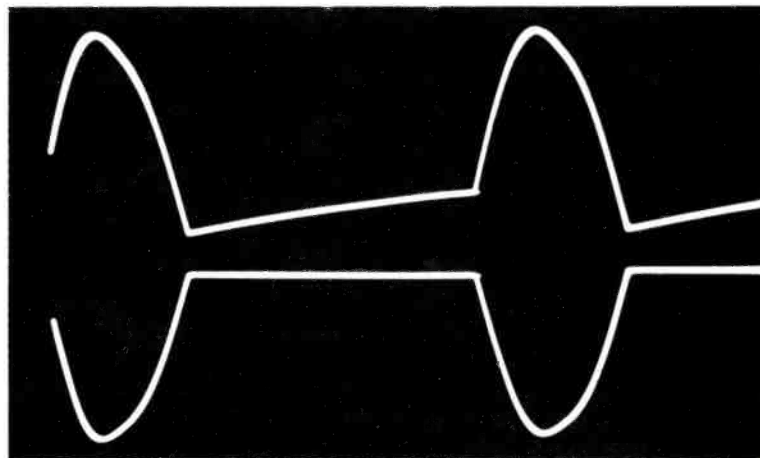

**(B)** Capacitor current and diode current can be seen on the scope screen by adding small resistors (27 ohms or smaller) between capacitor and ground, and between diode and ground. Attach the scope leads across the resistors one at a time (both, if the scope is dual-trace type.) The slope in the base line of the capacitor current waveform is the discharge of the capacitor into the load. Heavier discharge between cycles increases this slope and might indicate a capacitance that is too small for the value of the load.

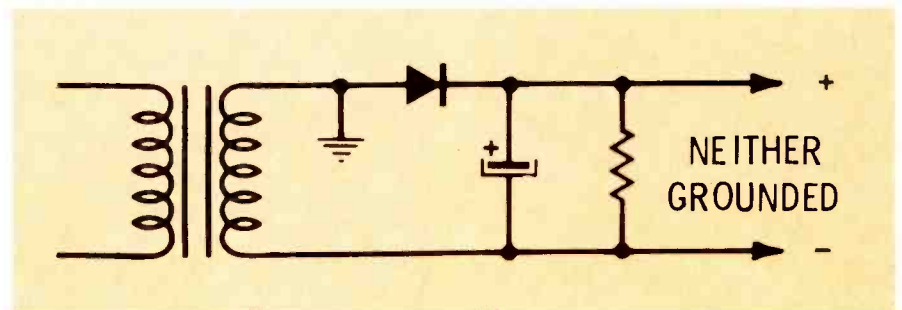

**(C)** Schematic of a rectifier circuit with the rectifier-transformer point grounded. Operation is the same as that of Fig. 5A, except the load cannot be grounded.

**Fig. 9** Operation of a rectifier circuit is not affected by location of the ground point.



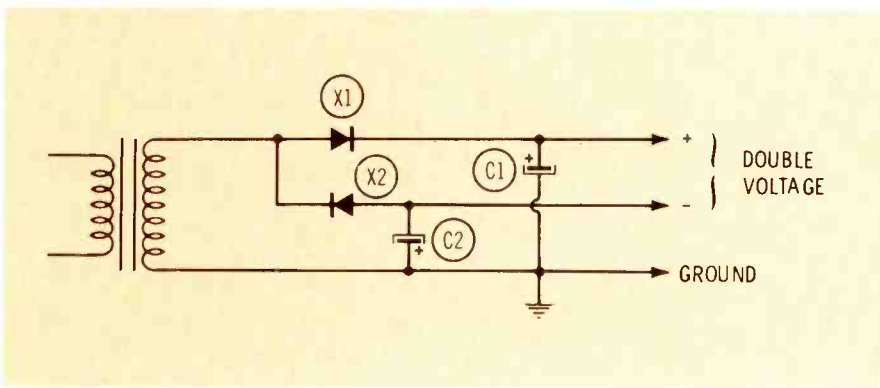

(A) Schematic of the positive/negative voltage supplies.

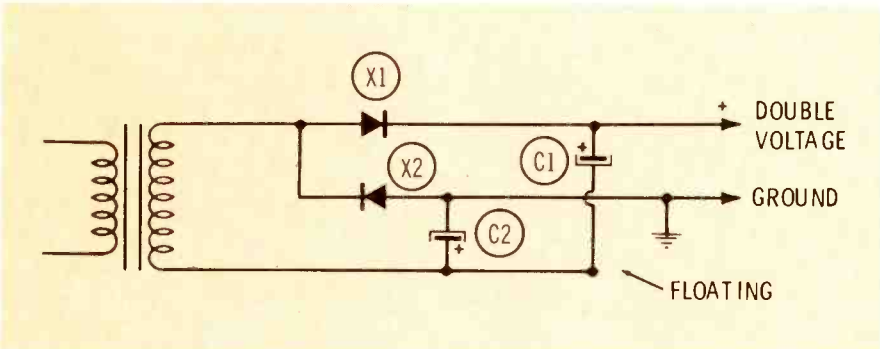

(C) The schematic of (A) with the common transformer wire floating and the - terminal grounded to produce voltage doubling.

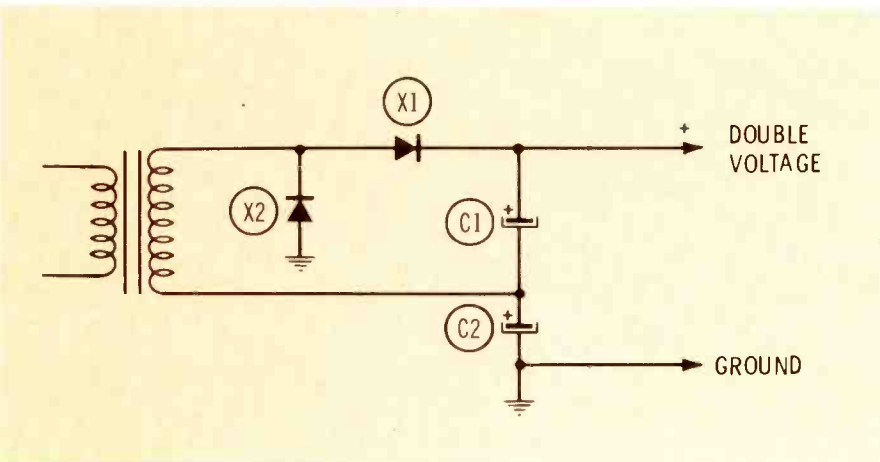

(D) Schematic of (C) redrawn as it often appears in service data. The circuit is much harder to understand in this form.

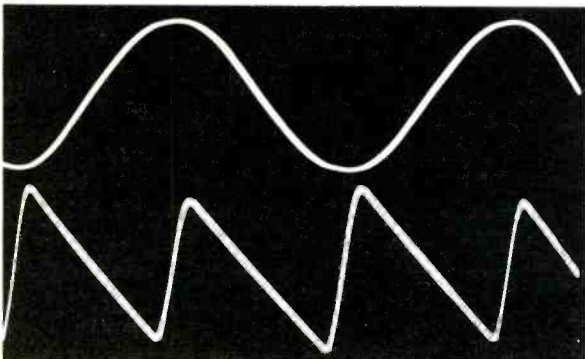
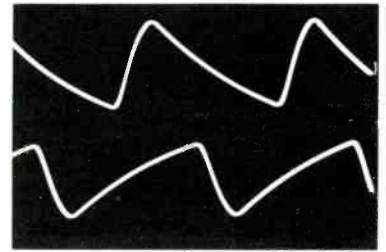

Fig. 10 Two half-wave, peak-reading circuits can produce both positive and negative voltages from one transformer winding.

(E) Scope waveform of the input sine wave and the output sawtooth of (C) and (D). The hum is 120 Hz; this circuit is both a voltage- and frequency-doubler.



(B) Waveforms at the output of the two supplies show each to be a half-wave rectifier operating on alternate peaks.

right frequency. More information on this important subject will be included in Shop Talk in a near-future issue.

A sine-wave horizontal oscillator is shown in Fig. 14C. An oscillator is an amplifier that supplies its own input signal. The shunt rectifier action of the grid is the same as in the first two examples. R134 is returned to the coil, but the circuit would function just as well if it were returned to cathode.

### Negative Voltage Made From Positive Peaks

To understand how it is possible to obtain negative voltage by rectifying positive peaks, consider the following facts:

- For diode conduction, the anode must be positive in relationship to its cathode.

- When rectified DC is obtained from a diode, the polarity of the voltage will be **negative** if it is taken from the **anode**, and **positive** if it is taken from the **cathode**.

- Analyze the voltages and the electron current path, as shown in Fig. 15.

During the time the positive peak of the sine wave is present at the peak-reading capacitor, the capacitor charges through the low resistance of the diode, which is forward biased by the capacitor current. When the positive peak is not

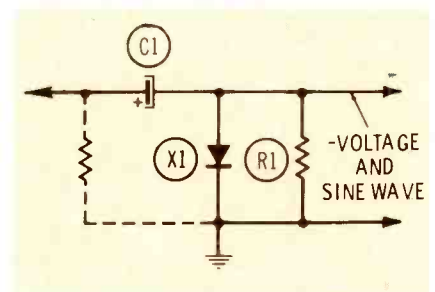
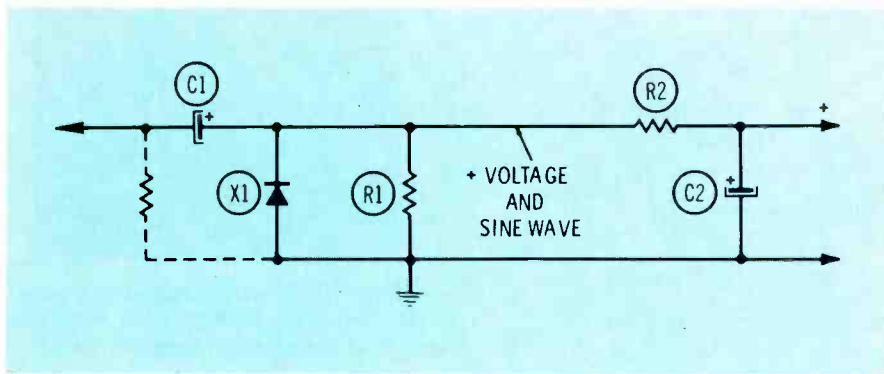

Fig. 11 (A) Schematic of a simple shunt rectifier with negative output.



(B) Schematic of a shunt rectifier with positive output and an extra RC filter section. Input voltage is 120 volts rms, C1 is 20 mfd, R1 is 4.7K ohms, R2 is 680 ohms (1 watt) and C2 is 40 mfd. Output voltages obtained were: +160 DC and 330 volts p-p AC at the cathode of X1; +150 volts DC and 45 volts p-p AC at the output and C2. **NOTE:** R2 becomes very hot; also, the hum is too large for most uses.

Fig. 11 Shunt rectifiers produce DC and full AC output.

maximum, the diode is no longer forward biased and is virtually an open circuit. The high positive end of the capacitor is grounded through the transformer winding (power wiring or circuit resistances in the case of VTVM's), and the capacitor partially discharges the stored power into the load. This end of the capacitor is highly negative relative to the plate that is connected to the transformer. The capacitor is replenished with power for the short period of time during each cycle when the anode of the diode becomes slightly positive, but the anode of the diode is negative for a much longer period of time (the rest of the cycle). Any DC meter will read this as a negative voltage.

### Base and Emitter of a Transistor Used as a Diode

The junctions of a transistor also exhibit diode characteristics. Fig. 16 shows two examples of rectification by the base/emitter junction.

The base of the transistor in Fig. 16A rectifies the pulse from the vertical output stage. A PNP-polarity transistor is used, and a meter reads the base voltage as a reversed bias of 1.4 volts. At the right is a transistor equivalent, symbolized as diodes; included are the normal voltages relative to the emitter. From this, it is clear the negative peak of the incoming waveform forward biases the base-emitter junction and causes diode-type conduction. Because the DC produced by this rectification is obtained from the "cathode" of the transistor used as a diode, the polarity is positive.

Fig. 16B shows the voltages on a VHF oscillator transistor of NPN polarity; and on the right, the transistor drawn with diode symbols and normal voltages relative to the emitter. Base-emitter rectification produces negative voltage, which is reversed bias for an NPN transis-

120 volts rms input, C2 is 20 mfd, load across C3 is 9.4K ohms

C1 (mfd)	Output Voltage at C2	Hum at C2
40	+318	18 PP
20	+310	17 PP
10	+295	16 PP
7	+280	14½ PP
1.5	+160	7½ PP
0	0	0

120 volts rms input, C1 is 20 mfd, C3 is 0, load is 9.4K ohms

C2 (Mfd)	Output Voltage at C2	Hum at C2
40	+315	10 PP
20	+310	17 PP
10	+300	37 PP
7	+295	50 PP
0	+165	325 PP (60 Hz sine)
0	+240	255 PP when C3 is 40 mfd (choke input)

120 volts rms input, C1 is 20 mfd, C2 is 20 mfd, C3 is 40 mfd,

Load	Load Current	Voltage at C2	AC at C2	AC at C3
inf.	0 mills	+340	¼ PP	—
39K	8 mills	+330	5 PP	.1 PP
9.4K	33 mills	+310	17 PP	.5 PP
4.7K	62 mills	+285	30 PP	1.1 PP
2.3K	104 mills	+245	50 PP	1.7 PP

Table 1 DC voltages and hum obtained with different sizes of capacitors and load resistors.

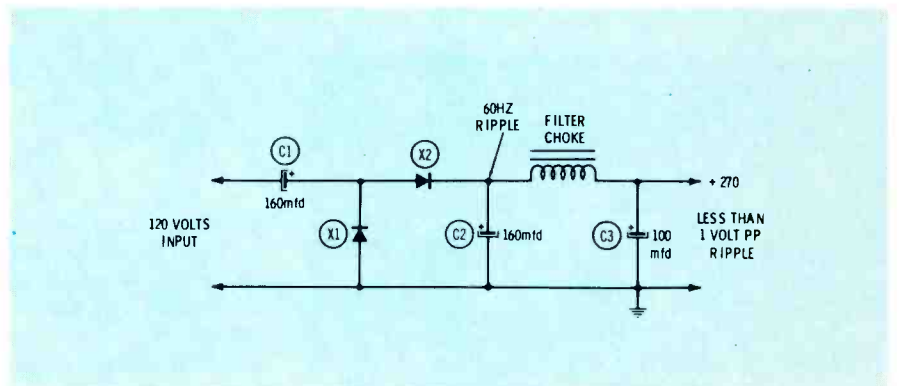
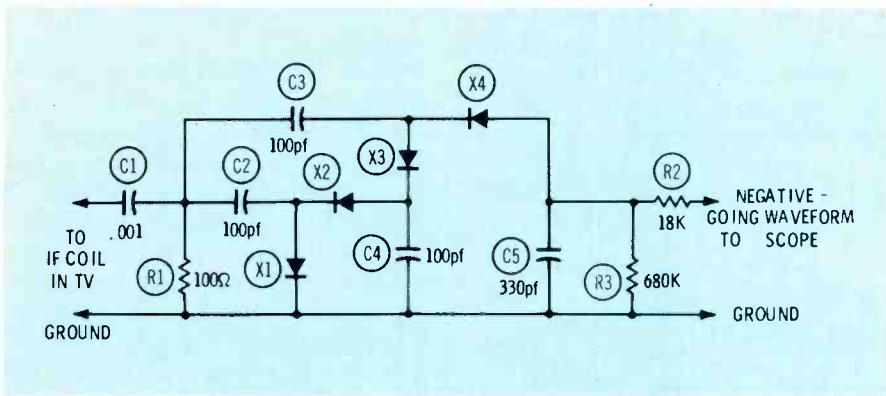

Fig. 12 Schematic of a typical voltage-doubler using both the shunt and series rectifier circuits. The hum frequency is 60 Hz even though the rectifiers conduct on opposite peaks.



table, but the cause of any power supply problem will be found in this simple list of four basic factors.

One open diode in the circuit shown in Fig. 8A or Fig. 8D will not stop all operation, but the DC voltage will be low and the hum level high, because a full-wave circuit has been changed to a half-wave configuration by the defect.

(A) Typical IF load and voltage quadrupling detector used for alignment of one IF stage.

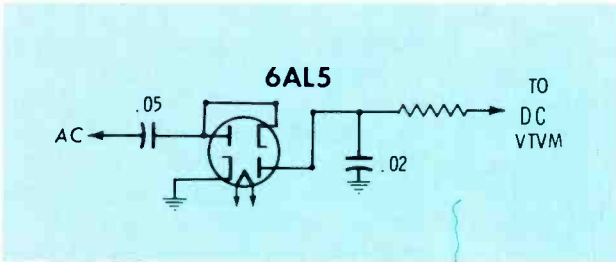

(B) Tube diodes used as p-p rectifiers in the RCA WV98C VTVM.

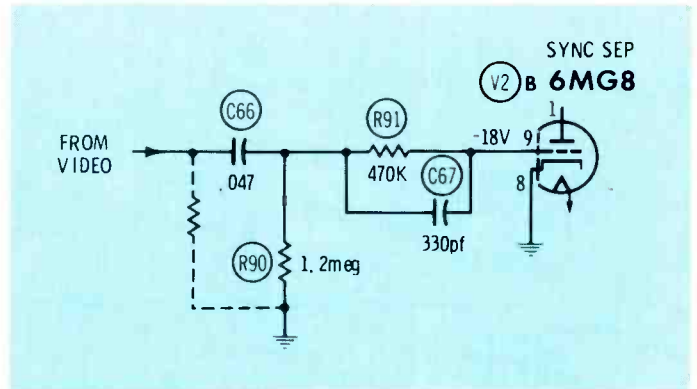

(A) Sync separator input of the Philco 18MT70 chassis.

tor. Many similar circuits provide a small forward bias to initiate oscillation, after which the much larger rectified voltage becomes more predominant.

If a transistor stage measures reverse bias, yet according to symptoms on the screen or other accurate tests, the stage is functioning normally, it is nearly a certainty that the transistor is operating as an oscillator or a class "C" amplifier. The reverse bias must become forward bias for a short period during each cycle.

### Troubleshooting Power Supplies

The primary factors which affect the output voltage and residual hum of any power supply are:

- Input voltage and waveform (always should be checked).
- Diode condition, including forward voltage drop and reverse current leakage. (Be sure an open in the wiring or a circuit board has not changed a full-wave circuit to a half wave.)
- Capacitor characteristics, including leakage and power factor.
- Load current (should be nearly normal).

Many variations in symptoms and the extent of the defect are inevi-

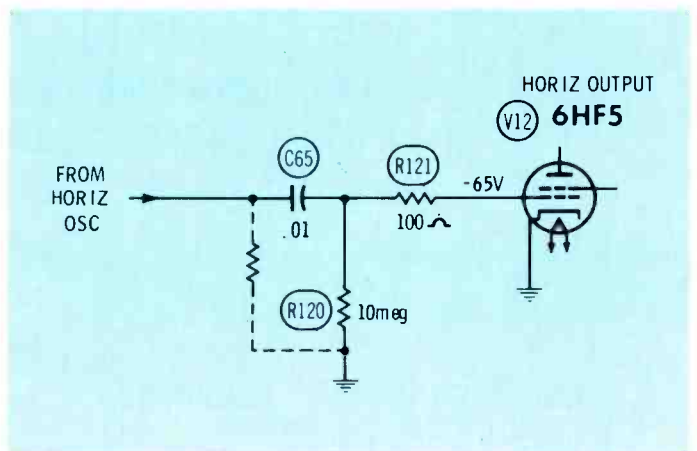

(B) Horizontal output tube grid circuit of the Zenith 25LC20 chassis.

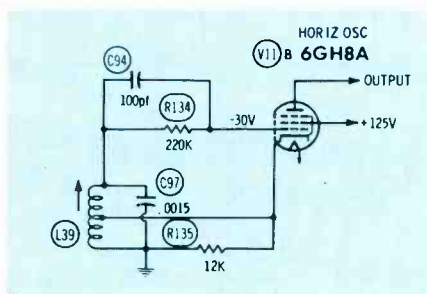

(C) Horizontal oscillator circuit of the Magnavox T924 chassis.

Fig. 14 Grids and cathodes of tubes used as diodes in TV receivers.

A scope, VTVM or FET meter, and perhaps an accurate line-voltage meter, should be your primary test equipment for power supply problems. Fig. 17 shows some of the

visual signs of defective parts. Fig. 17A is the capacitor current in the circuit of Fig. 8A when the load is light but one of the diodes has excessive leakage. When the capacitor

is part of a multiple unit can, it is difficult to look at the capacitor current, but Fig. 17B shows the difference in size of the alternate hum waveforms when a diode is leaking. Fig. 17C shows the peculiar waveform produced on the cathode of X2 in Fig. 12 when C2 is open. The sharp spike is an inductive kickback from the choke and C3. At higher current, the waveform becomes more like that of Fig. 4B.

In TV receivers, a pulse from the vertical output stage might be seen in some parts of the filter system. Often this is normal. The source can be identified by making the vertical roll; if the extra 60-Hz pulse rushes across the screen of the scope, it is from the vertical sweep. Or, disable the vertical and the pulse should be gone.

Practice measuring the hum frequency on several normal receivers until you can do it rapidly and accurately. This one technique might save you many hours of troubleshooting time.

#### A Postscript About Resistors

Several of our readers have written that the suggestions about resistor replacement in the Shop Talk column of ELECTRONIC SERVICING for June has given them fresh ideas on this old subject.

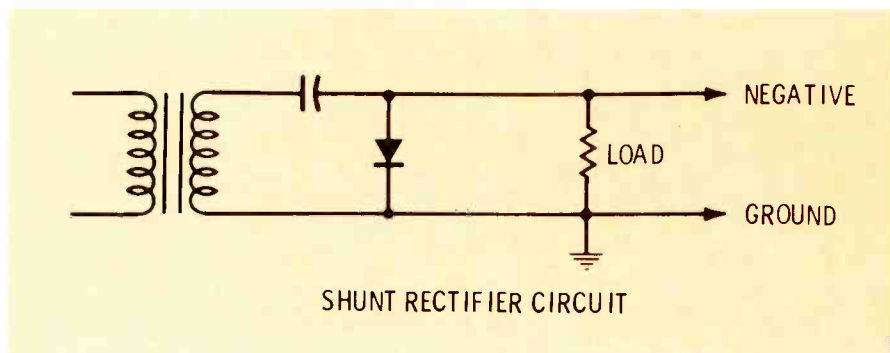

(A) Schematic of the shunt rectifier.

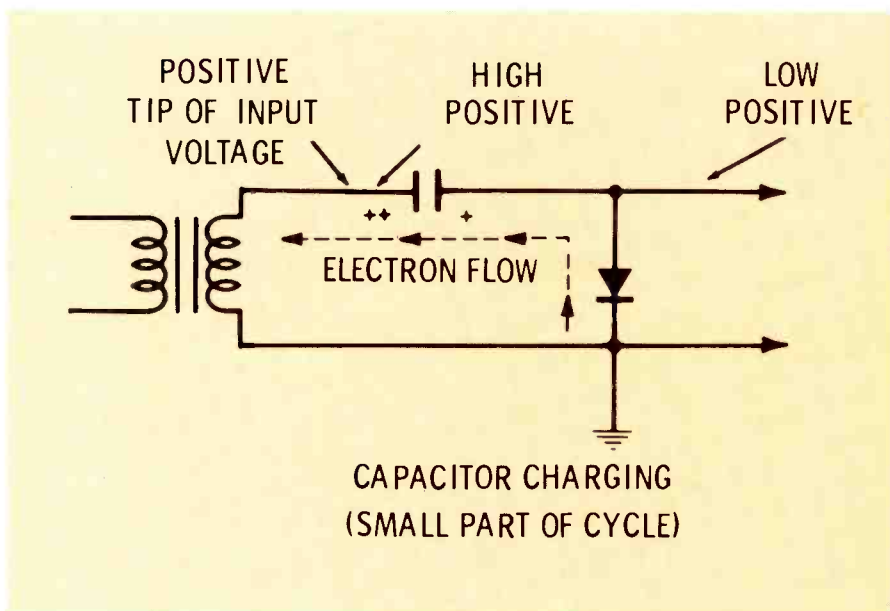

(B) Electron flow during the small part of the cycle when diode current is charging the capacitor.

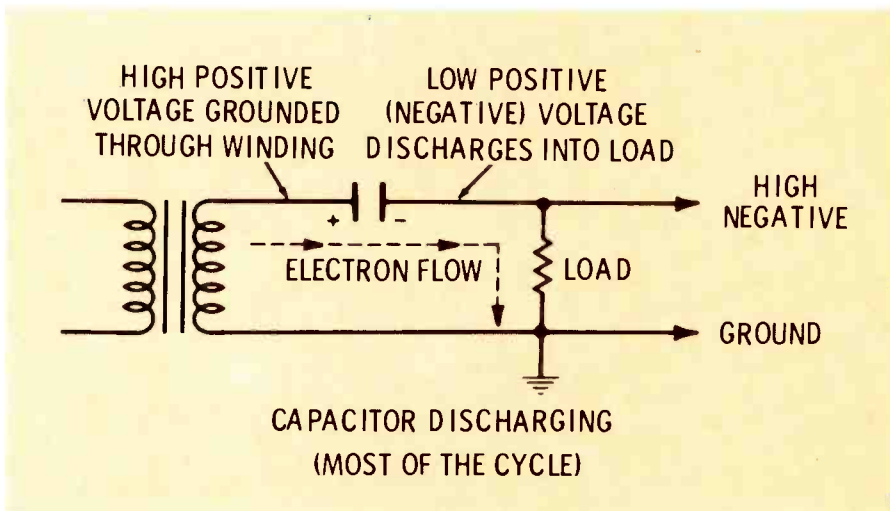

(C) Electron flow during the long part of the cycle when the capacitor is partially discharging into the load.

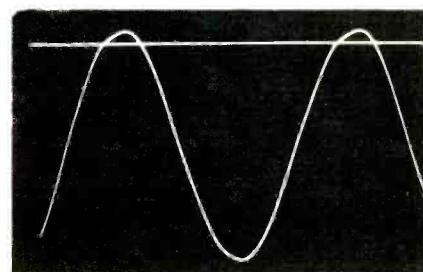

(D) The anode of the diode must become positive relative to the cathode for conduction to occur. Only the positive peak of the input sine wave fulfills this requirement. The horizontal line shows the part of the sine wave during which diode current flows. Consider the line zero, and below it as negative.

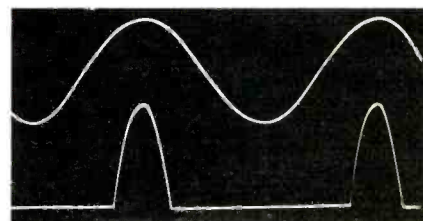

(E) Dual-trace waveforms of the input sine wave and the diode current.

Fig. 15 Explanation of how a positive peak creates negative voltage in the shunt rectifier circuit.

Mr. James Warner of Chicago writes that he intends to conduct some experiments of his own along this line.

We are very pleased with the attitudes and actions these men have taken. While we endeavor to make each article informative and com-

plete, it is even better when our readers use the article as a launching-pad to further their own technical experiences. We never should cease learning new things.

Mr. Ray Herzog, of the GE Product Service Division, reminds us that some resistors are important to product safety. The wattage of such resistors will act as a fuse in the event of any large overload or short circuit. This is a valid viewpoint, especially in this age of consumerism and related hysteria.

These safety resistors often will be B+ decoupling resistors in tube-equipped receivers and collector circuit decoupling or emitter resistors in solid-state equipment. Such resistors are relatively small in ohmic value, usually under 1,000 ohms.

Even in the realm of product safety, there are no totally right or totally wrong answers to the question of correct resistor wattage. Remember that a small amount of overload **increases** the resistance and a huge overload greatly **decreases** or burns open most carbon-composition resistors. Resistors do not **always** open from either type of overload, and the theory of the resistor acting as a fuse is not fulfilled.

We recommend this modification of our resistor replacement tip: If the defective resistor is a carbon-composition type, replace it with the same wattage and ratings as the original when the value is 2.2K-ohms or less. For increased dependability of the resistors having higher values, replace them with the next higher wattage (space permitting), especially in the higher megohm ranges. ▲

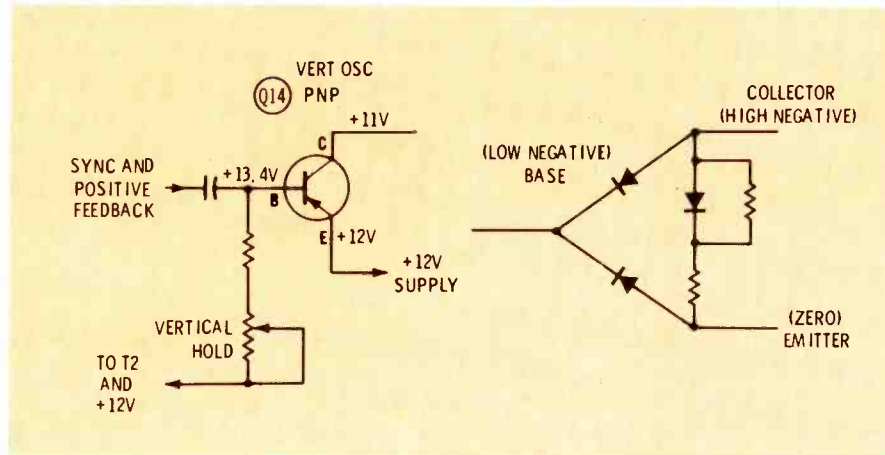

(A) Shunt rectification of the vertical pulse by the base and emitter produces reversed bias. The transistor equivalent, with the junctions shown as diodes, shows why this is true. Shunt rectification creates a positive voltage because the base is the same as the cathode in a diode.

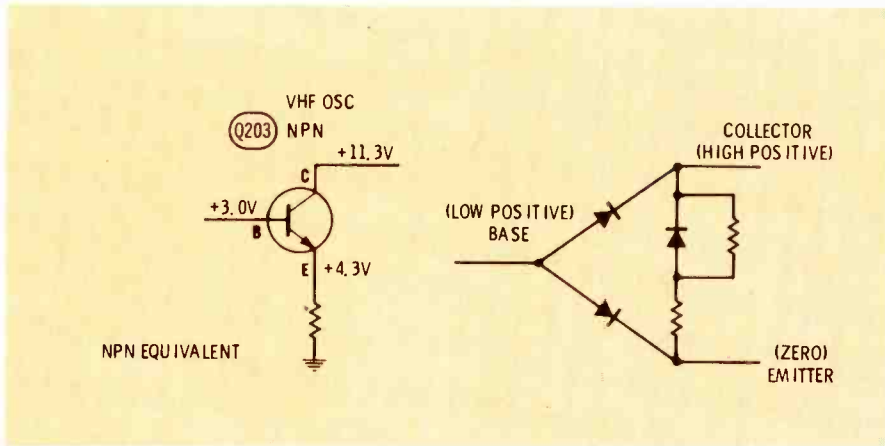

(B) The VHF oscillator transistor shunt-rectifies its own feedback signal and, because the base is the equivalent of the anode of a diode, the resulting voltage is negative, which measures as reverse bias.

Fig. 16 The base and emitter of transistors also can function as diodes. Both examples are from the RCA KCS157 chassis.

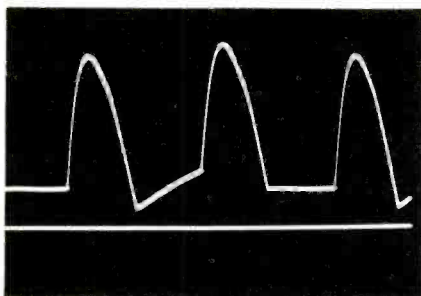

(A) A leaking diode rectifier in the full-wave circuit of Fig. 8A causes alternate capacitor charge/discharge waveforms to have an excessive amount of tilt between pulses.

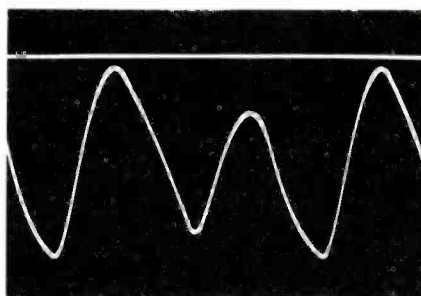

(B) A leaking diode rectifier in the full-wave circuit of Fig. 8A causes alternate hum waveforms to differ greatly in amplitude.

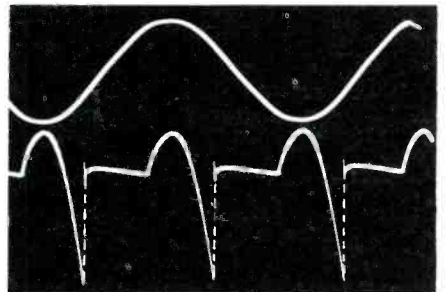

(C) An open C2 in Fig. 12 changes the circuit from peak-reading to choke-input and produces the lower waveform at the cathode of X2 when the load is light. With a heavy load, the waveform is damped to become a 120-Hz parabola, as shown in Fig. 4B.

Fig. 17 Scope waveforms aid in diagnosing trouble in the power supply.

# productreport

for further information on any of the following items, circle the associated number on the reader service card

## Tool Aids Cleaning of Controls

Workman has made available a new tool designed for cleaning and lubricating controls on television



and auto radio from the front panel. Made from an aluminum alloy with female threads machined on one end, the tool adapts to the

bushing of the control after the knob is removed. A plastic valve extension is contained on the other end, which reportedly will pressure-fit the aerosol valve of contact cleaners. Pressure on the valve will force-clean the control. An adapter is supplied for car radios, which reportedly eliminates the necessity of removing the radio from the car.

The GOZINTA Model WJL and car radio adapter, packaged with a 3-oz. aerosol can of Lubrite tuner cleaner, is priced at \$2.67.

Circle 60 on literature card

## Aid for Alphabetical Listing

A method for keeping lists in permanent alphabetical order has been developed by the Datastrip Corp.

The master list is kept current as additions or changes occur by typing an insert, sliding the existing inserts apart, and putting the new insert in its proper alphabetical place.

The inserts come in sheet form for typing and have split ends, which enables them to be inserted

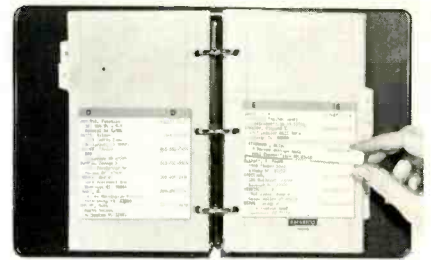

in the panels, stay where they are put, and still be slid apart for additions. Mylar panel protectors can be used to keep the lists clean.

The Datastrip system is available in many sizes, from pocket notebooks to large double-tier rotary units. They range in price from \$3.45 for the pocket-size notebook alone to \$274.40 for a complete double-tiered rotary system, including panels, insert sheets and stand.

Circle 61 on literature card

## Filament Transformers

Four new filament transformers are available from Essex International, Inc., Controls Division, Stancor Products.



Do TV service calls leave you weak in the knees?

We can put the spring back in your step

FREE illustrated brochure

Please send me informative brochure on YEATS labor savers — no obligation.

Name .....  
 Firm .....  
 Address .....  
 City .....  
 State ..... Zip .....

**YEATS**

Appliance Dolly Sales Company 1307 W. Fond du Lac Avenue., Milwaukee, Wis. 53205

Circle 28 on literature card

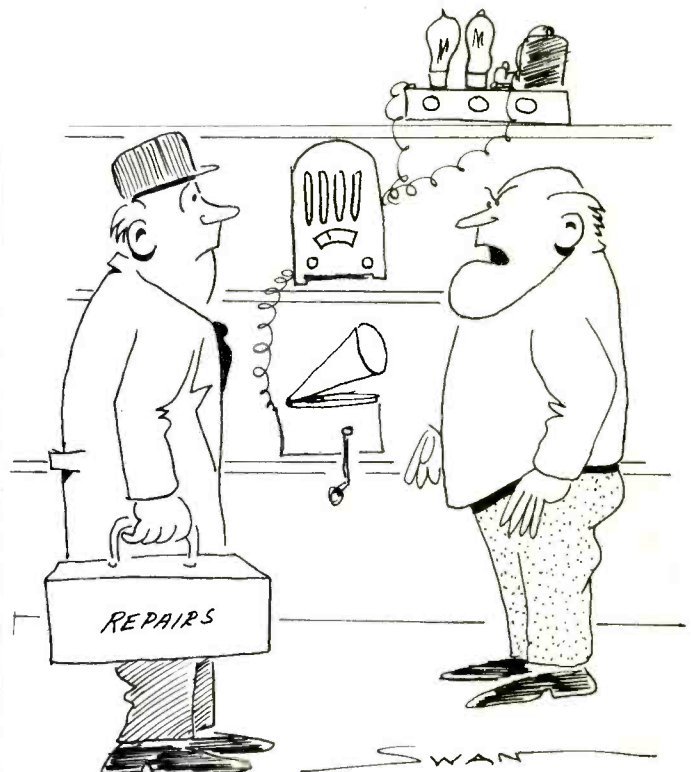

"In 1932 I was told it would be trouble free!"

Models P-8606 through P-8609 are designed for 117-volt, 60-Hz primary power supplies and have secondary ratings from 26 volts center tap at .04 amp to 26.8 volts

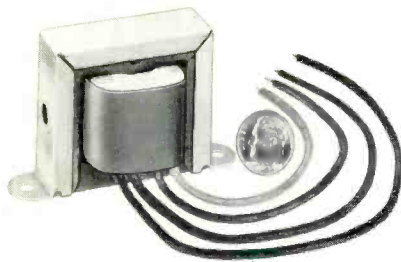

center tap at 1 amp. Models P-8606 and P-8607 have primary taps to adjust the secondary output voltage by -6, +6 and +12 percent.

The transformers range in price from \$4.25 to \$4.75 each in quantities of one to nine.

Circle 62 on literature card

### Soldering/Tool Kit

A new soldering and tool kit is now available from Calectro Products, GC Electronics Division of Hydrometals, Inc.

The Calectro soldering and tool kit, Part No. H3-378, contains a



soldering iron, solder-aid tool, solder, screwdriver, long-nose pliers, diagonal cutters and a heat sink. All tools are skin-packed so that each item is easily visible to the customer.

The price of the kit is \$7.95.

Circle 63 on literature card

### Audio Connectors

A new line of plastic audio connectors is available from Amphenol Sales Division's Distributor Marketing Operations.

Reportedly suited for use in au-

dio frequency and other low-level, high-impedance circuit applications, Amphenol Excellite® audio connectors include cord plugs and wall-mounting receptacles offering both plug and socket inserts in three-, four- and five-contact configurations. Features include: molded ABS bodies; nickel plating throughout; pushbutton lock/release; positive gripping cable clamps; unitized, removable inserts of high-impact type 6 nylon; silver plated brass



screw-machine contacts; and black neoprene rubber cable relief.

All Excellite connector contacts

# Introducing the world's only \$339 triggered scope.

Before you say you don't need a triggered scope, look what's happening to TV servicing: tubes are out, transistors and IC's are in.

With tubes you could play hit-or-miss, knowing the tube would take the overload. Try the same thing now, and good-bye transistors.

For new-era circuitry, Leader introduces a new-era troubleshooter. A triggered scope, just like the ones the TV designers use.

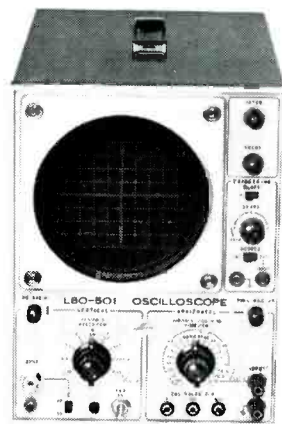

Now the wave shape is locked in and continuously displayed. Now you can look at a waveform containing high and low frequency components. Now you can determine voltage directly and instantly.

Before you say \$339 is a lot of bread, look what it buys: Leader's LBO-501 5-inch triggered scope, with a bandwidth of DC to 10MHz and a solid state package.

Going like hotcakes at your Leader distributor.

## Seeing is believing.

### LEADER INSTRUMENTS

37-27 27th Street, Long Island City, N.Y. 11101, (212) 729-7411

Circle 29 on literature card

are service rated for 133 volts rms operation. The three-pin version uses size 12 contacts and is current rated at 15 amps; the four-pin connector uses size 16 contacts at 10 amps; and the five-pin version uses #20 contacts and is rated for currents to 7.5 amps.

Excellite straight cord plugs with socket contacts measure  $\frac{3}{4}$ -inch in diameter (socket end) by  $3\frac{3}{16}$ -inch long (tip to tip). Pin-contact straight cord plugs are the same diameter at pin ends and are 3 inches long. Wall-mounting receptacles with pin contacts are  $\frac{3}{4}$ -inch diameter and are  $\frac{7}{8}$ -inch deep, with a mounting plate measuring  $1\frac{1}{16}$ -inch high by  $\frac{7}{8}$ -inch wide. Socket contact well-mounting receptacles are  $1\frac{1}{8}$ -inch in diameter by  $1\frac{1}{16}$ -inch long, with mounting plate measuring  $1\frac{1}{16}$ -inch high by  $1\frac{1}{16}$ -inch wide.

The price ranges from \$1.09 for a 3-male receptacle to \$3.10 for a 5-female jack, each in a standard package quantity of 10.

*Circle 64 on literature card*

#### Multi-Purpose Lubricant

RCA Deluxe Multi-Purpose Lubricant (stock number SC105) is in-

tended for use on computers, tape recorders, test instruments, office machines, record changers, small



motors, all moving parts, loosening rusted screws and loosening frozen TV yokes.

This lubricating oil, which reportedly has extra penetrating power, sells for \$1.20 for an 8-oz. spray can.

*Circle 65 on literature card*

#### Transient Voltage Suppressors

A new series of TransZorb® transient voltage suppressors, reportedly capable of dissipating 1500 watts of peak power, has been introduced by

General Semiconductor Industries, Inc.

The new series, Models JEDEC types 1N5629 through 1N5665A, is available in voltages from 6.8 volts to 200 volts. All reportedly dissipate 1500 watts of peak power for one millisecond with instantaneous clamping ability, thereby affording

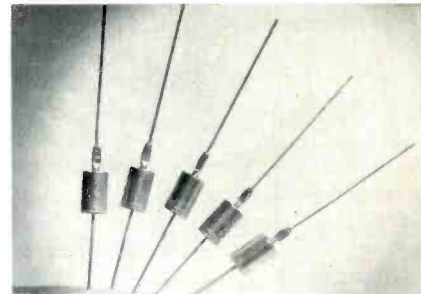

complete protection to systems using integrated circuits and other voltage-sensitive components.

All units in the TransZorb series are available in the standard DO-13 axial-leaded package. Prices start at \$3.25 each in 10-piece quantities.

*Circle 66 on literature card*

#### Versatile Work Benches

"Converta-Bench", available from Bay Products, starts as an open bench with top, two leg assemblies and stringer for added stability. The convertible feature allows the addition of many accessories and components, such as drawers on each side of the bench for storage of tools and small parts, edgeboards to keep tools from falling off the working surface, a riser to keep tool boxes and equipment from rear surface of bench, and a lower shelf for storage of boxes and bins. Leg covers, side and back panels and a disappearing door also can be added.

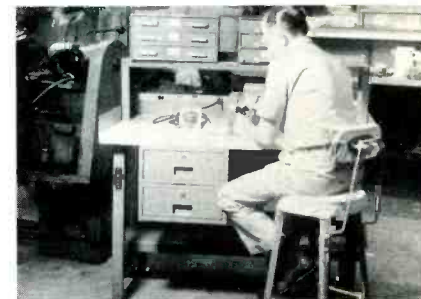

An electrical outlet strip includes 3-prong grounded sockets, 125 volts maximum. The bench comes in 24 bench-leg heights and depths and 5 top materials (steel, pressed wood, plastic laminate, laminated maple and wood resinates).

The prices for the benches range from \$38.45 to \$159.35. ▲

*Circle 67 on literature card*

# CLOSE is for HORSESHOES...

but not for  
**STANCOR**

We will never be content to rest on our laurels even though proof of customer satisfaction is expressed for Stancor Products by our position of leadership in the marketplace. Our Product Development Program is working every day to make our product not merely the best available... but the best possible.

Stancor's program is designed to give you exact replacement transformers that are better than original parts with servicing simplicity built right in... because close is not enough for Stancor's customer.



ESSEX CONTROLS DIVISION • STANCOR PRODUCTS • 3501 W. ADDISON ST. • CHICAGO, ILL. 60618

*Circle 35 on literature card*



# advertisers' index

B & K Mfg. Co.,  
Div. of Dynascan Corp. .... 1

Bussmann Mfg. Div. of  
McGraw Edison Co. ....10, 11

C.R.T. Equipment Co., Inc. ....36

Castle TV Tuner Service, Inc. .... 7

Channel Master .....59

Chapman Manufacturing Co. .... 6

Chemtronics, Inc. ....53

Eico Electronic  
Instrument Co., Inc. ....Cover 2

Essex International Inc. ....70

GC Electronics .....47

Heath Company .....13

Lakeside Industries .....46

Leader Instruments Corp. ....69

Littelfuse, Inc. ....Cover 4

Perma-Power Company .....54

Quietrol Company ..... 8

RCA Electronic Components .....Cover 3

RCA Parts & Accessories .....25

RMS Electronics Inc. ....71

Rohn Spaulding Inc. ....41

Howard W. Sams & Co., Inc. ....27

Sencore Inc. ....21, 37

Sylvania Electric Products Inc. ....1, 55

TV Tech Aid .....46

Tab Books .....19

Tuner Service ..... 5

Workman Electronic Products, Inc. ....8, 72

Yeats Appliance Dolly Sales Co. ....68

Zenith Radio Corporation .....33

## Next Month In ES:

- Tips About Transistor Substitution
- Solving Poor-Quality Color
- Causes of Distortion in Auto Radio
- Transistor TV Servicing Techniques
- How To Use a Stereo Generator
- Plus other "quicker-servicing" information.

# TOP PERFORMING UHF/VHF ANTENNAS FOR ALL AREAS!...

Color engineered for best reception on UHF/VHF Channels 2 to 83!  
Exclusively features Reynolds Aluminum durable Colorweld Gold finish!  
Single down-lead for economical, simple installation!  
Durable all-aluminum weather proof construction for long installation life!

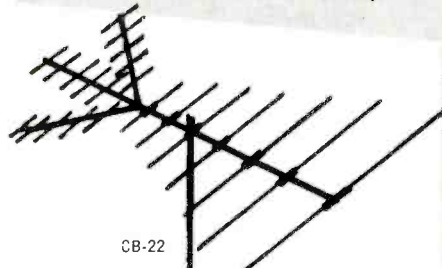

CB-22

## COLOR-BOOSTER SERIES

Model	Number of elements			Range of Reception		
	VHF	UHF	Total	VHF up to	UHF up to	
CB-22	7	5	10	22	50 miles	35 miles
CB-28	11	7	10	28	125 miles	60 miles
CB-34	15	9	10	34	150 miles	80 miles

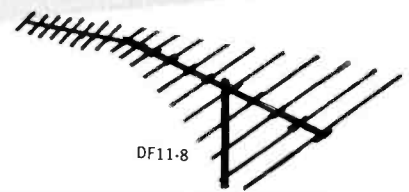

DF11-8

## DIRECTION-FINDER SERIES

Model	Number of elements			Range of Reception	
	VHF	UHF	Total	VHF up to	UHF up to
DF3-3	3	3	6	30 miles	20 miles
DF5-4	5	4	9	45 miles	40 miles
DF7-8	7	8	15	50 miles	75 miles
DF7-11	7	11	18	50 miles	100 miles
DF11-8	11	8	19	75 miles	75 miles
DF11-11	11	11	22	75 miles	100 miles
DF15-8	15	8	23	100 miles	75 miles
DF15-11	15	11	26	100 miles	100 miles
DF19-8	19	8	27	125 miles	75 miles
DF19-11	19	11	30	125 miles	100 miles

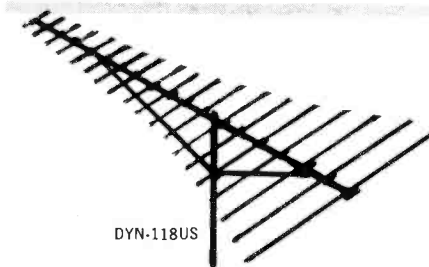

DYN-118US

## DYNERGY SERIES

Model	Number of elements			Range of Reception	
	VHF	UHF	Total	VHF up to	UHF up to
DYN- 33US	3	3	6	35 miles	20 miles
DYN- 54US	5	4	9	60 miles	30 miles
DYN- 66US	6	6	12	65 miles	50 miles
DYN- 88US	8	8	16	125 miles	75 miles
DYN-118US	11	8	19	125 miles	75 miles
DYN-158US	15	8	23	150 miles	75 miles

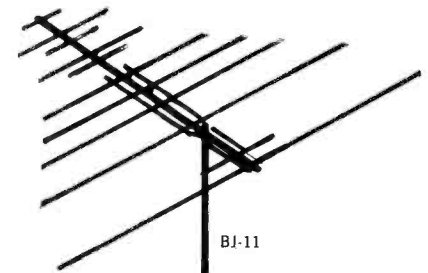

BJ-11

## BIG SHOT JR. SERIES

Model	Number of elements	Area Used
BJ-11	11	Metropolitan and Suburban
BJ-12	12	Semi-Fringe

For complete specs and Profit picture—Write:

**RMS ELECTRONICS, INC.**

50 Antin Place, Bronx, N.Y. 10462 • Tel. (212) 892-6700

Circle 30 on literature card

Model No. WGI

**SOLID STATE**

**ONE GUN BOOSTER**

**FOR COLOR TV**

**EXTENDS COLOR GUN LIFE**

**RESTORES RED, BLUE OR GREEN BRILLIANCE**

**EASY TO INSTALL**  
(INSTRUCTIONS ON BACK)

**WORKMAN Electronic PRODUCTS INC.**  
SARASOTA, FLORIDA

**WEAK**  
SERVICE LINE

MODEL NO. WGI

**BOOSTED**  
SERVICE LINE

**BEFORE** installation of **AFTER**  
**ONE GUN BOOSTER**

Boosts the one weak color needed for a **BALANCED** color picture.

**MANUFACTURED BY**  
**WORKMAN Electronic PRODUCTS INC.**  
SARASOTA, FLORIDA

Circle 31 on literature card

# STOP COMPLAINING

AND

# DO SOMETHING

Young or old... black or white... rich or poor... new left or right. You can help solve many of your community's social problems. Get in touch with your United Fund or United Way organization.

## NOW!

## catalogs literature

### AUDIO

100. *International Telephone and Telegraph Corp.*—has released a revised catalog (AUD-5) which includes an XLR cross-reference mating selection guide.

### COMPONENTS

101. *North American Electronics, Inc.*—has issued a 68-page dealer catalog of selected electronic products for technicians, hobbyists, engineers and experimenters. Included is a numerical index of parts for easy reference.

### SERVICE AIDS

102. *Telematic, Division of U.X. L. Corp.*—is making available a 16-page, illustrated catalog featuring their complete line of color and black-and-white television service aid accessories.

### SHOP EQUIPMENT

103. *Dazor Manufacturing Corp.*—is offering a 20-page, illustrated Catalog 70, featuring Dazor's line of lighting fixtures and magnifiers.

104. *Waber Electronics Inc.*—a new 1970 comprehensive catalog describing Waber's complete line of shop carts and equipment dollies is now available. This 16-page catalog provides full information on all Wabor models.

### TECHNICAL PUBLICATIONS

105. *Howard W. Sams & Co. Inc.*—literature describes popular and informative publications on radio and television servicing, communications, audio, hi-fi and industrial electronics, including their 1970 catalog of technical books on every phase of electronics.\*

106. *Sylvania Electric Products Inc., Sylvania Electronic Components Div.*—has published the 14th edition of its technical manual, which includes mechanical and electrical ratings for receiving tubes, television picture tubes and solid-state devices. The price of this manual is \$1.90.\*

### TEST EQUIPMENT

107. *Sencore, Inc.*—has issued its 12-page 1970 catalog, Form No. 517, which describes the company's complete line of test instruments and features 5 new instruments, with performance data and prices included.\*

108. *Triplett Corp.*—has issued a 2-page data sheet on their new Models 8000 and 8000-A digital volt-ohm-milliammeters (VOM's). Data sheet #5170 provides complete electrical ranges and mechanical specifications.

### TOOLS

109. *Weller Division of Cooper Industries*—has made available a "service soldering tool selection guide", featuring Weller's soldering tools and their applications.

110. *Xcelite Inc.*—has published 2-page, illustrated Bulletin N470, which describes a number of their "fix-it" tools, including full information and specifications.

\*Check "Index to Advertisers" for additional information. ▲

**ELECTRONIC SERVICING . . .**  
the country's only magazine  
devoted 100% to the  
**ELECTRONIC SERVICING**  
industry . . .

# ASK YOUR RCA DISTRIBUTOR FOR A FREE SHOW

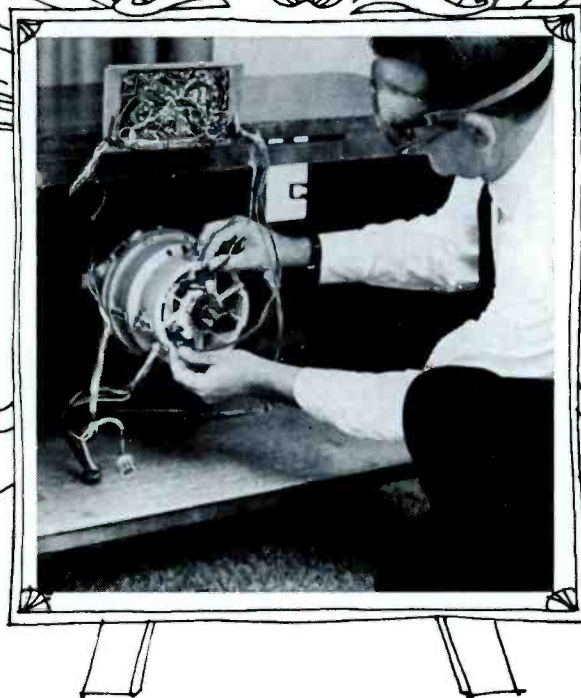

You'll profit from every minute of it.

Here's why:

With the development of new electronic home entertainment equipment, new problems arise. Because nothing tells a story the way pictures do, we're making audio visual slide/tape films available to our distributors to help you pinpoint and solve these problems. Faster. They're yours to see for the asking.

Whether you're an experienced service dealer or a newcomer, your participating RCA distributor can now help

you update your servicing know-how in three important phases of your business:

- RCA Color Picture Tube Installation Procedures and Associated Receiver Adjustments.
- RCA Television Servicing (Tube Replacement Techniques).
- RCA Transistor Servicing (Basic)

Ask your RCA Electronic Components distributor for a free show—today. Also ask for reference guides outlining the major steps and servicing short cuts covered by each show.  
RCA|Electronic Components|Harrison, New Jersey 07029

**Your Ticket to Faster Servicing Techniques!**



# EXACT

MAJOR-BRAND RF CHOKE & COIL REPLACEMENTS

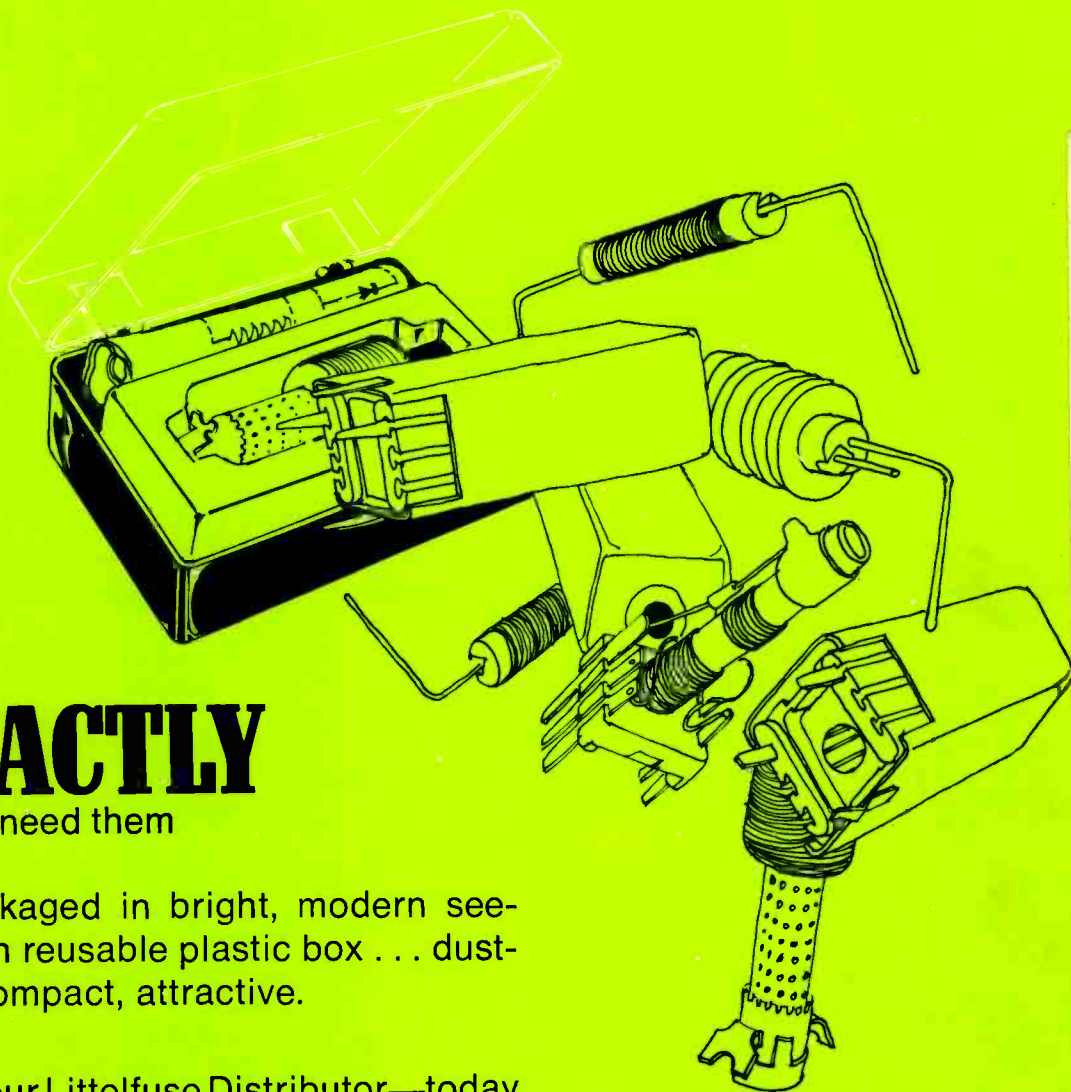

## EXACTLY

as you need them

... Packaged in bright, modern see-through reusable plastic box ... dust-free, compact, attractive.

from your Littelfuse Distributor—today

ES 11-409 N 1A 1071 4  
P J BREIDEL  
BREIDELS RADIO-TV SVC  
1316 S 13TH ST  
LA CROSSE WIS 54601

# LITTELFUSE

800 E. NORTHWEST HIGHWAY DES PLAINES, ILLINOIS 60016 312/824-1188

Circle 3 on literature card