

PF Reporter®

PHOTOFACT

the magazine of electronic servicing

TVI... its causes and cures

page 10

*other
servicing
features:*

**Record Changers
Transistor Radio
Multi-Trouble TV
Clock Radios
Stereo**

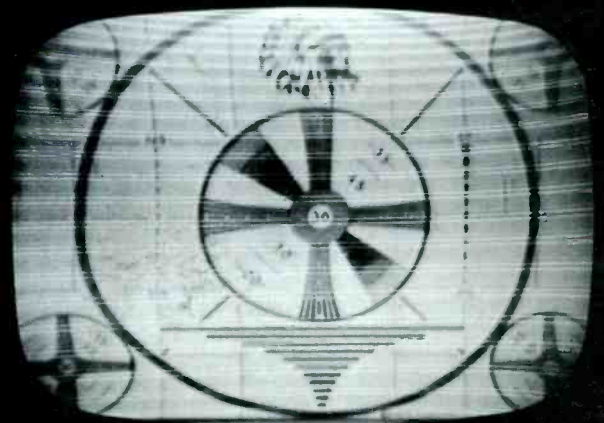
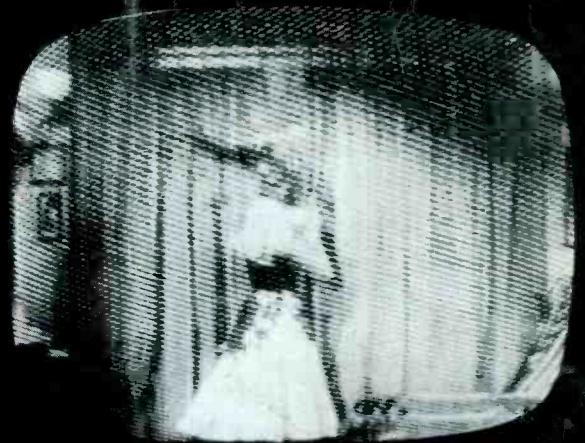
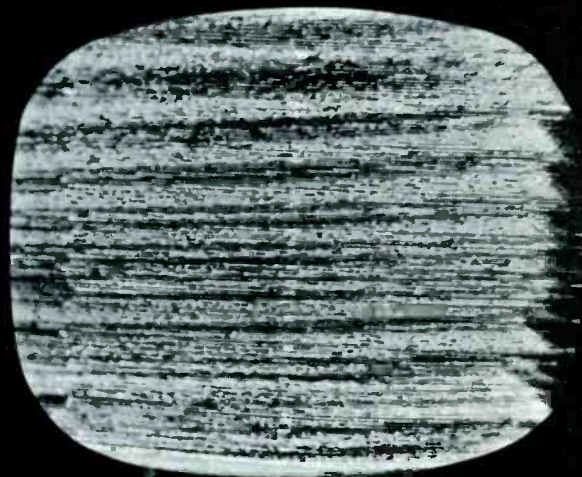

1A 7J 117 570
R. A. FRAMPTON
FRAMPTON RADIO SER
BOX 144
FLORENCE PA. 16431

The name of the game was hide and seek.

The good color picture hides. The viewer looks for it. And sometimes it takes quite a while to find. The good sound drifts, and between rotor

and tuning dial the search for a perfect stereo balance begins again.

Well now all that time-wasting and bother is over. Because CDE invented the Autorotor™ system. It's more than an ordinary rotor. Buttons are easily set for clear, bright, perfect color pictures. And pure stereo sound. There are five and they allow you to pre-set 10 to 15 channels. Leave one channel and whenever you choose to return to it, just press the button again.

CDE's famous heavy-

duty Bell Rotor gives you high repeatability and no antenna drift. It's an all-solid-state, silent operation. The Autorotor system's precision is within 1° and combining it with pushbutton electronic control, not mechanical control, makes it today's most advanced rotor.

CDE took another step forward in the Autorotor control design. They had William Snaith, of Loewy-Snaith, world famous designers, create the Autorotor console. He made it attractive. Made it so you can place it on a table top or shelf without it being an eyesore.

This is the story you can tell your customers to sell the top-of-the-line in rotors. The latest advance from the quality house of rotors — Cornell-Dubilier.

For complete information on new Autorotor write:

CDE **CORNELL-DUBILIER**

50 Paris Street, Newark, New Jersey 07101
"Remember to ask what else needs fixing!"



Circle 1 on literature card



OVERHAUL

\$975

GUARANTEED for 1 Year

OVERHAUL \$9.75 • REPLACEMENT TUNERS... \$10.45

Nine-seventy-five buys you a complete tuner overhaul—including parts (except tubes or transistors)—and absolutely no hidden charges. All makes, color or black and white. UV combos only \$15.

Guaranteed means a full 12-month warranty against defective workmanship and parts failure due to normal usage. That's 9 months to a year better than others. And it's backed up by the only tuner repair service authorized and supervised by the world's largest tuner manufacturer—Sarkes Tarzian, Inc.

Four conveniently located service centers assure speedy in-and-out service. All tuners thoroughly cleaned, inside and out... needed repairs made... all channels aligned to factory specs, then rushed back to you. They look—and perform—like new.

Prefer a universal replacement? Sarkes Tarzian will give you a universal replacement for only \$10.45. This price is the same for all models. The tuner is a new tuner designed and built specifically by Sarkes Tarzian for this purpose. It has memory fine tuning—UHF plug-in for 82 channel sets—universal mounting—hi-gain—lo-noise.

ORDER TUNERS BY PART NUMBER, AS FOLLOWS:

Part #	Intermediate Frequency	AF Amp Tube	Osc. Mixer Tube	Heater
MFT-1	41.25 mc Sound 45.75 mc Video	6GK5	6LJ8	Parallel 6.3V
MFT-2	41.25 mc Sound 45.75 mc Video	3GK5	5LJ8	Series 450 MA
MFT-3	41.25 mc Sound 45.75 mc Video	2GK5	5CG8	Series 600 MA

Prefer a customized replacement tuner? The price will be \$18.25. Send us the original tuner for comparison purposes, also TV make, chassis and model numbers.

SEND ORDERS FOR UNIVERSAL AND CUSTOMIZED REPLACEMENT TUNERS TO OUR OFFICE IN INDIANAPOLIS.



TUNER SERVICE CORPORATION FACTORY-SUPERVISED TUNER SERVICE

MIDWEST	817 N. PENNSYLVANIA ST., Indianapolis, Indiana	TEL: 317-632-3493
EAST	(Home Office) 547-49 TONNELE AVE., Jersey City, New Jersey	TEL: 201-792-3730
SOUTH-EAST	938 GORDON ST., S. W., Atlanta, Georgia	TEL: 404-758-2232
WEST	SARKES TARZIAN, Inc. TUNER SERVICE DIVISION 10654 MAGNOLIA BLVD., North Hollywood, California	TEL: 213-769-2720

WATCH FOR NEW CENTERS UNDER DEVELOPMENT

Circle 2 on literature card

PF Reporter

PHOTOFACT

the magazine of electronic servicing



in this issue...

- 10 **Eliminating TVI.** Methods for finding and curing the causes of television interference. **By Jack Darr.**

- 16 **Record Changer Repair.** Tips for servicing the "mechanics" of phonographs. **By Homer L. Davidson.**

- 24 **Troubleshooting a Multi-Trouble TV.** Sorting out each trouble symptom and handling it individually is the only logical approach to multiple troubles. **By Stan Prentiss.**

- 32 **Repairing Clock Radios.** Case histories that reveal common troubles and the techniques that quickly uncover their causes. **By Jim Houseknecht.**

- 36 **Troubleshooting Stereo.** Procedures for solving "dead" and poor-quality sound symptoms. **By Norman Crowhurst.**

- 42 **Time-Saving Techniques for Transistor Radio Repair.** Troubleshooting methods that make small radio repair profitable.

- 50 **Waveform Quiz.** Test your ability to interpret the clues provided by your scope.

ABOUT THE COVER

The TV screens on this month's cover exhibit the effects of interference caused by spurious signals picked up along with the desired TV signal.

DEPARTMENTS

Tube Substitution Supplement	a
The Electronic Scanner	4
Notes on Test Equipment	52
The Troubleshooter	58
Photofact Bulletin	61
Product Report	62
Book Review	66
Advertisers' Index	67
Free Catalog and Literature	68

Second-Class Postage Paid at Indianapolis, Ind. Published monthly by INTERTEC PUBLISHING CORP., 1014 Wyandotte St., Kansas City, Mo. 64105.

Copyright, 1968, Howard W. Sams Co., Inc. All Rights Reserved. Material may not be reproduced or photocopied in any form without written permission of publisher.

EDITORIAL

GEO. H. SEFEROVICH, Director
J. W. PHIPPS, Managing Editor
ELLSWORTH LADYMAN, Technical Editor
B. J. MILLER, Editorial Assistant
DUDLEY ROSE, Art Director
LEILA JOHNSON, Assistant Artist

TECHNICAL CONSULTANTS

JOE A. GROVES
C. P. OLIPHANT

EDITORIAL ADVISORY BOARD

LES NELSON, Chairman
Howard W. Sams & Co., Indianapolis

CIRCULATION

R. VINCENT WARD, Director
PAT OSBORNE, Manager

ADVERTISING

E. P. LANGAN, Director
R. JACK HANGCOCK, Manager
S. F. WILSON, Production
LEE MILLER, Promotion

REGIONAL ADVERTISING SALES OFFICES

Indianapolis, Indiana 46206

ROY HENRY
HOWARD W. SAMS & CO., INC.
4300 West 62nd St.
Tele: 317/291-3100

New York, New York 10019

ALFRED A. MENEGUS
3 W. 57th St.
Tele: 212/Murray Hill 8-6350

Los Angeles, California

THE MAURICE A. KIMBALL CO., INC.
2008 Carson St., Suites 203-204
Torrance, California 90501

San Francisco, California 94104

THE MAURICE A. KIMBALL CO., INC.
580 Market Street, Room 400
Tele: 415/392-3365

London W. C. 2, England

JOHN ASHCRAFT & CO.
12 Bear Street
Leicester Square
Tele: Whitehall 0525

Amsterdam C. Holland

JOHN ASHCRAFT & CO.
W.J.M. Sanders, Mgr.
Herengracht 365
for Benelux & Germany
Tele: 24.09.08

Paris 5, France

9 Rue Lagrange
ODEon 20.87

Tokyo, Japan

INTERNATIONAL MEDIA
REPRESENTATIVES, LTD.
3, Nakanochō, Akasaka, Minato-ku
Tele: 582-5881



PF REPORTER is published monthly by Intertec Publishing Corp., 1014 Wyandotte Street, Kansas City, Missouri 64105.

Subscription Prices: 1 year—\$5.00, 2 years—\$8.00, 3 years—\$10.00, in the U. S. A., its possessions and Canada.

All other foreign countries: 1 year—\$6.00, 2 years—\$10.00, 3 years—\$13.00. Single copy 75¢; back copies \$1.



Robert E. Hertel, Publisher

Intertec Publishing Corp.
Subsidiary of Howard W. Sams & Co., Inc.

"QT" keeps you ahead with the fastest moving RCA parts.

"QT" is a Quick Turnover Inventory system that brings you a steady supply of the fastest-moving RCA Home Instrument replacement parts. It practically guarantees you'll have the parts you need for most of your servicing jobs.

This means you get the jobs done, without backlogging and last-minute dashes to your distributor for essential "QT" parts.

A "QT" inventory helps you cut down on those stacks of dusty boxes and trays of unused parts—and the dollars you have tied up in them.

The entire system is incredibly handy and efficient

... lets you find parts quickly while you're working ... reminds you to reorder when your supply is low ... makes inventorying and reordering so fast that it's almost automatic.

Suddenly you'll find yourself with a lot more time to devote to additional servicing jobs.

Check it out with your RCA "QT" Parts Distributor. He'll discuss the different "QT" inventory plans with you and help you select one tailored to your operation.

After that, things go very smoothly.

Parts and Accessories, Deptford, New Jersey.

RCA



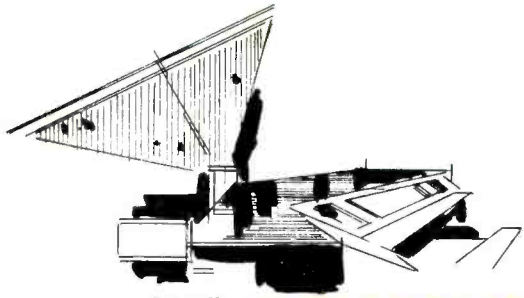

THE ELECTRONIC SCANNER

FTC Ruling on TV Servicing Rate Schedule

The Federal Trade Commission was recently requested to render an advisory opinion with respect to the legality of a trade association preparing and distributing a standard rate and service pricing manual for common use by electronic servicemen with the general public.

It was represented that a major problem in the industry is the lack of guides by which the public can determine whether prices charged for various repair services are fair and equitable. This lack has led to many customer complaints and to fraudulent operations by unethical repairmen. The association took

the position that a standard rate schedule would protect the public and free ethical servicemen from unjust accusations.

The Commission advised that it could not give its approval to the proposed common use of a standard rate and service pricing manual by competing electronic servicemen. While the adoption and dissemination by the association of such a manual may be motivated by a purpose to remove evils affecting the industry, it appears to go further than is reasonably necessary to accomplish the desired result.

Even though use of such a manual is accompanied by disclaimers, there is implicit, therein, too grave a danger that it will serve as a device through which service rates and fees would become uniform and stable throughout the industry. While adoption of a means likely to create competitive uniformity in terms of service pricing may be a convenience to trade association members, this factor is far outweighed by the benefits to the public of the intense competition between competing servicemen, and it is this competition which the law protects, the FTC stated.

—the Antenna, Oklahoma TESA

Facts About TV Radiation

In an effort to help eliminate any public misconceptions about color television radiation, Packard Bell Electronics Corporation has published, as a public service message, a 16-page pamphlet aimed at answering such questions as: What is radiation? How is it created? How is it blocked? What are the amounts of radiation caused by TV receivers? Is radiation harmful? What are the standards and tests for television radiation? Why all the publicity about it?

Also included in the pamphlet is the following full text of a recent statement by Dr. Victor P. Bond, M.D., Ph.D., associate director of Brookhaven National Laboratory and chairman of the Radiation Bio-Effects Advisory Committee for the Public Health Services National Center for Radiological Health:

“First let me say that X-ray protection standards for TV receivers have been established by appropriate authoritative groups such as the National Council on Radiation Protection (NCRP). The basic exposure guide is 0.5 milliroentgens (mR) per hour at 5 cm (2 in.) from the surface of the receiver under normal operating conditions (Radiology, Vol. 75, pg. 22, 1960). Standards such as this, particularly for the general public, are deliberately conservative, and are set well below levels of exposure that carry a significant probability of detectable medical effects in the exposed individual (“somatic effects”) or his progeny (“genetic effects”). Nonetheless, manufacturers can, and in my opinion should be required to, provide for adequate shielding and testing such that these guides are adhered to.

“The question arises of the probability of medical effects if, perhaps through faulty construction, this limit is exceeded by sizable factors in some receivers. Even if exceeded by perhaps 10 or 20 times, or even more, the doses and dose rates are still very low, and no medical effects have ever been demonstrated at the resultant levels of exposure of the viewer. On the other hand, there is evidence leading to the hypothesis that small

SAVES
your back...
SAVES
your time...

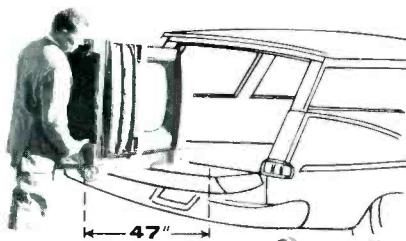

YEATS SHORTY DOLLY

for RADIO and TV

just 47 inches high for STATION WAGONS and PANEL PICK-UPS

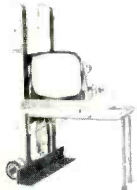

FOLDING PLATFORM
15 1/4" x 24 1/2" top.
Snaps on or off.
(Platform only)
\$11.95

Designed for TV, radio and appliance men who make deliveries by station wagon or panel truck... the short 47 inch length saves detaching the set for loading into the "wagon" or pick up. Tough, yet featherlight aluminum alloy frame has padded felt front, fast (30 second) web strap ratchet fastener and two endless rubber belt step glides. New folding platform attachment, at left, saves your back handling large TV chassis or table models. Call your YEATS dealer or write direct today!



YEATS
Model No. 5
Height 47"
Weight 32 lbs.



FURNITURE PAD

"Everlast" COVER AND PADS

YEATS semi fitted covers are made of tough water repellent fabric with adjustable web straps and soft, scratchless white flannel liners. All shapes and sizes — Write



TV COVER



APPLIANCE DOLLY SALES COMPANY

1307 W. Fond du Lac Ave. • Milwaukee, Wisconsin
Circle 3 on literature card

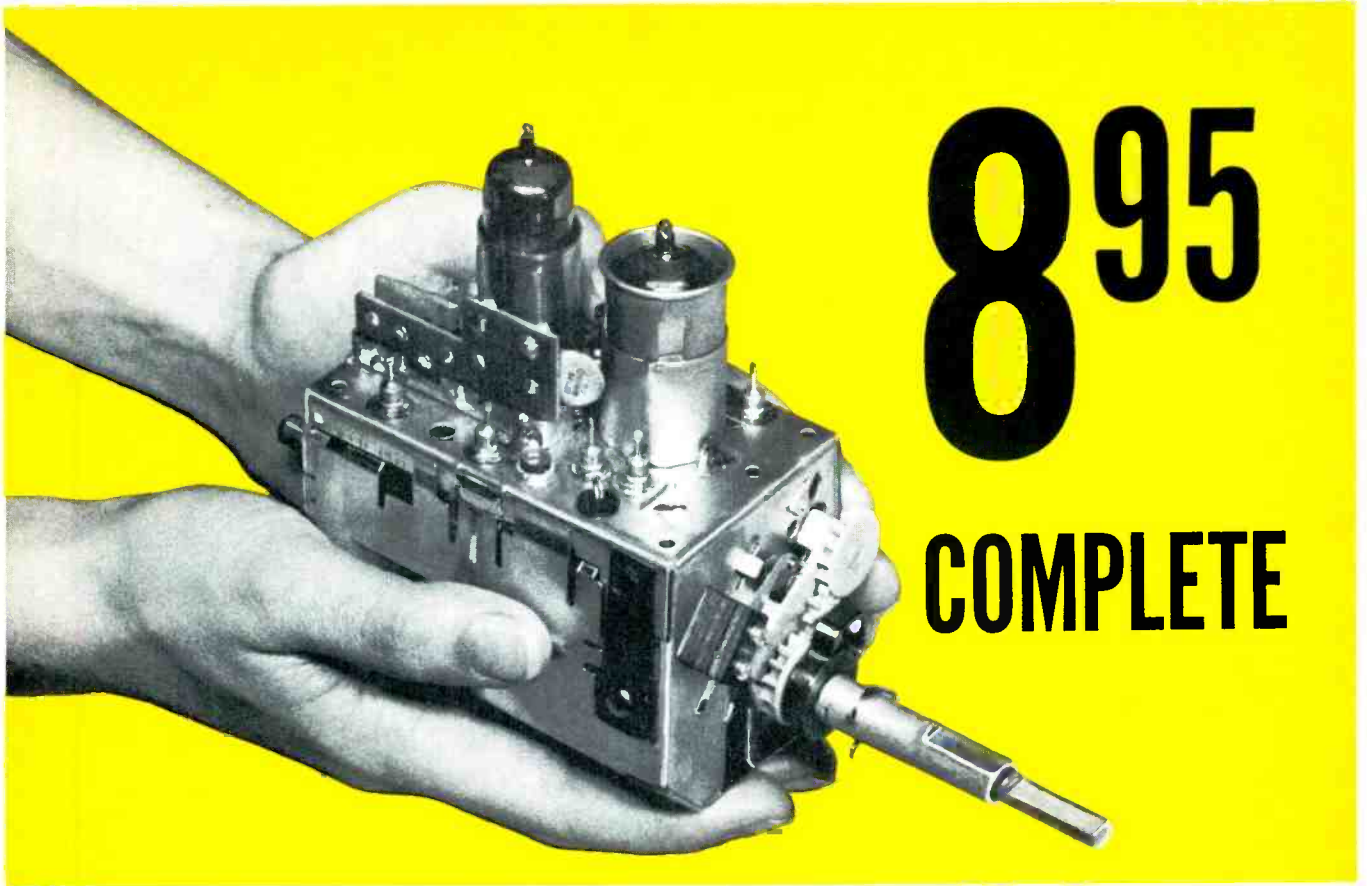

895 COMPLETE

Castle, the pioneer of television tuner overhauling, offers the following services to solve ALL your television tuner problems.

● **OVERHAUL SERVICE** — All makes and models.

- VHF or UHF tuner \$9.95
- UHF-VHF combination (one piece chassis) \$9.95
- TRANSISTOR tuner \$9.95
- COLOR tuner \$9.95
(Guaranteed color alignment . . . no additional charge)

Overhaul includes parts, except tubes and transistors.

Simply send us the defective tuner complete; include tubes, shield cover and any damaged parts with model number and complaint. Your tuner will be expertly overhauled and returned promptly, performance restored, aligned to original standards and warranted for 90 days.

UV combination tuner must be single chassis type; dismantle tandem UHF and VHF tuners and send in the defective unit only.

And remember—for over a decade Castle has been the leader in this specialized field . . . your assurance of the best in TV tuner overhauling.

● **CUSTOM REPLACEMENTS**

Exact replacements are available for tuners that our inspection reveals are unfit for overhaul. As low as \$12.95 exchange. (Replacements are new or rebuilt.)

● **UNIVERSAL REPLACEMENTS**

Prefer to do it yourself?

Castle universal replacement tuners are available with the following specifications.

STOCK No.	HEATERS	SHAFT		I.F. OUTPUT		PRICE
		Min.*	Max.*	Snd.	Pic.	
CR6P	Parallel 6.3v	1¾"	3"	41.25	45.75	8.95
CR7S	Series 600mA	1¾"	3"	41.25	45.75	9.50
CR9S	Series 450mA	1¾"	3"	41.25	45.75	9.50
CR6XL	Parallel 6.3v	2½"	12"	41.25	45.75	10.45
CR7XL	Series 600mA	2½"	12"	41.25	45.75	11.00
CR9XL	Series 450mA	2½"	12"	41.25	45.75	11.00

*Selector shaft length measured from tuner front apron to extreme tip of shaft.

These Castle replacement tuners are all equipped with memory fine tuning, UHF position with plug input for UHF tuner, rear shaft extension and switch for remote control motor drive . . . they come complete with hardware and component kit to adapt for use in thousands of popular TV receivers.

Order universal replacements out of Main Plant (Chicago) only.



CASTLE TV TUNER SERVICE, INC.

MAIN PLANT: 5701 N. Western Ave., Chicago, Illinois 60645

EAST: 41-90 Vernon Blvd., Long Island City, N.Y. 11101

Circle 4 on literature card

BUSS QUALITY

SMALL DIMENSION FUSES AND FUSEHOLDERS

For The Protection of All Types of Electronic and Electrical Circuits and Devices . . .

includes dual-element "slow-blowing", single-element "quick-acting" and signal or visual indicating types...in sizes from 1/500 amp. up.

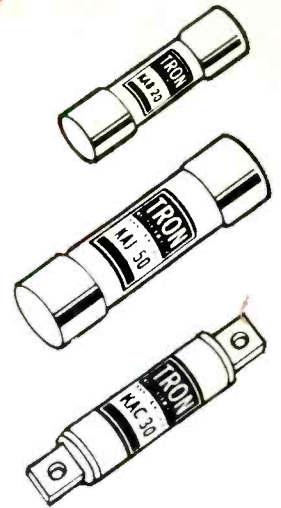

TRON Rectifier Fuses
For the Safe Protection of Solid State Devices

Provide extremely fast opening on overload and fault currents, with a high degree of restriction of let-thru current. Many types and sizes available. Ampere ratings from 1/2 to 1000 in voltage ratings up to 1500.

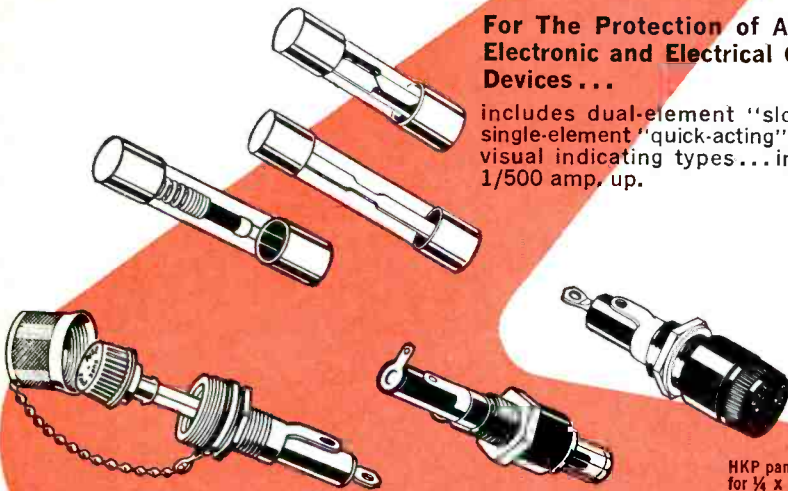

HMR-RF shielded holder for 1/4 x 1 1/4 in. fuses.

HKA lamp-indicating, signal activating holder.

HKP panel mounted holder for 1/4 x 1 1/4 in. fuses.

doses of radiation carry a probability, however small, of some damage, particularly genetic (genetic effects could, of course, be detected only in subsequent generations). Thus a categorical statement that there is no probability of any damage at the low doses and dose rates involved cannot and should not be made.

"However, the probability of such effects is extremely low, and is now lower than previously thought, particularly at low dose rates. This is because of the demonstration in the last decade that biological repair (effects are less "cumulative") does take place for genetic damage as well as for somatic damage. Thus it can be stated definitely that the probability of genetic effects at the low doses and dose rates involved is so low that they could not be demonstrated in subsequent generations even if a very large population of human beings were now exposed.

"With respect to the person actually exposed, no demonstrable or significant effect will result from viewing under usual conditions. The low doses and dose rates involved are unequivocally far below those that would lead to "radiation illness" in an exposed adult or child, and certainly they are not large enough to cause medical effects detectable by the practicing physician. Even with a markedly defective receiver and under most unusual circumstances (e.g., prolonged stay very close to the surface of the receiver emitting the most X-radiation), the probability of detectable medical effects is extremely small.

"Thus while it is prudent to control and severely limit exposure to radiation (as well as to all other potentially injurious agents), it is quite clear that the probability of significant or even detectable medical effects from X-rays emitted by faulty color TV receivers is vanishingly small."

—Packard Bell

Hermetic Sealing of Glass to Metal

A fundamental new discovery for the hermetic sealing of glass to metals—including semiconductor materials—with wide potential utilization in diversified consumer, industrial and government applications, has been announced by P. R. Mallory and Co.

G. Barron Mallory, president of the Indianapolis firm, said the process is unique in that it utilizes elec-

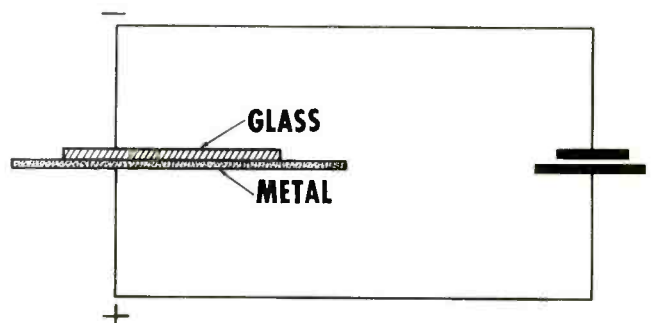

tric potential rather than adhesive, fluxes or conventional fusing techniques for achieving a bond stronger than the original materials.

Utilizing the new process, bonding can be accomplished in a matter of seconds and without the need for external pressure being exerted on the materials. Typical uses for the process, Mr. Mallory said, could include such diverse applications as the manufacture of hermetic seals for vacuum tubes and other vacuum system applications, and the encapsulation of electronic components.

The bond is formed by placing a flat piece of insulating material, such as glass, on a flat piece of metal, heating the two pieces to a temperature well below the softening point of the glass and then, applying a DC electrical voltage across the glass-metal sandwich with positive voltage applied to the metal.

The time required to complete the bond depends on the surface flatness, the temperature to which the material is heated and on the magnitude of the applied voltage. These factors have been varied from temperatures of about 150 to 1,250 degrees centigrade, from times ranging from several seconds to several minutes and with electrical voltages of a hundred to more than a thousand volts.

NEA Convention Activities

Richard Glass of Indianapolis, Indiana has been elected as the new president of the National Electronic

Associations (NEA) at their annual convention in Pasadena, California.

Glass, who is a past president of the same organization, was elected to lead the group of affiliated State Television Service Associations following an all-out election campaign.

Area vice-presidents were also elected and include: Warren Baker of Albany, New York; Warren Gill of Albany, Georgia; Kenneth Young of Washington, Iowa; Ray Demonbrun of Louisville, Kentucky; Charles Enyeart of Lincoln, Nebraska; Norris Brown of Houston, Texas; Colin Gregory of McMinnville, Oregon and Emmett Mefford of Fontana, California.

Leon Howland of Indiana was elected as the new national secretary for NEA and Homer Davidson of Iowa was re-elected as national treasurer.

Changes in Yellow Page Listings

Under three separate resolutions adopted by the convention delegates, it was suggested that because of the confusion and additional costs involved in being listed under many different categories to cover the complete range of business for the majority of electronic industry dealers, the new category headings should be: "Television & Radio, Sales—Service" and "High Fidelity Sound Equipment, Sales—Service."

The second resolution adopted concerns the area of phonographs and recorders. Under the new proposed headings the current six listings would be combined

The Complete Line of Signal-Indicating Alarm-Activating Fuses

For use on computers, microwave units, communication equipment, all electronic circuitry.



BUSS GLD-1/4 x 1 1/4 in. Visual-Indicating, Alarm-Activating.

BUSS GBA-1/4 x 1 1/4 in. Visual-Indicating.



BUSS MIC-13/32 x 1 1/2 in. Visual-Indicating, Alarm-Activating.

BUSS MIN-13/32 x 1 1/2 in. Visual-Indicating.



FNA FUSETRON Fuse 13/32 x 1 1/2 in. slow-blowing, Visual-Indicating, Alarm-Activating. (Also useful for protection of small motors, solenoids, transformers in machine tool industry.)



BUSS Grasshopper Fuse, Visual-Indicating, Alarm-Activating.



BUSS ACH Aircraft Limiter, Visual-Indicating.

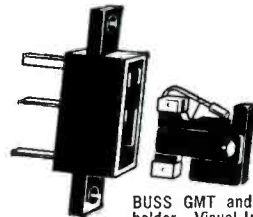

BUSS GMT and HLT holder, Visual-Indicating, Alarm-Activating.

SUB-MINIATURE FUSES

Ideal for space tight applications, light weight, vibration and shock resistant. For use as part of miniaturized integrated circuit, large multi-circuit electronic systems, computers, printed circuit boards, all electronic circuitry.

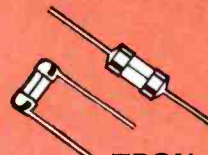

TRON Sub-Miniature Pigtail

Fuses — Body size only .145 x .300 inches. Glass tube construction permits visual inspection of element. Hermetically sealed. Twenty-three ampere sizes from 1/100 thru 15.



BUSS Sub-Miniature GMW

Fuse and HWA Fuseholder
Fuse size only .270 x .250 inches. Fuse has window for visual inspection of element. Fuse may be used with or without holder. 1/200 to 5 amp. Fuses and holders meet Military Specifications.

Write for BUSS Form SFB

BUSSMANN MFG. DIVISION, McGraw-Edison Co. St. Louis, Mo. 63107

SUPPLIED THE ECONOMICAL WAY
THRU DISTRIBUTORS

BUSS QUALITY

FUSES

For fuses and fuseholders of unquestioned high quality for every protection need...

Circle 5 on literature card

CLIP ME OUT

PLEASE SEND ME FULL INFORMATION ABOUT YOUR PICTURE TUBE REBUILDING EQUIPMENT.

NAME

ADDRESS

CITY..... STATE..... ZIP.....

COMPANY

SEND THIS COUPON TO:

C.R.T. EQUIPMENT CO., INC.

2740 OLD LEBANON ROAD
NASHVILLE, TENNESSEE 37214
TEL. (615) 883-0215

This coupon will provide you with full information about the world's finest low-priced picture tube rebuilding equipment

Circle 6 on literature card

NEW COAX MATCHING TRANSFORMER

For UHF/VHF Color/B&W TV

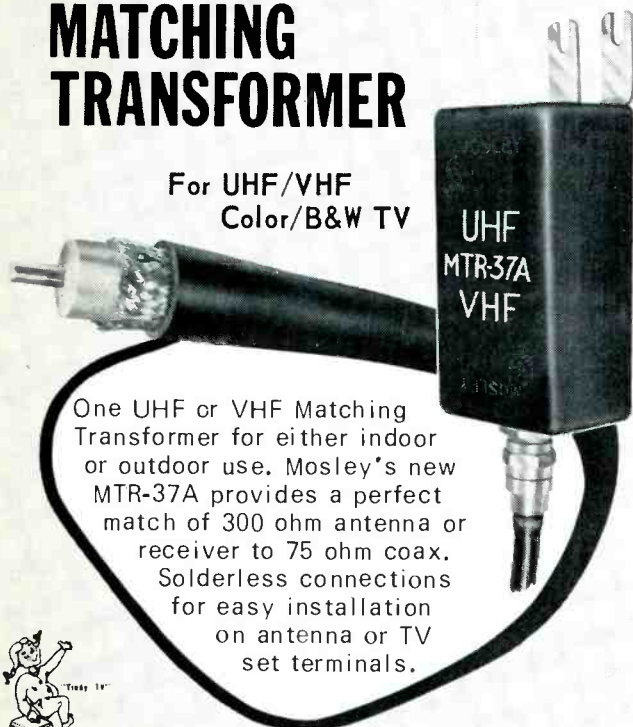

One UHF or VHF Matching Transformer for either indoor or outdoor use. Mosley's new MTR-37A provides a perfect match of 300 ohm antenna or receiver to 75 ohm coax. Solderless connections for easy installation on antenna or TV set terminals.



Write Dept. 160A for FREE detailed brochure.

Mosley Electronics, Inc. 4610 N. Lindbergh Blvd., Bridgeton Missouri 63042

Circle 42 on literature card

into: "Phonographs, Commercial—Sales-Service" and "Recorders, Commercial—Sales-Service." The same heading would be used with the addition of the word "Renting" for those interested in that category.

The third resolution was in regard to the current practice of placing the rental of television sets that also involves retail sales and service, under the letter "T". It is suggested that this be moved to a classification of "Rentals-Television" and that the directories adequately refer the subscriber to the rental section.

Committee To Work With Manufacturers

A new national committee on serviceability, to be directed by Dean Mock of Indiana, will concentrate on developing a series of national surveys to learn and record the problems involved in servicing new electronic home entertainment products.

According to NEA president, Dick Glass, "We hope that this information can be recorded as quickly as possible so that committee members can set up personal meetings with manufacturing officials in an effort to make their products more easily serviced."

Glass went on to state that, "This is not a gripe committee, but a functional and constructive effort to work with the manufacturers so that by simple adjustments the service industry will be in a better position to service their products faster and at less cost to the consumer. Often times a single test point can make the difference between minutes and hours for the service technician."

RCA Develops Higher-Output Transistors

RCA has announced the use of a new laminated construction technique to build experimental transistors that for the first time rival large electron tubes in power output.

Although the technique is still in advanced laboratory development, one of the new, super-power transistors has already generated radio waves oscillating at one million Hertz with a power of 800 watts. This is three times the 250 watts generated by many standard broadcast radio stations, according to John B. Farese, executive vice-president, RCA Electronic Components. Considerably higher powers and frequencies are expected, he added.

One of these new transistors was shown to the electronics industry for the first time at the company's exhibit at the Western Electronics Show and Convention (WESCON) in Los Angeles.

The new technology responsible for these transistors is being pioneered by a team of engineers led by Hans W. Becke of RCA's Electronic Components organization and is part of a long-term development program. This program, sponsored by the U.S. Air Force and U.S. Navy, may eventually make possible all-solid-state sonar, high-power communications systems, electric furnaces and other heavy duty items that have not previously been transistorized.

Samples of the experimental RCA transistor have been delivered to the military for their evaluation and testing.

This concept in transistor technology, which makes use of fusing or laminating of semiconductor materials, ultrasonic cutting rather than photo-etch techniques, and glass hermetic sealing, has been developed by RCA Electronic Components. ▲

COLOR GENERATORS

FOR EVERY NEED

**4 reasons why Sencore is your best buy
in professional test instruments**

1

LOBOY CG10

America's lowest priced professional quality standard color bar generator. All solid state. Battery powered for maximum portability.

\$89.95

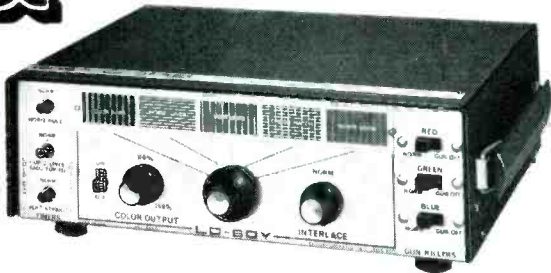

2

LOBOY CG12

AC operated version of the CG10. Also has 4.5 MHz crystal controlled signal for fine tuning adjustment.

\$109.95



3

COLOR KING CG141

Absolute stability assured by exclusive "Temp Control" and new timer circuitry. All standard patterns, plus new movable single dot and single cross. Analyzing features too.

\$149.95



4

COLOR ANALYZER CA122B

The complete analyzer for color and B&W—far more than just a color generator. Has variable RF and IF outputs, composite video, chroma, and horizontal and vertical sync pulses.

\$187.50



Whatever the need, Sencore has the color generator that is just right for you. Each has the built-in quality you expect from Sencore. Each has standard RCA licensed color bar patterns.

Each is triple tested for guaranteed accuracy. Each is steel encased with chrome panel. See your distributor for more reasons why Sencore is your best buy, always.



SENCORE

NO. 1 MANUFACTURER OF ELECTRONIC MAINTENANCE EQUIPMENT

426 SOUTH WESTGATE DRIVE ADDISON, ILLINOIS 60101

Circle 8 on literature card

Eliminating TVI . . . Methods of tracking

by Jack Darr

There are two types of television interference (TVI): temporary and permanent. The temporary kind comes from older cars without ignition-noise suppression and there is not a lot that can be done about it. The "permanent" type comes from such sources as home electrical appliances and power lines. This type of interference can be tracked down and eliminated.

Auto-Noise TVI

Modern cars have resistive ignition wiring and do not radiate ignition noise. However, an older car without noise-suppression is in effect, a transmitter with about 25,000 volts on the final. If a very sensitive TV antenna is used, such noise will be picked up along with the TV signal, since they are both electrical impulses.

From actual tests, it has been determined that practically all of this noise is picked up by the antenna itself. Thus, turning a highly directional antenna away from a busy highway, will eliminate most auto-generated noise.

Small Motor Noise

There is only one practical way to eliminate permanent noise—track it down and eliminate it at its source. There are two ways to eliminate noise: suppression and shielding. Usually both are required. Some permanent noise is radiated and some travel on the AC line. Stopping the noise at the source will prevent dispersion.

The source of most noise is an arc. Arcs generate purely random noise with frequency components in all bands up to and including the VHF TV channels.

The tiny arcs at the motor brushes of small home appliances are a common source of noise. Although most modern appliances have built-in noise-suppression devices, older or cheaper units do not.

The time period in which TVI occurs can be the best clue to its source. If the complaint is "This darn stuff always comes on just

when I'm trying to watch the evening news," chances are the noise source is an appliance being used to fix supper: mixer, blender, toaster or electric oven. Conversely, if the noise appears only on washday, look for trouble in the washer or dryer.

In all cases, noise interference from appliances can be determined by turning them on and watching the TV screen. Fig. 1 depicts the result of a small-motor noise. In this case the noise is so severe that it has blocked out the sync and made the picture unstable. A "harsh-noise" in the sound can also accompany this symptom. A less severe case of small-motor interference is shown in Fig. 2. The noise source for this symptom was an old electric shaver, another item to check when hunting for noise sources.

Cures for Motor Noise

Dirty or worn motor brushes or a dirty commutator (or both) are the prime causes of noise. The cure is easy: Replace the brushes with new ones, and seat them well. Clean the commutator with extra-fine sandpaper and reduce the arcing at the brushes to a minimum. If the motor throws a "ring of fire" all the way around the commutator, it may have a bad armature. The only cure for this is a new motor.

Once the arcing has been reduced to a minimum, add a pair of small bypass capacitors (.01 mfd) from each brush to the motor frame, as shown in Fig. 3. Small ceramic units with at least a 200-volt working-volt rating can be fitted inside even the smallest motors. Use good braid spaghetti on the leads, and place them so they cannot get into any of the moving parts.

If the motor is so small that even little ceramic capacitors cannot be placed inside, use plug-in filters. These are LC filters with a plug on one end and receptacle on the other. Most of the better types have a ground terminal on the side of the case, as illustrated in Fig. 4. The filter functions better if this is connected to ground or to the case of the appliance. Most kitchen appli-

ances have a three-wire line cord with the third-wire grounded to the motor-frame inside the appliance case. The ground terminal of a plug-in filter can be connected to this wire.

Fluorescent Lights

Older fluorescent lights of any size, can generate noise. This usually shows up as two horizontal bands of dots on the TV screen, as shown in Fig. 5. (This picture was taken on a blank channel to show the noise only; in bad cases, you can see this on the home TV without an incoming signal.) The noise shown in Fig. 5 has a basic 120-Hz characteristic. Fig. 6 is an illustration of how it would appear on a scope. The noise is concentrated in small bursts at each voltage peak,

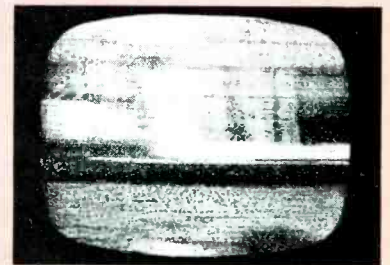

Fig. 1 Hash-noise from small motor appliance.

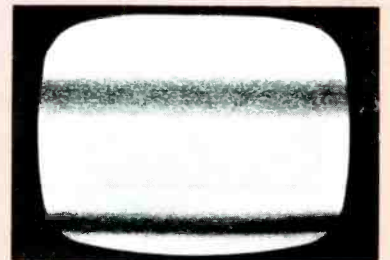

Fig. 5 Two bands of dots are typical of 120-Hz interference.

down and eliminating television interference

thus producing the typical two-bands-of-dots pattern.

Flourescent-light noise can be filtered out by a small LC filter like the one shown in Fig. 7. This is the basic circuit used in the plug-in filter shown in Fig. 4. It will work on the most severe cases of interference. Either end of this circuit can be used as the input, though it seems to work slightly better with the .001-mfd side as the input. This filter is also handy for small office machines. Such a filter also can be installed inside the housing of a light. The coils are wound with about 15-20 turns of enameled, #20 solid wire on an 1/8" form. The capacitors can be paper or ceramic. For best results, the common connection should be securely

grounded to the metal case of the light.

Line Noise

A noise similar to that illustrated in Fig. 5 can also be radiated from AC power lines. The basic cause is what is known as "hardware noise" on the poles. Each pole has a ground conductor fastened to the ground (top) wire, and an assortment of metal brackets to hold the pole assembly together. Even though these are not in contact with the line, they can pick up static charges and produce noise. A loose ground connection can corrode, developing an oxide layer between wires; this effectively forms a semiconductor diode that can generate "hash."

There is a simple method for locating line noise originating from

such sources. With the car radio on, drive slowly around the neighborhood. Set the dial between stations at about 800 KHz and turn up the volume. For some unexplainable reason, this noise is loudest at about this frequency. When the loudest noise is heard, and covers the entire broadcast band, the source is near. Getting closer to the source, other high frequency components become more audible. The strongest is at about 800 KHz. Once the source has been localized find the nearest light pole and tap it with a heavy hammer. If a pop is heard in the radio, or any change is evident in the noise, the offending pole has been located. Contact the local power company and report these findings to them. Such companies



Fig. 2 Less severe case of motor-noise from electric shaver.

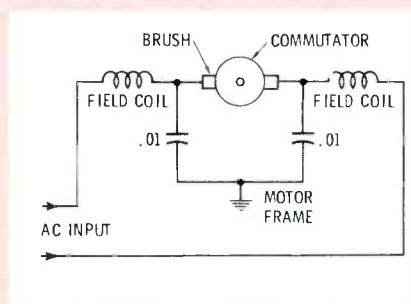

Fig. 3 Small bypass capacitors keep noise inside appliance.

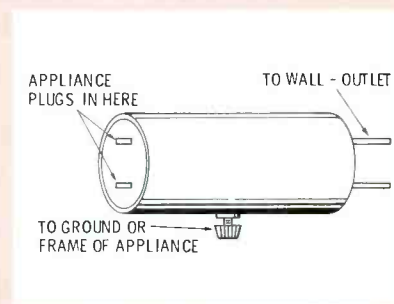

Fig. 4 Small plug-in filter for appliances with ground terminal.

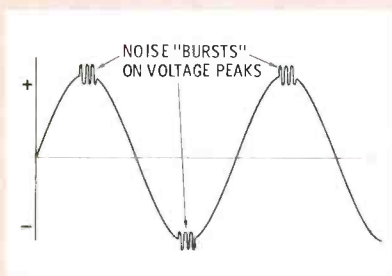

Fig. 6 Waveform of noise from flourescent light. Note small bursts of noise on voltage peaks.

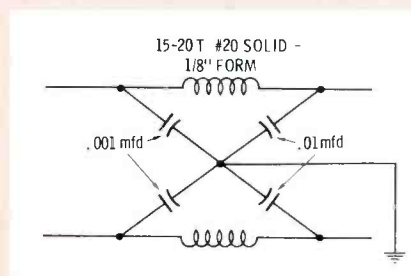

Fig. 7 Home-made filter for small appliances, flourescent lights, etc.

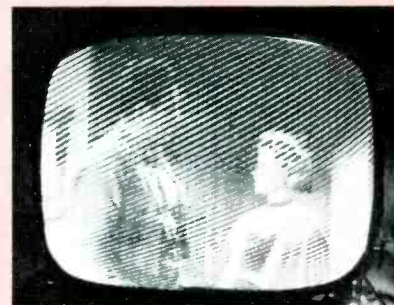

Fig. 8 Beat pattern on TV screen from RF signal.

FIRST AND ONLY compact Scrulox® screwdriver sets

Increasing use of Scrulox square recess screws in appliances, radios, TV sets, electronic instruments... even the control tower at Cape Kennedy... has created a need. A need for compact, versatile driver sets. Small enough to tuck in a pocket. Complete enough to be practical on shop bench or assembly line.

Now, here they are... from Xcelite, of course.



PS44
COMPACT
CONVERTIBLE SET

Five color coded midget Scrulox drivers—#00 thru #3

One midget nutdriver—1/4" hex
"Piggyback" torque amplifier handle increases reach and driving power

See-thru plastic case doubles as bench stand



99SL
INTERCHANGEABLE
BLADE KIT

Five Scrulox blades—#00 thru #3
Shockproof, breakproof, Service Master handle
Durable, see-thru plastic case

XCELITE®

Circle 7 on literature card

have a crew which can eliminate the noise source. This is done by cleaning and retightening the hardware on the offending pole(s). Some REA crews have had to rework as much as three miles of rural power lines to get rid of this type of interference.

Radio-Frequency TVI

Any RF signal that can get into the TV set will "beat" with the picture carrier to produce interference like that shown in Fig. 8. Ham and CB operators get blamed for a lot of TVI. However, ham radios do not operate on or even near the TV IF bands, not even in the TV IF bands. If the transmitter is in good shape (not radiating harmonics, etc.) it should not cause TVI. The best check for RF TVI is to take a small portable TV to the suspected ham station, turn it on, and then key the transmitter. Another method for checking this interference is to telephone the suspected radio operator asking him to key his transmitter. If the characteristic wrinkly or wiggly beat-pattern is displayed on the TV screen, the source has been determined.

As previously mentioned, most RF TVI is due to an RF signal getting into the IF stages of the TV set. Police radios and many others operate in the 40-60 MHz FM band. If a policeman in a cruising police car happens to key his transmitter just as he's passing the customer's house, a pattern similar to that in Fig. 8 will probably be seen on the screen. Such interference is rare, but it can happen. However, if the customer is unfortunate enough to be located near the base-station of a police radio system, such TVI can be nearly continuous.

Since this is FM, the lines in the noise pattern will probably be wrinkly or S-shaped, and jittering. Such TVI is NOT the fault of the radio transmitter. The fault is in the poorly-shielded IF stages of the TV itself. The cure in cases like this is better shielding of the IF stages in the TV. A cage of copper screen can be tacked over the IF strip, and metal plates placed inside the cabinet under the IF. If this doesn't stop the TVI, the cure may require a new TV set with better shielding and design.

Antenna pickup of TVI can be reduced by sharply tuned traps

made out of twin-lead cut to absorb the interfering signal. However, as pointed out before, most noise pickup like this seems to be in the IF, so antenna traps will usually not help. This can be checked at the shop: Use a sweep-generator set to the police-radio carrier-frequency as a simulated noise source and try different forms of shielding and traps.

Noise Tracing Around the Home

A transistor portable radio can be used to locate sources of interference around the home. Such sets are fairly directional, and any noise picked up can be pin-pointed by aiming the radio. This noise tracing method can also be used in the yard to locate the source of any noise that might be carried in on the service wiring from neighboring homes, small plants, or work shops. Powertools, such as bench saws and drill presses, seldom cause TVI because they use large induction or capacitor-start motors that have no brushes to arc. Small electric hand drills, sanders, etc., with brush motors can be quieted down with the LC filters described previously.

Diathermy Interference

In the past, when TV sets had IF's in the 20-MHz band, and diathermy equipment worked on about the same frequency, there was considerable diathermy interference. This caused a near-stationary band of wiggles right through the center of the picture. However, the FCC has banned this type of equipment. All diatherms now use microwave frequencies. If this type of interference is encountered, the offending unit should be traced and the operator informed that such equipment is no longer legal. If he persists, the situation should be reported to the FCC.

FCC Assistance

If the source of a very severe case of TVI cannot be located, the nearest FCC office should be notified. If the noise is bad, chances are it is also getting into important communication bands. The noise should be described as accurately as possible, giving times of maximum disturbance and type of noise (RF, hash, pulse, etc.). The FCC may be able to help, but they shouldn't be bothered for minor noises or suspected ham radio interference until such interference is checked thoroughly. ▲

Customers wear out the Yellow Pages getting to New Haven Appliance



"We average ten to fifteen calls a day and the majority are from Yellow Pages," says Edward P. Jesanis, president, New Haven Appliance Servicenter, Hamden, Connecticut. "We get an awful lot of college people that move into town, and Yellow Pages is about the only place they could find us. On the other hand, if old customers have lost that slip with our name on it, then Yellow Pages is the next best place to look. We also get calls from manufacturers in the area—their purchasing agents find us in the Yellow Pages. It's also a good back-up to other advertising we might run. People who see the newspaper ad still can go to Yellow Pages for our number when something breaks down. We've come to the conclusion that Yellow Pages is our best bet to reach the greatest number of people, and to keep our name in front of them at all times."



Advertise for action...

NEW HAVEN APPLIANCE
Servicenter

FACTORY AUTHORIZED SERVICE ON MOST BRANDS
38 CONNOLLY PKWY., HAMDEN 288-6229
(Across from Hamden High School - Next to A & P)
240 GEORGE ST., NEW HAVEN 865-4116

ARVIN	GENERAL ELECTRIC	REGINA
AMERICAN BEAUTY	HAMILTON BEACH	REMYNGTON
BERNS	HARDY	ROBINSON-ROCHESTER
BISSELL	HOOVER	ROYAL
BLACK & DECKER	IONA	SCOTCH
B.V.L.	JETSFRAY	STILEX
CASCO	JOHNSON	SNEYLAND
CAMP-BELD	KNAPP MONARCH	SHEL
CORBY	LEWITT	SPIERT SUN LAMPS
DARBY	MANKING-SOMMER	SUNBEAM
DOM DREXON	MCGRAW EDISON	TENSOR
DORMEYER	METRONOMATIC	THEIR
ELECTROLUX	MOTOROLA	TOASTMASTER
EUREKA	MORLCO	TRICOLATOR
FARBER	OSTER	UDCOO
FASCO	P.E.T.	UNIVERSAL
FRESH-D-MATIC	PRESTO	WARING
GENERAL FLOORCRAFT	PROCTOR	WEST BEND
	RAIN	
	WESTINGHOUSE	

REPAIRING

AUTO RADIOS	ELECTRIC POWER MOTORS	MIXERS
BLANKETS	FANS	PORTABLE TYPES
BLENNDERS	FLOOR POLISHERS	POWER DRILLS
BROLLERS	HAIR DRYERS	& SAWS
CLOCK REPAIRS	HEATERS	POLISHERS
COFFEE MAKERS	LAMPS	TAPE
DEEP FRYERS	IRONS (Steam Spray-Dry)	RECORDERS
TOASTERS	YACUUM CLEANERS Etc.	

TOASTMASTER

MON. to FRI. 8:30 A.M.-5:30 P.M. • SAT. 9 A.M. to 1:30 P.M.

Today's customers wear out the Yellow Pages instead of themselves. This ad*, under ELECTRIC APPLIANCES—SMALL—REPAIRING, leads them to New Haven Appliance. Call your Yellow Pages man to plan your program. Find him in the Yellow Pages under ADVERTISING—DIRECTORY & GUIDE. *shown reduced

measure



The RCA WV-38A Volt-Ohm Milliammeter is a rugged, accurate, and extremely versatile instrument. We think it's your best buy. Only \$52.00.* Also available in easy to assemble kit, WV-38A (K).

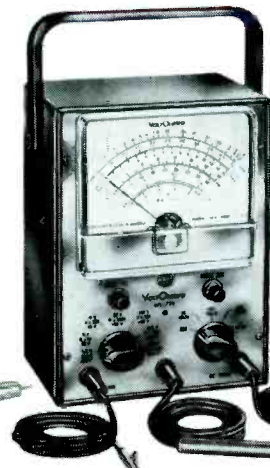

The RCA WV-77E Volt-Ohmyst® can be used for countless measurements in all types of electronic circuits. Reliability for budget price. Only \$52.00.* Also available in an easy to assemble kit, WV-77E (K).



The RCA WG-412A R-C circuit box can help you speed the selection of standard values for resistors and capacitors, either separately or in series or parallel R C combinations. Only \$30.00.* It's easy to use, rugged, and compact.

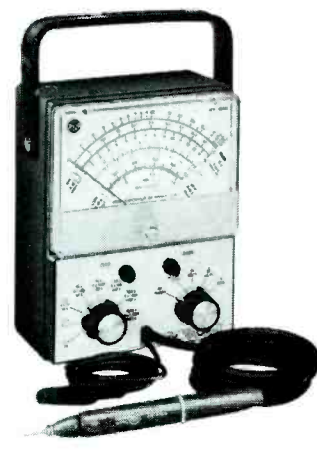

The RCA-500A all solid state, battery operated VoltOhmyst eliminates warm-up time, eliminates zero-shift that can occur in tube operated voltmeters. Completely portable. Only \$75.00.* Comes with shielded AC/DC switch probe and cables.

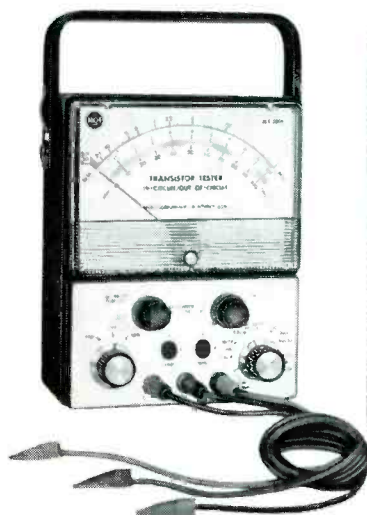

The RCA-WT-501A in-circuit out-of-circuit transistor tester is battery operated, completely portable. It tests both low and high power transistors, has NPN and PNP sockets for convenient transistor matching for complementary symmetry applications. Only \$66.75.*

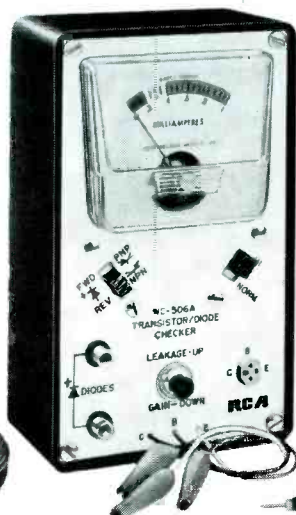

The RCA WC-506A transistor-diode checker offers a fast, easy means of checking relative gain and leakage levels of out-of-circuit transistors. Compact and portable, it weighs 14 ounces, measures 3¾ by 6¼ by 2 inches. Only \$18.00.*

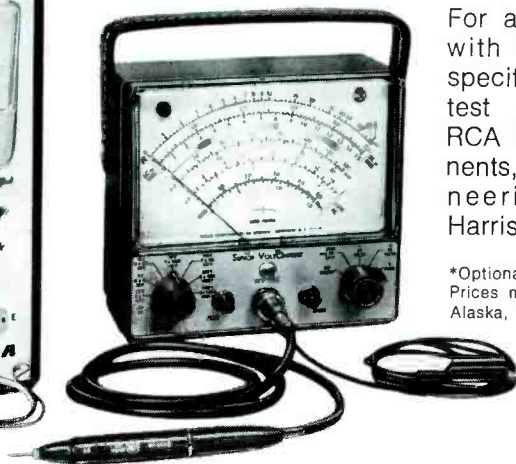

The RCA WV-98C Senior VoltOhmyst is the finest vacuum-tube voltmeter in the broad line of famous RCA VoltOhmysts. Accurate, dependable, extremely versatile, it is a deluxe precision instrument. Only \$88.50.* Also available in an easy to assemble kit, WV-98C (K).

For a complete catalog with descriptions and specifications for all RCA test instruments, write RCA Electronic Components, Commercial Engineering, Dept. J33WA Harrison, N.J. 07029.

*Optional Distributor resale price. Prices may be slightly higher in Alaska, Hawaii, and the West.

LOOK TO RCA FOR INSTRUMENTS TO TEST/MEASURE/VIEW/MONITOR/GENERATE

Circle 9 on literature card

RCA

VIEW

The RCA WO-33A Super-Portable 3-Inch Oscilloscope helps solve virtually any electronics servicing problem, inside or outside the shop. Its combination of exceptionally low cost and high performance have already made it popular as a monitoring and trouble shooting 'scope in black and white and color TV broadcasting studios, and in professional service. And why not? Here's a 3-inch 'scope that meets your requirements for gain, bandwidth, transient response, accuracy, versatility, and portability. AND IT'S ONLY \$139.00.* Also available in an easy to assemble kit, WO-33A (K).

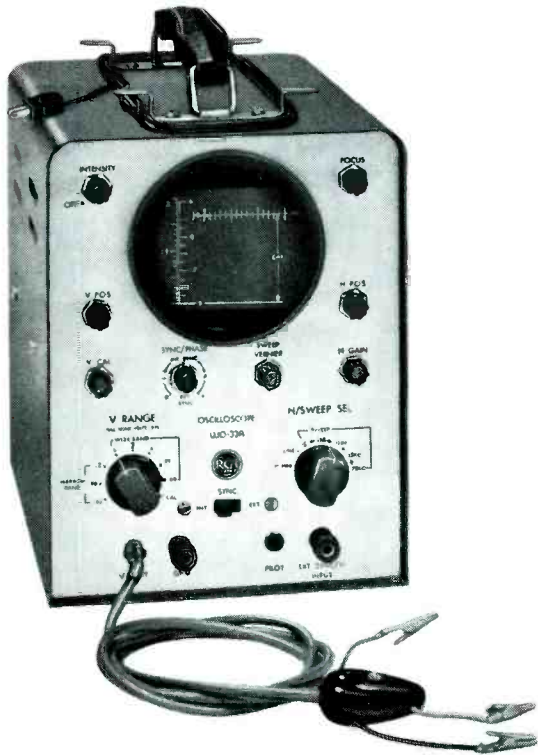

The RCA WO-91C 5-inch Dual Band Oscilloscope is a reliable, heavy-duty, precision 'scope in use in thousands of installations from classrooms to TV distribution systems...from service benches to broadcast stations. You probably can't find a better value. Applications include waveform analysis, peak-to-peak voltage measurement, square-wave testing, and observation of circuit characteristics. A front-panel switch gives you an easy choice of wide-band or narrow-band (high sensitivity) operation. It's easily portable, AND IT'S ONLY \$269.00.* The WO-91C-V1 is available for 240V operation, no increase in price.



*Optional Distributor resale price. Prices may be slightly higher in Alaska, Hawaii, and the West.

Write for a catalog with complete descriptions and specifications for all RCA test equipment: RCA Electronic Components, Commercial Engineering, Department No. J33WB Harrison, N. J. 07029

LOOK TO RCA FOR INSTRUMENTS TO TEST/MEASURE/VIEW/MONITOR/GENERATE

Circle 10 on literature card

Record changer repair

Troubleshooting procedures and solutions for a variety of common troubles

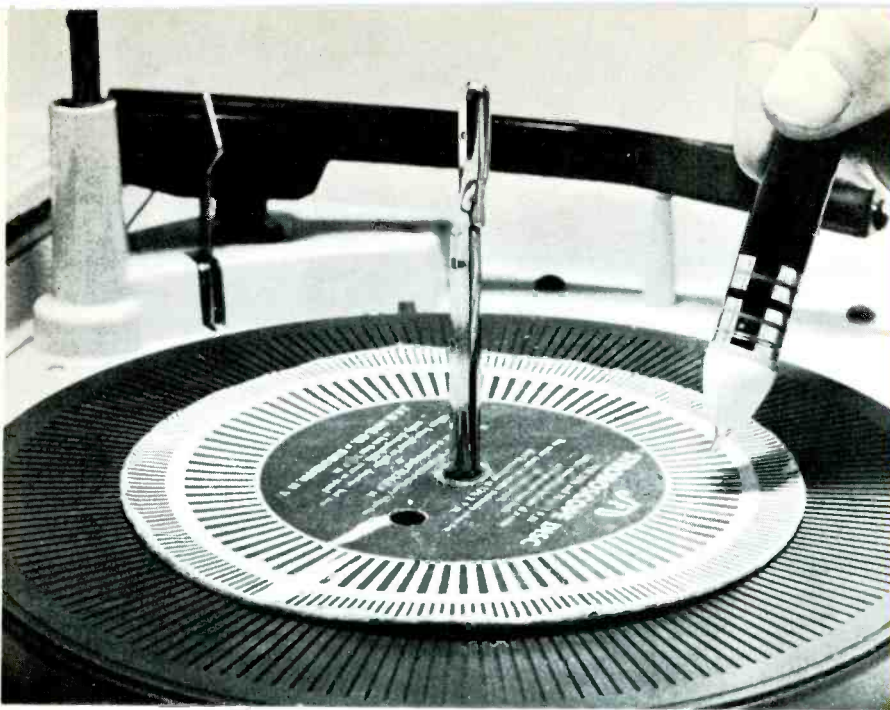

Fig. 1 Strobe disc is simple method for checking turntable speed.

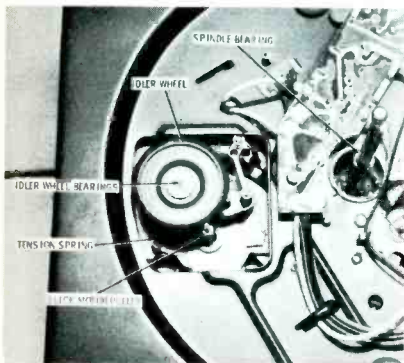

Fig. 2 Slick or worn spots on idler wheel can reduce turntable speed.

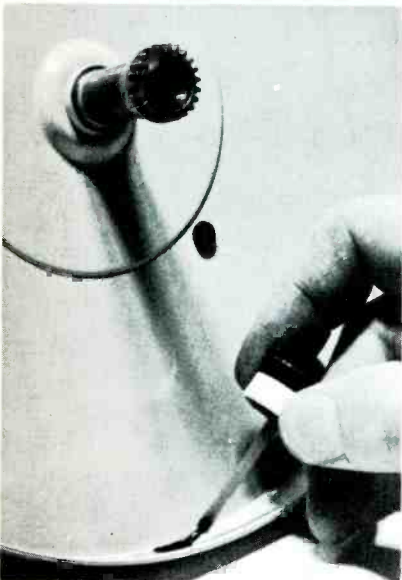

Fig. 3 Applying a non-slip dressing to inner surface of turntable.

by Homer L. Davidson

Most record changer troubles can be categorized as follows: The changer runs too slowly or stalls in cycling operation, won't shift speeds, has improper or erratic landing, fails to trip or keeps on tripping as the pickup arm sets down, fails to drop the records correctly, has wow or rumble noises or fails to shut off after the last record is played.

Speed Problems

The turntable speed can be checked with one of the speed indicators currently available. A simple, low-priced strobe disc will suffice (Fig. 1). Use either a neon or florescent light over the turning strobe disc. If the strobe lines are running backwards the turntable is running too slowly. At the correct speed the strobe lines appear to stand still. The properly adjusted turntable should run a little fast before the records are placed on it.

Slow Speeds

A slow turntable can be caused by a worn idler wheel, a slick turntable, insufficient lubrication, or an overheated motor. Check the idler wheel for slick or worn spots (Fig. 2). Even a minute drop of oil on the idler wheel will cause it to slip, reducing the speed of the turntable. Check for grease or oil on the turntable drive surface or motor drive pulley. Dry the turntable inner sur-

face, then dress with liquid rosin or another non-slip dressing (Fig. 3).

If the turntable thumps as it revolves, check for a dent or flat side on the rubber idler wheel. A shiny idler wheel can be cleaned with alcohol and a soft cloth. Check the idler wheel spring for correct tension (Fig. 4). If loose, snip off a couple of turns with a pair of side cutters and replace. Idler wheel defects cause most slow-speed problems and should be replaced.

Slow-speed problems can also be caused by dry or gummed motor bearings. Check the motor mounting assembly for proper seats, the turntable for dry or excessively worn bearings and the drive surface of the turntable for oil or fingerprints.

Some automatic changers employ separate idler wheels for each turntable speed. Determine which idler wheel is associated with the speed affected, then replace it. For example, if the turntable is running slow in the $33\frac{1}{3}$ RPM position and all other speeds are normal, replace the $33\frac{1}{3}$ idler wheel. Many times an idler wheel bearing becomes dry, reducing the speed. Pry up the idler wheel to remove it, clean the bearing, then place a drop of oil inside it. Be sure to clean the bearing shaft before replacing the idler wheel. Too much oil will, in a few rotations, work out onto the rubber drive part of the idler wheel causing the idler wheel to slip.

Wow and Flutter

Irregular motion of the turntable produces frequency deviations that distort the audio output of the phonograph. High-rate deviations in speed produce a type of distortion called flutter, while low-rate deviations produce another type of distortion referred to as wow. The jerky movements of the turntable that produce such distortion can be detected with the speed strobe disc.

Oil spots on the turntable drive surface or motor drive pulley, or an idler wheel that is not riding on the exact speed section of the motor drive pulley (Fig. 5), can cause wow or flutter. When the idler wheel is improperly positioned so that it periodically touches the higher speed section of the motor drive pulley, the speed will vary. This can happen when the motor rubber mounting grommets become old letting the motor sag out of position. A bent idler wheel assembly can also cause such variations in speed. Straighten the idler wheel for correct speed alignment on the motor drive pulley. After straightening, be sure the idler wheel sets in the correct position for each speed.

The Motor

A burned motor is easy to spot: The motor field windings will appear charred overall or will have burned spots. Also, shorted turns in the field winding can glow "red hot" and smell like a burned power transformer. In any event, replace the whole motor assembly.

Slow starting or reduced speed is usually the result of dry motor bearings. Often, gummed bearings will cause a motor to freeze. In some models the motor pulley becomes worn and can be replaced by removing a small set screw. If the motor gets "red hot" after running for several hours and then slows down, suspect a shorted field winding.

Normally, most motors run quite warm after a few hours operation. Experience will help you determine what is "normal hot" and "abnormal hot."

Motor Bearings

Dry bearings and an overheated motor will cause the armature shaft and bearings to freeze together. If frozen or dry motor bearings are found, disassemble the complete

It costs you less to repair a tuner than to buy a new one. Right?

Wrong!

Figure it out. Repairing costs about \$9.75. New tubes cost around \$3.00. Now add your time and cost for packing and shipping to say nothing of the money you're out while waiting for it to be returned. (And who pays for your call back if another part of the tuner fails.) A brand new SC Super Arbor Preset Tuner with mounting brackets and tubes costs \$12.95. And you can pick it up in whatever time it takes you to get to the distributor—5, 10, 15 minutes. You get a new tuner warranty—1 year from date of purchase. The new tuner costs you less in time and money. Your customer gets a brand new tuner instead of a used one. Everybody's happy. Right? Right. Available at your parts distributors.

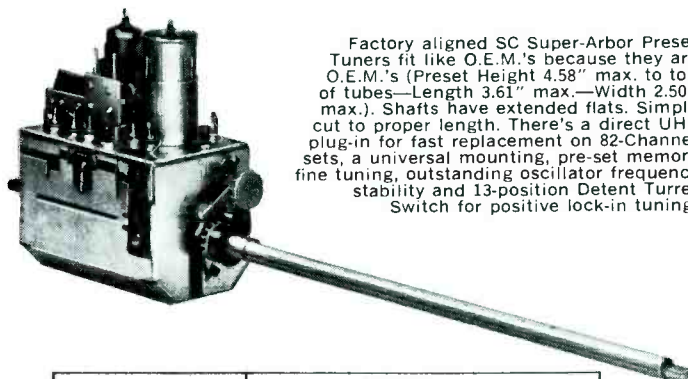

Factory aligned SC Super-Arbor Preset Tuners fit like O.E.M.'s because they are O.E.M.'s (Preset Height 4.58" max. to top of tubes—Length 3.61" max.—Width 2.50" max.). Shafts have extended flats. Simply cut to proper length. There's a direct UHF plug-in for fast replacement on 82-Channel sets, a universal mounting, pre-set memory fine tuning, outstanding oscillator frequency stability and 13-position Detent Turret Switch for positive lock-in tuning.

	MODEL		
13 Position Switch	SBR-250	SBRS-252	SBR4S-251
Antenna Input	300 ohms balanced to ground.....		
Intermediate Frequency	41.25 mc sound		
	45.75 mc video		
RF Amplifier Tube	6HQ5	2HQ5	3HQ5
Oscillator-Mixer Tube	6GJ7	5HB7	5GJ7
Heater	6.3 volts	600 ma	450 ma
B Plus	125-145 volts dc.....		

sk Standard Components

DIVISION OF STANDARD KOLLSMAN INDUSTRIES, INC.
2085 North Hawthorne Ave. • Melrose Park, Illinois 60160

Circle 11 on literature card

ARROW

Automatic STAPLE GUN TACKERS

Specially designed for
SAFE — FAST — SECURE
WIRE & CABLE FASTENING

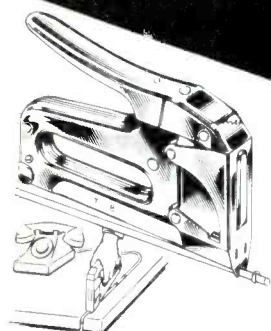

No. T-18
For wires up to
3/16" in dia.
Uses round crown
staples in
3/8" leg only.

BELL, TELEPHONE, THERMOSTAT,
INTERCOM, BURGLAR
ALARM and other
low voltage
wiring.

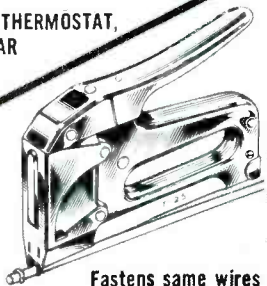

No. T-25
For wires up to
1/4" in dia.
Uses round crown
staples in 9/32",
3/8", 7/16", and
9/16" leg.

Fastens same wires
as No. T-18

Also
used for
RADIANT
HEATING
CABLE

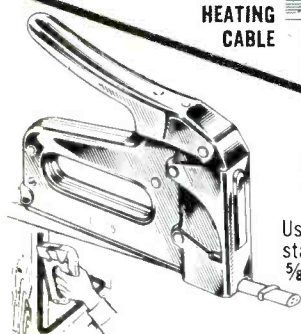

No. T-75
For wires and
cables up to
1/2" in dia.
Uses tack-pointed
staples in 9/16",
5/8" and 7/8" leg.

SHEATHED CABLE, RADIANT
HEATING CABLE, WIRE
CONDUIT, COPPER
TUBING, DRIVE
RINGS, ETC.

• All-steel,
chrome finish.
• Jam-proof mechanism
for trouble-free operation

SAFE! Driving blade automatically
halts staple at right depth of penetration!
Can't cut or injure wires and cables.

FAST! Powerful single stroke action
shoots staples in 1/1000 of a second!
Saves 70% in time, effort and efficiency!

HOLDS! Staple points diverge to
embed firmly in wood. Rosin-coated for
tremendous holding power!

Write for catalog and information.

ARROW FASTENER COMPANY INC
Saddle Brook, New Jersey 07863

"Pioneers and Pacesetters
For Almost A Half Century"

Circle 12 on literature card

motor. Remove the motor bolts and nuts, laying the parts on the service bench in the order in which they were removed (Fig. 6). Now mark the bottom of the field winding with a felt pen so that the motor coil will not be mistakenly turned over during reassembly, causing the motor to run backwards.

Remove both top and bottom bearing assemblies and pull the armature out of the motor assembly. Thoroughly wash and clean the whole motor assembly. Wash out the top and bottom bearing assemblies with a cleaning fluid. Remove old grease deposits from shafts and armature.

Place oil in the felt motor bearing cups. Use a thin sewing machine oil. (Contact shield is good for cleaning and oiling motor bearings.) Do not apply an excessive amount of oil.

A noisy or screeching motor indicates dry and worn bearings. If the bearings appear scarred or excessively worn, replace the whole motor assembly.

Sometimes the motor bearing casing will loosen in the motor end piece, causing the motor to slow down or freeze. In such cases, the bearings can easily be replaced and tapped into position with a cold chisel and hammer. Be sure to line up the motor bearing pieces with the motor field assembly. Give the motor a spin before tightening up the motor bolts.

If the speed of a monaural or older type changer can not be properly adjusted by normal methods, replace the motor drive pulley spring. Some motors have a spring that serves as the drive surface on the motor shaft. Simply slip a larger spring over the motor shaft (Fig. 7). File and smooth down any rough ends. This will increase the speed of the turntable.

Speed Control Units

A new motor speed control unit is found in the RCA RP-228 changer series. The unit employs a special field winding and silicon diode to accurately control the speed of the motor. A neon light and strobe disc indicate correct turntable speed. Pushing down on the speed control knob illuminates a neon bulb that indicates the exact turntable speed. Rotating the speed control knob varies the speed. A circuit dia-

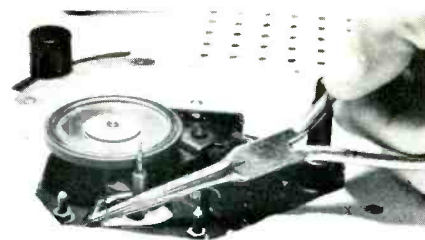

Fig. 4 Incorrect tension of idler wheel spring also can reduce the speed of the turntable.

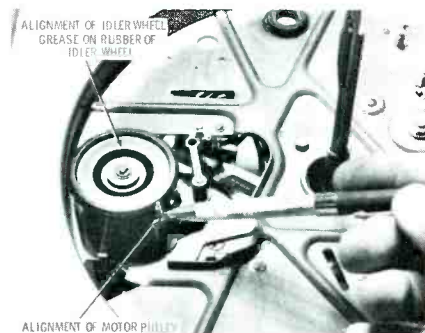

Fig. 5 Points to check for possible causes of wow or flutter.

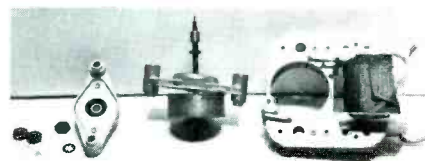

Fig. 6 Lay out parts in order of removal when disassembling motor.

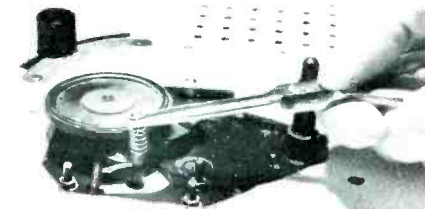

Fig. 7 Larger diameter spring will increase the turntable speed.

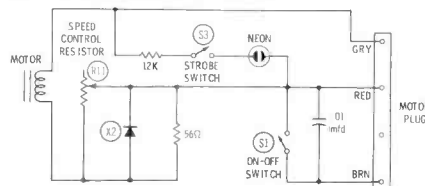

Fig. 8 Schematic diagram of the RCA motor speed control.

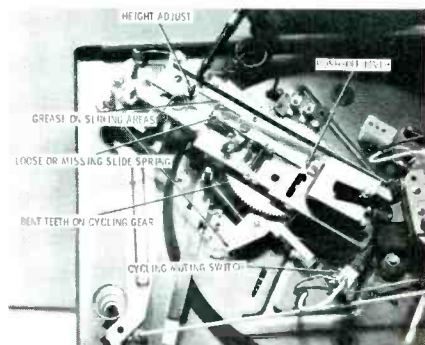

Fig. 9 Points to check for possible causes of tripping problems.

TRIPLET

EXTRA QUALITY IS HIDDEN*

MODEL 630 V-O-M PRICE † \$61.00

Standard Of The Industry



USES UNLIMITED:

- Field Engineers
- Application Engineers
- Electrical, Radio, TV, and Appliance Servicemen
- Electrical Contractors
- Factory Maintenance Men
- Industrial Electronic Maintenance Technicians
- Home Owners, Hobbyists

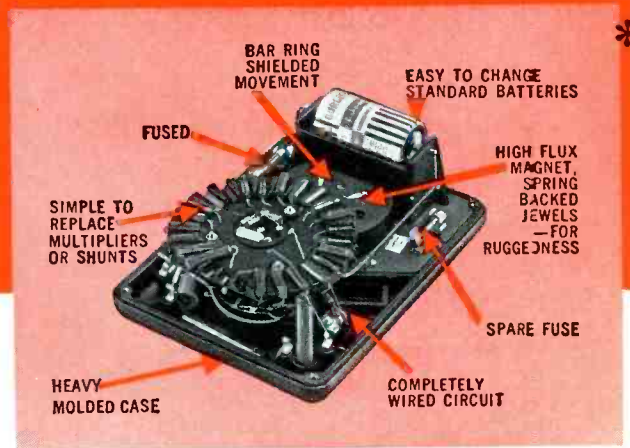

FACTS MAKE FEATURES:

- 1** One selector switch minimizes chance of incorrect settings and burnouts.
- 2** 4.4 ohm center scale, reads from 0.1 ohm up to 100 megohms resistance in 4 ranges.
- 3** 20,000 ohms per volt DC sensitivity; 5,000 AC.

Attention to detail makes the Triplet Model 630 V-O-M a lifetime investment. It has an outstanding ohm scale; four ranges—low readings .1 ohm, high 100 megs. Fuse affords extra protection to the resistors in the ohmmeter circuit, especially the X1 setting, should too high a voltage be applied. Accuracy 2% DC to 1200V. Heavy molded case.

†630A same as 630 plus 1% accuracy and mirror scale only \$71.00
TRIPLET ELECTRICAL INSTRUMENT COMPANY, BLUFFTON, OHIO

RANGES

DC VOLTS	0-3-12-60-300-1,200-6,000 at 20,000 ohms per volt.
AC VOLTS	0-3-12-60-300-1,200-6000 at 5,000 ohms per volt.
OHMS	0-1,000-10,000.
MEGOHMS	0-1-100.
DC MICRO-AMPERES	0-60 at 250 millivolts.
DC MILLI-AMPERES	0-1.2-12-120 at 250 millivolts.
DC AMPERES	0-12.

DB: -20 to +77 (600 ohm line at 1 MW).

OUTPUT VOLTS: 0-3-12-60-300-1,200; jack with condenser in series with AC ranges.



THE WORLD'S MOST COMPLETE LINE OF V-O-M'S. AVAILABLE FROM YOUR TRIPLET DISTRIBUTOR'S STOCK.
DON'T FORGET TO ASK 'EM "WHAT ELSE NEEDS FIXING?"

gram of the motor speed control is shown in Fig. 8.

Cycling Problems

Tripping

When the changer refuses to trip and will not go through a complete cycle of operation, look for a bent clutch lever, cycling gear, or trip pawl assembly (Fig. 9). A bent trip pawl assembly usually becomes dry and binds, and cannot be pushed up far enough to cause tripping of the small hub on the turntable. A misaligned or bent cycling gear assembly should be replaced along with

the trip pawl assembly since it is difficult to straighten jammed teeth on the cycling gear assembly.

If the changer keeps tripping and the pickup arm will not set down on the record, check the clutch lever and trip pawl assembly. On some changers the trip pawl lever will become stuck in the tripping position. Do not place oil on the trip lever assembly, as tripping action is done with friction movements. Check for grease between the clutch lever and the trip lever. It is also possible for the function knob to become locked

in the select position, thus causing continuous tripping.

Record Selection

If all the records fall on the turntable at once, it is probably caused by a pulled up retainer slide. (Also check for excessively large center holes in the records.) If the retainer slide is in its correct position, only one record at a time can fall. Sometimes, when a full load of records has been played and they are pulled up to be played again, the operator inadvertently pulls the retainer slide up with them. With the retainer slide in the up position, all of the records will fall. The records should be pulled completely off the record spindle and then reloaded. Also, check for a bent or dry retainer slide lever.

If the pickup arm slides across the record grooves, check for a worn stylus or improper leveling of the changer. Also, it is possible to have a defective record; substitute another record and see if the trouble symptom persists.

Shut Off

Most automatic changers are designed to shut themselves off when the last record has been played. The stabilizer arm (Fig. 10) that holds the records down against the spindle determines the shut off point (usually when the last record is played). The thickness of the last record will hold the trip lever up so the last record will play. If the changer shuts off with one or more records still unplayed, check for a bent stabilizer arm. Often, the owner will pull up on the stabilizer arm at the spindle shaft bending the arm out of position. This will cause the shaft of the stabilizer arm to lag and shut off before the last record is played.

On some changers, if the stabil-

Meet the Pro's Pro!

CONTINENTAL II

MU150

World's Finest Tube Analyzer

Sophisticated Circuitry
Plus Advanced
Mechanical Design
For The Ultimate
In Performance

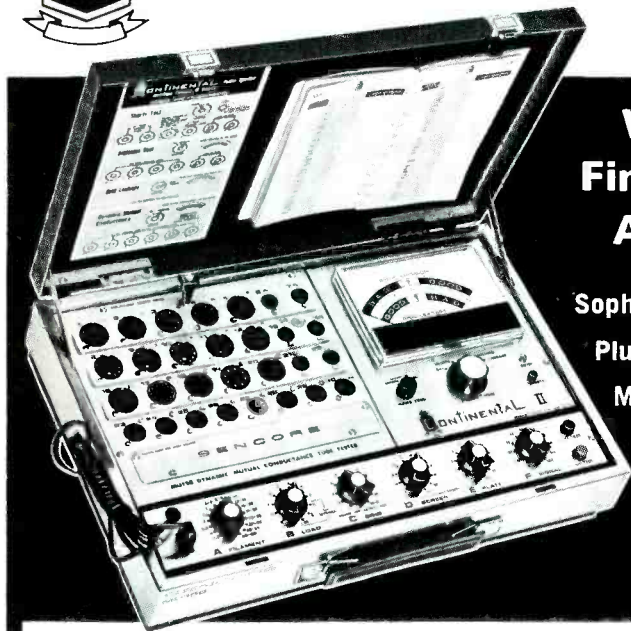

This is the MU150 Continental II—Sencore's new combination emission and mutual conductance tube tester. So precisely accurate you'll never have to guess again whether a tube is good or bad. See why we say it's the professional's professional tester.

NEW

Replaceable tube socket chassis
Simplified setup book
Sectioned and reinforced panel and case
Portable high-style attache case

- Checks over 3000 tubes—foreign and domestic.
- Mutual conductance test with 5000 Hz square wave truly analyzes the tube.
- Emission tests at near full rated cathode current on power tubes. Not available on other mutual conductance testers.
- 100 megohm grid leakage sensitivity check. A must to catch troublesome tubes with grid leakage or gas.
- 180K short sensitivity check. Compares each element in the tube against all others for possible shorts.
- Regulated for complete accuracy and assurance on marginal tubes.

If you want to go first class—go with the MU150 Continental II. **\$219⁵⁰** Only

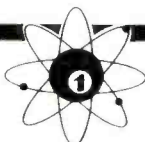

SENCORE

NO. 1 MANUFACTURER OF ELECTRONIC MAINTENANCE EQUIPMENT

426 SOUTH WESTGATE DRIVE, ADDISON, ILLINOIS 60101

Circle 47 on literature card

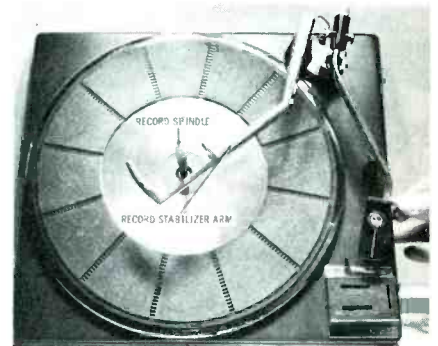
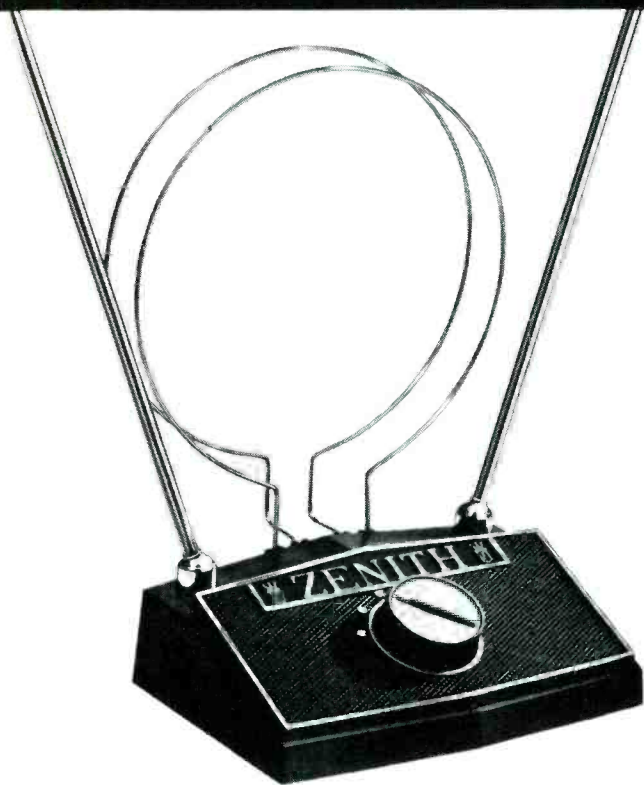

Fig. 10 Stabilizer arm determines the shutoff point.

For better TV reception and better business... sell Zenith Wavemagnet® Indoor TV Antennas!



Make your customers happier . . . with high-performance Wavemagnet antennas. Zenith-designed for sensitive TV reception in color or B/W. Telescopic dipoles, fully adjustable. Six-position selector switch for optimum reception on each channel. Handsome base of high-impact molded styrene. Individually packaged for attractive sales display.

Order Zenith TV Antennas and Accessories from your Zenith Distributor.

Deluxe All-Channel
Part No. 973-56

Two full-size UHF loops develop high front-to-back ratios equal to many outdoor antennas.



Economy All-Channel
Part No. 973-55.



VHF only
Part No. 973-58.

Exciting Surprises
for You—
and Your Family!
Fun for all!
Get the details
at your Zenith
Distributor's
Parts Department.



BEST YEAR YET TO SELL THE BEST

ZENITH®

*The quality goes in before
the name goes on*

**FAR
SUPERIOR
TO
ANY
VTVM
OR
VOM**

**-- and
for
less
money**



NEW FIELD EFFECT MULTIMETER

Here is the revolutionary new approach to circuit testing, the solid state Sencore FIELD EFFECT METER. This FE14 combines the advantages of a VTVM and the portability and versatility of a VOM into a single low-cost instrument. This is all made possible by the use of the new space age field effect transistor that is instant in action but operates like a vacuum tube in loading characteristics. Compare the features of the FIELD EFFECT METER to your VTVM or VOM.

Minimum circuit loading — 15 megohm input impedance on DC is better than a VTVM and up to 750 times better than a 20,000 ohm per volt VOM — 10 megohm input impedance on AC is 20 times better than a standard VTVM. The FIELD EFFECT METER is constant on all ranges, not like a VOM that changes loading with each range.

Seven AC peak-to-peak ranges with frequency response to 10MHz. Seven zero center scales down to 0.5 volt. Five ohmmeter ranges to 1000 megohms. DC current measurements to 1 ampere. Full meter and circuit protection. Mirrored scale. Low current drain on batteries — less than 2 milliamps. Built-in battery check. Unbreakable all-steel vinyl clad case. Optional Hi-Voltage probe adds 3KV, 10KV and 30KV ranges with minimum circuit loading for greatest accuracy in the industry... \$9.95.

**Only Sencore offers the FIELD EFFECT METER.
Ask for it by name at your distributor.**

only \$69.95 (less batteries)



SENCORE

NO. 1 MANUFACTURER OF ELECTRONIC MAINTENANCE EQUIPMENT

426 SOUTH WESTGATE DRIVE, ADDISON, ILLINOIS 60101

Circle 16 on literature card



izer arm is left to the right, out of normal playing position, the last record will play over and over again. Generally, the pickup arm will start over in the center of the record. This condition is normal with only one record on the turntable, since the index lever (pointed out in Fig. 11) must be tripped by a record or held back so the pickup arm will land at the beginning of the record.

Slow Cycling

When the turntable slows down and stalls during the cycling period, check for a bent or binding cycling gear, dry or binding turntable bearings, or determine if the cycling slide assembly is binding or is not properly lubricated along the slide points. Clean off all old grease and replace with new grease along all slide areas (Fig. 12). It is best to completely remove the cycling slide assembly from its position to do a thorough job.

Check for slippage between motor shaft, idler wheel and turntable. Slow motor speed will also cause slow or stalled cycling operation. Check for correct positioning of the height adjustment (Fig. 12). See if the sliding end of the pickup arm lift rod is smooth and properly greased, or it may be necessary to adjust the cycling slide tension spring.

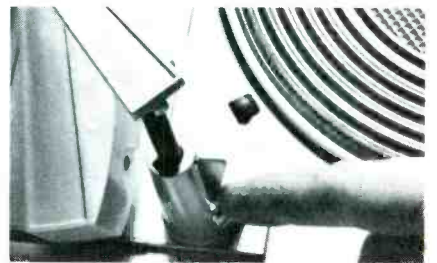

Fig. 11 Index lever must be tripped by record to correctly position pickup arm.

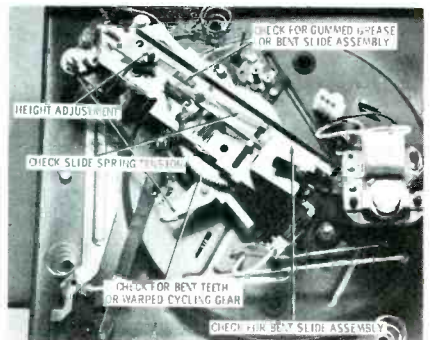

Fig. 12 Slide areas must be carefully greased to insure smooth cycling.

Adjustments

There are two important adjustments to be made on the record changer: the landing and height.

The landing adjustment determines where the pickup will drop at the beginning portion of the record. Set the landing adjustment so the arm drops approximately 1/16" from the edge of the record. This adjustment should be checked for all three record sizes. The location of the landing adjustment is usually located at the rear or bottom of the pickup arm (Fig. 13A), or underneath the turntable frame work directly under the pickup arm (Fig. 13B), depending on the specific model.

If the pickup arm lands too near the center of the record and will not adjust properly, check the landing lever for possible binding. For erratic landing, check for smooth operation of the cycling slide; also check for a clean and dry metal landing lever surface. Other defects that can cause erratic landing include improper height adjustments, a dull needle that skips several grooves or tight phono crystal wires that keep the pickup arm from landing properly.

Correct positioning of the height adjustment is to let the pickup arm go through a complete stack of records and not touch the records during the cycling period. The height

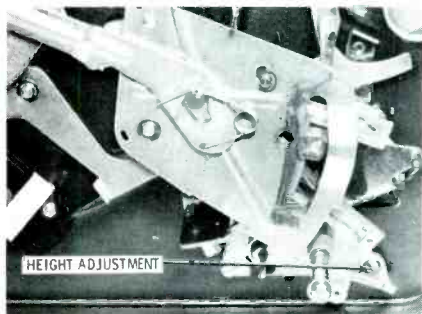
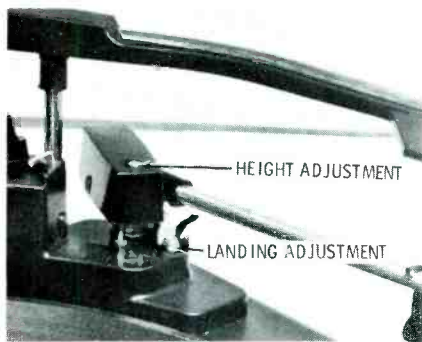

Fig. 13 Two common locations of the landing adjustment. Above, A, rear of pickup arm; below, B, under pickup arm.

adjustment screw is usually located under the back of the pickup arm. However, some changers have two height adjustments, one above the lift rod under the pickup arm and the other underneath the cycling slide assembly.

Lubrication

If the changer has been in operation for two or three years, the turntable and motor assembly should be lubricated. First, clean off old grease and dirty oil with alcohol or a suitable cleaning fluid. It is best to remove the parts from the changer to do a thorough job of cleaning. Do not let the cleaning fluid come in contact with any plastic parts as it might cause a reaction.

Use lubrication sparingly; it is important that no oil or grease get into any friction drive surfaces. Wipe off any oil that is on the drive wheel, idler wheel, motor pulley and turntable drive surface. Also, do not oil the tripping assembly. (Fig. 14 illustrates the various points that should or should not be lubricated.)

Check the manufacturers' literature for the correct grease or oil to be used. For instance, RCA uses Rycon No. 0 oil on shift plate, all glide areas, cycling gear cam surfaces and turntable bearing assembly; Sylvania uses a thin bearing oil, Shell AB11, for motor centered bearings. As a general rule of thumb, use a non-gumming oil on all sliding and bearing contacts and an adhesive oil for turntable and drive wheel bearings.

After all adjustments are made and the changer has been properly lubricated, test operate the changer for an extended period before reinstalling it in the cabinet. Also, perform a turntable speed check with a strobe disc before returning the unit to the customer. ▲

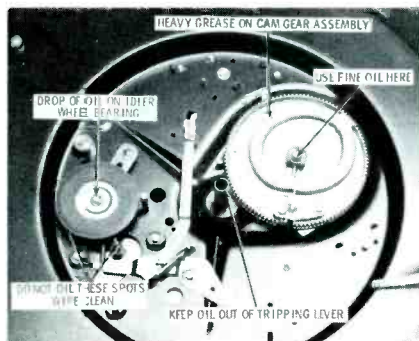
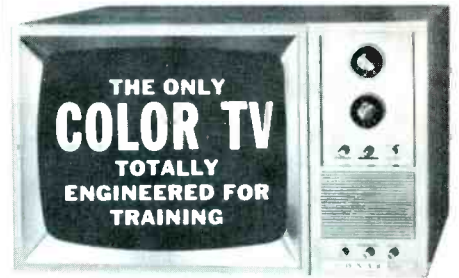

Fig. 14 Lubrication points on record changer assembly.

ALL NEW!

NRI learn-by-doing training in

ADVANCED COLOR TV



- Build your own custom color set in 5 training stages
- 50 designed-for-learning color circuit experiments
- Programmed with 18 "bite-size" lesson texts

A comprehensive training plan for the man who already has a knowledge of monochrome circuits and wants to quickly add Color TV servicing to his skills. DEFINITELY NOT FOR BEGINNERS. It picks up where most other courses leave off — giving you "hands on" experience as you build the only custom Color TV set engineered for training. You gain a professional understanding of all color circuits through logical demonstrations never before presented. The end product is your own quality receiver.

TRAIN WITH THE LEADER

This NRI course — like all NRI training — is an outgrowth of more than 50 years experience training men for Electronics. NRI has simplified, organized and dramatized home-study training to make it easy, practical, entertaining. You train with your hands as well as your head, acquiring the equivalent of months of on-the-job experience. Demand for Color TV Service Technicians is great and growing. Cash in on the color boom. Train with NRI — oldest and largest school of its kind. Mail coupon. No obligation. No salesman will call. NATIONAL RADIO INSTITUTE, Color Div., Wash., D.C. 20016.

MAIL FOR FREE CATALOG



NATIONAL RADIO INSTITUTE
Color TV Division
Washington, D.C. 20016 45-108

Send me complete information on NRI new Advanced Color TV Training. (No salesman will call)

Name _____ Age _____

Address _____

City _____ State _____ Zip _____

ACCREDITED MEMBER NATIONAL HOME STUDY COUNCIL



Circle 17 on literature card

October, 1968/PF REPORTER 23

Troubleshooting a Multi-Trouble TV

Step-by-step analysis takes the confusion out of multiple troubles.

by Stan Prentiss

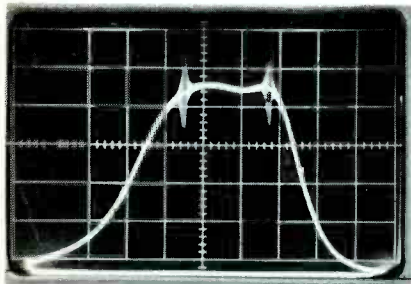

Fig. 1 Resultant waveform from an uncalibrated marker generator.

The multi-trouble-plagued receiver was an eight year old Emerson 1205 series chassis that had recently been traded in on a new color set. Sound and picture wouldn't hold very well on any station, particularly on channel 4, and after ten minutes of operation a slow vertical roll would develop. Also, the raster would occasionally slip out of sync, and the audio was noisy.

Preliminary Tests

First, all tubes were given a quick emission test, which uncovered a weak 6DT6 audio detector. All other tubes were normal. The weak audio detector was replaced, but the audio remained noisy and a buzz could be distinguished above the noise. B+ and high voltage were normal.

Step-by-Step Procedure

When the preliminary tests uncovered no clue to any of the trouble symptoms, it became necessary

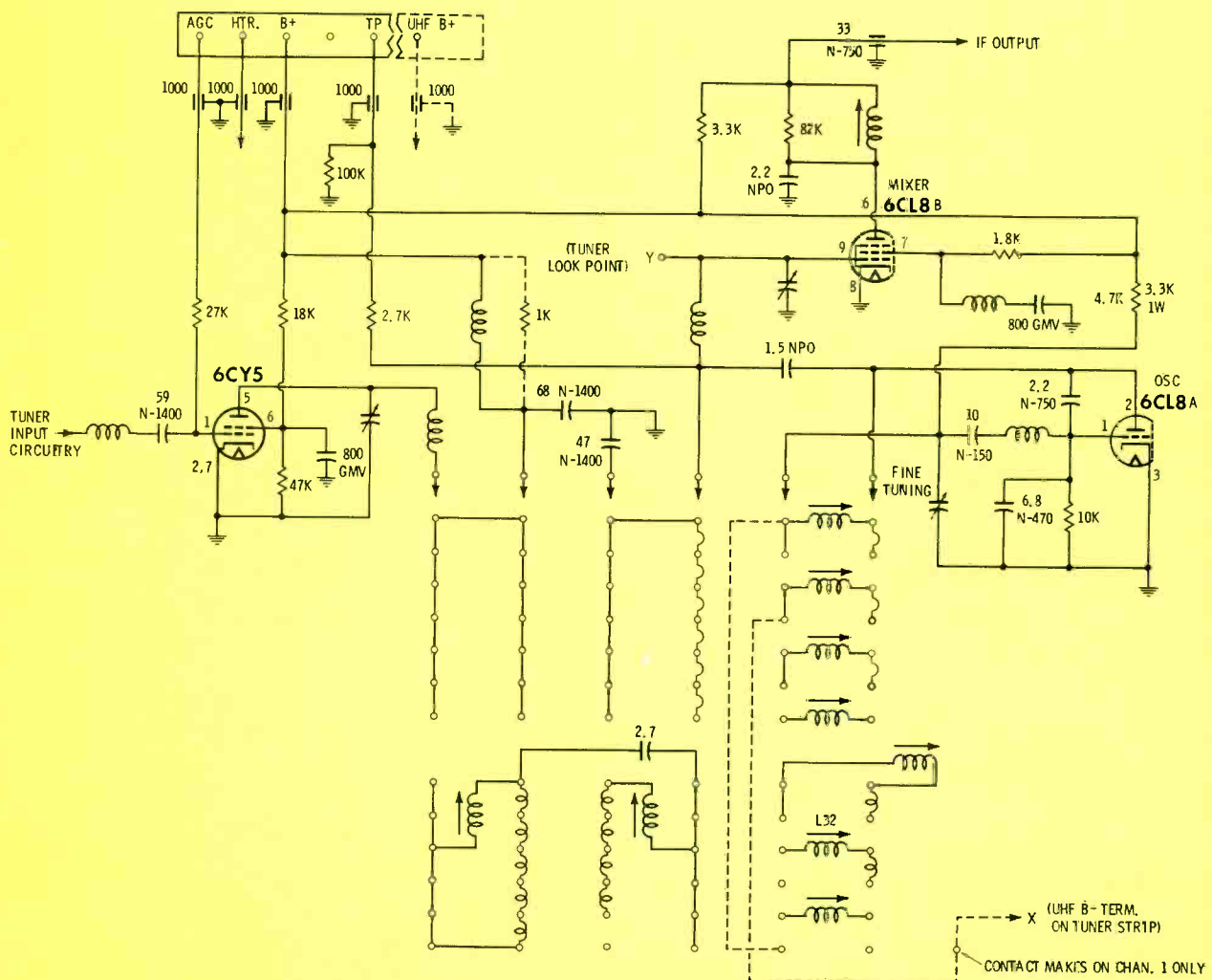

Fig. 2 Schematic diagram of oscillator circuit.

to decide which symptom should be tackled first.

Checking the Tuner

Since both sync and audio were affected, it was logical to suspect a defect in a circuit or circuits common to both—either in the RF stage, video IF's, video detector or video amplifier. The video IF's, video detector and video output were temporarily ruled out because the picture quality and sound was relatively good on some channels. This left the tuner as the most logical suspect.

The tuner oscillator-mixer and RF tubes were then rechecked for both mutual conductance and gas. The RF amplifier passed both tests, but the oscillator-mixer (6CL8) displayed an astounding 10 microamps of current during the gas test.

After the gassy oscillator-mixer tube was replaced, the picture was much better on all channels except channel 4; although there was still some tuner drift evident. The audio noise had also diminished, but the buzz could be eliminated or reduced only by periodically adjusting the audio takeoff transformer, audio IF and the detector coil.

Since further testing of the tuner was required, the tuner was removed from its mounting plate on the inside front of the cabinet and exposed for servicing.

A tuner response curve was

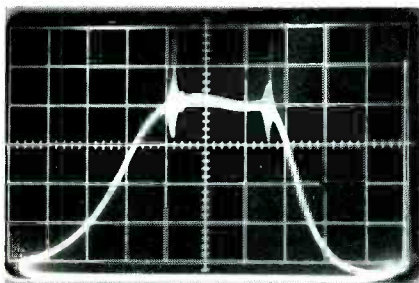

Fig. 3 Waveform shows a slight decrease in amplitude.

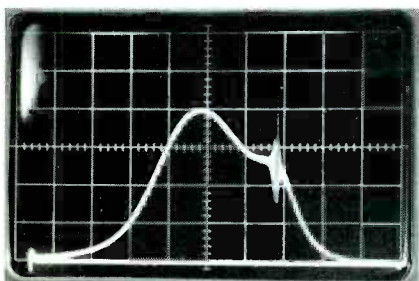
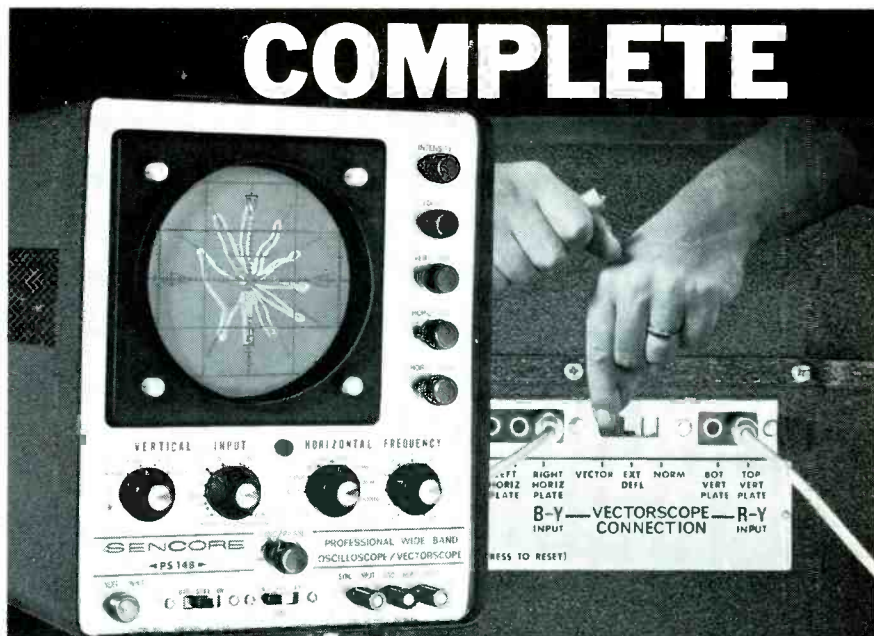

Fig. 4 Resultant waveform after 4-volt increase of the AGC bias voltage.



NEW OSCILLOSCOPE/VECTORSCOPE

With just the flip of a switch



A truly remarkable service scope; complete for every servicing test recommended by any and all TV manufacturers. For the very first time, here is a scope sensitive enough to view the IF tuner output but with adequate high voltage protection to view the plate of the horizontal output tube directly. Leave the rear view switches in their normal position and you can use the PS 148 to service color TV from chroma take off to the tri-color tube following the standard RCA "S" pattern approach. Flip the VECTOR switch on the rear and you have converted to a standard vectorscope . . . and for only \$20.00 more than the Sencore scope without vectors. Compare these specifications and you will be convinced that the PS 148 is the most complete, versatile, scope on the market today.

- **Direct Peak to Peak Voltage Measurements.** Read the peak to peak waveform voltage directly from the vertical input controls. Faster and easier than a VTVM and extremely accurate.
- **Wide Band.** Vertical amplifier frequency response is flat from 10HZ to 5.2MHZ \pm 1DB.
- **High Sensitivity.** Vertical amplifier sensitivity of .017 volts RMS per one inch deflection. Ultra sensitive for transistor servicing and for viewing signals directly off a TV tuner.
- **Direct and Lo-Cap Probe** on one cable for maximum versatility. The Lo-Cap probe can handle high voltage signals up to 6000 volts peak to peak.
- **Extended Horizontal Sweep Frequencies.** Horizontal sweep ranges from 5HZ all the way to 500 KHZ in five overlapping steps; allows you to look at higher frequency waveforms. Sync is so positive you would think it has triggered sweep.
- **Exclusive Vectorscope Features.** Flick one switch at the rear of the PS 148 and you have an easy to use vectorscope. This new vector pattern greatly simplifies chroma trouble shooting and bandpass alignment.
- **Minimum Circuit Loading on Vectors.** Prevents distorted vector patterns due to lead capacity loading by having vectorscope connections on rear of PS 148.
- **Special Vectorgraph Screen.** Shows exact degree of chroma demodulation.
- **Provisions for intensity modulation and direct connections to CRT deflection plates on rear for forming lissajous patterns, etc.** Just a flick of two switches; no need to disconnect leads or make special connections.

PS 148
\$219⁵⁰

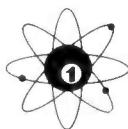
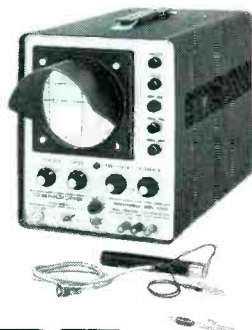

SENCORE

NO. 1 MANUFACTURER OF ELECTRONIC MAINTENANCE EQUIPMENT

426 SOUTH WESTGATE DRIVE, ADDISON, ILLINOIS 60101

Circle 18 on literature card

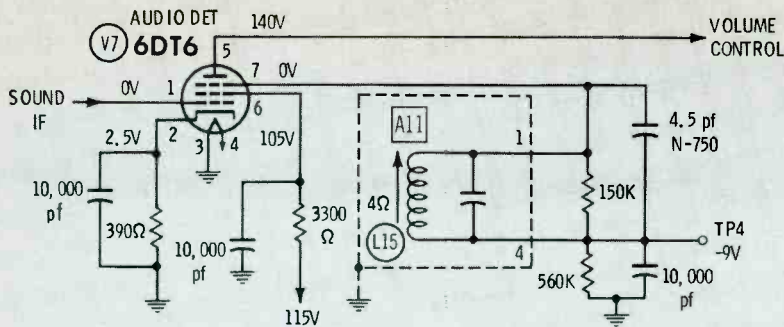

Fig. 5 Schematic drawing of the audio detector.

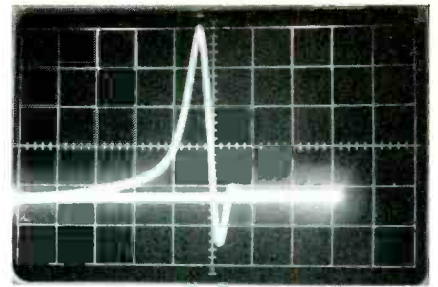

Fig. 6 Waveform produced by beating the marker of the sweep generator output, set at 4.5 MHz, against a 4.5-MHz crystal.

DISGRACEFUL

“Isn't it? The way Mercury shamelessly offers top quality test equipment at such low prices. Compare the features with costlier models and see how Mercury gives you top value for your dollar. It's Wonderful.”



Model 2000—MUTUAL CONDUCTANCE TUBE TRANSISTOR TESTER

Tests all tube types, old and new, plus transistors. Tests Magnovols, Nuvistors, 10-pin Decals, Compactrons, Novars, 10-pin types, foreign and hi-fi tubes, thyratrons and industrial types. Tests for true dynamic mutual conductance (GM). Spots shorts, leakage and gas. Tests Color and B/W picture tubes with use of MH-3A Multi-Head Adapter (optional). Lever switch test principle overcomes obsolescence. Automatic line voltage regulation.

\$10995



Model 1101—DELUXE TUBE TESTER

For new Magnovols, Decals, Nuvistors, All Popular Picture Tubes and most other receiving tube types. Checks tubes for dynamic cathode emission, shorts, grid leakage and gas. Picture Tube Adapter. Exclusive 2-point test principle safeguards against obsolescence.

Kit—\$3995/Wired—\$6995



Model 1100B—TUBE TESTER

Tests more tube types than any other tester in its price range. Tests for dynamic cathode emission, shorts, grid leakage and gas. Exclusive meter bridge circuit found only in more expensive testers. Professional quality at an economical price.

Kit—\$2495/Wired—\$3995

ALL MERCURY TEST EQUIPMENT GUARANTEED FOR ONE FULL YEAR! UPDATED TUBE TEST DATA AVAILABLE ON ALL UNITS.



MERCURY ELECTRONICS CORPORATION

315 ROSLYN ROAD, MINEOLA, N. Y. 11501 • (516) 742-5400

CANADA: WILLIAM COHEN CORP., 8900 PARK AVE., MONTREAL 11
EXPORT: SINGER PRODUCTS CO., INC., 95 BROAD ST., N. Y. C. 10004, U. S. A.

Circle 19 on literature card

needed to determine if the unit needed alignment and to see if there was any change in the original response after repairs. The sweep and marker generators and oscilloscope were allowed to warm up for 20 minutes before the test was made. The tuner was set on channel 4, and a bias of approximately —3 volts was applied to the tuner AGC line. The sweep generator output was connected to the antenna terminals and the vertical input of the scope to the IF output of the tuner. The resultant waveform is shown in Fig. 1 and was obtained with an uncalibrated marker generator. The left marker was at 71 MHz and the right marker at 66 MHz. Had the generator been calibrated, the sound carrier would have been positioned at precisely 71.75 MHz and the picture carrier at 67.25 MHz. The flat-top response and position of the markers indicated that the alignment of the tuner was basically okay. Thus, testing might cure both the picture and sound drift.

Before further testing was attempted, the tuner was cleaned. A spray cleaner took off any film and corrosion and left sufficient lubrication to prevent excessive contact wear. A toothbrush made the job much easier.

After cleaning, a visual inspection was made to see what might be worn or damaged. All contacts were clean and not excessively worn. The 4.7K-ohm and 10K-ohm resistors in the oscillator circuit (Fig. 2) were within tolerance. The 1.8K-ohm resistor in the screen circuit of the mixer, however, was slightly burned, indicating that it had suffered from a surge of excessive current, so it was replaced.

Next, the small capacitors in the grid-plate circuit of the oscillator were checked. These tiny units, with

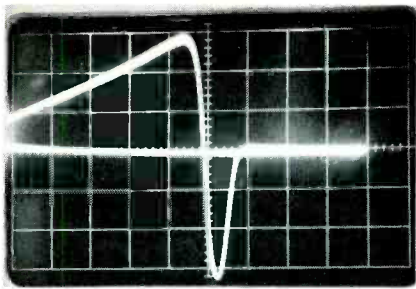

Fig. 7 Rounded "S" curve after a touchup of the transformers and detector coils.

values of 2.2, 6.8 and 10 pf, tune the plate-grid circuit of the oscillator so it will track at a selected frequency. This produces a signal that the mixer can beat with the individual TV channel frequencies to give an IF mid-frequency of 45 MHz. (In the alignment instructions for this particular tuner, is a warning against setting the low channels before adjusting the higher ones since the higher frequencies have an immediate effect on those in the lower bands.) These capacitors have negative temperature coefficients of N-750 or N-150 parts per million, respectively, to correspond to the values and tolerances demanded by the circuit. DC leakage in these ceramic capacitors will increase with age. The dielectric constant will change by chemical action over long periods, and any internal contamination will help degrade the dielectric.

A solder sucker and a hot-tipped iron was used to remove the defective capacitors from the printed-circuit board. These little ceramics were not easy to remove, but the new ones literally slid into place. When they were all soldered into the plate circuit, the tuner barrel and cover were replaced.

Now, there was no popping in the sound when the set was turned on. All channels, except 4, had a good picture when power was applied and, with a little tuning of the local oscillator slug, gave a bright, stable contrasty picture on every station including channel 4. The problem had been caused by the defective capacitors and by the 1.8K-ohm screen resistor of the mixer which was a current divider and, therefore, also a voltage divider.

But what about the response curve of the tuner? With neither the sweep nor scope controls read-

justed, the response curve appeared as in Fig. 3. There was a slight decrease in amplitude. The top of the signal appeared broader but was handling signals with more than 5 MHz difference. Just for curiosity the AGC bias voltage was increased to more than 4 volts. The resultant waveform is shown in Fig. 4. The right side of the response curve was immediately distorted, decreasing the amplitude and making the general configuration of the curve completely unacceptable—an example of the effects of excessive bias. When performing any IF or

tuner alignment, the technician must maintain the bias voltages exactly as given in the manufacturer's instructions. When a 3- or 4-volt bias is specified, this voltage should appear at the tuner terminals and not simply be the value of the raw supply furnished by the bias box. Negative DC voltages add, just as two in-phase positive AC waveforms combine to provide a single signal that is larger in amplitude than either.

Checking the Audio

There was still a slightly rolling

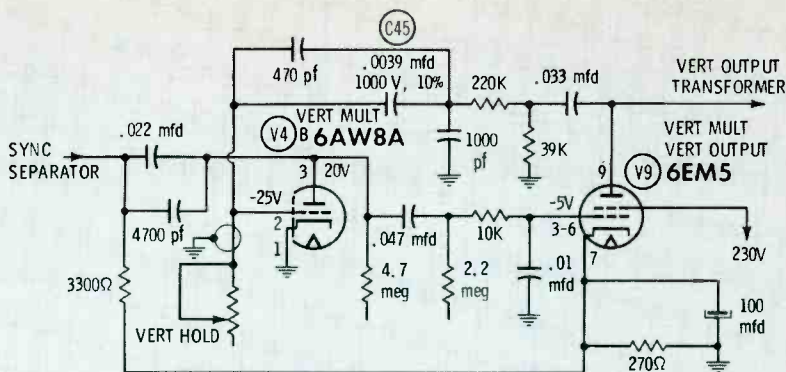
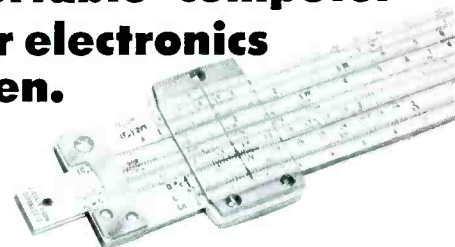

Fig. 8 Schematic diagram of the vertical circuit.



Portable "computer" for electronics men.



WANT FAST ANSWERS to math and electronics problems? Now, compute them in a flash with this new Electronics Slide Rule.

Calculate resonant frequencies, solve inductive or capacitive reactance problems, find reciprocals for resistance formulas, locate decimal points—all in just seconds, without pencil and paper.

Whiz through regular math problems, too: multiplication, division, square roots, logarithms, even trigonometric functions.

Sturdy 12-inch, all-metal slide rule comes complete with handsome leather carrying case—plus 4-lesson instruction course. Deliberately priced low as our way of making friends with electronics men. FREE booklet gives full details. Mail coupon below today.

Mail Coupon for FREE Booklet

CIE Cleveland Institute of Electronics
1776 East 17th Street, Cleveland, Ohio 44114

Please send me, without charge or obligation, your booklet describing the Electronics Slide Rule and 4-lesson instruction course. Also free if I act at once—a handy, pocket-sized Electronics Data Guide.

Name _____ (Please Print)

Address _____

City _____ State _____ ZIP _____

Accredited Member National Home Study Council
A Leader in Electronics Training... Since 1934

PF-124

Circle 20 on literature card

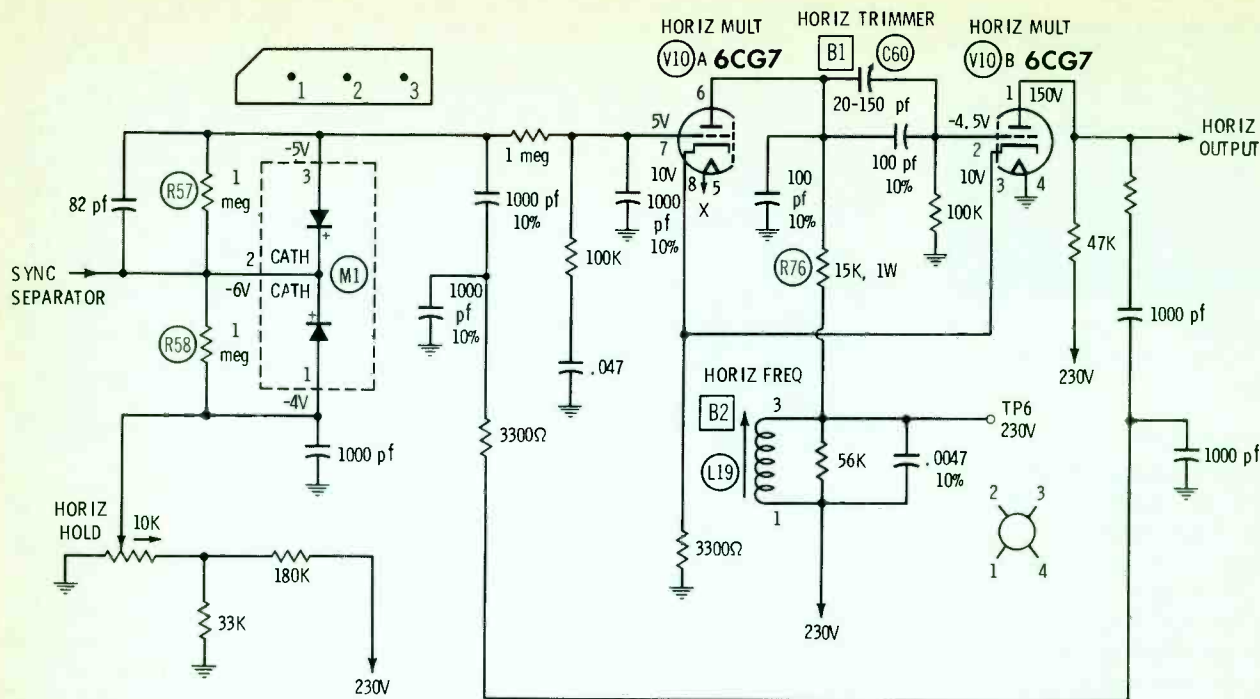

Fig. 9 Schematic diagram of the horizontal circuit.

picture and intermittent horizontal sync, but how about the audio? When the volume level was increased, the sound remained relatively good on all channels, but it did deserve a check.

V7, the audio detector (Fig. 5) is often described as a locked-grid detector classified, with all other FM detectors, as a discriminator.

Passage of the signal is limited by the control grid (as in the gated beam detector). The action is approximately the same, since L15 and the parallel resistors and capacitors at the screen form a quadrature circuit that is resonant at 4.5 MHz. When the incoming signal is exactly at carrier frequency (4.5 MHz), it, and the quadrature coil, are precisely 90 degrees out of phase. Signal excursions above 4.5 MHz result in a phase lag greater than 90 degrees. These leads and lags are proportional to the FM frequency deviations and induce varying surges of plate current that are applied to integrating components C33 and R37, and constitute the actual audio signal.

The basic difference between this circuit and the gated beam detector is the type of tube. The gated beam detector employs a sheet beam tube that uses electron optics to guide carriers through signal pro-

cessing, whereas the 6DT6 is a sharp cutoff pentode with low internal capacitance.

Under rushed circumstances, such as a quick field job, it would not be necessary to check the coupling transformer and the quadrature coil. But, here, the sweep and marker generators were already on and the injection of a signal at the plate of the video amplifier and the checking of the result at the top of the volume control would be little effort.

Tuning the sweep generator output to 4.5 MHz and momentarily beating the marker against a 4.5-MHz crystal in the sweep generator for calibration produced the waveform shown in Fig. 6. This waveform is similar to the "S" curve for the Foster-Seely discriminator and ratio detector. A touch-up of the transformers and detector coil rounded the "S" curve into the shape shown in Fig. 7. It is necessary to place the 4.5-MHz marker exactly on the center portion of the waveform for uniform audio tracking. A high amplitude marker is required, as is a sweep generator fitted with a post-injection marker system. This superimposes the marker on the waveform after it has passed through all tuned circuits. Any antenna connection

should be detached and the receiver channel selector turned to a position between channels to avoid RF interference and spurious signals in the marker and sweep waveforms. A final on-the-air check confirmed proper alignments.

This concluded the tough part of the repair job. The remainder was relatively routine. A quick check with a DC scope showed that all DC voltages in the vertical circuit (Fig. 8) were within tolerance and that all waveforms had sufficient amplitude.

Since $T=1/f$, and the horizontal rate is 60 Hz, the total time constant of the vertical circuit is 16.7 milliseconds. To simulate approximately half this rate, the value selected for capacitor C45 was 0.0039 microfarads and the vertical hold value was 1.5 megohms. The linearity control added 500K-ohms and brought the series total resistance to 2 megohms. The time constant here, then, was $2 \times 10^6 \times 0.0039 \times 10^{-6}$, or 7.8 milliseconds. If the ratio of this circuit is changed in either direction, the picture will roll.

C45 had become leaky as the ambient temperature increased upsetting the time constant. C45 is subject to constant charge and discharge and will deteriorate faster than most other capacitors in the

vertical circuit. Identifying C45 as being defective wasn't difficult since it was clearly evident. Applying heat to the capacitor for a minute caused the picture to roll. After C45 was replaced, vertical sync locked in and the vertical linearity peaked as it should. Thus, another trouble was diagnosed and repaired.

Checking Sync Stability

A check of the sync stability was made by shorting test point 3 (Fig. 9) to the chassis, jumpering L19, setting the horizontal hold control to center range and adjusting horizontal trimmer C60 for momentary lock-in. This rendered a stable picture only at the center of the horizontal locking range. Further adjustment of the stabilizer control brought no improvement. Using the oscilloscope, the top trace (Fig. 10) now corresponded to the waveform exhibited at point 29. The DC level was approximately 10 volts and the AC amplitude was 9 volts peak to peak. The lower trace was at the anode connection (pin 3) of M1 and rode at a DC level of 9 volts. (All AC-DC voltages are measured with signal coming in rather than no signal as shown on the schematic.)

At first, the configuration of the waveforms matched those of the

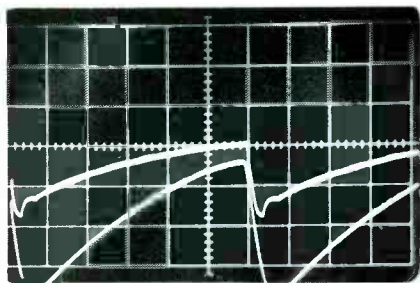

Fig. 10 Waveform with DC level at approximately 10 volts and AC amplitude at 9 volts p-p.

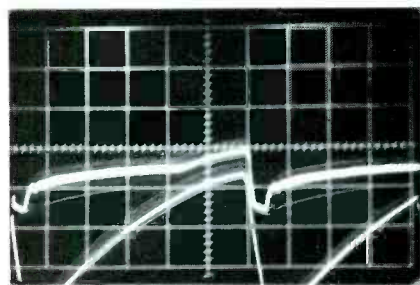

Fig. 11 Corrected waveform shows decrease in amplitude, slight non-linear notch and slightly longer cutoff time.

schematic fairly well, but the amplitude of the lower trace wasn't much over 15 volts; it should have been approximately 25 volts. (Any such deviation bears prompt investigation since these cathode-to-cathode diodes are constantly comparing the phase of the differentiated pulse waveform from the flyback transformer to the incoming horizontal sync pulses.) This caused the M1 diodes to generate a DC correction voltage across R57 and R58. This voltage controls the first section of the cathode-coupled multivibrator and speeds up or slows down the relaxation oscillator.

The waveforms at the grids of the horizontal multivibrator and horizontal output indicated that the AC signals at these two points were adequate. As a final test the anode of M1 (terminal 3) was shorted to ground to see if the horizontal sync could be adjusted almost stationary without the effect of the AFC diodes. It could. The AFC diodes needed to be changed because, like the ceramic capacitors, the selenium in these diodes develop leakage with age and deteriorate.

A pair of diodes in a 3-lead casing was needed for replacement. The old plastic diode package from the receiver was clipped out, leaving enough leads on which to solder the new part. In a few moments the new AFC package was in, the set turned on, and the adjustment procedure repeated.

This time the horizontal hold locked 90 percent of the way across its total range, and the channel selector could be flipped without disturbing the horizontal sync. Fig. 11 shows the corrected waveform. Note that the upper trace had decreased in amplitude, had a slight non-linear notch, and had developed a slightly longer cutoff time, while the lower trace had simply increased considerably in amplitude. It now measured well over 20 volts, as specified. The upper trace amplitude could be increased or decreased by adjusting the horizontal hold control, which provided proper holds in the center of its range.

Time and Labor Costs

The following is a breakdown of the cost: about 15 cents worth of tuner cleaner, \$1.90 for the 6CL8, \$1.10 for the 6DT6, 12 cents for the 1.8K-ohm resistor, 48 cents for

the diodes and 45 cents for the three tuner capacitors. The total parts cost was \$4.20, with 2 hours of labor. Labor and parts cost considered, this was a small price for a reconditioned receiver.

With some of the well-marked receiver chassis, the entire job can be done by simply taking off the back or bottom cover. In this case, it was not necessary to remove the chassis or the CRT from the cabinet—a definite advantage of printed circuits. ▲

FIRST WITH

- Digital Integrated Circuits
- 4 Crystal-Controlled Oscillators
- Battery & AC Operation Standard



The New Pace-Setting
CONAR Model 680

COLOR GENERATOR

KIT \$83.50 WIRED \$114.50

Until now, no commercially available color generator has offered so many quality features in a single instrument at such a low price. Only the CONAR COLOR GENERATOR has all these features at any price: exclusive digital integrated circuits; exclusive 4 crystal-controlled oscillators; exclusive AC or battery operation standard; completely solid state; color amplitude control; color phase adjustment; regulated power supply; stability control; TV station sync and blanking pulses; nine patterns; red, blue and green gun killers; compact; lightweight; portable.

For details write Dept. K08C

CONAR instruments

DIVISION OF NATIONAL
RADIO INSTITUTE
3939 Wisconsin Ave.,
Washington, D.C. 20016

WRITE FOR
FREE CONAR CATALOG



Circle 21 on literature card

**Sylvania goes into the
ghost-fighting business.**

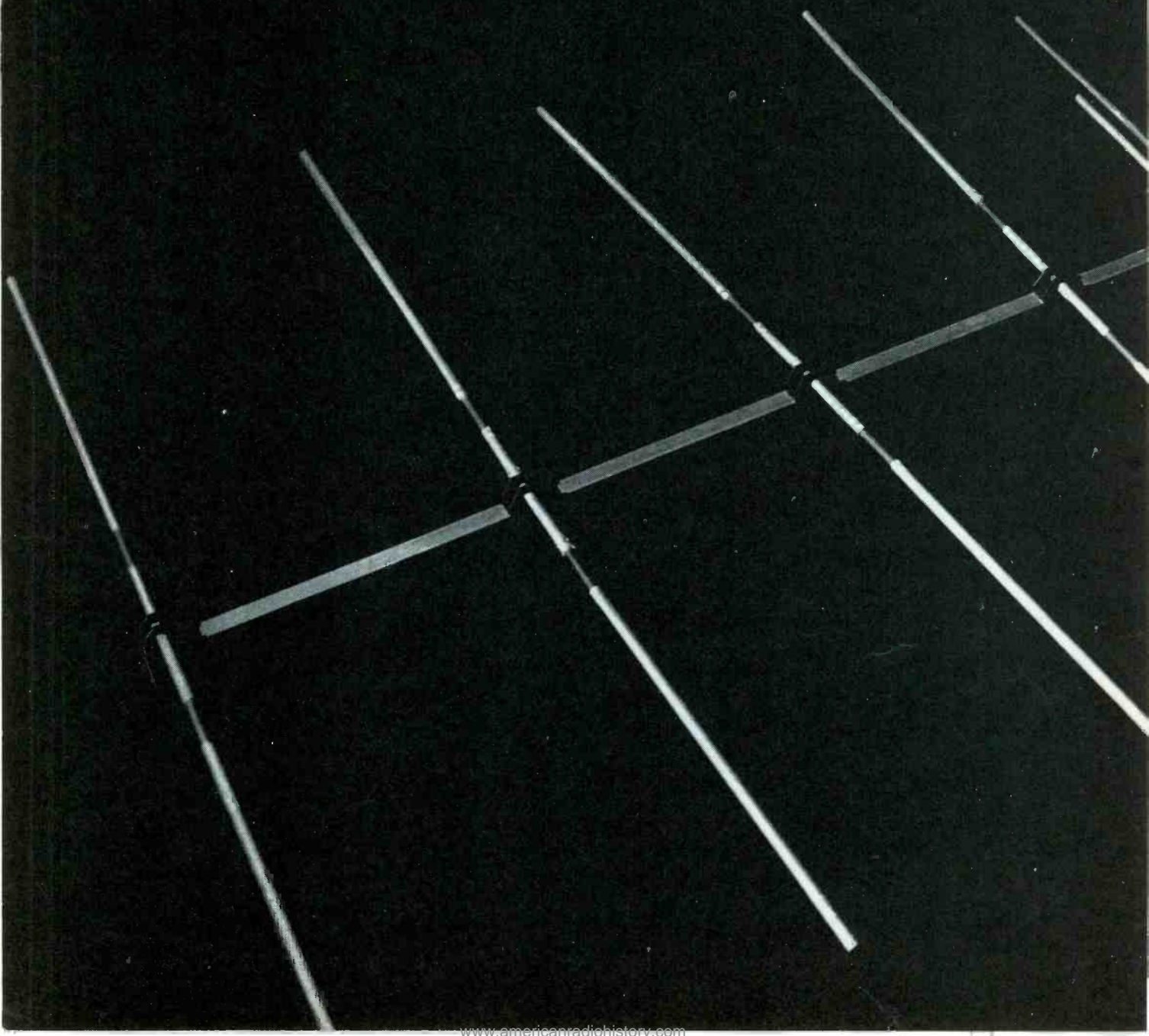

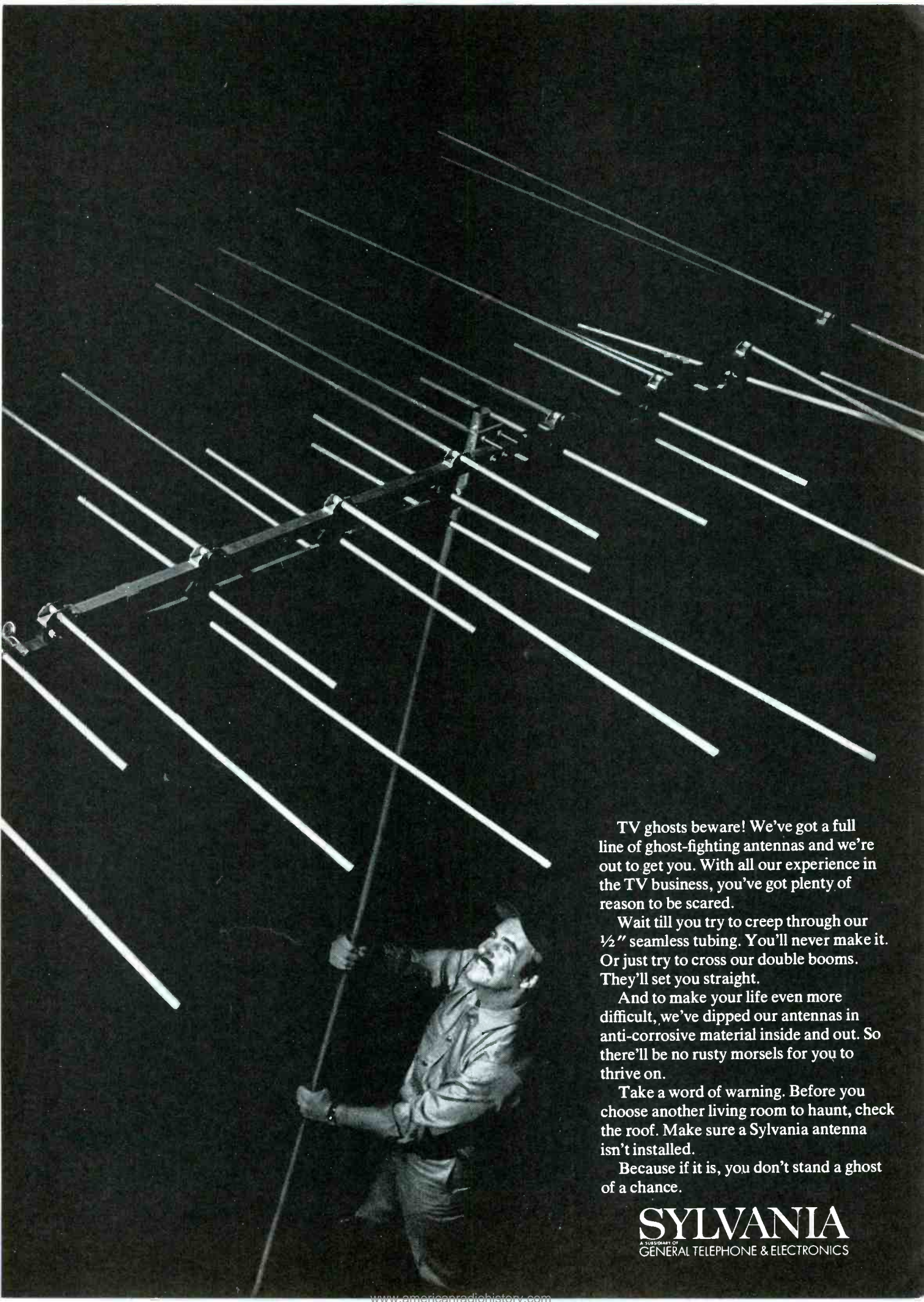

TV ghosts beware! We've got a full line of ghost-fighting antennas and we're out to get you. With all our experience in the TV business, you've got plenty of reason to be scared.

Wait till you try to creep through our 1/2" seamless tubing. You'll never make it. Or just try to cross our double booms. They'll set you straight.

And to make your life even more difficult, we've dipped our antennas in anti-corrosive material inside and out. So there'll be no rusty morsels for you to thrive on.

Take a word of warning. Before you choose another living room to haunt, check the roof. Make sure a Sylvania antenna isn't installed.

Because if it is, you don't stand a ghost of a chance.

SYLVANIA
A DIVISION OF
GENERAL TELEPHONE & ELECTRONICS

FAST

COMPLETE OVERHAUL ON ALL MAKES OF TV TUNERS

Maximum Time In Shop 24 Hrs.

Price Change Effective August 1, 1968

(WE SHIP C.O.D.)

\$9.95



Black &
White
or Color

VHF or
UHF

UV Combo's \$16.50

Price includes all labor and parts except Tubes, Diodes & Transistors. If combo tuner needs only one unit repaired, disassemble and ship only defective unit. Otherwise there will be a charge for a combo tuner. Ship tuners to us complete with Tubes, Tube Shields, Tuner Cover and all parts (including) any broken parts. State chassis, model number and complaint.

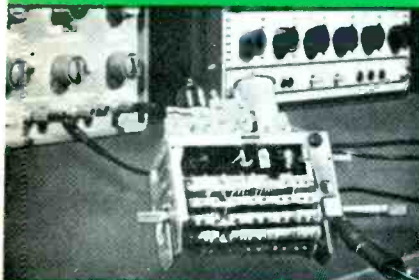

All tuners are serviced by **FACTORY TRAINED TECHNICIANS** with years of experience in this specialized field. All tuners are **ALIGNED TO MANUFACTURERS SPECIFICATION** on crystal controlled equipment and air checked on monitor before shipping to assure that tuner is operating properly.

GEM CITY TUNER REPAIR SERVICE

Box 6C Dabel Station
2631 Mardon Drive
Dayton, Ohio 45420

Circle 23 on literature card

32 PF REPORTER/October, 1968

← Circle 22 on literature card

TYPICAL CLOCK-RADIO TROUBLES

by Jim Houseknecht

Case histories of AM/FM clock-radio troubles and their solutions.

The following clock-radio troubles and related service hints apply to nearly all brands and models as the various designs are similar.

Intermittent Operation

The customer had said, "Sometimes it works if I turn it on and off several times." The on and off procedure was tried and, sure enough, the radio came on. Could the power switch be defective? The chassis was removed from the cabinet and the switch turned several times. When the radio failed to operate, a slip lead was connected from one switch terminal to the other. The radio came on and stayed on. The defective power switch was confirmed. This slide-type power switch is mounted on the clock assembly as shown in Fig. 1. A thorough cleaning of the switch cured the defect.



Fig. 1 Slide-type power switch mounted on clock assembly.

Switch Cleaning Procedure

Slide switch contacts tarnish and can cause the switch to become intermittent or completely inoperative. To clean the switch, first observe the way the parts fit together and mate with the clock assembly as in Fig. 1.

Carefully straighten the metal fingers at each side and lift the back off the switch being careful that the spring does not fly out (Fig. 2).

Spray contact cleaner on a cloth and rub all contact surfaces. Then, clean all contact surfaces with an eraser until bright and shiny. In cases of severe tarnish, use crocus cloth instead of the eraser.

Brush out all bits of foreign material. Again rub with contact cleaner and apply a thin coat of contact grease to all contact surfaces.

Before reassembling the switch, apply a small amount of contact grease to both ends of the spring to temporarily hold the small parts in place.

Fit the parts back together, making sure that the switch properly fits into the clock assembly. Then, carefully bend the metal fingers back into position.

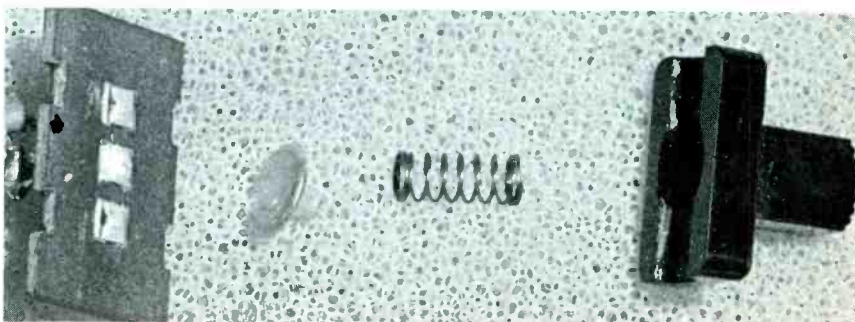
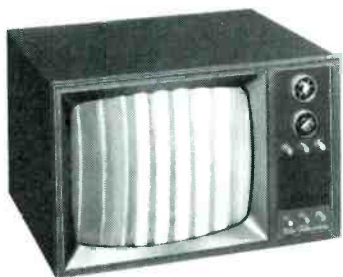

Fig. 2 Do not allow spring to fly out when straightening metal fingers.

You're making money in electronics now.

RCA offers 4 ways to make more.

Study at home... set your own pace.
RCA Institutes has an easy approach
to bring you bigger earnings.



COLOR TV During this course you'll perform over 50 experiments—and receive all parts and instructions to build your own color TV.

The cost of the Color TV Kit is included in the tuition—in both the beginner's program and the advanced course in color TV servicing.

Course is based on the latest receiver circuitry and equipment.

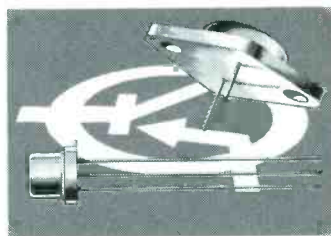

TRANSISTORS Transistor circuitry is what the TV repairman must cope with in most receivers today. This course gives you the necessary background.

You'll discover an easy way to an effective understanding of semiconductor technology, including characteristics of tunnel diodes, rectifiers and other solid state devices. Transistorized TV Receiver Kits also available.

FCC LICENSE TRAINING Get your license—or your money back! We're *that* sure you'll succeed with RCA Institutes Home Study Training. Course is all new—both in content and in the up-to-date method of study.

Choose the course for the FCC License you want: third, second or first phone. If you need basic training first, apply for the complete License Training Program.

CATV TRAINING Technicians are in short supply in CATV (Community Antenna Television Systems).

That's because CATV is expanding, as people seek better reception and more than local stations.

You'll receive two comprehensive lessons, covering the practical phases of CATV systems in either the Television Servicing or Communications courses.

WHEN YOU STUDY THROUGH RCA INSTITUTES HOME TRAINING, YOU CAN PAY FOR LESSONS AS YOU ORDER THEM, OR TAKE ADVANTAGE OF EASY MONTHLY PAYMENT PLAN. LICENSED BY NEW YORK STATE EDUCATION DEPARTMENT. APPROVED FOR VETERANS. ACCREDITED MEMBER NATIONAL HOME STUDY COUNCIL.

MAIL THE COUPON NOW FOR COMPLETE INFORMATION

RCA

RCA INSTITUTES, Inc., Dept. PF-08
320 West 31st Street, N.Y., N.Y. 10001

Please rush me FREE illustrated catalog. I understand that I am under no obligation, and that no salesman will call.

Name _____ Age _____
(please print)

Address _____

City _____

State _____ ZIP _____

Dead FM

An AM-FM clock radio operated normally on the AM function but failed to receive anything on the FM mode. Since all stages following the FM converter (Q2 in Fig. 3) function during both AM and FM reception, it was decided that the trouble must be located in either the FM RF amplifier or the FM converter stage. Voltage measurements on the elements of these two stages indicated that all voltages were within tolerance.

Next, the gain of each FM IF amplifier stage was checked by connecting the DC probe of a VTVM to test point A, and the VTVM common lead to test point C. Connected in this manner, the VTVM functions as an FM detector output indicator.

An RF signal generator was adjusted to 10.7 MHz (unmodulated), and the ground lead attached to the common ground of the receiver. After connecting a .0001-mfd capacitor in series with the generator output cable, the generator signal was injected at the base of Q5, the 3rd FM IF amplifier; and the generator output control adjusted to obtain a .3-volt reading on the VTVM. The signal was then injected at the base of Q4, the 2nd FM IF amplifier. The meter reading increased to .8 volt, indicating a signal voltage gain within that stage.

Next, the signal was injected at the base of Q3, the 1st FM IF amplifier, and a reading of 1.4 volts was obtained on the meter. When the generator lead was moved to the input element (emitter) of Q2, the FM converter, the meter reading decreased to .8 volt. This indicated a decrease in gain (about 50%) within the converter stage.

At this point, a decision was made to align L5, the 1st FM IF transformer, and the meter reading gradually increased to .85 volt. A peak reading should have occurred somewhere between the extremes of the adjustment; therefore, it was suspected that the transformer was defective.

L5 was removed from the PC board and carefully disassembled (Fig. 4). Upon inspection of the solder joints, it was observed that one wire from the primary capacitor was wrapped around a terminal, but had not been soldered. The connection was carefully soldered and the

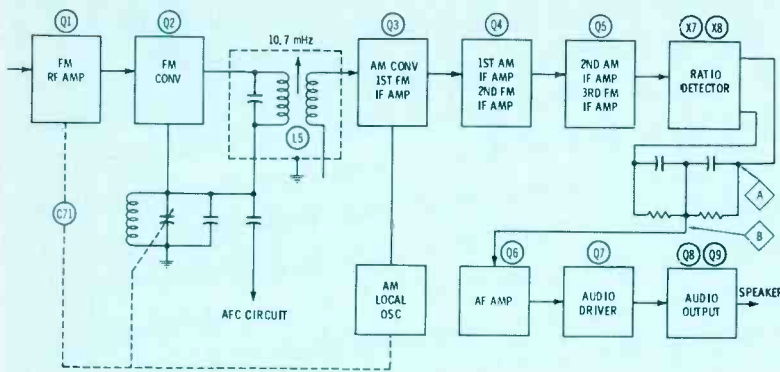

Fig. 3 Block diagram of clock-radio circuitry.

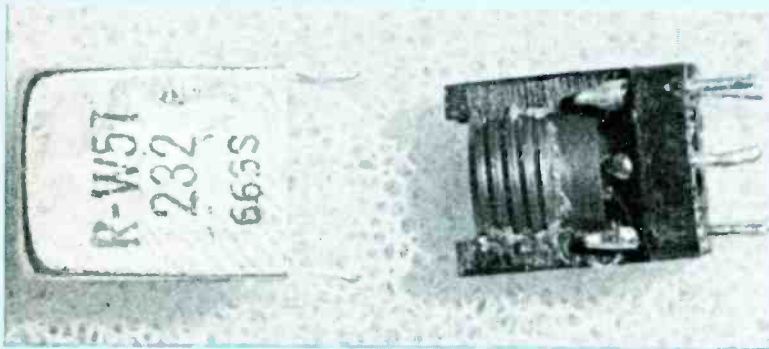

Fig. 4 L5 removed from PC board and disassembled.

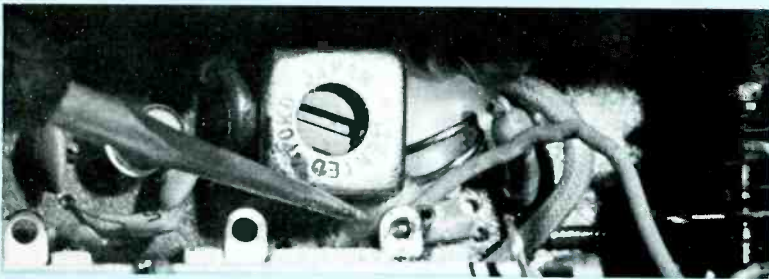

Fig. 5 Defective solder joint at terminals on FM oscillator section of C71.

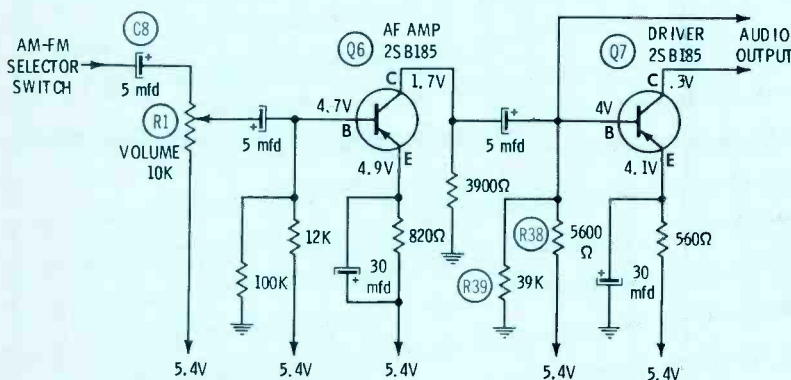

Fig. 6 Schematic diagram of AF amplifier and audio driver circuitry.

transformer was assembled and re-installed on the PC board.

Again the generator was attached to the emitter of Q2, and L5 was realigned. This time a definite peak meter reading of 1.5 volts was obtained with the slug near the center of the transformer adjustment.

It is evident from the preceding analysis that alignment not only can improve receiver performance, but will often pinpoint a defective stage.

Intermittent FM

FM reception was intermittent, and tapping the chassis affected the condition. When the signal disappeared, the volume was turned up and a local FM station was faintly heard all across the dial. This symptom suggested a dead FM oscillator circuit.

The components in the oscillator circuit were gently tapped in the process. A defective solder joint (Fig. 5) was discovered at one of the terminals on the FM oscillator section of the tuning capacitor, C71. After the connection was resoldered, the overall FM alignment was touched up, and the receiver restored to normal operation.

Low Volume on AM and FM

The volume was inadequate on both the AM and FM bands. A harmonic generator was used in the following manner to locate the defective component: The generator was switched to AF output and one lead connected to the receiver ground. When the other lead was attached to the base of the AF driver transistor (Q7 in Fig. 6), a tone was heard in the speaker. The generator was removed from Q7 and attached to the base of Q6, the 1st AF amplifier transistor, and the speaker tone increased in volume. This increase indicated that Q6 was amplifying the signal.

The volume control was turned up and the generator lead connected to the center terminal of this control. The volume level from the speaker remained about the same as in the previous test. Next, the generator lead was moved to the input side of C8, the 5-mfd coupling capacitor, and the speaker volume decreased considerably. A substitute capacitor was bridged across C8 which was open, and the volume increased to normal. Replacement of the capacitor cured the low volume.

15 CRYSTAL MARKERS 3 SWEEP RANGES ONLY \$135



New Heathkit IG-57 Solid-State Color TV Marker/Sweep Generator

The IG-57 combines the features of both a post marker and a sweep generator for less than you'd expect to pay for just one of these functions.

- Three linear sweep ranges for TV tuned circuits in sound IF, color bandpass, video IF circuits and proper overall RF/IF response
- External attenuator provides 1, 3, 6, 10 and 20 dB steps up to 70 dB maximum
- Can also be used with external sweep or marker
- 15 crystal-controlled markers provided for color bandpass alignment; picture and sound carrier frequencies for channels 4 and 10; FM tuner, FM IF and discriminator alignment; TV sound IF adjustments
- All crystals included
- Completely isolated 1-15 VDC variable voltage supply for positive or negative bias
- Built-in 400 Hz modulation for trap adjustment and checking and adjusting FM tuners
- Phase Control and Trace Reverse Switch so markers will appear from left to right as in set manufacturer's instructions, regardless of 'scope used
- Blanking Switch eliminates return sweep and provides base line
- Circuit Board Construction — three circuit boards, 27 transistors, 3 silicon diodes, 2 crystal diodes and 2 Zener diodes combine to make assembly faster with less chance of error
- Bias and Scope Horiz. leads, Attenuator, Demod In, Scope Vert., RF and Demodulator cables included in kit.

Kit IG-57, 14 lbs., \$135.00; Assembled IGW-57..... \$199.00

IG-57 SPECIFICATIONS — Marker frequencies: 100 kHz; 3.08, 3.58, 40.8, 4.50 MHz, ±0.1%. 10.7, 39.75, 41.25, 42.17, 42.50, 42.75, 45.00, 67.25, 193.25 MHz ±0.05%. Modulation frequency: 400 Hz. Input impedances: External Marker, External Sweep, & Attenuator — 75 ohm. Demod In — 220 k ohm. Output impedances: Marker Out, Sweep Output & Attenuator — 75 ohm. Scope Vert — 22 k ohm. Bias voltage: Positive or negative 15 volts DC at 10 milliamperes. Type of marker: Birdie. Controls: Bias control with pull-on/push-off switch; Marker/Trace — dual concentric; Sweep Width/Sweep Center — dual concentric; Marker Out — concentric with Sweep Range switch; Phase. Switches: Rocker type — separate switch for each of the above listed frequencies; Blanking, On/Off; Trace Reverse; Modulation On/Off. Transistor — Diode Complement: (19)-2N3692 transistor. (7)-2N3393 transistors. (1)-2N3416 transistor. (3)-silicon diode rectifiers. (2)-crystal diodes. (1)-13.6 volt zener diode. (1)-20 volt zener diode. Sweep frequency ranges and output voltage: LO Band — 2.5 to 5.5 MHz ±1 dB at 0.5 volts RMS fundamentals, and 10.7 MHz on harmonics. IF Band — 38 to 45 MHz ±1 dB, at 0.5 volts RMS, fundamentals. RF Band — 64 to 72 MHz ±1 dB at 0.5 volts RMS fundamentals, and 192 to 198 MHz on harmonics. Attenuator: Total of 70 dB of attenuation in seven steps — 1, 3, 6, 10, 20 and 20 db. Power requirements: 120 volts, 60 Hz AC at 20 watts. Dimensions: 13³/₈" W. x 5¹/₂" H. x 12¹/₂" D.

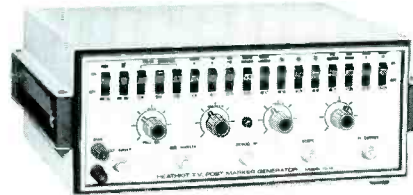

DON'T NEED THE SWEEP?

The IG-14 has the same features and specifications — without the sweep.

Kit IG-14
12 lbs. shpg. wt.
\$99.95

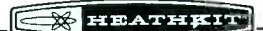

Free 1969 Heathkit Catalog

Describes these and over 300 other kits for test, stereo/hi-fi, color TV, SWL, Amateur Radio, CB, Marine, Educational, home and hobby. Save up to 50% the easy and enjoyable Heathkit way. Just mail coupon or write: Heath Company, Benton Harbor, Michigan 49022.

HEATH COMPANY, Dept. 25-10

Benton Harbor, Michigan 49022

Enclosed is \$ _____, plus shipping.

Please send model (s) _____

Please send 1969 Heathkit Catalog.

Name _____
(please print)

Address _____

City _____ State _____ Zip _____

(Prices and specifications subject to change without notice)

TE-182R

Circle 24 on literature card

Troubleshooting Stereo

Logical approaches to common troubles. by Norman Crowhurst

Many troubleshooting methods used for stereo are identical to those employed in troubleshooting other electronic equipment. If the set isn't working, the same sequence of checks should be followed: Is power reaching the set? Are the supply circuits providing working voltages? Then signal trace to find the circuit failure.

If only one channel is not working, similar advice applies: Signal trace the faulty circuit, starting at the output, until you find where the signal ceases. Whether the stereo amplifier uses tubes or transistors, it has a signal path from input to output that can be traced just like any other electronic equipment.

Distortion

If the circuit is working, but the sound seems distorted, you must be prepared to spend a little more time analyzing the symptom. What does the distortion sound like? Most distortion sounds give an impression characteristic of their origin. But such impressions can mislead.

Electronic or Mechanical?

Knocking or scraping sounds, like the voice coil hitting or rubbing, could be just that. But such sounds could also have an electronic origin. A clue that will partially resolve this is the question: Can you hear the distortion in both the left and right channels or only in one? If the same distortion is noted in both speakers, look in the electronics as it is unlikely for both speakers to be faulty.

A more probable cause is a defect in the supply circuit that affects both amplifiers identically. For example, a faulty electrolytic can decrease the output of the low-voltage supply, causing an inadequate working voltage to be supplied to both amplifiers.

When only one channel produces distortion, the inherent design of the stereo itself provides a simple method of checking whether the trouble is electronic or mechanical. Switch speaker systems, left with right, to see if the distortion remains on the same side or moves to the other. If the distortion moves to the other side (Fig. 1), the speaker is not faulty and you should troubleshoot the faulty amplifier. If the distortion stays with the same side, or speaker, the speaker then is the faulty part and should be replaced.

Most, if not all, forms of distortion that occur in amplifiers are accompanied by some change in the working voltages. When one side is normal and the other side distorts, check the voltages of the distorted side against the corresponding voltages of the normal side, looking for a significant difference.

Another useful check, where a stereo uses a number of input sources—radio, phono and tape, for example—is to determine whether the same thing happens to the inputs from all sources. This is a quick means of signal tracing.

If the same distortion occurs in all positions of the function switch, obviously it originates in the part of the amplifier system that is common to all functions. If it happens on only one position of the function switch, then look for the fault in the related circuitry before the function selector switch.

Trouble at the Input

Here, common things can be overlooked. If the phonograph reproduction is distorted, look for an accumulation of lint under the stylus. You would think the customer would have found it, but sometimes it builds up in a solid pad that is

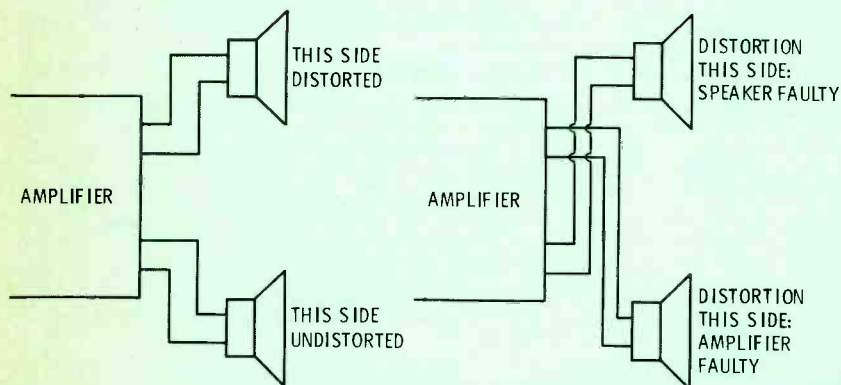

Fig. 1 Changing speaker connections will help you determine whether the speaker or the amplifier is faulty.

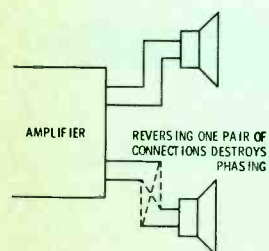
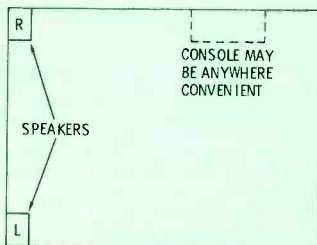
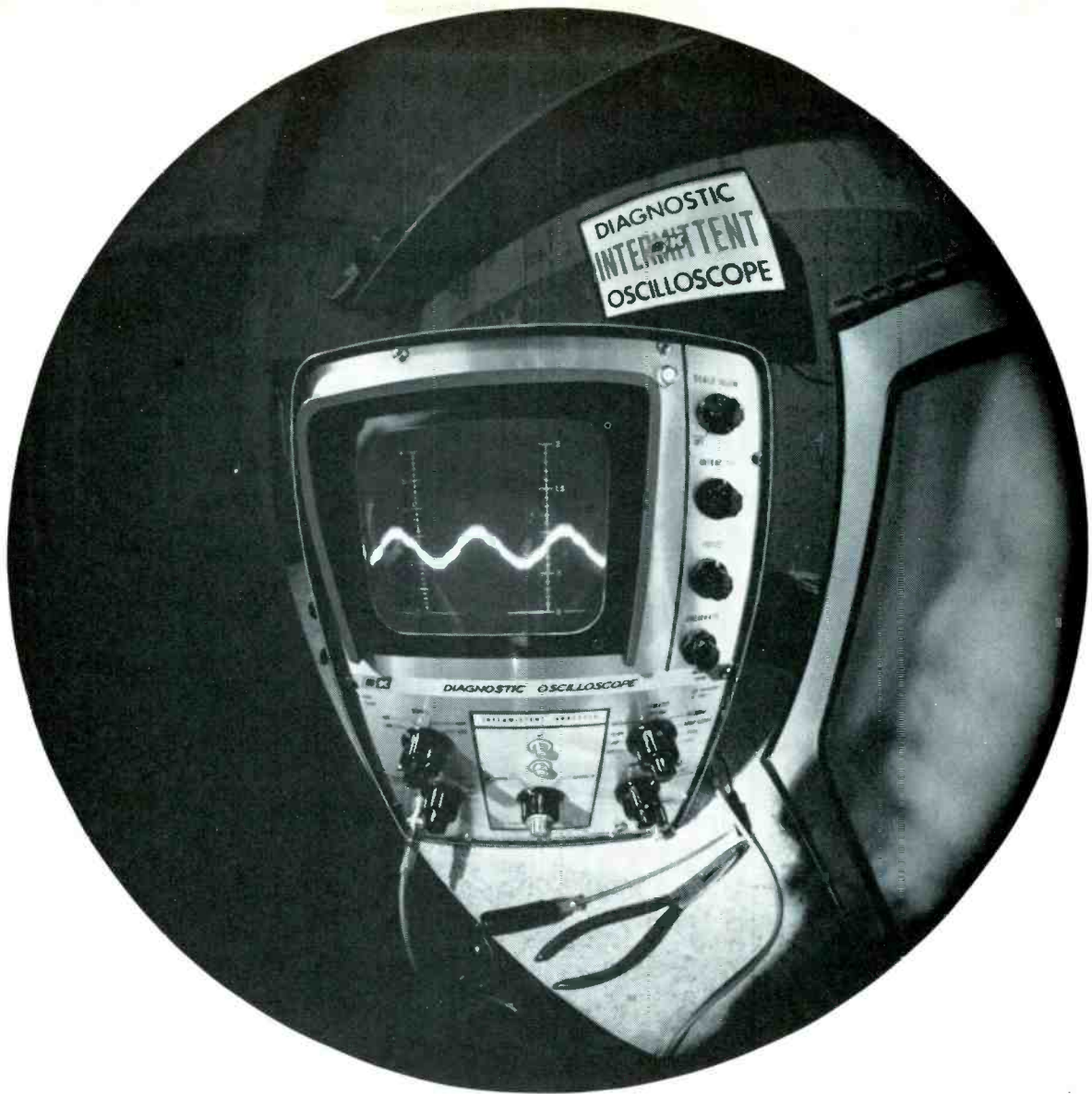

Fig. 2 How the effect of stereo can be lost by incorrect phasing.

Fig. 3 A good basic placement in a rectangular room of average furnishing.





Another benchwarmer?

Not this one. Our new B&K Diagnostic Oscilloscope is more than re-engineering of an old model to keep pace with TV technology. It is instead a basic departure from all other oscilloscopes. A departure that has simplified a complex instrument to make it easier for you to use. But there's something else.



What this oscilloscope has is exclusive. An Intermittent Analyzer with electronic memory—and optional remote Audio/Visual Alarm.

With it, the elusive intermittent conditions that make so many TV sets tough dogs can now be detected and identified in your absence. Preset one control.

When the faulty stage is detected, you'll know about it as soon as you come back from service calls. Then run the scope overnight to check another set for an intermittent condition.

All this adds up to greater shop efficiency, more time for profit-making service calls and a lot more mileage out of a very fine diagnostic oscilloscope.

An oscilloscope that shows vector patterns exactly as specified by color TV manufacturers. (All vectorscope inputs and controls are conveniently located on the front panel.) Also allows you to read peak-to-peak voltages in all ranges on a double-scale calibrated screen—just by turning a switch. (As the range is selected, the appropriate scale lights automatically.)

Automatic synchronization locks in all patterns at any signal level or frequency. There are also fewer controls and these are positioned for easier operation.

Give our Diagnostic Oscilloscope some thought. It's worth it not to be sidelined with a benchwarmer. See your B&K Distributor or drop us a note for detailed literature on Model 1450 and our full-line test equipment catalog, AP-24.

DIAGNOSTIC OSCILLOSCOPE
Model 1450, Net: \$279⁹⁵



B & K Division of DYNASCAN CORPORATION
1801 W. Belle Plaine • Chicago, Illinois 60613
Where electronic innovation is a way of life.

Circle 25 on literature card

"IN-CIRCUIT" CURRENT CHECKER

Eliminates most common cause of "callbacks" (unstable focus, shrinking pictures, etc.)! Should pay for itself on next months' calls alone!



Nothing else like the HC-8 available! Tune horizontal drive and linearity for "dip"—and in seconds—you've got best possible focus, width and stability at minimum cathode current. Makes convergence adjustments faster, easier—longer lasting!

Especially useful on color TV where a slight misadjustment of horizontal linearity or efficiency coils drives cathode currents sky high! 5 pre-wired sockets for all popular horizontal output tubes lets you plug into circuit fast—no clipping or unsoldering of leads!

Model HC-8
\$34⁵⁰
Net

ASK YOUR DISTRIBUTOR
or write for full details.

 **SECO ELECTRONICS CORP.**
1001 Second St. So. • Hopkins, Minn. 55343

Circle 26 on literature card

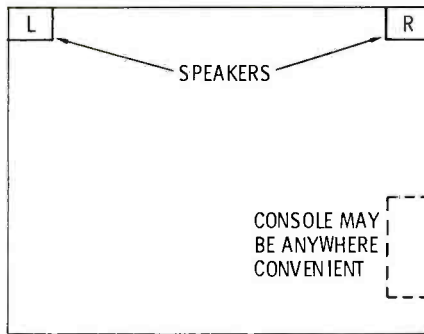

Fig. 4 In an especially 'dead' room, that gives the impression of "active silence" to your voice and other sounds produced or reproduced in it, this arrangement may be better.

not easily removed, or he may have just forgotten to check that. The stylus could also be worn or, less likely, chipped. This you will have to verify with a microscope.

If the trouble is in the tape section, the tape head may be out of alignment and lost its high-frequency response. If the loss is minimal, i.e., only above 3,000 Hz, it may not be noticed as a loss-of-highs but as a loss of character in certain instruments, such as violins, which may sound more like distortion than a loss-of-highs.

Loss of 'Stereo'

With both channels working, this can happen through incorrect connections. A wrong connection at the input may ground out one channel, or may parallel them so both channels are identical instead of properly separated. Incorrect phasing, usually at the output, can lose all sense of location, so realism disappears. Reversing connections to one channel can cause this (Fig. 2). This may have happened when the customer was trying some changes of his own and didn't get the connections replaced as they originally were.

The Intangible Faults

The faults discussed in the preceding paragraphs demand only well established troubleshooting techniques, in which the difference from any other system is the convenience of having two identical systems in one. Many of your stereo service calls will use these techniques, although improved reliability of modern equipment is making such service calls less frequent.

This last fact leads to an increasing proportion of calls where the

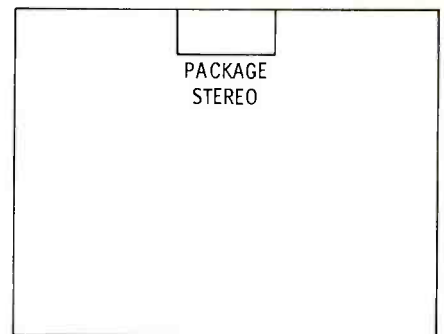

Fig. 5 The best lay-out for the typical recreation room.

trouble isn't in the **tangible** part of the set. It may call for some tact on your part in tracking it down. The complaint will often be derived from comparison: "My neighbor has a set just like this, but when he plays this very same tape (or disc) it sounds quite different. It sounds much cleaner on his set." You may or may not have the opportunity to verify this. If you can conveniently do so, you may be able to judge first-hand the cause of the difference. If not, you may have to play detective with your customer.

The mere statement that it doesn't sound as good does not tell you the cause of the difference. You must know in what way the sound differs. Does it lack something specific? What made your customer notice the difference?

Perhaps the violins sound like violins on the neighbor's set, but on his set they're just a screech. Listen for yourself. Is the set distorting (you can tell that by listening with your ear fairly close to each speaker in turn) or could it be the room acoustics? The neighbor may have a well-furnished living room, carpeted floor, drapes, well-stuffed furniture, which the customer's room lacks. That can make violins sound quite different.

If this is the reason for the difference, it didn't just happen. It's been there all along. But your customer may insist he's only just heard this difference.

This circumstance can be difficult to diagnose with any certainty. It may be something that has developed in the system, such as a tape head slightly out of alignment, which requires professional correction; or the fact may be that the difference was there all along, but was only recently noticed. In fact, the difference may be so subtle that only he can hear it which would

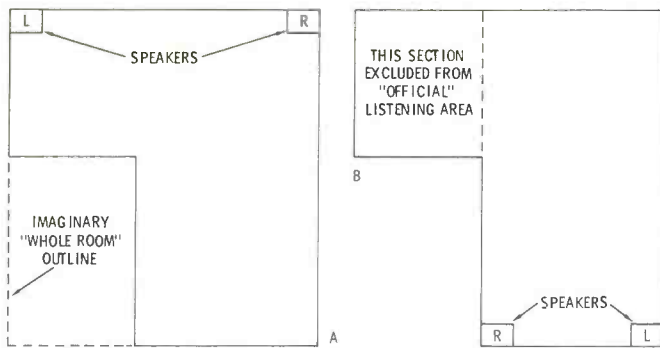

Fig. 6 A more common American room — L-shaped. A: the wrong way, regarding the room as part of a larger one that is rectangular; B: the right way, considering part of the room to be rectangular and using that part as a primary listening area.

lead you to believe he was imagining something.

Studies of human hearing have ascertained that the sounds we are aware of are so complicated that we never hear all of what we think we hear, even when trying. By concentration and practice we can make sounds audible that we didn't hear before, though they were always there. For this reason never assume your customer is hearing things. And even if you can't hear the distortion he complains about, don't assume that it isn't there. In this kind of situation, always recognize that your customer must be hearing something and try to identify what it is.

If your customer is a musician or a layman with some musical appreciation, he may complain about a non-musical sound. With your electronic background you think of noise as non-musical but to your customer the sound of a tinkling bell that shouldn't be there is equally non-musical. The same sounds convey different impressions to different people.

Acoustic Environment

When you conclude that the customer's dissatisfaction comes from his system not being suited to his acoustic environment, you may need to advise him on this. Could a

"and when did you first get the idea that you could possibly align a TV set without an **INJECTORALL ALIGNMENT KIT?**"



Circle 28 on literature card

NEW!

A BETTER WAY TO REPLACE SOLDERED COMPONENTS

LENGTH 8" WEIGHT 3 1/2 OZ.

ENDECO

Pencil Desoldering Iron MODEL 300

Now—remove miniature soldered components in seconds—without damage

Hollow tip fits over connection; vacuums all solder for easy removal of component. Leaves terminals and mounting holes clean. Then, with 360° contact, it resolders even faster and better than regular irons. Handles miniature and standard components in printed circuit boards and conventional wiring. Self-cleaning. All parts replaceable. 40 watts, 115-v. 5 tip sizes. Pays for itself in time saved. \$10.95 net East of the Rockies.

Larger model available. See your distributor or write:

ENTERPRISE DEVELOPMENT CORPORATION

5151 E. 65th St. • Indianapolis, Ind. 46220

Circle 27 on literature card

THE BEST ANTENNA INSTALLATIONS START WITH . . .

South River **QUALITY MOUNTING ACCESSORIES**

THE MOST COMPLETE LINE IN THE INDUSTRY

South River **HEAVY-DUTY / TUBULAR / TRI-POD ROOF TOWERS**

- Pre-assembled, individually boxed, opens like an umbrella.
- Gold baked enamel or Hot-Dip galvanized 1 1/4" OD steel tubing.
- Exclusive adjustable slide permits tower feet to fasten directly to non-standard spaced rafters, on peaked or flat roofs.
- For masts up to 1 1/2" OD.
- Roof sealing pitch patches, all hardware, 2" lag screws supplied.

AVAILABLE IN:

2 ft.	5 ft.
2 1/2 ft.	7 1/2 ft.*
3 ft.	10 ft.*

*Exclusive swing-lock feature permits mast to be placed in sockets from side of tower

SEND FOR CATALOG SHEET

AT SOUTH RIVER QUALITY IS OUR MOST IMPORTANT PRODUCT
SOLD THROUGH DISTRIBUTORS
SOUTH RIVER METAL PRODUCTS CO., INC. / SOUTH RIVER, N. J. 08882

Circle 29 on literature card

change of position help? The lady of the house may not like this, but it's a choice that must be made: Do they want better listening, or the stereo set in the position they fancy?

Much about placement seems contradictory because changing factors make the situation different. A question is often asked about which side of a rectangular room should be used: Should the stereo be placed on a short side or a long side?

Where the acoustics are good and the speakers are separate from the

operating console, the short side is usually best for the speakers. The control console can be anywhere that's convenient (Fig. 3).

Where the acoustics are too dead, which isn't often, the long side may be better (Fig. 4). A room with heavy carpeting, acoustic tile ceiling and highly absorbent walls will be almost as dead as an anechoic chamber. The widest possible spacing of speakers is desirable in such a room.

In a highly reverberant room,

such as the recreation room with no floor covering, hard walls and ceiling; a packaged set with the speakers built in placed against one of the longer walls (Fig. 5), would usually be the best arrangement.

Of course, the rectangular room is, in a sense, somewhat of an ideal. So many American homes come today with a combination room that is L-shaped. In such circumstances, the customer should determine which is the primary listening area. If you regard the room as rectangular with a piece cut out (Fig. 6-A) and try to fill the imaginary 'whole room' you may not get good listening anywhere.

It's better to think of one leg of the 'L' as being the primary listening area, and place your speakers or set to feed that area.

This kind of advice and help hardly seems like troubleshooting, in the accepted sense, yet really it is. Where else will your customer get the correct advice on such matters? The demonstration in a dealer's showroom merely shows him what sounds good in that acoustic environment, which may well be quite different from his own. The service technician is the man who gets called in where the trouble can really be diagnosed.

Don't be afraid to charge for your services. Even though you did not do anything to the electronics, you used your know-how, and acoustic experts charge rates for their time at least equal to yours. If your name gets around as a man who knows how to make stereo sound its best, you'll make better money than by working much harder on the service bench. And the service you give your customer will also be much more valuable to him.

It seems silly to be called because the set doesn't work at all, to find that it was unplugged during house cleaning, and nobody had checked to see if it was plugged in again. We've all had that happen with TV's, refrigerators and everything else. Stereos aren't exempt. Customers often grumble about paying your minimum service charge for finding that out. But such oversights still happen—and if plugging in a power cord restores a set to normal operation, you have performed a service to the customer just as if you had replaced a transistor. ▲

Now—Compare CRT Color Guns AUTOMATICALLY!

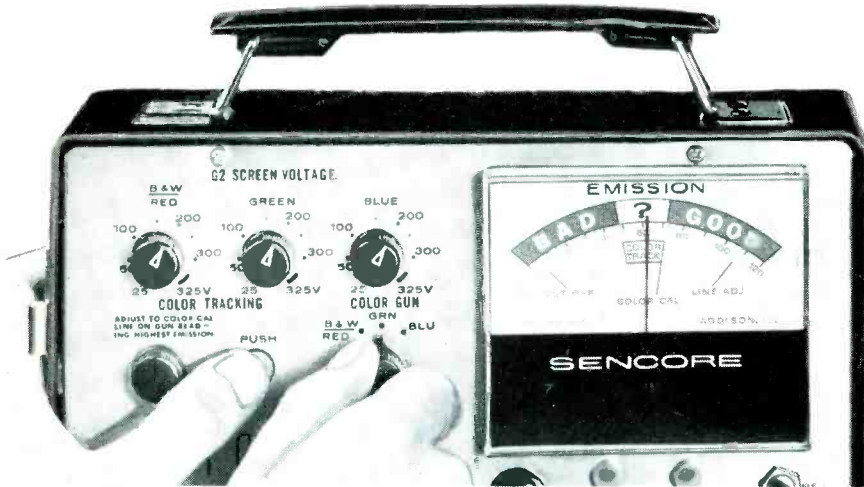

- Simplifies Color CRT Tracking Test
- Tests Each Gun in Color or B&W CRT's Completely

Now, for the first time, you can test CRT color guns for color tracking automatically; and exactly according to industry standards. No more time-consuming logging of each color gun reading at every setting of the G2 control like other testers.

Only the Sencore CRT CHAMPION has three separate G2 screen grid controls just like the color TV itself. A color tracking scale right on the meter makes the all-important tracking test easy, fast, and accurate. This is most important when claiming credit for a defective color CRT.

The CHAMPION also makes all the standard color and black and white CRT tests—short, emission, and life tests. Line Adjust control assures exceptional accuracy. An exclusive three step Automatic Rejuvenation Circuit lets you save many a faulty black and white tube or equalize gun currents in color tubes. Plug-in sockets are provided for fast testing and easy updating. Rugged vinyl-clad steel case has spacious lead compartment.

CRT manufacturers, set manufacturers, distributors, technicians all recommend the CR143 CRT tester as the only tester that does a complete job. Why not check with them before you buy.

Sencore CR143—CRT CHAMPION . . . \$99.50



SENCORE

NO. 1 MANUFACTURER OF ELECTRONIC MAINTENANCE EQUIPMENT

426 SOUTH WESTGATE DRIVE, ADDISON, ILLINOIS 60101

Circle 30 on literature card



Two New SK Devices Simplify Servicing of TV Deflection Circuits

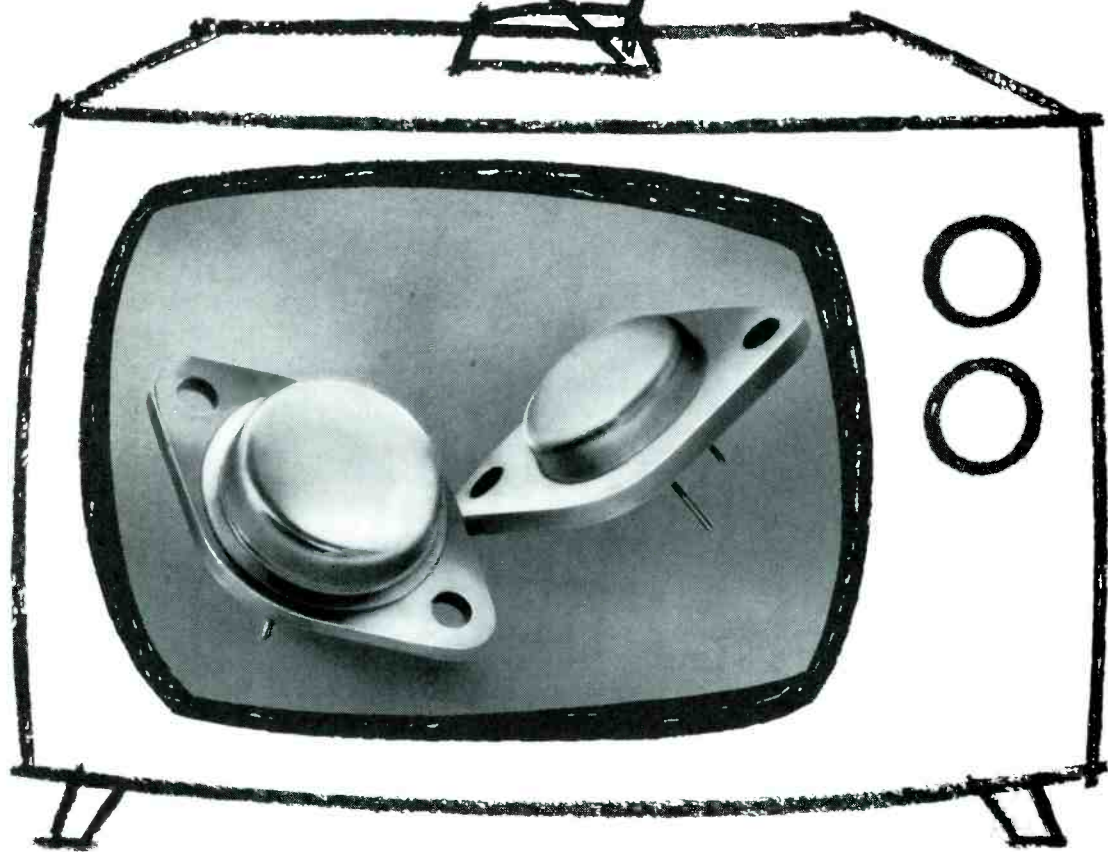

More than a dozen solid-state TV sets—RCA and others—can use these two new RCA SK-Series transistors—specifically designed for replacement use in deflection circuits.

The RCA SK3034 is for replacement use in horizontal driver and in vertical-deflection-output circuits; the SK3035 is for replacement use in horizontal-deflection-output circuits.

Both units are germanium p-n-p devices in hermetically-sealed TO-3 packages, and are for use in domestic and imported TV sets with anode voltages to 18 KV and with picture tubes having deflection angles up to 114°.

Add both to your stock of RCA "Top-Of-The-Line" SK-Series replacement transistors. See your RCA Distributor today about your supply of RCA SK-Series replacements . . . 33 individual units that can replace approximately 11,800 solid-state devices.

RCA Electronic Components, Harrison, N. J. 07029.

Circle 31 on literature card

Now available . . . a comprehensive and accurate source of solid-state replacement information! It's RCA's Solid-State "Top-of-the-Line" Replacement Guide, SPG-202F. Cross-referencing RCA SK-Series Transistors, Silicon Rectifiers, and Integrated Circuits, the Guide provides replacements for nearly 12,000 solid-state devices—including U.S. industry standard EIA types, foreign types, and types identified only by device-manufacturers' or equipment manufacturers' parts numbers. SPG-202F is available through your RCA Distributor. Ask him about it. Today.

*Ask your participating RCA Distributor for details.

RCA

Time-saving techniques for transistor radio repair

Service methods for profitable repair

The following case histories of transistor radio troubleshooting experiences were chosen to illustrate deceptive servicing problems. In each case detailed step-by-step procedures are given for locating the faulty component or components. The approaches taken in each instance are as direct and time-saving as possible.

Hissing, Frying, Static-Like Noise

The noise is not noticeable until the radio plays for a few minutes, then it grows louder and the station grows weaker. Such noise is nearly always caused by leakage between conductors on the printed board

(likely due to battery chemicals), or by a leaky capacitor (most often ceramic, but sometimes electrolytic). On rare occasions, transistors, transformers, and even resistors may cause this trouble. The first step is to localize the noise.

Step 1: Connect radio to power supply, measure current drain. Wait for noise to begin, measure current drain again.

Result: Current drain normal until noise begins (in about three minutes). Then current increases as noise becomes louder.

Decision: Current increase means nothing, since noise will cause class-

B output stages to draw more current. Localize noise to audio or other stages.

Step 2: Turn volume control to minimum.

Result: Noise remains.

Decision: Since noise does not decrease as volume is reduced, it must be in audio stages (Fig. 1).

Afterthoughts: At this point, two or three approaches to testing are possible. A voltmeter will show a fluctuation if the noise is severe. A drawback to this approach is that the current in the class-B stages varies with the noise in the signal circuit. Thus, voltages around the

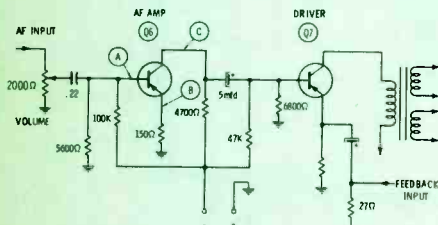

Fig. 1. Varying emitter voltage causes noise unaffected by volume control.

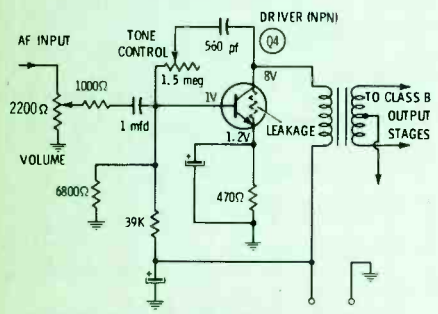

Fig. 3. Excessive transistor leakage in driver stage causes reverse bias.

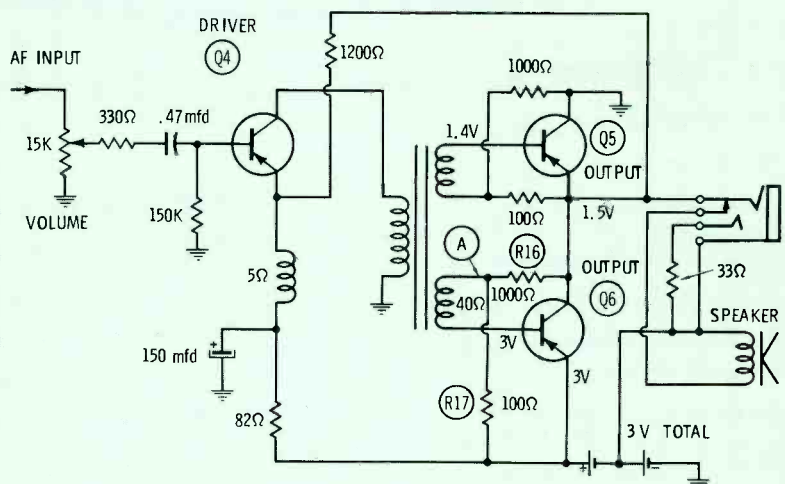

Fig. 2. Improper bias in audio stages causes distortion at low volume.

audio stages will fluctuate somewhat, making it hard to pinpoint the trouble. An audio signal tracer can be used, but the noise pulses so often upset the current in the whole radio that a tracer may detect pulses far from the source of the trouble. Used wisely, however, the audio tracer will usually suggest the source if the noise is traced back through each stage until it diminishes drastically. Step 3 indicates the most foolproof way to isolate noise.

Step 3: Zero-bias Q7 (Fig. 1) by shorting base to emitter with a jumper, wire, or screwdriver.

Result: Noise stops.

Step 4: Zero-bias Q6 in the same manner.

Result: Noise stops.

Decision: Noise must be in input stage of Q6 because volume control is turned to minimum.

Step 5: Measure voltage at point A (base of Q6).

Result: About -0.2 volts, fairly steady.

Step 6: Measure voltage at point B (emitter of Q6).

Result: Voltage fluctuates from -0.1 to -0.9 volt.

Decision: Noise voltage originates in emitter circuit. No capacitor in emitter circuit. Transistor may be defective.

Step 7: Unsolder collector lead at point C. Measure emitter voltage again.

Result: Still fluctuating.

Decision: Fluctuating emitter voltage rules out transistor leakage. It can't be base-to-emitter leakage either, since base stays near -0.2 volt whereas emitter rises to as much as -0.9 volt on peaks, nor can it be collector-to-emitter leakage, since collector voltage is disconnected. There is only one conclusion: leakage between printed conductors. A look at the board shows that the -6 -volt conductor is adjacent to the emitter conductor—an ideal setup for leakage.

Step 8: While reading emitter voltage, scratch a line (use the point of a knife or corner of a screwdriver blade) on printed board, between conductors.

Result: Voltage reading on emitter terminal disappears. (Collector is disconnected.)

Decision: Leakage occurred between two conductors on the printed board. Perhaps battery chemicals or other acids have accidentally been spilled on the board.

Afterthoughts: In some sets, even scratching a deep line between conductors will not eliminate all traces of leakage. The only alternative is to completely pry the leads from the printed tie point and leave them suspended in midair. Generally, though, such drastic measures are not necessary.

Distortion Most Prevalent at Low Volume

Distortion that is most noticeable at low volume is usually caused by improperly biased output or drive stages, or by a defective speaker.

Step 1: Connect radio to power supply (Fig. 2). Check current drain with volume turned down.

Result: About 4 ma.

Decision: Seems too low; should be about 8 ma for this model. Check speaker before disassembling radio.

Step 2: Plug test speaker into ear-phone jack.

Result: Same distortion level is present.

Decision: Speaker in radio is okay.

Step 3: Check bias (between base and emitter) on each output stage.

Result: Bias on Q5 is about .1 volt, which seems about right. Bias on Q6 is zero; should be same as bias on Q5.

Decision: Driver transformer open, R16 or R17 open, or Q6 shorted. Make tests to narrow down trouble.

Step 4: Check voltage at point A (junction of R16 and R17).

Result: Zero voltage.

Decision: Driver transformer isn't open; if it were open, voltage would be normal at point A. Transistor isn't shorted (base to emitter). If it were shorted, there would be some voltage at point A since the 40-ohm resistance of the transformer would prevent a complete short circuit. Therefore, R16 or R17 must be open. (Further inspection revealed R16 was cracked. Evidently the radio had been dropped.)

Dyna-Probe

New King-Size,
Hi-Voltage Tester With
2% Accuracy At 25,000 Volts!

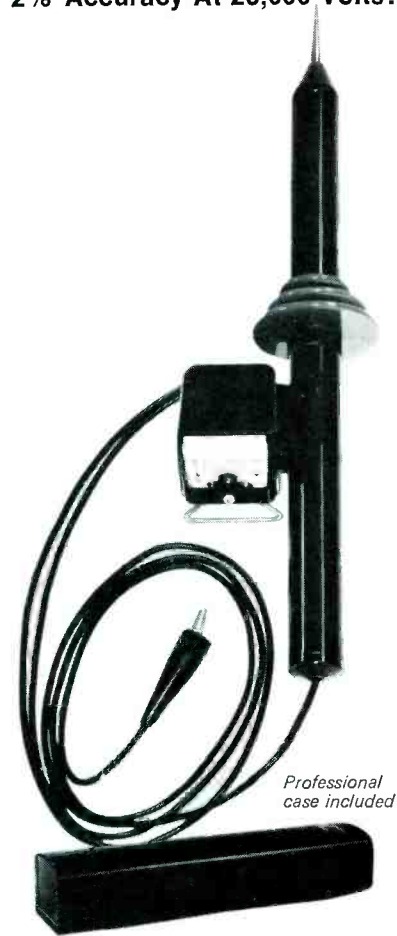

B&K is proud to introduce Dyna-Probe, the new, longer, safer length, hi-voltage tester designed to give more accurate voltage readings. Servicemen carry Dyna-Probe to in-home jobs—adjust high voltage with greater accuracy, thus relieving customer fear of color TV X-ray radiation. Detachable meter is easy to read in "hard-to-reach" areas. Meter, on auto-tilt stand, direct-reads 0 to 30,000 volts. Dyna-Probe—another engineering breakthrough from B&K.

Model HV-30, \$24.95 user net



B&K Division of Dynascan Corporation
1801 W. Belle Plaine Avenue/Chicago, Illinois 60613
Where Electronic Innovation Is A Way Of Life

Circle 32 on literature card

October, 1968/PP REPORTER 43

Weak and Distorted Audio

In this radio, distortion is the dominant problem; once the distortion is removed, the volume will probably return to normal.

Step 1: Connect radio to power supply (Fig. 3). Check current drain with volume down and the set tuned off station.

Result: About 7 ma of current flow.

Decision: Current drain approximately correct.

Step 2: Check current drain with volume turned up and set tuned to station.

Result: Current drain about 15 ma maximum on a strong station. Audio now very distorted.

Decision: Not enough current. This model should draw 50 or 60 ma on peaks at full volume on a strong station. The reason for low current is loss of volume. The class-B output stages are not being driven hard enough to draw higher current.

Since the current at no volume seems about right (indicating correct bias on the output stages), suspect the driver stage.

Step 3: Check bias (from base to emitter) on driver stage.

Result: Voltage on base is about $-.2$ with respect to emitter.

Decision: This is approximately the correct bias level, but the schematic shows the driver is an NPN transistor. Remembering the rule that the middle letter of the type of designation indicates the polarity of the base and collector voltages, we realize the voltage reading from base to emitter should be **positive**. In other words, the transistor is reverse biased. How can this be? The base circuit can be ruled out, since the only source of voltage across the emitter normally is the collector current which can flow only if the transistor is conducting. But reverse-biased transistors don't conduct. So the voltage source must be the transistor itself or a leak across the printed circuit board.

Step 4: With soldering iron, heat emitter connection to printed conductor. Blow away excess solder with a soda straw. With solder gone, break emitter loose from printed conductor. (You need not remove lead from the hole in the board; just center it so it doesn't make connection to the conductor).

Result: Voltage goes to zero on printed conductor.

Decision: Transistor must be excessively leaky. However, since emitter and collector were on adjacent printed conductors, heating and blowing away solder may have also removed unwanted path between conducting strips on the printed board. Still, most likely suspect is transistor.

Step 5: Remove transistor and check for excessive leakage, or, temporarily restore emitter connection. If original trouble persists, transistor is defective.

Afterthoughts: Although printed boards develop leakage paths that can cause such troubles, the transistor in this example **was** defective and a new one cured the trouble. Be sure the replacement driver transistor is neither too high nor too low in gain. When universal transistor replacements are used, the bias

50,000⁺ users can't be wrong!

TECHNICIANS EVERYWHERE RELY ON FAMOUS SENCORE MIGHTY MITES. HERE'S WHY.

- Grid Leakage Test with ultra-high sensitivity of 100 megohms
- Emission Test at full rated cathode current
- Shorts Test picks out interelement shorts of 180K ohms or less
- Mighty Mite accurately checks over 3,000 tubes, including foreign



NEW MIGHTY MITE V TC142

Now, Sencore's new Mighty Mite V gives you the same reliability and accuracy, plus new features that make the "V" the most up-to-date tester of all.

NEW—Magnoval socket so you check many more tubes.

NEW—Horizontal in-line switch layout saves setup time.

NEW—Rugged vinyl-clad steel case stays new longer.

NEW—Brushed chrome panel; detachable cover.

The new TC142 is truly Sencore's mightiest Mighty Mite and it's only

\$79.50

IN STOCK AT YOUR DISTRIBUTOR NOW.



SENCORE

NO. 1 MANUFACTURER OF ELECTRONIC MAINTENANCE EQUIPMENT

426 SOUTH WESTGATE DRIVE, ADDISON, ILLINOIS 60101

Circle 33 on literature card

must sometimes be juggled slightly in order to get maximum gain and minimum distortion.

Dead Radio

Since dead radios can be caused by many things, a systematic troubleshooting procedure should be followed in diagnosing them.

Step 1: Connect radio to power supply, and check current drain.

Result: Checks about 10 ma.

Decision: Probably about normal. Output stages seem all right.

Step 2: Turn volume control back and forth, and listen carefully to speaker.

Result: "Scratching" noise is heard in speaker.

Decision: Speaker and audio stages probably all right since sound is getting through them.

Step 3: Hold set close to fluorescent light, and listen for any noise in the speaker.

Result: No noise.

Decision: No signal getting through IF's.

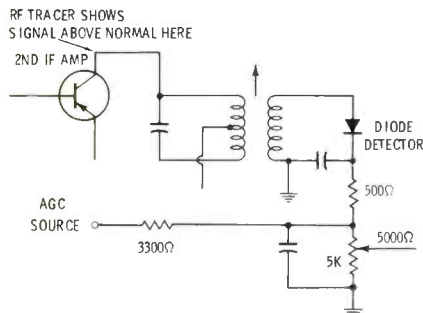

Fig. 4. An open detector diode results in no audio output and no AGC.

Step 4: Check with RF signal tracer or by signal injection.

Result: Signal at converter collector and first IF collector is normal. Signal at second IF collector is also good, except it is stronger than usual (Fig. 4).

Decision: Diode detector is probably open. Tipoff is that signal, although somewhat stronger than normal, is good up to second IF amplifier. This condition indicates no AGC action. Since AGC voltage nearly always originates at diode detector, diode must be at fault.

Afterthoughts: An open detector diode is fairly common. An in-the-circuit ohmmeter check will spot the trouble. A good diode reads about 100 ohms forward and from 2K to 10K in the reverse direction. ▲

NUVI-TRAN

tuner cleaner



New from
GC...
Quality Leader
in Electronic
Chemicals

CATALOG NO. 5555
Suggested Net \$2.29

A new aerosol, specifically formulated for cleaning sensitive nuvistor and transistor tuners. NUVI-TRAN is non-conductive, non-toxic, will not induce drift or detune neutralizing circuit. Safe for all plastics used on TV tuners, NUVI-TRAN leaves no residue, works in seconds. NUVI-TRAN is an exclusive GC product... another quality reason for leadership in electronic chemicals for over 40 years.

Always insist on **GC**...
you'll get more for your money, every time!

GC ELECTRONICS

DIVISION OF HYDROMETALS, INC.

MAIN PLANT: ROCKFORD, ILL. U.S.A.



Giant New FREE Catalog!...

Only GC gives you everything in electronics... has for almost 40 years. Match every part and service need from over 10,000 quality items. Write for your copy today!

Circle 34 on literature card

GC

has
everything
in
CHEMICALS



SPRA-LUBE
Cleaner-lubricant for
all color TV tuners.
Cat. No. 8888
8-oz. Aerosol Can
Suggested Net \$1.95



DC-29 Silicone
Heat Sink Compound
Cat. No. 8109-S
1-oz. Tube
Suggested Net \$2.63



EPOXY GLUE
Super grip, fast set.
NASA approved.
Cat. No. 347
2-Tube Kit
Suggested Net \$2.50

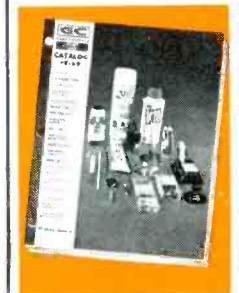

WINEGARD DEAL

Because Winegard delivers better

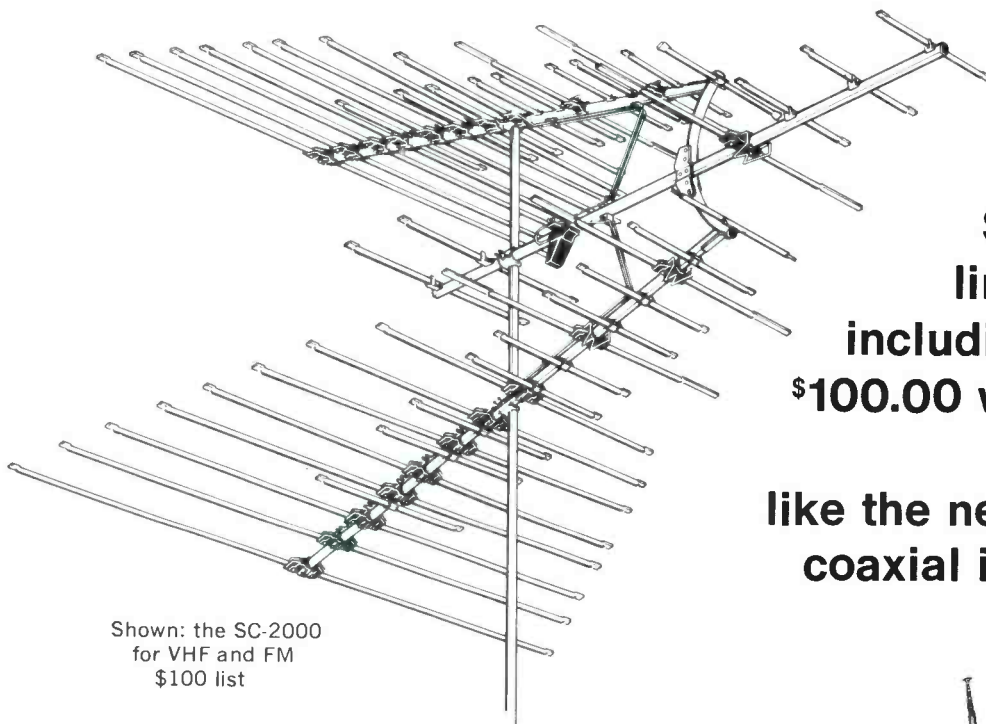

Shown: the SC-2000
for VHF and FM
\$100 list

like the great
Super Colortron
line of 16 models
including the two new
\$100.00 wedge antennas

like the new Color-Ceptor
coaxial indoor antennas
for super color

Just a few Super Colortron features:

- Written guarantee of satisfaction
- 7 patents and patents pending
- Exclusive built-in cartridge housing
- Exclusive impedance correlators
- Super compact, easy to install
- Genuine Winegard gold anodized
- Exclusive ellipsoidal boom
- Hi-impact wrap-around insulators
- Exclusive FM control elements
- And much, much more

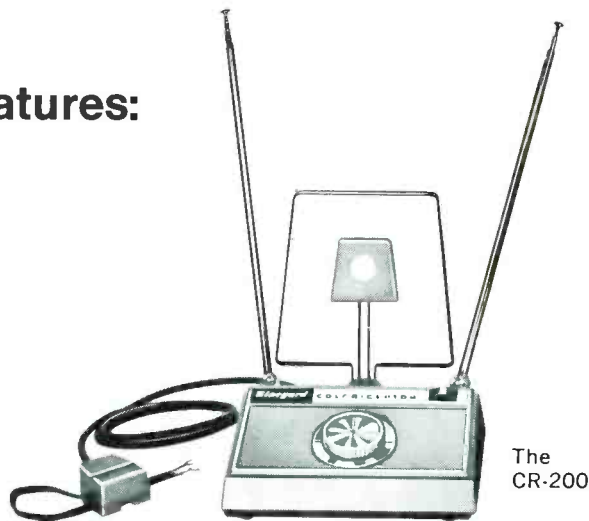

The
CR-200

WINEGARD COMPANY • 3000 KIRKWOOD ST. • BURLINGTON, IOWA 52601

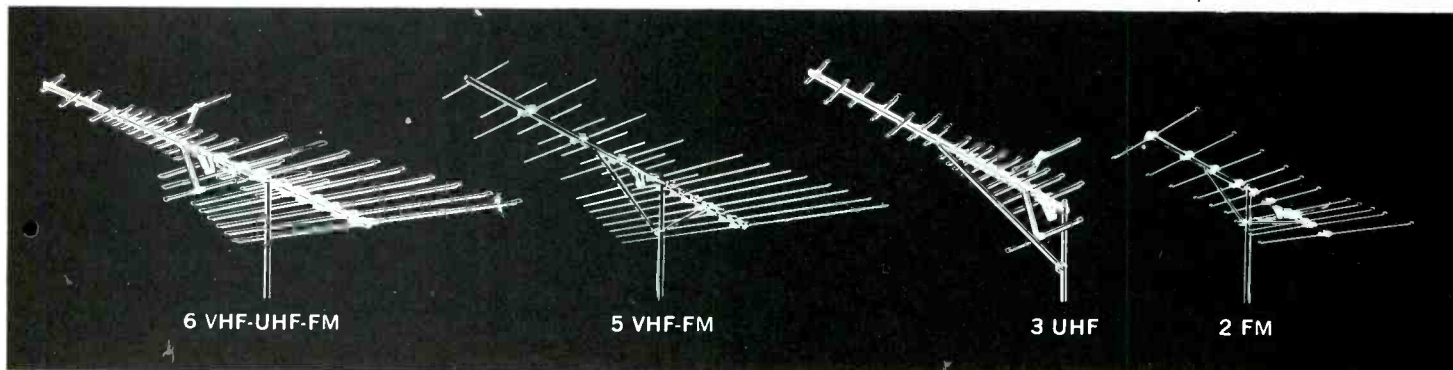

6 VHF-UHF-FM

5 VHF-FM

3 UHF

2 FM

ERS PROFIT MORE

products and better sales help!

like 8 ads in
Life and Look during
a 3 month period...
with a total of
123,000,000 readers

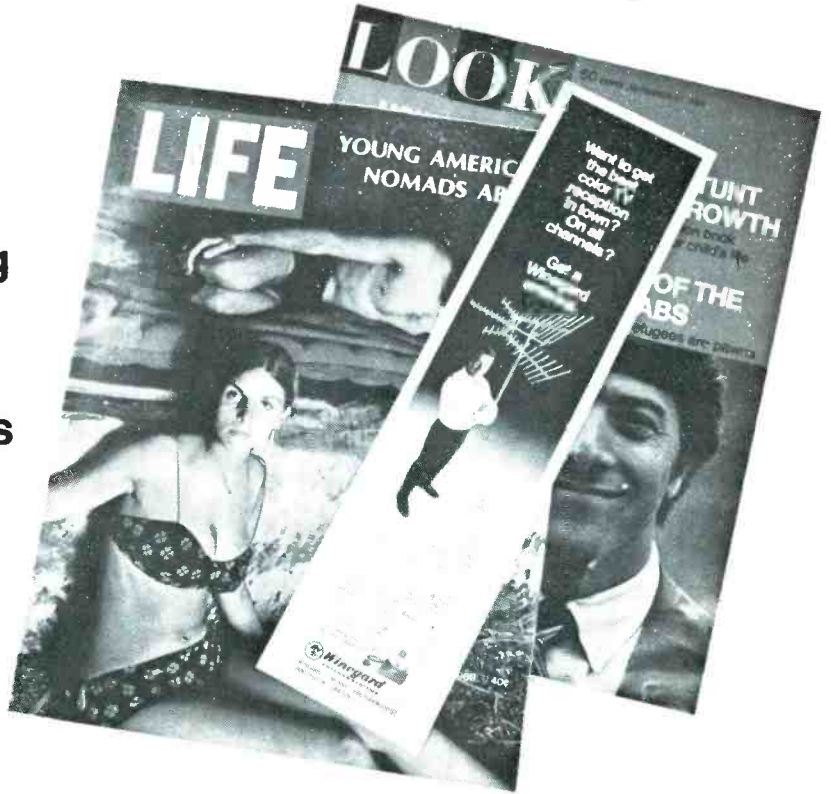

like a steady
stream of new
merchandising aids



AD MATS

BANNERS, BROCHURES



LIGHTED SIGNS

INDOOR ANTENNA DISPLAYS



© Copyright 1968



Circle 57 on literature card

WINEGARD PRESENTS SOMETHING NEW IN INDOOR TV ANTENNAS

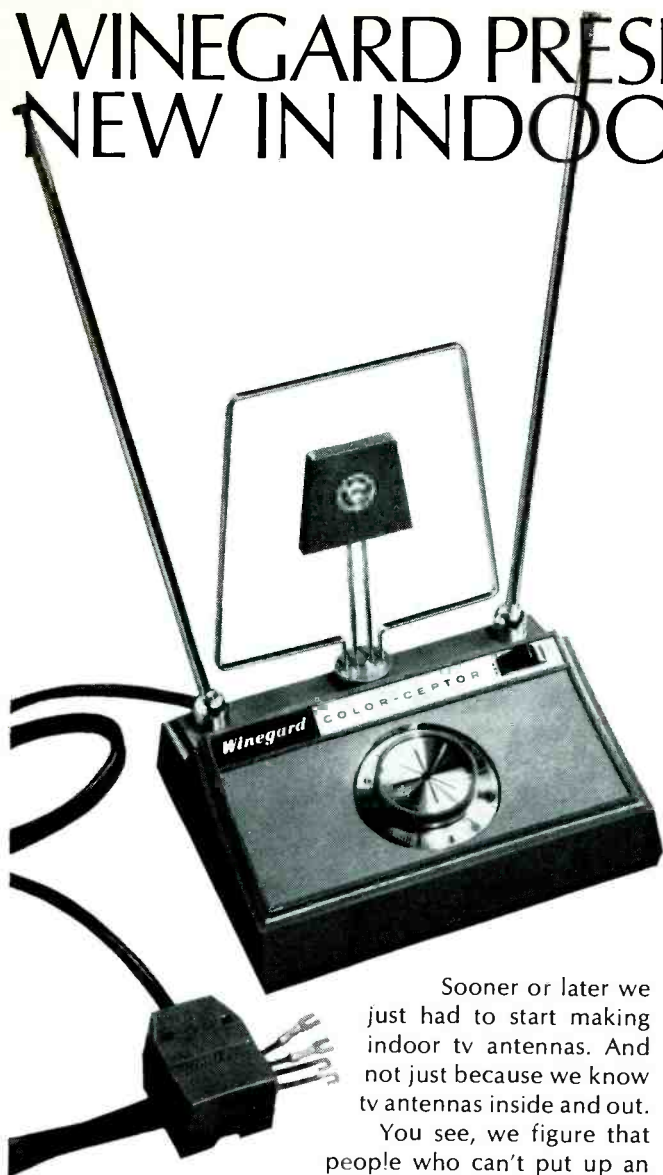

Sooner or later we just had to start making indoor tv antennas. And not just because we know tv antennas inside and out.

You see, we figure that people who can't put up an outdoor antenna shouldn't have to put up with anything less than the best reception. Especially in color.

And we can't understand why an antenna created to make color television look more colorful should make a room look drab.

So what we've done is create a complete line of low profile indoor antennas in decorator colors like avocado green, walnut brown, flame orange and shadow brown.

So much for the drab rooms.

As for the best possible reception (in color and black & white—and on all channels, 2 to 83) you'll find that our Color-Ceptor and Power-Beam antennas have what it takes to outperform and outsell everything else around.

Just what you'd expect from Winegard.

Exclusive ghost rejection color cable with built-in VHF/UHF signal filter. Our ultra-low-loss coaxial cable is electrically shielded to actually "shut-out" ghosts and to effectively eliminate electrical interference from cars and airplanes and appliances, among other things. The built-in signal filter eliminates the need for separate wires from the antenna to the VHF and UHF terminals on the back of the set; and automatically filters the VHF and UHF signals to help deliver the best possible color reception.

Then there's the *chrome-plated UHF driven element.*

featuring the CR-200...
The Coaxial Indoor Antenna for color tv with exclusive ghost rejection color cable and built-in VHF/UHF signal filter!

It's precision tuned to capture and deliver more signal to all UHF channels, 14 to 83. It rotates (without moving the antenna) to pick-up maximum signal. And its unique configuration assures the best color reception.

Our VHF/UHF isolation switch automatically separates VHF and UHF signals to help eliminate signal loss and interfering feedback common to color tv reception.

And there's the 12-position fine tuning signal control switch which allows for fast, accurate control of the color picture quality (black & white, too) on all VHF and UHF channels.

All those features, plus 45" long telescoping chrome-plated VHF dipoles; rubber cushioning pads; and, of course, colors and styling make our Color-Ceptor (CR-200) the finest indoor color tv antenna made.

List price is \$14.95, Fair Trade.

The CR-100 Color-Ceptor has most of the same matchless features, except for the color cable, signal filter and isolation switch. Plus a list price that's hard to match. \$11.95, Fair Trade.

The two antennas in our Power Beam series (PB-60 and PB-40) are designed for outstanding all channel reception (2 to 83) VHF and UHF.

They offer a bit less in the way of features, and a lot less in the way of price. The PB-60 is \$9.95, Fair Trade. Only \$6.95 Fair Trade for the PB-40.

We believe you'll think a lot of our Color-Ceptor and Power-Beam antennas. We do.

So much, in fact, that we're advertising them in Life and Look. And unconditionally guaranteeing them with a 10-day money back guarantee.

We don't expect to get any of them back. But if you expect to get any of them to sell, we suggest that you call your Winegard distributor or write for complete information today.



Winegard
ANTENNA SYSTEMS

© Copyright 1968, Winegard Company, Burlington, Iowa

Winegard Company • 3000 Kirkwood St. • Burlington, Iowa 52601

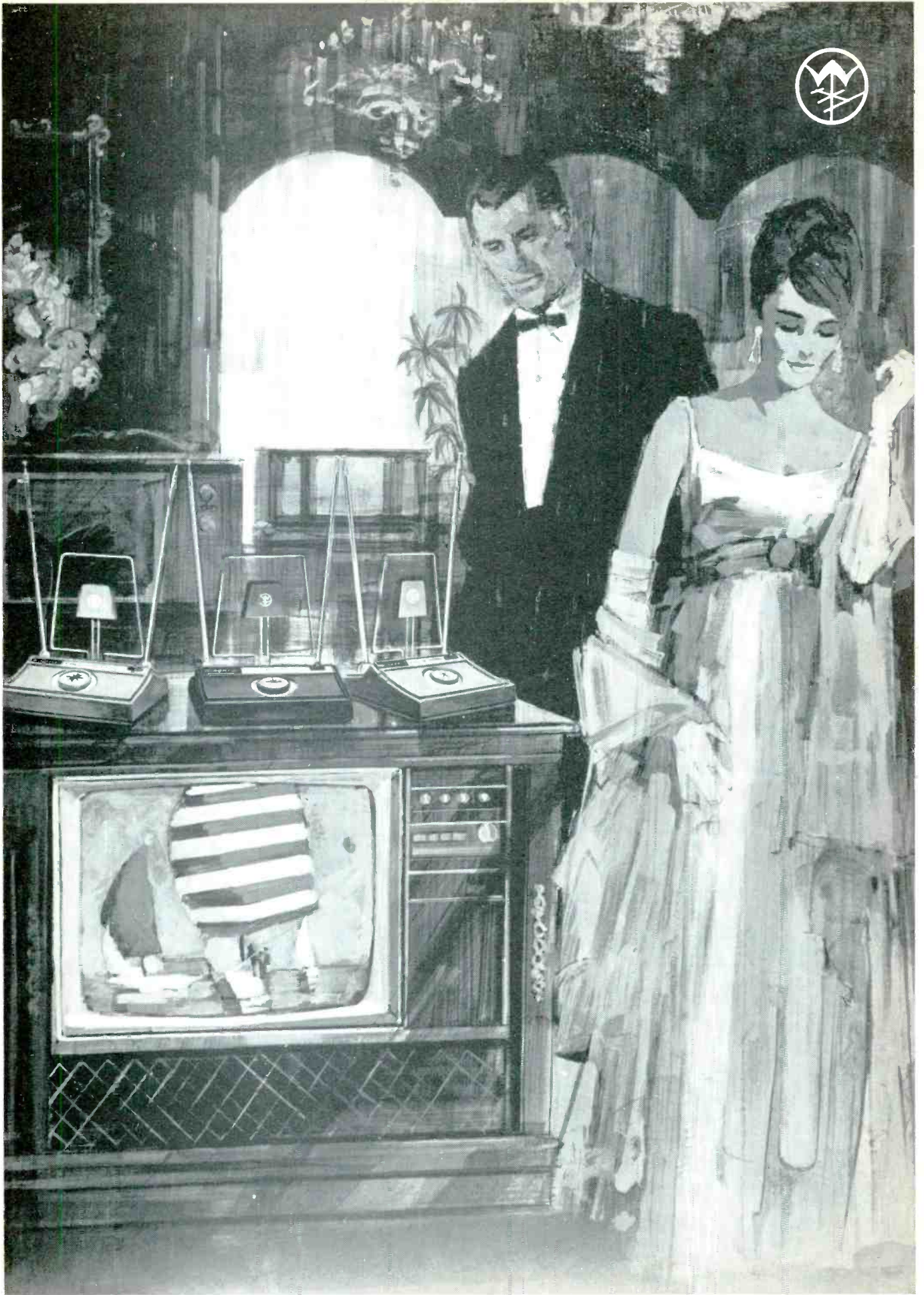

Circle 58 on literature card



123R CARDMATIC TUBE TESTER—Automatic tube testing using card-programmed switch, eliminates errors. A fast, automatic tube tester which includes tests for saturation and cut-off in addition to mutual conductance.

\$655.00

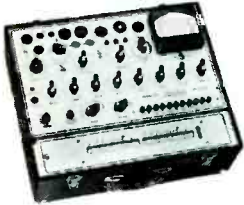

580A TUBE TESTER— Entirely new. Can be set up to any test condition, including handbook parameters. Also includes built-in roll chart. Features ultra-sensitive grid condition test with sensitivity to 0.05%.

\$585.00



539C TUBE TESTER— Laboratory and industrial instrument. Provides both handbook condition tests and tests "tailored" to specific individual conditions. Roll chart data.

\$545.00

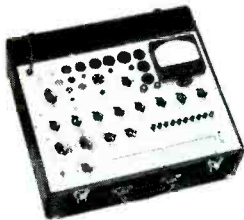

752A TUBE TESTER— Communications and industrial maintenance instrument. Includes tests for 4-digit industrial tube types, VR tubes, and low power thyatrons. Best buy for general purpose industrial maintenance. Roll chart data.

\$385.00



6000A TUBE TESTER— Service technician's high-speed, portable tester. Tests all popular entertainment types, also transistors and diodes. Time-saving leakage and short indicators. Replaceable socket plate for obsolescence protection. Roll chart data.

\$259.50

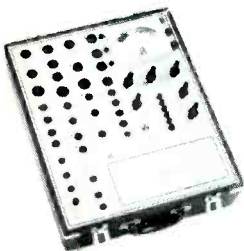

799 MULTI-SOCKET TUBE TESTER— Ideal for television service and repair. Provides true mutual conductance tests with no paralleled elements. Solid state sensing circuit provides 50 megohm leakage tests, 0.1 μ a gas and grid emission tests. Replaceable panel plate for future tube additions.

\$199.95

THE HICKOK ELECTRICAL INSTRUMENT COMPANY
10514 Dupont Avenue • Cleveland, Ohio 44108

Circle 35 on literature card

Waveform Quiz

Here is a short photo quiz to test your skill at interpreting scope waveforms. Six different waveforms are shown in pairs. One waveform in each pair is normal and the other is abnormal. Select the abnormal waveform in each pair, and from your own analysis determine what trouble symptom is most likely to appear on the screen of the receiver. The answers appear on page 60.

Scope point:
output of
sync separator

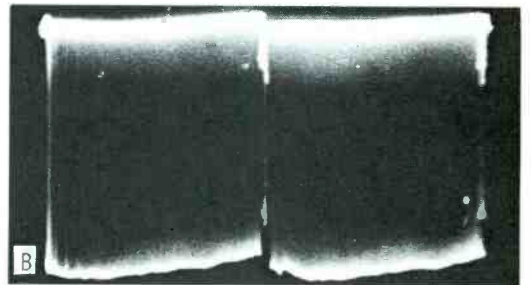
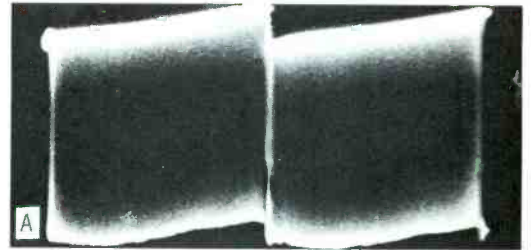

Scope point:
output of
sync separator

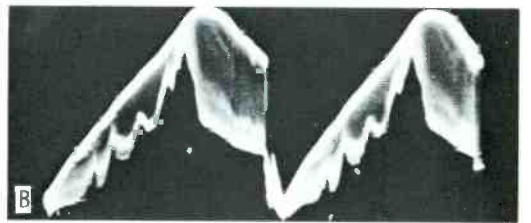
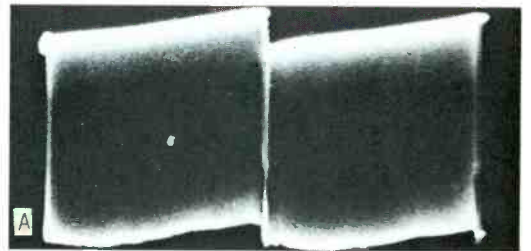

Scope point:
video input to
sync separator

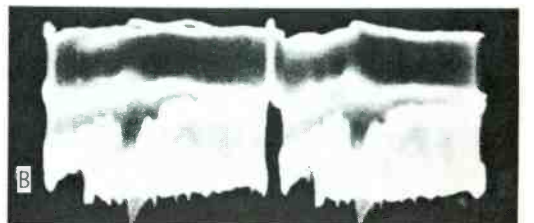
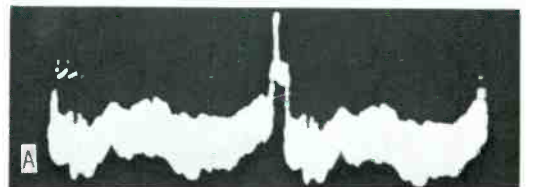

Back by popular demand-Another 1968 Krylon Giveaway



Win a can of
Krylon 1302.

Or

\$100.

Simply fill in the coupon below.

If you become our lucky winner, we have a pretty good idea what prize you'll choose. But we figure it this way: If you win \$100 on us, chances are you'll spend \$1.95 on us — for Krylon.[®]

(That way, you'll be a two-time winner.)

And while we've got you thinking about Krylon, think about our whole line of sprays. They're standard equipment for all TV/Radio installation and repair work.

Entry rules:

1. No purchase necessary. Print your name and address on entry coupon and mail to: Krylon Contest—Dept. 300 St. Clair Associates, 485 Madison Ave., New York, N.Y. 10022.
2. Entries must be postmarked no later than November 30, 1968.
3. Winner will be selected in random drawing by St. Clair Associates, whose decision will be final.
4. 1968 Krylon Giveaway is open to anyone in the U.S. except in Wisconsin and where prohibited or restricted by law. Employees (and their families) of Borden Inc, its affiliates and advertising agencies, or St. Clair Associates are not eligible.



Krylon Contest—Dept. 300
St. Clair Associates
485 Madison Avenue
New York, New York 10022

If I win, I'd prefer:

The Krylon The Cash

Name _____

Street _____

City _____

State _____ Zip _____

The number on the bottom of my Krylon can is _____

I don't use Krylon.



Circle 39 on literature card

analysis of test instruments . . . operation . . . applications

NOTES ON TEST EQUIPMENT

by ELLSWORTH LADYMAN

Vectorscopes

The vectorscope promises to take a lot of the mystery out of chroma circuits. Vectors, phase angles, etc.,

have always seemed a cloudy issue to the majority of service technicians. The ability of the vectorscope to display a vector pattern on the scope screen allows the service

technician to develop a variety of new service techniques to provide faster and more efficient service. It can be used for alignment and troubleshooting procedures throughout the chroma circuitry. By viewing the "petals" displayed on the screen, color alignment, tint range and possibly bandpass touch-up can be performed.

Fig. 1 Vectorscope patterns.

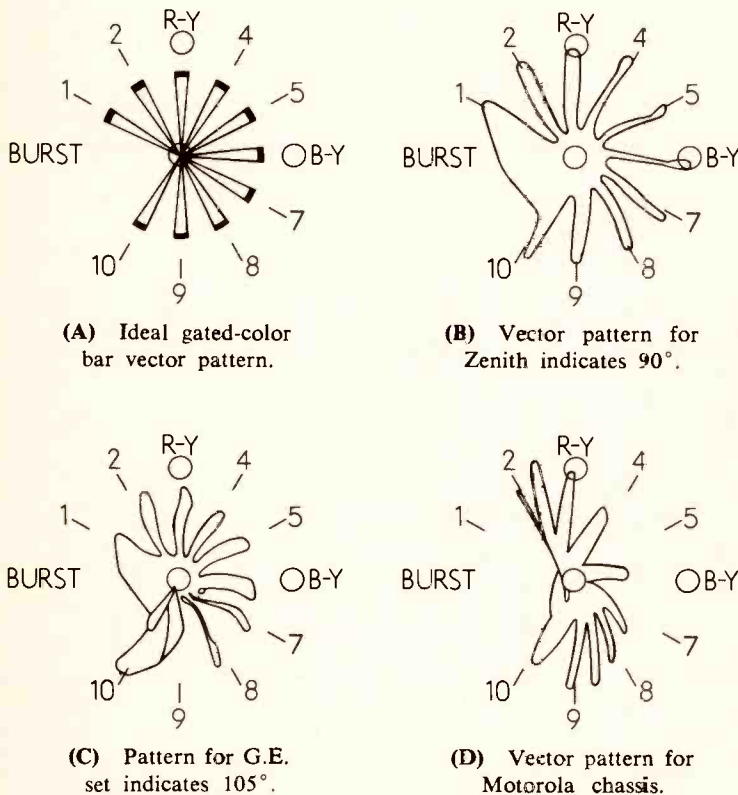

Vector Pattern

The vector pattern is obtained by connecting a color bar generator to the receiver in the conventional manner. R-Y and B-Y signals from the receiver CRT grids are then applied to the vectorscope. The pattern obtained is dependent upon the color bar system used. This discussion will be concerned with the gated color bar system, although, if the operator understands the system he is using, other systems may be used.

The gated color bar system produces the vector pattern illustrated in Fig. 1. This is an ideal pattern for demonstration purposes and will seldom be displayed under practical conditions. The ten petals indicate the ten color bars generated by the color bar generator, amplified and demodulated by the receiver circuitry. The vector pattern provides visual evidence of how effectively the receiver circuitry is responding to the input signal. The positions of the petals on the screen indicate the angle of demodulation. If the third

Know why RCA's color chassis are so easy to service?

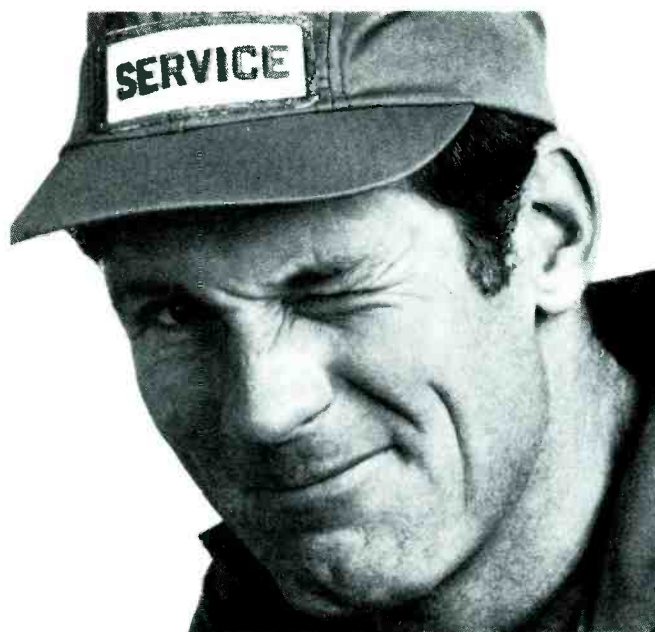

Because service men like you helped us design them.

First we got their advice, then we designed the whole assembly for easy servicing. For example, the chassis give you easy access. You don't have to pull out the chassis to get at the high-line voltage connection. Circuits and components on the circuit board are clearly marked so you can easily service them. The tuner assemblies are simplified for your convenience. And, we set up more test points. They're the kind of chassis we think you'd design yourself. Fact is, all our chassis designs are reviewed by a representative group of servicemen. And we appreciate their advice. We think you will, too—every time you service sets by RCA.

RCA

WORKMAN
believes
 that they make
 the best circuit
 breakers in the
 industry and
 are willing to
 send you one
FREE
 to prove it.

WORKMAN *Electronic*
 P.O. BOX 3828 SARASOTA, FLORIDA 33578 PRODUCTS, INC.

MANUFACTURES A
 COMPLETE LINE OF

FAIL SAFE
 IN
**MOLDED
 BLACK
 PLASTIC
 CASE**
**CIRCUIT
 BREAKERS**

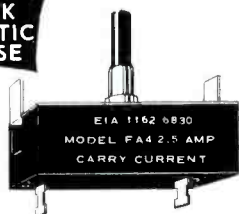

Model Numbers FA1.5 to FA7

When Red Button is depressed,
 contacts remain open, circuit is
 refused **ONLY** after Red Button
 is released.

RECOGNIZED UNDER THE
 COMPONENT PROGRAM OF

**UNDERWRITER'S
 LABORATORIES, INC.**

Circle 37 on literature card

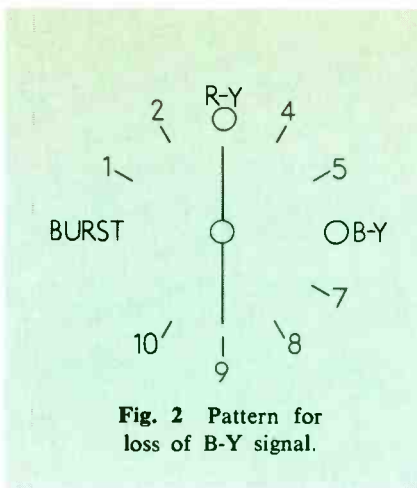

Fig. 2 Pattern for loss of B-Y signal.

and sixth petals fall on the R-Y and B-Y points on the graphs, respectively, the demodulation angle is 90 degrees. Should the sixth petal fall approximately halfway between the B-Y and the No. 7 point on the graph, the demodulation angle is 105 degrees. This knowledge of petal position on the vector display provides the service technician with a simple and fast method of adjusting the demodulation angle. This is accomplished by adjusting the injection transformer slug while viewing the vector display. The demodulation angle can be varied from 90 to 116 degrees and should be adjusted to conform to the manufacturer's specifications.

Tint Range Control Adjustment

The tint range of a specific color receiver can be easily checked using the vectorscope. While viewing the vector pattern on the scope, rotate the tint control. The third petal should move in accordance with rotation of the tint control through an arc 30 degrees each side of the R-Y point on the graph. Should the third petal fail to move in the arc as outlined, the tint range should be adjusted as follows: Set the tint range control to the exact physical center of its range and adjust the tint or hue transformer slug until the third petal is centered on the R-Y point of the graph.

3.58-MHz Oscillator Adjust

While viewing the vector pattern, short out the chroma reference oscillator control signal. If the vector pattern rotates in the manner of a wheel turning, the 3.58-MHz oscillator requires adjustment. Adjust the

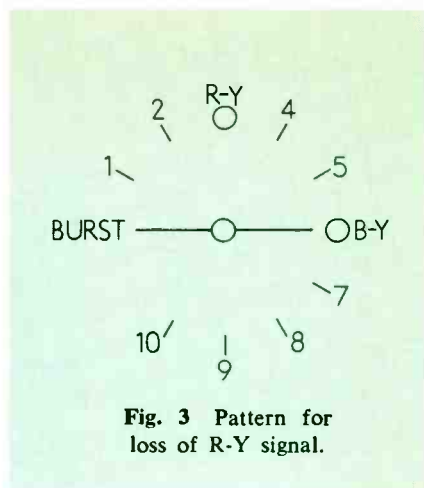

Fig. 3 Pattern for loss of R-Y signal.

oscillator slug until the vector pattern "locks-in" or slows to its slowest rotation. With some types of oscillator control circuits, the vector pattern will not rotate as a wheel turns but will pulsate from a minimum to a maximum.

Symptoms

Loss of B-Y signal is illustrated in Fig. 2. This straight vertical line indicates a loss of blue, and trouble can be expected in either the B-Y demodulator circuit or in the matrix system.

Loss of R-Y signal is illustrated in Fig. 3. The indication is a straight horizontal line across the screen. Trouble can be expected in either the R-Y demodulator circuit or in the matrix system.

The G-Y signal is not used in obtaining the vector pattern. Therefore, when a complete vector pattern is visible on the screen and the complaint is "loss of green," it fol-

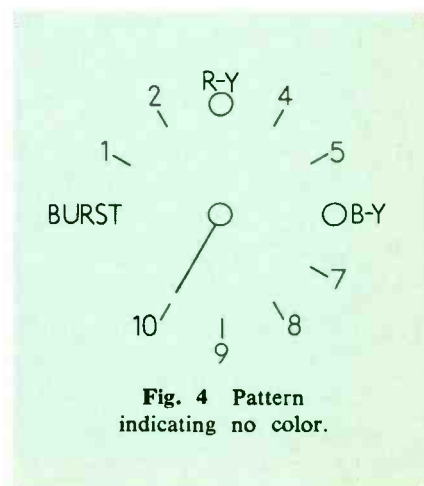
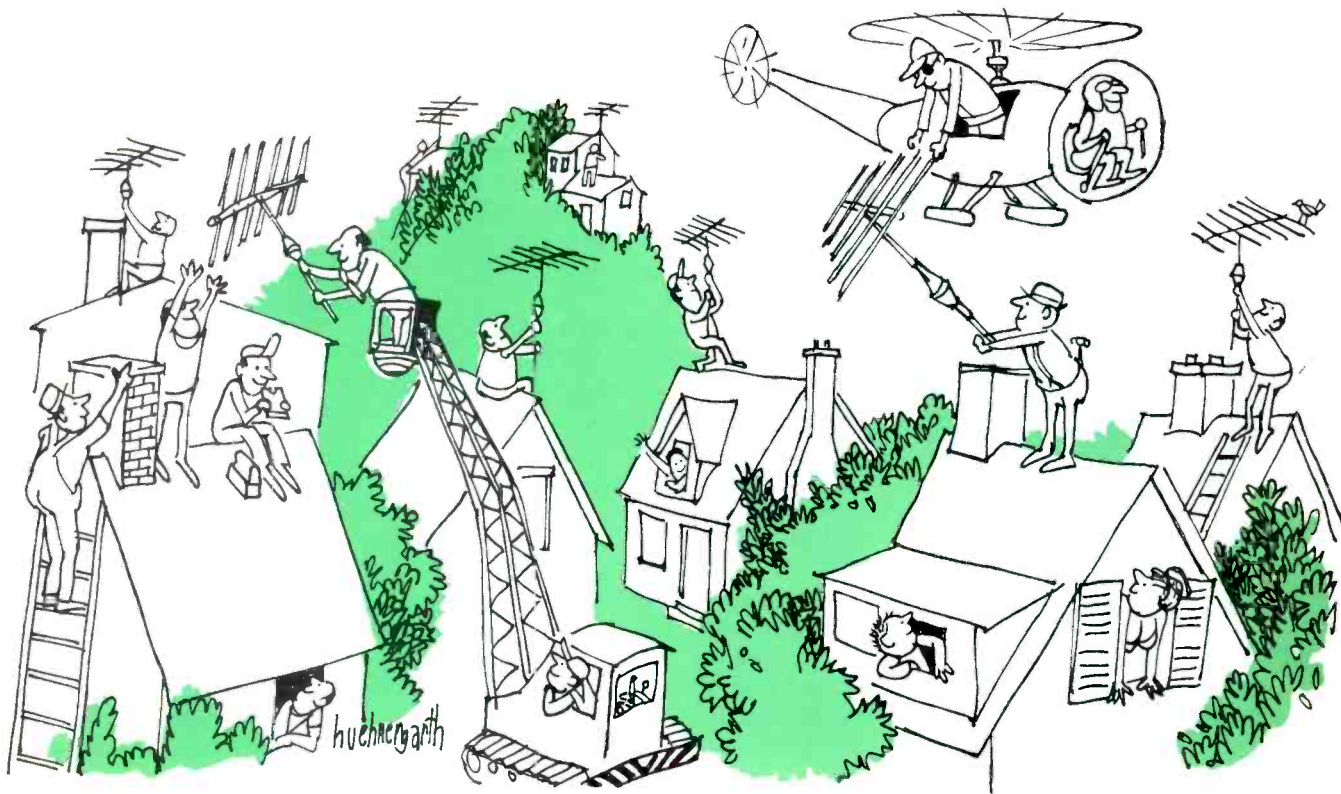

Fig. 4 Pattern indicating no color.

Join the rotor revolution...



with the fast-selling new Jerrold

DYNA ROTOR™



Orders are rolling in for the new Jerrold DYNA-ROTOR—fast. We're not surprised, for here... at last... is a profit-making rotor you can rave about:

- Combines all solid-state circuitry with unique dynamic spline drive
- Fully automatic rotor moves quickly—and precisely—to the point where it is aimed by the control unit—never loses synchronization, never drifts
- High torque drives through ice, snow, and high winds
- Rotates 360° in less than 40 seconds—fastest rotor available
- Kitten-quiet solid-state control unit. No clacking. No whirring. No relays, switches, solenoids, or escapements

- No lubrication required—operates reliably at -20°F
- Lightweight, easy-to-install rotor weighs only 5 pounds
- Consumes less than 1/10th the power of other rotors
- Decorator-designed control unit
- Streamlined aluminum rotor case—in-line design

What more could you ask? Ask for the special deals now available for Jerrold DYNA-ROTOR. See your Jerrold Distributor today or write Jerrold Electronics Corporation, Distributor Sales Division, P.O. Box A, Philadelphia, Pa. 19105.



Focusing on one thing... better reception

a GENERAL INSTRUMENT company

Circle 38 on literature card

FIX COLOR TV

FAST! Stay ahead
in Color TV—

Join the
P.O.M. Club!
(Photofact-of-the-Month Club)

only **PHOTOFACT**[®]
gives you the up-to-the-
minute data and know-how
you need to perform expert
Profitable Color TV Servicing



- 6 new Photofact Sets each month
- 6 to 9 Color TV Folders monthly
- Coverage of at least 50 new chassis
- Includes current b/w TV, Stereo Hi-Fi, Phonograph, and Record Changer Models

plus this big "Bonus":

Exclusively for P.O.M. subscribers—a minimum of 10 "advance" TV schematics (mostly Color) with each month's issue.

Join the P.O.M. Club!

**Act today—see your
SAMS Distributor**

allows that trouble can be expected in the G-Y demodulator or matrix system.

There are still many service problems that a vectorscope will not isolate. A good wide-band scope will still be required in color servicing. However, the addition of a vectorscope to your equipment inventory will cut service time on many jobs, resulting in faster, more efficient and more complete repair jobs.

Sencore Model PS-148

The Sencore Model PS-148 is a dual purpose instrument, combining the features of a wide-band and vector scope in a single unit. Very quick conversion from a wide-band oscilloscope to a vectorscope is accomplished by flicking two slide switches located on the rear apron of the cabinet. The test leads can be connected to the R-Y and B-Y chroma circuits or directly to the red and blue grids of the CRT. Circuit loading is kept to a minimum, preventing undue distortion of the vector pattern. Lead lengths and proximity capacitance are reduced to a minimum through the use of the rear vectorscope connections. The wide-band scope utilizes the features of the Sencore Model PS-127 previously covered in the May '65 issue of PF Reporter. Price of the unit is \$219.95. ▲

Sencore Model PS-148

Features

Peak to Peak Voltage Measurements

Peak to peak voltages are read directly.

Frequency Response

Vertical amplifier frequency response is from 10 Hz to 5.2 MHz ± 1 dB. Rise time of .055 microseconds.

Sensitivity

0.17 volts RMS per inch vertical deflection.

Horizontal Sweep Frequencies

Horizontal sweep ranges 5 Hz to 500 KHz in 5 overlapping ranges. TV horizontal and vertical ranges are preset on coarse control.

Input Impedance

27 megohms shunted by 9 pf (Lo-Cap probe)

2.7 megohms shunted by 99 pf (Direct probe)

Horizontal Frequency Response

3 dB from 10 Hz to 650 KHz

Standby Switch

Cuts instrument to half power when not in use and provides "instant on" when required.



Fig. 5 Sencore Model PS148 vectorscope.

More than 5 million two-way transmitters have skyrocketed the demand for service men and field, system, and R & D engineers. Topnotch licensed experts can earn \$12,000 a year or more. You can be your own boss, build your own company. And you don't need a college education to break in.

HOW WOULD YOU LIKE to earn \$5 to \$7 an hour...\$200 to \$300 a week ... \$10,000 to \$15,000 a year? One of your best chances today, especially if you don't have a college education, is in the field of two-way radio.

Two-way radio is booming. Today there are more than *five million* two-way transmitters for police cars, fire trucks, taxis, planes, etc. and Citizen's Band uses—and the number is growing at the rate of 80,000 new transmitters per month.

This wildfire boom presents a solid gold opportunity for trained two-way radio service experts. Most of them are earning \$5,000 to \$10,000 a year *more* than the average radio-TV repair man.

Why You'll Earn Top Pay

One reason is that the U.S. doesn't permit anyone to service two-way radio systems unless he is *licensed* by the FCC (Federal Communications Commission). And there aren't enough licensed experts to go around.

Another reason two-way radio men earn so much more than radio-TV service men is that they are needed more often and more desperately. A two-way radio user *must* keep those transmitters operating at all times, and *must* have them checked at regular intervals by licensed personnel to meet FCC requirements.

This means that the available li-

censed expert can "write his own ticket" when it comes to earnings. Some work by the hour and usually charge at least \$5.00 per hour, \$7.50 on evenings and Sundays, plus travel expenses. Others charge each customer a monthly retainer fee, such as \$20 a month for a base station and \$7.50 for each mobile station. A survey showed that one man can easily maintain at least 15 base stations and 85 mobiles. This would add up to at least \$12,000 a year.

How to Get Started

How do you break into the ranks of the big-money earners in two-way radio? This is probably the best way:

1. Without quitting your present job, learn enough about electronics fundamentals to pass the Government FCC License. Then get a job in a two-way radio service shop and "learn the ropes" of the business.

2. As soon as you've earned a reputation as an expert, there are several ways you can go. You can move out, and start signing up your own customers. You might become a franchised service representative of a big manufacturer and then start getting into two-way radio sales, where one sales contract might net you \$5,000. Or you may be invited to move *up* into a high-prestige salaried job with one of the same manufacturers.

The first step—mastering the fundamentals of Electronics in your spare time and getting your FCC License—can be easier than you think.

Cleveland Institute of Electronics has been successfully teaching Electronics by mail for over thirty years. Right at home, in your spare time, you learn Electronics step by step. Our AUTO-PROGRAMMED™ lessons and coaching by expert instructors make

everything clear and easy, even for men who thought they were "poor learners." You'll learn not only the fundamentals that apply to all electronics design and servicing, but also the specific procedures for installing, troubleshooting, and maintaining two-way mobile equipment.

Your FCC License... or Your Money Back!

By the time you've finished your CIE course, you'll be able to pass the FCC License Exam with ease. Better than nine out of ten CIE graduates are able to pass the FCC Exam, even though two out of three non-CIE men fail. This startling record of achievement makes possible our famous FCC License Warranty: you'll pass the FCC Exam upon completion of your course or your tuition will be refunded in full.

Find out more. Mail the bound-in post-paid card for two FREE books, "How To Succeed In Electronics" and "How To Get A Commercial FCC License." If card has been detached, send your name and address to CIE at the address below.

ENROLL UNDER NEW G.I. BILL

All CIE courses are available under the new G.I. Bill. If you served on active duty since January 31, 1955, or are in service now, check box on card for G.I. Bill information.



Cleveland Institute of Electronics

1776 E. 17th St., Dept. PF-52
Cleveland, Ohio 44114

How to get into one of today's hottest money-making fields—servicing 2-way radios!



He's flying high. Before he got his CIE training and FCC License, Ed Dulaney's only professional skill was as a commercial pilot engaged in crop dusting. Today he has his own two-way radio company, with seven full-time employees. "I am much better off financially, and really enjoy my work," he says. "I found my electronics lessons thorough and easy to understand. The CIE course was the best investment I ever made."

Circle 36 on literature card



Business is booming. August Gibbemeyer was in radio-TV repair work before studying with CIE. Now, he says, "we are in the marine and two-way radio business. Our trade has grown by leaps and bounds."

NEW

GOOD BAD

Transistor Testing... in or out-of-circuit!

- No guesswork or confusion
- No numerical readings to interpret.



NEW LECTROTECH TT-250 TRANSISTOR ANALYZER

One Year Warranty

IN-CIRCUIT TESTS. Positive Good/Bad in-circuit and out-of-circuit testing. No numerical readings to interpret. In-circuit testing is a measurement of dynamic AC gain. No transistor leads to unsolder or disconnect.

OUT-OF-CIRCUIT-TESTS (BETA OR GAIN). Measures transistor Beta or Gain on 2 scales: 0 to 250 and 0 to 500. Automatic biasing... no calibration required.

LEAKAGE. Measures transistor leakage. (I_{cbo}) directly in microamperes.

DIODES AND RECTIFIERS. Measures reverse leakage and forward conduction directly to determine front-to-back ratio.

POWER TRANSISTORS. Simple Good/Bad test instantly determines condition of power transistors. Power Transistor Socket on panel for ease of testing.

ELECTROLYTIC CAPACITORS. Measures leakage current of transistor electrolytics at a test voltage of 6 volts.

PNP OR NPN determined immediately... no set-up book needed for testing.

NON-DESTRUCTIVE TESTING. Regardless of misconnections, you cannot damage transistors or components tested.

SPECIFICATIONS

• Large easy to read 6" meter • 3 color-coded test leads with self-storing feature • Power and Milliwatt Sockets on panel for ease of out-of-circuit testing • Zener Diode Regulated Power Supply • All steel case • Size: 10½" x 7" x 4" • Wt. 5½ lbs. • 115 volts, 60 cycles.

NET 87⁵⁰



See your distributor or write . . . DEPT. PF-10

LECTROTECH, INC.

1221 W. Devon Ave., Chicago, Illinois 60626

Circle 40 on literature card

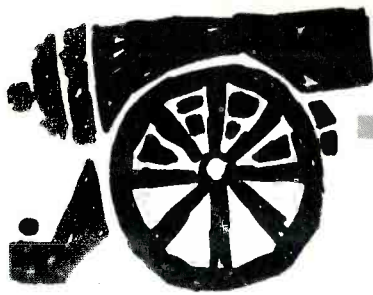

THE TROUBLESHOOTER

Multiple Troubles In a Sylvania

I recently ran across the following troubles in a Sylvania DO5-1 chassis:

1. The raster was reduced an equal distance from both top and bottom. Replacing the vertical output tube did not cure the trouble, so the chassis was pulled. Troubleshooting uncovered the incorrect voltages shown in the illustration here. The particularly unusual voltage on the grid of V8A focused attention on the feedback line. It was soon discovered that C58 was defective. Replacing this capacitor restored the full raster.

2. After operating for 15 minutes, the sound became distorted and the bottom portion of the picture turned excessively light and appeared to be "washed out." Also, a slight vertical roll and horizontal wiggle developed. A scope check of the composite video signal at the grid of the first video amplifier revealed the presence of hum riding on the signal. The video IF tubes were replaced one at a time. The hum and trouble

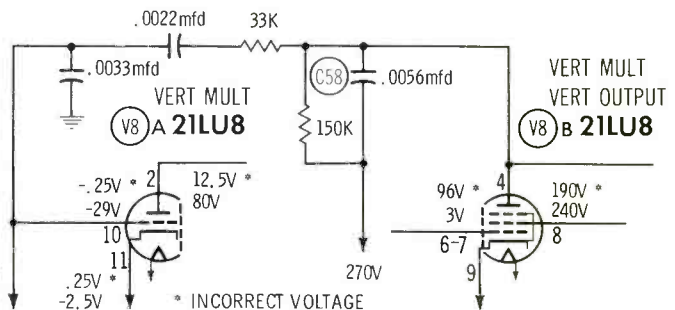

symptoms disappeared when the first video IF tube was replaced. This tube had previously checked normal on a tube tester.

3. Red was missing on the color-bar generator test pattern. Attaching the scope probe to the plate circuit of the R-Y amplifier showed that the R-Y signal was present and normal at this point. Probing the CRT base cap uncovered a loose connection.

R. J. HORSLEY

Buffalo, N. Y.

Horizontal Sweep

My problem is with a Hotpoint Model 21S407 (Photofact Folder 387). The receiver works well for about 20 minutes, then the high voltage starts decreasing and the picture narrows. After approximately 45 min-

ARE YOU A WINNER?

DEALER APPRECIATION CERTIFICATE

Serial Number



Receiving Tubes You Can Trust

This certificate has no cash value, but the radio/television service dealer in possession of this certificate may be a winner in Raytheon's 1968 Dealer Appreciation Program which ends September 30, 1968.

YOU ARE

—if you have a Raytheon Dealer Appreciation Certificate bearing any one of these 104 numbers:

1680	10050	12390	15092	18079
2070	10053	12574	15145	18168
4637	10129	12780	15151	18200
8100	10134	12863	15245	18210
8181	10580	12919	15455	18247
8226	10791	12994	15510	18309
8237	10810	13075	15905	18377
8290	10845	13209	15955	19025
8389	10930	13286	16000	19229
8555	10997	13526	17005	19233
8600	11035	13978	17073	19327
8723	11091	14007	17199	19423
8939	11111	14019	17211	29229
8981	11215	14101	17329	30897
9009	11380	14123	17362	33261
9048	11577	14179	17440	33397
9333	11607	14749	17600	35785
9650	11776	14797	17619	36900
9899	11888	15000	17706	37877
9958	12009	15037	18007	38088
9961	12127	15065	18030	

New! Ask your distributor about Raytheon's Stanley tools for box tops promotion!

Just take your prize-winning certificate to your Raytheon distributor. He'll make all arrangements to get your prize—whether a color TV set, golf clubs, savings bond, or one of many others—promptly to you.

Lucky you! You're always a winner with reliable Raytheon receiving tubes. *Raytheon Company, Receiving Tube Operation, Fourth Avenue, Burlington, Massachusetts 01803.*

Remember to ask "What else needs fixing?"



Circle 43 on literature card

on again, and horizontal output current will stabilize at 210 ma and remain constant for days or even weeks.

We have checked the output circuit completely, monitored it with meters, and substituted components. The trouble symptom only occurs when the receiver is first turned on. We have disconnected the degaussing coil and shorted the thermo switch. This has no effect.

C. B.

Redwood City, Calif.

Your description of the trouble symptom was long on remedial action, but extremely short on symptom evidence. However, here is a suggestion that might be of some help. It appears that your horizontal oscillator is slow in taking off. You didn't say whether or not you had drive voltage on the output tube at the times it was drawing excessive current. I'm betting that the off-on action that seems to remedy the current drain on the output tube is accomplishing this by shocking the horizontal oscillator into oscillation.

Arcing CRT Solved

While reading The Troubleshooter column of the August PF Reporter, I came upon the call for help from Mr. H. Gustafson, relating his trouble with an old Muntz TV set. The trouble is neither the fishpaper nor a gassy CRT. If Mr. Gustafson will open the high-voltage cage, he will find that the 1B3 is standing on a porcelain insulator. Replacing this insulator will solve his problem.

Such insulators eventually pick up enough moisture and dust to cause intermittent arcing, with the result that the whole chassis is hot with respect to the CRT. You can actually burn holes in the aquadag with the grounding springs.

I first encountered this particular problem when I entered the electronics servicing business in 1954. Three of us wasted a lot of time on this problem. We went so far as to change the yoke and flyback with no results other than a knowledge of what was **not** the trouble. I have since run across this same trouble twice and each time the trouble became evident after the CRT had been replaced.

RANDAL W. HOWARD

Dover, N. J.

(Answers to Waveform Quiz)

1. B is the abnormal waveform; A is normal. The prime clue is the attenuation of the vertical sync pulses in B (large white area at lower right of each portion of waveform represents the vertical sync tips). Critical vertical sync would be the screen symptom.

2. B is abnormal waveform; A is normal. The most obvious clue here is the distorted base line in B and the fact that the amplitude of the horizontal sync varies with the level of the incoming video signal. Horizontal sync would be unsteady.

3. A is abnormal waveform; B is normal. There is virtually no visual indication of horizontal sync in this waveform, although vertical sync is present. Very unstable horizontal hold action would result from the defect associated with waveform A.

PHOTOFACT BULLETIN™

PHOTOFACT BULLETIN lists new PHOTOFACT coverage issued during the last month for new TV chassis. This is another way PF REPORTER brings you the very latest facts you need to keep fully informed between regular issues of PHOTOFACT Index Supplements issued in March, June, and September. PHOTOFACT Folders are available through your local parts distributor.

Arvin	Chassis 1.48101	989-1
Bradford	CATV-55335	990-1
Catalina	122-741A, 122-732A, 122-774A, 122-775B	988-1
Coronado	TV2-7109A	987-1
Curtis Mathes	Chassis CMC21 Series (AFC, Remote Version)	990-2
Electrohome	Chassis C4	991-1
RCA	Chassis CTC22AA, CTC22D	988-2
	Chassis CTC28E/F	991-2
	Remote Control Receiver CTP12C, Transmitter CRK10A	991-2A
	Chassis CTC31C/D	987-2
	Remote Control Receiver CTP11H, Transmitter CRK9A	987-2A
	AL266W (Chassis KCS175A)	989-2
Sharp	CJ-45P	990-3
Truetone	WEG2865A-96/67A-96	988-3

Your next tuner cleaning job could cost somebody 15 bucks.

You.

You blow about 15 bucks every time you have a contact cleaning call back. Isn't it worth spending a few extra minutes to save that \$15 and your customer's good will? Then do the job right the first time with ContaCare Kit III. Unlike sprays that simply push the "gunk" around to dry and harden, ContaCare does a thorough cleaning and lubricating job. You just pour the special liquid cleaner on the lint-free cloth applicator and wipe away all film, dust and dirt. Then apply a little of our permanent lubricant to the contacts. The job's done—*right*. And you may have saved yourself \$15. ContaCare is non-flammable, non-conductive, and provides trouble-free results for both black & white and color sets. Properly used, ContaCare Kit III will provide you with over 100 cleanings. Available at parts distributors. Price \$1.98



HELPFUL TUNER SERVICE
TIPS INSIDE
EACH CARTON!

A valuable booklet on repair and servicing written by one of the world's largest tuner manufacturers is packed with each kit.

 *Standard Components*

DIVISION OF STANDARD KOLLSMAN INDUSTRIES, INC.
2085 North Hawthorne Ave. • Melrose Park, Illinois 60160

Circle 44 on literature card

October, 1968/PF REPORTER 61

Ten More Popular Color TV Coil Replacements

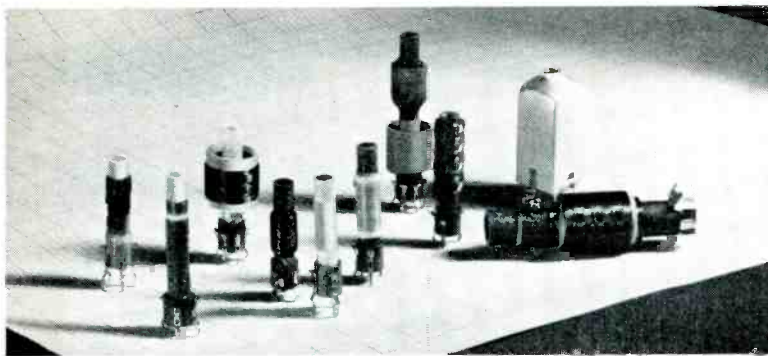

Cat. No.	Function	Manufacturer	Part No.
6355	Dynamic Convergence	Admiral	94C305-6
6058	Chroma Bandpass	Emerson	720563
6356	Blue Phasing	GE	ET36X789
6059	Burst Phase	Hoffman	109-033700
6357	Pin Cushion	Motorola	24C65127A90
6060	Chroma Take-Off	Philco	32-4878-2
6358	Horizontal Linearity	RCA	120794
6359	Horiz-Osc. & Waveform	Silvertone	10-88-5
7150	Sound Take-Off	Sylvania	50-16206-5
6061	3.58 mHz Osc.	Wells Gardner	9A2660-001



Write for your copy of Cross Reference Bulletin 1068

J.W. MILLER COMPANY

5917 South Main Street ■ Los Angeles, California 90003

SEE YOUR LOCAL DISTRIBUTOR FOR THE FULL LINE OF RF AND IF COILS, CHOKES, FILTERS AND TRANSFORMERS

Circle 45 on literature card

Product Report

For further information on any of the following items, circle the associated number on the reader service card.

Mixing Transformer (60)

Alco has introduced a "mix-n-match" transformer for installing monaural remote speakers to an existing stereo system.

The transformer receives audio signals from both the left and right stereo channels and mixes them together to provide a single monaural output without upsetting the original stereo separation. The balanced monaural signal can then be distributed to individual extension speakers throughout the house.

The transformer can also be used as a means of adding a center channel to an existing stereo system providing monaural sound to any outside location such as patios or pool areas where stereo sound is not effective. In addition, it may be used for matching low impedances and for phase reversal purposes.

THE BEST COLOR ANTENNAS FOR ALL AREAS!

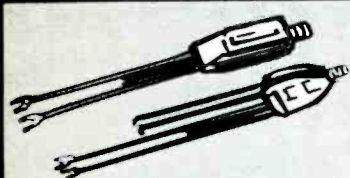

Universal 75-300 ohm Matching Transformers for every home, master antenna, and CCTV installation need!



"Secure-Lock" Gold Masts. Heavy gauge steel. With swaged end and "Secure-Lock." Economical "Lock-Seam" masts also available!



UHF Converters. New CR-800 has 30db Gain! Solid-state with powerful amplifier and Local, Distant Switch for all areas! Complete range of economical and performance proven models!

Indoor Antennas... top of the set, behind the set, and replacement rods.

ONLY RMS ANTENNAS FEATURE REYNOLDS ALUMINUM COLORWELD® THE MOST DURABLE GOLD FINISH!

UHF
VHF
FM

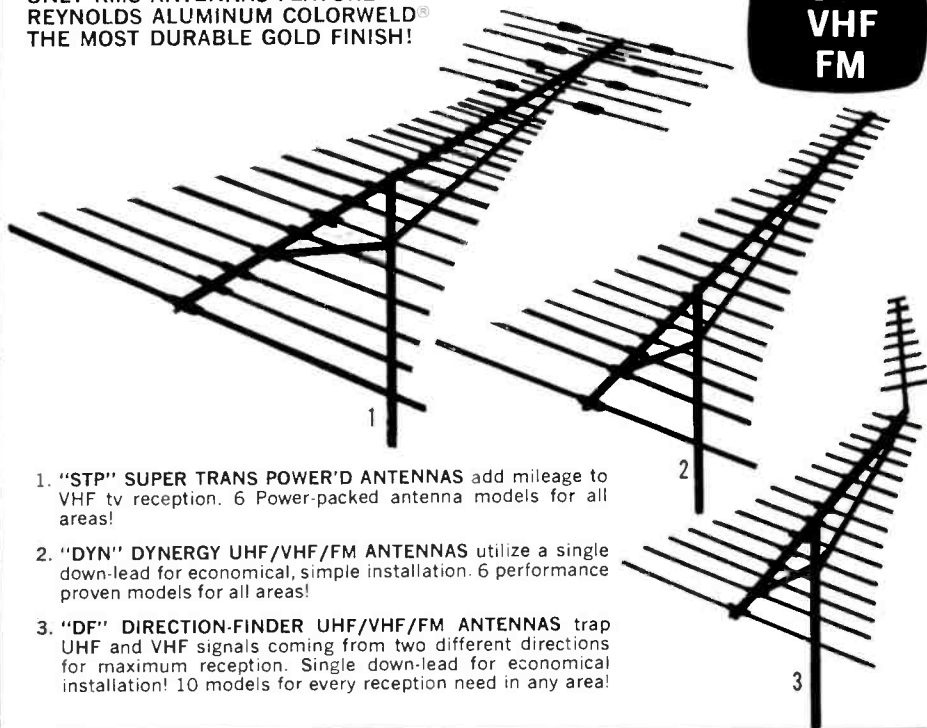

1. "STP" SUPER TRANS POWER'D ANTENNAS add mileage to VHF tv reception. 6 Power-packed antenna models for all areas!
2. "DYN" DYNERGY UHF/VHF/FM ANTENNAS utilize a single down-lead for economical, simple installation. 6 performance proven models for all areas!
3. "DF" DIRECTION-FINDER UHF/VHF/FM ANTENNAS trap UHF and VHF signals coming from two different directions for maximum reception. Single down-lead for economical installation! 10 models for every reception need in any area!

RMS ELECTRONICS, INC.

Write for complete Catalog.

50 ANTIN PLACE, BRONX, N. Y. 10462

Circle 46 on literature card

Roof Tower Line

(68)

South River, Inc. announces a new line of HDT tripod roof towers designed for color TV, FM and ham beam antenna installations. Suitable for mounting on either peaked or flat roofs, these heavy duty 1 1/4" O.D. tubular steel towers have adjustable slides to alter the tripod stance of each tower. The HDT tower line includes pitch patches for each tripod foot for a watertight, leakproof installation.

Scientific metal form blending at the flattened ends of each HDT tub-

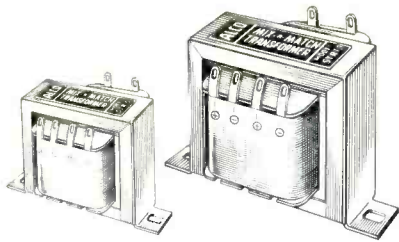
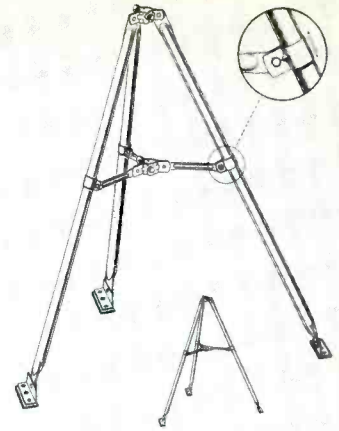

Specifications: frequency response 10-30,000 Hz (-3 db), impedance 8 ohms, ratio 1:1:1.

There are two models: STR-5 (5 watts RMS) at \$3.95 and STR-10 (10 watts RMS) at \$5.95.

Miniature Soldering Iron (61)

Caig, Inc. has added the Model 170, a miniature soldering iron, to their line. The unit is designed for printed circuits, micro soldering operations, plugs, relays, etc. It is equipped with a flexible cord, approximately 5 feet, pistol grip and table rest spacer.

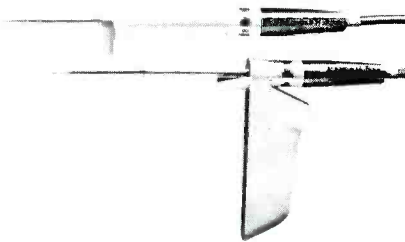

The unit comes in three sizes and two voltages: 8, 15, 25 watts each in 6 volts or 115 volts. Weights, less cord, range from 18 to 26 grams and heating time is from 60 to 90 seconds. Approximately eight different tip configurations are available in each wattage. Price ranges from \$4.87 to \$6.67.

Transformer (62)

A new Stancor standard isolation /power transformer is available from Essex Corp., Controls Division. The Stancor P-6411 reduces shock hazard by isolating equipment from the power line.

It is rated 117 volts to 117 volts

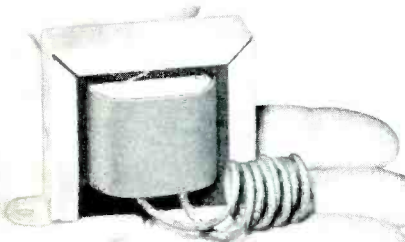

at 15 volts amps and is 2" x 3 1/4" x 1 7/8". The unit is priced at less than \$6.00.

SNOB

“ Jackson quality built for the technician who wants more—more accuracy, more speed, more profits. After all, test instruments are the most important equipment you own, so why not get the best. ”



\$24995

Model CRO-4—5" WIDE BAND OSCILLOSCOPE & VECTORSCOPE

The only 5 Mc oscilloscope in the medium-low cost class which permits the technician to measure the amplitude of waveforms (as in TV servicing) as easily as using a VTVM or a Volt-Ohm-Milliammeter. The "Readout" is an instant-removable graticule with 2 sets of calibrations exactly like a Meter scaleplate.

Model CRO-4 is also a complete VECTORSCOPE. It incorporates simplified vectorscope calibration facilities to insure correct Horizontal/Vertical vectorscope pattern proportion. In addition to standard graticule, model CRO-4 includes a special, uncluttered graticule only for vectorscope use.



\$14995

Model X-100—SOLID STATE COLOR GENERATOR

Extraordinary wide range of patterns (NTSC type colors) for faster, more accurate Color TV installation and servicing. Solid State stability under extreme temperatures, push button selector switches and many other quality features make this unit one you'll be proud to own.



\$8995

Model 810—DYNAMIC IN-CIRCUIT TRANSISTOR TESTER

Tests all transistors for A.C. BETA in circuit or out of circuit. Tests for leakage (Icbo). Tests diodes in and out of circuit. Exclusive features: Simplified pushbutton operation. Built-in transistorized signal-tracer generator. Plus many design advantages.



JACKSON ELECTRICAL INSTRUMENT COMPANY

35 WINDSOR AVENUE, MINEOLA, N. Y. 11501 • (516) 742-5400

CANADA: WILLIAM COHEN CORP., 8900 PARK AVE., MONTREAL 11
EXPORT: SINGER PRODUCTS CO., INC., 95 BROAD ST., N. Y. C. 10004, U. S. A.

Circle 14 on literature card



LOOKING FOR MINIATURE ELECTROLYTIC CAPACITORS

CALL

AEROVOX

CRE - MINIATURE ALUMINUM CASED ELECTROLYTICS

The modern replacement for a wide range of low-voltage, compact devices like transistor radios, hearing aids and tape recorders. Values from 1 mfd to 500 mfd, rated from 3 to 150 volts.



BCD - UPRIGHT MOUNTING BAKELITE CASE ELECTROLYTICS

The natural choice for solid-state equipment where printed wiring and tightly-cramped circuits make space a premium. BCD uprights are available in all popular capacities and working voltages from 3 volts to 50 volts.

PTT - AXIAL LEAD PLASTIC CASED ELECTROLYTICS

Small in size — Big in performance! Second only to metal cans in "no leak" reliability. Voltage ratings and capacities to suit any replacement need. "Polycap" cases permit reliable operation from -30°C to +65°C.



NEW AEROVOX AK530 ELECTROLYTIC CAPACITOR KIT

20 popular Type EKA upright mounting, plastic-cased miniature electrolytics in values from 1 to 500 mfd and voltages from 3 to 50 VDC. Perfect for those transistorized circuits in radios, recorders, musical instruments, etc. Packaged in compact, plastic box



that fits in tube caddy. Assortment contains \$28.00 worth of capacitors and dealer cost is only \$7.95.

Available from your local
Aerovox Distributors



AEROVOX CORPORATION

DISTRIBUTOR SALES, New Bedford, Mass. 02741

Circle 48 on literature card

64 PF REPORTER/October, 1968

ular tower leg acts to take up maximum stress and strain. Connector links are of embossed, heavy gauge steel. According to the manufacturer, each HDT tower will support a 10-foot mast and antenna without guy wires.

HDT towers are available in either a hot-dip galvanized or gold, baked enamel finish. Sizes available are: 2', 2½', 3', 5', 7½' and 10'. Shipped preassembled the price ranges from \$7.35 to \$29.20.

Pressure-Sensitive Truck Signs

(63)

New self-adhesive, weather-proof truck door signs in a choice of a round design or rectangular design are offered by the **Seton Name Plate Corporation**.

These signs are printed on pressure-sensitive vinyl or mylar. To apply, peel off the backing sheet and press into place. They are wash-



able, won't wrinkle or buckle and resist oils, solvents and acids. Special style lettering can be reproduced at no extra charge.

Outlet Boxes

(64)

New heavy-duty power electrical outlet boxes, featuring individual timers have been developed by **Waber Electronics, Inc.**

Models 26 and 27 enable the user to set the timer for any period up to 12 hours. The timer in Model 26 turns power on at the end of the pre-set time, while Model 27 is designed to turn power off following the pre-set period.

Both units provide five color-keyed outlets, each with its own pilot and on-off switch. A master on-off switch controls the entire box. In addition, the units are available with individual pilot lights for each switch-outlet set.

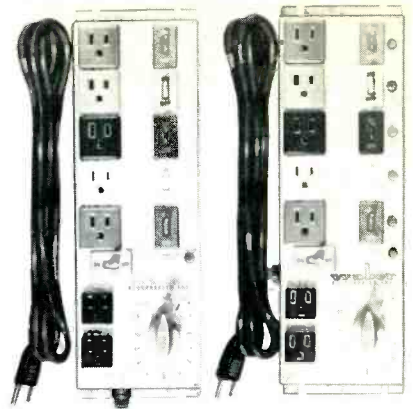

Waber models are pre-wired and ready for use, and are rated at 15 amps, 130 volts continuous duty. The units are priced from \$24 to \$30 depending on customer requirements and length of cord-set.

Transistor Analyzer

(65)

A new, compact transistor analyzer capable of doubling as a sensitive DC voltmeter has been developed by the **Amphenol Corp.** Designated Model 830 "Transistor Commander," the new test instrument combines semi-conductor checks with ability to measure supply voltages to 100 volts DC.

The unit can be employed for troubleshooting all solid-state equipment. It contains a current-limiting circuit for protection against accidental burn-out of transistors and diodes.



A high-impedance DC voltmeter input permits the technician to make accurate measurements to 100 volts DC with the same probes used in other checks.

The unit measures 5¾" x 9¼" x 6¾" and weighs 3 lbs. complete with a built-in 117-volt AC power supply. It sells for \$79.95.

WHY SEND TO JAPAN?

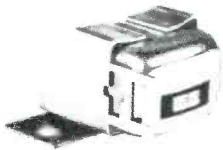

You Can Get Same Day
Shipment of Replacement
Heads for Norelco and
Most Import Cassette
Tape Recorders From

MICHIGAN MAGNETICS

A DIVISION OF VSI CORPORATION
VERMONTVILLE, MICHIGAN 49096
Telephone (517) 259-8911

**FREE
CATALOG**

Send for
Your Copy of
Consumer Audio
Catalog # 680

Circle 49 on literature card



Now! Prepare Co-Ax Cable in 5 Seconds!

R-SERIES CO-AX CABLE STRIPPER*

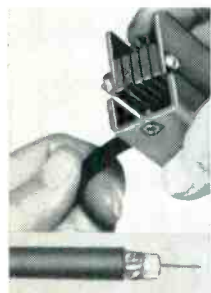

Accurate cuts are easy:

(A) Open tool, place CO-AX cable in groove and while closing -

(B) Rotate tool around cable, cutting jacket, shield and dielectric.

(C) Special Shield Dressing Fitting prepares braid for easy cable insertion in tap-off or connector.

*Pat. Pending

Here's the only tool made that offers you simultaneous cutting of jacket, shield and dielectric! It's fast, precise, time-saving, trouble-free and versatile! Uses inexpensive razor blades.

Model R-100 - Prepares RG59 cable for "F" and "C" fittings, tap-offs, splitters, couplers, PL259, etc.

Model R8/11 - Prepares RG8, RG11 cable for PL259 fittings, cable splices, etc.

Model R58 - Prepares RG58, RG58AU cable for PL259, phono plugs, etc.

Model R6/CAC - Prepares .275" all-channel cable for "F" fittings, tap-offs, splitters, couplers, etc.

Only \$4.95 guaranteed.

See them at your distributor's

UNITED TEL-TRONICS COMPANY

Allison Park, Pa. 15101

412/443-6200

Circle 50 on literature card

Drive Socket Set

(66)

A new 15-piece set of 1/4" drive sockets, handles and accessories, designed for electronic and appliance assembly and repair, has been introduced by Kraeuter Tools.

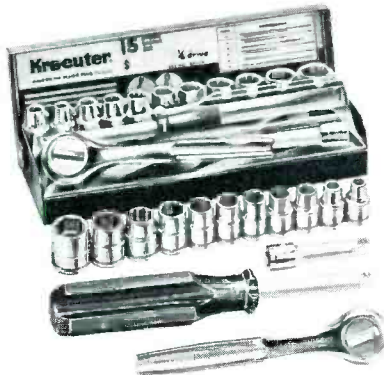

Set No. 30115 features a close-acting Kraeuter ratchet plus 11 thin-wall sockets, 1/4" through 1/2". Also included are a 2" extension and 6" spinner handle. All components are double-nickel chrome-plated and plastic-sealed in a compartmentized tray contained in sturdy metal box that measures 6 1/2" long. The price is \$13.25.

Portable Analyzer

(67)

A completely solid-state and portable vacuum tube analyzer that accommodates all types of industrial tubes has been developed by the **Triplet Co.** The unit applies a true Gm small signal test and has a 60,000 Gm range.

Designated Model 3444-A, Type 1, it is equipped with 16 built-in sockets of which two are multiple, giving the operator the equivalent of 19 sockets. CRT's can be tested with an optional adapter.

The gray, leatherette-covered wooden case measures 15 3/16" x 18 13/16" x 7 3/4" and has a hinged removable lid, a sloping etched aluminum panel, a compartment for line cord, leads and a removable roll type tube chart. Weight is approximately 30 pounds. Price: \$470.

Erratum

The price quoted for Perma Power's Liftmaster 600 garage door opener in the August, 1968 Product Report department was wrong. The price is not \$50.00. Instead, the release should have read, "Price is reportedly \$50 less than other openers with comparable features."

Listen!



Service Dealers ...Eliminate the "Time Killer"!

It's not that we have anything against catalogs or those who must refer to them umpteen times a day. It's just that we're in complete sympathy with the time-conscious dealer who'd rather turn a profit than a page.

That's one reason why Jensen has *every* loud-speaker in the book . . . so you won't need a book. Simply tell your Jensen distributor the type speaker you need and he'll take it right off the shelf. Easy as that!

When you need a speaker—any speaker—call your local Jensen distributor.

. . . insist on Jensen.

Jensen

Jensen Manufacturing Division, The Muter Company
5655 West 73rd Street, Chicago, Illinois 60638

Be sure to ask

"What Else Needs Fixing?"

Circle 51 on literature card

New! IRC STRIPTROL

A real time and money saver. Striptrol is a fast, convenient way to do shop replacement of side-by-side strip controls in leading color and black and white sets. Big selection of IRC/CTS adjusters, elements, and housings. No need to wait for original parts. Parts are easy to assemble. Low cost, too.

JUST 3 PARTS...



**ASSEMBLE
QUICKLY...**

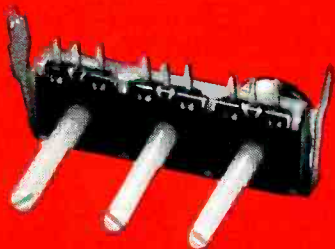

2 LOW-COST STOCKS

Your IRC Distributor offers two versatile stocks. Both include a sturdy, 12-drawer steel cabinet, dividers, labels, Striptrol assembly instruction, and replacement data.

STRIPTROL

Now at leading IRC Distributors



DIVISION OF TRW INC.

401 N. Broad St., Phila., Pa. 19108

Circle 52 on literature card

Book Review

Understanding Electronic Test Equipment: Joseph A. Risse, Howard W. Sams and Co., Inc., Indianapolis, Indiana, 1968; 192 pages, 5 $\frac{3}{8}$ " x 8 $\frac{1}{2}$ ", soft cover, \$4.25.

This text provides a practical understanding of the design and applications of the most common types of test instruments used in electronic servicing. The natural progression of subject matter from basic measuring circuits to specific equipment designs makes this book equally suitable for both beginners and experienced electronic service technicians.

In-depth analysis of circuit action and equipment operation and applications are supplemented by examples of typical instruments currently in use. Equipment types discussed include VOM's; VTVM's; battery, tube and semiconductor testers; signal generators and basic and advanced oscilloscopes.

RCA Receiving Tube Manual, RC-26: RCA Electronic Components, Harrison, New Jersey, 1968, 656 pages, 8" x 5 $\frac{3}{8}$ ", soft cover, \$1.75.

This revised and expanded edition contains up-to-date information on tube types and technology. Detailed descriptive data and application information are provided on the complete RCA line of home entertainment types of receiving tubes, picture tubes for b-w and color television, and voltage-regulator and voltage-reference tubes.

Servicing Transistor Equipment: Gordon J. King, Hart Publishing Co. Inc., New York, 1968, 151 pages, 6 $\frac{1}{4}$ " x 9", hard cover, \$7.95.

The text discusses transistor fundamentals, circuit application and testing without comparing the transistor to a vacuum tube. Chapters 1-3 are devoted to fundamentals, circuit applications and tests, respectively. Specific troubleshooting techniques in audio, video, RF and oscillator stages are presented in Chapters 4-6. Chapter 7 discusses techniques that relate to transistor radios and hi-fi amplifiers. Test equipment requirements and repair procedures are outlined in the final chapter.

*Plug in
with a
winner...*

**TV
SERVICE
CORDS** by

Columbia

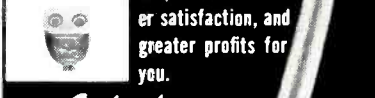
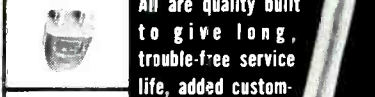
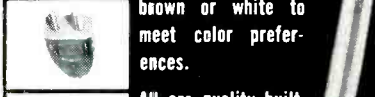
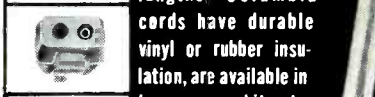
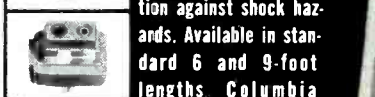
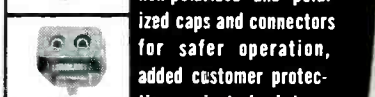
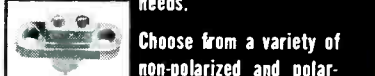
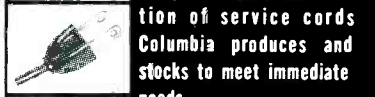
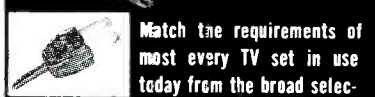
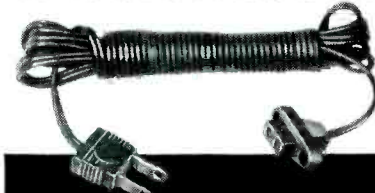

Match the requirements of most every TV set in use today from the broad selection of service cords Columbia produces and stocks to meet immediate needs.

Choose from a variety of non-polarized and polarized caps and connectors for safer operation, added customer protection against shock hazards. Available in standard 6 and 9-foot lengths. Columbia cords have durable vinyl or rubber insulation, are available in brown or white to meet color preferences.

All are quality built to give long, trouble-free service life, added customer satisfaction, and greater profits for you.

*Order from
your
distributor today!*

Columbia
WIRE PRODUCTS COMPANY

2850 Irving Park Road
Chicago 60618

Circle 53 on literature card

new SAMS books

Practical Design with Transistors

by *Mannie Horowitz*. This book provides the circuit designer with a clear and practical approach to the design of a wide variety of solid-state circuits. Covers biasing, feedback, and high-frequency considerations, as well as various methods of coupling. Includes latest semiconductor developments, with emphasis on new applications of FET's. 288 pages. Order 20659, only. \$5.95

Using Scopes in Transistor Circuits

by *Robert G. Middleton*. The leading authority on test equipment tells when and how to use oscilloscopes to analyze and/or troubleshoot transistor circuits; major emphasis is on scope waveform analysis. The book is intended primarily for the electronic technician. It includes detailed treatment of waveforms and circuit theory in transistor oscillators, amplifiers, waveshaping circuits, monochrome and color TV, and computers. 192 pages. Order 20662, only. \$4.50

101 Easy CB Projects

by *Robert H. Brown*. Here are fascinating do-it-yourself projects for a wide variety of simple, inexpensive, yet practical citizens band radio equipment and accessories. Each easy-to-build device, designed to be a useful addition to any CB radio operator's gear, is covered by a description and complete parts list, with full instructions for its construction. 128 pages. Order 20663, only. \$3.25

IMPORTANT RECENT BOOKS

Transistor TV Training Course

by *Robert G. Middleton*. Provides a complete understanding of modern transistor television circuitry. Progresses functionally through a typical receiver from signal input or tuner stages, through video and audio I-F and detector stages, picture and sound amplifier stages, vertical and horizontal deflection and synchronizing systems; concludes with analysis of power supply circuits. Includes review questions. 128 pages. Order 20619, only. \$3.95

Know Your Tube and Transistor Testers

by *Robert G. Middleton*. Explains principles and circuits used in tube and transistor testers. Includes schematics, specifications, and analysis of typical service and lab-type instruments. Packed with troubleshooting and repair data for various instruments. 144 pages. Order 20630, only. \$3.50

North American Radio-TV Station Guide

by *Vane A. Jones*. NEW 5th EDITION. Completely updated, listing frequencies, call letters, locations, etc., for all a-m, f-m, and tv stations in the U.S. and possessions, Canada, Cuba, Mexico, and the West Indies. Includes over 5,000 a-m stations, over 2,200 f-m stations, and nearly 1,100 vhf and uhf tv stations. 144 pages. Order 20635, only. \$2.95

FET Principles, Experiments & Projects

by *Edward M. Noll*. Explains in detail the theory and use of field-effect transistors. Black-box equivalent circuits are developed for the various modes of operation. Experiments involving the measurement of parameters and projects using FET's in practical circuits are included. 272 pages. Order 20594, only. \$4.95

These and over 300 other SAMS Books are available from your local Electronics Parts Distributor . . .

Howard W. Sams & Co., Inc.

Order from your Sams Distributor today, or mail to Howard W. Sams & Co., Inc., Dept. PF-10 4300 W. 62nd Street, Indianapolis, Ind. 46268

Send me the following books:

20659 20663 20630 20594
 20662 20619 20635

\$_____ enclosed

Name _____

Address _____

City _____ State _____ Zip _____

My Distributor is _____

Circle 59 on literature card

Advertisers' Index

October, 1968

Aerovox Corp.	64
American Telephone & Telegraph	13
Arrow Fastener Co., Inc.	18
B & K Mfg. Co., Division of Dynascan Corp.	37, 43
Borden, Inc., Chemical Div.	51
Bussmann Mfg. Div., McGraw-Edison Co.	6, 7
Castle TV Tuner Service, Inc.	5
Chemtronics, Inc.	67
Cleveland Institute of Electronics	27, 57
Columbia Wire Products, Inc.	66
Cornell-Dubilier	C-2
C.R.T. Equipment Co., Inc.	8
Enterprise Development Corp.	39
GC Electronics, Div. of Hydrometals, Inc.	45
Gem City Tuner Repair Service	32
Heath Co.	35
Hickok Electrical Instrument Co.	50
IRC, Inc.	66
Injectorall Electronics Corp.	39
Jackson Electrical Instrument Co.	63
Jensen Manufacturing Div.	65
Jerrold Electronics Corp.	55, 68
Lectrotech, Inc.	58, 59
Littelfuse	C-4
Mercury Electronics Corp.	26
Michigan Magnetics, Div. of VSI Corp.	65
J. W. Miller Co.	62
Mosley Electronics, Inc.	8
National Radio Institute	23, 29
RCA Electronic Components (Distributor Products)	41
RCA Electronic Components (Entertainment Receiving Tubes)	C-3
RCA Electronic Components (Test Equipment)	14-15
RCA Institutes, Inc.	33
RCA Parts and Accessories	3
RCA Sales Corp.	53
RMS Electronics, Inc.	62
Raytheon Co.	60
Howard W. Sams & Co., Inc.	56, 67
Seco Electronics	38
Sencore, Inc.	9, 22, 25, 40, 44, 20
South River Metal Products, Inc.	39
Standard Components, Div. of Standard Kollsman Industries, Inc.	17, 61
Sylvania Electric Products, Inc.	30-31
Triplet Electrical Instrument Co.	19
Tuner Service Corp.	1
United Tel-Tronics Co.	65
Winegard Co.	46-49
Workman Electronic Products, Inc.	54
Xcelite, Inc.	12
Yeats Appliance Dolly Sales Co.	4
Zenith Sales Corp.	21

THERE'S ONLY ONE
COLOR LUBE®
That's
CHEMTRONICS
INSIST ON IT!
ACCEPT NO IMITATIONS



NO. CL-8

NON-DRIFT COLOR TV TUNER CLEANER

TEST AFTER TEST HAS PROVEN
COLOR LUBE

- To clean better
- To be safe on plastics used in TV sets
- Non-flammable
- To cause no drifting

\$2.39
Net

Another First

SUPER FROST AID

Cools Faster • Leaves No Liquid Residue

SUPER FROST AID is a faster circuit freezer designed to locate intermittent components . . . without leaving a liquid residue. 2.79 Net



No. 1550



1206 Ralph Avenue
Brooklyn, N. Y. 11236

Circle 54 on literature card

October, 1968/PF REPORTER 67

NOW—a single instrument for the Professional TV Serviceman, MATV Systems Engineer, and Antenna Installation Expert



Jerrold AIM-718 Signal Strength Meter

First signal strength meter designed with the diverse technical tasks of today's TV Professional in mind.

- All solid-state
- Separate VHF and UHF tuners and channel dials
- Compact, lightweight design
- Long-life battery operation
- Audio output jack, crystal earphone provided
- Two built-in attenuators (20 dB on UHF; 20 or 40 dB VHF)
- Safety switch turns off power when cover is closed

Loaded with profit-making uses

Since it weighs only 4 lb. 6 oz., the AIM-718 can be used at the bench or taken right up on the roof to:

- Measure incoming TV signal strength—channel by channel
- Orient antennas for best reception
- Troubleshoot MATV and CCTV systems
- Measure loss in downlead and distribution lines
- Determine noise figure, S/N ratios of TV amps and preamps
- Make power and voltage gain checks
- Check output level of signal generators
- Signal trace TV preamps, amplifiers, and tuners

You'll satisfy more customers when you use an AIM-718. And satisfied customers will let the word get around about you. So do the job the professional way... the business-building way... the profitable way. With the Jerrold AIM-718 Signal Strength Meter. Price: less than \$200.

For further information on the AIM-718, write: Jerrold Electronics Corporation, Distributor Sales Division, P.O. Box A, Philadelphia, Pa. 19105.



Focusing on one thing...
better reception

a GENERAL INSTRUMENT company

Circle 55 on literature card

FREE CATALOG & LITERATURE SERVICE

COMPONENTS

100. *Allied Electronics*—600-page 1969 catalog lists prices, specifications, descriptions, illustrations for all products including components, test equipment and technical books.
101. *Allied Radio*—536-page 1969 catalog includes hi-fi components, monitors and cameras, portable TV's, CB 2-way radios and accessories, antennas and towers, and electrical accessories.
102. *Carborundum*—Bulletin lists product information and applications for VDR's (varistors).
103. *Robins*—12-page brochure includes information on patch cords, adaptors and connectors.

SERVICE AIDS

104. *Alpha Metals*—6-page bulletin describes 17 common soldering faults and their remedies.

SPECIAL EQUIPMENT

105. *AMCO*—Brochure describes "Style Pak" line of small equipment enclosures.
106. *Dialight*—24-page catalog, CR680, provides data, illustrations and military designations for Lens Cap As-

semblies (LC11-LC37) and Base Assemblies (LH50-LH92).

TECHNICAL PUBLICATIONS

107. *Sams, Howard W.*—Literature describing popular and informative publications on radio and TV servicing, communication, audio, hi-fi and industrial electronics, including special new 1968 catalog of technical books on every phase of electronics.*

TOOLS

108. *Oncida*—Bulletin PF-68 describes with illustrations the use of the patented Flogun.
109. *Upson*—Catalog page describes the 4-in-1 Ball End and Reversible Screwdrivers and other tools.

TUBES AND SEMICONDUCTORS

110. *Amperex*—Catalog/brochure contains listings of entire line of semi-conductors available in micro-miniature Leadless Inverted Devices package with primary electrical characteristics.
111. *ITT*—12-page brochure describes line of special purpose tubes listing characteristics and type numbers.
112. *Metropolitan*—Directory lists 5000 tube types in alpha numerical order with quantity discount prices and list of manufacturers.
113. *Motorola*—Catalog MHA-27-4 lists 175 semiconductors, books and accessories, and a replacement series for devices including zener diodes.

Got A Troubleshooting Tip?

If you've recently run across an unusual trouble symptom and have determined what caused it, why not pass the info on to the other readers of PF REPORTER. You'll not only be saving other service technicians valuable troubleshooting time, you'll also be making a little extra change yourself. Send a thorough description of the trouble symptom and the solution along with a brief discussion of your troubleshooting technique to:

Troubleshooting Tip
PF REPORTER
1014 Wyandotte Street
Kansas City, Missouri 64105

Van Heusen Gift certificates are Available with your purchases of RCA Entertainment Receiving Tubes!

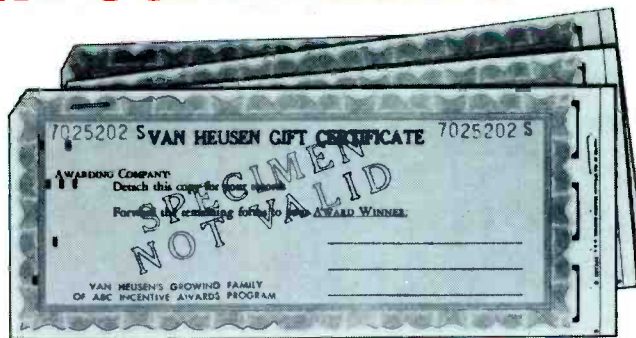

Hundreds of choices in quality Van Heusen dress and sportswear can be yours with Van Heusen Growing Family Gift certificates which are available with your purchases of RCA entertainment receiving tubes from your participating RCA distributor. Select from Van Heusen's Growing Family Award catalog.

Section "B"—2 certificates. French cuff dress shirts, action sportswear, Vanawool sweaters, Lady Van Heusen shirts, skirts, slacks.

Section "D"—4 certificates. Rich, comfortable men's and women's Alpaca blend cardigan sweaters, and sets of 3 permanent press dress shirts and button-down oxfords.

Section "E"—8 certificates. Windbreaker Parliament Raincoats, Cricketeer Herringbone Sports Coats, Cricketeer Hopsack Blazers.

Section "C"—3 certificates. The Arnold Palmer Windbreaker® jacket, poplin walk shorts and Tycora knit shirts, slacks, pajamas, Lady Van Heusen dress shirts, sport shirts, men's accessories.



Section "A"—1 certificate. Vanopress™ dress shirts and sports shirts, casuals for men, women and boys. Knits and Lady Van Heusen shirts for the ladies.

Section "F"—14 certificates. Fine suits from Van Heusen's Tempo, Cricketeer and J&F Divisions, including the black Tempo Mohara, the J&F Classic Sharkskin in grey, and the navy Cricketeer Vested.

See your local participating RCA Distributor today for complete details on RCA's "Growing Family" Clothing Award Certificates. RCA Electronic Components, Harrison, N. J.

Introducing a Complete Line of Littelfuse Quality Circuit Breakers



Actual Size
1 3/4" x 1 3/16" x 1/2"

Exact replacement from factory to you

Designed for the protection of television receiver circuits, the Littelfuse Manual Reset Circuit Breaker is also ideally suited as a current overload protector for model railroads and power operated toy transformers, hair dryers, small household appliances, home workshop power tools, office machines, small fractional horsepower motors and all types of electronic or electrical control wiring.

LITTELFUSE

DES PLAINES, ILLINOIS

Circle 56 on literature card