

OCTOBER, 1964

50 CENTS



PHOTOFACT RF REPORTER

Including **Electronic Servicing**

Highlights

of the
1965
TV Sets

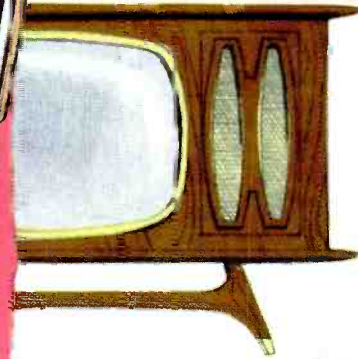

also Wid'h and Lin-
earity Problems Solved

New Scund from
Old Cabinets

Make the Most of
Your Attorney

•••and••• Communi-
cations Supplement

JA. 2L 1104 1266
WA. M. DAVIS
RAD. & TV SERV.
118 RIVERSIDE AVE.
CANN CITY, CALIF.



How to replace top quality tubes with identical top quality tubes

Most of the quality TV sets you are presently servicing were designed around special Frame Grid tubes originated by Amperex. More and more tube types originated by Amperex are going into the sets you'll be handling in the future.

Amperex Frame Grid tubes provide 55% higher gain-bandwidth, simplify TV circuitry and speed up your servicing because their extraordinary uniformity virtually eliminates need for realignment when you replace tubes.

Amperex Frame Grid Tubes currently used by the major TV set makers include:

2ER5	2GK5	2HA5	3EH7	3GK5	3HA5	4EH7	4EJ7	4ES8	4GK5	4HA5	5GJ7
	6EH7	6EJ7	6ER5	6ES8	6FY5	6GJ7	6GK5	6HA5	6HG8	7HG8	8GJ7

If your distributor does not yet have all the Amperex types you need, please be patient—in some areas the demand keeps gaining on the supply. Amperex Electronic Corporation, Hicksville, Long Island, New York 11802.



Circle 1 on literature card

The trend to small-screen personal receivers is continuing into the '65 season. In the opposite direction, however, is the introduction of 25" and 27" black-and-white picture tubes. If both trends continue, you will soon be able to name almost any size screen and find it available in some manufacturer's standard line.

The tiny screen, previously a Japanese product alone, is being challenged by 9", 11", and 13" American introductions. Semiconductors, in transistor form, are finding increased use in this year's receivers. A hybrid sound circuit, mixing tubes and transistors together (see text under Arvin), and a four-stage all-transistor IF (Electrohome), both make the current scene. Silicon rectifiers, too, appear more often than ever in power supplies—in sets with or without transformers. UHF tuners, mostly transistor types, are standard equipment on all models as a result of the All-Channel Law.

Color receivers are being offered by virtually all American manufacturers, and a 16" color set from Japan is presently on the market. The release date of the new 25" color tube has not yet been finalized; however, we look for them late this year. Look for news of developments in color receivers and circuits in next month's (November) PF REPORTER.

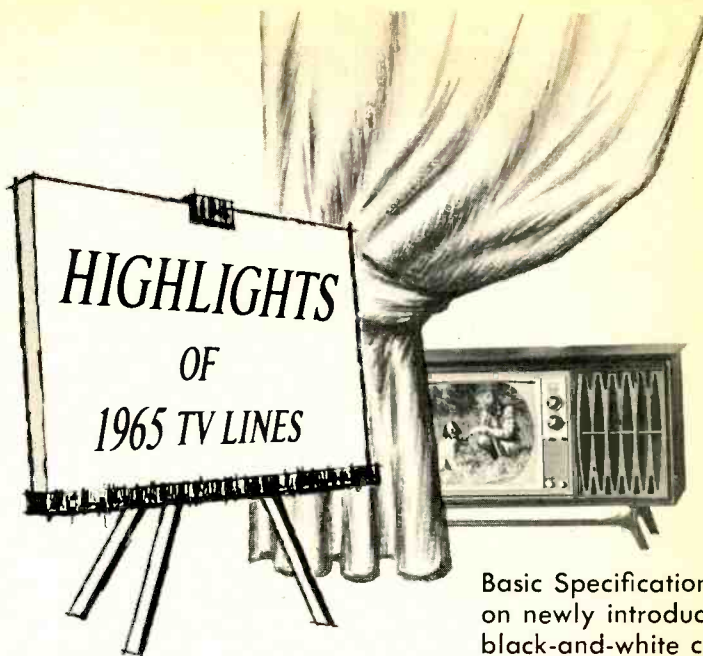

Basic Specifications on newly introduced black-and-white chassis.

ARVIN

Dominant among Arvin's introductions for '65 are 12" and 16" portables, imported from Japan. At this time, little information on the 12" Model 65K28 is available. Weighing only 18 lb (size is 11½" x 16" x 11"), this set features two frame-grid IF stages among its 13-tube complement. The majority of normal operating controls are adjustable from the front of the cabinet, with controls for horizontal and vertical hold located to the rear. Two built-in antennas—a telescoping rod for VHF and a loop for UHF—are included. The UHF loop is mounted on the rear of the cabinet and can be rotated for best signal reception. The UHF tuner is a transistorized type, with the tuning control located at the side of the cabinet.

Arvin's 16" Model 65K38 has a number of new features—transistorized UHF tuner, new tube types (some unfamiliar), and a hybrid sound circuit, to mention a few. No alternate-replacement informa-

tion is yet available on the AW40-12 CRT used in this set. Two stages of IF amplification use the familiar 6EH7 and 6EJ7 frame-grid tubes. A multigrid 6JX8 provides keyed AGC and noise limiting; the triode section is a sync separator. Other new tube types in this chassis include 18GU8 vertical multivibrator and output, 8A8 horizontal multivibrator, 25E5 horizontal output, 17Z3 damper. A 1X2B is the HV rectifier. Width is controlled by a jumper wire, in the screen circuit of the output stage, used to select the proper screen voltage from a divider network.

The hybrid sound circuit (see partial schematic), includes three PNP transistors and a triode-pentode 6AB8. The circuit is similar to those used in transistor radios, with common transistor types—2SA102BA for the first and second sound-IF amplifiers, and a 2SB171 for the first audio amplifier. Sound demodulation is handled by a ratio-detector circuit using diodes. The low operating voltage (18-volt DC supply) for the tran-

sistors is obtained from the main B+ supply through a large dropping resistor. B+ for the set is developed by two silicon diodes wired as a voltage doubler. Protection for the rectifiers is afforded by a 4.7-ohm, 10-watt, surge-limiting resistor. A 2-amp line fuse protects all receiver circuits from overload.

DUMONT

Four chassis and three picture-tube sizes are in evidence this year. New to the line is the 120746-B chassis used in the "Voyager" 11" portable. Two compactrons are employed in this chassis: 5HA7 or 5HC7 sync separator and AGC, and 33GY7 damper and horizontal output.

The two 19" chassis, 120759-A and 120760-A, are electrically similar to each other and to those used in previous 19" models; the only major changes are relocation of the auxiliary controls to the top rear of the cabinet and the use of a new sound interstage IF transformer. The same changes have been incorporated in the 120758-A chassis used in 23" sets.

All chassis have a turret-type VHF tuner and a transistor UHF tuner. All except the 11" portable have transformer-operated, tube-type B+ supplies.

EMERSON

An assortment of 11", 16", 19", and 23" models comprises this year's line. The chassis used in the larger-screen models are basically the same as in previous models; the 120746-B chassis used in the 11" portables is new. One interesting feature of this chassis is the use of a compactron (33GY7) combining the horizontal output and damper tubes in one envelope. Another new tube type is the 5HA7 or 5HC7 compactron in the

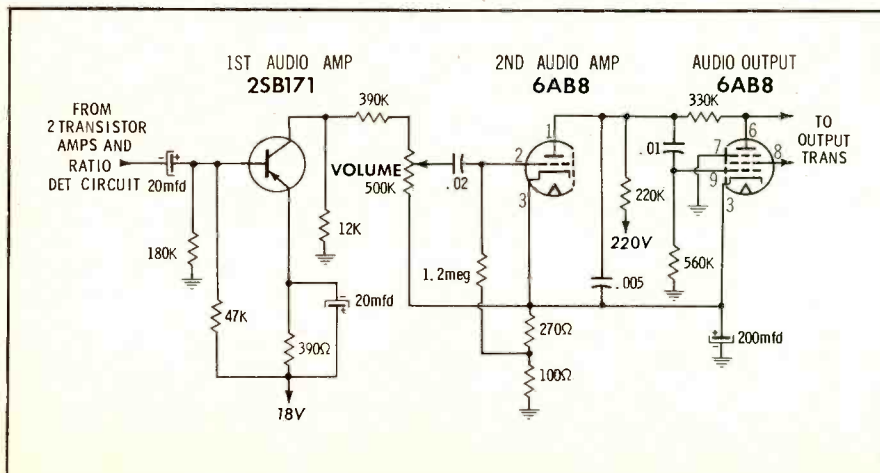

CHASSIS NO.	CRT TYPES	DEG DFL	UHF TUNER	PWR XFM	B+ RECT	IF AMP	DC CPL	AGC	NL	HOR AFC	WIDTH CTRL	FOCUS	SOUND DET	PROTECTED CIRCUITS			
														LINE	B+	FIL	
ARVIN 65K28 65K38	NA AW40-12	NA NA	* TR		HW dbl HW dbl	2H 2H	NA	NA M-C	NA M	NA CC	NA jumper	NA jumper	NA ratio	NA fuse 2A	NA *	NA	
CHANNEL MASTER 6572	19XP4	114	2DZ4		HW dbl	3		S		T	coil	pot	ratio	fuse 3A(2)			
DUMONT 120746-B 120758-A 120759-A, 76GA	11GP4 23GFP4 19EDP4, 19DKP4	110 110 114	TR TR TR		one sil 5U4GB 5U4GB	2H 3H 3H		T-C T-C T-C			CC CC CC	coil coil	NA NA	quad quad quad	fuse 1.2A	fuse .45A fuse .45A	link link
EMERSON 120698 K, 765 K 120707-B, 756-J, 758A 120725 B, 737 A, 759-A, 760-A 120746-B 120750 G, 764J 120751-G, 755-G	19DNP4, 19EHP4 23GFP4 19DKP4, 19EDP4 11GP4 16ANP4, 16BRP4 19ELP4	114 110 114 110 114 114	TR TR TR TR TR TR		one sil 5U4GB 5U4GB one sil one sil one sil	2H 3H 3H 2H 2H 2H		T-C T-C T-C T-C T-C			CC CC CC CC CC	coil coil	NA NA NA NA	quad quad quad quad quad	fuse 1.2A fuse .45A fuse .45A fuse 1.2A fuse 1.2A	link link	
GENERAL ELECTRIC AA DA EA SA	23DYP4, 23FYP4 19DVP4, 19ECP4 16BUP4, 19DZP4 11HP4	114 114 110, 114 110	TR TR TR TR		FW dbl one sil one sil one sil	3H 3H 2H 2H		T-C T-N T-N T-N			D D D D	coil coil *	jumper	quad quad quad quad	fuse 2A fuse 1.5A fuse 1.5A fuse 1.5A	#26 link	
MAGNAVOX 47 Series 48 Series	19DQP4 12AYP4	110 114	TR 3DZ4		one sil one sil	3 2H		P-N T-C			S D	jumper jumper	quad quad	ckt brkr fuse 2A	#24 link		
MOTOROLA TS-586, 587 TS-588 TS-589	19CHP4, 19DHP4, 19DSP4 23ARP4 19EBP4 23CMP4, 23FSP4	114 110 114 110	* TR *		one sil HW dbl FW dbl	3 3 3		P-N T-N T-N	T T T	CC CC CC	capacitors capacitors coil	NA jumper jumper	quad quad quad	ckt brkr ckt brkr ckt brkr			
OLYMPIC 9P40 NAP NB	NA NA NA	NA NA NA	tube TR TR		HW dbl HW dbl 5U4GB	3 2H 2H		S-C S M-C			D CC CC	sleeve sleeve	NA NA NA	ratio quad quad	fuse .5A NA NA		
PACKARD BELL 88-14K, etc. 88-16	19AYP4, 19CZP4, 19DQP4 23EKP4, 23FLP4	114 92	TR 6DZ4 TR		5U4GB FW dbl	3 3		T-C P-C	T T	CC CC	coil coil		ratio ratio	ckt brkr ckt brkr			
PHILCO 15G20 15J25 15J27 15N30 15N50	16BVP4 19CUP4 19DUP4 23DSP4A 23DSP4A	114 114 114 92 92	TR TR TR TR TR		one sil one sil one sil one sil FW dbl	2 2 2 2 2		T-N T-N T-N T-N			CC CC CC CC	wire link pot pot pot pot	quad quad quad quad	FR 5.6 FR 1.45 FR 1.45 FR 1.45 FR 5.6	#28 link		
RCA VICTOR KCS136X KCS143F KCS144D KCS148A, B KCS149A KCS151A KCS152	23BKP4, 23BLP4, 23EFB4, 23ENP4 19DQP4 19DQP4 19DQP4 19DQP4 19DQP4 16AYP4, 16BGP4	114 114 114 114 114 114 114	TR TR TR TR TR TR		FW dbl HW dbl HW dbl FW dbl HW dbl one sil	3 3 3 3 2H 2H 2H		P-N P-C P-C P-C P-C T-N			CC CC CC CC CC CC	coil coil coil coil coil pot	pot	quad quad quad quad quad quad	ckt brkr FR 5 FR 5 ckt brkr ckt brkr FR 5 FR .35 fuse	#28 link #28 link #28 link	
SETCHELL-CARLSON 202 301 401 UX600	16BRP4 19DCP4, 19DQP4 19DCP4, 23FSP4 23FSP4	114 114 114, 110 110	TR TR TR TR		FW dbl FW dbl FW dbl FW dbl	2 2 2 2		M-H M-H M-H M-H	M M M M	CC CC CC CC		* * *	quad quad quad ratio	ckt brkr ckt brkr ckt brkr cki brkr	link link link link		

CHASSIS NO.	CRT TYPES	DEG DFL	UHF TUNER	PWR XFM	B+ RECT	IF AMP	DC CPL	AGC	NL	HOR AFC	WIDTH CTRL	FOCUS	SOUND DET	PROTECTED CIRCUITS			
														LINE	B+	FIL	
SEARS/SILVERTONE 528.60530, 31 528.60700, 01 528.60730, 31 528.61390, 91 528.61420, 21 528.61450, 51 528.61480, 81 528.61510, 11	19DQP4, 19DWP4 23EQP4, 23EWP4 19DQP4, 19DWP4 19DQP4, 19DWP4 23EQP4, 23EWP4 23EQP4, 23EWP4 19DQP4, 19DWP4 23ENP4, 23EQP4	114 114 114 114 114 114 114 114	3DZ4 TR TR TR TR TR TR TR		one sil one sil one sil HW dbl HW dbl HW dbl HW dbl HW dbl	2 2 2 2H 2 3 2H 3		S-N S-N S-N M-N S-N M-N M-N M-N			CC CC CC CC CC CC CC CC	sleeve sleeve sleeve sleeve sleeve sleeve sleeve sleeve	jumper pot jumper pot pot pot pot NA	quad quad quad quad quad quad quad quad		ckt brkr ckt brkr ckt brkr ckt brkr ckt brkr ckt brkr ckt brkr ckt brkr	
SYLVANIA 583 585-1, -2 589	19CVP4 23BGP4 23BGP4, 23BHP4	114 110 110	TR * TR		HW dbl 5BC3 FW dbl	2H 2H 3		T-C T-C T-C	*	CC CC CC	pot pot sleeve	jumper jumper pot	quad quad quad	#28 link	ckt brkr ckt brkr ckt brkr	#28 link #28 link #28 link	
WELLS-GARDNER T750 T821 T840	19DRP4, 19ERP4 23DLP4A, 23ENP4 23GTP4, 23ETP4	114 92 110	TR TR TR		HW dbl one sil HW dbl	3 2 3		S-C S S-C		CC CC CC	sleeve sleeve sleeve	CRT base	quad quad quad		ckt brkr FR 4.7 ckt brkr		
WESTINGHOUSE V2474 V2475 V2478-1, -2	19CMP4, 19EJP4, 23EZP4 19CMP4, 19EJP4, 23EZP4 12BDP4	114 94 114 94 NA	TR TR tube		one sil HW dbl one sil	2H 3 2H		*	T	CC CC CC	sleeve pot jumper		quad quad ratio	fuse 1.75A fuse 2A FR 5			
ZENITH 14M20 14M23 14M25 14M27 14M28 14M29 14M30 14M31 15M22 16M24	16BCP4 23EYP4 19CXP4, 19DBP4 19CXP4, 19DBP4 19DBP4, 19EKP4 19DBP4 19CRP4 19DBP4 23FNP4 23EYP4	114 92 114 114 114 92 92 114 92 92	TR TR TR TR TR TR TR TR TR TR		HW dbl FW dbl FW dbl FW dbl FW dbl HW dbl HW dbl FW dbl FW dbl	3 3 3 3 3 3 3 3 3H 3		M-C M-C M-C M-C M-C M-C M-C M-C	M M M M M M M M	CC CC CC CC CC CC CC CC	pot sleeve pot pot pot pot sleeve pot sleeve sleeve		quad quad quad quad quad quad quad quad quad quad	fuse 2A ckt brkr quad quad quad quad quad quad quad quad	ckt brkr ckt brkr ckt brkr ckt brkr ckt brkr ckt brkr ckt brkr ckt brkr ckt brkr ckt brkr	#24 link #24 link #24 link #24 link #24 link #24 link #24 link #24 link	

ABBREVIATIONS AND SYMBOLS—In any column, **CHECK MARK** indicates chassis has feature named; **ASTERISK** means "see text"; **NA** means data not available at press time. For individual columns—**UHF TUNER**: tube type given, if known; **TR**, transistorized. **B+ RECT**: one sil, one silicon rectifier; **HW dbl**, half-wave voltage doubler using two silicon rectifiers; **FW dbl**, full-wave silicon doubler. **IF AMP**: Figure indicates number of stages; "H" indicates use of two or more tubes having substantially higher gain than the 6CB6. **DC CPL** means set has DC path or DC restoration in video drive circuit of CRT. **AGC**: First letter—M, multipurpose tube ('HS8, 'BUB, or similar); P, pentode keyer; T, triode keyer; S, simple (no tube). Second letter—C, has AGC potentiometer; N, no AGC adjustment. **NL** (noise limiter): M, part of multipurpose tube ('HS8, 'BUB, etc.); T, triode noise inverter. **HOR AFC**: CC, common-cathode dual selenium diode; CT, common-cathode dual diode plus triode section of tube (controlling sinewave or "Synchroguide" oscillator); S, two selenium diodes in series; D, dual diode sections of tube; T, triode used. **SOUND DET**: quad, quadrature circuit; ratio, ratio detector circuit. **FOCUS**: jumper, set has wire from CRT to select voltage; pot, has focus potentiometer; **CRT base**, focus jumper located on base of picture tube. **PROTECTED CIRCUITS**: figure following "fuse" is rating in amps; **FR** indicates fusible resistor and is followed by rating in ohms; "link" means short wire, of gauge indicated.

AGC and sync-separator stages. An ear-phone jack for private listening is included on some models.

In the 16", 19", and 23" sizes, a variety of chassis numbers are in evidence. As shown in the chart, however, these can be categorized (electrically) into two basic groups. One group has a transformerless solid-state power supply and a two-stage IF section; the other group has a transformer-operated tube-type power supply and a three-stage IF amplifier. The solid-state supply is used in the 16" and 19" portable models. In the second category, chassis 120707-B and 120758-A are used in the 23" consolettes, and chassis 120756-J is used in the 23" table models. Chassis 120759-A, 120760-A, 120737-J, and 120725-B are used in 19" portables.

GENERAL ELECTRIC

Again this year, a lightweight 11" portable is being offered using the SA chassis. It is very similar to last year's 11" SY chassis; however, some changes have been made both in electrical design and physical layout. The keyed-AGC circuit uses the triode section of a 6JN8. A single printed-circuit board replaces the two boards used last year. The CRT has been changed to an 11HP4 which has implosion protection and a polished faceplate. The vertical-multivibrator-output tube is a 23Z9 compactron; all other tubes are the same as those used last year in the 11" set.

The EA chassis includes four basic models; some use a 16" CRT while others have a 19" tube. This series is transformerless and uses a single printed-

circuit board with six compactrons. These six tubes make up the entire complement except for the tuner tubes, HV rectifier, and picture tube. Types and functions for these multipurpose compactrons are as follows: 11AR11 first and second video IF amplifiers; 15BD11 video output, sound IF, and AGC keyer; 17BF11 audio detector and output; 23Z9 sync separator, vertical multivibrator, and vertical output; 8B10 horizontal AFC and oscillator; and a 33GY7 horizontal output and damper. A parallel resistance network in the screen of the horizontal-output tube controls width. Either of two resistors may be added to or deleted from the network (changing the total resistance) to obtain the desired width.

The DA chassis line is much the same as the 1964 MY line: the entire DA series consists of 19" table models having

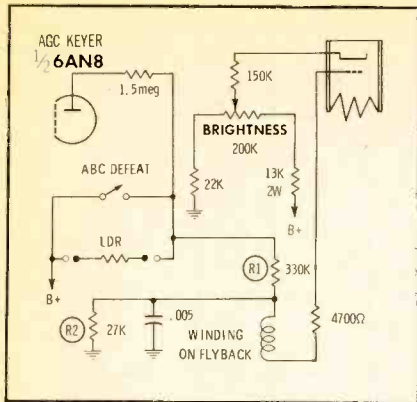

either plastic or metal cabinets. The model with the plastic cabinet is known as the *Designer*; the *Custom Designer* has a metal cabinet. The DA series is much the same as the EA, except that two tube types are different: An added stage of video amplification is provided by the pentode section of a 6JN8; the triode section is an AGC keyer. The horizontal-output stage uses a 21HB5A.

Another new chassis in the '65 line is the AA. Top of the line, it has a power transformer and employs a full-wave voltage-doubler network. Tubes used in this set are not of the low B+ types, as is the case in the other three chassis. The AA chassis is available as a 23" table model, console, or home entertainment center. This year's entire line is equipped for UHF reception, and all models incorporate transistorized UHF tuners. Many of the models are equipped with an automatic brightness circuit (ABC). Control is accomplished by changing the CRT grid voltage through use of the voltage-divider network of R1 and R2 and the resistance of an LDR (its resistance varies as room light changes). In the AA chassis, the LDR also acts as an automatic contrast control. This is accomplished by connecting the plate of the AGC keyer through a resistor to one side of the LDR. The other end of the LDR is tied to B+, therefore a change in resistance of the LDR consequently alters the AGC voltage, which thus affects the contrast.

The remaining chassis, and the most notable this year, is the all-transistorized TA just being introduced. A 9" personal portable, this all-American-made set is designed to operate on 117 volts AC or 12 volts DC. Two power cords are standard equipment—one equipped with an attachment to obtain power from a 12-volt (negative ground) automobile system.

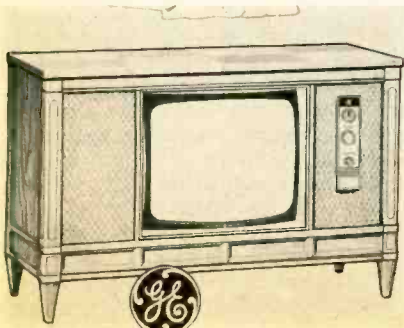

Physical design of the new set features a large printed-circuit board. The majority of the circuit components, including most of the transistors, are mounted on this board. The board can be lowered to a 45° angle to facilitate servicing. The semiconductor complement of the TA chassis includes a total of 24 transistors and 16 diodes.

MAGNAVOX

A new 48-series chassis is being introduced this year. These receivers use a 12" picture tube (12AYP4) along with many other new tube types, several of which are compactrons. Some of the tubes used are 10JY8 video output and sound-IF amplifier; 8B10 AGC keyer, sync separator, and horizontal AFC; 17JZ8 vertical multivibrator and vertical output; and the 33GY7 horizontal output and damper. Both the horizontal and vertical output tubes are of the low-B+ type enabling them to operate from the DC voltage derived from a single silicon rectifier. Other than the different type tubes, circuits in this receiver are much the same as those used in previous years.

A second series—the type 47 chassis—is appearing in the 19" sets. This is a transformer-powered chassis using a total of 15 tubes (not including the 19DQP4 picture tube), one silicon rectifier, a dual selenium diode for horizontal-AFC action, and a transistor in the UHF oscillator. Tubes found in this chassis are of a familiar type except for the 6KV8 which is being used for the first time in the vertical-multivibrator-output stage. The VHF-tuner tubes have somewhat unfamiliar designations (6HQ5 RF amplifier and 6HB7 mixer and oscillator). The chassis consists of three printed-circuit boards: one has the video-IF, sync, and video-output stages; a second has the entire audio section; the third mounts the vertical- and horizontal-sweep circuits. Electrolytic capacitors, output transformers, and other large components of this nature are mounted on the main chassis. Some models are equipped with the new *Magnalux* circuit which varies the brightness as the room light changes. A clock-timer switch, found on some models, turns the set on automatically at a time predetermined by the clock setting.

The 36 series (19", 23", 24", and 27") and 40 series (19") chassis are being offered again this year. All '65 chassis are vertically mounted and incorporate printed circuits—on one (as in the 48 chassis) or three (in all other chassis) printed-circuit boards.

MOTOROLA

Four basic chassis are being used this year. The TS-586 has been retained with only one major change; a four-circuit VHF tuner is being used, and, of course, UHF has been added. The TS-587 is electrically similar to the TS-586, except that the TV portion of the -7 chassis has no audio-output stage; that function is served by the amplifiers in the stereo consoles with which this chassis is used.

The TS-588 and TS-589 chassis, intro-



duced last December, are also being retained. The main difference between these two chassis is that the TS-589 uses a power-supply transformer and a full-wave silicon voltage doubler; the TS-588 has no power transformer.

Both of these chassis incorporate a circuit to rapidly extinguish the CRT spot after the set is turned off. The brightness control is connected to the 270-volt source through a voltage-dependent resistor (VDR). During normal operation, the VDR has a resistance of about 100K. When the AC switch is turned off, the supply voltage decreases (but not to zero), and the resistance of the VDR increases to about 1 meg. The brightness control and the VDR form a

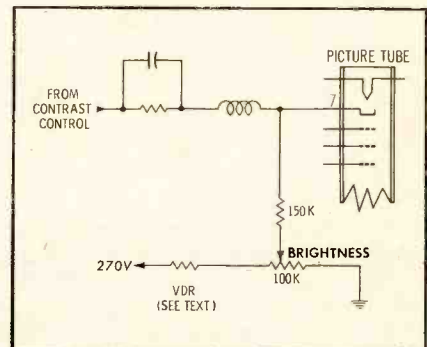

voltage divider; together they reduce the portion of the residual B+ voltage on the CRT cathode to a low value. The grid-cathode bias of the CRT is thus reduced, the tube conduction is increased, and the high-voltage filter is quickly discharged to extinguish the spot.

Another interesting innovation is used in these two chassis to improve interlace stability (see diagram). A diode is

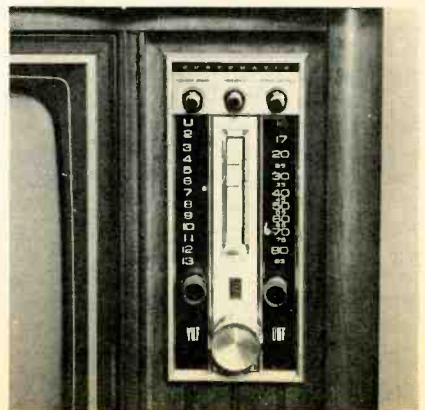

connected across the cathode resistor of the vertical oscillator so that the diode is reverse biased by the negative sync pulses applied to the cathode. When the oscillator tube goes into conduction, a voltage that forward biases the diode appears across the cathode resistor. The diode goes into conduction and effectively short-circuits the resistor. The result is that the tube reaches maximum conduction very rapidly. Further stabilization is provided by the integration network between the plate of the vertical-output tube and the grid of the vertical oscillator.

The use of "Shelbond" picture-tube implosion protection eliminates the necessity for a safety glass. A metal flange surrounding the tube is bonded to the glass with epoxy fiber. Due to this bonding, total collapse of the tube is prevented (see photo).

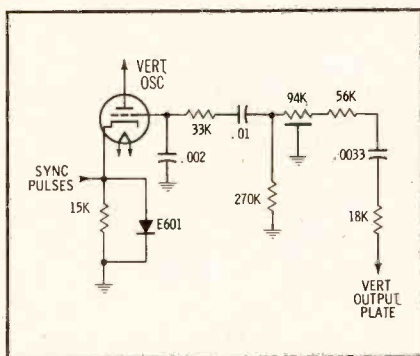

Transistorized UHF tuners are being used in most sets; however, the older tube types will be used in a few models. Pushbutton UHF tuning is provided on some console models. The UHF tuners used in these models are electrically similar to those in other models; the major differences are mechanical.

PACKARD BELL

Again this year, two basic chassis series are used in new receivers. All 19" models use a version of the 88-14 chassis (few modifications from last year's -14 series). The S, V, and Y versions are available with remote control—either as purchased, or field installed using kit No. RMK-32. Two models come equipped with clocks, giving a choice of manual or automatic operation.

VHF tuners are either switch or turret types; two different UHF tuners are used—one has a 6DZ4 oscillator, the other uses a transistor. The 6CM8 third IF and noise inverter used last year has been displaced by a 6EA8. The remainder of the tubes are types used in last year's 88-14 chassis. Deluxe models have the *Computer Dial*—an illuminated channel indicator; some are also equipped for carphone operation.

Chassis 88-16 (also a vertically mounted, hand-wired chassis) is used in 23" sets. Two remotes are available—a wireless or a wired type can be added in the field. A single VHF-UHF tuner assembly is used in this chassis. The tuners are mounted together, and a dual control shaft is used for tuning; the UHF action operates through a gear train at-



tached to the outside of the main shaft.

B+ for the -14 chassis is developed by a full-wave circuit using a 5U4GB; the -16 chassis has a power transformer, and silicon-diode rectifiers replace the tube. Other tubes are familiar types: A couple of 6BZ6's for the first and second IF amplifiers, a 6GM6 for the third; a 6AU6A for keyed AGC; and the triode section of a 6GH8 in the sync-separator stage. Horizontal AFC is developed by a common-cathode diode. One of two picture-tube types is used—either a 23EKP4, or a 23FLP4. Pictured here is the new Tea Cart cabinet; slightly different from last year's similar furniture styling.

PHILCO

Five basic chassis are being used this year. There has been no general overhaul of last year's circuit designs, but a few changes have been made. The *Kimcode* CRT protection has been changed somewhat: The fiberglass mesh around the bell of the tube has been eliminated; the combination of a rim band and a steel tension band provides protection from implosion. New 13-position, four-wafer VHF tuners and transistorized UHF tuners are used in all models. In all chassis except the 15G20 (used in the 16" *Courier* models) and the 15N50 (used in the console and consolette models), a new silicon rectifier and a fusible resistor are used. This modification provides increased DC-supply voltage for the receiver.

New frame-grid video-output tubes are being introduced. The 10KR8 is used in the 15J25, 15J27, and 15N30 chassis. The design of this tube provides higher gain and a greater linear operating range; this contributes to improved picture quality. The video-output stage has been

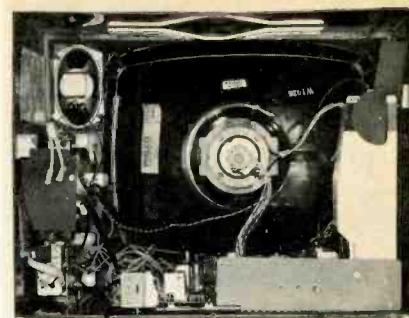
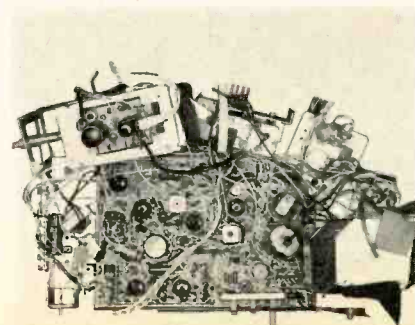

modified to accompany the use of the new tube (see diagram). The higher gain of the new tube permits the use of a cathode resistor (R39) in this stage. High-frequency compensation is accomplished through the use of a .047-mfd capacitor in parallel with R39. The screen-supply network provides low-frequency compensation. The 100-ohm resistor (R22) is for suppressing parasitic oscillations. The contrast control is in the plate circuit as it was in previous chassis. A 6KR8 is used in a similar circuit in the 15N50 chassis; the contrast control in this case is in the screen-supply portion of the circuit.

Printed-circuit boards in the new chassis have thin conductor lines instead of the sectionalized circuit coding previously used. (Early production of the 15N50 will use the former style; the new style will be adopted later.) Test points, B+ points, and component symbols are still included.

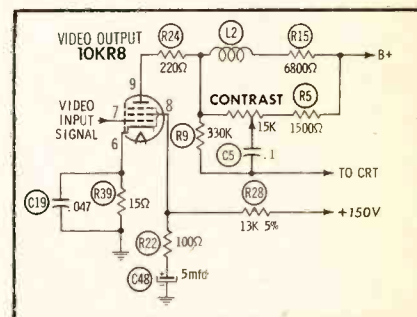

Some of the features retained from last year are: gated AGC, black-level video circuitry, and frame-grid IF tubes.

RCA VICTOR

The new RCA chassis are essentially modifications of previous models. In the 19"-portable category, the KCS 148 chassis is similar to the previous KCS 142; the primary differences are the addition of a power transformer and the change to parallel heaters. The KCS 151 is an updated version of the KCS 146, and the KCS 149 is essentially a transformer-powered KCS 144. The KCS 143 and KCS 144 chassis continue in use in some of the new models. The KCS 136X chassis, used in 23" models, is similar to the older KCS 136Y series.

The KCS 148, KCS 149, and KCS 136X make use of two special tube types to achieve an interesting warmup feature. The audio-output tube (new type 6HG5)

is electrically identical to the 6AQ5A; however, a layer of insulation between the heater and the cathode slows the warmup time about 40%. The 6AY3 damper tube is modified to speed its warmup about 20%. The combined effect of the two tubes is to ensure that the audio-output tube does not function

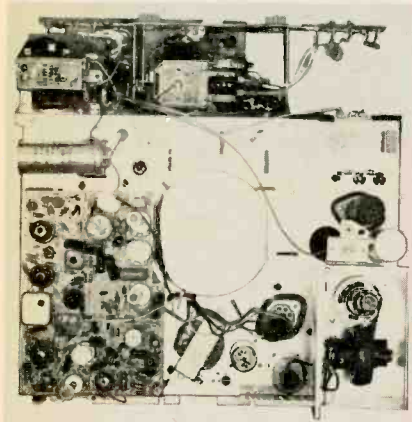

before the rest of the receiver begins operating. The possibility of an annoying buzz during warmup is thus precluded.

Noise-limiting action in all models has been improved by changing the value of the sound-IF plate-dropping resistor and adding a resistor from plate to ground (see diagram for typical circuit). The bleeder current is large enough that normal variations in plate current have little effect on the plate voltage.

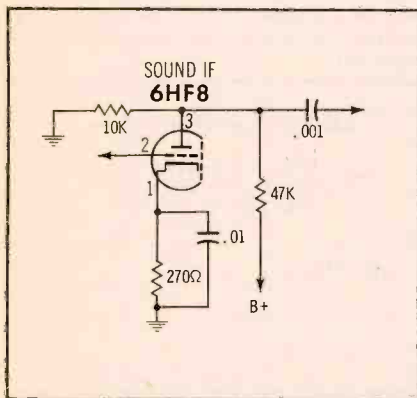

A manual-reset circuit breaker is used on all models except those having series filaments. The breaker is designed to withstand surges but opens on sustained overloads.

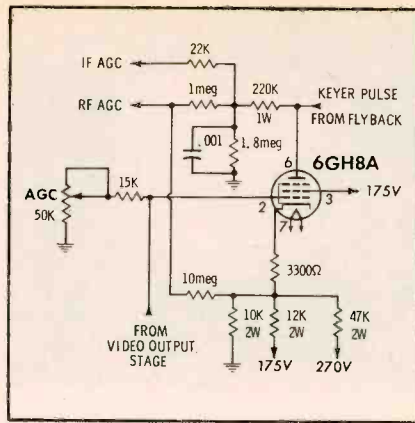
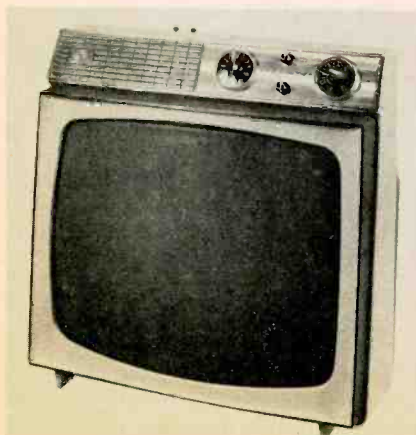

Linearity coils are incorporated in the KCS 136X and KCS 149 chassis; in the KCS 136X a fixed coil is used; a variable, tapped-coil arrangement is used in the KCS 149.

In the KCS 151, a 3300-ohm cathode resistor is used to provide degeneration in the AGC section of the 6GH8A (see circuit). Since the suppressor grid of the section is tied directly to the cathode, no noise cancellation is developed by this grid. The use of negative feedback prevents excessive tube conduction during noise pulses.

SEARS/SILVERTONE

Eight different chassis are being offered this season. With the exception of one chassis series (see chart), all come equipped with transistorized UHF tuner, circuit breaker, and rim-bonded picture tube.

The 528.60530 chassis is used in some 19" models, and a similar chassis (.60700) in some 23" sets. Included in the tube lineup for both chassis are three novar-type tubes introduced last year: 15KY8 vertical multivibrator, vertical output; 22JG6 horizontal output; and 17BS3 damper. An 8JY8 again fills the video-output and sound-IF slot. Simple AGC (developed at the video detector) is used; no control is included. Physical design follows the cabinet-contour shape introduced last year; a small printed circuit board contains the vertical and horizontal oscillators; the video and audio circuits are on a larger board.

The 528.61420 is a popular 23" chassis; it's being used in five models. A two-stage IF, a half-wave doubler using silicons, and one printed circuit board are features you'll find in this series.

The 528.61450 appears in nine different 23" models. Features include a familiar three-stage IF strip, and a multipurpose 4HS8 stage combining AGC keyer, noise limiter, and sync separator. Chassis .61510 is similar in its physical and electrical designs.

Chassis 528.60730 is used in one 19" model, the 5124. It features two video-IF amplifiers, using high gain tubes. This model is available with remote control and/or clock-timer assembly.

Rounding out the 19" line are the .61390 and .61480 chassis. Both feature two compactrons: 17BF11 for audio detector-output, and an 11KV8 for video output-sound IF. The two-stage IF uses

a 4EH7 and a 4EJ7; both are high-gain frame-grid tubes. (Note: Chassis may carry a 456, 528, or 529 designation preceding the chassis series number. For example, the 456.60530 and 528.60530 chassis are identical.)

SETCHELL-CARLSON

Models with 16", 19", and 23" screens are available this coming year. The UX600 chassis introduced last year is being carried over in '65, except that the UHF tuner, which was optional in 1964, will be standard equipment.

Three other '65 chassis are the 202, 301, and 401 (used in both 19" and 23" models). Actually, all chassis have similar features and circuits: *Unit-ized* construction; two-stage IF's using 6EH7 and 6EJ7 frame-grid tubes; keyed AGC, sync separator, and noise limiter combined in

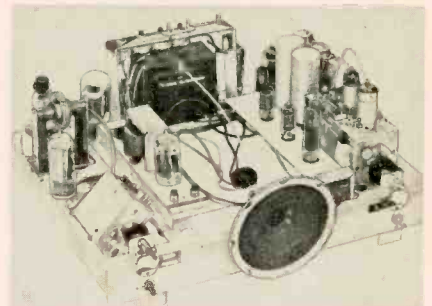

a multipurpose tube; a dual selenium diode for horizontal AFC (common cathode type); a turret tuner with 6HQ5 RF amplifier and 6GX7 mixer-oscillator;

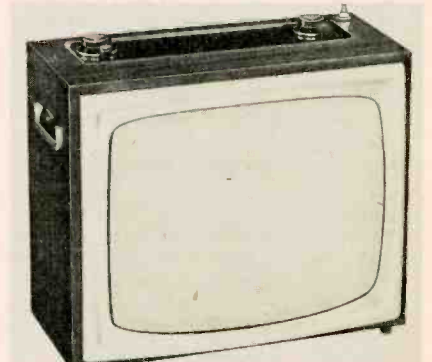

transistorized UHF tuner; and power transformers in all models. No remote control is available in the series.

The ratio detector in the sound channel, familiar in the company's line for years, has been moved out in favor of a quadrature detector using a 6HZ6. An

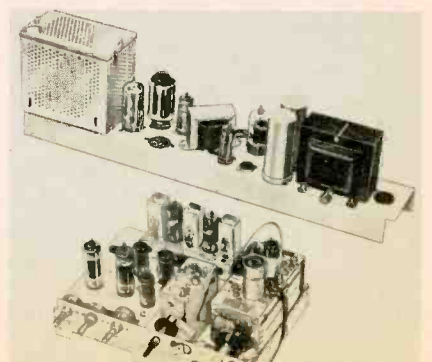

exception is the UX600, which has the familiar 6AL5 stage. The 301 and the 401 are depicted in the photos. The Model 19T65 pictured uses the 301 chassis.

SYLVANIA

This year's line includes 19" portables and 23" table and console models. The basic chassis for the large-tube models is the 585 series; its transformer power supply is the main feature distinguishing it electrically from the 583-series chassis used in the 19" models. The 589-series chassis, used in the *HaloVision* series, has a transformer power supply and a three-stage video-IF strip.

VHF TERMINALS

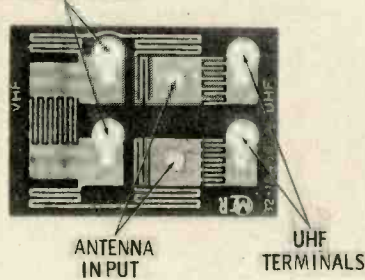

All models are supplied with a printed-circuit signal splitter (see photo and diagram). Using this device, a single antenna (either built-in or external) may be connected to the receiver. If separate VHF and UHF antennas are to be used, the splitter can be removed entirely by loosening the screws on the antenna terminal board of the receiver.

Most of the chassis are equipped with transistorized UHF tuners; however, some chassis in the 585 series have an alternate tube-type tuner.

One significant change from last year is the sync-separator circuit. In all chassis, the 6CS6 tube used in last year's circuit has been replaced with the triode section of a 10JT8 (6JT8 in transformer-powered sets). A transistor-type noise gate is used in the cathode circuit of the sync separator stage.

Again this year, some models are de-

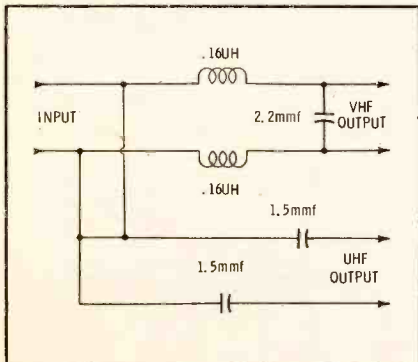

signed for use with an optional clock timer.

WELLS-GARDNER

Among this private-label manufacturer's new line are three basic chassis:

the 19" T750 and two 23" chassis, T821 and T840. The 19" chassis is similar to last year's design, using printed circuitry except for the tuner and deflection circuits. A straightforward three-stage IF uses 3BZ6's and one 3CB6. Other familiar tubes include the 8BQ5 video output, 8EM5 vertical output, 12AY3 damper, 8CG7 vertical multivibrator and sync separator; another 8CG7 functions as the horizontal multivibrator.

Two silicon rectifiers, wired in a half-wave doubler circuit, develop B+; a circuit breaker provides the main protection for this circuit; added safety is afforded by a 5-ohm, 15-watt surge-limiting resistor. Automatic brightness and contrast control is available in some models. The circuit is identical to last year's; a light-dependent resistor is connected in parallel with the contrast control (see circuit). You'll find a separate filament transformer for the pilot light, in some models. Width is adjustable by moving a metal sleeve located between the yoke and the picture tube.

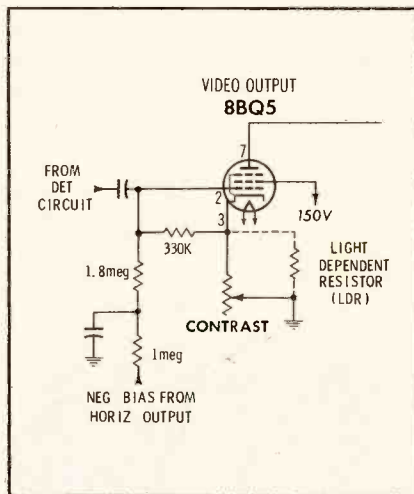

The 23" T840 chassis has the same tube complement and circuitry as the 19" just described, although the physical design differs. In all three chassis, a turret-type VHF tuner and a transistorized UHF tuner are used. The VHF RF amplifier is a new type 2HQ5; another new tube is the 5HB7 mixer-oscillator.

A 92° 23ENP4 or 23DLP4 is used in the T821 chassis series. Low B+ (140 volts) is used, obtained from a single silicon rectifier. Other features of this series include a two-stage IF strip (with high-gain 3DK6's), 8CW5 audio output, 8CW5 vertical output, and 12JT6 horizontal output. The latter three tubes are types designed to operate with B+ values around 140 volts. Focus is adjusted by changing the position of a wire jumper located on the base of the CRT; connection is from pin 6 to pin 2 or 10.

WESTINGHOUSE

In addition to the usual 19" and 23" sets, this year's line has an added attraction—12" portables. These new portables are powered by the V-2478 chassis—shown in operating position (top) and servicing position (bottom)—which is electrically similar to last year's V-2446.

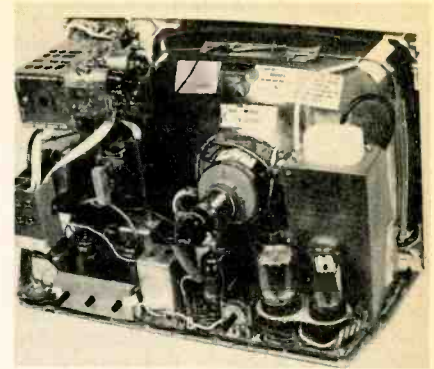

The little portables are made in Japan, but parts are interchangeable with Westinghouse parts made in the United States. There are four of these small-screen models; two have the "Instant-On" circuit (see below) and jacks for earphone listening.

The V-2474 and V-2475 chassis are used in both 19" and 23" receivers. Some new tube types make their appearance in these chassis. The 17BE3 compactron is used as a damper tube; a 6HB7 serves as a mixer-oscillator and a 3HQ5 as an RF amplifier in the VHF tuner. (The UHF tuner in these chassis is a transistor type.)

A number of circuit features have been retained from last year's lineup. For example, the neon-lamp horizontal-blanking circuit used in the V-2472 chassis has been carried over to this year's V-2475 series.

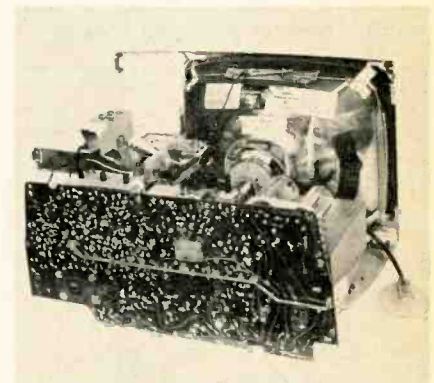

Most of the new models incorporate the "Instant-On" filament-circuit arrangement; a rectifier is used to apply pulsating DC to the tube filaments at all times when the power cord is plugged in. When the power switch is turned on, one switch section shorts the rectifier, and AC is applied to the filament string. At the same time, another switch section energizes the B+ supply. The purpose of this system is to provide rapid warm-up; to protect the tubes from damage due to current surges during cold starts; and, by constantly generating a small amount of heat, to reduce deterioration of the set due to the effects of humidity.

Other circuit holdovers: The separate bias supply for the video output stage, found in some previous models, is incorporated in the V-2474 chassis; and in both the V-2474 and V-2478 chassis, a trimmer capacitor is used to set the amplitude of the keying pulse fed to the AGC tube.

ZENITH

A total of ten new chassis is being introduced this year, ranging from the combination models using the deluxe 16M24 chassis to the 16" portable with the 14M20 chassis. Physical layouts of the new chassis are similar to last year's comparable models. Hand wiring is used throughout the entire line. Three of these new chassis are transformerless types; the others have power transformers, but all models use silicon rectifiers in the power supply. Circuit breakers are used for low-voltage protection; the only fuse this year is a 2-amp line fuse in the 14M20 chassis.

Aside from the CRT, all Zenith's transformerless sets use the same tube lineup. Many of these tubes are new and unfamiliar types. Some new types are: 10GN8 video output, sound-IF amplifier; and 13J10 audio discriminator, audio output. In the vertical multivibrator-output stage you may find either 13FM7 or 15FM7. The horizontal AFC and oscillator may use either a 5KD8 or 6GH8, while the horizontal output uses a 17J16; the damper is a 22BW3.

A factory-installed remote-control unit is available on all chassis except the transformerless ones—the 14M20, 14M29, and 14M31. As required by law, all sets are equipped with a UHF tuner; they use a transistor as the UHF oscillator. All models have a width adjustment; some use a width sleeve and others have a control. Those that have a control for varying the width also have a sleeve which is used for horizontal linearity.

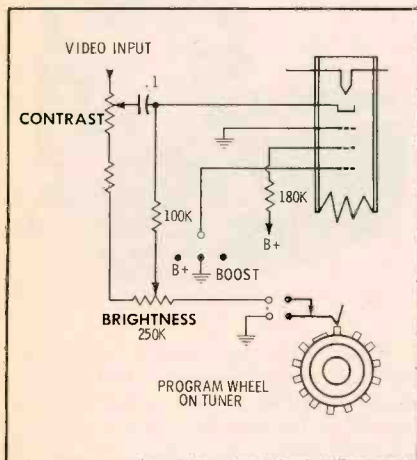

The 14M25 is called the "hospital set" and has an additional control (known as the *Volume Limit*) in the audio circuit. Accessible from the rear of the chassis, it sets the maximum limit of volume obtainable.

Some remote-control models have a raster-blanking switch to extinguish the raster while the tuner is moving between channels. The ground connection is removed from one side of the brightness control as the program wheel moves between contacts. This circuit is shown in the diagram. If a loss of brightness occurs and high voltage is still present, remember to check the blanking switch to make sure proper contact is achieved by the program wheel.

Two new *lightweight* portables are late drop-ins, designed to replace earlier 16" introductions. No specifications on these sets were available at presstime.

OTHER U.S. BRANDS

Editor's Note: Complete information from these companies hadn't been received by press time.

Admiral's '65 line includes a new 13" portable and a 25" chassis used in four models. The latter models feature a tilt-out control panel; all controls are concealed when the panel is recessed.

Hoffman has acquired Trav-Ler and will probably return to the television market—with a receiver bearing their own brand name—by late '65.

Portables will again be available from **Muntz** (first in three years); several 19" chassis are planned.

Olympic is introducing two new chassis: The 9P40 used in 16" and 19" sets, and the NAP chassis used in 23" models. The handwired NB chassis—used in the majority of 23" receivers in '64—is being held over for use in both the 23" and new 27" models.

Pilot, last seen in the television ranks in 1952, will offer a 21" color television receiver to complement the company's home entertainment centers.

FROM CANADA

The 18MIX chassis is being used in all black-and-white sets manufactured by **Clairtone**. Features include a three-stage

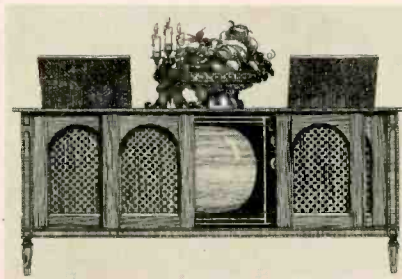

IF, dual diode (common cathode) for horizontal AFC, power transformer, and silicon rectifiers. Two color combinations, including the Duchess Color Theatre shown here, have been introduced.

Chassis 2301 is used in 23" sets introduced by **Sparton of Canada**; the 19" models use chassis 1901. Both are hand-wired designs, with the picture tube mounted on the chassis. Portables, table

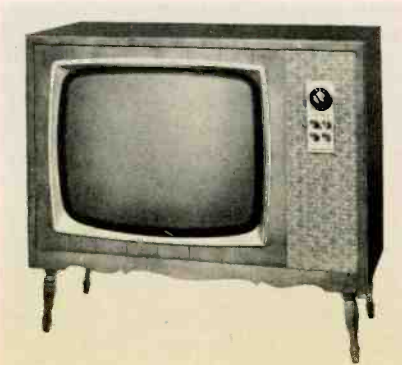

models, consolettes, and combinations are available.

To the best of our knowledge, **Electrohome** is the first manufacturer to utilize a completely transistorized IF strip in a mostly-tube receiver. Three of their four new chassis have four stages of video amplification, using four transistors. Other semiconductors include four silicones in the full-wave power supply and a transistor as the UHF oscillator. These chassis are used in both 19" and 23" versions. The 19PR323 (19" and 23" version) features three IF amplifiers, using frame-grid tubes; the UHF tuner is a tube type.

FROM JAPAN

Channel Master will import their 19"



portable Model 6572 . . . **Delmonico** continues their trend of offering several different tinyvision models, including the 12" portable shown here . . . **Sony's** addition to their "personal portable" television line is a completely new 4" receiver (see photo). Weighing only 6 lb,

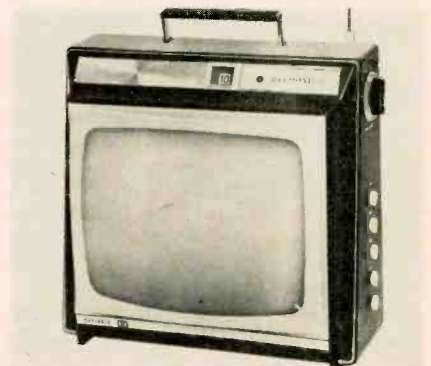

this tiny set can be operated from a battery pack or AC voltage . . . The '65 Panasonic line by **Matsushita** hasn't been firmed up at this time. ▲

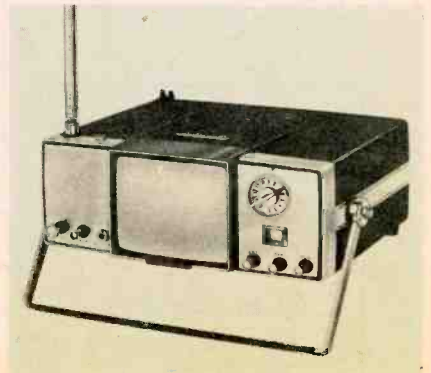

Tarzian offers
**FAST, DEPENDABLE
 TUNER REPAIR
 SERVICE** (ALL
 MAKES)

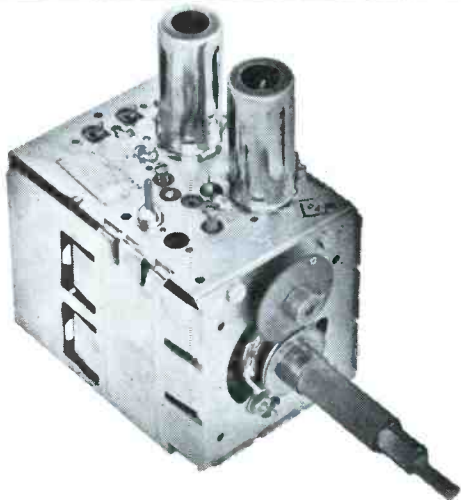

It just makes sense that a manufacturer of tuners should be better-qualified, better-equipped to offer the most dependable tuner repair and overhaul service.

Sarkes Tarzian, Inc. pioneer in the tuner business, maintains two complete, well-equipped Factory Service Centers—assisted by Engineering personnel—and staffed by specialized technicians who handle **ONLY** tuner repairs on **ALL** makes and models.

Tarzian-made tuners received one day will be repaired and shipped out the next. Allow a little more time for service on other than Tarzian-made tuners.

Tarzian offers a 12-month guarantee against defective workmanship and parts failure due to normal usage. And, compare our cost of \$9.50 and \$15 for UV combinations. There is absolutely no additional, hidden charge, for **ANY** parts except tubes. You pay shipping costs. Replacements on tuners beyond practical repair are available at low cost.

Ⓢ Tarzian-made tuners are identified by this stamping.

When inquiring about service on other tuners, always give TV make, chassis and Model number. All tuners repaired on approved, open accounts. Check with your local distributor for Sarkes Tarzian replacement tuners, replacement parts, or repair service.

 **SARKES TARZIAN, INC.**
 Bloomington, Indiana

MANUFACTURERS OF TUNERS . . . SEMICONDUCTORS . . . AIR TRIMMERS . . . FM RADIOS . . . AM/FM RADIOS . . . AUDIO TAPE . . . BROADCAST EQUIPMENT

ONLY
\$9.50
INCLUDING

ALL PARTS
 (except tubes)
and LABOR

24-HOUR SERVICE
1-YEAR WARRANTY

**TWO SERVICE CENTERS
 TO SERVE YOU BETTER**

**See your distributor, or use the
 address nearest you for fast fac-
 tory repair service**

537 South Walnut St.
 Bloomington, Indiana
 Tel: 332-6055

10654 Magnolia Blvd.
 North Hollywood, Calif.
 Tel: 769-2720

Circle 3 on literature card

publisher
Howard W. Sams

editor
Forest H. Belt

managing editor
George F. Corne, Jr.

associate editors
James M. Moore
Allen B. Smith
Stuart N. Soll
Norman D. Tanner

consulting editors
William E. Burke
Joe A. Groves
C. P. Oliphant

production manager
Robert N. Rippy

circulation manager
Pat Tidd

Katherine Krise, Ass't.
Cori La Von Willard, Ass't.

art directors
Gene La Rue
Robert W. Reed

advertising & editorial assistants
Hazel Boyer
Rebecca Clingerman

photography
Paul Cornelius, Jr.

advertising sales offices
David L. Milling, advertising sales manager

midwestern
Hugh Wallace
PF REPORTER
4300 West 62nd Street,
Indianapolis 6, Ind.
AXminster 1-3100

eastern
Gregory C. Mosefield
Howard W. Sams & Co., Inc.
3 West 57th Street,
New York, N. Y.
MUrray Hill 8-6350

western
The Maurice A. Kimball Co., Inc.
2550 Beverly Blvd., Los Angeles 57, Calif.
DUnkirk 8-6178; and 580 Market Street,
Room 400, San Francisco 4, Calif. EXbrook 2-3365

Address all correspondence to
PF REPORTER, 4300 W. 62nd Street,
Indianapolis, Indiana 46206



Copyright © 1964 by Howard W. Sams & Co., Inc.
PF REPORTER is a trademark of Howard W. Sams
& Co., Inc. No part of PF REPORTER may be
reproduced without written permission. No patent
liability is assumed with respect to use of
information herein. Acceptance of advertising does
not in any manner signify the products, policies
and services so advertised have been approved,
endorsed or recommended by this magazine.
Subscription Prices: 1 year—\$5.00, 2 years—\$8.00,
3 years—\$10.00, in the U.S.A., its possessions and Canada.
All other foreign countries: 1 year—\$6.00, 2 years—
\$10.00, 3 years—\$13.00. Single copy 50¢; back copies 65¢.

Indexed in *Lectrodex*.
Printed by the Waldemar Press Div.
of Howard W. Sams & Co., Inc.



PF REPORTER

including **Electronic Servicing**

VOLUME 14, No. 10

OCTOBER, 1964

CONTENTS

SPECIAL COMMUNICATIONS SUPPLEMENT

Rebuilding Carbon Mics Larry Allen	82
Quick and easy service and repair of the commonest mobile microphone.	
Communications Tower Maintenance	86
A pictorial reminder of several hints that ensure safe and sane installation and service.	
Transistor Power Supplies for Two-Way Edward M. Noll	88
Two-Way Talk—Sensible appraisal of solid-state power units removes doubts about their operation.	
Book Review	66

Highlights of 1965 TV Lines	1
Basic specifications on new black-and-white chassis, including new tubes, circuits, and sizes.	
Letters to the Editor	14
The Electronic Scanner	18
The Troubleshooter	20
Symfact: Horizontal Output (Grid as Bias Source)	27
See what happens to voltages and waveforms when troubles occur.	
Shrunken Rasters Allan F. Kinckiner	32
Shop Talk—Horizontal-sweep and HV troubles that reduce rasters to narrowed ribbons.	
New Sound From Old Cabinets	34
Audio Facts—Give those tired phonos a brand-new lease on liveliness.	
Problem: Width and Linearity—Solved Art H. Meyerson	36
Quicker Servicing—Hints on troubleshooting narrow TV images.	
Guide to Unusual Test Equipment	38
A useful list of test equipment for solving special problems.	
Applied Reasoning for Auto Sets William C. Caldwell	42
Increase the dollars in your cash register by speeding up auto-radio troubleshooting.	
Make the Most of Your Attorney Dave Cox	48
Dollar and Sense Servicing—Good advice from a qualified attorney on keeping yourself out of hot water, legally speaking.	
Notes on Test Equipment	58
Lab reports on Cornell-Dubilier Model BF 71A Capacitance-Resistance Analyzer, Hickok Model 470A VTVM, and Standard Kollsman VHF-UHF Translator.	
Product Report	74
Book Reviews	79
Free Catalog & Literature Service	80
Monthly Index on free literature card	

ABOUT THE COVER

With the new year just around the corner, set makers are busy with a bewildering array of changes and improvements. The 8-page special book section in the front of this issue will bring you up-to-date quickly on features of the 1965 chassis.

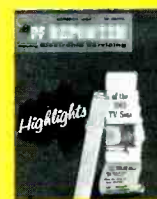

WHY risk your reputation with "just-as-good" capacitors?

When you pay little or no attention to quality in tubular replacement capacitors, you leave yourself wide open for criticism of your work . . . you risk your reputation . . . you stand to lose customers. It just doesn't pay to take a chance on capacitors with unknown or debatable performance records when it's so easy to get guaranteed dependable tubulars from your Sprague distributor!

There's no "maybe" with these 2 great SPRAGUE DIFILM® TUBULARS!

The ultimate in tubular capacitor construction. Dual dielectric . . . polyester film and special capacitor tissue . . . combines the best features of both. Impregnated with HCBX®, an exclusive Sprague synthetic hydrocarbon material which fills every void in the paper, every pinhole in the plastic film *before it solidifies*, resulting in a rock-hard capacitor section . . . there's no oil to leak, no wax to drip. Designed for 105°C (220°F) operation without voltage derating.



DIFILM® BLACK BEAUTY®
Molded Tubular Capacitors

The world's most humidity-resistant molded capacitors. Tough, protective outer case of non-flammable molded phenolic . . . cannot be damaged in handling or installation. Black Beauty Capacitors will withstand the hottest temperatures to be found in any TV or radio set, even in the most humid climates.



DIFILM® ORANGE DROP®
Dipped Tubular Capacitors

A "must" for applications where only radial-lead capacitors will fit . . . the perfect replacement for dipped capacitors now used in many leading TV sets. Double-dipped in rugged epoxy resin for positive protection against extreme heat and humidity. No other dipped tubular capacitor can match Sprague Orange Drops!

For complete listings, get your copy of Catalog C-616 from your Sprague distributor, or write to Sprague Products Company, 105 Marshall Street, North Adams, Massachusetts.



WORLD'S LARGEST MANUFACTURER OF CAPACITORS

For window-size blow-ups of this message, send 10¢ to Sprague Products Co., 105 Marshall St., North Adams, Mass., to cover handling and mailing costs.



ARE TV SERVICE DEALERS GYPS?

Every so often, some magazine or newspaper sounds off about TV-radio service shops.

“Service technicians are a bunch of gyps,” is the general theme. “They’ll clip you if you don’t watch out.”

They might just as well write the same thing about doctors, lawyers, storekeepers, auto mechanics—or anyone else. There are gyps in every line of business. Actually the percentage in TV-radio is lower than in most.

The average service technician is a hard-working, straight-shooting individual. Rather than gyp customers, he is far more likely to spend more time on a job than he knows he will be paid for—simply as a matter of personal pride in doing things right.

We recently heard about someone’s TV set going bad. A service technician called for it with his truck and returned it in good working condition within 48 hours. His bill came to \$10 for service plus \$2.68 for replacement parts.

The set owner argued that this was too much—yet he would never dream of complaining to the medical specialist who charged him \$10 for a 15-minute office visit; the lawyer whose bill for writing a simple will was \$75; or the garage man who laughingly admits that he charges \$5 for “just raising the hood” of a car.

In one of our very large cities, the Better Business Bureau received fewer than 500 complaints about serv-

ice in a year. Most of the complaints came from folks who expected first-class reception in doubtful fringe areas; who tried to operate their sets without suitable antennas; or who had bought sets “wholesale” at ridiculously low prices from cut-rate dealers who could offer little or no service.

Actually, it takes almost as long to become a good service technician as it does to train for any other profession. Beyond this, it calls for regular study to keep up with the constant stream of new developments. Also, it requires a surprisingly big investment in test instruments, manuals, and other shop equipment. The modern TV or radio receiver is by far the most intricate piece of equipment the average person ever owns or uses.

Service technicians are not fly-by-night businessmen—99 out of 100 run their businesses properly. The other one per cent—the gyps—can usually be spotted a mile away. Nine times out of ten, they are the shops that feature “bargain” prices and ridiculously liberal service contracts. And their victims are generally set owners who expect to beat the game by “getting something for nothing.”

Good television sets or good TV service are not things to be bought on a “bargain counter” basis. Set owners who recognize this aren’t likely to get gyped.

Instead, they’ll find that they get more real value for their television entertainment dollars than for any other dollars they spend!

THIS MESSAGE WAS PREPARED BY SPRAGUE PRODUCTS COMPANY,
DISTRIBUTORS’ SUPPLY SUBSIDIARY OF SPRAGUE ELECTRIC COMPANY, NORTH ADAMS, MASSACHUSETTS, FOR . . .

YOUR INDEPENDENT TV-RADIO SERVICE DEALER

65-123-63

Circle 4 on literature card

Get The GENERATOR That Has EVERYTHING!

3. EXCLUSIVE 5:4 CROSSHATCH

Faster convergence, easier linearity checks

4. SINGLE COLOR BAR

3.58MC color reference signal, gives *positive*, simple color performance check

2. GUN KILLERS

Check all three color guns, speed purity checks

1. READY FOR THE FUTURE

Broad-Coverage signal for VHF and UHF. Interchangeable CRT assemblies handle *all* color tubes

5. 500-DOT PATTERN

0.1 μ sec dot—smallest anywhere! Complete screen coverage, more accurate convergence

6. SEPARATE HORIZONTAL & VERTICAL BARS

Spot vertical and horizontal misconvergence faster, speeds over-all job

HICKOK

Model 662
\$159.⁹⁵

- 1. Ready For The Future**—Untuned, broad-coverage RF signal injects signal directly into antenna terminals, covers both VHF and UHF. Interchangeable CRT assemblies assure coverage of all present and anticipated color tubes, including new 25" tubes.
- 2. Gun Killers**—Individual pots and switches control each of the CRT guns separately. You can check the picture for emission, gas, shorts, in addition to individually checking the R-Y, B-Y and G-Y signals.
- 3. 5:4 Crosshatch**—Means more vertical lines, more horizontal lines and complete screen coverage including hard-to-converge areas at the edges.
- 4. Single Color Bar**—Simplified color reference bar at 3.58MC color burst frequency for definite color performance checks, impossible with gated rainbow generators.
- 5. 500-Dot Pattern**—Superior to 150-dot system because dot size is smaller (actual size, 1 line or 0.1 μ sec) for accurate convergence and complete screen coverage—no blank spots.
- 6. Separate Horizontal and Vertical Bars**—Quickly determines major areas of misconvergence, saves time by showing you where to start first.

HICKOK

THE HICKOK ELECTRICAL INSTRUMENT CO.

10566 Dupont Avenue · Cleveland, Ohio 44108

Represented in Canada by Stark Electronics, Ajax, Ontario

Internationally by Hughes International, Husint, S. A., Culver City, Cal.

Circle 5 on literature card

ATR PRODUCTS FOR MODERN LIVING



NOW...
THE FABULOUS
* **G. E. COMBO**

PLAYS ANYWHERE
ON 110 AC OR 12V DC
BATTERY CURRENT

For

Auto • Boat • Plane
Camps • Picnic • Trailer

ATR MODEL 12T-RME-1 INVERTER... \$39⁹⁵

*G.E. MODEL M110Y 11" PORTABLE TV \$99⁹⁵

*Available at G.E. TV Dealers

Both Only **\$139⁹⁰** Retail
THE **ATR** MODEL 12T-RME-1 ONLY ONE
OF A FAMILY OF FAMOUS DC-AC **INVERTERS**

Also NOW...

HAND WIRED—
NO PRINTED
CIRCUITRY

ATR ALL-TRANSISTOR
ULTRA COMPACT
UNIVERSAL MODEL 707



Karadio
IN DASH...
UNDER DASH...

Complete with variable tone control . . . R. F. stage
. . . Built-in speaker . . . and External speaker jack.

ATR MODEL 707 \$29⁹⁵ Retail



ATR ALL-TRANSISTOR
ROOF-MOUNT and
IN-DASH MODELS

TRUCK

Karadio

MODEL TR-720

FITS ALL TRUCKS • BOATS •
STATION WAGONS
INSTANT PLAY . . . POWERFUL

Complete with patented antenna-yoke assembly.
(U.S. Patent No. 3,087,118. Canadian Reg. 575,567)

ATR MODEL TR-720 \$44⁹⁵ Retail



ATR "A" Battery
ELIMINATOR

For Demonstrating and
Testing Auto Radios—
TRANSISTOR or VIBRATOR
OPERATED!
Designed for testing D.C.
Electrical Apparatus on Reg-
ular A.C. Lines.

MAY ALSO BE USED AS A BATTERY CHARGER
MODEL 610C-ELIF . . . 6 volts at 10 amps. or 12 volts
at 6 amps. Shipping weight 22 lbs.

USER NET PRICE \$55⁰⁰

ATR AUTO RADIO and
COMMUNICATION

LONGER-LIFE
VIBRATORS

"The Best by Test!"



SEE YOUR ELECTRONIC PARTS DISTRIBUTOR OR
WRITE FACTORY FOR LITERATURE & DEALER PRICES

ATR ELECTRONICS, INC.

Quality Products Since 1931



St. Paul, Minnesota 55101—U.S.A.

Circle 6 on literature card



**Letters to
the Editor**

Dear Editor:

I enjoy PF REPORTER every month. My first stop is "The Troubleshooter," and then I read the magazine from cover to cover. In the June issue, I noticed a problem ("Lost Audio") that a Mr. Miller had with a Chevrolet radio. Having just solved a similar problem, I felt perhaps I could help Mr. Miller further: The output stage employs a 4.7-ohm, 5-watt fusible resistor in the emitter circuit, and I've found it quite prone to failure. This may be the trouble in Mr. Miller's auto radio. The resistor is located on the component side of the PC board, hidden behind a tubular electrolytic.

ERNEST F. SIEGEL

Baltimore, Md.

The Troubleshooter sends his thanks. The fusible resistor is a common troublemaker; even though the stage is disabled, audio can sometimes "couple through" the transistor. On the other hand, we've seen several technicians repair other trouble in the set, only to find they have extremely weak audio on the test bench. In the auto, they later find, the set works okay. The solution has generally been that the technician has failed to "cheat" the interlock that protects the output transistor. Just be sure a speaker is connected before opening the interlock contacts. In the car, of course, the speaker plug automatically opens the interlock.—Ed.

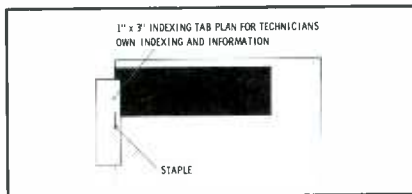

Dear Editor:

The enclosed sketch shows a method I use for quickly locating information I need from among the various copies of PF REPORTER on my shelf. I staple (pasting would do) a 1" x 3" plain tab at the top left-hand corner; when the magazine is standing upright in the row of issues on the shelf, the tab projects out of the row. I then list on the tab any subjects I am particularly interested in. Thus, I can find which issue contains the articles without having to take down several issues and thumb through them.

H. E. MCKINNEY

McKinney Repair Shop
Winter Haven, Fla.

This is an excellent system for keeping a highly personalized listing of items of especial interest. For locating information more extensively, a file containing the perforated Index Cards from the back of the issues will also prove valuable.—Ed.

Why doesn't
everybody
stock

Jensen
**SNAP-IN
CARTRIDGES?**

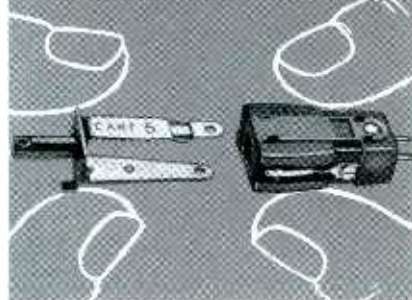

If you've been shying away from profitable cartridge replacement business because of the cost and conniptions of cumbersome inventories, let Jensen get you back on the right "track." Here's how:

- Less inventory
- Complete coverage
- Superior performance
- Respected, accepted brand name

Why doesn't everybody stock Jensen Snap-In Cartridges? Give 'em time. Soon they will.

SPECIAL K-1964 DEAL

Write for details on special Dealer Starter Kit K-1964—12 brackets and 6 interchangeable cartridge bodies which will replace 80% of all basic cartridge requirements.

World's finest phonograph needles, cartridges, drives, accessories

Jensen
INDUSTRIES, INC.
301 Interstate Rd., Addison, Ill.

In Canada: A. T. R. Armstrong,
P.O. Box 244, Islington, Ontario

Circle 7 on literature card



for color and UHF...

Belden All-Weather Lead-In delivers 25% to 51% more power

It's no great news to you that when your customer pays a good price for a color TV set, he's going to be pretty choosy about the quality of his picture. He'll be a lot more aware of a poor color picture than a poor black and white picture.

So it's to your advantage . . . and his . . . to install the best TV lead-in you can get your hands on . . . Belden All-Weather Permohm*! When wet, this all-channel, 300-ohm line delivers 25% to 51% more signal power to the receiver. This means clearer color and UHF TV reception the year 'round in all areas . . . including areas where there's extreme salt spray, rain, snow, ice, and industrial contamination.

Save yourself callbacks and headaches. Install Belden All-Weather Permohm . . . and forget it. That's pretty good insurance for pennies a foot!



**Be a Cartoon
Gag Writer!
Win a \$25.00
Savings Bond**

Send us your gag ideas for future cartoons. For each of your gag ideas used, we'll send you a \$25 Savings Bond. Write Belden Manufacturing Company. Attention: Mrs. Madelsa Allison, P.O. Box 5070-A, Chicago, Illinois 60680.

*This month's winner: E. J. Stanmyre,
Route 2, Box 306, Canton, North Carolina

Better Built . . . Better Buy . . .

Belden

WIREMAKER FOR INDUSTRY
SINCE 1902 CHICAGO

*U.S. Patent No. 2782251

B-9-4

power supply cords • cord sets and portable cordage • electrical household cords • magnet wire • lead wire



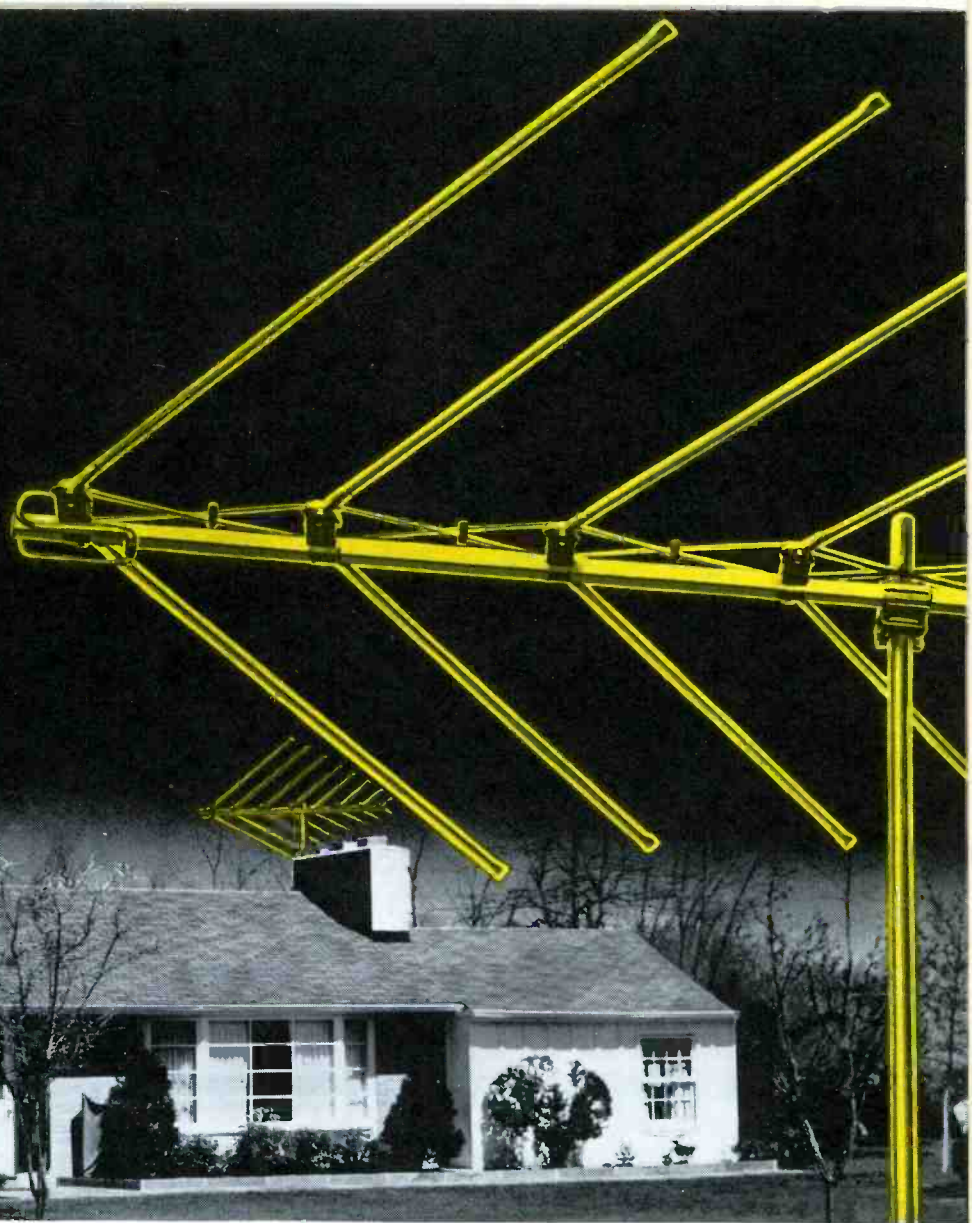
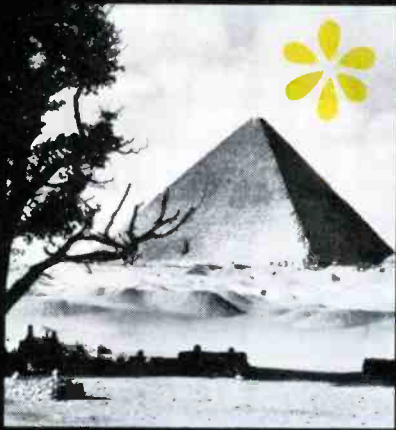

some homes do not need

—but 51,300,000 DO* Certain folk don't go for TV! But—millions of new color set fanciers (plus millions more black/white TV owners) are realizing that times now call for a modern new antenna to get the ultimate in reception. Awareness such as this has helped make our LPV Log Periodic first in antenna sales.

WHY MORE JFD LPV LOG-PERIODICS ARE BEING INSTALLED THAN ANY OTHER VHF ANTENNA . . . The JFD Log-Periodic is a revolutionary new concept in antenna design. Its frequency-independent performance does not sacrifice gain, directivity, bandwidth or impedance match as other conventional antennas must on certain frequencies to achieve all-VHF-channel reception. Harmonically resonant V-elements operate on the patented Log-Periodic cellular formula $\frac{L_{(n+1)}}{L_n} = \tau$ to provide the same superb performance on every VHF channel—color or black and white—plus FM/Stereo.

STOUTLY BUILT OF HEAVY WALL GOLD ALODIZED ALUMINUM . . . Inch for inch, ounce for ounce, JFD LPV Log-Periodics deliver more mechanical

strength in less mass. Gleaming gold alodizing (the same used by NASA and the military services) does not insulate vital contact points as does anodizing. Instead, electrically conductive gold alodizing improves signal continuity.

DEVELOPED FROM RESEARCH PERFORMED AT THE UNIVERSITY OF ILLINOIS ANTENNA RESEARCH LABORATORIES . . . The JFD Log-Periodic is the commercial end result of six years of electronic research. No other design has undergone such intensive research and development by leading antenna scientists.

INSTALLED BY MORE WORLD'S FAIR PAVILIONS THAN ANY OTHER BRAND . . . The New York World's Fair House of Good Taste, Formica House, New York City Pavilion, House of Japan, Eastman Kodak exhibit, Florida and Hawaii Pavilions installed JFD Log-Periodics to assure best possible performance of their color TV sets. Millions of Fair visitors will remember and ask for the JFD Log Periodic LPV, paving the way for more sales by you.



*A. C. Nielsen estimate of U.S.A. homes with TV, September, 1963

NEW! THE FIRST COMBINATION VHF/UHF/FM/STEREO —THE LOG PERIODIC "ALL-VU"—WITH SINGLE LEAD-IN



model	description	list
LPV-VU18	18 Cells	\$69.95
LPV-VU15	15 Cells	\$59.95
LPV-VU12	12 Cells	\$49.95
LPV-VU9	9 Cells	\$39.95

NEW! LOG PERIODIC ZIG-A-LOG FOR PROBLEM "UHF" AREAS

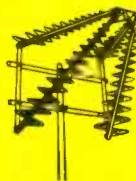

description	model	list
LPV-ZU20	E-Plane Stacked	\$37.50
LPV-ZU10	1-Bay	\$17.95

NEW! LOG PERIODIC LPV FOR UHF CHANNELS 14 TO 83 & VHF 7 TO 13

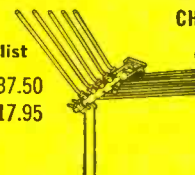

description	model	list
LPV-U21	21 Cells	\$27.95
LPV-U15	15 Cells	\$18.95
LPV-U9	9 Cells	\$12.50
LPV-U5	5 Cells	\$ 6.95

LICENSED UNDER ONE OR MORE OF U.S. PATENTS 2,958,081; 2,985,879; 3,011,168; 3,108,280 AND ADDITIONAL PATENTS PENDING IN U.S.A. AND CANADA. PRODUCED BY JFD ELECTRONICS CORPORATION UNDER EXCLUSIVE LICENSE FROM THE UNIVERSITY OF ILLINOIS FOUNDATION.

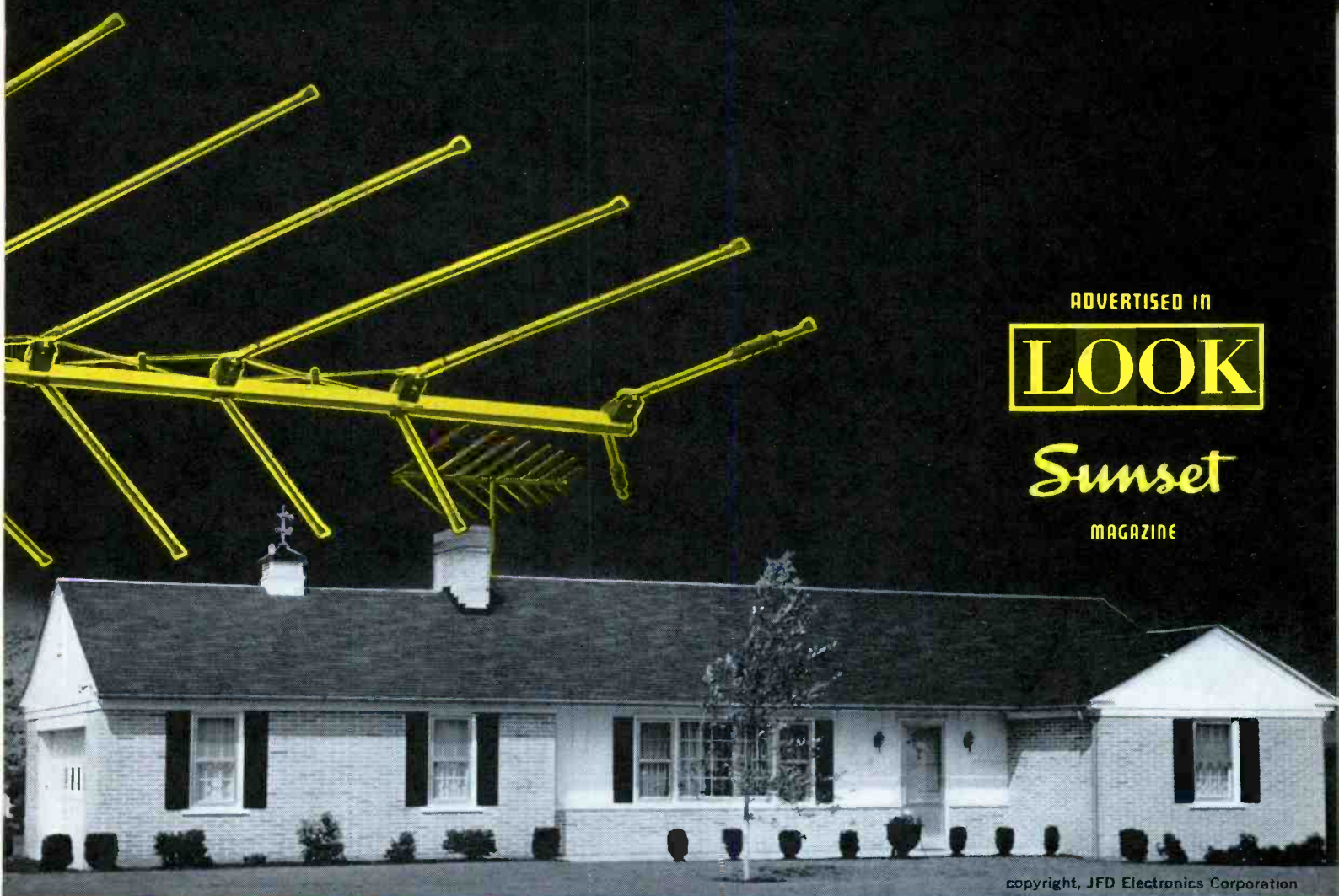

ADVERTISED IN

LOOK

Sunset

MAGAZINE

copyright, JFD Electronics Corporation

a JFD LPV Log-Periodic TV/FM antenna

JFD FREQUENCY-INDEPENDENT LPV LOG-PERIODIC BREAKS THROUGH THE BANDWIDTH BARRIER FOR

GAIN: As high as 14 db (in model LPV17)—with extra gain on the high band where it is needed most.

BANDWIDTH: Complete from 54 mc. to 216 mc., including the FM/Stereo frequencies.

RESPONSE: Consistently flat ($\pm \frac{1}{2}$ db) across both low and high bands for the finest color reception.

DIRECTIVITY: No need to give up directivity to obtain bandwidth as other antennas do. Log-Periodic backfire horizontal radiation patterns, for example, are the narrowest of any all-channel antenna. Reject noise, ghosts, interference and other unwanted signals more effectively because: sharpness of beamwidth affects directivity more than any other factor.

VSWR: As low as 1.2 to 1 for maximum transfer of signal to line across the full bandwidth. Low VSWR's are typical of JFD LPV Log-Periodic antennas because of their constant 300 ohm impedance characteristic.

EVERY LPV YOU BUY EARNS YOU VALUABLE FAIR FESTIVAL POINTS . . . Each JFD Log-Periodic VHF, UHF, VHF/UHF/FM, or FM/STEREO you install includes Fair Festival certificates which you can trade in for FREE World's Fair tickets, trips or cash.

Whether it's VHF, UHF, VHF/UHF/FM, or FM/STEREO, JFD HAS THE LOG PERIODIC TO HELP YOU MAKE THE SALE OTHERS CAN'T!

SEE WHY AT THE MOMENT OF TRUTH, THE PICTURE IS THE PROOF—THE JFD LPV LOG-PERIODIC WORKS BEST!

JFD ELECTRONICS CORPORATION

15th Avenue at 62nd Street, Brooklyn, N. Y. 11219

JFD Electronics-Southern Inc., Oxford, North Carolina
JFD International, 64-14 Woodside Ave., Woodside 77, N. Y.
JFD Canada, Ltd., 51 McCormack Street, Toronto, Ontario, Canada

NEW! LOG PERIODIC LPL-FM STEREO

description	model	list
LPL-FM10	10 Cells	\$49.95
LPL-FM8	8 Cells	\$39.95
LPL-FM6	6 Cells	\$29.95
LPL-FM4	4 Cells	\$19.95



Circle 9 on literature card

NEW! UHF CONVERTERS

description	model	list
CR2-J	2-Transistor and Diode	\$39.95
CR1-J	1-Transistor and Diode	\$29.95



NEW! TELE-AMP ANTENNA AMPLIFIERS FOR VHF, UHF & FM

description	model	list
VUT-3	3-Transistor VHF/UHF/FM Amplifier	\$49.95
VN-2	2-Nuvistor VHF Amplifier	\$39.95
VT-2	2-Transistor VHF Amplifier	\$39.95
VT-1	1-Transistor VHF/FM Amplifier	\$34.95
UHT-1	1-Transistor UHF Amplifier	\$39.95
FT-1	1-Transistor FM Amplifier	\$34.95



NOW, MORE THAN EVER...

THE FINEST SERVICE IN TV TUNER OVERHAULING

CASTLE TV TUNER-EAST HAS MOVED TO NEW LOCATION WITH IMPROVED FACILITIES

In Long Island City near Postal Concentration Center to provide faster service by mail.

All other U.S. and Canadian Servicemen will get the same fast service from CASTLE-CHICAGO and CASTLE-CANADA.

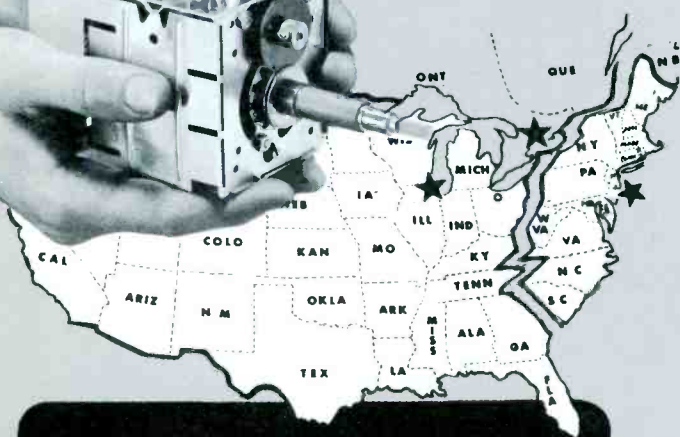
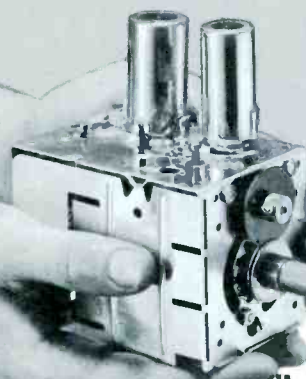

**ALL MAKES
ALL LABOR
AND PARTS
(EXCEPT TUBES)*
ONE PRICE**

995

THIS ONE LOW PRICE INCLUDES ALL UHF, VHF AND UV COMBINATION* TUNERS

Simply send us your defective tuner complete; include tubes, shield cover and any damaged parts with model number and complaint. 90 Day Warranty.

Exact Replacements are available for tuners unfit for overhaul. As low as \$12.95 exchange. (Replacements are new or rebuilt.)

*UV combination tuner must be of one piece construction. Separate UHF and VHF tuners must be dismantled and the defective unit only sent in.

Pioneers in TV



Tuner Overhauling

CASTLE TV TUNER SERVICE, INC.

EAST: 41-90 Vernon Blvd., Long Island City 1, N. Y.

MAIN PLANT: 5701 N. Western Ave., Chicago 45, Illinois

CANADA: 136 Main Street, Toronto 13, Ontario

*Major Parts are additional in Canada

Circle 10 on literature card



The Electronic Scanner

news of the servicing industry

New UHF Stations

Since the all-channel requirement for television receivers went into effect, there has been increased interest in UHF TV broadcasting. This interest is reflected in renewed UHF station activity. TELEVISION DIGEST reports that a number of new stations either have started or are about to start operation. KSLN-TV (Channel 34) Salina, Kansas, resumed operation August 1; the station had been off the air since April, 1963. Stations expected to begin operation in September were: KCET* (Channel 28) Los Angeles, Calif; KCSM-TV* (Channel 34) San Mateo, Calif; WEIQ (Channel 42) Mobile, Alabama; WJSP-TV* (Channel 28) Columbus, Georgia; WKEF (Channel 22) Dayton, Ohio; and WUCM-TV* (Channel 19) University City, Mich. Anticipated October starters include: WCMC-TV (Channel 40) Wildwood, N. J. and WTVI* (Channel 42) Charlotte, N. C. KTEH* (Channel 54) San Jose, Calif. is tentatively scheduled to begin operation in November or December, and the target date for the start of operation of KTXN (Channel 42) Austin, Texas is January, 1965. Stations identified with asterisks are noncommercial education stations; the others are commercial stations.

Expands UHF Tuner Plant



Gavin Instruments, Inc. has occupied an additional 26,000 sq. ft. plant for the production of UHF television tuners. The company expects its first production runs to be delivered from the new facilities some time in September. The production of Gavin's line of consumer products, including UHF converters, television boosters, antennas, etc., will continue at their present location. Gavin Instruments, Inc. is one of the subsidiaries of Advance Ross Corp., a major supplier of components to the TV industries.

Source for G-E Radio Parts

Under a new arrangement, Workman Electronic Products, Inc., of Sarasota, Florida, has been made exclusive nationwide distributor of General Electric Co. radio replacement products. The sales and service centers operated by General Electric will continue to sell these parts, but they will now also be stocked by a nationwide network of jobbers. The objective of the change, in addition to increasing the sales of radio replacement parts, is to provide better service to customers and to provide good quality products at a competitive price.

Enters Packaged Stereo System Market

Shure Brothers, Inc., Evanston, Ill., has begun selling, through selected dealers, a premium-quality, packaged-component high-fidelity stereo system of its own design and manufacture. This is the first time Shure has ventured into any major product area outside the manufacturing of its line of phono cartridges, tone arms, and microphones. The M100 "Maximum Performance Phono System" was designed and produced by Shure engineers to meet predetermined performance specifications. In addition to records, the M100 may be used with other music sources, such as a tuner or tape recorder. It may also be used as a public-address system; a separate microphone jack is provided for this purpose. Because of hand assembly, individual unit testing, and other quality-control procedures applied to each M100, production will probably be limited. ▲

New and improved VOMs from Simpson

SIMPSON ELECTRIC COMPANY 5209 W. Kinzie St., Chicago, Ill. 60644



DIVISION

Phone: (312) ESTebrook 9-1121
In Canada: Bach-Simpson Ltd., London, Ontario



Ⓐ NEW MODEL 263

Ⓐ **Dual Sensitivity** combined with 28 overlapping voltage ranges. Switch back and forth to get the reading on the more accurate scale location. Accuracy is $\pm 1.5\%$ DC and $\pm 3\%$ AC (F.S.). Other features are 55 ranges, large 7" meter, and movement overload protection.

Model 263 \$78.95

Ⓑ **Five Highly Desirable Features**—For today's closer test requirements, you'll appreciate the self-shielded annular movement, spring backed jewels, movement overload protection, mirror scale, and calibration circuit. Guaranteed accuracies at 77°F run from $\pm 1\%$ (F.S.) for 0-50 DC ua range to $\pm 3\%$ AC (F.S.).

Model 261* \$59.95

Ⓒ **Increased Accuracy for Lab VOM**—Guaranteed accuracies at 77°F now run from $\pm 0.75\%$ (F.S.)



Ⓑ NEW MODEL 261*



Ⓒ IMPROVED 270-2*

for 0-50 DC ua range to $\pm 2\%$ AC (F.S.). Other improvements are: the use of a high flux, self-shielded annular movement; spring backed jewels; gold bonded, temperature compensated diodes; mirror scale; and calibration circuit.

270-2* \$64.95

Ⓓ **Five Improvements in Popular 100,000 Ohms/Volt VOM**—Changes include: new 400 VAC and 800 VDC ranges; 12 ohm center scale; accuracies increased to $\pm 2\%$ DC, $\pm 3\%$ AC (F.S.); and external battery compartment.

Model 269-2 \$89.95

*Converts to transistor tester, DC VTVM, temperature tester or any of 9 different instruments with Simpson's exclusive VOM adapters.

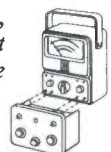

WRITE FOR BULLETIN No. 2066

Representatives in Principal Cities... See Telephone Yellow Pages or ESP Specific

Circle 11 on literature card

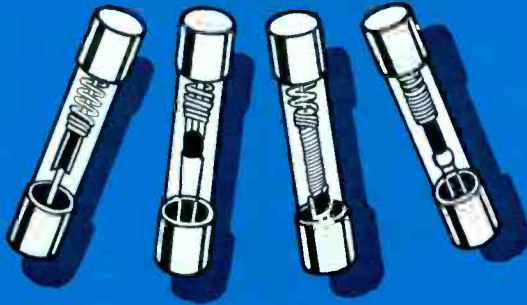

FUSETRON

dual-element Fuses

time-delay type

"Slow blowing" fuses that prevent needless outages by not opening on motor starting currents or other harmless overloads—yet provide safe, protection against short-circuits or dangerous overloads.

BUSS

Write for BUSS
Bulletin SFB

BUSSMANN MFG. DIVISION, McGraw-Edison Co., St. Louis, Mo. 63107

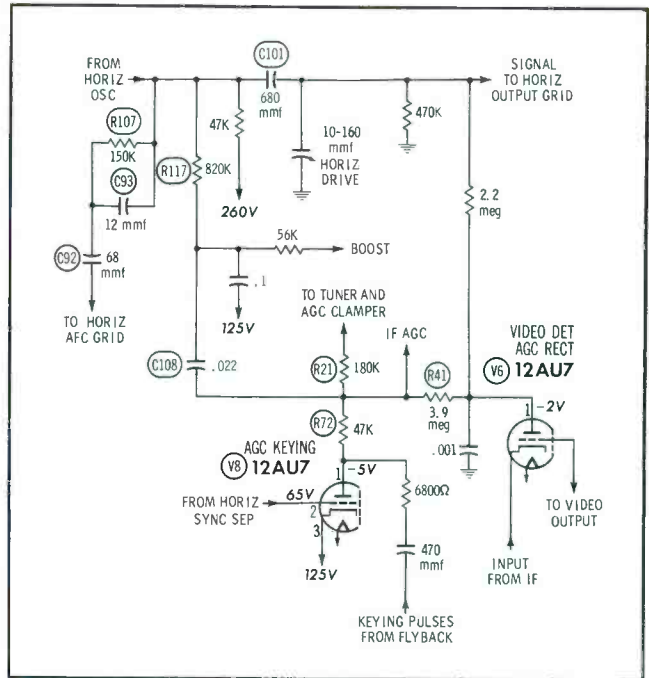

It should be possible to install a capacitor of correct value for C101 (680 mmf) without causing sync trouble. The use of proper capacitance values in this circuit is important, because this assures that a drive signal of normal strength is fed to the output tube. If you find the value of C101 must be increased to lock in the picture, check other components in the circuit—especially C92, C93, and R107 in the feedback network to the AFC grid.

If the horizontal circuit shows no defects, you may find that

BUSS: 1914-1964, Fifty years of Pioneering....



The Troubleshooter

answers your servicing problems

Wonder Why It Works

In servicing an RCA chassis KCS82 that had lost horizontal sync, I readjusted the oscillator circuit without success, although every part in this section of the set measured at its rated value. However, I substituted for various capacitors as I went along and found that replacing C101 with a 1000-mmf unit restored good sync. Why? Horizontal stability is good now, except that the hold control must usually be adjusted once after the set warms up.

While troubleshooting this receiver, I found -20 volts on the plate of the AGC rectifier tube (pin 1 of V6); tracing back to the junction of R21 and R41, I found -50 volts, which seems too highly negative. I'm puzzled by this voltage; could the -2 volts at pin 1 of V6 in PHOTOFAC Folder 207-7 be a misprint?

FRANK C. STAHL

San Francisco, Calif.

There are several possible explanations for the horizontal sync trouble you experienced. The simplest and most likely case is that leakage or a change in value of C101 caused distortion of the drive signal. Since this signal is fed back to the AFC stage, a faulty waveshape would make it difficult to maintain normal sync.



All Types Available

for Every
Application

BLOCKS

for BUSS FUSES

Single pole, multiple pole, small base, full base, molded base, laminated base, porcelain base for fuses from 1/4 x 5/8 inches up. Also signal fuse blocks and special blocks of all types.

Tell us what you need or...

BUSS

Write for BUSS
Bulletin SFB

BUSSMANN MFG. DIVISION, McGraw-Edison Co., St. Louis, Mo. 63107

Circle 12 on literature card



BUSS quick-acting Fuses

"Fast Acting" fuses for protection of sensitive instruments or delicate apparatus;—or normal acting fuses for protection where circuit is not subject to starting currents or surges.

BUSS

Write for BUSS
Bulletin SFB

BUSSMANN MFG. DIVISON, McGraw-Edison Co., St. Louis, Mo. 63107

like oscillator trimmer difficulties. To check the oscillator trimmer, unplug the antenna, turn the volume to maximum, and tap the trimmer sharply. If you hear a loud pop in the speaker when the trimmer is tapped at approximately a 45° angle, the unit is defective. In several cases this component has been known to cause the symptoms you describe. The Delco replacement part number is 7291933.

Ratio Detector Hookup

I have a Silvertone Model 7102S in for repairs, and the ratio-detector transformer has been removed. My problem is this: How do I determine which internal wires go to the corresponding external connections? I have been unable to read the resistances of the windings with my VTVM.

ERNEST J. BROWN

West Roxbury, Mass.

The Silvertone Model 7102S is covered in PHOTOFAC T Folder 339-13. Although you state that you can't obtain VTVM resistance readings, you should be able to determine

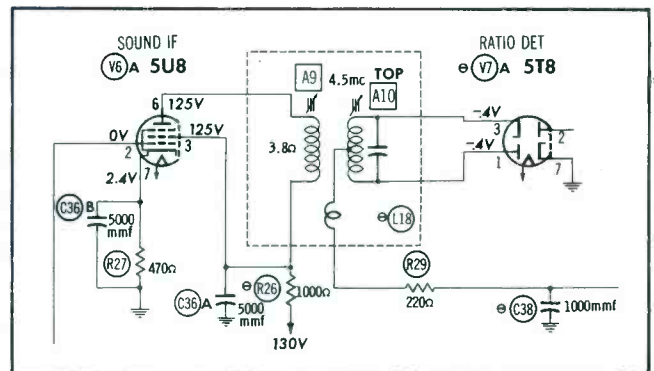

• Please turn to page 54

....New Developments in Electrical Protection

a fault involving the AGC system is partly or wholly responsible for the poor sync. The readings on the AGC line may or may not be abnormal, depending on signal conditions. It is not at all unusual for the plate of a keying tube (or a nearby point in the plate circuit) to read -50 volts when a strong local signal is being received. However, the reading in your set may be too negative for existing conditions. The -20 volts on the AGC-rectifier plate of the video detector tube would tend to bear out this suspicion; that's an unusually high voltage for this point.

Perhaps the following situation exists: Tube, transformer, or grid-bypass capacitor leakage in the IF strip is reducing AGC bias on the IF's, resulting in an overly strong signal at the video detector. When amplified and fed to sync-AGC tube V8, the signal causes overconduction of the AGC keying section. Thus, the AGC voltage is greater than normal, but much of it is lost before it reaches the IF grids. In the process of overamplifying the video signal, the sync pulses are somewhat compressed—and this happens to interfere with the horizontal sync more than with the vertical. For other clues to possible AGC troubles, see "AGC Troubles and Solutions" in the September, 1964 issue.

Volume Fades

I am having trouble with a Chevrolet car radio, Model 985432. It plays just fine on the service bench, but when the radio is installed in the automobile the volume fades completely out. A little later the volume comes back and a local station can be received at three different points on the dial. All voltage checks are well within range. Can you help?

MORRIS BOBO

Union, S.C.

Chevrolet Model 985432 is covered in the PHOTOFAC T Auto Radio Series, Volume 19. The trouble you are having sounds

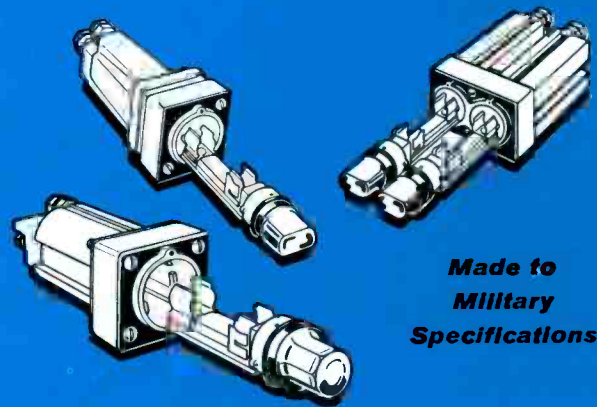

Made to
Military
Specifications

BUSS FUSEHOLDERS • LAMP INDICATING SERIES HG

Quick, positive, visual identification of faulted circuit. Transparent knob permits indicating light to be readily seen.

Fuses held in clips on fuse carrier which slides into holder and locks in place with bayonet type knob.

Holder designed for panels up to 1/8 inch thick.

BUSS

Write for BUSS
Bulletin SFB

BUSSMANN MFG. DIVISON, McGraw-Edison Co., St. Louis, Mo. 63107

Circle 12 on literature card

October, 1964/PF REPORTER 21

GOOD VIEWS

Servicemen across America agree ...

JERROLD PARALOG

FOR BEST PERFORMANCE, MOST SATISFIED CUSTOMERS

Paralog is sweeping the country . . . and it's no wonder! From Washington to Winston-Salem, TV service dealers tell us that Paralog performance is outstanding—even in the toughest reception areas. Dealers in every part of the U. S. find that customer satisfaction is a sure thing with powerful Paralog antennas.

What's more, these are men with years of antenna experience, and the kind of know-how that made them make extensive comparisons with competitive antennas before taking on the Paralog line. Has it paid off? Well, Russ Helveston, of Morrisville, Pa. says that "My antenna business is growing faster

than ever now," while Eugene Doll of Perham, Minn. tells us that "Business has been terrific on Paralogs."

Best of all, rugged, easy-to-install Paralog antennas come with better, built-in profits, the kind that make it mighty worthwhile to "sell up to a Paralog."

What about *your* antenna requirements? Have *you* made a side-by-side comparison of your present antennas against the Jerrold Paralog line? If not, be ready to switch! Have your Jerrold distributor show you *why* Paralog is the fastest-growing antenna line in the country today.

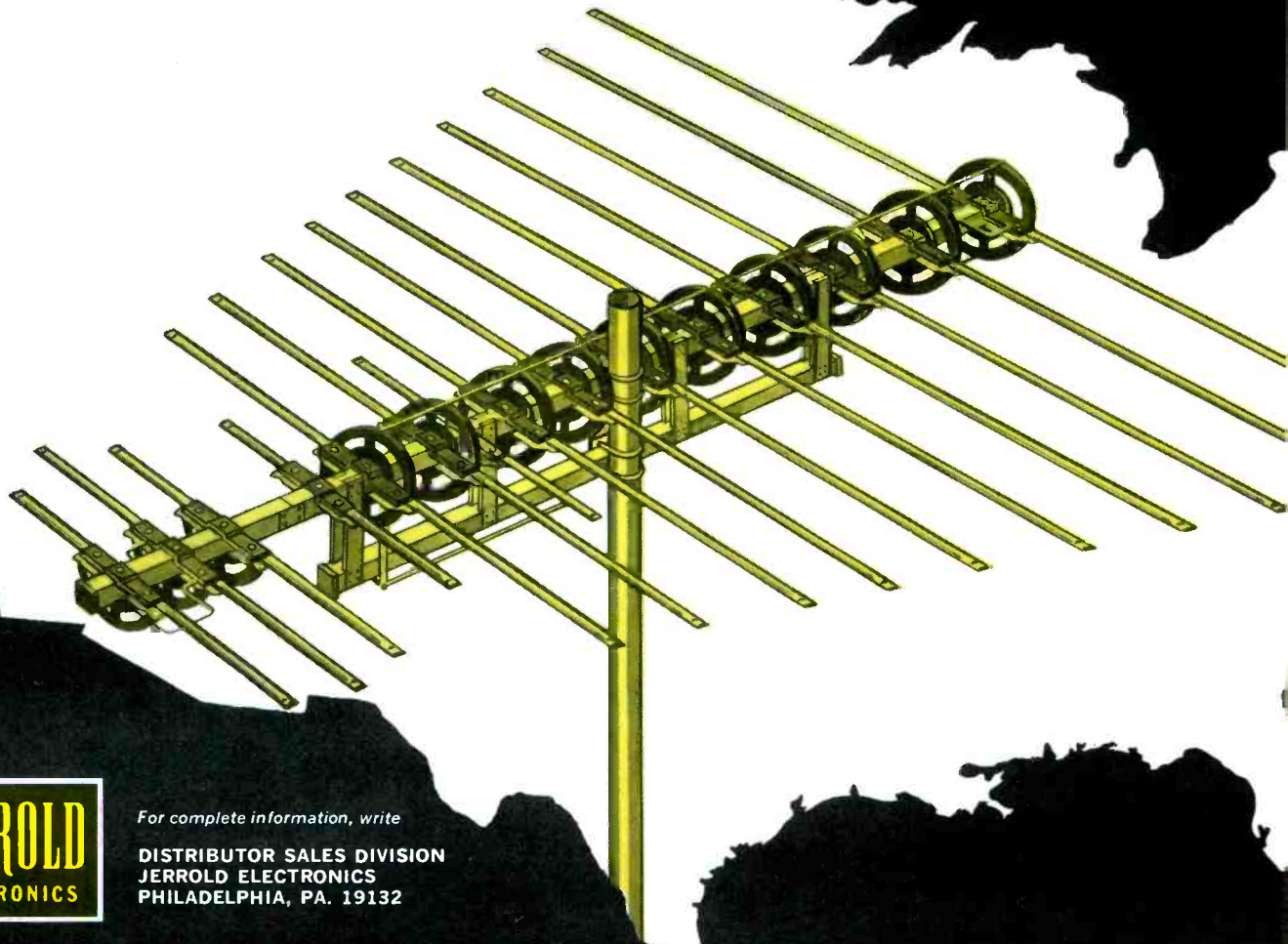

JERROLD
ELECTRONICS

For complete information, write

DISTRIBUTOR SALES DIVISION
JERROLD ELECTRONICS
PHILADELPHIA, PA. 19132

TRAVEL FAST!



**RALPH LEENDERS, LEENDERS' TV,
EVERSON, WASHINGTON**

"We use Paralog Antennas because of their outstanding performance and their rugged construction."



**RALPH CLARK, VALAS TV CORP.,
DENVER, COLORADO**

"As the largest TV sales and service company in Colorado, we can't afford to use anything but the best. After extensive comparisons and field testing, we found the Paralog to be exactly the antenna we had been looking for."



**W. B. WEIDNER, ED MARLING
STORES, INC., TOPEKA, KANSAS**

"I've found that it pays to sell up to a Paralog. Profits are much better than on the economy antennas, and I wind up with a more satisfied customer every time."



**EUGENE DOLL, DOLL'S TV,
PERHAM, MINNESOTA**

"Business has been terrific on Paralogs in our territory. And no wonder. Everybody who buys a Paralog is happy with the reception. We've gone to Paralog 100%."



**TED WAINSCOTT,
T & H SERVICE & SALES, INC.
ANDERSON, INDIANA**

"The Paralog has proven to be far superior to any other antenna in this area. You can't beat the performance, especially on the hard-to-get channels."



**RAY MAGER,
MONTGOMERY WARD, LIMA, OHIO**

"Paralog works better than any other VHF antenna ever made. We had 200 calls within two weeks. Some of our customers pull in Cleveland, over 160 miles away, consistently."



**RUSS HELVESTON, MAKEFIELD TV,
MORRISVILLE, PENNSYLVANIA**

"It's very tough to get New York channels in this area, but since I've been using Paralog antennas, I can offer guaranteed reception to my customers. My antenna business is growing faster than ever now."



**W. RAYMOND JONES, JONES TV
& RADIO SERVICE,
WINSTON-SALEM, N. CAROLINA**

"We've been using TACO antennas for 15 years. In fact, we've installed several thousand. The new Paralogs are the most powerful and rugged antennas we've ever used."

Circle 13 on literature card



Receiving Tubes

AN OLD FASHIONED GOOD DEAL



Get in on a deal like you haven't seen for years.

From October 15 through December 15, your General Electric Receiving Tube Distributor is offering an old fashioned good deal on top quality merchandise. It is all available to you with the purchase of G-E tubes.

During this limited time, only you limit how much and how often you choose. And, from the wide choice of merchandise, you can select gifts for yourself, your wife, your home, or your shop.

Ask your G-E Distributor*, he can tell you how easy it is to have AN OLD FASHIONED GOOD DEAL on General Electric Receiving Tubes. Stock up on merchandise and tubes at the same time. *Distributor Sales, Owensboro, Ky.*

*Premiums available at option of your G-E Distributor.



Perfume set by D'Orsay comes in gift box. "Intoxication" scent will send you as well as your playmate. Order ETR-3916.

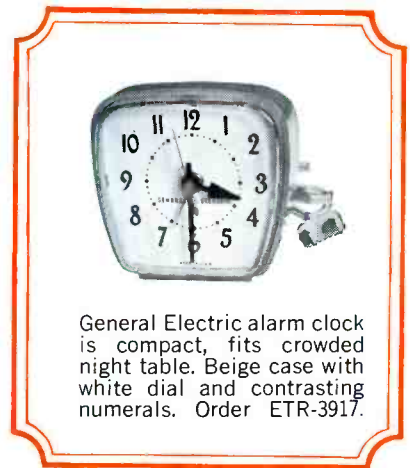

General Electric alarm clock is compact, fits crowded night table. Beige case with white dial and contrasting numerals. Order ETR-3917.



Steak knives—four to a set—have serrated edges, stainless-steel blades. Knives have good looking stag handles. Order ETR-3927.

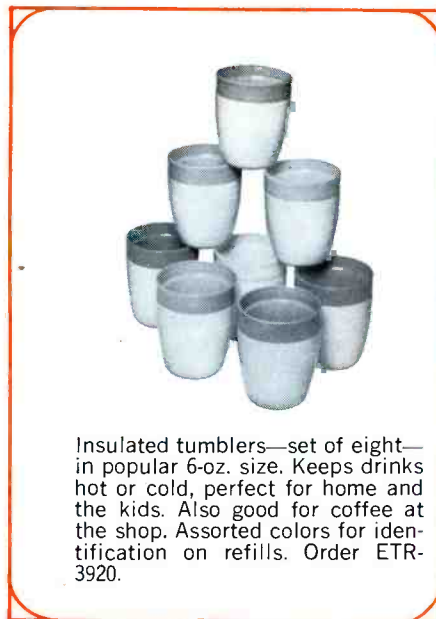

Insulated tumblers—set of eight—in popular 6-oz. size. Keeps drinks hot or cold, perfect for home and the kids. Also good for coffee at the shop. Assorted colors for identification on refills. Order ETR-3920.



Party-Perk makes 25 cups of coffee—keeps perfect serving temperature too, all automatically. Plenty of coffee for parties at home—or for a coffee break at the shop. Order ETR-3922.

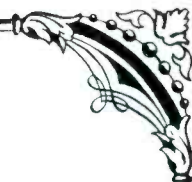

Black and Decker 1/4" utility drill is the jack-of-all drills... the handiest home tool you ever saw. UL listed drill from a top-name manufacturer. Order ETR-3918.



G-E electronic speed control lets low cost power tools do work of costly more powerful tools. Use at work or home for any universal motor-driven tool with name-plate rating up to 5A, 120V, ac. Particularly good for resistive type soldering irons to give low-heat tip temperatures for printed circuits. Order ETR-3921.

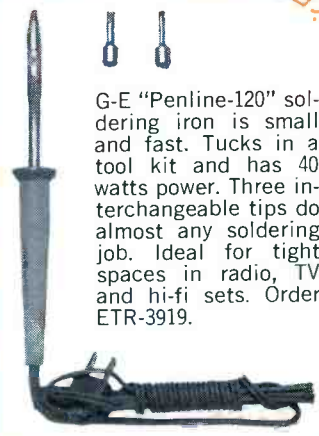

G-E "Penline-120" soldering iron is small and fast. Tucks in a tool kit and has 40 watts power. Three interchangeable tips do almost any soldering job. Ideal for tight spaces in radio, TV and hi-fi sets. Order ETR-3919.

Three pair of Anchor Knit stretch nylon socks in stylish Fisherman knit. Vyrene elastic tops. One each of blue, brown and black. Order ETR-3923.



Shirt-jacket of 100% Ban-Lon[®] with long or short sleeves. A style introduced this summer and now available in winter weights. Your choice of assorted colors. Order ETR-3924.



5-piece stainless steel kitchen set with wall bracket. Heavy-duty insulated handles with popular provincial decoration. Order ETR-3925.

GENERAL  **ELECTRIC**

270-04

What's all this talk about "exact replacement" Twist-Prong Electrolytics?

What is an "exact replacement?" To CDE it's the proper capacitor to do the job intended—available when you need it. To others, it means number matching by the service technician—matching the numbers on the old unit with those of the replacement—without regard to availability or cost. CDE's new Twist-Prong line is based on our service-oriented definition.

Matching numbers may be fun, but there comes a time when it's a losing game. In Twist-Prongs the growth in ratings used in original equipment has been phenomenal. Even the loudest advocates of number matching have to hedge. One advertises over 1700 "exact replacements"—catalogs about 1200—and, of that 1200, lists possible alternates for 297 "if the listed capacitor is not available." Then, there's the problem of popular and "less popular items"—or, you're lucky if your distributor has the number you're trying to match in stock.

To Cornell-Dubilier, the availability of a proper replacement to do the job intended is most important. That's why we've designed a complete new Twist-Prong line for the professional electronic service technician. It's a line that recognizes the broad tolerances inherent in electrolytic manufacture and widely recognized throughout the industry—a fact you've used repeatedly in making replacements. It's a line that enables your distributor to have a complete stock so units will be available when you need them. It's an "exact replacement" line in the proper sense of the word.

Only the CDE Twist-Prong line is designed to make your job easier. A new Twist-Prong Replacement Guide and Cross Reference details manufacturers recommended in-stock replacements for every current Twist-Prong rating. The line is listed, too, in the new CDE Replacement Component Selector. Ask your distributor for copies today and end the old fashioned matching numbers game.



CDE **CORNELL-DUBILIER**
INNOVATION WITH RELIABILITY

Circle 15 on literature card



Grid as Bias Source

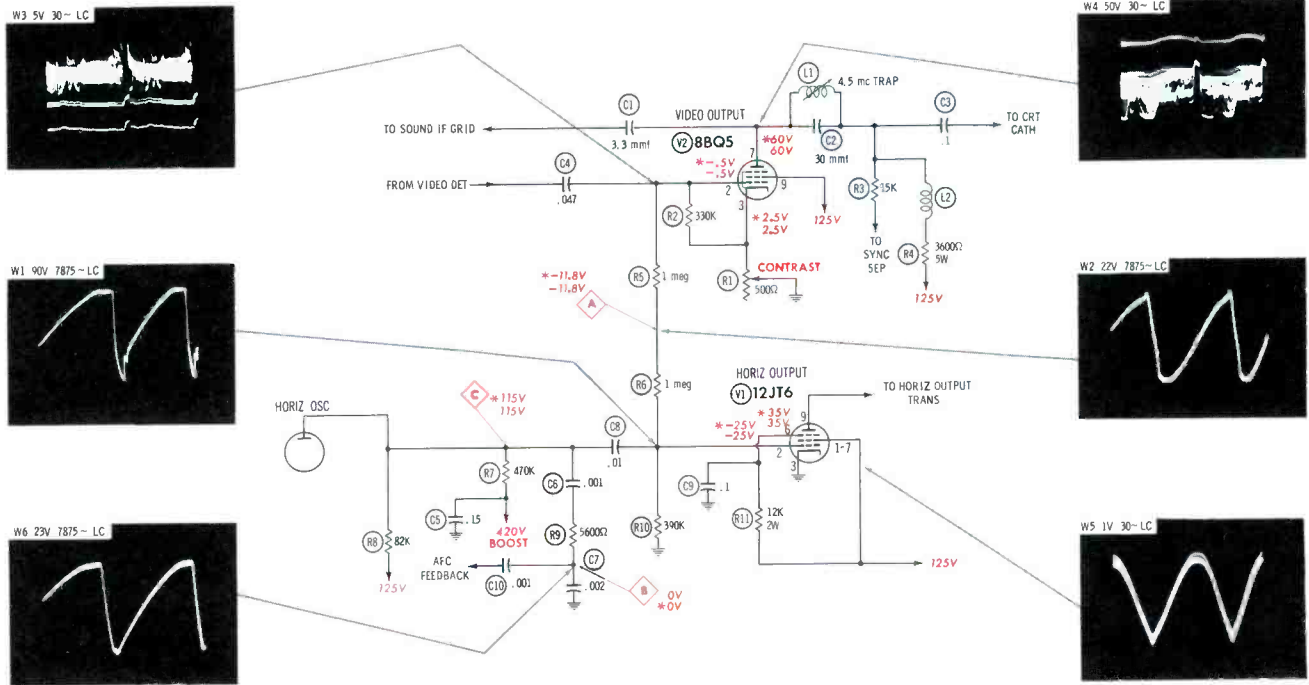

DC VOLTAGES taken with VTVM, on inactive channel; antenna terminals shorted. *Indicates voltages taken with signal present—see "Operating Variations."

WAVEFORMS taken with wideband scope; TV controls set for normal operation (50 volts p-p at CRT). Low-cap probe (LC) used to obtain all waveforms.

Normal Operation

Horizontal output circuit is typical of those found in modern receivers. In this circuit (from Bradford Model WGEC-91124A), pulse — known as drive signal — is taken from plate of horizontal oscillator and coupled through C8 to output grid. Shape of drive waveform is determined primarily by network composed of C6, C7, and R9. C5 is boost filter — decouples any ripple that may be present. In some receivers, this capacitor is connected between boost and B+; same purpose is served, but capacitor can have lower voltage rating. R7 and R8 both supply oscillator plate voltage; connecting one resistor to B+ and one to boost provides stabilization, so load variations on either boost or B+ will have little effect on oscillator operation. New tube type 12JT6 is used in output stage because it can operate from low B+ voltage; B+ in this receiver is 125-volt output of single rectifier. In this circuit, screen grid is tied directly to B+; in some sets, a resistor network from B+ to boost provides screen-supply stabilization. Through R5 and R6, negative grid voltage from horizontal output tube provides fixed negative bias for grid of video output tube. Other sets use similar arrangement for supplying negative voltage to vertical output grid; occasionally, both vertical and video output tubes are biased from this source. Any change in horizontal-output grid voltage consequently varies bias voltage applied to dependent stage.

Operating Variations

- PIN 2 V1** Voltage remains same with or without signal. Operating controls in this set have little effect on voltage. Drive control (in sets so equipped) will change DC voltage noticeably, should be adjusted for only slight overscan.
- PIN 6 V1** Voltage changes only as suppressor current varies. Positive DC suppresses internal oscillations which cause "snivets" in UHF. VHF-only sets usually have suppressor tied to cathode (chassis ground).
- PIN 2 V2** DC measures 3 volts at minimum setting of contrast, -3 volts at maximum; average with signal, -.5 volts.
- PIN 3 V2** Voltage ranges from .08 volts at maximum contrast to 7 volts at minimum. Design of control leaves 2-ohm resistance with slider at low-end stop, accounts for slight positive voltage when contrast is maximum. Affects pin 7, too.
- WAVEFORMS** W3 changes from 3 volts on fringe signal to 7 volts on strong local. W4 varies from 30 volts (minimum contrast) to 100 volts (maximum contrast).

Picture Washed Out

SYMPTOM 1

Buzz in Sound

R6 Open

(Bias Supply Resistor—1 meg)

Symptom Analysis

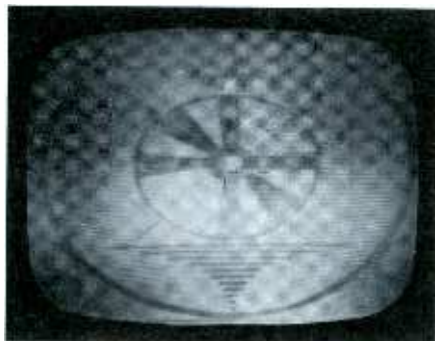

Picture has milky appearance accompanied by annoying buzz in sound. At maximum setting of contrast control, picture improves somewhat, but buzz is still present. Absence of snow in picture throws suspicion to video-output stage rather than RF or IF section.

Waveform Analysis

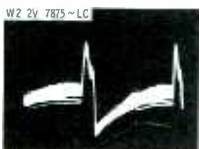
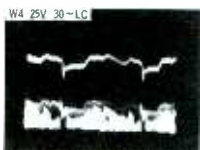
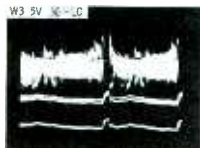

Normal W3 confirms suspicion that trouble isn't in tuner or IF stages. Fact that W4 is only 25 volts p-p, greatly reduced from normal 50 volts p-p, indicates trouble is in video output stage. Absence of horizontal sawtooth in W2 is most significant clue to origin of trouble. Existence of raster proves bias is present at horizontal-output grid, so scope indicates open R6 or break in printed board.

Voltage and Component Analysis

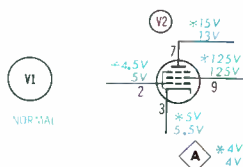

Reduced plate voltage on V2 offers clue to trouble in video output stage. Low plate voltage could be caused by increased value of R4. However, insufficient bias between grid and cathode explains low plate voltage—tube is overconducting. Contrast control has normal effect in varying cathode voltage; therefore, trouble is probably in grid circuit. Positive 4 volts at A shows negative bias from horizontal-output stage is missing. If value of R6 were merely increased, there would still be some negative voltage at A.

Best Bet: Scope or VTVM will do the job.

Width Reduced

Picture and Sound Fairly Normal

C8 Leaky

(Drive-Coupling Capacitor—.01 mfd)

SYMPTOM 2

Symptom Analysis



Picture is narrow on all channels — in about 1/2" on each side. Operation of brightness and contrast controls is normal; vertical sweep is okay; slight reduction of contrast and volume is barely noticeable. Symptoms indicate trouble in horizontal oscillator or output.

Waveform Analysis

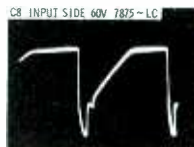
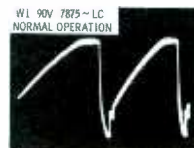
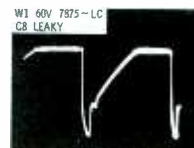

Decreased amplitude, faster rise, and increased duration of flat portion on W1 (compare to normal) offer definite clue that average drive being applied to output grid is insufficient. Trouble is isolated to plate circuit of oscillator tube or grid circuit of V1. Waveform is same on both sides of C8 but still doesn't pin down defective component. Condition of C8 is vital to proper discharge of oscillator tube.

Voltage and Component Analysis

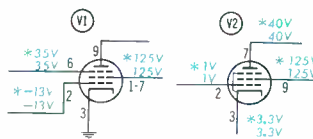

Negative voltage at V1 grid reduced almost 50%; wrong drive signal (W1) and low bias both contribute to decreased width. Pins 1 and 6 are normal, defects in R11 or B+ thus ruled out. Plate voltage on V2 is low, and grid is positive. Indicate tube is conducting harder than normal because of partial loss of bias supplied from V1 grid. Voltage readings and waveforms definitely indicate trouble between oscillator plate and output grid. Definite leakage check — unsolder grid end of C8, check it for positive DC.

Best Bet: Scope, then VTVM.

Width Insufficient

SYMPTOM 3

Video and Sound Slightly Affected

C6 Shorted

(Waveshaping Capacitor—.001 mfd)

Symptom Analysis



Raster fails to fill screen by about 1" on each side; picture can be synchronized horizontally, but hold control is near end of range. Brightness range is decreased; reduced contrast is noticeable on weak stations. Lowered B+ or boost voltage could cause symptom.

Waveform Analysis



Drastically reduced amplitude and distorted shape of W1 (see normal W1) points to defect in oscillator rather than output or high-voltage sections. Higher initial rise and flatter slope in W1 show longer charge-discharge time of network. Cause might be changed capacitance due to shorted C6 or C7. Presence of W6, though shape is incorrect, indicates C6 isn't open, C7 isn't shorted. Shorted C6 is likely.

Voltage and Component Analysis

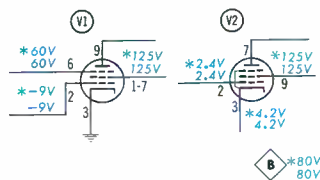

Presence of mere -9 volts on V1 grid is decisive clue that trouble is in oscillator circuit. Increased voltage on pin 6 (60 volts) indicates suppressor current is lowered due to reduced tube conduction; decreased drive voltage lowers cathode current and lessens drop across suppressor resistor (also screen resistor, when used). Definite clue is gained from metering point B; voltage here reads 80 volts — should be zero. Leaky C6 would give similar indication; however drive would not be as low, and less DC would be present at B.

Best Bet: Scope isolates; VTVM locates component.

Picture Extremely Narrow

Loss of Horizontal Sync

SYMPTOM 4

C6 Open

(Waveshaping Capacitor—.001 mfd)

Symptom Analysis

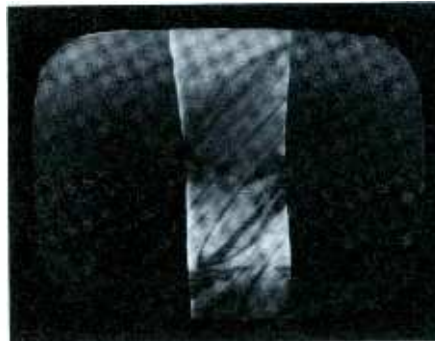

Raster is only 2" wide, and very dim even at maximum setting of brightness control. Picture can't be synchronized at any setting of hold control. Adjusting hold control may increase width but causes "Christmas-tree." Oscillator frequency is definitely affected.

Waveform Analysis

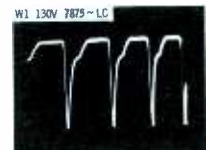

Examination of W1 shows oscillator is far off frequency; with scope preset to 7875 cps, 4 cycles of the waveform are seen. Increased amplitude, distorted shape indicate wave-shaping network is probably open. No AFC feedback pulse is present, evidenced by missing W6; free-running oscillator operates way off frequency. Absence of signal at junction of C6-R9 points to open C6 or break in printed board.

Voltage and Component Analysis

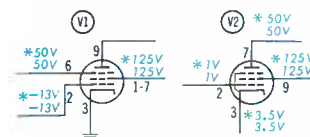

The -13 volts on grid of V1 doesn't point conclusively to troubled stage; defect in either output or oscillator can cause lowered voltage on output grid. In this particular case, trying to locate defective component with VTVM is lengthy process, requiring checks throughout AFC and oscillator. Using scope at V1 grid definitely reveals trouble in oscillator stage, eliminating time wasted in troubleshooting output circuit. Operation of oscillator and output stages are closely associated, and voltage readings may not pinpoint component.

Best Bet: Scope does adequate job.

No Raster

Buzz in Sound

SYMPTOM 5

Open Connection Pin 3 of V1

(Horizontal Output Cathode)

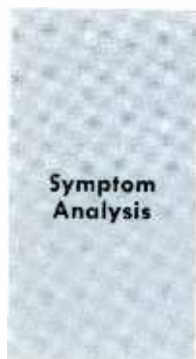

Screen is blank; sound has loud, annoying buzz. Brightness control has no effect. Arc cannot be drawn from high-voltage anode lead; loss of high voltage is indicated. Trouble must be somewhere in horizontal oscillator and/or high-voltage stage.



Waveform Analysis

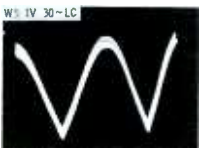

W1 is low in amplitude, and shape is changed considerably (compare to normal W1); however, this amount of drive signal should produce a raster. Suspicion is thus directed to output stage rather than oscillator. Since screen is tied directly to B+, normal ripple in W5 shows supply voltage is present. Scope would be little use in sets using screen-dropping resistor; ripple would appear with bad resistor.

Voltage and Component Analysis

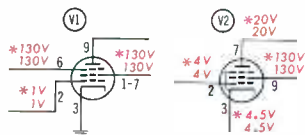

Screen of V1 measures 130 volts DC (normal is 125), provides no definite clue; variations up to 15% are permissible in B+ supply voltages without noticeable change in operation. Absence of negative voltage on pin 2 of V1 is rather odd; strong W1 should develop grid bias. Above-normal voltage readings on pins 2 and 6 prove tube isn't drawing current. Measuring pin 9 (with tube removed temporarily from socket) shows plate voltage is present. Cathode shows continuity to ground; obvious open cathode connection in socket.

Best Bet: VTVM for voltage and resistance checks.

Narrow Picture

Picture and Sound Fairly Normal

SYMPTOM 6

R8 Increased In Value

(Horizontal-Oscillator Plate Resistor—82K)



Raster edges are about 1" from each side of screen. Adjusting horizontal hold control varies width, but synchronization of picture is lost before proper width can be obtained. Reduced contrast and volume are noticeable on weak channels. Vertical hold is normal.

Waveform Analysis

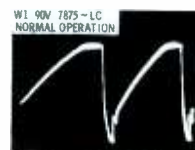

Shape of W1 is correct (compare with normal W1), but p-p amplitude — only 60 volts — holds answer to reduced width. Lowered drive at V1 grid results in decreased boost and high voltage. Oscillator plate waveform (not shown) is also reduced in amplitude — normal is same as W1. Scope doesn't locate defective component; however, it localizes trouble to oscillator rather than output or HV stage.

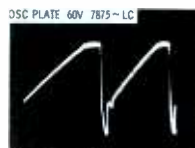

Voltage and Component Analysis

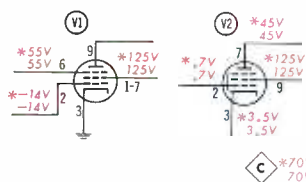

Decreased voltage at pin 2 of V1 bears out that waveform amplitude is insufficient to develop necessary DC bias. Conduction time, and therefore average cathode current of V1, is reduced — as evidenced by higher voltage on suppressor grid. Shortened conduction time decreases total current drawn by stage. Reduced oscillator plate voltage (point C) isn't helpful clue because lowered boost also will lower plate voltage. All voltages and waveforms are dependent on boost; makes this trouble difficult to isolate. Resistance checks help.

Best Bet: Scope, followed by VTVM.

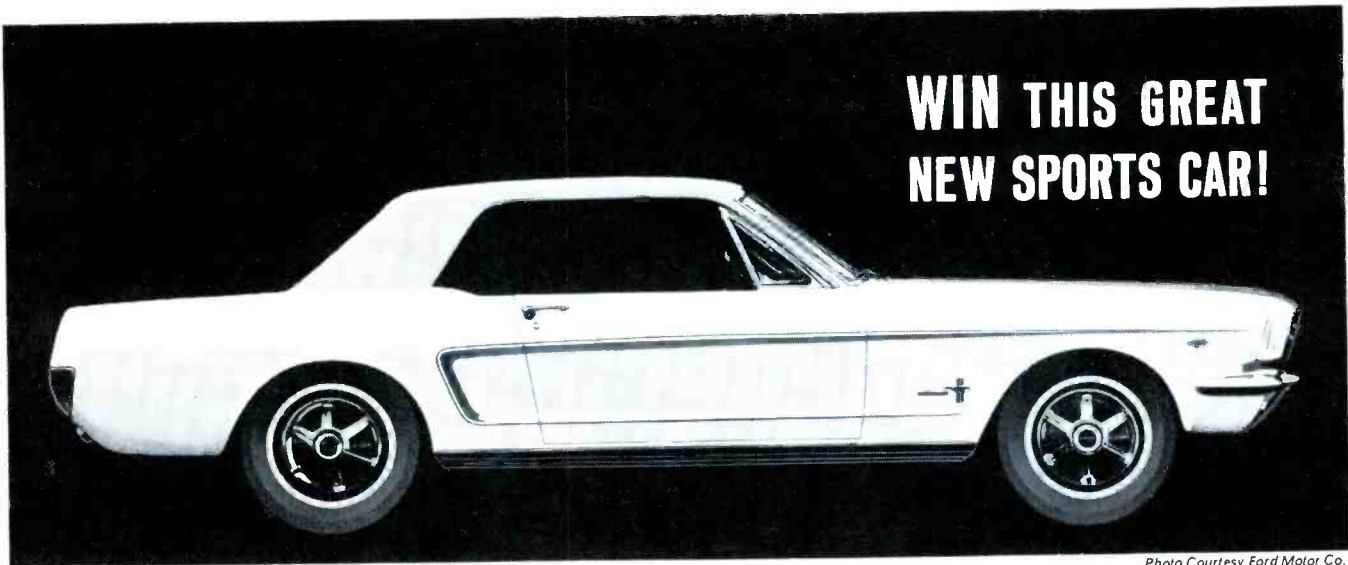

**WIN THIS GREAT
NEW SPORTS CAR!**

Photo Courtesy Ford Motor Co.

ENTER THE BIG PHOTOFACT[®] "WIN-A-MUSTANG" CONTEST!

**EVERYONE WHO ENTERS
IS A WINNER!**

FIRST PRIZE

New 1964 Mustang Sports Car
(as illustrated)

SECOND PRIZE

Luxurious Mink Stole

THIRD PRIZE

Ladies Elgin Diamond Wrist Watch

**All entrants will receive a
special gift just for entering
this PHOTOFACT contest...**

Contest period is open between September 1, 1964 and December 31, 1964. Entry forms are available from your Sams Distributor or from Howard W. Sams & Co., Inc. (only one entry per contestant accepted). All you do is fill out the entry form, and have it validated by your Distributor. Winners will be determined by a drawing. (Contest limited to U.S.A.; not valid where prohibited by State or local laws.)

**DRAWING WILL BE HELD ON
JANUARY 15, 1965**

winners will be notified

YOU'RE ELIGIBLE IF YOU USE PHOTOFACT
the world's finest TV-Radio service data

The contest is open to everyone who: **1**—is a subscriber to PHOTOFACT or one of the new PHOTOFACT Specialized Series—or—**2**—owns a PHOTOFACT Library of 60 or more Sets. There is nothing to do except fill out the entry form. Everyone has an equal chance to win at the drawing. Contest closes December 31, 1964, and all entry forms must be postmarked before January 1, 1965. Enter this worthwhile contest now!

**GET YOUR ENTRY FORM FROM YOUR
SAMS DISTRIBUTOR OR SEND COUPON**

**DO IT
TODAY!**

HOWARD W. SAMS & CO., INC., Dept. PFF-10
4300 W. 62nd St., Indianapolis, Indiana 46206

- Send my entry form for the "Win-A-Mustang" Contest
 - I am presently a subscriber to a PHOTOFACT Service
 - I am not a subscriber to a PHOTOFACT Service

Name _____

Shop _____

Address _____

City _____ State _____ Zip _____

My Distributor is: _____



HOWARD W. SAMS & CO., INC.
INDIANAPOLIS, INDIANA 46206

Although the incidence of shrunken-raster troubles has decreased over the past several years, primarily due to better tubes and rectifiers, the technician must still cope with this problem when it arises. Both horizontal and vertical shrinkage can and do occur. This article is primarily concerned with the former type, although some cases of vertical shrinkage related to horizontal shrinkage are included.

Power-Supply Failures

Selenium rectifiers are probably the most common cause of shrunken rasters. From the moment one of these units is placed in service, it starts to age and lose rectification efficiency. While slow, the loss is steady until eventually the rectified supply voltage drops off enough to affect raster size.

Germanium and silicon rectifiers, which have generally superseded selenium units in new sets, do not age in the same fashion; they retain their efficiency for a long period of time and thus are rarely responsible for raster shrinkage. Fig. 1 shows the result of one of those rare failures. This small raster was found on a Motorola TS-433 having the power-supply circuit shown in Fig. 2. In this case M2 open-circuited, and the voltage doubler became a simple half-wave rectifier. The supply voltage was reduced to 140 volts from its normal 280.

Loss of capacitance in power-supply filters can also cause shrunken rasters. With this defect, the small raster often contains an additional clue—hum bars such as those you see in Fig. 3. Although a low input capacitance in the power-supply filter caused the effect in Fig. 3, a similar defect in a Zenith 19K gave



Fig. 1. Raster is reduced in size in both directions due to defective power-supply rectifier.



RASTERS

by Allan F. Kinckiner

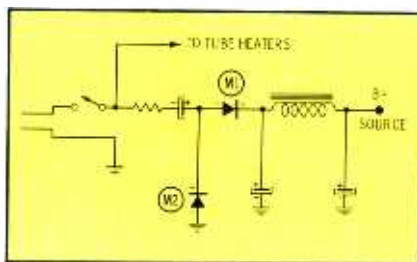

Fig. 2. Low-voltage supply of set in Fig. 1.

neither a shrunken raster nor a hum-bar condition. Instead, the raster was intermittent; a raster would not always develop when the set was turned on. Insufficient horizontal sweep in an Admiral 14YP (Fig. 4) also resulted from reduced capacitance in the power-supply filter. Note in this case that the horizontal shrinkage is accompanied by vertical overscan. This was because the second-anode voltage was also lowered; this in turn decreased the CRT beam velocity and allowed the normal vertical-sweep power to over-deflect the beam.

When both vertical and horizontal sweep lack size, keep in mind that, although it is fairly likely the low-voltage supply is at fault, sometimes a horizontal-circuit defect will also decrease vertical sweep, especially if boost voltage supplies the vertical stage. (On the other hand, a horizontal defect might cause vertical blooming, as illustrated in Fig. 4.)

Degrees of Shrinkage

Shrinkage occurs in varying degrees. There are no rigidly defined categories, but shrinkage can usually be considered severe if the raster leaves more than 1" of dark space on a 17" screen (or a proportional amount on a picture tube of another

size). Generally, severe shrinkage is easier to correct than a small amount, since the cause can be more readily detected with scope or voltage checks. Points to examine are the input of the horizontal deflection amplifier (for horizontal drive signal) and the screen and cathode of the horizontal amplifier (for excessive unbypassed signals). Voltages throughout the horizontal oscillator, horizontal amplifier, and damper circuits should be examined critically. Usually these voltage and scope checks either reveal the cause of severe horizontal shrinkage or quickly clear these stages so that troubleshooting efforts can be directed to the yoke or flyback transformer.

Shrinkage can be considered mild when it is less than the 1" described earlier. Mild shrinkage is frequently more difficult to troubleshoot because the defect causing it is usually also mild; in fact, the trouble may not produce scope or voltage deviations outside accepted tolerances. A good example of mild shrinkage is illustrated in Fig. 5, which shows the horizontal blanking bar at the right edge of the raster. If this picture is shifted to the right, the blanking bar appears on the left edge, and if the picture is centered, a small unswept area appears at either edge. (The latter condition is not always the same on all stations because of slight variations between the blanking signals transmitted by different stations. Thus a certain amount of overscan is normally needed to prevent blank areas from appearing at the picture edge when different stations are received.)

Case Histories

The variety of causes of narrow

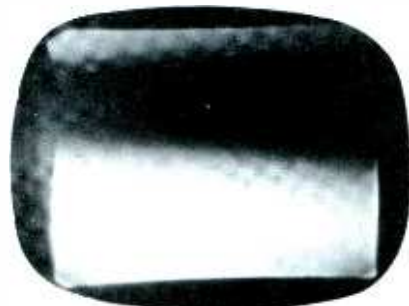

Fig. 3. Defective filter capacitor caused this raster condition in a Motorola TS-530 chassis.

rasters is extensive. The case histories that follow are typical of the problems you can expect to encounter.

Mild Shrinkage

A baffling case of mild shrinkage involved one of the first RCA models to use a 110° picture tube. The voltage and scope checks in the horizontal circuits of this receiver were almost perfect. Luckily, another RCA set using the same type of yoke was brought in for servicing, and when the yoke from this second set was substituted in the mild shrinker, a raster with plenty of overscan was obtained. The three ceramic capacitors on the suspected yoke were replaced to no avail, so a new yoke was installed. Ringing checks on the bad yoke, the substituted yoke, and the replacement yoke showed no significant differences; substitution was the only way to isolate the defect.

Another case of mild shrinkage involved a Motorola TS-539. This set had a well-cooked high-voltage coil, so a new coil was installed on the flyback core. (This type of repair is quicker than replacing the entire transformer and involves soldering only one wire.) This replacement restored the high voltage, but the raster was slightly narrow even at the extreme setting of the width-adjustment screw. This adjustment is the type that reduces the gap in the flyback-transformer core to increase the width. The narrow raster was finally remedied by placing a fiber shim under the end of the flat spring that retains the core segments (Fig. 6). This brought about a slight further closing of the gap; the desired overscan was the result.

In many RCA sets, ranging from chassis KCS47 to KCS97, slightly narrow width has been corrected by replacing the sawtooth capacitor (C1

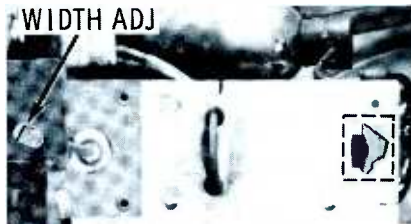

(A) Overall view of transformer



(B) Location of fiber shim

Fig. 6. Method of obtaining sufficient width in older receiver having variable flyback gap.

in Fig. 7). The result of this replacement in one set is illustrated in Fig. 8. The waveform in Fig. 8A shows the horizontal-oscillator output signal (at point A) with the original capacitor; the waveform appears to be normal according to the service data for this receiver. Fig. 8B shows the waveform at the same point after the capacitor was replaced. The amplitude has now increased but is within normal tolerance. The double point at the bottom of the trace in Fig. 8A has been found to be a good indicator of a bad sawtooth capacitor. Very often such a capacitor can be subjected to all the usual tests without any form of deficiency being detected.

The improved drive obtained with the waveform of Fig. 8B not only provides more sweep but also increases second-anode voltage. This is in contrast to the method of increasing width by shunting a por-

tion of the flyback transformer with a .01-mfd or larger capacitor. The latter trick does increase width, but it also decreases high voltage, often to the extent of softening the focus.

Component deterioration is a common cause of shrunken rasters. In one set, a Westinghouse V-2344, the 4-watt wirewound screen resistor changed in value from 8200 ohms to 18K. The horizontal sweep failed to fill the tube face by a fraction of an inch. Surprisingly, the screen voltage did not decrease enough to cause suspicion; it dropped to 145 volts, only 15 volts below normal. Wirewound resistors very rarely shift in resistance, and the fact that this one did, plus the fact that the screen voltage was affected so little, made necessary the use of more than routine troubleshooting procedures.

Another Westinghouse (a V-2346 chassis) had both vertical and horizontal shrinkage. In this set a 30-mfd electrolytic capacitor from boost to the B+ line had developed a very stable 2500-ohm leakage resistance. This is an unusual condition; a defective electrolytic normally presents either a low-resistance short or a leakage resistance that varies according to the applied voltage. Nor was routine troubleshooting enough to pinpoint this trouble quickly, since boost voltage was still appreciably above the B+ voltage.

The preceding three cases illustrate an important point: Horizontal-sweep circuits are sensitive to unusual component defects that produce no noticeable effects when the components are used in other circuits.

Probably the hardest "mild shrinkers" to correct are those sets in which the manufacturer finds this trouble in a certain percentage of the total production. This leads to the issuance of production-change

• Please turn to page 63

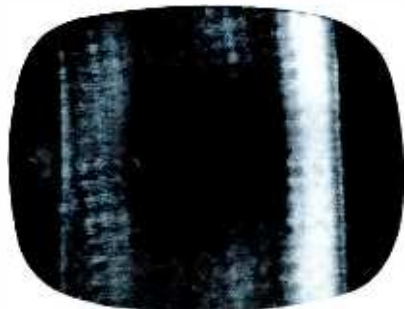

Fig. 4. Horizontal shrinkage, vertical overscan both resulted from bad filter capacitor.



Fig. 5. Typical case of mild raster shrinkage depicted here may not show on all stations.

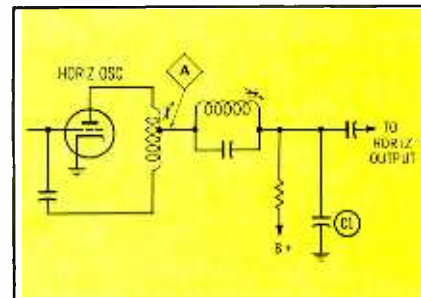

Fig. 7. Nondetectable fault in C1 causes reduced amplitude, results in narrow raster.

NEW SOUND

from OLD CABINETS



Fig. 1. The phono console shown here was monophonic, but was converted to stereo.

As modern phonographs outmode those of the pre-stereo period, set owners are beginning to find it difficult to obtain popular recordings, since most are available only in stereo.

In many cases, the cabinets that house these outdated phonographs are constructed of solid wood and are quite elaborately designed. If the cabinet offers no special attraction to the owner, he will usually scrap it or give it away after purchasing a new, modern stereo system. Most of the better-built, fancy cabinets are not discarded; they are reincarnated. The owner is usually aware that all he needs is a new amplifying system and a new changer—not an entirely new cabinet and insides. He therefore either shops for a changer, speakers, and amplifier for himself, or has his local electronics serviceman rework the system.



Fig. 2. To accommodate the changer, new plywood mounting facilities were needed.

If the system involves only a phonograph, amplifier, speakers, and maybe a radio, the existing cabinet will usually suffice as is, without shelving or separate compartments being built. Of course, since the modern trend is to natural-colored or blond wood, the owner may want the cabinet refinished.

Refinishing the Old Cabinet

Unless you are experienced at using a sander and paint remover, you should refer the customer to a cabinetmaker, or take the cabinet to one yourself. Keep in mind that, in this case, the only reason you have the customer's business is the fact that he wants you to convert what's inside the cabinet—not what's outside. Oh, it's true he wants it refinished, but not finished off. Don't take a chance on fouling up the appearance of the cabinet for a paying customer. Should you desire to rework a friend's cabinet, or one for resale, here are some points you'll want to remember.

Sanding is usually a first step. A disc sander may leave swirl marks where it cuts across the grain of the wood; these marks will show through shellac and varnish, no matter how many layers you apply. Vibrator and belt sanders do a better job with less destruction to the grain.



Fig. 3. $\frac{3}{8}$ " plywood cut by paper template becomes mounting board for the new changer.

Sanders do a good job on flat surfaces, but don't attempt to use one on a curved surface or scrollwork, or you'll ruin the design. On such surfaces it is best to use a chemical paint remover. A point to bear in mind here is that paint remover will never get the paint quite as clean as a sander. If you sand the flat surfaces before applying paint remover to the scrollwork, the sanded surfaces will be much lighter in color than the chemically treated surfaces. A sander cuts clean; it removes the surface of the wood, and the stain or paint with it. On the other hand, the paint remover soaks in, and you can't get all of the color out of the wood. Thus, it is best to use paint remover first, and then sand only enough to match the color of the chemically treated wood.

Once the wood has been sanded, and you are ready to apply the finish, you should seal the wood with either a clear or orange shellac. This keeps the varnish or paint from soaking in. A clear shellac is transparent when applied; the orange shellac produces a slight tinge of orange and emphasizes the grain. A primary coat or two of shellac gives the cabinet a professional-appearing finish. When the shellac has thoroughly dried, sand the surface lightly with very fine sandpaper or steel wool. Be sure to brush or vacuum the cabinet thoroughly after sanding, and before varnishing.

The modern trend is to natural colored wood with the grain showing. To produce this effect, merely varnish the finish using a fine-hair brush and warm varnish (not too warm, or it will run). Experience has shown that surfaces varnish best when they are horizontal to the ground. If you varnish on vertical surfaces, you'll have a runny finish and "tear drops." Once a surface has been varnished, leave it in the horizontal position until dry; then you can turn the cabinet and do another surface. Upon completion of the varnish job (you may want two coats for added depth), and after it has set a couple of days, add a good coat of dry, hard wax for added lustre. Buff and polish this final coating to a very high tone.

Selecting the System

The first consideration in choosing the changer, amplifier, and

speakers for most cabinets is that they fit into the cabinet without changing its outward appearance. With the wide variety of changers and amplifiers on the market, it is relatively simple to select units that will provide the features desired and still fit into the allotted space. True, shelves may have to be rearranged or added, but this is no great problem if done properly. You can situate the new units so no holes need be drilled in the cabinet to accommodate controls.

The speakers may pose a problem. Seldom does the cabinet have room for two sets of woofers, tweeters, and midrange speakers. If such is the case, and the customer desires all these, he has no choice but to use an external cabinet that houses nothing but speakers. If he can be satisfied with fewer speakers, it is often possible to fit two coaxial speakers into the existing speaker enclosure.

Converting to Stereo

With the advent of stereo, phonograph manufacturers began producing stereo changers and adapter kits to convert existing monophonic changers to stereo. While it is relatively easy and inexpensive to replace or modify a changer, it is not always so easy to find space for another amplifier and set of speakers without reworking the cabinet. However, in certain cabinets, and with a little ingenuity, it is easy to convert an old hi-fi system to full stereo operation.

Fig. 1 pictures an AM-FM-Phono system originally built for strictly monophonic operation. It has a French Provincial cabinet, with attractive facing and controls on the radio unit. The owner was experiencing difficulty in obtaining his favorite records in mono, but he hesitated to discard his old cabinet completely, just because it wasn't stereo. He brought the problem to his serviceman.

The technician considered using a replacement stereo changer and adding a stereo amplifier to the existing system. Although one amplifier was already provided in the radio circuitry, two were needed. He thought a separate, external amplifier might suffice, but this would be bulky and would require careful location of controls. His next thought was that additional circuitry inside the

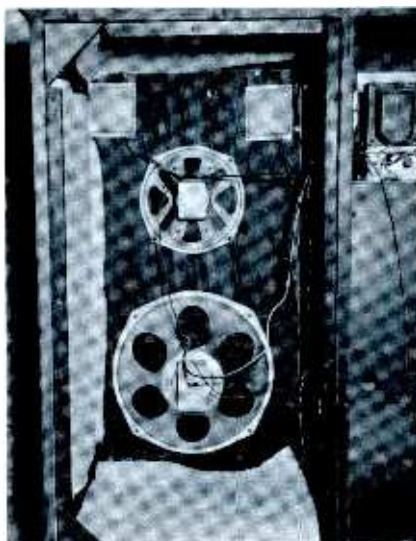

Fig. 4. The existing speaker arrangement of woofer, midrange, and tweeters was retained.

radio itself, using the radio's power supply, could provide the second channel. But, matching the bass and treble networks of the radio—which is what the owner desired—would necessitate much time, labor, and expense. It was finally decided that a separate dual-channel amplifier having all dual controls (bass, treble, and volume) on single shafts would be best. Thus, there would be no need to continuously juggle the separate controls of two different amplifiers.

Fig. 1 also shows a stereo amplifier located in what used to be the record storage compartment. An amplifier unit was chosen that would



Fig. 5. A solid oak dining-room buffet converted into a stereo hi-fi system for the home.



Fig. 6. Buffet drawers were removed and a shelf added for the amplifier in this unit.

present a custom appearance. This location may be unhandy for some, but the owner preferred that the cabinet be left in its original shape and appearance; thus, the small inconvenience of having to bend down to operate the stereo amplifier was justified.

Fig. 2 shows the details that were involved in modifying the changer compartment to accommodate a different style changer. The assembly, which slides on dual tracks, was fitted with a piece of $\frac{3}{8}$ " plywood cut to shape and mounted on the tracks. Next, a frame suitable for supporting the changer was selected from odds and ends lying around the technician's shop. This particular base provided more than enough room for the underside of the changer, so only the changer-mounting holes were different from those in the original base.

In order to mount the changer, the adapter board shown in Fig. 3 had to be fashioned. By trial and error, a paper template was made, using the underside of the changer as a guide. The mechanism and motor were allowed plenty of clearance to provide for the technician's amateur carpentry. When a suitable template had been cut from paper, the plywood mounting board was cut using the template as a guide. The finished product was placed on the old base, and the stereo changer mounted on the new board.

With the amplifier in the cabinet and the changer mounted, only one detail was left—the speakers.

Fortunately, as shown in Fig. 4, the cabinet had four speakers already: a woofer, a hard-cone midrange speaker, and two tweeters. Since the owner didn't care to hear the rosin squeak on the fiddler's bow, and was—as he put it—"merely interested in good music," three of the existing speakers were retained and a soft-cone midrange speaker substituted for the old one. A tweeter and the woofer were then used for the right channel, and the midrange unit and one tweeter for the left. Although this was not the best or most complete speaker system, it turned out rather well. Stereo records sounded almost as good as on elaborate, expensive stereo systems.

But, this is putting the cart before the horse! To get the system work-

• Please turn to page 67



to a truly defective component, but the real braintwister is to find some way to increase width when only slight fringes show. A slight lack of width may be due to a loss of Q in the width coil, the horizontal output transformer, or the yoke. Time, dust, grease, moisture, and the repeated heating and cooling of these inductances can reduce their efficiency. In some width-control networks, capacitors and resistors may change value slightly. Individual units may not change enough to warrant replacement on their own, but several small changes may be enough to impair circuit efficiency.

Outside Troubles

The place to start servicing for a width problem is at the AC input. Line voltage can affect width. A few volts lost in the plug, line cord, or interlock might be enough to decrease the width materially in an already borderline sweep circuit. A small line voltage reduction could represent several volts of B+ or quite a large reduction in boost voltage.

If the AC input to the power supply is normal, yet B+ is low, replace the low voltage rectifier tubes and watch for an increase in B+. If semiconductor rectifiers are used in a doubler circuit, the B+ should read 250 volts DC or better; single rectifiers develop about 130 volts DC.

Early in the service procedure, the horizontal tubes should be changed. Special consideration must be used when exchanging the horizontal output tube: If the new tube reduces the width, it may not have the proper characteristics for the circuit, or it may have boosted high voltage enough to decrease the width. Check the high voltage under both conditions; if necessary, try several tubes.

In the Width Circuit

The next thing to check is the circuit containing the width control. Some width controls—usually coils—are “losser” devices; greatest possible width is achieved when their effect is removed from the circuit entirely. Fig. 1 shows two circuits of this type.

In Fig. 1A, the coil absorbs flyback energy that would otherwise be developed across the horizontal windings of the yoke; this absorp-

How many times have you replaced a tube in the horizontal stages, and opened up a Pandora's box of troubles and complaints? Or, worse yet, replaced the picture tube and found conditions that weren't visible before you replaced the tube?

Width and linearity problems can arise from a multitude of sources, to tax the ingenuity of many a competent serviceman. Replacement of a high voltage rectifier may have increased the high voltage, thereby reducing the width; a new picture tube, operating at normal brightness settings, could have introduced a slight width reduction, if the higher settings used with the weak CRT had caused enough blooming to fill the screen. These are only examples of peculiarities that may result in sudden horizontal sweep trouble.

The Basics

At this point it would be well to discuss the design of width and linearity circuits and the philosophy of their troubles. Increasing the waveform amplitude across the hori-

zontal windings of the yoke will increase the width. Greater high voltage speeds up the CRT electron beam, in effect “stiffening” it, thus narrowing the raster. Therefore, width will be affected by a fault of either sweep amplitude or high voltage.

Carry the analysis a bit deeper, and we find that sweep amplitude can be reduced by altering DC voltages in the horizontal stages, or by somehow changing the signal waveform itself. Control of width is handled in either way, as we'll soon see.

Linearity is a bit more complicated. It is achieved by insuring that sweep voltage fed to the yoke is a smooth, linear sawtooth. Linearity control starts at the horizontal oscillator, but the greatest influence is usually exerted by a special linearity network associated with the output stage, damper, or yoke.

Width problems are most aggravating when just a wee amount of width is lacking. A serious lack of width can usually be traced quickly

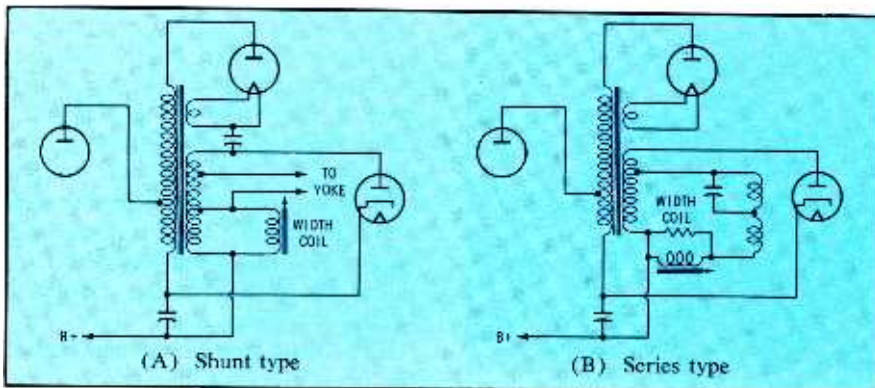

Fig. 1. Inductances used to control width, by either of two usual methods.

tion decreases the sweep waveform amplitude. In Fig. 1B, sweep amplitude is reduced by increasing the impedance (inductance and resistance) in series with the width control.

The simplest check for trouble in "losser" circuits is to remove the controls from the circuits. For Fig. 1A, disconnect one side of the coil; for Fig. 1B, simply short it out. Either way, maximum possible width will be determined. If there still isn't enough to fill the raster, other trouble is certain. If too much width is gained with the controls removed, reconnect them and reduce their effectiveness by shunting them with small values of capacitance ranging from .0001 to .005 mfd (1600 volt ratings are best). For the circuit in Fig. 1B, a lesser value of shunt resistance will accomplish the same purpose.

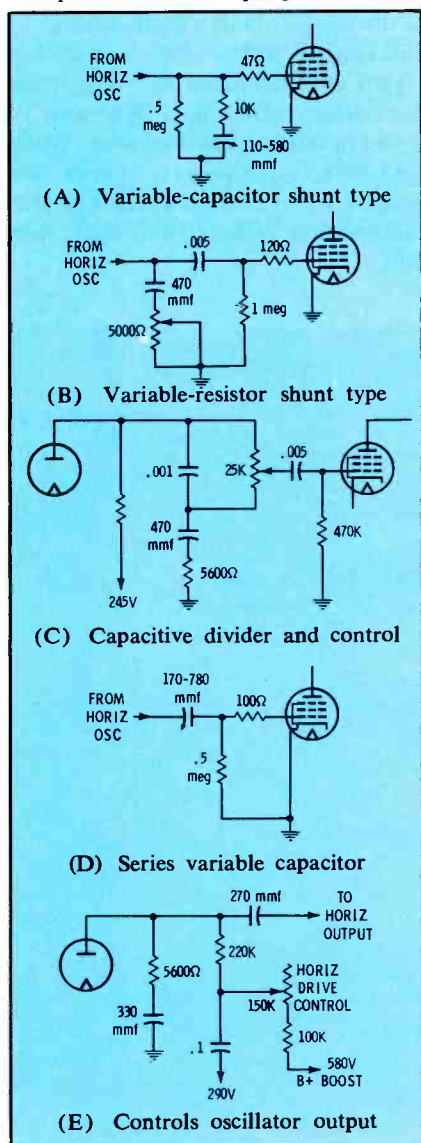

Fig. 2. Drive controls also affect width, and in a number of different arrangements.

Some words of caution: In many sets, the width coil may also be used as part of the AGC arrangement; care must be exercised not to disturb the AGC connections. Another point to check when width changes are made is the cathode current of the horizontal output tube; be sure the maximum rating is not exceeded (the tube manual or circuit diagram will give you a clue to normal ratings).

Fig. 2 shows some older circuits in which width is controlled by various systems of horizontal drive adjustment. The idea in all of these is to regulate the amount of signal fed from the horizontal oscillator or multivibrator to the output tube.

Fig. 2A shows the shunt or bypass method of controlling drive. As capacitance is increased, more signal voltage is shunted to ground; thus less of the waveform reaches the grid of the output tube, reducing drive. The circuit in Fig. 2B is similar, except that adjusting a resistance in series with the capacitor accomplishes the same result; wave-shape is affected, but the basic effect is a reduction of drive. In Fig. 2C, this control over drive is obtained by using a potentiometer and a capacitive divider network. In Fig. 2D, the value of coupling capacitance is varied.

Fig. 2E is considerably different, although the end result is the same. The amplitude of the drive signal is made greater by increasing the DC voltage fed to the plate of the horizontal oscillator. The consequence is greater signal voltage fed to the output stage, and more width.

Fig. 3 elaborates some of the circuits using inductance to control width. In Fig. 3A, the horizontal deflection coils and a width coil are connected by a switch to various taps on the output transformer. As the switch is turned, the sweep voltage applied to the yoke is varied. The relative effectiveness of the width coil is also controlled by the same switch, working with a tap on the inductance. In one position of the switch, the width control is removed from the circuit entirely.

Fig. 3B shows another method. Here, an inductance may be connected or disconnected, or a capacitance shunted across the flyback, to alter the width. We've discussed how the coil reduces width. The

capacitance increases width by raising the Q of the horizontal output load, thus increasing the waveform amplitude.

Fig. 3C shows another way to solve the width problem. Instead of a coil, a 250 ohm potentiometer is used in series with the deflection coils.

In one 24" set, a standard 21" flyback is used; however, a .22 mfd capacitor shunts the 33 ohm resistor that ties the flyback windings together at the "cold" end. Additional energy is developed by shunting the horizontal deflection coils with a 47 mfd capacitor. Fig. 3D shows this system.

A simple method for controlling width is shown in Fig. 3E; the screen grid voltage of the output tube is varied with a rheostat, there-

• Please turn to page 69

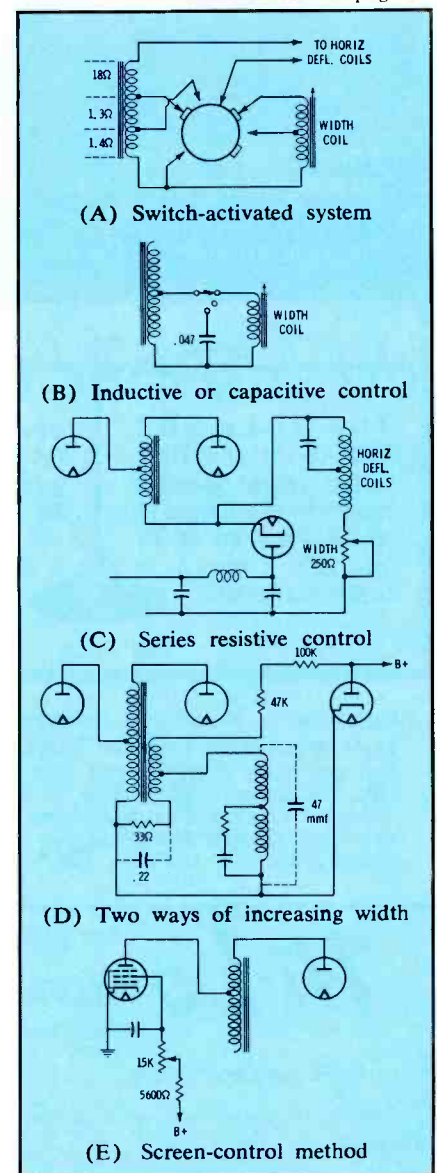
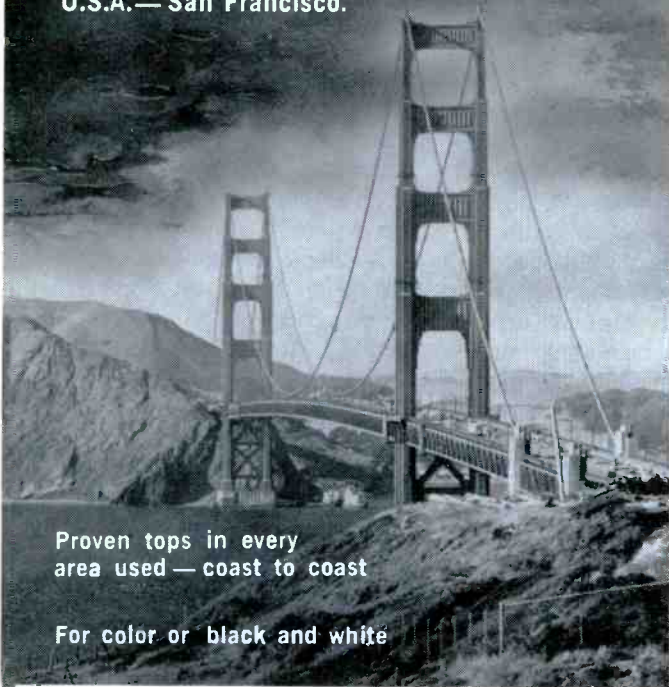

Fig. 3. Several unusual approaches to width control are illustrated in these circuits.

The greatest indoor TV antenna ever made

Tops all others in the roughest TV reception area in the U.S.A.—San Francisco.



Proven tops in every area used—coast to coast

For color or black and white

The Hi-Lo 202 covers all channels VHF (2-13) and UHF (14-83). Exclusive patented spiral feature guarantees 300 ohm TV set. Operates anywhere, in closet, or attics. You gain 2 ways—top satisfaction full profit to you— from customers.

List Price ... **9⁹⁵**

Outdoors — install the industry's top all-color, all-channel Yagi, the Tricraft ACY-9.

High gain, sharp directivity, high front to back ratio. Outstanding fringe reception on all VHF channels. Pre-assembled for rapid installation with Hi-Lo's patented "Allsnap" method of assembly. List Price **1675**

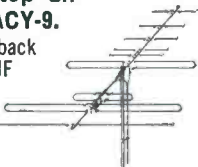

Hi-Lo

See your distributor or write

MANUFACTURING CORP.

1126 W. Newport Ave., Chicago 60657

Send complete details

Name _____

Street _____

City _____

Guide to UNUSUAL TEST EQUIPMENT

Test equipment, whether it be multipurpose or specialized, is the right hand of every technician. Tube testers, multimeters, oscilloscopes—they're all necessary. However, these are limited to certain general functions. For specific servicing jobs, there is usually a speciality instrument that will do the job better than others.

The purpose of this chart is to introduce you to some of the lesser used types of specialized test equipment. Some may be familiar; others unfamiliar. Whatever the case, they can assist you in doing a good job even better.

All types presented here, especially those with multiple functions, may have slight feature variations from manufacturer to manufacturer. Their basic uses, however, remain the same.

AC Ammeter-Voltmeter (wrap-around)

Indicates voltage and current by measuring flux surrounding a conductor. Used where heavy current drain is common.

AC VTVM

Measures audio voltages; measures decibels in audio circuits. Extreme sensitivity (few millivolts) is characteristic.

CB Transmitter Tester

Checks modulation percentage and power output. Often includes field strength meter as indicator for transmitter tuning.

Distortion Meter

Measures intermodulation or harmonic distortion in audio equipment.

Field Strength Meter

Indicates strength of an RF carrier at location of instrument. TV types help find better antenna locations. Communications units—see CB Tester.

Flyback Tester

Tests flyback transformers and sometimes yokes.

Frequency Meter	Measures frequency of RF carrier; accurate to within specified percentage. Needed for CB and two-way servicing.
Grid Dip Oscillator	Multifrequency oscillator, with meter in grid circuit, finds resonant point of coils and tuned circuits. Modern units use tunnel diode oscillator.
Impedance Bridge	Determines the impedance or reactance ratio between any two of three types of components—capacitors, resistors, and inductors.
Modulation Meter	Measures modulation on RF carrier. Different models for amplitude, frequency, phase, or pulse modulation.
Electronic Switcher (for scope)	Allows two separate waveforms to be displayed simultaneously on scope screen.
Q Meter	Measures the selectivity of a resonant circuit or inductance.
Recording Voltmeter	Provides voltage graph on paper chart. Useful for monitoring what happens in circuit over given period.
RF Wattmeter (in-line)	Measures RF power delivered to antenna. Also indicates SWR by measuring any power reflected back from the antenna.
Signal Injector	Usually small, and contains audio-frequency pulse oscillator. Signal injected at points in circuitry aids troubleshooting.
Signal Tracer	Amplifies audio signal fed to it via test probe. Demodulator probe allows troubleshooting RF stages.
Stroboscope	Determines speed of turntables and tape recorders.
SWR Bridge	Measures directly the ratio of forward to reflected power in antenna circuit.
Voltage Calibrator	Supplies accurate AC voltage for comparison on scope screen with other waveforms to determine voltage.

Communications, mobile radio...

A First Class FCC License

...or Your Money Back!



Your key to future success in electronics is a First-Class FCC License. It will permit you to operate and maintain transmitting equipment used in aviation, broadcasting, marine, microwave, mobile communications, or Citizens-Band. Cleveland Institute home study is the ideal way to get your FCC License. Here's why:

Our training programs will *quickly* prepare you for a First-Class Commercial Radio Telephone License with a Radar Endorsement. Should you fail to pass the FCC examination after completing your course, you will get a *full refund* of all tuition payments. You get an FCC License . . . or your money back!

You owe it to yourself, your family, your future to get the complete details on our "proven effective" Cleveland Institute home study. Just send the coupon below TODAY. There's no obligation.

Mail Coupon TODAY For FREE Catalog

Cleveland Institute of Electronics

1776 E. 17th St., Dept. PF 17
Cleveland, Ohio 44114

Please send FREE Career Information prepared to help me get ahead in Electronics, without further obligation.

CHECK AREA OF MOST INTEREST—

- | | |
|---|--|
| <input type="checkbox"/> Electronics Technology | <input type="checkbox"/> First Class FCC License |
| <input type="checkbox"/> Industrial Electronics | <input type="checkbox"/> Electronic Communications |
| <input type="checkbox"/> Broadcast Engineering | <input type="checkbox"/> Advanced Engineering |

Your present occupation _____

Name _____ (please print) Age _____

Address _____

City _____ State _____ Zip _____

Accredited Member National Home Study Council

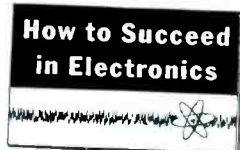

The antenna that challenges

NEW Swept Element

"COLOR-VE-LOG"

BY

FINCO

Finco's Color Ve-Log challenges all competition on color or black and white reception and stands behind this challenge with a "Guarantee of Supremacy". ■ The swept element design assures the finest in brilliant color and sharply defined black and white television reception — as well as superb FM monaural and stereo quality. ■ FINCO precision-engineered features make these advanced-design antennas indispensable to good home sight-and-sound systems. And, of course, they carry the famous unconditional guarantee from the leading manufacturer in the field — FINCO. ■ Promote the Color Ve-Log Antennas with pride, sell them with confidence, and profit handsomely.

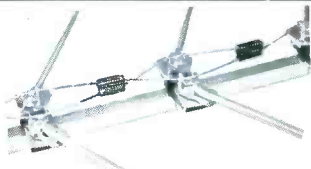

One-piece cross-over drive line assembly has no joints between adjacent driven elements. Eliminates loose connections, shorts, broken drive line sections. Polystyrene snap-lock spacers, with center 'air insulator' space.



Elements are made of triple thick aluminum to stand up in severe weather. Die stamped bracket fastened with tough, thick-gauge rivet holds proportional length sleeve reinforcing shell into which element fits.



First from Finco and exclusive — double contact between drive line and driven element bracket assembly for perfect drive-line support and electrical continuity. Positive, vibration-free, non-corrosive contact.



Boom reinforcing back up brackets at elements add triple strength to the riveted assembly, mounted on a rigid, non-crushable 1" heavy duty square boom. Boom rolled square from 1 1/4" diameter round aluminum for increased strength.

Write for color brochure #20-307, Dept. 310 .

all competition!

LOG



VL-10
9 driven elements
1 parasitic element
List price \$34.95

Featuring Finco's Exclusive Gold Corodizing



Finco's boom-mast bracket, rust-proofed by zinc plate-gold di-chromate dip process, is the finest available. It has positioned cleats to assure sag-free positive direction of the antenna. Locks tight. Can't tilt. Antenna stays in proper position at all times.



High impact polystyrene insulators are reinforced with strong aluminum shields. This gives quadruple strength in supporting triple-thick snap-in elements. Lifetime assembly with fitted aluminum cup to hold oversize aluminum rivet.

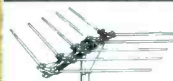

VL-5
5 element VHF-FM
5 driven elements
List price \$16.95

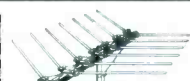

VL-7
7 element VHF-FM
7 driven elements
List price \$23.95

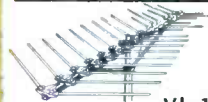

VL-15
15 element VHF-FM
9 driven elements
6 parasitic elements
List price \$46.95



VL-18
18 element VHF-FM
9 driven elements
9 parasitic elements
List price \$54.50

The FINNEY Company • 34 Interstate Street • Bedford, Ohio

Circle 17 on literature card

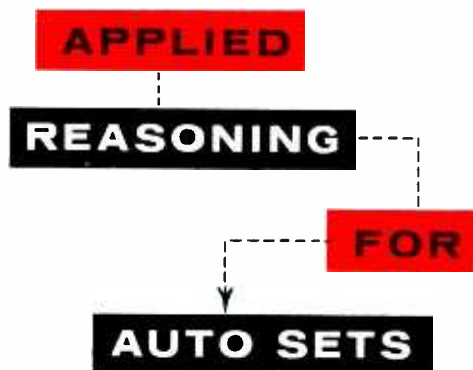

Good repair kits make the job easier.

by William C. Caldwell

Will you be tricked by illusive time-consuming, seemingly baffling auto radio troubles, sometimes referred to as intermittents or "tough dogs," or will you turn this type of trouble into a profit-making, routine diagnosis? It all depends on whether you keep in mind certain facts about these radios—facts that can make you or break you on this type of problem.

When servicing anything, we must always keep in mind the environment in which the product operates. Then, on our test bench, it is very important to simulate as closely as possible these same environmental conditions. If this is not done, the trouble may never show up, and we have a so-called tough dog on our hands, one that requires an excessive amount of our valuable time.

The three major conditions affecting proper operation of an auto radio are voltage variations, vibration, and temperature changes.

Voltage Variations

The input voltage to an auto radio may vary as much as 30%. When the car lights are on and the engine is idling or turned off, a poorly-charged 12-volt battery may get

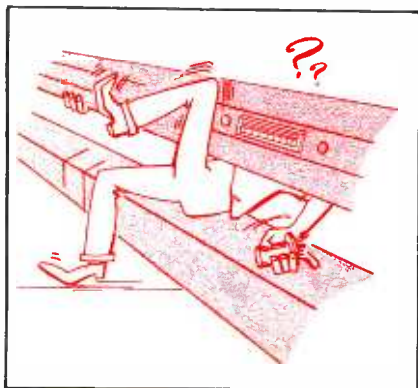

Fig. 1. OZ4 was common culprit in older sets.

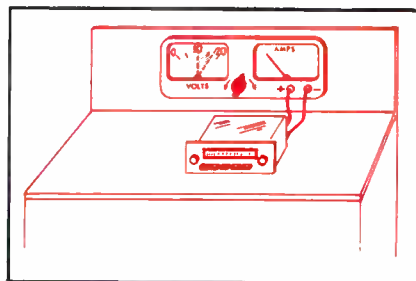

Fig. 2. When bench checking auto radios, vary the voltage to simulate car conditions.

down to 10 or 11 volts. With the generator charging, a good battery and generator system may put out 14 or 15 volts. What a difference this voltage variation can make in auto radio operation, especially if the radio has certain defects!

This point was driven home vividly in the days when OZ4 rectifiers were being used extensively. When the customer complained that the radio worked okay sometimes, but faded out completely at stop lights, you knew exactly what to do. In fact, the customer was usually quite amazed at the speed with which you assumed the customary position (Fig. 1) in his car and came up with the culprit—a defective OZ4.

If, however, you didn't get to talk to the customer, an entirely different problem existed. You had to make certain tests to locate the defective part, and if you didn't think to check the operation of the radio with low input voltage (Fig. 2), a lot of time was wasted listening to a seemingly "normal" radio.

Also, the reverse circumstance can exist. Troubles that fail to show up with 12 volts input may become evident at higher input voltages, such as 14 or 15 volts. This is true even in some of the more recent hybrid and all-transistor sets.

"Voltage Sensitive" Troubles

The 12AD6 tube, commonly employed as a converter in many hybrid auto radios, has been known to squeal or quit oscillating at 14 volts but work fine at 12 volts.

Certain transistors may become intermittent or cause distortion at the higher working voltages, but act perfectly normal at 12 volts.

Electrolytic filter capacitors that work normally at a constant voltage occasionally act up with sudden changes. In the car, sudden voltage changes occurring when the brakes are depressed or the lights are turned on may cause the radio to start oscillating or motorboating. On the bench, this voltage change can sometimes be simulated by turning the radio on and off several times at a rapid rate. The sudden surge of voltage will often cause the oscillation to start or stop, making us suspect a defective filter.

Vibration

Automobile radios undergo a lot of vibration during their travels. This is far different from a home radio which sits in a cabinet and may never be moved.

Therefore, to test for intermittent conditions, parts should be tapped gently with the handle of a small screwdriver or other suitable tool (Fig. 3). Pressure on the side of IF

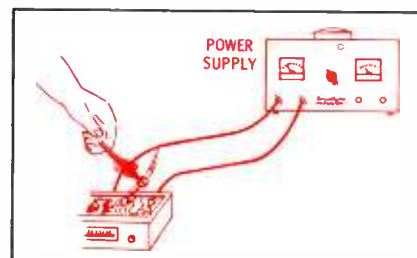
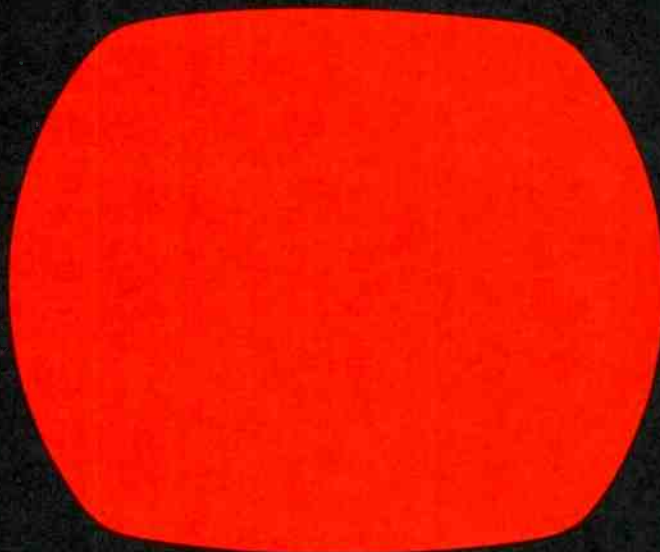

Fig. 3. Vibrations are simulated by tapping.

you get **PRODUCT PLUS** from your Sylvania Distributor

suddenly

**COLOR TV
HAS A NEW
RED STANDARD**



Sylvania's new EUROPIUM RED.

New COLOR BRIGHT 85 picture tube brings more natural color to television and increases monochrome brightness 43%.*

The startling news in the television industry is Sylvania's new picture tube, and its new, truer red phosphor.

EUROPIUM RED, developed at GT&E Laboratories, is the brightest red known to the industry. And, to match it, now the full brightness of blue and green is used. The result is a color picture tube that gives the entire television industry a boost.

Because the COLOR BRIGHT 85 tube is *really* bright, dealers can demonstrate color TV effectively in normally lighted showrooms. As the set's brightness is adjusted, the colors remain true—not shifting to unnatural tones in the highlights of the picture.

Another thing, black and white performance is far better than you've ever seen before in a color tube. Be-

sides the increased brightness, there's improved contrast in a sharp, vivid picture.

The new, exciting COLOR BRIGHT 85 picture tube is a product plus from Sylvania for the entire color television industry, and particularly for dealers. In color, as in black and white, you know it's good business to handle the Sylvania line.

SYLVANIA
SUBSIDIARY OF
GENERAL TELEPHONE & ELECTRONICS GT&E

NEW CAPABILITIES IN: ELECTRONIC TUBES • SEMICONDUCTORS • MICROWAVE DEVICES • SPECIAL COMPONENTS • DISPLAY DEVICES

*Tests show the COLOR BRIGHT 85 tube is 43% brighter, on the average, than standard color picture tubes.

Circle 18 on literature card

October, 1964/PF REPORTER 43

look to Xcelite for the best in pliers & snips, too

LONG NOSE AND DIAGONAL PLIERS

CHAIN NOSE ELECTRICIAN'S PLIERS

COMBINATION SLIP JOINT PLIERS

NEEDLE NOSE PLIERS

RADIO AND TV PLIERS

SIDE CUTTING PLIERS

TRANSVERSE CUTTING PLIERS

UTILITY PLIERS

ELECTRONIC SNIPS

Same professional quality as famous Xcelite screwdrivers and nutdrivers. Forged alloy steel construction. Precision machined. Scientifically proportioned. Variety of sizes. All available with permanent, plastic coated Cushion Grip handles for extra working comfort (except slip joint models).

WRITE FOR CATALOG SHEET N664



XCELITE, INC., 18 BANK ST., ORCHARD PARK, N. Y.
Canada: Charles W. Pointon, Ltd., Toronto, Ontario

Circle 19 on literature card

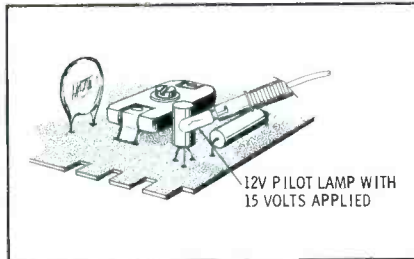

Fig. 4. Heat the transistor with a pilot light. coils may often uncover loose connections inside the can.

Circuit boards should be tapped and wiggled up and down to uncover any illusive loose connections or hairline breaks.

After repairing any automobile radio, regardless of what trouble was found, always replace the covers and shake or tap the complete radio to make sure no intermittents have been missed. A rubber mallet or the heel of the hand can be used to tap the case.

Temperature Variations

The temperature in an automobile may vary by as much as 180°; from -30° F. in the northern U.S. to 150° F. in the South. This high temperature is reached with the windows closed and midday sun beaming through the windshield.

A radio may perform very well at 75° room temperature in the shop, but it may conk out again after it is installed in the car. Get the customer complaint whenever possible. If the trouble is "intermittent," try to find out if it has anything to do with temperature. Typical examples of such intermittents are:

1. Radio plays good until the car warms up, then it quits.
2. Radio squeals when I first turn it on, then it works O.K.
3. On cold mornings I can't turn the dial.

Some temperature problems typically found in transistor auto radios are shown in Chart I. Several bad converter transistors have been found in 1963 all-transistor radios by touching a lighted pilot lamp to

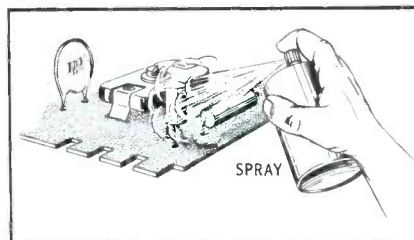

Fig. 5. Cool the transistor with cooling spray.

DON'T REPAIR STEREO PHONOS!



(Modernize them with the Positive Scratch Protection of a new E-V featheride!)

It's as easy as exact replacement—and much more profitable! Upgrade your stereo phono customers to featheride performance and record protection—until now only available with high-priced console phonographs and custom hi-fi systems.



Exclusive E-V featheride mechanism lifts needle off record before accidents can damage grooves. Unique soft felt pad absorbs all shocks.

featheride high compliance design keeps tracking pressure low for longer record life—two models match all modern changers. Specially designed mount permits tracking even badly warped records every time!

If a featheride cartridge prevents damage to just one record, your customer has saved the slight extra cost. Start installing today's most wanted phono feature—E-V featheride—available at your E-V distributor's today.

ELECTRO-VOICE, INC., Dept. 1047R
Buchanan, Michigan 49107

featheride

Electro-Voice
SETTING NEW STANDARDS IN SOUND

Circle 20 on literature card



MODEL 107B FEATURES "NO-SET-UP" TESTING

40 prewired sockets accommodate 63 basic pin arrangements for testing all modern TV, radio, industrial and foreign tubes. Also included is a plug-in chassis with 8 sockets wired to 14 lever type pin selectors for testing tubes circuit by circuit. To eliminate errors in reading, all information reads on *one* meter and *one* scale. Three comprehensive tests—Grid Circuit Test, Dynamic Mutual Conductance Test and Cathode Emission Test. Model 107B is always up to date—data book pages covering new tubes are mailed periodically to registered owners. ONLY \$189.50 net.

SECO'S patented Grid Circuit Test detects "hard to find" tube faults

GRID CIRCUIT TEST makes up to 11 simultaneous checks
for leaks, shorts and grid emission

MODEL 98 FEATURES PICTURE TUBE TEST

Tests over 400 cathode ray picture tubes including 110° deflection types—has 12-pin picture tube socket. Also has replaceable plug-in chassis for receiving tubes—guaranteed up-to-date including novars, nuvistors, 10-pin types, compactrons and magnovals. This chassis can be replaced for new tubes or customized for special uses. Dial controls isolate or transpose tube circuits and select test current—Grid Circuit Test, Tube Merit Test and Heater Current Test. Removeable cover holds speed-indexed tube data cards, pin straighteners and condensed operating instructions. ONLY \$99.50 net.



MODEL 88—COMPLETE TESTER AT LOW COST

Performs the same picture tube test as Model 98. Tests all receiving tubes including novars, nuvistors, 10-pin types, compactrons and magnovals. Grid Circuit Test, Tube Merit Test and Filament Continuity Test—you can find cathode emission, leaks, shorts, grid emission, gas error, filament continuity and cathode-to-heater emission. Stationary receiving tube chassis. Unit comes complete with speed-indexed setup data, pin straighteners and 12-pin picture tube socket on a 3-foot cable. ONLY \$74.50 net.



For complete information on Seco test equipment, see your electronic supply distributor or write:

SECO ELECTRONICS, INC.

1221 S. CLOVER DRIVE • MINNEAPOLIS, MINNESOTA 55420
A DIVISION OF DI-ACRO CORPORATION

Circle 21 on literature card

sooner
or
later...



you will demand the extra quality and precision of Nortronics tape heads! All Nortronics heads feature:



laminated core structures and deposited quartz gaps for superior high frequency response, and . . .



hyperbolic, all-metal faces for intimate tape-to-head contact—longer wear with minimum oxide loading.

Now, you can demand the best! Offer your customers Nortronics tape heads . . . designed and produced to the highest standard of excellence.

Get full details! Write today for your FREE copy of Nortronics Tape Head Replacement Guide.

Nortronics

8161 Tenth Ave. N., Minneapolis, Minn. 55427

Circle 22 on literature card

CHART I

How Radio Acts	Most Common Cause
Motorboats or squeals only when radio is first turned on.	Leaky power output transistor.
Goes dead after car warms up.	Some part (capacitor, small transistor, etc.) oversensitive to heat.
Gets distorted on hot days.	Defective audio driver transistor or speaker.
Transistor radio is dead until one or two minute warmup in car.	Possible defective detector diode (spray cooler will determine).

the transistor case and holding it there for 2 or 3 minutes (see Fig. 4). The heat of the bulb (which is about 135° F., with 15 volts applied to the bulb) is sufficient to make the transistor kick out, but it will not damage the transistor as a soldering iron might. To be effective in this test, the bulb must rest against the transistor, otherwise sufficient heat will not be transferred. The heat will usually cause the transistor to open up if it has a bad internal connection. A circuit coolant sprayed on the transistor will bring it back into operation—Fig. 5. Something else that will often cause the defective transistor to resume operation is a strong signal applied to its base element.

Oscillator trimmers can also be intermittent, and if they are, there is a good chance they will be unusually sensitive to vibration of jarring (see Fig. 6). This type of defect can not only make the radio quit, but can also make the stations shift on the dial or drift badly.

Summary

Voltage changes, temperature changes, and vibration can all be factors in intermittent auto radios. None of them should be overlooked, and getting the owner's description of the trouble is the greatest help to the technician. This is often difficult to do, when the radio is sent in by a car dealer who may fail to obtain or pass along this information. However, this problem can

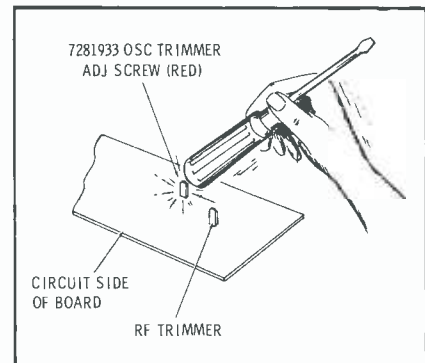

Fig. 6. Find a defective trimmer by tapping.

usually be worked out by more frequent contact with the dealer and by stressing how much better is the service you can give when supplied with a good trouble description.

Certain bench tests closely simulate car conditions. Some affect the whole radio; others are designed to check certain components and are used only when those components are suspect.

These general tests—voltage variations and vibration—should be applied to every automobile radio before it leaves the bench. It takes only ten extra seconds to swing the input voltage through the expected range (10-16 volts on 12 volt models) and to tap the case of the radio to be sure no noise or intermittent conditions exist. ▲

IT ONLY COSTS
1/100 OF 1¢ MORE*
PER SOLDER JOINT
TO KNOW YOU
ARE USING THE
WORLD'S FINEST
CORED SOLDER

ERSIN
Multicore
FIVE-CORE SOLDER

Sold only by Radio Parts Distributors

*Based on cost comparison in current catalogs. MULTICORE SALES CORP., PORT WASHINGTON, N. Y. Circle 23 on literature card

GHOST TOWN!



Clean it up...take it over...
with this unique new
Channel Master antenna

The Coloray. A new kind of antenna **GUARANTEED** to make city (and suburban) TV sets give up the ghost, knock out interference. And has proved it time after time. Right out there in the field—among the tall buildings that cause 80 % of the city's TV troubles.

The Coloray is so effective, in fact, that we dare guarantee it to do a better ghost-killing job than any other antenna on the market . . . regardless of size, type, or price . . . or your money back! It is the only antenna in the world backed by such a guarantee.

Enjoy Fringe-Area-Type Profits! No longer are you forced to sell metropolitan antennas on a low price, low profit basis. No longer need you envy fringe-area dealers their high profits on expensive antennas.

The Coloray gives you a real **performance** advantage . . . that means big new profits from a waiting market willing to pay a little more for it. Model 3110-G. Includes E.P.C. protective "Golden Overcoat." Also available in kit form, Models 3115-G, 3116-G.

**Higher Front-To-Back Ratio Than
a 10-Element Single-Channel Yagi.**

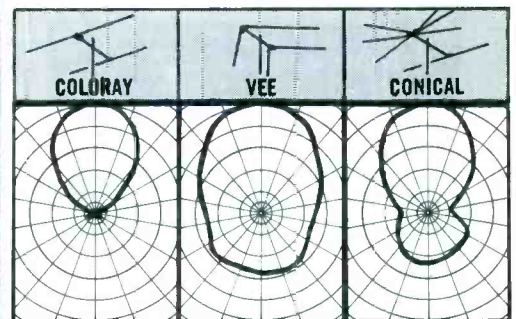

Compare polar pattern of Coloray with those of most commonly used city antennas.

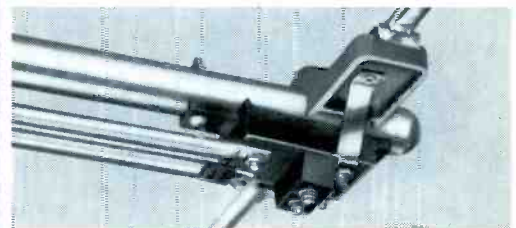

The secret! A transposed phasing harness with an impedance balancing Power Equalizer Circuit that is really unique.

CHANNEL MASTER COLORAY *
hands you the key to the ghost city

BUZIT TRANSISTORIZED SIGNAL TRACER

FOR ONLY \$8.70 DEALER NET
WITH BATTERIES

NO CLIPS
NO WIRES



MADE IN
U.S.A.

USED FOR TROUBLE SHOOTING

- A.F. CIRCUITS • I.F. CIRCUITS
- R.F. CIRCUITS • CONTINUITY CHECKS • SPEAKERS, ETC.

EXCELLENT FOR TRANSISTOR RADIOS BECAUSE BUZIT USES ONLY A 3VOLT POWER SUPPLY

ASK YOUR ELECTRONIC PARTS DISTRIBUTOR FOR

MODEL NO. **BZ-1**



Circle 25 on literature card

DON'T GUESS!



BE SURE WITH A SADELCO FS-2 completely transistorized TV-FM FIELD STRENGTH METER

Accurate measurement of peak visual and aural carriers. Small, light weight and completely portable. Ideal for field surveys and T. V. distribution service. Accurately calibrated in microvolts and DBs the meter uses 16 semi-conductors and weighs only 3½ pounds. The best truly portable TV Field Strength Meter available today.



Inquire about our Free Trial offer. Write to:
SADELCO, INC.
601 W. 26th St.
N. Y., N. Y. 10001
212 WA 9-2528

Circle 26 on literature card



make
the
most

OF YOUR
ATTORNEY

by David B. Cox

Your attorney can save you hundreds—perhaps thousands—of dollars a year in the operation of your business.

Electronic servicing, like any other business, cannot be trouble-free; but the prudent businessman knows that the best way to deal with trouble in his business is to avoid it. He realizes that an ounce of prevention is far cheaper than a pound of cure, and that his attorney—as counselor and friend—can help him put all operations of his business on the side of the law and avoid trouble before it begins.

Your lawyer can help you in other ways, too; ways that can cut your tax liabilities, reduce your overhead, and save you money—

and time and trouble—by better business planning.

Below are some specific ways he can help you, if you will consult him *before* you expand, *before* you start a new credit policy, *before* you make better guarantees on parts and labor, *before* you buy new kinds of insurance. Get the benefit of your lawyer's advice *then*, not after things go wrong and you find yourself in trouble.

Proprietor, Partner, or Corporation

If you are just starting your business, or have been thinking of expanding it, see your attorney and obtain his advice as to what kind of business entity yours should be. There are distinct advantages and disadvantages in each of the three entities—sole proprietorships, partnerships, and corporations.

If you decide to form a partnership, you should have your lawyer draft a written partnership agreement. Don't rely on a verbal understanding, even if you and your partners have been lifelong friends; memories fail, new circumstances occur, and contingencies develop. A written agreement avoids these pitfalls. Each partner knows his responsibility for debts of the partnership, his liability for unauthorized acts of another partner, and what happens if one partner quits or unexpectedly dies.

Your business may have become large enough and profitable enough that you are considering incorporating. Let your attorney advise you whether to do so. He will point out the advantages and disadvantages so

Ed. Note—David B. Cox is a member of the Indiana, Colorado, and American Bar Associations.

PRECISION TUNER SERVICE

P. O. BOX 272 1200 S. WALNUT ST.
BLOOMINGTON, IND. EDISON 99653

7.50

V or U
COMBO PLUS
9.95 POSTAGE

6 MONTH WARRANTY



All Types T.V. Tuners Cleaned, Repaired and Aligned to Factory Specifications. Same day in shop service on most Tuners. Price Includes Minor Parts, Major Parts at Cost Price. We use Original Parts if possible. State Make Model and Enclose all Parts and Tubes. Pack Well and Insure.

ALSO HAVE LARGE STOCK OF EXCHANGE TUNERS, WRITE FOR TYPES AND PRICES.

Circle 27 on literature card

SNOW COUNTRY!

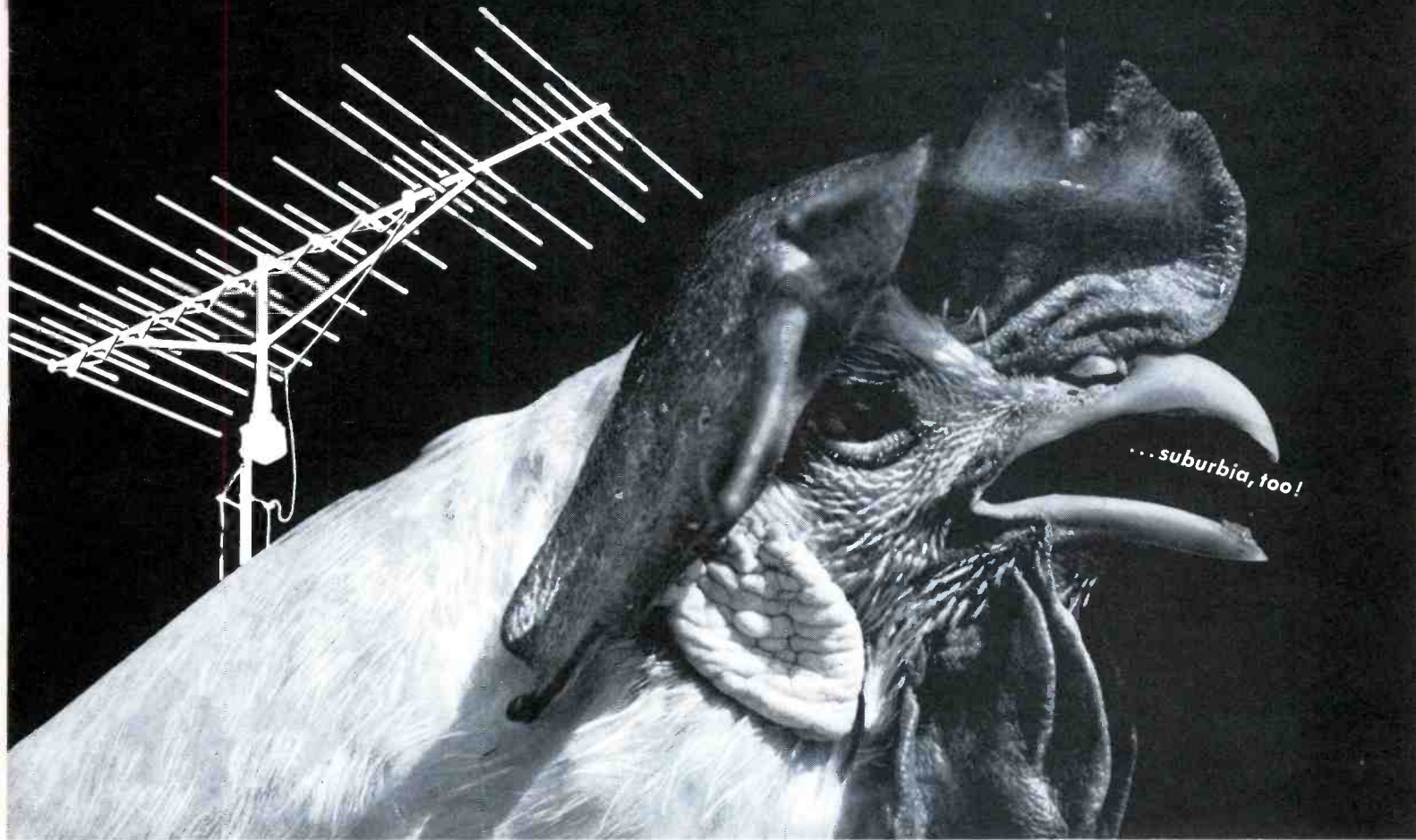

Clean it up...take it over... with **CHANNEL MASTER CROSSFIRES**

The world's most powerful TV/FM antennas. Way-out farm country is snow country. Real weak signal. Without the right antenna, there's a good chance televiewers are seeing "spots" on their TV screen. Near fringes and often suburbia are also weak signal. Smart watchers know what to do about this problem in all these areas. They get the right Crossfire.

Top snow removal team! The revolutionary Golden Crossfire alone works on the principle of Proportional Energy Absorption. Meaning? There are more driven elements working with greater efficiency on the Crossfire than in any other antenna. It actually delivers the highest antenna gain of all time. Cleanest, too. The unique transposed feed line cancels rear pick-up beautifully. Perfect for color. And exclusive E.P.C. "Golden Overcoat" protects against every type of corrosion.

8 rugged, handsome Crossfire models are available... 1 for every area and budget. Feature them and you've got the snow country, the near fringes, and the commuter belt... right where you want 'em! In your money belt. Shown above: 28-element Crossfire for deep-fringes. Model 3600.

**Now! Channel Master
Reduces Booster Prices
Up to \$10.**

World's most effective antenna amplifiers.

... Because no boosters anywhere give you more extra signal power when and where you need it. Plus lowest possible noise figure. Built-in lightning resistance. Complete line covers model for every purpose and area... including an all-in-one rotator-TV amplifier. Write for catalog.

WAS \$39.95

NOW! \$29⁹⁵

Transistorized Telstar TV/FM,
with 4-set coupler. Model 0023B.

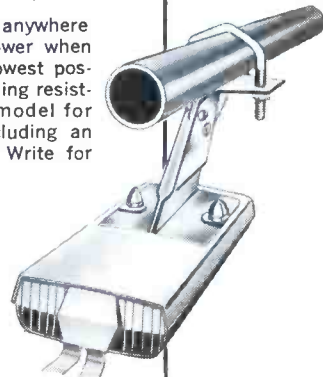

Model 3604, 11-element
Crossfire Suburban
... for high gain and
top directivity.

CHANNEL MASTER hands you the keys to the snow country

ELLENVILLE, N. Y.

Circle 48 on literature card

you can make an intelligent, informed decision.

He will tell you, among other things, that for tax purposes corporations are treated much differently than proprietorships and partnerships. In addition to special taxes in many states, corporations are in effect taxed twice on income. The corporation itself must pay taxes on its corporate income, and its officers and shareholders must pay taxes on their income in the form of salaries and dividends.

On the other hand, corporations

enjoy "limited liability." This means in general terms that the liabilities of a corporation are limited to its assets. Although the wide use of insurance has reduced this advantage in relatively recent times, by incorporating you can place your own personal assets (your home, your bank account, your car) out of the reach of creditors should the unexpected happen.

Tax Deductions and Depreciation

If you have been preparing your tax returns yourself, chances are

that you pay more taxes than you should. Consult your attorney or tax accountant, and show him the most recent returns you filed. He can advise you what expenses are deductible that you haven't been deducting, and what items you can depreciate that you haven't been depreciating. Then you can begin keeping proper records for next year's tax returns.

Generally, all the expenses in the operation of your business are deductible. Similarly, most of the equipment you use can be capitalized and depreciated over a period of years—your cars and trucks, your test and repair equipment.

Make certain you are paying no more in taxes than you need to.

"Sorry, I Can't Pay You"

You can minimize this problem, even if you can't avoid it altogether, if you know how the law can help you.

The steps you take to obtain the money owed you should be laid down for you by your attorney. Even the billing forms you use should have his examination and approval. Remember that while there are laws to protect you, there are also laws to protect the customer.

Explain to your attorney what your operating procedures and credit policies have been. He can show you how they might be improved.

Who Owns the Set?

This question, legally speaking, can be a difficult one to answer. If you have been selling sets to recover your unpaid repair bills, make sure that you know what the legal implications and consequences are.

It may be, for example, that the customer who owes you may not own the set you have repaired. Let your attorney explain the law in your state regarding "legal title," "ownership," and "liens." It will save you time and trouble, and probably money, too.

Even if you did obtain your lawyer's advice as recently as a year or two ago, see him again soon; at least call him on the phone. Half of the 50 states have recently enacted wide-sweeping changes affecting commerce and business within their borders, and your state may have been—or soon will be—one of them. Be informed and safe, not sorry.

easily service transistor radios...and make money!

B&K
Model 960



TRANSISTOR RADIO ANALYST

with Exclusive

Dyna-Trace Single-Point Probe and Built-in Metered Power Supply and VTVM.

Check all circuits - Pinpoint any trouble... in minutes

This is the way to profit from transistor radio servicing. *There's no hit or miss, no waste of time and work.* The B&K "960" Analyst gives you a complete transistor radio service shop in one easy-to-use instrument. It provides signal-generator, power supply, milliammeter, VTVM, battery tester, ohmmeter, and both in-circuit and out-of-circuit transistor tester—all in one. Also speeds servicing of tube-type radios. Brings you new customers, and new profit. Net \$9995

Unique Point-to-Point Signal Injection
Easily enables you to troubleshoot any stage of any transistor radio—fast.

Built-in Metered Power Supply
Makes it easy to operate radio under test. Provides from 1 to 12 volts in 1½ volt steps. Supplies bias taps.

Simplifies In-Circuit Transistor Test
Dyna-Trace single-point probe needs only the one contact to transistor under test. Gives fast, positive meter indication.

Built-in VTVM
Includes essential high-input-impedance vacuum-tube voltmeter for correct servicing.

Test All Transistors Out-of-Circuit
Meter has "good-bad" scale for both leakage and beta; and direct-reading beta scale. Also automatically—determines NPN or PNP. Meter is protected against accidental overload and burn-out.

See Your B&K
Distributor
or Write for
Catalog
AP21-R



B&K MANUFACTURING CO.

DIVISION OF DYNASCAN CORPORATION
1801 W. BELLE PLAINE AVE. • CHICAGO 13, ILL.
Canada: Atlas Radio Corp., 50 Wingold, Toronto 19, Ont.
Export: Empire Exporters, 253 Broadway, New York 7, U.S.A.

Circle 28 on literature card

MIRACLE WORKER

in professional TV service shops

PINPOINTS ANY TV TROUBLE FAST! UPS YOUR PROFIT!



FLYING SPOT SCANNER

transmits B&K patterns or your own pictures onto TV screen

It's like having your own TV station! You can inject your own TV signals at any time, at any point—and quickly solve tough dogs, intermittents, any TV trouble, as you watch the generated test pattern on the raster. Checks any and all circuits in any stage throughout the video, audio, r.f., i.f., sync and sweep sections of the TV set. No external scope or waveform interpretation is needed. And if you wish, you can transmit your own slide-pictures.

Makes Color TV Servicing Easy, Too.

Generates white dot, crosshatch and color bar patterns for convergence. Generates crystal-controlled keyed rainbow color display to check color sync circuits, check range of hue control, align color demodulators. Demonstrates correct color values.

Saves time and work for the "pro." Makes servicing easier and faster for the beginner technician. Most valuable instrument in TV servicing.

Net, \$329.95



DELUXE B&K

MODEL 1076 B&W and COLOR TELEVISION ANALYST

*with Crystal-Controlled Keyed Rainbow Color Display
and Highly-Stable Horizontal Oscillator Sync*

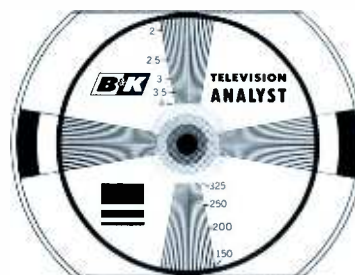

*Profit with a B&K Service Shop
See your B&K Distributor
or Write for Catalog AP21- R*

B & K MANUFACTURING CO.
DIVISION OF **DYNASCAN CORPORATION**
1801 W. BELLE PLAINE AVE. • CHICAGO, ILL. 60613
Canada: Atlas Radio Corp., 50 Wingold, Toronto 19, Ont.
Export: Empire Exporters, 123 Grand St., New York 13, U.S.A.

Circle 29 on literature card

new!

CAN MEAN EXTRA PROFITS FOR YOU!



\$6.95 DURA-GOLD FINISH **MODEL Y-7-G**

The Y-7-G is an excellent all channel UHF YAGI antenna. Sold in a "Big 6 Pack" carton that contains 7 antennas (one free) completely factory pre-assembled. Stacking kits are also available for the Y-7-G.

2 NEW GOLD UHF ANTENNAS

GUARANTEED FOR BLACK AND WHITE OR COLOR



Antennacraft's famous Model G-1483, UHF antenna operates on an extremely efficient, patented principle. It is available in several different models and can also be stacked for fringe area reception.



A dependable antenna that is completely factory pre-assembled. Saves time and "call backs."

DURA-GOLD FINISH

Pat. No. 2918672

\$9.95

See your distributor about these two big antenna values. Be ready for the UHF boom.



Circle 30 on literature card

What Kind of Insurance and How Much?

Whether you operate your business from your garage with a station wagon that also serves as your family car, or whether you have a large air-conditioned shop with 15 servicemen and a fleet of radio-equipped trucks, you need insurance, and many kinds of it, to cover all the operations of your business where losses or liabilities may occur.

One of the blessings of our modern economic society is low-cost insurance providing needed, necessary protection for the risks inherent in all kinds of business activity.

Let your attorney examine the insurance policies you now have. You may not have enough, they may be the wrong kinds, or they may contain limitations or restrictions that make them inadequate.

Fire and Casualty

In your business, the hazard of electrical fire is ever present. Your equipment is expensive to replace. So are the sets in the shop for repair. Flood, windstorms, and the like *do* happen, too.

And your employees are subject to temptations. While a part of theft losses can be recovered through insurance and bonding companies, know and obtain the protection you should have. (See "The High Cost of Employee Theft," by Dale Morey in the July, 1964, issue of PF REPORTER.)

Be certain your insurance coverage is broad enough to cover these losses. More importantly, make sure you know what risks should be covered, and what *causes* of loss are contained in your policies. Your attorney can tell you.

Liability

Automobile accidents, a hot soldering iron left on the carpet during a service call, an employee who steals in a customer's home during a service call, an account mistakenly turned over to a collection agency—these and other such situations can be covered by liability insurance.

Although costs are continuing to rise, liability insurance is still an inexpensive protection. Your attorney can assess the liability risks in all phases of your business and give you the assurance of the protection you should have.

Life, Accident, and Disability

There *is* a substitute for the income from your business in the event of illness or accident, or in the event of your death. Your attorney would be happy to go over your needs with you and help you weigh cost against risk and the protection these kinds of insurance provide.

If you have been considering a group participating plan for your employees, let him explain to you the tax consequences of the different plans available so that you can choose wisely.

Conclusion

These are some of the ways your attorney can help you make your business more efficient, saving you money through better business planning. There are others. He will be happy to enumerate them for you. ▲



Basic for the professional service shop

multiple socket
SPEED plus
*Gm** **ACCURACY**
 CREATES
MORE
PROFIT

Sell more tubes per customer | Save call-backs | Satisfy more customers

**B & K MODEL 700 DYNA-QUIK
 DYNAMIC MUTUAL CONDUCTANCE TUBE TESTER
 with obsolescence protection**

**Makes test under actual set-operating conditions*

Everyday use by thousands of professional servicemen has proved its speed . . . its accuracy . . . its efficiency.

You can quickly check all the tubes in the set, detect hard-to-locate weak tubes that need replacement . . . and sell more tubes. Provides multiple-socket section to quick-check most of the TV and radio tube types the true dynamic mutual conductance way*—plus simplified switch section to check new tube types in Dyna-Quik emission circuit. Also includes provision for future new sockets.

Makes test under set-operating conditions. Checks each section of multi-section tubes separately. Checks for all shorts, grid emission, leakage, and gas. Makes quick "life" test. Exclusive adjustable grid emission test provides sensitivity to over 100 megohms. Insures your reputation. *Quickly pays for itself.*

Net, \$179⁹⁵

- TESTS All TV and Radio Tubes, Old and New
- TESTS Nuvistors and Novars
- TESTS 10-Pin Tubes
- TESTS 12-Pin Compactrons
- TESTS European Hi-Fi Tubes, Voltage Regulators, and Most Industrial Types

See your B & K Distributor or Write for Catalog AP 21-R

NEW TUBE INFORMATION SERVICE
 Keep your tube tester up-to-date. Subscribe now to tube information service, available every 3 months.



B & K MANUFACTURING CO.
 DIVISION OF **DYNASCAN CORPORATION**
1801 W. BELLE PLAINE AVE. • CHICAGO, ILL. 60613
 Canada: Atlas Radio Corp., 50 Wingold, Toronto 19, Ont.
 Export: Empire Exporters, 123 Grand St., New York 13, U.S.A.



New stick-on wiring system eliminates mechanical fasteners

New "Scotchflex" Brand Flat Cable System lets you install low-voltage hookups anywhere in seconds. Applies like tape to tile, concrete, brick, paneling, any surface. No stripping necessary . . . sharp "U" shaped prongs in the connectors pierce the insulation and establish firm contact with each of the round wire conductors. "Scotchflex" Cable saves installation time and provides better looking wiring on intercoms, call systems, hi-fi, and other low voltage systems. For details, write: 3M Co., St. Paul, Minn. 55119.

3M Electrical Products Division
 MINNESOTA MINING & MANUFACTURING CO.
 "SCOTCHFLEX" IS A REGISTERED TRADEMARK OF 3M CO.
 Circle 32 on literature card

where space is small
 and reliability
 essential...



SWITCHCRAFT BUTTON SWITCHES

Unusually small completely metal enclosed push-button switches are not much bigger than a 1/2" threaded bushing—yet they feature a wide variety of circuits coupled with smooth, non-sticking action. Non-locking, red or black buttons. Behind panel mounting (left), or front-of-panel mounting (right). Which one is right for you?

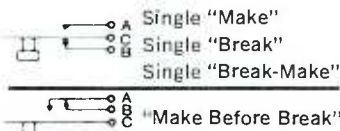

Write for Catalog S-301

SWITCHCRAFT®

5573 Elston Ave., Chicago, Illinois 60630
 Canada: Atlas Radio Corp., Ltd., 50 Wingold Ave., Toronto, Ontario

Circle 33 on literature card

Troubleshooter

(Continued from page 21)

a distinct difference between the meter indications across the primary winding and those across the secondary. Assign arbitrary numbers to all the terminals. Then measure the resistances between pairs of terminals, and write down the readings you obtain. The primary resistance is almost 4 ohms. The secondary resistance is quite low; however, the resistance of the entire secondary winding will be slightly greater than the combined resistance of the tertiary winding and either half of the secondary. Watch the meter very closely; the difference will be very slight, but it will be detectable.

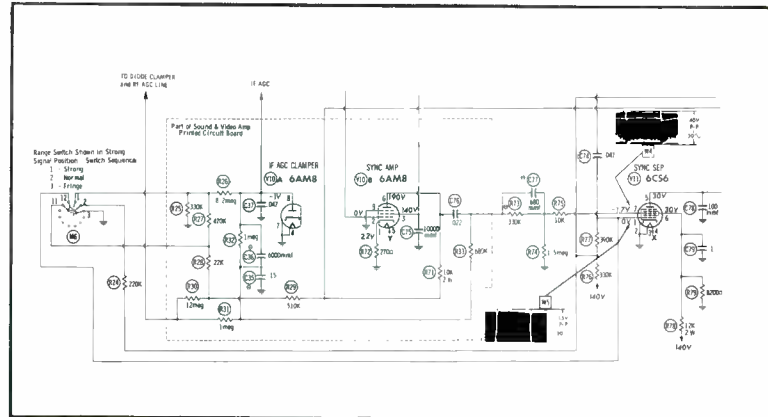

Jittery Picture

I have in my shop a Philco TV Model 24D6126, chassis 444, that has AGC flutter. I have checked all components in the IF and AGC circuits and can't find any that are defective. The only thing that corrects the problem is changing C35 (.15 mfd) to a .25 mfd unit.

I would certainly appreciate any information you might have that would help me.

J. KELLY JORDAN

Roxboro, N.C.

Your description of AGC trouble implies a defect in the tuner branch of the AGC system. AGC bias for the RF amplifier is largely developed by grid-leak action at pin 7 of the 6CS6 sync separator, and C35 is a factor in the grid-leak circuit. Thus, you may be covering up sync-separator trouble by increasing the value of C35.

Other possible sources of trouble are erratic operation of RF-AGC delay resistor R30, RF-AGC clamper V8B (diode section of 6T8), or the range switch. This switch could be upsetting AGC action by causing improper operation of the circuit related to pin 1 of the 6CS6; you might try grounding this pin and see if the flutter is remedied.

There might also be a fault in the RF amplifier stage—such as a gassy tube—that tends to bleed off the AGC bias voltage. Such a trouble could be recognized by the presence of a voltage drop across either of the RF amplifier grid resistors.

Short-Lived Rectifier

I have a Matsushita Model 748 table radio which keeps burning out the 75-ma selenium rectifier and the 50-ohm surge-limiting resistor. The only information I have on this radio is a schematic glued on the bottom of the cabinet. The 75-ma rating for the selenium was derived by adding the current in the tube complement. All tubes have been replaced and the filter capacitor substituted. The set will play for about two weeks, then out go the resistor and the rectifier.

E. R. YOUNG

Bridgeport, Conn.

According to PHOTOFAC T Folder 630-10, the radio should be drawing 68 ma; this is very close to the rectifier rating. Perhaps the 75-ma selenium is not sufficient; in many similar sets, 100-ma units are used.

On the other hand, there is the possibility that an intermittent short is ruining the rectifier and burning up the resistor. The most logical suspects for a short of this nature would be

Dollar-for-Dollar...

THE MOST POWERFUL UHF COLOR TV ANTENNA TODAY!

TRIO®

COLOR-BRITE

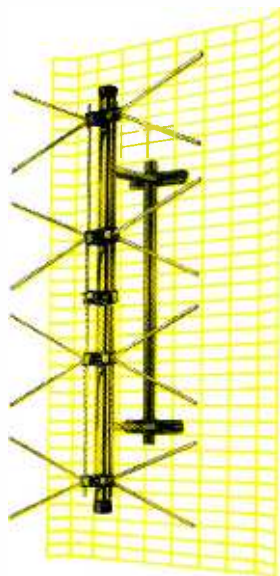

Model CB-4 - TRIO COLOR-BRITE ALL-CHANNEL UHF TV ANTENNA MORE UHF COLOR POWER at 1/2 The Cost

HERE ARE FACTS PROVED BY INDEPENDENT ENGINEERING RESEARCH:

- A. Four "Bow Ties" Stacked On A Flat Screen Provide Gain Of 10 db. Two Such Units Offer 13 db Gain!
- B. Single "Bow Tie" Corner Reflector Averages 6 db Gain. Double "Bow Tie" Corner Reflector Will Show 9 db Gain.
- C. 16 Element Yagis, Stacked, Offer Just 9 db Gain. The Narrow Bandwidth Characteristic Is Undesirable For Color TV Reception.

NOW...COMPARE COSTS!*

CORNER REFLECTOR (6 db gain).....	\$7.50 to \$10.00
STACKED CORNER REFLECTOR (9 db gain)....	\$17.00 to \$25.00
16 ELEMENT YAGIS, STACKED, (9 db gain)....	\$22.95 to \$25.00
TRIO COLOR-BRITE (10 db gain!)	Just \$11.95

*Based on average advertised list prices for antennas of comparable construction.

WITH THESE EXCLUSIVE TRIO FEATURES:

- no-strip Lead-in Connector** — Stops Broken Leads at the Antenna!
- Insta-Lok Element Clamps** — Eliminate Roof-top Assembly!
- TGP (TRIO GOLDITE PROCESS)** — Unique TRIO Golden Finish Replaces Anodizing to Protect The Entire Antenna From Corrosion!



TRIO® MANUFACTURING COMPANY,

Griggsville, Illinois

Circle 34 on literature card

RCA indicates that in modern receivers the "X" axis is 280.9° from reference zero, and the "Z" axis is placed at 343°. The two are separated by 62.1°. However, you'll probably find these figures vary, depending on the exact circuit used in a particular chassis. Actually, the "X" and "Z" demodulation is -(R-Y) and -(B-Y) respectively, modified in phase to allow for the phase-shift error in the common-cathode circuit that generates the G-Y signal. The circuits are designed to correct the phase, producing the correct R-Y, B-Y, and G-Y signals—90°, 180°, and 299.9°—at the grids of the CRT.

Circuit Coolant Was Valuable

I ran into a problem with a Westinghouse Chassis V-2346 which may be of interest to some of your readers. The complaint was severe tearing and excessive snow after the set was on for about one minute. Replacing the 5BT8 (AGC keyer and horizontal AFC) cured the pulling, but the snow was still present. Monitoring the RF AGC voltage showed that it had considerably increased, although the IF AGC voltage was unaffected.

Spraying the components around the base of the RF amplifier with a circuit cooler would cause the snow to disappear, but it would gradually come back into the picture as the components again warmed up. This certainly looked like tuner trouble, but checking all of the components in the tuner revealed nothing.

Going back to the TV chassis, I substituted all of the AGC components, but the snow was still present. Thinking for sure that this was a thermal problem, I sprayed the printed circuit board in the vicinity of the AGC components. About half the time this would cure the trouble.

Being thoroughly confused and grasping for straws, I luckily checked the filament voltage of the 5BT8 and it read 6 volts instead of the normal 4.7 volts. Further checking revealed the filament dropping resistor to be 20 ohms rather than the normal 49 ohms; replacing this resistor cured the trouble.

The only explanation I have for the change in operation caused by the circuit cooler is that it evidently would ooze between the tube's filament pins and the socket connections of the RF amplifier, video amplifier, and the discriminator (these tubes are located near the area which I have sprayed) and cause the series filament resistance to increase, thus decreasing the filament current drawn by the entire string. This apparently would allow the 5BT8 to operate normally for awhile.

GARY G. BACKEM

Dover-Foxcroft, Maine

Thanks, Gary, for passing along this information. It would seem that your analysis of why the circuit cooler cleared the trouble is feasible. Incidentally, a trouble such as this could only occur in a set using series filaments where the operation of the entire string can be changed by any of the individual tubes. ▲

*makes other
tube testers*
OBSOLETE

HICKOK

Model 800A



Honest tests on today's tubes demand 14-position selector switches. Compactrons, novars, 5- and 7-pin nuvistors, 10-pin headers, transistors and diodes, along with the older type tubes, can all be checked out — completely and correctly — including high sensitivity leakage and gas tests, with the truly modern Hickok Model 800A. This quality tube tester includes these other recognized Hickok-quality features: Hickok-developed G_m test on all tubes • Sensitive, instantaneous inter-element leakage and shorts test • Filament continuity test — and the original HICKOK roll chart subscription service keeps it up-to-date!

Best of all, Hickok's low price for this portable do-it-all tester is only \$199.95. Available from stock at your franchised Hickok distributor. Let him give you a demonstration.

**Ask to see
these other
Hickok
instruments, too**



677
Wide Band Oscilloscope

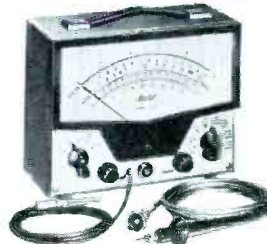

470A
Uni-scale VTVM



661
Color Bar Generator

THE HICKOK ELECTRICAL INSTRUMENT CO. • 10563 Dupont Avenue • Cleveland, Ohio 44108
Circle 35 on literature card

CONTACT CLEANER



AND LUBRICANT

NEW FASTER ACTING FORMULA! NON-FLAMMABLE

Spra-Kleen! The easy way to remove noise caused by dust, dirt and corrosion. Cleans electrical contacts like new! Controls, relays, switches are cleaned and lubricated quickly, easily, in one simple operation. Spra-Kleen may be applied effectively up-side-down or right-side-up without removing the chassis. Merely apply, work the controls, Spra-Kleen does the rest. A must for every serviceman!

Part No.	Net
8666-16 16 oz. spray can	1.95
8666 6 oz. spray can	.99
8666-3 3 oz. pocketsize spray can	.78



NEW CATALOG
JUST OFF THE PRESS
GC CATALOG FR-65
WRITE TODAY!



GC ELECTRONICS CO.

400 So. Wyman St., Rockford, Ill., U.S.A.

Circle 36 on literature card



Notes on Test Equipment

analysis of test instruments... operation... applications

Resistor-Capacitor Checker



Fig. 1. Unit measures resistors and capacitors, acts as voltmeter and milliammeter.

Cornell-Dubilier's new BF-71A Analyzer (Fig. 1) is designed for checking, without damage, capacitors with voltage ratings as low as one volt. Maximum bridge-terminal voltage while checking capacitance is only .5 volt AC; this compares to 25 to 50 volts AC on many capacitance bridges.

In addition to capacitance checks, the BF-71A can be used to make resistance checks in the range from 2.5 ohms to 25 megohms, check capacitor leakage with applied voltage up to 500 volts, make insulation-resistance readings to above 500 megohms, and determine power factor of electrolytic capacitors from 0 to 50%. To prevent shock, a switch coupled to the voltage control discharges the

tested capacitor through a 10K resistor when in the OFF position.

The front-panel meter has seven switch-selected ranges: 5, 50, and 500 volts; 100 ma, 10 ma, .2 ma, and .1 ma. The switch has an OFF position between the 500-volt and 100-ma ranges. The meter is used to read the voltage of the internal power supply when making leakage or insulation-resistance checks, to read leakage current through a capacitor under test, and to make external voltage or current readings. Loading on DC voltage scales is 10,000 ohms per volt.

Fig. 2 is a block diagram of the BF-71A. Leakage checks are made by adjusting the internal power supply to the appropriate voltage and then switching to one of the milliammeter ranges. For capacitors of less than about 1 mfd, there should be almost no leakage at all, especially if the capacitor is to be used in a high-impedance circuit. More leakage can be tolerated if the circuit impedance is low. However, any noticeable leakage in a smaller capacitor is usually an indication that the component is nearing the end of its useful life and probably should be replaced.

Some leakage in electrolytic capacitors is normal. Dry electrolytics that have not been in use for some time may require "aging" in order to bring them up to top efficiency; this can be done by slowly applying voltage from the BF-71A until the leakage current drops to normal. Table 1 shows the approximate values of leakage that can be tolerated in electrolytics.

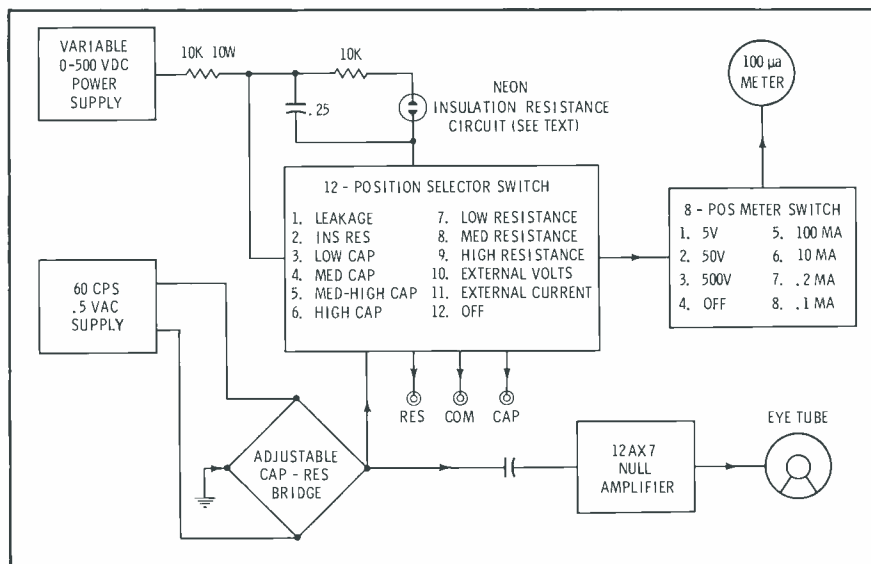

Fig. 2. Functional block diagram of the BF-71A shows available functions of the instrument.

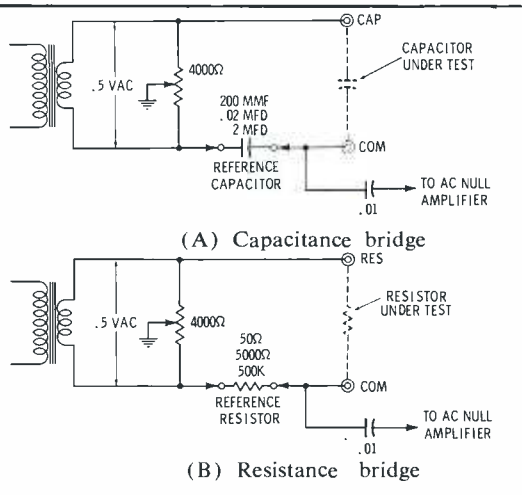

Fig. 3. Bridge circuits used in Model BF-71A.

Measurements of insulation resistance are vital if you are selecting capacitors for a high-impedance circuit. This portion of the instrument uses a neon-lamp circuit, but the lamp is not used as an indicator. It is placed in an RC circuit that relies on the insulation resistance of the tested capacitor to determine the firing rate of the lamp. When the lamp does fire, the voltage change is applied to the AC-eye amplifier, and this causes the eye tube to blink. Insulation resistance is determined by counting the number of blinks per second. A rate slower than one blink every two seconds indicates a leakage resistance of over 100 megohms; this is an acceptable value for most capacitors.

Fig. 3 is a simplified schematic of the low-voltage bridge circuit. Fig. 3A shows the circuit arrangement for capacitors, Fig. 3B for resistors. The 4K-ohm variable resistor is turned until a null is reached (eye opens widest), and then the size of the capacitor or resistor is read directly from the dial. The low voltage used on the bridge requires that the output signal be amplified before application to the tuning eye. This is done by a resistance-coupled, dual-triode 12AX7 circuit.

Power factor of electrolytic capacitors is measured by inserting an adjustable 750-ohm resistor in series with the reference capacitor. This resistor is adjusted in conjunction with the main dial for the best null. Electrically, the power factor of a capacitor can be considered to depend on the value of an equivalent resistance connected in series with the capacitor. Therefore, this bridge arrangement makes it possible to check the apparent power factor of a capacitor under test. Most electrolytics should have power factors less than 30%.

Table 1. Permissible Electrolytic Leakage

DC Working Volts	DC Leakage in Milli-amperes
25 to 100	.01 ma per mfd plus .5 ma
150 to 300	.02 ma per mfd plus .5 ma
400 to 500	.03 ma per mfd plus .5 ma

NOBODY CAN CHANGE THE WEATHER BUT OXFORD HAS CHANGED THE PUBLIC ADDRESS SPEAKER MARKET . . . with the introduction of the All New "Outdoor Specialist Series"

Oxford OP-8 and OP-6 Models represent the first major change in weather-proof paging and talk-back speakers in more than ten years. Not just a rehash of other speakers now on the market, but entirely new units incorporating new features, new materials and new design concepts throughout.

NEW BELL DESIGN: Not a compromise, but a true "exponential flair" for maximum efficiency. Molded from *Implex*, a space age material that is practically indestructible and impervious to weather extremes. The 1/4-inch bell sections guarantee vibrationless, resonance-free reproduction.

NEW COUPLING DESIGN: Integral close coupled inner horn and diaphragm allows maximum energy transfer with minimum distortion. Heavy-duty slug magnets are used, not "gimmicked" or less efficient ring magnets.

NEW TRANSFORMER OPTION: The OP-8 and OP-6 are available from stock with 25 or 70 volt transformers built in, or without any transformer. For those who wish to install their own transformers, a standard mounting bracket is provided.



NEW LEVER-LOCK* MOUNTING BRACKET: An Oxford exclusive that swivels 360° in the horizontal plane and 180° in the verticle with a flip of a single lever. The horn may be adjusted to any position without tools or disassembling . . . no thumbscrews to drop either! Stays locked until you unlock it.

Oxford's OP Series is the first in a program that will bring many startling new speakers for public address applications . . . speakers that will meet and exceed the requirements of the dynamic sound industry.

*patent pending

For Complete Information and Specifications,
Write for Product Information Bulletin No. C-103

**OXFORD
TRANSDUCER
CORPORATION**



A Subsidiary of Oxford Electric Corporation

2331 North Washtenaw Avenue • Chicago 47, Illinois

Circle 37 on literature card

As with most bridges of this kind, the common terminal is at neither ground nor negative polarity. It is connected to the positive terminal during leakage and insulation-resistance checks and to one junction of the bridge during resistance and capacitance measurements. Because of the extreme sensitivity of the unit, it is recommended that the chassis be grounded. A three-prong, polarized AC plug is used so that the chassis will be automatically grounded where this kind of receptacle is available. (An adapter plug must be used when such a receptacle is not available.) We tried the instrument with and without a ground-wire connection and found little difference in the readings. Of course, grounding is

always an intelligent safety measure.

We tested a number of low- and high-voltage capacitors. The BF-71A gave us quick and accurate readings in all cases. We checked capacitors "in circuit" by clipping one lead and disconnecting the power from the circuit being tested; in every case an erratic reading could be stabilized by reversing the test leads. It is preferable to disconnect the "hot" side of the capacitor (if it can be easily determined) when making a test of this type.

Resistance readings were also accurate, and the external meter readings were within 3% of full scale on all ranges.

For further information, circle 64 on literature card

High-Impedance VTVM

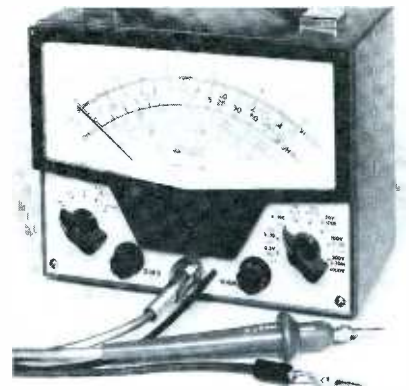

Fig. 4. New VTVM features high AC and DC impedances to reduce loading effect.

Just five meter scales are used on this new Hickok Model 470A VTVM (Fig. 4). Two scales—0-5 and 0-1.5—cover all DC and rms AC readings up to 1500 volts in eight ranges. The OHMS scale is between the DC-RMS scales and the two P-P scales. Eight resistance ranges provide center-scale readings from 10 ohms to 100 megohms. The P-P AC scales are in red and are marked 0-40 and 0-140; they allow readings up to 4000 volts. Frequency response for the AC ranges is approximately flat to 3 mc.

A detachable probe with a movable head switches from DC to AC-OHMS. In the AC-OHMS position, the connection from the probe tip is straight through to the VTVM; in the DC position, a 2.7-megohm isolating resistor is connected in series with the probe tip. This resistor decouples the cable capacitance to minimize disturbance of the tested circuit.

An interesting feature of the 470A is its high input impedance; instead of the usual 11 megohms, it is 17.7 megohms on DC and 15 megohms shunted with 150 mmf on AC. The resulting reduction of loading on high-impedance circuits permits more accurate readings.

Fig. 5 is a block diagram of the 470A. The familiar 12AU7 bridge circuit is used. However, on the AC ranges (Fig. 6) all signals are amplified before they are rectified. This is especially important when dealing with low-level signals that could be masked by the contact potential of the rectifiers.

The ohmmeter circuit (Fig. 7) is much

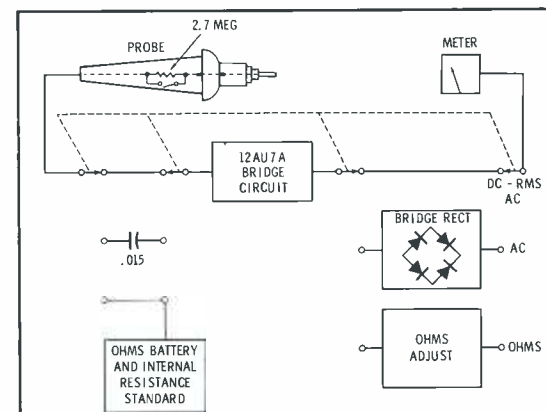
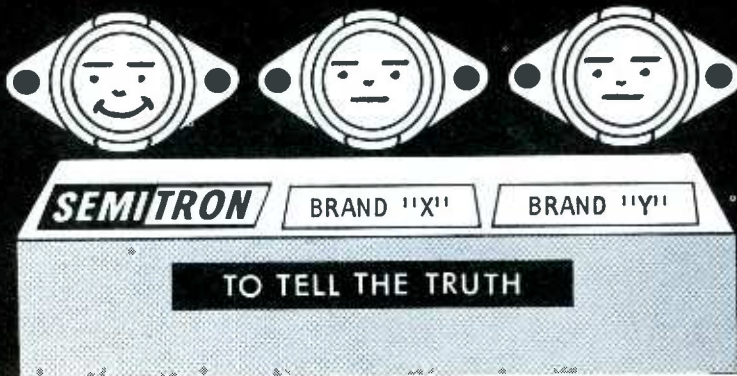

Fig. 5. Block diagram shows how function switching is accomplished in Hickok 470A.

WILL THE REAL REPLACEMENT TRANSISTOR PLEASE STAND UP?



Semitron transistors "stand up" because they are service-engineered to the specifications and safety ratings of the transistors they replace.

To "tell the truth," Semitron is the only professional line for the Service Technician. For the businessman who works professionally and can't afford to experiment, only Semitron guarantees instant replacement.

- 40 Semitron transistors and diodes replace over 3000 semiconductors, "entertainment" or other. This includes any germanium transistor in any type of equipment (auto ignition, portable TV, hi-fi, CB, power supply) from any part of the world (U. S., Europe, Japan).
- Performance-proven, guaranteed, American-made line. No doubtful substitutions. Only first-quality semiconductors, service-engineered to the ratings of the originals they replace.
- Guaranteed instant availability. Your next replacement is now "on-the-shelf" of 1200 local distributors coast to coast — as near to you as your phone. All you need is to check the type number on the Semitron 1964 Transistor & Diode Replacement & Interchangeability Guide. Get a free Pocket Edition from your distributor, or send us 25¢ with your name and address.
- Rely on Semitron — the 5-year pioneer in semiconductor replacement. You'll see for yourself why 60,000 professional service technicians acknowledge Semitron as the only complete program for the professional.

SEMITRON

Semitronics Corp.
265 Canal Street
New York, N. Y. 10013



Please send me the 1964 Semitron Transistor & Diode Replacement and Interchangeability Guide, (Pocket Edition). I enclose 25¢ for postage and handling.

Name.....
Address.....
City or Town.....State.....Zip Code.....

the same as that used previously by Hickok and other manufacturers. An internal resistance standard, selected by the range switch, is connected in series with the resistance to be measured. A 1.5-volt cell supplies voltage to this network. The meter is calibrated in ohms but uses its voltmeter circuit to measure the voltage drop across the tested resistor.

A three-wire AC cord and plug eliminate any shock hazard. The ground pin of the plug is internally connected through the cord to the chassis and case. An adapter is required when the 470A is operated from a regular two-wire receptacle,

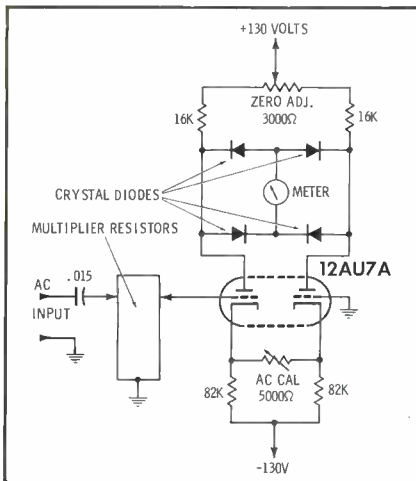

Fig. 6. Simplified schematic diagram of bridge and post-bridge rectifier for AC tests.

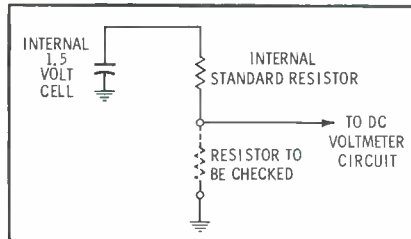

Fig. 7. Simplified diagram of ohms circuit.

unless the ground pin is removed from the plug.

The entire unit measures 6" x 7 $\frac{3}{4}$ " x 4", not including the fold-flat carrying handle.

We used the meter to service transistor radios, TV sets, PA systems, two-way radios, etc. The stability and accuracy were exceptionally good even on the low AC ranges; we had no difficulty reading .05 volt p-p, and the DC, AC, and ohms ranges all maintained accuracies within 3% of full scale. Probe isolation was unusually good—we were able to read the oscillator grid voltage in an FM receiver with only slight detuning.

The businesslike arrangement of the scales on the 7" x 3" meter made interpretation of readings easy. The meter pointer is close to the scales to minimize parallax errors when reading from an angle. All the scales are boldly printed on a white background to give excellent readability.

For further information, circle 65 on literature card

UHF From VHF

The TV service technician can expect to encounter an increasing number of all-channel receivers and converter-equipped sets. However, a UHF station signal may not always be available when the technician needs it. The simplest solution to this servicing problem is to take an available VHF signal and shift it to the desired UHF channel. Standard Kollsman's new VHF-to-UHF translator (Fig. 8) is designed to do this job.

The operation of this unit is quite simple. Incoming signals on VHF channels are processed in the usual way by a conventional VHF tuner (Fig. 9), and the IF output of this tuner is applied through a filter network to the IF termi-



Fig. 8. Translator provides signals on UHF channels from the signals of VHF stations.

The only solid state TENNA-ROTOR® ALLIANCE C-225

Distributors and dealers are enjoying amazing sales results with the solid state C-225 Tenna-Rotor®.

Its patented phase-sensing bridge circuit is patterned after scientific test equipment to afford the TV and FM stereo owner life-like 'studio' reception.

Alliance Tenna-Rotors are built to handle today's larger new antennas. They will support, hold and turn any antenna that can be lifted and placed on them. Careful workmanship and precision components provide longer life and dependable, trouble-free operation.

Check the C-225 "plus" features

- accurate repeatability
- constant synchronization
- silent operation
- greater sensitivity

Quality features you expect from the world's leading manufacturer of antenna rotating devices. Sell the line you sell with confidence — Alliance Tenna-Rotor®!

Order the C-225 and other quality Alliance models today.

Circle 38 on literature card



"TV's better color getter"

For Complete Details write...



The **ALLIANCE**

Manufacturing Co., Inc.
Alliance, Ohio

(Subsidiary of Consolidated
Electronics Industries Corp.)



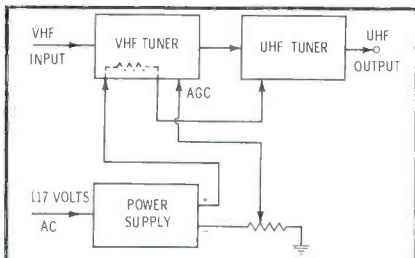

Fig. 9. Functional block diagram of translator shows how two tuners shift frequency.

nals of a UHF tuner. Mixing the IF signal and the local-oscillator signal in the second tuner results in the generation of a UHF signal, which appears at the antenna terminals of the UHF tuner; this signal is the output of the translator. (Most UHF tuners can be operated in this "reverse" fashion because of the relative simplicity of the mixer section.) Any VHF channel can be translated to any UHF channel.

A single transformer-operated power supply serves both tuners. A 12K-ohm, 1-watt dropping resistor reduces the supply voltage to the 20 volts needed by the transistor UHF tuner. A potentiometer provides a variable voltage that is applied to the AGC input of the VHF tuner. The potentiometer thus serves as a gain control for the unit and makes possible a wide range of input levels to the receiver.

We tried the unit in an area where one weak and three strong VHF signals were available. We were able to get usable pictures (on UHF) for all stations, even using a rabbit-ears antenna. The pictures obtained from the strong, local stations were clear and sharp. The signal from the more distant station was weakened somewhat in the translation process but was still discernible. We noticed some spurious signals while tuning across the band, but the desired signal was strong enough to be readily identified.

The translator has three controls, a VHF selector, a UHF selector, and the gain control. The unit operates from 117 volts AC, is fused, and has an on-off switch and a pilot light. Screw terminals are provided for the input and output connections. ▲

For further information, circle 66 on literature card

now in our lab . . .

The latest test instruments being analyzed for future "Notes" columns:

RCA Model WV-76A AC VTVM

EICO Model 667 Tube Tester
SENCORE Model PS127 Oscilloscope

Mercury Model 900 Color TV Analyzer

Heath Model IM-13 VTVM

styled to blend with any tv set

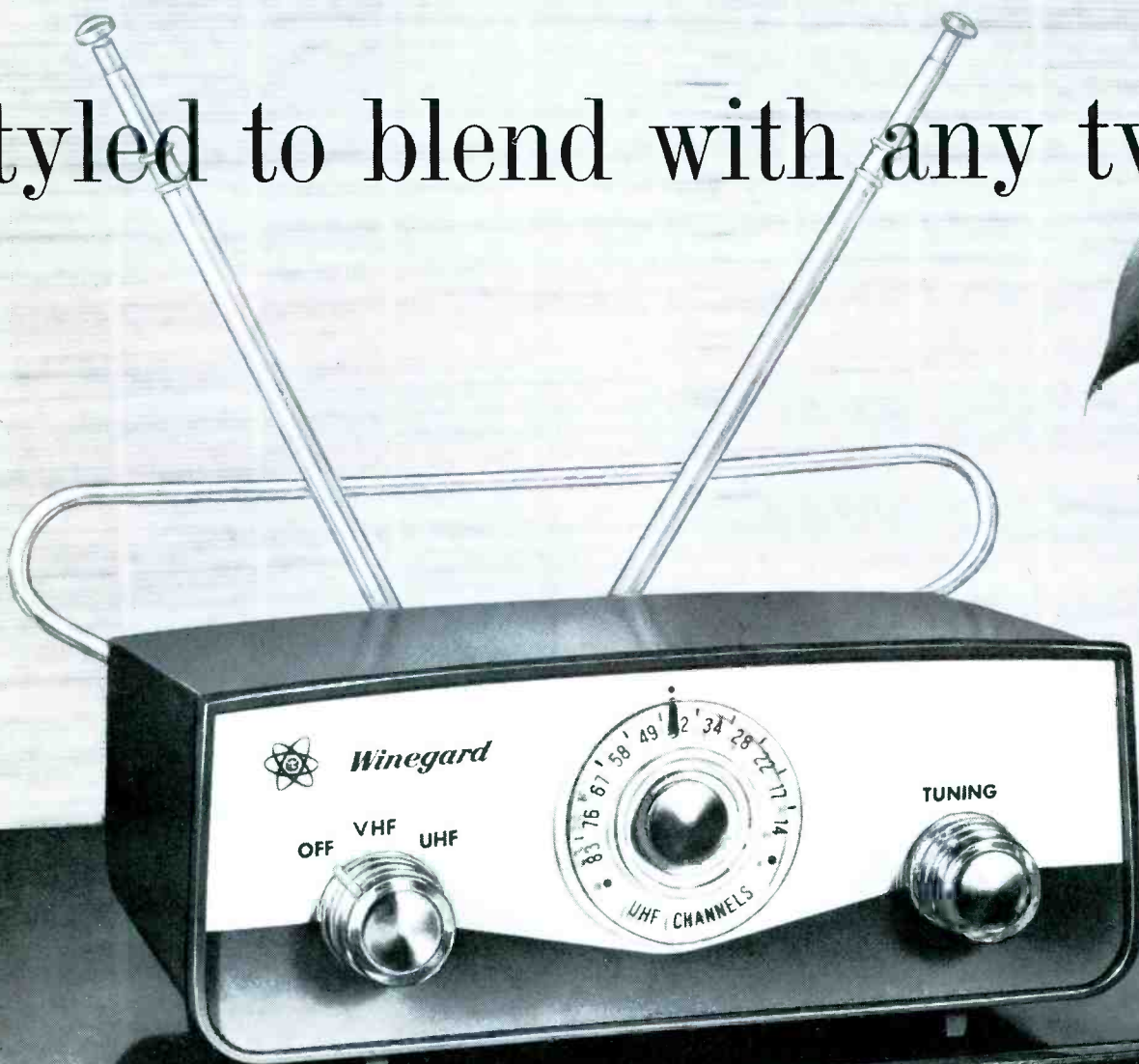

Shrunken Raster

(Continued from page 33)

bulletins listing changes in parts values, circuit wiring, or both, to acquire sufficient raster size. In some stubborn cases, the manufacturer's suggestions may not overcome the trouble.

In a typical case, the volume control and switch, and an IF tube, were replaced in a Muntz T37L05. When the set was run for a time, the raster alternately appeared and disappeared. Tapping the 25DN6 proved that tube to be defective. Eleven different tubes, made by several manufacturers, were tried, but none gave sufficient sweep. Making the changes recommended in production-change bulletins also failed to correct the condition. A solution

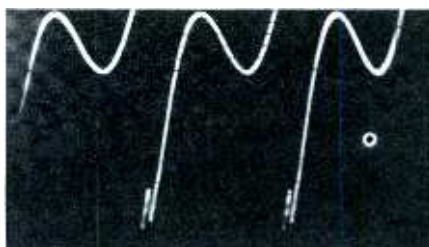

(A) With defect

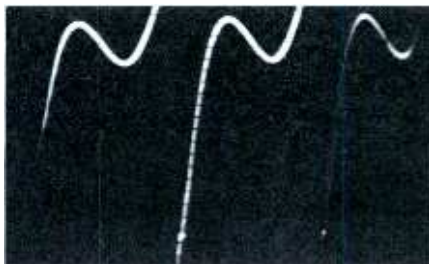

(B) Without defect

Fig. 8. Waveforms at output of horizontal oscillator when sawtooth capacitor is defective.

was finally achieved by adding the resistor shown as R1 in Fig. 9. Apparently the factory-installed tube was one with characteristics such that it produced abnormally high gain. Actually, the addition of the resistor is better than hunting a substitute tube with higher-than-average gain; the next time the 25DN6 needs replacing, any normal new one should provide sufficient sweep.

Time-Lapse Shrinkage

Rasters sometimes shrink after a time lapse. In these cases a full-size raster appears when the receiver is first turned on; but, as the set continues to operate, the raster shrinks. Defective selenium rectifiers are one cause of this type of shrinkage and are easily located with voltmeter

Winegard uhf converters

6 HIGH PERFORMANCE UHF CONVERTERS REGULAR AND AMPLIFIED WITH BUILT-IN UHF AND VHF ANTENNAS

Now Winegard engineering, styling and merchandising have combined to bring you the finest UHF converters on the market. Models UC-100A (one tube) and UC-200A (two tube) have built-in UHF and VHF antennas to receive all channels 2-83. Models UC-310 and UC-410 have a transistorized pre-amplifier that improves signal-to-noise ratio up to 12 DB. All models are furniture styled in handsome polystyrene cases in rich autumn brown trimmed with brushed gold. *Look at these features:*

- 3 gang capacitive tuning element eliminates sliding contacts in main circuit.
- Oscillator has new 6DZ4 tube... no drift, no microphonics... has better performance and longer life.

- Safe, cool chassis—isolated power supply with silicon rectifier.
- Only cabinet that is *completely* enclosed.
- Lowest noise 1N82A mixer diode • Exceed FCC radiation requirements • Exact 300 ohm impedance match
- Work perfectly with color or black and white

Models UC-200, UC-200A, UC-310 and UC-410 UHF converters have AC receptacle for TV set with "on-off" control that turns on TV set and also switches to UHF or VHF. All models have a built-in dial light.

Ask your distributor or write today for specification sheets on Winegard UHF converters.



Model UC-100 UHF converter (one tube) \$29.95

Model UC-100A UHF converter (one tube) with built-in UHF and VHF antennas \$34.95

Model UC-200 UHF converter (two tube) with nuvistor IF amplifier stage \$42.50

Model UC-200A UHF converter (two tube) with nuvistor IF amplifier stage and built-in UHF and VHF—antennas \$47.50



Model UC-310 high gain converter with built-in transistor RF amplifier and nuvistor IF amplifier—improves signal-to-noise ratio up to 12 DB \$64.95

Model UC-410 high gain converter with built-in power supply, nuvistor IF amplifier and remote transistor RF pre-amp for mounting on antenna or anywhere along transmission line. For very weak signal areas, this is the most sensitive UHF converter made. \$69.95.

World's most complete line of TV-FM reception equipment



Winegard Co.

3009B KIRKWOOD BOULEVARD, BURLINGTON, IOWA

readings. Unfortunately, this trouble can have other causes that are not so easy to find.

In more difficult cases of time-lapse shrinkage, the cause of trouble can often be pinpointed by checking voltages on the horizontal output and damper tubes and by observing the drive signal with a scope. If such monitoring fails to indicate a defect, the yoke and flyback transformer (and their associated components) come under suspicion. A good servicing procedure is to disconnect components on the yoke or flyback

transformer that are not absolutely necessary for the development of sweep and high voltage (for example, those parts included primarily for control of width or improvement of linearity).

In one Sears Meteor set, the width began to shrink after about 20 minutes of operation; after about 40 minutes it became very severe. Disconnecting the width coil, which shunted a portion of the flyback windings, allowed the set to run for hours without changing raster size, so a replacement width coil was in-

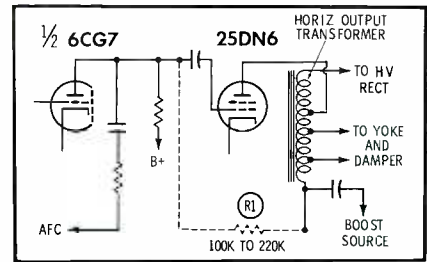

Fig. 9. Modification in horizontal section produces increased width, brightness in raster.

stalled. If the raster had not been excessively overscanned with the width coil disconnected, the coil could have been omitted entirely.

Time-lapse shrinkage in a Philco was cured when it was noted that the shrinking did not occur when a resistor on the yoke socket was removed from the circuit. This resistor was connected from the center of the two yoke windings to a tap on the flyback transformer. The resistor primarily affects horizontal linearity, so it was necessary to replace this defective unit.

An unusual case involved a Motorola TS-534. The selenium rectifiers in this set gave off the odor of sulfur-dioxide gas, so replacements were installed. The now overscanned raster was adjusted for correct size, and the set was moved to the cooking rack. When the set was checked about an hour later, it had acquired the condition shown in Fig. 10. This was easily corrected by turning the width adjustment in a clockwise direction.

The foldover drive line in Fig. 11 differentiates this case from any of these previously presented. The set, a Motorola TS-101, presented shrinkage that had both time-lapse and intermittent characteristics. The symptom would never occur unless the set had been operated for more than an hour; then the fault would appear and disappear in intermittent fashion. No amount of monitoring gave any useful clue, and the trouble was finally cured by the process

Give new life, new brightness to aging picture tubes—and watch your customer's confidence in you bounce back, too, when you sell a \$4.00 britener instead of a \$70.00 tube. (Then you're a cinch for the tube sale later.)

It's easy with Perma-Power's **Tu-Brite**. Handsomely packaged for instant acceptance, color-coded by base type for instant selection. The right voltage is assured. With Tu-Brite, *if the base is right, the boost is right*. Make sure you have all three models in stock.

Model C-202 for duodecal base CRT's.

Model C-212 for 110° button base CRT's.

Model C-222 for 110° shell base CRT's. Net \$2.25 each.

Write for free **Britener Selector Chart**, your guide to the base type of every picture tube now in the field.

YES! Perma-Power Brightens Color Sets, Too. **Color-Brite Model C-501**, Net \$5.85 each.



Perma-Power COMPANY

5740 North Tripp Avenue • Chicago, Illinois 60646

Phone: 539-7171 (Area Code 312)

Circle 40 on literature card



Fig. 10. Shrinkage of raster resulted from unnoticed shift in width-adjustment control.



Fig. 11. Drive line, compressed right side with shrinkage due to bad screen resistor.

of elimination. First, the ceramic capacitor across the damper was replaced—wrong guess. Next, the damper filament winding was suspected—another bad guess. (These two wrong guesses were prompted by previous experiences in which quite similar faults were traced to the damper circuit.) Finally, the screen resistor in the horizontal output stage was replaced, and the trouble was eliminated. The change in the resistor did not affect the screen voltage enough to arouse suspicion, nor did it read off-value when out of the circuit.

Shrinkage Plus

In some instances shrunken rasters are accompanied by other raster defects. The picture in Fig. 12, taken from a Capehart CX-32, is such a case. The symptom was due to an open electrolytic capacitor between B- and ground.

Conclusion

Shrunken rasters are caused by trouble in one of three receiver sections, the power supply, the horizontal deflection amplifier, or the horizontal oscillator. In addition to electronic defects in components in these stages, mechanical defects in the flyback transformer or yoke are possibilities not to be overlooked. The various cases cited here provide a reasonable sampling of the causes of this symptom. ▲



Fig. 12. Shrunken raster had irregular edges.



NOW BETTER THAN EVER!

The famous RCA WV-38A Volt-Ohm-Milliammeter

NEW FEATURES...

COLOR-CODED FRONT PANEL MARKING simplifies operation, reduces chance of error.

METER MOVEMENT PROTECTED AGAINST BURNOUT. Special silicon diodes guard meter against overload.

PLUS...

POLARITY REVERSAL SWITCH. Reverses polarity of test leads without need for re-connecting. Handy for checking front-to-back resistance ratio of electrolytic capacitors and many types of semiconductor devices.

39 DIFFERENT MEASUREMENT RANGES.

MEASURES CURRENT from 50 microamps full scale to 10 amps full scale.

SPECIAL 0.25 volt and 1.0 volt (full-scale) DC ranges... useful in checking transistor circuits.

... and many additional features that have made this instrument the best V-O-M buy on the market today. Only \$47.95*. Kit version, WV-38A(K), only \$29.95*.

See it at your Authorized RCA Electronic Instrument Distributor.

*Optional distributor resale price. Prices subject to change without notice. Prices may be higher in Alaska, Hawaii and the west.

RCA ELECTRONIC COMPONENTS AND DEVICES, HARRISON, N.J.



The Most Trusted Name in Electronics

Coming . . . The November Annual

All Color-TV Issue

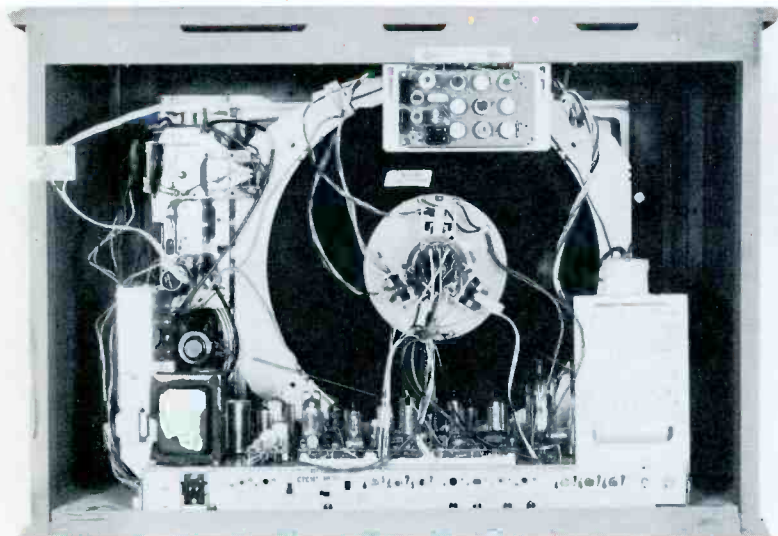

- **Know Your '65 Color Circuits**
8-page book section giving features of all new chassis.
- **Chroma Reference and Control Circuits**
Learn how these important stages operate.
- **Color Instruments for 1965**
Features of new test equipment are given.
- **Color Countermeasures Special**
A valuable collection of color servicing tips.
- **Checking Phase of Color-Bar Generators**
Methods to test your servicing gear are discussed.
- **Symfact on Chroma Bandpass Stage**

Plus:

Replacing a Color CRT Tips for Color Servicing
Notes on Test Equipment Troubleshooter

and many more valuable color articles!

Get Free Premium Books With Subscription

Enter my subscription to PF REPORTER
and send me free book(s) checked.

3 Years \$10.00 2 Years \$8.00 1 Year \$5.00

- Symfact Handbook Vol. 1
- The Troubleshooter's Handbook No. 2
- Servicing Industrial Electronics
- Servicing TV from Tuner to Picture Tube

Check one for
each year you
subscribe

Bill Me Remittance Enclosed Extend Present Subscription

Take this coupon to your distributor, or mail to:

Howard W. Sams & Co., Inc.

4300 W. 62nd St., Indianapolis, Ind. 46206

Name _____

Firm _____

Address _____

City _____ State _____ Zip Code _____

Please Check Your
Business Classification

- Independent Radio, TV Serviceman Owner, Mgr.
- Retailer with Service Department Service Mgr.
- Industrial Electronics Service Employee
- Other (Specify occupation and title)

BOOK REVIEW

Two-Way Mobile Radio Handbook

Author, Jack Helmi; Howard W. Sams & Co., Inc., Indianapolis, Ind.; 224 pages, paperbound, \$3.95. Recent surveys reveal a preponderance of radio-television technicians who want to become communications technicians. This newly revised book (published first in 1960) updates information presented in the early version and has two new chapters on ways to make money in the communications business.

The first chapter acquaints the reader with an overall picture of the field of two-way radiocommunications, elaborating on uses for two-way radio and introducing equipment used in modern systems.

The next three chapters are devoted to analyzing receiver circuits. Starting with the RF, crystal oscillator, and mixer stages, these chapters show circuits used in different equipments and explain their operation. A comprehensive study of IF stages leads logically to FM detectors, audio amplifiers, squelch systems, noise limiters, and AFC circuits. In one chapter, dual- and triple-conversion sets are analyzed, and a simple means is shown for computing frequencies in this seemingly complex heterodyning process. The matter of receiver alignment is also introduced.

A separate chapter on transmitters treats them in much the same manner as receivers were treated—explaining oscillator, multiplier, RF amplifier, and speech circuits. Alignment is also discussed, since this is the most popular way to troubleshoot transmitters.

Control systems—remote and local—are covered in Chapter 6, and Chapter 7 is devoted to antennas, transmission lines, and antenna supports. Special-purpose antennas are described for unusual applications. Chapter 8 details power supplies for almost any imaginable two-way radio system—fixed, mobile (in many vehicle types), and portable.

Troubleshooting hints are included in almost every chapter, but there is also a special chapter on servicing. This is accompanied by a chapter on setting up a shop for servicing two-way gear, thus rounding out the usefulness of the book to the prospective communications technician. These chapters list what equipment is needed, suggest shop layouts for expeditious servicing, and tell the reader how to apply his knowledge of communications.

An entirely new chapter on selling, and on the business end of running a communications shop, further tells the reader how to use his knowledge profitably. The final chapter—also new—is devoted to the Common Carrier Service, companies that are licensed to provide communications services and equipment for public use. These latter systems are explained in detail, and include mobile telephone systems, radio paging services, and miscellaneous common carriers.

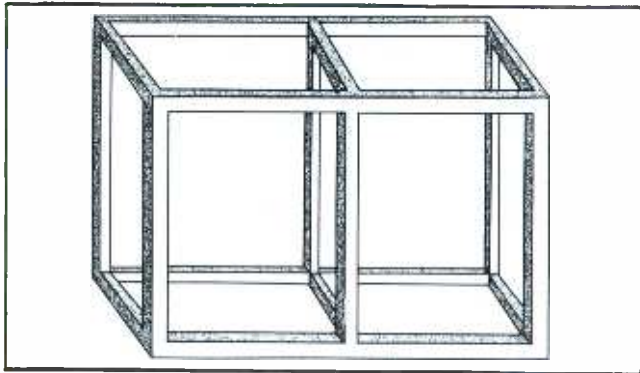

Fig. 7. Square box shape of most console TV's makes job easier. ing, it first must be wired. The amplifier and changer both receive AC power through the "Phono" setting of the control switch. Both amplifier and changer can be turned off on their own chassis, even with the radio on.

The entire changeover was very pleasing to the customer. He now had a satisfactory stereo system that even the most discriminating listener would not find fault with, and at a fraction of the cost of a new cabinet and system.

Stereo—Buffet Style

Almost any kind of cabinet can be made into a home music center. Customers seldom realize the potential in old furniture—even dining room furniture, and it is up to you to call their attention to it. For example, the buffet shown in Fig. 5 has no outward features of a stereo hi-fi system, yet it has been equipped with a changer, and amplifier, and two speaker systems to provide full stereo reproduction.

This particular piece of furniture is built of solid oak, and was sanded down to its natural finish; however, some dark stain was left to provide an antique grained effect. The legs were shortened somewhat, and the panel doors on either end of the buffet were replaced with speaker baffles and grill cloth. The facing of the two center drawers was remounted on a swinging door to provide access to the changer and amplifiers (Fig. 6). The drawer shelving was pulled out, and one new shelf installed for the amplifier. Careful shopping provided just the right combination of amplifier and changer to fit the available space.

Discarded TV Cabinets

Old TV cabinets are another source of good cabinetry for the radiophono systems. Many of the first TV sets were housed in elaborately designed cabinets, in a wide variety of shapes and sizes. Most generally, the picture tube is small, but the opening for it is quite large, although filled with masking similar to veneered plywood. This board can be removed with a wood chisel and a little elbow grease. If there are rough edges, select some half-round moulding or wood tape to go around them. This type of finishing work can add a professional touch to what might appear an otherwise amateurish job.

Other types of TV cabinets are built of panels. The framework is usually of 1" x 1" boards with panels cut to fit on the sides, front, and back. The sketch in Fig. 7, shows the type of framework used in most console sets. With such a framework,

**a new money-making,
traffic-building tube tester**

for you or your customer!



After thousands of requests here is the "counter/bench" version of the famous Sencore Mighty Mite Tester; designed for the ultimate in tube checking thoroughness and operational simplicity! Designed for two-way use — as a professional shop tester and customer self-service unit. Tests over 2500 tubes — including Nuvistors, Compactrons, 10-pins, Novars, Magnovals and foreign tubes with a big 6-inch meter for easy reading. Semi-automatic; simply turn function control to any test and watch lighted arrow on meter automatically stop on right scale. User can't go wrong — no guess work — everything is read right on the meter (no tricky neon lights to misread); only 3 set-up controls. Easy to read, speed-indexed set-up cards make every test fast and sure. Like the famous Mighty Mite, the TC131 uses 100-megohm grid leakage sensitivity to spot those "tricky" tubes other testers miss; tests inter-element shorts and makes cathode emission tests under full operating levels. A real profit maker as a counter checker or self service tube seller in your shop . . . and it's only

\$129⁹⁵

See your distributor about the big TC131 trade-in deal.

professional quality — that's the difference!

SENCORE

426 SOUTH WESTGATE DRIVE • ADDISON, ILLINOIS

Circle 41 on literature card

October, 1964/PF REPORTER 67

any number of possibilities arise; the system shown in Fig. 8 was built from such a cabinet.

One side, already equipped with a speaker board and grill cloth, was used for the speakers. On the other side, only shelves were needed for the tuner and amplifier.

The shelving is of 1" lumber. To disguise the end cuts that could be seen, strips of wood tape were applied. Even a close inspection does not reveal that the finish is not professional.

When converting a cabinet like

that shown in Fig. 8 to a hi-fi cabinet, remember that all wood or metal parts must be securely fastened to the cabinet. Merely gluing the shelves in place does not serve; they must be glued and then screwed down. Perhaps the best method of attaching shelves is by use of small metal brackets. Make sure they are tight; if they aren't, you may notice a few rattles when the volume is high. Loud musical vibrations can loosen glued joints over a period of time, just as certain high notes can crack glass.



Fig. 8. Discarded TV cabinet converted into an FM-Phono stereo hi-fi home music center.

You will notice there is no door on the front of the set in Fig. 8; however, with this arrangement of tuner and amplifier, a door might actually detract from the appearance. As shown in Fig. 9, there is a lid over the changer compartment; although there was room for a turntable in the cabinet, none was included originally.

The partial floor and screen of the original arrangement were replaced by a piece of plywood cut to the exact measurements of the bottom of the enclosure.

As mentioned previously, selection of the changer and amplifier depends a good deal on available space. The changer in Fig. 9 was chosen for this cabinet because it is easy to operate from above. Some changers are built to be used with pull-out tracks; others, in the minority, are built with controls set just back from the front edge of the changer.

The Perfect Combination?

There is no such thing! What is perfect for one person is not for another. Therefore, it is seldom you will completely satisfy every hi-fi customer with your modernization techniques. However, most customers realize you are providing a considerable savings by transforming their old cabinet into a new, up-to-date stereo system. If you point out any limitations before you start, the finished system should be thoroughly acceptable. ▲



Fig. 9. Record changer compartment located in the top of the cabinet has pullup lid.

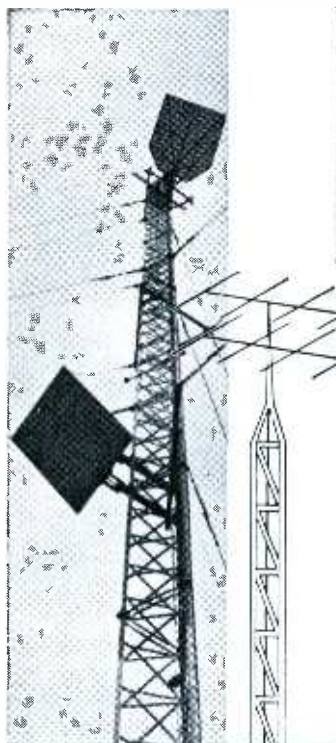

The most Famous Name in
TOWERS of ALL KINDS!

Here are the advantages you get
when you insist on **ROHN TOWERS**

LARGEST FULL RANGE OF TOWERS—you can get anything from home TV and amateur radio towers to heavy-duty communication and micro-wave towers. Included are 500 foot self-supporting towers, 1,000 foot guyed towers, "fold-over" and crank-up towers. Regardless of your needs, ROHN can supply it.

UNQUESTIONED LEADERSHIP IN DESIGN AND MANUFACTURE—you get the latest in advanced tower engineering. All communication towers are engineered to EIA specifications, and are proved by thousands of installations. No other manufacturer can surpass the quality and fine reputation of ROHN.

QUALITY MATERIALS AND WORKMANSHIP—Only highest quality steel is used which fully meets the specifications for the job. ROHN towers are hot-dipped galvanized **after** fabrication—a feature ROHN pioneered!

SERVICE WHEREVER YOU WANT IT—ROHN representatives are world-wide. Complete erection service for communication systems, broadcasting, micro-wave, and other needs is available; also competent engineering service to help you.

Settle for the BEST in TOWERS—ROHN—today the world's largest, exclusive manufacturer of towers of all kinds!

Also available: Rohn Lighting Kits, Microwave Passive Reflectors, Tower Installation Service and Engineering Assistance. Representatives World-Wide to Serve You.

For your needs, contact your local ROHN salesman, distributor or dealer; or write direct for information.

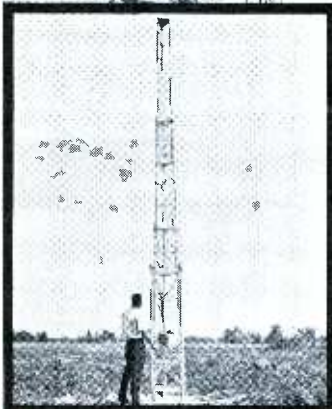

SEND THE HANDY COUPON INDICATING YOUR NEEDS

ROHN
Manufacturing
Co.
BOX 2000
PEORIA, ILLINOIS

Send me complete literature on the following ROHN Products:

- | | |
|---|--|
| <input type="checkbox"/> Home TV Towers | <input type="checkbox"/> Amateur Towers |
| <input type="checkbox"/> Communication Towers | <input type="checkbox"/> AM-FM Broadcasting Towers |
| <input type="checkbox"/> Micro-Wave Towers | <input type="checkbox"/> Government |

Name _____

Firm _____

Address _____

City _____ State _____

"World's Largest EXCLUSIVE Manufacturer of Towers; designers, engineers, and installers of complete communication tower systems."

Width and Horizontal Linearity

(Continued from page 37)

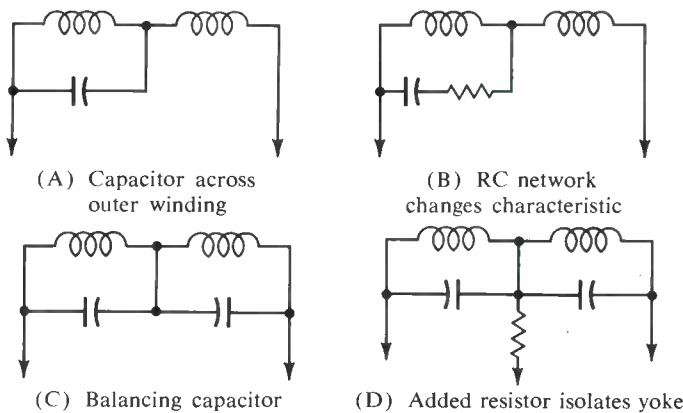

Fig. 4. Compensating yoke windings for difference in Q, capacitance, by controlling output to the flyback transformer.

The Path to Linearity

Linearity problems are not so easily attacked. For one thing, it is difficult to check variations in linearity without using some form of linearity pattern. Linearity is controlled most effectively with a coil in the damper circuit, or with RC networks in the yoke circuit. However, component values which control waveshape in the horizontal output and oscillator stages are frequently involved. In extreme cases, particularly when the width coil must be disconnected to achieve necessary width, nonlinearity may occur only on the right side of the screen. Taping small magnets to the bell of the picture tube will help stretch the picture, the degree of stretch depending on the placement of the magnets.

Fig. 4 shows some yoke configurations. Resistors and capacitors equalize the Q and balance the distributed capacitance of the yoke segments. Aging yokes and flyback transformers may develop ringing and crosstalk, which may in turn necessitate changing the values of shunt capacitance and resistance. A handy device for determining the best values is shown in Fig. 5. It consists of two variable tuning capacitors and a 5 watt, 2500 ohm potentiometer. The unit is connected the same as the original network, and the values juggled for best linearity and minimum ringing. Equivalent fixed values are then substituted.

In some yokes, a wire is connected to a center tap on the horizontal windings, wrapped around the vertical yoke leads, and the end taped. This wire is a form of shield; attaching additional wire, extending its length, or wrapping it more tightly around the vertical wires will sometimes increase its effectiveness in curing ringing and crosstalk.

Another component that frequently changes value with age is the resistor at the yoke center tap. You can check for best linearity and width by substituting a 5 watt control. Be careful in handling it (as well as

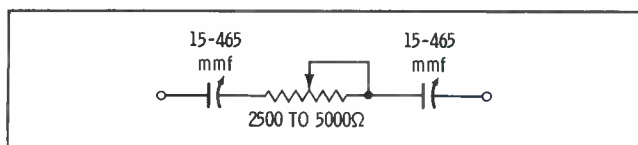

Fig. 5. Device for ascertaining best values of needed components.

add an fm-stereo service center
with this one new
sencore unit!



THE SENCORE MX129 FM STEREO MULTIPLEX GENERATOR & ANALYZER

FM-Stereo growth continues to mount and is fast becoming as big a field as Color TV. This means more FM-Stereo service business for you, now and in the future. Is your shop equipped? It can be — completely and economically — with the MX129, the FM-Stereo "Service Center in a Case." The instantly stable, 19-Transistor, crystal controlled MX129 is the most versatile, most portable (only 7½ pounds), most trouble free and efficient multiplex unit on the market — just like having your own FM-Stereo transmitter on your bench or in your truck. Powered by 115 volts AC, it produces all signals for trouble shooting and aligning the stereo section of the FM receiver . . . can be used to demonstrate stereo FM when no programs are being broadcast. Self-contained meter, calibrated in peak to peak volts and DB, is used to accurately set all MX129 controls and as an external meter to measure channel separator at the FM-Stereo speakers. **NO OTHER EQUIPMENT IS REQUIRED.** **\$169⁵⁰** only

SIGNALS AVAILABLE FOR ALIGNMENT, TROUBLE SHOOTING AND ANALYZING:

FM-RF carrier with composite multiplex audio signal with 38kc suppressed carrier, 19kc pilot and 67kc SCS signals • Multiplex signal formed by 60 or 1000 cycle internal tones or any external signal • Full control over left and right channel amplitude (modulation) • External 67kc SCA signal available for trap adjustment • Composite signals available for signal injection FM detector •

professional quality — that's the difference!

SENCORE

426 SOUTH WESTGATE DRIVE • ADDISON, ILLINOIS

Circle 42 on literature card

October, 1964/PF REPORTER 69

at last...
instant color patterns
at your finger tips...
zero warm-up time



THE ALL NEW SENCORE CG135 DELUXE TRANSISTORIZED COLOR GENERATOR

The big push is on in Color TV. Equip yourself now with the new, solid state Sencore CG135 and cash in on the zooming volume of new service business as Color-TV booms! Instant, service-ready RCA standard color bars, cross-hatch, white dots and individual vertical and horizontal bars enable you to set up or trouble-shoot more Color TV sets per day; earn top money in this fast growing service field. It's an analyzer too: Color gun interruptors, unmodulated video for chroma circuit trouble isolation and unmodulated sync pulses to keep Zenith receivers in sync for this test, make color trouble shooting a snap. Sturdy all-steel construction for rugged, heavy duty in the field or shop. Another Best Buy in profit-building service instruments from Sencore at

\$149⁹⁵

COMPARE THESE FEATURES: SEE WHY THE CG135 IS IN A CLASS BY ITSELF

- Solid state construction employs high priced GE "Unijunctions" to develop six "jump out proof counters" that guarantee stable patterns at all times with no warm-up
- Standard RCA licensed patterns as shown on schematics throughout the industry
- Handy universal color gun interruptors on front panel
- Lead piercing clips insure non-obsolence
- CRT adaptors optional
- Crystal-Controlled 4.5mc Sound Carrier Analyzing Signal to insure correct setting of fine tuning control
- RF output on Channel 4 adjustable to Channel 3 or 5 from front of generator when Channel 4 is being used
- No batteries to run down; uses 115 V AC
- Less than one foot square, weighs only 8 lbs.

professional quality — that's the difference!

SENCORE

426 SOUTH WESTGATE DRIVE • ADDISON, ILLINOIS

Circle 43 on literature card

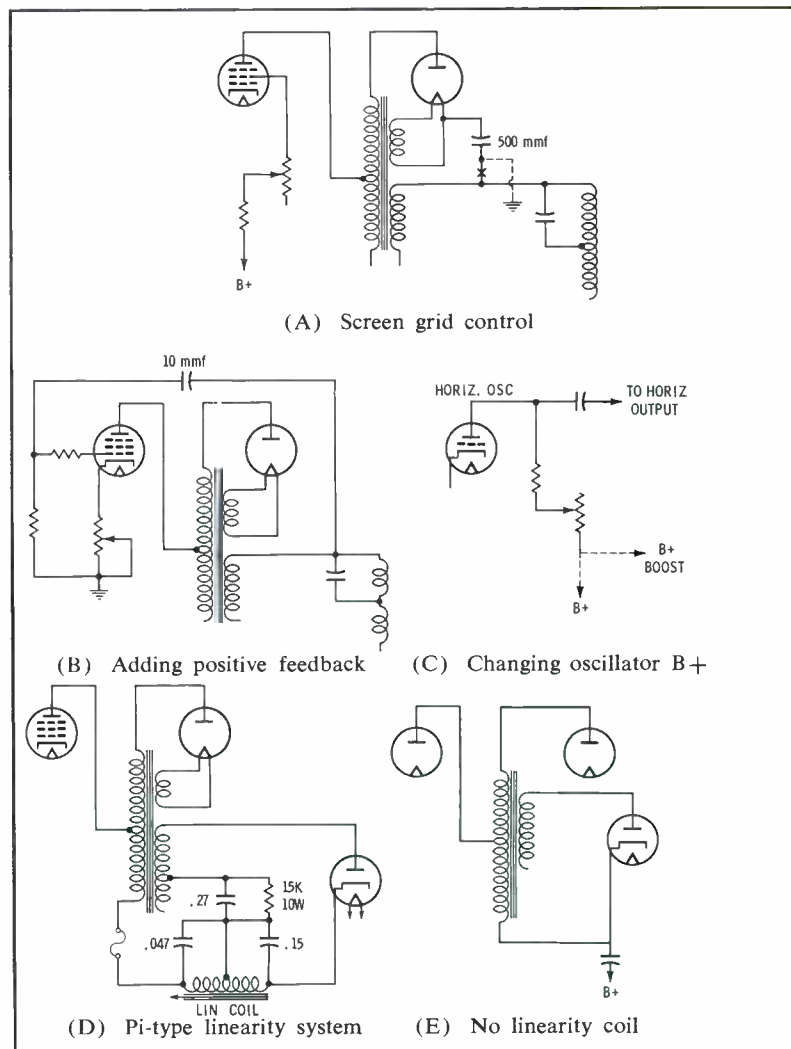

Fig. 6. Five different ways width can be altered in existing circuits.

the previous device) since the voltages are high enough to shake you up considerably. When the correct value is found, wire the proper value of 5 watt resistor in place of the control.

Servicing Tips

In the study of width and linearity control system design, ways can be discovered to cure service problems quickly. Fig. 6 shows some typical examples of short cuts to width and linearity servicing.

In Fig. 6A is shown how output waveform amplitude may be optimized by inserting a control in series with the screen grid and varying it for maximum performance. (Be sure the current rating of the tube is not exceeded.) Also, the 500 mmf high voltage filter capacitor may be returned to ground instead of to the high side of the yoke; this increases width. Conversely, to reduce width, a filter that returns to ground can be changed to the connection shown.

Fig. 6B shows a method of feedback that can increase both high voltage and sweep. Be sure the capacitor has at least a 3 kv rating, and stick to very low values—15 mmf or less. Also shown is a method for increasing output by reducing the value of the cathode resistance—unless the cathode is grounded. (Again, tube rating must be considered carefully.)

In Fig. 6C, additional drive is achieved by returning the horizontal oscillator plate resistor to boost instead of to B+. Be sure the change doesn't affect oscillator stability or waveform shape.

Fig. 6D shows a typical pi-network linearity circuit, working with the damper tube. The input capacitor has its greatest influence on the boost voltage, while the output filter capacitor is mainly responsible for linearity. A similar circuit is displayed in Fig. 6E, but without the linearity network. The damper cathode filter is expected to establish the boost voltage and maintain linearity, so its value may be somewhat critical.

Case Histories

In a few cases, the reason for lack of width will be found rather remote from the horizontal network. Fig. 7 shows three such instances; the troubles in these circuits fooled one very competent technician for quite a while. Studying them will give you an insight into how external circuits can affect the horizontal linearity and width, if the circumstances happen to be just right.

A trouble in an Admiral looked as if it might be caused by a power-supply defect, since the entire raster was shrunken. Examination of the schematic revealed the circuit arrangement shown in Fig. 7A; the vertical circuit takes power from the boost circuit. It developed under testing that leakage in the vertical output transformer was loading the boost, causing raster shrinkage and poor focus.

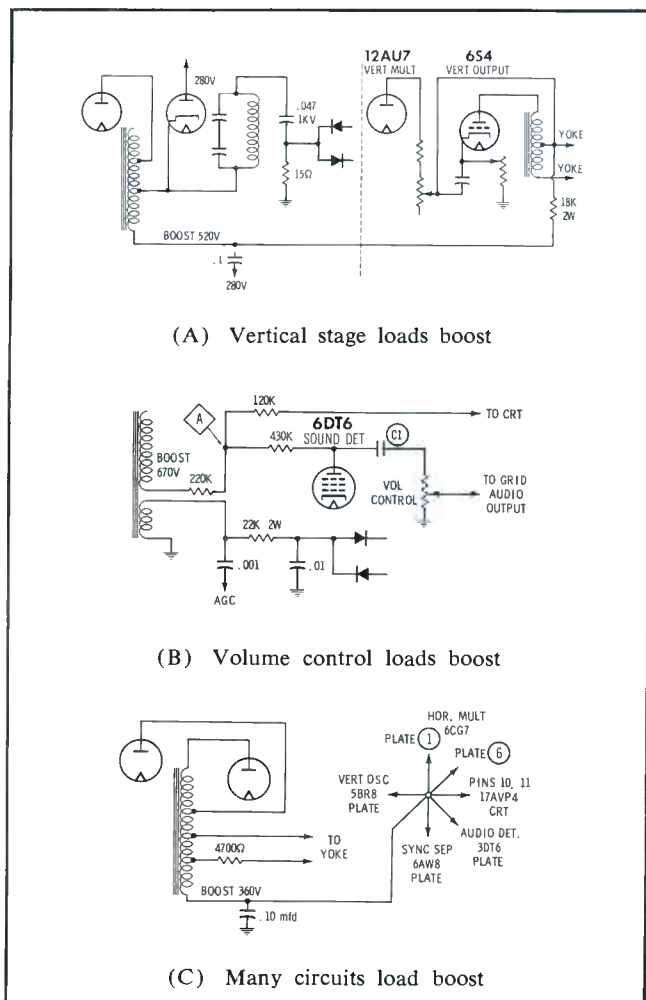

Fig. 7. Three case histories of trouble in different circuits.

top money maker in
the service business



NEW IMPROVED SENCORE CR133 CRT CHECKER & REJUVENATOR

The new, improved CR133 CRT Checker is designed to test all present picture tubes — and it's ready for future tubes too! Two plug-in replaceable cables contain all sockets required. The compact, 10 lb., CR133 checks CRT emission, inter-element shorts, control grid cut-off capabilities, gas and expected life. Checks all tubes: conventional B&W, new low drive B&W, round color tubes and new rectangular color picture tubes. Exclusive variable G2 Volts from 25 to 325 Volts insures non-obsolescence when testing newly announced "semi-low" G2 CRT tubes. New Line Voltage Adjustment insures the most accurate tests possible. Uses well-filtered DC for all checks to avoid tube damage and reading errors. Color guns are individually tested as recommended by manufacturers. Exclusive automatically controlled rejuvenator applies rejuvenation (ACR) voltage as required by individual tube condition; precisely timed to prevent over-rejuvenation or tube damage. The ACR feature is most useful for color tube current equalization to insure proper tracking. Hand-wired and steel-encased for protection of meter and panel in truck or shop, the new improved CR133 is only . . . **\$89⁹⁵**

The famous CR128 CRT Checker and Rejuvenator is similar to above, but with a three position G2 slide switch and without Line Voltage Adjustment at \$69.95

professional quality — that's the difference!

SENCORE

426 SOUTH WESTGATE DRIVE • ADDISON, ILLINOIS

Circle 44 on literature card

October, 1964/PF REPORTER 71



Be a wise owl!

How to cut call backs, increase profit on receiving tubes!



Engineered for peak performance... priced for extra profit! Every Admiral Supertron Electronic Tube must pass rigorous *super-quality* control tests and life tests to meet the high premium standards required for circuit approved tubes.

The remarkable Admiral price and volume discount helps you make *more dollar profit* on every service job! Reduce expensive call backs.

Order a complete supply of new Admiral Supertron Receiving Tubes today... start pocketing big profits tomorrow! Call your Admiral Distributor now!

Be wise... standardize on

Admiral® SUPERTRON RECEIVING TUBES

Always Precision Crafted Quality
Circle 45 on literature card

Another Admiral came into the shop with its volume control acting more like a brightness control; that is, varying the volume always changed the brightness of the raster. The trouble was found by examining the circuit design, a simplified version of which is shown in Fig. 7B. Boost voltage powers both the sound detector and the accelerator grid of the CRT. Coupling capacitor C1 had developed considerable leakage. As the volume control was varied, the load on the boost line was changed, and the voltage at point A was altered. This voltage change was transferred to the CRT, causing a change in brightness.

In a Magnavox that was brought into the shop with boost quite low, we checked the possibilities for overload. Fig. 7C shows that there were six different possibilities for overload, because there were that many circuits being powered from the boost line: vertical oscillator, audio detector, sync separator, picture tube focus and accelerator anodes, and both sections of the horizontal oscillator tube. Disconnecting the first four was easy enough, but removing connections to the horizontal oscillator didn't prove anything, since without the oscillator the boost couldn't function anyway. The fault was finally isolated by furnishing B+ for the horizontal oscillator from an external supply, thus relieving the boost line of its entire load. As it turned out, the trouble was only a faulty boost capacitor, and overload was not the problem after all.

Common Faults

There are certain types of trouble common to width and linearity circuits. The screen grid of the output tube can be a prime source of trouble. The resistance value is very important, and any change will seriously affect width, brightness, and linearity. Width controls in this circuit are particularly prone to failure. Coupling capacitors that are leaky will usually cause trouble to the right side of the picture, as will drive capacitors that become shorted.

Filter capacitors on B+ lines feeding the horizontal stages can create hum defects, picture bending, poor horizontal linearity, loss of width, or almost any type of horizontal trouble. Substitution is about

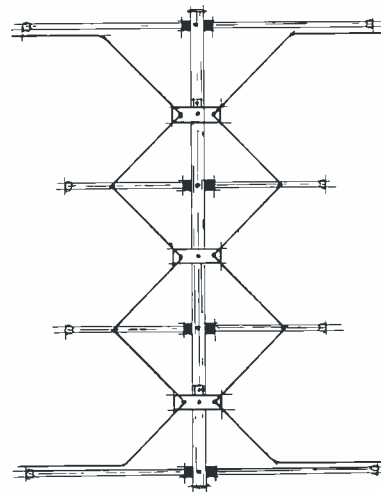

THE ANTENNAS ADVERTISED ON PAGE 52 ARE AVAILABLE FROM LEADING DISTRIBUTORS EVERYWHERE. IN DAYTON OHIO SEE

STOTTS-FRIEDMAN
108 N. Jefferson

Circle 46 on literature card

CAR OWNERS SAY...

"Terrific," "Fabulous,"
"Improves radio 100%!"



VERBA-MATIX

America's Prestige

REVERBERATION

The only system with

- 4 Transistors • Heavy 7 oz. Ceramic-Magnet Speaker • Complete Control Panel (with Reverb % Control) • No Drilling, No Screws, for easy installation • Fits all Cars, Neg. or Pos. Ground (12 volt) • All Speakers 2 to 40 ohms • No Noise Driving Over Bumps.

Made in U.S.A.

For complete details see your Distributor or write PF-10



kinematix, inc.

2040 W. Washington Blvd.,
Chicago, Illinois 60612
Area Code 312 666-0066

Circle 47 on literature card

the only sure check, since bridging electrolytic filters will not always give a conclusive indication.

Another source of difficulty to watch for is the pulse resistor or capacitor feeding the AGC or AFC. Resistors will sometimes arc internally under load, causing intermittent width loss as well as wrinkles on the left side of the raster. Capacitors may break down under stress and load the output transformer heavily.

Any capacitor on the "high" side of the output transformer will eventually fall under suspicion. The very high pulse voltages present may cause breakdowns that will not show up in conventional tests; in these cases, substitution seems the only sure answer.

A few really unusual circuit arrangements might fool the technician who is unaware of them. For example, one set uses a foil patch on the neck of the CRT to achieve proper linearity; when the tube is changed for any reason, the patch must be transferred to the new one. In another set, a .1 mfd capacitor connects to ground from the linearity coil; removing the capacitor and shunting the coil with an 18K resistor is a common cure for drive lines that may occur in this set.

Keep Up With Changes

The TV sets of recent years are a new breed. The wider deflection angle has introduced problems in width and linearity that are far different from those in older models. New techniques have been incorporated in the design of width and linearity networks and components.

A check of 69 typical 1963 models reveals the following systems: 17 used a width coil, 8 did it with potentiometers, 13 had yoke sleeves, 2 employed width jumpers, and 29 had no device at all for controlling width.

The trend is unmistakable. For the technician, this means width loss will more often be due to aging components. Linearity will depend even more on accurate component values. Keep abreast of the circuit designs each year, and you'll find the servicing suggestions for the older sets can be applied to the new. ▲

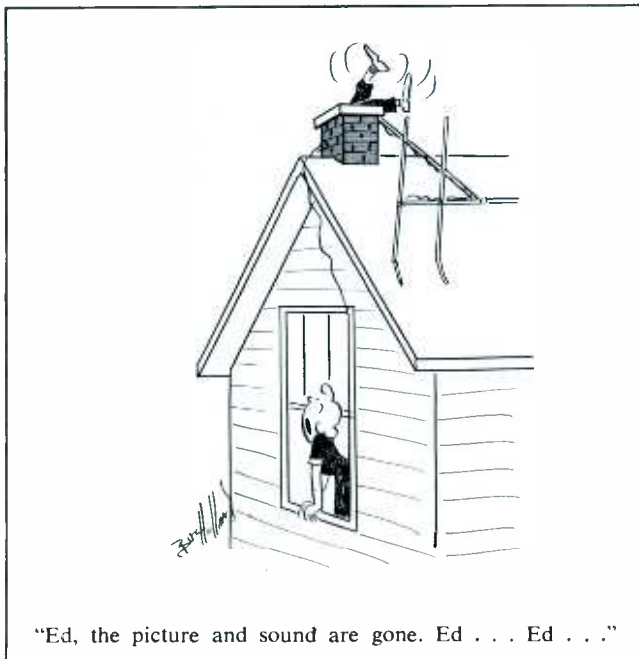

KIT or ASSEMBLED!



Either Way, These HEATH Instruments Are Your Best Buy!

Heathkit IM-21 Laboratory AC VTVM!

- 10 voltage ranges—0.01 to 300 volts RMS full scale • ± 2 db, 10 cps to 1 mc • 10 megohm input impedance for high accuracy • Calibrated DB scale • VU-type ballistic damping of meter movement.

Kit IM-21, 5 lbs. . . . \$33.95 Assembled IMW-21 \$52.95

Heathkit IM-11 VTVM . . . World's Largest Selling VTVM!

- 7 AC (RMS & Peak to Peak), 7 DC, 7 Ohms ranges • Wide frequency response ± 1 db, 25 cps to 1 mc • Easy-to-read 4½" 200 UA meter • 1% precision resistors • Single AC/Ohms/DC probe with switch.

Kit IM-11, 5 lbs. . . . \$24.95 Assembled IMW-11 \$39.95

Heathkit IM-13 "Service Bench" VTVM!

- 7 AC, 7 DC, 7 Ohms ranges • Separate 1.5 & 5 v. AC scales • ± 1 db, 25 cps to 1 mc • Large 6" 200 UA meter • Tilts to any angle • 1% precision resistors • Single AC/Ohms/DC probe with switch • Mounts anywhere.

Kit IM-13, 7 lbs. . . . \$32.95 Assembled IMW-13 \$49.95

Heathkit Variable-Voltage Regulated Power Supply!

- Ideal for design & development • B+, Bias & Filament voltages • DC output variable 0-400 volts, 125 ma max. • Output varies less than 1%, no load to full load • Ripple less than 10 mv • Voltage & Current Panel Meters.

Kit IP-32, 16 lbs. . . . \$56.95 Assembled IPW-32 \$84.95

Heathkit "Extra-Duty" Wide Band 5" Oscilloscope!

- Professional styling & features • 5 MC bandwidth, ideal for color servicing • Rise time 8 microseconds or less • Sweep range 10 cps to 500 kc plus 2 switched preset frequencies • Push-pull vertical & horizontal output.

Kit IO-12, 24 lbs. . . . \$76.95 Assembled IOW-12 \$126.95



FREE CATALOG

Fully describes these and over 200 other different and exciting Heathkits at savings of 50% or more! Fill out the coupon below and send for your FREE copy today!



HEATH COMPANY, Dept. 25-10-2
Benton Harbor, Mich. 49023

Please send my free 1965 Heathkit Catalog.

Enclosed is \$ _____, plus postage. Please send model(s) _____

Name _____ (Please Print)

Address _____

City _____ State _____ Zip _____

TE-132



Product Report

For further information on any of the following items, circle the associated number on the Catalog & Literature Card.

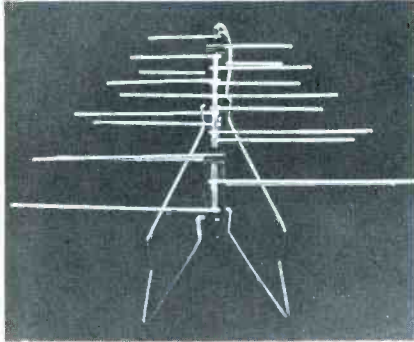

Indoor UHF (133)

An ultrahigh-gain, periodic-type indoor antenna is the latest addition to **Blonder-Tongue's** line of antennas and UHF products. The "Golden Arrow" provides excellent color or black-and-white reception. The new unit can be used both with all-channel sets and converters. The shorter wavelength at UHF permits true high-gain indoor antennas to be used on this band.



Stereo Systems (134)

Connections for tuner and tape recorder are provided on both of these **Fisher** transistorized stereo systems. The lightweight "50 Portable" consists of a master control amplifier, a Garrard 4-speed

automatic turntable, and two inductance-capacitance speaker systems. The "75 Custom Module" is electrically identical to the portable but has 8" woofers instead of 6" woofers. Both models have 30 watts output and are provided with a five-position selector switch: bass, treble, balance, and volume controls; and a front-panel headphone jack.

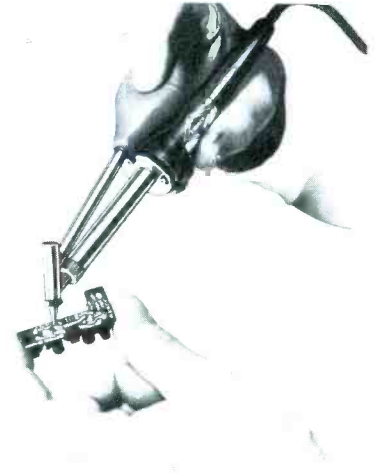

Desoldering Iron (135)

A new pencil-style desoldering-resoldering iron for removing and replacing miniature components on printed-circuit boards and in conventionally wired circuits is **Enterprise Development's** Model 300. Action on the rubber bulb lifts solder from the heated connection by

THE WONDERFUL WIZARD 300*

1 ANTENNA + 2 WIZARDS = 2 OUTLETS
 1 ANTENNA + 3 WIZARDS = 3 OUTLETS
 1 ANTENNA + 4 WIZARDS = 4 OUTLETS
 1 ANTENNA + 5 WIZARDS = 5 OUTLETS
 1 ANTENNA + 6 WIZARDS = 6 OUTLETS
 1 ANTENNA + 7 WIZARDS = 7 OUTLETS
 1 ANTENNA + 8 WIZARDS = 8 OUTLETS
 1 ANTENNA + 9 WIZARDS = 9 OUTLETS
 1 ANTENNA + 10 WIZARDS = 10 OUTLETS
 1 ANTENNA + 11 WIZARDS = 11 OUTLETS
 1 ANTENNA + 12 WIZARDS = 12 OUTLETS
 1 ANTENNA + 13 WIZARDS = 13 OUTLETS
 1 ANTENNA + 14 WIZARDS = 14 OUTLETS
 1 ANTENNA + 15 WIZARDS = 15 OUTLETS
 1 ANTENNA + 16 WIZARDS = 16 OUTLETS
 1 ANTENNA + 17 WIZARDS = 17 OUTLETS
 1 ANTENNA + 18 WIZARDS = 18 OUTLETS
 1 ANTENNA + 19 WIZARDS = 19 OUTLETS
 1 ANTENNA + 20 WIZARDS = 20 OUTLETS
 1 ANTENNA + 21 WIZARDS = 21 OUTLETS

TV SERVICEMEN ARE
 MAKING GOOD MONEY
 Installing Wizard Systems



The Beacon St. Apts. (62 outlets in 32 units): Another fast, simple, profitable Wizard System done entirely in twinlead. Two separate systems eliminated the need for amplification.

WRITE FOR SCHEMATIC DIAGRAM & SPECIFICATIONS
CHARLES ENGINEERING, INC.
 3421 NORTH KNOLL DR., LOS ANGELES, CALIF. 90028
 LIST \$1.95. OBTAINABLE AT YOUR DEALER OR WRITE.

*U. S. LETTERS PATENT NO. 2,913,679

Circle 50 on literature card



TYPE IL . . . why use old fashioned wax end-filled cardboard capacitors in radio repairs? Avoid call-backs with Planet type IL dual section tubular electrolytics . . . hermetically sealed in aluminum tubes with wax impregnated insulating jacket. Planet IL's are also available in 450 volts for TV servicing. Ask for them by type number at your distributor.

PLANET SALES CORP.

225 Belleville Ave.
 Bloomfield, New Jersey

Circle 51 on literature card

vacuum, so parts can be removed without damage. The standard tip measures .080" in diameter, but tips in four additional sizes are available. List price is \$13.49.

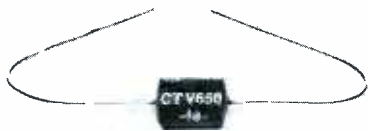

Color-TV Focus Rectifier (136)

A common cause of poor focus in color receivers is the change in characteristics of the selenium focus rectifier. A simple solution to the problem is to replace the selenium unit with a **Sarkes Tarzian** type CTV650 silicon focus rectifier. Maximum ratings of this replacement are: 6500 piv, 60 DC ma, 4550 volts rms. The CTV650 can be substituted for the following rectifiers: Airline 66X0035-001, Dumont 1440977-1, Emerson 817123, Magnavox B530096-1, Olympic 1440977-1, Packard Bell 72110, Philco 34-8053-2, RCA 1440977-1, Silvertone 86-44-3, Sylvania 16106-1, and Zenith 212-48. List price is \$8.35.

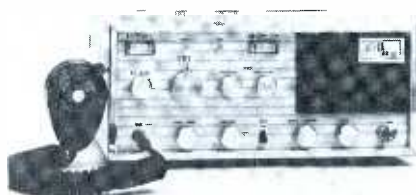

CB Equipment (137)

The T & C III Citizens-band transceiver, produced by **Utica Communications Corp.**, provides 23-channel crystal-controlled operation. The unit has a built-in dual power supply operating on 117 volts AC or 12 volts DC. Circuitry includes push-pull modulation, a built-in PA system, 14 tubes, 5 diodes, and 2 transistors.

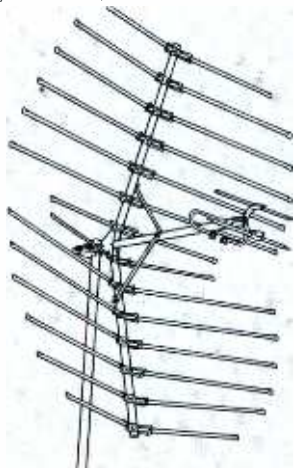

UHF Antenna (138)

This new antenna, using the "incident wave" principle with a tangent paraboloid reflector system is designed to give uniform gain of 13 db across all UHF channels. **Winegard's** "Tracker" has

R. N. JOHNSON ADVERTISING

it's here! most advanced color TV test instrument ever developed



- OBSOLETES ALL OTHERS
- ELIMINATES ALL GUESSWORK

LECTROTECH V7*

A sensational new color generator with 4 major Lectrotech exclusives . . . plus all of the time-proven standard features . . . in one compact, portable unit. For the first time you can install and service color TV completely, accurately and faster! Here are the facts:

EXCLUSIVE—COLOR VECTORSCOPE—Until now, available only in \$1500 testers designed for broadcast. Accurately measures color demodulation to check R-Y and B-Y plus all 10 color bars for color phase angles and amplitude. A must for total color and those hard to get skin tones.

EXCLUSIVE—SELF-CALIBRATING — Adjust timing circuit without the use of external test equipment. No need to return unit to a factory for adjustment.

EXCLUSIVE—DIAL-A-LINE — Now, you can adjust horizontal line to any width desired from 1 to 4 lines wide.

EXCLUSIVE—SOLID STATE RELIABILITY — Only two tubes are used in combination with fully transistorized diode-rectifier circuit.

PLUS— the V7 produces all Crosshatch, Dots, Vertical only, Horizontal only and Keyed Rainbow Patterns. RF at channels 3, 4 or 5. Video Output (Pos. and Neg. adjustable) for signal injection trouble-shooting. Red-Blue-Green Gun Killer. All transistor and timer circuits are voltage regulated to operate under wide voltage ranges. Lightweight, compact — only 8¼" x 7½" x 12½". Net.....**189.50**

**Designed and produced by the men who introduced and developed the modern approach to TV testing — Bill Grossman and Bob Karet.*

For the full story on the V7, write for complete catalog or see your distributor.

Distributors: Phone or Wire Collect.



LECTROTECH INC.
1737 Devon Ave. • Chicago, Ill. 60626 • Area 312 465-2622

Circle 52 on literature card

an impedance match into 300 ohms of 1.5:1 at all UHF-TV frequencies. The antenna is constructed of anodized aluminum, and snap-lock hardware holds the elements securely in place and facilitates installation. A one-piece mast clamp automatically aligns the antenna on the mast and won't crush the antenna boom. List price of the Model U-540 is \$29.95.

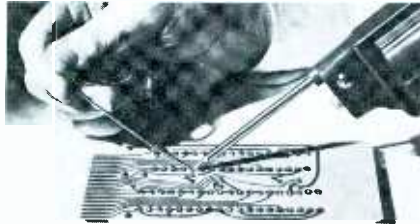

Fine Point Soldering Pistol (139)

A new fine-point tip for the Wen Model 75 soldering pistol permits fine soldering work in hard-to-reach places. The new

design also permits easy soldering and unsoldering of printed-board connections. The 3" tip tapers to a very fine point, and is readily interchangeable with the standard chisel-shaped tip. Just a few turns of a slotted head set screw enables the change to be made.

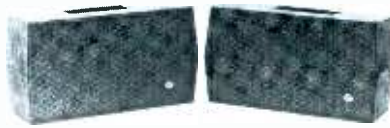

Special Speaker Deal (140)

A special half-price offer on the Revere S-422 "stereo twins" matching extension speakers is now in effect. This offer from **Revere-Wollensak** enables the dealer to purchase one set of twins at the regular price and a second set at half price. Each twin handles 12 watts of amplifier output and has a frequency response of

60-15,000 cps. When the twin speakers are held back to back, a convenient carrying handle is formed. Accessory cords are supplied with the units.



Antenna Rotation Monitored (141)

A finger-touch lever to control antenna rotation and compass lights to show antenna direction are features of the TR-2C control unit. **Cornell-Dubilier's** antenna-rotator control system is encased in a neat, trim control box designed to fit nicely into any living room.

NEW 'CONTROLLED INCIDENT WAVE'* ANTENNA

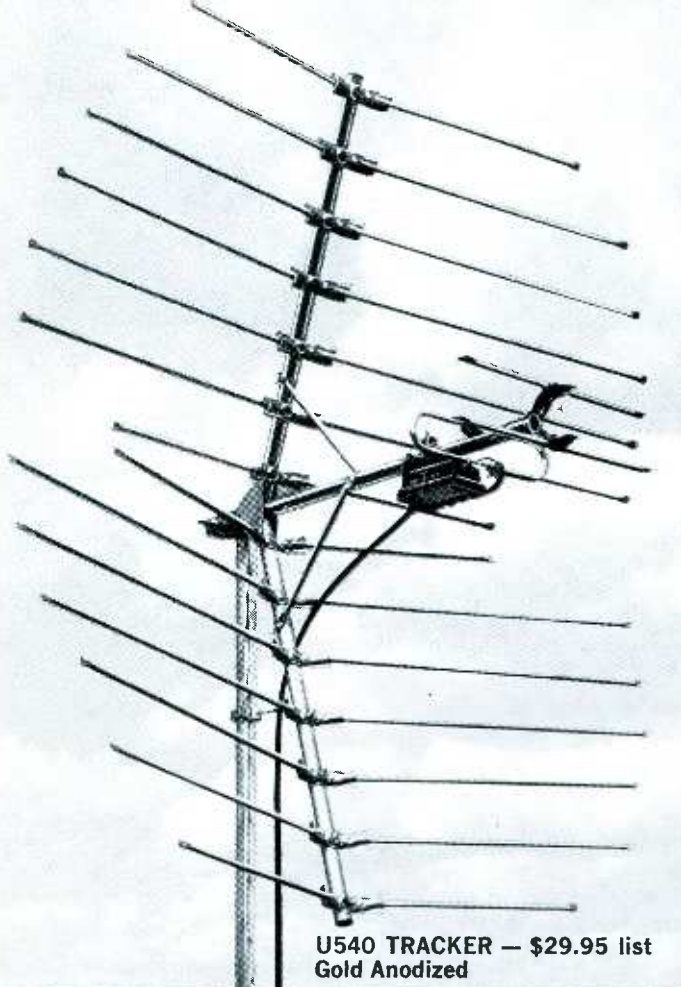

U540 TRACKER — \$29.95 list
Gold Anodized

HERE'S THE PHOTOGRAPHIC PROOF OF TRACKER'S TREMENDOUS PULLING POWER. EACH OF THESE STATIONS WAS PICKED UP ON THE TRACKER INSTALLED IN OUR BURLINGTON, IOWA LABS!



Peoria
75 miles away

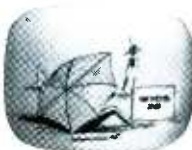

Springfield
110 miles away



Peoria
75 miles away

TWICE

New! Winegard TRACKER all-channel UHF Antenna

- BRINGS HUNDREDS OF THOUSANDS OF TV VIEWERS INTO RANGE OF GOOD UHF RECEPTION FOR THE FIRST TIME.
- The TRACKER, in combination with Winegard's all-new UHF 212 Transistorized amplifier, is the biggest contribution to UHF reception in a decade.
- Brings new plus profit opportunities for thousands of Winegard dealers.

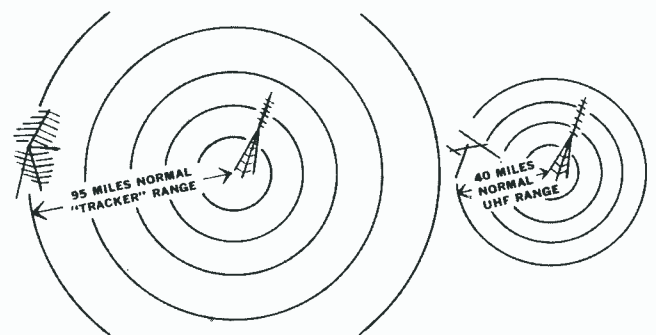

NOW UHF WITH THE SAME LONG DISTANCE RANGE AS VHF

With the development of the Winegard Tracker antenna and UHF 212 transistorized amplifier, UHF has been brought within reach of thousands of customers in your area who were outside UHF reception. This opens a new source of profits to Winegard dealers in the sale of UHF antennas, amplifiers, converters and other UHF accessories.

*At the Winegard laboratories, our engineers have discovered a new and more efficient way to focus the reflected signal (incident wave) on the collector element. For the first time, this made possible a UHF antenna with as good a signal capture ability as a VHF. The first antenna designed around the "controlled incident wave" principal is the Tracker.



Color-Bar Generator Plus (142)

The Model V-7 incorporates the standard features of color-bar generators plus the "Color Vectorscope." This feature provides a visual display for measuring phase and amplitude of R-Y, B-Y, and all ten color bars. Besides the built-in scope display, this unusual new **Lectro-tech** unit includes: a self-calibration feature that permits adjustment of the timing circuits without external test

equipment; "dial-a-line," for adjusting horizontal lines to any desired width between 1 and 4 lines; crosshatch, dots, vertical lines, horizontal lines, and a keyed-rainbow color pattern; adjustable video output with selectable polarity; and red, blue, and green gun killer. This portable color-TV test instrument has permanently attached cables; net price is \$189.50.



Snap-In Electrolytic (143)

This series of aluminum electrolytic capacitors features a new mounting method. **Mallory's** "Snap-Cap" unit is a cardboard tubular wax-filled capacitor with a safety vent and standard wire

leads. A metal ring, permanently attached to the base, allows the dual- or triple-section capacitor to be snapped, with positive alignment, into any metal capacitor-mounting plate. All units are 1" in diameter and rated at 150 working volts DC.



Capacitor Tester (144)

The Model 1400, a reasonably priced in-circuit capacitor tester by **Mercury Electronics Corp.**, cuts capacitor testing

THE RANGE of ordinary UHF antennas!

How good is the Tracker? With pre-amp, it's actually 17 times more sensitive than ordinary UHF antennas.

While other high gain antennas maintain high gain for only about 30% of the band, the Winegard Tracker has extremely high gain across *all* UHF channels 14-83. The Tracker does not favor some channels at the expense of others. Trackers' exceptional VSWR of 1.5: 1 or better on all channels is the best 300 ohm impedance match yet obtained on a broad band UHF antenna. It's an amazing antenna that will extend the range of UHF far beyond what you have previously known.

ADVANCED CONSTRUCTION FEATURES



Tracker is factory pre-assembled, has one-piece mast clamp... light weight... **ALL ALUMINUM (NO STEEL). GOLD ANODIZED** for all weather protection.

COMPACTLY PACKAGED

All elements unfold... snap in place in seconds with Winegard's new snap-lock automatic hardware. Box size 45"x7"x4 1/2".



UHF-212 Amplifier
\$44.95 list

NEW WINEGARD UHF 212 TRANSISTORIZED AMPLIFIER MOUNTS ON TRACKER.

For fringe and difficult reception areas, Winegard's new UHF-212 Twin Transistor amplifier maximizes the pulling power of the TRACKER to bring UHF signals to areas that previously could receive only VHF. It boasts an extremely high gain across all channels, 14-83, with a bandpass of 460MC to 900MC, yet the noise measured figure does not exceed 7DB even at the high end of the band.

The circuitry of the UHF-212 is completely enclosed in a black polystyrene, weather-proof housing with pre-notched twin-lead slots. Included is a unique 5-way mounting bracket for easy attachment to any UHF antenna boom or mast, under a roof eave, on side of house or wall. Separate power supply draws only 1.4 watts, plugs into any 117 VAC, 50 60 CPS outlet, and includes a detachable mounting bracket.

Try the TRACKER and UHF 212 now. See for yourself the best-performing UHF antenna and pre-amp on the market. Write for spec. sheets today.

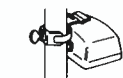

NEW UHF-VHF COUPLER CA-283—Serves as coupler or splitter for channels 2-83. List \$4.50.



NEW UHF-VHF PIGTAIL SPLITTER (CS-283)—Attaches to back of set. Separates UHF-VHF to proper terminals. List \$3.00.



NEW SUPER COUPLERS—2 set CC200 list \$4.50, 4 set CC400 \$5.50.



NEW MATCHING TRANSFORMER (TU-1483)—for channels 14 to 83, 75 to 300 ohm. List \$5.00.



UHF ANTENNA AMPLIFIER (UHF-110X)—Single transistor amplifies channels 14-72 only. List \$34.95. UHF-110T—translator model. List \$34.95.



Winegard Co.

ANTENNA SYSTEMS

3009J Kirkwood • Burlington, Iowa

Circle 53 on literature card

www.americanradiohistory.com

NEW SAMS BOOKS

Know Your Color-TV Test Equipment

by Robert Middleton. To use Color-TV test equipment properly, the technician must understand its capabilities and limitations, and its proper application. This book explains clearly and easily the function and circuit action of each Color-TV instrument—shows how to service, calibrate, and maintain it for continuous, reliable service. Covers: White-Dot and Cross-Hatch Generators, Color-Pattern & Color-Bar Generators, Rainbow & NTSC Generators, Principles of Video-Frequency Sweep Generators & Testing, Lab-type equipment, and useful setup information. Profusely illustrated. An invaluable book for anyone using Color-TV test equipment. 5½ x 8½". Order KOC-1, only. . . . \$250

Radio Service Training Manual

by Edward P. Rice. Offers an extremely successful system for quickly locating troubles in radio receivers—based on the use of carefully selected key circuit points, where test results will give positive indications. Programmed trouble-shooting charts show how to quickly isolate trouble to specific components. Covers both tube and transistor type receivers. Fully illustrated. 5½ x 8½". \$495
Order RSS-1 (softbound), only. . . . \$6.95
Order RSH-1 (hardbound), only. . . . \$6.95

Radar License Endorsement Handbook

by Edward M. Noll. Provides all the information needed to pass the FCC Element 8 license examination for the radar endorsement. Provides, in addition, a firm grasp of radar fundamentals, plus a practical knowledge of modern marine and other radar equipment. The book includes tables, laws, and procedures which will remain permanently helpful after you have passed the examination. 5½ x 8½". \$295
Order RLH-1, only. . . . \$295

ONLY COURSE OF ITS KIND
5-Volume HOWARD W. SAMS

Basic Electricity/Electronics

New, unique positive training worth hundreds of dollars. First completely new course to be published in the last 10 years...using the latest programmed method for quick, effective learning.

Vol. 1. Basic Principles & Applications
Vol. 2. How AC & DC Circuits Work
Vol. 3. Understanding Tube & Transistor Circuits
Vol. 4. Understanding & Using Test Instruments
Vol. 5. Motors & Generators—How They Work

(Complete Set contains over 1300 pages; 1250 illustrations; 51 chapters; in sturdy slipcase)
Order ECY-50, only. . . . \$1995

Mathematics for Electronics Engineers & Technicians

by Norman H. Crowhurst. This book, intended for the use of the advanced technician and engineer, helps to bridge the gap between "book learning" and practical experience. Uses a unique programmed method showing how to apply textbook math toward the solution of practical problems in electronics. Begins with Ohm's and Kirchhoff's laws and goes on to selective networks, properties of coils and transformers, feedback circuits, etc. 5½ x 8½". \$695
hardbound. Order MEA-1, only. . . . \$695

TV Receiver Tube Usage Guide

A "must" for the shop and the tube caddy—saves time and eliminates wasted service calls. Lists all tubes, semiconductors, and fuses used in 1963-64 TV receivers, so you can quickly check your caddy before you start out on a service call, to see whether it contains the proper tubes. Tubes are listed by function; a tube usage section provides a valuable guide to proper tube stocking. Where wire or circuit-breaker performs fuse function, this fact is noted. Indexed by receiver model and chassis number. Includes information on alternate tubes when used. 5½ x 8½". Order TUR-1, only. . . . \$195

HOWARD W. SAMS & CO., INC.

Order from your Sams Distributor today, or mail to Howard W. Sams & Co., Inc., Dept. PF-10, 4300 W. 62nd Street, Indianapolis, Ind. 46206

Send me the following books:

KOC-1 RSH-1 ECY-50 TUR-1
 RSS-1 RLH-1 MEA-1

\$ _____ enclosed. Send FREE Booklist

Name _____

Address _____

City _____ State _____ Zip _____

My Distributor is _____

IN CANADA: A. C. Simmonds & Sons, Ltd., Toronto 7

time by eliminating unsoldering and resoldering. The unit tests capacitors in the circuit for shorts and opens and gives an approximation of the capacitance value. Shorted capacitors with shunt resistance as low as 6 ohms can be detected; open capacitors as small as 7 mmf shunted by resistance as low as 150 ohms can be detected: electrolytics from 2 mfd to 450 mfd are tested for value. A special low test voltage of 2.9 volts prevents damage to the new low-voltage electrolytics used in transistorized equipment; this is an important feature, as low-voltage electrolytics are being used more and more today. Price of the unit is \$29.50 net.

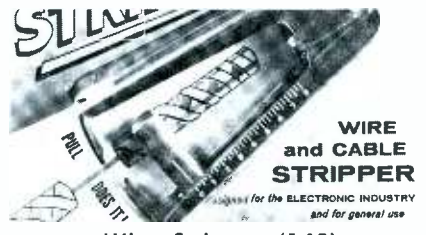

Wire Stripper (145)

The new "Strip-It" wire and cable stripper is designed to offer ease and simplicity of operation. Small enough to fit into the palm of a hand, the stripper adjusts instantly to any wire size by finger-tip adjustment of a stop. Insulated wire is prepared by inserting the end of the wire into the tool, closing the jaws, twisting, and pulling. This Audiophonics tool can also be used to cut wire or

cable. Replacement steel blades are available and are easily installed.

New Literature

Technical Booklets You Can Buy



Commercial Loudspeaker Booklet (146)

University Loudspeakers, Inc. has prepared "The University Technilog on Loudspeakers" for the commercial sound-system installer and designer. The 64-page booklet covers each type of loudspeaker and gives a full set of specifications directed to the technician and to the architect who may need to know more about speaker location and installation. Much useful information concerning the technical aspects of loudspeakers—phasing, power ratings, response, impedance matching, and suitable enclosures—is also included for each loudspeaker. In addition to specifications for commonly-used types, notes are provided for using high-fidelity speakers in commercial installations. The "Technilog" is priced at \$1.00, from University Loudspeakers, Inc., 80 South Kenisco Avenue, White Plains, New York. ▲

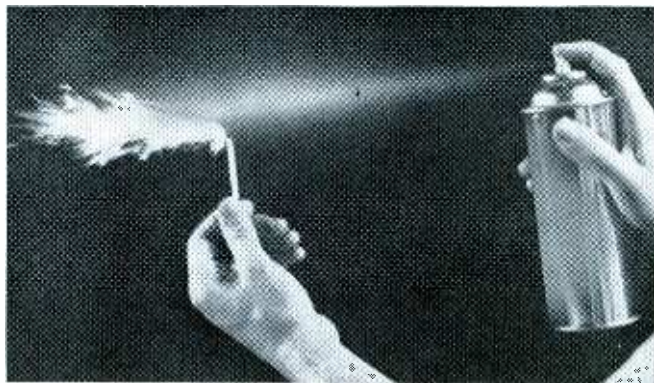

Are You Using a Safe Tuner Cleaner ...or a Flame Thrower ?

Put your tuner cleaner to the 'match-test'. If Chemtronics Tun-O-Lube is not your brand . . . take extreme care. If Chemtronics Tun-O-Lube is a steady companion on your service calls then you already know it is 'GUARANTEED NON-FLAMMABLE'.

Tun-O-Lube is the original deluxe quality tuner cleaner and lubricant. It is specially formulated to be particularly non-corrosive, quickly loosen particles from contacts, and of course . . . to be absolutely harmless to all types of plastics used in television tuners.

Chemtronics Tun-O-Lube is the preferred choice of TV service and repairmen throughout the world. It has been for a long time . . . perhaps a tribute to our leadership is the fact that recently there has been a veritable epidemic of attempted copies of our cleaner. Chemtronics Tun-O-Lube cannot be duplicated, it was developed through many years of dedicated service and remains the undisputed leader in the Tuner Cleaner Field. Don't be switched . . . ask for it by name.

CHEMTRONICS INC., 1260 Ralph Avenue, Brooklyn 36 N. Y.

Circle 54 on literature card

BOOK REVIEW



Handbook of Electronic Tables and Formulas, Second Edition

Howard W. Sams Engineering Staff; Howard W. Sams and Co., Inc., Indianapolis, Ind.; 192 pages, \$3.95. The title of this book might lead one to believe that the entire contents of the volume was in the form of formulas and mathematical tables. In fact, these useful aids comprise only a relatively small part of the electronic reference information available in this revised and expanded edition. A complete listing of the comprehensive coverage this book gives to a broad range of electronic subjects would be nearly impossible, but an examination of the general areas covered should give one a good idea of the scope of the handbook.

The first section is devoted to a discussion of the basic laws and most commonly used formulas. Included are nomographs, conversion charts, and a table of decibel equivalents. The second section contains such highly diverse items as a detailed table of conversion factors (kilowatt hours to joules, kilometers to feet, etc.), an analysis of standard frequencies and time signals from WWV, the content of the composite television signal according to FCC specifications, and the requirements for various classes of FCC licenses. The remaining sections on Symbols and Codes, Service and Installation Data, Design Data, Mathematical Tables

and Formulas, and Miscellaneous Data are equally varied and useful in content.

The Oscilloscope, Second Edition

George Zwick; Gernsback Library, Inc., New York, N.Y.; 224 pages, \$3.65. Many books have been written about test equipment operation and applications, some too basic for wide appeal and some lacking enough practical information to be initially valuable to the less-experienced technician. To properly familiarize the reader with the use of an instrument, a manual must provide him with a good working knowledge of what goes on behind the control panel. *The Oscilloscope* is based on this premise.

Pointing out that, unlike most other popular test instruments, an oscilloscope depends to a great extent on the operator's ability to properly set up a test and interpret the results, the author first lays a solid groundwork of scope-circuit functions and then explains techniques and usage. In the first chapter, the basic function of cathode-ray-tube devices is set forth; the nature of waveforms and their properties are discussed. Next, the cathode ray tube is analyzed, as are the means of controlling the electron beam. The next two chapters explain sweep systems, the makeup of typical scopes, and the differences between instruments for various applications.

With equipment familiarity thus established, the remainder of the book discusses techniques particular to the oscilloscope, measurements and tests, methods of receiver alignment employing a scope, and experimental procedures which can help the operator become comfortable with external oscilloscope features and interpretation of the scope indications.

Winegard

Dealer of the month

No. 26 of a Series

Don Schmelzer says: "Our success has been built on quality products and service . . . that's why we specify Winegard."



Winegard salutes Suburban Television and Appliances, Matteson, Illinois and their distributor, Melvin Electronics, Oak Park, Ill.

Don Schmelzer has been building a service business in the Chicago suburb of Matteson for 3 years now after spending 11 successful years in Chicago Heights. His service area reaches out in a heavily populated 15 mile radius where he installs several hundred Colortron C-41's each year.

"After trying many other brands over the years, we've gone to Winegard Colortron...in our opinion, it's the best TV antenna on the market." Don has been especially pleased with the fine color reception he gets with Colortron. "Here in the Chicago area where we have two very popular stations transmitting in color, we specify Winegard for every one of the many color installations we make."

The confidence Don Schmelzer has shown in Winegard comes from installing Winegard antennas and seeing them in action. He's one more important service man who knows Winegard's standards of excellence first hand.

Winegard Co.
Antenna Systems
D3009J Kirkwood • Burlington, Iowa
Circle 55 on literature card

INDEX TO ADVERTISERS

ATR Electronics, Inc.	14
Admiral Sales Corp.	72
Alliance Mfg. Co.	61
Amperex Corp.	Cover 2
Antennacraft Co.	52, 72
Atlas Sound	94
Belden Mfg. Co.	15
B & K Mfg. Co.	50, 51, 53
Div. of Dynascan Corp.	
Bussmann Mfg. Div.	20-21
Castle TV Tuner Service	18
Channel Master Corp.	47, 49
Charles Engineering, Inc.	74
Chertronics, Inc.	78
Cleveland Institute of Electronics	39
Cornell-Dubilier Electric Corp.	26
Electro-Voice, Inc.	44
Electronics Communications, Inc.	95
Finney Co.	40-41
GC Electronics Co.	58
General Electric	24-25
Hallcrafters Co.	96
Heath Co.	73
Hi-Lo Antenna Co.	38
Hickok Electrical Instrument Co.	13, 57
JFD Electronics Corp.	16-17
Jensen Industries	14
Jerrold Electronics	22-23
Kinematix, Inc.	72

Lafayette Radio Electronics Corp.	93
Lectrotech, Inc.	75
Littelfuse, Inc.	Cover 4
Miller, J. W. Co.	94
Minnesota Mining and Mfg. Co.	54
Multicore Sales	46
Nortronics Co., Inc., The	46
Oxford Transducer Co.	59
Perma-Power Co.	64
Phileo Corp.	84-85
Planet Sales Corp.	74
Precision Tuner Service	48
RCA Electronic Components and Devices	Cover 3, 65, 89
RCA Institutes, Inc.	55
Rohn Mfg. Co.	68
Sadelco, Inc.	48
Sams, Howard W. and Co., Inc.	31, 78
Sarkes Tarzian, Inc. Tuner Service	9
Seco Electronics, Inc.	45
Semitronics Corp.	60
SENCORE, Inc.	67, 69, 70, 71, 90, 91
Simpson Electric Co.	19
Sonotone Corp.	92
Sprague Products Co.	11, 12
Switchcraft, Inc.	54
Sylvania Electric Products, Inc.	43
Trio Mfg. Co.	56
Winegard Co.	62, 63, 76, 77, 79
Workman Electronic Products, Inc.	48
Xcelite, Inc.	44



FREE Catalog and Literature Service

*Check "Index to Advertisers" for further information from these companies.

Please allow 60 to 90 days for delivery.

SPECIAL EQUIPMENT

113. **ANTENNA SPECIALISTS**—Literature describing line of portable AC-power equipment and charting wattage requirement.
114. **GREYHOUND**—The complete story of the speed, convenience and special service provided by the Greyhound Package Express method of shipping, with rates and routes.
115. **VOLKSWAGEN**—Large, 60-page illustrated booklet, "The Owner's Viewpoint," describes how various VW trucks can be used to save time and money in business enterprises, including complete specifications on line of trucks.

TECHNICAL PUBLICATIONS

116. **CLEVELAND INSTITUTE OF ELECTRONICS**—"Pocket Electronics Data Guides" with handy conversion factors, formulas, tables, and color codes. Additional folder, "Careers and Opportunities in Electronics," describes home-study electronic training program, including preparation for FCC license exam.*
117. **RCA INSTITUTES**—64-page book, "Your Career in Electronics," detailing home study courses in TV servicing, communications, automation, drafting, and computer programming; for beginners and experienced technicians.*
118. **HOWARD W. SAMS**—Literature describing popular and informative publications on radio and TV servicing, communications, audio, hi-fi, and industrial electronics, including special new 1964 catalog of technical books on every phase of electronics.*

TEST EQUIPMENT

119. **B & K**—Catalog AP-21R describing uses for and specifications of new Model 1074 Television Analyst, Model 1076 Television Analyst, Model 850 Color Generator, Model 960 Transistor Radio Analyst, new Model 445 CRT Tester-Rejuvenator, new Model 250 Substitution Master, Model 375 Dynamic VTVM, Model 360V-O-Matic VOM, Models 700 and 600 Dymo-Quik Tube Testers, and Model 1070 Dyna-Sweep Circuit Analyzer.*
120. **EICO**—New 32-page, 1964 catalog of test instruments, hi-fi components, tape recorders, and Citizens band and amateur radio equipment.
121. **HICKOK**—Complete description and specification information on newly introduced equipment—Model 662 installer's color generator; Model 580 portable tube tester; Model 727 multiplex generator; Model 235A portable field-strength meter.*
122. **JACKSON**—Complete catalog describing all types of electronic test equipment for servicing and other applications.
123. **MERCURY**—Complete catalog on line of test equipment to help the serviceman.
124. **SECO**—New color folder describing complete line of test equipment, including color-bar generators, tube testers, and semiconductor testers.
125. **SENCORE**—New color catalog on complete line of company products; oscilloscopes, generators, testers, and many others.*
126. **SIMPSON**—Complete 16-page brochure on entire line of electronic test equipment.*

TOOLS

127. **ACME LITE**—Descriptive bulletin on line of *Magniflex* fluorescent lamps.
128. **ADEL**—Literature on "Nibbling Tool" that cuts, notches, and trims round or irregular holes to any size over 7/16"; ideal for radio chassis, templates, or shims.
129. **ENTERPRISE DEVELOPMENT**—Time-saving techniques in brochure from Endeco demonstrate improved desoldering and resoldering techniques for speeding up and simplifying operations on PC boards.
130. **LUXO LAMP**—Catalog on line of "touch-and-stay-put" lamps.
131. **VACO**—Condensed catalog sheet on hand tools and solderless terminals.

TUBES & SEMICONDUCTORS

132. **GENERAL ELECTRIC**—New pocket-folder wall chart with condensed, but comprehensive, listings of semiconductor rectifiers, zener diodes, controlled rectifiers, etc.*

ANTENNAS & ACCESSORIES

68. **ALLIANCE**—Colorful 4-page brochure describing in detail all features of the famous *Tenna-Rotors*.*
69. **ANTENNACRAFT**—Latest information on FM antennas, featuring new omnidirectional model for multiplex or monophonic broadcasts.*
70. **FINNEY**—Catalog No. 20-307 listing four newly announced multielement, single-boom, VHF-FM antennas.*
71. **JERROLD**—Illustrated brochure describing full line of new antenna preamplifiers and *Paralog* antennas.*
72. **JFD**—Literature on complete line of VHF, UHF, FM, and FM-stereo antennas. Brochure showing converters, amplifiers, and accessories; also complete 64-65 dealer catalog.*
73. **MOSLEY ELECTRONICS**—Illustrated catalog giving specifications and features on large line of antennas for Citizens band, amateur, and TV applications.
74. **SPAULDING**—Specification booklet on all types of antenna towers for TV, ham, and commercial applications.
75. **STANDARD KOLLSMAN**—Catalog sheet on UTC-051 transistor UHF converter kit with IF amplifier.
76. **TRIO**—Brochure on installation and materials for improving UHF translator reception.*
77. **WINEGARD**—"Factfinders" describes channel coupler that couples, equalizes, and matches any number of yagis to single downlead; also information on twin-transistor antenna pre-amp.*
78. **ZENITH**—Informative bulletins on universal loudspeakers and a new line of log-periodic vee-type antennas for FM and monochrome or color TV.

AUDIO & HI-FI

79. **ADMIRAL**—Parts and accessories catalog listing replacement components; also includes cross reference for phono needles and cartridges.*
80. **ASTATIC**—Catalog #111 on microphones, phono cartridges, and needles.
81. **ATLAS SOUND**—New 1964 catalog No. 564 contains illustrations and specifications on PA speakers, microphone stands for commercial and industrial installations, and other new products.*
82. **GIBBS SPECIAL PRODUCTS**—Folders describing principles of sound reverberation and *Stereo-Verb* reverberation units for automobiles.
83. **NUTONE**—Two full-color booklets illustrating built-in stereo music systems and intercom-radio systems. Includes specifications, installation ideas, and prices.
84. **OAKTRON**—"The Blueprint to Better Sound," an 8-page catalog of loudspeakers and baffles giving detailed specifications and list prices.
85. **OXFORD TRANSDUCER**—Product information bulletin describing complete line of loudspeakers for all types of sound applications, including replacements for public address and intercom systems.*
86. **PERMA - POWER**—New catalog sheet on all-transistor background music and paging amplifier Model S-400.*
87. **PRECISION ELECTRONICS**—Specification sheets on AM, FM, FM-MPX tuner and stereo amplifier; also sheets on public-address line.
88. **QUAM-NICHOLS**—General catalog listing replacement speakers for public address, hi-fi, and radio-TV applications.
89. **RECOTON**—Simplified phonograph needle replacement guide, 11th edition.
90. **SONOTONE**—New audio-products catalog SAH-76, containing photos and specifications on phono needles, cartridges, microphones, and speakers.*

91. **SWITCHCRAFT**—Products bulletin 144 describes new molded coil-cord assemblies with straight, right-angle and/or microphone connectors; also latest catalog on complete line of audio connectors.*
92. **UNIVERSITY**—Guide to stereo high fidelity; also specifications on Models 8000 and 8100 dynamic cardioid microphones.
93. **WATERS CONLEY**—Full line catalog sheet showing new line of stereophonic and hi-fidelity phonographs.

COMMUNICATIONS

94. **LAFAYETTE**—Complete information on obtaining a dealership for new line of Citizens band equipment.*
95. **SONAR RADIO**—Specification sheet on Model BR-21 linear RF power amplifier, AC or DC operated units available.
96. **PEARCE-SIMPSON**—Specification brochures on *Companion II* and *Escort* Citizens band transceivers.

COMPONENTS

97. **ANTRONIC**—Catalog sheet on new products being introduced to the industry; includes tube and continuity checker.
98. **BUSSMANN**—Bulletin SFUS listing complete line of Buss and Fusetron small-dimension fuses by size and type. Indicates proper fuse holders and gives list prices.*
99. **CHANNEL MASTER**—Booklet containing information on *Contact Shield*, a silicone-base contact conditioner that cleans, lubricates, and protects.
100. **COMPONENTS SPECIALIST**—Catalog listing line of *Speco* electronic replacement components.
101. **CORNELL - DUBILIER**—Replacement component selector, TV-FM reception booklet, and 4-page rotor brochure.*
102. **E-Z-HOOK**—Catalog sheets showing complete line of test connectors, harness cable board binding posts, and test leads and clips.
103. **GC ELECTRONICS**—Updated Walsco phono drive chart #FR-236-W.*
104. **J-B-T- INSTRUMENTS**—General catalog 563A has information on frequency meters, elapsed-time meters, and numerous relays and switches.
105. **MILWAUKEE RESISTOR**—Information on transistorized ignition system, wire-wound and rib-wound resistors.
106. **RCA BATTERIES**—Brochure 1P1162 illustrating various selections of counter display racks and promotional items for radio batteries.
107. **SARKES TARZIAN**—Service bulletin 64-SB-6 gives quick cure for focus problems in color television receivers.*
108. **SPRAGUE**—Latest catalog C-616 with complete listing of all stock parts for TV and radio replacement use, as well as *Transfarad* and *Tel-Ohmike* capacitor analyzers.*

SERVICE AIDS

109. **CASTLE**—How to get fast overhaul service on all makes and models of television tuners is described in leaflet. Shipping instructions, labels, and tags are also included.*
110. **PENCO**—48-page catalog of work benches and steel storage equipment.
111. **PRECISION TUNER**—Literature supplying information on complete, low-cost repair and alignment services for any TV tuner.*
112. **YEATS**—The new "back-saving" appliance dolly Model 7 is featured in a four-page booklet describing feather-weight aluminum construction.



SPECIAL
COMMUNICATIONS
SUPPLEMENT

REBUILDING CARBON MICS

Specifics of
preventive maintenance
and repair.
by Larry Allen

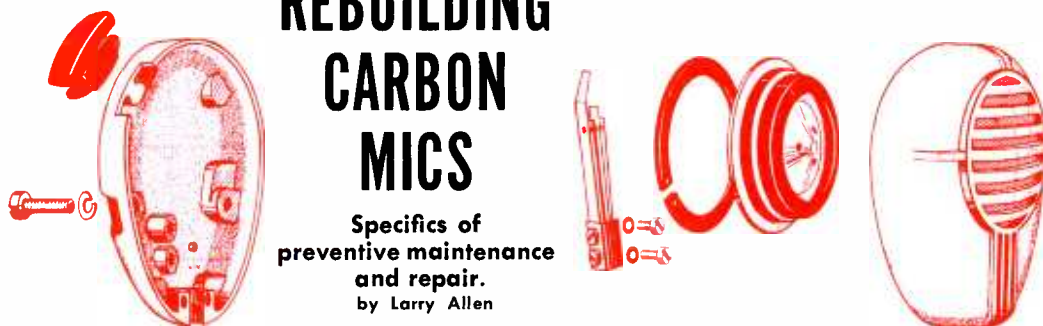

One of the oldest electronic devices is the carbon microphone. It dates back to the earliest days of wired telephony, and remains today as a highly dependable and effective type of microphone for voice communications. The rugged carbon mike absorbs more shock, withstands greater temperature extremes, and requires less maintenance than almost any microphone yet devised. Modern dynamic mikes may offer greater clarity, and transistorized units more output, but the workhorse of the communications field remains the sturdy carbon-button microphone.

Yet, even these units develop certain problems. Output may deteriorate; transmitter keying may become intermittent; the unit may appear completely dead. To the observant communications technician, however, most troubles in carbon mikes can be analyzed and solved with ease, for these units are decidedly uncomplicated. Grouping symptoms suggests that mike faults can be similarly grouped into recurring troubles.

Analyzing Symptoms

A dead mike—one that keys the transmitter on, but provides no voice modulation—is usually considered the easiest of all to service. On the other hand, it may be a bit less simple if the unit is dead only part of the time—in other words, an intermittent. The trouble can range all the way from the plug to the carbon element itself, although the latter is not often the cause of a dead mike. To be dead, a mike need only have an open in either lead of the two-wire circuit (Fig. 1) associated with its audio portion. Obviously, this can be caused by nonclosing contacts on the push-to-talk switch, a break in any portion of either wire, or a poor contact in the pins of the plug.

A nonkeying microphone—one that won't even turn on the transmitter—can be suffering from any of the above symptoms, in either of the two wires associated with keying. In this case, too, the symptom may be intermittent. A variation of the nonkeying mike is the one that sometimes (or all the time) keeps the transmitter on; with a little thought, you will deduce that something—either the switch or broken insulation—is keeping the two wires shorted together.

The weak carbon microphone—not enough modulation—is encountered less often than either of the first two troubles, but often enough to merit consideration. Distortion is less easy to spot because—let's face it—the fidelity of a carbon mike isn't exactly wideband to start with.

Considering these few possible symptoms, you can work out a program of servicing these units thoroughly . . . a series of troubleshooting steps that will reveal any possible malfunction and eliminate it. In other words, if a quick analysis and inspection fails to reveal the fault, you can overhaul an entire microphone-and-cord assembly in very short order by following a set procedure from start to finish.

First, A Quick Check

If a transmitter isn't available for bench-testing a suspected microphone, your ohmmeter offers a quick means for checking it out. A closer examination of the wiring diagram

of a typical mike (in Fig. 1) will clarify these checks for you.

If the microphone is operating properly, the ohmmeter should show infinite resistance between any pin of the plug and all others, with the push-to-talk button untouched. With the button depressed, you should read a dead short between pins 3 and 4 of the plug, and from 200 to 1500 ohms between pins 1 and 2. Obviously, a mike of another brand, with a different pin-wiring arrangement, would read accordingly; however, comparison of readings with the mike's schematic should make analysis easy.

Lastly, read the resistance of the element while whistling into it. The change in ohmmeter reading should be quite noticeable with each whistle. The direction of change is immaterial; just notice if the change is significant—20% to 50% is not out of the ordinary.

With the above standards as a guide, and looking back at the symptoms we've already described, we can find ways to correlate them and perhaps speed our diagnosis.

A dead mike would undoubtedly cause the ohmmeter to show infinite resistance between pins 1 and 2, even though the button is pressed. (The keying leads could be all right, in which case the ohmmeter would indicate zero ohms between pins 3 and 4 with the button down.) As indicated before, the actual fault could be in the switch, the cord, the carbon element, or the plug.

A nonkeying mike would fail to show continuity from pin 3 to pin 4, even when the switch button is depressed. On the other hand, if a short appeared across these two pins without the button down, the mike would key the transmitter constantly.

A weak or distorted mike would be less likely to be spotted through

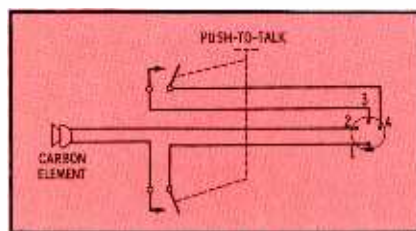

Fig. 1. Typical microphone has separate wiring circuits; one for audio, one for keying.

an ohmmeter quick-check, but some clues might still be noticeable. For example, if the carbon granules were impacted in the element (a common cause of weak output), a constant and unusually low reading would result on the ohmmeter. As we pointed out earlier, the reading should be above 200 ohms in most mikes, and should vary significantly with whistling. Another occasional cause of weak output and distortion is the capacitor across the carbon element; if it becomes leaky, it will cause the same ohmmeter indications as a faulty element.

The aforementioned quick-check procedures can give you only a general indication of the fault. You have yet to decide what to do about it. There are two approaches: Trace down the exact trouble spot, or simply put the mike through a complete rebuilding procedure. Because of the nature of microphone defects, and because of the importance of thorough servicing, experience has proven that the latter—when conducted in the correct manner—is by far the superior approach. The procedures we'll outline here, if followed in proper order, will result in a quick repair (if that is all that is needed) or a timely and thorough overhaul.

Start With the Plug

A majority of microphone faults are caused by a broken wire at or near the plug. This sounds like a rather flat statement, but it is true. The problem is so common that many technicians include a new



Fig. 3. A close visual inspection, while pressing switch, helps to locate the trouble.

plug-dress job as part of any microphone repair.

Fig. 2 shows how simple plug redress really is. A pair of diagonal cutters clips the cord (Fig. 2A) about 1" from the plug, beyond the point where the coil-cord receives constant flexing. Then disassemble the plug and ferrules as shown in Fig. 2B; keep track of the tiny set-screw, for it's easy to lose. Make a chart of which colored wire goes to each pin, to avoid a mixup later. Clean the old wiring from the pins, as shown in Fig. 2C, by holding one pin with needle-nose pliers while the others are heated, then rapping the pliers against the edge of your bench.

To dress the fresh end of the coil-cord, remove enough of the rubber coating that houses the four wires to expose about 1 1/4" of each insulated wire—Fig. 2D; a single-edge razor blade makes an excellent tool for this step. Remove about 3/4" of insulation from each wire, twist the strands securely, and tin these bare portions thoroughly (this is an important step)—Fig. 2E.

One at a time, insert the wires into the proper pin in the plug and solder them as shown in Fig. 2F. Don't use excessive solder; the prior

tinning will make soldering inside the pins quite easy. Reassemble the plug, and you have eliminated the most probable cause of a dead or nonkeying mike.

At the Mike

Constant flexing of the cord near the mike creates a problem similar to that at the plug. But, before you spend time redressing the cord there, certain simple tests will possibly save you the trouble by indicating a fault inside the mike shell. Of course, you may still wish to redress the cord later, as we'll point out; but first concentrate on the mike itself, particularly if the preceding step didn't eliminate the trouble symptoms.

Open the mike shell by removing two screws at the rear. All there is to check inside the mike shell is the switch, a capacitor, and the carbon cartridge. You can test the switch first, since it is easiest.

Checking the Switch

With the microphone lying disconnected on the bench, make a visual check of switch action (Fig. 3). Both contact sets should close at approximately the same time; if one pair closes slightly before the other, be sure it is the pair that activates the carbon element—not the keying-contact pair.

If you find it necessary to adjust any of the leaves, here is exactly how it should be done: First, make sure the contacts are clean, and that the main leaf (the one that contacts the button) is exactly straight; if this

• Please turn to page 94



A



B



C



D

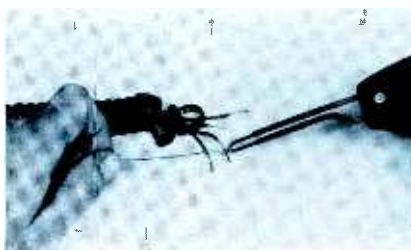

E



F

Fig. 2. Several important steps are necessary to properly redress cable wires to the connecting plug.

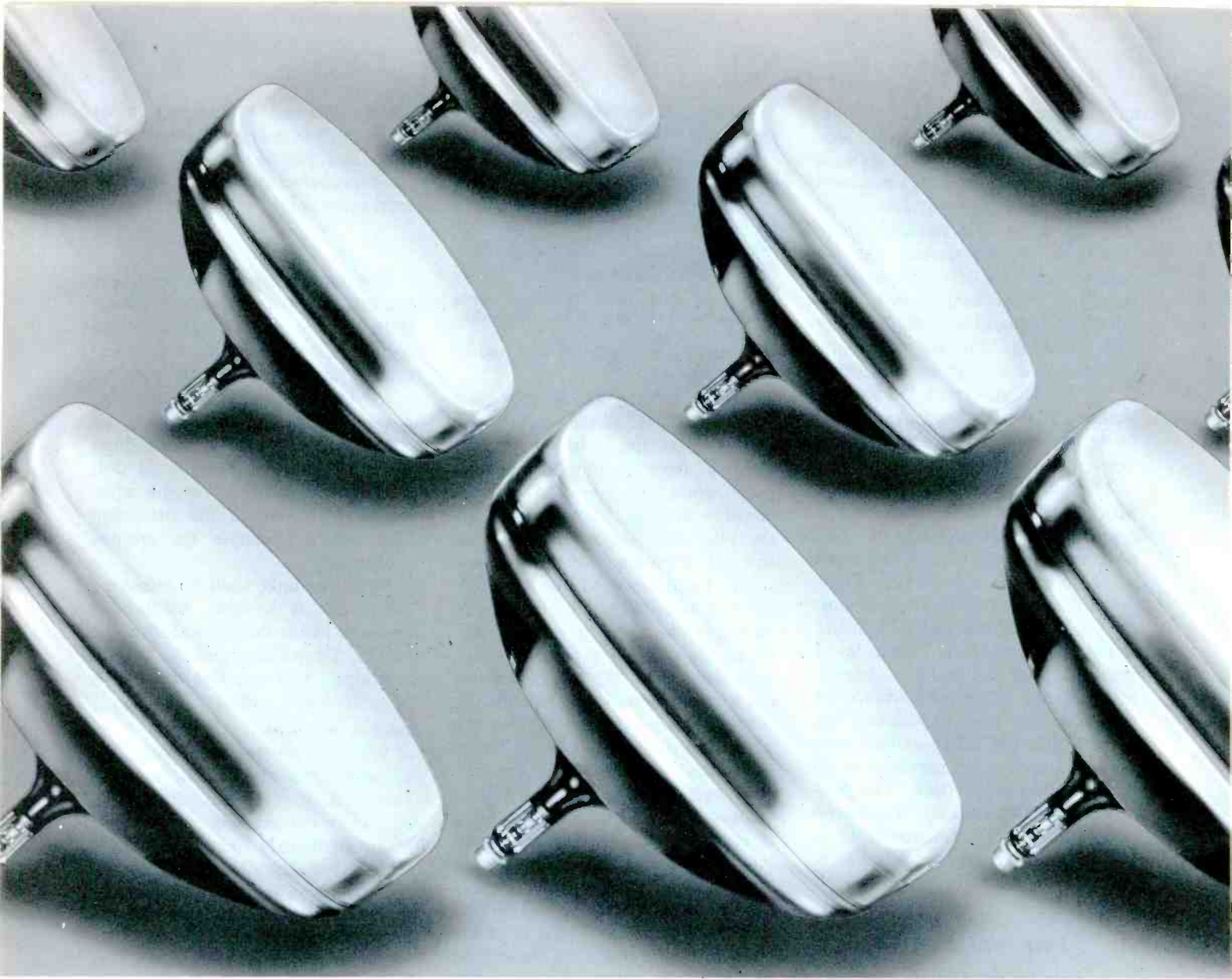

THE QUALITY OF YOUR SERVICE DEPENDS ON THE PARTS YOU USE...DEPEND

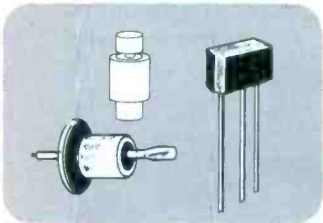

Diodes, Rectifiers, Condensers and Resistors
Complete variety for all makes and models.

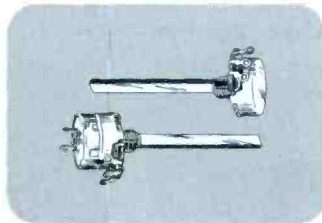

Universal Controls
With or without on-off switch. Standard taper, 3 inch shaft, half flat. 1 meg, 2 meg, 500 K. Complete selection. Fit Philco and other makes.

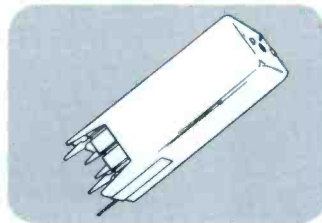

I.F. Transformers
For printed circuits, 4 lug, 5 lug or 6 lug types . . . to fit Philco or other makes. Dependable Philco Quality.

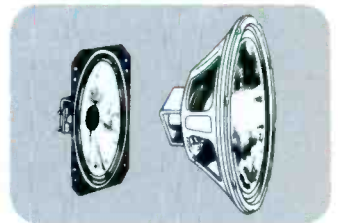

Replacement Speakers
All sizes, round, oval or rectangular types. 3.2, 8, 16, 20 ohms. From tiny 1 3/4" to giant 15" sizes.



Philco Receiving Tubes
To fit any make, any model TV or radio, manufactured to exact Philco standards, thoroughly inspected. Original factory cartons.



Rotary Switch Antenna
High gain type with 6 position switch for best possible signal selectivity. 3 section brass dipoles. Padded cast iron base.



Contact Cleaner
Philco TV and Radio Contact and Control Cleaner, Lubricant in self spray can, complete with protective cap and spray nozzle.



Philco TV Yoke
Genuine Philco TV yokes, made to original factory specifications. Accurately wound and inspected. Packed in individual boxes, ready to install.

There's a Philco Fully Stocked Parts Center Near You!

IF YOU NEED A PHILCO PART...YOU CAN GET IT FAST...HERE'S WHY

1. Philco has a nationwide network of Parts distributors—THERE'S one in your area.
2. Philco distributors are backed up by Parts Warehouses with millions of dollars in Parts inventory.
3. NEW Parts for NEW Philco models are shipped automatically along with the NEW products.
4. All Parts orders are handled by experienced Parts specialists.
5. ALL EMERGENCY orders are transmitted over the nation's largest industrial communications system and processed within 24 hours.

Whatever you need—whenever you need it—if it's a Philco Part just dial your Philco distributor. He has thousands of Philco Parts right now on his shelves. If the item you need is temporarily out of stock—he can get it for you FAST. You may DEPEND on your Philco Parts distributor.

Customer Confidence Begins When You Use Genuine Philco Star Bright 20/20 Picture Tubes

Every CR Tube you replace represents a high-dollar service sale for you . . . and your customer. Play it safe with a brand that's known for Quality . . . PHILCO. All material and parts used in the manufacture of Philco Star Bright 20/20 Picture Tubes are new except for the envelope, which prior to reuse, has been inspected and tested to the same standards as new envelopes.

ON YOUR PHILCO DISTRIBUTOR FOR ALL YOUR PARTS AND ACCESSORIES



M62A 4-speed Record Changer
Intermixes all size records. Light-weight tone arm with retractable scratch protection assembly and famous Euphonics U8 cartridge. Changer ideal for built-in installations or "modernizing" record playing equipment. Template and instructions included.

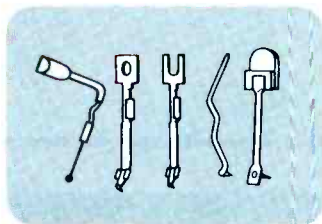

Philco Phono Needles
A complete selection of types and numbers for Philco and most all other makes. Carefully made, attractively-packaged. ALL TIP TYPES and sizes, including Diamond. Special now available—"THE BIG 18 KIT." This attractive compact metal case contains 18 of the industry's fastest selling needles.

Your Philco Distributor Features These Famous Makes

PHILCO • PHILCO-Bendix • CROSLEY • EVEREADY Batteries and Flashlights • CAROL Cables • GOODRICH V-Belts • GC Products • AUDIOTEX • WALSCO Products • COLORMAGIC Antennas • PRECISION Test Equipment • SPRAGUE Capacitors

Philco Parts are Available Through a nationwide network of Parts Distributors. Mail the Coupon Today for the Name of the One Nearest You.



PARTS AND SERVICE OPERATIONS

PHILCO

A SUBSIDIARY OF *Ford Motor Company*

Philco Parts & Service Operations
C & Tioga Streets, Phila. 34, Pa.

I am interested in receiving information about special Philco Parts offers, prices and facts. Please send me the name of the nearest Parts distributor.

Name _____

Address _____

City _____ Zone _____ State _____

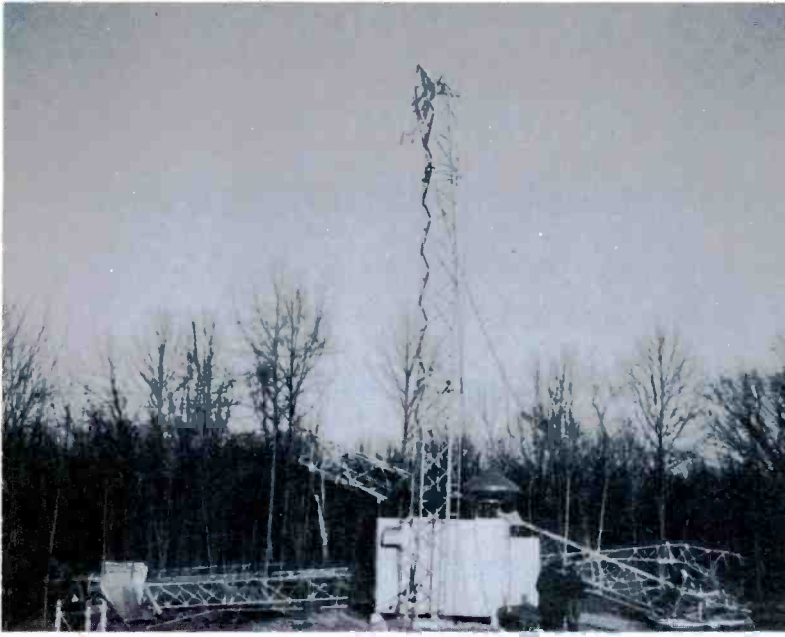

Inspection and maintenance could prevent mishaps such as this.



COMMUNICATIONS TOWER MAINTENANCE



Tighten U-bolts on both sides of replacement strain insulator.



Series dynamometer used for checking and adjusting guy tension.

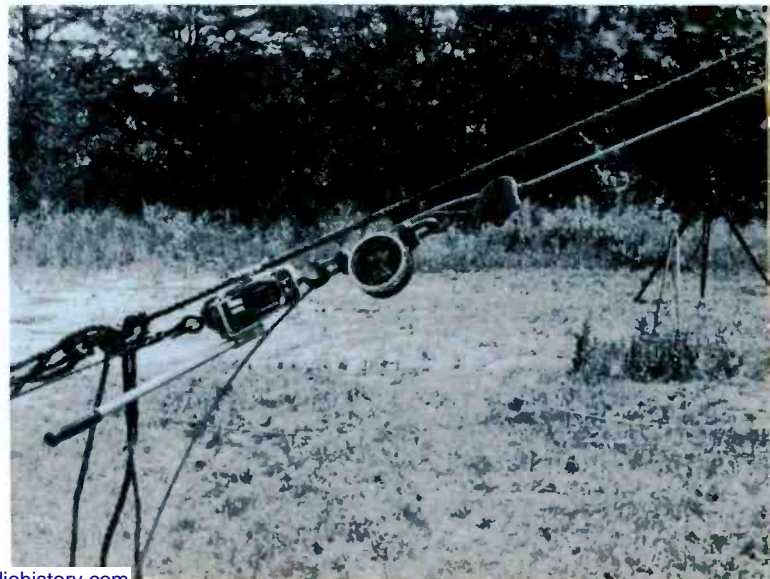



Climb inside, whenever possible, and wear rubber-soled shoes.

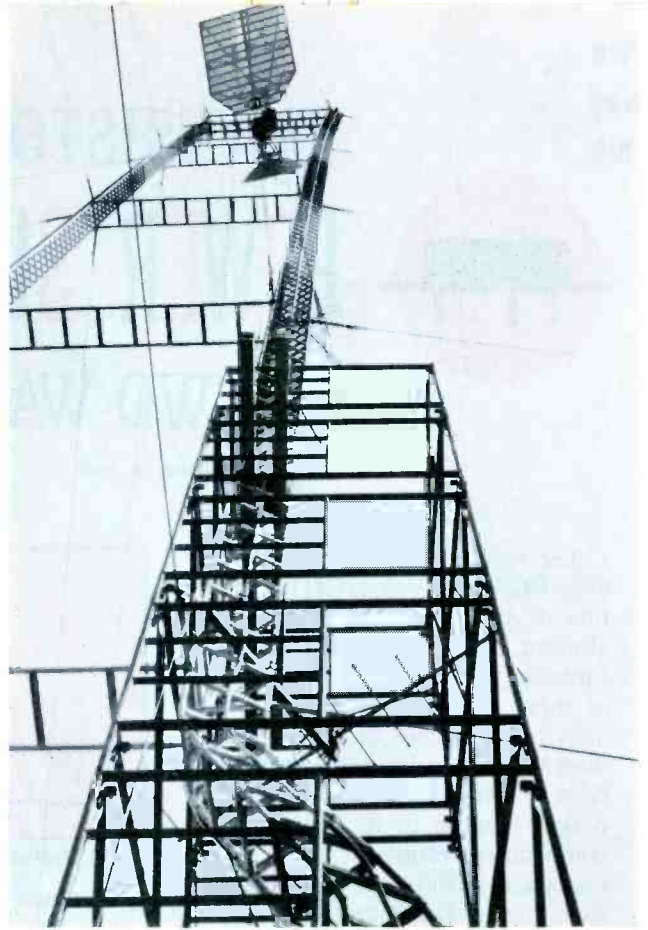

Scaffold supports tower leg while damaged portions are replaced.

A glimpse at a few factors in the inspection and maintenance procedures used with communications antenna supporting structures.

Wire looped through anchor and turnbuckles discourages turning.

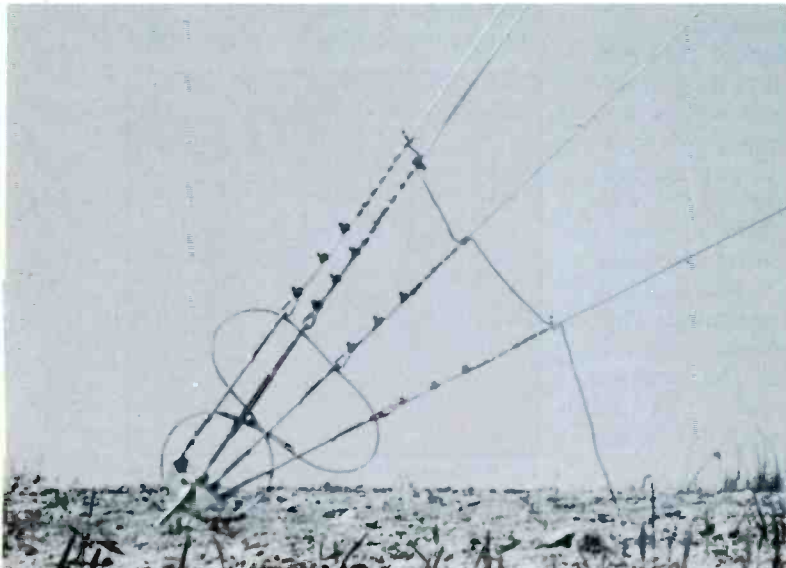

Inspect tower bases for wear around bolts and grounding wires.

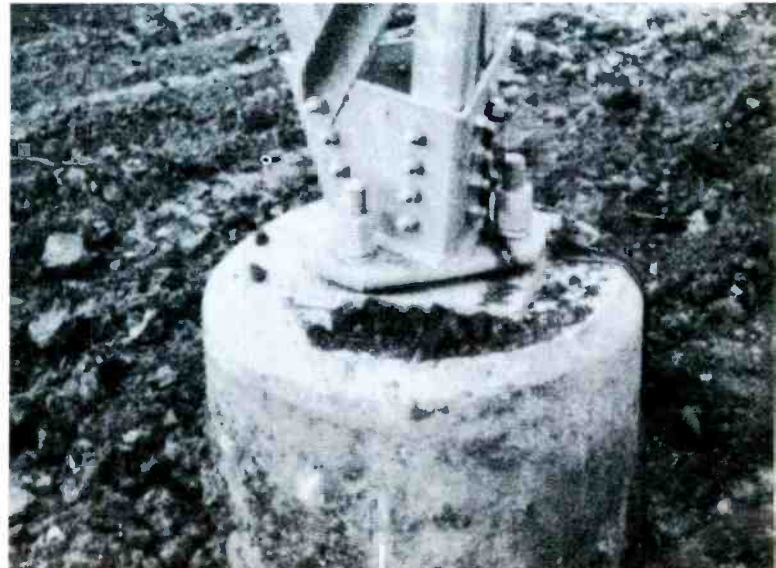



TRANSISTOR POWER SUPPLIES for TWO-WAY

by Edward M. Noll

The transistorized power supply, alias DC-to-DC converter, is a mixture of a feedback circuit, a multi-vibrator, a transistor switch, and a saturated transformer—although all of these elements are not immediately recognizable on a schematic diagram. The solid-state supply has been a real boon to two-way radio design because of its light weight, compactness, economy, and stability under a switched load. The troublesome mechanical vibrator has been shunted to well-deserved near oblivion.

The most popular basic converter circuit, Fig. 1, uses two power transistors in a common-emitter oscillator circuit. Note that the collector is not at ground potential and must be insulated electrically from the heat sink. The insulator must have a low thermal resistance to ensure heat transfer from the collector case to the heat sink.

Although a common-collector circuit could be designed easily, it would be of no particular value for mobile two-way radio equipment because both negative and positive ground systems are common in modern vehicles. Most transistor power circuits are wired for negative-ground operation; a few minor changes will adapt them for posi-

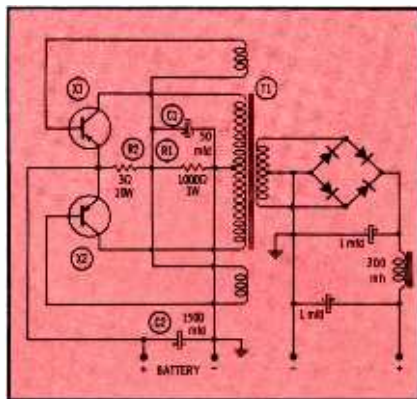

Fig. 1. A basic transistorized power supply.

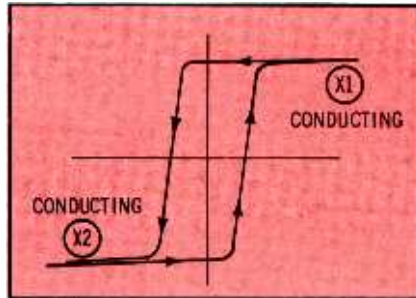

Fig. 2. Typical square loop hysteresis curve. tive-ground installations.

Circuit Description

Since the feedback windings associated with the transformer primary are connected into the base-emitter circuits, the oscillator is often referred to as an inductively-coupled multivibrator. If we assume that transistor X1 (Fig.1) begins to conduct when power is applied, then its collector current increases, and the collector voltage swings positive (less negative because the PNP transistor operates with a negative collector voltage). The changing magnetic field in the primary winding of T1 induces a voltage into the feedback winding of X1. As a result, the base-emitter circuit of X1 is more heavily forward biased, and a high collector current results, driving X1 into saturation.

The changing magnetic field generated in the top half of the primary winding also induces a voltage into the bottom half; its polarity is negative on the side of the primary connected to the collector of X2. The resultant magnetic field induces a voltage into the lower feedback winding, the phase of which swings the base of X2 toward cutoff. This, in turn, causes a decrease in the collector current of X2. The feedback activity occurs very quickly, and X2 is driven to cutoff while X1 is saturated.

Although the transistors operate as saturated switches and swing between cutoff and saturation, the duration of each cycle of the oscillator is largely the responsibility of the transformer. The transformer has a squared saturation or hysteresis characteristic similar to that shown in the square-loop magnetization curve of Fig. 2. Note that magnetization of the transformer's core increases rapidly and then flattens out quickly at the saturation level. Feedback switching takes place very quickly because of the high feedback voltage that results from the rapidly changing magnetic field generated in the primary windings. In the circuit of Fig. 1, the fast rise in X1 collector current drives the transformer core very quickly to its saturation level.

During the feedback interval, collector voltage remains low and constant, and the voltage across the top half of the primary approaches the value of the supply voltage. However, when saturation occurs, there is no changing field to induce a sustaining voltage into the feedback winding. As the base-emitter forward bias begins to drop, the collector current of X1 decreases.

The magnetic field of the primary winding of X1 collapses gradually as the core desaturates, because of the square-loop response of the core. As the core passes its residual magnetic value, the flux lines reverse direction, and all voltages in the windings of T1 change polarity. This, in the same manner as for the first half of the flip-flop cycle, initiates a new feedback sequence that switches off X1 and turns on X2. The transformer is again driven quickly to saturation in the opposite direction by the rise in X2 collector current. As it goes into heavy saturation, the feedback voltage drops

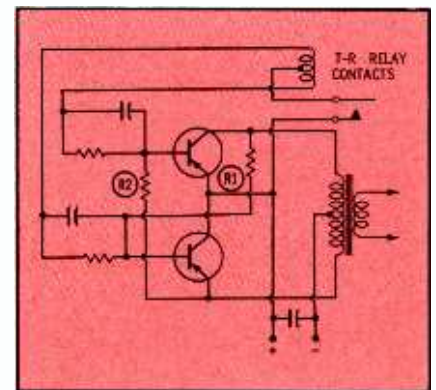

Fig. 3. Control of feedback with T-R switch.



**Keep Inventories Low!
Save Time and Money!
Speed Up Repairs!**

NOW, WITH ONLY 10 RCA "TOP-OF-THE-LINE" TRANSISTORS YOU CAN REPLACE OVER 1900 ENTERTAINMENT TYPES

RCA's ten new "Top-of-the-Line" transistors can solve nearly every transistor replacement problem you will encounter in your servicing of phonographs, tape recorders, battery-operated portable radios, auto radios, and other entertainment-type equipment.

With an inventory of only 10 types, the RCA SK-Series transistors can quickly, easily, and economically provide you with hundreds of replacements—over 1900 in all, including many types of foreign manufacture.

For example, if you are active in the servicing of auto radios, you will find that just three types, the SK-3008, SK-3009 and SK-3012, will speed up repairs by providing you with replacements for virtually every transistor type used in auto radios.

RCA Type

SK-3003
SK-3004
SK-3005
SK-3006
SK-3007
SK-3008
SK-3009
SK-3010
SK-3011
SK-3012

Application

pnp type, AF Driver and Output Stages (9 V Supply)
pnp type, AF Driver and Output Stages (15 V Supply)
pnp type, RF, IF, and Converter Stages of Broadcast Receivers
pnp type, RF, IF, and Converter Stages of FM and AM/FM Receivers
pnp type, RF, IF, and Converter Stages of All-Wave Receivers
pnp types, RF, IF, and Converter Stages of Auto Radios
pnp type, Audio Output Stages of Auto Radios
nnp type, AF Driver and Output Stages of Broadcast Receivers
nnp type, RF, IF, and Converter Stages of Broadcast Receivers
pnp type, Audio Output Stages of Auto Radios

Ask your RCA Distributor for your copy of the new RCA replacement wall chart. It lists in alphabetical-numerical order the more than 1900 types which the 10 RCA SK-Type Transistors can replace.

RCA Electronic Components and Devices, Harrison, N. J.



The Most Trusted Name in Electronics

**america's most popular
tube tester**

*... because it
finds the
"tough dogs"
others miss!*



**THE NEW SENCORE TC130
MIGHTY MITE III TUBE TESTER**

New in looks and compactness, updated with many exclusive features. The MIGHTY MITE tester, long America's most popular tube checker because it has the versatility and reliability professional servicemen demand! The MIGHTY MITE III checks them all — more than 2,500 tubes plus picture tubes, including the new frame grid tubes (has four extra sockets for latest tubes). It's fast and thorough, checks for control grid leakage, then, with the flick of a switch, tests for interelement shorts and cathode emission at full operating levels. Uses costly moving coil meter for high sensitivity (100 megohms) to find those "tough dog" tubes other low-sensitivity testers miss. In versatility, reliability, portability and operating simplicity, the TC130 is your best buy in tube checkers at **\$74.50**

COMPARE THESE MIGHTY MITE III FEATURES:

Lower voltage for Nuvistors and all frame grid tubes • Unique circuit tests for inter-element shorts, each and every element • Checks cathode emission at full operating levels • Checks control grid leakage at 100 megohms sensitivity, like "eye tube" testers.

Speed-indexed set-up cards greatly reduce look-up time • Simplified panel layout speeds checks, prevents errors • Burn-out proof, stick-proof meter • Sturdy, all-steel case, rubber feet • Styled for modern, professional look

professional quality — that's the difference!

SENCORE

426 SOUTH WESTGATE DRIVE • ADDISON, ILLINOIS
Circle 56 on literature card



Fig. 4. Typical transistorized power supply.

off (no changing magnetic field), and the base of X2 loses its supporting forward bias. More slowly, the transformer desaturates toward its residual level. The magnetic field reverses, and feedback of opposite polarity results. Events speed up again as X2 is cut off, and X1 collector current drives the transformer once again into positive saturation.

The operating frequency of the inductively-coupled multivibrator is dependent, to a great extent, upon transformer saturation—the time required to reverse the magnetization of the core. It is during this period that the effect of the flat-topped region of the collector-current flow is apparent. Operating frequencies for typical transistorized power supplies range between several-hundred and several-thousand cps.

The common-emitter circuit just discussed is biased to ensure easy starting. Resistors R1 and R2 form a voltage-divider circuit across the battery; current flow through resistor R2 provides the bias current needed for easy starting of the oscillator. During normal operation, substantial current flows through resistor R2, and it must have a high wattage rating. Resistor R1 is simply a part of the bias-voltage divider network. The strong base-emitter current does not flow through this resistor, so it can have a substantially lower wattage rating.

One problem of the transistorized power supplies is the development of high-voltage transients, or spikes, at the leading edge of each pulse. In particular, each collector tends to swing positive whenever the cutoff

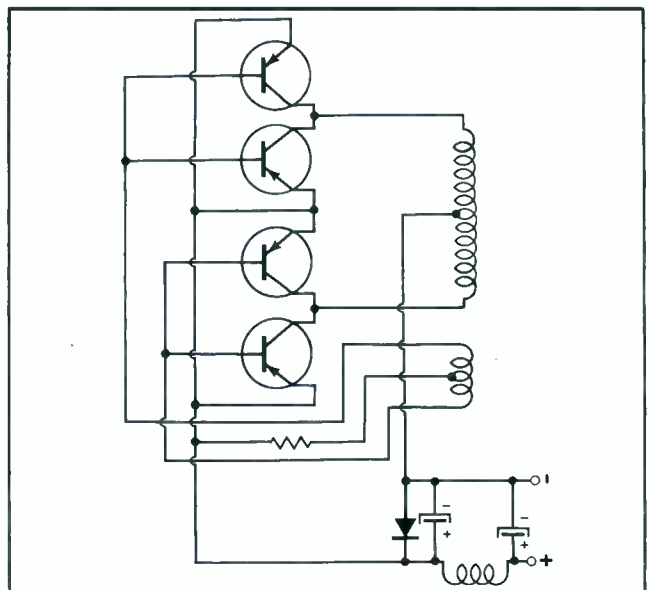

Fig. 5. Parallel paired for increased power.

transition occurs. This tendency can be reduced by using high values of capacitance at C1 and C2.

Two-Way Radio Modifications

One of the problems of two-way radio sets is that power demands while transmitting are substantially greater than while receiving. Efficiency and component life in a solid-state supply are linked to load demands and to the amount of feedback. For low-level requirements, optimum operating conditions are obtained with much less feedback than is required for the most favorable operation under a heavy load.

In the arrangement of Fig. 3, the transmit-receive switching circuit also determines the feedback factor. For receive operation (low level), a cross-coupled resistor-capacitor network is used to establish the proper level of feedback. Resistor R1 is in the feedback path from the top of the primary winding to the base of the lower transistor. Resistor R2 provides the feedback path from the bottom of the primary winding to the base of the top transistor. In so doing, a feedback-polarity shift is made as required to provide regeneration. In the receive position, the feedback winding is not activated.

Notice that, in the transmit position, the relay contacts connect the centertap of the feedback winding to the emitter (positive battery voltage). In this case, the usual inductively coupled arrangement provides the strong feedback for a heavy secondary load.

Rectifier-Filter

Any type of rectifier circuit can be attached to the secondary; however, the bridge rectifier is much preferred over single-wave and full-wave types. When vacuum-tube rectifiers are used, the bridge circuit is not usually practical because of filament transformer isolation and space requirements. These problems do not exist with the silicon-diode bridge rectifier.

The bridge rectifier produces a rectified voltage output that compares favorably in level to the full secondary voltage. Filter requirements are lowered because the output ripple percentage is reduced (at twice the frequency of the oscillator). Inasmuch as the oscillator frequency itself is relatively high (typically in the 1000-cps range), filter-capacitor value requirements are reduced.

Alternate Arrangements

Fig. 4 shows the major components of a typical transistorized power supply. The two transistors in their heat sinks are at the lower right; circuit capacitors at the center. The power supply (along with the loudspeaker and various two-way radio controls) is mounted in a removable front-panel section of the single-unit two-way radio. Components are few, small in size, and readily accessible.

For increased power demands, the switching transistors can be connected in parallel pairs as shown in Fig. 5. The diode provides power-supply protection

**just in time for the
fm and uhf boom!
an all transistorized
field strength meter.**



THE ALL NEW SENCORE FS134 FIELD STRENGTH METER

Once again, you can turn to the roof tops for a fast dollar in antenna installations. But this time, you can do it the easy way. No more running up and down ladders, locating cumbersome AC extension cords, lugging heavy tube operated field strength meters on the roof, or worse yet, getting the shock of your life from the AC line as you hold onto a soil pipe. Here is a new portable field strength meter to fill your every need in VHF, UHF or FM antenna installations. Many customers want all antennas on one mast thus creating interaction. Here is where the FS134 goes to work. You can optimize antenna location and orientation in seconds. Just connect the antenna, tune in the station and adjust. Self-contained speaker blasts forth the sound from the TV or FM station to insure that you have the exact signal that you are looking for. The FS134 is so light weight (only 9 lbs.) that you can take it with you up the chimney if necessary. Get rid of the assistant at the other end of the transmission line and the needless "yelling" back and forth. Get the FS134 today . . .

\$199⁵⁰
only

COMPARE TO ANY OTHER FIELD STRENGTH METER AT TWICE THE MONEY

- Sensitivity . . . 5 microvolts on VHF and FM, 15 microvolts on UHF
- Input impedance . . . 300 ohms or 75 ohms with plug-in transformer
- 500 KC band width
- Powered by easy to get "C" cells
- 4 inch meter with 2 percent accuracy calibrated in DB and microvolts.

professional quality — that's the difference!

SENCORE

426 SOUTH WESTGATE DRIVE • ADDISON, ILLINOIS
Circle 57 on literature card

October, 1964/PF REPORTER 91

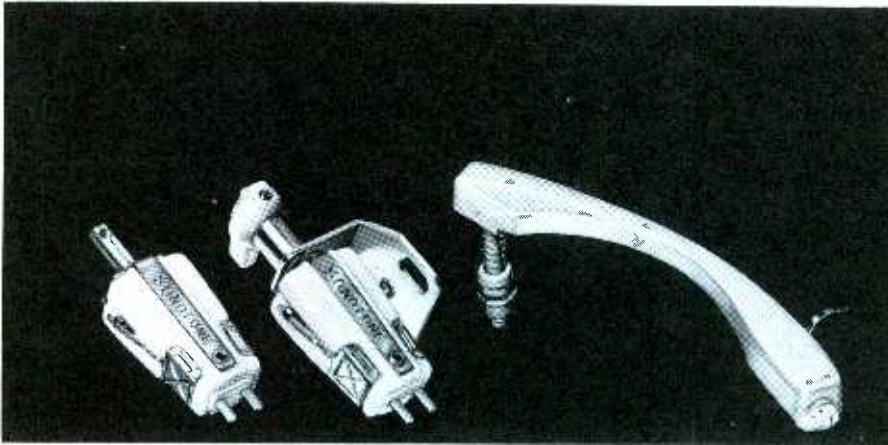

How to turn crystal

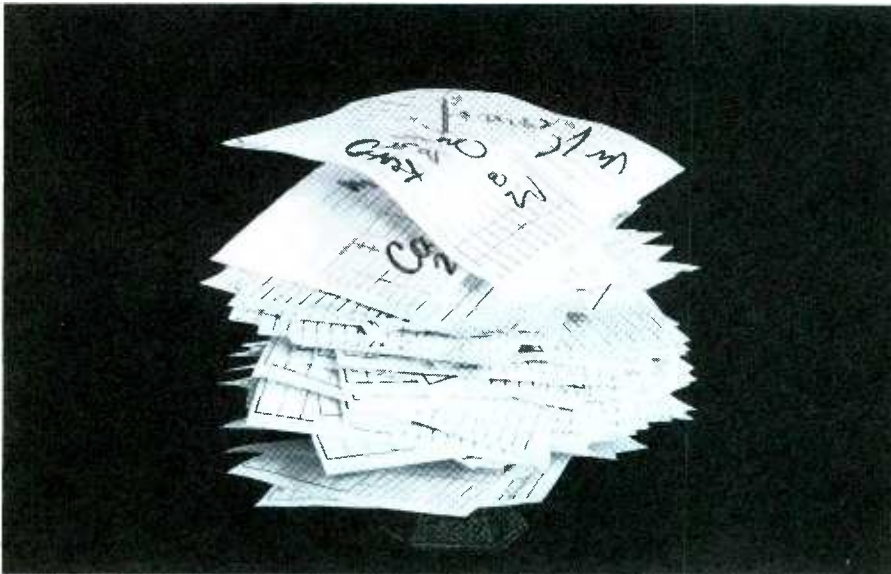

into gold

You can strike it rich with the new Sonotone line of crystal cartridges. It offers direct replacements for "Ronette," "Vaco" and "BSR" models with typical Sonotone quality.

Here are the extras you get—New improved crystal elements for longer pickup life. Mono ("14T") and stereo ("20T") models. High output voltage. Modern turnover type for LP, 45 and 78 rpm records. Available with or without mounting brackets or turnover knobs to fit most arms.

Oh yes, they come in a slim, lightweight plastic tonearm, too. You have a choice of the mono ("14T") or stereo ("20T") cartridge. It's easy to install because it's prewired. It has a shielded cable, spring mounting post and a plated finger lift. It's complete with arm rest and all necessary hardware. Get details today. Write:

SONOTONE
audio products

Sonotone Corp., Electronic Applications Div., Elmsford, New York
Cartridges • Speakers • Microphones • Headphones • Hearing Aids • Batteries

Circle 58 on literature card

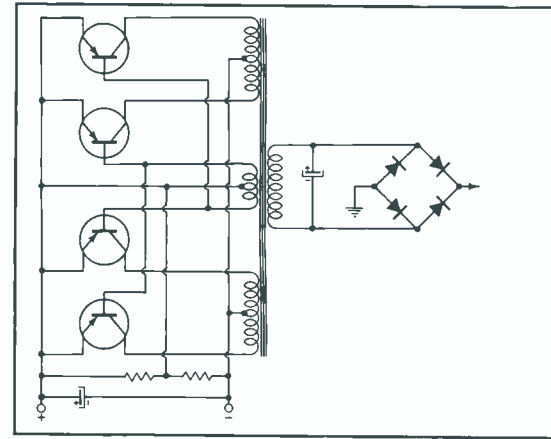

Fig. 6. Push-pull paired for higher power.

in case a voltage of incorrect polarity is applied.

Still another solid-state power supply circuit arrangement is shown in Fig. 6. This time, the transistor pairs are connected in push-pull, using two separate primary windings and a single feedback winding.

DC-to-AC Conversion

First cousins to DC supplies, DC-to-AC converters are often used to convert a low DC voltage to a higher AC voltage. A typical unit could be operated from the battery of a car or boat, supplying an output of 110 volts. Hence, conventional 110-volt radios and other equipment can be powered from a battery system. A typical circuit is shown in Fig. 7. In this circuit, the primary winding of the transformer is connected across the 110-volt-AC output, thus providing the necessary feedback paths. DC-supply voltage is connected into the base-emitter circuit. Voltage developed across resistor R1 sets the forward bias. Such a unit can often be used as a direct replacement for a vibrator, the plug being inserted into the vibrator socket. ▲

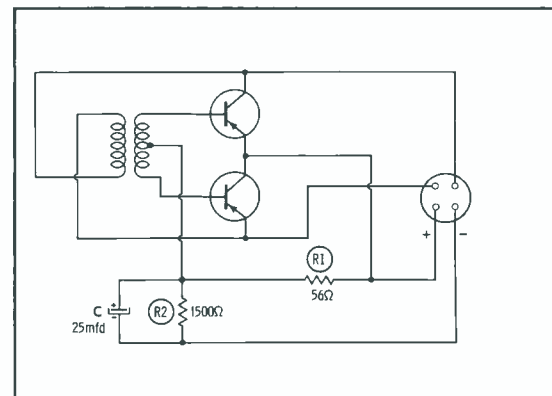

Fig. 7. Typical DC-to-AC converter circuit.

TWO NEW HIGH-PERFORMANCE CB TRANSCEIVERS FROM LAFAYETTE...*Leader In CB Equipment*

NEW! LAFAYETTE 23-CHANNEL CRYSTAL-CONTROLLED DUAL CONVERSION 5-WATT CB TRANSCEIVER



Model HB-400
169⁵⁰

With Advanced "Range-Boost"

- ✓ Ruggedly Built For Reliable 2-Way Radio Communication
- ✓ Easy To Use... Easy To Maintain. With Every Feature CB Users Want!
- Frequency Synthesis Offers 23 Crystal Controlled Transmit/Receive Channels—No Extra Crystals Needed!
- "Range-Boost" Circuit for Increased Sideband Power... Greater Range!
- 17-Tube Performance With 13 Tubes
- Low Noise Nuvistor "Front End"
- 5 Double-Tuned IF Transformers
- Sensitive 3/10 μ V Dual Conversion Receiver
- Built-in 117V AC & 12V DC Power Supply
- Plug-in Facilities For Lafayette Selective Call Unit ■ Imported

NEW! LAFAYETTE ALL-TRANSISTOR DUAL CONVERSION 5 WATT CB TRANSCEIVER With Mechanical Filter For Ultra-Sharp Selectivity

- ✓ 100% Solid-State... Full 5-Watt Performance!
- ✓ 11 Rugged Silicon Mesa Transistors Used In Critical Areas
- ✓ Small, Compact—Only 3" High!
- ✓ Low Battery Drain—Less Than 350 ma on Receive, 850 ma on Transmit!

- 12 Crystal Transmit & Receive Positions
- 23 Channel Tunable Receiver with Spotting Switch
- 15 Transistors, 5 Diodes
- Sensitive 5/10 μ V Dual Conversion Receiver
- Variable Squelch, plus ANL
- For 12V DC, or 117V AC with Optional Solid State AC Power Supply ■ Imported



Model HB-500
139⁵⁰

**Dealerships
Now Available for**

LAFAYETTE'S NEW "HOT-LINE"

Lafayette Radio Electronics, "World's C.B. & Electronics Center" has available dealerships for its new "Hot Line" of Citizens Band equipment. A leader in the C.B. field, Lafayette equipment has been performance proven and customer accepted.

Lafayette is now introducing its new C.B. "Hot Line" for '65—Transceivers, Walkie-Talkies, Accessories,

etc. Engineer-designed, precision-crafted and field-tested to make Lafayette THE NAME in Citizens Band.

Be the first one to hook-up with Lafayette's

NEW "HOT-LINE."

Get complete information without obligation—mail the coupon today.

LAFAYETTE RADIO ELECTRONICS CORP.
Dept. ASPFJ-4
111 Jericho Turnpike
Syosset, L. I., N. Y. 11791

Mr. Robert Laub:
Please send me full information on how I can become an exclusive Lafayette dealer. I understand there is no obligation.

Name _____
Address _____
City _____ State _____ Zip _____

THERE'S A RIGHT WAY TO BUY

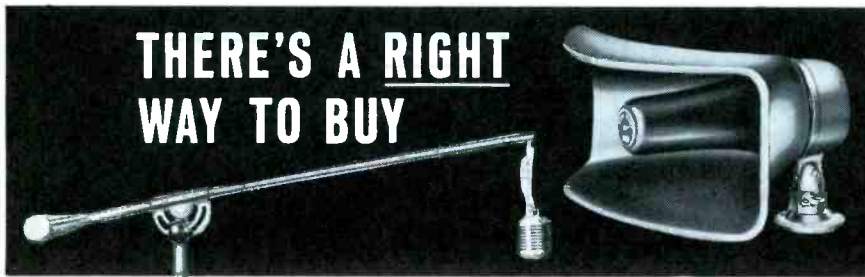

You profit more by using the same dependable brand of public address speakers and microphone stands for all your needs.

Your ATLAS SOUND distributor makes one-stop shopping easy with a wide selection of proven models...backed by our years of commercial sound experience...concern for product reliability...pricing for your profit.

Look for the ATLAS SOUND mark of quality on all paging and talkback speakers, trumpets, drivers, explosion-proof speakers, sound columns... floor, desk, boom stands... accessories for all. This trademark makes a world of difference. Write for catalog PF-10E



ATLAS SOUND, Division of
AMERICAN TRADING AND PRODUCTION CORPORATION
1419-51 39th Street, Brooklyn, New York 11218
Canada: Atlas Radio Corporation, Toronto



THIRTY YEARS OF LEADERSHIP IN COMMERCIAL SOUND

Circle 59 on literature card

Carbon Mics

(Continued from page 83)

first leaf is not straight, it will be very difficult to set the others. Second, adjust the second leaf for a distance between contacts exactly the thickness of a new penny. Third, be sure the push-rod of the third leaf (which holds it a fixed distance from the first) firmly contacts the first leaf, but without pushing the first leaf more than just the tiniest bit. And last, set the fourth contact just slightly closer to the third-leaf contact than the penny-thickness used for the first contact pair. Check the operation of the switch by pushing the first leaf; see that contacts 3 and 4 close ever so slightly before the 1 and 2 contacts touch. Use your ohmmeter to check the contacts finally, before pronouncing the switch okay.

The Capacitor

In cases of distortion and weak microphone output, the culprit is not uncommonly the capacitor that bridges the carbon element. The mike will operate without it, but this capacitor considerably reduces random noise, and helps protect the carbon granules from impacting with sudden voltage surges. Thus, if the capacitor is open, you may not even get a complaint from the user. However, if it is leaky or shorted, the complaint can range from "garbled voices" to a dead mike.

Naturally, leakage or a short will show up on the ohmmeter. So, one way to check the capacitor is to check the carbon element with the capacitor in place and then repeat the test with the capacitor unsoldered. Any change in resistance characteristics is a sign of a faulty capacitor. Obviously, you can also simply unsolder the capacitor and test it.

In any case, be sure to disconnect one end of the capacitor during the tests that follow.



Fig. 4. To remove cartridge, remove C-ring.

Pre-packaged Pre-tuned IF Strip

NOW IN STOCK AT
YOUR DISTRIBUTOR



Model 8902 pre-tuned 455 KC IF Strip provides excellent gain (55 db) and selectivity (6 db bandwidth: 8 KC). No alignment is required. Included among the 21 components on the PC board are a mechanical filter, 2 transistor amplifiers and a diode detector capable of driving earphones. Overall dimensions: $\frac{1}{2}$ " x $\frac{1}{2}$ " x $1\frac{1}{2}$ "

Model 8901 input IF transformer adapts the IF strip for use with a converter in capacity detectors, AM and CB receivers. Both units are included for \$5.75 net.



J. W. MILLER COMPANY

5917 South Main Street • Los Angeles, California 90003

See your local distributor for the full line of RF and IF coils, chokes, filters and transformers.

Circle 60 on literature card

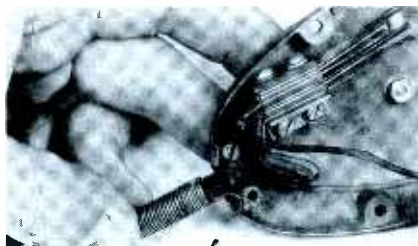

A

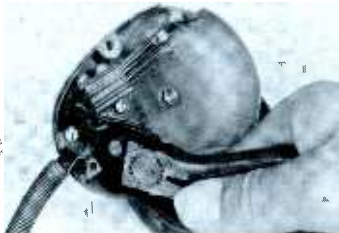

B



C



D

Fig. 5. Use sequence depicted here to redress wires into the microphone shell.

Checking the Cartridge

A metal ring and a fiber washer hold the microphone cartridge in place. Fig. 4 shows how to remove the cartridge. Merely squeeze the ends of the C-ring together with the points of your needle-nose pliers, and lift the ring from its groove.

The cartridge itself is surrounded by a rubber mounting grommet. It will generally be unnecessary to remove this grommet unless the element has to be replaced. Use an ohmmeter to check the cartridge resistance. As indicated earlier, the element will usually measure somewhere between 200 and 1500 ohms, depending upon the packing of the carbon granules. Whistle into the mike; the ohmmeter reading should vary quite noticeably. If it doesn't, or if the ohmmeter reading is considerably below 200 ohms, the granules in the button are probably packed. A remedy for this can

often be effected by rapping the element lightly against the benchtop, edgewise, rotating the cartridge until it has been rapped from every direction. Rechecking it with the ohmmeter will then result in the normal indications described; if not, the element must be replaced.

And Then the Cord

If all is okay within the shell, the remaining step is to redress the coil-cord next to the mike. Even if the trouble has been cured, inspect the wire closely. If the outer covering at this point appears at all worn

or cracked, good preventive maintenance suggests redressing this end.

You can follow the steps in Fig. 5. Remove the strap (one screw only is enough) across the cable, and unhook the strain-relief spring—Fig. 5A. Slide the spring backward up the cord several inches. Using your diagonal cutters—Fig. 5B—cut the four wires just inside the mike shell. Cut at least 1½" off of the free end of the cord, thus eliminating any portions that may have been damaged from flexing and strain. Remove about 4" of the

ANOTHER CB GREAT



Courier 12

INCLUDES TRANSISTOR POWER SUPPLY; MOUNTING BRACKETS; 2 POWER CORDS & MICROPHONE

FEATURING:

- 12 Crystal-Controlled Transmit and Receive Channels
- Tunable Receive — 23 Channels
- Transistorized Power Supply
- P. A. Facility
- Illuminated "S" & "RF" Meter
- Illuminated Dial
- Single Knob Tuning
- Chrome Cabinet
- Noise-cancelling Mike
- Made in U.S.A.

e.c.i. electronics communications, inc.
56 hamilton ave., dept P10
white plains, n. y.

Please send me full details about the e.c.i. Courier 12 and all other e.c.i. citizens band products.

name

address

city state

World famous manufacturers of quality CB & BB equipment including Courier 23, Courier 1M, Courier 30B, Fleet Courier, Port-A-Lab, Transistorized Power Supply, Linear Amplifier.



e.c.i. electronics communications, inc. 56 hamilton ave., white plains, n. y.

Circle 61 on literature card

outer rubber covering (Fig. 5C), and clip the four wires as follows: red lead—3½" long; black, green, and white leads—1½" long. Remove ⅛" of insulation from the end of each wire, and tin the strands.

Connect the red wire directly to one terminal of the cartridge. There should already be a 2½" black lead between the other terminal of the cartridge (the one next to the element surface) and the number-4 leaf of the mike switch (farthest from the button). Place a ½" length of spaghetti on the black lead from

the coil-cord and connect the lead to the third terminal of the switch (Fig. 5D); slide the spaghetti over the switch terminal. The green lead is soldered to leaf 2, and the white lead—with spaghetti on it—connects to the long leaf (the one that contacts the push-to-talk button). Only two pieces of spaghetti are necessary if they are used as shown.

Reassembling the Microphone

Assuming the microphone has been completely disassembled for any or all of the various steps we've

outlined, the following order of re-assembly will result in the quickest and easiest wrapup of the job. If any steps don't apply, skip them.

- (1) Replace the rubber mounting grommet around the microphone element. Place the fibre washer next to the rubber mount (if the leads are already connected, you may have to disconnect them).
- (2) Make sure the grill cloth is in place, and then put the cartridge into its well. Slip the C-ring into place, compress its ends together, and push it down to its groove, allowing the ends to release and snap the ring into the groove.
- (3) Connect the coil-cord leads to the switch as described earlier.
- (4) Connect the leads to the cartridge as described.
- (5) Place the spring and cord in the half-hole provided in the front half of the mike shell, and fasten the clamping strip in place with the two screws.
- (6) Place the push-to-talk button in place, making sure it depresses the switch leaves only slightly.
- (7) Fit the two shell halves together, using the two screws to hold them together.
- (8) Check out the microphone for proper operation, using the ohmmeter if a transmitter isn't handy.

Summary

All the steps outlined in this article can be carried out in just a few minutes. An entire microphone can be overhauled without much trouble if there is any doubt as to the exact nature of its defect. Before rebuilding, however, always be sure to analyze the symptoms carefully. A weak or distorted output will almost always be caused by the element or capacitor. An intermittent unit is generally the fault of the coil-cord, but can occasionally be traced to the switch or plug.

If a microphone shows signs of wear, rebuild it by newly dressing both ends of the cord, and by giving the element the "tap" treatment. Then, if possible, check the unit on an actual transmitter before returning it to service. Care and thoroughness will result in a mike repair that won't bounce. ▲

New CB-10 solid state transceiver



Ideal for business and personal communications

ACTUAL PERFORMANCE:

The CB-10 is a completely transistorized, extremely compact transmitter/receiver offering five-channel operation and the highest performance levels yet achieved in solid state CB transceiver design.

Its three stage transmitter is rated for full authorized power with maximum modulation capability. The dual-conversion receiver provides excellent adjacent-channel and image rejection • A series-type noise limiter drastically cuts auto and local interference • A special jack permits use of an external paging or P.A. speaker • Receiver sensitivity is less than 1 μV S/N ratio • Power requirement is just 1.0 amps on transmit (max. modulation) and 0.2 amps on receive.

ACTUAL SIZE:

2⅝ inches high, 6 inches wide, 9½ inches deep.

ACTUAL PRICE: **\$149⁹⁵**



"Quality through Craftsmanship"

hallicrafters

5th & Kostner Aves. • Chicago, Ill. 60624

Dealer franchises available in selected territories. Write for information.
Circle 62 on literature card

TOY Festival!

RCA presents a...



Get these and other wonderful toys *now*—in plenty of time for Christmas. THEY'RE AVAILABLE WITH YOUR PURCHASE OF FAMOUS RCA ENTERTAINMENT RECEIVING TUBES FROM YOUR PARTICIPATING RCA DISTRIBUTOR. Shown below are some of the toys.



AMF ROADMASTER 26" BICYCLE. The sleek "Skyrider" in both boys' and girls' models. Chrome-plated headlight and other "most wanted" features will make it the hit of the year under your Christmas tree.

Boys (TFP-9675): red with white trim
Girls (TFP-9685): blue with white trim

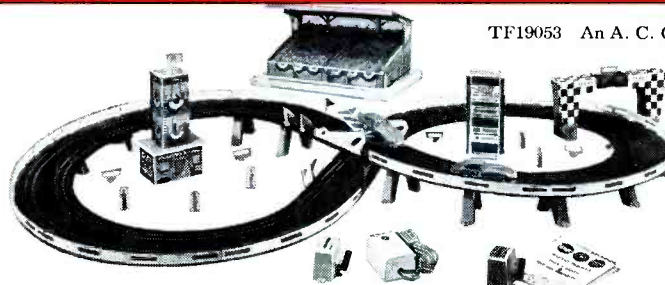

TF19053 An A. C. Gilbert Toy



AUTORAMA SPEEDWAY RACE. Action car racing with separate speed controls for each car. New "See-Saw Ramp" can be used as a jump ramp for extra thrills. Comes with all accessories to simulate a race track.



DELI-CAT. Cute as a button. Comes with brush for stroking her long silky hair. Prettiest little cat a girl ever owned.



TF7325-0 An Ideal Toy



TINY PEBBLES DOLL. From the "Flintstone" family of TV fame... a prehistoric peach of a doll. Jointed arms and legs. 12" high.

TF0720-3 An Ideal Toy

TF4722-5 An Ideal Toy



U.S.N. ANZIO INVADER. A 31" landing craft complete with tank destroyer, helicopter and pilot, 14 combat-ready soldiers with weapons. Made of rugged plastic.

These and other exciting toys are available NOW with your purchase of RCA Entertainment Receiving Tubes. See your nearest participating RCA Distributor for details.

RCA ELECTRONIC COMPONENTS AND DEVICES, HARRISON, N.J.



The Most Trusted Name in Electronics

FASTER THAN A SHORT CIRCUIT

LITTELFUSE fuses.

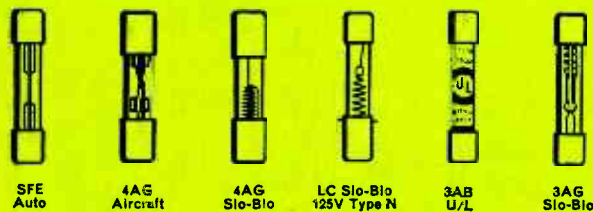

SFE Auto 4AG Aircraft 4AG Slo-Blo LC Slo-Blo 125V Type N 3AB U/L 3AG Slo-Blo

LITTELFUSE fuse posts and holders.

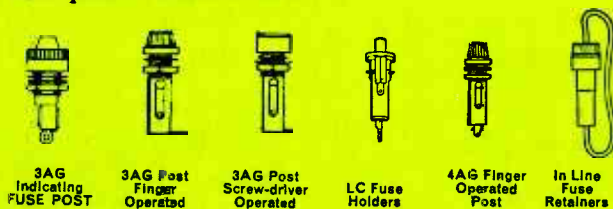

3AG Indicating FUSE POST 3AG Post Finger Operated 3AG Post Screw-driver Operated LC Fuse Holders 4AG Finger Operated Post In Line Fuse Retainers

LITTELFUSE fuse mountings.



Through Panel Mounting Screw Terminal Mounting Solder Terminal Mounting Terminal Clip Fuse Clip (earless)

LITTELFUSE Microfuse line.



New Glass Capped Microfuse 1,500 thru 5 amps. @ 125 v. Microfuse panel type holder Indicating Microfuse Holder voltage ranges 2 1/2-125 v.

As critical circuitry advances in sophistication, precision fuse protection becomes increasingly vital. For 35 years, Littelfuse has enjoyed a fine reputation as a manufacturer of top quality products in the electronic circuit protection field. Each and every Littelfuse product receives the ultimate in precision engineering, design know-how and quality craftsmanship. These are the reasons why the name Littelfuse has become the synonym for quality in the field of electronic circuit protection.

LITTELFUSE
DES PLAINES, ILLINOIS