

MAY, 1963

35 CENTS



PHOTOFACT

# RF REPORTER

Including **Electronic Servicing**

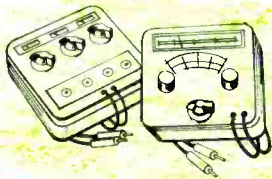

**Special Equipment  
Speeds Servicing**

**Molecular Electronics  
Explained**



**Tuner Repairs  
Made Easy**

**Resistors With More  
Than One Job**

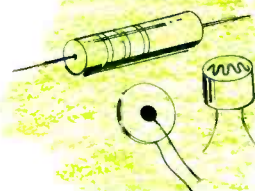

WM. M. DAVIS  
RAD. & TV SERV.  
118 RIVERSIDE AVE.  
CANON CITY, COLO.  
1104 1266

# BIG-SYSTEM MUSCLE...

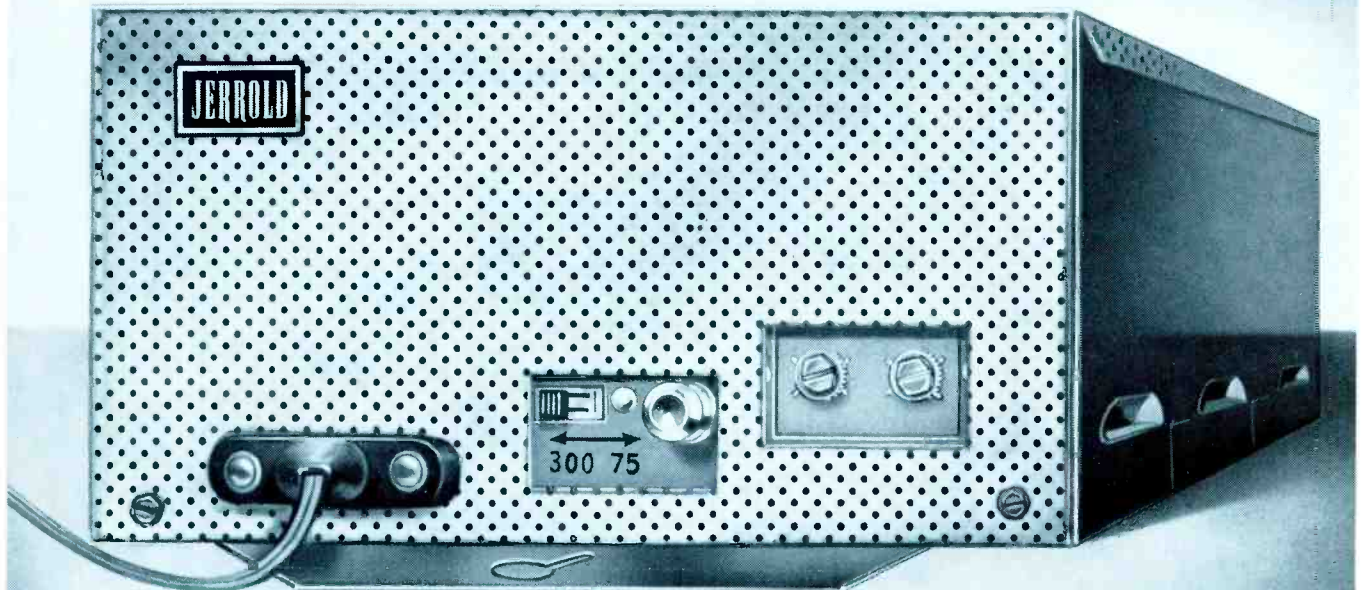

## SMALL-SYSTEM PRICE!

### NEW JERROLD *Challenger* TV DISTRIBUTION SYSTEM

ENGINEERED FOR THE NEW COLOR-TV ERA

- Designed for TV shops, dealers' showrooms, small apartments and motels
- Feeds up to 32 TV and FM sets
- No controls or adjustments
- New "Quick-Disconnect" plug-in outlets

Here's the distribution system to sell to TV and FM dealers for their color-TV showrooms... perfect too for the small apartment building or motel that's been needing an antenna system but couldn't afford one before. It's also ideal for your own service shop.

The JERROLD "Challenger" Amplifier, Model ACL-200, delivers 20db minimum gain over the low band, 19db over the high band. Flat response—unique in a low-price amplifier, but necessary for good color TV. Easy to install, no controls to adjust. Famous JERROLD quality is built in to stay.

*Model ACL-200, \$38.97 net*

See your JERROLD distributor or write Jerrold Electronics, Distributor Sales Division, Philadelphia 32, Pa.



New 4- and 8-way high-isolation networks.



New crown-washer screw terminals for stripped or unstripped twin lead.

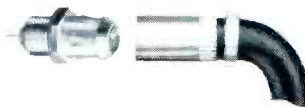

Exclusive "Gamma" chassis fittings for quick disconnect of any set.



A subsidiary of THE JERROLD CORPORATION

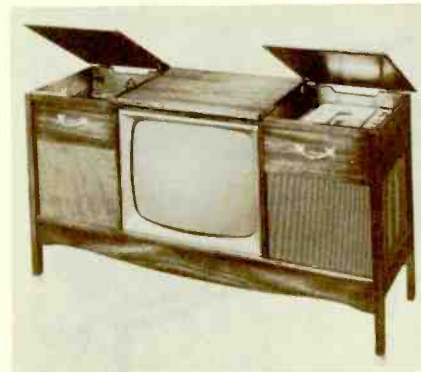
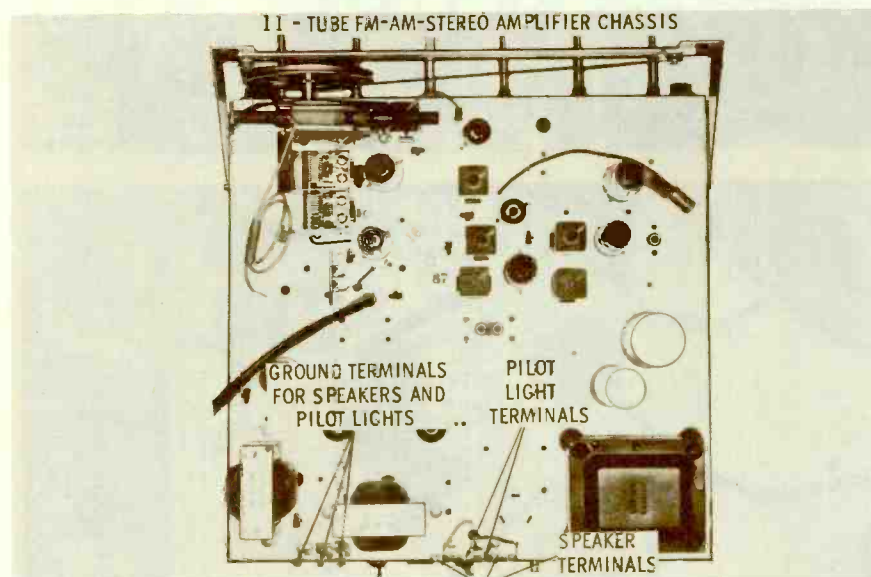
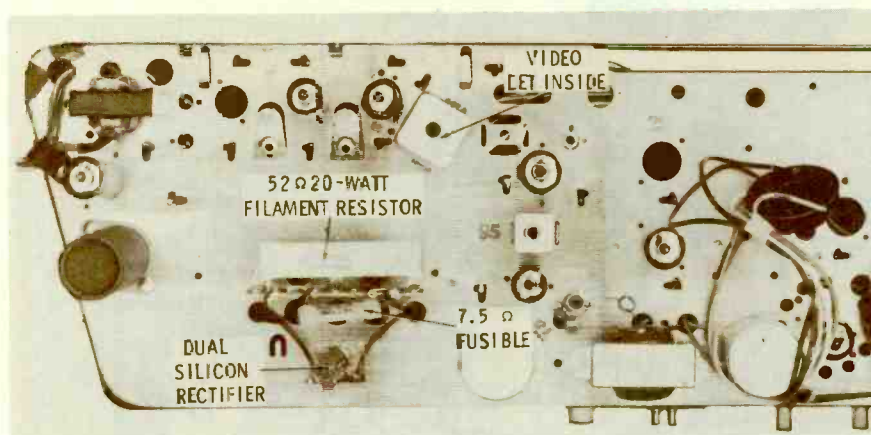
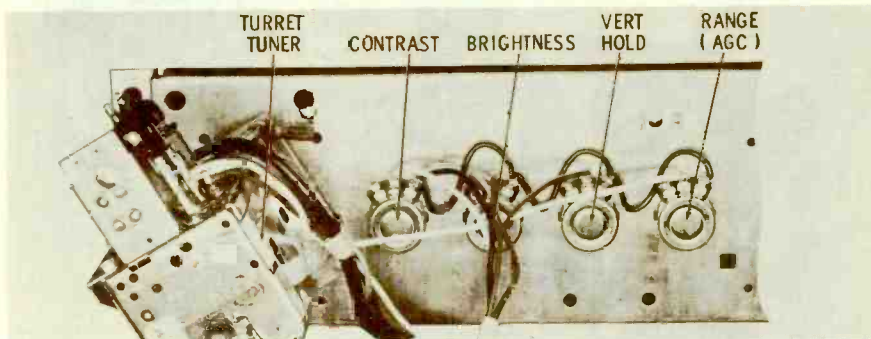
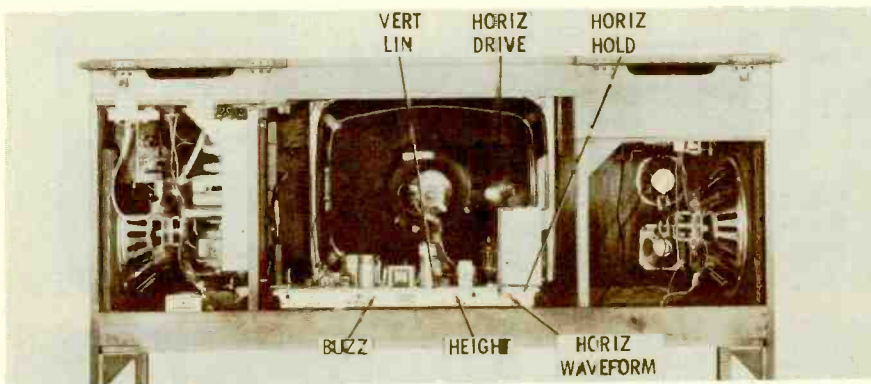

**Airline**  
**Model WG-5713A**  
**TV Chassis 23S31**  
**FM-AM-Stereo Amplifier Chassis**  
**10A51**

Eleven different Airline models introduced this year use the same pair of chassis as this model. The TV chassis is horizontally mounted, as were those in several of last year's sets. The separate eleven-tube radio-amplifier chassis provides for both FM-AM radio reception and stereo amplification. It has its own power supply and operating controls, and functions independently of the TV chassis.

The TV can be operated separately, but a few steps must be taken before it can be operated on the service bench without connection to the other chassis. You must connect the brown and gray leads on the TV-radio interconnecting cable together to complete the AC supply circuit. The audio circuit in this set is not designed to drive a speaker, so you'll also need a separate audio amplifier for bench testing. The 8BQ5 audio output stage is a cathode follower, with the output transformer in its cathode circuit. The secondary of this transformer connects through a shielded lead to the radio chassis, and terminates in a phono-type connector.

B+ is developed by a dual silicon rectifier; this unit can be replaced, if it becomes necessary, without removing the chassis from the cabinet. The 7.5-ohm fusible resistor (for B+ protection), and the 52-ohm, 20-watt filament dropping resistor, can also be replaced without disassembly. All three of these components are clustered near one another on the top side of the chassis.

Most of the tubes in this chassis are familiar types. Worth mentioning, however, are the 6CG7 (6FQ7 alternate) horizontal oscillator-AFC (no diode for AFC in this set) and the 23AHP4 picture tube, a 92° type. You'll find a 1N60 (alternate CK706) being used as a video-detector diode; it's located under the snap-off shield shown in the photo.

The operating controls for channel selection, fine tuning, brightness, vertical hold, and range (AGC) are mounted on a separate control panel. Adjustments for buzz, vertical linearity, height, horizontal waveform, horizontal drive (a trimmer), and horizontal hold are all located on the rear of the chassis.



**Emerson  
Model C-2001A  
TV Chassis 120587A  
Radio Chassis 120585  
Amplifier Chassis 120594**

This combination model features a TV with a 23" viewing screen, stereo amplifier, FM-AM tuner, and four-speed phonograph. The TV chassis is physically similar to one of last year's designs, using a single large printed-circuit board.

The turret-type tuner in this set has a 6GK5 RF amplifier and a 6CG8A mixer-oscillator. It also incorporates the preset fine-tuning feature; pushing in and rotating the fine-tuning knob engages and adjusts each channel oscillator slug.

A 5U4GB develops the B+ voltage in this receiver, and the protection device for the LV supply is a .45-amp chemical-type fuse. A #26 wire-link fuse protects the power transformer in case of filament-circuit overload.

Tubes used in the IF stages include two high-gain 6GM6's for the first and second amplifiers, and the pentode section of a 6AS8 for the third amplifier; the diode section of the latter tube is used as the video detector. The pentode half of a 6AW8A serves in the video output stage, while the triode section works in conjunction with a 6EM5 to form the combined vertical multivibrator-output system. The tube complement of the horizontal circuit includes a 6CG7 (6FQ7 alternate) oscillator, 6DQ6B (6GW6 alternate) output, 6DA4 (6DE4 alternate) damper, and 1G3GT (1K3 alternate) high-voltage rectifier. The picture tube is a 110° bonded 23CP4. A soldered-in dual diode is used for AFC.

The on-off switch is operated by a push button on the front control panel. The operating controls for contrast, brightness (height inside), and vertical hold (vertical linearity inside) are also accessible from the front of the cabinet. The local-distance (AGC), horizontal hold, horizontal frequency (trimmer), and horizontal drive controls are located at the rear of the set.

Focus voltage is selected by connecting the lead from pin 4 of the CRT to one of the four terminal points provided for this purpose; each terminal is connected to a different voltage. Width is controlled by a jumper across one of the resistors in the screen circuit of the 6DQ6B; maximum width is obtained when the jumper is in place.

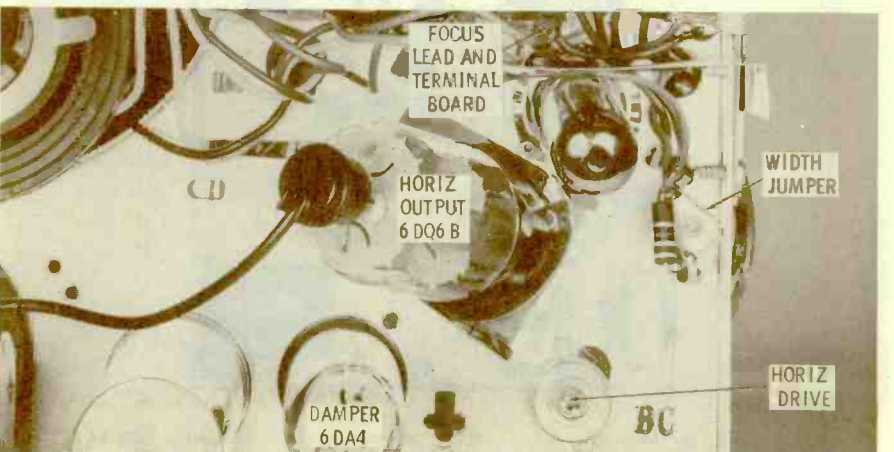
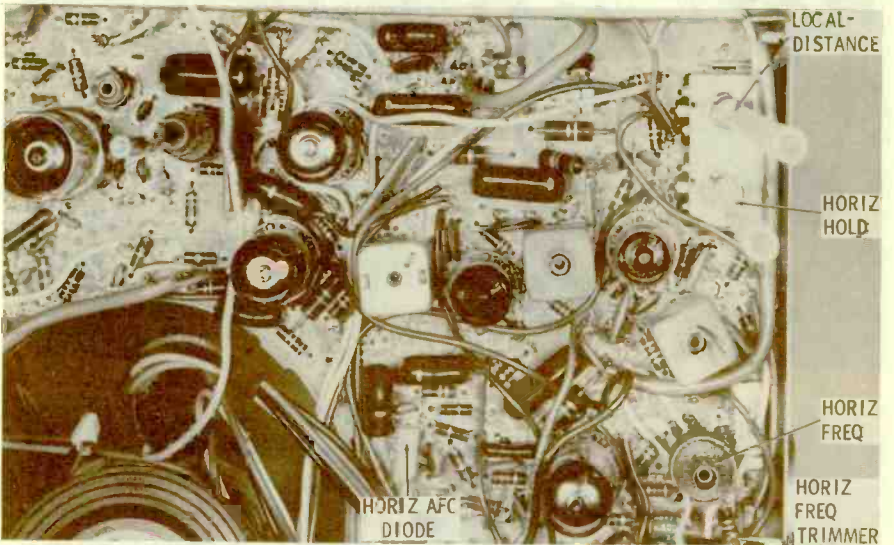
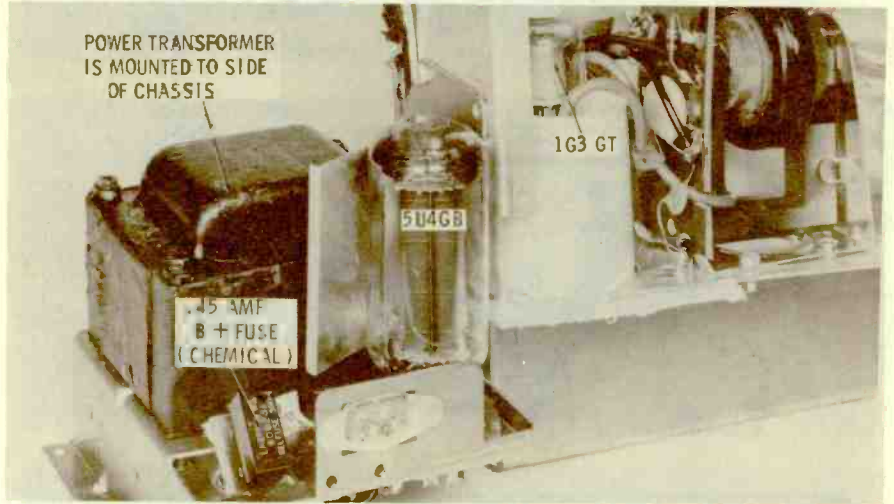
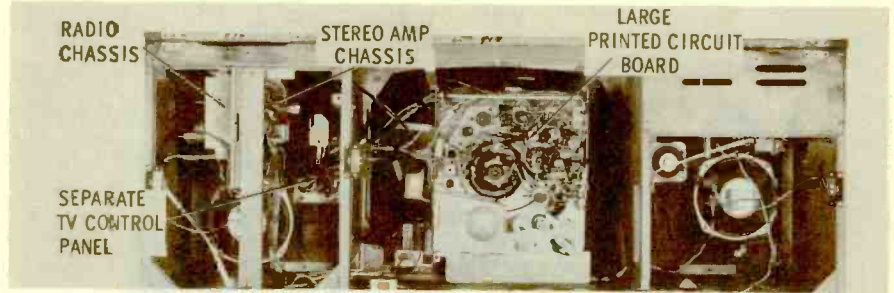

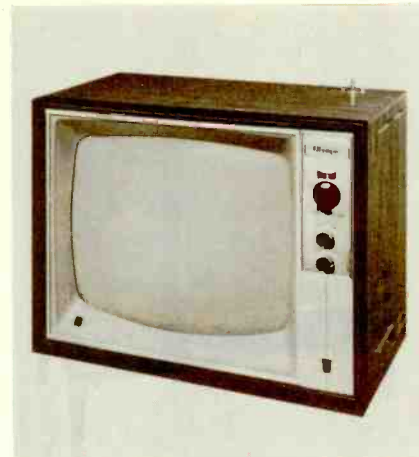
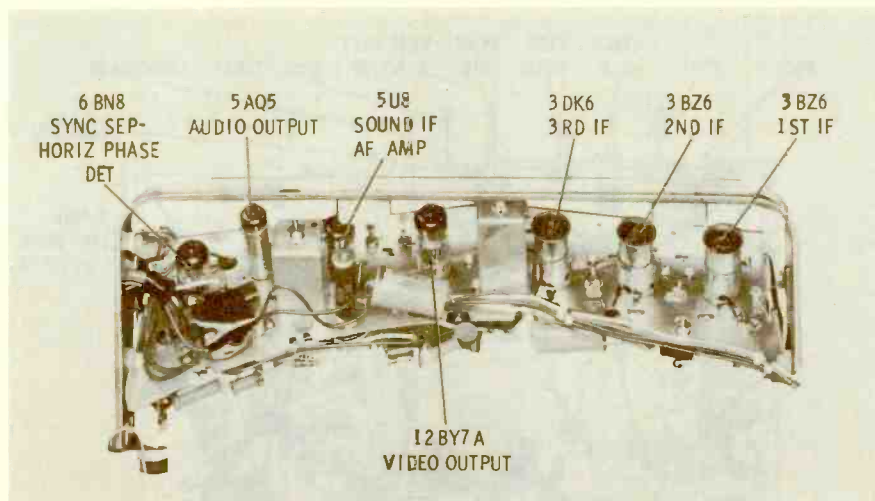
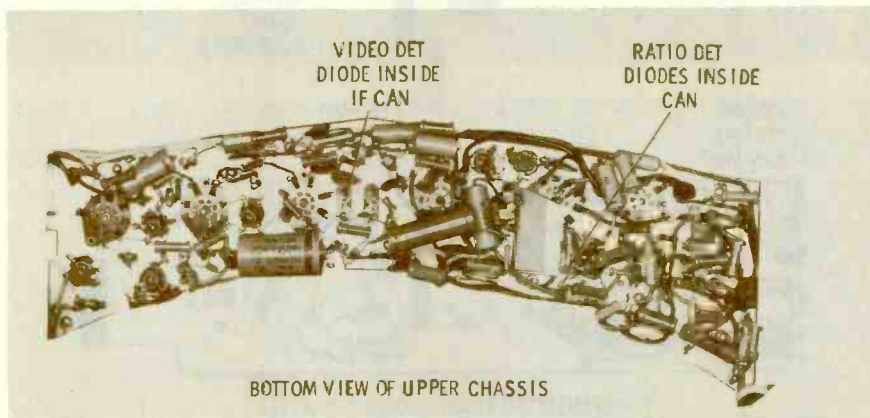
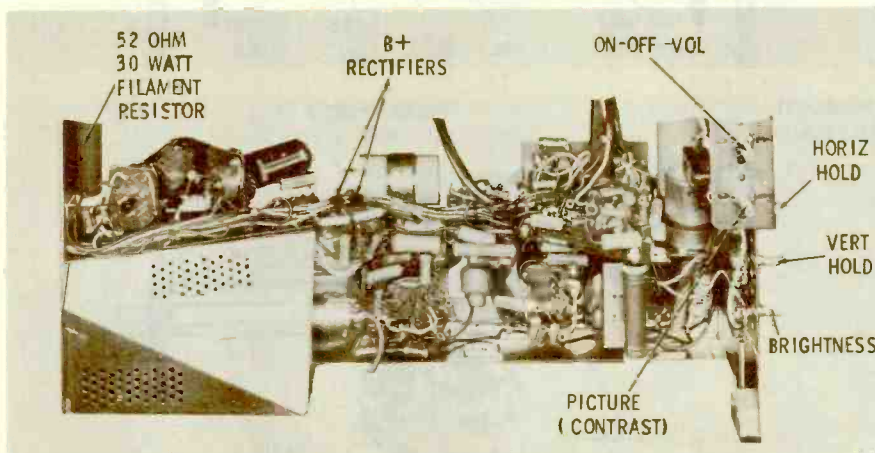
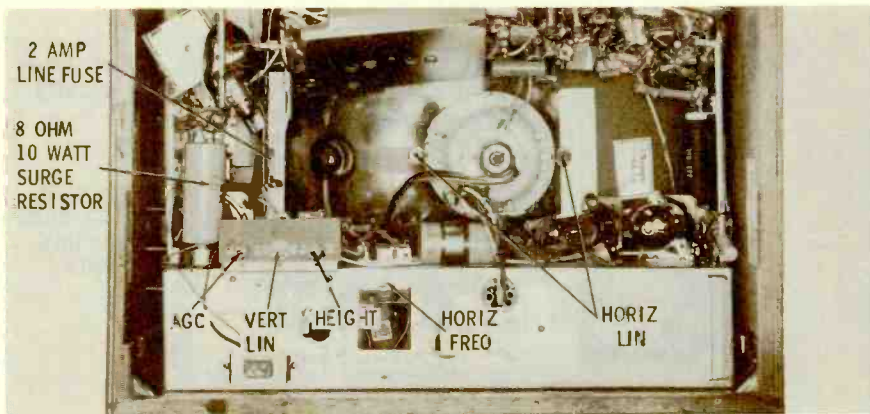

**Olympic  
Model 9T22  
Chassis 10119**

Pictured here is the 19" table-model television receiver being manufactured in Japan for Olympic. The chassis—in two separate sections—is completely hand-wired, and uses tubes familiar to most service technicians in this country. The 19XP4 picture tube, a 114° type, is the same that is being used in a number of domestic Olympic chassis. The switch-type tuner uses a 2GK5 RF amplifier and a 5CG8 mixer-oscillator. The oscillator slugs can be adjusted without removing the chassis from the cabinet. However, you must first remove the on-off-volume and picture control knobs, four Phillips-head sheet-metal screws holding the front-control escutcheon, and then the escutcheon. Then, after removing three more metal screws that hold the channel-selector retaining bracket, and removing this bracket (along with the channel-selector and fine tuning knobs), you can adjust the slugs through slots at the front of the tuner—clearly labeled with each channel number.

Two silicon rectifiers, wired so as to double the input voltage, develop B+ for this chassis. Overload protection for the entire set is provided by a 2-amp line fuse. An 8-ohm, 10-watt surge-limiting resistor further protects the B+ rectifiers. A 52-ohm, 30-watt filament dropping resistor is wired in series with the tubes; one of the photos shows its exact location.

Three diodes are used in this chassis: one for video detection, and two more in the ratio-detector circuit. All three diodes are located inside metal shields—the latter two within the same shield.

A 6BN8 has an unusual function in this chassis—it's the sync separator-horizontal phase detector. Many other tube types perform familiar functions: 10DE7 vertical multivibrator-output; 6CG7 horizontal oscillator-AFC; 12DQ6 horizontal output; and 1G3 HV rectifier. The damper is a 12GK17, which can be replaced directly by a common 12AX4GTB.

Operating controls for AGC, vertical linearity, height, and horizontal frequency (a coil) are all adjustable from the rear of the cabinet. Also at the rear, and located on the yoke bracket, are two slugs for controlling horizontal linearity. Horizontal hold, vertical hold, and brightness controls extend from the right side of the cabinet.



**Zenith  
Model K3341H  
TV Chassis 16K23QS  
Remote Chassis 5-56853**

Zenith is making wide use of this chassis in '63 consoles. Some models containing it also have an FM-AM radio, stereo amplifier, and/or remote control. The set shown here uses a 92° bonded 23ANP4 picture tube, and comes equipped with a six-transistor remote-control chassis.

No provision is made on this power-tuning model for changing channels manually from the front of the set; channel-selector rotation must be initiated by pressing a push button on the control panel. However, you can change channels manually with a knob on the rear cover. A spring-loaded shaft extends from the rear of the tuner (see photo); when pushed straight in, the shaft engages the tuner drum, and permits you to rotate the tuner. If the same shaft is slipped slightly to the right before it is pushed in, it engages the channel-indexing keys that select the channel upon which the tuner will stop when power tuning is used. Before you can adjust the individual oscillator slugs, you must first remove the tuner from the cabinet.

Protective devices used in this chassis include a 5-amp bayonet-type line fuse, a 7/10-amp bayonet-type B+ fuse, and a wire-link filament fuse. You'll also find a separate .15-amp, slow-blow fuse protecting the remote-control chassis, in models so equipped. This fuse is located on the top side of the remote chassis, as shown in one of the photos.

The video detector diode is located under the metal shield covering the third IF transformer, and the dual diode for horizontal AFC plugs into a socket on top of the chassis.

The main operating controls are located on the upper control panel; others are inside the lower control-panel door. Adjustments on the rear apron include the FRINGE LOCK, buzz, AGC, and sound-detector quadrature coil. Width is controlled by a metal sleeve located between the yoke and the CRT neck. Antipinch magnets, familiar in Zenith chassis for a number of years, are again used in this set.

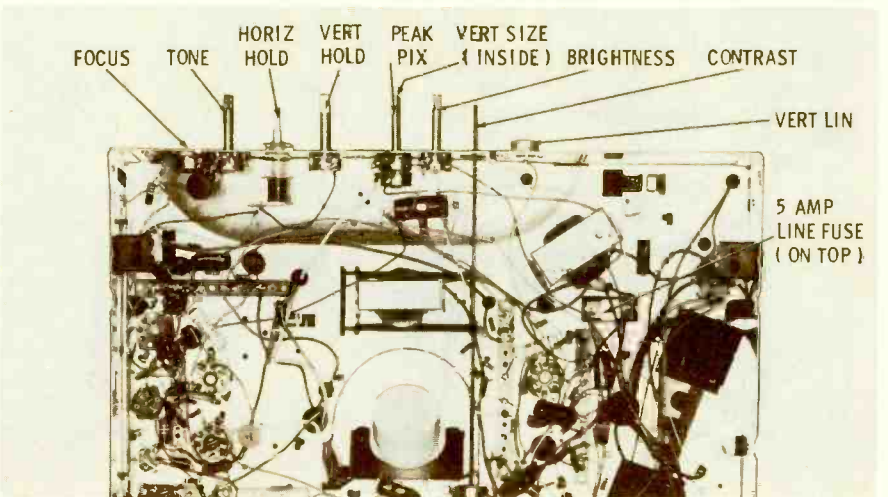
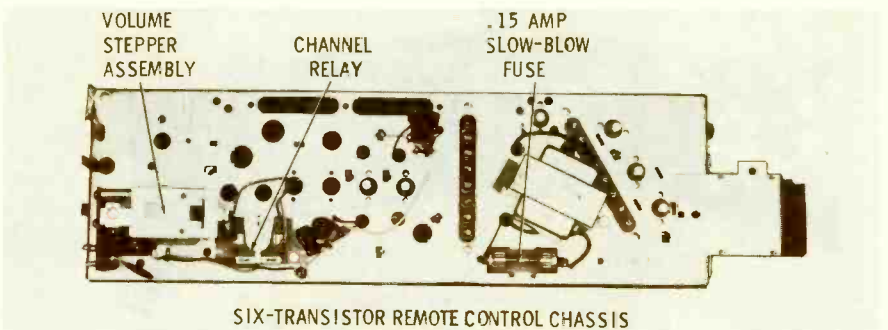
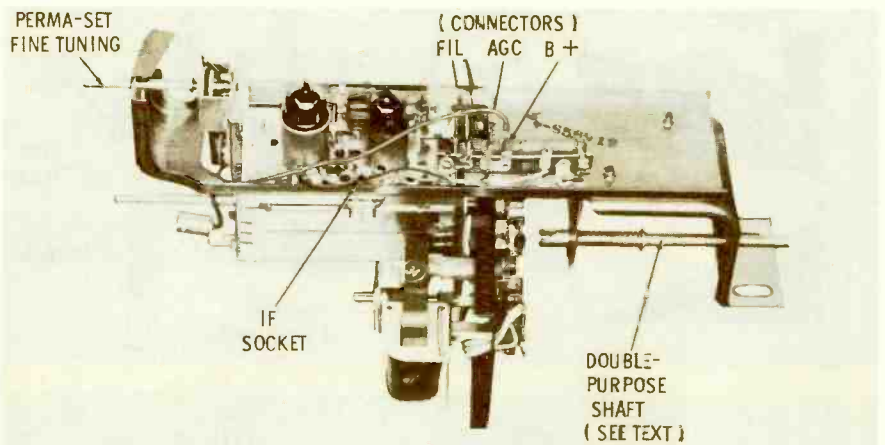
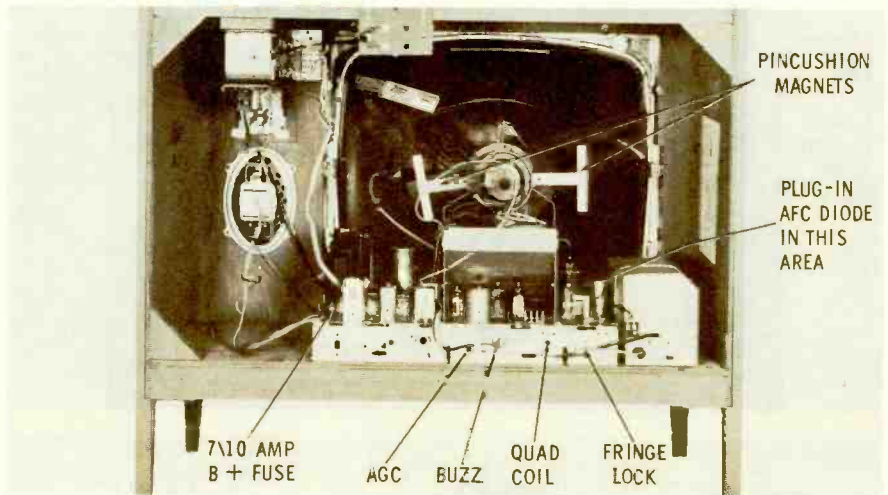

See PHOTOFAC Set 533, Folder 1

Mfr: Motorola Chassis No. TS-435

Card No: MO TS-435-1

Section Affected: Raster.

Symptoms: Vertical jitter. Voltage fluctuates at plate (pin 3) of V4B (8GN8).

Cause: Defective vertical size control.

What To Do: Replace R4A (2 meg).

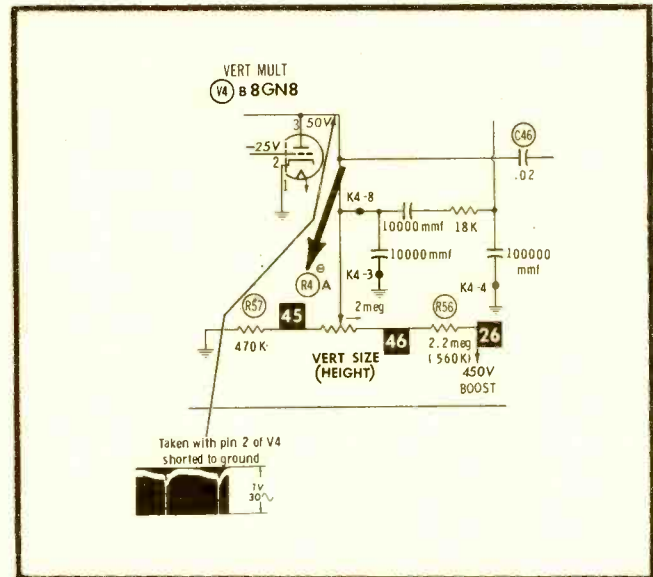

Mfr: Motorola Chassis No. TS-435

Card No: MO TS-435-2

Section Affected: Sync.

Symptoms: Poor horizontal hold.

Cause: Leaky capacitor in horizontal phase detector circuit.

What To Do: Replace C48 (1000 mmf—2000V).

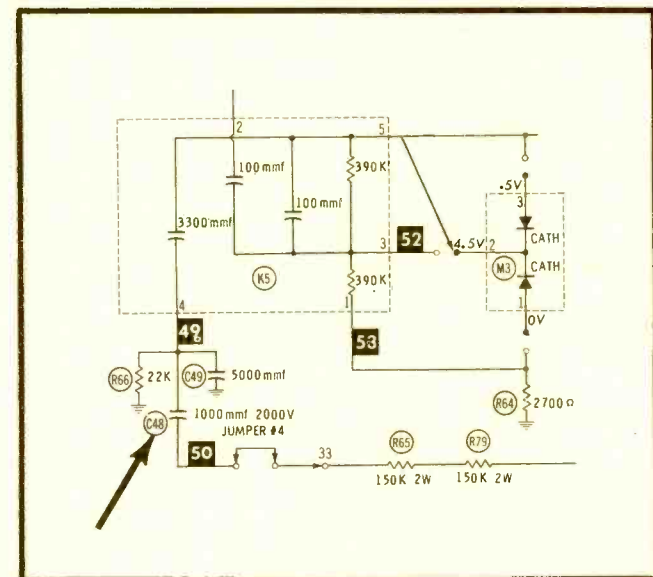

Mfr: Motorola Chassis No. TS-435

Card No: MO TS-435-3

Section Affected: Pix.

Symptoms: Badly smeared video. Low voltage at plate (pin 9) of V4A (8GN8).

Cause: Defective solder joint causes open connection to video peaking coil.

What To Do: Replace L15 or resolder its leads.

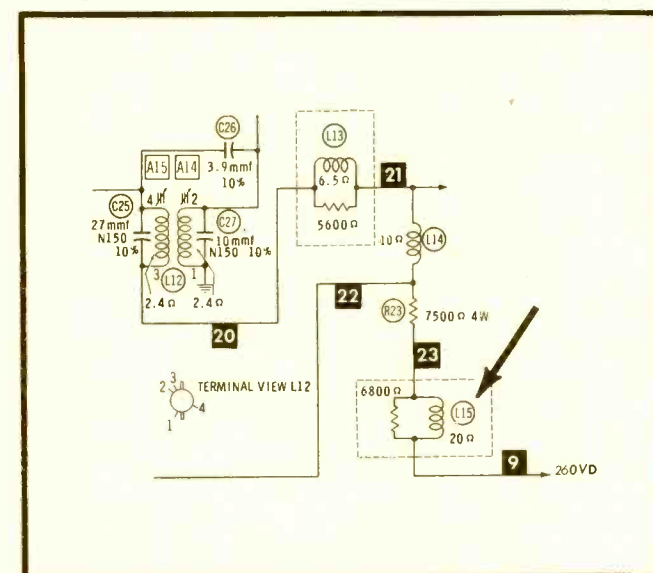

See PHOTOFAC Set 533, Folder 1

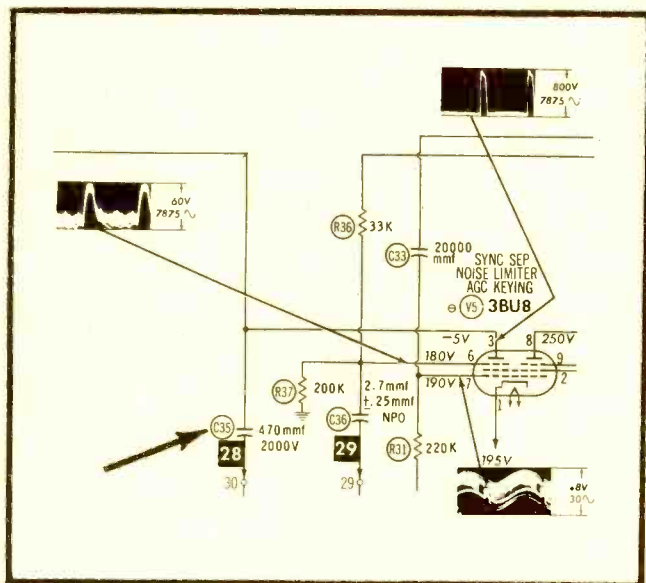

See PHOTOFACT Set 533, Folder 1

Mfr: Motorola Chassis No. TS-435

Card No: MO TS-435-4

Section Affected: Pix.

Symptoms: Video overload. High positive voltage at AGC plate (pin 3) of V5 (3BU8).

Cause: Leaky pulse-coupling capacitor in keyed AGC stage.

What To Do: Replace C35 (470 mmf—2000V).

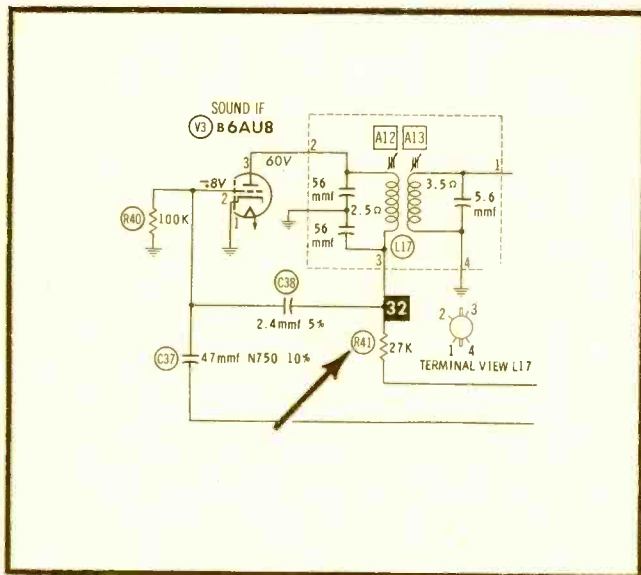

Mfr: Motorola Chassis No. TS-435

Card No: MO TS-435-5

Section Affected: Sound.

Symptoms: Sound fades out after fairly long period of operation. Voltage at plate (pin 3) of V3B (6AU8) decreases.

Cause: Plate resistor increases in value, possibly due to damage from defective V3.

What To Do: Replace R41 (27K) and V3 (6AU8).

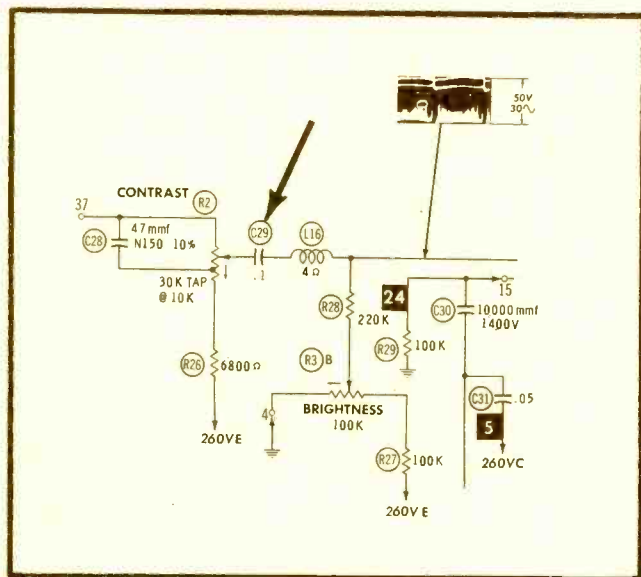

Mfr: Motorola Chassis No. TS-435

Card No: MO TS-435-6

Section Affected: Raster.

Symptoms: No raster. Voltage at cathode (pin 7) of CRT is too high.

Cause: Shorted coupling capacitor between video output stage and CRT.

What To Do: Replace C29 (.1 mfd).



See PHOTOFACT Set 560, Folder 1

Mfr: Sylvania Chassis No. 555-1

Card No: SY 555-1-1

Section Affected: Sync.

**Symptoms:** No horizontal or vertical hold.  
Zero voltage on screen grid (pin 6) of V8 (6CS6).

**Cause:** Screen resistor has burned open.

**What To Do:** Replace R52 (10K — 2W).  
Check C44 (.1 mfd) and V8 (6CS6) for leakage or short.

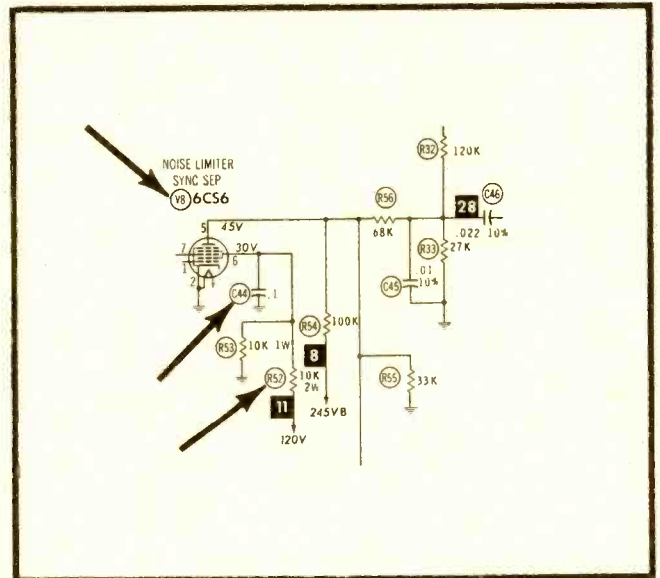

Mfr: Sylvania Chassis No. 555-1

Card No: SY 555-1-2

Section Affected: Pix.

**Symptoms:** No video. Zero voltage at cathode (pin 3) of V5A (6BR8A).

**Cause:** Open AGC control.

**What To Do:** Replace R5 (190K).

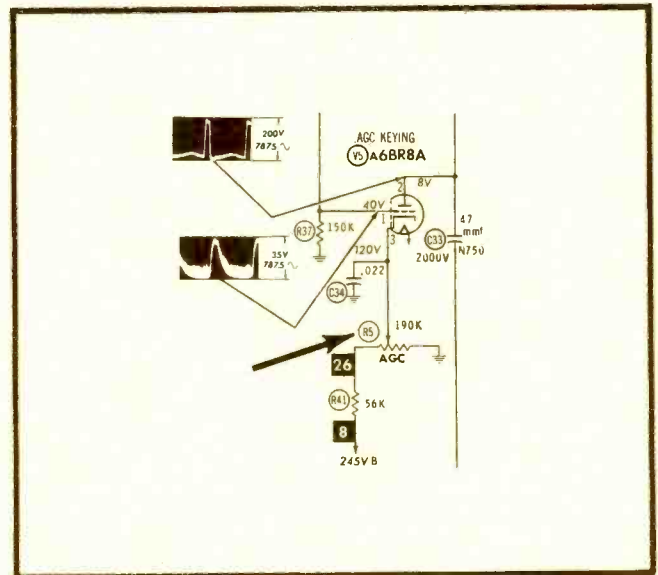

Mfr: Sylvania Chassis No. 555-1

Card No: SY 555-1-3

Section Affected: Raster.

**Symptoms:** No vertical sweep.

**Cause:** Shorted feedback capacitor in vertical multivibrator.

**What To Do:** Replace C52 (.1 mfd).

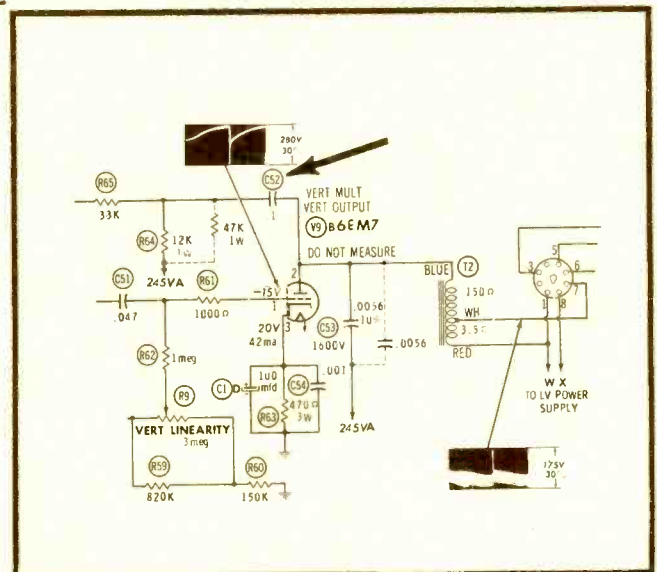

See PHOTOFACT Set 560, Folder 1

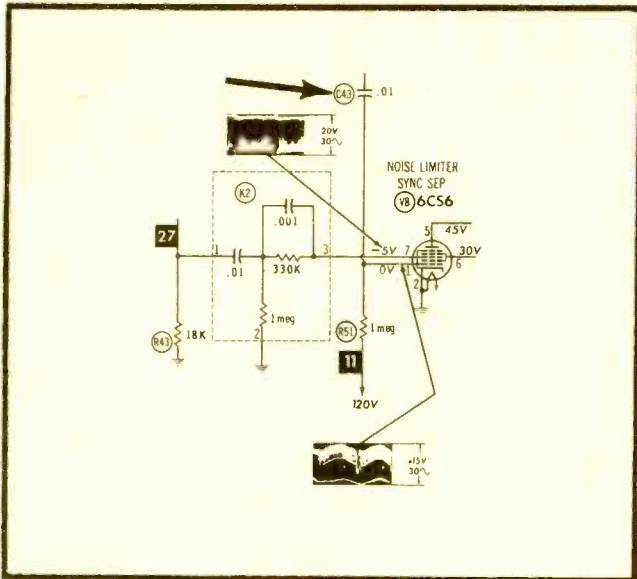

See PHOTOFACT Set 560, Folder 1

Mfr: Sylvania Chassis No. 555-1

Card No: SY 555-1-4

Section Affected: Sync.

Symptoms: Unstable vertical and horizontal hold. Positive voltage on noise-limiter grid (pin 1) of V8 (6CS6).

Cause: Leaky coupling capacitor in noise-limiter circuit of sync separator.

What To Do: Replace C43 (.01 mfd).

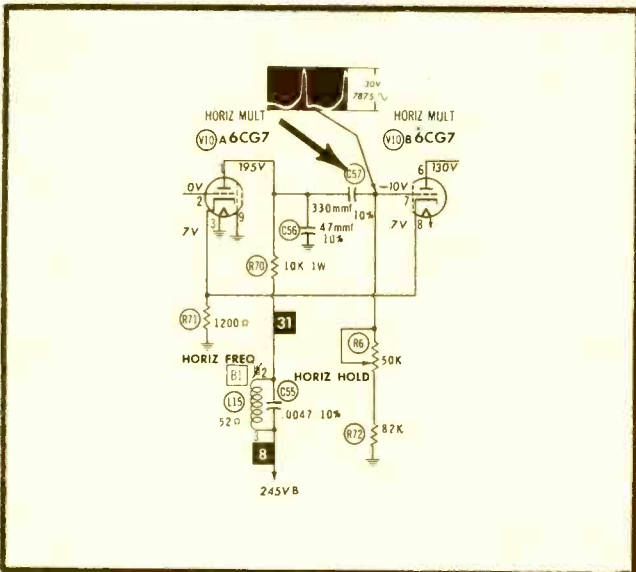

Mfr: Sylvania Chassis No. 555-1

Card No: SY 555-1-5

Section Affected: Sync.

Symptoms: Horizontal hold drifts out of range. Voltage at pin 7 of horizontal multivibrator becomes less negative than normal.

Cause: Leaky coupling capacitor between sections of horizontal multivibrator.

What To Do: Replace C57 (330 mmf).

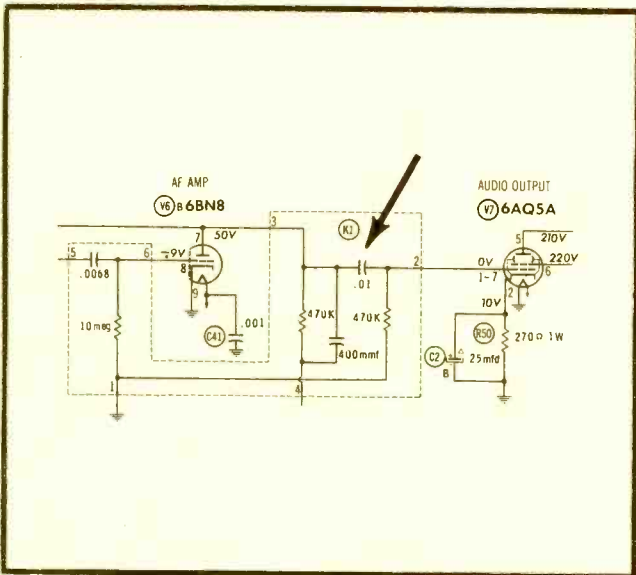

Mfr: Sylvania Chassis No. 555-1

Card No: SY 555-1-6

Section Affected: Sound.

Symptoms: Distorted sound. Positive voltage on grid (pins 1 and 7) of V7 (6AQ5A).

Cause: Leaky coupling capacitor in grid circuit.

What To Do: Replace component combination K1, which contains defective capacitor.

Prices effective January 1, 1963

# Tarzian offers FAST, DEPENDABLE TUNER REPAIR SERVICE (ALL MAKES)

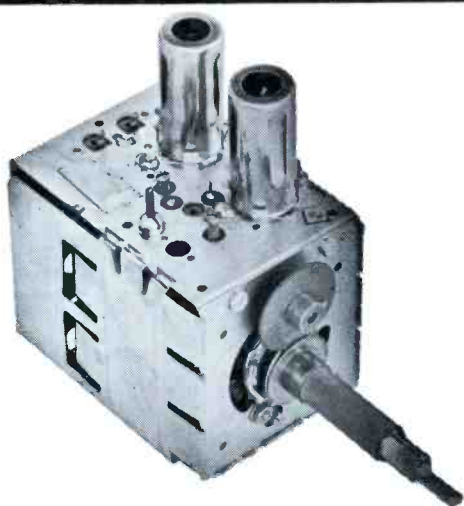

It just makes sense that a manufacturer of tuners should be better-qualified, better-equipped to offer the most dependable tuner repair and overhaul service.

Sarkes Tarzian, Inc. pioneer in the tuner business, maintains two complete, well-equipped Factory Service Centers—assisted by Engineering personnel—and staffed by specialized technicians who handle ONLY tuner repairs on ALL makes and models.

Tarzian-made tuners received one day will be repaired and shipped out the next. Allow a little more time for service on other than Tarzian-made tuners.

Tarzian offers a 12-month guarantee against defective workmanship and parts failure due to normal usage. And, compare our cost of \$9.50 and \$15 for UV combinations. There is absolutely no additional, hidden charge, for ANY parts except tubes. You pay shipping costs. Replacements on tuners beyond practical repair are available at low cost.

Ⓢ Tarzian-made tuners are identified by this stamping. When inquiring about service on other tuners, always give TV make, chassis and Model number. All tuners repaired on approved, open accounts. Check with your local distributor for Sarkes Tarzian replacement tuners, replacement parts, or repair service.

 **SARKES TARZIAN, INC.**  
*Bloomington, Indiana*

MANUFACTURERS OF TUNERS . . . SEMICONDUCTORS . . . AIR TRIMMERS . . . FM RADIOS . . . AM/FM RADIOS . . . AUDIO TAPE . . . BROADCAST EQUIPMENT

ONLY  
**\$9.50**  
INCLUDING

**ALL PARTS**  
(except tubes)  
**and LABOR**

**24-HOUR SERVICE**  
**1-YEAR WARRANTY**

**TWO SERVICE CENTERS  
TO SERVE YOU BETTER**

**See your distributor, or use the  
address nearest you for fast fac-  
tory repair service**

537 South Walnut St.  
Bloomington, Indiana  
Tel: 332-6055

10654 Magnolia Blvd.  
North Hollywood, Calif.  
Tel: 769-2720

For window-size blow-ups  
of this message, send 10¢ to  
Sprague Products Co.,  
105 Marshall St., North Adams,  
Mass., to cover handling  
and mailing costs.



# EVERY DAY IS INDEPENDENCE DAY



FOR YOU AND YOUR  
 **INDEPENDENT**    
TV SERVICE DEALER



Your independent TV Service Dealer is in business for himself because he too wants to exercise his independence just as you do. You purchased your TV or radio set where you wanted to . . . when you wanted to . . . and at the price you decided was right.

Your TV service dealer is also an independent in the things he buys in his day-to-day work. He buys repair parts where he can get the highest quality and the best service. And, he trained himself in his own way, on his own time, at his own expense, to be able to do the very best for YOU.

He stands or falls on what you think of him and his work. He has to do good work to keep your business . . . and he knows it!

We're lucky in these United States that every day is Independence Day. Independent buying, selling, and servicing is the very lifeblood of American business. Let's keep it that way.

**THIS MESSAGE WAS PREPARED BY SPRAGUE PRODUCTS COMPANY,  
DISTRIBUTORS' SUPPLY SUBSIDIARY OF SPRAGUE ELECTRIC COMPANY, NORTH ADAMS, MASSACHUSETTS FOR . . .**

**YOUR INDEPENDENT TV-RADIO SERVICE DEALER**

**publisher**  
Howard W. Sams  
**general manager**  
Mal Parks, Jr.  
**editor**  
Verne M. Ray  
**managing editor**  
Forest H. Belt  
**ass't. managing editor**  
Thomas A. Lesh

**associate editors**  
George F. Corne, Jr.  
Fred G. Biesecker

**consulting editors**  
William E. Burke  
Joe A. Groves  
C. P. Oliphant

**production manager**  
Robert N. Rippy

**circulation fulfillment**  
Pat Tidd, Mgr.  
Katherine Krise, Ass't.  
Cora La Von Willard, Ass't.

**art directors**  
Dick Lovell  
Robert W. Reed

**advertising & editorial assistants**  
Gladys Bauer  
Georgeanna Caldwell  
Clare Hult  
Ellie Rother

**photography**  
Paul Cornelius, Jr.

**advertising sales offices**  
John Groce, advertising sales manager

**midwestern**  
Hugh Wallace  
PF REPORTER  
4300 West 62nd Street,  
Indianapolis 6, Ind.  
AXminster 1-3100

**eastern**  
Charles Horner  
Howard W. Sams & Co., Inc.  
3 West 57th Street,  
New York, N. Y.  
MUrray Hill 8-6350

**western**  
The Maurice A. Kimball Co., Inc.  
2550 Beverly Blvd., Los Angeles 57, Calif.  
DUmkirk 8-6178; and 580 Market Street,  
Room 400, San Francisco 4, Calif. EXbrook 2-3365

**Address all correspondence to**  
PF REPORTER, 4300 W. 62nd Street,  
Indianapolis 6, Indiana



Copyright © 1963 by Howard W. Sams & Co., Inc.  
PF REPORTER is a trademark of Howard W. Sams & Co., Inc. No part of PF REPORTER may be reproduced without written permission. No patent liability is assumed with respect to use of information herein. Acceptance of advertising does not in any manner signify the products, policies and services so advertised have been approved, endorsed or recommended by this magazine.  
Subscription Prices: 1 year—\$4.00, 2 years—\$7.00, 3 years—\$9.00, in the U.S.A., its possessions and Canada.  
All other foreign countries: 1 year—\$5.00, 2 years—\$9.00, 3 years—\$12.00. Single copy 35c; back copies 50c

Indexed in *Lectrodex*.  
Printed by the Waldemar Press Div.  
of Howard W. Sams & Co., Inc.



# PF REPORTER

including **Electronic Servicing**

VOLUME 13, No. 5

CONTENTS

MAY, 1963

<b>Previews of New Sets</b>	1
Airline Model WG-5713A (Chassis 23531) Emerson Model C-2001A (Chassis 120587A) Olympic Model 9T22 (Chassis 10119) Zenith Model K3341H (Chassis 16K23QS)	
<b>Video Speed Servicing</b>	5
Service hints on Motorola Chassis TS-435 and Sylvania Chassis 555.	
<b>Letters to the Editor</b>	12
<b>The Electronic Scanner</b>	16
<b>Resistors With More Than One Job</b>	20
Special types that undergo predictable changes in value can perform automatic control functions.	
<b>Symfact: Sync Separator and Splitter (Using Two Triode Stages)</b>	25
See what happens to voltages and waveforms when troubles occur.	
<b>Tuner Repairs Made Easy</b>	28
When you know your way around inside a tuner, it's just another TV circuit.	
<b>More Visual Symptoms Tell a Story</b>	30
Unusual CRT presentations give many good trouble clues.	
<b>Know Your '63 Color Circuits: Convergence Panel</b>	32
Simplified schematics make the multiple control circuits more readily understandable.	
<b>Special Equipment Speeds Servicing</b>	38
Quicker Servicing—Auxiliary instruments have countless uses in bench troubleshooting.	
<b>Molecular Electronics Explained</b>	50
Servicing Industrial Electronics—Microminiaturization is advancing on many fronts.	
<b>Guaranteeing Your Service Work</b>	58
Dollar and Sense Servicing—Let there be no room for misunderstanding between you and the customer.	
<b>Notes on Test Equipment</b>	64
Lab reports on the Jackson Model 800 Color Generator and Heath IO-10 Scope.	
<b>The Troubleshooter</b>	74
<b>Product Report</b>	90
<b>Free Catalog &amp; Literature Service</b>	92
<b>Monthly Index</b>	on free literature card

## ABOUT THE COVER

This month's issue contains an extra-long string of articles on practical TV servicing. Among other things, you'll learn more about analyzing picture symptoms, tear into tuners, examine color convergence circuits, find out how thermistors work, and see some unusual approaches to troubleshooting at the bench.

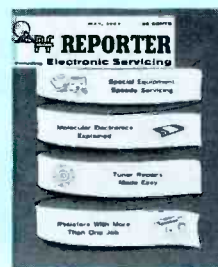

# ATR PRODUCTS FOR MODERN LIVING



## ATR PLUG-IN TYPE PORTABLE INVERTERS\*

A. C. HOUSEHOLD ELECTRICITY Anywhere in your own car, boat or plane

- Operates Standard A.C.
  - Record Players
  - Dictating Machines
  - Small Radios
  - Electric Shavers
  - Heating Pads, etc.
- In your own car or boat!

**MODELS**  
 6-RMF (6 volts) 60 to 80 watts. Shipping weight 12 lbs. DEALER NET PRICE \$33.00  
 12T-RME (12 volts) 90 to 125 watts. Shipping weight 12 lbs. DEALER NET PRICE \$33.00  
 \*Additional Models Available

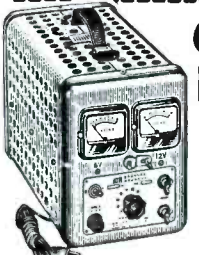

## ATR "A" BATTERY ELIMINATOR

For Demonstrating and Testing Auto Radios—TRANSISTOR or VIBRATOR OPERATED!

Designed for testing D.C. Electrical Apparatus on Regular A.C. Lines—Equipped with Full-Wave Dry Disc-Type Rectifier, assuring noiseless, interference-free operation and extreme long life and reliability.

MAY ALSO BE USED AS A BATTERY CHARGER  
 MODEL 610C-ELIF . . . 6 volts at 10 amps. or 12 volts at 6 amps. Shipping weight 22 lbs.  
 DEALER NET PRICE \$49.95  
 MODEL 620C-ELIT . . . 6 volts at 20 amps. or 12 volts at 10 amps. Shipping weight 33 lbs.  
 DEALER NET PRICE \$66.95

## AUTO-RADIO VIBRATORS



By every test ATR Auto-Radio Vibrators are best! and feature Ceramic Stack Spacers, Instant Starting, Large Oversized Tungsten Contacts, Perforated Reed, plus Highest Precision Construction and Workmanship and Quiet Operation!

There is an ATR VIBRATOR for every make of car!  
 Ask your distributor for ATR's Low Priced type 1400, 6 volt 4-prong Vibrator; and 1843, 12 volt 3-prong; or 1840, 12 volt 4-prong Vibrator. THE WORLD'S FINEST!



## ATR UNIVERSAL KARADIO MODEL 600 SERIES

Easily installed in-dash or under-dash. Amplifier power-supply chassis may be separated from tuner chassis for easy servicing. Utilizes 6-tube superheterodyne circuit (2 dual-purpose tubes). Supplied with separate 5" x 7" speaker. Neutral gray-tan baked enamel finish. Overall size 4" deep x 6 1/2" wide x 2" high. Tuner Chassis; with Amplifier Chassis, 2 3/8" deep x 6 1/2" wide x 3 3/8" high. Shipping weight 7 lbs. WILL OUT-PERFORM MOST SETS!  
 Model 612—12 Volt, Dealers Net Price \$31.96  
 Model 606—6 Volt, Dealers Net Price 31.96



Airplane Style Overhead Mounting under Cab Roof NO PRINTED CIRCUITRY

**ATR TRUCK KARADIO**  
 Excellent Tone, Volume, and Sensitivity!  
 Compact, yet powerful. Fits all trucks, station wagons, most cars and boats. Just drill a 3/8 inch hole in roof and suspend the one-piece unit (aerial, chassis and speaker) in minutes. Watertight mounting assembly holds antenna upright. Yoke-type bracket lets you tilt radio to any angle.  
 Extra-sensitive radio has 6 tubes (2 double-purpose), over-size Alnico 5 PM speaker for full, rich tone. Big, easy-to-read illuminated dial. Fingertip tuning control. Volume and tone controls. 33-in. stainless steel antenna. Neutral gray-tan enameled metal cabinet, 7 x 6 1/2 x 4 in. high over-all. Shipping weight 10 1/2 lbs.  
 Model TR-1279—12A for 12V Dealer Net Price \$41.96  
 Model TR-1279—6A for 6V Dealer Net Price \$41.96

See Your Electronic Parts Distributor Write Factory For Free Literature

**ATR ELECTRONICS, INC.**  
 Formerly: American Television & Radio Co.  
 Quality Products Since 1931  
 ST. PAUL 1, MINNESOTA—U.S.A.



# LETTERS TO THE EDITOR

Dear Editor:

I'd like you to know PF REPORTER is tops with me; I've dropped my other subscriptions, but never this one. In the February issue, the article "Tough Dogs Lose Their Bite" was very good; the analyses were just like having an instructor right there giving the explanations. Let's have more like that. Incidentally, *Symfact*'s great; keep them coming!

JOHN DUBSKY

Cleveland, Ohio

Great to hear from you, John—particularly such fine compliments. We'll continue trying to live up to them.—Ed.

Dear Editor:

I'm a little confused about the video-output circuit diagram in March *Symfact*. Although the text describes three parallel paths to B+, I can find only one, through the contrast control and R11. Should there be a connection from between R8 and L2 to B+?

H. V. WILLIAMS

San Angelo, Texas

Dear Editor:

In explaining Symptom 1 of March *Symfact*, you say, "With R11 open, one of parallel paths to plate of V1A is broken, and plate voltage drops to 115 volts." It seems to me that, if R11 opens, the plate voltage will be zero. The "Normal Operation" section states there are three parallel paths, but I've failed to see an alternate source of B+ after thoroughly studying your diagram. Could it be that a voltage is supposed to be applied at the junction of R8 and L2?

VIRGIL PRIDDY, JR.

Louisville, Ky.

LOST: One small line, one arrow, and a small sign reading "250V." Urgently needed for survival of half-starved video circuit. Apply at junction of L2 and R8 in March *Symfact*.—Ed.

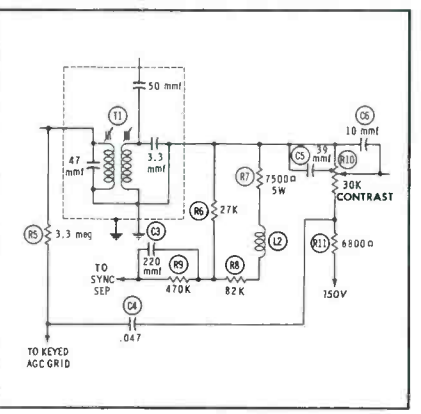

# NEW

antenna specialists brand

## Black Beauty Fiberglas CB antennas

now you can whip two problems most common to fiberglas antenna performances!

First: through the "black magic" of exclusive Thermofit PVC process, brittleness and cracking are eliminated. Much more resistant to constant abrasions.

Second: The durable, black finish is inconspicuous yet gives an impressive, clean, classic look to your car. Looks good even after long, hard use. Center loaded and only 48" high. Choice of mounts.

"Stripes of Quality"











the antenna specialists co.

12435 Euclid Avenue  
 Cleveland 6, Ohio  
 Export Div., 15 Moore St.,  
 New York 4, N.Y.



# TAKE 9 NUMBERS... AND YOU'VE GOT IT

B	I	N	G	O
 SG-20HP4D	<del>20CP4A</del>	<del>21A1P4A</del>	<del>24ANP4</del>	 SG-21XP4A
<del>17BP4</del>	 SG-24AEP4	<del>21B1P4</del>	 SG-20CP4D	<del>24TP4</del>
<del>20BP4</del>	<del>21C1P4</del>	 SG-24CP4A	<del>20HP4C</del>	<del>21CP4A</del>
<del>21A1P4A</del>	 SG-21FLP4	<del>21XP4</del>	 SG-21ACP4A	<del>24TP4</del>
 SG-17BJP4	<del>21A1P4</del>	<del>21C1P4</del>	<del>20DP4C</del>	 SG-21AUP4B

## WHAT HAPPENED TO ALL THE OTHER "NUMBERS"?

Who needs them? They're all gone . . . finis, kaput, raus mit, ausgespilt! NOW, with PHILCO Star Bright 20/20 Picture Tubes, 9 basic types do the job of 91 numbers that you needed before. That means that just about all of the popular tube replacement jobs can be done with just 9 Philco CR Tube numbers.

That's only part of the story. It's important that just one tube replaces 19 you needed before . . . but it is equally important to you that you can meet most ANY tube need . . . from 10" sizes up to 27" tubes with just 30 Philco "universal" tube numbers.

This saves you time. Saves you money. It means that

your Philco Distributor will have the tube you need IN STOCK . . . when you need it!

Philco Star Bright 20/20 Picture Tubes give you a big advantage in customer satisfaction . . . with clearer, brighter pictures. Every Philco Star Bright 20/20 Picture Tube is made from all new parts and materials, except for the envelope, which, prior to re-use is inspected and tested to the same exacting standards as a new envelope and of course, every one still carries a full year warranty!

Stop in at your Philco Distributor today. Nine Philco Star Bright CRT numbers are all you need to win . . . on most replacement jobs.

DEPEND ON YOUR PHILCO DISTRIBUTOR . . . Your one stop shopping center for all your tubes, parts and accessories.

PHILCO MODERN COPPER  
ENGRAVED CIRCUITS

*— for Simplified Service*



PARTS AND SERVICE OPERATIONS

**PHILCO**

A SUBSIDIARY OF *Ford Motor Company*

# WHY THE *Winegard*

# COLORTRON

DESIGNED ESPECIALLY FOR COLOR TV

Genuine **GOLD ANODIZED** Finish  
for permanent protection

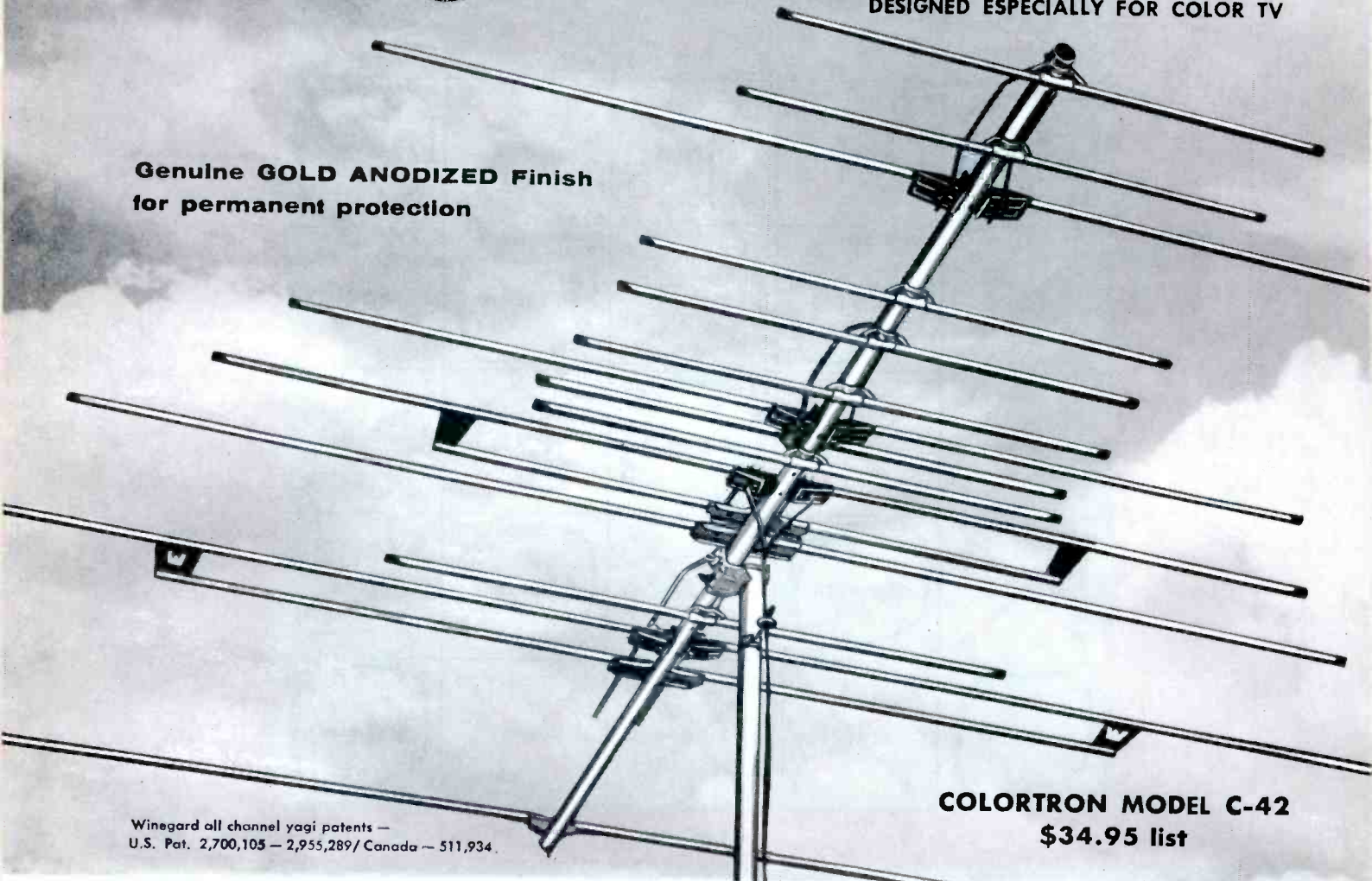

**COLORTRON MODEL C-42**  
**\$34.95 list**

Winegard all channel yagi patents —  
U.S. Pat. 2,700,105 — 2,955,289/ Canada — 511,934.

**The world's BEST performing VHF all channel TV antenna, size for size and dollar for dollar, is the Winegard Colortron. The Colortron is more nearly perfect than any other all channel antenna made. It is the only all channel antenna you can buy that carries a factory written guarantee of best performance.**

#### HERE'S WHY COLORTRON IS BEST

1. A perfect all channel, high gain TV antenna would have the following characteristics:

—the sensitivity of a well-engineered cut channel yagi of equal physical length on each of the 12 channels.

—sharp directivity. A single frontal lobe and absolutely no pick-up of signal from back or sides on any channel.

—it would have an exact 300 ohm non-reactive impedance on every VHF channel 2 through 13.

2. There are several basic designs for high gain, all channel TV antennas. For practical reasons, only two of these are used today.

(A) The *all channel yagi* that incorporates only 2 driven elements—but *many* directors. This design was invented by John R. Winegard in 1954. Until then, the high efficiency of the yagi was limited to single channel antennas.

(B) The all channel antenna that incorporates a *multiplicity of driven elements* in a single plane. These are *End-Fire* arrays.

This basic design was first used for TV in 1952. Some end-fire antennas are called "log periodic".

IT IS A SCIENTIFIC FACT that a single  $\frac{1}{2}$  wave director element\* will absorb 4 times more signal energy from a TV wave than a  $\frac{1}{2}$  wave driven element\*\*. Because of this indisputable fact, the Winegard Colortron all channel yagi uses multiple *directors* to get its gain—not multiple driven elements.

To obtain a near perfect impedance match across the entire VHF TV band, it takes only two driven elements. More than two driven elements will not improve the match any more than extra wheels would improve a car. The only purpose of driven elements on a TV antenna is to transfer the signal energy to the line.

As every antenna engineer knows, a well-engineered cut-to-channel *yagi* (with but *one* driven element and *many* directors) is superior to any other design when peak performance is desired on a single channel. The same fact holds true for best results in all channel reception . . . the yagi design is the most efficient, sensitive ever created on a size for size basis.

\*Directors are elements connected electromagnetically (not by means of phasing lines) to the driven elements.

\*\*Driven elements are connected together with phasing lines and the transmission line is attached to these elements.



# Antenna is World's BEST

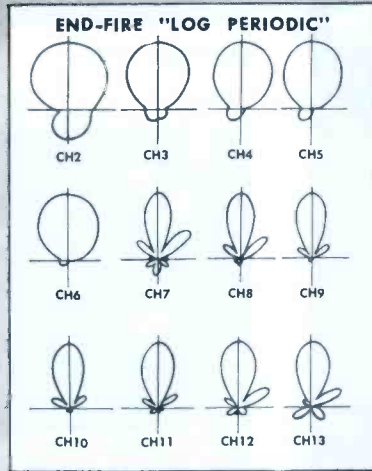
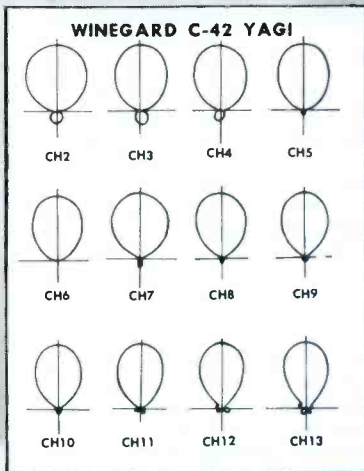

## COMPARE POLAR PATTERNS

**WINEGARD C-42 YAGI.** Polar patterns from Polar coordinate Recorder Speedomax Type G.

NOTE uniform directivity patterns and high uniform front-to-back ratio on all channels. NOTE absence of spurious lobes and total absence of side pick-up.

**END-FIRE "LOG PERIODIC"** model comparable with C-42. Polar patterns taken from same recorder.

NOTE large variation between directivity from channel to channel. NOTE reduced front-to-back ratio from C-42. NOTE spurious lobes (especially on high band) which pick up interference. Also has undesirable side pick-up on low band.

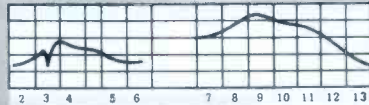
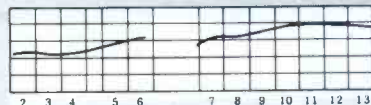

## COMPARE FREQUENCY RESPONSE CURVES

**WINEGARD C-42 YAGI** shows consistent sensitivity across all channels. No roll-off on ends of bands, no suck-outs to ruin color reception.

**END-FIRE "LOG PERIODIC"** (in same price range) shows varying sensitivity across the bands. Peaks in middle of bands with sharp roll-offs on ends. Serious suck-out in middle of channel 3.

**PERFECT PARTNER TO THE COLORTRON ANTENNA... THE TWIN NUVISTOR COLORTRON AMPLIFIER**

Winegard's revolutionary new circuit, employing 2 nuvistors, enables the Colortron to overcome the service problems and limitations of other antenna amplifiers. Colortron will not oscillate, overload or cross modulate because it takes up to 400,000 microvolts of signal input. This is 20 times better than any single transistor amplifier.

The Colortron amplifier will deliver clean, clear, color pictures or black and white, sharp and bright without smear. It can be used with any good TV antenna but will deliver unsurpassed reception when used with a Colortron antenna.

Nothing on the amplifier is exposed to the elements—even the terminals are protected. A rubber boot over the twin-lead keeps moisture out. Colortron comes complete with an all AC power supply with built-in 2 set coupler. Colortron model AP-200N 300 ohm input and output \$39.95 list. Model AP-275 300 ohm input 75 ohm output \$44.95 list.

## NOW WHAT ARE THE BASIC DIFFERENCES BETWEEN THESE TWO TYPES OF ALL CHANNEL ANTENNAS?

One big difference is in **SENSITIVITY**. The Winegard Colortron patented yagi with multiple directors has far more ability to absorb signal power from a TV wave than multiple driven element antennas. In fact, all fringe-type antennas with multiple driven elements have one or more directors out front. Why add directors if the multiple driven elements are supposed to be so efficient? The reason is obvious... directors are added to get the gain they can't get with extra driven elements.

Another big difference is in **DIRECTIVITY**. The Winegard Colortron patented yagi has far better directivity characteristics than multiple driven element antennas and the *directivity pattern is essentially the same on every channel*. The Colortron has no signal pick-up from the sides (as you can see above). It offers no receiving surface to side signals and has no complex phasing problems to cause extra pick-up lobes. It has *minimum* pick-up from the back.

On the other hand, multiple driven element antennas have large side lobes because the driven elements are always out

of phase at some frequencies in the TV band—particularly on the high band.

The Winegard Colortron excels, too, by having the *best 300-ohm match in the industry*—an average VSWR of better than 1.5 to 1 across both bands.

In addition to its performance superiority, the Winegard Colortron has the finest quality construction and *permanent gold anodizing* for weather protection. A personal examination of a Colortron tells this quality story far better than words.

(The polar patterns and frequency response curves above have been illustrated to give you a basis of comparison between Winegard's popular Colortron Mod. C-42 and a highly advertised multiple driven element antenna which we have tested (along with other models in this line.) Constant testing of all new outdoor TV antennas proves to our satisfaction that no other design equals or excels the Winegard Colortron in quality or performance. We are so positive of this performance superiority that we put a written guarantee on it.

For technical data sheets write today!

Nationally advertised month after month.



There's an Extra Bonus of Quality and Performance in Every Winegard Product

-   
**COLORTRON ANTENNA**  
 Model C-44—Gold Anodized  
**\$64.95**
-   
**COLORTRON ANTENNA**  
 Model C-43—Gold Anodized  
**\$51.90**
-   
**COLORTRON ANTENNA**  
 Model C-42—Gold Anodized  
**\$34.95**
-   
**COLORTRON ANTENNA**  
 Model C-41—Gold Anodized  
**\$24.95**



**Winegard**  
ANTENNA SYSTEMS

3009-5 KIRKWOOD • BURLINGTON, IOWA

## BUSS quick-acting fuses

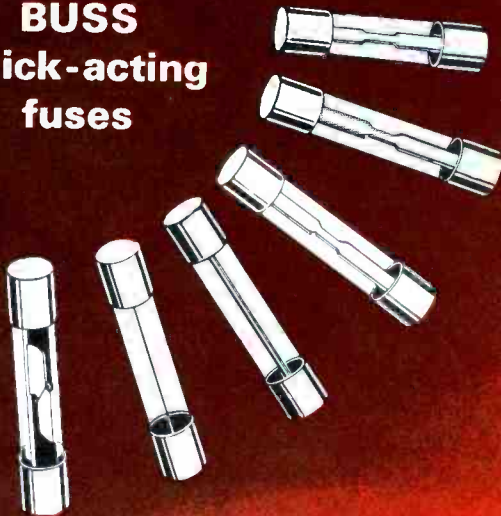

"Fast Acting" fuses for protection of sensitive instruments or delicate apparatus;—or normal acting fuses for protection where circuit is not subject to starting currents or surges.

# BUSS

Write for BUSS  
Bulletin SFB.

BUSSMANN MFG. DIVISION, McGraw-Edison Co., St. Louis 7, Mo.

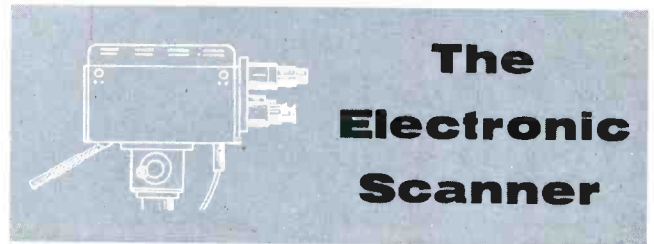

## The Electronic Scanner

### CCTV Banking



Tellers at Chicago's Union National Bank are using a new banking system with RCA closed-circuit television equipment. The system is designed so that the bank customer, upon approaching the drive-in station, sees himself on the TV screen. By pressing a signal bar, he summons the teller, who switches the "hear-see" system to two-way operation. In the photo, the teller is removing a deposit slip from a pneumatic tube which whisks banking items between the bank and the outdoor station in a matter of seconds. Several television banking systems of this type are presently in operation in numerous areas throughout the United States.

### New RF Amplifiers

The Electron Tube Division of Sylvania is now producing a new family of RF amplifier triodes for use in VHF tuners of television receivers. The 2HK5, 3HK5, 4HK5, and 6HK5, all alike except for filament ratings, feature "strap-frame" construction of the control grids.

## BUSS : the complete line of fuses . . . .

### Joins Recorder Industry



Argus Incorporated, well known as a manufacturer of photographic equipment, has recently entered the tape recorder field. Initial models include the Argus 800, a four-track stereo unit; the Argus 400, a four-track monophonic unit; and the Argus 200, a dual-track unit. Herbert R. Leopold, president, indicated additional recorders will join the line later this year.

### Win a New Console TV



Four "Telequiz" sweepstakes contests, especially for service technicians and dealers, are being conducted by Amperex Electronics Corp. during 1963. The rules call upon the technician to identify — from a photograph of a widely used TV chassis—the manufacturer's name and the chassis number. A different chassis will be represented in each of the four contests: January, April, September, and December are the "lucky" months. Entry cards, rules, and full color illustrations of the chassis will appear in leading electronic service magazines—see the January PF REPORTER and this issue. Entry is simple—just fill out and mail the card.

## FUSETRON dual-element fuses time-delay type

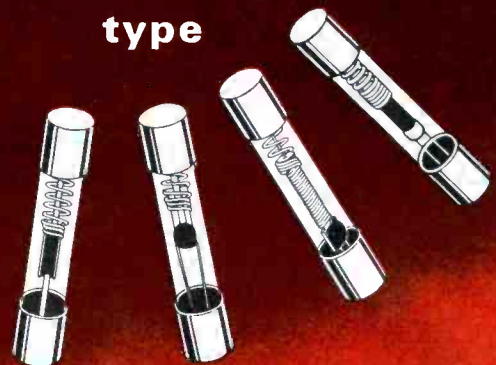

"Slow blowing" fuses for circuits where harmless surges occur. These fuses prevent needless outages by safely holding starting currents or surges;— yet they provide safe, positive protection against short-circuits or continued overloads.

# BUSS

Write for BUSS  
Bulletin SFB.

BUSSMANN MFG. DIVISION, McGraw-Edison Co., St. Louis 7, Mo.

## signal or visual indicating fuses

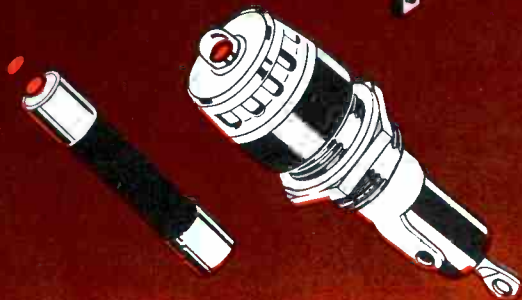
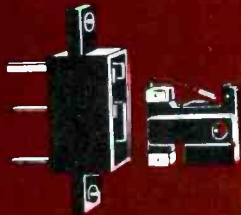

Indicating fuses provide quick, positive identification of a faulted circuit. There are fuses that give a visual signal; fuses that activate an alarm;— and fuses that give a visual signal and activate an alarm.

# BUSS

Write for BUSS  
Bulletin SFB.

BUSSMANN MFG. DIVISION, McGraw-Edison Co., St. Louis 7, Mo.

## And One to Grow On



Construction has begun on a 290,000-square-foot, multipurpose building for **Texas Instruments, Inc.** Site of the new building is the firm's 350-acre property in Dallas, Texas. Initially, a major portion of the building will be used to consolidate some of the TI Apparatus Division's electronic and electromechanical systems designing and manufacturing activities. The plant is to be completed in sections, with partial occupancy to begin this fall.

## Trade Name Changed

Sidney Harman, president of **Jerrold Corporation**, announced consolidation of two company subsidiaries on March 1, 1963: Technical Appliance Corp., Consumer Products Division (TACO) is being combined with Jerrold Electronics Corp., Distributor Sales Division. The TACO line of antennas for consumers will be marketed under the trade name "Jerrold-TACO." The first series of new products is expected to appear on the market later this year.

## Capacitor Wall Chart Available

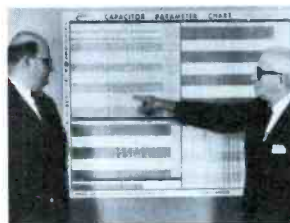

Complete information on all types of **Aerovox** capacitors is contained in a chart designed to hang on a wall. Measuring 36" x 48", the chart categorizes capacitors according to type — paper, electrolytic, and mica, among others. Voltage ratings and power factor are also included in the listings.

... of unquestioned high quality

## New, Larger Plant



Construction of a new 125,000-square-foot plant for **Littelfuse, Inc.** began in mid-March. Site of the new building is in Des Plaines, a suburb of Chicago. The company's sales, engineering, research, administrative, and production personnel all expect to be moved into the new quarters sometime in November of this year.

## How Loud Is Too Loud?

According to Karl Jensen, president of **Jensen Industries**, many consumers have the wrong conception of high fidelity: "People seem to feel that high fidelity means high volume, so they turn everything up as loud as it can go, and let the result blast them out of their house." Mr. Jensen further pointed out that if you must shout to be heard when the hi-fi is playing, something is wrong with your sound system. High fidelity actually means a high degree of faithfulness in sound reproduction. Not only is the type and arrangement of equipment important, but so is the quality of service.

## High-Fidelity Speakers



**Vidaire Electronics Mfg. Corp.** has been appointed to market a complete line of **Lorenz** speakers, on a nationwide basis, through parts distributors. In addition to the biaxial unit shown (a 12" dual-cone speaker with twin tweeters attached), the line includes both 8" and 12" dual cone models. An armored-horn 2½" tweeter, and a 2000-cps crossover network for use with two- or three-way speaker systems.

# Let BUSS Fuses Help Protect Your PROFITS

To make sure BUSS fuses will operate as intended under all service conditions, each and every BUSS fuse is individually tested in a sensitive electronic device.

This is your assurance that when you sell or install BUSS fuses, you are safeguarded against complaints, call-backs and adjustments that might result from faulty fuses and eat away your profit.

It is just good business  
to sell fuses the BUSS way.

# BUSS

Write for BUSS  
Bulletin SFB.

BUSSMANN MFG. DIVISION, McGraw-Edison Co., St. Louis 7, Mo.

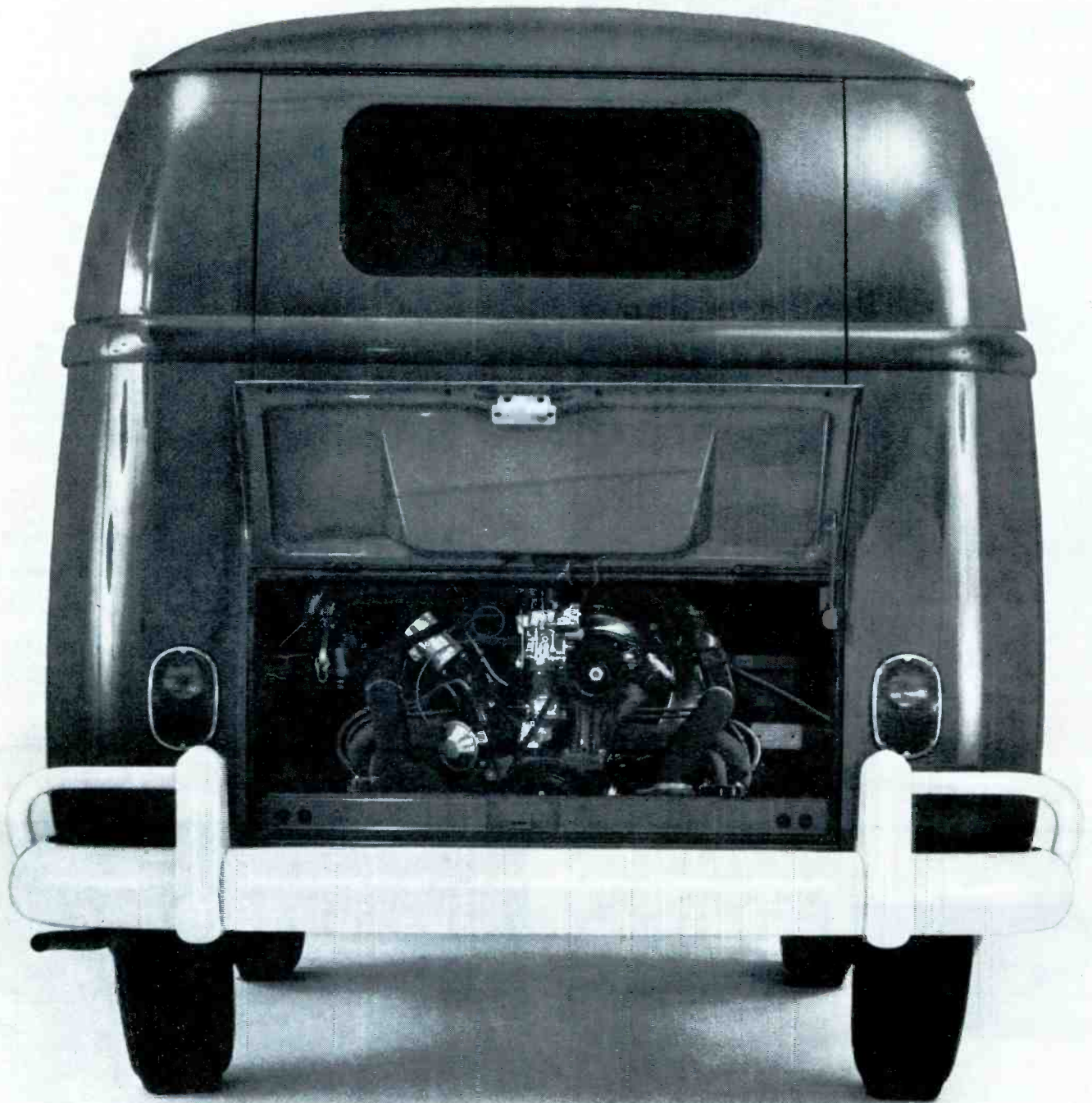

© 1963 VOLKSWAGEN OF AMERICA, INC.

## Our '63 story begins at the end.

Under the back cover.

That's our new air-cooled engine sitting in there, the largest any Volkswagen Truck ever had. The most powerful, too. It turns out 25% more horsepower than the engine it replaces.

You'll want the extra power if your business takes you out on the highway. (Top speed tops that of any other VW

Truck going.) Or over a stop-and-go delivery route. (Pick-up is quicker.) Or up steep hills. (You can climb 28% grades with a full load: 1,830 pounds.)

Best of all, you get the extra power without burning extra gas. We still average about 24 mpg. On regular.

Other new features?

Bigger brakes and a larger clutch to

go with the more powerful engine.

Up front, in the cab, a new individual driver's seat that adjusts to give you all the legroom you need. A new oversize passenger seat. A new fresh air heater/defroster.



And that's the inside story on the '63 Volkswagen Truck.

From end to beginning.

are you replacing  
top quality tubes  
with identical  
top quality tubes  
?

Now you can carry the identical tubes that you find designed into most of the quality TV sets you service. Chances are, you were not aware that these TV sets were designed around special Frame Grid tubes originated by Amperex and that even more tube types originated by Amperex are being designed into the sets you'll be handling in the future. Amperex frame grid tubes provide 55% higher gain-bandwidth, increase TV set reliability by simplifying circuits and speed up your servicing because their extraordinary uniformity virtually eliminates need for realignment when you replace tubes.

Tubes introduced by Amperex, currently used by major TV set makers include:

Frame Grid				Others	
2GK5	4GK5	6GK5	6EH7	6AL3	9A8
2ER5	4EH7	6ES8	6EJ7	6BL8	15CW5
3GK5	4EJ7	6ER5	6HG8	6BQ5	16AQ3
3EH7	4ES8	6FY5	7HG8	12AX7	27GB5

For optimum satisfaction for your customers and a better profit operation for yourself, make room in your caddy now for these matchless-quality tubes. Next time you visit your distributor, look for the green-and-yellow boxes and enjoy confidence in your work such as you never have before. Amperex Electronic Corporation, Hicksville, L. I., New York.



# RESISTORS

## with more than one job

A change in value during operation is sometimes desirable . . . by Robert G. Middleton

Technicians are used to thinking of resistance as the most constant characteristic of electronic circuits. Even with no power applied, definite amounts of resistance can be measured between various points; so, when electrons are sent racing through a circuit, it's easy to imagine resistors as being changeless lumps that just sit astride the current paths and enforce Ohm's law.

However, the resistance of some circuit elements can be varied by a change in heat, light, or applied voltage. Components which react in this way can be utilized for a number of automatic control functions, and as circuit-protecting devices.

### Thermistors

One of the most familiar examples of a "resistor with more than one job" is the *thermistor*, which responds to a temperature rise by proportionally decreasing in resistance. It is able to counterbalance the tendency of some other components to increase in resistance as they become hotter; therefore,

it can stabilize the *overall* resistance of a circuit.

In many late-model TV sets, a thermistor is used to maintain constant height and vertical linearity of the raster. Some models achieve direct control of yoke current by having the thermistor in series with the yoke windings; others use the more indirect form of control indicated in Fig. 1. Here, thermistor R70 is in the charging circuit that develops drive signal W9. As heat builds up inside the TV cabinet, R70 acts to lower the charging-circuit resistance, and W9 rises in amplitude. Vertical output tube V12B then develops the stronger output needed to overcome the increasing resistance of the yoke.

Some transistor radios also use thermistors—as "life preservers" for the transistors. Many of us have learned the hard way that power transistors will "run away" and destroy themselves if permitted to rise above their rated operating temperature. Since this unwanted characteristic is directly opposite to thermistor action, it can be thwarted

by connecting an ordinary thermistor in the base-emitter circuit (Fig. 2).

The bias between these two elements is determined in part by the voltage drop across the thermistor. When the temperature begins to edge upward, the decrease in thermistor resistance lowers the voltage across it, and the emitter-base bias becomes less. With lower bias, the collector current decreases enough to stabilize the junction temperature inside the transistors.

The thermistor may be ineffective if it is called upon to operate beyond its rated limits. This situation can occur when power transistors are replaced, as a consequence of wide tolerances on some types. Hence, you will often find a service control in the circuit (such as the 3000-ohm pot in Fig. 2) to compensate for differences among transistors.

Tubes, as well as transistors, need to be protected—but for a different reason. Since the cold resistance of tube heaters is much less than their hot resistance, a large current surge will flow through an unprotected series string when power is first applied. To protect heaters from this first rush of current, various devices have been used. Sometimes a simple series resistor with a high wattage rating is used to absorb the surge. In other cases, you may find *Global* resistors connected in series heater strings. These are merely thermistors which are suitably rated for this application. A typical unit has a cold resistance of 130 ohms and a hot resistance of 31 ohms.

Another approach to the heater-surge problem in series strings is the thermal relay illustrated in Fig. 3. The resistor, a wire-wound type,

• Please turn to page 81

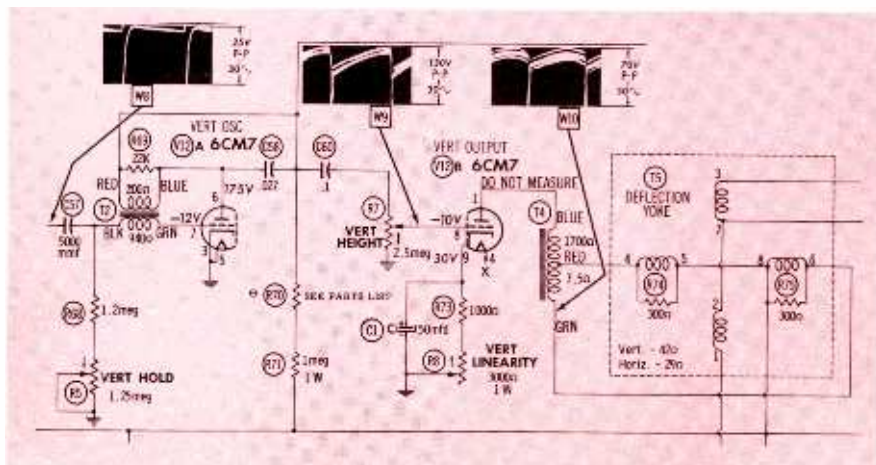

Fig. 1. Thermistor R70 modifies W9 to stabilize raster height and linearity.



NEW ADDED FEATURES—NEW LOW COST

The Famous RCA

# SENIOR VOLTOHMYST®

NOW AVAILABLE AS A KIT  
FOR ONLY \$57.95\*

Added features for extra versatility. An improved kit version of the famous RCA SENIOR VOLTOHMYST.

Most important new feature: a half-volt full-scale DC range for more accurate measuring of low voltages used in transistor circuits.

Extra plus feature: Pre-assembled, factory-tested DC/AC-OHMS probes (WG-299D) included with every kit.

Other deluxe features:

- Big 6½" meter—one of the most readable ever designed into a V-VM—electronically protected against burnout
- Color-coded scales differentiate peak-to-peak and rms readings
- ±3% accuracy full-scale on both AC and DC measurements
- Less than 1% tracking error
- Precision multiplier resistors accurate to ±1%
- Rugged die-cast aluminum case with leather handle
- Brushed aluminum control panel with etched markings

MEASURES: { AC voltages (0.1 to 4230 volts peak-to-peak and 0.1 to 2500 volts rms)  
DC voltages (0.005 to 1500)  
Resistances (0.2 ohms to 1,000 megohms)

RCA Senior VoltOhmyst WV-98C, also available factory-wired and calibrated, \$79.50\*

## OTHER OUTSTANDING RCA KIT VALUES



RCA VOLTOHMYST® KIT  
WV-77E(K) Only \$29.95\*

Famous VoltOhmyst® quality and performance at a low price! Special test features include: separate 1.5-volt rms and 4-volt peak-to-peak scales for accurate low AC measurements. Measures AC and DC voltages to 1500 volts, resistances from 0.2 ohm to 1,000 megohms. Complete with ultra-slim probes, long flexible leads, special holder on handle to store leads.

RCA WV-77E available factory-wired and calibrated: \$43.95\*



RCA WV-38A(K)  
VOLT-OHM-MILLIAMMETER KIT  
Only \$29.95\*

The V-O-M with the extras! • 0.25-volt and 1.0-volt DC ranges • Big easy-to-read 5¼" meter • Non-breakable sealed plastic case—no glass to crack or shatter • Jacks located below switches to keep leads out of the way • Spring clips on handle to hold leads • Attractive, scuff resistant, rugged carrying case, only \$4.95\* extra.

RCA WV-38A available factory-wired and calibrated: \$43.95\*



RCA SUPER-PORTABLE  
OSCILLOSCOPE  
KIT WO-33A(K) Only \$79.95\*

Now in kit form. A 'scope you can carry anywhere! Rugged and compact, yet weighs only 14 pounds. Just right for in-the-home and shop troubleshooting and servicing of black-and-white and color TV, radio, hi-fi components, tape recorders, etc. Ample gain and bandwidth for the toughest jobs. Scaled graph screen and internal calibrating voltage source for direct reading of peak-to-peak voltage.

RCA WO-33A available factory-wired and calibrated: \$129.95\*

Call your Authorized  
RCA Test Equipment Distributor



The Most Trusted Name in Electronics

\*User Price (Optional)

RCA ELECTRON TUBE DIVISION, HARRISON, N. J.



**ITT BATTERIES**



**ITT TUBES**

**GET EXTRA PROFIT MARGIN AND**  
**FULL CONSUMER ACCEPTANCE**  
**WITH THESE FOUR ITT LINES**





## ITT WIRE & CABLE



## ITT TRANSISTOR RADIOS



"To remain competitive today, dealers must have access to worldwide sources of manufacture of many lines," says L. J. Battaglia, president of ITT Distributor Products Division.

You no longer have to make the choice between an extra profit margin and a brand name respected by your customers when buying tubes, batteries, wire and cable, and transistor radios.

Now, the worldwide facilities of ITT and your ITT Distributor bring you these four complete lines... each carrying the nationally-known ITT label... each priced to give you extra profit margin.

Each product line contains the *right* models and types and the *right* prices to give you maximum profit.

**TUBES:** a comprehensive receiving tube line for entertainment use. **Batteries:** penlites, C, D, and 9-volt miniatures, poly-packed in display box and pegboard assortments. **Wire and cable:** a com-

plete line of wire and cable including twin-lead, coax, multi-conductor cable as well as most popular commercial and MIL-spec types from ITT-Royal and ITT-Surprenant facilities.

**TRANSISTOR RADIOS:** a full line from 6-transistor shirt pocket to AM-FM-SW long range models in regular step-ups.

Other ITT product lines—ITT capacitors, semiconductors, speakers, intercoms—also available. Still more will soon be added from ITT worldwide facilities and divisions and subsidiaries recently acquired in the United States.

Contact your ITT Distributor or write for full details. ITT Distributor Products Division, International Telephone and Telegraph Corporation, Box 99, Lodi, New Jersey.

# ITT

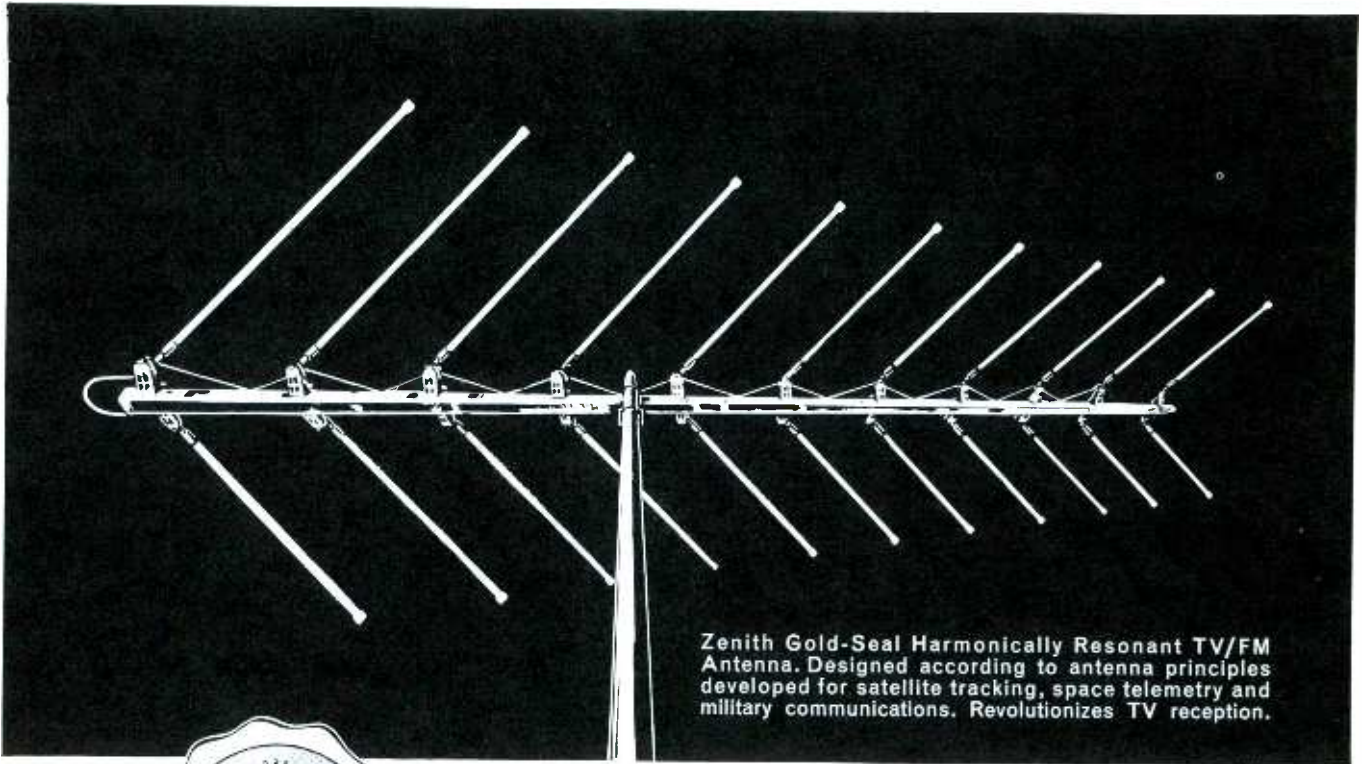

Zenith Gold-Seal Harmonically Resonant TV/FM Antenna. Designed according to antenna principles developed for satellite tracking, space telemetry and military communications. Revolutionizes TV reception.



# ZENITH QUALITY COMES TO INDOOR AND OUTDOOR TV & FM ANTENNAS!

Now Zenith brings you a complete line of **Stereo FM, Color TV, UHF and VHF** quality antennas—easy to sell, easy to install, packed with profits! Zenith Gold-Seal Antennas cover every installation requirement, from super fringe to metropolitan areas. And you can offer your customers a wide selection of indoor and outdoor antennas,

plus a complete line of exact replacements for Zenith instruments. Best for Color TV! Best for black-and-white TV! Best for FM and Stereo FM! Best for UHF! Zenith Gold-Seal Antennas are built to the highest Zenith quality standards to give you extra sales and profit opportunities!

ZENITH QUALITY ANTENNAS FOR B&W OR COLOR TV • FM AND STEREO FM • REPLACEMENTS

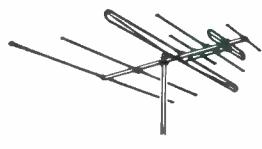

Zenith Gold-Seal Broadband Yagi VHF Antenna (Channels 2 to 13)



Zenith Gold-Seal VHF Folded Inline Antenna (Channels 2 to 13)

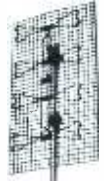

Zenith Gold-Seal UHF Stacked Bow-tie Antenna (Channels 14 to 83)

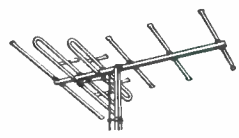

Zenith Twin Driven FM Stereo Yagi Antenna (For FM frequencies 88-108 MC)



Zenith indoor TV antennas and exact replacements for Zenith instruments

**BUILT TO HIGHEST ZENITH QUALITY STANDARDS!**

Contact your Zenith Distributor for further information or write: Zenith Sales Corp., Parts Sales Division, 5801 W. Dickens, Chicago 39, Illinois  
Specifications subject to change without notice.



Using Two Triode Stages

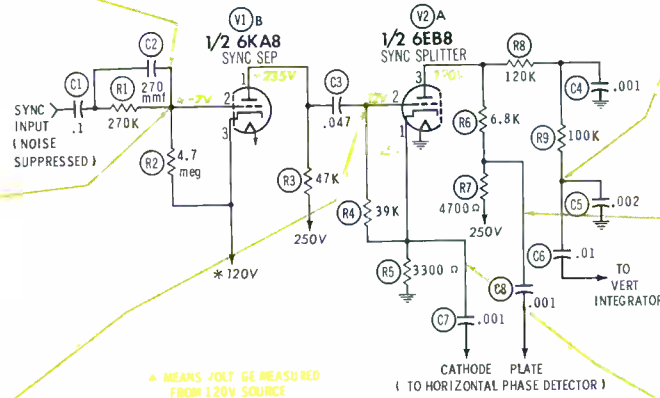
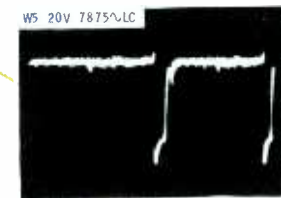
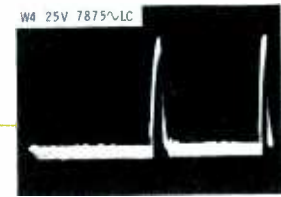
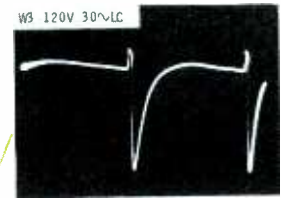
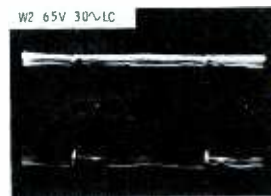
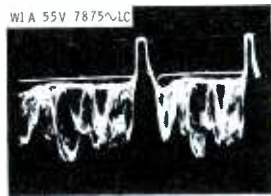
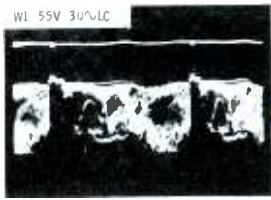

DC VOLTAGES taken with VTVM, on inactive channel; antenna disconnected. \* Means voltage varies with signal conditions—see "Variations."

WAVEFORMS taken with wide-band scope; controls set for normal contrast (60-volt p-p video to CRT). Low-cap probe (LC) used to obtain all waveforms.

### Normal Operation

In circuit shown here, triode section of 6KA8 (V1B) functions as sync separator; other half of tube (not shown) is used in keyed AGC stage incorporating unusual noise-limiter circuit. 6KA8 has common cathode for both sections, returned to 120-volt B+ source to meet operating requirements of AGC-noise stage. In most other receivers, cathode of sync separator returns to ground. Signal input to grid of V1B is composite video with noise pulses suppressed. Signal sets high negative grid-leak bias on V1B, permitting tube to conduct only during positive peaks (sync-pulse tips). Separated sync signals from output of V1B are fed to triode section of 6EB8 (V2A); this tube, wired as a phase splitter, supplies negative sync signals from cathode and positive signals from plate circuit to balanced dual-diode horizontal phase-detector stage. Vertical sync, also taken from plate circuit, passes through integrator network—R8, R9, C4, and C5—to grid of vertical multivibrator. Voltages on V2A stay nearly constant, with or without signal applied; for this reason, no mention is made of V2A in "operating variations" section.

### Operating Variations

#### PIN 3

With station signal present, DC voltage rises to average of 135-145 volts, because AGC bias on RF and IF stages causes reduced current drain on low B+ source. This action is normal in many receivers, but usually has no effect on sync-separator bias.

#### PIN 2

Voltage measurement at this pin is misleading unless cathode is used as common point. With no station signal present, unusually high DC bias of -7 volts is generated by internal receiver noise. Signals obtained from nearby stations produce bias voltage ranging from -20 to -30 volts. Contrast control is located after sync-takeoff point, so its setting has no direct bearing on amplitude of W1.

#### PIN 1

DC voltage increases by only 5 volts with signal present. Much greater shift is normal in other separator circuits that operate near zero bias with no signal input. Waveform on this pin is nearly identical to W2.

## SYMPTOM 1

### Critical Sync

Vertical and Horizontal  
Both Affected

R5 Open

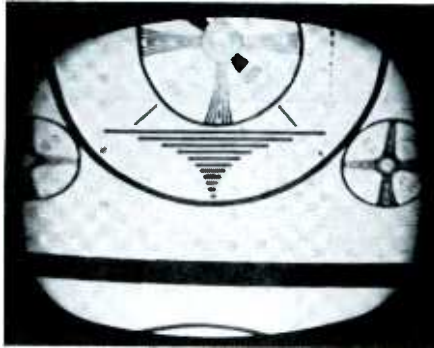

### Waveform Analysis

Amplitude and appearance of W2 show sync signal is passing through separator stage. W4 is low in amplitude—5 volts instead of normal 25 volts—and contains virtually no sync signal; pulses are lost in random noise and video. However, some semblance of horizontal sync enters W5 via path through R4 and stray coupling through tube. This signal, fed to cathode of phase detector, probably accounts for reason horizontal sync is a little steadier than vertical. Decent W2 and abnormal W4 isolate trouble to phase-splitter circuit.

### Voltage and Component Analysis

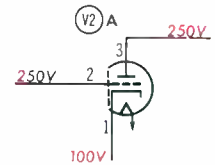

Voltages on V1B are normal. Plate voltage of V2A rises close to 250-volt B+ value because there is no plate current through tube. Almost full B+ voltage is also measured on grid and cathode of V2A; it is developed across high resistance of meter, which is only path completing circuit from these elements to ground. If R4 had been connected to ground instead of cathode, pin-2 voltage would not have appeared to rise so high; however, cathode voltage close to B+ value would still have been measured.

## SYMPTOM 2

### No Horizontal Sync

Foldover in Center of Raster

R7 Increased in Value

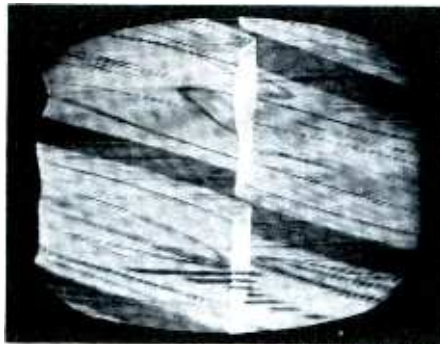

### Waveform Analysis

Removing AFC voltage input to horizontal oscillator eliminates foldover; therefore, trouble isn't in oscillator or output. In sets with keyed AGC, loss of horizontal sync throws off timing of keying pulses, thus killing AGC bias. Clamping AGC line (see October, 1962 *Symfact*) makes sync trouble easier to isolate. With AGC clamped, W1 looks fairly normal. However, W5 is a bit weak, and an even bigger change is noted in amplitude of W4; it's increased to 45 volts. For proper operation of AFC, W4 and W5 must be nearly equal.

### Voltage and Component Analysis

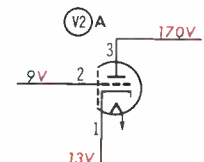

Plate voltage on V2A is 20 volts too low, but this small error probably wouldn't arouse suspicions of most servicemen. Likewise, voltages on grid and cathode don't offer conclusive evidence in themselves. Slightly low voltages on both plate and cathode, considered together, furnish subtle clue to insufficient plate current caused by excessive resistance in plate circuit. R7 in this case increased to approximately 15K. Further increase in resistance naturally lowers voltage at plate of V2A, and makes symptoms worse.

### SYMPTOM 3

## Loss of Sync

Vertical and Horizontal  
Affected Equally

C3 Open

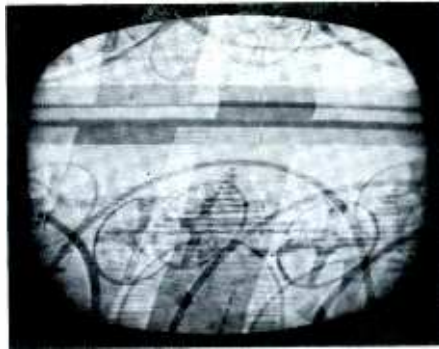

### Symptom Analysis

Trouble looks like complete loss of sync—as when sync separator fails. Both vertical and horizontal hold controls change frequency of oscillators in normal manner. Problem could be inoperative sync stage, AGC fault, or video-circuit defect causing compression of sync pulses.



### Waveform Analysis

Importance of clamping AGC as troubleshooting aid is again illustrated by this case. With no clamping bias applied, W1 has more than enough amplitude, but look at its content: virtually no sync pulses, and video signals riding high into sync area. Now, look at W1 with AGC clamped—normal sync pulses are present. This test indicates normal signal path as far as grid of V1B. Decent waveform (similar to normal W2) is present on plate, but separated sync pattern is missing in W2 at grid of V2A; this causes suspicion of capacitor C3.

### Voltage and Component Analysis

**NO  
VOLTAGE  
CLUES**

Grid and cathode voltages on V2A shift by only 1 or 2 volts, so are not really significant help in locating open C3. This fault is more likely to be troublesome than leakage in C3, which must be severe to upset DC operating voltages in circuit; a portion of voltage impressed on V2A grid through leaky C3 would be coupled to cathode, minimizing shift in operating bias. First symptom of leaky C3 would be horizontal pulling, or phasing line in raster, due to unbalance in signals fed to phase detector from V2A.

### SYMPTOM 4

## Horizontal Pulling

Jittery Vertical Sync

C1 Leaky

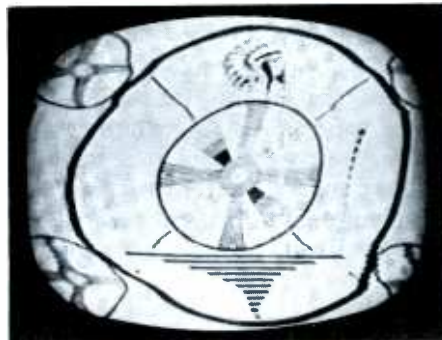

### Symptom Analysis

Picture is troubled by pulling and bending, especially at top of screen; intermittently drops out of vertical and horizontal sync. When vertical hold control is adjusted, picture seems to lock in with reasonably good stability, proving some sync is reaching vertical multivibrator.



### Waveform Analysis

Two clues indicate need for checking sync circuits: Both vertical and horizontal hold are affected, and inspection of blanking bar in picture shows good sync reaching CRT. W1 shows badly compressed sync, with video peaks riding up into sync area. Its amplitude is normal 55 volts. That of W2 is well above normal (85 volts), but signal content is distorted, as in W1. Notice how useful scope is for locating troubles of this type; even though defect is not too severe on screen, it steps out and “hits” you when viewed on a scope.

### Voltage and Component Analysis

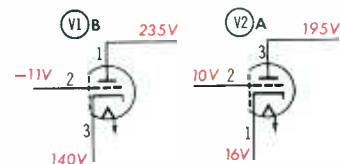

Bias on grid of V1B offers biggest clue; it's lower than normal, with or without signal applied to receiver (-11 volts with; -2 volts without). Lowered bias is result of positive voltage trickling through leaky C1. This component must become quite leaky before it will cause significant trouble. Secondary clue, which could be misconstrued as trouble in circuit of V2A, is increased bias on tube: -6 volts between grid and cathode. However, this is merely excessive grid-leak bias built up by abnormally strong W2.

# TUNER REPAIRS

## made easy

An understanding of the circuits is your most important service aid . . . by Wayne Lemons

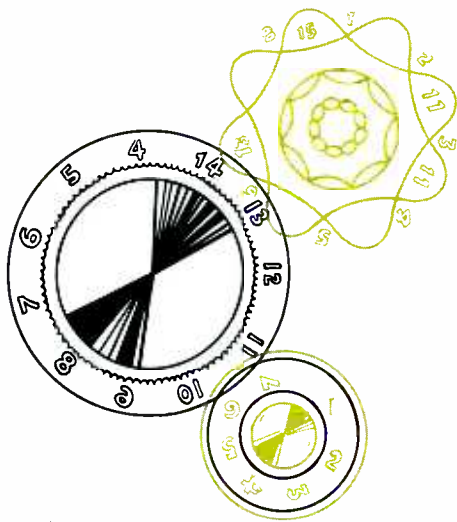

If you can repair other parts of TV sets, you can also make most of the repairs in tuners. Outside of a few mechanical faults or drastic realignment, most tuner repairs are as easy as those in other circuits.

### Understanding Tuners

From a mechanical standpoint, there are only two types of tuners in present-day use: The turret (rotating drum) and incremental-inductance (switch) types. Fig. 1 shows both mechanisms as they are depicted on most schematics.

Electrically, tuners are classified according to the kind of RF stage they use — pentode, tetrode, cascode, or neutrode. (Oscillator stages invariably use triodes; mixer stages previously used triodes, but today tetrodes or pentodes are used.)

#### Pentode RF

One of the earliest television RF amplifiers was the pentode circuit shown in Fig. 2; it is still seeing service. This circuit is so familiar

that a discussion of how it works is unnecessary. The advantages of the pentode are multiple: The tube is simple to build and its circuit is noncritical. It has reasonably high gain, with excellent stability. Its prime disadvantage is that its inherent noise, especially on high TV channels, is greater than in other RF circuits.

#### Tetrode RF

Noise in RF amplifiers is closely associated with the number of grids in the tube used. One way of reducing this problem is to use a tetrode. The tetrode tube can approach the gain of the pentode, but is more difficult to build, and the circuit is more critical to adjust for best performance.

Special tetrodes have been developed for use as RF amplifiers. These operate at a considerably lower screen voltage than pentodes, and the reduced screen current further improves the signal-noise ratio of the circuit. In the tetrode RF

amplifier of Fig. 3, coil L3 in the screen circuit provides degeneration for the stage, which prevents self-oscillation and also helps solve the noise problem.

#### Cascode RF

A circuit used in radar during World War II was adapted for television RF stages, and for several years was the standard for high performance. This "cascode" circuit approaches the low noise figure of a triode while producing gain comparable to a pentode amplifier.

A typical cascode circuit (using the familiar 6BQ7) is shown in Fig. 4. V1A acts as a matching device between the antenna and grounded-grid amplifier V1B. L3 combines with the interelectrode capacitances of the two tubes to perform the job of neutralization at VHF frequencies.

In troubleshooting this circuit, one of the main factors to consider is the DC voltage distribution. Note that triodes V1A and V1B are in series across the DC supply. This means that the grid of V1B must be biased so the DC supply voltage will divide almost equally across the two triodes. The necessary fixed bias is provided by voltage-divider resistors R2 and R3. If plate-to-cathode voltages of the triodes are not equal, one of these bias resistors may have changed in value. (Of course, a short in C2 or a defective tube could also cause the same trouble.) If R4 is discolored or burned, be sure to replace the tube—whether or not it checks defective—for this tube is a common source of intermittent trouble.

#### The Neutrode RF

To achieve greater simplicity,

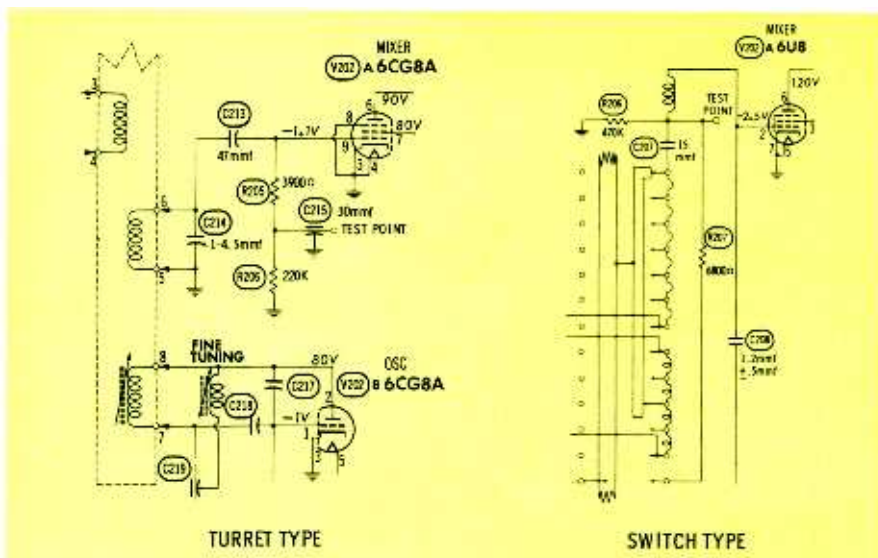

Fig. 1. Mechanically, nearly all tuners are either turret or switch types.

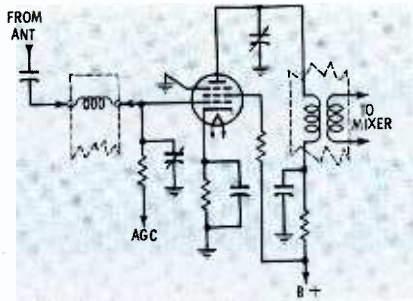

Fig. 2. RF pentode is stable, high-gain tube, but has high noise level.

while maintaining or exceeding previous performance. Engineers have almost unanimously turned to the neutralized triode (neutrode) circuit in the last couple of years. One form of the circuit is shown in Fig. 5. The RC-coupled neutralization makes the amplifier stable over a wide range of frequencies, while also keeping the mechanical arrangement of the tuner simple.

Oscillation can occur in the circuit if C1 is not adjusted correctly or if, as sometimes happens, it breaks loose from its mounting. If you have oscillation in this type of RF stage, first try a new tube; if that doesn't help, use an insulated screwdriver to readjust C1 slightly—a quarter turn in one direction or the other. This adjustment should stop the oscillation. An open C4 can also cause oscillation, since the circuit would then resemble an ultra-audion oscillator.

#### Oscillators and Mixers

Early tuners utilized a triode mixer because it theoretically created little noise, but more recent designs have universally incorporated the tetrode or pentode mixer for higher gain and greater stability. Oscillator injection is accomplished at the mixer control grid, where it is applied along with the RF signal. Coupling is usually by a capacitor, except in a few turret tuners where the oscillator signal is

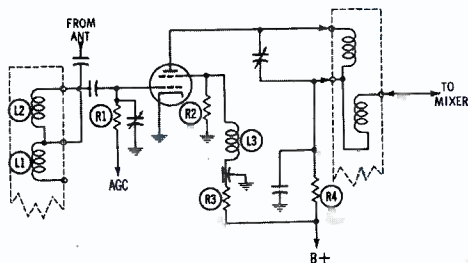

Fig. 3. Tetrode circuit is more critical than pentode, but has lower noise.

inductively coupled to the mixer.

The oscillator tube, a triode, is normally in the same tube envelope with the mixer. Oscillators in most modern tuners are of the configuration shown in Fig. 6, a form of Colpitts circuit. Capacitor C1 serves as an overall frequency adjustment for the oscillator, with L1 as the fine-tuning coil and S1 as the channel selector. C2 and C3 form a capacitive divider for feedback; you'll notice C3 is an NPO capacitor, a reminder that it has a critical effect on frequency. C4 is the injection capacitor for the mixer.

#### Tuner Troubleshooting

The compact construction and tightly packed layout of modern tuners create considerable uncertainty on the part of most service technicians. It's true that tuner parts aren't exactly easy to get at, but testing them is certainly not impossible; in fact, there are quite a few techniques which will immensely simplify this problem.

#### Using Test Points

Fig. 7 shows a test point (TP) that is incorporated in many tuners. It can be used as a scope connection for checking the RF amplifier bandpass with a sweep generator, and it is also useful as a VTVM test point to see if the oscillator is working. If the oscillator is operating (though not necessarily on frequency), a negative 2 or 3 volts—varying somewhat from one channel to another—will be developed here. If the tuner oscillator is not working (or you suspect it isn't), you can insert a signal from your marker generator at this point; by selecting a signal approximately 20 or 40 mc above the channel frequency (depending upon the IF frequency of the set), you can substitute for the missing or off-frequency oscillator signal.

If the tuner you are servicing doesn't have a test point, you can make one by temporarily tacking a 10K resistor to the mixer grid. The purpose of the resistor is to isolate the mixer grid from the capacitance of the test cable, thus minimizing any external effect on the circuit.

#### Socket Adapters

Although parts placement and layout are important for achieving optimum performance in a tuner,

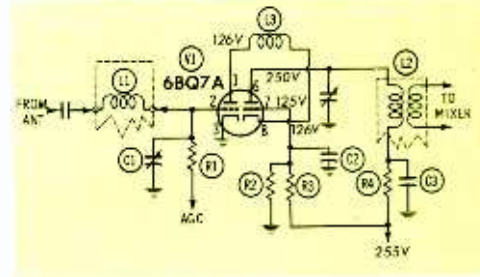

Fig. 4. Cascode RF circuit uses two stages for high signal-noise ratio.

and stray circuit capacitances must be considered carefully, these considerations are not quite so important during servicing—the tuner is not operating as it should, anyway! Thus, tube-socket test adapters can be used to good advantage in troubleshooting, even though they usually cause slight abnormalities in the operation of the tuner. (Special adapters are available for tuners with captive tube shields.) For instance, if you find incorrect values of plate or screen voltage, you'll know you must correct them before making other evaluations of tuner performance. In cascode circuits, the socket adapter can be used in measuring the voltage across the tubes; also, by making resistance measurements from the adapter, you can often localize the defective part.

#### Specific Tests

The socket adapter can be used to check coupling capacitors between the RF and mixer stages or from the oscillator circuit. Leaky coupling capacitors won't always stop a tuner from working, but they may cause a considerable loss of sensitivity. To check them, remove the oscillator-mixer tube and insert just the adapter socket. If the set uses a series heater string, short out the heater pins to complete the circuits. Using a VTVM, check the voltage at the mixer grid; a positive

•Please turn to page 86

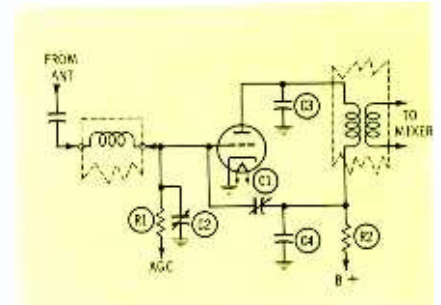
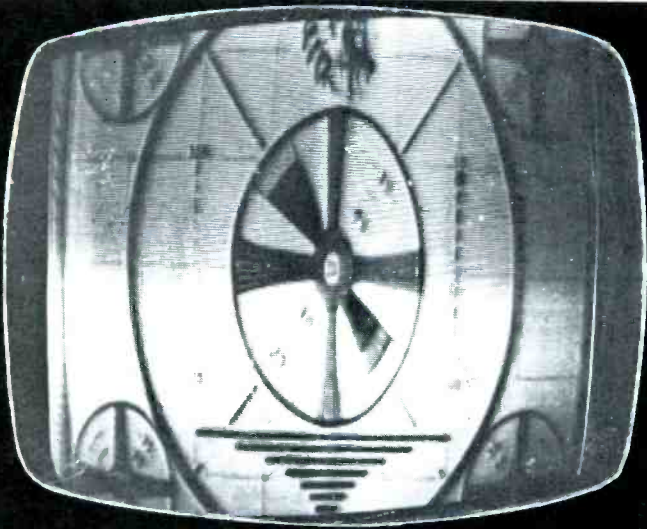

Fig. 5. Neutralized triode is now the most popular high-efficiency circuit.

# MORE VISUAL SYMPTOMS

## TELL A STORY!



**1** This dim raster is a consequence of weak high voltage. Blooming accounts for the greatly increased height. The width has decreased instead of expanding, so the horizontal output stage is apparently not operating as it should—this is probably the basic cause of insufficient HV. The slight drive line in the middle is a sign of a normal drive signal being fed to a weak output stage. (A screen resistor had increased value, lowering the screen voltage.)

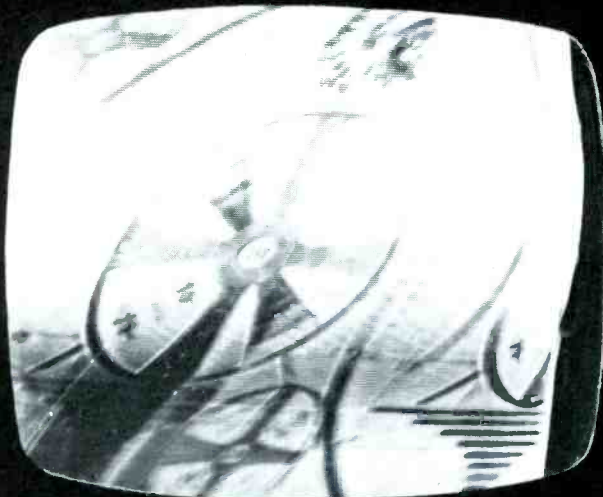

**2** This case of unstable horizontal sync is complicated by foldover at the right side of the raster. The latter symptom could be due to an output-stage fault, but in this case, it is more probably caused by distortion of the drive signal reaching the grid of the output tube. Whatever trouble is warping the drive signal could also be erratically pulling the multivibrator off frequency. (A plate-decoupling capacitor in the second section of the multivibrator had become leaky.)

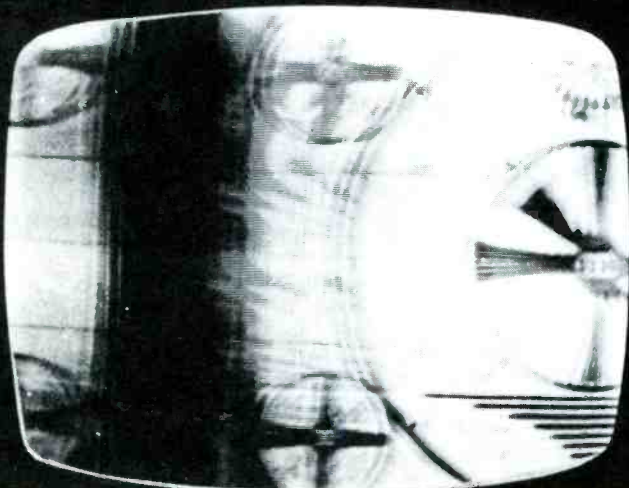

**3** Horizontal sync is almost locked in, but the picture tends to "slip" sideways; periodically it falls out of sync. The horizontal blanking bar isn't centered on the screen; thus, the trouble isn't simply a phase error in the signal fed back to the horizontal AFC from the fly-back. Instead, the AFC has lost some of its control over the horizontal multivibrator. This particular circuit is stable enough to keep operating close to the correct frequency without being synchronized. (The sync-input coupling capacitor in the AFC stage was open.)

**4** Stretch the raster vertically, cut in half, lay the bottom piece over the top piece—and this is what you'll have. The vertical multivibrator is running at 120 cps. The loss of height doesn't mean a weak output stage; there just isn't enough time during each sweep cycle to develop a full-strength sawtooth drive signal.



Unusual trouble effects on a TV screen are more meaningful to the trained eye than run-of-the-mill symptoms, since the less familiar patterns often contain multiple clues that greatly aid trouble isolation.

Troubleshooting should concentrate on the frequency-determining networks, including the feedback system of the multivibrator as well as the hold-control circuit. (Leakage to ground through a faulty capacitor in the feedback network was the answer to this one.)

**5** This linearity problem is not the usual stretching or compression at the extreme top or bottom of the raster; it involves a stretched-out area halfway from the top to the center. Thus, instead of looking for bias troubles, it makes more sense to check for improper shaping of the drive waveform. The RC network that develops this signal often consists of several components, and various faults in this circuit can introduce peculiar types of distortion. (There was an increased resistance to ground from the sync-input line, which is connected to the plate of the multivibrator and shunts the sawtooth-forming network.)

**6** The picture has plenty of contrast, but the brightness is always too low. Video overloading isn't the trouble, because sync stability is good, and contrast can be varied in a normal manner. Furthermore, well-focused raster lines make CRT or high-voltage troubles seem unlikely. The defect is probably applying too much DC bias between the grid and cathode of the CRT. (An isolating resistor in the brightness-control circuit had increased value. The CRT cathode current, passing through it, developed too much bias voltage.)

**7** No signal getting through the tuner? Look again—there are diagonal bars on the screen, so a certain amount of video must be reaching the picture tube. It's obscured by a grainy pattern—not exactly the same as ordinary snow—with a suggestion of a herringbone effect. Oscillation of some RF or IF stage seems to be the most probable explanation. (An open screen-bypass capacitor was found in the third IF stage, by using the technique of bridging with a good unit.)

4

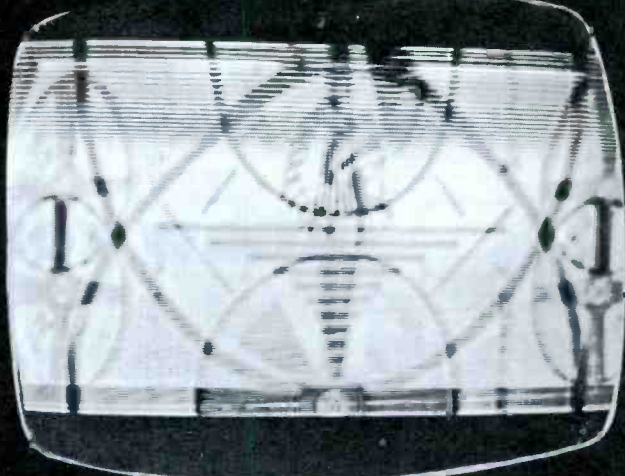

5

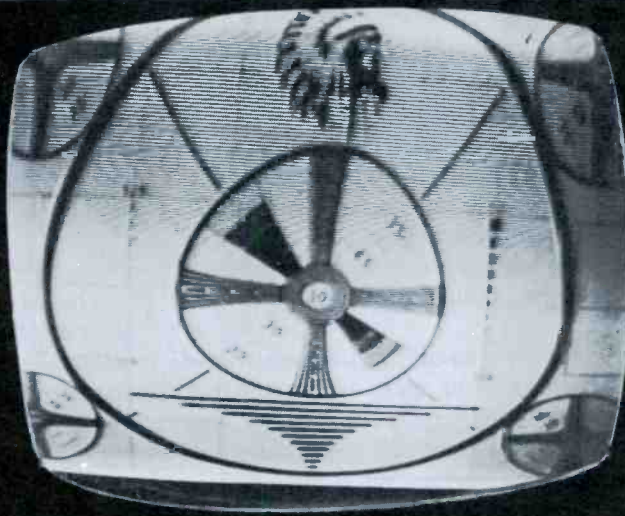

6

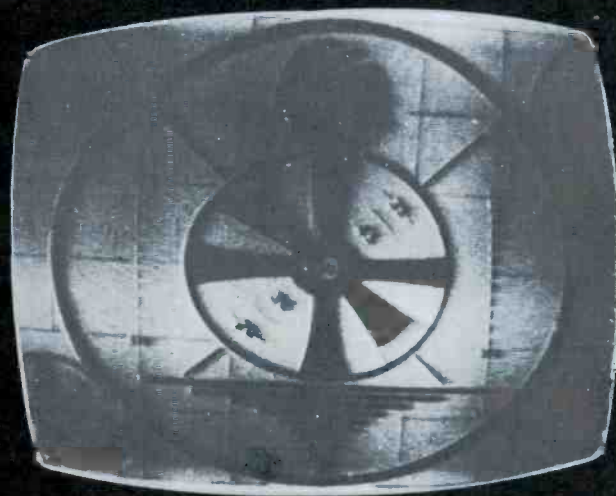

7



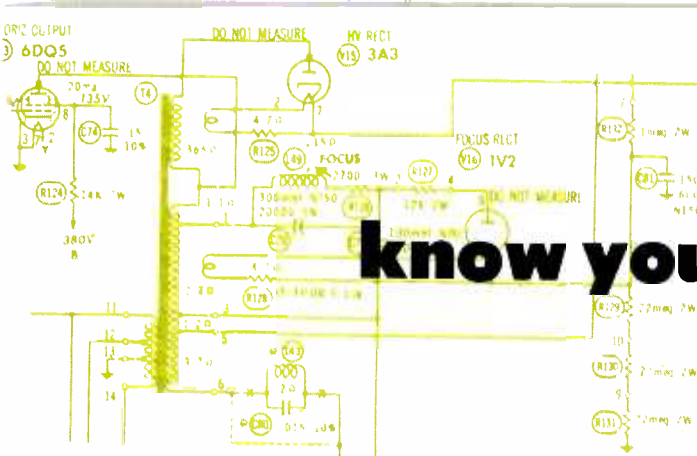

# know your 63 COLOR CIRCUITS

## The Convergence Panel . . . by George F. Corne, Jr. and Thomas A. Lesh

Current models of color TV sets use practically the same convergence arrangement as last year's models; in addition, both major types of '63 color chassis have very similar circuitry and setup procedures. Therefore, one basic description of how convergence circuits operate can be applied to all late-model receivers.

Many color technicians have been slow to gain an understanding of convergence principles, because the circuits are totally unfamiliar (having no counterpart in black-and-white TV) and because the many controls, plug connections, and multiple circuit loops make the convergence section look difficult to trace. However, it is not as complex as it seems. The sections for controlling vertical and horizontal convergence are com-

pletely independent of each other, greatly simplifying matters. These have been drawn separately in the schematics accompanying this article so each one section can be studied by itself.

### What is Convergence?

The basic idea of convergence is to control the direction of all three electron beams in the tricolor CRT, so they will stay in "tight formation" and land on adjacent phosphor dots, regardless of what portion of the screen is being scanned. The deflection yoke is not able to exert this precise control, because the beams are not exactly centered within the yoke coils. To provide accurate positioning of the beams with respect to each other, a *convergence yoke* is placed behind the deflection yoke on the CRT neck. It consists

of three sets of coils, positioned so they can control vertical and horizontal convergence of the individual red, green, and blue beams. A movable pole piece in each coil serves as a *static* convergence adjustment, to insure that the beams will land on the proper trio of dots when they travel straight through to the center of the screen without being deflected. (An additional adjustment, the blue lateral magnet, provides further accuracy in positioning the blue beam relative to the red and green beams.)

As the magnetic fields of the deflection yoke bend the beams away from midscreen, the distance from the deflection point to the landing point on the screen is increased—reaching maximum when the edges of the screen are being scanned. This changing distance of beam travel adds to the difficulty of keeping the beams converged. The solution is to apply AC currents to the six convergence coils, producing magnetic fields around each beam which vary in step with the vertical and horizontal deflection fields—becoming strongest near the beginning and the end of each sweep cycle, when the most correction is needed.

This dynamic convergence could be accomplished in a crude way by just feeding a sample of the vertical and horizontal sweep currents to the convergence coils. Basically, this is what actually happens; however, elaborate control circuits are used to vary the waveshape and amplitude of the convergence currents. This flexible means of control makes it possible to correct for manufacturing tolerances in CRT's, interaction between the various magnetic fields, and other factors.

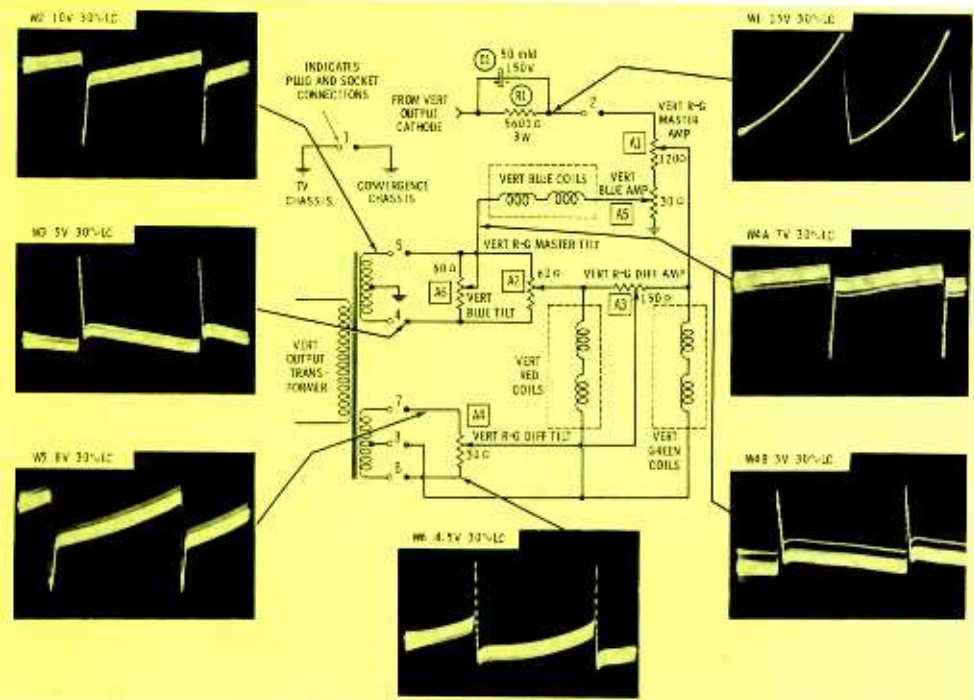

Fig. 1. Vertical convergence circuits used in RCA color chassis CTC12.

Present sets use a bank of 12 dynamic - convergence controls, mounted on a small panel that can temporarily be attached to the top rear edge of the receiver for greater accessibility during adjustments. Although most of the controls affect a rather widespread area of the screen, and a great deal of interaction is noted, the results of adjustments can still be judged quite accurately by following a recommended sequence and checking a specified portion of the screen during each step. Details of the prescribed method, using a crosshatch generator, were presented in "Objective: Pure White" (November, 1962 PF REPORTER). In a general way, the technique can be summarized as follows:

1. For vertical convergence, observe only the center line running from top to bottom, (especially near its ends) and its intersecting horizontal lines.
  - (a) Use four controls to merge the red and green lines.
  - (b) Use two more controls to merge the blue lines with the red and green lines.
2. For horizontal convergence, observe only the line running through the center of the screen from left to right (especially near its ends) and its intersecting vertical lines.
  - (a) Use four controls to merge the red and green lines.
  - (b) Use two more controls to merge the blue lines with the red and green lines.
3. Repeat the entire procedure, if necessary, to "rock" the various controls into optimum adjustment. Good convergence over approximately 85% of the screen is generally considered normal; full convergence in the remaining edge and corner areas will probably be impractical.

Of course, the manufacturer's actual instructions are more definite than this about which control should be adjusted first, and whether vertical or horizontal lines of the crosshatch pattern should be inspected during a particular adjustment. The logic behind these rules will be clearer after you study the schematics and see where each control fits into the circuitry.

In the schematics shown this month, the various coil and potentiometer adjustments are labeled with "A" numbers in a sequence that indicates the order of adjustment recommended by the manufacturer. Waveforms of AC voltage, measured with respect to ground, are shown for all key input points and certain other points in the circuits. Remember, these are not the same as the current waveforms in these high-reactance, low-resistance circuits; thus, they cannot be used to tell if the current applied to a convergence coil has the exact waveshape desired. (This information can be deduced from the screen presentation, anyway.) Nevertheless, voltage waveforms are of definite value in determining whether the convergence-panel circuits are receiving proper inputs; they can also show up certain defects in the convergence section.

#### RCA's Circuit

The vertical dynamic convergence controls in the RCA Chassis CTC12 (Fig. 1) are named for their effects on the current waveforms applied to the convergence

coils. Some, which mainly affect the overall amplitude of the inputs, are labeled AMP controls; others, which affect waveshape more than amplitude, are called TILT controls.

The basic waveform W1, developed in the cathode circuit of the vertical output tube, appears as a sawtooth of voltage at pin 2 of the convergence plug. However, the current at this point actually has a more nearly *parabolic* waveshape—after a current peak at the beginning of each cycle, the current gradually falls to minimum in the middle of the cycle, and then gradually rises again. Portions of this waveform are tapped off by A1 for the red and green convergence coils, and by A5 for the blue coil. These adjustments operate somewhat the same as volume controls; the higher they are set, the more convergence correction is provided.

Another input-waveform source is a center-tapped secondary winding on the vertical output transformer, connecting to pins 4 and 5 of the convergence plug. Two pulse waveforms of opposite polarity (W2 and W3) are developed here and applied to opposite ends of TILT

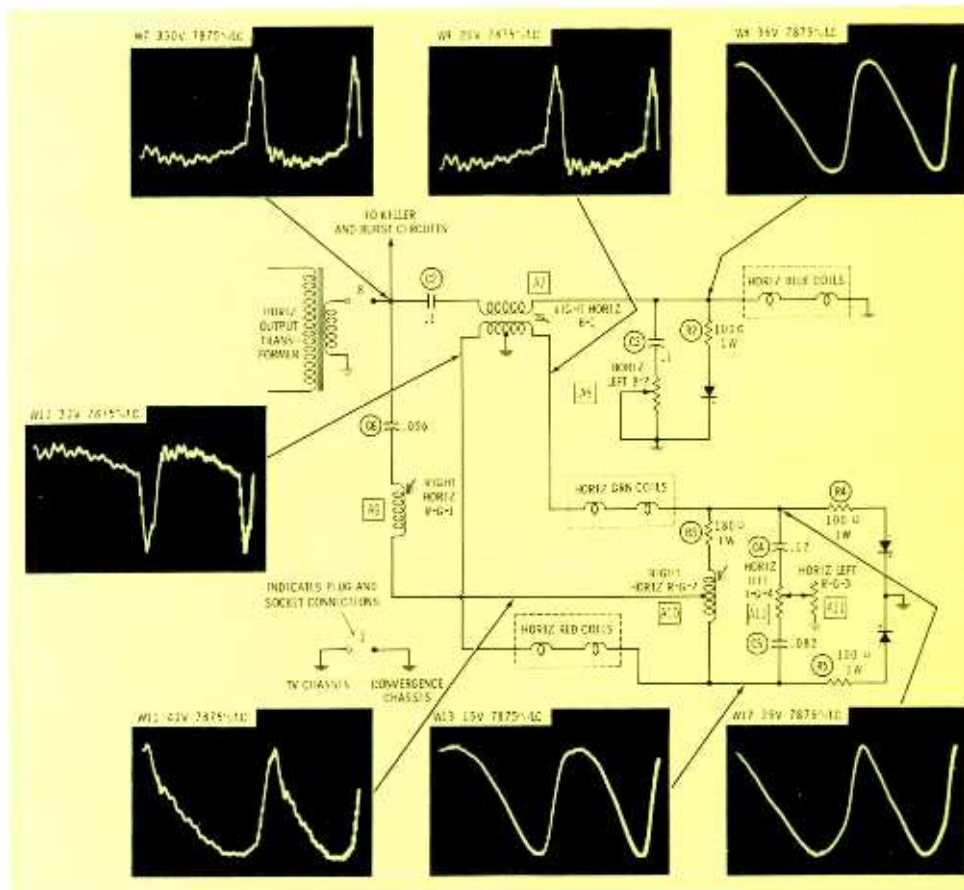

Fig. 2. Simplified schematic of RCA's horizontal convergence circuits.

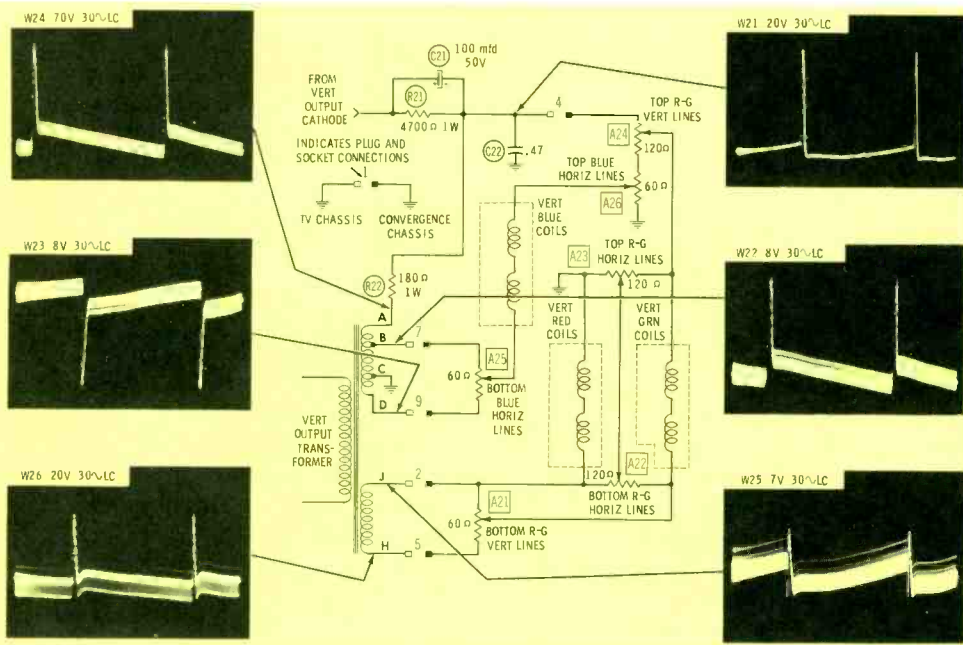

Fig. 3. Zenith uses extra tap on transformer for vertical convergence.

controls A2 and A6. The resultant output from each control arm varies in polarity and amplitude according to the control setting; this is demonstrated by W4A and W4B, which show the output voltages at two different settings of A6. This waveshape of voltage corresponds to an approximate sawtooth wave of current, with the steepness and

direction of the sawtooth slope variable by means of the TILT controls. The output of A2 is mixed with W1 to alter the waveshape of the current fed to the red and green coils, and the output of A6 is fed to the end of the blue coils opposite A3 (also modifying the waveshape of the current in these coils).

To vary the red- and green-coil currents in respect to each other, one more pulse waveform is made available to the red and green coils, using the secondary winding connected to pins 3, 6, and 7 of the convergence plug. Waveforms W5 and W6 look unequal; however, if the common lead of the scope were moved from ground to pin 3 of the plug, equal and opposite waveforms with a smaller sawtooth slope would be seen. The shape of the current fed to the coils is adjusted by A4, and a greater share of the current is fed to either the red or the green coils—depending on the setting of A3.

In this close-knit system, there is much interaction, and resetting any control is likely to have some effect on all the coil currents. However the standard adjustment procedure results in a well-balanced setup with coil-current waveforms “custom-made” for the requirements of a particular set.

Horizontal convergence circuitry (Fig. 2) follows a similar basic plan, but the controls are simply lettered and numbered to indicate the coils affected and the recommended order of adjustment. Only one input from the horizontal sweep system is needed: a pulse (W7) from an isolated secondary on the flyback transformer. When this pulse is applied to the circuit including the blue coils, ringing occurs, and the resulting waveform (W8) is similar to a sine wave. A7 has a noticeable effect on the voltage amplitude, and A8 broadens or narrows one peak. (The shape of W8 can range from a nearly pure sine wave to something like W12.)

Coil A7 has a secondary, across which small pulse waveforms W9 and W10 are developed for the lower ends of the red and green coils. (Adjustment of A7 has only a slight effect on W9 and W10.) The main red-green input is applied through A9 to the center tap of A10.

The voltage amplitude of this waveform (W11) is affected by both adjustments to some extent, mostly by stretching or compression of the negative peak. But the main function of A10 is to proportion the amounts of W11 fed to the red and green coils; as the slug is

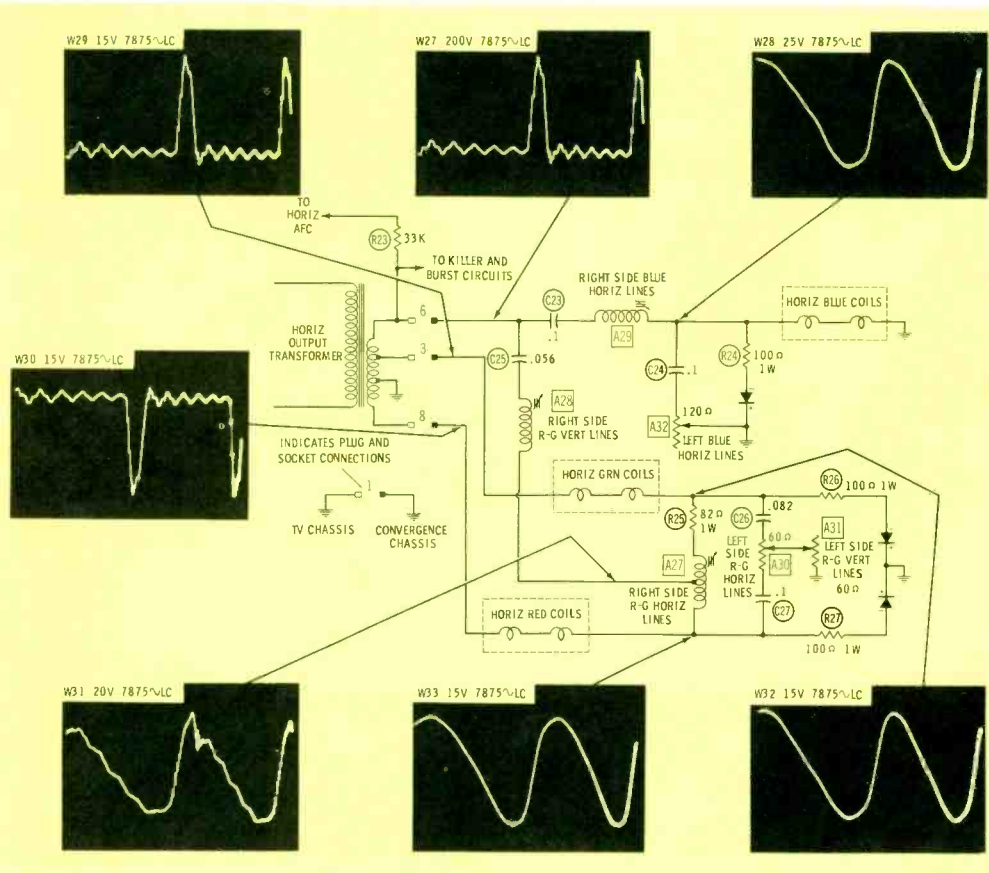

Fig. 4. Horizontal convergence circuits used in new Zenith chassis 27KC20.

# Find it and Fix it in 1/2 the time!

EASILY SOLVES "TOUGH DOGS"... INTERMITTENTS... ANY TV TROUBLE



MODEL  
1076

**TELEVISION ANALYST**  
BLACK & WHITE AND COLOR

**ANALYST**

**By Easy Point-to-Point Signal Injection, You see the Trouble on the TV Screen and Correct it—Twice as Fast and Easy!**

Simplified technique stops lost hours never recovered on "tough dogs", intermittents, and general TV troubleshooting. This one instrument, with its complete, accurate diagnosis, enables any serviceman to cut servicing time in half... service more TV sets in less time... satisfy more customers... and make more money.

With the Analyst, you inject your own TV signals at any time, at any point, while you watch the generated test pattern on the picture tube of the television set itself. This makes it quick and easy to isolate, pinpoint, and correct TV trouble in any stage throughout the video, audio, r.f., i.f., sync and sweep sections of black & white and color television sets—including intermittents. No external scope or waveform interpretation is needed. Checks any and all circuits—solves any performance problem. Gives you today's most valuable instrument in TV servicing—proved by thousands of professional servicemen everywhere.

Available on Budget Terms. As low as \$30.00 down.

Net, \$32995

**SIMPLIFIES COLOR TV SERVICING, TOO**

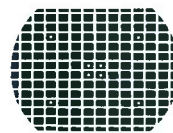

Enables you to troubleshoot and signal trace color circuits in color TV sets, or facilitate installation.

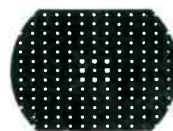

Generates white dot, crosshatch and color bar patterns on the TV screen for color TV convergence adjustments.



Generates full color rainbow display and color bar pattern to test color sync circuits, check range of hue control, align color demodulators. Demonstrates to customers correct color values.

**Time-Saving, Money-Making Instruments Used by Professional Servicemen Everywhere**



Model 960 Transistor Radio Analyst



Model 360 V O Matic Automatic VOM



Model 375 Dynamatic Automatic VTVM



Model 700 Dyna-Quik Tube Tester



Model 440 CRT Rejuvenator Tester

See Your B&K Distributor  
or Write for Catalog AP20-R



**B & K MANUFACTURING CO.**

Division of DYNASCAN CORPORATION

1801 W. BELLE PLAINE AVE. • CHICAGO 13, ILL.

Canada: Atlas Radio Corp., 50 Wingold, Toronto 19, Ont.

Export: Empire Exporters, 253 Broadway, New York 7, U.S.A.

turned, W12 will increase in amplitude as W13 decreases, or vice versa. Final adjustments A11 and A12 vary the phase or waveshape of W12 and W13.

### Zenith's Circuit

The 12 dynamic convergence controls in the Zenith Chassis 27KC20 are named according to the portion of the crosshatch pattern that should be checked during each adjustment. For instance, the label BOTTOM R-G VERT LINES is a reminder to observe the red and green vertical lines at the bottom center of the screen. Although the names are different, the control functions are basically the same as in the RCA chassis. However, there are some changes in the circuit hookup—especially in the vertical convergence section—which cause the controls to have a slightly different action.

The vertical circuits are shown in Fig. 3. The current waveform taken from the cathode of the vertical output tube is accompanied by the voltage waveform W21; note the difference in shape between it and W1 in Fig. 1. A24 and A26

act as amplitude controls for the R-G and blue circuits.

To modify the waveshape of the convergence-coil currents, separate pulse-takeoff windings on the vertical output transformer are used for the red-green circuit and the blue circuit. For the latter, opposing waveforms W22 and W23 are combined in a proportion set up by A25; the action is similar to that of A6 in the RCA. A pulse (W24) is also taken from terminal A on the transformer and mixed with the incoming cathode waveform for proper shaping of W21.

To "tilt" the red-green waveform, the pulse represented by W25 and W26 is applied to the end of the red and green coils opposite the W21 input. Its overall waveshaping effect is increased or decreased by varying A21, and the proportional effect of both inputs on red vs. green depends largely on A22 and A23—which are roughly similar to the "differential" controls in the RCA circuit. W25, in particular, can be expected to change shape quite radically when either A21 or A22 is adjusted; so the main reason for checking this waveform would be

to see if the controls are operative.

The horizontal convergence circuits (Fig. 4) have fewer innovations; the main difference between this schematic and Fig. 2 is that the pulses for the lower end of the green and red horizontal coils (W29 and W30) are taken directly from the flyback winding, rather than from a secondary on the blue adjustment coil. Note that the various waveforms are very similar in shape to those in Fig. 2, but generally have lower amplitudes.

### Points to Remember

1. Convergence controls interact to a great extent, partly because of interconnected circuits and partly because of intersecting magnetic fields in the picture tube. Thus, achieving a perfect setting in one area of the screen may result in deconverging another area. The goal of convergence, then, is to attain a good balance between all adjustments.
2. To preserve this balance, it's important not to reset any single control too drastically at one

• Please turn to page 80

## REDUCE INVENTORY! INCREASE SALES!

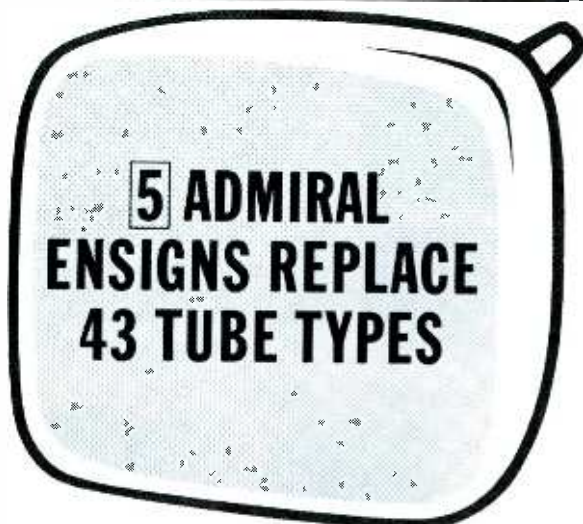

Be wise...standardize on

# ADMIRAL® ENSIGN

REPLACEMENT PICTURE TUBES

Always Fine/Precision Quality

Save space, save dollars! Make more profit per sale with the Admiral ENSIGN "Big 5" as your basic tube inventory. All materials and parts used in the manufacture of these tubes are *new* except for the envelopes, which prior to reuse, have been inspected and tested to the same standard as new envelopes. Every Admiral ENSIGN tube is of fine/precision quality manufacture.

ENSIGN 17BJP4 REPLACES	} 17ATP4 17ATP4A 17AVP4	17AVP4A 17BUP4 17CBP4	17CLP4
ENSIGN 21AMP4A REPLACES	} 21ACP4 21ACP4A 21AMP4	21AQP4 21AQP4A 21CUP4	21BSP4
ENSIGN 21CBP4A REPLACES	} 21FLP4 21ALP4 21ALP4A 21ALP4B 21ANP4 21ANP4A	21ATP4 21ATP4A 21ATP4B 21BAP4 21BNP4 21BTP4	21CBP4B 21CMP4 21CVP4 21CWP4 21DNP4 21CBP4
ENSIGN 24CP4A REPLACES	} 24ADP4 24CP4 24QP4	24ATP4 24VP4 24VP4A	24XP4
ENSIGN 24AEP4 REPLACES	} 24DP4A 24YP4	24ANP4 24ZP4	



Call your ADMIRAL DISTRIBUTOR tomorrow...start cutting inventory cost, pocketing new profits right away!

# New TRANSISTOR RADIO ANALYST

makes it Easy and Profitable to Service all Transistor Radios



**B&K** Model 960  
**TRANSISTOR RADIO ANALYST**  
*with Exclusive DYNA-TRACE  
 Single-Point Probe—and Built-in  
 Metered Power Supply and VTVM*

**Complete Transistor Radio  
 Service Shop in One Instrument**

*Signal-Generator, Power Supply, Milliammeter, VTVM, Battery Tester, Ohmmeter, and Both In-Circuit and Out-of-Circuit Transistor Tester—All in One*

Also Speeds Servicing of Tube-Type Radios

Check all circuits - Pinpoint any trouble ... in minutes

Now you can profit from transistor radio servicing! This amazing new B&K "960" ANALYST gives you *everything* in one complete easy-to-use instrument. Makes transistor radio servicing *quick and easy*. Nothing else is needed except the transistor radios themselves waiting to be serviced. Brings you new customers for service, parts, and batteries. Makes this new business *yours*.

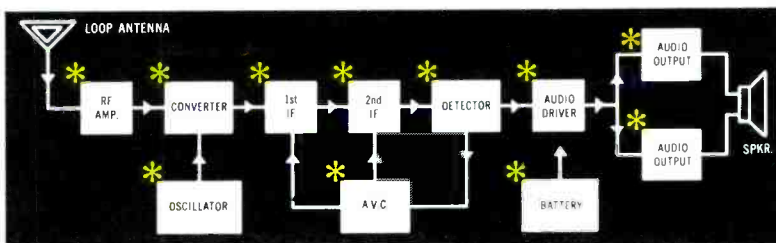

**EASILY TROUBLE-SHOOT ANY STAGE  
 BY UNIQUE POINT-TO-POINT SIGNAL INJECTION**

The ANALYST gives you a complete signal-generating source for point-to-point signal injection. Easily enables you to trouble-shoot any transistor radio—check all circuits stage-by-stage—isolate and pinpoint the exact trouble in minutes.

Supplies modulated signals, with adjustable control, to check r.f., i.f., converter, and detector. Supplies audio signal to check audio driver and audio output. Provides unmodulated signal to test local oscillator. Provides separate audio low-impedance output for signal injection into loudspeaker voice coils to check speaker performance.

**BUILT-IN METERED POWER SUPPLY FOR EASY SERVICING**

Makes it easy to operate radio under test, while you inject your own signals. Provides from 1 to 12 volts in 1½ volt steps. Supplies all bias taps that may be required.

**SIMPLIFIES IN-CIRCUIT TRANSISTOR TEST  
 WITH NEW DYNA-TRACE SINGLE-POINT PROBE**

Unique single-point probe needs only the one contact to transistor under test. No longer are three wires required to connect to emitter, base, and collector. Gives fast, positive meter indication. Saves time. Makes trouble-shooting simple and easy.

**BUILT-IN VTVM**

Includes high-input-impedance vacuum-tube voltmeter, which is so necessary for transistor radio servicing.

**TESTS ALL TRANSISTORS OUT-OF-CIRCUIT**

Meter has "Good-Bad" scale for *both* leakage and beta. Also has direct-reading Beta scale, calibrated 0-150. Assures quick, accurate test. Also automatically determines whether transistor is NPN or PNP. Meter is protected against accidental overload and burn-out.

Model 960. Net, **\$99<sup>95</sup>**

Solve Every Service Problem and Profit with a Modern B&K Service Shop. See Your B&K Distributor or Write for Catalog AP20-R



**B & K MANUFACTURING CO.**  
 Division of DYNASCAN CORPORATION  
 1801 W. BELLE PLAINE AVE. • CHICAGO 13, ILL.  
 Canada: Atlas Radio Corp., 50 Wingold, Toronto 19, Ont.  
 Export: Empire Exporters, 253 Broadway, New York 7, U.S.A.



# SPECIAL EQUIPMENT

# Speeds SERVICING

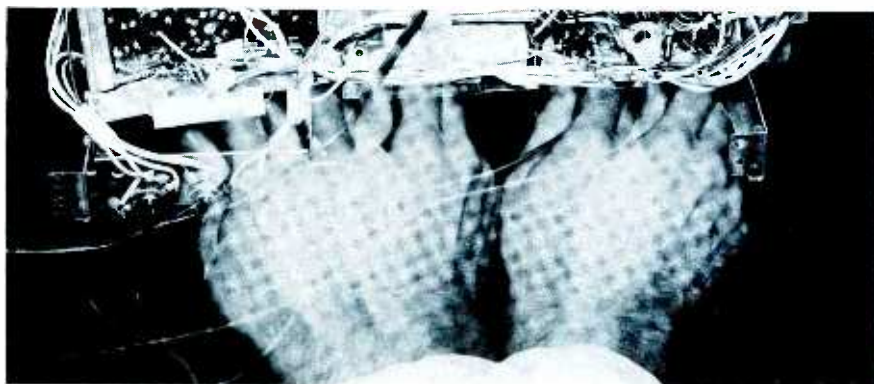

A large proportion of all TV service work can be done with just a few general-purpose test instruments such as the VOM, VTVM, tube tester, and scope, occasionally aided by parts substitution. However, quite a few additional pieces of equipment have proved their usefulness in the TV shop, because they permit the technician to do certain jobs faster. By inventive use of these specialized items, he can bypass a great number of tedious measurements, and can eliminate many uncertainties that tend to turn service problems into "dogs."

To give a simple example, too many TV sets become bench cases because of tube faults that don't

show up in transconductance or emission tests. Tube substitution will catch the trouble—if the suspected tube is a fairly common type that the technician is carrying in his caddy. Otherwise, a shop job is in the offing, unless the technician has brought along a tube tester that can make a reliable check for grid leakage and similar defects. If the rare tube proves to be faulty, he can make an extra trip to obtain a replacement, at much less trouble and expense than would be required for pulling the chassis.

Tests with a special instrument may only provide peace of mind—but this counts for a lot in some cases! To illustrate this point, a

serviceman who has just replaced a fusible resistor, and wonders if the set still has a B+ overload, could banish most of his doubts by taking a reading with a wattmeter or a rectifier-circuit tester.

Speaking of things that bestow peace of mind—nothing is as welcome as a service aid that will definitely indicate whether or not a particular circuit or component is causing trouble. Auxiliary test instruments, if their capabilities are fully used, are often more efficient than the "old standbys" for making such tests. Here are several examples, drawn from service-record files:

## Hot Rolls

In a Silvertone Chassis 528.51130 (PHOTOFACT Folder 397-3), vertical sync became touchy after the set warmed up. Rolling could be stopped by critically setting the vertical hold control, but slight re-adjustment was necessary at frequent intervals. The lock-in point was fairly well centered in the control range, so the vertical multi-vibrator was apparently trying to run at the correct frequency. As a quick way of finding out if an adequate sync signal was reaching the vertical circuit, the technician decided to try sync-signal injection.

Using the special sync output from a signal-substitution unit, he fed negative pulses into the grid of the 5U8 sync amplifier (Fig. 1), setting their amplitude at 25 volts to duplicate the signal normally present at that point. Vertical hold became much more solid, testifying to the ability of the 5U8 and the integrator to pass the pulses in normal fashion. Apparently, the sync signals from the TV stations were being weakened before they reached the sync amplifier. When the test setup was changed to inject a 30-volt composite video signal into the grid of the sync separator, vertical sync became unstable again, so it was concluded the separator circuit was not operating as it should. VTVM readings showed a plate voltage even lower than the specified 20 volts. The technician immediately suspected a fault in plate resistor K1D, but realized that a "cold" ohmmeter reading might be valueless in checking for this elusive condition. Then he had an idea:

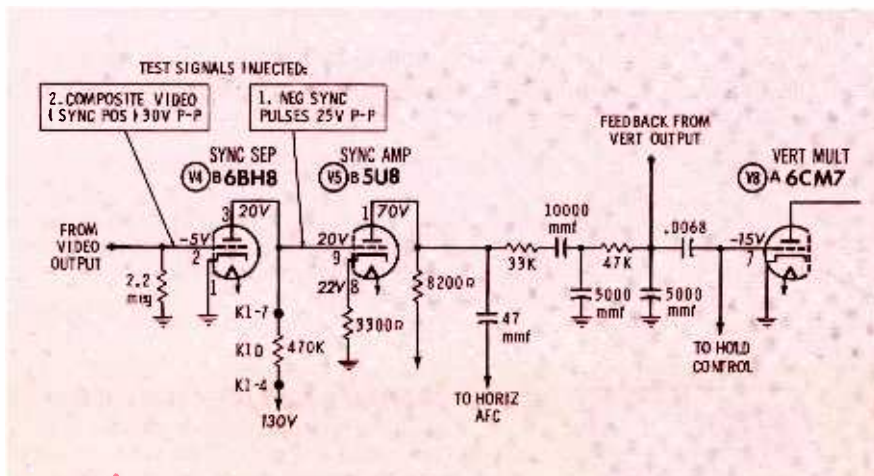

Fig. 1. Sync-pulse signal injection helped find cause of poor vertical hold.



says **BILL HULBERT, WATERTOWN ELECTRONICS...**



Left: Jerry Eamer, Electronics Serviceman

Right: Bill Hulbert, Watertown Electronics, Watertown, N. Y.



Look for the Semitron famous tested and proven Transistor Replacement Display. Replaces over 2000 EIA American, foreign and special type transistors — 90% of your needs.

“Our technician customers ask for **SEMITRON REPLACEMENTS** because they’re quality products **engineered** to the serviceman’s needs.”



**FREE** — ask your Distributor for Semitron replacement and substitution charts for transistors and diodes.



**ANOTHER SEMITRON EXCLUSIVE!**  
Silicon Rectifier with exclusive Thermal Jacket Heat Sink. **SPECIAL INTRODUCTORY OFFER** — Kit #TH850 — 10 Silicon Rectifiers (850MA, 500PIV), PLUS High Voltage Tester, BOTH for ONLY \$6.95.

**SEMITRONICS CORP.**  
265 Canal Street  
New York 13, N. Y.  
(212) CANal 6-5401

**SEMITRON**

**SERVICE ENGINEERED REPLACEMENTS**

• TRANSISTORS • RECTIFIERS • DIODES • IF TRANSFORMERS • CAPACITORS

SOLD THRU  
DISTRIBUTORS  
ONLY

if K1D were increasing in value after the warmup period, wouldn't the symptom disappear if enough parallel resistance were added to bring the total plate resistance down to normal? He connected the leads of a resistor substitution box to module terminals K1-4 and K1-7, bridging the suspected part, and fired up the set. Starting at 10 megohms, he gradually reduced the shunt resistance; as he passed the 2-meg point, the trouble began to clear up. This was proof enough—he replaced K1, and had no more trouble.

Some sweep-circuit analyzers also provide a sync-pulse output that can be used with equal success in troubleshooting this type of problem. An important requirement for the substitute sync signal is variable amplitude, which makes it possible to simulate normal operation on either local or distant stations.

### Flat-Top

Tricky work with a resistor substitution box also helped to shorten the service time on a General Electric Chassis 21TF (PHOTOFACT Folder 229-7) which was suffering

from a different type of thermal problem: The top third of the raster took several minutes to fill out to normal height after the set was turned on. A defect in either of two control circuits—vertical linearity or vertical size (Fig. 2)—could possibly cause the observed symptom; the linearity circuit might develop excessive bias on the vertical output tube during warmup, and the size-control circuit might attenuate and distort the drive signal fed to the output-tube grid.

Ohmmeter checks didn't definitely indicate any wrong resistance values. Tests with power applied would have to be made in the least possible time, since the trouble existed only during warmup; thus, the technician decided to try a "triple-threat" test. The boost line was monitored with a VOM to make sure the vertical-multivibrator plate supply was staying constant. A VTVM was connected to the plate of the multivibrator, where the DC voltage would respond to a change in the value of R6, R72, R73, or R74. Finally, a resistor substitution box was connected from the output-tube cathode to ground so shunt resistance could be used to counteract any rise in value of the linearity control or R77.

If the trouble actually were in one of these cathode resistors, the technician figured the shunt resistance would enable him to set the output-tube bias for a linear raster; however, in case of drive-signal distortion, he shouldn't expect good linearity at any resistance setting. In the latter situation, a change in one of the meter readings would give supporting evidence.

**THE INDUSTRY'S STANDARD**  
Most Widely Used Today  
by Professional Servicemen

# SAVE CUSTOMERS MAKE MONEY



**FAMOUS DELUXE**



## CRT 440



**For Black & White and Color**

*"Most valuable and useful" . . . "Wouldn't be without it" . . . "Pays for itself over and over again" . . . servicemen say. Quickly checks and corrects television picture tube troubles in a few minutes right in the home without removing tube from set. Gives new life to weak or inoperative tubes. Checks for leakage, shorts, open circuits and emission. Removes inter-element shorts and leakage. Repairs open circuits and low emission. Restores emission and brightness. Life Test checks gas content and predicts remaining useful life of picture tube. Makes new tube sales easier. Completely self-contained. Rich leatherette-covered carry-case. Net, \$74.95*

**TESTS AND REJUVENATES**  
all picture tubes at correct filament voltage from 1 to 12 volts

**TESTS AND REJUVENATES**  
110° tubes and the new 19" and 23" tubes

**TESTS AND REJUVENATES**  
color picture tubes. Checks each gun of color tube separately

**UP-DATE YOUR B&K CRT WITH THESE ACCESSORIES**

**Model C40 Adapter.** For use with previous Models 400 and 350 CRT's—to test and rejuvenate TV color picture tubes and 6.3 volt 110° picture tubes. **Net, \$9.95**

**Model CR48 Adapter.** For use with previous Models 400 and 350 CRT's—to test and rejuvenate 110° picture tubes with 2.34, 2.68, and 8.4 volt filaments. **Net, \$4.95**

**B&K MANUFACTURING CO.**  
Division of DYNASCAN CORPORATION  
1801 W. BELLE PLAINE AVE • CHICAGO 13, ILL.  
Canada: Atlas Radio Corp., 50 Wingold, Toronto 19, Ont.  
Export: Empire Exporters, 253 Broadway, N.Y. 7, U.S.A.



Subscribe to New Picture Tube Information Service

See Your B & K Distributor, or Write for Catalog AP20-R

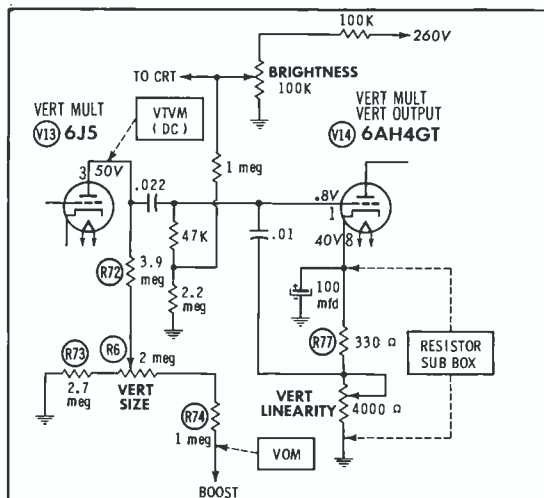

Fig. 2. Substitution box was used to check for change of value in resistors.



## Tips for Technicians

Mallory Distributor Products Company  
P. O. Box 1558, Indianapolis 6, Indiana  
a division of P. R. Mallory & Co. Inc.

# Why some filter capacitors develop hum... and some don't

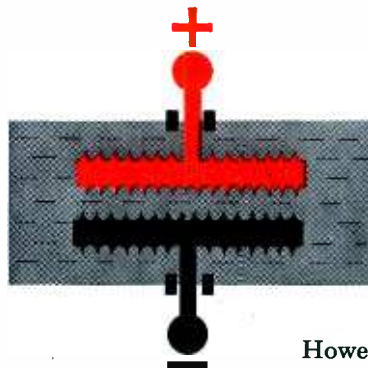

Aluminum electrolytic capacitors are widely used as filters in DC Power Supplies. This is because of their large capacitance in relatively small size. All in all, they do an efficient job of reducing ripple (hum) to acceptable levels.

However, all electrolytic capacitors are not alike. This is often why some types seem to allow hum to rise to objectionable levels more quickly than do others. In order to understand why, we must investigate actual construction methods.

As you know, electrolytics are basically made by depositing a film of aluminum oxide on aluminum foil to form the positive anode. The oxide is the dielectric. A semi-liquid electrolyte surrounds the anode and is actually the negative cathode. In order to connect this semi-liquid cathode to a terminal, a second piece of aluminum foil is used. This is often called the cathode, but it is not. It is actually only the *cathodic connection*. (The preceding describes a "polarized" electrolytic capacitor.)

When high ripple currents are applied to polarized electrolytics, a thin oxide film forms on the so-called "cathode". It begins to assume the characteristics of a second anode. This in turn, has the same effect as placing two capacitors in series. Consequently, overall capacitance is reduced. Inevitably hum increases.

This action is especially noticeable in electrolytics which use plain foil as the "cathode". This is simply because the oxide builds up over a relatively small area.

Mallory avoids this problem by etching the "cathode" on electrolytics. As a result, oxide build-up is spread over a vastly increased area. Therefore, ripple currents are maintained at very low levels for very long time periods.

Of course etched "cathodes" cost a lot more to make. But you get them from Mallory at *no extra cost*. There's much more to the Mallory capacitor story, but we'll leave that to another TIP.

Meanwhile, see your local Franchised Mallory Distributor for capacitors, resistors, controls, switches, semiconductors, and batteries. In fact, he's the man to see for *all* of your electronic component requirements.



# NEW CONTACT CLEANER



## FORTIFIED with SILICONE NOT HARMFUL TO PLASTIC!

JIF away dust, dirt and corrosion on contacts, switches, controls with this NEW siliconized cleaner. JIF cleans and lubricates, providing contacts and controls with the longest possible protection. Fast and efficient, JIF saves time and money. CLEAN — LUBRICATE — PROTECT. Simply apply and work controls a few times. Safe, quick-easy to use — JIF won't harm plastics.

Part No. Net  
8670-6 New 6 oz. spray can 1.79  
8670 New 3 oz. Pocket size spray can .99



**NEW CATALOG**  
JUST OFF THE PRESS  
GC CATALOG FR-65  
WRITE TODAY!



**GC ELECTRONICS CO.**  
400 So. Wyman St., Rockford, Ill., U.S.A.

The way things turned out, the substitution box *could* be adjusted to bring back good linearity, and the meter pointers hardly budged. After a cool-down, the test was repeated with the substitution box connected directly across the linearity control. The results were identical, proving the control was changing value.

Bridging with a resistor-substitution box has to be done with some caution. There must be a reasonable suspicion beforehand that the trouble is due to a value drift of a resistor in the circuit; otherwise, tampering with resistance values may only serve to cover up some other fault such as slowly developing leakage in a capacitor. But resistance bridging still has definite advantage in some tough cases.

### Cross Talk

The substitution-box method of testing works even better with electrolytic capacitors, which are more easily and conclusively checked in this way than by any other means. When the trouble is poor filtering, and an open electrolytic or one with a high power factor is suspected, it isn't even necessary to disconnect the original—just bridge a good unit across it. This test has particular advantages in checking to see if signals are being coupled between sections of a receiver via a B+ line, since the filtering action of two or more electrolytic capacitors can often be checked simultaneously. If the bridging test clears up the symptoms, the individual filters can then be tested.

Even slightly inefficient filtering can cause a number of vague and disturbing symptoms. In one such case, affecting a Hoffman Chassis 211 (PHOTOFACT Folder 194-4),

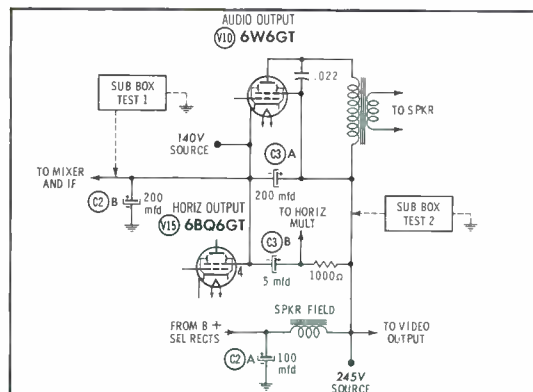

**Fig. 3. Substitution tests located defective filter in "stacked" B+ circuit.**

"sound bars" appeared in the picture; coinciding with these were erratic bends in the raster. The most probable source of the sound interference was the "stacked" B+ system, in which the low B+ potential was developed at the cathode of the audio output tube. (See Fig. 3.) The combination of symptoms might be caused by poor filtering on the low B+ (140-volt) line, which would allow audio to reach the screen of the horizontal output tube, as well as the plates of the mixer and video-IF stages. On the other hand, the audio might be traveling via the 245-volt line to the plates of the horizontal multiplier and video output stages.

The technician first tried bridging an electrolytic substitution box from the 140-volt line to ground. There was no definite improvement in set operation, so C2B (the only electrolytic filter between these points) was cleared of suspicion. But bridging across the 245-volt line eliminated the trouble. The technician could find no electrolytics wired between this line and ground on the output side of the filter choke; all filtering was being performed by C3A (aided by C3B),

# TV TUNERS <sup>\*</sup> REBUILT OR EXCHANGED

ALL TYPES

## \$9.95

Including all parts and labor  
(except broken wafers—billed at cost)

- Normally shipped same day received
- 90 day full guarantee
- U/V combinations \$17.95

FREE—If Mailing carton sent to you on request

Phone REpublic 3-9189

## L. A. TUNER EXCHANGE

4611 West Jefferson Blvd.  
Los Angeles 16, California

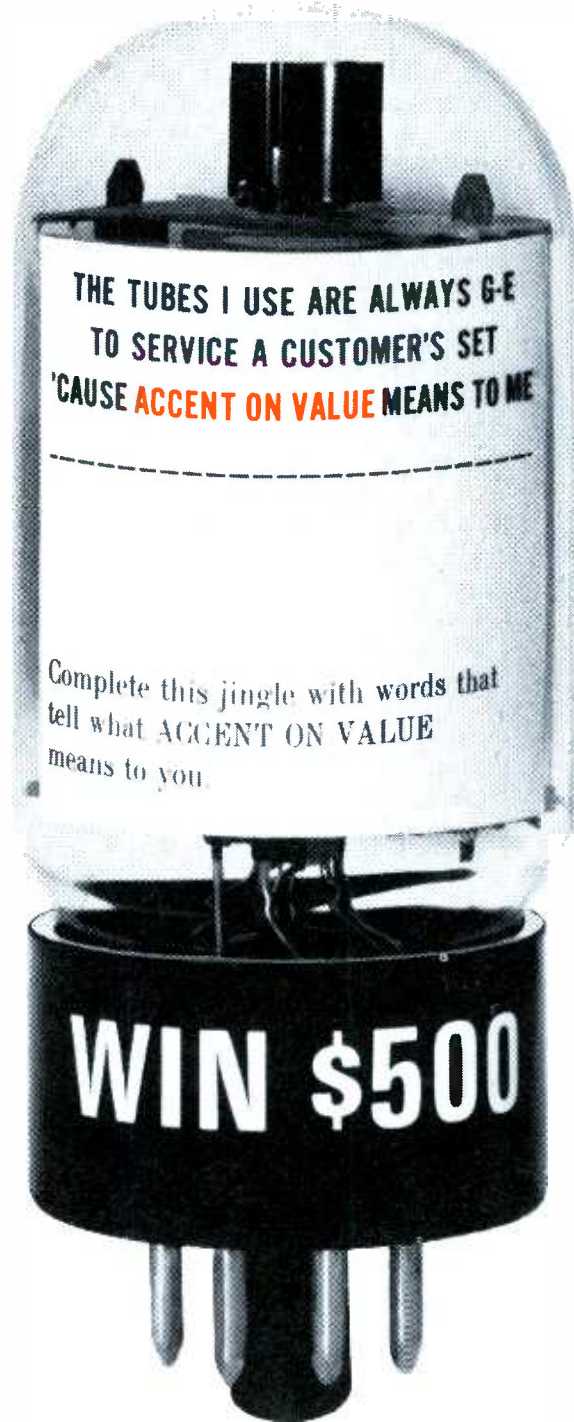

Enter General Electric's ONE-O-ONE Contest. 101 prizes given every month... \$10 to \$100 with a Grand Prize of \$500 in cash. See your General Electric tube distributor for complete rules and official entry blank.

Get this book **FREE** with the purchase of G-E tubes. Here's *101 Tele-Clues* to help make TV repair easier and more profit-



able for you. Your General Electric tube distributor will give it to you free in appreciation of your purchase of G-E tubes and electronic equipment. Enter the ONE-O-ONE Contest. Get *101 Tele-Clues*. See your General Electric Distributor today.

*Progress Is Our Most Important Product*

**GENERAL  ELECTRIC**

Another Accent on Value from G-E *ELECTRONICS* Distributors

## Exact Replacements for Original T.V. Equipment

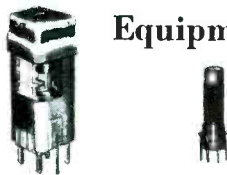

Cat. No.	Use	O.E.M. Part No.
<b>Admiral</b>		
1471-A	Sound Take-Off	72B185-2
1472-A	Sound Take-Off	72C132-19
6332	Horiz. Osc.	94C17-4
<b>Crosley</b>		
7101	2nd Sound I.F.	157856-1
<b>Dumont</b>		
7103-DE	Discriminator	20004441
7104-DE	Sound I.F.	20004511
<b>Emerson</b>		
6339-E	Width	708275
6340-E	Horiz. Osc.	716102
7112-E	4.5 Mc. Disc.	708276
<b>General Electric and Hotpoint</b>		
6206-PC	TV Ratio Det. RTD-026	(WT56X38)
6207-PC	TV Ratio Det. RTD-025	(WT56X37)
6208-PC	TV Ratio Det. RTD-020	
6209-G1	TV Ratio Det. RTD-024	(WT 56X36)
6334-G	Horiz. Phase RLI-365	
6335-G	Horiz. Osc. WT36X402	
<b>Hallcrafters</b>		
1482 IFT	Sound I.F. and Trap	51B1996
7101	2nd Sound I.F.	51A1859
<b>Muntz</b>		
7111-M	4.5 Mc. Disc.	LO-0076
<b>Philco</b>		
6209-P1	TV Disc.	32-4721
6209-P2	TV Disc.	32-4689-1, 2
6209-P3	TV Disc.	32-4735-1, 2
7102-P	4.5 Mc. I.F. and Trap	32-4688-10
<b>R.C.A.</b>		
1483 IF	Sound I.F.	76437
1484 RD	Sound Ratio Detector	102692
1485 RD	Sound Ratio Detector	102644
1486 RD	Sound Ratio Detector	102253
1487 RD	Sound Ratio Detector	100364
1488 RD	Sound Ratio Detector	79141
1489 RD	Sound Ratio Detector	101219
6333	Horiz. Osc.	103103
6336-R	Horiz. Osc. and Sync.	107284
<b>Westinghouse</b>		
6204-W3	TV I.F.	V12128-1, 2, 3

Available  
through your local distributor

**J. W. MILLER CO.**



5917 S. Main St.  
Los Angeles 3, Calif.



returned to the 140-volt line. Deterioration of C3 would leave input filter C2A as the only good electrolytic anywhere on the main B+ line, and it couldn't do all the necessary filtering by itself. When C3 was replaced, operation of the set was greatly improved. The technician would also have replaced C2 as a callback preventive, but he discovered that it had been recently changed. So, in the absence of further trouble symptoms, it seemed unnecessary to take this extra precaution.

### Biased Analysis

"Troubleshooting by substitution" encompasses not only components and signals, but also DC operating voltages. Along this line, a bias box is a familiar accessory in many TV shops. Many bench men think of it only in connection with AGC and alignment jobs, and are missing a good bet in limiting it to these applications. Since many "bias packs" can supply continuously variable negative potentials ranging as high as -45 volts, they can come in handy to substitute for various bias voltages other than AGC.

Particularly in older TV models, a portion of the grid-leak bias from some stage is often "borrowed" to supplement the bias on another stage; breaking this cross-connection by substituting fixed bias is frequently helpful in isolating trouble. This technique can be demonstrated by reviewing a recent case involving a Magnavox 105L-series chassis. The fault was at first diagnosed as a loss of AGC. When a bias pack was hooked up to the AGC line, some of the symptoms disappeared, but sync was still completely absent. Waveform checks showed distorted signals in the vicinity of the sync separator, but not in the video output stage. This set has a triode noise inverter (Fig. 4), always a likely suspect in troubles of this nature—so a careful check of this circuit seemed advisable.

Studying the schematic, the technician noted that an input signal was coupled from the video detector to the cathode of the noise inverter, and that an output from the plate of this stage was coupled to the grid of the sync separator. The grid was simply being held at some negative DC voltage, sufficient to keep the tube cut off ex-

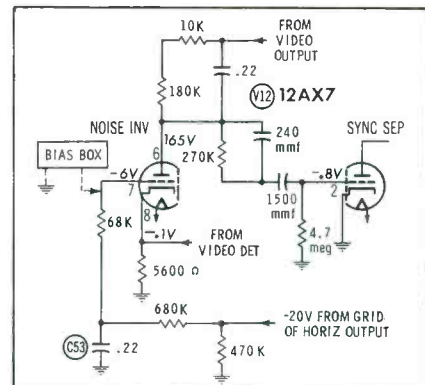

Fig. 4. Bias box was used to "clamp" grid of noise inverter during tests.

cept on the most negative peaks of the cathode signal (noise spikes more negative than the sync-pulse tips). The necessary DC potential was obtained from the grid of the horizontal output tube via a network of divider resistors and an RC filter.

The technician switched the bias-box connection from the AGC line to the noise-inverter grid, and found he could restore a normal picture at any setting of the bias control above a certain point. This suggested that some of the regular bias was being lost. Further investigation uncovered leakage in C53, which was reducing the bias to half its normal value. The noise inverter was conducting each time it received a sync pulse at the cathode, and the resulting negative-pulse output was cancelling the normal input pulses at the grid of the sync separator. Loss of horizontal sync upset the operation of the keyed AGC stage, adding considerably to the list of trouble symptoms.

One precaution should be noted in the use of bias boxes for trouble isolation: They should not be used to substitute for a B-minus branch of a power supply, or for any other source that may be required to deliver heavy current. As a general hint, avoid connecting a bias box in the cathode circuit of a tube.

### Everything Went Blank

Even when an auxiliary troubleshooting aid doesn't carry a problem through to a solution, it can render valuable service in reducing the number of unknown factors. For instance, an 8" test CRT can sometimes be the only expedient means of finding out whether the picture tube in a set is bad, as in the case of a certain Motorola Chassis TS-531 (PHOTOFACT Folder

# Control replacement: *It's a snap!*



## WITH CENTRALAB'S NEW **FASTATCH® II** CONTROL KIT

**NEW CENTRALAB KIT PROVIDES COMPREHENSIVE COVERAGE OF SINGLE AND DUAL CONCENTRIC CONTROLS. STOCK ADJUSTMENTS ON YOUR PRESENT CENTRALAB CONTROLS, TOO!**

FASTATCH II gives you these new exclusive features:

1. Just one control system for dual concentric or single controls.
2. Plug-in permanent locking shafts.
3. Universal terminals.
4. Both front and rear units accommodate KR (snap-on) line switches.

• **IT'S A SNAP to own!** Trade-in your present stock of Fastatch parts.

• **IT'S A SNAP to use!** Single and dual concentrics snap together without tools! Current cross-reference guide is included. Choose from 6 types of universal shafts for either singles or duals—shorten to exact length for your specific needs. 139 exact shafts also available.

• **IT'S A SNAP to guarantee!** Assembled units can't loosen—shafts can't pull out.

• **IT'S A SNAP to store!** Your Fastatch II FRK-100 Kit is built into a heavy gauge steel cabinet. All of your control needs and your cross-reference guide are ready for instant service.

### The FRK-100 KIT contains:

27 assorted front controls	5 SPST on/off switches
9 assorted rear controls	2 DPST on/off switches
40 assorted universal shafts for singles and dual concentrics	1 DP on/off switch

Packaged in heavy gauge steel cabinet: complete with current cross-reference guides.

Total Value: \$55.80 Your money-saving price: **\$48.55**

LESS CREDIT for your Old F and R stock!  
**See your Centralab distributor!**

B-6307

## Centralab®

THE ELECTRONICS DIVISION OF GLOBE-UNION INC.  
942E E. KEEFE AVENUE • MILWAUKEE 1, WIS.  
In Canada: Centralab Canada Ltd., P.O. Box 400, Ajax, Ontario

over 100,000,000  
already sold!



MINIATURIZED

**ELMENCO**

Dipped Mylar\*Paper Capacitors

**first choice with service technicians!**

Now being used in millions of television sets, radios, phonographs, electronic circuitry and military applications. ■ Operates at 125° C without derating. ■ Standard Tolerance ±10% ■ Missile Reliability ■ Completely moisture proof ■ Up to 50% smaller than other types.

**NOW AT NEW LOW PRICES**

**DON'T ACCEPT SUBSTITUTES OR IMITATIONS!**

Available at all authorized ARCO distributors in U.S.A.

**ARCO**  
electronics inc.

Community Drive  
Great Neck, New York  
Branches:  
Dallas 7, Los Angeles 35

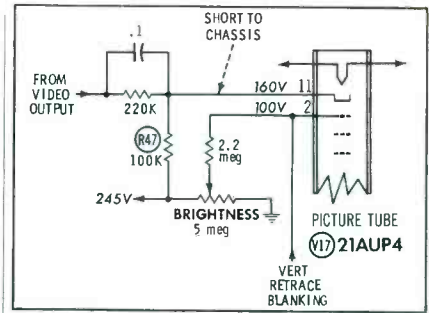

Fig. 5. Intermittent short in CRT was suspected, but trouble was elsewhere.

295-8). The symptom—occasional loss of all video, leaving a blank screen with no control over brightness—was a foreboding of an intermittently shorted picture tube, but a CRT tester could find no defects. When the “white-out” also appeared on a temporarily installed check tube, the customer’s anxiety about buying a new 21” CRT was relieved, and shop service of the chassis was gladly okayed.

Probing around the set in an effort to make the trouble appear, the technician met with success when he moved the picture-tube cathode lead. It was shorting at the point where it passed through the chassis. Since the cathode normally operates at 160 volts in this DC-coupled set (see Fig. 5), the short to ground placed a positive bias on the CRT and accounted for the perpetually bright raster.

The resulting increase in current through R47 had damaged it, but had not yet caused it to burn open. Replacing this resistor and repairing the worn insulation on the cathode lead took care of the trouble. Fortunately, the picture tube was not permanently damaged by the short periods of positive-biased operation.

#### Faint Glimmer

A check tube, useful as it is, may not give an absolutely conclusive substitution test; in some borderline cases, additional test equipment has to be brought into play before the condition of the set’s picture tube can be accurately judged.

A seven-year-old Admiral presented an extremely dim and rather poorly focused picture at the highest setting of the brightness control. No raster was visible under any other conditions, so it was impossible to rely on symptoms such as blooming to tell whether the trouble was due to poor high voltage or to a bad picture tube. The CRT



It used to take 2 men to pull  
a color TV set into the shop...

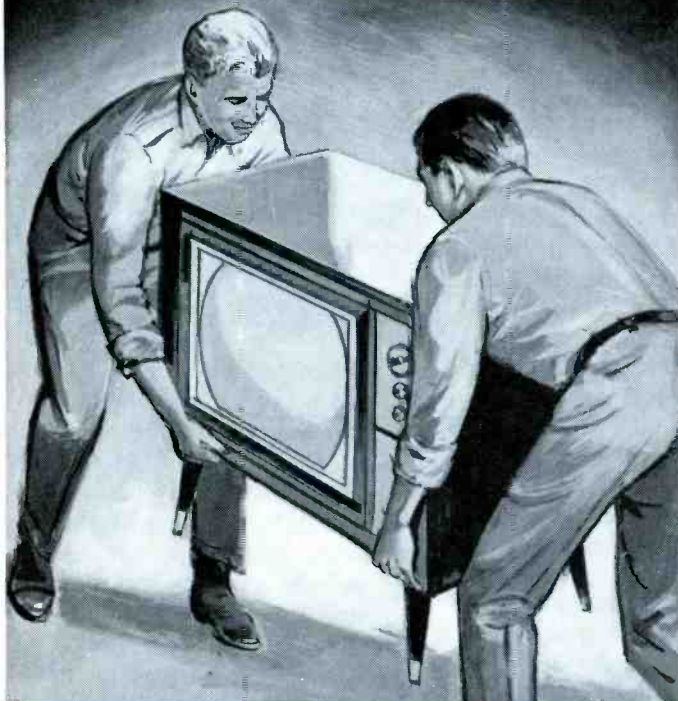

BUT NO MORE



## RCA COLOR TV TEST JIG

Cuts your manhours on Color-TV home service calls

Here is a real "must" for anyone servicing or planning to service color TV sets.

No longer must you send two men to a customer's home to pull in his entire color set. Now, one man can simply remove the chassis and bring it back to your shop for testing, troubleshooting and alignment in your RCA Color TV Test Jig.

Look at some of the extra advantages built into this money-saving unit:

- **Minimizes costly damage claims.** Pulling chassis eliminates possibility of scratching or damaging a customer's cabinet when transporting it to and from his home.
- **Saves time.** Eliminates need to reconverge a customer's set when chassis is returned. Convergence control panel on Test Jig provides static and dynamic convergence for CTC-10, CTC-11 and CTC-12 chassis.
- **Versatile.** Can be used with CTC-4, 5, 7, 9, 10, 11 and 12 chassis.
- **Safe.** Supplied with factory-installed safety glass and kine mask.
- **Complete components kit,** supplied with unit, provides all necessary service components and instructions for installing RCA Color Picture Tube.
- **Professional appearance.** Finish matches that of your other RCA test instruments.

The RCA Color TV Test Jig is available through your Authorized RCA Parts and Accessories Distributor. See him this week to find out how this versatile instrument can help you capitalize on the growing Color TV servicing market.

For information on where you may obtain the RCA Color TV Test Jig, and for additional specifications, fill out and mail the coupon below.

RCA PARTS AND ACCESSORIES, CAMDEN, N. J.



The Most Trusted Name in Electronics

RCA Parts and Accessories  
P.O. Box 654, Camden, New Jersey

Please send me full specifications on the RCA Color TV Test Jig, and the name of the nearest distributor where I may obtain it.

Name \_\_\_\_\_

Company or Service Shop \_\_\_\_\_

Address \_\_\_\_\_

City \_\_\_\_\_ Zone \_\_\_\_\_ State \_\_\_\_\_

# NEW

## LEAN 'N MITY



EDP SHOW  
Room 641A  
(Sound Section)

MODEL 8HA8

## ALNISPHERE ALNICO V

Soon to be the industry's most imitated speaker . . . a new heavy magnet, slim profile sound speaker designed and built to give unexcelled performance through the use of ALNICO V, the industry's most efficient speaker magnet material . . . from Oaktron.



**AKTRON**  
INDUSTRIES, INC.  
MONROE, WIS.

tested rather weak, but this was expected, since it was the set's original tube.

A check tube presented a somewhat brighter raster, but the brightness still didn't seem normal. Thus, the technician felt that an actual measurement of high voltage would provide much-needed evidence. When a VTVM with a high-voltage probe was pressed into service, the voltage measured 9 kv—just barely enough to make the raster visible on an average CRT.

No trouble could be found in the high-voltage rectifier circuit. Another measurement with the HV probe—this time a peak-to-peak AC check at the rectifier plate cap—showed a lower reading than in a good set used for comparison. Apparently, then, the horizontal flyback circuit was not operating at full efficiency. The drive signal at the grid of the output tube was normal, as were all voltages on this tube; no defects could be found in the damper circuit, either. All indications so far were pointing to a defective flyback transformer, so the technician set up his flyback and yoke tester for an evaluation of this component. Its efficiency was found to be below normal. After a new flyback was installed, the raster on the aging picture tube was bright and clear enough to give it a reprieve from the scrap heap.

### Keep 'em Running!

Wise use of all available test instruments and service aids can save entire sets from going to the scrap heap before their time. By taking advantage of all possibilities for short cuts in servicing, you can hold repair costs down to reasonable levels, and still make a profit.

### Regulated DC Supply

Here is a power supply to use with equipment containing transistors or tunnel diodes. The Seco Model RPS-4 Power Supply uses a 2N376A power transistor to regulate its output voltage to within  $\pm 3\%$  over a wide range of load currents. The voltage at the permanently attached test leads is continuously variable from 0 to 28 volts DC by a potentiometer on the panel of the instrument.

The panel meter contains scales



for measuring values up to 30 volts DC and up to 150 ma. A switch—incorporated with the on-off switch—selects the function and range of the meter. By merely setting this switch to different positions, the user can monitor either the voltage being supplied to a load or the current drawn by that load.

Regulation of the RPS-4 is almost perfect at voltages up to 15 volts DC; that is, the voltage remains constant at current drains from a few microamps all the way up to the 150-ma capacity of the unit. Above 15 volts, however, the regulation is somewhat less effective. At 20 volts, regulation is excellent up to about 90 ma, and then the voltage drops slightly with increasing loads; at 25 volts, regulation is effective only to about 50 ma. It is worth noting, however, that these limits are well beyond the power needs of most transistor receivers.

Another point worth mentioning is that the regulation of the RPS-4 contributes to its "hum-free" operation, and makes the output impedance very low. This eliminates the motorboating problem found when transistorized sets are tested with some battery supplies, or with certain unfiltered power supplies. A special tap is provided for operating transistor receivers that use tapped power supplies.

The Model RPS-4 is completely isolated from the power line by its transformer, thus eliminating the danger of damage that sometimes exists when a transistor receiver is tested with power-line-operated instruments. ▲



't ain't so

(a G-E "SG" picture tube *never* gets trapped)

G-E "SG" *straight gun* picture tubes\* don't *need* ion traps. Their rugged guns fire electrons with uncanny precision straight at the aluminized phosphor screens —assuring sharply resolved pictures up to 80% brighter. No fuss, no call-backs. How's that for "Accent on Value"? These features save your time and give your customers thousands of hours of viewing pleasure.

And that's not all the value accents you get with these "straight shooters." A single G-E "SG" picture tube replaces as many as twenty other types, bent gun or straight gun—the types that get "trapped." In fact, with only 25 G-E "SG's", you're ready to replace 250 other picture tube types. You'll serve

customers faster—and say *good-bye* to emergency pick-ups and the ion trap nuisance.

**GET THIS "ACCENT ON VALUE" BONUS TODAY**



This 16" x 12" x 1/2" polyurethane foam bench pad neatly protects the picture tube from marks and scratches. The handy pad's yours with the purchase of a G-E SG-21FLP4 Service-Designed "straight shooter." Your reliable General Electric distributor is waiting for your order now. Call him today.

\*All new parts and material in a reused envelope.

*Progress Is Our Most Important Product*

**GENERAL  ELECTRIC**

**MORE "ACCENT ON VALUE" FROM YOUR  
G-E ELECTRONICS DISTRIBUTOR**

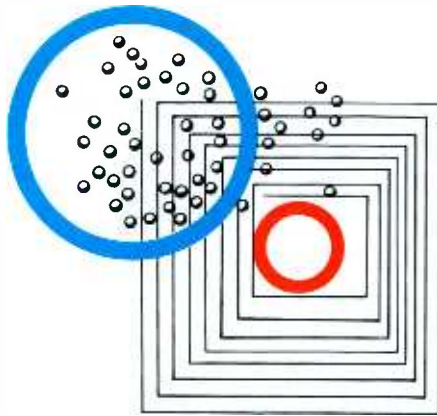

# Molecular Electronics

## explained

It seems clear that the next few years will see some major changes in electronic equipment, both in appearance and in basic design philosophy. These changes are being brought about by a concentrated effort to microminiaturize circuits, which ultimately will create in *microcircuit* form the functional equivalents of most conventional circuits. Whether this process becomes a breakaway evolution, or expands gradually from one level of sophistication to another, will depend largely upon how successfully and economically the various new techniques can be applied to equipment and systems.

A wide variety of formulative techniques are being employed in microminiaturization. Some manufacturers are fabricating *microelements* consisting of thin films deposited on very tiny glass or ceramic wafers; these microelements are then stacked, interconnected, and encapsulated into complete electronic circuits. One firm has de-

posited a complete 14-part circuit on a surface  $\frac{1}{2}$ " square. Several other semiconductor manufacturers have developed complete circuit modules—on silicon or germanium base material—no larger than a conventional transistor. Resistance welding and small encapsulated printed circuits provide additional means for high-density packaging of very small parts into extremely compact modules. For high-temperature use, an evacuated ceramic thermionic circuit is being developed by one firm.

Another approach to microminiaturization utilizes special techniques to obtain circuit effects from a single block of material, containing no visually identifiable components.

In producing these various modular electronic devices, many fabrication techniques are used, ranging from the electrical, vacuum, and chemical depositing of thin films to the growing of flat semiconductor ribbons (known as the *den-*

*dritic* crystal process). Spectrographic plates, screen and photolithographic printing, micromachining, air abrasion, ultrasonic machining, and electronic etching are just a few of the special processes that are being used to build and develop these ultra-tiny circuits.

### Molecular Electronics

The technique of preparing a complete circuit from a single block of semiconductor material offers what seems to be the ultimate in electronic design—a circuit whose manner of operation depends almost entirely on the molecular structure of the various circuit "components." This form of electronic circuitry is divided into two classes—*integrated* and *functional*.

*Integrated* molecular circuits are those in which multiple component parts are formed in a single block of semiconductor material. This classification also includes those modules in which the component parts appear on more than one

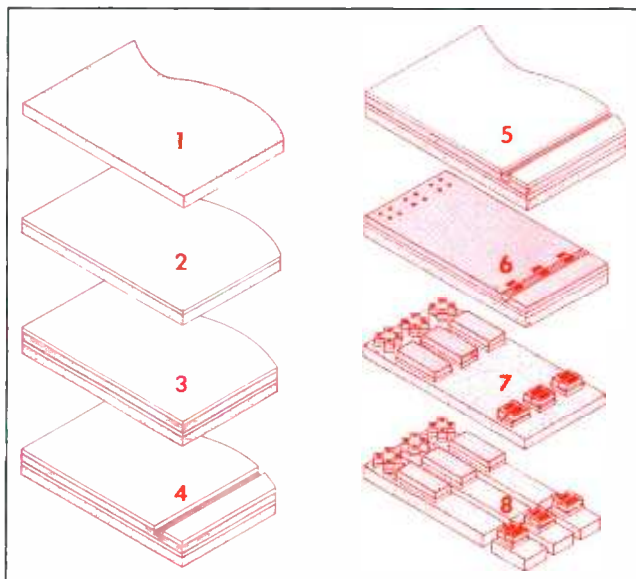

Fig. 1. Steps in the fabrication of a set of molecular electronic modules.

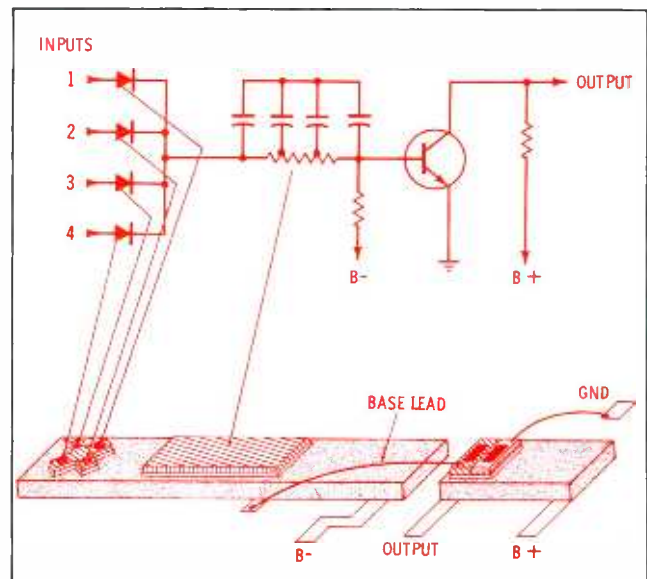

Fig. 2. Each portion of the molecular unit is equal to a circuit element.

# SENCORE

## SIMPLIFIES COLOR SERVICING

### NEW! CA122

### COLOR CIRCUIT ANALYZER

A simple approach to a complex problem

Here is an instrument that is designed to eliminate the guesswork in color TV servicing. A complete analyzer that provides all required test patterns and signals for testing from the tuner to the tri-color tube. Additional analyzing signals for injection at each stage including audio, video and sync, brings to life a truly portable and practical TV analyzer for on the spot service; virtually obsoleting other analyzers with the advent of color. Sencore's simplified approach requires no knowledge of I, Q, R-Y, B-Y, G-Y or other hard to remember formulas. The CA122 generates every signal normally received from the TV station plus convergence and color test patterns.

The CA122 offers more for less money:

**TEN STANDARD COLOR BARS:** The type and phase that is fast becoming the standard of the industry. Crystal controlled keyed bars, (RCA type) as explained in most service literature, offer a complete gamut of colors for every color circuit test.

**WHITE DOTS:** New stabilized dots, a must for convergence, are created by new Sencore counting circuits.

**CROSS HATCH PATTERN:** A basic requirement for fast CRT convergence.

**VERTICAL AND HORIZONTAL BARS:** An added feature to speed up convergence, not found on many other color generators.

**SHADING BARS:** Determines the ability of the video amplifier to produce shades (Y Signal) and to make color temperature adjustments. An important feature missing on other generators.

**COLOR GUN INTERRUPTOR:** For fast purity and convergence checks without upsetting color controls. Insures proper operation of tri-color guns, preventing wasted time in trouble shooting circuits when CRT is at fault.



A must for color . . .

a money maker for black and white TV servicing

**ANALYZING SIGNALS:** RF and IF signals modulated with any of the above patterns for injection into grid circuits from antenna to detector. IF attenuator is pre-set for minimum signal for each IF stage to produce pattern on CRT thus providing a check on individual stage gain. Sync and video, plus or minus from 0 to 30 volts peak to peak, have separate peak to peak calibrated controls for quick checks on all video and sync circuits. Crystal controlled 4.5 mc and 900 cycles audio simplify trouble shooting of audio circuits.

**NEW ILLUMINATED PATTERN INDICATOR:** A Sencore first, offering a rotating color film that exhibits the actual color patterns as they appear on color TV receivers. Locks in with pattern selector control.

You'll pay more for other color generators only.

Dealer Net . . . . . 187.50

### NEW! PS120 PROFESSIONAL WIDE BAND OSCILLOSCOPE

A portable wide band 3 inch oscilloscope for fast, on-the-spot testing. An all new simplified design brings new meaning to the word portability . . . it's as easy to operate and carry as a VTVM. Though compact in size, the PS120 is powerful in performance: Vertical amplifier frequency response of 4 MC flat, only 3 DB down at 7.5 MC and usable to 12 MC, equips the technician for every color servicing job and the engineer with a scope for field and production line testing. AC coupled, with a low frequency response of 20 cycles insure accurate low frequency measurements without vertical bounce. Sensitive single band vertical amplifier; sensitivity of .035 volts RMS for one inch deflection saves band switching and guessing. Horizontal sweep frequency range of 15 cycles to 150 KC and sync range from 15 cycles to 8 MC (usable to 12 MC) results in positive "locking" on all signals. New exclusive Sencore features are direct reading peak-to-peak volts — no interpretation; dual controls to simplify tuning; lead compartment to conceal test leads, jacks and seldom used switches. Rear tilt adjustment angles scope "just right" for easy viewing on bench or production line.

Size: 7" x 9" h x 11 1/4" d. Weight: 12 lbs.

Dealer Net . . . . . 124.50  
(with low cap. probe)

Kit . . . . . 74.50



A must for servicing color TV in the home . . . lowest priced broad band scope. All hand wired — all American made

Watchmaker's Precision  
plus a  
**BULL-DOG GRIP**



Specially  
Designed

**CHAN NEL LOCK**<sup>®</sup>

No. 718 Long-reach  
**Flat-Nose Plier**

Looking for a precision plier that really takes hold in hard-to-reach places? Here's your answer . . . this specially designed CHANNELLOCK Flat-Nose Plier. Just the ticket for electrical, radio, TV, Hi-Fi and other electronics work. Micro-matched, scored, long, flat jaws. Comfortable, blue-plastic grips. Top quality, polished forged steel. Ask your tool supplier for a CHANNELLOCK No. 718 Flat-Nose Plier. If he's out of them, ask him to order one for you.



Write for Catalog of  
Complete Line of Pliers



# 728 LONG-REACH DIAGONAL CUTTER



# 738 LONG-REACH ROUND-NOSE PLIER



# 748 LONG-REACH END CUTTER

Channellock Pliers are made only by

**CHAMPION DeARMENT TOOL COMPANY**  
Meadville, Pennsylvania

block, because (in some cases) these circuits operate better when subdivided.

Functional molecular circuits are those which use the functions usually associated with conventional semiconductor devices (transistors, thermistors, photodiodes, etc.) to achieve the same overall purpose that the integrated circuit achieves with its multiplicity of related "parts."

#### Integrated Circuits

In conventional electronics, the various circuit functions are performed by assemblies of components such as tubes, transistors, diodes, resistors, capacitors, and inductors. In integrated molecular circuitry, all these circuit functions are performed within a single block of apparently solid material. This method makes use of special effects within a semiconductor to perform circuit functions, achieving results by the use of "charges" and "spins" within the molecules. By using only PN junctions, and eliminating other forms of components, certain transfer effects are obtained that can be employed for circuit operation.

A complete integrated circuit can be fabricated in or on a block of semiconductor material by means of 15 to 20 steps that include such techniques as oxide masking, diffusion, metal deposition, alloying, and surface shaping. For example, resistors are developed from properly doped bulk material or from thin surface layers formed by diffusion techniques. Capacitors are obtained by reverse-biasing a PN junction, or by building up a layer of silicon oxide on the top surface of the semiconductor material and depositing a layer of metal on top of the silicon oxide. Active compo-

nents such as transistors and diodes can be fabricated by the usual methods of diffusion or alloying.

Such integrated modules represent functionally complete circuits rather than assemblies of components. This concept eliminates many complicating design parameters (such as individual lumped resistances, capacitances, and inductances) by making possible the lumped parameter of a complete circuit.

When a semiconductor material is employed as the body of an integrated molecular circuit, it is useful to consider various regions of the semiconductor as being equivalent to conventional circuit elements. Fig. 1 indicates the procedure used by one manufacturer to mass-produce logic circuits for a computer. For step 1, an N-type silicon wafer is cleaned and made ready for processing. In step 2, a coating of silicon is allowed to form on the surface. Step 3 involves diffusing a thin layer of P-type silicon through the oxide to form a collector-base junction. In step 4, the oxide on the P-layer is removed from a narrow strip—in preparation for step 5, adding a strip of N-type material (the emitter). Step 6 prepares the module for interconnecting and for external connections by removing the oxide coating from this layer and adding metal contacts. In step 7, "mesa" etching selectively removes the unwanted materials from the block.

The end result is a block of molecular circuits that can now be separated (step 8) into individual modules. Each module contains all the elements necessary for the computer circuit. Fig. 2 shows the interrelationships between the various regions of the module and the sche-

## Western T.V. Tuner Rebuilders

VHF or UHF ALL MAKES

**\$9.95** Including all parts  
and labor

major parts extra at (low) net price.

UHF-VHF COMB. \$17.00

90 Days Guarantee — 24 Hour Service

All tuners are thoroughly cleaned, mechanically and electrically overhauled, aligned with crystal-controlled equipment, and finally given air check for sensitivity with TV transmitters.

**WESTERN TUNER REBUILDERS**

1140 No. Vermont, Los Angeles 29,  
California—NOrmandy 2-1397

4130 El Cajon Blvd., San Diego 5,  
California—ATwater 4-2733



**STOP!**

**LOOK!**

**SAVE!**



A  
STANDARD  
COLOR BAR  
GENERATOR

at **1/2**  
THE COST OF  
OTHERS

only **\$99<sup>50</sup>**

All crystal controlled

*the all new* **SENCORE**  
CG126 STANDARD COLOR BAR GENERATOR

A standard color bar, white dot, crosshatch generator especially made for field service on color TV . . . and at a great savings to you.

Check these outstanding features and you will see why this generator belongs on the top of your list for color TV servicing.

**All patterns crystal controlled** offering "rock like" stability. You'll think the patterns are painted on the TV screen.

**Simplified operation speeds up every servicing job.** Just dial the standard keyed bars, white dots, crosshatch, vertical bars or horizontal bars and watch them "pop" on the screen. That's all there is to it.

**Exclusive adjustable dot size.** The white dots can be adjusted to the size that satisfies your needs by a screwdriver adjustment on the rear. No need to argue about dot size anymore. Just select the size that you like to work with best.

**Pretuned RF output to Channel 4.** Other low channels can be selected if Channel 4 is being used in your area by simple slug adjustment. Patterns are injected directly into antenna terminals, simplifying operation and saving servicing time.

**Reserved output on color bars** for forcing signal through defective color circuits. The color output control is calibrated at 100 percent at the center of rotation, representing normal output. A reserve up to 200 percent is available on the remainder of rotation.

**Smaller and more portable.** With color receivers weighing much more than black and white TV, portable equipment becomes essential for home servicing. The CG126 weighs less than 10 pounds and measures only 11" x 8" x 6".



Ten standard keyed color bars (RCA type) that automatically provide all colors at specified NTSC phases . . . but without need of interpretation when servicing.



Stable white dots with new exclusive dot size adjustment in rear.



Stabilized crosshatch pattern for simplifying convergence adjustments.



10 thin white vertical lines for horizontal dynamic convergence adjustments . . . often missing on other generators.



14 thin horizontal lines for vertical dynamic convergence. Also missing on many high priced generators.

**March into your local parts distributor and demand the CG126 Sencore color generator that sells at 1/2 the price of others. Don't let him switch you.**

**SENCORE**  
426 SO. WESTGATE DRIVE • ADDISON, ILL.

CHECKS AND REJUVENATES ALL PICTURE TUBES  
WITHOUT ADAPTORS OR ACCIDENTAL TUBE DAMAGE



the all NEW

Featuring Automatic  
Controlled  
Rejuvenation

\$69.95

# SENCORE

## CR125 CATHODE RAY TUBE TESTER

From SENCORE, designers of the famous Mighty Mite Tube Tester and other valuable time savers, comes another industry best. An all new method of testing and rejuvenating picture tubes. Although the method is new, the tests performed are standard, correlating directly with set-up information from the RCA and GE manuals.

Check these outstanding features and you will see why this money making instrument belongs on top of your purchasing list for both monochrome and color TV testing.

**Checks all picture tubes thoroughly and carefully;** checks for inter-element shorts, cathode emission, control grid cut-off capabilities, gas, and life test.

**Automatic controlled rejuvenation.** A Sencore first, preventing the operator from over-rejuvenating or damaging a tube. An RC timing circuit controls the rejuvenation time thus applying just the right amount of voltage for a regulated interval. With the flick of a switch, the RC timer converts to a capacity type welder for welding open cathodes. New rejuvenation or welding voltage can be re-applied only when the rejuvenate button is released and depressed again.

**Uses DC on all tests.** Unlike other CRT testers that use straight AC, the CR125 uses well filtered DC on all tests. This enables Sencore to use standard recommended checks and to provide a more accurate check on control grid capabilities. This is very important in color.

**No interpretation chart.** Two "easy view" neon lights clearly indicate shorts between any element. A chart is included for interpretation of shorts, if desirable. This chart is not necessary for normal testing on the CR125.

**No adaptor sockets.** One neat test cable with all six sockets for testing any CRT. No messy adaptors, reference charts or up-dating is required. The Sencore CR125 is the only tester with both color sockets. (Some have no color sockets, others have only the older type color socket.)

**No draggy leads.** A neat, oversized compartment, in the lower portion of the CR125 allows you to neatly "tuck away" the cable and line cord after each check in the home.



All six sockets, including latest color socket, on one neat cable.

**SENCORE, INC.**  
426 S. WESTGATE DRIVE  
ADDISON, ILLINOIS

**SPECIAL INTRODUCTORY OFFER  
WORTH \$5.00**

Most SENCORE products are sold by recommendation. So that you will be first in your area to buy and recommend the CR125, this coupon is worth \$5.00 on the purchase of the CR125 when presented to your parts distributor.

Why not save \$5.00 now? Herb Bowden  
President

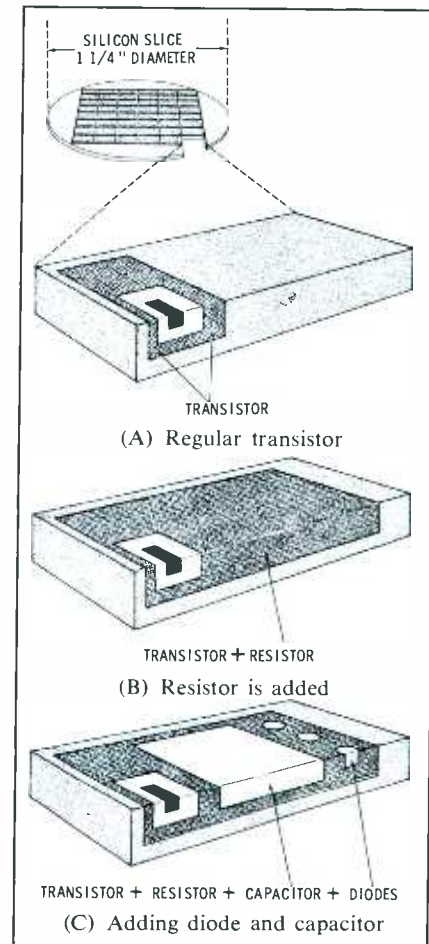

**Fig. 3. Steps in the plating process of making a molecular circuit module.** The module is smaller than any single conventional component shown in the schematic—proof that molecular electronics can provide circuits miniaturized almost beyond imagination. Although this circuit can be designed on a single silicon wafer, in practice it has been found desirable to separate the resistors of the input circuit from the load resistor—thus, the two blocks shown in Fig. 2.

Another semiconductor module (Fig. 3) begins life as a slice of pure semiconductor material—usually silicon. This slice is divided into many small wafers—one of which is shown, enlarged, in Fig. 3A. A transistor region is formed near one end of this piece, by standard diffusion techniques. Fig. 3B illustrates the addition of a resistor as an integral part of the collector region of the transistor. The resistor was formed at the same time as the transistor, and by the same diffusion process. Fig. 3C shows the module with three diodes and a capacitor added. The diodes are diffused into the end of the bar opposite from the





**MOTOROLA**  
takes the  
**GUESSWORK**  
out of buying radio  
communications tubes

THIS NAME IS YOUR ASSURANCE  
OF GETTING MAXIMUM RELIABILITY,  
LONGEST SERVICE LIFE AND  
HIGHEST DOLLAR VALUE

As the leading supplier of new FM 2-way radio, Motorola insists on utmost reliability and top performance in tubes used in its original equipment. Naturally, we maintain the same high standards in controlling the quality of our replacement tubes.

Motorola's laboratory research, testing, evaluation and painstaking tube selection procedures are virtually unique in the tube distribution market. Yet, this costs you no more.

Motorola Communications Quality tubes are competitively priced . . . are immediately available from strategic locations throughout the country . . . are conveniently packaged for shop and field use. And our wide selection of receiving and special purpose tubes meet virtually every servicing requirement.

**BONUS BENEFITS FOR YOU**

The Premium Coupon program of Motorola's Communications Division is an added bonus for tube buyers. These coupons are redeemable for a huge selection of name brand merchandise including small appliances, sporting goods, test equipment and hand and power tools for the home and shop. This is a continuing program that has been available to all for years. It's not seasonal or turned on and off as the market dictates.



GET THE FULL MOTOROLA COMMUNICATIONS QUALITY TUBE STORY. Write today for your FREE Tube Fact Kit.



**MOTOROLA**  
COMMUNICATIONS AND ELECTRONICS, INC.  
A SUBSIDIARY OF MOTOROLA INC.

**Motorola Communications & Electronics, Inc.**

Attention National Parts Department  
4910 West Flournoy Street  
Chicago 44, Illinois

Please send Motorola's FREE Tube Fact Kit

Name \_\_\_\_\_

Company \_\_\_\_\_

Address \_\_\_\_\_

City \_\_\_\_\_ State \_\_\_\_\_

# SHOP TALK

by DICK PAVEK

This is the first installment of a column that will appear in this magazine. It will contain shop hints, product news and advice for technicians. We hope you will like it.

● Did you know that hardened twin lead may be stripped easily without breaking the wires if the insulation is heated first with a match?

● Ever think what happens when you cut someone out at an intersection and he sees the name on the side of your truck? He's not going to be YOUR customer.

● The greatest service aid we've seen in a long time is a tiny coil of wire used to splice new parts into printed or wired circuits. They're known as Colman SPLICERS and are available from any good jobber. (A good jobber is one that handles our line). Try the SPLICERS; you'll never be without them again.

We will send a special kit of \$10 worth of Colman service aids to any technician whose tip we publish.

Write to me care of:

**COLMAN ELECTRONIC PRODUCTS**  
P. O. Box 2965 Amarillo, Texas



Sticky sludge in your  
needle profits?

USE DUOTONE  
FOR FAST SUCCESS

Needle replacement problems go down the drain when you use Duotone needles. Genuine diamond, synthetic sapphire and osmium tipped. No phonograph can be considered completely serviced if its worn needle is not replaced. Most of your customers don't know that worn needles ruin their records. Tell them. Remember Duotone is a name they know and trust.



You'll be bubbling with increased sales.

**DUOTONE**  
COMPANY, INC. KEYPORT, N.J.  
Parts show display rooms 614A-615A

transistor, while the capacitor is formed by a larger diffused area over the center of the resistor region. Thus, the same diffusion steps required to form a conventional transistor were used in this module to form the entire circuit.

These same techniques can be employed to form more complex units. All semiconductor modular networks like those in Fig. 3 are fabricated by using the same three process steps, the various elements (transistors, diodes, resistors, and capacitors) being formed by diffusions on the surfaces of the material. The initial silicon slice has a very high resistivity, which effectively isolates each diffused area.

The dimensions and positioning of the diffused areas are accurately determined by a photolithographic process in which a silicon dioxide coating is formed on the wafer. (Silicon dioxide is an effective masking agent for the diffusants used in this process.) Thus, diffusion paths will be formed only in areas where the silicon dioxide has been selectively removed by the photo process. During diffusion, then, silicon dioxide is reformed over the remainder of the wafer, protecting all conductive paths and the surface area. After diffusion, the wafer contains a predetermined pattern of isolated electronic paths and terminals. Aluminum is then deposited over the insulating silicon dioxide surface to provide point-to-point connections between the various electronic junctions.

### Functional Circuits

In producing functional molecular circuits, the desired overall electronic purpose is conceived at the outset, and then designed into multilayer semiconductor modules. As an example, suppose an AC-to-DC converter is required. It could be built from conventional parts (transformer, rectifier, and three filter components) as indicated in Fig. 4A. On the other hand, it could be built as a functional block of semiconductor material, as shown in Fig. 4B. In the latter case, the unit is designed on an unusual concept of physics: transferral of energy from one form of molecular material to another.

Each form of material is called a domain. When AC energy is ap-

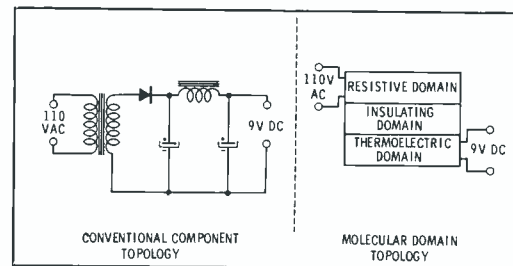

Fig. 4. Two types of DC power supply.

plied to the resistive domain, heat is passed through the center (thermal) domain, which is electrically an insulator but a very efficient thermal conductor. The heat causes DC to be generated by the thermoelectric domain; the DC output has no ripple—requiring no filter—because the rate of heat flow to the thermoelectric domain is uniform.

One company, prominent in this field, has built a number of classes of functional blocks to operate at frequencies ranging from the infrared spectrum to DC. These include several types of amplifier, a variety of multivibrators, a variable potentiometer, a few multiposition switches, an analog-to-digital converter, and a two-stage computer coder. Some of these molecular circuits are produced by dendritic growth of single-crystal germanium, resulting in a long, precisely flat ribbon that requires no "lapping." Conventional techniques of diffusion, evaporation, and plating are applied to this crystal ribbon as it leaves the melt; therefore, the germanium semiconductor devices are completed in one continuous operation, except for attaching of leads.

As a more recent development,



Fig. 5. Modules do the work of large number of conventional printed boards.

multizoned germanium crystals are being grown as dendrites, thus reducing the number of separate steps to a finished circuit. These circuits have at least three zone-layers — or domains — and two interfaces. Combining these two techniques to mass-produce molecular electronic equipment as complex as complete amplifiers is one long-range objective of the research taking place in this field.

#### Thin Films

Thin-film deposition (by evaporation), long considered a laboratory phenomenon, is today a recognized method for producing molecular electronic circuits with special functional characteristics. This process, depending upon its application is comparatively simple, fast, and inexpensive.

A work chamber is partially evacuated by means of vacuum pumps to eliminate molecular interference that can be caused by gases normally present at atmospheric pressures. Unless removed, these gases accumulate in the space between the evaporant and the surface upon which it is to be deposited. The evaporant is placed at a carefully chosen point in the work chamber and heated to a high intensity. It then vaporizes and travels in a straight line, condensing to form a thin film on the comparatively cool surface of the substrate material.

The thin films on molecular electronic devices are deposited through masks or stencils, and accuracy is absolutely essential; unwanted results would be obtained if deposited areas did not have sharp edges.

Substrates for film-type molecular components can be passive elements like germanium, or active elements such as barium titanate. These substrates, in wafer form, are cleaned chemically or ultrasonically before being plated with their thin films of such substances as silicon oxide, silicon dioxide, aluminum, gold, silver, or nichrome.

Fixturing and masking is extremely critical. The masks are carefully designed and manufactured, and the work must be positioned exactly in the work chamber to permit deposition only where desired. In many cases, where more than one layer of different materials are to be deposited on a single substrate, it is necessary to mask for several circuits at once. As many as 18 successive layers have been successfully deposited on a single substrate, permitting considerable complexity of circuit arrangements.

Semiconductor molecular networks can be contained in a very small package. Lying on the table in Fig. 5 are several conventional circuit boards using individual transistors, diodes, resistors, and capacitors; each board includes five electronic circuits, each performing a basic circuit function. By contrast, the single board in the engineer's hand contains modules which can perform the functions of 23 of the regular boards. Each molecular module is enclosed in a hermetically sealed package (like that held by the tweezers)—some as small as  $\frac{1}{4}$ " x  $\frac{3}{8}$ " x 1.32", a total volume of only .001 cubic inch. Compare that with the volume (nearly one cubic inch) for each individual circuit using conventional components, and you have some idea of the progress already achieved in microminiaturization. And with better molecular techniques constantly under development, there's little telling just how tiny electronic systems will eventually become. ▲

# NOW! CASTLE OFFERS YOU THE BIGGEST BARGAIN IN TV TUNER OVERHAULING!

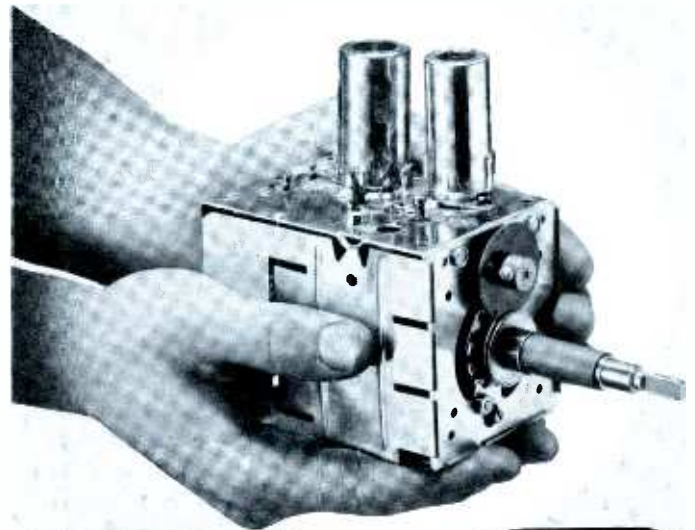

ALL MAKES

ALL LABOR  
AND PARTS  
(EXCEPT TUBES)\*

ONE PRICE

995

THIS ONE LOW PRICE INCLUDES ALL UHF, VHF  
AND UV COMBINATION\* TUNERS

In a decade of experience overhauling TV Tuners of ALL MAKES, Castle has developed new handling and overhauling techniques which give you . . .

**Fast Service**

A recent study at our Chicago Plant revealed that of all tuners accepted for overhauling, over 30% were completed and shipped within . . . **Seven Hours** . . . all others within 24 Hours.

Simply send us your defective tuner complete; include tubes, shield cover and any damaged parts with model number and complaint. 90 Day Warranty.

Exact Replacements are available for tuners unfit for overhaul. As low as \$12.95 exchange. (Replacements are new or rebuilt.)

\*UV combination tuner must be of one piece construction. Separate UHF and VHF tuners must be dismantled and the defective unit only sent in.

Pioneers in TV



Tuner Overhauling

# CASTLE

TV TUNER SERVICE, INC.

5701 N. Western Ave., Chicago 45, Illinois  
653 S. Palisade Ave., Cliffside Park, New Jersey  
Canada: 136 Main St., Toronto 13, Ontario

\*Major Parts are additional in Canada



# GUARANTEEING YOUR SERVICE WORK

In these days of ever-extended guarantees and warranties, with many of the major manufacturers assuming longer and broader liabilities, perhaps it is high time we re-evaluate our own service guarantees.

What is your guarantee to your customer? It's surprising just how many service dealers have only a vague notion beyond the rather well advertised idea of giving a 90-day guarantee on parts. Will you replace the parts absolutely free of charge? If other parts go bad at the same time, will you charge for *all* your labor? Is your guarantee spelled out on your service order or bill? Does your guarantee make sense to the customer? Does it make sense to you? Do you explain your guarantee to your customer when the service job is finished?

## Stingy or Generous?

Attitudes concerning guarantees range between two extremes. A few servicemen take the chip-on-the-shoulder attitude that all customers are chiselers who work in collusion to milk the profit from a service call. Others have such a liberal guarantee that they often lose money on some jobs. Both extremes are bad business, perhaps; but of the two, those with the liberal guarantee (unless their work is atrocious) will be the companies that will grow and stay healthy, for in reality the number of deliberate chiselers among customers is small even though their vocal output is sometimes alarming.

Whatever your guarantee policy

is, it will almost surely be more profitable for you in the long run if it leans toward a liberal philosophy. Basic as it may seem, customer satisfaction is the only thing that can be definitely counted on to build a business. Low-priced service may get you some customers, but unfortunately those it draws are seldom the ones you really want. The customer to cultivate is the one who is willing to pay a fair price for good service — but make sure you keep him by promptly and courteously taking care of any problems he has and making reasonable adjustments on callbacks. Nobody likes to pay twice for service that should have been guaranteed!

One successful technician friend of mine has always had one of the most liberal guarantees I've known. He guarantees not only the parts he installs, but every part in the set (except the picture tube) for 90 days after a shop repair. "I have fewer callbacks than anyone I know," he says, "because I give the set a thorough going over in the shop, and I *know*—don't just guess—that it is working right when it leaves. I charge a little more, sure, but not *much* more; and there is no problem with explaining my guarantee and trying to siphon off more money from the customer when a callback does occur. The customer is happy because he's assured that he won't likely have to spend any more money for 90 days. Then, if he does phone in with a complaint, there is no hemming or hawing around. I just say I'll be there to

take care of it as soon as possible—and I do!"

Whether you choose to be this liberal is a matter of your own policy, of course, but it does point out that your guarantee *can* be more liberal if you do good service, charge a reasonable price for it, and count your callbacks as just another overhead expense.

Notice I said *count* your callbacks. Keep track of how much free work you would have to do (on the average) to permit a liberal guarantee policy. It may be less than you realize, and you wouldn't have to raise your regular service rates by any exorbitant amount to cover the cost of guarantee work. Don't forget the cost of replacing parts (other than those you replaced the first time) under such a guarantee.

Some shop owners prefer to use a "share-cost" type of warranty to take care of parts that were not replaced during a service job, but that subsequently go bad. Under this plan, the serviceman can guarantee the service labor and those parts which he had replaced, while the customer pays for any additional parts that fail during the normal guarantee period. This plan relieves the technician of responsibility for parts other than those for which he has been paid, and which carry the manufacturer's ordinary 90-day warranty.

## How to Write Your Guarantee

Unlike most other writing, a guarantee statement often suffers

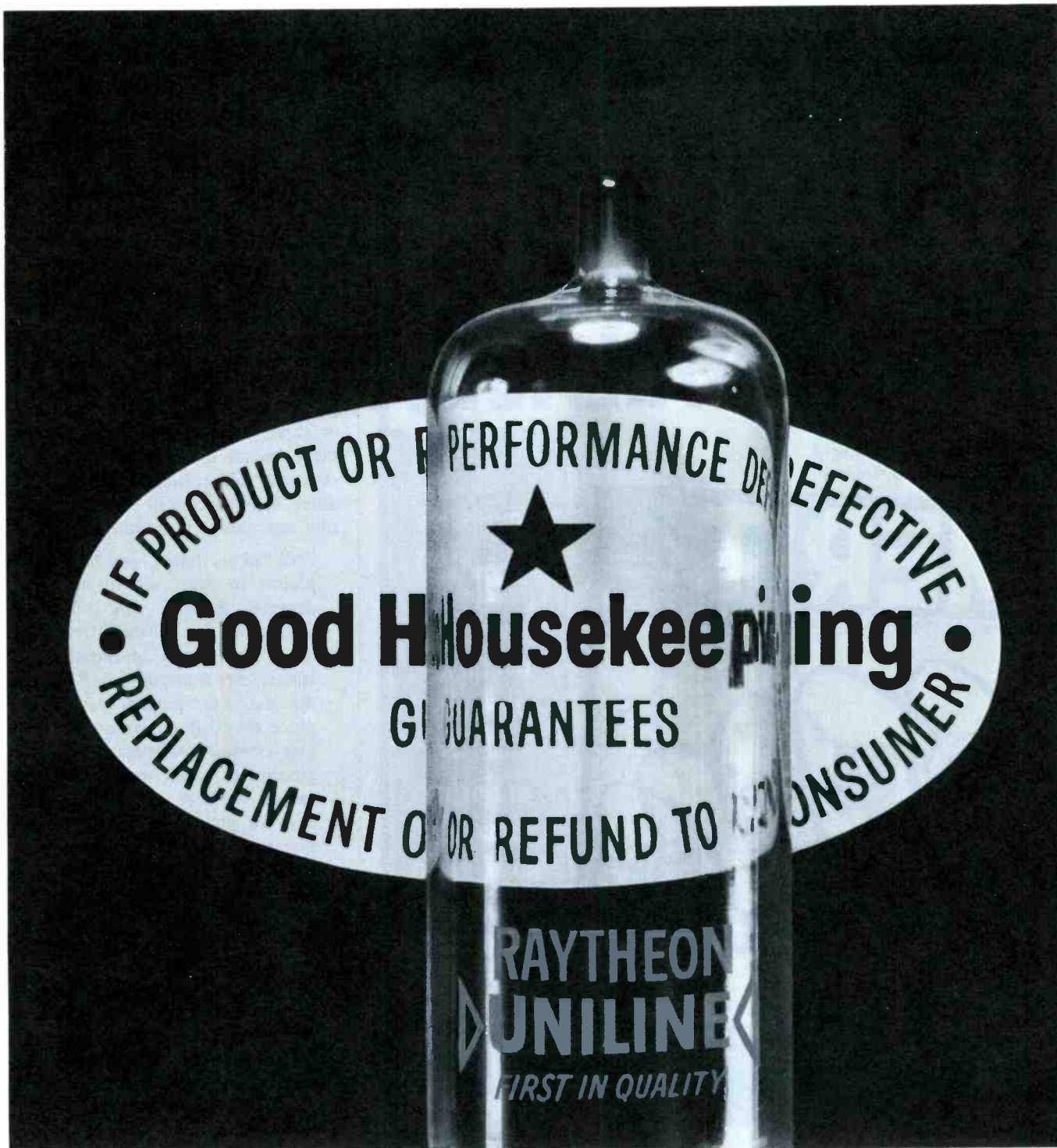

## trusted buy sign, profit's high sign

The Raytheon Receiving Tubes you install are specified by many well-known manufacturers of radio, TV sets, hi-fi, stereo and tape recording units. They are designed in because of proven dependable performance. (Raytheon Tubes are used in 23 of America's missile systems, where they've earned a top reputation for rugged reliability.)

Every Raytheon Tube—receiving and picture tubes—carries the famous Good Housekeeping Guaranty Seal, trusted buy sign of 40,930,000 American women. Your customers will appreciate you even more when you offer them this extra satisfaction Guaranty.

Result—customer loyalty that means more business.

**FREE** — *business-building Good Housekeeping Seal promotion material for your use. Mailed to you direct. Please write Raytheon, Distributor Products Division, Westwood, Massachusetts.*



# MERIT CATALOG NOW AVAILABLE

Most Complete Catalog &  
Replacement Guide

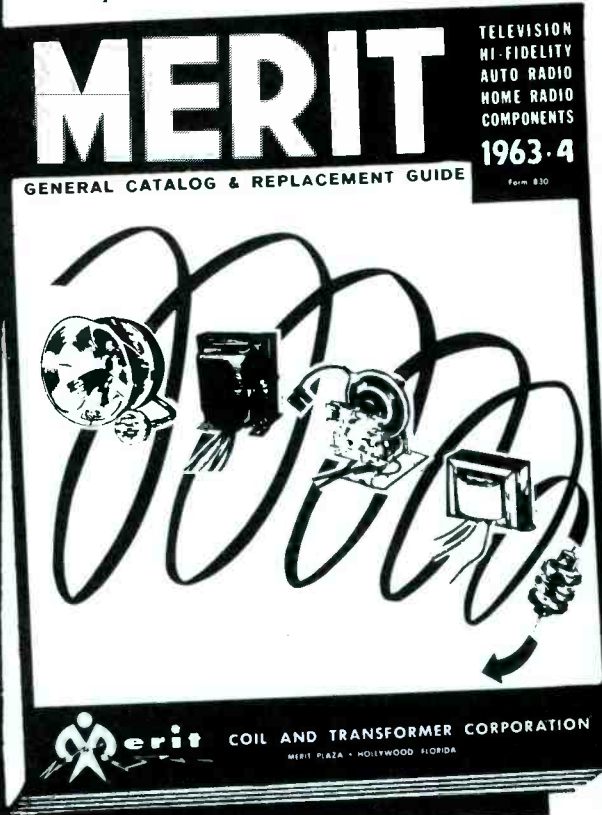

Form 830  
1963-64

COVERS ALL  
YOUR NEEDS  
FOR  
QUALITY  
ELECTRONIC  
COMPONENTS

• •  
HI-FIDELITY  
TELEVISION  
HOME RADIO  
AUTO RADIO  
RECORDERS  
P-A SYSTEMS

• •  
MINIMUM  
RETURNS

Order Your Merit Catalog & Replacement Guide Now.

Name \_\_\_\_\_ Position \_\_\_\_\_

Firm \_\_\_\_\_

Address \_\_\_\_\_

City \_\_\_\_\_ Zone \_\_\_\_\_ State \_\_\_\_\_

**MERIT COIL & TRANSFORMER CORPORATION**  
Merit Plaza Hollywood, Florida

from brevity. It should spell out the conditions of your guarantee in no uncertain terms! Once you have established a policy, *let the customer know about it.* Explain the situation even though the explanation might seem redundant to you. A statement like, "Parts not replaced not guaranteed," may seem ridiculous to you, but if that's your policy—say so! A simple guarantee like "Parts and labor guaranteed 90 days" might seem adequate to you, but to your customers, especially the tricky ones, this means you intend to fix the set no matter what happens during the 90 days. Spell it out—in two or three ways if you have to. Let there be no doubt as to what the customer can expect from his guarantee. One successful company uses this guarantee, in writing:

"All tubes, parts, and materials placed in your set by us, and charged for on this bill, are guaranteed for 90 days from this date. Should any of these parts, tubes, or materials fail within the guarantee period, we will replace them at no charge to you. For obvious reasons we cannot guarantee tubes, parts, or materials we did not replace, nor can we guarantee labor we did not perform. We do guarantee that the work described on this bill has restored your set to normal performance unless otherwise specified on this bill. Please notify us if your set does not perform properly. This guarantee does not cover damage resulting from accidents, abuse, or neglect on the part of anyone except the members of this firm, nor does it cover either parts or labor on repairs necessitated by the



"I'll bet Mrs. Smith will be surprised at the condition of her set when we deliver it!"



*...leave sooner—get there faster!*



*It's there in hours...and costs you less!*

	Buses Daily	Running Time	15 Lbs.	25 Lbs.	35 Lbs.*
BOSTON— NEW YORK	18	5 hrs. — min.	\$1.80	\$2.10	\$2.35
PITTSBURGH— CLEVELAND	14	2 hrs. 55 min.	1.60	1.85	2.15
CHICAGO— ST. LOUIS	8	6 hrs. 10 min.	1.90	2.15	2.45
LOS ANGELES— SAN DIEGO	38	2 hrs. 30 min.	1.25	1.45	1.70
CINCINNATI— LOUISVILLE	15	2 hrs. 40 min.	1.50	1.70	1.95

\* Other low rates up to 100 lbs.

Save time! Save money! Ease those inventory control problems too! Ship via Greyhound Package Express! Packages go everywhere Greyhound goes, on regular Greyhound buses. Very often they arrive the same day shipped. Ship nationwide, anytime... twenty-four hours a day, seven days a week, weekends and holidays. Ship C.O.D., Collect, Prepaid, or open a charge account. Insist on Greyhound Package Express. **It's there in hours... and costs you less.**

GREYHOUND PACKAGE EXPRESS, Dept. 52-R,  
140 S. Dearborn St., Chicago 3, Illinois

Please send, without cost or obligation, complete information on Greyhound Package Express service... including rates and routes.

NAME \_\_\_\_\_ TITLE \_\_\_\_\_

COMPANY \_\_\_\_\_

ADDRESS \_\_\_\_\_

CITY \_\_\_\_\_ STATE \_\_\_\_\_ PHONE \_\_\_\_\_

**CALL YOUR LOCAL GREYHOUND BUS TERMINAL  
OR MAIL THIS CONVENIENT COUPON TODAY**

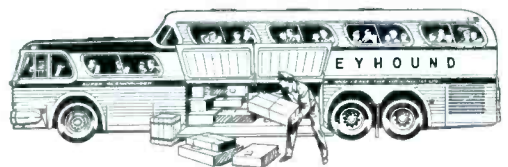



THINK FIRST OF  
**PHILCO**  
FOR QUALITY

### PHILCO QUALITY TESTED RECEIVING TUBES

A complete line of receiving tubes to fit any make, any model TV or radio, manufactured to exact Philco standards, thoroughly tested and each with the famous Philco "extra"—"satisfied customers".



### PHILCO FURNITURE POLISH

Make your customers smile with delight when you give their hi-fi or TV cabinet that "factory-fresh" look with Philco Furniture Polish. Specially created for your TV and radio, and other fine furniture. Gives a bright, glowing sheen impossible with ordinary waxes.



### PHILCO DELUXE HIDE-ANTENNA

Mounts on back of any television receiver. Telescopes out of sight when not in use. The best performing, trouble-free antenna available. Chrome finished. 39" elements fitted into Ivory plastic base. Spring-loaded pressure plate holds elements in positive position.



### POPULAR PRICED ANTENNA

Deluxe model "rabbit-ear" antenna with 3 sectional collapsible elements. Polished styrene base. Twin-X lead with open spade lugs for easy installation.



### PHILCO "8" BALL AUTO RADIO TOP COWL OR FENDER MOUNT ANTENNA

Excellent for general replacement as well as new installations. Triple chrome plating over brass. Adjusts to any angle up to 35°. Three sections telescope into 22" length, extend to 56". 54" loss lead, fully shielded.



### DEPEND ON YOUR PHILCO DISTRIBUTOR

Your one-stop-shopping center for all parts and accessories.



### PARTS & SERVICE OPERATIONS

**PHILCO**

A SUBSIDIARY OF *Ford Motor Company*

failure of parts not listed on this bill. Thank you."

This sort of wording clearly states the terms of the guarantee and should leave no doubt in the customer's mind as to what is and what is not covered. It states in two different ways that only the parts you installed and labor you performed are covered in the guarantee—an important point. A guarantee need not be drawn up in legal terms unless the firm is more interested in eluding than fulfilling its guarantee obligations. No guarantee is any better than the responsibility of the firm that offers it. A guarantee is an "act of faith" on the part of the company, and all companies—large and small—sometimes make adjustments exceeding their liabilities because of extenuating circumstances, or to keep a good customer. Remember that it nearly always costs less to keep a customer than to round up a new one.

### Stopping Price Squabbles

It is an axiom of selling that when you mention the price you should *not* stop talking. Mention it and proceed right into the advantages of what you're selling. Don't let the customer fix his mind so much on the price that he misses the values.

Say something like, "The bill is \$32.50, Mr. Jones, and I want you to note our guarantee here on the bill. Every part we had to replace is guaranteed for 90 days, and we'll replace it free should it fail. We have completely checked out your set's performance and made all the necessary adjustments. If you have any trouble, you just let us know and we'll be glad to take care of it for you." You can be more or less elaborate than this, and of course you must say it in your own words, but above all *you must mean what you say!* Your guarantee is a customer advantage that you can sell—use it!

### When You Get A Callback

When the customer calls back with a complaint, whether it is real or imagined, your fault or not, you can nearly always keep the customer happy with friendliness, diplomacy, and willingness to listen sympathetically. These will all come to you naturally if you have a genuine desire to please your customer. If you don't have this desire, you shouldn't be in business, and you're not likely to be for long.

Always offer prompt "servicing of your guarantee." Then go out and do it. The worst part of most callbacks is dreading them. Usually a problem is more than half solved when you start doing something about it. Don't let the customer's hysterical description of the trouble put water in your backbone—the trouble is almost sure to be less complex than the one described. Don't delay making a callback—make it even faster than you did the original call. Even the most obnoxious customer is often appeased by promptness.

In airlines, the pilot will nearly always announce to his passengers the reason for any delay, and it is remarkable how patient and understanding the passengers are; but let there be even a 10-minute delay with no effort on the part of the airlines to explain, and even the most tranquil passengers are fit to be tied. This psychology holds true for you, too, because it is basic to human nature. Sympathize with the customer, offer help, and then give it promptly, and you'll find the customer meeting you more than halfway.

I guarantee it.



*Every RCA Victor New Vista® TV uses  
Space Age Sealed Circuitry... extra  
dependable easy-to-service circuits that are...*

# more precise

*than old-fashioned all hand-wired circuitry!*



Old-fashioned all hand-wired Circuitry



Precision Crafted RCA  
Space Age Sealed Circuitry

Let your own TV  
service records  
prove the   
dependability  
of RCA Victor  
New Vista® TV

SEE WALT DISNEY'S "WONDERFUL WORLD OF COLOR" SUNDAYS, NBC-TV NETWORK



The Most Trusted Name in Electronics

TMK (s)®

May, 1963/PF REPORTER 63

# FOR SHARP, CLEAR 2-WAY COMMUNICATION

Fixed or mobile,  
business or pleasure  
Get the new, low-cost

## RCA MARK VIII

27-Mc Citizens Band Radio-Phone

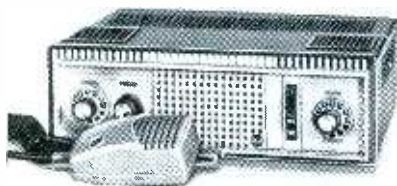

Here's the LOW-COST C-B radio-phone for car, boat, home, office, or shop. High sensitivity receiver pulls in weak signals. 2½ watt speaker output delivers ample volume to overcome engine noise. Automatic noise suppressor minimizes ignition interference. Light and compact—only 3½ inches high, weight only 9 pounds; fits easily under the dashboard of even compact cars.

### PLUS THESE PREMIUM FEATURES— RCA MARK VIII RADIO-PHONE

- 9 crystal-controlled transmit and receive channels
- Tunable receiver permits reception of all 23 C-B channels; dial marked in both channel numbers and frequency
- Exceptionally good voice reproduction—high intelligibility
- Excellent modulation characteristics
- Operates from standard 117-volt AC; separate 6- and 12-volt DC power supplies (optional) for mobile installations
- Electronic switching—no relay noise or chatter
- Illuminated "working channel" feature plus many more features to increase usefulness and efficiency.

AC Unit only **\$149.50\***

DC Power Supplies, Where Needed, \$19.95\*  
\*Optional list price



The Most Trusted Name  
in Electronics

MAIL COUPON FOR MORE INFORMATION

RCA Electron Tube Division  
Commercial Engineering Dept. E-33-R  
415 South Fifth Street, Harrison, N. J.  
Please send more information on the RCA  
Mark VII (1) 27-Mc 2-Way Radio-Phone.

Name \_\_\_\_\_

Address \_\_\_\_\_

City \_\_\_\_\_ Zone \_\_\_\_\_ State \_\_\_\_\_



# NOTES ON TEST EQUIPMENT

by Forest H. Belt

## Push-Button Color

A "new look" in test equipment is exemplified by the instrument shown in Fig. 1 — the Model 800 Color Bar-Dot Generator from Jackson. Its low, wide appearance adds to the prominence of the rows of push-button selector switches that dominate the front panel.

Specifications are:

1. Power Required—95-120 volts AC, 50-60 cps; 60 watts.
2. RF Output — Channel 3, 4, or 5 selected by rear-panel switch; unmodulated sound carrier displaced 4.5 mc from the video carrier.
3. Video Patterns — Convergence signals consisting of dots, 12 vertical lines, 14 horizontal lines, or crosshatch of 12 vertical and 14 horizontal lines; sync available at panel jack; video available at panel jack, with polarity controlled by panel switch and amplitude controlled by potentiometer.
4. Color Signals — Green, cyan, blue, B-Y, magenta, R-Y, red and yellow; signal phases all correspond to those on the NTSC color-phase wheel; each hue presented singly as a wide color



Fig. 1. Push buttons are distinctive features of this color-bar generator.

bar on color-TV screen.

5. Controls and Terminals—Row of twelve PATTERN-SELECTION push buttons; row of four FUNCTION-SELECTION push buttons; rotary GUN-KILLER switch; VIDEO-GAIN potentiometer; VIDEO (+ and -) slide switch; VIDEO, SYNC, COLOR DEMOD, GND pin jacks; CHANNEL SELECTOR slide switch (on

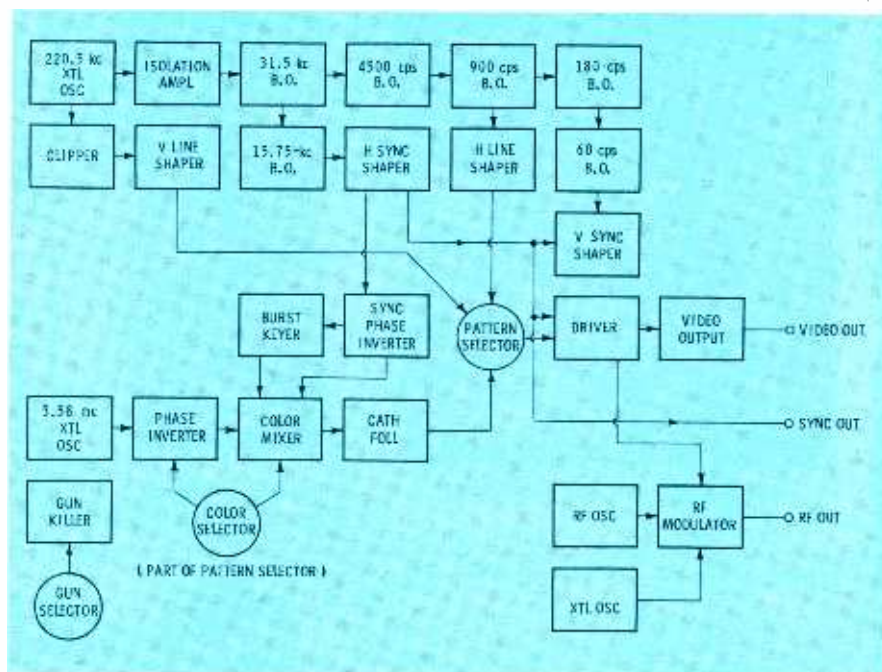

Fig. 2. Block layout shows interrelation of various sections of the unit.



## This is the 300 ohm Belden Weldohm they're ordering...

... Yes, it is strong ... it has one and a half times the breaking strength and two and a half times the flexing life of ordinary lead-in. Order No. 8230.

Here's the Belden microphone cable Butch is going to take along for the high school job ... No. 8410. It's abrasion and impact resistant. It's limp ... lies flat on the floor. It has long flex-life and high tensile strength.

Call your Belden jobber. He carries a complete line of lead-in cable ... also microphone and shielded power supply cables; hi-fi, stereo and phonograph cables; power supply cords; rubber-vinyl, multi-conductor portable cordage; antenna rotor cables; hook-up wire; TV and cheater cords; aluminum ground wire ... and related items. He has it all ... in stock.



### Be a Cartoon Gag Writer!

Win a \$25.00 Savings Bond



Send us your gag ideas for future cartoons. For each of your gag ideas our advertising manager uses, he'll send you a \$25.00 Savings Bond ... plus a Belden Gag Writer's Certificate. Write Belden Manufacturing Company, Att: Mrs. Madelsa Allison, 415 South Kilpatrick Avenue, Chicago 80, Illinois.

# TRANSISTORIZED CHARGER

MADE IN U.S.A.

## FOR WINTER-WEAK BATTERIES



• TO AC WALL OUTLET

• TO CIGAR LIGHTER

- MODEL NO. BC-6 FOR 6 VOLT
- MODEL NO. BC-12 FOR 12 VOLT

ONLY **\$280** DLR. NET

AT YOUR ELECTRONIC DISTRIBUTOR



### New **BERNS** Perfect Pin Crimper

#### Picture-Tube Repair Tool

Also for—5U4, 65N7, 6BQ6, etc.

Eliminates that hard soldering job

only \$1.25 each

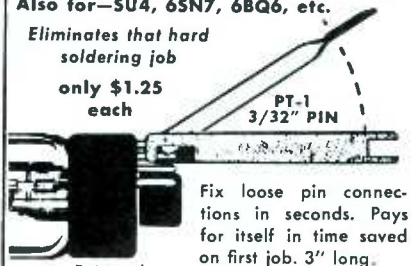

Fix loose pin connections in seconds. Pays for itself in time saved on first job. 3" long.

Patented

Intermittent operation of picture tubes due to defective solder connections easily corrected. Provides solid electrical connections, can also be used as channel-selector wrench and screwdriver. Pin keeps its original form. A 3-in-1 tool.

#### 3 MODELS ELIMINATE SOLDERING

#### Makes Solid Electrical Connections Phono Pin-Plug Crimper

Slip wire in "pin plug," insert in tool, and squeeze job is done.

AU-2 1/8" PIN

Use end of tool to push on C-ring for ground connection.

C-rings 1c ea.

Ant. plugs, hifi, multiple plugs, public address, radio and TV tubes, radar, speakers, and loop connections. Many, many more uses.

Model LC-3 for 5/32" pin diameter

At your parts distributor or write us



Mfg. Co.  
9853 Chalmers,  
Detroit 13, Mich.

rear panel); pilot lamp; four-lead gun-killer cable; three-lead RF output cable.

6. Size, Weight, Price—13½" x 4¾" x 9"; 12½ lbs; \$239.95.

The Model 800 is different from other color-bar generators in its use of push buttons for selecting the functions of the instrument, including power on-off. The faces of all the buttons are stamped with either the name of the function performed or a picture of the pattern (color or lines) produced by the signal being generated. This enables the user to see at a glance what presentation to expect on the screen of the television set being tested.

The unit furnishes all the patterns needed for making convergence adjustments to color sets, as well as the NTSC color-bar patterns for alignment of chroma sync and demodulator circuits. The R-Y and B-Y signals can be used for either the "solid-bar" or the "null" method of aligning color demodulators.

Fig. 2 shows the various stages of the instrument, and indicates how they work together to provide the several signals. The master oscillator is crystal-controlled at a frequency of 220.5 kc — different from the 189-kc circuit used in most dot-bar generators. Blocking-oscillator divider stages — controlled by the master oscillator — are used to deliver the precise frequencies needed for various functions of the unit. Shaper stages form the pulses necessary to develop sharp, clean lines; vertical lines are taken from the 220.5-kc oscillator, and horizontal lines are initiated by the 900-cps divider circuit.

Horizontal and vertical sync pulses are taken from 15,750-cps and 60-cps dividers, shaped, and fed to the driver stage for mixing with the composite pattern signal. The horizontal and vertical lines are mixed in the PATTERN-SELECTION switch according to the chosen pattern; dots are formed by developing a cross-hatch signal and clipping out the lines with a diode, leaving only the points of intersection.

The color-bar signal starts with the 3.58-mc crystal. The color phase is selected by the COLOR-SELECTION switch, which uses a phase-inverter stage and an LC delay-line arrangement to feed the chroma burst to the color mixer in correct phase to produce the desired color. A pulse from the horizontal sync shaper keys the color mixer, to form a color bar only one-half as wide as the raster; a phase inverter works with a diode delay arrangement to slow the start of the chroma burst, so the color bar will be in the center of the screen, with no color on either side.

The bar of chroma information is coupled through a cathode follower tube to the PATTERN-SELECTION switch, and then to the driver stage where it is mixed with the horizontal and vertical sync sig-



Fig. 3. Best way to push the buttons.

nals. From the driver, the composite signal is coupled through a video output stage to the VIDEO jack; a potentiometer controls the amount of video signal fed to the jack, and the setting of a slide switch determines the polarity.

The driver signal is coupled also to the RF modulator stage, where it is mixed with a television-channel signal from the RF oscillator. A 4.5-mc crystal oscillator, when actuated, provides a sound-carrier signal for testing 4.5-mc traps in color sets.

The Model 800 can be used with any color receiver simply by connecting the output cable to the set's antenna terminals and feeding the signal into an unused channel — 3, 4, or 5. If for some reason it is desirable to bypass the RF and IF circuits of the television receiver, you can clip a lead from the VIDEO jack to a point just past the video detector. This could be handy for testing the chroma stages without depending on the front end of the television set — a situation which often arises when you are asked to estimate the cost of overhauling a set.

We used the Model 800 on one of our lab receivers, and made several observations concerning its operation. Being unused to the push buttons, we encountered a bit of trouble with the instrument sliding across the smooth bench top as we pushed button after button, but we soon wised up and used the technique shown in Fig. 3; we simply placed a hand on top of the instrument with the thumb downward, pushed the buttons with the thumb, and had no further trouble.

The sync of the unit was stable, both horizontally and vertically, although we had to set the fine tuning of the receiver rather critically. This is not an uncommon experience in using dot-bar generators that haven't been calibrated with a station sync signal. (This calibration is not too difficult, although it is not recommended unless you are familiar with the use of your scope as a counting instrument. Directions for this procedure are included in the instruction manual which accompanies the Model 800.)

We found the sync output of the unit useful for stabilizing scope displays, especially when using the scope for de-

# JUST RIGHT...

## RTV

Exact replacement controls factory assembled, ready to install.

## Dual

Dual controls in field-assembled form. Meet all popular needs with few components.



## Standard Controls

The industry's longest line of wire-wound and carbon potentiometers.

# for fast, profitable servicing



## UNI-TITE

Field-assembled dual concentric combination controls. Easy, fast, positive assembly.



No compromises here — for all your servicing needs, get Clarostat replacement controls. Entire line is designed for the technician, providing the fastest, most convenient, and most profitable replacement for every need. See your Clarostat distributor, or write for catalog . . .

DISTRIBUTOR SALES DIVISION

# CLAROSTAT

CLAROSTAT MFG. CO., INC. DOVER, NEW HAMPSHIRE

## New Sonotone Sono-Flex<sup>®</sup> Stylus

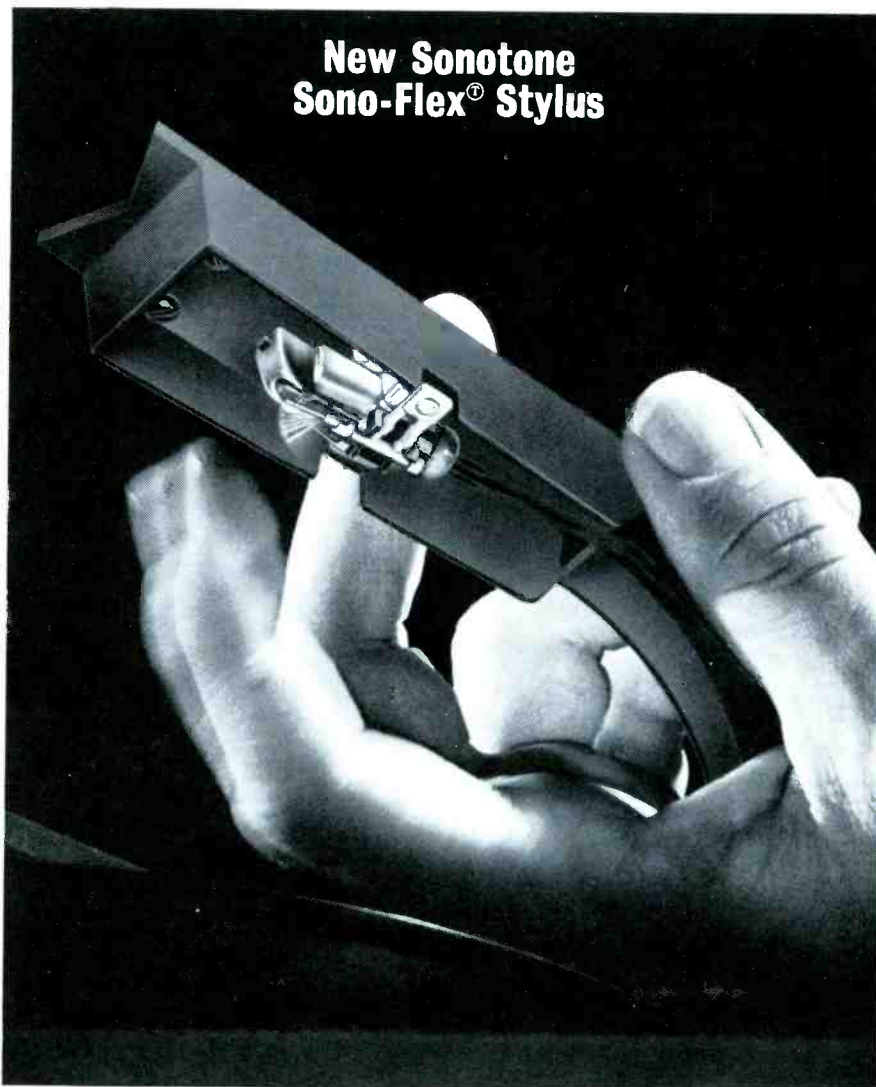

**try this with any other cartridge**  
(at your own risk)

No way to treat a cartridge, for sure—That is, any cartridge except the Sonotone models featuring the new Sono-Flex<sup>®</sup> needle. No more bent or broken needle shanks caused by flicking off some lint, dropping the arm, or scraping it across the record.

The newly developed Sonotone Sono-Flex<sup>®</sup> needle to the rescue! Gripped in a resilient butyl rubber mount, you can flex this needle shank in a 360-degree orbit without breaking. Pluck it—flick it—bend it—bump it—it will continue to perform as good as new.

Moreover, the Sono-Flex brings advantages in performance never before offered by any replacement cartridge: Higher compliance, wider and flatter frequency response, lower IM distortion, and longer needle and record life.

### Sonotone Sono-Flex<sup>®</sup> increases your profits two ways

☐ Sonotone cartridges are better than ever, easier to sell, because they're better performers. Further, you eliminate callbacks because of broken needle shanks. Sono-Flex needles are standard right now in these Sonotone cartridges models: 9TAF, 16TAF, 916TAF and the Velocitone Mark III.

☐ Sono-Flex opens up lucrative needle replacement business for upgrading these Sonotone cartridges models: 9T, 9TA, 9TV, 9TAV, 16T, 16TA, 16TAF and 916TA, original equipment in over a million phonographs. Replacement is fast, simple—requires no tools—assembly snaps into position easily, and gives immediate proof of better performance plus abuse-proof, longer needle life.

See your distributor today and ask for Sonotone cartridges with the Sono-Flex<sup>®</sup> needle.

**SONOTONE CORPORATION** Electronic Applications Division Elmsford, New York  
In Canada: Atlas Radio Corp., Ltd., Toronto • cartridges • speakers • batteries  
• microphones • electron tubes • tape heads • hearing aids • headphones

modulator adjustments. Means are provided for aligning the demodulators with or without a scope, but many experienced color-TV technicians prefer the scope method since it permits closer and more precise alignment. With the Model 800, it is not necessary to make separate scope connections to the various CRT grids, for the connections are already made via the gun-killer cable, and are automatically brought to the COLOR DEMOD jack on the panel of the instrument. By using this easy connection, and the B-Y and R-Y signals from the generator, aligning color demodulators is quite an uncomplicated procedure.

The top row of four push buttons includes one marked "Stand By"; in this position, the ground tap on the transformer secondary is opened, disabling the B+. Thus, the 800 can be left "idling" while connections and/or adjustments are made, without interference from the unit, while it remains ready for instant use whenever it is needed.

### DC Scope

DC scopes are becoming more popular, as service technicians discover the unique advantages of measuring DC and AC voltages simultaneously. A recent addition to this class of scopes is the Heath Model IO-10 DC Oscilloscope, pictured in Fig. 4.

Specifications are:

1. *Power Required*—105-125 volts AC; 50-60 cps; 100 watts.
2. *Vertical Amplifier*—Frequency response, within 2 db from DC to 200 kc; sensitivity, .1 volt peak to peak for 1/4" deflection; input loading, 3.6 megohms shunted by 35 mmf; coupling, AC or DC, selected by switch.
3. *Horizontal Amplifier*—identical with vertical amplifier; less than 5° phase shift between horizontal and vertical.
4. *Sweep Ranges*—From 5 cps to 50 kc, in four ranges; external capacitance

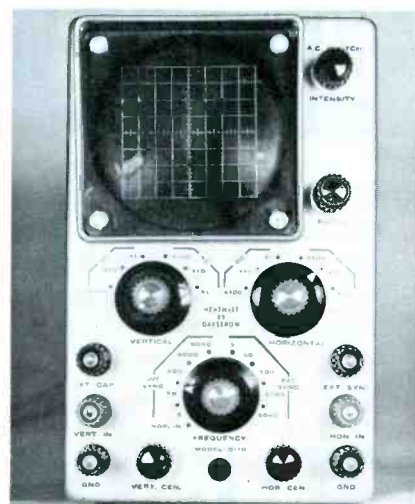

Fig. 4. DC scope features DC or AC operation and amplifiers exactly alike.



HOW TO CUT THE COST OF POWER TRANSISTORS—WITHOUT CUTTING CORNERS:

# simply say **Delco**

Now you can offer your customers inexpensive replacements for their Delco audio output transistor needs. The DS 520 and our new DS 525 can be used in place of the Delco DS 503 and DS 501 where low cost is a factor. Each of these low-priced transistors can produce 4 watts of output with top Delco reliability. They're ideal for the servicing of older car radios or for the experimenter or ham operator. The DS 520 and the new DS 525 will be a profitable addition to your basic line of Delco transistors: the DS 501 and DS 503 —to restore full power audio output in all Delco

Radios; the DS 25 and DS 26 to cover small signal needs in Delco and just about every other auto radio or small portable on the market. How's that for a complete line of transistors? Oh, you need application and cross reference charts too? Look in the package. They come with all Delco transistors. All are available now through your United Delco electronics parts distributor.

**Delco Radio** automotive radio service parts and electro-mechanical devices are distributed nationally through **United Delco.**

DELCO RADIO, Division of General Motors, Kokomo, Indiana



can be added for lower sweep rates; sync either internal or external, selected by switch.

5. Cathode-Ray Tube—3RP1, 3" face, green trace, medium persistence; covered by green graticule with cross-hatch design.
6. Controls and Terminals—Three rotary range switches for VERTICAL, HORIZONTAL, and FREQUENCY; three potentiometers (concentric with the rotary switches) for fine control of VERTICAL and HORIZONTAL gain, and FREQUENCY; VERT and HORIZ positioning controls; FOCUS and INTENSITY-AC OFF controls; pilot lamp; six binding posts: two for GROUND, one for EXT SYNC, one for EXT CAP, and one each for

HORIZ and VERT inputs.

7. Size, Weight, Price—7 $\frac{5}{8}$ " x 4 $\frac{5}{8}$ " x 11"; 12 $\frac{1}{2}$  lbs.; \$79.95, Kit.

The Model IO-10 is designed primarily for the industrial service technician. Its frequency response fits it best for use in testing all sorts of electronic switching systems, ultrasonic devices, and computer circuitry. The horizontal and vertical amplifiers are identical in this instrument, and the almost nonexistent phase shift between the two amplifier systems makes the Model IO-10 especially useful as a computer readout device or a phase checking instrument.

As shown in the diagram of Fig. 5, the Model IO-10 is characterized by two exactly identical horizontal and vertical

amplifiers. A frequency compensated six-step attenuator is used to couple the input signal to the first stage, which is a phase splitter. Three of the six attenuator steps connect the scope for DC operation, while the other three set up the scope for AC operation. The phase splitter divides the input signal for push-pull operation. The signal is then fed in push-pull form to the driver stage. In the driver stage, DC balancing networks are included to permit accurate DC and AC measurements at all signal levels. The amplified signal is then DC coupled to the grids of the push-pull output stages, which are in turn DC coupled to the CRT deflection plates.

The horizontal amplifier is identical to the vertical, except that a switch connection provides for inserting the sweep signal from the internal generator. Neither amplifier contains the frequency-peaking components commonly found in wide-band scopes, since the intended applications of the IO-10 eliminate the necessity for such wide response.

The sweep generator is the multivibrator type that is very common in modern oscilloscopes. The frequency of the sweep generator in the scope we examined extends well below the 5 cps marked on the frequency dial. The medium-persistence CRT used in this instrument seems best suited for sweep rates above 30 cps; we noticed quite a bit of flicker in traces scanned at lower sweep rates. However, such low sweep rates could prove a distinct advantage in several industrial operations, although a longer-persistence phosphor would make slow scan rates easier to use and analyze.

Synchronization for the sweep generator can be supplied externally or taken internally from a sample of the vertical input signal tapped off in the plate circuit of one of the push-pull driver stages. In fact, the horizontal FREQUENCY switch has nine positions; four of them encompass the sweep rates from 5 to 50 kc using external sync, four more cover the same sweep-frequency range using internal sync, and the ninth position disconnects the horizontal amplifier from the sweep generator and connects it to the horizontal input jack. The sync signal, whether internal or external, is fed to a cathode follower which isolates the sweep generator from any loading or detuning effects the sync source might have.

Another cathode follower prevents any

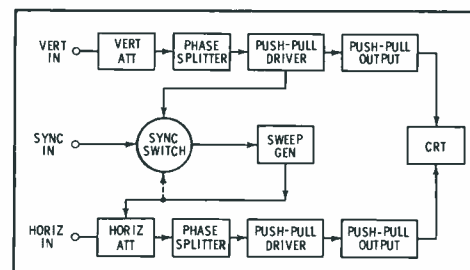

Fig. 5. Sync switch controls both the horizontal sweep frequency and sync.

# There are 2 Kinds of Radio-TV Servicemen-

Those who use  
**QUAM**  
replacement loudspeakers

Those who use  
other brands of  
replacement loudspeakers



We're proud to say that  
this group is bigger\*

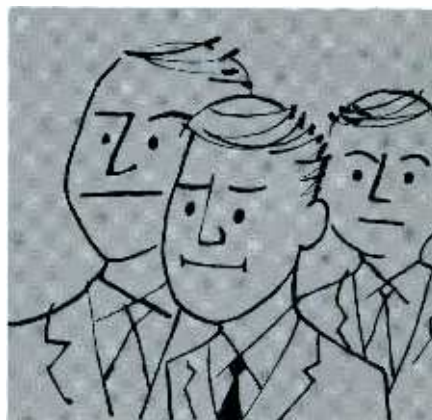

- \* According to the findings of Brand Name Surveys, Chicago, Illinois in March and April 1963, more servicemen prefer Quam speakers than all other replacement brands combined. Major reasons stated for the preference: Quality! Availability! Performance!

**QUAM-NICHOLS COMPANY**

234 E East Marquette Road, Chicago 37, Illinois



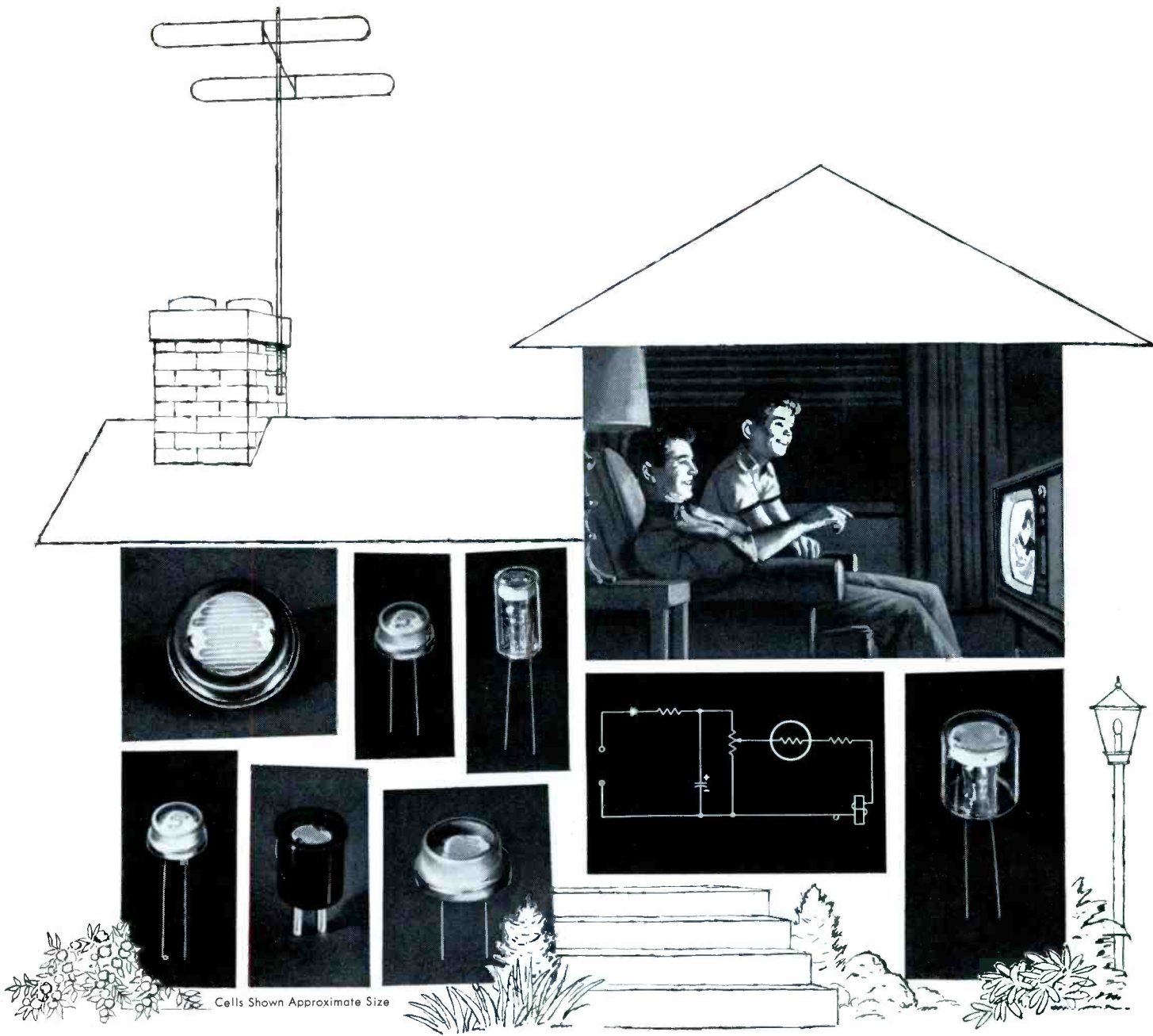

Cells Shown Approximate Size

# RCA PHOTOCELLS

An extremely wide choice for design or replacement

The RCA family of Photoconductive, Photojunction and Photovoltaic Cells is designed to provide a wide choice in electrical ratings, cell size and shape. It includes both glass and glass-metal types.

RCA's cadmium-sulfide Photoconductive Cell line is the widest in the industry.

Each RCA Photocell type meets the most exacting specifications and environmental demands... is characterized by high sensitivity, reliability, and long life.

RCA Photocells are in use in a wide range of light-operated control, switching, and measurement applications... have been adopted as a standard component by many leading manufacturers of business machines and home

appliances. RCA Photoconductive Cells are the sensor element in automatic door openers, pilot-flame monitors in home heating systems, light flashers, storage level indicators, home, industrial and municipal automatic lighting controls. RCA Photojunction Cells are used extensively for sound pick-up from film, and rapid reading of punched tape and cards. RCA Photovoltaic Cells find use in the direct conversion of solar power into electrical power and in light measuring units.

For proven reliability and performance, plus widest selection, specify and use RCA Photocells. For detailed information, the booklet, "Photocells and Circuits," ICE-261, is available from your RCA INDUSTRIAL TUBE DISTRIBUTOR.

RCA Type	Volts DC or Peak AC	Power Dissipation Watts		Photo-current (ma)	Volts	Illumination Foot Candles	Photocurrent (ma)	
		Contin-uous	Demand*				Min.	Max.
4403	250	0.3	0.75	50	50	1	7	16
4404	600	0.3	0.75	50	50	1	2.5	5
4448	600	0.3	0.75	50	50	1	1.5	4
4453	600	0.3	0.75	50	50	1	3	7
7163	600	0.3	0.75	50	50	1	1	3
4423	250	0.2	—	20	50	1	1.5	4
4424	110	0.2	—	50	12	1	3.6	14.5
4425	110	0.2	—	50	12	1	3.6	14.5
SQ2500	250	0.2	—	20	12	1	0.24	0.80
4402	200	0.05	—	5	12	10	1.6	—
4413	110	0.05	—	5	12	10	1.0	2.75
7412	200	0.05	—	1	12	1	0.065	0.275
7536	200	0.05	—	1	12	1	0.065	0.275
6694A	150	0.03	—	—	90	30	0.057	0.65

\*The demand rating may be utilized for a period of 20 minutes each time twice every 24 hours.

For name and address of your local RCA Industrial Tube Distributor write or call your nearest RCA Distributor Products Sales Office

NEW YORK, N. Y.: 36 W. 49th St., Murray Hill 9-7200  
 NEEDHAM HEIGHTS 94, MASS.: 80 "A" St., Hillcrest 4-8480  
 WASHINGTON 6, D. C.: 1725 "K" St., S.W., Federal 7-8500  
 ATLANTA, GA.: 134 Peachtree St., N.W., Jackson 4-7703  
 CLEVELAND, OHIO: 1621 Euclid Ave., Cherry 1-3450  
 CHICAGO, ILL.: Merchandise Mart, 467-5900  
 DALLAS 7, TEXAS: 7901 Carpenter Freeway, Melrose 1-3050  
 KANSAS CITY 14, MO.: 7711 State Line, Emerson 1-6462  
 LOS ANGELES 22, CAL.: 6801 E. Washington Blvd., Raymond 3-8361



The Most Trusted Name in Electronics

interaction between the sweep generator and the horizontal amplifier. This is necessary because the internal sweep signal is applied at the input of the horizontal attenuator, and without the cathode follower the attenuator components could affect the frequency of the sweep generator.

An interesting sidelight on the Model IO-10 is the availability of a sample sawtooth waveform taken from the internal sweep generator; this sawtooth waveform is connected to the EXT CAP binding post. Many service technicians are making use of ringing checks for testing all sorts of inductances (see "Ringing Checks for Coils" in the March issue), and one of the requirements is a signal

source—preferably a sawtooth—to shock-excite the inductance. The sweep ranges, and the vertical amplifier sensitivity and response, make the IO-10 useful for this test, with no modification whatsoever.

As in any DC scope, balancing is very important. In an instrument as sensitive as the Model IO-10, even the very slightest supply voltage variations can easily upset this balance and cause all sorts of erroneous readings, so two of the DC voltage supplies (Fig. 6) in the instrument are regulated. The -75 volt supply is regulated by an OC2 voltage regulator tube; a silicon diode serves as rectifier in this circuit. The 330-volt high B+ is rectified by a 6X4 vacuum-tube rectifier; a portion of this is applied to a divider

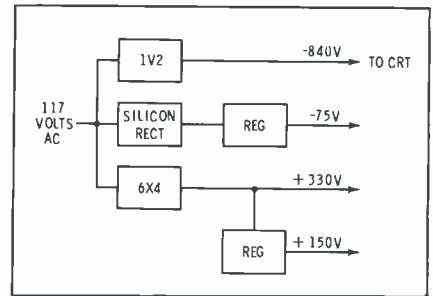

Fig. 6. Power supply partly regulated.

network and an OA2 voltage regulator, to provide a regulated B+ of 150 volts DC.

High voltage for the CRT is rectified by a 1V2 high voltage rectifier tube, and filtered by a pi-type filter network, developing nearly 850 volts of negative DC potential. The CRT voltage is negative with respect to ground so the beam-accelerating elements can be connected either to ground or to normal B+ voltages, simplifying circuit design.

One function of the Model IO-10 we found particularly useful was checking for phase shift within a stereo amplifier. Since the horizontal and vertical amplifiers are exactly alike, this check is very accurate. A sine-wave signal source is connected to the input of the stereo amplifier in such a way as to feed both channels in phase. To "calibrate" the scope, the signal is fed simultaneously into the scope's vertical and horizontal input jacks. The vertical and horizontal gain controls are adjusted for a small line crossing the center of the scope graticule at exactly 45°. We used the AC function of both scope amplifiers.

The overall phase shift between channels can be checked by connecting the scope to the respective outputs of the left and right stereo channels. Any difference in the two channels of the amplifier will reflect itself in a change in the "tilt" of the 45° sweep line on the scope. Balance of the stereo amplifier can be adjusted using this system as an indicator.

To locate the point where any unbalance might be occurring, merely start at the inputs of the two amplifier channels, and proceed testing stage by stage through both channels of the entire unit. When the line tilts, there is a difference in phase or gain in one of the amplifier channels, just prior to the point being checked. (It will be necessary, when checking stage by stage, to shift the attenuator switches of the scope as you progress to higher-level stages.) ▲

### now in our lab . . .

We're analyzing these test instruments for future "Notes" columns.

EICO Model 427 DC-AC Scope  
Electro Model EC-3 Power Supply  
G-C Model 36-568 Transistor Radio Troubleshooter  
Heath Model IM-30 Transistor Tester  
SENCORE Model CA122 Color Generator

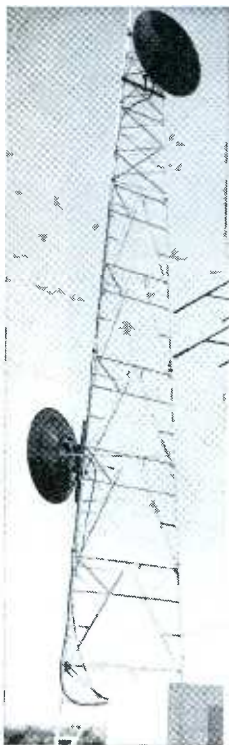

*The most Famous Name in*  
**TOWERS of ALL KINDS!**

**Here are the advantages you get when you insist on ROHN TOWERS**

**LARGEST FULL RANGE OF TOWERS**—you can get anything from home TV and amateur radio towers to heavy-duty communication and micro-wave towers. Included are 170 foot self-supporting towers, 1,000 foot guyed towers, and "fold-over" towers. Regardless of your needs, ROHN can supply it.

**UNQUESTIONED LEADERSHIP IN DESIGN AND MANUFACTURE**—you get the latest in advanced tower engineering. All communication towers are engineered to EIA specifications, and are proved by thousands of installations. No other manufacturer can surpass the quality and fine reputation of ROHN.

**QUALITY MATERIALS AND WORKMANSHIP**—Only highest quality steel is used which fully meets the specifications for the job. ROHN towers are hot-dipped galvanized **after fabrication**—a feature ROHN pioneered!

**SERVICE WHEREVER YOU WANT IT**—ROHN representatives are world-wide. Complete erection service for communication systems, broadcasting, micro-wave, and other needs is available; also competent engineering service to help you.

**Settle for the BEST in TOWERS**—ROHN—today the world's largest, exclusive manufacturer of towers of all kinds!

*For your needs, contact your local ROHN salesman, distributor or dealer; or write direct for information.*

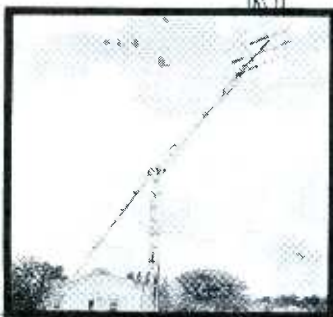

SEND THE HANDY COUPON INDICATING YOUR NEEDS

**ROHN**  
Manufacturing  
Company  
BOX 2000  
PEORIA, ILLINOIS

ROHN Manufacturing Company  
Box 2000  
Peoria, Illinois

Send me complete literature on the following ROHN Products:

- |   |  |
|---|--|
| <input type="checkbox"/> Home TV Towers       | <input type="checkbox"/> Amateur Towers            |
| <input type="checkbox"/> Communication Towers | <input type="checkbox"/> AM-FM Broadcasting Towers |
| <input type="checkbox"/> Micro-Wave Towers    | <input type="checkbox"/> Government                |

Name

Firm

Address

City  State

# NOW! PHOTOFACT®—BETTER THAN EVER—

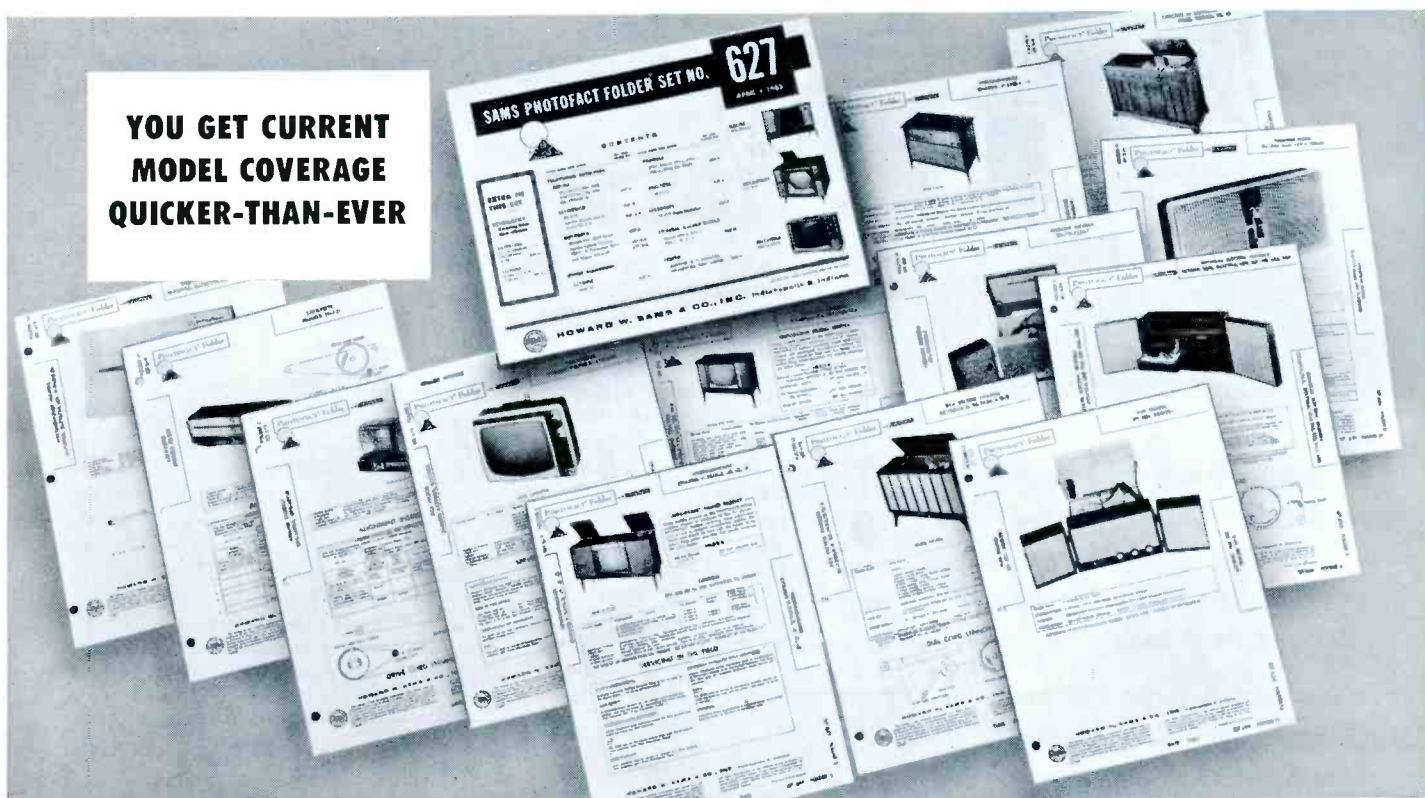

**YOU GET CURRENT  
MODEL COVERAGE  
QUICKER-THAN-EVER**

## Now! More TV Coverage in Every PHOTOFACT Set More coverage of the type of equipment you service most!

- MORE TV COVERAGE
- MORE AC-DC COVERAGE
- MORE AM-FM COVERAGE
- MORE HI-FI COMBINATIONS
- MORE RECORD CHANGER COVERAGE
- MORE PHONOGRAPH COVERAGE

**SEND  
COUPON**

### UP-TO-THE-MINUTE COVERAGE KEEPS YOU AHEAD

Here it is—beginning with April releases—quicker service data coverage for more of the kind of equipment you most frequently repair. And it's the same famous PHOTOFACT time-saving, troubleshooting help—*everything* you need to earn more daily. You get: Exclusive Standard Notation Schematics packed with all the service details you need; full photo coverage of all chassis views; complete replacement parts lists, tube placement diagrams; actual waveform photos; CircuiTrace® for printed boards; alternate tuner data; terminal identification and connections; disassembly instructions; field servicing notes; dial cord stringing diagrams—plus dozens of other great features. Take the *right* step to time-saving, profit-building servicing—see your Sams Distributor for details on an Easy-Buy PHOTOFACT Library and Standing Order Subscription—or send coupon today!

### HOWARD W. SAMS & CO., INC.

Howard W. Sams & Co., Inc., Dept. 7-E3  
4300 W. 62nd St., Indianapolis 6, Indiana

- Enter my Photofact Standing Order Subscription  
 Send full information on money-saving Easy-Buy Plan

My Distributor is: \_\_\_\_\_

Shop Name \_\_\_\_\_

Attn. \_\_\_\_\_

Address \_\_\_\_\_

City \_\_\_\_\_ Zone \_\_\_\_\_ State \_\_\_\_\_

**SAVE 30¢  
PER SET!**

**SIGN UP TODAY FOR A MONEY-SAVING  
PHOTOFACT STANDING ORDER SUBSCRIPTION!**

With a Standing Order Subscription to receive PHOTOFACT regularly each month as issued, you pay only \$1.95 per Set instead of the regular \$2.25 price. You save 30¢ per Set—and you keep right up with the rapidly-increasing current model output! You enjoy the same 30¢ per Set savings when you purchase an Easy-Buy PHOTOFACT Library. Take advantage of substantial savings—sign up for a Standing Order Subscription or Easy-Buy Library with your Sams Distributor, or send coupon now for full details.

**SAVE WITH A STANDING ORDER SUBSCRIPTION!**



There is no substitute for reliable service! Every **T&C II** has the extra built in feature of dependability. Everytime you switch on a Utica product, you tune in quality.

The deluxe **T&C II** features all the performance you could possibly want. Dual conversion 6 channel crystal controlled transceiver with tunable receiver. S meter and signal strength output indicator, external crystal socket, auxiliary speaker terminal and universal power supply are only a few of the many plus features that make **T&C II** a terrific buy at **only \$199.95**



**TOWN & COUNTRY MC-27 TRANSCEIVER**

Dual conversion 6 channel crystal controlled. Exceptional sensitivity and selectivity. Double Gated Noise Suppression circuit, AVC with improved squelch circuit. Universal power supply. Deluxe chrome cabinet. List Price 179.50

**UTICA COMMUNICATIONS CORP.**  
2917 W. IRVING PARK RD., CHICAGO 18, ILLINOIS

Please send complete literature.

Name \_\_\_\_\_

Address \_\_\_\_\_

City \_\_\_\_\_ State \_\_\_\_\_

**B**

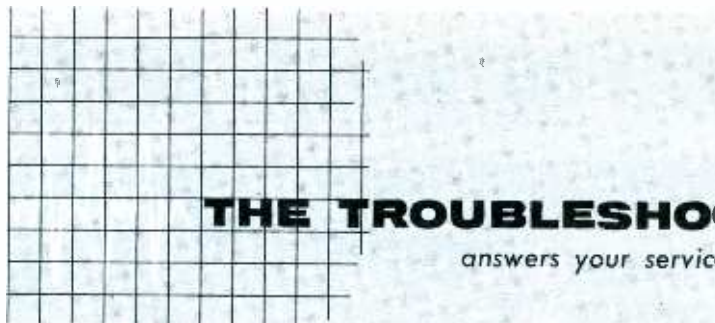

answers your service problems

### Flaming Flyback

Only 18 months ago, we replaced the original flyback in a Motorola Chassis TS-533 (PHOTOFACT Folder 316-10), which was overheating. This replacement recently caught fire—ruining itself, several tubes, and the customer's disposition. We installed another recommended replacement unit, but the same symptom of overheating in the small lower winding has developed again.

The set will operate for a period ranging from a few minutes to a whole evening. When it conks out, a vertical line remains on the screen, gradually shrinking to a height of 6" or 8". This would seem to indicate yoke trouble, but the yoke is apparently okay. All parts and

tubes in the flyback circuit are new except R105 and linearity coil L41, and these check good.

The 3/10-amp sweep fuse didn't blow when the flyback burned out — how come?

H. G. Cox

Garden City, Iowa

*L41 could have a defect that wasn't revealed by the test you made, or the associated .068-mfd capacitor could be faulty. The coil is very dependent on this capacitor for correct operation, and the value of the capacitor is extremely important. Substituting the coil-capacitor combination should be your next move.*

*A number of other defects, mostly hard-to-find intermittent conditions, could cause the flyback to overheat. A fairly common*

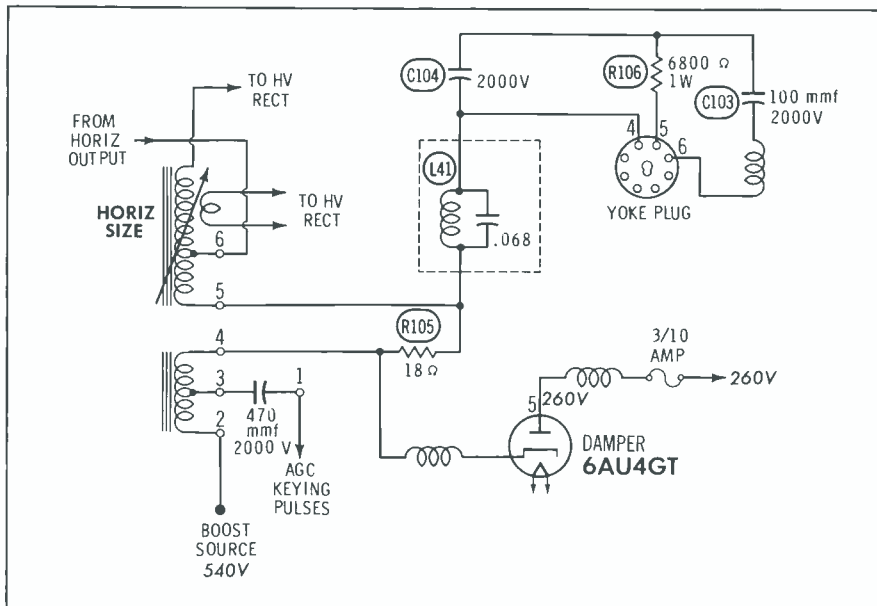

## PRECISION TUNER SERVICE

P. O. BOX 272      1200 S. WALNUT ST.  
BLOOMINGTON, IND.      EDISON 99653

# 7.50

V or U

**COMBO PLUS**  
9.95 POSTAGE

6 MONTH WARRANTY

All Types T.V. Tuners Cleaned, Repaired and Aligned to Factory Specifications. Same day in shop service on most Tuners. Price Includes Minor Parts, Major Parts at Cost Price. We use Original Parts if possible. State Make Model and Enclose all Parts and Tubes. Pack Well and Insure.

**ALSO HAVE LARGE STOCK OF EXCHANGE TUNERS. WRITE FOR TYPES AND PRICES.**

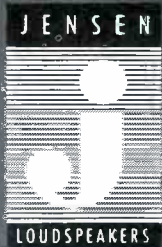

# LOW LISTS! LONG DEALER DISCOUNT! TOP DISTRIBUTOR PROFIT MARGIN!

No businessman in electronic parts distribution can afford to overlook the remarkable pricing and profit features that have been built into the new, broader, updated Viking Series of general purpose and replacement speakers by JENSEN.

This collection of fast-moving items has what it takes to deserve first place in your speaker marketing plans with the undisputed plus of the JENSEN reputation for quality and advanced design.

Low lists make your dealer's resale easier. New discount gives him a better margin YOU buy at lowest cost—and we can prove—that the highest profit percentage ever offered on a loudspeaker line.

Facts are facts. Ask your JENSEN representative about the new JENSEN Viking setup—or drop us a line at the factory.

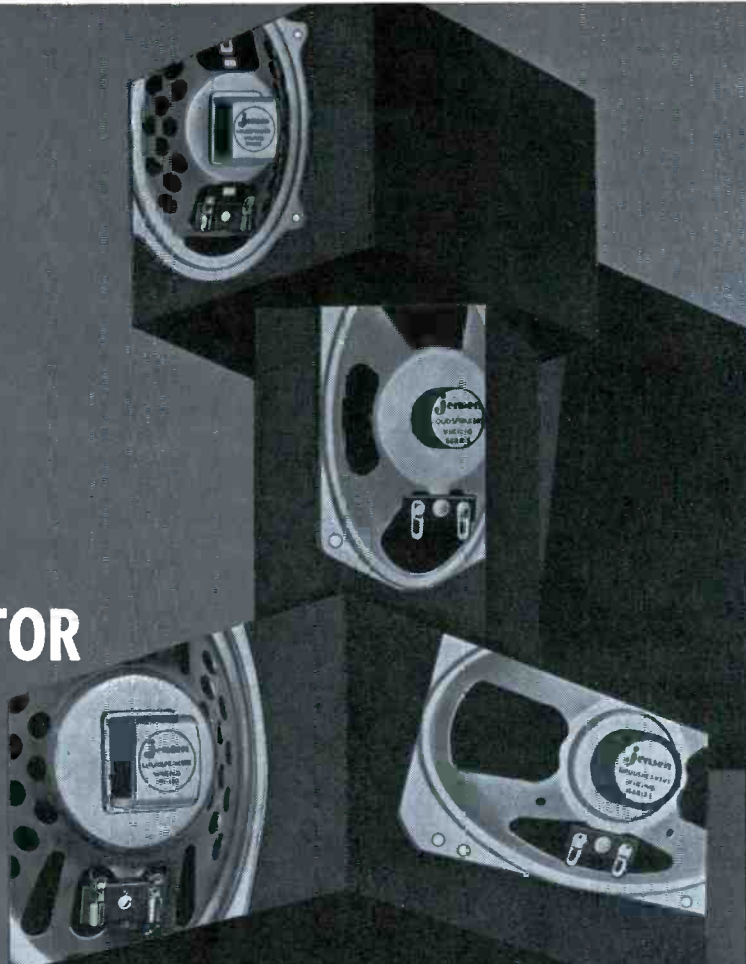

## NOW NEW OVALS!

All the popular oval sizes and impedances are now available in the new JENSEN Viking series of replacement and general purpose loudspeakers. You get them at the right prices . . . and best profit margin!



Nom. Size	Model No.	Magnet Wt. Oz.	Imped. Ohms	List Price
3	3K7	.68	3.2	\$ 3.80
3½	35K7	.68	3.2	3.80
4	4K5	.53	3.2	2.90
4	4K7	.68	3.2	3.55
5	5K5	.53	3.2	3.25
5	5K7	.68	3.2	3.85
5¼	525K7	.68	3.2	4.35
6	6K7	.68	3.2	4.35
7	7W3	1.00	3.2	6.55
7	7J9	1.47	3.2	6.65
8	8W3	1.00	3.2	5.85
8	8J9	1.47	3.2	6.90
10	10J10	1.73	3.2	9.00
12	12J10	1.73	3.2	10.50
3x5	3X5K5	.53	3.2	4.10
4x6	4X6K7	.68	3.2	4.80
4x8	4X8W9	1.00	8-10	6.00
4x10	4X10W9	1.00	8-10	6.50
5x7	5X7W3	1.00	3.2	5.35
5x7	5X7W9	1.00	8-10	5.35
5x7	57J9	1.47	3.2	5.40
6x9	6X9W3	1.00	3.2	5.95
6x9	6X9W9	1.00	8-10	5.95
6x9	69J9	1.47	3.2	6.40

JENSEN MANUFACTURING COMPANY/DIVISION OF THE WESTER COMPANY/3631 SOUTH LARAMIE AVENUE, CHICAGO 38, ILLINOIS  
Canada: Radio Speakers of Canada, Ltd., Toronto • Argentina: UCOA, S.A., Buenos Aires • Mexico: Fapa tel, S.A., Naucalpan, Mex

# NEW SAMS BOOKS

**JUST OUT! Enlarged 6th Edition of the famous Howard W. Sams Tube Substitution Handbook**  
 Still Biggest and Best—Over 1000 New Substitutions—New Section on Communications Tubes!  
 Still Only \$1.50!

Completely updated—now lists over 8,800 direct substitutions—over 1000 more than in Vol. 5! Expanded Receiving Tube Directory now includes over 2,100 types, listing 5,152 substitutions. Picture Tube Section lists 537 types, with 1,835 recommended substitutions. Other Sections list over 370 subminiature types with recommended substitutions, industrial and foreign substitutes for American receiving tubes, and American receiving tube substitutes for foreign types. A "must" for tube caddy and bench. 128 pages; 5½ x 8½". Order **TUB-6**, still only... **\$1.50**

## Amateur Radio Station Manual

Nothing else like it—a complete log book designed the way radio amateurs want it! Consists of 10 Sections, separated by heavy-stock index dividers, providing log sheets for entering complete information on all transmissions, frequently worked stations, operating records for WAS, WAC, WAZ, DX, special schedules, network data, and equipment. Includes complete prefix listings for countries all over the world. Generous log space permits entries for over 1,000 transmissions. 128 pages; 8½ x 11"; comb binding. Order **ASM-1**, only... **\$3.95**

## Practical TV Tuner Repairs

by Robert G. Middleton. Here, at last, is a "shirt-sleeves" book to help you solve those front end servicing troubles. Explains how you can quickly determine if a tuner is at fault; gives step-by-step procedures for isolating troubles to specific circuits and components. Illustrations and check charts guide you through preliminary analysis, test and measurement techniques, and practical repair and alignment procedures. Shows you how to evaluate test data, make complete tuner replacements, etc. 128 pages; 5½ x 8½". Order **TUN-1**, only... **\$2.50**

## Understanding Electronic Components

by Earl J. Waters. A basic understanding of components is the key to understanding electronics. This book thoroughly explains the physical structure and electronic principles, operation, and application of all major components. Chapters cover: Introduction to Electronic Theory; Resistors; Capacitors; Inductors; Transformers; Electron Tubes; Semiconductors; Transducers; Switches & Relays; Antennas; Conductors; Miscellaneous Components. 160 pages; 5½ x 8½". Order **UEC-1**, only... **\$2.95**

## Computer Circuit Projects You Can Build

by Lee Boschen. Beginning with a simple flip-flop circuit, this book details the construction of 13 basic computer-circuit projects. The theory and applications of each circuit are fully explained. The end result is a working knowledge of fundamental computer circuitry found in modern digital or analog types, as well as the construction of useful devices. Each chapter explains the use of the circuit in a computer, its operation, and how to construct it. 128 pages; 5½ x 8½". Order **BOC-1**, only... **\$2.95**

## ABC's of Electricity

Another of the famous SAMS basic books for beginners. Explains in simple terms the nature of electricity, its characteristics, effects and "how it works." Describes simple battery circuits, explains Ohm's Law, electro-magnetism, development of alternating current, conductors and insulators, electrical components, etc. Complete; easily understandable. 96 pages; 5½ x 8½". Order **LEK-1**, only... **\$1.95**

## Electronics Data Handbook

A valuable selection of articles from *Aerovox Research Worker*, offering technical information of vital interest to technicians, engineers, experimenters, and students. Subject areas include: Receiver circuits, components, tests and measurements; circuits for specialized design applications. Special section on filter design includes a 9-part series covering constant-K and M-derived circuits. 128 pages; 8½ x 11". Order **ERA-3**, only... **\$2.95**

## HOWARD W. SAMS & CO., INC.

Order from your Sams Distributor today, or mail to Howard W. Sams & Co., Inc., Dept. E-33, 4300 W. 62nd Street, Indianapolis 6, Ind.

Send me the following books:

TUB-6     TUN-1     BOC-1     ERA-3  
 ASM-1     UEC-1     LEK-1

\$\_\_\_\_\_ enclosed.  Send FREE Booklist

Name \_\_\_\_\_

Address \_\_\_\_\_

City \_\_\_\_\_ Zone \_\_\_\_\_ State \_\_\_\_\_

IN CANADA: A. C. Simmonds & Sons, Ltd., Toronto 7

trouble in this type of transformer is a short between one of the windings and the frame, and there's a possibility this same trouble has recurred in both replacement units. Trouble in the yoke circuit, such as a short in C103 or C104, might also be causing your problem. If the yoke has a high-resistance leakage to its core, it might cause the overheating without necessarily having too great an effect on the picture.

By all means, be very sure screen resistor R104 in the output stage is in good condition, and double-check the drive signal at the output-tube grid. Also investigate the possibility of a short or leakage causing a current overload on the boost line. The flyback failure is probably due to excessive circulating current in the

sweep system, without overloading the B+ supply; that's why the fuse didn't blow.

## Sync Cuts Loose

A General Electric Model 17T026 (PHOTOFAC Folder 342-7) plays normally until a station break occurs; then the picture falls out of sync. Since I suspect AGC trouble, I've checked and monitored the AGC line; in addition, I've replaced the IF tubes and checked all the way through the picture and sync circuits, but can find nothing abnormal.

WILLIAM L. SECOR

Indianapolis, Ind.

You have the right idea in checking for AGC or video trouble, since the

## COLOR COUNTERMEASURES

Symptoms and service tips from actual shop experience

Chassis: Zenith 29JC20, 27KC20

Symptoms: High-voltage corona arcing around bell of picture tube; loud crackling and popping noise.

Tip: The first thing to do, when these symptoms appear, is to replace the 6BK4 regulator. You should also replace the 3A3 high-voltage rectifier. This condition is usually caused by an inoperative regulator tube, permitting the high voltage to increase in value—to as high as 30 kv. The same fault could occur if some defect developed in the regulator circuit—necessitating shop repairs. Whatever the cure, check and reset the high-voltage adjustments—output current, regulator current, and high voltage—to insure the circuits are operating within their limits.

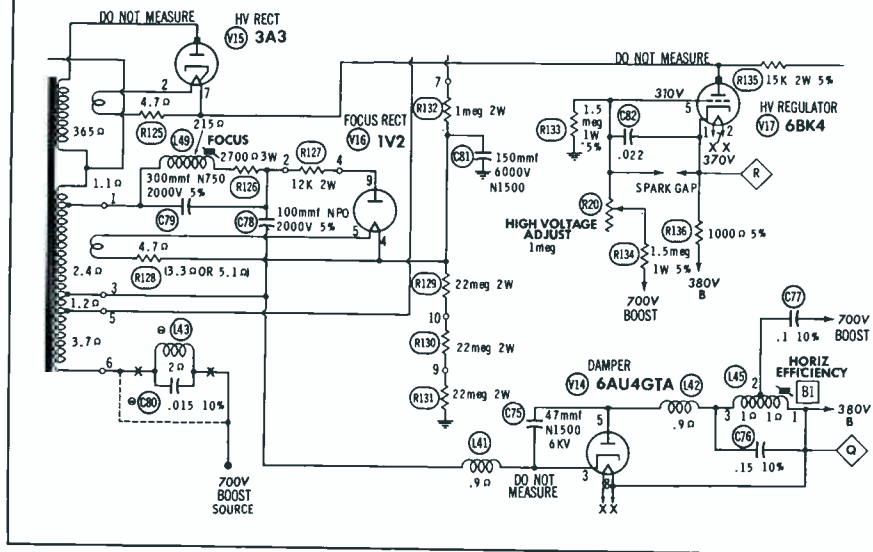

## Latest Jackson Tube Test Data

Model 648					Model 658											
Tube Type	Fil.	D.	E.	Plate Test	Tube Type	Sec.	Heater	H-K	Plate	Grid Test	Heater Current					
6BD11♦	6.3	AC6	179	35V	P	6.4L	C6	178	22R	10WY•						
		Nor. -S switch in S position										T	C9	ac 40	26Q	10WY•
		AC9	AC48	67V								T	C5	ac 23	24Q	15WY•
		C5	AC23	80V												
6BJ3♦	6.3	C5	3	14W	6BJ3♦	D	6.4L	C5	3	18U	V					
6GV5♦	6.3	AC3	126	30VW	6GV5♦	P	6.4L	C3	126	10Q	95VY•					
Connect top cap to octal socket pin 2					Connect top cap to octal socket pin 2											
6HB5♦	6.3	AC3	AB125	22Z	6HB5♦	P	6.4M	C3	ab 125	15R	85VY•					
6HF5♦	6.3	AC3	126	15W	6HF5♦	P	8.5E	C3	126	17R	95VY•					
Connect top cap to octal socket pin 2					Connect top cap to octal socket pin 2											

SUPPLEMENT TO LATEST ROLL CHART 648-27

658-6

# powerful and portable



**POWERFUL**—5-watts, 5-channel crystal-controlled channels, 100% all-transistor, the Cadre series of transceivers can be used in any vehicle, boat or office. They deliver sharp, clear reception over the greatest transmission range possible in the 27 mc citizens band. Five fixed crystal-controlled channels spell accurate, fast communication contact. Sensitive dual superheterodyne circuit responds to weakest signals. Tuned ceramic filters increase selectivity. Reception is clear, free of noise—automatic noise limiter defeats ignition noise; adjustable squelch eliminates annoying background signals. Extended range AGC provides uniform audio output. Solid state circuitry throughout means no heat problems, no tubes to burn out, ability to withstand vibration and shock, negligible current drain, compact size.

**Four Cadre 5 watt, 5-channel models—one is best for your CB application.** CADRE '515'—AC/DC transceiver can be used anywhere. \$194.50

CADRE '510'—AC/DC unit. Offers 23 channel manual tuning. \$209.95

**NEW!** CADRE '520'—DC only with DC power cord and mounting kit—ideal for mobile and portable use—operates from 12 volt auto battery or special battery pack. \$187.50

**NEW!** CADRE '525'—for complete field portability. Standard AC cord permits recharging of two built-in nickel-cadmium batteries, telescoping antenna, aluminum carrying handle. \$269.95

**PORTABLE**—Power is only a part of the story with Cadre transceivers. These units go anywhere—operate anywhere. An optional accessory, (Cadre 500-1 Portable Pack) adapts Cadre 510, 515 and 520 for field use. The Portable Pack is a lightweight case which contains rechargeable battery supply (two 500-2 nickel cadmium 6-volt batteries). These units can be used for base or mobile application as well as in the field. Cadre 5-watt models in the Portable Pack weigh less than 9 lbs. Cadre 500-1, \$29.95, Cadre 500-2, \$10.95.

For the finest CB transmission anywhere, rely on Cadre. For literature write:

## 4 CADRE 5-WATT, ALL TRANSISTOR CB RADIOS



**CADRE INDUSTRIES CORP.** □ COMMERCIAL PRODUCTS DIVISION □ ENDICOTT, NEW YORK □ AREA CODE 607, 748-3373  
Canada: Tri-Tel Assoc., Ltd., 81 Sheppard Ave. West, Willowdale, Ont. Export: Mo-han Exporting Corp., 485 Broadway, New York 13, N. Y.

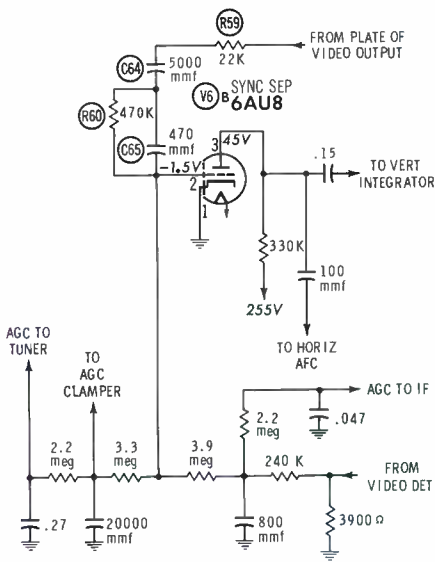

simple sync circuit in this receiver is sensitive to distortion in the input signal. The most conclusive isolation test you can make is to check the appearance of the vertical blanking bar in the picture when the trouble occurs, as described in "Speaking of Stable Sync" on page 30 of the June, 1962 PF REPORTER. Better yet, monitor the video-output waveform with a scope. Whether or not distortion is noted, substitution of R59, C64, C65, and R60 would be advisable. Trouble in these components can cause insufficient DC bias or distortion of the signal at the sync-separator grid; these faults not only will interfere with the operation of the separator, but also may result in reduced or poorly filtered AGC voltage.

### Deflated Vertical

A Sylvania Model 21C407 (PHOTOFACT Folder 389-4) had no vertical sweep—just a white line across the screen. A short was found in the vertical multivibrator-output tube; when a replacement was installed, the raster was still only 2" or 3" high. Tuning the set to an unused channel restored full vertical sweep, but when the tuner was switched back to an occupied channel, the raster collapsed again to a height of only a few inches.

Bench tests disclosed that R62, a 1.2-meg resistor, had increased in value to

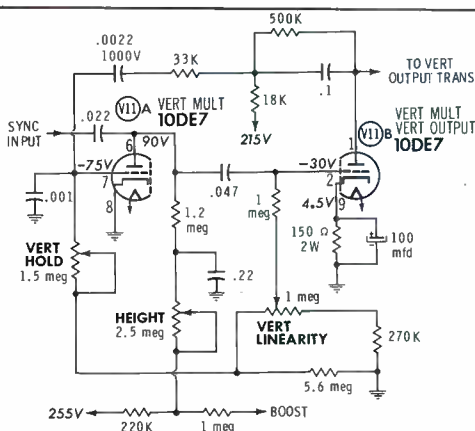

about 4 megohms—probably because of the short in the tube. With this defect present, the circuit could produce normal sweep as long as it was free-running, but not when a sync signal was applied.

DON DUDLEY

Fond du Lac, Wis.

Thanks, Don, for sharing your unusual experience with us. Here's a probable explanation for why the circuit acted as it did: With R62 greatly increased in value, the drive signal developed for the output-tube grid would build up more slowly than normal to a positive peak. This would affect the feedback from the output stage to the grid of V11A in such a way as to delay the start of the next cycle. (Remember, the feedback circuit, as well as the

hold-control circuit, has considerable influence on operating frequency in this type of multivibrator.) Probably the free-running frequency of the circuit was considerably below the normal 60 cps.

Incoming sync pulses, amplified by V11B and fed back to the grid of V11A, forced the multivibrator to speed up to 60 cps. Because of the abnormally slow charging of the RC network including R62, the resulting drive waveform was too weak to produce more than a few inches of vertical sweep.

### Sing Along With . . .

I have a Model 21C3Z Admiral (PHOTOFACT Folder 275-2) with a B+ overload, no high voltage, and a singing flyback transformer. A meter connected

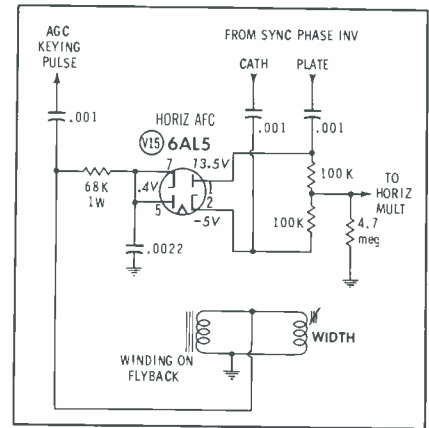

in place of the 3/8-amp sweep fuse indicates excessive current in the horizontal output stage. The drive waveform at the grid of the horizontal output tube is okay when I pull this tube. With the tube in the socket, however, I can barely make out this waveform, and can't even come close to locking it in on my scope. I've replaced the yoke, flyback, boost capacitors, and all the resistors in the output and damper stages; what should I do next?

JOE A. DUERRINGER

Toledo, Ohio

The "singing" flyback, and your inability to get a normal waveform at the grid of the horizontal output tube, both indicate the horizontal-multivibrator frequency is much too low. This isn't the multivibrator's fault, because the drive waveform is normal when the output tube is disabled. Apparently, the multivibrator is being thrown off frequency by faulty AFC action; this could be caused either by trouble in the AFC phase-detector stage itself, or by faulty feedback from the width-coil winding of the flyback transformer. Check for any condition, including a wiring error, which might unbalance the phase detector. To speed up troubleshooting, you can pull the AFC tube; this should restore normal horizontal sweep and allow you to check the quality of the sawtooth signal being fed back from the width coil to the AFC stage.

### LC Probe Attenuation

My scope is equipped with a jack that supplies a reference signal of 6.3 volts rms (18 volts peak to peak). To use this source in calibrating waveforms taken with my low-capacitance probe, would it be advisable for me to set up the calibration using a direct probe, and then deduct the 10:1 attenuation factor of the LC probe? Or is it practical to feed the calibrating waveform to the scope's vertical input through the LC unit, and use no attenuation factor? I'd also like to know of some other handy sources of, various AC voltages that I can use to calibrate the scope for higher peak-to-peak readings.

ROBERT GOLDSTEIN

Brooklyn, N.Y.

If you use the low-capacitance probe for all measurements, you might just as

# Model 301 COMBINATION TESTER

**NEW**

**3 INSTRUMENTS IN 1**

**1**

**TUBE TESTER**

**2**

**CRT TESTER-REACTIVATOR**

**3**

**V. O. M.**

**20,000 OHMS PER VOLT**

only **\$10975**

Slightly higher in the West

**TUBE TESTER SECTION . . .** will test cathode emission, inter-element leakage and gas content of all present tube types and new tube types . . . NUVIATORS, COMPACTRONS, NOVARS, 10-PIN TUBES, battery type tubes, auto radio hybrid tubes, voltage regulators, foreign and hi-fi tubes, thyatronns and most industrial tube types • Advanced heater pin switching feature overcomes obsolescence caused by the introduction of new base pin arrangements.

**CRT TESTER-REACTIVATOR SECTION . . .** will test, repair and reactivate all black and white and all color picture tubes • Checks for shorts, leakage and emission • Eliminates inter-element leakage and shorts • Restores emission and brightness with a specially designed high voltage pulse • Exclusive feature enables you to watch the reactivation on the meter as it takes place — eliminating the possibility of over-activation • Provides correct filament voltages including the 2.35 and 8.4 volt types.

**VOM SECTION . . .** sensitivity is 20,000 ohms per volt/DC . . . 5000 ohms per volt/AC • **6 DC Voltage Ranges:** 0-15/75/150/300/750/1500 volts • **6 AC Voltage Ranges:** 0-15/75/150/300/750/1500 volts • **3 Ohms Ranges:** 0-1000/100,000/10 megohms (10 ohms center scale) • **5 DC Current Ranges:** 0-75  $\mu$ a/7.5 ma/75 ma./750 ma./15 amps. • **2 Capacity Ranges:** .001-15/.1-80 mfd.

See your electronics parts distributor or write for complete literature

**Mercury ELECTRONICS CORPORATION**

manufacturers of quality electronic products

111 Roosevelt Avenue, Mineola, New York



well apply the calibrating waveform to the scope through the probe, and thus eliminate the need for figuring in an attenuation factor. If you frequently switch back and forth from a low-capacitance to a direct probe, it would be better to make your initial calibration by use of the latter. Then, for all waveforms taken with an LC probe, the apparent amplitude should be multiplied by 10 to obtain the actual value.

You can extend the calibrating range of the 18-volt waveform simply by careful choice of vertical-attenuator switch settings. I'd recommend using the x10 scale, and letting the 18 volts peak to peak equal 18 squares or marks on the CRT graticule. Then a waveform of the same height would be produced by a 1.8-volt signal on the x1 setting, or by a 180-volt signal on the x100 scale. Actually, you would be setting up a ratio whereby each division on the graticule would be equal to .1, 1, or 10 volts, depending on the switch setting used; this simple arrangement would allow quick and easy measurements of all signals from less than a volt to over 200 volts.

If you want unusually precise measurements of signals, coupled with the freedom to calibrate with any signal amplitude, I'd recommend an external scope-calibration unit. This piece of equipment provides a continuously variable voltage of known amplitude over a range from less than 1 volt to more than 100 volts.

### Off Again, On Again

An Olympic Model KD119 (PHOTOFACT Folder 397-2) occasionally fails to develop high voltage; sometimes it goes dark after playing awhile, and must be turned off and back on again to bring back the high voltage. Twice, I attempted to check voltages, but the high voltage returned to normal as soon as I touched the probe to the horizontal output grid. Have you any idea how I can fix this trouble?

ABE PUMPER

Brooklyn, N. Y.

Apparently, the horizontal multivibrator is stopping, and making the test connection shocks it into operation. Try connecting your scope or VTVM to the horizontal output grid before you turn the set on; then, when the symptom appears, you can quickly determine whether the fault is in the multivibrator or in the output stage. If the trouble is a slow-starting multivibrator, carefully check component

values in that stage. Be especially critical of R82, R87, R106, C64, and C66.

### Critical Leakage

In servicing an Olympic Model 1CB72 (PHOTOFACT Folder 365-10) which had quite a few faults, I ended up with insufficient width and only 9.5 kv on the HV anode. The drive signal applied to the horizontal output tube appeared slightly weak, so I tried troubleshooting the grid circuit. The input coupling capacitor showed the correct value (.001 mfd) and no leakage when I tested it on a capacitor checker; but just to be sure, I replaced it anyway. The width increased, and high voltage went up to 13 kv. Can you explain what might have

been wrong with this capacitor?

R. E. FERGUSON

Wolf Point, Mont.

There could have been a poor solder joint which you corrected in the process of checking, or perhaps your capacitor checker doesn't apply sufficient voltage in the leakage test to show up a breakdown that occurs in actual operation. Since this capacitor is continually subjected to high pulse voltages, it can develop defects that will cause malfunctioning of this circuit, even though it can still pass a conventional DC leakage test. When you have suspicions about a capacitor in a critical spot such as this, the most conclusive test you can make is to substitute a known good part. ▲

## Model 501 COMPONENT SUBSTITUTOR

...places a complete range of components at your fingertips

NEW



for fast substitution

only  
**\$3750**

Slightly higher in the West

All hand wired ...  
All American made

**Will substitute up to 4 different components at the same time**

**A surge protector switch prevents arcing, sparking, or heating of electrolytics**

**Electrolytics are discharged automatically**

The Model 501 provides all the substitutes for electronic components you want and need in your every day work ... more than any other instrument of its type. No longer do you have to handle hard-to-manipulate crumpled parts ... solder and unsolder components as you trouble shoot a set. With a twist of a knob and a flip of a switch you can set the 501 to any one of over 80 component values ... substituting as many as four different components simultaneously. Smart, sturdy grey hammertone steel housing ... handy storage compartment accommodates the insulated test leads provided with the instrument. Size: 10" wide x 6 1/4" high x 4 1/2" deep.

### SUBSTITUTES FOR:

**CARBON RESISTORS**  
 12 VALUES 1 watt: 10/18/33/56/100/180/330/560/1000/1800/3300/5600 ohms  
 12 VALUES 1/2 watt: 10,000/18,000/33,000/56,000/100,000/180,000/330,000/560,000/1,000,000/1,800,000/3,300,000/5,600,000 ohms

**POWER RESISTORS (20 watt Wire Wound)**  
 20 VALUES: 2.5/5/7.5/10/15/25/50/75/100/150/250/500/750/1,000/1,500/2,500/5,000/7,500/10,000/15,000 ohms

**CAPACITORS (600 volts)**  
 12 VALUES: .0001/.0005/.001/.0025/.005/.01/.015/.02/.05/.1/.22/.5 mfd.

**ELECTROLYTICS (450 volts)**  
 17 VALUES: 4/8/10/12/14/18/20/28/30/40/50/70/80/130/150/200/230 mfd.

**RECTIFIERS (Universal)**  
 CRYSTAL DIODES—all general purpose low voltage types  
 SELENIUM POWER RECTIFIERS—up to 500 ma., 800 PIV  
 SILICON POWER RECTIFIERS—up to 750 ma., 800 PIV

See your electronics parts distributor or write for complete literature



**MERCURY ELECTRONICS CORPORATION**  
 manufacturers of quality electronic products

111 Roosevelt Avenue, Mineola, New York

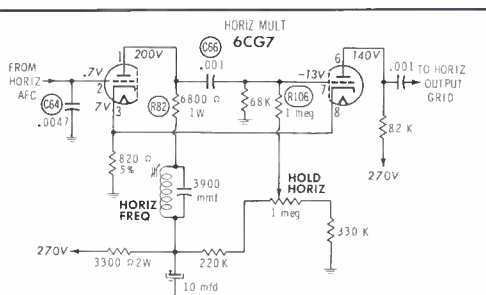



**PLANET**

TYPE IL . . . why use old fashioned wax end-filled cardboard capacitors in radio repairs? Avoid call-backs with Planet type IL dual section tubular electrolytics . . . hermetically sealed in aluminum tubes with wax impregnated insulating jacket . . . U/L approved plastic covered leads . . . wrap-around mounting strap. Planet IL's are smaller and longer lasting. Planet IL's are also available in 450 volts for TV servicing. Ask for them by type number at your distributor.

Write today for complete information.

**PLANET SALES CORPORATION**  
 225 Belleville Avenue      Bloomfield, New Jersey

**NEW..  
 FOR SOLDERING  
 EASE..**

---

**THE  
 SOLDERING AID  
 KIT**



No. 348 The Soldering Aid Kit Only \$3.00

Put it in your pocket or carry it in your case . . . X-Acto's new Soldering Aid Kit is always handy, whenever you need it and *with the tools you need.*

This time-saving kit contains a double-chuck handle and five different tools—a fork, a knife & scraper, a tracer, a reamer and a brush, each made of hard chrome-plated steel to which solder will not adhere. Perfect for printed circuits and other repairs.

348a Fork .....	.40	348d Reamer .....	.40
348b Knife & Scraper.....	.50	348e Brush .....	.60
348c Tracer .....	.40	348h Handle .....	1.00

Each tool individually replaceable from X-Acto.

See it and X-acto's many other high-quality tools today at your distributor's, or write to:

**X-ACTO PRECISION TOOLS, INC.**  
 48-41 VAN DAM ST., DEPT. T-6, LONG ISLAND CITY 1, N. Y.



**'63 Color Circuits**

(Continued from page 36)

- time. If convergence isn't just right on the first try, it's better to proceed with the whole sequence and go back a second time to "rock in" the inaccurate adjustments.
3. Perfect convergence, especially around the edge of the screen, can't reasonably be expected; trying to achieve it is a waste of time. At least 85% accuracy is normal, and excellent convergence over the central area of the screen should be easy to obtain.
  4. Periodically during dynamic convergence procedures, the static convergence magnets — including the blue lateral magnet — should be reset for accurate merging of the beams in the middle of the screen.
  5. If good dynamic convergence cannot be obtained by repeated attempts, it's advisable to set all controls for minimum effect to permit starting over with a "clean slate." In general, amplitude controls are positioned for least output, and tilt controls are adjusted to mid-position.
  6. Failure of any control to produce the prescribed effect on the screen is the surest sign of trouble in the control circuit. All controls should have a clearly visible effect on a cross-hatch pattern if they are working normally.
  7. After trouble has been partially isolated by turning controls, conventional scope waveforms with help to determine if the proper pulse inputs are reaching the convergence circuits. In many cases, the scope can also be used to check the action of controls.
  8. Most troubles can be finally located by ohmmeter checks, since faults such as open coils, poor control-arm contacts, and loose plug or terminal connections are the most common. One end of the suspected part must usually be unsoldered for this test, but at least there's no problem of accessibility when you're working on a convergence panel! ▲

## Resistors

(Continued from page 20)

initially holds the current to a safe level. As the heater temperature rises, so does that of the resistor. Heat expansion warps the bimetallic blade until the contacts close, shorting out the resistor and applying full voltage to the receiver. Although the resistance of the blade is quite small, normal operating current develops enough  $I^2R$  loss to keep the blade warm and the contacts closed as long as the receiver is left on.

Thermal relays have also been used to some advantage for extending the life of tubes in parallel heater configurations—usually by connecting the relay in the B+ circuit to hold back the application of plate and screen voltage until the heaters have attained operating temperature.

A device similar to a thermal relay, but working in reverse, can protect equipment from damage caused by short circuits. This unit is a thermal circuit breaker (M7 in Fig. 4). In case of a current overload, the thermal element heats until it opens a set of relay contacts. This thermally induced operation explains why the breaker frequently cannot be reset for several seconds after it opens: it has to cool enough so the contacts can be returned to their original position.

Another type of resistor with a protective function is the fusible unit. Like the resistor in a circuit breaker, it acts as a B+ surge limiter during normal operation. Although a fusible resistor can survive a momentary increase in current beyond its rated limit, a continued

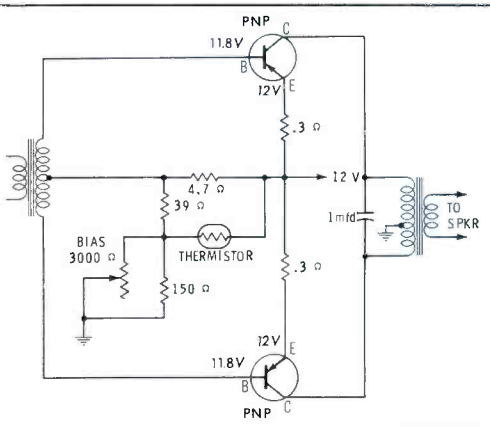

Fig. 2. Bias circuit includes thermistor to counteract "thermal runaway."



## NEW VERSATILITY & COMPACTNESS in PROFESSIONAL TEST EQUIPMENT

**EICO®**

### AC VOLT-WATT METER #261

Formerly designated as #260  
Kit \$49.95 Wired \$79.95



AC voltmeter and load-compensated audio-wattmeter of unique quality and accuracy. Measures AC voltage from 1 millivolt to 1000 volts in 11 ranges, and power from .015 milliwatt to 150 watts in 7 ranges, across standard loads from 4 to 600 ohms. The instrument incorporates a tapped power resistor load (4, 8, 16, and 600 ohms) to handle up to 80 watts of power on 8 ohms, and 40 watts on other taps. It may be switched to external load up to 150 watts. The meter is automatically compensated for any load selected, internal or external, to provide a single watt scale for all loads and ranges.

**VOLTMETER:** Ranges: .01, .03, .1, .3, 1, 3, 10, 30, 100, 300, 1000 RMS volts. Frequency Response:  $\pm 0$ db 10c to 150kc,  $-3$ db at 500 kc. Input Impedance: 2 megohm shunted by 15mmf. Accuracy:  $\pm 4\%$ .

**WATTMETER:** Ranges: 15mw, 1.5mw, 15mw, 150mw, 1.5W, 15W, 150W. Frequency Response:  $\pm 0$ db 10c to 100kc. Accuracy:  $\pm 5\%$ . Internal Loads: 4 (40W), 8 (80W), 16 (40W), 600 (40W). External Loads: 4, 8, 16, 600 (all to 150W).

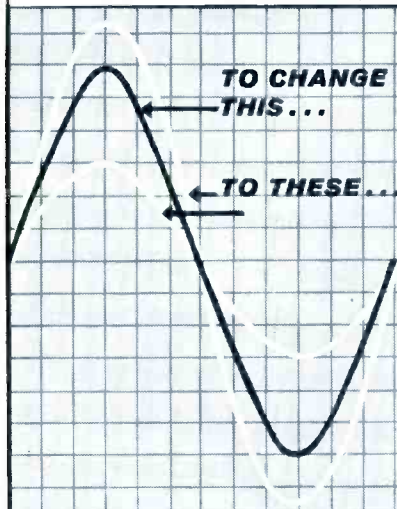

### ...USE THESE!



#### METERED VARIABLE AUTO-TRANSFORMER AC BENCH SUPPLIES

# 1073 (3-amp rating)  
Kit \$35.95 Wired \$47.95  
# 1078 (7 1/2-amp rating)  
Kit \$42.95 Wired \$54.95

Connect to 60 cycle, 120 volt line and obtain any desired voltage between 0 and 140 volts. Highly efficient variable auto-transformer of toroidal core design gives you continuously variable output, linear versus rotation, with excellent regulation and negligible waveform distortion. Model 1078 permits either 50 or 60 cycle operation.

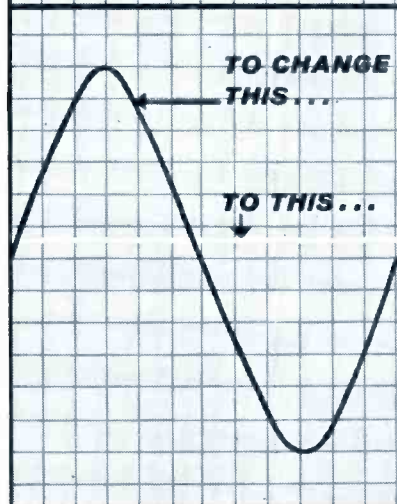

### ...USE THIS!



#### Extra-Low-Ripple 6- and 12-Volt BATTERY ELIMINATOR AND CHARGER #1064

Kit \$45.95 Wired \$54.95

Connect to 60 cycle, 120 volt line and obtain highly filtered low dc voltage continuously variable over two ranges 0-8, 0-16 VDC. Heavy-duty pi-type LC filter is rated to take the full rated current output continuously (10 amps on 8V range, 6 amps on 16V range), reduces ripple as low as 0.3% at 2 amps on the 16V range. An essential instrument for servicing battery-operated equipment, including transistor or hybrid types, and an excellent battery charger.

#### Also New From EICO:



AC VTVM &  
AMPLIFIER  
#250  
Kit \$49.95  
Wired \$79.95



TRANSISTOR  
AND CIRCUIT  
TESTER #680  
Kit \$25.95  
Wired \$39.95



IN-CIRCUIT  
CAPACITOR  
TESTER #955  
Kit \$19.95  
Wired \$39.95

For complete catalog of over 106 EICO kits and wired units—hi-fi, test equipment, citizens radio, ham gear—plus name of nearest distributor, write to dept. PF-5

**EICO®**

ELECTRONIC INSTRUMENT CO., INC.

3300 Northern Blvd., Long Island City 1, N. Y.

ADD 5% IN THE WEST

Export Dept., Roburn Agencies Inc., 431 Greenwich St., New York 13, N. Y.

**THE INDUSTRY'S  
ONLY COMPLETE  
"LOOK-ALIKE" LINE  
OF BOTH NEEDLES  
AND CARTRIDGES!**



150 Exact  
Replacement  
Cartridges

300 Exact  
Replacement  
Needles

Speeds your phono service . . . assures consistent high quality and complete compatibility of needles and cartridges. Inventory and handling costs are cut to the bone. And the industry's greatest array of sales tools — cross-reference catalogs, wall charts, displays and merchandisers — is available to suit your requirements. Ask your E-V distributor, or send coupon for profitable details, today.

**Electro-Voice**

ELECTRO-VOICE, INC., Dept. 537R  
Buchanan, Michigan

Please send my free needle and cartridge catalogs plus name of nearest distributor.

Name \_\_\_\_\_  
Address \_\_\_\_\_  
City \_\_\_\_\_ State \_\_\_\_\_

overload will cause it to burn open. Since this type of component is deliberately operated close to its failure point, the value of a replacement unit is quite critical. An ohm or two, one way or the other, can make the difference between no protection, satisfactory operation, or premature burnout.

### Thermistor Measurements

The specifications of thermistors are rather critical, if they are to produce exactly the desired amount of temperature compensation. Their response to current, voltage, and temperature changes depends on a number of factors such as the electrode contact area, ratio of surface to volume, surface characteristics that determine the air-interface coupling, and whether they are mounted in still or moving air.

Thermistors are also made of various materials to obtain different operating characteristics. Some consist of iron oxide; others are of nickel oxide or manganese dioxide, with binders such as titanium dioxide or clay. To minimize the number of different types that have to be manufactured or stocked, thermistors are sometimes shunted with ordinary resistors (as in Fig. 2) to obtain the optimum temperature characteristic for a particular circuit.

The specifications of greatest interest in servicing are the *cold resistance* and *hot resistance*. The former is easily determined with an ohmmeter at room temperature; for example, R70 in Fig. 1 will measure about 800K ohms unless it is defective. On the other hand, hot resistance does not lend itself to direct measurement. By the time the power has been switched off and the ohmmeter probes have been connected to the thermistor, its temperature has usually dropped enough to result in a false reading.

Hence, accurate hot-resistance measurements require checking the thermistor with power on, in terms of voltage and current. Voltage drop across the component is readily determined with a VTVM, and the easiest way to figure the current is to find the voltage drop across a known resistance in series with the thermistor. Referring to Fig. 1 again, if 100 volts is measured across 1-meg resistor R71, the current through it (according to Ohm's



Fig. 3. Thermal-relay contacts close when resistor is heated by current.

law) is 0.1 ma. Then, if the voltage across R70 is 50 volts, the hot resistance figures out to be 500K ohms.

### Temperature Checks

The work of some technicians includes taking measurements *with* thermistors, as well as measurements *of* thermistors. Many industrial shops, in particular, make use of an electronic thermometer. This may be either a separate instrument or an adapter to be used in conjunction with a VTVM. Some probes used with this type of meter contain a thermistor, which operates as part of a bridge circuit. Other probes for

**PROLINE**

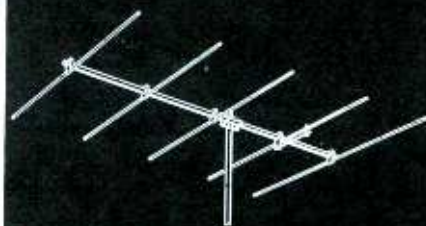

**MASTER TELEVISION AND  
COMMUNICATION ANTENNAS**

The achievement of five years of research and development. **PROFESSIONAL LINE** means Quality through precision machining, all aluminum construction. Performance through tested electrical design. Value at moderate pricing.

Constant "in-service testing" has established new commercial standards for performance and reliability. Proline has been proven by exceeding the toughest requirements of remote mountain top and heavily metropolitan installations.

See your distributor or write for free literature on Prolines for all television channels, FM bands, and communications frequencies.

**Cush  
Craft**

621 HAYWARD ST., MANCHESTER, N. H.  
DISTRIBUTED NATIONALLY

the same purpose are *thermocouple* types. These usually consist of two small wires made of different materials (for instance, copper and *constantan*), twisted together and welded. When the probe is heated, the bimetallic element generates a current that can be measured with a microammeter.

### Other Variable Resistors

The hot resistance of a thermistor is related to the voltage present across its terminals, but this factor is given much less attention than the temperature-vs-resistance characteristic. However, in certain other types of special resistors, a change of resistance resulting from a change in applied voltage is of primary importance. One component in this category is the *varistor* used in recent Philco TV sets to provide automatic regulation of width and high voltage. This unit is connected in the grid-bias circuit of the horizontal output tube, and also receives a pulse voltage from the flyback transformer. When the pulses increase in amplitude for any reason, the resistance of the *varistor* is lowered; this action causes additional bias to be placed on the output tube, so the flyback pulses will be brought back to the normal level. A more complete description of this circuit is given in "Highlights of '62 TV Lines" (October, 1961 PF REPORTER).

Still other resistors respond to fluctuations in light. These are not photoelectric cells, because they do not generate current when illuminated, but merely decrease in resistance. A typical *photoconductor* contains a deposited film of cadmium sulfide, vacuum-sealed inside a glass cell. Its *dark resistance* may be about 100K ohms, or perhaps as high as several megohms. In normal room light, the resistance drops to 50K or less; very bright

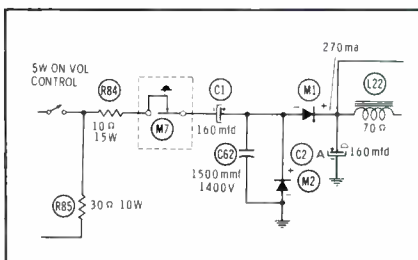
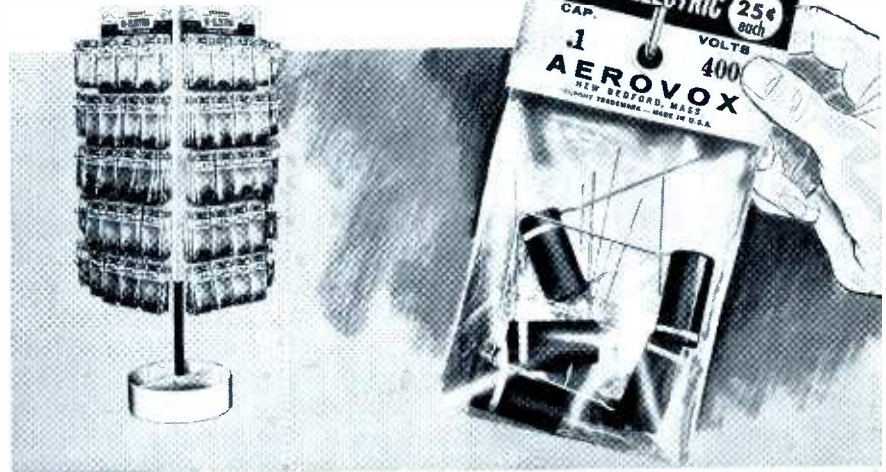
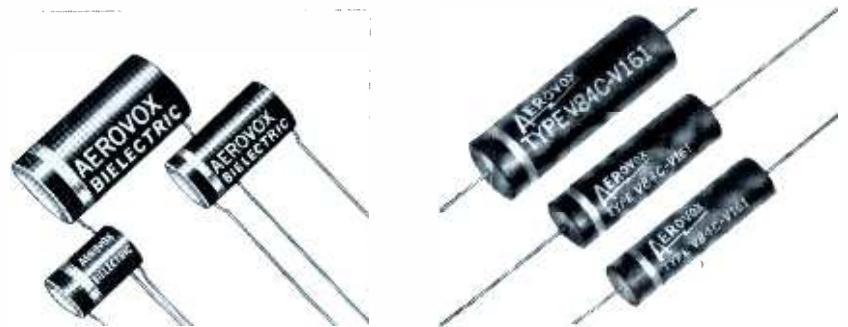

Fig. 4. Excessive B+ current overheats circuit breaker and opens contacts.

# AEROVOX MYLAR\* BYPASS CAPACITORS PROVIDE SUPERIOR PROTECTION FOR EVERY SERVICE JOB!



Registered DuPont trademark  
Aerovox Bi-Electric Capacitors are packaged in handy see-thru plastic bags for your convenience . . . sealed for your protection. Look for the famous Bi-Electric stand at your distributor's store.



Aerovox Type BE Bi-Electric® Mylar Paper Bypass Capacitors combine the advantages of an exclusive Polycap® case from end-to-end, and process controlled end-fills to provide complete sealed protection for every service job! Over and over again, actual tests prove that this superior, uniform construction eliminates the cracking and chipping problems common with conventional dipped bypass capacitors—even when the Bi-Electric units are used for axial lead installations.

It's no wonder that Aerovox Mylar Paper Bypass Capacitors, featuring the Polycap case, are becoming more popular every day. Protect your reputation and your profits by asking your Aerovox distributor salesman or counterman for Aerovox Type BE or Type V84C-V161 Bypass Capacitors.

Aerovox Type V84C-V161 Aerofilm® Mylar Capacitors are extremely stable axial lead units offering the exceptional protection of the Polycap® case and epoxy end-seals which will not flow, soften or melt at any operating temperature! These high-quality capacitors have high insulation resistance and low dielectric absorption and power factor.

Aerovox Bypass Kits AK-100 and AK-101HS provide you with a ready supply of the most popular V84C-V161 units in a practical metal cabinet. Eliminate costly delays and increase your profits with these money-saving kits now available from your Aerovox distributor.



Remember—it pays to use Aerovox!

**AEROVOX CORPORATION**  
DISTRIBUTOR DIVISION  
NEW BEDFORD, MASS.

Technical Leadership — Manufacturing Excellence

See Us In Room 529 At May Parts Show

light can reduce it to as low as 300 ohms.

"Automatic Brightness and Contrast Control" in the April, 1962 PF REPORTER explains how cadmium sulfide cells are used in TV receivers to control CRT bias, video amplifier gain, or both. Detailed testing procedures are also given. To summarize these, valid tests can be made with an ohmmeter, since illumination of the photoconductor is easily controlled even when this component is disconnected from the circuit. The first sign of impending failure is a decrease in the resistance spread—or ratio—from maximum dark to maximum light.

### "Acting" Resistors

A component doesn't have to be labeled a resistor to function as one! It might be startling to find a semiconductor diode doing the job usually assigned to a thermistor, but such an arrangement is occasionally used. Diode X1 in Fig. 5 conducts continually in the forward direction, and helps to establish the base-emitter bias. When the transistor tends to conduct excessively,

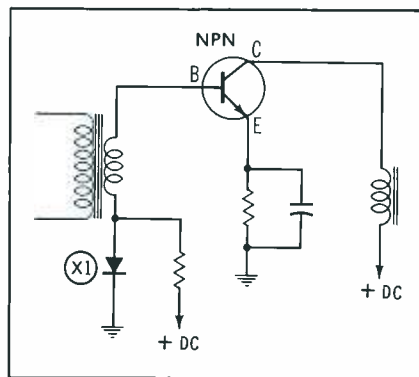

Fig. 5. Diode X1 in bias circuit performs same function as a thermistor. more current flows through the diode—heating it and lowering its forward resistance. In turn, the diode reduces the bias, stabilizing the flow of collector current.

Another "resistor by a different name" is a voltage regulator (VR) tube, which is essentially a voltage-sensitive resistor having a negative characteristic. As the applied voltage attempts to rise above a predetermined level, the VR tube inserts just enough shunt resistance in the circuit to hold the voltage at this level.

It wouldn't be stretching a point too far to refer to all amplifier tubes

and transistors as "signal-sensitive resistors." In fact, the name *transistor* is a condensation of the words *transfer resistor*. As diagrammed in Fig. 6, the amplifying device and its output load resistance form a voltage divider across a DC source. When the effective resistance of the tube or transistor is varied by applying an input signal to it, voltage fluctuations are produced at the midpoint of the voltage divider. This changing voltage is utilized as an output signal.

The amplifying action of a tube makes use of its AC plate resistance. There is also a DC plate resistance which, in a class-A amplifier, is independent of the AC characteristic. In the "stacked" B+ circuit of Fig. 7, this DC resistance is used as a simple voltage-dividing element to drop the power-supply voltage from 250 to 135 volts—without affecting the amplifying ability of the tube. Here's a good example of a "resistor" doing more than one useful job.

### On the Other Hand . . .

So far, this article has stressed

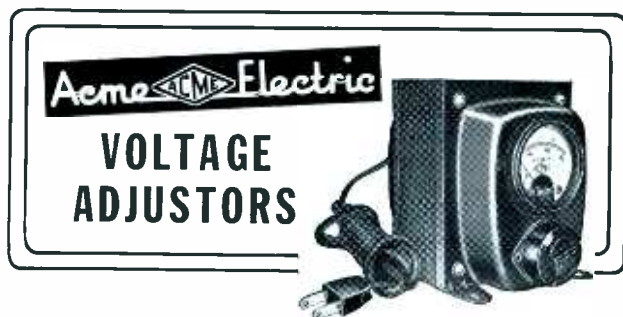

**a quick, inexpensive way to correct off-standard voltage**

TV sets, hi-fi's and other electronic equipment operate best when voltage holds closely to the normal 115-120 volts for which they were designed. Over-voltage and/or under-voltage affects the performance of the tubes and the life expectancy of all other components. Why fight an off-standard voltage condition? Correct it with an Acme Electric T-8394M Voltage Adjustor.

Corrects voltage over a range from 95 to 125 volts to normal 115/120 volts, simply by turning a regulating switch. Includes voltmeter which indicates output voltage; cord and plug and plug-in receptacle. Tell your supply dealer you want the Acme Electric T-8394M 300 watt, Voltage Adjustor. No other so compact, complete, practical, inexpensive. Write for Bulletin 091.

**ACME ELECTRIC CORPORATION**

945 Water St.

SAA 3581-2033

Cuba, N. Y.

In Canada: Acme Electric Corp. Ltd., 50 Northline Rd., Toronto, Ont.

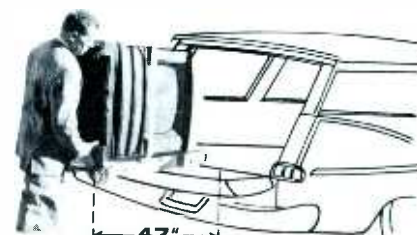

**YEATS SHORTY DOLLY**  
for RADIO and TV

just 47 inches high for STATION WAGONS and PANEL PICK-UPS



**FOLDING PLATFORM**  
15 1/4" x 24 1/2" top.  
Snaps on or off.  
(Platform only)  
\$11.95

Designed for TV, radio and appliance men who make deliveries by station wagon or panel truck . . . the short 47 inch length saves detaching the set for loading into the "wagon" or pick up. Tough, yet featherlight aluminum alloy frame has padded felt front, fast (30 second) web strap ratchet fastener and two endless rubber belt step glides. New folding platform attachment, at left, saves your back handling large TV chassis or table models. Call your YEATS dealer or write direct today!

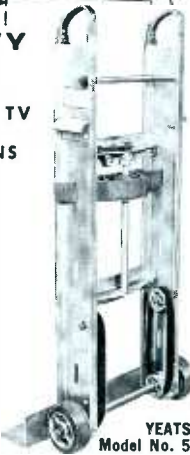

**YEATS Model No. 5**  
Height 47"  
Weight 32 lbs.



**FURNITURE PAD**

### "Everlast" COVER AND PADS

YEATS semi fitted covers are made of tough water repellent fabric with adjustable web straps and soft, scratchless white flannel liners. All shapes and sizes — Write



**TV COVER**



**APPLIANCE DOLLY SALES COMPANY**

2103 N 12th STREET MILWAUKEE, WISCONSIN

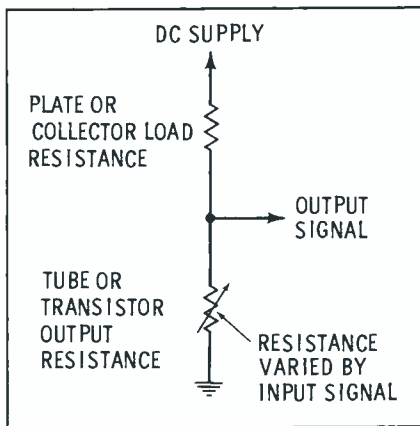

Fig. 6. Tube or transistor operates as variable element of voltage divider.

some common examples of resistors which do two *desired* jobs. Sometimes, however, the second job is either undesired or unsuspected; in this case, it can lead to problems in designing or servicing equipment.

One such difficulty arises when an ordinary resistor in a TV sweep-oscillator circuit develops thermistor characteristics (usually increasing in resistance as the temperature goes up). Experienced technicians learn to expect this trouble in some cases of intermittent rolling or tearing, and make a point of checking oscillator resistors with a soldering gun or a squirt of freeze spray.

Resistors can also make trouble by volunteering for second jobs as noise generators (in TV tuners and hi-fi amplifiers) or as thermal relays. As a consequence, they lose both jobs; they must be replaced.

### Conclusion

Ohm's law hasn't been repealed, but the relationship of E, I, and R is sometimes confused by resistors which change value under certain conditions. Whenever you're puzzled by seemingly inconsistent readings in a circuit, check to see if a dual-function resistor (by design or accident) is pulling the wool over your eyes. ▲

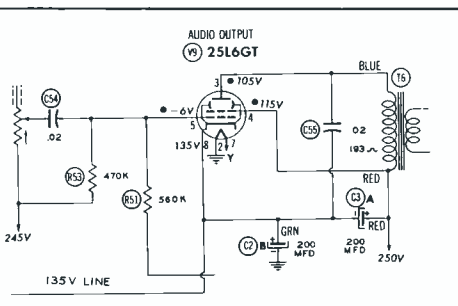

Fig. 7. DC plate resistance of 25L6 is utilized as B+ dropping resistor.



more!

Harman-Kardon TROUBADOR offers more operating features, more application versatility, more value than any other transistorized mobile or portable public address amplifier.



TR-1  
15-watt amplifier



TR-2  
30-watt amplifier

Until you see and hear Troubador for yourself, the dramatic performance and economy benefits of this remarkable series may only be advertising claims to you. Here's why these amplifiers will satisfy virtually every rental, conventional or unusual field requirement:

THE TR-1 is a compact 15 watt amplifier ideal for fire, police, marine, sight-seeing, ambulance, military, utility, construction, resort and other mobile or portable commercial uses where only low voltage D.C. power may be available from a battery or vehicle ignition system. Troubador gives you all the operating facilities you'll ever need—more than you ever expected! Separate channels for a low impedance microphone (no input matching transformer needed) and a music source (crystal or ceramic phono, tuner, tape recorder) ... with full mixing! A really useful tone control employing a 4-position filter network (normal / lo-cut / anti-feedback / hi-cut), to help overcome problems with program material, acoustics, speaker and microphone characteristics. Optional plug-in preamplifier with built-in, legitimate RIAA and NARTB equalization to accommodate any magnetic phono cartridge or tape head—and still be able to drive the amplifier to full output.

It draws only *one* ampere for full output on average voice or music program. Cannot be damaged by accidental application of incorrect battery polarity; operates on positive or negatively grounded vehicles. A solid-state converter is available to adapt the TR-1 for use on 117 VAC; locks to the side of the TR-1 to make it a combination AC/DC amplifier.

*More!* A plug-in relay permits the amplifier to be turned on or off from a remote location, even from the microphone. There is an output to feed a tape recorder. In

addition to usual voice coil impedance outputs, a 25V constant voltage output makes adding or deleting speakers easy. And the TR-1 can be used free-standing, flush mounted, or with universal mounting brackets to affix it to any convenient surface.

THE TR-2 is a 30 watt amplifier incorporating *all* features and advantages of the TR-1, plus some unique others. It has two microphone channels; there are two music inputs on a fader control; individual boost-cut bass and treble controls; both 25V and 70.7V balanced and unbalanced constant voltage outputs as well as voice coil impedance outputs. There is space on the TR-2 chassis for a drop-in AC-to-DC converter. Provision has also been made for a special plug-in relay that automatically and instantly switches the amplifier over to a standby battery in the event of AC power failure. This makes the TR-2 a continuous-duty fail-safe amplifier especially suited for applications where uninterrupted communication is essential; ideal as an "emergency control" sound system. A combination cover and carrying handle makes the TR-2 as neat and easy to transport as a small portable typewriter.

*Want more details? Send us the coupon or, better yet, visit your authorized Harman-Kardon distributor and see for yourself.*

HK-100

Harman-Kardon, Inc.  
Commercial Sound Div.  
55 Ames Court, Plainview, L.I., N.Y.

Desk **PFR-5**

Rush me the full Troubador story.

Name \_\_\_\_\_

Address \_\_\_\_\_

City \_\_\_\_\_ State \_\_\_\_\_



# THE SPEAKER THAT SELLS ITSELF



## New Utah Thin-Drive Speakers in self service bubble pack display

Utah's radically new Thin-Drive Speaker is available in all popular sizes. It uses a completely new magnetic material (Lodex by G.E.). The "pot" is reduced in size and weight—efficiency and performance increased. The Thin-Drive is thinner in profile, allowing more knuckle room in tightly packed sets.

### A beautiful combination!

Utah's new Thin-Drive speakers come individually carded—sealed in clear plastic bubbles for optimum protection and display.

Utah's attractive self service display rack offers fingertip convenience, self-merchandising—self-pricing. See your Utah distributor.



## Tuner Repairs

(Continued from page 29)

voltage here indicates a leaky capacitor. Capacitors with even very slight leakage should be replaced as a precautionary measure against future callbacks.

Oscillator troubles are often caused by leaky capacitors, especially the fine-tuning capacitors in some tuners. However, bad tubes, open resistors, or defective coils also come in for their share of suspicion. Sometimes it is necessary to select tubes for replacement in the oscillator circuit or else readjust the "overall" oscillator frequency. Usually there is an adjustment that affects all channels—like C1 in Fig. 6; but sometimes there will be one adjustment for the high channels and another for the low.

For tuners that do not have these adjustments, it is usually wise to keep trying tubes until you find one that gives you the correct channel at the right point on the channel selector. If absolutely necessary, a short, stiff, insulated wire soldered to the plate pin of the oscillator tube can be moved closer to or farther from the chassis to alter the oscillator frequency. An increase in frequency of any single channel coil will occur if you squeeze its turns closer together; but, in an incremental-inductance (switch-type) tuner, changing one coil in this way will affect the frequency on all lower channels.

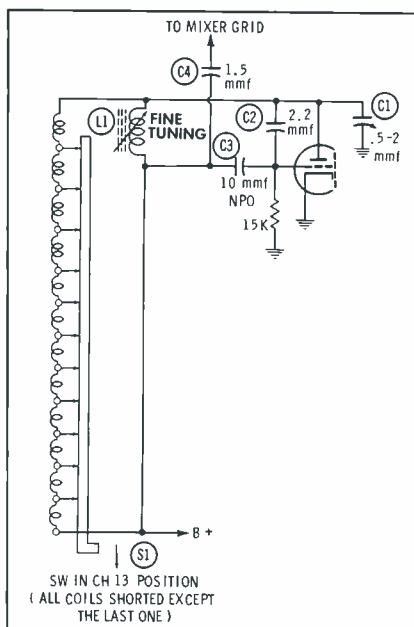

Fig. 6. This typical TV tuner oscillator is a form of the Colpitts circuit.

## PROFESSIONAL technicians

use

*Dave Rice's*

OFFICIAL

ORDER BOOKS

for every

TV-RADIO

service

call



This is the businesslike approach to service record keeping. TriPLICATE forms serve as order form, invoice and office record, with spaces for complete information on every job. Separate listings for receiving tubes, pix tube, parts, serial numbers, labor and tax charges, signatures, etc. 75c a book, \$6.50 for dust-proof box of 10. In stock at your distributor.

\*\*\*\*

## FREE

Write for your free folder describing Dave Rice's OFFICIAL ORDER BOOKS, including an actual size sample copy of the handy order form.

ELECTRONIC  
PUBLISHING CO., INC.  
133 N. JEFFERSON ST.  
CHICAGO 6, ILLINOIS

## Now you can correct off-standard voltage

with a

# terado

## VOLTAGE ADJUSTER



Electronic equipment operates best at the 115-120 volts for which it was designed! No longer do you have to make-do with high or low voltage, which affect the performance and operating life of tubes and other components. Use a Terado Voltage Adjuster, which will correct any voltage within a 95 to 135 range, to a normal 115-120. Great for TV, hi-fi, and universal A.C., motors in low or high voltage areas.

TWO MODELS:

Planet (up to 300 Watt) Dealer Net.....\$7.80  
Polaris (up to 500 Watt) Dealer Net.....\$9.20

See your electronics parts jobber, or write:

**terado CORPORATION**  
1073 Raymond Ave.  
St. Paul 8, Minnesota  
In Canada, Atlas Radio Corp., Ltd., Toronto, Ont.



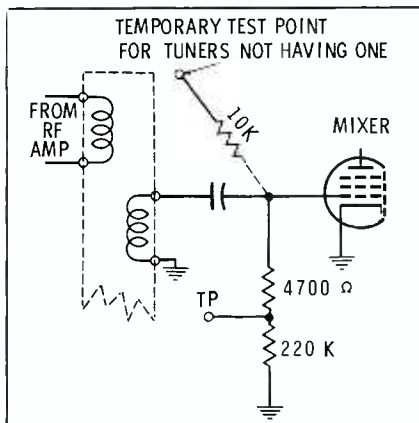

Fig. 7. Mixer-grid test point is helpful for checking RF and oscillator.

### Antenna Coils

In metropolitan areas the antenna coil—or balun—is seldom a problem, but in areas where outside antennas are used, the coils are often damaged by lightning or static discharges. Checking the coils with an ohmmeter is not always valid, because the resistance of the coils is extremely low, and they sometimes parallel one another in such a way that an ohmmeter check means nothing.

The device shown in Fig. 8A can be used to bypass the antenna coil, and connect the antenna directly to the RF amplifier grid. You simply connect one of the capacitors to the grid pin and the other one to ground. If a noticeable improvement in picture quality results, there is trouble in the antenna coil.

### RF Amplifier Stage

You can also use the same device to check an RF stage: Just remove the RF tube from its socket, connect one capacitor to ground,

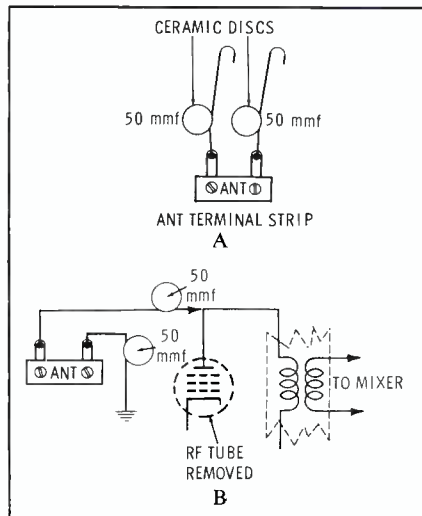

Fig. 8. To check antenna coil, bypass signal around it through capacitors.



## SERVICE YOUR C/B CALLS TO TOP TALK POWER WITHOUT A SCOPE!

Here's a modulation meter and transmitter tester for Citizens Band and low power transmitters. Wide meter scale reads modulation direct in percentage—0%—120%—BOTH positive and negative peaks. No expensive scope needed! Reads transmitter RF output to a fraction of a watt. Meter scale calibrated for 0-5 watts RF output; 0-400 ma RF output. Will serve as field strength or remote RF indicator. Also detects presence of A.M. and hum modulation on FM transmitters. Has high impedance input for Handy Talkies—jack for headphone or scope monitoring. A compact unit complete with adaptor and accessory kit. Attenuator accessory available for power output to 50 watts (Model 511A).

MODEL 510B	\$48.95 NET
MODEL 511A (attenuator accessory)	\$15.95 NET



**IN-LINE ANTENNA TESTER**—tests antenna efficiency and RF power output DIRECTLY IN WATTS! Dual air coupler rated at 1000 watts maximum. Unit is designed for 50 ohm coaxial lines—inserts no error in coax up to 160 MC. Top meter scale reads antenna efficiency three ways: in Standing Wave Ratio from 1:1 to 8:1—in per cent—or simply in GOOD-POOR. Bottom scale reads FORWARD POWER AND REFLECTED POWER DIRECTLY IN WATTS! Three watts ranges—0-10, 0-100 and 0-1000. Model 520AP accessory adaptors consist of a 24" coaxial cable with Motorola and phone tips to coax adaptor.

MODEL 520 A	\$49.95 NET
MODEL 520 A with 520AP	\$54.95 NET
MODEL 520AP (Accessory-Adaptors only)	\$5.25 NET



**2-WAY RADIO TEST SET**—Combination Crystal Checker, RF Signal and Field Strength Meter. Checks crystal activity on third overtone receiver crystals—checks fundamental types and third overtone receiver crystals at fundamental frequency. Use 0-50 ma meter for final RF amplifier tuning. Quick-checks a crystal's "on channel" operation. Supplies low power, unmodulated RF signal for adjusting squelch, etc.—or tone modulated RF signal for peaking. Comes with 15 ft. remote cable—uses two 1.5 V "C" cells.

MODEL 500, wired and factory tested	\$29.95 NET
-------------------------------------	-------------



**TRANSISTOR REGULATED POWER SUPPLY**—A metered variable DC supply that maintains constant voltage over wide load variation. Five output and meter ranges—0-1.5 V, 0-15 V, 0-30 V, 0-30 ma and 0-150 ma. Max ripple 10 mV—output impedance 1.8 ohms. Two variable bias voltages (0-1.5 V and 0-7.5 V) available as well as 0-15 V simultaneously.

MODEL RPS-4	\$36.95 NET
-------------	-------------



**TRANSISTORIZED "S" METER**—Indicates signal strength accurately with no loading on AVC. Illuminated "zero" to "30 db over 9" meter—controls for zero set and sensitivity. Self-powered by 9 V transistor battery. Easily adapted to both transistor and tube type receivers—makes handsome matching set with Signal Filter below.

MODEL 540	\$13.88 NET
-----------	-------------



**SIGNAL FILTER**—Noise limiter and controllable squelch electronically clips noise pulses—increases reception range. Filters ignition noises without costly suppression installations. For most C/B tube-type transceivers—all AM superhet receivers with 6 or 12 V AC or DC and 150 V "B" power supply.

MODEL 530	\$15.88 NET
-----------	-------------

For complete information on Seco C/B or 2-Way Radio test equipment, see your electronic supply dealer or send this coupon.

**SECO ELECTRONICS, INC., 1221 S. Clover Drive, Minneapolis 20, Minn.**

Please rush information on following equipment and include folder describing complete range of Seco test equipment:  510B  520A  500  RPS-4  540  530

NAME \_\_\_\_\_

COMPANY \_\_\_\_\_

ADDRESS \_\_\_\_\_

CITY \_\_\_\_\_ STATE \_\_\_\_\_

and clip the other to the plate pin in the socket—as shown in Fig. 8B. If the picture quality improves when you bypass the stage, it obviously is faulty.

#### AGC Delay Resistors

One common cause of low tuner sensitivity is excessive AGC voltage. This happens if the delay resistor (Fig. 9) opens or increases in value. To overcome the positive bucking voltage supplied by the delay resistor, the AGC voltage must be more negative than would otherwise be required. For this reason, if the delay resistor

opens, the AGC voltage will be excessive and the tuner output will be lowered drastically.

A quick test is to simply ground the AGC terminal with a screwdriver or jumper, and see if the picture improves. If so, check the condition of the delay resistor.

#### Mechanical Troubles

Intermittent, weak, or inoperative tuners can also be caused by mechanical faults. You can repair many of these mechanical troubles with a minimum of equipment and a certain amount of ingenuity.

For example, molded tube sockets can often be repaired with an ice pick. You can tighten the connections by inserting the pick between the socket body and the outside of the contact, forcing the contact in toward the center so it will take a firmer grip on the tube pin when the tube is reinserted. If the point of the pick is flattened, it becomes an ideal reamer for cleaning and brightening the inside of the contact.

Check carefully underneath sockets to make sure all the connections are tight; if in doubt, resolder. Check wires leading away from the socket to other contacts and check for tight connections at both ends. (Sometimes a seemingly intermittent socket is really a loose connection somewhere else in the tuner.)

If a tuner has a broken switch wafer or rotor, it may be more economical to buy a replacement tuner. Tuner-repair companies offer most types on an exchange basis. However, some tuners are designed so at least a portion of the wafer switches can be replaced without too much difficulty. Remember, though, the shaft often can be inserted into the switch rotor in more than one way. So one special precaution to take, if you do replace a switch wafer, is to make sure that all the switches “track” when you reinsert the shaft.

#### Parts Replacement

Parts buried deep inside the tuner may be difficult to reach and replace. Removing the components necessary for free access to the part may be time-consuming, or virtually impossible. Here, the techniques often suggested for printed-circuit repair are helpful: Instead

# 1962-63

## TV Replacements

### Lead Stancor's

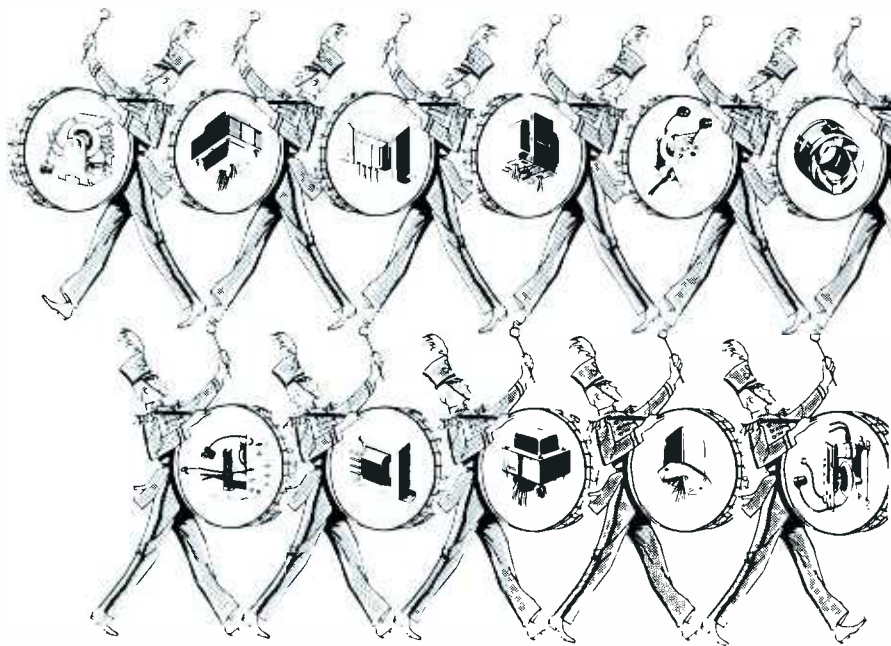

# PARADE OF PARTS

Stancor exact replacement transformers for 1962 and 1963 television sets are now available from your distributor. For the first time in the history of the transformer replacement market, parts are in stock for sets the dealers are selling today. These brand-new units are among the more than 90 yokes, flybacks, powers, and vertical output transformers added to the Stancor line so far this year.

This 1963 Stancor Parade of Parts dramatizes our continuing program of providing an exact replacement transformer for your every need, available through your electronic parts distributor.

*You can rely on him . . . and on*

**STANCOR**  
ELECTRONICS, INC.  
3501 E. ADDISON • CHICAGO 18, ILL.

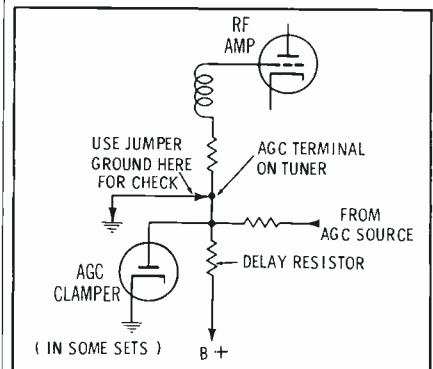
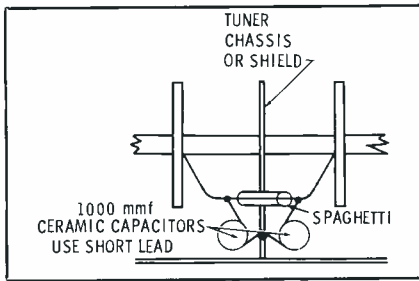

Fig. 9. Simply grounding tuner AGC line checks for delay-resistor fault.



**Fig. 10. Feedthrough capacitor can be replaced with two ceramic disc cuits.**

of clipping the old part close to where it is soldered, either crush it or clip it out to leave as much as possible of the old lead still connected. Then you can bend a hook in the new lead and slip it over the old lead; thus, you can make the solder joint out in the open where it is easier to reach.

#### Feedthrough Capacitors

These capacitors are sometimes hard to replace because of their location or because an exact replacement is not available. For bypass types, except in certain neutralizing or tuned circuits, you can use the method shown in Fig. 10. In many circuits, only one of the capacitors will be required if the leads are kept short, but the use of two capacitors is a wise precaution.

#### Positioning of Parts

Only a few parts in the tuner are extremely critical in positioning. Many parts may be moved from their original position if necessary (or if the position of the original part is unknown) without undue effect on tuner operation. A good precaution to follow is to keep the leads of components — especially bypass capacitors — as short as possible, and not to change the point at which these capacitors are grounded.

#### Send the Tuner to a Specialist?

The answer is: Certainly, if you cannot do the repair *profitably* yourself. Remember, though, you are in a good position to make sure the tuner is operating properly, since you have the rest of the set and can check its performance under the best of conditions.

With tuners, as with all servicing, a lack of familiarity is what makes most technicians reluctant to tackle the job. Familiarity, however, comes only with practice; with enough of this, you can become a tuner expert. ▲

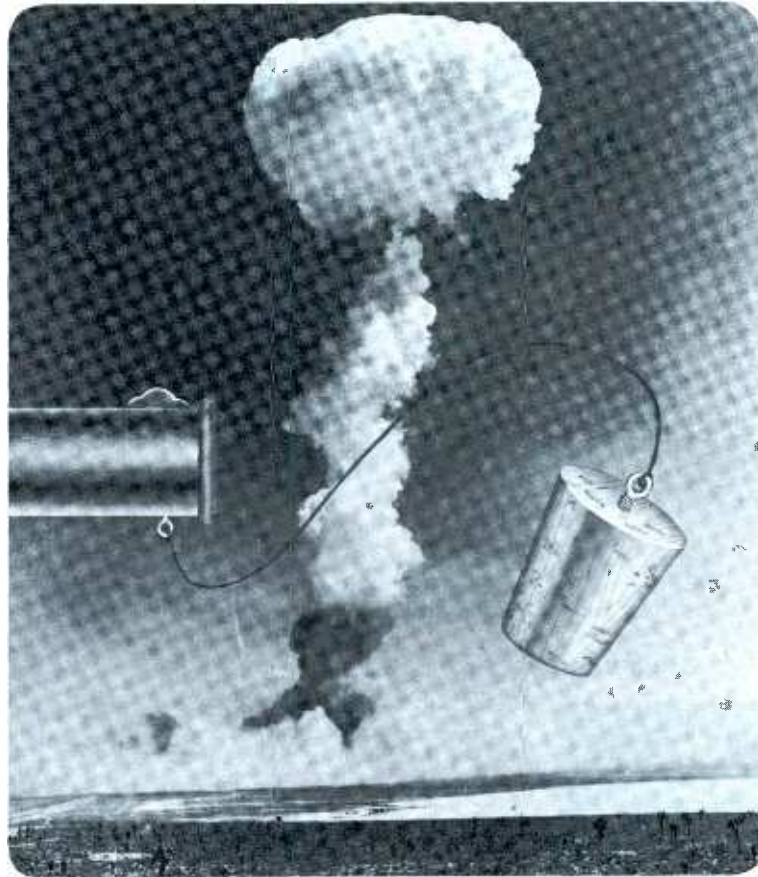

# full-range SOUND

**Popgun or atomic blast...** There's a Precision PA amplifier to handle any sound requirement, large or small. Realistically power-rated, you can select a unit to provide uniform coverage on every job.

You can count, too, on Precision's reputation for quality... dependable design that means versatility and operating simplicity throughout the entire line.

Write for Popular PA and Professional Sound Catalogs.



**MODEL 10PA**  
Low end of a popular line of PA equipment ranging up to 100 watts of audio output.

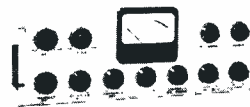

**MODEL G5M**  
Deluxe preamplifier, mixer, equalizer from Precision's professional sound group.



**MODEL 25MPA**  
All-transistor 25 watt mobile PA amplifier featuring low current drain from 12 volt car battery.

## *Precision*

**PRECISION ELECTRONICS, INC.**

9101 KING STREET • FRANKLIN PARK, ILL.

# PRODUCT report

For further information on any of the following items, circle the associated number on the Catalog & Literature Card.

## Silicon Rectifier (44Z)



A new silicon rectifier with built-in heat sink is the TH800 from **Semitronics Corp.** The metal jacket covering the main body of the rectifier is isolated from the electrical elements: thus, it can be placed in physical contact with the chassis without risk of shorting. Rated at 850 ma, the unit is obtainable with several peak-reverse-voltage ratings from 100 to 1000 volts.

## High-Voltage Wire (45Z)

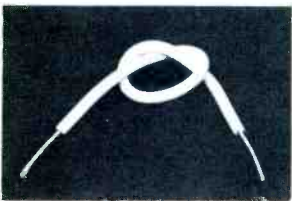

Designed to fulfill the need for a flexible high-voltage lead, the **Oneida "Hi-Flex"** has an insulation rating of 22,000 volts. The wire contains 16 strands of 30-mm pure tinned copper. It comes packaged in 15' coils or bulk wound on 250' spools.

## New Novar Tubes (46Z)

Three new novar types for use in the horizontal output stages of TV receivers have been released by the Electron Tube Division of **RCA**. The 6JB6, 12JB6, and 17JB6 are identical except for their filament ratings. The latter two, for use in series strings, have heaters with controlled warm-up. These tubes feature a separate base-pin for connecting to grid 3, so a positive voltage can be applied to minimize "snivets." Other features are increased voltage and dissipation ratings for the plate.



## Battery Showcase (47Z)

Popular transistor radio battery replacements are featured in this 15" x 24½" x 10½" "Eveready" showcase display from **National Carbon**. Its glass-topped cabinet invites customers to stop, look, and buy. There is an abundance of extra storage space in the rear of the case. Also included at no extra cost is a battery tester capable of checking all the various types of batteries likely to be encountered.



## Stylus-Pressure Gauge (48Z)

This new **Robins** stylus-pressure gauge will measure the tracking force of almost any stylus and cartridge assembly. The unit is calibrated in ½-gram increments from ½ gram to 8 grams. Designated Model SG-2, it has a list price of \$1.45.

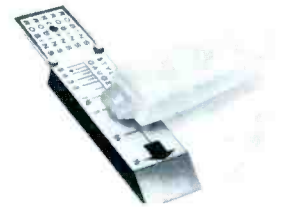

## Antennacraft SA-242 TV-FM ANTENNA

Antennacraft Company P. O. Box 1005 · BURLINGTON, IOWA

NO MORE NEED FOR AN UNSIGHTLY AND COMPLICATED ARRAY OF ANTENNAS ON ANY ROOF. IF IT'S TELEVISION, PLUS FM RADIO RECEPTION YOUR CUSTOMER WANTS, THE SA-242, BY ANTENNA-CRAFT, IS THE ANTENNA TO INSTALL. THIS ALL CHANNEL TV ANTENNA IS ESPECIALLY DESIGNED TO RECEIVE THE FM BROADCAST BAND AS WELL. AND ONLY ONE LEAD-IN IS REQUIRED. FOR STERLING PERFORMANCE ON TV AND FM, AND TO INSURE SATISFIED CUSTOMERS, INSIST ON ANTENNA-CRAFT'S SA-242. MORE INFORMATION IS AVAILABLE ON REQUEST.

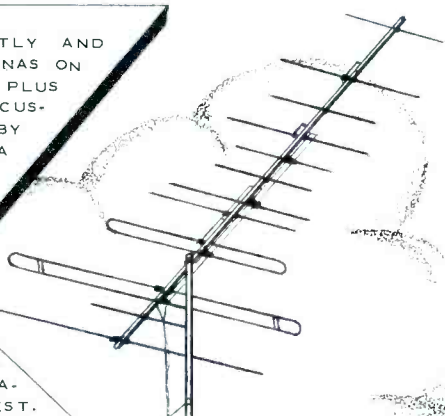

Model SA-242  
For Black and  
White or Color

# COMBINATION FM TV antenna

See us at the May Parts Show, Room No. 529

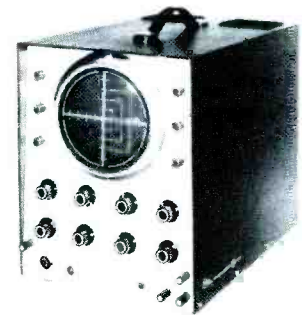

## 5 inch WIDE - BAND HIGH SENSITIVITY OSCILLOSCOPE

Laboratory quality scope with highly stable circuitry and every feature for accurate TV work, COLOR and BLACK and WHITE. Widely used, too, in many laboratory and industrial applications.

**Jackson** Electrical Instrument Co.  
124 McDonough St. Dayton, Ohio

### Lead Splicers (49Z)



For quicker and easier replacement of components such as resistors and capacitors on printed-circuit boards, Colman "Splicers" can be used as follows: Clip the faulty component from the printed board, leaving short lead stubs. Slip a "Splicer" over each stub; insert the new component leads

in the other end of the "Splicers," and solder. The job is completed before appreciable heat is conducted to the printed board.

### Compact Speaker (50Z)



This 10-watt speaker by Jensen Mfg. Co. features special corrosion- and weather-proof construction, in a slim 8 1/8" x 2 3/16" size. Designed primarily for schoolrooms, offices, restaurants, stores, and similar installations, the C-835 can also be used for time-warning and alarm signals. Its impedance is 8 ohms, and its frequency response is from 35 cps to 18 kc, with a bass resonant point at 70 cps. Net weight is only 1 lb., 10 oz. The unit carries a list price of \$10.00.

### VOM (51Z)



This 200K-ohm-per-volt VOM from Triplett features a meter movement with taut-band suspension; no pivots, bearings, or hairsprings are used. The unit has a 5-ua meter, and can measure semiconductor leakage from .1 ma to 12 amperes. The Model 630-NS, in a molded black case measuring 3 11/32" x 5 1/2" x 7 1/2", carries a list price of \$99.50.

### Desoldering Tool (52Z)



Available from local distributors is this new desoldering tool for removing and replacing compactron sockets on printed boards. The unit is designed by Eversole Industries to fit your present soldering gun. It is possible with this tool to heat all the terminals simultaneously instead of one at a time. Similar tools for removing other multicontact components are available.

### Miniature Tubes (53Z)

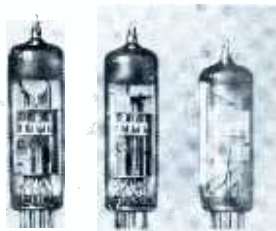

Three 9-pin miniature vacuum tubes designed for home entertainment equipment are being marketed by ITT. The ECL800 (6KH8) is used for push-pull audio amplification with phase inversion, and has a total power dissipation of 12 watts. The ELL80, capable of up to 9 watts of push-pull output, is designed for use as an

audio output tube in stereo amplifiers, recorders, and radios, or as a reactance tube in TV receivers. The EM84A voltage-indicator tube can provide a visual tuning indication for AM-FM radios, as well as audio-level monitoring in tape recorders.



SEE NEW  
INDUSTRIAL MODELS  
BOOTH 4008

**"Don't tell me  
all power supplies are the same  
... I've used Electro for 10 years  
and I know better!"**



(... quote from a user who refused to be sold a substitute)



**30 ADC output  
at 1% AC ripple**

... up to 50 ADC  
for short periods

"PS-30" 12 VDC Power Supply offers many performance/operating advantages of high-priced brands.

**Broad application** ... service all communication equipment; use as power source for base station operation, quality control, varied industrial and laboratory needs.

**Variable voltage** ... 8-position selector switch gives wide range of voltage adjustment.

**Low DC impedance** ... 0.27 ohms, no load to full load.

**Guaranteed 1 year** ... many years of satisfactory service assured with special circuitry, patented conduction cooling and top quality components.

*Stocked at Your Electronic Distributor*

**18 OTHERS FROM 6 TO 125V ... \$19.95 TO \$195.00  
FREE SELECTION GUIDE PS-562R ON COMPLETE LINE**



**ELECTRO PRODUCTS  
LABORATORIES**

6125-T Howard, Chicago 48 (Niles), Ill.  
Phone: 647-6125

Canada: Atlas Radio Ltd., Toronto

Since 1936 ... Pioneers in Low Voltage DC Power Supplies

MAY, 1963

Acme Electric Corp. .... 84  
 Admiral Sales Corp. .... 36  
 Aerovox Corp. .... 83  
 Ampere Electric Corp. .... 19  
 Antennacraft Co. .... 90  
 Antenna Specialists Co., The ..... 12  
 Arco Electronics, Inc. .... 46  
 ATR Electronics, Inc. .... 12  
 B & K Mfg. Co.  
 Div. of Dynascan Corp. .... 35, 37, 40  
 Belden Mfg. Co. .... 65  
 Berns Mfg. Co., Inc., The ..... 66  
 Bussmann Mfg. Div. .... 16-17  
 Cadre Industries ..... 77  
 Castle TV Tuner Service ..... 57  
 Centralab, Div. of Globe-Union, Inc. .... 45  
 Champion DeArment Tool Co. .... 52  
 Clarostat Mfg. Co., Inc. .... 67  
 Colman Electronic Products ..... 56  
 Cush Craft ..... 82  
 Delco Radio Div. (GMC) ..... 69  
 Duotone Co., Inc. .... 56  
 EICO Electronic Instrument Co., Inc. .... 81  
 Electro Products Labs ..... 91  
 Electronic Publishing Co., Inc. .... 86  
 Electro-Voice, Inc. .... 82  
 GC Electronics Co. .... 42  
 General Electric Co.  
 Receiving Tube Dept. .... 43, 49  
 Greyhound Corp. .... 61  
 Harman-Kardon, Inc. .... 85  
 ITT Distributor Products Div. .... 22-23  
 Jackson Electrical Instrument Co. .... 76, 90  
 Jensen Mfg. Co. .... 75  
 Jerrold Electronics Corp. .... 2nd Cover  
 L. A. Tuner Exchange ..... 42  
 Littelfuse, Inc. .... 4th Cover  
 Mallory, P. R. & Co., Inc. .... 41  
 Mercury Electronics Corp. .... 78, 79  
 Merit Coil & Transformer Corp. .... 60  
 Miller, J. W. Co. .... 44  
 Motorola Communications &  
 Electronics, Inc.—Comm. Div. .... 55  
 Oaktron Industries, Inc. .... 48  
 Philco Corp.  
 Parts & Service Operations ..... 13, 62  
 Planet Sales Corp. .... 80  
 Precision Electronics, Inc. .... 89  
 Precision Tuner Service ..... 74  
 Quam-Nichols Co. .... 70  
 Raytheon Co. .... 59  
 RCA Electron Tube Div.  
 Electronic Instrument Section ..... 21  
 Commercial Engineering Dept. .... 64  
 Receiving & Picture Tubes ..... 71, 3rd Cover  
 RCA Parts & Accessories ..... 47  
 RCA Sales Corp. .... 63  
 Rohn Mfg. Co. .... 72  
 Sams, Howard W. & Co., Inc. .... 73, 76  
 Sarkes Tarzian Inc.  
 Tuner Div. .... 9  
 Seco Electronics, Inc. .... 87  
 Semitronics Corp. .... 39  
 SENCORE, Inc. .... 51, 53, 54  
 Sonotone Corp. .... 68  
 Sprague Products Co. .... 10  
 Stancor Electronics, Inc. .... 88  
 Terado Corp. .... 86  
 Utah Electronics Corp. .... 86  
 Utica Communications Corp. .... 74  
 Volkswagen of America, Inc. .... 18  
 Western TV Tuner Rebuilders ..... 52  
 Winegard Co. .... 14-15  
 Workman Electronic Products, Inc. .... 66  
 X-Acto Precision Tools, Inc. .... 80  
 Yeats Appliance Dolly Sales Co., Inc. .... 84  
 Zenith Sales Corp.  
 Parts Sales Div. .... 24

ANTENNAS & ACCESSORIES

- 1Z. **BLONDER-TONGUE**—28-page catalog, "Planning Master TV Antenna Systems;" also booklet, "Closed-Circuit Television Guide for Business and Industry."  
 2Z. **CHANNEL MASTER** — Brochure describing *Super-Crossfire* high-gain antenna, designed for both stereo-FM and TV reception.  
 3Z. **CUSH CRAFT**—Illustrated brochure on complete line of Citizens-band antennas and accessories, including *Blitz Bug* coaxial lightning arrester. See ad page 82.  
 4Z. **JERROLD** — Information on Model UVC-7083 *Ultra-Vista* UHF converter for MPAT1 and translator areas, with RF amplifier preceding nuvistor oscillator. See ad 2nd cover.  
 5Z. **JFD**—Brochure on LPV log-periodic TV antennas and *Transis-tenna*; also bulletins and catalogs showing entire line of TV-FM indoor antennas and accessories.  
**AUDIO & HI-FI**  
 6Z. **DUOTONE**—Supplemental 1963 catalog and needle-replacement Wall Chart. See ad page 56.  
 7Z. **QUAM-NICHOLS** — *Speaker Replacement Guide* listing the speakers used in all automobiles from 1955 through 1962. See ad page 70.  
 8Z. **SONOTONE**—Specification sheet SAH-70 giving information on *Sono-Flex* flexible phono needle. See ad page 68.

COMMUNICATIONS

- 9Z. **CADRE**—Bulletins on four 5-watt Citizens-band radios, and on new 1.5-watt hand-held transceiver. See ad page 77.

COMPONENTS

- 10Z. **BUSSMANN**—Bulletin SFUS, 12-page booklet listing the complete line of *Buss* and *Fusetron* fuses by size and type; also shows proper fuseholder and list price. See ad pages 16-17.  
 11Z. **SPRAGUE** — Catalog C-614 showing complete listings of all stock parts for TV and radio replacement use, as well as *Transfarad* and *Tel-Ohmike* capacitor analyzers. See ad page 10.

SERVICE AIDS

- 12Z. **CASTLE**—Leaflet describing fast overhaul service on television tuners of all makes and models; also illustrated lists of universal and original-equipment tuners. See ad page 57.  
 13Z. **INJECTORALL** — New 1963 catalog showing complete line of chemicals used in electronics.  
 14Z. **PRECISION TUNER**—Information on repair and alignment service for any TV tuner. See ad page 74.  
 15Z. **YEATS** — Literature describing the Model 5 appliance dolly, featuring all aluminum I-beam construction. See ad page 84.

SPECIAL EQUIPMENT & SERVICES

- 16Z. **ACME ELECTRIC**—Specifications and applications for control-type magnetic amplifiers with capacities from 5-1000 watts and voltage ranges from 24-160 volts. See ad page 84.  
 17Z. **ATR**—Literature on 1963 series Karadios, including both transistor-powered and tube types. All sets available as "universal" or "customized." See ad page 12.  
 18Z. **ELECTRO PRODUCTS** — Descriptive folder ECS-363 and cross-reference *Selection Guide* PS-562R giving specifications and information on available DC power supplies. See ad page 91.  
 19Z. **GC ELECTRONICS**—New FR-65 general catalog containing 330 pages of new products and standard lines of all divisions. See ad page 42.  
 20Z. **GREYHOUND** — Complete information on Greyhound Package Express, including rates and routes. See ad page 61.  
 21Z. **LAFAYETTE RADIO**—Brochure with information about owning associate store.  
 22Z. **OLYMPIC**—Catalog showing complete line of stereo and monophonic hi-fi, radios, and TV receivers.  
 23Z. **PACO** — Information on Model 1010 stereo-FM multiplex unit, including preamp and amplifier; also data on new stereophonic tape deck.  
 24Z. **PRECISION ELECTRONICS**—Catalog giving information on popular PA and

professional sound equipment. See ad page 89.

- 25Z. **SEMITRONICS**—Replacement and substitution charts for transistors and diodes; also *Telechron* clock troubleshooting and replacement guide. See ad page 39.  
 26Z. **VOLKSWAGEN** — 60-page illustrated booklet "The Owner's Viewpoint," describing how various business enterprises use VW trucks; complete specifications on truck line. See ad page 18.

TECHNICAL PUBLICATIONS

- 27Z. **CLEVELAND INSTITUTE OF ELECTRONICS** — "Pocket Electronics Data Guides" with conversion factors, formulas, tables, and color codes. Also folder, "Choose Your Career In Electronics," describing home-study electronics training programs, including FCC-license preparation.  
 28Z. **GRANTHAM SCHOOL OF ELECTRONICS**—Booklet describing resident and correspondence courses available to prepare you for an FCC commercial radiotelephone operator license.  
 29Z. **MOTOROLA TRAINING INSTITUTE** — Comprehensive home-study course on FM two-way communications servicing, including a section on transistors and transistorized equipment.  
 30Z. **HOWARD W. SAMS** — Literature describing all current publications on radio, TV, communications, audio/hi-fi, and industrial electronics, including Fall-Winter 1962 Book Catalog and descriptive flyer on 1962 *Test Equipment Annual*. See ads pages 73, 76.

TEST EQUIPMENT

- 31Z. **ANTRONICS**—General catalog describing Anchor Model T-475 *Reacto-Tester*, which repairs, analyzes, and tests every type of picture tube.  
 32Z. **B & K**—Catalog AP20-R giving data and information on Model 850 *Color Analyst*, Model 960 *Transistor Radio Analyst*, Model 1076 *Television Analyst*, *Dynamatic* 375 VTVM, *V-O-Matic* 360, Model 625 *Dyna-Tester*, Models 600 and 700 *Dyna-Quik* tube testers, Models 420 and 440 CRT Tester-Reactivators, and Model 1070 *Dyna-Sweep* Circuit Analyzer. See ads pages 35, 37, 40.  
 33Z. **EICO**—New 32-page catalog of kits and wired equipment: test equipment (including new Model 902 IM/Harmonic Distortion Meter and AC VTVM), stereo and monophonic hi-fi, Citizens-band transceivers, ham gear, and transistor radios. Also information on general construction procedures, "Short Course for Novice License," and "Visu-tronic Teaching Aids." See ad page 81.  
 34Z. **HICKOK**—Information about specifications of new Model 677 Wide Band Oscilloscope; also "Scope Facts."  
 35Z. **KARG**—Data sheet and instruction booklet for MX-1G Stereo Multiplex Signal Generator; also "Alignment And Adjustment of Stereo-FM Tuners And Adapters."  
 36Z. **MERCURY**—Literature giving information and specifications on popular-priced servicemen's test equipment. See ads pages 78, 79.  
 37Z. **PEL ELECTRONICS**—Bulletins giving information on DM201 all-transistor "grid" dip meter and SG101 signal generator.  
 38Z. **SECO**—Information on *Transistor and Tunnel Diode Analyzer*, a "complete transistor lab" requiring no setup data. See ad page 87.  
 39Z. **SENCORE** — Complete information on CA122 *Color Circuit Analyzer* and PS120 *Wide-Band Scope*. See ads pages 51, 53, 54.

TOOLS

- 40Z. **BERNS**—Data on 3-in-1 picture tube repair tools, on *Audio Pin-Plug Crimper* that lets you make pin-plug and ground connections for shielded cable without soldering, and on *ION* adjustable "beam bender." See ad page 69.  
 41Z. **ENTERPRISE DEVELOPMENT** — Literature from Endeco on improved desoldering and resoldering techniques for use on PC boards.  
 42Z. **EVERSOLE** — Sheets describing and listing prices of *DeSod* desoldering tools for removing and replacing parts on printed circuit boards, including new tip for miniature IF transformers.

TUBES

- 43Z. **AMPEREX** — 33-page condensed tube catalog with numerical index, descriptions, and basic specifications. See ad page 19.

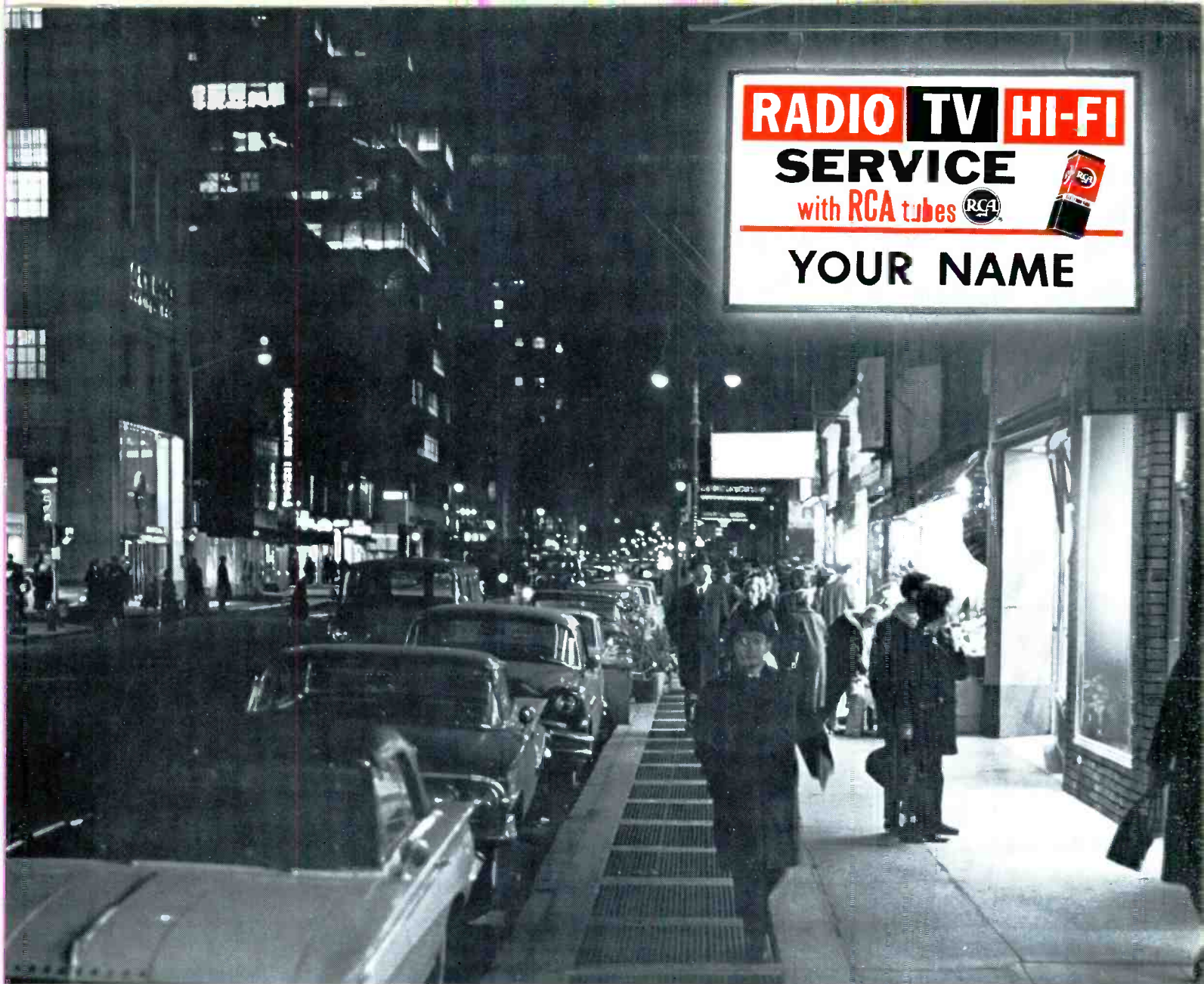

## Let RCA put your name in lights

Put a bright new face on your store front with a striking illuminated outdoor hanging RCA business sign. Through Authorized RCA Tube Distributors, RCA offers you a choice of two new double-faced illuminated shop signs imprinted with your business name. Made of weather-proof translucent plastic, RCA business signs:

- Brighten your entire shop front
- Give your business a smart, modern, efficient appearance
- Focus attention on your services
- Fix your shop location in the minds of potential customers
- Associate your business with the prestige and customer acceptance of RCA—the most trusted name in electronics



### SIGNS IN TWO POPULAR SIZES

3' x 5' Double-Faced Illuminated Hanging Sign—1A1341

2' x 5' Double-Faced Illuminated Hanging Sign—1A1340

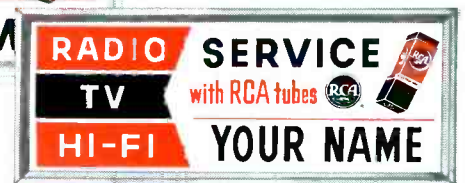

Find out now how you can get yours. Your participating Authorized RCA Electron Tube Distributor has all the facts. Call him today.

RCA ELECTRON TUBE DIVISION, HARRISON, N. J.



**The Most Trusted Name in Electronics**

# FASTER THAN A SHORT CIRCUIT



## SUB-MINIATURE MICROFUSES

and microfuse holders  
for internal connection  
and panel mounting.

1/500AMP. thru 5 AMPS.  
@ 125 volts. Will  
interrupt 10,000 AMPS.  
DC short circuit.



## 8AG INSTRUMENT FUSES

1/500 AMP. thru 5 AMPS.

For instrument and meter protection, Littelfuse  
pioneered the design and  
development of reliable fast-acting fuses.

# LITTELFUSE

Des Plaines, Illinois