

DECEMBER, 1961

35 CENTS

# PHOTOFACT REPORTER

including **Electronic Servicing**

Handling IF Transformer Troubles  
There's Big Money in the  
Antenna System Business  
Troubleshooting Diode AFC Systems  
Test Setups for 2-Way Service

IA OK 7496 1264  
WM. M. DAVIS  
RAD. & TV SERV.  
118 RIVERSIDE AVE.  
CANNON CITY, COLO.

# Standard Made It...



## STANDARD CAN FIX IT BEST

**\$11<sup>50</sup>** Plus Parts . . . **\$13.50 Maximum Total Cost**

**FREE** Specially designed shipping cartons to prevent damage in transit

### 6 Months GUARANTEE

Only BRAND NEW PARTS Used • 48 Hour  
Service on All STANDARD Tuners • Latest  
Testing Techniques Assure Proper Alignment •  
\$3.00 Defective Tuner Trade-in Allowance  
Against a New STANDARD Replacement Tuner  
Carrying a 12 MONTH GUARANTEE

IN TV IT'S *Standard*

STANDARD has maintained uniform mounting centers for the last 13 years. Over 50% of the TV sets in existence today have STANDARD tuners—in the case of most other tuners one of the 8 STANDARD replacement models can be easily adapted or will fit directly in place of these units. All STANDARD replacement tuners carry a 12 Month Guarantee.

**SEE YOUR AUTHORIZED  
STANDARD DISTRIBUTOR**

MORE PROFIT FOR THE SERVICE DEALER • GREATER CUSTOMER SATISFACTION  
GUARANTEED BY THE WORLD'S LARGEST TV TUNER MANUFACTURER

**standard kollman INDUSTRIES INC.**

FORMERLY STANDARD COIL PRODUCTS CO., INC., MELROSE PARK, ILLINOIS

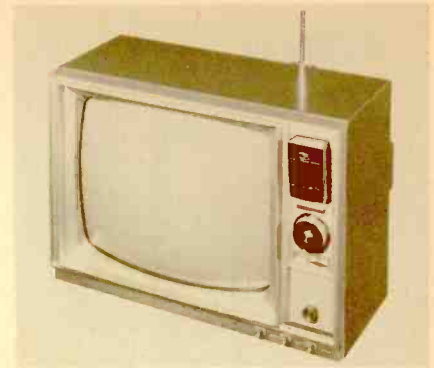
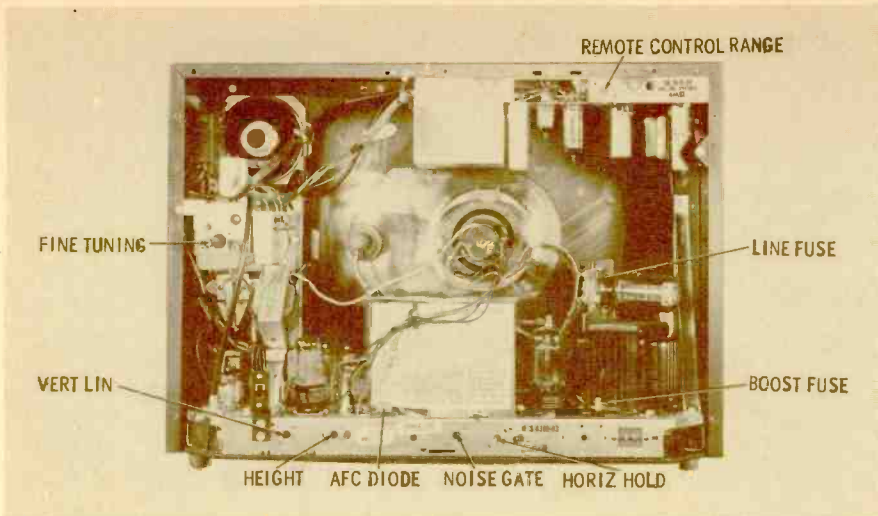

### Motorola Model A19T8 Chassis WTS-436B (03)

This model is representative of Motorola's 1962 line of 19" compact sets, and incorporates most of the optional features offered in this chassis series.

Unusual tube types include a 6BL8 sync amplifier-horizontal oscillator, 6GK6 video-output and audio-output amplifiers, and 6AL3 or 6AF3 dampers. The 6EY6 is used in the vertical output circuit of some sets; however, later production runs are using a newer type, the 6EZ5.

With the rear cover removed, the tube-layout and filament-continuity diagrams can be seen on the rear aprons of the main and remote-control chassis. The 110° aluminized CRT, a 19XP4, is mounted on the chassis. For cleaning the separate safety window (Motorola suggests using very mild soap), it is necessary to remove the chassis-CRT assembly. The chassis is fastened to the cabinet by four bottom screws, another near the tuner, and two at the remote-control chassis. Removing these and the control knobs will permit the chassis to be slipped out the rear.

The horizontal-AFC diode is a plug-in type, located near the HV cage. The line fuse is clip-mounted near the 5U4 rectifier (or its alternate type, the 5DJ4), while the sweep fuse is a plug-in type located near the power transformer. The sweep circuits use modules similar to those found in earlier models. This year, however, the modules plug in rather than being soldered in.

This chassis series uses more than one tuner design; a switch type is used with manual sets, while a turret tuner (something new for Motorola) is used in remote-control models. The latter can be programmed by removing the channel-selector control knob and cover plate, and using a Phillips screwdriver to turn the exposed screw heads — clockwise for stops, and counterclockwise for skips. Fine tuning is of the preset type, adjusted by use of the large knob at the rear. UHF tuning can be added by means of special adapter kits.

The remote control chassis is mounted on the support brackets at the rear of the chassis assembly, above the CRT neck. It is actuated by a two-button rod-and-hammer transmitter. The distance over which the remote system operates can be varied by a RANGE control on the rear apron of the remote-control chassis. For manual operation, a switch on the rear of the main TV chassis serves to disable the remote-control receiver.

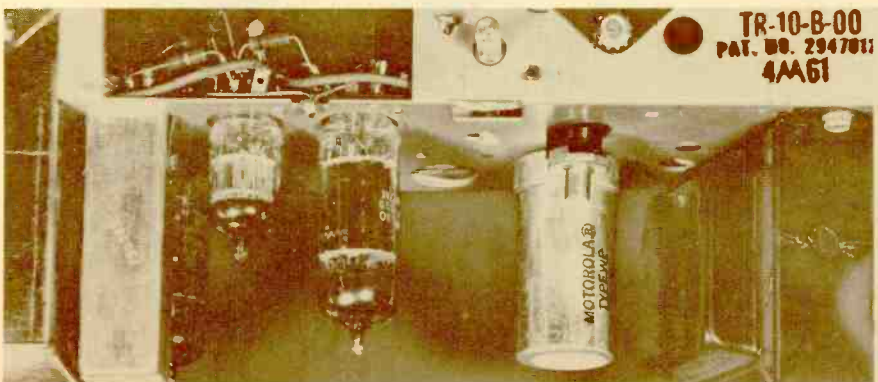
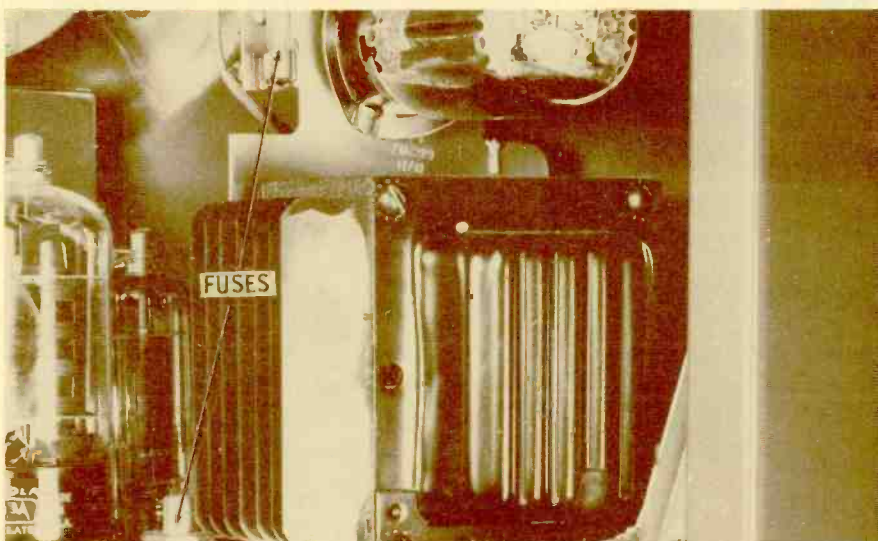

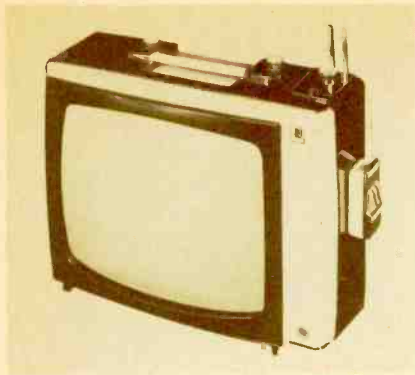

**RCA Model 192-A-079RS  
Chassis KCS137P**

RCA's new "Sportabout" portables are available either with or without remote control. Either of two CRT's may be used—the 19AXP4 or 19AYP4—both aluminumized 114° types.

The remote control is a conventional RCA sonic type. The three-button transmitter controls volume, on-off, and channel selection. The remote-control chassis, a PC board seen in the lower left corner of the rear-view photo, makes use of four standard tubes and an RCA 3852 transistor. The transistor is used as a switcher for the channel-selector relay, which in turn operates the tuner-drive motor. The volume "up and down" action makes use of two diodes (M10, M11) and a tube (V18) to control a stepping relay connected to the volume control and on-off switch.

A variety of tuner types are used. UHF tuners are available only in manually-tuned receivers, and are used with switch-type VHF tuners. Remote-controlled sets incorporate a motor-driven turret tuner. Setup for the preset fine tuning in the latter units is accomplished in a distinctive manner. The power-tuning knob, which is pushed to change channels, is *pulled up* for presetting. To adjust the tuner for channel skip, pull this knob and rotate it six turns clockwise. To change a skipped channel to a "stop" position, turn the set off and remove the knob and cover plate; then, using a screwdriver, rotate the channel selector to the desired channel. Next, pull up on the knob shaft, and rotate it three turns counterclockwise. After programming any channel, be sure to recheck its fine-tuning setting.

To remove the chassis, pull off the control knobs and remove the six rear-cover screws and the four bolts securing the chassis to the cabinet. Disconnecting the speaker, CRT and yoke leads permits complete removal. The CRT can then be removed from the cabinet for cleaning.

To expedite the location of an open filament in the series string, key numbers (such as H5 and H6 in the photo) are printed on the PC board to identify each point along the string. In addition, the tube-location diagram inside the rear cover shows the filament sequence. These features make it possible to check filament continuity without circuit-tracing or tube removal.

Other features include a built-in dipole antenna, a polarized line plug to minimize "hot-chassis" dangers, an optional jack for an external speaker, and accessibility to servicing controls on the rear apron without removal of the rear cover.

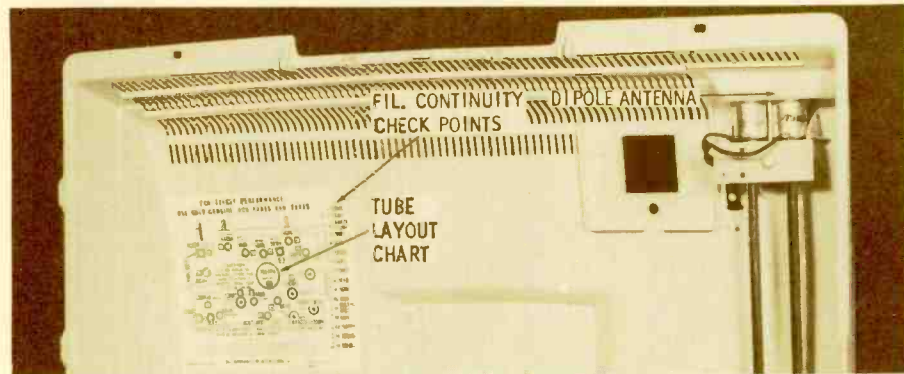
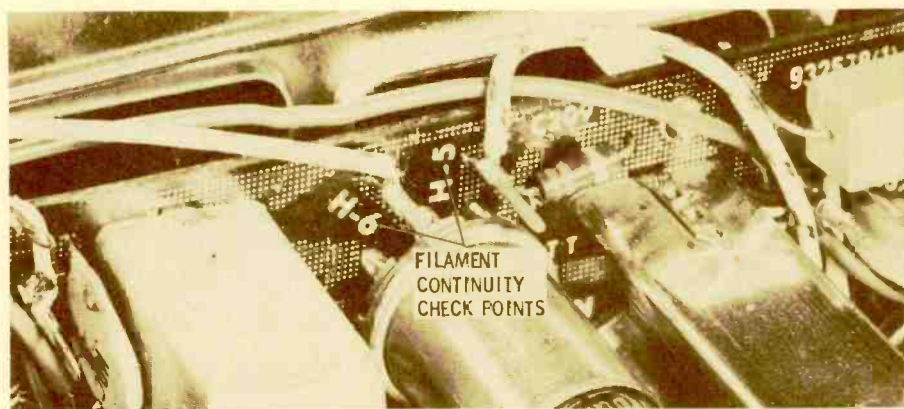
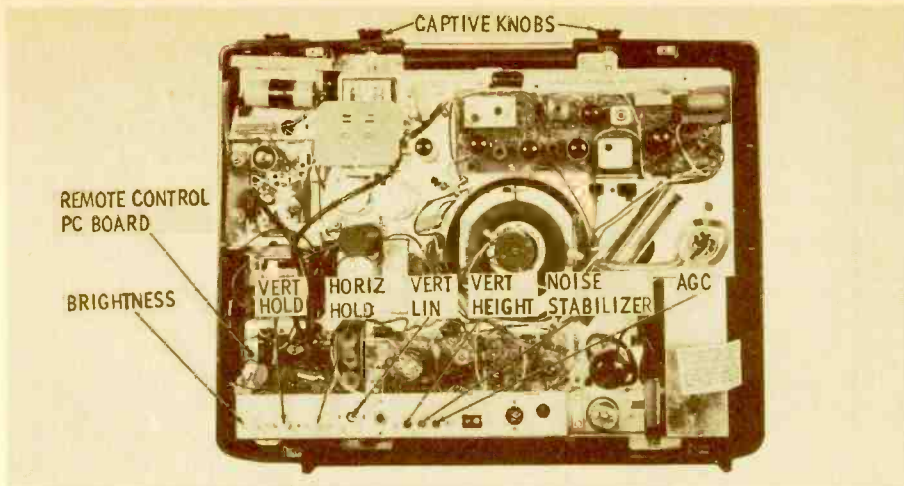

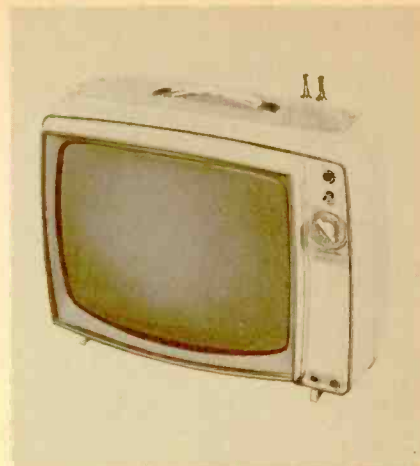
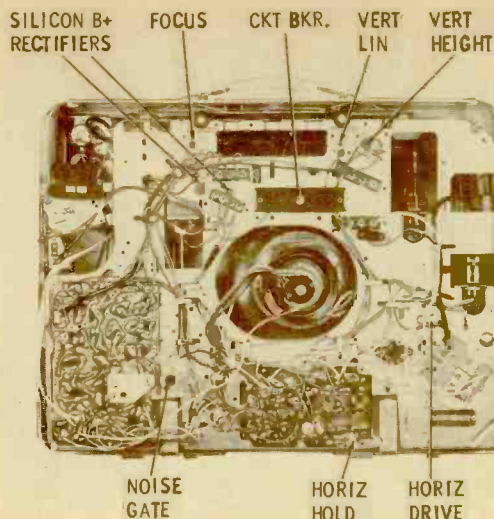

**Silvertone Model 21061**  
**Chassis 528.52422**

The *Medalist* series of Silvertone portables uses a 19AYP4 CRT and several 450-ma controlled-warmup tube types. An 8FQ7 is often used in place of an 8CG7 as the horizontal oscillator, and a 13EM7 serves in the vertical multivibrator-output stage. A 22DE4 is used in the damper circuit. The tuner-tube line-up consists of a 3GK5 low-noise RF amplifier and a 6FG7 oscillator-mixer.

A conventional silicon-diode voltage-doubler arrangement, protected by a 4.5-ohm fusible resistor, is used in the low-voltage power supply. Additional protection is furnished by a thermal-overload circuit breaker. An 18.5-ohm, 5-watt dropping resistor is wired in series with the filament string.

The CRT face is accessible from the front of the cabinet for cleaning. By pressing downward on the frame, the safety window can be unsnapped at the top and dropped forward as shown. The rear cover is removed in a similar manner—by unsnapping it at the top, and tipping it back until it disengages from the bottom hinges.

All tubes are mounted on the front side of the chassis. Removing three screws on top of the set will allow the chassis (which is mounted on hinged brackets) to be swung away from the CRT in briefcase fashion — exposing the tubes and components.

For CRT replacement, the chassis must be separated from its hinge-bracket mounting. A spring-clip combination can then be unclipped to release the CRT from the mask.

A chart on the high-voltage cage shows tube and component locations, as well as the filament-continuity sequence. Most service controls are accessible from either side of the chassis, as shown in the photos. The AFC diode, a soldered-in unit, is located on the PC sweep board.

The width control, a sheet of metal foil fastened to a plastic sleeve, is mounted between the deflection yoke and the neck of the CRT. To adjust this device, the yoke-clamping ring must be loosened. Then, while the yoke is held in place, the sleeve can be slid forward and backward on the neck of the CRT until correct raster width is obtained. Vertical sweep is sometimes affected, so vertical height and linearity should be rechecked. The final positioning of the yoke should be checked before its clamp is tightened.

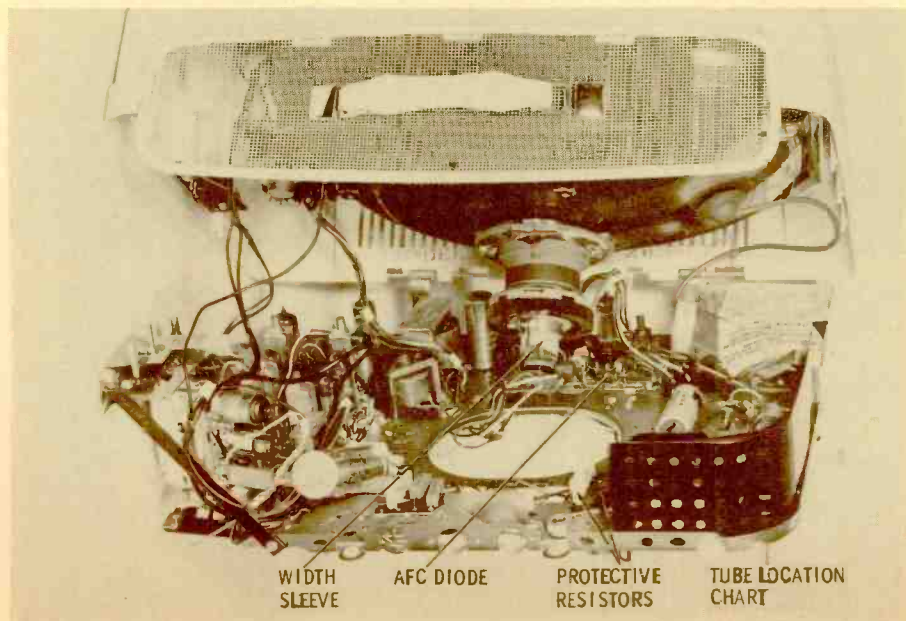
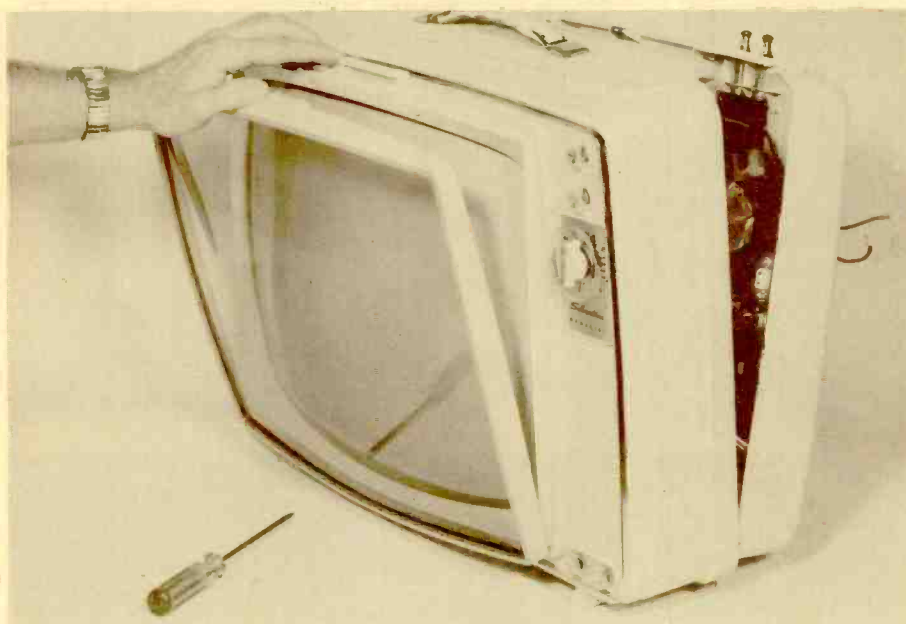

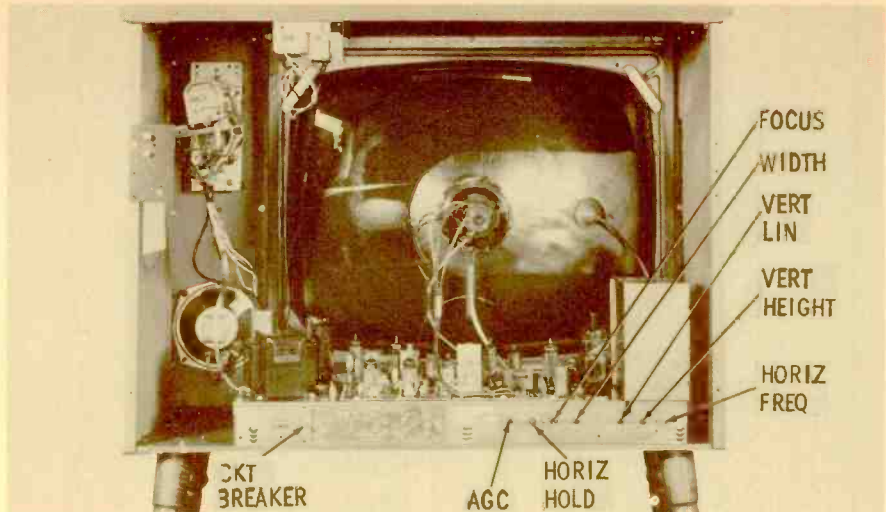

### Sylvania Model 23L48F Chassis 555-01

This model, like most 23" sets in the 1962 Sylvania line, contains the 555 chassis—which includes a number of features new to this manufacturer. The use of a power transformer and parallel filament wiring represents a diversion in design for Sylvania, who has been producing only series-string, transformerless sets since 1957. Additional features include a thermal-overload circuit breaker to protect the B+ circuitry, circuit-identification aids printed on the top side of the PC board, and a horizontal-linearity control.

The 110° aluminized 23BHP4 and 23BGP4 CRT's incorporate a bonded, antiglare etched surface. *Accuratronic focus*, which increases both contrast and brightness, is accomplished with an improved gun design.

The 555 chassis has the same basic circuit design as other recent Sylvania sets. However, because of the changeover to parallel filament wiring, the 555 employs 6-volt versions of the previously-used 600-ma series-string tubes. One of these, the 6ET7 (a combination video amplifier and horizontal AFC dual diode) has never appeared on the market until this year.

Chassis removal is simple, but a few points should be kept in mind. There are seven plug-and-socket combinations which must be disconnected, including the yoke cable, tuner-to-chassis leads, CRT cable, volume-control cable, HV lead, IF input to the chassis and speaker leads. On some models, the *Halolight* and remote-control receiver antenna must also be disconnected. Finally, there is a braided grounding cable connecting the tuner with the main chassis. Removal of the three mounting screws will release the chassis from the cabinet. The tuner assembly can then be taken out by removing the knobs, the board holding the built-in antenna, and one mounting screw.

The front-panel control knobs are connected to their associated controls by means of flexible drive cables which slip over the ends of the control shafts.

For remote control, this series makes use of a transistorized two-button transmitter, which controls volume and channel selection. Mounted at the rear of the cabinet, the 8-kc remote-control receiver chassis makes use of two standard tubes (a 12AT7 and a 12AX7), along with several diodes.

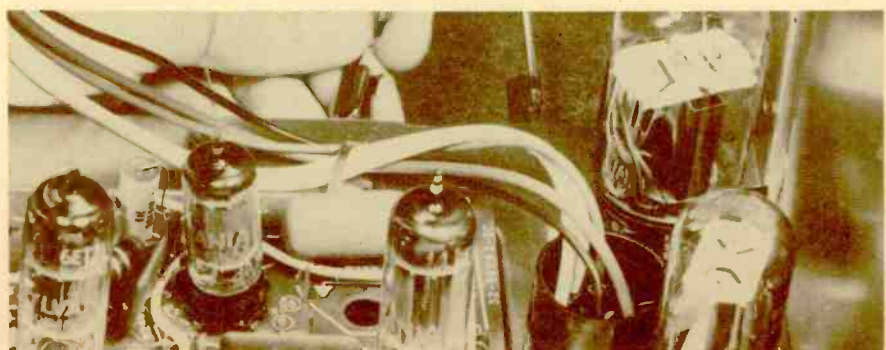
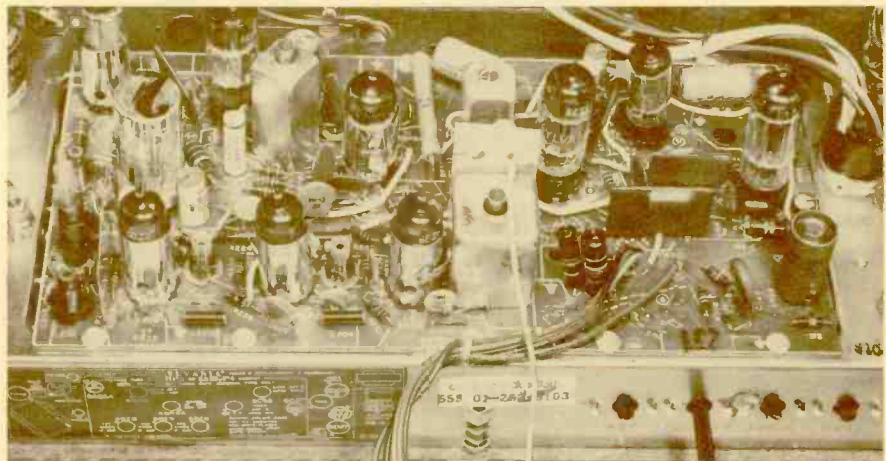
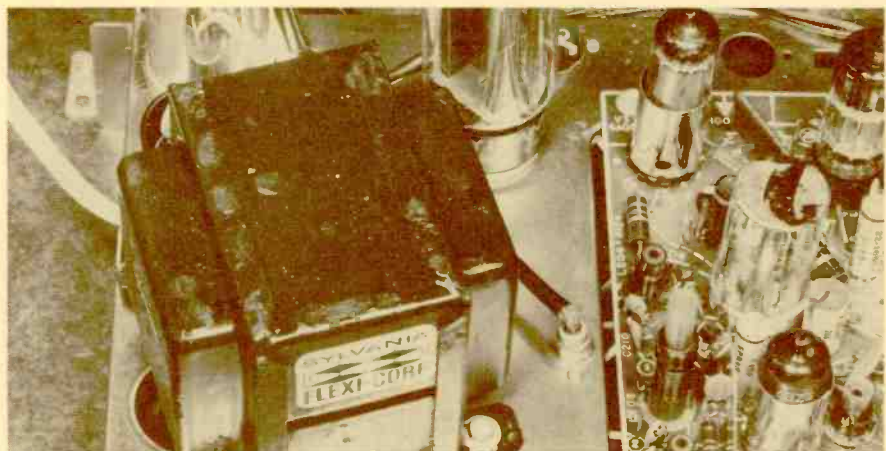

See PHOTOFAC Set 505, Folder 2

Mfr: Airline Chassis No. WG-5200A

Card No: AI-5200A-1

Section Affected: Raster.

Symptoms: Poor vertical linearity.

Cause: Defective capacitor in vertical sawtooth-forming network. Low voltage on plate of vertical oscillator.

What To Do: Replace C28 (.047 mfd).

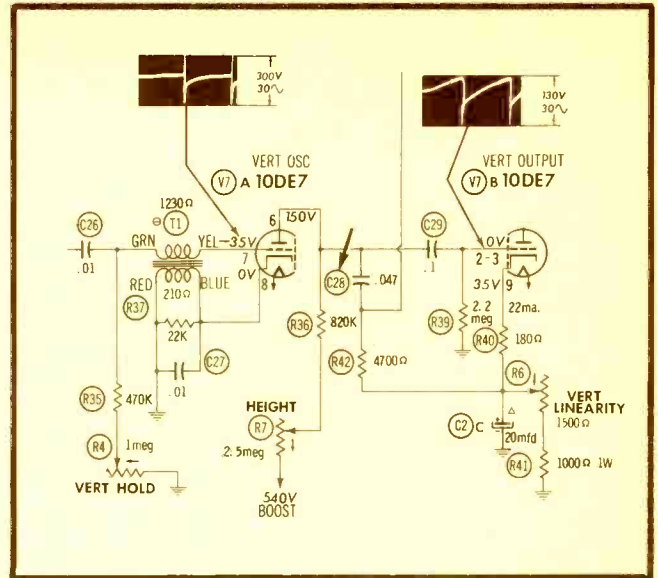

Mfr: Airline Chassis No. WG-5200A

Card No: AI-5200A-2

Section Affected: Raster.

Symptoms: Wrinkles on left side of raster.

Cause: Resistor in yoke circuit has changed value.

What To Do: Replace R59 (5600 ohms).

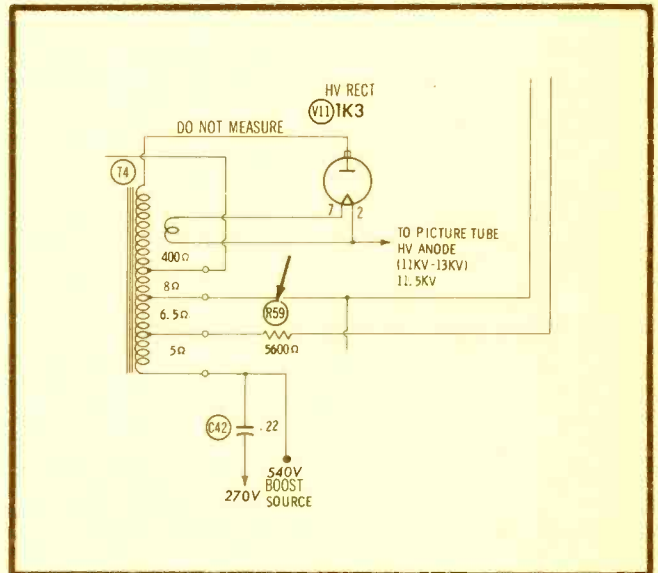

Mfr: Airline Chassis No. WG-5200A

Card No: AI-5200A-3

Section Affected: Sync.

Symptoms: Picture cannot be synchronized horizontally or vertically.

Cause: Defective AGC filter capacitor.

What To Do: Replace C12 (.47 mfd).

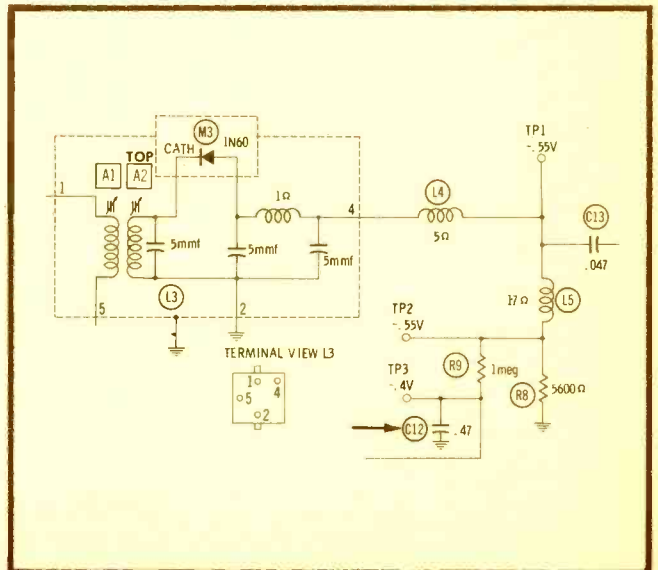

See PHOTOFAC Set 505, Folder 2

See PHOTOFACT Set 505, Folder 2

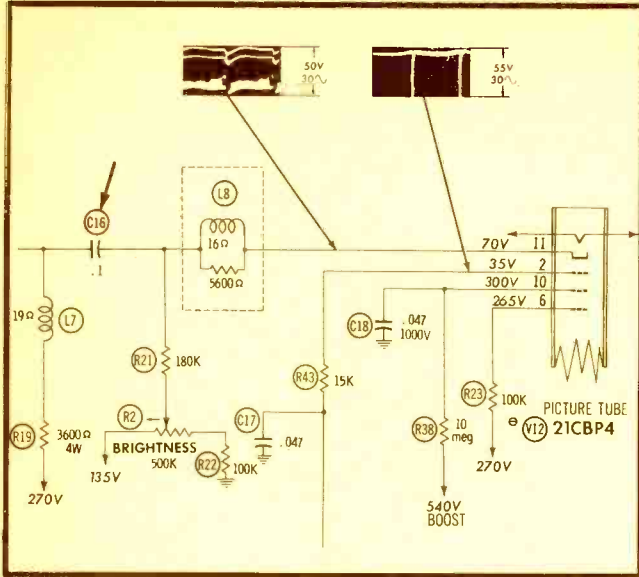

See PHOTOFACT Set 505, Folder 2

Mfr: Airline Chassis No. WG-5200A

Card No: AI-5200A-4

Section Affected: Pix.

Symptoms: Poor picture resolution. Little or no control of brightness. High positive voltage on cathode of picture tube.

Cause: Leaky video-output coupling capacitor.

What To Do: Replace C16 (.1 mfd).

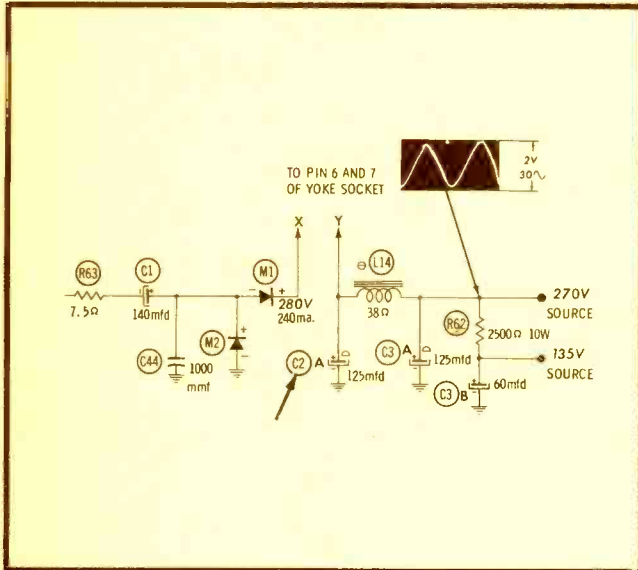

Mfr: Airline Chassis No. WG-5200A

Card No: AI-5200A-5

Section Affected: Raster and pix.

Symptoms: S-curve distortion in entire raster or picture.

Cause: Defective filter capacitor in power supply.

What To Do: Check C2A (125 mfd); if found leaky or open, replace C2 (125-20-20 mfd —300-300-50V).

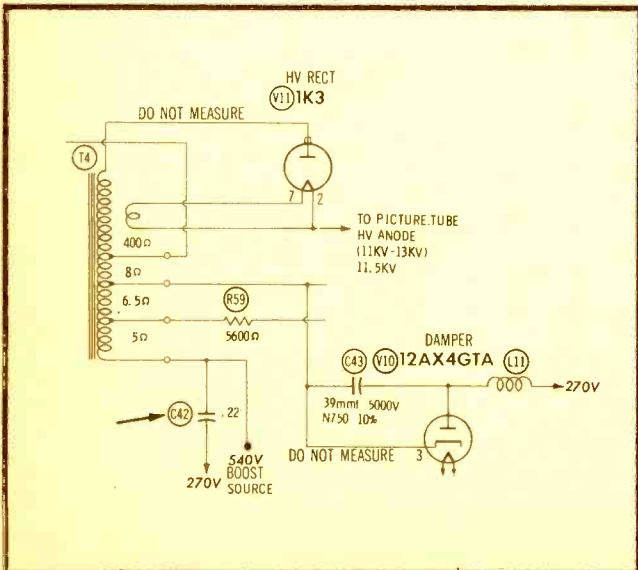

Mfr: Airline Chassis No. WG-5200A

Card No: AI-5200A-6

Section Affected: Pix.

Symptoms: Poor horizontal linearity.

Cause: Defective boost filter capacitor.

What To Do: Replace C42 (.22 mfd).



See PHOTOFACT Set 534, Folder 2

Mfr: Westinghouse Chassis No. V-2412-1

Card No: WE-2412-1

Section Affected: Raster.

Symptoms: Vertical black bars.

Cause: Defective capacitor across secondary of vertical output transformer.

What To Do: Replace C51 (.33 mfd).

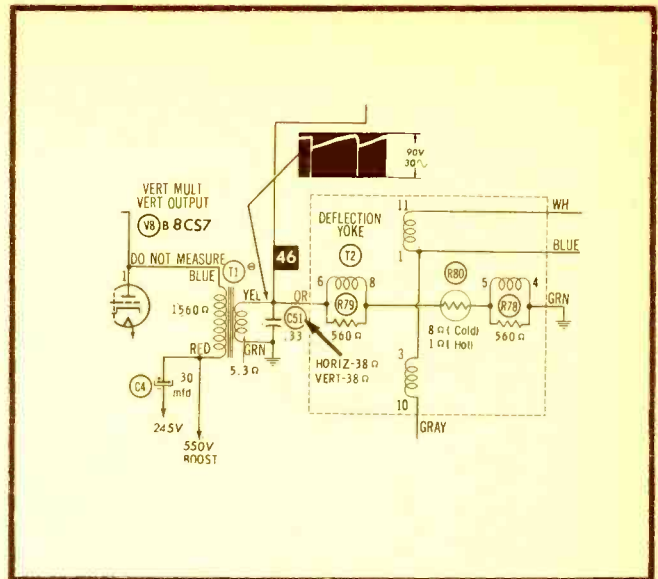

Mfr: Westinghouse Chassis No. V-2412-1

Card No: WE-2412-2

Section Affected: Pix.

Symptoms: Retrace lines in picture.

Cause: Defective capacitor in vertical retrace-blanking circuit.

What To Do: Replace C33 (.047 mfd).

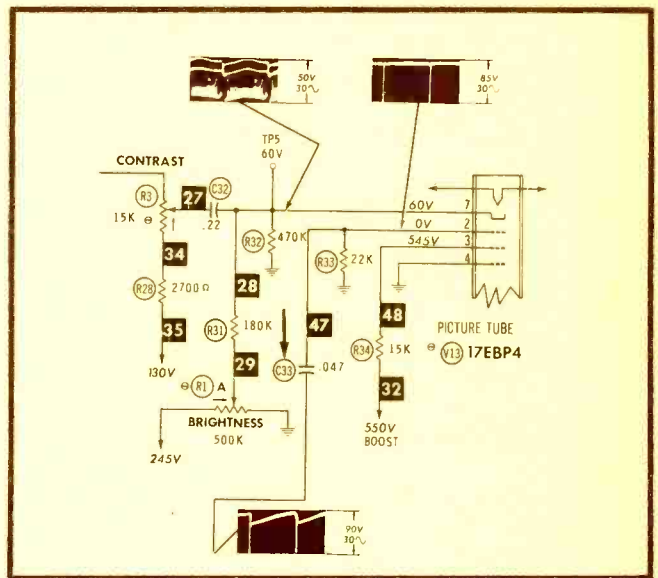

Mfr: Westinghouse Chassis No. V-2412-1

Card No: WE-2412-3

Section Affected: Sync.

Symptoms: Horizontal sync critical or completely lost.

Cause: Open AFC filter capacitor.

What To Do: Replace C52 (10000 mmf).

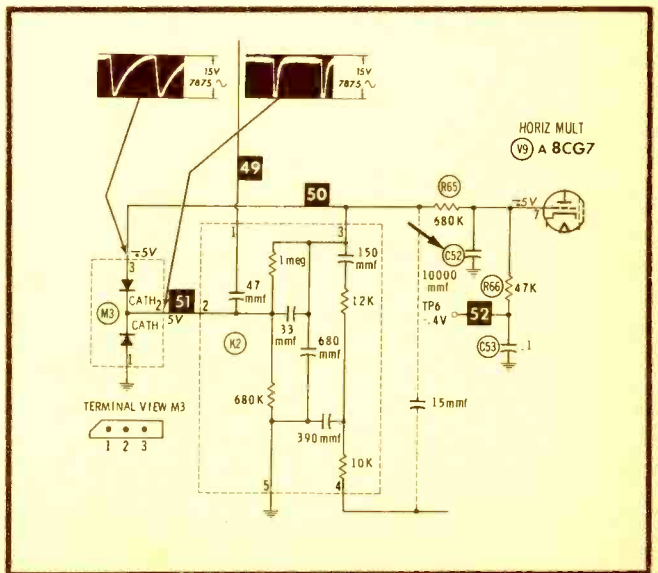

See PHOTOFACT Set 534, Folder 2

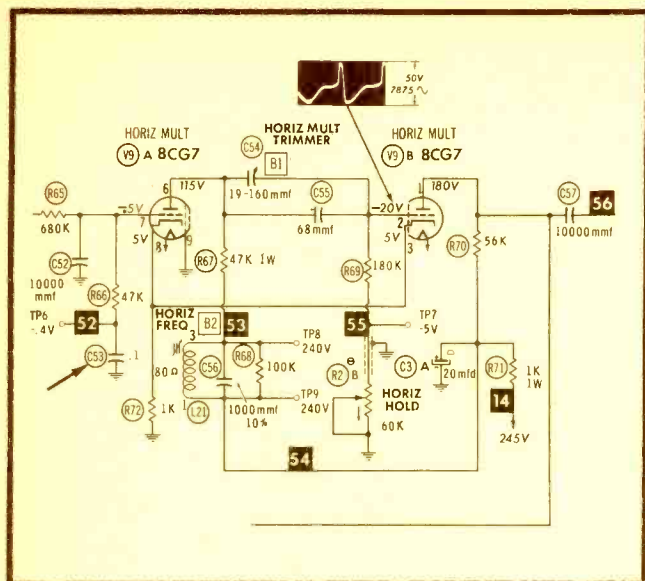

See PHOTOFACT Set 534, Folder 2

Mfr: Westinghouse Chassis No. V-2412-1

Card No: WE-2412-4

Section Affected: Sync.

Symptoms: Bend in top of picture.

Cause: Open capacitor in horizontal-AFC filter circuit.

What To Do: Replace C53 (.1 mfd).

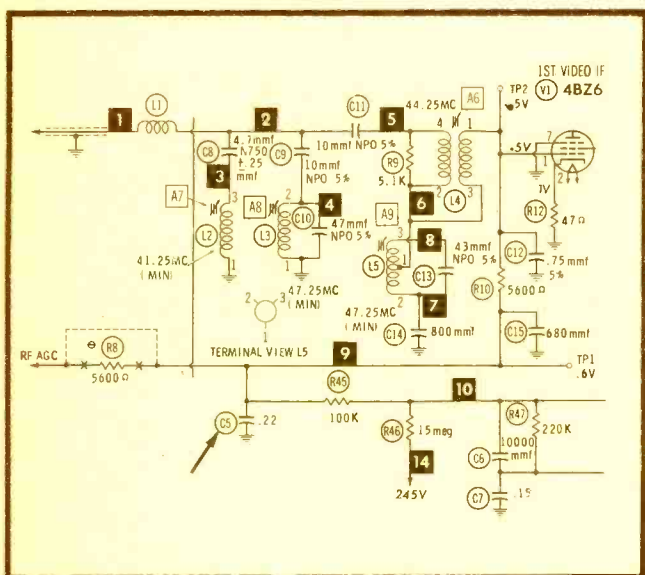

Mfr: Westinghouse Chassis No. V-2412-1

Card No: WE-2412-5

Section Affected: Pix and sync.

Symptoms: Slight overload; bend in top of picture.

Cause: Open AGC filter capacitor.

What To Do: Replace C5 (.22 mfd).

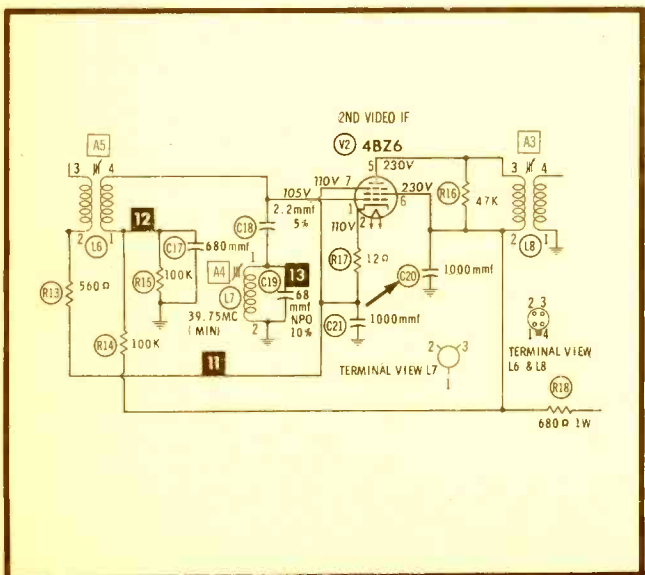

Mfr: Westinghouse Chassis No. V-2412-1

Card No: WE-2412-6

Section Affected: Pix.

Symptoms: Picture break-up indicating oscillation in IF strip.

Cause: Open screen-bypass capacitor in second video IF amplifier.

What To Do: Replace C20 (1000 mmf).

Tarzian offers

# FAST, DEPENDABLE TUNER REPAIR SERVICE

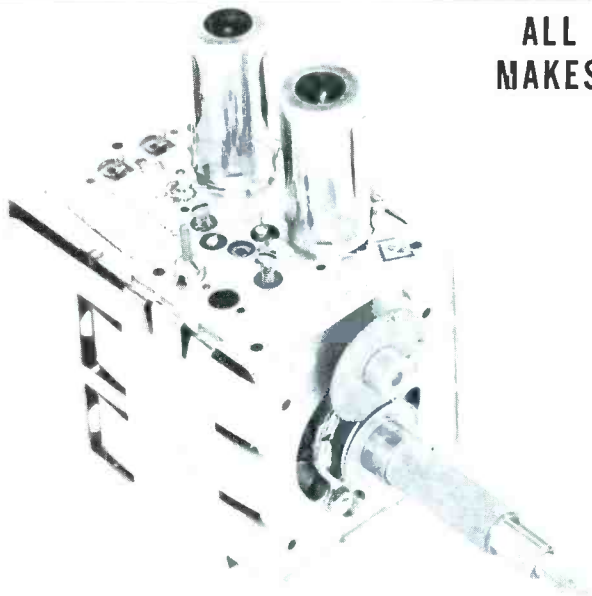

ALL  
MAKES

ONLY  
**\$850**  
INCLUDING

**ALL PARTS  
and LABOR**

**24-HOUR SERVICE  
6-MONTH WARRANTY**

**Tuners Repaired on  
Approved, Open Accounts**

**See your distributor, or  
use this address for fast,  
factory repair service**

It just makes sense that a manufacturer of tuners should be better-qualified, better-equipped to offer the most dependable tuner repair and overhaul service.

Sarkes Tarzian, Inc., pioneer in the tuner business, maintains a complete, well-equipped Factory Service Dept.—assisted by Engineering personnel—and staffed by specialized technicians who handle ONLY tuner repairs . . . on ALL makes and models.

Tarzian-made tuners received one day will be fixed and shipped out the next. Cost is only \$8.50 and \$15 for UV combinations. That includes ALL parts and labor, and a 6-month guarantee against defective workmanship and parts failure due to normal usage. Replacements available at low cost on tuners beyond practical repair.

Ⓢ Tarzian-made tuners are identified by this stamping. When inquiring about service on other tuners, always give tube complement . . . shaft length . . . filament . . . voltage . . . series or shunt heater . . . IF frequency . . . chassis identification. All tuners repaired on approved, open accounts. Check with your local distributor for Sarkes Tarzian replacement tuners, replacement parts, or repair service.

SERVICE MANAGER • TUNER DIVISION • DEPT. 3A  
 **SARKES TARZIAN INC**  
east hillside drive • bloomington, indiana  
edison 2-7251

MANUFACTURERS OF TUNERS . . . SEMICONDUCTORS . . . AIR TRIMMERS . . . FM RADIOS . . . AM-FM RADIOS . . . AUDIO TAPE . . . BROADCAST EQUIPMENT and SHISH-KABOB GRILLES

**publisher**  
Howard W. Sams

**general manager**  
Mal Parks, Jr.

**editor**  
Verne M. Ray

**associate editors**  
Forest H. Belt  
James F. Galloway  
Thomas A. Lesh

**consulting editors**  
William E. Burke  
Robert B. Dunham  
Joe A. Groves  
George B. Mann  
C. P. Oliphant  
Paul C. Smith

**art director**  
Don W. Bradley

**advertising & editorial assistants**  
Georgeanna Caldwell  
Paula Haffner  
Jean Sekulski

**production manager**  
Robert N. Rippy

**circulation fulfillment**  
Pat Tidd, Mgr.  
Constance Bland, Ass't.  
Katherine Smith, Ass't.

**photography**  
Robert W. Reed

**advertising sales offices**  
**midwestern**

John Groce, advertising sales manager  
PF REPORTER  
2201 East 46th Street, Indianapolis 6, Ind.  
Clifford 3-6441

**eastern**

Charles Horner  
Howard W. Sams & Co., Inc.  
3 West 57th Street,  
New York, N. Y.  
Murray Hill 8-6350

**western**

The Maurice A. Kimball Co., Inc.  
2550 Beverly Blvd., Los Angeles 57, Calif.  
Dunkirk 8-6178; and 681 Market Street,  
San Francisco 5, Calif. Exbrook 2-3365

**Address all correspondence to**  
PF REPORTER, 2201 East 46th Street,  
Indianapolis 6, Indiana



Copyright © 1961 by Howard W. Sams & Co., Inc. PF REPORTER is a trademark of Howard W. Sams & Co., Inc. No part of PF REPORTER may be reproduced without written permission. No patent liability is assumed with respect to use of information herein. Acceptance of advertising does not in any manner signify the products, policies and services so advertised have been approved, endorsed or recommended by this magazine.

Indexed in Lectradex.  
Printed by the Waldemar Press Div.  
of Howard W. Sams & Co., Inc.



# PF REPORTER

including **Electronic Servicing**

VOLUME 11, No. 12    **CONTENTS**    DECEMBER, 1961

<b>Previews of New Sets</b>		<b>3</b>
<small>Motorola Model A19T8CHA (Chassis WTS-436B), RCA Model 192-A-079RS (Chassis KCS137P), Silvertone Model 21061 (Chassis 528-52422), Sylvania Model 23L48F (Chassis 555-01).</small>		
<b>Video Speed Servicing</b>		<b>7</b>
<small>Service hints on Airline Model WG-5200A and Westinghouse Chassis V-2412-1.</small>		
<b>Letters to the Editor</b>		<b>21</b>
<b>Handling IF-Transformer Troubles</b>	<i>Allan F. Kinckiner</i>	<b>26</b>
<small>Shop Talk—Techniques for repairing defects in unreplaceable cans.</small>		
<b>The Electronic Scanner</b>		<b>28</b>
<b>Circuit Voltages Tell the Story</b>	<i>Paul Goldberg</i>	<b>32</b>
<small>Quicker Servicing—How a "pro" makes short work of bench jobs, using only a VTVM.</small>		
<b>The Troubleshooter</b>		<b>37</b>
<b>FM Stereo and the Serviceman</b>	<i>Norman H. Crowhurst</i>	<b>38</b>
<small>Audio Facts—Familiarizes you with stereo receiver circuits and typical installation problems.</small>		
<b>TV Service-Charge Survey</b>	<i>Forest H. Belt</i>	<b>40</b>
<small>Servicemen across the nation report on their price schedules.</small>		
<b>Test Setups for Servicing Two-Way Radio</b>	<i>Richard Martin</i>	<b>42</b>
<small>Test sets for metering transmitter and receiver circuits.</small>		
<b>There's Big Money in Antenna-System Business</b>	<i>Jim Galloway</i>	<b>44</b>
<small>... and a crying need for someone to go out after it.</small>		
<b>Solving the Unclaimed Merchandise Problem</b>	<i>Art Margolis</i>	<b>56</b>
<small>Dollar and Sense Servicing—What you can do, legally, to dispose of "abandoned" sets.</small>		
<b>A Burglar's-Eye View of Service Shops</b>	<i>William R. Morey</i>	<b>62</b>
<small>Words of wisdom—from an inmate of a state prison in Michigan.</small>		
<b>Troubleshooting Diode AFC Systems</b>	<i>Irving Tepper</i>	<b>66</b>
<small>Knowing what happens in this stage makes it much easier to service.</small>		
<b>Notes on Test Equipment</b>		<b>74</b>
<small>Lab reports on the EICO Model 1064 Battery Eliminator and Charger, RCA Model WV-98B (K) VTVM kit, and Seco Model 520 Antenna Tester.</small>		
<b>Service Dealer Advertising Program</b>		<b>85</b>
<small>Last of a 12-month series.</small>		
<b>Product Report</b>		<b>98</b>
<b>Free Catalog &amp; Literature Service</b>		<b>100</b>
<b>Monthly Index</b>	<b>on free literature card</b>	

## ABOUT THE COVER

Whatever your favorite subject in electronics may be—TV troubleshooting, the business aspect of running a service shop, two-way radio testing, or stereo hi-fi—we've put something special under our "tree" for you.

Let us be among the first to wish you a Merry Christmas!



*the only one of its kind!*



NOW . . . THE *First* ANALYZER DESIGNED EXCLUSIVELY FOR TESTING TRANSISTOR CIRCUIT CAPACITORS!

## SPRAGUE MODEL TCA-1 TRANSFARAD\*

**THERE'S NOTHING LIKE IT ON THE MARKET ANYWHERE . . . AT ANY PRICE!**

Here, for the first time, is a precision-made instrument which is specifically designed to *safely* test low-voltage aluminum and tantalum electrolytic capacitors, film and paper capacitors, and ceramic capacitors. *No laboratory or shop working with transistor circuit capacitors can afford to be without one!*

**CAPACITANCE BRIDGE:**  $1\mu\text{f}$  to  $2,000\mu\text{f}$  in five overlapping ranges, with laboratory accuracy.

**INSULATION RESISTANCE:** 50 megohms to 20,000 megohms. Only 25v d-c is applied, permitting measurements on low-voltage ceramic, paper, mica, and film capacitors. For ceramics rated below 25 volts, IR may be calculated from leakage current measurements at exact rated voltage.

**POWER FACTOR:** Measured by Wien Bridge from 0 to 50%.

**LEAKAGE CURRENT:**  $0.6\mu\text{a}$  to  $600\mu\text{a}$  in 7 ranges. Measured directly on meter at exact rated d-c voltage of capacitor. No guessing on eye-width or counting lamp blinks!

**A-C BRIDGE VOLTAGE:** Only 0.5v is applied to the bridge. The voltage across the capacitor is less than this applied voltage, the amplitude depending upon capacitance being measured. No danger of overheating and ruining even a 1-volt electrolytic or a 3-volt ceramic.

**POLARIZING VOLTAGE:** Continuously adjustable, 0 to 150v.

**STABILITY:** Dual regulation of the power supply assures short-time reliability, while specially processed etched circuits and complete encapsulation of the critical meter amplifier insure long-time stability.

**MAGIC-EYE TUBE:** Simplifies bridge balancing for capacitance and power factor measurements.

**HIGH GAIN AMPLIFIER:** Sensitivity control for magic-eye null detector permits accurate measurements of small capacitances.

**CAPACITANCE DIAL:** Latest design jet black dial with brilliant white calibrations for quick, accurate readings from any position.

**BINDING POSTS:** Shielded for protection against pick-up of strays, assuring greater accuracy during low-capacitance measurements. 5-way connection feature for use with all types of test leads.

**SAFETY DEVICES:** Automatic discharge of capacitor after testing. Three-wire line cord grounds instrument case.

**OPERATING PROCEDURES:** Easy-to-follow operating procedures clearly shown on pull-out slide at base of instrument. Always handy for ready reference.

**MODERN CASE:** Handsome grey Hammerloid finish on heavy-gage steel. Measures  $8\frac{1}{2}$ " high,  $14\frac{1}{2}$ " wide,  $9\frac{1}{2}$ " deep. Weighs only 21 pounds.

See the remarkable new TCA-1 TRANSFARAD at your Sprague distributor or write for descriptive folder M-792a to Sprague Products Company, 105 Marshall St., North Adams, Massachusetts.

ONLY  
**\$197.50**  
NET

\*Trademark

# SPRAGUE®

world's largest capacitor manufacturer

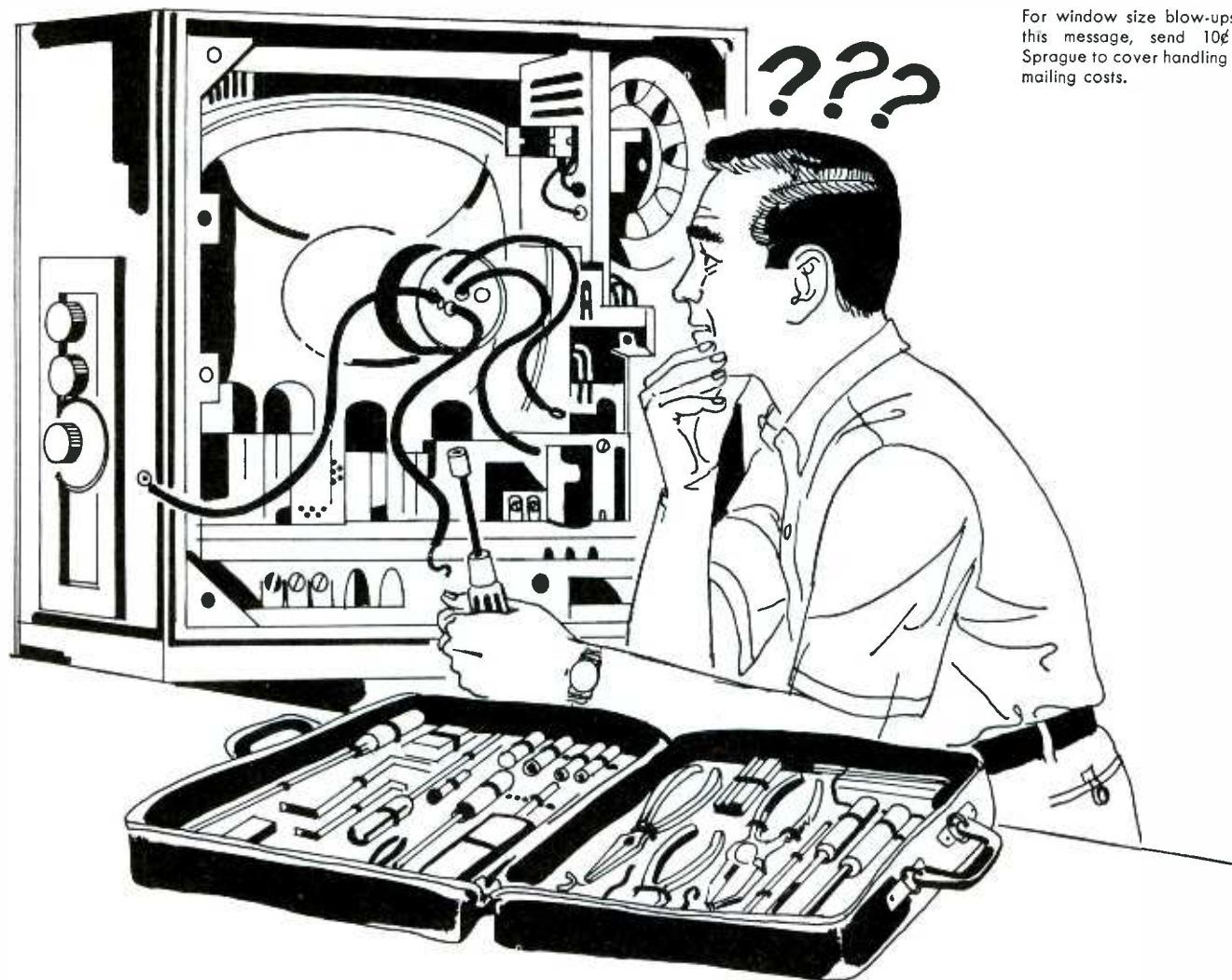

For window size blow-ups of this message, send 10¢ to Sprague to cover handling and mailing costs.

## ***It takes MORE than TOOLS to be a TV Technician!***

Just what IS the difference between the "screwdriver mechanic" and the expert TV-Radio Technician?

NOT expensive tools and test equipment—although they ARE essential.

TRAINING is the first big difference. The tinkerer guesses, but the expert technician KNOWS—because he spent years in the study of electronic theory and its application to television techniques.

EXPERIENCE is the next big difference. The professional TV specialist has repaired hundreds—perhaps thousands—of sets. He knows the complexities and the variations in circuits. He is familiar with the hundreds of parts which make up the "innards" of each type of TV. He can diagnose trouble and cure it quickly and safely.

PROGRESSIVENESS is another big difference. The expert TV Technician continually spends countless hours and hundreds of dollars on manuals, keeping up to date on new developments, new circuits, and new troubleshooting techniques. When trouble develops, he knows what to do about it.

Well-meaning, but poorly informed "screwdriver mechanics" and "do-it-yourself-ers," frequently unable to accurately diagnose TV trouble, often "butcher" a set to the point where it can be dangerous as well as expensive.

DON'T RISK YOUR SAFETY OR NEEDLESS EXTRA EXPENSE—CALL AN EXPERT TECHNICIAN AT THE FIRST SIGN OF TROUBLE! HIS FEE IS YOUR INVESTMENT IN SAFETY AND SATISFACTION.

**THIS MESSAGE WAS PREPARED BY SPRAGUE PRODUCTS COMPANY,  
DISTRIBUTORS' SUPPLY SUBSIDIARY OF SPRAGUE ELECTRIC COMPANY, NORTH ADAMS, MASSACHUSETTS FOR...**

**YOUR NEIGHBORHOOD TV-RADIO TECHNICIAN**

# LETTERS TO THE EDITOR

Dear Editor:

As a needle manufacturer, I was extremely gratified to see the article, "Phono Cartridge and Needle Replacement Guide," in your October issue. For years, I have felt that someone should do just such a story on this subject.

No question about it—extreme confusion exists when it comes to needle replacement. The innumerable types of needles that are made are necessary because of the innumerable types of cartridges found in tone arms. Because of this, the selection of the proper needle is quite a problem, and so is the technique of replacing it in the cartridge.

Therefore, I regard what you have done to simplify the replacement procedure as a really helpful step in the right direction.

STEPHEN NESTER

President  
Duotone Co., Inc.  
Keyport, N. J.

*Much of the thanks goes to you folks, for your help in the research behind this article.—Ed.*

Dear Editor:

I have been reading PF REPORTER for a long time, and find nothing else like it, but there is one fault I think you should do something about. Schematics seem to get smaller and smaller, and the parts shown in some photos are so small you can hardly find them with a magnifying glass. You seem to forget that some of us are getting older.

A. TAYLOR

Taylor TV and Radio Service  
Louisville, Ky.

*A point well taken. This issue any better?—Ed.*

Dear Editor:

Since joining the "team" (of radio-TV repairmen), I find that a new problem has arisen. Visiting friends and relatives have all indicated that they expected to find my home full of electronic marvels, such as push-button walls containing TV and hi-fi sets, disappearing bars, and other such gadgets.

I've been wondering if you could take a poll of your readers, and if others are interested, devote a few pages each month to projects of this type. Maybe a gadget-filled home would add to a repairman's prestige and increase his business.

JOSEPH J. BRUCOLEIRI  
Washington, D. C.

*An interesting thought, Joe, but of course the "few pages" would be in place of something else. Let's hear from other readers on the subject.—Ed.*

Dear Editor:

I notice that you did not include the Video Speed Servicing feature in the October issue. I hope you don't plan on dropping this subject, which is a great help to servicemen.

Thank you and all your staff for a great magazine, and for all your help in the past and future.

JOSEPH P. SHERMAN

Clawson, Mich.

*We haven't dropped this feature, only skipped it in favor of extra-long "specials" of great interest. Don't you think "Highlights of 1962 TV Lines" and "Fundamentals of Color TV" made the "skips" worthwhile?—Ed.*

Dear Editor:

After reading Charlie Bennett's letter in the October Letters column, I think he is the man to write a book (or long article) on "Repairing TV Sets With Only a VTVM." You would be surprised at the number of service shops where sweep generators and scopes are gathering dust. In these shops, a VTVM does 99% of the work, without bothersome setups or concern about spurious responses. None of your contributing authors seem able to operate without at least a scope for every job.

I would also like to see a common-sense article on tube interchangeability. Most caddies haven't room for a 6BQ7, 6BZ7, 6BK7, 6BS8, and 6DJ8, for example. Which of these is the best universal replacement? The same applies to the 6CB6, 6DE6, and 6BZ6; also 6AX4, 6AX4GTB, 6DA4, and 6DE4. The author might also mention that a handy tube to keep on the shelf is a 2B3 for sets which are hard on 1B3's. Too bad there isn't also a 2X2B to replace the 1X2B—or is there?

JIM LEE

Mission City, B. C., Canada

*We found the author for the "VTVM" article—see "Circuit Voltages Tell the Story" in this issue. We published "What You Should Know About Tube Changing" in the October, 1960 issue. Also, the third edition of Howard W. Sams Tube Substitution Handbook is now out, listing more substitutes than ever before. There is a 2X2B tube, but it won't substitute for the 1X2B. Your best bet is to take the strain off the tube by making sure the circuit performs as it should.—Ed.*

Dear Editor:

Regarding Charlie Bennett's letter in the October issue, I frankly don't understand how the man can take such a dim view of signal generators and scopes. I disagree with him 100% on this point. Agreed, a Gm tester is a must for any TV repair shop, and his "standing rule" (test all tubes in all sets brought to the shop) is one I have always believed to be universal. However, without a sweep and marker generator, I find it impos-

## PRODUCTS FOR MODERN LIVING



**ATR PLUG-IN TYPE PORTABLE INVERTERS\***

MODELS  
6-RMF (6 volts) 60 to 80 watts. Shipping weight 12 lbs. DEALER NET PRICE \$33.00  
12T-RME (12 volts) 90 to 125 watts. Shipping weight 12 lbs. DEALER NET PRICE \$33.00  
\*Additional Models Available

**ATR "A" Battery ELIMINATOR**

For Demonstrating and Testing Auto Radios—TRANSISTOR or VIBRATOR OPERATED!

Designed for testing D.C. Electrical Apparatus on Regular A.C. Lines—Equipped with Full-Wave Dry Disc-Type Rectifier, assuring noiseless, interference-free operation and extreme long life and reliability.

MAY ALSO BE USED AS A BATTERY CHARGER

MODEL 610C-ELIF . . . 6 volts at 10 amps. or 12 volts at 6 amps. Shipping weight 22 lbs.  
DEALER NET PRICE \$49.95  
MODEL 620C-ELIT . . . 6 volts at 20 amps. or 12 volts at 10 amps. Shipping weight 33 lbs.  
DEALER NET PRICE \$66.95

**AUTO-RADIO VIBRATORS**

By every test ATR Auto-Radio Vibrators are best! . . . and feature Ceramic Slack Spacers, Instant Starting, Large Oversized Tungsten Contacts, Perforated Reed, plus Highest Precision Construction and Workmanship and Quiet Operation!

There is an ATR VIBRATOR for every make of car!

Ask your distributor for ATR's Low Priced type 1400, 6 volt 4-prong Vibrator; and 1843, 12 volt 3-prong; or 1840, 12 volt 4-prong Vibrator. THE WORLD'S FINEST!

There is a complete kit for YOUR CAR!

**ATR CUSTOMIZED KARADIO**

Vibrator-Operated with Tone Control

ATR KARADIO . . . is ideal for small import cars or compact American cars! Unit is completely self-contained—extremely compact! Powerful 8-tube performance provides remarkable freedom from engine, static, and road noises. The ATR Customized Karadio comes complete with speaker and ready to install. Can be mounted in-dash or under-dash—wherever space permits! No polarity problem. Neutral Gray-Tan, baked enamel finish. Overall size, 7" deep, 4" high, and 6½" wide. Shipping weight, radio set, 7 lbs. Model K-1279—12 for 12V Dealer Net Price \$33.57 Model K-1279—6 for 6V Dealer Net Price \$33.57

Airplane Style Overhead Mounting under Cab Roof

**ATR TRUCK KARADIO**

Excellent Tone, Volume, and Sensitivity!

Compact, yet powerful. Fits all trucks, station wagons, most cars and boats. Just drill a ¾ inch hole in roof and suspend the one-piece unit (aerial, chassis and speaker) in minutes. Watertight mounting assembly holds antenna upright. Yoke-type bracket lets you tilt radio to any angle.

Extra-sensitive radio has 6 tubes (2 double-purpose), over-size Alnico 5 PM speaker for full, rich tone. Big, easy-to-read illuminated dial. Fingertip tuning control. Volume and tone controls. 33-in. stainless steel antenna. Neutral gray-tan enameled metal cabinet, 7 x 6½ x 4 in. high over-all. Shipping weight 10½ lbs. Model TR-1279—12 A for 12V Dealer Net Price \$41.96 Model TR-1279—6A for 6V Dealer Net Price \$41.96

See Your Electronic Parts Distributor Write Factory For Free Literature







**ATR ELECTRONICS, INC.**  
Formerly: American Television & Radio Co.  
Quality Products Since 1931  
ST. PAUL 1, MINNESOTA—U.S.A.

**Servicemen everywhere are saying:**

**TACO** brings in sharp

**pictures where other electronic antennas fail**

It stands to reason that TACO would produce, in the T-BIRD ELECTRA, the world's best electronic antenna. Only TACO gives you the combination of the most rugged, highest-performance antennas plus the finest in antenna-mounted transistorized preamplifiers (designed by Jerrold).

So, with the T-BIRD ELECTRA you assure customer satisfaction, even in severest "problem" areas. Rigid chrome-alloy aluminum elements and

contacts eliminate the antenna "friction noise" and "signal flutter" inherent in some so-called "high-gain" antennas. There's a T-BIRD ELECTRA for every TV/FM home need, priced from \$79.75. And it's completely pre-assembled for your convenience.

Only TACO offers custom area-engineering on electronic antennas to help you solve any type of signal problem. For these special services, see your TACO distributor.

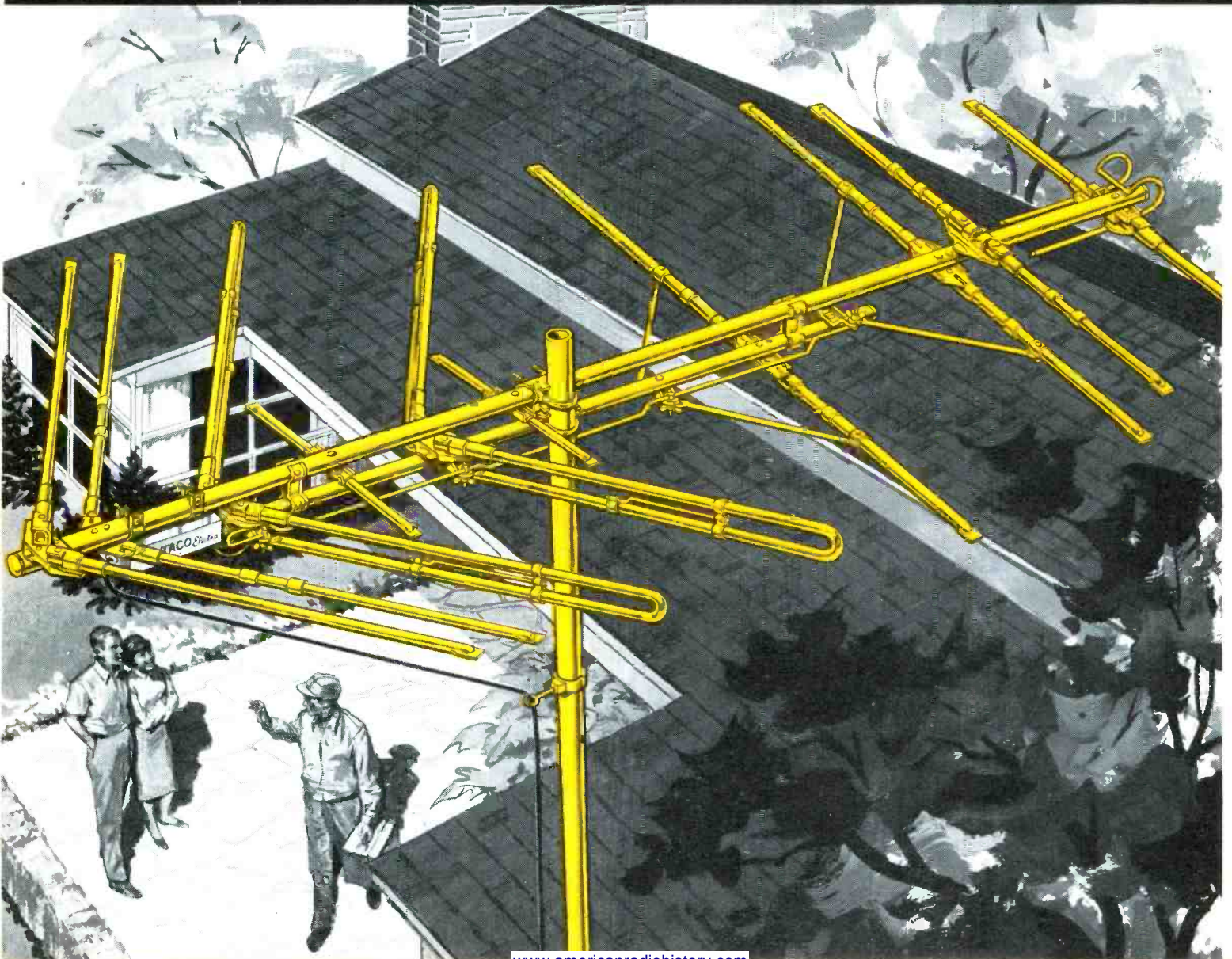



# HOW THE NEW



## combines the leading talents in electronics and antenna design

- Built rugged like all TACO antennas, the T-BIRD and T-BIRD ELECTRA use 7/16" tubing, sturdiest in the industry.
- "Delta" ("T"-match) feed system gives sharpest forward pattern — on every channel. Better than 10:1 front-to-back ratio.
- 100% rustproof. Gold-anodized and iridited (a conductive coating). Exclusive stainless-steel U-bolts.
- Engineered to eliminate unnecessary elements or harnesses that add weight and invite wind damage.
- Chrome-alloy aluminum used throughout—twice as strong as other antennas.
- Complete pre-assembly makes installation fast, sure and permanent.

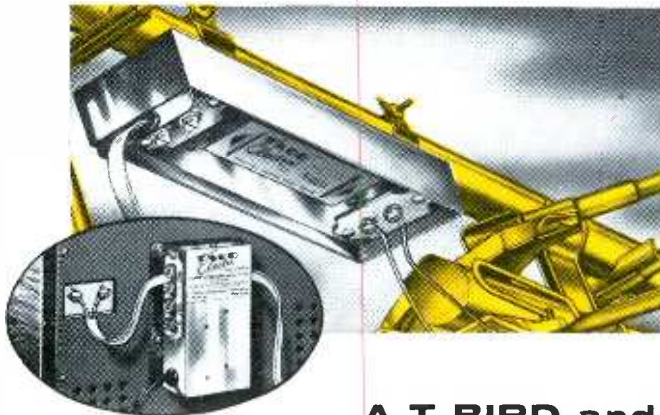
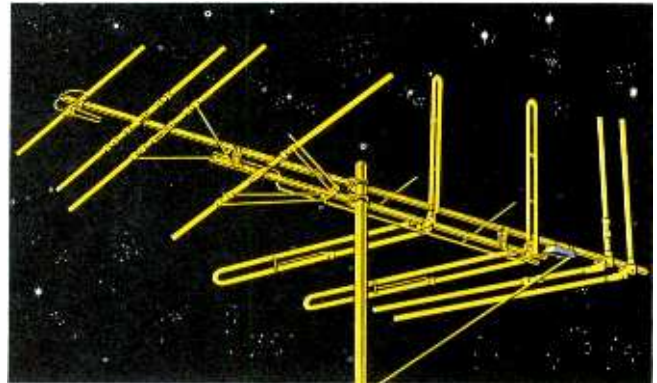

- TACO transistor preamplifier, designed by Jerrold, is matched to perform ideally with T-BIRD ELECTRA.
- Highest gain on both high and low channels, lowest System Noise Figure.
- No batteries, no polarity problems when connecting download.
- Remote a-c power supply feeds two sets.
- No maintenance worries—put up the T-BIRD ELECTRA and forget it!
- Every TACO antenna carries, in writing, a one-year warranty.

### A T-BIRD and a T-BIRD ELECTRA for every home

With six models of T-BIRD (non-powered) and three models of T-BIRD ELECTRA (powered) antennas, TACO gives you the right antenna for every suburban-to-fringe-area requirement. Performance, reliability, and long life found in no other antenna at any price.

**G990-8**  
The world's most powerful electronically-amplified antenna. Gets pictures and sound where others fail. Supplies the finest signal source for multi-set installations.  
List \$109.75

**G990-6**  
Just right for installations not requiring the ultra-powerful gain of the G990-8. Will provide sparkling clear, sharp pictures in black-and-white or color, on one, two, or more sets.  
List \$91.75

**G990-5**  
Lowest-price T-BIRD ELECTRA. Offers all the inherent advantages of transistor amplification plus a matched system of amplifier and antenna. Brings in stations beyond the reach of ordinary antennas.  
List \$79.75

## WATCH TACO GO!

The new T-BIRD and T-BIRD ELECTRA are without doubt the line to watch in the big months ahead. When you're handling the TACO line, you'll be watching from the driver's seat. So don't be passed by—get all the facts on T-BIRD and T-BIRD ELECTRA antennas—the line that's making antenna history! Ask your distributor, or write for details.



### TECHNICAL APPLIANCE CORPORATION

A Subsidiary of Jerrold Electronics Corporation

Dept. JTD-7, Sherburne, New York

# QUICK PROFITS!

with this New **Mosley**  
4-SET COUPLER

E  
A  
S  
I  
E  
R  
T  
O  
I  
N  
S  
T  
A  
L  
L



You'll enjoy installing the new PC-4 four-set coupler because your work and time will command a better price.

These neat new couplers, with a compactly engineered printed circuit design, provide high inter-set isolation and low forward loss — result more satisfied customers. PC-4 Dealer Net, \$3.04 each and Suggested List, \$5.06 each.

Pick up one of these handy cards at your Mosley distributor or write...



4610 NORTH LINDBERGH BLVD.  
BRIDGETON, MISSOURI

## Letters

(Continued from page 21)

sible to check bandwidth accurately—not only in the IF strip, but in the video amplifier as well. This test has often enabled me to find and replace video detector diodes and drifting video-amplifier load resistors, in much less time than if I had taken a series of voltage and resistance checks.

My scope is kept standing by at all times, ready for instant use. I have tamed many a would-be "tough dog" with this instrument alone. Spotting leaky filters and bypasses is only one of its advantages over a volt-ohmmeter. Also, I have yet to see a better way of testing yokes and flybacks, other coils, and resonant circuits in general.

I have not had 13 years of experience, like Mr. Bennett, but I feel I have learned to use time-saving test instruments to the best of my ability.

PETER FEHR

Service Manager  
D. Batty Appliances  
Picture Butte, Alta., Canada

*Perhaps Mr. Bennett will be more inclined to agree after he reads "Only a Scope Would Tell" next month.—Ed.*

Dear Editor:

The June, 1959 issue of PF REPORTER included an article, "Keeping Posted on TV Tubes," which was very helpful—even to this "old-timer" in the business. I believe it's about time for more information similar to that article. A substitution chart would also be welcome.

I also have another request. Since there's a very good possibility that more transistors will begin to be used in TV receivers within the next three to five years, how about keeping us servicemen up to date on these pesky things?

HORACE D. WESTBROOKS

Griffin, Ga.

*We'll keep on printing articles from time to time to point out the major new trends in tube development. Latest in this series was "New Ideas in Tube Design" (September issue), which discussed the "Compactron," "novar," and enlarged 9-pin minatures. For up-to-date information on where latest rare types are used, see the special October coverage, "Highlights of 1962 TV Lines."*

*To keep you informed on transistors, we've published the following in the last 12 months: "Fundamental Transistor*

*Theory" (November, 1960); "Voltage Analysis of Transistor Circuits (August, 1960); "Servicing Imported Transistor Portables" (July, 1961); and "Charting the Way for Transistor Replacements" (August, 1961).*

Dear Editor:

I somehow missed receiving my September issue. Don't let me down; I'd rather eat without my uppers (or even go hungry) than go without PF REPORTER.

E. A. BLACK

West Palm Beach, Fla.

*Guess the "copy-snatchers" are at it again. We're rushing another copy to you. With the fat September and October issues both on your reading table at the same time, you'll be having a banquet.—Ed.*

Dear Editor:

Like John B. Huckaly (October Letters column), I use a protective cover for PHOTOFACT Folders when I have them out on the bench for servicing sets. This cover also serves an additional purpose which he did not mention, and I thought your readers would like to hear about this idea.

While using a PHOTOFACT schematic to check through a TV set, I always like to mark the diagram to indicate the different capacitors and resistors as I test them. I also jot down the voltages I measure at various points. This habit saves a lot of rechecking, but it sure makes a mess of the schematic when you mark all over it with a pencil. Thus, to keep the diagram clean for later use, I've adopted the following solution, which has worked out very satisfactorily:

A clear, flat safety glass salvaged from an old 21" TV set goes on top of the schematic. Then, to keep the glass from shifting as I work, the chassis I'm servicing is rested on the section of the glass that extends beyond the schematic. The glass is strong enough that it won't crack if laid flat. I can then use a marking pencil to make all the notations I want on the glass. The schematic stays neat, and the glass is easily washed off when the job is finished.

LEROY BECWAR

Davenport, Nebr.

*With such inventive genius, your customers must be clamoring for your services. Hope you haven't started a "run" on safety glass!—Ed.*

### Erratum

The chart on page 30 in last month's article, "Test Equipment for Color TV," failed to indicate the usability of B & K's Model 1076 "Analyst" as a color-TV servicing instrument. For the benefit of those who may use the chart for future reference, we suggest you enter the 1076 in the first two left-hand columns, opposite the manufacturer's name. This instrument generates a 3.58-mc rainbow signal, and with the appropriate film patterns, also serves as a white-dot and crosshatch generator.

# NEW

TESTS All TV and Radio Tubes  
—both old and new

TESTS the Nuvistors

TESTS the new 10-pin tubes

TESTS the new 12-pin Compactrons

TESTS voltage regulators, thyratrons,  
auto radio hybrid tubes,  
European hi-fi tubes, and  
most industrial types.



## Model 600 DYNA-QUIK

only \$69<sup>95</sup>  
NET

8½" x 11" x 4½"  
Handsome, sturdy  
leatherette-covered  
carrying case

### NEW TUBE INFORMATION SERVICE

available every 3  
months for all B&K  
Dyna-Quik Tube Testers



for the first time, a  
**B & K QUALITY**  
**TUBE TESTER**  
at this  
amazing low cost!

Checks for all shorts, grid  
emission, leakage, and gas

Checks each section of multi-  
section tubes separately

Checks tube capability under  
simulated load conditions

Rejects bad tubes  
—not good tubes

For the man who wants the performance and reliability of a B&K professional-quality tester at minimum cost . . . there's nothing like the new "600". No other tube tester in this price range is so complete and up-to-date. Tests the newest tube types, as well as the old. It's fast . . . it's accurate . . . it's easy to use. Quickly reveals tube condition. Saves customers. Sells more tube replacements. Stops call-backs. Steps up servicing profit . . . day after day. Pays for itself over and over again.

*Exclusive adjustable grid emission test. Sensitivity to over 100 megohms. Phosphor bronze socket contacts. Complete tube listing in handy reference index. Extremely compact.*

**B & K MANUFACTURING CO.**  
1801 W. BELLE PLAINE AVE • CHICAGO 13, ILL.  
Canada: Atlas Radio Corp., 50 Wingold, Toronto 19, Ont.  
Export: Empire Exporters, 277 Broadway, New York 7, U.S.A.

# Handling IF Transformer Troubles

One of the equipment troubles that most frequently confront servicemen is a loss of sensitivity. This defect (more prevalent in table-model radios than in TV) can often be cured by tube replacement. In many cases, however, the trouble stems from one of the IF transformers. This is not to say that all IF-transformer troubles result only in lowered sensitivity. Other symptoms such as complete loss of output, crackling and popping in the speaker, or intermittent operation are often present.

These troubles in IF cans usually may be located by the signal-injection method. If this technique appears to isolate the trouble to a specific IF transformer, it is then advisable to reinforce the diagnosis with a couple of quick checks that may pinpoint the trouble within the can. If an ohmmeter indicates no continuity through the primary or secondary circuit, an open coil is the probable cause. Should the meter show a primary-to-secondary leakage resistance that cannot be explained by looking at the circuit

diagram, it is highly probable that one of the silvered mica capacitors inside the can is a victim of "silver migration."

This effect is a result of surface leakage on the mica. In the average radio IF transformer, a single sheet of mica is printed with two or more silvered areas on each side to form capacitors. The primary and secondary transformer windings are each shunted by one of these capacitors. Trouble occurs when leakage develops between two silvered areas on the same side of the mica — one connected to the primary winding, and the other to the secondary. This surface leakage is called "silver migration" because the silver actually moves or migrates outside its original boundaries, as shown in Fig. 1. The condition progresses more rapidly in periods of high humidity.

If the presence of silver migration is suspected, a more positive test for this condition may easily be made. The skeletonized circuit in Fig. 2 will facilitate an explanation of such a test procedure. This circuit, typical of the most common radio circuitry now in use, includes the RF, IF and detector tubes plus the first and second IF transformers.

VTVM readings at TP1 and TP2 on the AVC line are the only tests necessary to reveal the leakage. In normally-operating receivers, only about -0.5 volt will be found at TP1 when the set is not receiving a signal. As stations are tuned in, this voltage will increase to about -5 volts on strong stations, or to

•Please turn to page 86

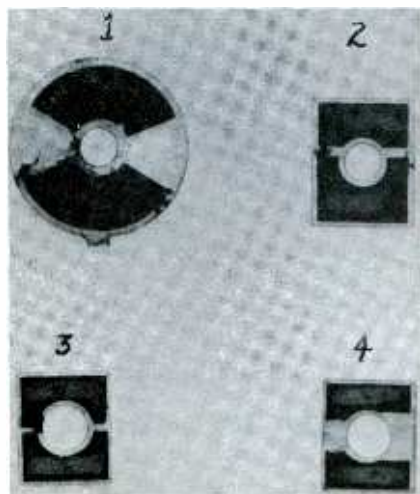

Fig. 1. Silver-migration leakage paths are present in capacitors 1, 2, and 3.

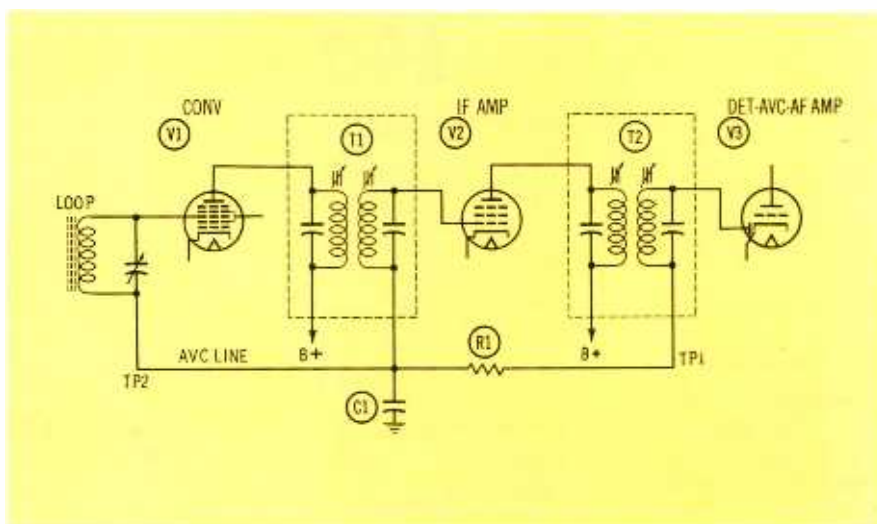

Fig. 2. Voltage checks at TP1 and TP2 help reveal silver-migration leakage.

# New TRANSISTOR RADIO ANALYST

## makes it Easy and Profitable to Service all Transistor Radios



**B&K** Model 960

**TRANSISTOR RADIO ANALYST**  
with Exclusive *DYNA-TRACE*  
Single-Point Probe—and Built-in  
Metered Power Supply and VTVM

**Complete Transistor Radio  
Service Shop in One Instrument**

Signal-Generator, Power Supply,  
Milliammeter, VTVM,  
Ohmmeter, and Both In-Circuit and  
Out-of-Circuit Transistor Tester—  
All in One

Check all circuits - Pinpoint any trouble ... in minutes

Now you can profit from transistor radio servicing! This amazing new B&K "960" ANALYST gives you *everything* in one complete easy-to-use instrument. Makes transistor radio servicing *quick and easy*. Nothing else is needed except the transistor radios themselves waiting to be serviced. Brings you new customers for service, parts, and batteries. Makes this new business *yours*.

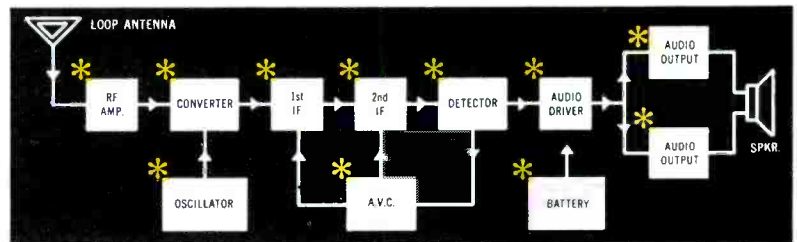

### EASILY TROUBLE-SHOOT ANY STAGE BY UNIQUE POINT-TO-POINT SIGNAL INJECTION

The ANALYST gives you a complete signal-generating source for point-to-point signal injection. Easily enables you to trouble-shoot any transistor radio—check all circuits stage-by-stage—isolate and pinpoint the exact trouble in minutes.

Supplies modulated signals, with adjustable control, to check r.f., i.f., converter, and detector. Supplies audio signal to check audio driver and audio output. Provides unmodulated signal to test local oscillator. Provides separate audio low-impedance output for signal injection into loudspeaker voice coils to check speaker performance.

### BUILT-IN METERED POWER SUPPLY FOR EASY SERVICING

Makes it easy to operate radio under test, while you inject your own signals. Provides from 1 to 12 volts in 1½ volt steps. Supplies all bias taps that may be required.

### SIMPLIFIES IN-CIRCUIT TRANSISTOR TEST WITH NEW DYNA-TRACE SINGLE-POINT PROBE

Unique single-point probe needs only the one contact to transistor under test. No longer are three wires required to connect to emitter, base, and collector. Gives fast, positive meter indication. Saves time. Makes trouble-shooting simple and easy.

### BUILT-IN VTVM

Includes high-input-impedance vacuum-tube voltmeter, which is so necessary for transistor radio servicing.

### TESTS ALL TRANSISTORS OUT-OF-CIRCUIT

Meter has "Good-Bad" scale for *both* leakage and beta. Also has direct-reading Beta scale, calibrated 0-150. Assures quick, accurate test. Also automatically determines whether transistor is NPN or PNP. Meter is protected against accidental overload and burn-out.

Model 960. Net, \$99<sup>95</sup>

Solve Every Service Problem and Profit with a Modern B&K Service Shop. See Your B&K Distributor or Write for Catalog AP18-R



**B & K MANUFACTURING CO.**

1801 W. BELLE PLAINE AVE • CHICAGO 13, ILL.

Canada: Atlas Radio Corp., 50 Wingold, Toronto 19, Ont.

Export: Empire Exporters, 277 Broadway, New York 7, U.S.A.

# Stancor. n.

## Synonym for quality and dependability in coils and transformers

It makes good sense for you to choose replacement parts from the manufacturer who is the world's largest supplier of electronic transformers to the original equipment market. The complete Stancor line includes the unit you need, at the fine performance level you expect. For quality and dependability in transformers and coils, always specify Stancor.

### The Stancor TV Guide

gives you always up-to-date replacement information—through regular mailings of loose-leaf pages direct to you from Stancor. Register with your distributor to get the Stancor TV Guide.

# STANCOR

**STANCOR ELECTRONICS, INC.**

(Formerly Chicago Standard Transformer Corporation)

3501 WEST ADDISON STREET • CHICAGO 18, ILLINOIS

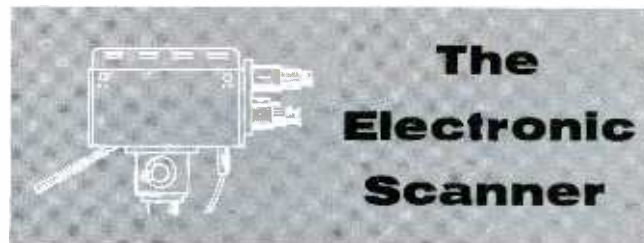

## The Electronic Scanner

### Survey Shows More Second and Third TV Sets

A recent consumer survey for the **Kimble Glass Co.** (a subsidiary of Owens-Illinois), maker of glass bulbs for TV picture tubes, indicates that 24.1% of U. S. homes now have two or more TV sets — almost a 5% increase over the 19.2% figure of two years ago (potential for multiple antenna hook-ups). The survey also revealed these other facts: Most of the primary sets in TV households are no older than five years, but 9.7% of all sets are at least 10 years old (potential new-set sales). During 1960, 75.9% of the primary sets required service — an average of 1.8 calls on each set serviced. According to our calculations, this means you should have at least 700 customers (a fourth of them two-set owners) for each full-time (40-hour) TV technician. How many customers are on your active list?

### They Want to Keep it Quiet



A mysterious cave on the moon? No, this soundproof microphone testing chamber, entirely padded with sound-deadening wedges of spun glass, was recently installed in the new plant addition of **Shure Brothers, Inc.** To eliminate any sound resulting from tiny vibrations in the building structure itself, further isolation is achieved by an air cushion that suspends the room independently from the rest of the building.

### Reprint from TELS (Connecticut) NEWS:

"A friend of mine from New Haven shopped five TV dealers in an effort to pick up a channel-selector knob. Finally paid \$1.25 for one that was not a replacement, but would turn the selector. It lasted only a week, and he stopped in on a wholesale dealer where he bought an assortment of 20 for 99c. Where do you think he will look now for tubes, antennas, and radios?"

### Winegard Builds Second New Plant in Four Years



A 15,000 - square - foot plant has just been completed on an eight - acre site in Burlington, Iowa to house manufacturing facilities of the **Winegard Co.** The new facilities will be devoted solely to manufacturing VHF TV-FM preamplifiers for both home and commercial distribution systems. John Winegard, company president, stated that the new facilities would allow the company to keep pace with rapidly increasing sales of TV and FM reception aids. The company is currently planning a large addition to its 35,000-square-foot antenna-production plant.

### Robins to Gift-Wrap Audio Accessories

"Gibson Girl" Tape Splicers, "Gibson Girl Tape Kare Kits," "Engineered Sound Record Kare Kits," and HD-3 and HD-6 head demagnetizers are some of the audio accessories scheduled to be gift-wrapped for the holiday season by **Robins Industries Corp.** The special wrapping will serve to remind both customers and store salesmen that Robins audio accessories make excellent Christmas gifts. The wrapping is designed so that it can be easily removed by dealers after the holiday season.

### Motorola Training Institute Offers Home-Study Course

A pay-as-you-learn plan is now available to technicians who wish to take the **Motorola Training Institute** home-study course covering the principles and servicing of two-way radio systems. Initiated this fall, the new program is designed to provide technicians with a greater opportunity for learning the techniques of two-way servicing. The 38-lesson course is divided into nine study sections. These sections are paid for one at a time, and the course may be dropped at any time without obligation.

# What Does F.C.C. Mean To You?

## What is the F.C.C.?

F. C. C. stands for Federal Communications Commission. This is an agency of the Federal Government, created by Congress to regulate all wire and radio communication and radio and television broadcasting in the United States.

## What is an F. C. C. Operator License?

The F. C. C. requires that only qualified persons be allowed to install, maintain, and operate electronic communications equipment, including radio and television broadcast transmitters. To determine who is qualified to take on such responsibility, the F. C. C. gives technical examinations. Operator licenses are awarded to those who pass these examinations. There are different types and classes of operator licenses, based on the type and difficulty of the examination passed.

## What are the Different Types of Operator Licenses?

The F. C. C. grants three different types (or groups) of operator licenses—commercial radiotelePHONE, commercial radioteleGRAPH, and amateur.

**COMMERCIAL RADIOTELEPHONE** operator licenses are those required of technicians and engineers responsible for the proper operation of electronic equipment involved in the transmission of voice, music, or pictures. For example, a person who installs or maintains two-way mobile radio systems or radio and television broadcast equipment must hold a radiotelePHONE license. (A knowledge of Morse code is NOT required to obtain such a license.)

**COMMERCIAL RADIOTELEGRAPH** operator licenses are those required of the operators and maintenance men working with communications equipment which involves the use of Morse code. For example, a radio operator on board a merchant ship must hold a radioteleGRAPH license. (The ability to send and receive Morse is required to obtain such a license.)

**AMATEUR** operator licenses are those required of radio "hams"—people who are radio hobbyists and experimenters. (A knowledge of Morse code is necessary to be a "ham".)

## What are the Different Classes of RadiotelePHONE licenses?

Each type (or group) of license is divided into different classes. There are three classes of radiotelePHONE licenses, as follows:

(1) Third Class RadiotelePHONE License. No previous license or on-the-job experience is required to qualify for the examination for this license. The examination consists of F. C. C. Elements I and II covering radio laws, F. C. C. regulations, and basic operating practices.

(2) Second Class RadiotelePHONE License. No on-the-job experience is required for this examination. However, the applicant must have already passed examination Elements I and II. The second class radiotelePHONE examination consists of F. C. C. Element III. It is mostly technical and covers basic radiotelePHONE theory (including electrical calculations), vacuum tubes, transistors, amplifiers, oscillators, power supplies, amplitude modulation, frequency modulation, measuring instruments, transmitters, receivers, antennas and transmission lines, etc.

(3) First Class RadiotelePHONE License. No on-the-job experience is required to qualify for this examination. However, the applicant must have already passed examination Elements I, II, and III. (If the applicant wishes, he may take all four elements at the same sitting, but this is

not the general practice.) The first class radiotelePHONE examination consists of F. C. C. Element IV. It is mostly technical covering advanced radiotelePHONE theory and basic television theory. This examination covers generally the same subject matter as the second class examination, but the questions are more difficult and involve more mathematics.

## Which License Qualifies for Which Jobs?

The THIRD CLASS radiotelePHONE license is of value primarily in that it qualifies you to take the second class examination. The scope of authority covered by a third class license is extremely limited.

The SECOND CLASS radiotelePHONE license qualifies you to install, maintain, and operate most all radiotelePHONE equipment except commercial broadcast station equipment.

The FIRST CLASS radiotelePHONE license qualifies you to install, maintain, and operate every type of radiotelePHONE equipment (except amateur, of course) including all radio and television stations in the United States, and in its Territories and Possessions. This is the highest class of radiotelePHONE license available.

## How Long Does it Take to Prepare for F. C. C. Exams?

The time required to prepare for FCC examinations naturally varies with the individual, depending on his background and aptitude. Grantham training prepares the student to pass FCC exams in a minimum of time.

In the Grantham correspondence course, the average beginner should prepare for his second class radiotelePHONE license after from 300 to 350 hours of study. This same student should then prepare for his first class license in approximately 75 additional hours of study.

In the Grantham resident course, the time normally required to complete the course and get your license is as follows:

In the DAY course (5 days a week) you should get your second class license at the end of the first 9 weeks of classes, and your first class license at the end of 3 additional weeks of classes. This makes a total of 12 weeks (just a little less than 3 months) required to cover the whole course, from "scratch" through first class.

In the EVENING course (3 nights a week) you should get your second class license at the end of the 15th week of classes and your first class license at the end of 5 additional weeks of classes. This makes a total of less than 5 months required to cover the whole course, from "scratch" through first class, in the evening course.

**HERE'S PROOF** that Grantham Students prepare for F. C. C. examinations in a minimum of time. Here is a list of a few of our recent graduates, the class of license they got, and how long it took them:

	License	Weeks
James C. Bailey, 217 Behrends Ave., Juneau, Alaska	1st	12
Edward R. Barber, 907 S. Winnifred, Tacoma, Wash.	1st	20
M. A. Dill, Jr., 20 Cherry St., Gardiner, Maine	1st	12
Bernhard G. Fokken, Route 2, Canby, Minn.	1st	12
Thomas J. Hoof, 216 S. Franklin St., Allentown, Pa.	1st	22
Clyde C. Morse, 7505 Sharonlee Dr., Mentor, Ohio	1st	12
Louis W. Pavek, 838 Page St., Berkeley 10, Calif.	1st	16
Wayne Winsauer, 2009 B St., Bellingham, Wash.	1st	12

To better serve our many students throughout the nation, Grantham School of Electronics maintains four separate schools—located in Los Angeles, Seattle, Kansas City, and Washington, D. C.—all offering the same resident courses in F. C. C. license preparation. (Correspondence courses are conducted from Hollywood.)

For further details concerning F. C. C. licenses and our training, send for our FREE booklet, "Careers in Electronics". Clip the coupon below and mail it to the School nearest you.

Get your First Class Commercial F. C. C. License Quickly by training at



## GRANTHAM SCHOOL OF ELECTRONICS

1505 N. Western Ave. Los Angeles 27, Calif. (Phone: HO 7-7727)      408 Marion Street Seattle 4, Wash. (Phone: MA 2-7227)      3123 Gillham Road Kansas City 9, Mo. (Phone: JE 1-6320)      821 - 19th Street, N.W. Washington 6, D. C. (Phone: ST 3-3614)

MAIL COUPON NOW—NO SALESMAN WILL CALL →

Accredited by the National Home Study Council

(Mail in envelope or paste on postal card)

To: GRANTHAM SCHOOL OF ELECTRONICS

1505 N. Western • 408 Marion • 3123 Gillham Rd. • 821-19th, NW  
Los Angeles • Seattle • Kansas City • Washington

Please send me your free booklet telling how I can get my commercial F.C.C. license quickly. I understand there is no obligation and no salesman will call.

Name \_\_\_\_\_ Age \_\_\_\_\_

Address \_\_\_\_\_

City \_\_\_\_\_ State \_\_\_\_\_

I am interested in:  Home Study,  Resident Classes 19-T

MAIL COUPON TO SCHOOL NEAREST YOU

# STA-LOC<sup>®</sup> CONTROLS

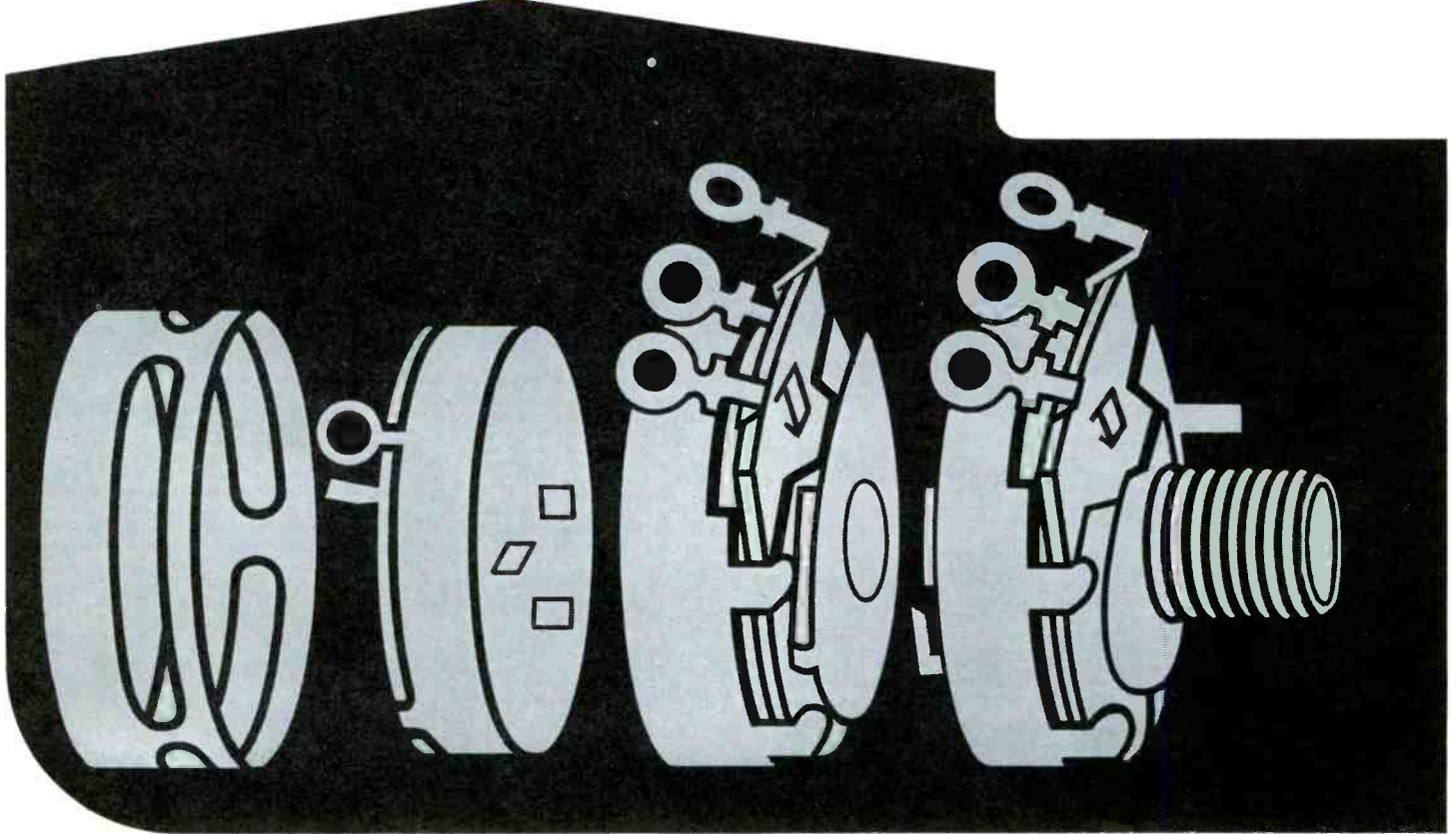
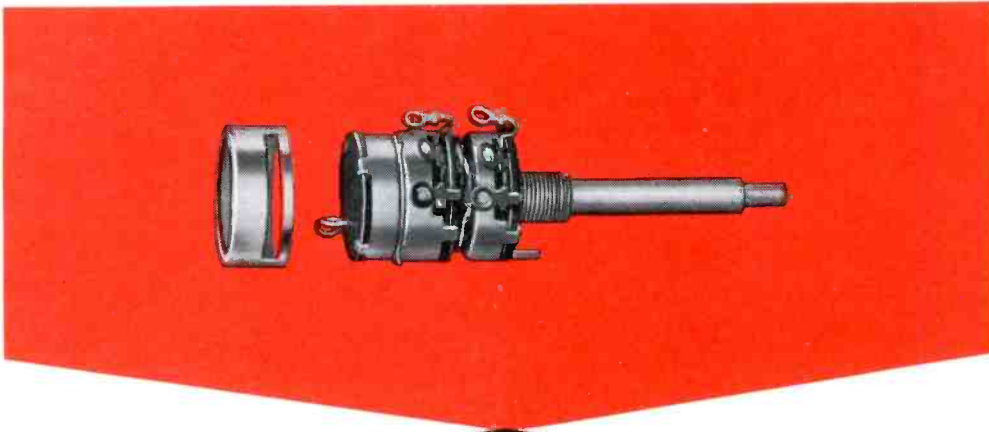

## ELECTROLYTIC CAPACITORS

Famous FP-WP metal can types, reliable TC tubulars, and tiny TT tubulars.



## VIBRATORS

Sure-start Gold Label<sup>®</sup> and every other type for auto or mobile communications.



## PVC CAPACITORS

Top quality Mylar\*\* Capacitors in zip-lip package.

\*\*Du Pont Reg. Trademark



## SILICON RECTIFIERS

Top performance, moisture-proof. 50 to 600 volt ratings. 5-packs, in re-usable jewel boxes.



# ...always the best...always available

You can get the exact replacement control you need when you ask for STA-LOC. Your Mallory Distributor can fix you up in a hurry . . . singles, duals, tandems, clutch, printed circuit . . . with or without a switch (there's a push-pull switch, too). You name it, he has it.

You'll get the best service-engineered control ever made when you ask for STA-LOC. Snaps together

(without tools) and stays together.

But be sure to get the real thing. STA-LOC is patented\*, but like any hot item there are lots of imitations.

You should ask your Mallory Distributor about the STA-LOC Dealer Kit . . . it's inexpensive and can save you lots of phone calls and extra trips.

\*U.S. Patent 2,958,838

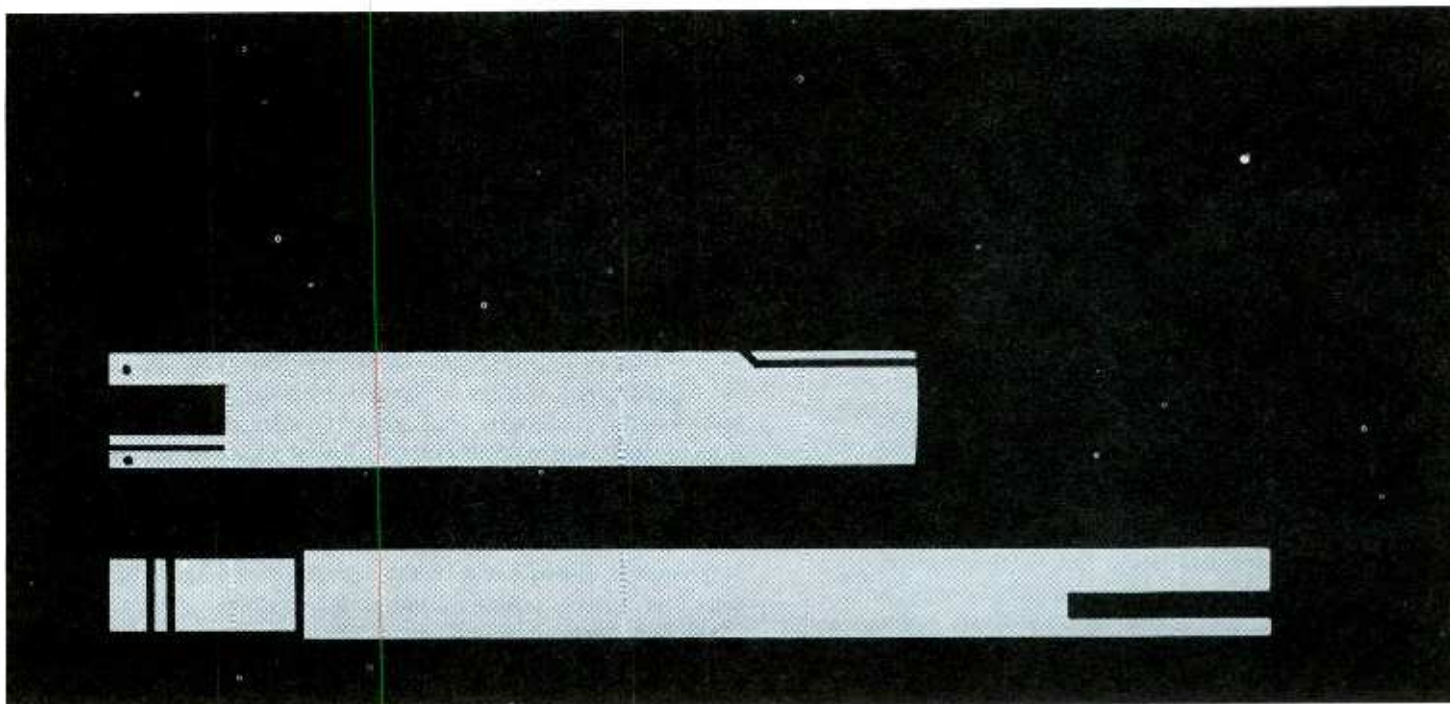

#### DISCAPS®

Standard of quality in ceramic capacitors.

©Trademark Radio Materials Co., a Mallory Division



#### MALLORY BATTERIES

Mercury and Manganese Batteries outlast all others. Advertised in LIFE.

Distributor Division, Indianapolis 6, Indiana



In Canada: A. C. Simmonds & Sons, Ltd., Toronto 7, Ontario



QUICKER SERVICING  
by Paul Goldberg

# Circuit Voltages Tell the Story

The information supplied by voltage readings is of prime importance in troubleshooting, because incorrect circuit voltages are among the most helpful clues for pinpointing defects. You can solve the greatest share of service problems by first localizing the trouble through keen diagnosis of picture and sound symptoms, and then discovering the defective component by voltage measurement.

To make full use of your VTVM, you need to consult service schematics frequently—and read them accurately. It's especially important to note any special conditions, such as control settings, that influence the accuracy of voltage readings. Also, the more thoroughly you understand the operation of the circuits you are testing, the more clues you can obtain by noticing the amount and direction of voltage errors.

## Routine Bench Work

To illustrate the usefulness of voltage measurements as a servicing aid, let's run through several typical bench jobs and see how quickly they can be completed with the aid of intelligent voltage analysis. The first set, an RCA KCS127AE (Fig. 1), has a vertical sync problem, and the behavior of the set makes us suspect that the vertical sync signal being fed to the multivibrator is not of sufficient amplitude to sustain vertical hold.

We check the tubes and find them all functioning normally. Thus, we proceed to make a key voltage check at the plate (pin 1) of sync amplifier V8A. In this receiver, the plate-voltage reading with no signal applied is 50 volts instead of the 65 given on the schematic. The plate voltage could be lowered in this man-

ner by a positive grid voltage on the sync amplifier, but we dismiss this thought because such a trouble would surely affect horizontal as well as vertical sync. The trouble is more likely to be found in the plate circuit.

A visual inspection of R34 and R51 shows no obvious damage to either of these resistors, so we ignore them for the time being and consider the possibility of capacitor faults. Examining the circuitry, we see that vertical sync is fed to the multivibrator through an integrator network consisting of R50, C45, and C44. Under normal operating conditions, there should be no DC path through the integrator. However, if fairly serious leakage should develop in either C44 or C45, the faulty capacitor and the sync-amplifier plate circuit would form a DC voltage divider across the B+ source. As a result, the sync-amplifier plate voltage and the sync-pulse amplitude would both be diminished. The quickest way to check for this condition is to see if there is a DC voltage drop across R50. When we measure the voltage at both terminals, we find 50 volts on the plate side, but only 10 volts at the junction of R50 and C45. Thus, we know that one of the capacitors must be leaky; now we have to find out which one is the culprit. We clip the ground connection of C44, turn the set on, and check the DC voltage between the clipped end of the capacitor and the chassis. The meter pointer swings far upscale, proving there is considerable leakage in the capacitor.

This test is one of the best and simplest methods of checking DC leakage resistance in capacitors. Some defective units will not give any indications of trouble on an ohmmeter check, but when normal circuit volt-

• Please turn to page 80

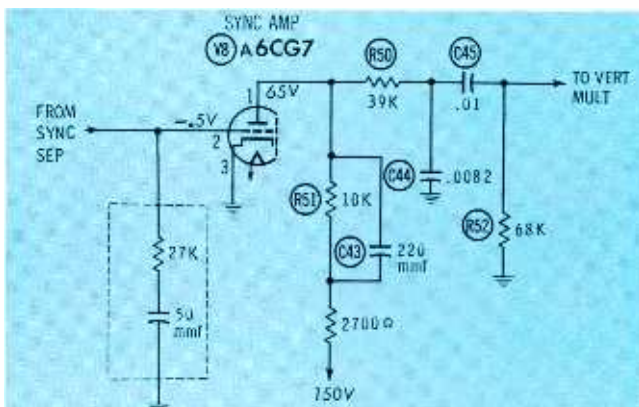

Fig. 1. Sync amplifier and integrator, RCA KCS127AE.

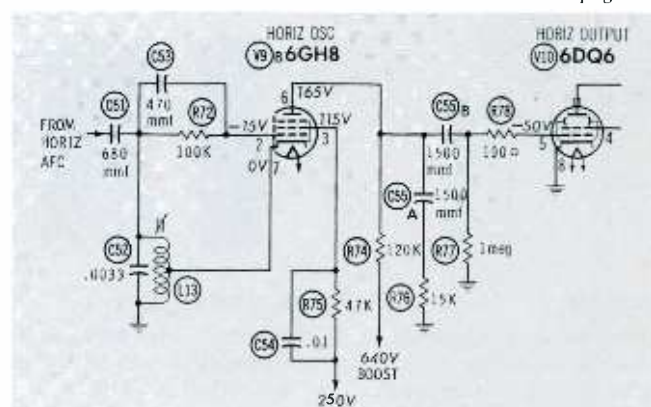

Fig. 2. Horizontal oscillator, Zenith Chassis 16E20.

# SENCORE Simplifies SERVICING

with 17 "made for the job" tools that pay for themselves in time saved

## SENCORE Simplifies TUBE TESTING

### SENCORE MIGHTY MITE TUBE CHECKER

A complete tube tester that is smaller than a portable typewriter yet outperforms testers costing hundreds of dollars. A real money maker for the serviceman and a trusty companion for engineers, maintenance men and experimenters. The original Mighty Mite has been acclaimed from coast to coast as the real answer for the man on the go. Even though the Mighty Mite weighs less than 8 pounds, new circuitry by Sencore enables you to use a meter to check grid leakage as high as 100 megohms and gas conditions that cause as little as one half microamp of grid current to flow. Then too, it checks for cathode current at operating levels and shorts or leakage up to 120,000 ohms between all elements. And it does all this by merely setting four controls labeled A, B, C, & D. Check these plus Sencore features . . . Meter glows in dark for easy reading behind TV set . . . Stainless steel mirror in cover for TV adjustments . . . Rugged, all steel carrying case and easy grip handle. . . Smallest complete tester made, less than one foot square.

And now comes Mighty Mite II as shown here. This improved version will test every radio and TV tube that you encounter, nearly 2000 in all, including foreign, five star, auto radio tubes (without damage) plus the new compactrons, Novar, Nuvistor, and 10 pin tubes. Mighty Mite II also has larger, easy-to-read type in the set-up booklet to insure faster testing. Size: 10 1/4" x 9 1/4" x 3 1/2".

Model TC114

Dealer Net ..... \$67.50

Checks them  
all . . . finds  
them fast.



Fast . . . accurate . . .  
never lets you down

### NEW TM116 TUBE TESTER MODERNIZING PANEL . . .

Now, you can test all of these new tubes in the Sencore Mighty Mite or any other tube tester except the "cardomatic" type. Don't throw away your tube tester just because you can't check the RCA Nuvisors, the GE compactrons, the Sylvania 10 pin tubes or the all new RCA Novars.

These new tubes which are the industry's answer to the transistor are causing a revolution in electronics today. Thousands are being installed in electronic equipment every day from coast to coast. You will be called on to test them tomorrow. Be prepared with the TM116 tube tester modernizing panel.

Tests are made by plugging the TM116 into an octal socket on your tester and setting controls from the chart provided with the unit. All tests are the same as your tester now makes. Some other adaptor units merely reduce all tests to an emission check. Sencore uses additional internal circuitry to provide complete mutual conductance or high grid leakage checks if your tester now makes them.

You can own the TM116 for less money than it costs to keep substitutes in your shop or lab.

TM116

Dealer Net \$24.95



### FILAMENT CHECKER FC4

The ideal tool for servicing series string filaments. Purposely works off your cheater cord to give you a positive check on line voltage. Only checker that checks all tubes automatically and has no batteries to replace. Cost half that of battery operated testers. Patented.

FC4 Dealer Net ..... \$2.75



### VIBRA-DAPTER VB2

Checks 3 and 4 prong Vibrators Faster and Easier. Plugs into any tube checker; ideal for use with LC3 or the Mighty Mite. To check 6v. vibrators, set for 6AX4 or 6SN7; for 12v. vibrators, set for 12AX4 or 12SN7. Two No. 51 lamps indicate whether vibrator needs replacing. Instructions on front panel.

VB2 Dealer Net ..... \$2.75



# SENCORE Simplifies TRANSISTOR TESTING

## SENCORE TRANSI-MASTER-TR110

A new transistor tester that will analyze the entire transistor circuit in minutes. Transistors can be checked in-circuit or out-of-circuit. Here is how it works:

First, check the batteries or power supply with the 0 to 12 volt voltmeter. Next, check the current drain with the 0 to 50 milliamp meter. A special probe is provided so that you do not need to break the circuit. Intermittents caused by cracked boards can be localized by the current check.

If trouble is not located by now, isolate the trouble to a specific stage by touching the output of the harmonic generator to the base of each transistor and note spot where sound from speaker (or scope where no speaker is used) stops or becomes weak. The generator becomes a sine wave generator for audio stages to help find distortion.

If trouble points to a transistor, check it in a jiffy with the exclusive in-circuit power oscillator check provided by the TR110. A special probe is also provided for this.

If the transistor checks bad in-circuit, remove it and give it an out-of-circuit check with the oscillator check or the more accurate DC check.

The DC check is provided for comparison reasons, experimental or engineering work and to match transistors in audio output stages. Beta (current gain) is read direct or on a good-bad scale for service work.

**Model TR110** Dealer Net ..... **only \$49.50**



*Tests all transistors in-circuit or out-of-circuit*

**Model TR110**  
**It's a COMPLETE TRANSISTOR TESTER**  
 • SIGNAL TRACER • VOLTMETER  
 • BATTERY TESTER • MILLIAMMETER



**TRANSISTOR — DIODE CHECKER TR115**

Here is a low cost tester that has become America's favorite. The TR115 provides the same DC out-of-circuit checks as the TR110; leakage and current gain. Current gain (Beta) can also be read direct or as good or bad. Opens or shorts in the transistor are spotted in a minute. The TR115 checks them all from power transistors to the small hearing aid types. Japanese equivalents are listed also. This famous tester is used by such companies as Sears Roebuck, Bell Telephone and Commonwealth Edison. New circuit enables you to make service checks without set-up charts even though charts are provided for critical checks.

Dealer Net ..... **\$19.95**



**BATTERY ELIMINATOR — TROUBLE SHOOTER PS103**

Replaces Batteries During Repair. Many servicemen say that they wouldn't service transistor circuits without this power supply. The tried and proven PS103 is a sure fire answer. It can be used to charge the nickel cadmium batteries as well. Dial the desired output from 0 to 24 volts DC and read on meter. Low ripple insures no hum or feedback. Total current drawn can also be read on the PS103 by merely flicking the function switch to milliamps. The PS103 is the only supply that will operate radio with tapped battery supplies such as Philco, Sylvania, and Motorola. No other supply has a third lead.

Dealer Net ..... **\$19.95**



**HARMONIC GENERATOR HG-104**

Finds Defective Stage in a Minute... a real time saver. Just touch the output leads of the HG104 to inputs and outputs of transistors and a clear 1000 cycle note from speakers will tell you whether or not the stage is defective. Here is an unexcelled time saver, not a "pencil" gimmick. It actually works every time from speaker to antenna. Two leads and calibrated output (not found on pencils) are a must for speaker connection, grounding to prevent RF spray and front end checks. Also saves time when servicing Hi-Fi, TV and radios. With life-time batteries.

Dealer Net ..... **\$9.95**

# SENCORE Simplifies CIRCUIT TESTING

## SENCORE "SERVICE MASTER" SM112

Sometimes, you want a VTVM where circuit loading is a problem. Other times, you want a VOM because power is not available or you do not wish to wait for a VTVM to warm up and stabilize. The SM112 is your answer. Merely flip the function switch to left and you have a complete Deluxe VTVM; flip it to the right and you have a handy VOM that operates from a standard 1.5 volt flashlight battery. Especially made for the "time saving" man. Automatic scale indication on VTVM; a lighted arrow points to the correct scale to read no matter where you place the switches. Two 115 volt AC outlets to provide power to the unit under test. One permanent test probe to do every job for both VOM and VTVM; even the high voltage probe fits on the end of the permanent probe to save wasted time in connecting and disconnecting leads. And, for the first time, an easy grip handle and all steel case with cover and storage compartment so that you leave the job with no leads or line cord hanging. The removable cover is "loaded" with that hard to remember technical data such as standard transistor testing guide, etc. The SM112 is truly a master of service.

6 AC and DC ranges from 0 to 1000 volts on both VTVM and VOM; 6 resistance ranges from 0 to 1000 megohms on VTVM with 2 ranges on VOM; one easy reading scale and a 2 percent six-inch meter provide laboratory type specifications. Zero center scale and peak to peak voltage measurements on VTVM place the SM112 in the category of the finest on any bench or in any laboratory. Dealer Net ..... **\$69.95**

New Combination VTVM-VOM

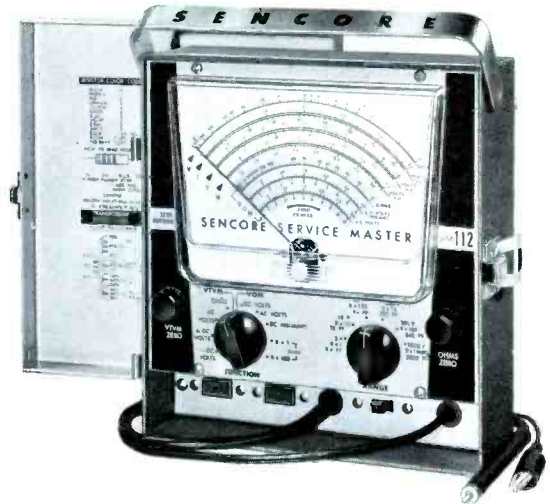

Model SM112

# SENCORE Simplifies Parts SUBSTITUTION

## SENCORE "HANDY 36" H-36

Substitute for Capacitors, Resistors . . . provides the 36 most often needed resistors and capacitors for experimenting, substituting or testing. Eliminates searching for replacement components, unnecessary soldering and unsoldering and the mess it creates. Says goodbye to crumpled parts. Flick of a switch instantly selects any of: 24 Resistors from 10 ohms to 5.6 megohms, 10 Capacitors from 100 mmfd to .5 mfd, 2 Electrolytics, 10 mfd and 40 mfd at 450 Volts. All components are standard American brands.

Dealer Net ..... **\$12.75**



## SENCORE "ELECTRO-SUB" ES102

Complete, safe substitution for Electrolytic Capacitors from the smallest types used in transistor radios to the largest used in Hi-Fi amplifiers. Contains 10 electrolytics from 4 to 350 mfd. Select correct value with the flick of a switch. Features automatic discharge, surge protector circuit. Prevents accidental "healing" of capacitor being bridged. Completely safe — no arc or spark when connecting or disconnecting. Usable from 2 to 450 volts, DC. Dealer Net ..... **\$15.95**



## SENCORE "BIG 20" PR11

For all resistors up to 20 watts from 2.5 to 15,000 ohms. Covers all power resistors encountered in Radio, Hi-Fi and TV Circuitry. Substitute for all questionable power resistors; determine values of burned out 2 and 4 watt carbon resistors, wire wound potentiometers, fuse resistors and resistor values in a hundred and one places in servicing and engineering. Restores circuit to normal fast so that you find the actual defective component. Each resistor stands up to 20 watts during normal testing time. The Big 20 pays for itself the first month in time saved.

Dealer Net ..... **\$12.75**



## SENCORE DUAL TV BIAS SUPPLY BE113

A single 0 to 20 volts DC bias supply or two separate 0 to 20 volts DC bias supplies — without interaction. Save time in AGC trouble shooting and when aligning TV sets. This special low impedance bias supply instantly provides all TV biases recommended in photofact schematics and by all TV manufacturers. The BE113 is extremely well filtered providing virtually pure DC with less than one tenth of one percent ripple. Calibration accuracy is better than equivalent battery tolerance. Dealer Net ..... **\$12.75**



## SENCORE "FUSE SAFE" CIRCUIT TESTER FS-3

Instantly tells you whether or not it is safe to replace fuse resistors, fuses, or circuit breakers. Separate red and green scale for each commercially available fuse resistor used in radio and TV. Eliminates guesswork, wasted time. Also handy for wattage checks up to 1100 watts at 115v.

Dealer Net ..... **\$8.95**



## SENCORE RECTIFIER TROUBLE SHOOTER RS106

Locate faulty Rectifiers, Diodes . . . This unique substitution unit simplifies trouble shooting rectifiers and diodes, gives you a positive check every time. Substitute for suspected rectifier or diode, watch picture or listen to sound and you'll know in seconds whether or not the rectifier or diode should be replaced. No guess work, soldering mess or time lost. The RS106 costs less than having loose rectifiers and diodes in the shop for testing and is worth many times more. A must for servicing voltage doubler circuits. Protected by a 1/2 amp. Slow Blow Fuse.

Dealer Net ..... **\$12.75**



# SENCORE Simplifies SWEEP CIRCUIT TROUBLE SHOOTING

Now in minutes you can analyze any sweep, sync, or high voltage circuit!

## NEW SS117 SWEEP CIRCUIT ANALYZER



For Black and White and Color TV

CHECKS THEM ALL

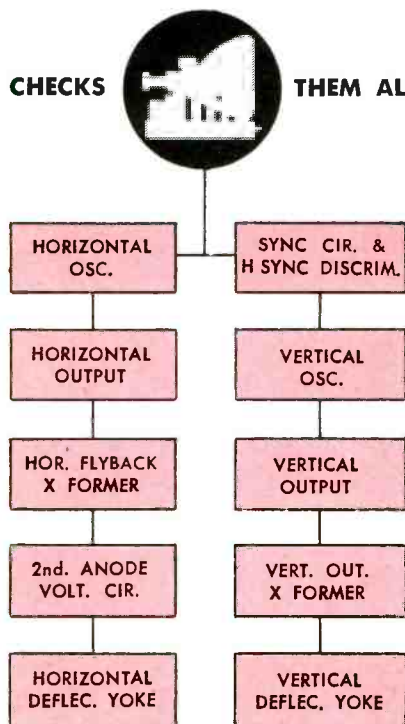

- Make all important checks from the top of the chassis without removing from cabinet.
- Disconnect only one yoke lead for all tests, can be disconnected at yoke to save pulling chassis.
- New "push button" testing greatly simplifies test procedures.



Sencore Sam says . . . How can you miss . . . EACH PACKAGED UNIT CONTAINS:

- An Easy to Follow Instruction Book Especially Prepared and Edited by H. W. Sams.
- A complete 33 RPM, 10 inch Permanent Record on "How to Simplify Sweep Circuit Trouble Shooting."

**You may ask . . .** why test just the sweep, sync and high voltage circuits? Because, this is over 60 percent of the entire TV set and up to 90 percent of the tough dog troubles; especially in the horizontal sweep section where loss of 2nd anode voltage leaves you working in the dark. Most technicians can easily find tuner, IF, and sound troubles.

**Circuits are tested completely . . .** all checks are made under dynamic conditions with the TV turned on. No need to worry about some make-shift "current off" test that indicates the circuit good but break down occurs after the TV is turned on.

**Roll chart provides all necessary data** for setting controls or interpreting readings. Average peak-to-peak driving voltages, cathode currents and grid and screen pin numbers are listed for each horizontal output tube.

**See how easily you can check:**

**HORIZONTAL OSCILLATOR:** Checked by signal substitution from a known good oscillator in the SS117. Restoration of raster or full width when injecting signal from horizontal output grid to TV oscillator determines exact point of trouble. Just push the button in this section and the meter will indicate the P to P drive from SS117 oscillator.

**HORIZONTAL OUTPUT:** Checked by the reliable Cathode Current Check using an adapter socket. Cathode current or screen voltage automatically read by depressing push button.

**HORIZONTAL DEFLECTION YOKE:** Checked a sure fire way by substituting a universal yoke from the SS117. Restoration of 2nd anode voltage or bright vertical line indicates a bad yoke every time. TV yoke is left on picture tube.

**HORIZONTAL OUTPUT TRANSFORMER:** Checked by depressing flyback transformer button. Meter automatically indicates whether or not the transformer is delivering adequate power to sweep the tube in set being checked.

**SYNC AND DISCRIMINATOR CIRCUITS:** Check by connecting sync input lead to any sync stage and attempting to sync SS117 oscillator with horizontal hold control on front of SS117.

**VERTICAL CIRCUITS:** Checked by injecting universal vertical oscillator at grid or plate of output tube.

**VERTICAL DEFLECTION YOKE:** Checked with special vertical signal to give full height if yoke is good.

**2ND ANODE VOLTAGE:** Checked by connecting picture tube 2nd anode lead into high voltage lead on SS117. Meter reads from 0 to 30,000 volts. Meter provides a load that simulates average picture tube load.

**EXTERNAL CHECKS:** • 0 to 300 and 0 to 1000 volts DC for checking B plus and Boost Volts. • 0 to 300 and 0 to 1000 volts P to P for checking sync and osc. outputs. • 0 to 300 DC milliamp range for checking horizontal output fuse current.

**SPECIAL SERVICING FEATURES:** All steel case. Mirror in detachable cover for setting up TV after repair. Two 115 Volt AC outlets provided in lead storage compartment. Size: 10 1/4" x 9 1/4" x 3 1/2". Wt. 10 lbs.

**SS117 Dealer Net \$89.50**

# THE TROUBLESHOOTER

answers your service problems

## Slow Snow

A Westinghouse Chassis V-2346-61 develops a snowy picture about 25 minutes after the set is turned on. Before the snow shows up, the picture is perfect. I've tried to trace the trouble in every way I know, all to no avail. What's your suggestion?

JOE YAKLICH

Verona, Pa.

*Snow that develops after a period of time can be caused by many different things. The most likely trouble area is the RF-amplifier stage of the tuner. However, since this is a series-string receiver, you may be having trouble in the filament circuit. Check the AC voltage at the tube end of the filament-dropping resistor after the snow develops to see if you still have the required voltage. If not, the dropping resistor is your prime suspect. Also, double-check all of the tube types to make certain that a tube with improper filament ratings has not been installed.*

*Make very critical voltage measurements in the RF-amplifier circuit, and, of course, substitute for this tube. Pay particular attention to the bias developed between pins 7 and 8, since a change in value of R10 or R11 may be biasing the tube to the point of producing snow.*

*If you still haven't located the trouble, inject a signal from your sweep generator to various points in the IF and RF*

*sections when the receiver is operating normally. At each point record the peak-to-peak amplitude of the video-detector output signal. Then, after the trouble develops, repeat the test and compare detector-signal amplitudes to isolate the defective stage.*

## "Splits" on UHF

We receive two UHF TV stations in this area, on channels 14 and 50. Both are about 30 miles away, and we get good reception. However, I have a Westinghouse Model H934TU21 that gives either good picture or good sound—but I can't get both to come in together. I've had similar troubles on other sets, but this one is the worst yet. I'm sure others in similar areas would appreciate information on this subject the same as I would.

J. B. SMITH

Stanley, Ky.

*From all indications, the trouble most probably stems from improper alignment of the VHF tuner or video IF stages, or from a defective crystal in the UHF tuner. The sound and picture should come in together, or at least not far enough apart to make it impossible to obtain both at the same time. Therefore, if substituting the mixer crystal doesn't solve the problem, it would be advisable to make a complete over-all alignment check.*

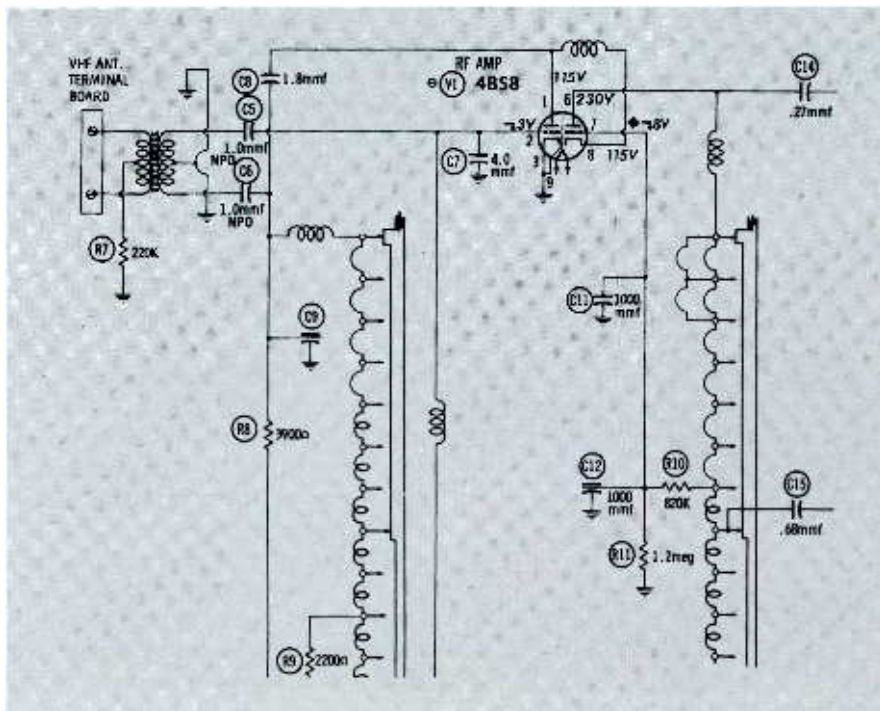

## Noisy Fans

We have a number of DC fans aboard ship that cause interference in TV sets. Bypassing the fans with 1-mfd, 600-volt capacitors has helped in some cases but not in others. Can you recommend a solution?

TED LAMERS

Stmr. W. W. Holloway

*Undoubtedly the interference is caused by brushes which arc as they ride on the commutator. The best solution is to clean the commutator with fine sandpaper (not emery cloth) and install new brushes under proper tension. I presume the TV sets are operating from an AC line rather than the DC line feeding the fans. Therefore, it is safe to assume that the interference is a radiated signal. It may be necessary to screen in the fans and ground the improvised shield to eliminate the trouble completely.*

## Temperamental Sound

I'm fighting intermittent sound in a G-E Model 24C182UHF. The sound comes on and stays for about half an hour. Then it cuts out almost completely for about an hour before coming back to full volume for the rest of the day.

RAY D. ELLIS

Erie, Pa.

*One of the best ways to isolate the trouble is to feed in a signal from a generator and use a scope to trace through the sound circuit to see where the loss is occurring. Since the trouble is thermal in nature, you may be able to use one of the chilling chemicals to spray individual components in the sound circuit when operation is normal. When the defective component is cooled, it should cause the trouble to occur.*

## Auto Radio Bench Tips

Not too long ago you ran an article regarding hum in auto radios being bench-serviced. I have had the same problem, but have found that I can generally eliminate the hum by putting a 10K-ohm resistor between the antenna and chassis. Most auto radios are capacitively coupled from the antenna to the RF stage; thus, they usually develop some kind of hum when serviced out of the car. I hope this hint will help some of your readers.

MARK H. SMITH

Pittsfield, Mass.

*Hum trouble in auto radios may be due to RF hash being radiated from the vibrator power supply. I've found a simple way to stop the interference: "Hang" a 1/2-mfd paper capacitor between the hot "A" lead and the case. I usually clip this to the eliminator lead at the radio and hook the other end through a hole in the case.*

JACK WATT

Ontonagon, Mich.

*Thanks for the tips, fellows. Our other readers are sure to appreciate your good-neighbor policy.*

• Please turn to page 84

**AUDIO FACTS**  
by  
**Norman H. Crowhurst**

Most audio manufacturers now have FM stereo adapters and tuners on the market, and an increasing amount of practical information is becoming available on circuit features, installation, and servicing of this new class of equipment.

**Receiver-Circuit Operation**

To equip an FM tuner for stereo reception, several unfamiliar-looking circuits similar to those in Fig. 1 must be added. The circuitry shown in this schematic does not correspond to any particular model, but is a composite of several widely-used design features. Although

circuits can be explained, it is necessary to describe the stereo signal transmitted by the FM radio station. The RF carrier is modulated by three separate signal components, as outlined in Fig. 2. Two of these, designated as  $L + R$  and  $L - R$ , are produced by mixing the left- and right-channel outputs from a dual microphone setup or a stereo recording. The third, or pilot, signal

form  $L + R$ , which represents the total sound energy picked up in both stereo channels. This combined output is the equivalent of a monophonic signal, and is transmitted in the same way — as direct frequency modulation of the station carrier by frequencies ranging from 50 cps to 15 kc.

In the formation of  $L - R$ , the right-channel signal is fed through a phase inverter before being combined with the left-channel signal. Thus,  $L - R$  represents the differences between the two signals, and can be used to create corresponding differences in the right and left

# FM STEREO AND THE SERVICEMAN

somewhat simplified, it contains all essential circuitry used in converting the FM stereo signal into left- and right-channel audio outputs.

**Signal Characteristics**

Before the functions of these cir-

is used for synchronizing the receiver circuits to maintain the proper phase relationship between the demodulated  $L + R$  and  $L - R$  signals.

The right and left outputs from the audio-signal source are added to

speaker outputs of the stereo-receiving equipment. The  $L - R$  signal also consists of audio frequencies from 50 cps to 15 kc. For transmission, however, these frequencies are applied to a supersonic (38-kc) subcarrier as amplitude modulation, and the resulting sidebands from 23 to 53 kc are used for additional frequency modulation of the main carrier.

The 38-kc subcarrier is suppressed in order to prevent beat-frequency interference with other portions of the stereo signal. This does not degrade the  $L - R$  information, but it does make it necessary for the receiver to reinsert a subcarrier so that the stereo information can be detected. This requirement accounts for the presence of the pilot signal. Continuously transmitted as a weak frequency modulation of the station carrier, the pilot signal enables the receiver to

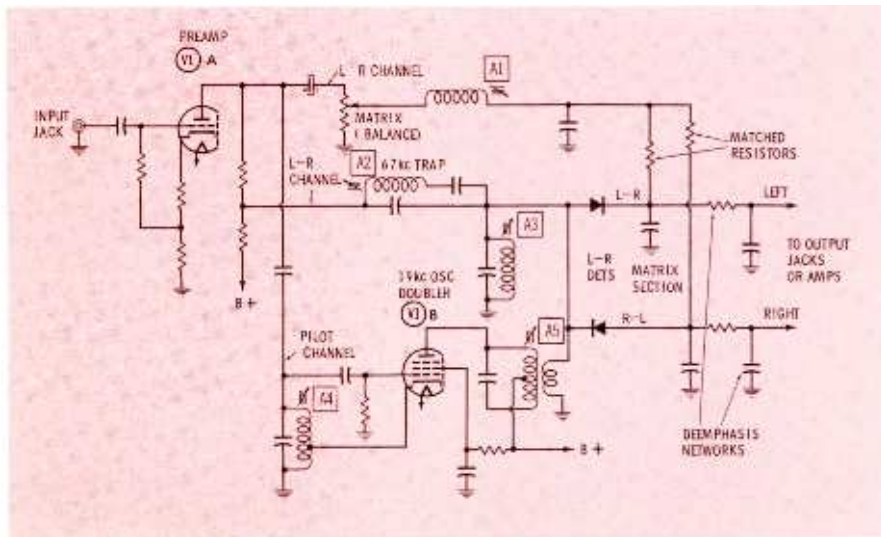

Fig. 1. Simplified schematic of typical circuits for FM stereo reception.

• Please turn to page 24





# 30-second story on the WISE BUY in picture tubes



**Make \$2<sup>85</sup> to \$16<sup>00</sup> more profit on a 21" Admiral Ensign**

Now Admiral's vast purchasing power and national distribution give you the one picture tube line with everything: Finest quality workmanship and material... famous brand-name acceptance... attractive list prices... plus the biggest profit margin in the industry.

You can actually pocket from \$2.85 to \$16.00 more profit on a 21"

Admiral Ensign than on other brands. (Comparably higher margin on all other tube sizes.) Get the facts! Compare Ensign quality, performance, prices and profits. Discover for yourself why dollar-wise servicemen are switching to the Admiral Ensign. Call your nearby Admiral Distributor today! Start earning more right now!

**NOTICE:** All materials and parts used in the manufacturing of Admiral Ensign tubes are new, except for the envelope, which prior to re-use, was carefully inspected to meet the standards of the original new envelope.



**NEW Admiral Tube Carton**

Remarkable new package is lighter, stronger... has built-in carrying grips... takes 40% less space! Another Ensign "Extra."

# ADMIRAL® ENSIGN Picture Tubes

# TV SERVICE-CHARGE SURVEY

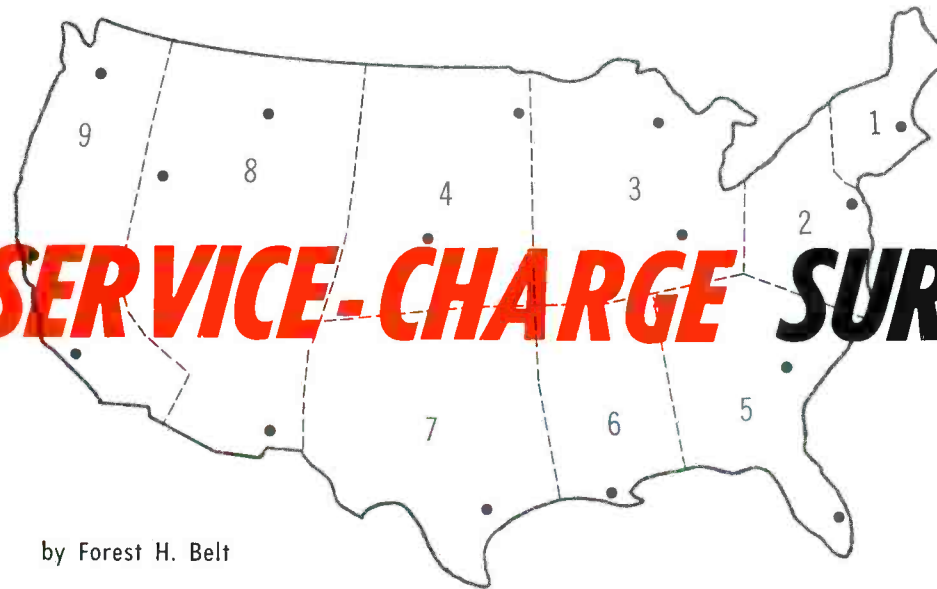

by Forest H. Belt

We contacted servicemen in every state of the Union to find out "What the other guy's charging."

From time to time, many of our readers have indicated a desire to learn whether their service charges were in line with those of other service shops. In answer to these requests, we surveyed a representative cross-section of independent servicers throughout the nation. This survey covered all the major areas of the United States, including Alaska and Hawaii.

We tried to procure information which would help us determine what prices are being charged for radio and TV service. Naturally, prices vary from one area to another, from large city to small town, and from east coast to west coast. For this

reason, we have tabulated the results of the survey by areas, so that comparisons can be readily made by the reader.

Table I shows the survey results by geographical areas (see map above). The information provided in the first three tabular columns indicates the percentages of service shops which use (a) hourly rates, (b) flat rates, or (c) both methods of computing charges. Several different means of computing service rates were recorded during the survey. Most shops preferred some type of flat-rate system, although a large number reported use of hourly-rate figures for much of their

work. A few systems were quite unusual. One serviceman even followed a formula derived from the original selling price of the equipment.

Average hourly charges in different sections of the country are shown in column 4. These rates vary considerably within each area, but the predominant number are below the mean level. Compared with hourly service rates in other industries, TV service seems to be somewhat toward the low end of the totem pole.

The next section of Table I lists average charges for home calls on both black-and-white and color tele-

Table I—Replies Tabulated by Sections of Country

SECTION	% Hrly. Rate	% Flat Rate	% Both	Avg. Hrly.	Avg. Home Call		Avg. Flat Bench			Avg. P/U & Del.
					BWTV	CTV	Rad.	BWTV	CTV	
1. New England	9%	58%	33%	3.75	3.75	4.00	3.50	9.50	12.50	3.00
2. Middle Atlantic	61%	32%	7%	4.00	3.60	4.85	3.50	10.65	15.25	3.40
3. E. No. Central	36%	45%	19%	3.75	3.50	5.25	2.70	6.70	12.50	3.75
4. W. No. Central	34%	62%	4%	4.00	3.75	5.50	2.20	6.25	14.50	3.50
5. So. Atlantic	11%	77%	12%	3.75	3.50	5.25	3.50	7.30	10.25	3.50
6. E. So. Central	32%	60%	8%	3.50	3.35	5.40	3.00	5.20	10.00	2.50
7. W. So. Central	11%	80%	9%	4.25	4.25	6.40	3.35	9.60	12.75	2.70
8. Mountain*	45%	49%	6%	5.00	4.35	7.50	2.40	7.50	10.00	4.00
9. Pacific	50%	22%	38%	5.50	4.75	7.75	3.95	9.00	16.00	4.25
				Hi 8.00	6.50	12.50	6.00	15.50	25.00	6.00
Nationwide	32%	54%	14%	Avg. 4.20	3.90	5.75	3.10	7.95	12.65	3.40
				Lo 1.50	2.00	4.00	1.00	3.00	5.00	free

\*Returns unusually light

vision sets. Notice the trend of consistency in the Eastern and Midwest sections, and the relatively higher hourly rates in the West and Southwest. Reasons for this stem from a number of factors. The cost-of-living index seems to be the greatest influence, although the availability of qualified technicians for a given population density is also a strong factor.

Flat-rate charges, given in the fourth portion of the table, are a compilation of average minimum fees for bench-servicing radio, television, and color television sets. A number of different practices are used in setting and applying minimum bench charges. Some shops figure on the basis of a certain amount for the first hour, and so much for each succeeding hour or fraction thereof. Most of these shops set a maximum figure beyond which they cease to charge. Other shops use a flat-rate minimum to which they add a service charge for each specific job.

A surprising number of service people make use of printed pricing charts which list suggested charges related to the replacement of specific components. The figures are based on the complexity involved in diagnosing and replacing a defective component, and do not include the price of the component itself. A user of such charts will do well to remember that, unless prepared for his specific use, they do not reflect his particular overhead expenses.

When queried about pickup and delivery charges, those who took part in this survey offered a wide choice of opinions. Comments ranged from "We refuse to charge for this," to "Pickup and delivery free." The last column in the table was compiled from the prices given by those who do charge for pickup and delivery. As you can see, the averages are pretty much in line with the home-call rates, although almost invariably 10 to 25% less.

The figures at the bottom of Table I represent country-wide averages, along with the highest and lowest prices for a given service. These summaries can be used to equate the over-all picture of service charges by area.

Population density is another factor which enters the picture in try-

ing to determine the average service charge for a particular locality. Table II shows that average prices in metropolitan districts are normally higher than in rural or small-town areas. However, some of the record "highs" were found in small towns, and some of the shops in metropolitan areas charged much less than the nationwide average. For purposes of this tabulation, a metropolitan area is considered to be a concentration of more than 50,000 people.

A few interesting sidelights were uncovered by the survey. For example, only 50% of the respondents indicated any activity in auto radio service. Some 15% stated definitely they did not service auto radios, while 35% failed to commit themselves. The minimum bench charge for this service came to a nationwide average of \$3.95 per set, so

it seems a lot of profitable service work may be going begging.

The same situation held true with transistor radios. Several shops insisted they will service only American-made models; others emphatically stated they wanted no part of transistor radios. Minimum charge for bench work averaged slightly over \$3.50 per radio. Again, it seems many service technicians are bypassing opportunities for additional service revenue.

Of course, your own service prices must reflect the conditions in your own locality, as well as your own particular circumstances. They must pay your wages and business overhead, provide for keeping test equipment up to date, and furnish a profit as well. Perhaps the results of this survey will help determine if *your* charges are just about what they should be. ▲

**Table II—Comparing Metropolitan and Small-Town Areas**

		Metropolitan Areas	Small-Town Areas
<b>Hourly Rates</b>	HI	8.00	7.50
	AVG	6.25	4.25
	LO	4.50	1.50
<b>Home-Service Call B-W TV</b>	HI	6.00	6.50
	AVG	3.95	3.75
	LO	2.50	2.00
<b>Home-Service Call Color TV</b>	HI	8.00	12.50
	AVG	5.95	5.95
	LO	3.95	2.00
<b>Minimum Bench Charge B-W TV</b>	HI	14.00	15.50
	AVG	9.95	8.00
	LO	5.00	3.00
<b>Minimum Bench Charge Color TV</b>	HI	25.00	19.00
	AVG	14.50	12.00
	LO	5.00	6.00
<b>Minimum Bench Charge Radio</b>	HI	6.00	6.00
	AVG	3.50	3.00
	LO	2.00	1.00



# TEST SETUPS for SERVICING 2 WAY

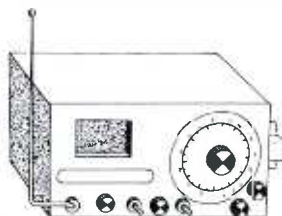

Servicing of two-way radios can be made easy by the use of an appropriate testing arrangement. The procedure is considerably simpler than the methods usually employed in TV servicing, where assorted knobs and screws have to be removed and the set practically turned inside out in order to measure voltage and current. A commercial two-way radio need only be unlocked from its case and slipped out—you needn't be a contortionist to get at it. Furthermore, most two-way radios have metering sockets which allow you to check the important stages in the transmitter and receiver without turning the set upside down and probing for test points. Once the radio is removed from its case, you can plug your voltmeter into the appropriate socket terminals to check the voltage or current at particular key metering points.

These test points may be individual banana or pin jacks on the chassis, but it is a more common practice to connect all transmitter and receiver test circuits to an 11-pin socket of the Amphenol "S" type. As an example of how metering points are wired into various circuits, Fig. 1 shows the driver and final stages of a Comco transmitter. Notice the metering resistors (R1, R2, R5, R6, R8, and R9) between the circuits being checked and the test receptacle. These resistances have two functions; they isolate the effect of the meter circuits, and they act as multipliers to keep the reading on scale.

A two-way radio that uses 11-pin metering sockets can be easily checked by using a test set wired for metering various voltages and cur-

rents. The test set provides controls for the radio, in addition to metering functions. Portable metering sets can be purchased from many of the larger manufacturers of two-way radio. These units may incorporate various additional features such as a crystal oscillator (for alignment), a field-strength meter, an RF peaking generator, etc. These extra features are fine, handy, and nice to have. However, if you just want a serviceable unit which will serve the main purpose of a test set (convenient metering of key stages in transmitters and receivers), but do not wish to go to the expense of purchasing a factory-built instrument, you can build your own.

Fig. 2 is a schematic of a well-designed test set for controlling and metering two-way radios. This versatile instrument can be built using any case design or material desired. A typical panel layout is shown in Fig. 3. The unit has a built-in field-strength meter (FSM), plus a 4-ohm speaker; the audio across the speaker can be measured on the 50-ua meter. This test set is designed for use with any RCA or Motorola two-way radio. By the use of adapters described later in this article, almost any other brand of two-way radio can be metered directly.

Refer to the Motorola metering positions listed in Fig. 4 during the following description of the metering procedure using this test set. To meter the receiver stages, S5 is placed in the MOTOROLA position, and S3 is left in its counterclockwise, or RCVR, position. The 11-pin plug is inserted into the receiver-metering socket, and S4 is put in the No. 1 position, so as to meter

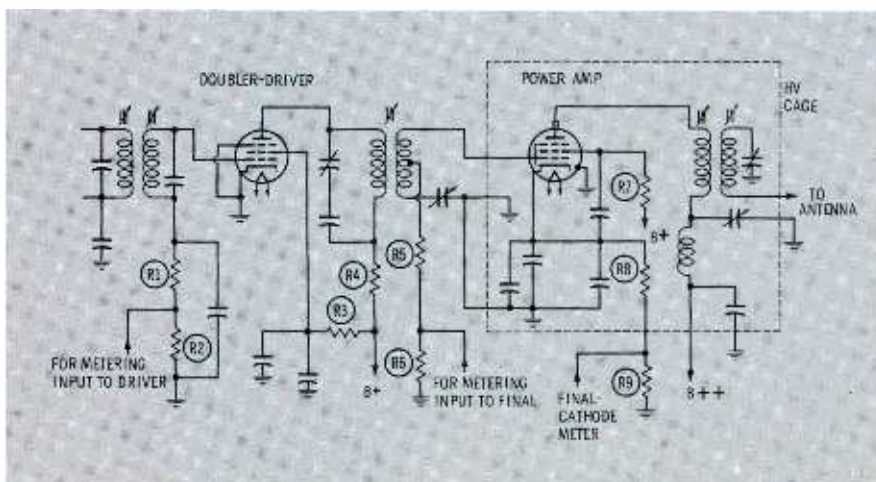

Fig. 1. Metering points in driver and final stages of a Comco transmitter.

the grid circuit of the third low-IF (455-kc) amplifier. The reading shown on the meter can range between 2 and 15  $\mu$ a in normal operation of the two-way radio.

Considering the action of the metering circuit, note that pin 11 of plug P1 serves as a common ground between the test set and the radio. A voltage applied at pin 1 of P1 would be connected through S4A, the FSM-jack contacts, meter-reversing switch S1, and fuse M2 to the negative terminal of meter M1. The ground return of the meter would be back through S1, the FSM-jack contacts, multiplier resistor R2, and S4B to ground.

Switch positions 2, 3, 5, and 6 are used in the same manner. Positions -4 and +4 meter the discriminator output of the two-way radio receiver. Internal connections for this measurement are made in the test set through function switch S3, as positions -4 and +4 are used for

other purposes in metering a transmitter.

The audio output from the receiver is fed into the test set through pins 9 and 10 of P1. The path from P1-10 to the speaker is via ground through S3B; from P1-9 the audio goes through S3B to the volume control and thence to the speaker. Diode M4 rectifies the audio and feeds the DC component through S3B to the negative terminal of the meter via S4B. The meter return for this voltage is the same as described earlier. This reading is very useful in making 20-db quieting measurements to determine receiver sensitivity.

In order to use the test set for metering transmitter stages, S3 is thrown to the clockwise position (XMTR), and plug P1 is inserted into the transmitter-metering socket. The transmitter can be keyed with a microphone plugged into receptacle J1, or by using transmitter-

keying switch S2. The keying-circuit path is from pin 9 of P1 through S3B to J1. This completes the circuit to ground, energizing the transmit-receive relay in the radio. When the tripler grid is to be metered, S4 is placed in the No. 3 position. Circuit action is similar to that described for receiver metering. Positions 2, -4, 5, and 6 are metered in the same way.

The plate current in the final amplifier is developed across a metering resistor in the transmitter. The voltage across this resistor is brought into the test set on pins 7 and 8 of P1. From P1, the circuit to meter M1 is completed through S3A and S4B. The return circuit from M1 is through S4A, S3A, and back to the transmitter circuit through P1. Position +4 of switch S4 is used for metering the final-amplifier plate current.

In order to provide modulation

• Please turn to page 89

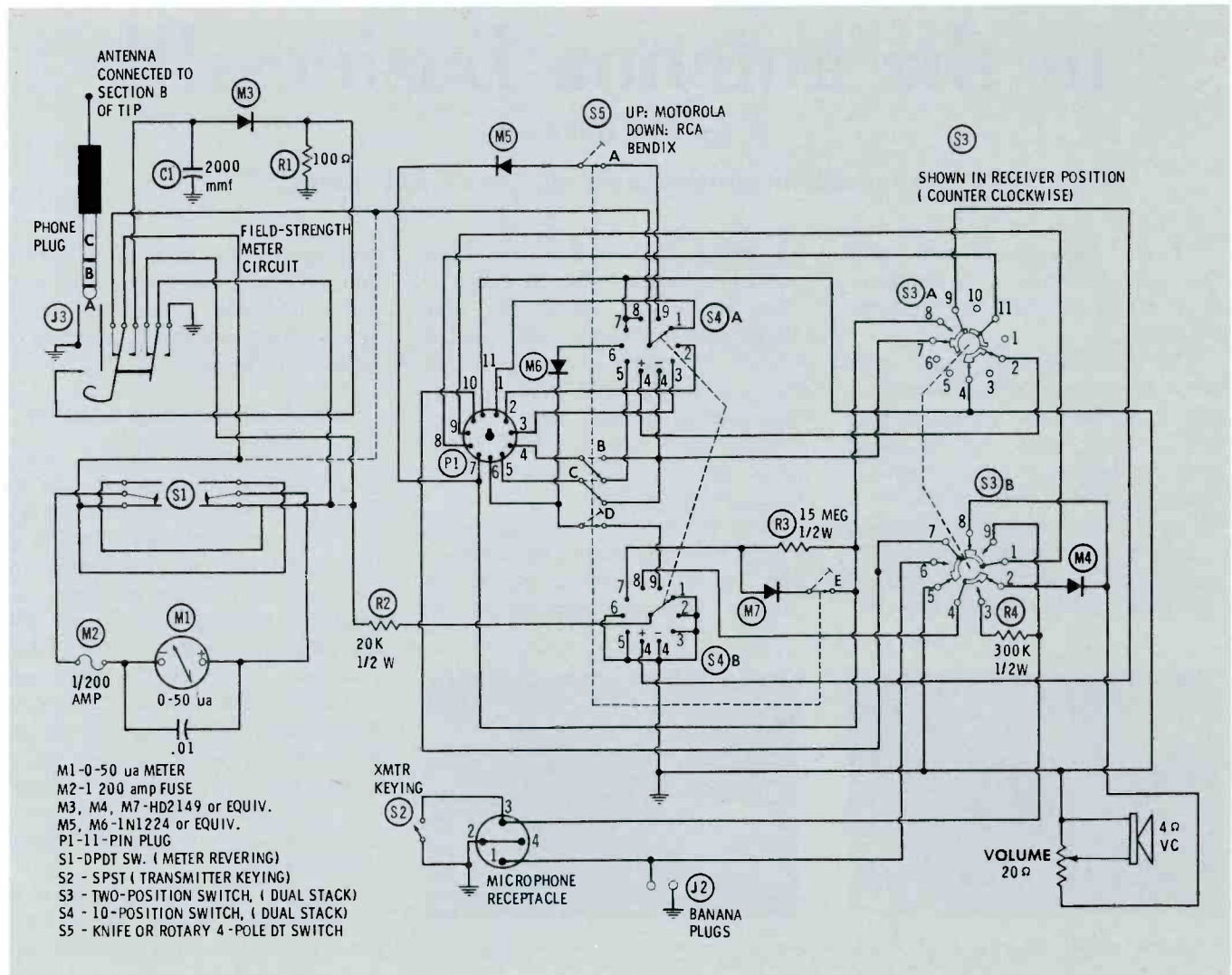

Fig. 2. Complete schematic of a test set for metering several brands of two-way transmitters and receivers.

# THERE'S BIG MONEY in the antenna business!!!

by Jim Galloway

Personal interviews help us prove our point.

*"By the way, sir, did you know that your picture could be improved by as much as 100% with a good antenna?"*

This one comment could open the way to a profitable antenna repair or replacement. There are very few locations where TV reception can't be improved by a properly-designed antenna system. The trouble is, most customers have been led to believe that outside antennas are needed only in rural areas and do very little good in the city. This mis-

conception can be traced to fast-talking salesmen trying to clinch a sale, or to lazy servicemen who "don't want to bother with antenna work." The truth of the matter is that any service shop not promoting antenna repairs and sales is pushing profit out the door. Want proof? We thought you would, so we went out and got it.

First of all, there are three areas where you can expect to increase your antenna business: Repair of existing systems, replacement of

present systems, and new installations. Usually, however, the only way to find out if a customer is even aware of his antenna problem is to point it out to him.

#### Repair of Existing Systems

In many cases, lead-in wires deteriorate in a matter of two or three years. Most customers can tell if a lead run inside the house is in poor condition, but are completely unaware of troubles outdoors — which are more likely to occur. The loss of picture quality usually takes place over a long period of time, and is therefore not noticed. These customers will be glad to pay for an improvement in picture quality, especially when you point out to them that they are not getting the most use out of their original investment in an antenna.

Another common occurrence is mismatched hook-ups. Many families have acquired additional sets and paralleled the antenna hook-up with their old set, resulting in a mis-



A concrete example of what antenna sales helped to accomplish. The new shop, pictured on the right, became necessary when business outgrew the old place on the left. Two men with the same ideas decided to combine their efforts. Both partners believe in looking for extra business, including many antenna sales.

matched load for the antenna. Often they have cases of cross-channel and IF interference. It wouldn't take much talking to sell a multiset coupler here.

Sometimes a complete renovation of the system is in order. This type of work brings in high gross receipts, with a substantial percentage of profit.

There are very few systems over three years old that don't need some type of repair. We checked four consumers who needed work on their present systems, and found that three of them were unaware of this fact. For instance, two installations had only one lead of the 300-ohm flat lead-in connected at the antenna. The broken lead was plainly visible, but when it was pointed out, the owner said he hadn't noticed it. In these instances, proper operation could probably be restored by removing the corrosion from the antenna terminals and running a new lead-in wire. This job would take about an hour to perform. The other case called for replacement of all stand-off insulators and rerouting of the lead-in. The customer had noticed the lead-in draped across the roof and gutter, but didn't know this could affect his picture. This job could also be performed in about an hour's time. In all four instances, these people were interested in, and willing to talk to a serviceman about, the necessary repairs. No selling was required—it was only necessary to apprise the customer of his problems.

### Replacement of Existing Systems

There are a surprising number of homes which sport an outside antenna of rather ancient vintage. In many cases, these old relics have fallen into disuse because a better picture could be obtained with rabbit ears. These people probably need a new antenna as much as they needed the old one when it was installed. Some salesmanship is required here, but it is made easier in many cases because the people who occupy the house did not live there when the original system was purchased and, therefore, did not make the initial outlay. One lady we talked to was definitely in the market for a new system because she had recently purchased a color set. All we had



Draping the lead-in across the roof can cause high losses in the line. Proper cabling techniques, using stand-off insulators, remedies this problem.

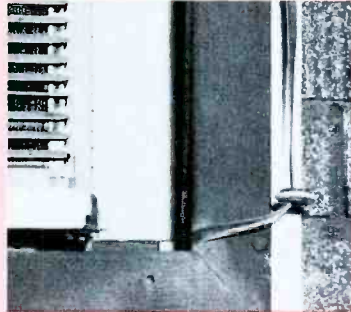

This installation is minus a drip loop. Furthermore, notice how the lead-in is pinched by the window casing.

Two separate leads to the same antenna can cause mismatch and interference.

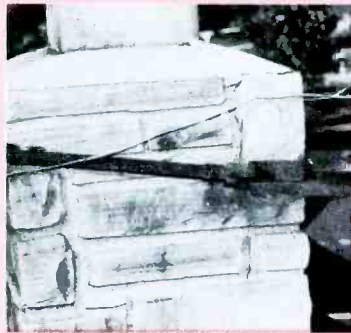
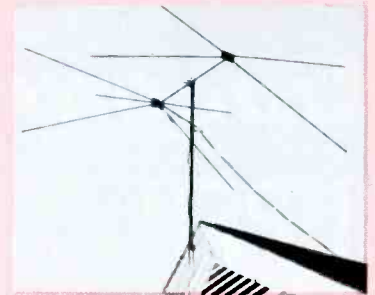

The rusted straps holding this chimney mount are likely to break at any time.

A suggested checkout form which can be presented to customers at the completion of a house call. This courtesy often results in antenna-repair orders.

Dear Customer,

Your antenna system is a major factor affecting the quality of your TV picture. As a service to our customers, our trained technicians automatically check out the antenna system on every service call. Here are the results of checking over your system:

DEFECT	COST ESTIMATE
1. ___ Generally deteriorated lead-in.	_____
2. ___ Improper entry of lead-in.	_____
3. ___ Lead-in draped against gutter or roof.	_____
4. ___ Lead-in broken at antenna terminals.	_____
5. ___ Improper multiset coupling.	_____
6. ___ Corrosion of antenna terminals.	_____
7. ___ Broken or otherwise damaged stand-offs.	_____
8. ___ Improper lightning arrester.	_____
9. ___ Missing or damaged elements on antenna.	_____
10. ___ Rusted mast-mounting straps.	_____
11. ___ Missing or damaged guy wires.	_____
12. ___ Other _____.	_____
TOTAL	_____

**SHOP NAME**  
Please call **PHONE NO.**

# ACTUAL PHOTOS OF TV PICTURES RECEIVED UP TO 248 MILES AWAY

## PULLED IN BY A *Winegard* SUPER POWERTRON TV ANTENNA

We can't guarantee that everyone will get results like this but long distance reception performance is not unusual for the world's most powerful TV antenna.

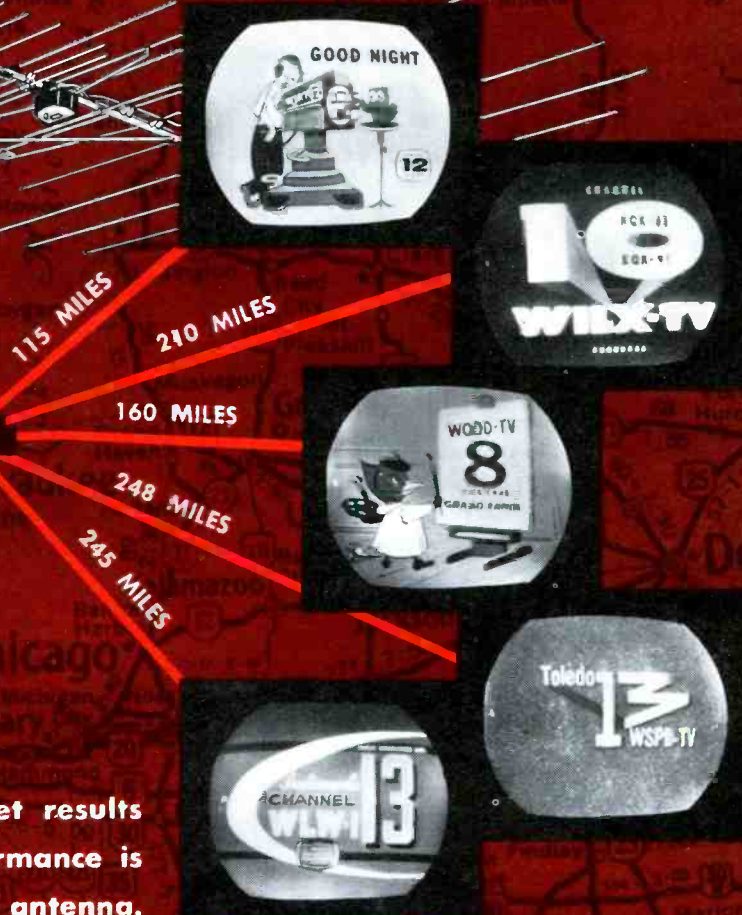

### Why the Winegard Super Powertron is the Most Effective Antenna Ever Designed—



**IT CAPTURES MORE SIGNAL** than any other all-channel antenna ever made. Patented design, electro-lens director system, dual "TAPERED T" driven elements, 30 precision-tuned elements in all.



**IT'S THE ONLY TRUE ELECTRONIC ANTENNA.** Only the Winegard Powertron is built with the amplifier as part of the driven element — not an "add-on" attachment.



**IT ELIMINATES ALL SIGNAL LOSS** that normally occurs between the driven element and the amplifier due to transmission and coupling mis-match.



**IT BOOSTS WEAK SIGNALS UP OUT OF THE SNOW** far better than any other antenna or antenna-amplifier combination made.

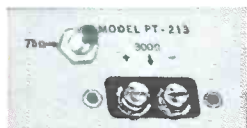

ONLY POWERTRON HAS BOTH 300 OHM TWIN LEAD AND 75 OHM COAX TERMINALS ON BUILT-IN AMPLIFIER.



ONLY POWERTRON GIVES YOU YOUR CHOICE OF TRANSISTORS OR TUBES (TUBE MODELS 300 OHM ONLY).



ONLY POWERTRON HAS RANGE AND POLARITY CONTROL SWITCH TO PREVENT OVERDRIVING ON STRONG CHANNELS.



ONLY POWERTRON HAS AC PLUG-IN OUTLET FOR TV SET BUILT INTO THE POWER SUPPLY.

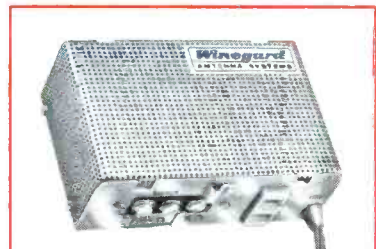

**POWERTRON POWER SUPPLY IS ALL AC—SAFE, SHOCKPROOF.**

Transistorized Model has rectifier and filter in power supply — not in amplifier, where servicing is difficult. No nuisance batteries. Costs 27c to operate for a full year.



# Read what Charles J. Milton of Moyer TV, Milwaukee, has to say about the Winegard Super Powertron...

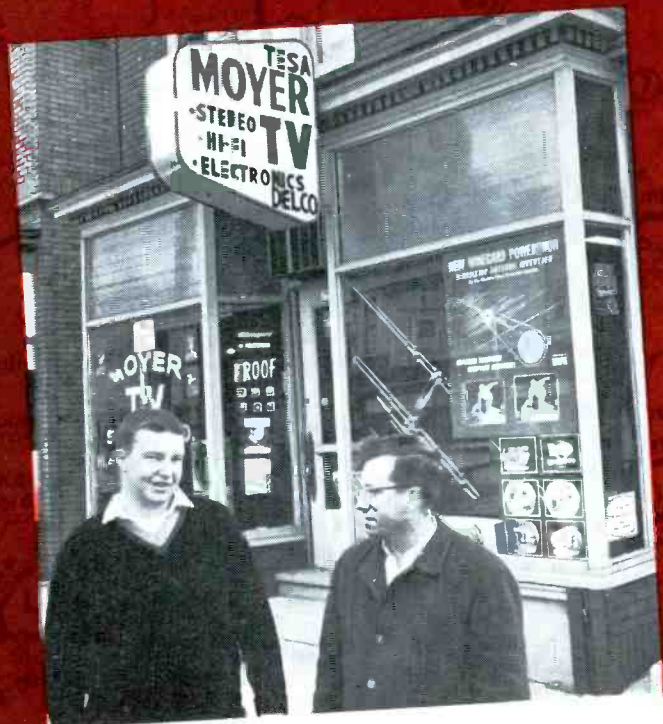

Charles Milton and Jim Moyer  
in front of Moyer TV

Of course, everyone can't get reception results like Charles Milton has experienced. Each area has its own unique reception characteristics and problems. But one thing we can promise, the Powertron will deliver more clear pictures on your TV screen than any antenna you can own.



## MOYER TV & RADIO SERVICE

3111 W. NORTH AVE.

2913 W. NORTH AVE.

TESA-MILW.

MILWAUKEE 8, WIS.

Hilltop 4-0740

Winegard Company  
3000 Kirkwood  
Burlington, Iowa

Gentlemen:

I would like to thank the Winegard Company for building the Super Powertron SP-44X.

With this antenna, reception at the local station level is perfect in both black and white and color. At medium range, the Powertron outperforms all others. Channel nine from Chicago, about 90 air miles, comes in clear and regularly. This is the Cubs baseball station and the one Milwaukeeans are willing to pay big money to get.

When the "Big Winegard", as it is affectionately called around the shop, is on long range it probes the unknown alone. All other antennas have fallen far behind. I have picked up eleven stations over 100 air miles away. The farthest of these is WWJ, Channel Four, Detroit, an unbelievable 251 miles. I have included a few pictures that I took off the TV with a Rolliflex F 3.5 at one second using Verichrome Pan.

We use the pictures in a window display and I use a set of pictures to explain the advantages of a Winegard to prospective customers. Believe me the pictures work -- and so does the "Big Winegard."

Sincerely,

*Charles J. Milton*

**POWERTRON IS 100%  
CORROSION-PROOFED**

ANTENNA IS GOLD ANODIZED,  
ALL HARDWARE IRRIDIZED,  
AMPLIFIER HOUSING OF HIGH  
IMPACT POLYSTYRENE.

## PHOTOGRAPH YOUR OWN TV STATION PICTURES AND SEND THEM IN!

If you own a Powertron, chances are you too are experiencing unusual results. Why not photograph the stations you receive and send them in to us. We are always interested in hearing from Winegard antenna dealers and owners. We will be glad to enlarge your camera shots so that you can make your own window or store display like Moyer TV has done. The photos make

great sales persuaders to prospects and can be used in many ways to sell more Powertrons.

If you have never tried a Winegard Electronic Powertron, give it a test and be agreeably surprised. Don't take our word for it—let your eyes and ears and field strength meter tell the story. For full details and spec sheets, ask your distributor or write.



**Winegard**  
ANTENNA SYSTEMS

Winegard Co., 3009-12A Kirkwood St., Burlington, Iowa

# NEW *Winegard* ELECTRONIC CUT-CHANNEL YAGIS

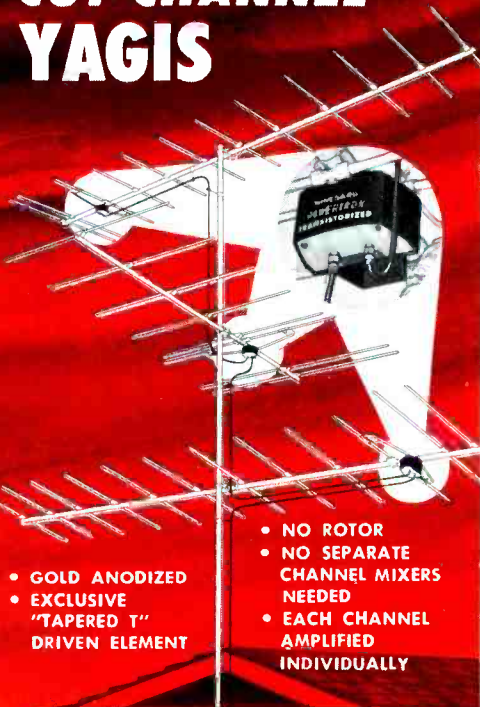

- GOLD ANODIZED
- EXCLUSIVE "TAPERED T" DRIVEN ELEMENT

- NO ROTOR
- NO SEPARATE CHANNEL MIXERS NEEDED
- EACH CHANNEL AMPLIFIED INDIVIDUALLY

## AMPLIFIED TV RECEPTION IN ALL DIRECTIONS

**ABSOLUTELY THE ULTIMATE IN BLACK AND WHITE AND COLOR FRINGE AREA RECEPTION!**

Winegard's new cut channel yagis are the HIGHEST GAIN (28 DB) TV ANTENNAS EVER MADE! Each is powered by a transistor amplifier individually peaked for perfect results. Because TV signals are amplified at the point of interception, the finest possible signal-to-noise ratio results.

Each Powertron yagi amplifier has two 75 ohm coaxial connectors: for down-lead to the power supply and from built-in mixing coupler for connection to another Powertron without interaction.

Power consumption is only .05 Watt each. Eight Powertron yagis can be run from one power supply on one down-lead. Low band, FM and all channel models can be stacked 72" apart. High band models can be stacked 30" apart and placed between low band.

There are six (8-element) cut channel and broad low band models—eight (12 element) cut channel and broad high band models plus two FM and three all channel models. Ideal for motels, apartments, trailers, wherever the finest installation is needed.

Run up to 8 antennas from one power supply

For full details ask your distributor or write for technical bulletin.



# Winegard

3009-12E Kirkwood • Burlington, Iowa

to do was point out how much more of a problem snow was with color than with black and white. She had been aware that the picture did not look as good as it had in the showroom, but figured she didn't know how to adjust the set properly.

The fact is, people with a useless antenna are in the same shape as people who have no antenna at all, and many times these old systems are doing more harm than good. For instance, we talked with one lady who had her set hooked into a surface-mounted outlet. There was no lead-in from the antenna, so in effect, she was using two pieces of lead-in about two feet long for an antenna! When we showed her the improvement obtained by connecting the built-in antenna, it was simple to get her to agree she would obtain a much better picture with a new roof mount. It would probably have been relatively easy to sell a complete system if we had pressed the matter.

### Installation of New Systems

The rapid rise in the number of TV sets in use has not been paralleled by an increase in antenna sales in recent years. This is largely due to the failure of many dealers to even mention an antenna when they sell sets. Most TV dealers don't sell antennas because they're not equipped to install them.

While driving through the newer suburbs, we were able to find only about one house in ten with an outside antenna. In contrast, the housing developments which were built about ten years ago sprouted a profusion of masts even though many of these homes were actually closer to the transmitting antenna.

Most of the people interviewed in these areas had not been asked if they would like an antenna by the dealer. While many were uninterested when approached, enough prospects were receptive to make it worth the time to solicit business.

Many people have bought sets with reduced sensitivity, built to operate in close-in areas. When these sets are taken into the more distant suburbs, they may receive all the usual channels, but they don't provide all the amplification necessary for a class A picture. With an outside antenna, however, these sets will perform as well as the



This motel installation was worth a nice profit to an enterprising shop. The contract also led to the sale of several sets and a long-term service policy. Apartment houses also offer golden opportunities for antenna-system sales.

more expensive models.

If a customer has a properly-functioning antenna system and is still not satisfied with his picture, he is a potential purchaser of a pre-amplifier or booster. Television preamps have been greatly improved in the last few years, and a variety of mast-mounted types are now on the market. There's money to be made by the serviceman willing to spend some time selling these units, especially in fringe areas.

Speaking of preamps, it's often possible to sell a customer a complete home distribution system. In large homes, where two or more sets are in use a long distance from the antenna, line losses are often too severe unless a distribution amplifier is used. These amplifiers are available in a variety of models in many price ranges.

Sometimes a customer has the problem of severe ghosting. In this case, it should be possible to sell a highly directional antenna. Once again, this antenna should sell itself by the noted improvement in the picture.

Color sets offer perhaps the best market for antenna sales. Many of the owners we talked with were dissatisfied with the reception they were getting, and the trouble could generally be traced to snow in the picture. In many cases, it was only necessary to point out that they were not getting enough benefit out of their investment, and by spending a few extra dollars on a good antenna, they could enjoy the full advantages of color TV.

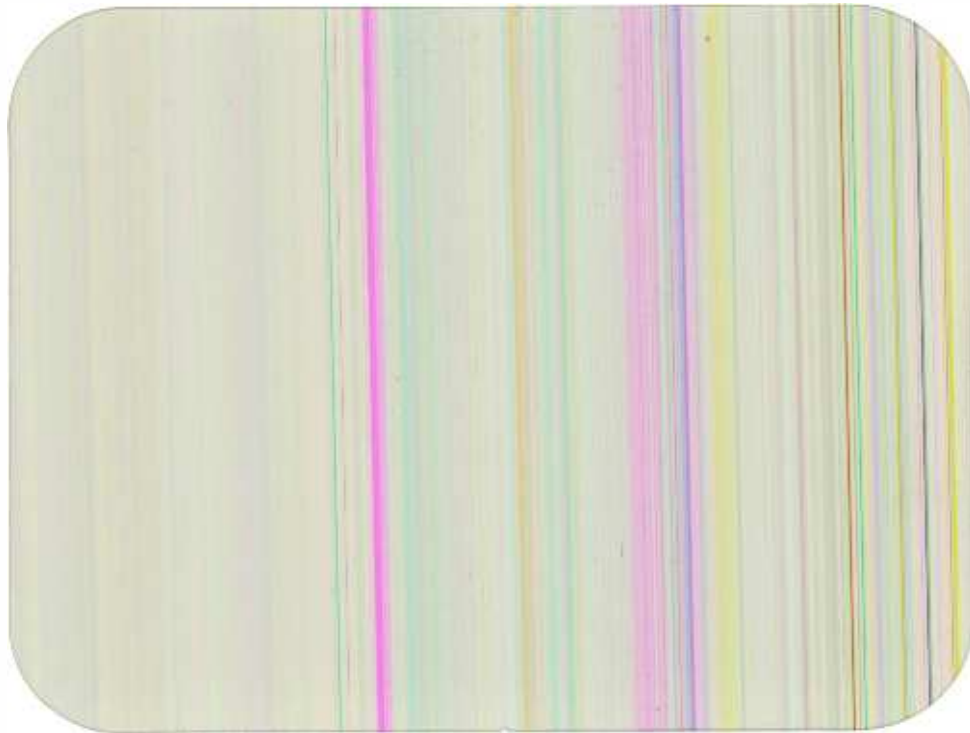

THE DIFFERENCE IS CLEAR!

**ONLY WESTINGHOUSE HAS  
NEW GLAS-GARD FILM...  
TOTAL SCRATCH-PROTECTION FOR  
EVERY GOLD-STAR PICTURE TUBE!**

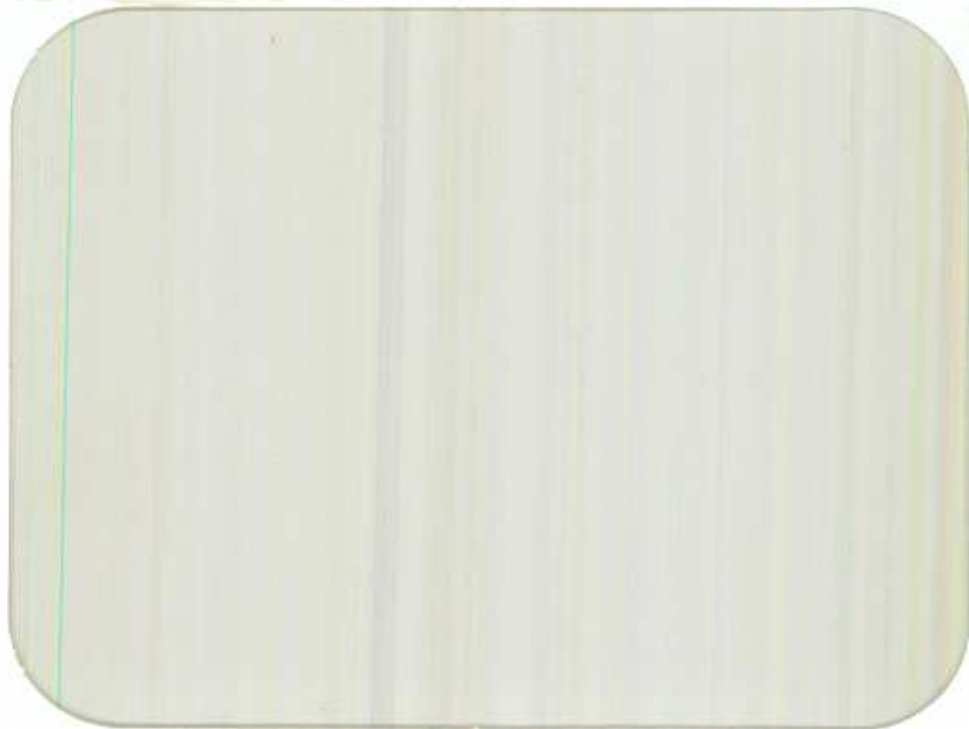

# THERE'S NEW POWER IN

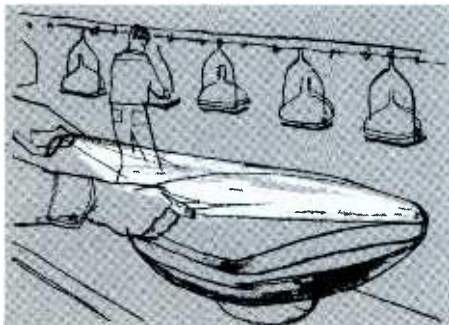

**1.** Glas-Gard polyethylene film is applied to every Gold Star Picture Tube at the factory.

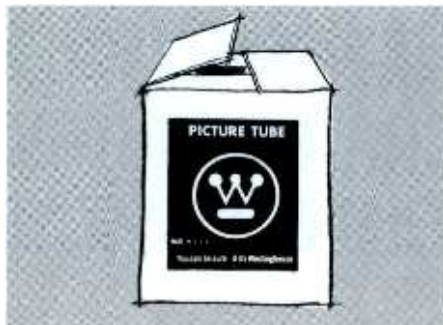

**2.** Protects tube in shipping from scratching, and chemical action of packing materials.

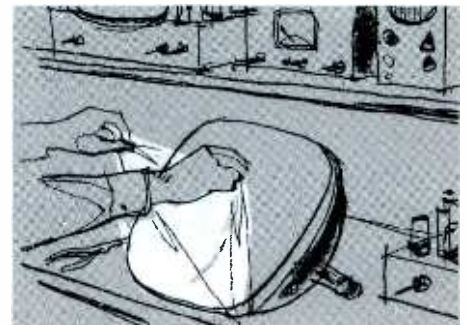

**3.** Film is easily removed just before tube is installed in set.



# WESTINGHOUSE TUBES!

Now GLAS-GARD film protects tube face... gives you exclusive selling "extras"

An industry first . . . from Westinghouse! Every Westinghouse Gold Star Picture Tube now comes wrapped in Glas-Gard polyethylene film. Glas-Gard protects the tube face against scratching . . . eliminates corrosion of glass sometimes caused by conventional cardboard packaging. Glas-Gard positively identifies the picture tube as new and fresh from the factory. Glas-Gard gives you a powerful, exclusive selling story. Make the most of it! Point out its benefits to your customers.

Glas-Gard packaging is one of many features in

the Westinghouse NEW POWER program for marketing electronic tubes. Others include: ■ HIGHER PROFIT MARGINS—Realistic and constant—result of outstanding product quality and competitive product-cost ratios. ■ THE ULTIMATE IN FINANCING PLANS—offers distributors a flexible line of credit ■ MARKETING AND FINANCIAL COUNSEL—to help distributors solve financial, advertising, promotion problems ■ FAST TIE-LINE SERVICE—Distributor orders processed in one hour of receipt ■ INDUSTRY INNOVATIONS—New packaging, merchandising builds more business.

You can be sure . . . if it's **Westinghouse**





There's NEW POWER in Westinghouse Tubes. Turn to get the full story on new Glas-Gard film—exclusive scratch-protection for all Westinghouse Gold Star Picture Tubes.

Distributors and servicemen-dealers who wish to sell Westinghouse Gold Star Picture Tubes with exclusive Glas-Gard protection are invited to call or write any of these Westinghouse sales offices:

**ATLANTA 2, GA.**  
1299 Northside Drive, N.W.  
TRinity 4-1641

**BLOOMFIELD, NEW JERSEY**  
MacArthur Avenue  
HUmboldt 4-3000

**BOSTON, MASS.**  
10 High St.  
LIberty 2-0600

**CHARLOTTE 8, N. C.**  
P.O. Box 1399, 2001 W. Morehead St.  
FRanklin 7-3471

**CHICAGO, ILL.**  
2211 West Pershing Road  
WHitehall 4-3860

**CINCINNATI 2, OHIO**  
6th & Main Streets  
GARfield 1-2250

**DENVER 10, COLORADO**  
710 E. Louisiana Ave.  
PEarl 3-5528

**DES MOINES, IOWA**  
2515 Dean Ave.  
AMherst 2-3181

**DETROIT, MICHIGAN**  
P.O. Box 502, 5757 Trumbull Ave.  
TRinity 2-7010

**ELMIRA, NEW YORK**  
P.O. Box 284  
REgent 9-3611

**KANSAS CITY 6, MO.**  
101 West 11th St.  
HARRison 1-7122

**KAILUA, HAWAII**  
Box 188

**LOS ANGELES, CALIF.**  
600 St. Paul Ave.  
MAdison 6-3881

**MELROSE 76, MASS.**  
Box 131, 53 Youle St.  
NORmandy 5-0879

**PHILADELPHIA 4, PA.**  
3001 Walnut St.  
EVergreen 2-1200

**PITTSBURGH, PA.**  
306 Fourth Avenue  
EXpress 1-2800

**SAN LORENZO, CALIFORNIA**  
2222 Grant Avenue  
BRowning 6-1800

**TAMPA, FLORIDA**  
4304 Corona St.  
62-4071

**SEATTLE, WASHINGTON**  
1209 Poplar Place

**INDIANAPOLIS 7, INDIANA**  
1560 Stadium Drive  
GARfield 1-6911

Westinghouse Electric Corporation,  
Electronic Tube Division, Elmira, N. Y.

You can be sure . . . if it's

**Westinghouse**





This serviceman is just about ready to enter the house and attach the antenna lead of his quick-rig, antenna-comparison setup to the customer's set. A demonstration is a sure way to sell an antenna.

Many prospective antenna buyers are under the impression that any outside antenna is bound to be expensive. One housewife revealed that she and her husband had decided the \$150.00 necessary to install an antenna was more than they could afford. In this case, telling her that a good system could be installed for \$70.00 would undoubtedly result in a sale.

### The Business is There

In most of the homes we found in need of antenna repairs, the homeowner had not been advised of this fact by any serviceman, even though the defects were obvious. Most times, you merely need to point out such defects to sell antenna-repair work. For example, a customer usually will be more than glad to pay \$10 or so for the installation of a new lead-in. This job normally requires about a half hour, and can be performed by one man. By the way, soliciting extra work of this type is an excellent way to make a callback profitable instead of an outright loss.

Several people we talked with had been refused antenna service by repair shops, and had been advised, "Call Acme — they do this type of work." One lady had called three

TV shops trying to buy a complete antenna system. All three refused to sell her an antenna, and the last of the three gave her the name of a shop that did the work. She called and made an appointment, but no one ever called on her.

In an effort to find out why TV shops refused to sell antennas, we called on several and asked their reasons. In most of the one-man operations, the reason was, "Putting up antennas is a two-man job, and I can't afford to hire an extra man." It was nearly the same in the two- or three-man shops. "We can't af-

ford to tie up two men on one job all day."

Many of the larger operations told me they did the work on request, but didn't solicit antenna business. They couldn't pinpoint any specific reason other than the fact that they didn't feel it was profitable.

Why should antenna work be any less profitable today than it was ten years ago? Granted, it is less profitable if done only occasionally, but there is no reason why repairs can't be made on a regular basis. If a serviceman made it a regular practice to call the attention of his cus-

## THAT SOLVES ALL YOUR TV TUNER PROBLEMS

*Ask yourself*

- ... do you have the time to fool around drilling, sawing, filing . . . trying to make a "Universal" replacement tuner fit in place of the original?
- ... do you have all the expensive instruments and equipment to complete the alignment so essential after each tuner repair or replacement?
- ... can you spare the time repairing and adjusting your own TV tuners and can you charge enough to justify the time spent?

**A Castle Overhaul eliminates every one of these problems.** Castle replaces all defective parts, (tubes and major parts are extra at net prices) and then aligns your tuner to the exact, original specifications. Simply send us your defective tuner complete; include tubes, shield cover and any damaged parts with model number and complaint.

Send for **FREE Mailing Kit** and complete details.

ONE PRICE

**9<sup>95</sup>**

ALL MAKES

**VHF TUNERS  
UHF TUNERS  
UV COMBINATIONS\***

\*UV combination tuner must be of one piece construction. Separate UHF and VHF tuners with cord or gear drives must be dismantled and the defective unit sent in.

90 Day Warranty

**CASTLE**  
TV TUNER SERVICE, INC.



5710 N. Western Ave., Chicago 45, Illinois • 653 Palisade Ave., Cliffside Park, New Jersey  
In Canada: 136 Main St., Toronto 13, Ontario

tomers to needed antenna work while he was on a call, it could become an integral and profitable portion of his business.

One plan we suggested to some one-man shops was to line up several jobs and schedule them all for one or two specific days. On these days, the shop owner could hire a day laborer to assist him, and then he wouldn't need a full-time employee. Men to whom we suggested this plan responded favorably.

One of the best ways to increase antenna sales is by demonstration. Many shops have a portable antenna that can be set up in a manner of minutes. In this way, the customer has a chance to see what he is getting, and the improvement over his present reception is usually enough

in itself to sell a new antenna.

There are some servicemen who do a lot of antenna business. Typical of those we interviewed is Mr. Duane Vaught, who recently joined forces with Mr. Victor Saulter to form V & V Electronics in Bloomington, Indiana. We were very favorably impressed by what they have done with antennas and what antennas have done for them.

These two partners of a recent merger have managed to grow while others are merely holding their own. Mr. Vaught told us that approximately 1/3 of their business is in antennas and distribution systems. They have found business so plentiful they have hired a full-time antenna-system installation man. V & V were recently awarded a job

on a 20-outlet motel distribution system. Not only did they realize a handsome profit from this installation — they also sold 20 new sets to the motel. Even at a discount price, the profit on 20 sets is quite enough to justify the work that went into preparing the bid.

It isn't difficult to sell people something they need, and in many areas an antenna is a must. The one greatest factor in favor of the serviceman who would like to increase his profits is picture improvement. Therefore, why not take the time to ask your customers if they are interested in getting a definite improvement in picture quality at a nominal cost?

The business is there — it just needs to be brought to the surface.▲

**GUARANTEED FM AND  
FM STEREO RECEPTION  
FROM 200 MILES!**

# Winegard STEREO-TRON

World's Most Powerful FM Antenna!

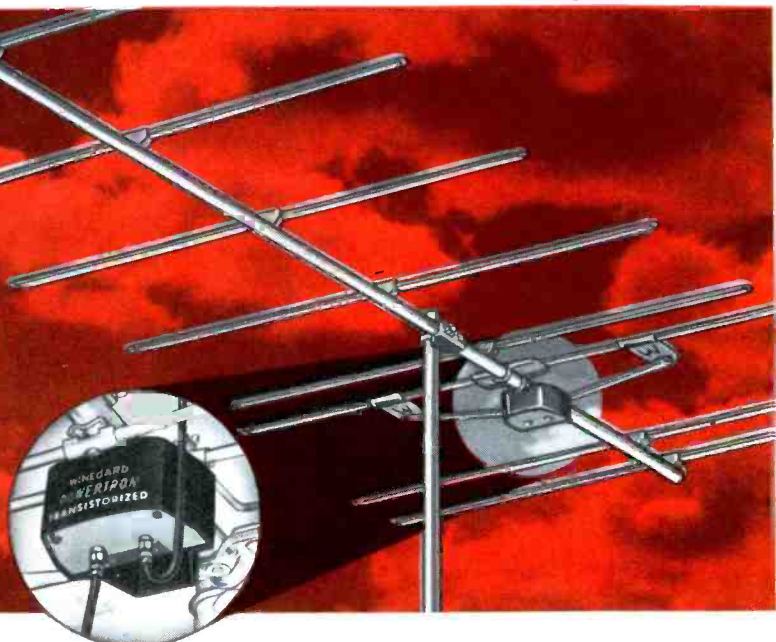

**NEW ELECTRONIC FM ANTENNA FOR LONG DISTANCE FM AND STEREO!** Now Winegard Guarantees unexcelled FM performance with the new Winegard electronic Stereo-Tron. Actually **GUARANTEES** your customer will receive 85% of all FM stations in a 200 miles radius over normal terrain with a rotor. Built in transistor amplifies signals, really gets L-O-N-G distance reception. Opens a new field of opportunity in the fast growing FM and FM stereo market.

**MODEL PF-8 FM STEREO-TRON YAGI—Gold Anodized!** This is the world's most powerful FM antenna. Because Multiplex requires an antenna with greater sensitivity and gain to offset the power loss of the carrier and subcarrier, Winegard's PF-8 is the best antenna you can install for Multiplex. When you hook up a PF-8, weak signals come in like "locals." Recommended for use where signals are under 10,000 microvolts. For strong signal areas, same antenna without amplifier, Model FM-8, is recommended.

The PF-8 has a minimum gain of 26 DB over a folded dipole with a flat frequency response of  $\pm 1/4$  DB from 88 to 108 m.c. It features a built-in TV-FM coupler and has eight elements with EXCLUSIVE "TAPERED T" driven element engineered

to perfectly match the powerful transistor, direct coupled, built-in amplifier. It is available two ways—Model PF-8 for 300 ohm twin lead or Model PF-8C for 75 ohm coax.

#### Important Features of Winegard Electronic FM Antennas

1. Transistor amplifier is designed as part of the "Tapered T" driven element (model PF-8) for unprecedented efficiency and signal-to-noise ratio.
2. At no extra charge, built-in FM-TV coupler allows you to use one power supply and down lead when used with a WINEGARD POWERTRON TV antenna.
3. Beautiful gold anodized permanent finish—100% corrosion proofed—all hardware irridized. This is the finest finish of any antenna—has richest appearance—meets U.S. Navy specifications.
4. The quality of craftsmanship and fine materials in these antennas tell their own story—perfect mechanical balance — 100 m.p.h. wind tested.

Winegard makes a complete line of FM antennas. Write for information and spec. sheets. Also get FREE, Station Log and FM map of U.S.



**MODEL PF-4 FM ELECTRONIC TURNSTILE**  
Gold Anodized! Non-directional FM antenna with 16 DB gain in all directions over a folded dipole. Has Winegard offset mount and transistor amplifier with TV-FM coupler. Also available without amplifier, Model FM-3T.

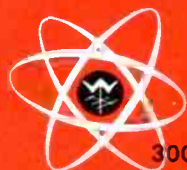

# Winegard

**ANTENNA SYSTEMS**

3009-12D Kirkwood Avenue, Burlington, Iowa



# NEW CALLBACK-PROTECTION WELDED INTO EVERY SILVER SCREEN 85 TV PICTURE TUBE

Sylvania technique  
eliminates tube failures  
caused by open heater or  
cathode lead welds.  
Protects your profits.

Sylvania . . . the leader in picture tube improvements . . . now gives you another built-in plus — “Controlled Atmospheric Welding”! Engineering investigations revealed that in the welding of picture tube gun parts something more than automatic controls, skilled operators and careful inspection was needed. The uncontrolled factor was the degree of oxidation occurring at the time of welding. The answer—control the atmosphere surrounding the weld at the instant it is made!

Now . . . through “Controlled Atmospheric Welding” Sylvania Silver Screen 85 TV picture tubes give you maximum assurance against callbacks. Common field problems of intermittent, poor, or open connections due to oxidized welds have been eliminated. Every year hundreds of thousands of TV picture tubes are replaced with Silver Screen 85. No wonder. It's more profitable in the long run.

Electronic Tubes Division, Sylvania Electric Products Inc., 1740 Broadway, New York 19, New York.

Early welding techniques oxidized or “burned” the metal surfaces. As shown in the enlarged cross-section view of the heater to stem lead weld, this prevented clean metal to metal joints—caused high-resistance electrical contact.

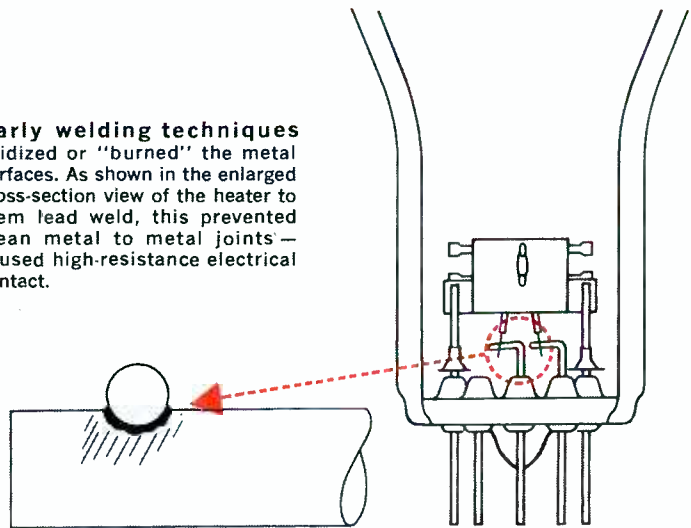

**NEW SYLVANIA** welding techniques keep metal surfaces clean during welding, which is essential for low-resistance contacts and strong mechanical bonds.

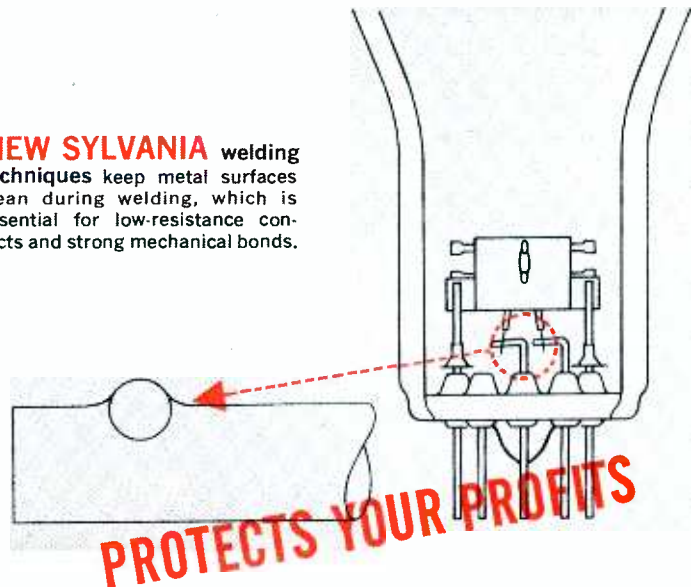

# SYLVANIA

SUBSIDIARY OF

## GENERAL TELEPHONE & ELECTRONICS



solving the

# UNCLAIMED MERCHANDISE

## PROBLEM

by Art Margolis

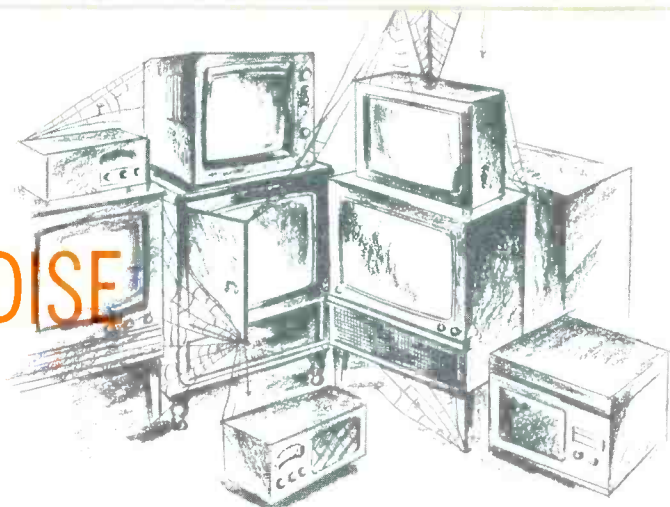

From a recent telephone survey, I discovered that 18 out of 20 TV service shops had untapped “gold veins” on their property—consisting of repaired, but unclaimed, equipment ranging in value from several hundred to several thousand dollars. The other two were actively mining their claims.

Why were so many shops tying up valuable storage space, parts, and labor? The only conclusion I can come to is that they are bogged down in the confusion that accompanies the problem of unclaimed merchandise.

We are so preoccupied with handling our everyday business that we don't take the trouble to unravel the legal ramifications of the problem, see where we stand, and launch a plan of action. Thus, we simply let our hard-earned dollars gather dust.

One of the two outfits taking action toward solving the problem, I'm pleased to admit, is our place. Let me explain our approach.

### According to Law

For a fee, a lawyer explained to us our legal position. He said it has been established in common law for many years that a repairman who receives for repair a piece of personal property (TV, radio, etc.), under an expressed or implied contract, has a specific lien on that property in the value of the labor and materials used.

The repairman can enforce this lien, after a reasonable period of time, as long as the property remains in his possession.

Most states have additional statutes that back up this fact, but even where there are none, the common law is in effect.

In essence, the laws are all very much the same, the major differ-

ence being the amount of time required before you can enforce the lien. Some states say 10 days—others 120. Your policy sign stating, “Not Responsible for Mer-

chandise Left Over ..... Days” can be telling the truth if you take your state law into consideration when you set the number of days.

Universally, you must do two

### TYPICAL STATE LAWS ON UNCLAIMED REPAIRS

This chart will give you a rough idea of the legal procedure to follow in redeeming your time and materials. We have listed key points from the laws of a large number of states (29) to show that no two are exactly alike. Note that most states require the following three steps:

1. Wait a specified period of time after completing the repair.
2. Then give the owner written or published notice of your intent to sell the unclaimed merchandise.
3. Advertise and sell the merchandise on public sale, in compliance with local rules and regulations.

Be sure to check carefully into the laws of your own state, with the help of your legal adviser, in order to form a policy for your shop regarding the unclaimed-merchandise problem.

STATE	WAITING PERIOD	GIVE OWNER NOTICE	ADVERTISE PUBLIC SALE FOR
Arkansas	30 days	10 days	10 days
Arizona	20 days	10 days	5 days
California	10 days	-----	10 days min., 20 days max.
Colorado	120 days	20 days	20 days
Delaware	60 days	-----	3 weeks
Florida	3 months	-----	10 days
Idaho	2 months	-----	10 days
Illinois	None	10 days	3 weeks
Indiana	6 months	10 days	3 weeks
Iowa	None	10 days	10 days
Kansas	30 days	Can return merchandise	and foreclose chattel mortgage
Kentucky	None	30 days	one week
Massachusetts	90 days	30 days	not necessary
Michigan	9 months	30 days	30 days
Mississippi	30 days	Can obtain special order for sale upon showing proof of value to authority	
Montana	30 days	Turn over to sheriff or constable	
Nebraska	90 days	10 days	15 days
New Jersey	3 months	5 days	2 weeks
New Mexico	3 months	10 days	20 days
New York	None	10 days	-----
North Carolina	30 days under \$50 90 days over \$50	-----	2 weeks
Oklahoma	None	Must give notice within 60 days	Must be sold within 12 months
Oregon	3 months	10 days	10 days, also send notice to owner
Pennsylvania	30 days	30 days	10 days, also send notice to owner
Rhode Island	None	30 days	-----
South Carolina	None	60 days	15 days
Tennessee	6 months	10 days	15 days
Texas	60 days	20 days	-----
Vermont	3 months	10 days	10 days

TRAIN . . .

THEN SHARE THE PROFITS



# IN THE BOOMING COMMERCIAL TWO-WAY AND CITIZENS BAND RADIO SERVICE BUSINESS

## HERE'S HOW RAYTHEON WILL HELP YOU —

Now Raytheon can train you and franchise you as a Certified Raytheon Service Station operator, qualified to service Raytheon's expanding line of commercial two-way and citizens band radio equipment, as well as other brands. There are 2.5 million units in use today, and the number is growing every day!

**TRAIN TO SERVICE** — Raytheon's Communication Technician's Correspondence course will give you a thorough groundwork in the operation, installation and maintenance of this equipment. On completion of the course, you will be qualified to take the exam for the FCC Class II license which is required for servicing CB and commercial two-way radio. The cost is \$96.00 and it is available either direct or through your local Raytheon distributor.

**PROFIT AS A RAYTHEON CERTIFIED SERVICE STATION** — Then, with Class II license and adequate test equipment you can become one of a national network of independent service facility operators franchised to service Raytheon Ray-Tel CB equipment. Operating a Certified Service Station, you'll be reimbursed by Raytheon for all authorized parts and labor required in repair of in-warranty Ray-Tel units.

## MAIL THIS COUPON NOW

Mail this coupon now for full details. Join others cashing in on this growing new field.

### RAYTHEON COMPANY

Distributor Products Division  
411 Providence Turnpike  
Westwood, Massachusetts  
Box No. 26

- Please send me your brochure describing the Raytheon Communication Technician's Course.
- Please send me details on the Raytheon Certified Service Station Service Program.

Name \_\_\_\_\_

Company Name \_\_\_\_\_

Address \_\_\_\_\_

City \_\_\_\_\_ State \_\_\_\_\_

Name and Address of Raytheon Distributor  
\_\_\_\_\_

**RAYTHEON**

# RAYTHEON COMPANY

DISTRIBUTOR PRODUCTS DIVISION

# RCA TUBE ROADSHOW

“Step right up, folks—  
hurry, hurry, hurry...”

“All right, friends, tell you what this show’s about. For a limited time now, you’re going to earn yourself valuable certificates when you buy famous RCA Electron Tubes. You can redeem your certificates any time through July, 1962, at any Firestone store or dealer for a wide selection of auto accessories and valuable gifts.

“Just cast your eyes upon a few of the items you can get with your RCA ROADSHOW Certificates.”



Car and truck tires, standard or snow-tread



Firestone or Delco batteries, 6- or 12-volt



Dialomatic car-wash brush



Sno-Chaser brush



AC or Autolite spark plugs



Auto rugs and floor mats



# COMES TO TOWN

## FEATURING Firestone

"And here's the best part of all, friends. This year you can do your Christmas shopping at Firestone stores with ROADSHOW Certificates. Look what you can get for your family, just for buying RCA tubes..."



Bicycles, tricycles



Pedal-driven fire engines

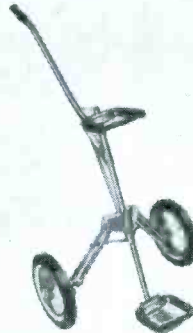

Golf cart



Scooters

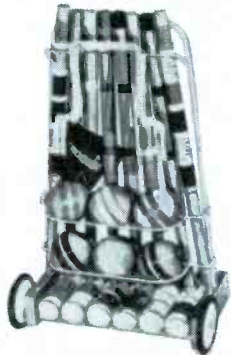

Croquet set



Wagons

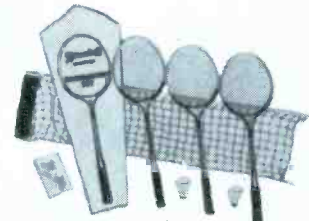

Badminton set

"Now how about that, friends? A brighter, happier Christmas for your entire family. So go down and talk to your Authorized RCA Distributor today. Ask him about the wonderful things you can get with RCA ROADSHOW certificates."

RCA ELECTRON TUBE DIVISION



The Most Trusted Name in Electronics



# NEW VERSATILITY & COMPACTNESS in PROFESSIONAL TEST EQUIPMENT



**AC VOLT-WATT METER #260**  
Kit \$49.95      Wired \$79.95



AC voltmeter and load-compensated audio-wattmeter of unique quality and accuracy. Measures AC voltage from 1 millivolt to 1000 volts in 11 ranges, and power from .015 milliwatt to 150 watts in 7 ranges, across standard loads from 4 to 600 ohms. The instrument incorporates a tapped power resistor load (4, 8, 16, and 600 ohms) to handle up to 80 watts of power on 8 ohms, and 40 watts on other taps. It may be switched to external load up to 150 watts. The meter is automatically compensated for any load selected, internal or external, to provide a single watt scale for all loads and ranges.

**VOLTMETER:** Ranges: .01, .03, .1, .3, 1, 3, 10, 30, 100, 300, 1000 RMS volts. Frequency Response:  $\pm 0$ db 10c to 150kc,  $-3$ db at 500 kc. Input Impedance: 2 megohm shunted by 15mmf. Accuracy:  $\pm 4\%$ .

**WATTMETER:** Ranges: 15mw, 1.5mw, 15mw, 150mw, 1.5W, 15W, 150W. Frequency Response:  $\pm 0$ db 10c to 100kc. Accuracy:  $\pm 5\%$ . Internal Loads: 4 (40W), 8 (80W), 16 (40W), 600 (40W). External Loads: 4, 8, 16, 600 (all to 150W).

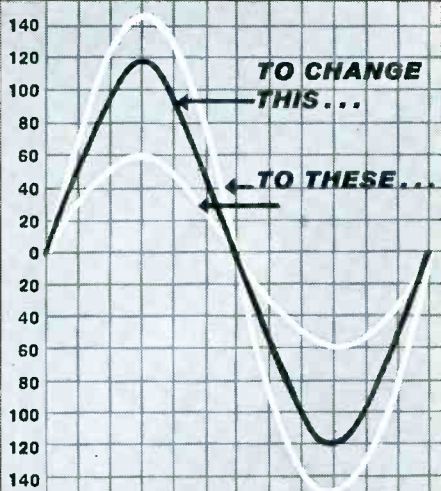

## ...USE THESE!



**METERED VARIABLE  
AUTO-TRANSFORMER  
AC BENCH SUPPLIES**

# 1073 (3-amp rating)  
Kit \$35.95    Wired \$47.95  
# 1078 (7½-amp rating)  
Kit \$42.95    Wired \$54.95

Connect to 60 cycle, 120 volt line and obtain any desired voltage between 0 and 140 volts. Highly efficient variable auto-transformer of toroidal core design gives you continuously variable output, linear versus rotation, with excellent regulation and negligible waveform distortion. Model 1078 permits either 50 or 60 cycle operation.

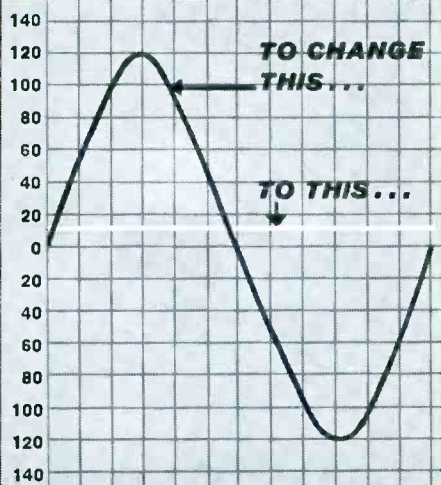

## ...USE THIS!



**Extra-Low-Ripple  
6- and 12-Volt  
BATTERY  
ELIMINATOR AND  
CHARGER #1064**

Kit \$43.95    Wired \$52.95

Connect to 60 cycle, 120 volt line and obtain highly filtered low dc voltage continuously variable over two ranges 0-8, 0-16 VDC. Heavy-duty pi-type LC filter is rated to take the full rated current output continuously (10 amps on 8V range, 6 amps on 16V range), reduces ripple as low as 0.3% at 2 amps on the 16V range. An essential instrument for servicing battery-operated equipment, including transistor or hybrid types, and an excellent battery charger.

### Also New From EICO:



**AC VTVM &  
AMPLIFIER  
#250**  
Kit \$49.95  
Wired \$79.95



**TRANSISTOR  
AND CIRCUIT  
TESTER #680**  
Kit \$25.95  
Wired \$39.95



**IN-CIRCUIT  
CAPACITOR  
TESTER #955**  
Kit \$19.95  
Wired \$39.95

For complete catalog of over 80 EICO kits and wired units—hi-fi, test equipment, citizens radio, ham gear—plus name of nearest distributor, write to dept. PF-12



**ELECTRONIC INSTRUMENT CO., INC.**  
3300 Northern Blvd., Long Island City 1, N. Y.

ADD 3% IN THE WEST    Export Dept., Roburn Agencies Inc., 431 Greenwich St., New York 13, N. Y.

things in order to enforce the lien:

1. Notify the customer that you are going to enforce your "mechanic's lien." This is done by registered mail—or, if the customer cannot be located, by a legal ad in a newspaper.

2. In the notice, inform the customer of the date you are going to enforce the lien. This, of course, must be in accordance with the time specified by your state.

Once these two simple steps are executed, if the customer still does not pick up his equipment, you are entitled to sell it at a public sale. If you do not recover all your money from the sale, you can then sue the customer for the difference plus costs.

### From a Practical Standpoint

The legal procedure, as you can see, really does protect your interests. Can you imagine a once-a-year public sale of this merchandise? You could bill it, "COST OF REPAIR SALE!" You'll be mobbed by bargain-seekers, and at the end of the sale, you'll have a lot of additional storage space plus a pocketful of money you were sure had been lost.

However, as good as the straight legal procedure is, we have an even better program from a practical standpoint. The only units that end up at our public sale are the "last-resort" jobs.

Our program begins at a door to a storage room in the back of the shop. A sign over the door reads UNCLAIMED. On the door, a composition book labeled "Unclaimed Log Book" hangs by a string. Whenever a repaired piece of equipment stays in our shop too long, for no good reason, it enters this door. All vital statistics are entered into the log book. The customer is then called by telephone; if there is no answer, a form post card is sent out.

This simple procedure jolts some 35% of the tardy into rushing in to rescue their equipment. That takes care of those who cared but couldn't get around.

Those that are not concerned enough to show up within one week are sent a registered letter which politely notifies them that we are in the process of enforcing our lien, and asks them to contact us

immediately for some kind of negotiation.

This letter galvanizes another 50% into contacting us. This time, we learn where we stand. We find out that Mr. Smith has purchased a new TV even though he gave us the "go-ahead" on a lightning-strike job. We learn that Mrs. Jones ran over her budget the last few months, and so we arrange a time-payment loan for her through a local finance company. We discover that Mr. Carter left Mrs. Carter, and we arrange to purchase their TV at an equitable figure. All in all, we get rid of some would-be dust gatherers and salvage our investment in the repairs.

The rest of the unclaimed repairs sit around awhile longer. In our state, we must wait 90 days before enforcing the lien. During this time, another 10% come straggling in and square their problems.

At the end of our waiting period, any remaining units are scheduled for public sale. We hold one of these events every year. If a customer should show up before the sale and want his merchandise, we are glad to redeem it for him.

This sums up our unclaimed-merchandise program, which we find very effective. It covers all the situations that result when people decide not to pick up their merchandise after you have invested your labor and materials in it.

The procedure also covers other odd reasons, too. In one such case, I received a frantic call from the owner of a fairly new 19" portable TV after he received our first post card.

"For gosh sakes, don't sell my TV," he pleaded. "I'm glad you sent me this card. We're new in the area, and my wife lost the claim check and forgot the name of your place!" ▲



## Centralab L&T PAD ATTENUATORS

offer these advantages  
in any  
sound installation

### SMALL SIZE...

less than 1 $\frac{3}{16}$ " deep from mounting surface, these units fit into any standard junction or switch box with room to spare... diameter is only 1 $\frac{3}{32}$ ".

### HIGH WATTAGE...

conservatively rated at 20 watts audio, 5 watts D.C. yet they are no larger than units rated at 2 watts D.C. One size takes care of all your 2, 3, 4, and 5 watt requirements. Centralab's exclusive "thermo-pass" insulation combines fast heat transfer with a high dielectric constant to achieve this high rating.

### ANTI-BACKLASH CONSTRUCTION...

the "play" frequently found in dual controls is eliminated. The wiper contacts move in unison, assuring that there will be no alteration in frequency response due to variations in wiper position on the resistance tracks.

B-6124

**Centralab**

THE ELECTRONICS DIVISION OF GLOBE-UNION INC.  
942M EAST KEEFE AVENUE • MILWAUKEE 1, WISCONSIN  
In Canada: Centralab Canada Ltd., P.O. Box 400, Ajax, Ontario

ELECTRONIC SWITCHES • VARIABLE RESISTORS • CERAMIC CAPACITORS  
PACKAGED ELECTRONIC CIRCUITS • ENGINEERED CERAMICS

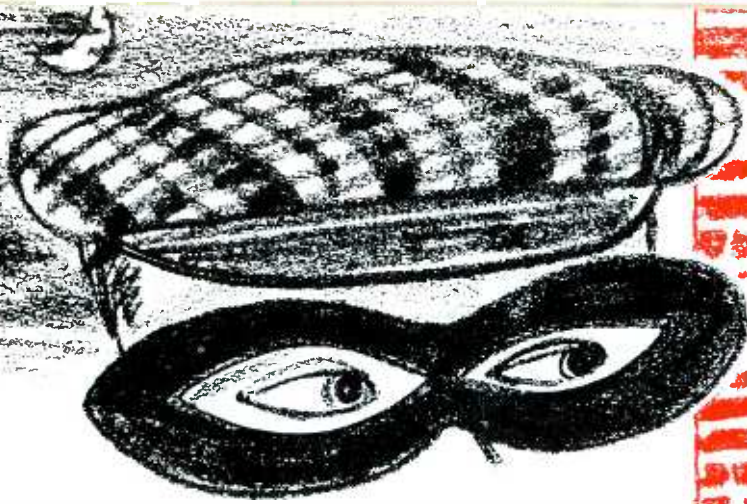

# A BURGLAR'S- EYE VIEW OF Service Shops

by Henry Clanton, #84339, as told to William R. Morey

*Tips on what to watch out for — straight from State Prison of Southern Michigan.*

With a business volume of over \$3 billion, 1960 was a good year for the electronics industry. It was also a very good year for me; out of the hundreds of service outlets kicked in by burglars, I personally had my foot in 30 of them. That was my last year as a professional thief before the law retired me. But in the previous nine years I lived fast and I lived well, just by specializing in the robbery of service shops.

I didn't have any monopoly on this specialty. Every year more and more practitioners of my somewhat shady profession are turning their attention to the electronics business, and dealers who don't want to take a whopping loss from theft would do well to make note of it.

Appliance and radio-TV service shops offer certain advantages that make them especially attractive to burglars. Most obvious is the fact that they contain valuable merchandise that can be moved easily and disposed of for a good price. TV sets, radios and record changers have long been popular targets for the larceny-bent, and the increasing popularity of hi-fi equipment in recent years has become an added inducement.

Equally important from the criminal's point of view, service shops are generally located in areas where few people live, and where pedestrian traffic is at a minimum after most business places have closed. And they are easy to crack; few owners bother with expensive alarms, and the locks are uniformly cheap. Many shops can be entered with nothing more elabo-

rate than a screwdriver.

Because they aren't overstaffed with sales personnel, they are also vulnerable to boosters — thieves who wander in during business hours and take whatever they can get their hands on. A booster knows that the employees of a shop are usually spread thin, with most of them out on service calls or doing bench work in the back. There is rarely more than one person on hand to deal with customers. If that one salesman's attention is diverted for only a moment, the skilled booster can stash an amazing number of transistor portables inside his coat. Often they work in pairs, entering the store separately. One does all the dirty work while the other holds the salesman's attention.

A carelessly-run shop can lose plenty just to boosters, but the real bite comes from men like me — professional burglars who won't let you off with just a radio or two. I know some guys in the business who always work in teams, and if conditions are right they can strip a shop to the bone in nothing flat. That includes everything from the safe to the tube inventory.

As a rule, I confined my own efforts to color TV and high-fidelity components, with a preference for the hi-fi stuff because it was easier for one man to carry. The items always brought a good price when sold out of town, or even locally through the newspapers.

I sometimes worked with partners, but the best confederate I ever had was complacency. I could rely on this to do 90% of my work

on any caper. Most people, it seems, consider burglary a rare phenomenon that usually occurs in jewelry or fur stores, or a bad break that always happens to someone else. And the owners of shops dealing in less glamorous merchandise seldom take adequate precautions until it is too late. For this very reason, most burglars prefer to work on the smaller places. And, according to FBI reports, we work on them at the rate of one a minute, twenty-four hours a day, for an annual haul of \$86 million.

Actually, only a small percentage of these burglaries are committed by professionals. The majority are the work of amateurs — vandals and drunks who operate largely on impulse. Aside from the fact that amateurs rarely profit from their crime, however, the results are much the same: A heavy financial loss, and possibly an expensive waste of time due to broken instruments.

But the smart service dealer can easily protect himself from such losses.

If an experienced burglar wants into a place badly enough, he can generally make it in spite of all practical barriers. But he *can* be discouraged from trying. And what discourages a professional will completely demoralize the amateur. By taking a few simple precautions, you can put the odds very much in your favor.

Most burglaries could be prevented by nothing more complicated than a good set of locks and a little protection on the windows. Still, many of the shops I've hit



# RCA *MERCURY* RADIO BATTERIES

**GUARANTEED**  
AGAINST DAMAGE FROM LEAKAGE



The Radio Corporation of America guarantees to repair your radio or replace it with one of comparable value (at RCA's option) and supply the appropriate battery complement without charge, if ever damaged by leakage of an RCA mercury radio battery. If RCA mercury radio batteries should ever leak and damage your radio set, send radio with batteries, transportation collect to:

**RCA BATTERY DEPARTMENT**  
415 South Fifth Street, Harrison, New Jersey



The Most Trusted Name in Electronics



## Step up to Bigger Profits

with RCA Mercury Batteries  
now **GUARANTEED** against  
damage from leakage in any radio



This RCA guarantee on Mercury Batteries makes it easier than ever to sell this high-profit line of batteries.

With their long life, fade-free performance and outstanding reliability, Mercury Batteries are the smartest, most economical battery buy your customers can make. Get the most out of the booming transistor radio market by displaying and promoting **GUARANTEED** RCA Mercury Batteries.

Contact your Authorized RCA Distributor for new sales-building promotional material featuring this RCA guarantee.



The Most Trusted Name in Electronics



More good news! The popular, fast-selling VS 322 and VS 300A zinc-carbon types now carry this same guarantee!

## YOU WON'T FIND THIS

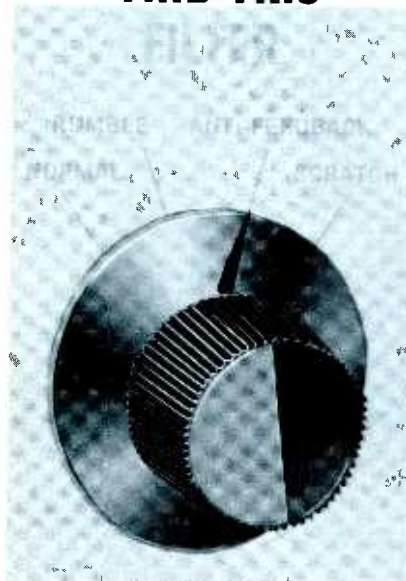

## CONTROL ON ANY OTHER P.A. AMPLIFIER IN THIS PRICE CLASS



What's different? The anti-feedback position—which equalizes frequencies most sensitive to generation of feedback "howl" without reducing articulation. This increases sound output under difficult acoustical conditions by at least 100%. And there's plenty more that makes the new Harman-Kardon COMMANDER Series of public address amplifiers different. Features usually reserved for much costlier equipment are included: 25/70 v and recorder outputs, fader/mixer and master volume controls, magnetic cartridge input, locking covers, etc. Find out why sound men now use the COMMANDER Series for all their needs. Write for detailed catalog. Commercial Sound Division, Harman-Kardon, Plainview, L.I., N.Y.

Send free detailed catalogs: Desk 12H

Name \_\_\_\_\_

Address \_\_\_\_\_

City \_\_\_\_\_ State \_\_\_\_\_

**harman kardon**

had cheap snap locks on the doors, and very few had bars on the windows. Money saved on these items isn't worth the risk.

Good insurance is a sturdy set of locks with deadlocking mechanisms that can't be opened by the first burglar to come along with a strip of celluloid. It is also good practice to limit the number of keys and know exactly where each one is. If any turn up missing, the locks should be replaced; on more than one occasion, I've gone into shops during business hours and managed to filch a key to the front door.

The back door, where most forcible entries are made, should be doubly secured with an iron bar on the inside. Skylights are another touchy point. Protecting these and other windows with steel security frames will add enormously to your protection without detracting from the appearance of your shop.

Light is still one of your best protections. No burglar in his right mind will work under a light, and he doesn't dare turn any off. He has to assume that the police are familiar with the number and the location of lights showing in the building. If one of them is out, the first prowler to come by will stop to investigate. You can take advantage of this by making sure your shop and the entrances to it are well lighted. The bulbs don't have to be large, and the small addition to your electric bill will be worth it.

Safes and cash registers should be well-lighted and clearly visible from the street windows. As an added bit of insurance, the drawer of the register should be left open, and if the safe is a small one it should be bolted to the floor. The New York City Police Safe and Loft Squad recommends that the bolt be enclosed in a steel pipe to hamper attempts at sawing. It is also a good idea not to have any wheels on your safe. A technique gaining much favor among less sophisticated criminal circles is to smash in the door of a shop—regardless of lights, alarms and noises—dash inside, grab the safe, roll it out to a waiting car and drive off with it, all in less than two minutes.

Burglar alarms are an effective deterrent, but be certain you use a

good one and have it checked periodically. The toughest alarms I ever encountered were the acoustic type—and most of these, I suspect, had been rigged up as spare-time projects by shop personnel working out of junk boxes. I ran into a number of other custom-made types; most of them were more ingenious than effective, but some were downright fiendish. The owner of one place, for instance, had his display counter wired hot. The jolt I took when I put my greedy hands on his merchandise shook me up so bad I was seriously thinking of going straight.

Any alarm, however, to be really effective, should operate independently of the building's electric service. Aside from this, the only major requirement is that it should make one devil of a lot of noise—which is very unpopular with people in my line of work.

Don't ask to be robbed by putting too many valuable items right up front in your display windows. This is an open invitation for someone to use the hit-and-run technique on you. It's noisy, but one of the safest forms of burglary from the thief's standpoint. He just pulls up in front of your shop, checks to make sure the street is empty, then smashes the window and makes off with your nice, tempting display of high-fidelity equipment. Alarms can go off hither and yon—but it's always too late by the time they're answered.

By ignoring any one of these precautions, you are setting yourself up for a robbery. It might be this week, next month or next year; but sooner or later some enterprising burglar is going to take a crack at you. And if he's even a mediocre burglar, it's going to cost you plenty.

To insure that this does not happen, just look your shop over from my point of view and compare it with other nearby businesses for burglar appeal. Burglars always pick the softest touch, and there are plenty of other places where they can ply their trade—places with poor lighting arrangements, weak locks, and plenty of negotiable merchandise.

See to it that *your* shop is too much trouble to burgle . . . and it just won't be burgled. ▲

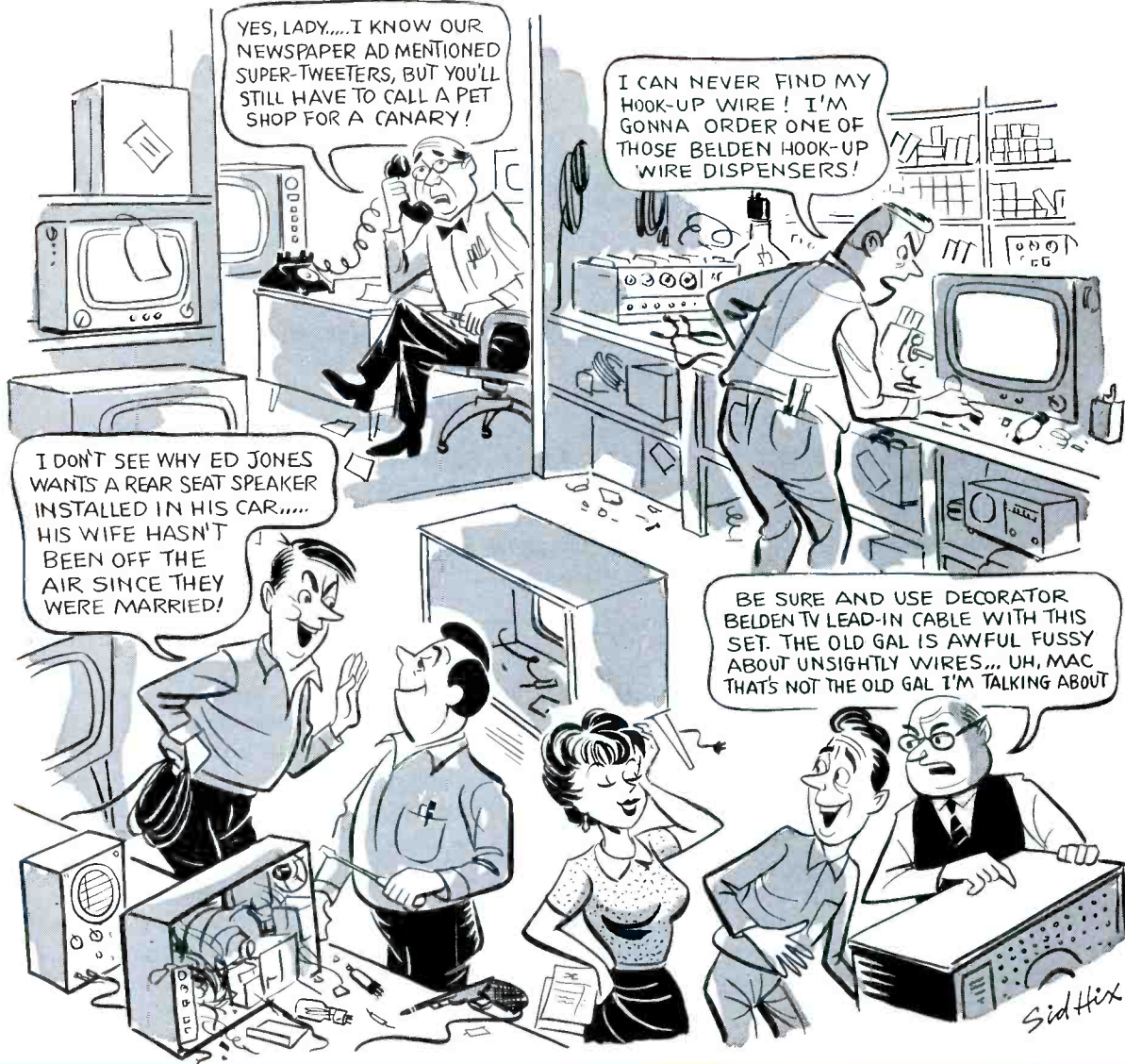

*Here's the Decorator 300 ohm TV lead-in cable they're talking about...*



Its neutral color blends into any interior decorating arrangement. This popular cable comes in 25, 50, 75 and 100 foot lengths—put-ups in pancake coils for easy handling and display (8226).

This is the work-bench hook-up wire dispenser. No fumbling around for the right spool. It's always in the same place—right in front of you.



Your Belden jobber carries a complete line of TV lead-in cable . . . also microphone and shielded power supply cables; hi-fi, stereo and phono-graph cables; power supply cords; rubber-vinyl, multi-conductor portable cordage; antenna rotor cables; hook-up wire; TV and cheater cords; aluminum ground wire . . . and related items. It's all in his stock.

8-13-1

power supply cords • cord sets and portable cordage • electrical household cords • magnet wire • lead wire

December, 1961/PF REPORTER 65

# Troubleshooting Diode

## AFC Systems

A meaty article that spells out what happens in the most popular AFC circuits.

by Irving Tepper

Horizontal-AFC circuits have always been a thorny problem for the service technician. When you delve into a frequency-stabilizing circuit of this nature, you are likely to encounter small voltages with minute deviations. Waveforms seldom appear as they should, even in properly operating sets. Faced with this set of circumstances, the technician who wishes to service AFC systems efficiently must first understand how they accomplish their function. For this reason, let's begin with a review of the more common diode-type AFC circuits.

### Basic Horizontal AFC Systems

The function of the horizontal AFC system is to keep the sawtooth output signal of the horizontal oscillator exactly on frequency and in phase with the sync pulses supplied by the television signal. A simple block diagram illustrating AFC action is shown in Fig. 1. The sync pulses and oscillator-output signal are fed to the comparison circuit. If these signals differ in frequency or phase, a correction voltage appears at the output of the AFC circuit. The correction voltage is filtered and applied, as a DC voltage, to one of the grids in the horizontal oscillator. In this type of circuit, the horizontal oscillator is generally a cathode-coupled multivibrator using

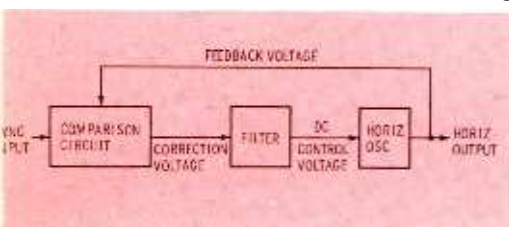

Fig. 1. AFC circuit compares sync pulses with a sample of oscillator output.

a dual triode tube. The grid of one triode section is free to accept the correction voltage, since it receives no signal. Any variation in the voltage at this grid will cause a change in the oscillator frequency.

### Early Phase Detector Circuit

The circuit in Fig. 2, one of the earliest forms of AFC, is still found in many sets currently in use. We will study the circuit under three conditions: With sync pulses applied, with feedback voltage applied, and with both pulses and feedback present.

The positive-going sync pulses obtained from the plate of sync phase inverter V13 are coupled to the plate of V15A through C61. At the same time, the negative-going sync pulses from the cathode of V13 are coupled to the cathode of V15B via C62. The combined action of these two signals causes electron flow along the path of R74, C62, V15B, V15A, C61, and R76. This electron flow charges both C62 and C61 to approximately the peak value of the sync pulses.

After passage of the sync pulse, C61 discharges through R92, R93, the B+ supply, and R76. Also, C62 discharges through R74, R93, and R91. Two voltages are developed across R93, one negative and the other positive with respect to ground. Since each voltage was caused by an equal capacitor discharge, the two voltages across R93 are of equal amplitude and opposite polarity. These voltages cancel each other, and the net voltage across R93 is zero. We may then conclude that the sync input alone will produce zero DC output voltage.

Another point to consider is the

action of C61 and C62 during the time between sync pulses. The discharge time constants of these two capacitors are sufficient to hold V15A and V15B at cutoff. This action allows the diodes to conduct only when sync pulses are present.

Let's consider the action of the circuit when only the reference signal is present. Various receivers obtain this signal from different points in the horizontal sweep circuit. In the case of Fig. 2, the reference voltage is obtained from the horizontal yoke and has the waveform shown in Fig. 3. This waveform is applied to both diodes at point Y (Fig. 2). When the sawtooth is in its negative area, V15A conducts, and a negative voltage appears at point X. When the sawtooth is in its positive area, V15B conducts, and a positive voltage appears at X.

Let us now consider the circuit with both signals applied and the oscillator on frequency. A combination of the two signals is shown in Fig. 4A. When the sync pulses arrive at V15, both diode sections conduct. The reference signal applied to the diodes is zero volts at this instant. The only voltage developed

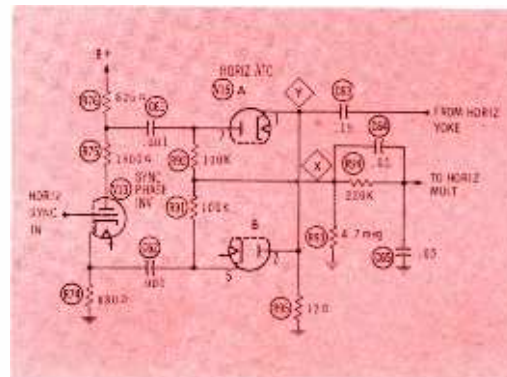

Fig. 2. Older-type AFC circuit that receives sync pulses of two polarities.













**NOW  
REPLACE  
WITH.  
FACTORY  
ORIGINALS...**

*New RCA  
All-American  
Transistors*

Replace with

# 8 ALL AMERICAN 8 TRANSISTORS

The same RCA transistors used in original equipment

 <p>2N405 LOW COST</p>	 <p>2N406 LOW COST</p>	 <p>2N407 LOW COST</p>	 <p>2N407 LOW COST</p>
 <p>2N408 LOW COST</p>	 <p>2N408 LOW COST</p>	 <p>2N409 LOW COST</p>	 <p>2N409 LOW COST</p>
 <p>2N410 LOW COST</p>	 <p>2N410 LOW COST</p>	 <p>2N411 LOW COST</p>	 <p>2N412 LOW COST</p>

portable radio receivers • tape recorders • table radio receivers • portable equipment

## Free RCA transistor replacement guide

FORM NO. 56-1

RCA, a major supplier of entertainment transistors to U.S. transistor radio manufacturers, now offers these same transistor types to service technicians for direct replacement use.

Check the types shown in the All-American Display . . . RCA 2N405, 2N406, 2N407, 2N408, 2N409, 2N410, 2N411 and 2N412. . . . All eight are original equipment types—the same types used in many of today's transistor radios. This means

no circuit changes, no guesswork, next time you replace.

And to help you further, you can now obtain the new RCA 12-page transistor replacement guide with each All-American package. It lists over 80 brands and a total of 450 models.

So why substitute when you can get factory originals. Call your RCA Distributor for one-stop service and fast local delivery of this new RCA All-American Transistor package.



You can get this new 12-page RCA Semiconductor Replacement Guide FREE when you buy the new RCA ALL-AMERICAN TRANSISTOR PACKAGE

Semiconductor Products  
Distributor Sales  
Harrison, N. J.



The Most Trusted Name in Electronics

## Exact Replacements for Original Equipment



The following special parts have been manufactured as exact replacements for the set manufacturers shown, so as to assure top performance.

Cat. No. Use O.E.M. Part No.

### Admiral

1471-A	Sound Take-Off	72B185-2
1472-A	Sound Take-Off	72C132-19
6332	Horiz. Osc.	94C17-4
7701	455 KC I.F.	72 B 31,2

### Bendix

6501	Auto Radio I.F.	2090237-1
6502	Auto Radio I.F.	2090237-2
6503	Auto Radio I.F.	2090237-3
6504	Auto Radio I.F.	2090237-4
6505	Auto Radio I.F.	2090237-5
6506	Auto Radio I.F.	2090239-1
6507	Auto Radio I.F.	2090239-2
6508	Auto Radio I.F.	2090239-3

### Crosley

7101	2nd Sound I.F.	157856-1
------	----------------	----------

### General Electric and Hotpoint

12-C11	Home Radio	RTL-143 and 163
12-C13	Home Radio	RTL-172
6206-PC	TV Ratio Det.	RTD-026 (WT56X38)
6207-PC	TV Ratio Det.	RTD-025 (WT56X37)
6208-PC	TV Ratio Det.	RTD-020
6209-G1	TV Ratio Det.	RTD-024 (WT 56X36)

### Hallcrafters

1482 IFT	Sound I.F. and Trap	51B1996
7101	2nd Sound I.F.	51A1859

### Philco

6209-P1	TV Disc.	32-4721
6209-P2	TV Disc.	32-4689-1, 2
6209-P3	TV Disc.	32-4735-1, 2

### R.C.A.

1483 IF	Sound I.F.	76437
1484 RD	Sound Ratio Detector	102692
1485 RD	Sound Ratio Detector	102644
1486 RD	Sound Ratio Detector	102253
1487 RD	Sound Ratio Detector	100364
1488 RD	Sound Ratio Detector	79141
1489 RD	Sound Ratio Detector	101219
6333	Horiz. Osc.	103103

### Westinghouse

12-C14	Home Radio I.F.	235V025H-11, 2 (V157661)
68 Osc	Home Radio Osc.	230V039H-01 (V15764-1)
6204-W3	TV I.F.	V12128-1, 2, 3



**J. W. MILLER CO.**  
5917 S. Main Street  
Los Angeles 3, California

EXPORT REPRESENTATIVE:  
Roburn Agencies, Inc., N.Y. 13, N.Y.

CANADIAN REPRESENTATIVE:  
Atlas Radio Corp., Ltd., Toronto 19, Ont.

at point X will be due to the sync pulses, and we have shown before that this will be zero. Since the applied correction voltage is zero, the oscillator will remain on frequency.

Should the oscillator drift so that its frequency is lower than that of the sync pulses, a new set of conditions will occur as shown in Fig. 4B. Since the oscillator frequency is lower, a single cycle will take longer to complete, and the sawtooth waveform will still be below the zero line when the sync pulses allow the diodes to conduct. Since the sawtooth signal places a negative voltage on the cathode of V15A and on the plate of V15B at this time, V15A will conduct more heavily than V15B. (The latter tube will usually conduct to some extent, since the sync-pulse voltage applied to the cathode will generally be more negative than the sawtooth voltage applied to the plate.) The net voltage developed across R93 will then be negative. This voltage, when filtered and applied to the horizontal oscillator, will cause the frequency to rise to normal.

If the frequency of the oscillator should increase, the condition shown in Fig. 4C will apply. When the sync pulses arrive and allow the diodes V15A and V15B to conduct, they will produce the net voltage of zero across R93. However, when the diodes conduct, the reference voltage will still be in the positive area. This will cause diode V15B to conduct more heavily than V15A and produce a net positive voltage across R93. This voltage will be filtered and applied to the horizontal oscillator causing the frequency to drop to normal.

To summarize: When the oscil-

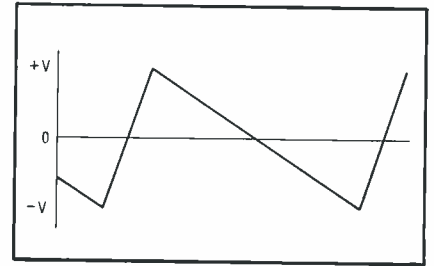

Fig. 3. Ideal waveform of signal fed back from yoke in the circuit of Fig. 2.

lator is on frequency, no output correction voltage is obtained. When the oscillator frequency drops, a negative correction voltage appears; and when the oscillator frequency rises, the correction voltage developed is positive.

With the foregoing facts in mind, we are now able to consider some troubles that might arise and which components could be the cause. Following is a list of several common AFC problems and possible causes.

1. Horizontal oscillator off frequency—This could be caused by troubles outside the AFC circuit, but assuming the oscillator is operating properly, this trouble could be caused by one of the following:
  - A. Defective phase detector diode(s) V15.
  - B. No reference voltage (check C63).
  - C. No sync-pulse input (check C61 and C62)
  - D. Any component which, by its failure, causes the wrong potential to be developed across R93.
2. Horizontal rolling — This symptom may be caused by all the factors mentioned for symptom 1. The difference is that the oscillator is on frequency but not locked in.
3. "Pie-crusting" — This symp-

# TV TUNERS \* REBUILT OR EXCHANGED

ALL TYPES



## \$9.95

**Including all parts and labor**  
(except broken wafers—billed at cost)

- Normally shipped same day received
- 90 day full guarantee
- U/V combinations \$17.95

FREE—If Mailing carton sent to you on request

L. A. TUNER EXCHANGE

Phone REpublic 3-9189  
4611 West Jefferson Blvd.  
Los Angeles 16, California

# NOW! HERE'S YOUR CHANCE TO QUALIFY AS AN EXPERT IN ELECTRONICS & COMMUNICATIONS!

ANNOUNCING A COMPLETE, PRACTICAL, UP-TO-DATE 20-LESSON

## "SECOND-CLASS RADIOTELEPHONE LICENSE COURSE"

AVAILABLE AS AN EXCLUSIVE BONUS FEATURE TO

## PHOTOFACT® SUBSCRIBERS!

**DON'T MISS IT!**  
FIRST LESSON IN  
**PHOTOFACT**  
**SET No. 561**  
(JANUARY 1962)



TO HELP YOU PASS THE F.C.C. LICENSE EXAM –  
HERE'S THE COMPLETE COURSE YOU GET  
WITH YOUR PHOTOFACT SUBSCRIPTION:

- Lesson 1. Introduction to Communications Electronics
- Lesson 2. Services and Frequency Assignments
- Lesson 3. Radio Communications Systems
- Lesson 4. Laws, Licensing, and Operating Practice
- Lesson 5. Class C Amplifiers
- Lesson 6. Oscillators and Multipliers
- Lesson 7. Antenna Systems
- Lesson 8. Microphones and Audio Amplifiers
- Lesson 9. FM Modulation Principles
- Lesson 10. AM Modulation Principles
- Lesson 11. Power Sources
- Lesson 12. Detectors
- Lesson 13. Receiving Systems
- Lesson 14. Two-Way Radio Circuit Descriptions (FM)
- Lesson 15. Two-Way Radio Circuit Descriptions (AM)
- Lesson 16. Test Equipment
- Lesson 17. Basic Transmitter Tuning Procedures
- Lesson 18. Citizens Band Installation and Adjustment
- Lesson 19. Two-Way Radio Installation and Adjustment
- Lesson 20. Two-Way Radio Maintenance and Guidance for FCC Examinations

**PLUS—carefully-designed Questions and Answers to help reinforce your learning!**

### YES! YOUR PHOTOFACT SUBSCRIPTION CAN HELP YOU EARN A 2ND-CLASS LICENSE WHICH:

1. Upgrades your professional status in electronics...the Federal Government License is a nationally recognized "diploma" of proficiency...gains the recipient immediate respect as a qualified electronics technician.
2. Automatically identifies you as an expert in electronics... qualifies you to install, maintain and operate two-way communications equipment.

The two-way and CB radio market is expanding at a tremendous rate. Well over 1,500,000 transmitters (industrial, aviation, public safety, CB, etc.) are now licensed, with approximately 400,000 new license applications yearly. To help you get your share of this profitable new business, Howard W. Sams offers you with your PHOTOFACT subscription, his Second-Class Radiotelephone License Course that can be worth hundreds of extra dollars to you yearly!

**SUBSCRIBE NOW—Get This Timely BIG BONUS Course!**

**DON'T MISS A SINGLE ISSUE!**

Enter your subscription with your Sams Distributor today to receive all PHOTOFACT Sets as issued each month. Beginning in January, 1962, you will start receiving the 20-Lesson Second-Class Radiotelephone License Course as a bonus with your subscription!

**SUBSCRIBE TODAY!**

AS SEEN in TV GUIDE

### Now! Powerful National Advertising Builds Prestige and Business for "PEET" Members!

**TV GUIDE** now carries each month to 7,500,000 TV families the "PEET" (Photofact-Equipped Electronic Technician) Program message... to build dynamic support and demand for the services of "PEET" members. There's never been a national ad program like this for the electronic servicing profession—with so many valuable tie-in promotional aids!

**NOW MORE THAN EVER, IT PAYS TO QUALIFY AS A "PEET" MEMBER!**

Howard W. Sams & Co., Inc., Dept. 7-M1  
1724 E. 38th St., Indianapolis 6, Ind.

I would like to enter my subscription to Photofact, effective with Set No. 561

My Distributor Is: \_\_\_\_\_

Send me details on how to become a "PEET" Member

Shop Name \_\_\_\_\_

Attn. \_\_\_\_\_

Address \_\_\_\_\_

City \_\_\_\_\_ Zone \_\_\_\_\_ State \_\_\_\_\_

# COLOR CODED NUTDRIVER SETS

no fumbling...  
you reach for  
the right one  
every time!



No. 17  
HANDY  
BENCH STAND

- 7 Most-used sizes —  $\frac{3}{16}$ " thru  $\frac{3}{8}$ "
- High carbon steel, polished and plated
- Precision fit case-hardened sockets
- Shockproof plastic handles (UL)
- Large, readable size indexes



No. 127  
SPACE-SAVING  
WALL RACK (Lockable)

OTHER SETS, TOO: hollow-shaft or mixed  
PLUS A FULL RANGE OF SEPARATE NUTDRIVERS:  
 $\frac{3}{32}$ " thru  $\frac{3}{4}$ " — Regular, Stubby, Extra-long,  
Midget (Pocket clip)  
available through leading electronic distributors

XCELITE, INC. — ORCHARD PARK, N. Y.  
Canada: Charles W. Poynton, Ltd., Toronto, Ont.

## XCELITE

### HAND TOOLS

Quality screwdrivers, nutdrivers, pliers,  
wrenches, service kits, and special purpose tools.

tom, also sometimes identified as "cog-wheeling," is a sign of improper filtering. The cause most frequently lies in the RC filter circuit. Components that would be suspect are:

- C64 (open).
  - C65 (open).
  - R94 (changed value).
- Top weave — This symptom indicates that vertical sync is upsetting the horizontal. This would point toward a lengthened time constant of an RC circuit in the AFC stage; the most likely cause is an increase in value of R91, R92, or R93.
  - Unstable horizontal hold — Although generally caused by defective diodes, this trouble can also be due to inadequate sync or reference voltage. Some components that may cause instability are:
    - R95 (lowered resistance).
    - C62 or C61 (loss of capacitance).
  - No raster—Should C61 short, a large positive voltage will be developed at the control grid of the horizontal multivibrator, causing a radical shift in oscillator frequency. When the frequency is shifted too far, the efficiency of the horizontal output stage drops so low that no high voltage is produced. Sometimes the oscillator simply ceases to function. In some sets, shorted diodes will produce the same effect.

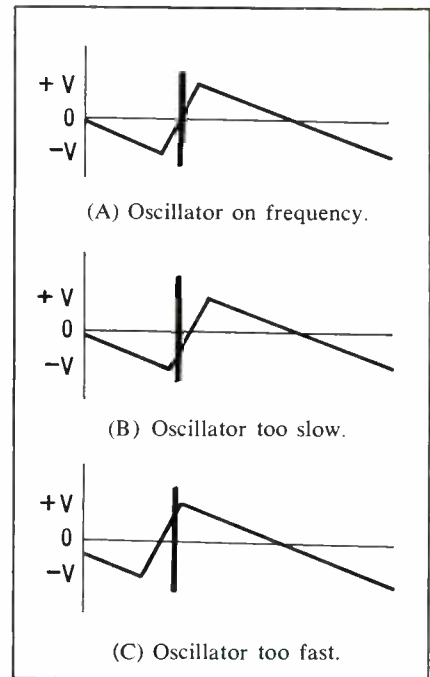
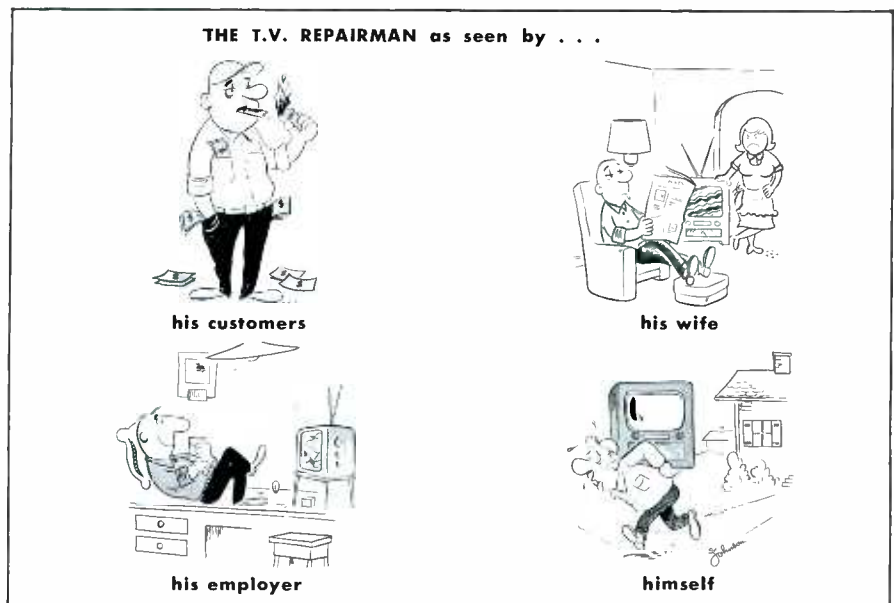

Fig. 4. Combined AFC waveforms.

### Later Circuits

While the circuit previously described is found in some recent-model receivers, a simpler type of circuit is more often encountered. This newer circuit is shown in Fig. 5. Note that a single sync pulse is fed to the common cathodes of the dual AFC diodes. The reference voltage is taken from the plate of the horizontal oscillator and applied to the diodes. Essentially we have the same ingredients as employed in the previous circuitry, but with slight differences.

Again, let us consider the circuit with only the sync pulses applied. When the negative sync pulse is coupled through C64, both diodes





**BUY  
"ET"**



**THE TRANSISTOR LINE THAT TUNG-SOL TAILORED TO YOUR NEEDS**

- LOW INVENTORY ■ HIGH TURNOVER
- RELIABILITY ■ PROFIT
- CUSTOMER SATISFACTION

"ET" is your guide to the compact transistor line engineered and packaged specifically for entertainment replacement. You can make just about every radio and TV replacement from only a handful-size inventory. Eleven PNP and NPN types replace hundreds of older numbers.

Each package is plainly marked with the type of service as well as the part number to save you time in selecting the units you need. Every Tung-Sol

transistor is fully warranted. Tung-Sol takes *your* responsibility seriously and spares no effort to provide the very highest in transistor performance. So make your transistor purchases with an eye to convenience, profit and customer satisfaction. Tell your supplier you'd rather have Tung-Sol "ET" transistors. Write for the Tung-Sol Transistor Interchangeability Guide. Tung-Sol Electric Inc., Newark 4, New Jersey

 **TUNG-SOL®**

**A TYPE FOR EVERY JOB**

**PNP TYPES**

**Low power**  
 ET1 Mixer/oscillator/converter  
 ET2 IF amplifier  
 ET3 AF amplifier 6v.  
 ET4 AF amplifier 12v.  
 ET5 AF amplifier 9v.

**Medium power**  
 ET6 AF power amplifier

**High power**  
 ET7 AF high power amplifier

**NPN TYPES**

**Low power**  
 ET8 Mixer/oscillator/converter  
 ET9 IF amplifier  
 ET10 AF amplifier 9v.  
 ET11 AF amplifier 12v.



# NEW SAMS BOOKS



## ABC's of Ultrasonics

Alan Andrews tells the fascinating story of how sound waves above the normal audible range are being used to perform jobs ranging from cleaning tiny watch movements to huge missile cases, homogenizing milk, relieving lumbago, measuring thickness and depth, locating schools of fish. Clearly understandable, from the first chapters on the nature and behavior of sound waves, to the final chapter on the unique uses of "silent sound." Covers maintenance and testing of ultrasonics equipment, transducers, typical circuitry, cavitation applications; describes specific commercial equipment used for various applications. 96 pages; 5 1/2 x 8 1/2". Only **\$1.95**

## Electronic Games & Toys You Can Build

Len Buckwalter presents complete, easy-to-follow instructions for building 15 fun-filled projects. Each project is excitingly different and not available commercially. Some challenge the player's judgment; some test manual dexterity; others achieve "magic" effects. Projects include: Test Your Nerve; Reaction Timer; Crack the Combination; Penny Pitch; Electronic Card Trick; The Flipper; The Maze; Space Shot; Moving Mouse; Party Pooper; Countdown; Find the Airport; Mind-Reading Act; Treasure Hunt; The Musitron. All you need is a soldering gun, a few tools and parts, and you're headed **\$2.50** for fun. 128 pages; 5 1/2 x 8 1/2". Only



## Howard W. Sams Citizens Band Radio Manual

Here are famous Standard Notation Schematics and PHOTOFAC<sup>®</sup> Folders on nineteen 1960-61 CB Transceiver models. Includes valuable section on servicing CB equipment, outlining typical service problems and their solutions, qualifications required for servicing CB radio, potential market for CB sales and service. This initial volume covers: Apelco; Citi-Fong; Globe; Gonset; Hallicrafters; Heath; Lafayette; Morrow; RCA; Radson; Raytheon; Realistic; Regency; United Scientific Labs; Vocaline; Viking. 160 pages; 8 1/2 x 11". Only **\$2.95**

## Servicing TV Remote Controls

Sam Marshall helps you solve the pesky problem of servicing TV remote controls currently used with most new TV sets. Tells how the various systems work. Includes thorough analyses of transmitters, receivers, relay and motor control systems. Nine chapters include: Basic Principles of TV Remote Control Systems; Remote Control Transmitters (5 basic types); Remote Control Receivers (descriptions of all popular types). Outlines installation, adjustment, alignment and troubleshooting. **\$2.95** 160 pages; 5 1/2 x 8 1/2". Only

### NEW! VOL. 13 AUTO RADIO MANUAL!

Just out—coverage of 50 popular models produced in 1959-60. Complete Photofact<sup>®</sup> data. 160 pages; 8 1/2 x 11". Only **\$2.95**

## HOWARD W. SAMS & CO., INC.

Order from your Sams Distributor today, or mail to Howard W. Sams & Co., Inc., Dept. M-31 1720 E. 38th St., Indianapolis 6, Ind.

Send me the following books:

- ABC's of Ultrasonics (ULT-1)
- Electronic Games & Toys (EGT-1)
- Citizens Radio Band Manual (CB-1)
- Servicing TV Remote Controls (REM-1)
- Auto Radio Manual, Vol. 13 (AR-13)

\$.....enclosed.  Send Free Book List

Name \_\_\_\_\_

Address \_\_\_\_\_

City \_\_\_\_\_ Zone \_\_\_\_\_ State \_\_\_\_\_

IN CANADA: A. C. Simmonds & Sons, Ltd., Toronto 7 (outside U.S.A. priced slightly higher)

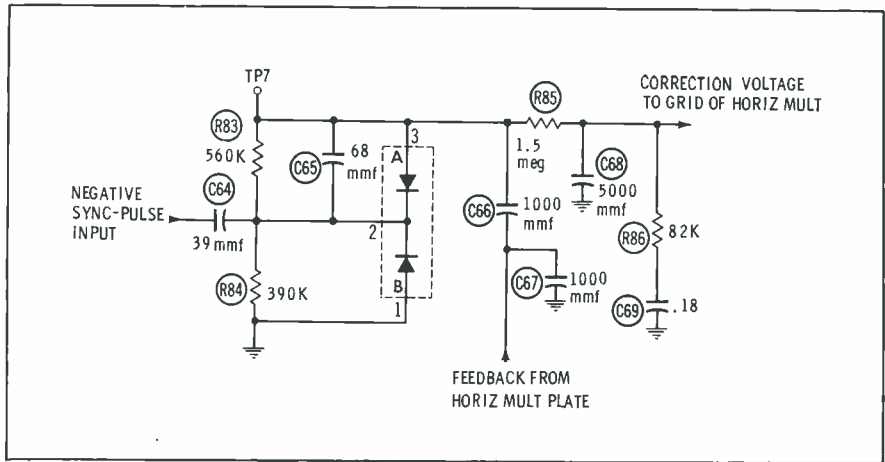

Fig. 5. AFC circuit with common-cathode diodes used in most late-model sets.

conduct simultaneously and develop DC voltages across R83 and R84. These voltages, while not equal, are of opposite polarity. The sum of these two voltages will set the operating point for the input grid of the horizontal multivibrator.

A correction voltage is obtained in a manner similar to that discussed in connection with the other AFC circuit. Sweep waveforms obtained from the output of the horizontal multivibrator are shaped into a sawtooth by C67 and coupled to the top of diode A through C66. This sawtooth voltage is divided across diode A and diode B. If the oscillator is on frequency, the sawtooth will pass through zero (during fly-back time) at the instant the diodes are pulsed into conduction by the sync input. No correction voltage is developed, and the multivibrator is unaffected.

Should the oscillator frequency increase, the sawtooth will lead the sync pulse, and diode B will conduct more heavily than diode A. This action will produce a more positive voltage on the grid of the horizontal multivibrator, which will lower the oscillator frequency.

In this same manner, a lowered oscillator frequency will cause diode A to conduct more heavily than diode B, applying a less positive voltage to the grid of the horizontal multivibrator. This less positive voltage causes the multivibrator frequency to increase.

Most of the service problems encountered in the previously-discussed circuit also apply to the circuit just considered.

### Other Circuits

The AFC circuits of many newer sets incorporate small printed-circuit modules containing several resistors and capacitors. In many instances, individual parts are inaccessible for testing, so it becomes necessary to replace an entire printed component pack.

Most diode AFC circuits encountered in TV can be shown to resemble either one or the other of the two types discussed in this article. Sometimes it may be necessary to rearrange the circuit configuration in order to see the resemblance, but the theory of operation is still the same. ▲

## PRECISION TUNER SERVICE

P. O. BOX 272

1200 S. WALNUT ST.

BLOOMINGTON, IND.

EDISON 99653

**7.50**  
V or U  
COMBO PLUS  
9.95 POSTAGE

6 MONTH WARRANTY

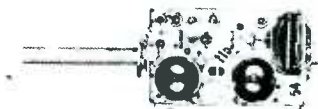

All Types T.V. Tuners Cleaned, Repaired and Aligned to Factory Specifications. Same day in shop service on most Tuners. Price Includes Minor Parts, Major Parts at Cost Price. We use Original Parts if possible. State Make Model and Enclose all Parts and Tubes. Pack Well and Insure.

ALSO HAVE LARGE STOCK OF EXCHANGE TUNERS, WRITE FOR TYPES AND PRICES.

# EXTRA VALUE AT NO EXTRA COST RCA ELECTRONIC INSTRUMENTS

## The V-O-M with the EXTRAS!

Compare this superlative RCA VOM with the instrument you may have been thinking of buying. See if the RCA WV-38A doesn't offer you more "plus" features.



### RCA WV-38A VOLT-OHM-MILLIAMMETER

- 1.5 volt and 0.25 volt DC ranges!
- Big easy-to-read 5 1/4" meter!
- Post-breakable plastic case; no glass to crack or shatter!
- Frequency response of low AC ranges is flat within 1 db to 300,000 cycles!
- Red test lead has probe and size-on alligator clip for added versatility!
- Orderly location of jacks below location of jacks below switches keeps leads out of the way!
- Spring clips on handle to hold test leads!
- DB scales clearly marked: no squinting!
- Regged, scuff-proof, stain-resistant laminated vinyl carrying case. Optional equipment. Only \$4.95\*

Factory wired and calibrated **\$43.95\***  
KIT ONLY \$29.95\*

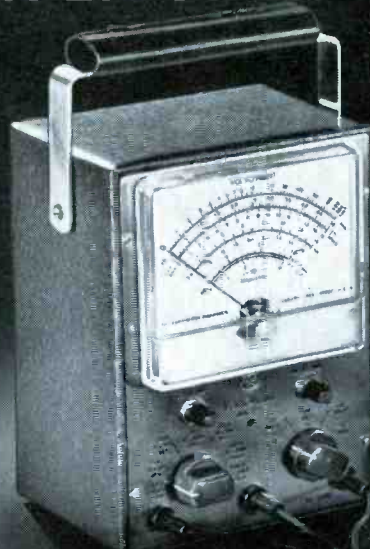

### RCA WV-77E VOLTOHMYST®

Measures AC and DC voltages to 1500 volts; resistance from 0.2 ohm to 1,000 megohms. Separate scales for 1/2 volts rms and 4 volts peak-to-peak for accurate low AC measurements, color coded scales for easier readings.

Factory wired and calibrated **\$43.95\***  
KIT ONLY \$29.95\*

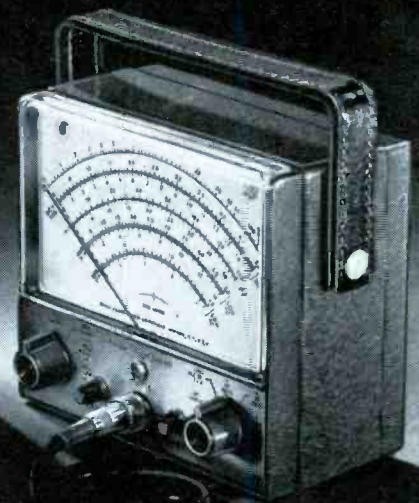

### RCA WV-98B SENIOR VOLTOHMYST®

Measures AC and DC voltages (3% accuracy full-scale); resistance from 0.2 ohm to 1,000 megohms. Measures peak-to-peak values of complex waveforms. Rugged cast aluminum case field tested etched circuits. Big 6 1/2" meter.

Factory wired and calibrated **\$79.50\***  
KIT ONLY \$62.50\*

## RCA SCOPES



### WO-91A 5-INCH OSCILLOSCOPE

High-performance, wide-band oscilloscope especially suited for color-TV, black-and-white TV, and other electronic applications. Dual bandwidth (4.5 Mc with 0.053 volts rms/in. sensitivity and 1.5 Mc with 0.018 volts rms/in. sensitivity). Internal calibrating voltage and calibrated graph screen. Includes special direct/low-cap shielded probe and cable.

Factory wired and calibrated **\$239.50\***



### WO-33A SUPER-PORTABLE OSCILLOSCOPE

A low-cost all-purpose scope you can carry anywhere—only 14 pounds—designed for in-the-home servicing of black-and-white and color-TV, audio and ultrasonic equipment. High gain and wide bandwidth to handle the toughest jobs! Rugged and compact—3" graph scale screen.

Factory wired and calibrated **\$129.95\***  
complete with low-cap/direct input probe and cable.  
KIT ONLY \$19.95\*

## RCA GENERATORS



### WR-64A COLOR-BAR DOT/CROSSHATCH GENERATOR

Gives you all essential Color-TV test patterns; Color-bar signals for checking, adjusting and troubleshooting Color-TV circuits; dot and crosshatch pattern signals for adjusting convergence in color receivers and for adjusting linearity and overscan in both color and black-and-white receivers. Designed for in-the-home or shop servicing.

Factory wired and calibrated **\$189.50\***



### WA-44C AUDIO GENERATOR

Generates sine and square wave signals for testing audio systems. Frequency range: 20 cps to 200 Kc. Use in the measurement of intermodulation distortion, frequency response, input and output impedances, speaker resonance, speed of recording and playback mechanisms, transient response, phase shift, etc.

Factory wired and calibrated **\$98.50\***



### WR-49B SIGNAL GENERATOR

For alignment and signal tracing of AM, FM and AM/FM receivers, low-frequency signal tracing and alignment of TV video amplifiers. Six ranges—35 Kc to 30 Mc. Internal 400 cps modulation. Low rf signal package!

Factory wired and calibrated **\$79.50\***



### WR-69A TELEVISION/FM SWEEP GENERATOR

For visual alignment and troubleshooting of TV rf/ift circuits and other electronic equipment IF/video frequency ranges 50 Kc to 50 Mc, TV channels 2 to 13, plus FM range—88-108 Mc Sweep width continuously adjustable to 12 Mc.

Factory wired and calibrated **\$295.00\***



### WR-99A CRYSTAL- CALIBRATED MARKER GENERATOR

Supplies a fundamental frequency rf carrier of crystal accuracy for aligning and troubleshooting color-TV, black-and-white TV, FM receivers and other electronic equipment operating in 13 Mc to 260 Mc range.

Factory wired and calibrated **\$242.50\***

Every RCA test instrument brings you extra value at no extra cost, and there's one to help you with every job. See your Authorized RCA Test Equipment Distributor for full information on any instrument.



The Most Trusted Name in Electronics

\*User Price (Optional)

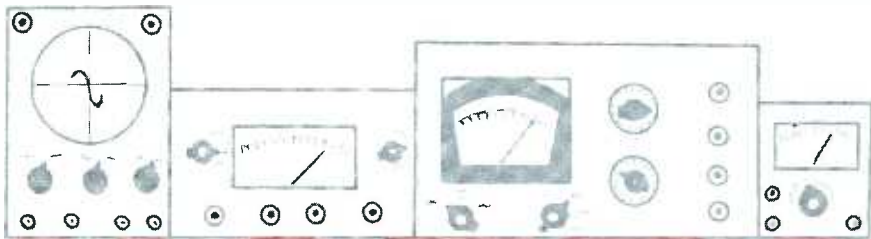

# NOTES

## ON TEST EQUIPMENT

by Les Deane

### Smooth DC—In Quantity



Fig. 1. The EICO 1064 operates DC-powered radios and charges batteries.

A new DC power supply introduced by EICO of Long Island City, N. Y. delivers sufficient output current to charge automotive and other heavy-duty batteries, but the ripple content of the output is so low that the unit can be used as a power source for transistorized equipment—even portable radios. The Model 1064 *Low-Ripple Battery Eliminator and Charger* is available in either kit or factory-wired form.

Specifications are:

1. *Power Requirements*—105/125 volts, 50/60 cps; maximum power consumption 150 watts; "ON" lamp and a 5-amp line fuse on panel;

supply isolated from AC line by power transformer.

2. *DC Output*—continuously variable in two ranges of 0-8 and 0-16 volts; positive and negative binding posts provided on front panel.
3. *Output Currents*—maximum for 8V range 10 amps continuous, 20 amps intermittent; maximum for 16V range 6 amps continuous, 10 amps intermittent.
4. *Panel Meters*—2 1/4" DC voltmeter with 0-20V scale (smallest scale division 1V); 2 1/4" DC ammeter with two scales (0-10 and 0-20 amps); current range determined by setting of toggle switch on front panel.
5. *AC Ripple*—approximately .3% at 2 amps, 1% at 6 amps, and 1.5% at 10 amps for 16V range; for 8V range, 1.5% at 2 amps, 2% at 6 amps, and 4.5% at 10 amps.
6. *Size and Weight*—10 1/2" x 7 3/4" x 8 3/4", 16 lbs.

The output of the Model 1064 is filtered by a pi-type network consisting of dual 5000-mfd electrolytic capacitor C1 and heavy-duty 5-mh choke L1 (see Fig. 2). A pair of dual selenium units, connected for full-wave operation, are employed in the rectifier circuit. The input to the rectifier is obtained from two identical secondary windings on power transformer T1. When front-panel toggle switch S1 is in the 6V position, these windings are connected in parallel; in the

12V position, they are switched over to a series connection in order to double the input voltage to the rectifier. Another set of contacts on S1 selects the appropriate ammeter range—10 amps for 12-volt output, or 20 amps for 6-volt output.

The ammeter, series-connected in the negative leg of the output circuit, continuously monitors output current. An overload relay in series with the meter automatically resets itself after the overload is removed. For additional protection, the primary circuit of the power transformer is fused.

The front-panel VOLTAGE control simultaneously adjusts movable taps on both secondary windings of the power transformer, thus continuously varying the input voltage to the rectifier. The DC output voltage is indicated on a meter connected across the output terminals. Incidentally, no test leads are supplied with the unit; the + and - terminals are universal-type binding posts, suitable for attachment of several different styles of leads.

Since battery charging is one of the major applications of the Model 1064, EICO has devoted considerable space in the service manual to an extensive treatment of this subject. In addition to operating instructions for using the DC supply to charge lead-acid and other types of batteries, you will find practical information on hydrometer readings, cell-voltage testing, and electrolyte freezing points.

### "Senior" Kit

RCA Electron Tube Div. of Harrison, N. J. is now making the Model WV-98B *Senior VoltOhmyst* available as a kit, at a price almost twenty dollars below the cost of a factory-assembled instrument. A prewired printed board, and a completely assembled input cable and probe, are included to minimize the time required by the buyer to construct the kit. The Model WV-98B(K) is pictured in Fig. 3.

Specifications are:

1. *Power Requirements*—105/125 volts, 50/60 cps; power consumption approximately 6 watts; power-on indicator light on face of panel meter; unit isolated from AC line by power transformer; one 1.5-volt battery supplied for resistance measurements.
2. *Voltmeter*—seven DC ranges from 0 to 1.5, 5, 15, 50, 150, 500, and 1500 volts; seven peak-to-peak AC ranges from 0 to 4, 14, 42, 140, 420, 1400, and 4200 volts; maximum recommended input, peak-to-peak AC or DC plus peak AC, 2000 volts; input impedance variable from .83 megohms/70 mmf to 1.5 megohms/60 mmf (depending on range selected); over-all accuracy  $\pm 3\%$  of full-scale deflection; useful frequency response extends to 3 mc for all AC ranges up to 500V rms and 1400V p-p.

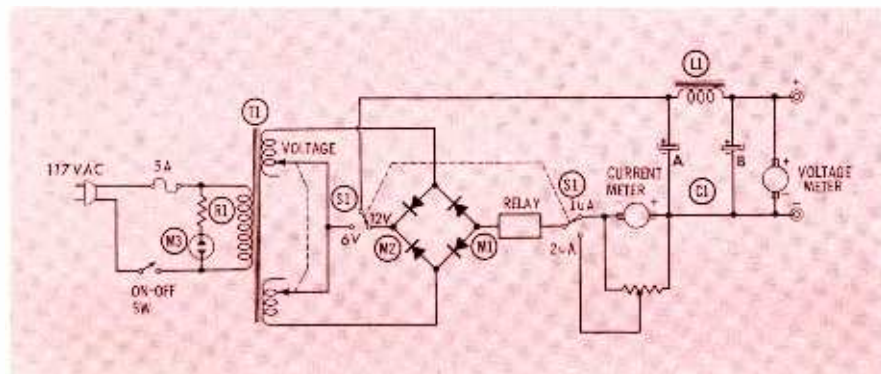

Fig. 2. Voltage-range switch S1 also selects correct current-meter range.

# new

A **must** for any serviceman now servicing or planning to service Color TV receivers ■ Make a one man service call out of a costly two man cabinet pulling job ■ Eliminate possibility of damage to the customer's set when transporting to and from his home ■ Eliminate the need to reconverge the customer's set when the chassis is returned ■ Professional Appearance—Finish matches that of RCA Test Equipment ■ Partial Assembly—Safety glass and kine mask assembled at factory ■ Components Kit furnished with Test Jig includes all necessary components, hardware and Instructions for installation of an RCA Tri-Color Kinescope ■ Convergence control panel supplied provides dynamic as well as static convergence for the CTC-10 and CTC-11 chassis ■ Instructions included with test jig provides data for utilization with CTC-4, 5, 7 and 9 chassis and lists extension cables required ■

## act now for the color season

### see your RCA distributor for details

*RCA parts & accessories/camden, n. j.*

# RCA COLOR TEST JIG

#11A1015



**RCA The Most Trusted Name in Color Television**  
**RADIO CORPORATION OF AMERICA**



Tarzian 400 and 600 volt F and H series units are available in handy Ten-Paks, in Doubler Replacement Kits, and in bulk; M150 and M500 units are available in Conversion Kits and in bulk. Nine standard tube replacement rectifiers replace over 95% of all popular

vacuum tube rectifiers; S5347 replaces 6BW4 or 12BW4 in Citizen's Band radios; your 50 to 500 ma requirements are covered by four "condensed stack" selenium rectifiers, which Sarkes Tarzian has made more efficient—and smaller—than before.

## Sarkes Tarzian

*...the preferred silicon rectifiers that mean fewer call-backs*

■ Tarzian silicon rectifier dependability virtually eliminates call-backs that waste your time and profits. Units are available immediately from distributors throughout the country... in the shapes, sizes, and specifications you need to do your work quickly and easily.

Tarzian's industry-wide reputation for high quality at a pace-setting low price is a basic reason why more technicians like yourself prefer Sarkes Tarzian rectifiers than the next two most popular makes combined.

That statement is firmly based on the results of a 1961 mailing by Brand Name Survey, an independent research organization, to 23,000 service technicians in all major market areas of the United States, covering 36 states. You're in good company—and lots of it—when you make Tarzian rectifiers your first choice for replacement applications.

Free Tarzian "Distributor Line" catalog is available now as your guide to replacement rectifier quality. Ask your nearest Tarzian distributor for your copy.



### SARKES TARZIAN, INC.

World's Leading Manufacturers of TV and FM Tuners • Closed Circuit TV Systems • Broadcast Equipment • Air Trimmers • FM Radios • Magnetic Recording Tape • Semiconductor Devices

SEMICONDUCTOR DIVISION • BLOOMINGTON, INDIANA

In Canada: 700 Weston Rd., Toronto 9 • Export: Ad Auriema, Inc., New York



Fig. 3. RCA Model WV-98B Senior Volt-Ohmmyst is now available in kit form.

4. Ohmmeter—seven ranges with multipliers of Rx1, 10, 100, 1K, 10K, 100K, and 1 meg; center-scale value 10; smallest scale division .2 ohm; zero and ohms-adjust controls provided on front panel.
5. Meter — 6½" unit with 200-ua movement; nine separate scale arcs plus zero-center indication; less than 1% tracking error.
6. Other Features — combination DC/AC-OHMS probe and cable supplied; function selector provides DC polarity reversal; RF and high-voltage probes available as accessories.
7. Size and Weight — 6½" x 7" x 3¾", approx. 6 lbs.

The components supplied in the WV-98B kit are "laid out for inspection" in Fig. 4. These items include a printed-board assembly, small power transformer, two controls, two multisection switches with several resistors, meter assembly and control panel, neon indicator, coaxial jack, battery and holder, line cord and ground lead, various pieces of small hardware, two tubes (6AL5 and 12AU7A), cast metal case and front, plus two support brackets, carrying handle, and test probe-cable assembly.

The only major wiring to be done is on the function and range switches. About two dozen resistors, eight capacitors, four calibrating controls, two tube sockets, and a selenium rectifier are al-



Fig. 4. WV-98B kit includes preassembled printed-wiring board and probe.

ready wired and soldered on the printed board. The small rings of wire found all over the board are lengths of hook-up wire, each numbered and ready for connection to the meter, switches, controls, and other components.

The high input impedance of the WV-98B makes the meter useful for measuring critical grid-circuit voltages in vacuum-tube stages and small bias potentials normally found in transistor circuits. Another feature of great value in troubleshooting TV receivers is the peak-to-peak AC function, with which even complex nonsymmetrical waves can be measured directly and compared to standards given in service literature. In addition, many special applications for use of the *Senior VoltOhmyst* are outlined in the manual supplied with the instrument.

## Antenna Problems?

Seco Electronics of Minneapolis has recently announced a test instrument designed specifically for installing and troubleshooting radio transmitting antenna systems. When connected in series with the RF transmission line, the Model 520 *Antenna Tester* (Fig. 5) provides system-efficiency and RF-power readings at any operating frequency between 3.5 and 180 mc. Since the unit is actuated by RF energy fed into the indicating circuit, no external AC or DC power is required.

Specifications are:

1. *SWR Meter*—measures forward and reflected power in coaxial transmission lines; three types of indications provided (standing-wave ratios from 1:1 to 8:1, GOOD-POOR scale calibrations, and percentage of system efficiency); insertion error negligible to 180 mc; correction factor for 72- to 75-ohm lines provided in manual.
2. *Wattmeter*—measures RF power in 50-ohm lines; values from .5 to 1000 watts covered in three ranges; direct readings provided at frequencies from 7 to 180 mc, and readings between 3.5 and 7 mc accurate when multiplied by 10; relative power scale with linear 0-to-100 calibrations provided.
3. *Panel Meter*—3½" unit with 80-ua



Fig. 5. Seco 520 measures power and SWR in transmitter antenna circuits.

Season's  
Greetings



**THANKS...**

**FOR YOUR  
CONTINUED SUPPORT**

**THANKS...**

**FOR EVERYTHING**

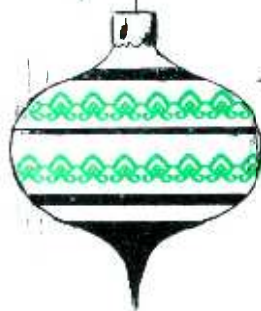

Thanks

Merit

**Coil & Transformer Corporation**

MERIT PLAZA

HOLLYWOOD, FLORIDA

movement; over-all accuracy  $\pm 5\%$  of full-scale deflection.

4. Size and Weight —  $5\frac{1}{2}'' \times 6\frac{7}{8}'' \times 2\frac{1}{2}''$ , 2 lbs.

In order to check the efficiency of the circuit between the output stage of the transmitter and the radiating elements of the antenna, the 520 can be inserted at the base of the antenna or anywhere in the transmission line. To take an SWR reading, which is directly proportional to antenna-system efficiency, the 50-ohm line from the transmitter is attached to the coax connector labeled RF on the left side of the tester case. The line from the antenna or matching device is attached to the other coax connector on the right side of the case. The function switch to the left of the meter is next

placed in the CALIB position and the SWR CALIB control on the right is rotated fully counterclockwise. The transmitter is then turned on, the SWR CALIB control is adjusted for about half-scale deflection on the meter, and the transmitter is tuned for the desired output.

Sometimes you may find that the tester will detune the transmitter so that high output levels cannot be reached. In such cases, remember that the SWR readings are based only on the difference between forward and reflected waves, and that the indications are only relative.

To complete the SWR measurement, the SWR CALIB control is advanced until the meter pointer reaches full-scale deflection (SET mark on top scale). Next, the function switch is placed in its sec-

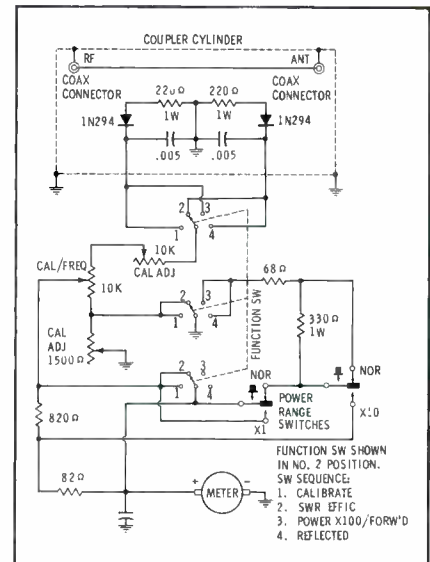

Fig. 6. Coupler cylinder absorbs RF power from antenna to operate meter.

ond position, marked EFFIC. The meter should then indicate the standing-wave ratio. A numerical reading is given on the top scale, with a reading of 1 (no deflection) considered as the ideal. Efficiency of the system can also be determined by referring to either the GOOD-POOR calibration or the percentage scale.

The other two positions on the function switch provide direct readings of forward and reflected power in watts. For these measurements, the FREQ SEL control (which is combined with the SWR CALIB control) is set to the operating frequency of the transmitter. The meter circuit is set up for a full-scale reading of 1000 watts; thus, the 0-to-10 markings on the wattage scale should be multiplied by 100 to obtain the actual power. For more sensitive measurements at lower levels, the X10 or X1 push buttons on the panel can be pressed to provide full-scale readings of 100 and 10 watts, respectively.

Since an instrument of this type may not be familiar to many of you, let's see how it works. A complete schematic of the 520 is shown in Fig. 6. RF energy for all measurements is sampled by a directional coupler. This coupler is housed in a sealed cylinder within the instrument. It picks off RF energy through both inductive and capacitive coupling, and yet offers negligible loss to the transmission system.

The two 1N294 diodes rectify the RF signal for application to the DC microammeter. Due to placement of the components within the coupler cylinder, one diode detects reflected power, while the other detects actual incident or forward power. Once the meter has been calibrated on incident power (with the SWR CALIB control), a measurement of reflected wave energy will provide an SWR reading.

Aside from SWR and direct wattage measurements, the Model 520 is also useful for determining input impedances of power amplifiers, checking the adjustment of traps and coupling devices, and permanent in-line monitoring. ▲

**FOR ALL BLACK & WHITE PICTURE TUBES**

2 volt / 4 volt / 6 volt / 8 volt series or parallel electrostatic or electromagnetic

# Perma-Power

INTRODUCES THE

## 2-Brite

### IF THE BASE IS RIGHT THE BOOST IS RIGHT

**7 POWER RATINGS**

VOLTS	AMPS
2.34	.600
2.68	.450
4.70	.300
6.30	.300
6.30	.450
6.30	.600
8.40	.450

MODEL C202 for duodecal base sets



MODEL C212 for 110° button base sets (RCA type)

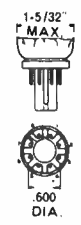

MODEL C222 for 110° shell base sets (Sylvania-Dumont type)

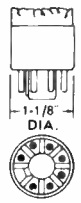

A Britener with a slide switch for series or parallel wiring is nothing new—but those previously available could only be used on picture tubes with heater ratings of 6.3 volts, .600 amps. For all other heater ratings, a single-purpose auto-former has been necessary.

Now Perma-Power has developed a truly universal series/parallel Britener—one that can be used on ANY set without endangering the delicate filaments through too much boost. Only Perma-Power—the leader—offers you this convenience.

You can brighten any TV picture with Perma-Power's 2-Brite. If the base is right, the boost is right! You don't even have to take the time to consult a Britener Selector Guide. Just choose the right base style—and install with confidence.

List Price \$3.75

**Perma-Power COMPANY**  
3102 N. ELSTON AVE. • CHICAGO 18, ILL.



# BUSS and FUSETRON FUSES

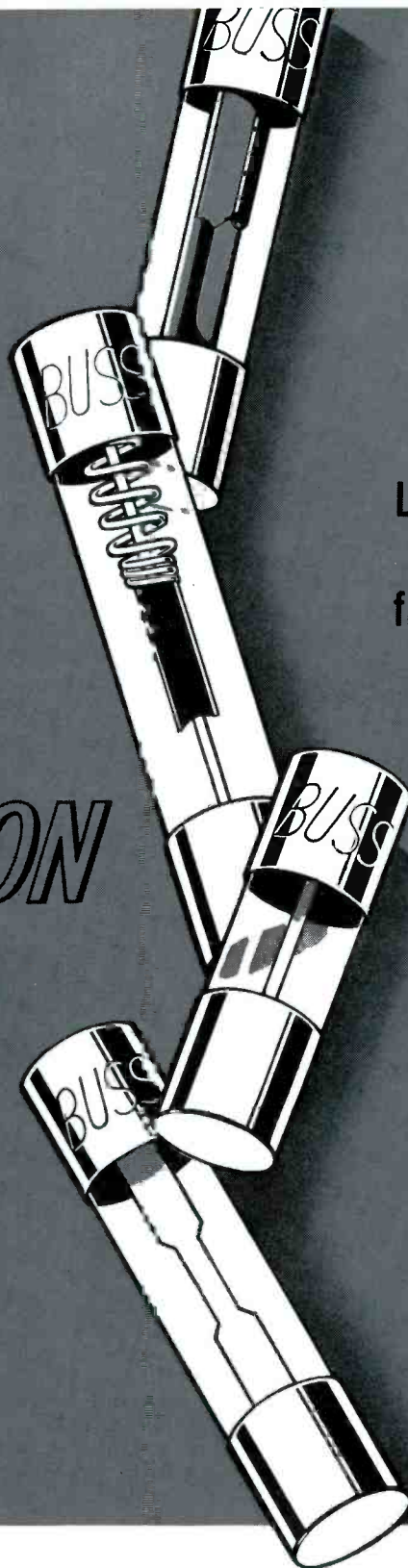

A Complete  
Line of Fuses  
in sizes  
from 1/500  
Amps. up

Plus  
a companion  
Line  
of Clips,  
Blocks  
and Holders

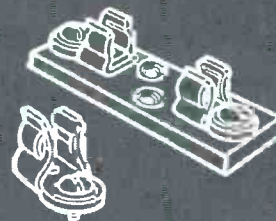

Probably your best insurance against call-backs and loss of customer satisfaction is to install components of the highest quality.

To assure trouble-free service that helps protect your good name, each BUSS and FUSETRON fuse is tested in a sensitive electronic device that automatically rejects any fuse not correctly calibrated, prop-

erly constructed and right in all physical dimensions.

Thus, you help protect yourself against possible service troubles when you say to your jobber, "I want only genuine BUSS and FUSETRON fuses."

For more information, write for the BUSS bulletin on small dimension fuses and fuseholders. Form SFB.

1261

BUSSMANN MFG. DIVISION, McGraw-Edison Co., UNIVERSITY AT JEFFERSON, ST. LOUIS 7, MO.

# Next Month In PF Reporter

## Tracking Down Troubles

**TAKES THE LION'S  
SHARE OF ATTENTION**

**8 PAGE SPECIAL SECTION**  
Covers Vertical Sweep  
Troubleshooting from A to Z

**MORE TV COVERAGES:**  
Checking Up on Video Amplifiers  
Getting Rid of the  
"Christmas Tree"  
Eliminating TVI

**TEST-EQUIPMENT FEATURES:**  
Picking the Probe for the Job  
Only a Scope Would Tell

**INDUSTRIAL**  
Troubleshooting in a Small Plant  
**AUDIO**  
Hum-Hunting in Audio Equipment

**Bonus! Complete 1961 Subject Reference Index**

Renew your subscription now, while you can still have  
your choice of FREE Premium books.

Enter my subscription to PF REPORTER  
and send me free book(s) checked.

3 Years \$9.00     2 Years \$7.00     1 Year \$4.00

- The Troubleshooter's Handbook  
 Servicing Industrial Electronics  
 Servicing TV from Tuner to Picture Tube

Check one for  
each year you  
subscribe

Bill Me     Remittance Enclosed     Extend Present Subscription

Please Check Your  
Business Classification

- Independent Radio,  
TV Serviceman     Owner, Mgr.  
 Retailer with Service  
Department     Service Mgr.  
 Industrial Electronics  
Service     Employee  
 Other (Specify occupation and title)

Name \_\_\_\_\_

Firm \_\_\_\_\_

Address \_\_\_\_\_

City \_\_\_\_\_ Zone \_\_\_\_\_ State \_\_\_\_\_

Take this coupon to your distributor, or mail to: Howard W. Sams & Co., Inc.,  
2201 E. 46th Street, Indianapolis, Indiana.

## Circuit Voltages

(Continued from page 32)

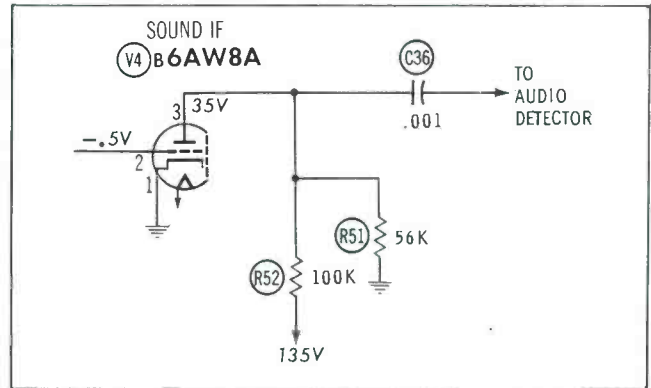

Fig. 3. Sound-IF circuit of Admiral Chassis 20K7.

age is applied to them, the leakage will immediately be evident.

### Oscillator Trouble Kills Raster

Our next "patient" is a Zenith Chassis 16E20 with a sine-wave horizontal-oscillator circuit (Fig. 2). The trouble in this receiver is a loss of output from the horizontal oscillator, and therefore no high voltage. We narrow down our search to the oscillator circuit by making a voltage check at the grid (pin 5) of the 6DQ6 output tube. Instead of a normal -50 volts, our reading is zero volts. When this bias is missing, we can usually assume that the input signal which produces the bias is also absent.

The 6GH8 oscillator tube checks okay; thus, some other component in the oscillator circuit must be at fault. To localize a trouble of this nature, we must first know whether the oscillator has stopped operating, or whether some defect in the plate section is preventing the oscillator signal from reaching the 6DQ6 grid. The operation of this type of oscillator can be reliably checked by measuring the grid bias. In this case, the voltage at the grid (pin 2) measures zero volts instead of the -15 volts that should appear when the circuit is oscillating. We also note that the screen voltage is 250 instead of 115 volts. This second measurement indicates an absence of screen current—a sign that the 6GH8 is not conducting even with zero volts on the grid.

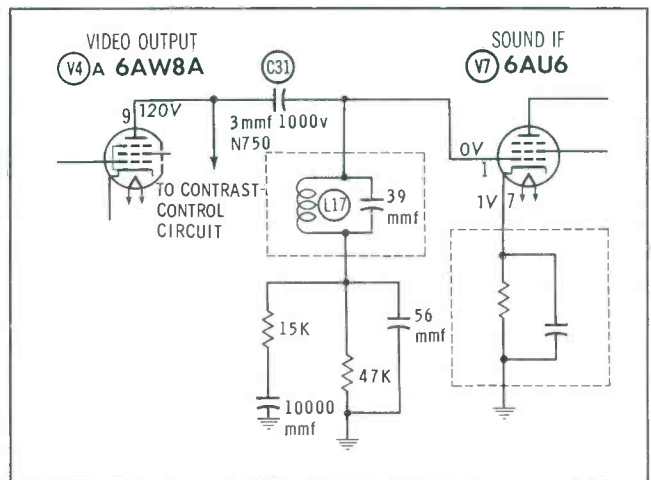

Fig. 4. Sound take-off circuit, RCA Chassis KCS108K.

When we make a cathode-voltage check at pin 7, we find a positive 35 volts instead of zero volts. With no screen current being drawn, it seems probable that the high positive cathode voltage means an open cathode circuit. Referring to the diagram, we see that the cathode is returned to ground through horizontal oscillator coil L13. On visual inspection, we discover an unsoldered ground connection on the coil. Once again, voltage measurements have led us directly to the trouble spot.

Following the Zenith, we tackle an Admiral Chassis 20K7 with weak and distorted sound. The plate voltage of the sound IF amplifier is suspiciously high; instead of the 35 volts shown on the schematic in Fig. 3, it is 50 volts. A new 6AW8A sound IF tube does not solve the problem.

The plate-voltage error does not give us much to go on. However, we do notice that when the 6AW8A is pulled out of its socket, there is no change in the plate voltage at pin 3. Apparently, then, we have either a nonconducting tube or a defective socket connection. Wiggling the 6AW8A in its socket reveals a poor solder connection between the socket and the printed-wiring board at pin 3. When this terminal is resoldered, the voltage goes down to the normal 35 volts, and the sound-IF circuit again functions properly.

Now we turn to another sound trouble. This time, we are working on an RCA Chassis KCS108K. Although the chief complaint is buzz in the sound, we also observe that the video is slightly smeared; for this reason, we begin troubleshooting at the junction of the video and sound circuitry.

In this set, the sound take-off point is at the plate of video output tube V4A (Fig. 4). A voltage measurement at pin 9 of V4A shows only 100 volts present instead of 120. This voltage error may be evidence of trouble, but it doesn't give us all the information we need. Therefore, we also check the voltage at the control grid (pin 1) of the 6AU6 sound IF tube V7. The schematic calls for zero volts, but we actually measure +10 volts. By studying the diagram, we can see that the only trouble which could place a positive voltage on the sound-IF grid is leakage in sound take-off capacitor C31. Clipping the pigtail on the grid side of this 3-mmf capacitor, we check for positive DC voltage on the disconnected lead. Our measurement tells us that C31 is very leaky. After we replace it, the buzz is gone, and so is the smear in the video.

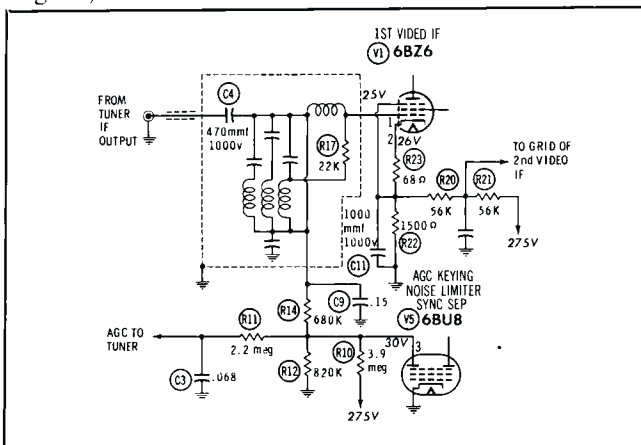

Fig. 5. AGC and first IF, Zenith Chassis 16D25.

*1st in a series:*

# It pays to stock General Electric "SERVICE-DESIGNED" Capacitors



## INCREASE YOUR PROFITS

Save the premium you pay for slow-moving "exact" replacements in ordinary capacitor lines. General Electric "Service-Designed" capacitors are engineered for both mechanical and electrical interchangeability and are clearly marked for range of capacitance and voltage requirements. No slow movers. No more guessing or substituting for exact replacements. Make all your electrolytic capacitor replacements from smaller inventory and turn it into profits faster.

The complete "Service-Designed" line contains tubulars, twist-prong and miniature electrolytic and paper Mylar\* types. Get the full profit picture from your General Electric capacitor distributor. General Electric Company, Distributor Sales, Electronic Components Division, Room 8247B, Owensboro, Ky.

\*T. M. duPont Company

*Progress Is Our Most Important Product*

**GENERAL  ELECTRIC**

# NEW! SARGENT ELECTRONIC CHEMICALS and FINISHES

## SARGENT TUNER CLEANER

Thoroughly cleans tuners and controls. Protects against future corrosion, oxidation and contact wear. Non-flammable.

Giant 16.4 Ounce Can **\$1.47** Dealer Net

Includes plastic extension tube.

## SARGENT GEAR AND PARTS CLEANER

Instant cleaning power for turntables, tape recorders, business machines and electronic devices. Flushes away dirt, oil and grease in gears and parts. Non-flammable.

Giant 16.4 Ounce Can **\$1.29** Dealer Net

Includes plastic extension tube.

### OTHER PRODUCTS IN THE SARGENT ELECTRONICS LINE

Red Insulator, Degreaser, Clear Acrylic Plastic, Penetrating Oil, Squeak Stopper, Enamels, Lacquers, Metallics, Engine Enamels, Stop Rust, and other Specialties.

For Free Literature and Prices, Check Your Electronics Parts Distributor, or write . . . **ELECTRONICS DIVISION**

## THE SARGENT-GERKE CO.

Producer of Paints and Chemicals for Over 60 Years  
P. O. Box 729 • INDIANAPOLIS 6, INDIANA

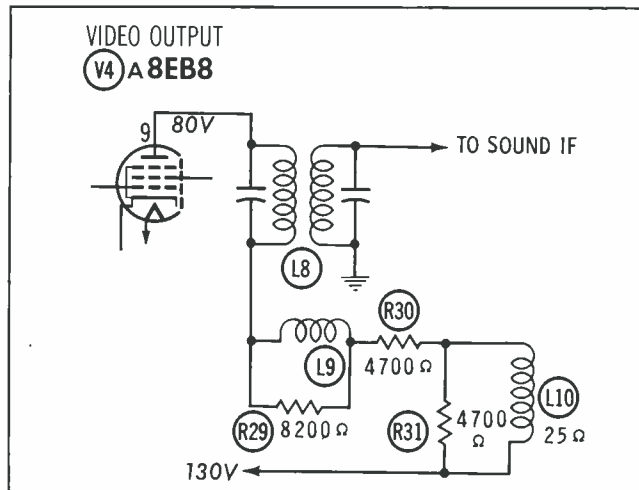

Fig. 6. Video plate-load circuit, Emerson 120507A.

Buzzy sound is also present in the next set (a Zenith Chassis 16D25), but the main problem is severe video overloading. Since we appear to be dealing with a classic case of AGC failure, we try a new 6BU8 keying tube and two 6BZ6's in the first two IF stages. This doesn't correct the trouble, so we check the plate voltage at pin 3 of the 6BU8 (see Fig. 5), in an attempt to find out if the keying stage is functioning. The meter indicates +30 volts. While this highly positive reading would be an alarm signal in most receivers, it's normal for late-model Zeniths. As shown in the schematic, the cathode circuit of the first video IF stage includes a voltage divider (R22, R20, and R21) that produces +26 volts on the cathode. Therefore, the grid voltage supplied by the AGC system must be only a few volts less positive than the cathode voltage to set the proper bias.

We check the grid voltage of the first IF, expecting to find about 25 volts at this point. To our surprise, the VTVM reads 40 volts. The grid voltage is 10 volts higher than the AGC-tube plate voltage! Where did the additional voltage come from?

This condition might possibly be due to a short in the first IF tube, but we've already eliminated this possibility by replacing the tube. The only other likely trouble is leakage to B+ through a defective C4 and the plate circuit of the mixer stage in the tuner. Current through this circuit could produce sufficient voltage drop across R18 and R14 to raise the grid voltage to the 40-volt level. When we disconnect the grid side of C4 and give it a leakage test, our suspicion is proved correct. After replacement of C4 and adjustment of the AGC control, a normal picture is restored.

### Chasing Intermittents

Voltage checks are unbeatable for analyzing intermittent troubles. Many of the most erratic defects can be caught by simply comparing the VTVM readings obtained at some key test point during normal and abnormal operation.

As an example of this technique, let's look at an Emerson Chassis 120507A which develops a badly smeared picture after it plays awhile. Probing for trouble when the symptom is present, we find that the smear quickly disappears when we try to check the voltage at the junction of R31 and R30. This leads us

## Service Dealer Program No. 12 in a Series

All 5 ads only

\$1.00 for glossy proofs

\$1.75 for ad mats



USE THIS COUPON TO ORDER ADS DESCRIBED ON PAGE 85

**PF REPORTER**  
2201 E. 46th Street  
Indianapolis 6, Indiana

Please send me:

ad mats @ \$1.75     glossy prints @ \$1.00     both for \$2.50

Entire series, 60 mats, plus bound glossy proof book @ \$25.00.

Discount \$\_\_\_\_\_ for previous orders.

Enclosed is \$\_\_\_\_\_ to cover cost.

Name \_\_\_\_\_

Address \_\_\_\_\_

City \_\_\_\_\_ Zone \_\_\_\_\_ State \_\_\_\_\_

1261

to suspect that peaking coil L10 is opening.

To see whether or not we have guessed right, we connect the VTVM across L10—being careful to hook up the probes so they do not place any physical stress on the coil. (The weight of the test leads might be enough to “heal” any bad connection which might be present.)

Naturally, the voltmeter reading is negligible at first, since only a small voltage drop is produced across the 25-ohm DC resistance of L10. After a short while, however, we notice that the reading has leaped to 35 volts. This proves to us that L10 has opened and removed the low-resistance shunt from across R31.

At this point, I’m sure you will agree that voltage analysis is of great value in servicing. Of course, you won’t solve *all* your service problems by checking voltages, since some trouble symptoms are caused by signal distortion which produces no change in DC voltage levels. However, most defects do result in abnormal circuit voltages; so, when you’re looking for the cause of a service problem, voltages will usually tell the story.



**Final Polishing**

Some TV owners neglect the appearance of their sets, allowing a film of grime to build up on the cabinet and CRT safety window. Others mar the finish by too-diligent use of dust cloths. In either case, the outside of the set soon takes on a time-dulled look. Thus, putting a TV set in “like-new” condition often requires sprucing up the cabinet as well as restoring good pictures and sound.

For putting on this final touch, Injectorall Co. of Brooklyn, N. Y. has introduced two new polishes: No. 30WC *Renew-Spray* for cabinets, and No. 20 *Lens-Kleen* for safety windows and other clear plastic surfaces.

Although these preparations are supplied in aerosol cans, they are not sprayed directly on the surface to be treated. Both types are heavy foams that fall straight down from the spout. The foam is collected on a polishing cloth, and then applied to the cabinet or glass in the same manner as a liquid polish.

*Renew-Spray* can be buffed to a high luster. It contains a dark reddish stain which helps to hide small surface scratches; for this reason, it should not be used on light-colored furniture.

*Lens-Kleen* has antistatic properties, and also aids in concealing shallow scratches that give clear plastic a “cloudy” appearance. ▲

*2nd in a series:*

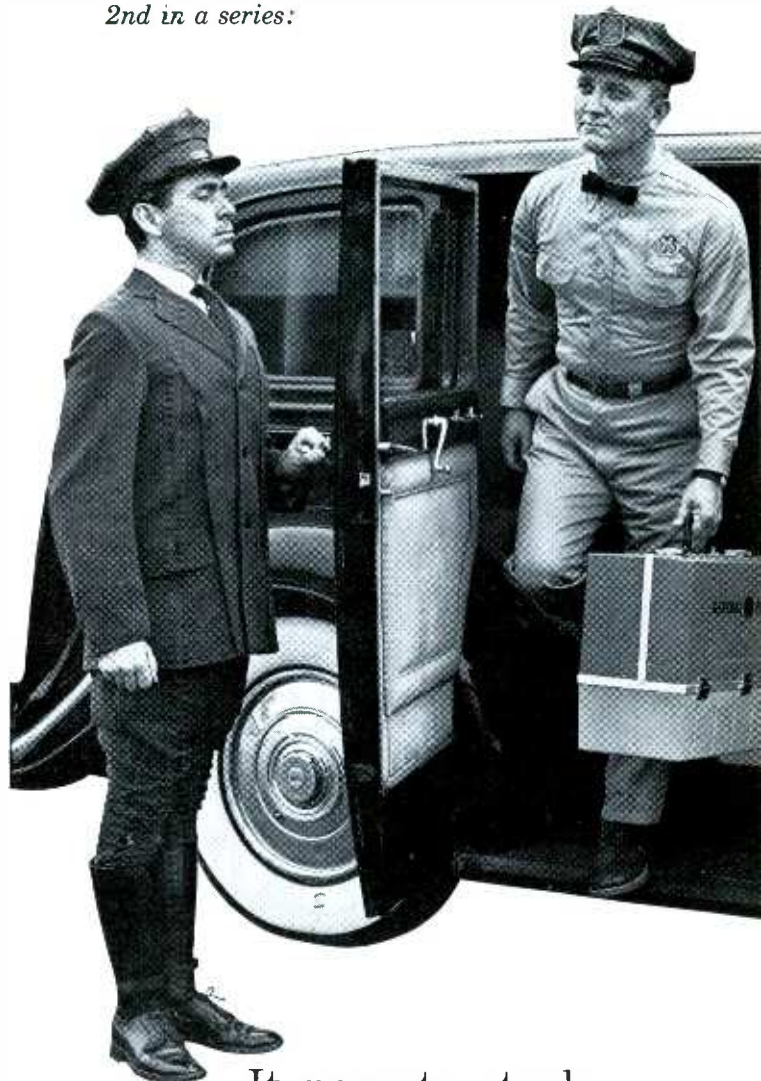

It pays to stock  
General Electric  
“SERVICE DESIGNED”  
Capacitors

**MAKE AN EXTRA SERVICE CALL A DAY**—With the time you save in single-unit ordering and pick-up from your distributor, you could average one extra service call a day just by stocking G-E “Service-Designed” capacitors. Turn wasted time into profitable time.

General Electric “Service-Designed” capacitors are especially designed to the requirements of the replacement market, based on an exhaustive survey of all capacitors used in radio and television during the past ten years. The result: It is now *practical* for you to stock this important replacement item. Smaller inventory. Faster turnover. More profits because—A FEW WILL DO. For complete information on G-E capacitors, stocking kits and literature, see your authorized General Electric capacitor distributor. General Electric Company, Distributor Sales, Electronic Components Division, Room 8240B, Owensboro, Kentucky.

*Progress Is Our Most Important Product*

**GENERAL  ELECTRIC**

# CLEAN-UP WITH CHEMTRONICS CLEANERS and POLISHERS



## NEW! WATERLESS HAND CLEANER

The latest addition to the Chemtronics line of fine Electronic Servicemen's chemical aids is WIPE-A-WAY, a waterless hand cleaner in an AEROSOL can. Here is a valuable aid to any serviceman. It takes only 10 seconds to rub on and wipe off to have really clean hands. Wipe-A-Way is fortified with lanolin and germ killing trichlorophenate.

Available at all leading distributors

ONLY **\$1.49** net  
6 oz. can



## NEW! PLASTIC AND GLASS CLEANER

To really "clean up" on the job we highly recommend the use of Chemtronics' MASK-N-GLAS cleaner and polisher. Containing only the finest ingredients, MASK-N-GLAS is non-abrasive, non-staining and will not harm plastic masks, glass or cabinets and also has anti-static properties. Another of the many fine Chemtronics' chemicals you'll find at your distributors.

Available at all leading distributors

ONLY **\$1.79** net  
6 oz. can

**CHEMTRONICS inc.**  
870 East 52nd Street, Brooklyn 3, New York

## Troubleshooter (Continued from page 37)

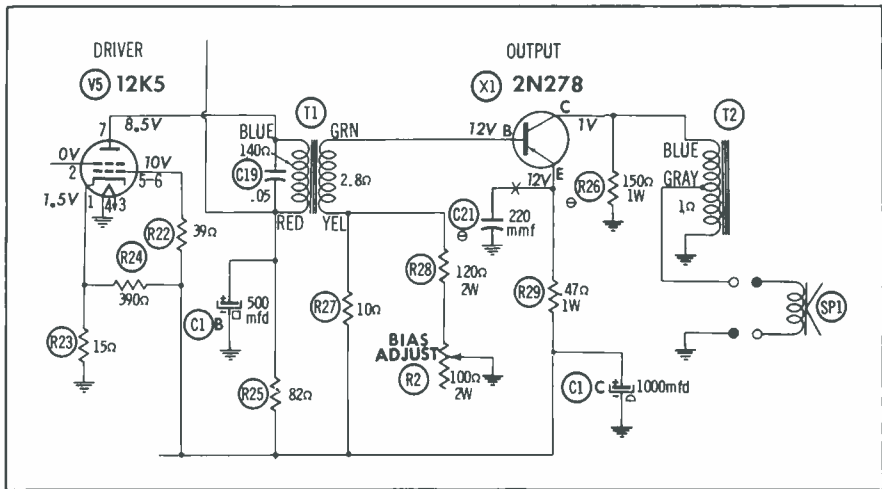

### Reckless Driver

We've had a Pontiac Model 988671 auto radio in our shop for some time. Signals are good from the antenna to the grid of the 12K5 driver tube V5, but very weak at its plate. We have replaced V5, the driver transformer, the power transistor, and resistors R24 and R29 (both were slightly burned), but haven't licked our problem.

Grid voltage on the 12K5 is OK. The cathode voltage is 1.2 volts and the plate voltage is about 10 volts; on the screen grid, we measure only 7.8 volts. All voltages on the output transistor check OK.

L. R. PAYNE

Nipawin, Sask., Canada

The signal tests and voltage readings all point to trouble in the driver stage. Try changing R22; if this fails to solve your problem, be very critical of C19 across the primary of the driver transformer. Also, make sure the bias of the output stage is properly adjusted.

### Negative Power Supplies

Several issues back, you showed a power supply with the center tap of the

transformer going to the negative lead of an electrolytic capacitor and the positive terminal grounded. Just how does C3 function and what does it do?

HARRY SITKOFF

Far Rockaway, N.Y.

Here's the same schematic, Harry. C3A and C3B in the negative leg of the power supply are in the circuit to smooth the negative DC voltage—just as C1 and C2 are in the positive leg to filter the positive supply. If it were not for C3, the negative terminals of C1 and C2 would be isolated from AC ground by R116 and R115. This would make it impossible for them to filter properly, and excessive ripple would prevail. Also, since some of the receiver circuits operate from a negative potential applied to the cathode, the negative supply must be filtered as well as the positive supply.

During rectifier conduction, electrons go from the heater to the positive plate, pass through one-half of the transformer secondary, and appear on the negative voltage line. These electrons are isolated from ground by R115 and R116 and develop a voltage drop across them. It is this negative voltage that is put to work in various circuits of the receiver, and filtered by C3.

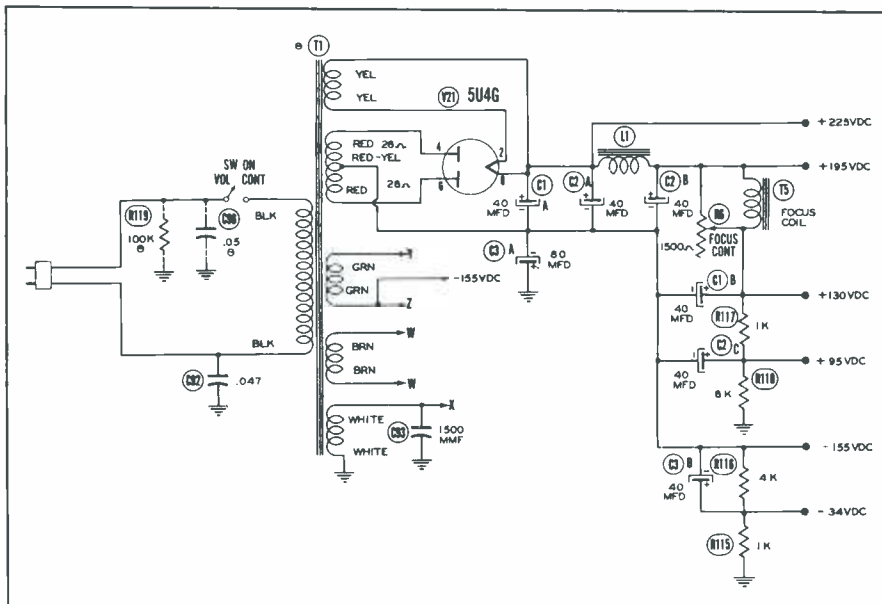

3rd in a series:

# SERVICE DEALER ADVERTISING PROGRAM

When the holiday season is over, and winter tightens its grip, consumers will feel the need to take care of radio-TV repairs they may have put off during hectic December. Be ready with ads that will help you capture this business.

This month's set of ads is the last in a series which have appeared in PF REPORTER every month through-out 1961. If you do not yet have the complete collection, you can still order any set for the same price as this month's selection—\$1.75 per set of 5 newspaper mats, \$1 per set of reproduction proofs, or \$2.50 for both mats and proofs. You can also obtain the entire program for the special price of \$25.00, with a credit allowance for any sets you have already purchased. Just fill in the handy coupon on page 82.

## It pays to stock General Electric "SERVICE-DESIGNED" Capacitors

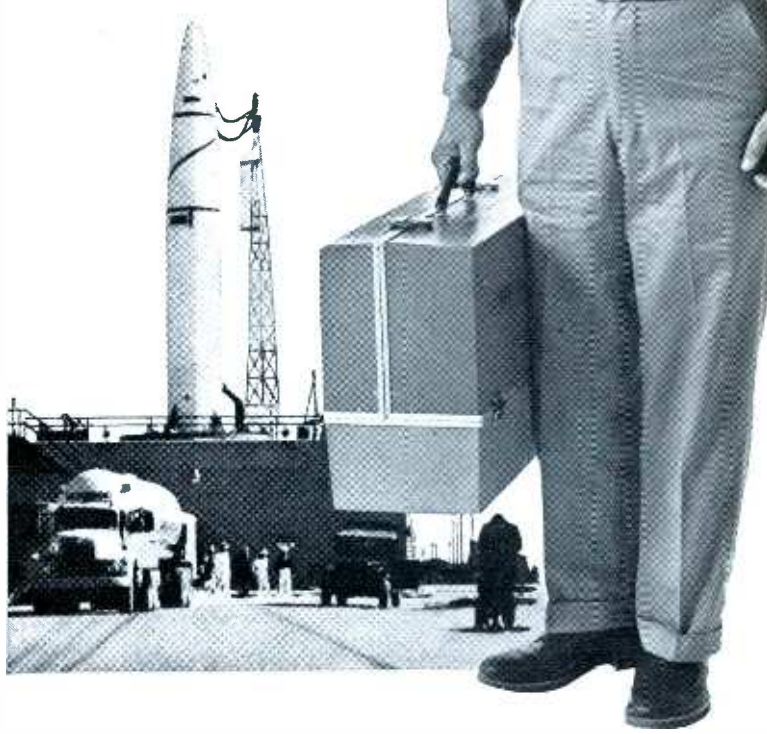

DO YOU SUFFER FROM TV FATIGUE

from watching a dim TV picture?  
For prompt TV REPAIR  
CALL ME 0-0000  
**YOUR NAME**

**ES-9** 1 7/8" x 3 7/8"  
If you think this guy looks bad, you should see the decrepit TV set he's been watching! This cartoon makes the point that your prompt TV service not only restores a good picture, but also perks up the owner.

PUTTING UP WITH POOR TV RECEPTION  
Fading, streaking, skipping TV set  
tones can usually be corrected very  
economically. For prompt prompt!  
TV REPAIR  
CALL ME 0-0000  
**YOUR NAME**  
ADDRESS

**ES-53** 1 7/8" x 4 3/8"  
The upraised hand commands attention to a message which emphasizes that you do TV repairs economically — a welcome word to householders loaded down with post-Christmas expenses.

EXCESSIVE TV REPAIR BILLS ARE "FOR THE BIRDS!"

We do all repeatable repair shops, replace only parts that are needed and use the latest test equipment to save you money. For economical TV repair call  
**YOUR NAME**  
ME 0-0000 - ADDRESS

**ES-21** 3 3/4" x 2 1/2"  
Taking sides with the consumer against excessive repair bills, you reassure him that you will save him money by using modern test equipment and replacing only those parts actually needed.

TAPE RECORDER SERVICE - REPAIR

We'll get your tape recorder in top shape... at reasonable price. Complete repair service for most makes and models.  
ALWAYS CALL ME 0-0000 FOR TV RADIO HI FI REPAIR  
**YOUR NAME**  
ADDRESS

**ES-46** 1 7/8" x 4 3/8"  
Do you like to service tape recorders? This "two-reeler" will publicize your specialty, while reminding people that you also work on other types of electronic equipment.

POOR TV PERFORMANCE DRIVING YOU CRAZY?

phone ME 0-0000  
If it doesn't work...  
...we'll make it...  
...on any make or model...  
TV - RADIO - HI-FI  
**YOUR NAME**  
ADDRESS

**ES-31** 1 7/8" x 4 3/8"  
This ad will bring you business from viewers whose patience with their TV sets has reached the breaking point.

**BENEFIT FROM G-E LEADERSHIP** in capacitor design and manufacture—General Electric's 70-year record as a leading manufacturer of advanced-design capacitors stands behind this line of replacement capacitors. G-E Alumalytic® Capacitors are being used as original components in many leading radio and TV sets. As the nation's largest supplier of aluminum and tantalum capacitors for military use, General Electric has furnished capacitors for every major U. S. missile. The same design and manufacturing skill that led to General Electric's development of foil-type Tantalytic® capacitors, the type most widely used for critical military applications, has created this line of "Service-Designed" capacitors. Get them from your authorized G-E capacitor distributor. General Electric Company, Distributor Sales, Electronic Components Division, Room 8239B, Owensboro, Kentucky.

*Progress Is Our Most Important Product*

# SOLVE! 90%

OF YOUR PROBLEMS  
IN CONNECTING TWO  
PIECES OF EQUIPMENT  
THAT DO NOT HAVE  
MATCHING CONNECT-  
ORS WITH

## THE NEW ADAPTER KIT



Contains 11 popular audio adapters and 1 "universal" interconnecting cord—all in a handy reusable plastic box. Applicable for hundreds of various connections, such as —

- Two "Y" connectors let you drive both channels of a stereo amplifier with one signal generator — also, feed two inputs into one phone jack.
- Connect coaxial test leads directly to input or output jack of equipment (such as TV Remote Controls) —No clip-lead Hook-Ups.
- Save time, eliminate "make-shift" connectors, avoid soldering. Always a neat job with Switchcraft Adapters. When a special connector is needed — just slip on an adapter from your Kit.
- Also a handy - profitable way to stock adapters for your customers every need. The 331A Adapter Kit is now in stock at your distributors. Write for Bulletin No. 112.

**SWITCHCRAFT**  
INC.

5573 N. ELSTON AVE. CHICAGO 30, ILL.

## IF Transformers

(Continued from page 26)

a slightly less negative voltage on weaker stations. The voltage at TP2 will also be slightly negative when no station is being received, and will increase to about the same value as at TP1 when a signal is present.

If T2 is suffering from surface leakage across the silvered mica capacitor, B+ voltage will leak across from primary to secondary and will place a positive voltage on TP1. If this voltage is more than 5 volts, the radio will then be unable to tune in any signal, and a loud "sparking" noise may be heard from the speaker. If the leakage across T2 is insufficient to produce more than a very slight positive voltage at TP1, the receiver might possibly receive stations weakly with considerable noise.

If T1 has silver - migration leakage, the voltage at TP1 will be more negative than normal, and the reading at TP2 will be anywhere from several volts less negative than TP1 to several volts positive, depending on the amount of leakage. If the leakage is great enough to produce a positive voltage at TP2, this voltage applied to the grid of converter tube V1 will either kill the oscillator altogether or will disable it at certain frequencies. If the leakage in T1 is so slight that the voltage at TP2 is still negative, the radio will probably have low output and a low signal-to-noise ratio.

The usual and most economical cure for all IF transformer troubles is replacement. In cases where an exact replacement is unavailable, there are several universal-type replacements (such as the component in Fig. 3) on the market. If the time element does not allow the serviceman to order an exact replacement, or a universal type is either unsuitable or unavailable, he might be placed in the position of having to repair the defective transformer.

### Repairing IF Cans

All connections should be carefully unsoldered, and the transformer removed from the chassis. Next, the shield should be removed from the transformer and a visual inspection made. If an open coil was indicated by the previous tests,

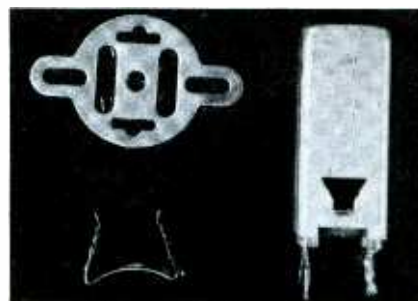

Fig. 3. Universal-replacement IF transformer with mounting clips and plate.

the open spot is likely to be found at one of the terminals. This defect can often be repaired by careful soldering. Should the open be in the windings of the coil, there is no hope, and the unit should be junked. If the tests indicated a short between primary and secondary due to silver migration, the following procedure can be used to cure the trouble.

Remove the silvered mica capacitors, either by snipping all the mica out with diagonal cutters as shown in Fig. 4, or by scraping it all out with a pointed tool as in Fig. 5. One type of transformer that must be taken apart to remove the silvered mica element is shown in Fig. 6. Disassembly is easily accomplished by unsoldering two leads and removing the nut. Before reassembling, cut an insulator the same size and shape as the removed mica element and mount the insulator in place of the element (between the contact shoes of the terminals). Replace the nut and resolder the wires.

Reinstall the transformer in the radio chassis and resolder all wires. Since it is necessary to replace the removed capacitors with their equivalents, you must now determine the correct values of capacitance to add. Turn the radio on; also turn on your signal generator, set it to the IF frequency, and feed a signal into the grid of the converter. The most obvious way to find the proper replacements is to try small fixed capacitors of differ-



Fig. 4. Removing defective mica capacitor from IF can with diagonal cutters.





Fig. 5. In this type of transformer, mica is removed with a scraping tool.

ent sizes across the primary and secondary windings, while checking for maximum signal output from the speaker. Another method of obtaining an output indication is to check for maximum negative voltage on the AVC line, measured at TP1 of Fig. 1.

Here is a better and quicker method for determining the capacitance necessary to tune the transformer: Attach a short (1½") section of 300-ohm line to a compression-type trimmer, and solder the ends of the 300-ohm line across the primary or secondary of the transformer. Hold the trimmer with plastic tweezers or a similar tool, and tune the trimmer to obtain maximum signal from the transformer. Unsolder the trimmer leads and measure the capacitance of the trimmer on a capacitor checker.

For jobs like these, we use the "double-header" unit shown in Fig. 7, which includes two different sizes of trimmers (5-80 and 40-200 mmf) mounted on opposite ends of a handle.

After determining the capacitances needed, permanently install fixed, molded silver mica capacitors or NPO-type ceramics having the proper values. In the converter-to-IF transformer (T1 in Fig 1), the primary and secondary are tuned with capacitors of the same size. On the other hand, primary and secondary capacitors of different sizes are used in the IF-output transformer (T2 in Fig. 1). After the correct

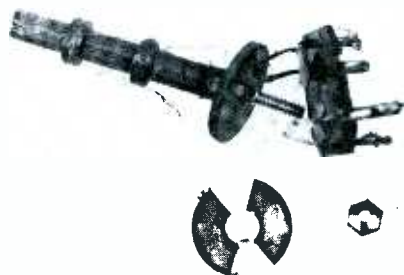

Fig. 6. Mica can be extracted after base of this transformer is unscrewed.

# Special Combination Offer

# SAVES \$244



## Weller Instant Heat Gun PLUS Solder Dispenser Tool

New, money-saving Weller combination assures faster, better soldered connections. Gun tip heats instantly when trigger is pulled—cools immediately when trigger is released. Spotlight illuminates work. Tip made of copper for maximum heat transfer, iron-plated for long life. Weller-Kormat Dispenser saves time—particularly in difficult-to-reach spots. It eliminates manual handling of the solder, and resulting

contamination that causes faulty connections. It also reduces solder waste and prevents finger burns.

**100 Watt Soldering Gun**  
Guaranteed 1 year.  
Model 8100B. Reg. list price.....\$6.44

**Weller-Kormat Dispenser**  
for wire solder from .028 to .074". Reg. list price.. \$5.95  
Reg. list price value....\$12.39

**COMBINATION PRICE.....\$9.95**  
list



AT YOUR ELECTRONIC PARTS DISTRIBUTOR

WELLER ELECTRIC CORP., EASTON, PA.

capacitors have been installed, a very slight retuning of the coil may be necessary to peak the IF. The whole operation can be done in as little as 15 minutes, including diagnosis of the trouble.

One other common defect of silvered mica elements in transformers is an intermittent condition resulting from poor contact between the silvered area and its contacting shoe. This complaint is also curable by the method just discussed—removing the mica element and replacing it with an external capacitor.

Once again it should be stressed that repairing IF transformers is uneconomical except when replacements are unavailable or difficult to obtain, as in the case of radios using the circuit shown in Fig. 8. Notice the tapped primary of the IF transformer. A universal transformer is unsuitable in this case, and if an exact replacement cannot be obtained, repair is the best solution.

#### TV IF Transformers

IF transformers used in TV receivers do not normally have shunting capacitors to peak the windings.



Fig. 7. Trimmers used in determining values of IF replacement capacitors.

Instead, they depend on the tube capacitances for such tuning. However, exceptions are found in traps and sound IF's. Where any transformer contains silvered mica elements having the printed capacitors on a single sheet of mica, that transformer is liable to the same condition of silver-migration leakage noted in radio IF transformers.

#### Use Extreme Care

When an IF can is being removed from a chassis, it is always a good rule to treat it as though no replacement were available. Then, if it actually is impossible to obtain a replacement, the unit can be repaired and returned to the chassis without the serviceman having to repair damage caused by his own haste or carelessness.

Just as important as careful testing of transformers is careful diagnosis of troubles in these components. The prevalence of one fault in particular — silver-migration leakage — has not yet been widely recognized. Its effects (slightly noisy reception and loss of sensitivity) are often overlooked by customers and by too many servicemen. The ease of noting this condition by merely taking two VTVM readings should not be overlooked by any serviceman after repairing any radio, regardless of the nature of the original trouble. ▲

## give faster, better service with GC's NEW RADIO TROUBLE SHOOTER LAB

ALL NEW  
indispensable time saver

A needed "right arm" to every serviceman who works on transistorized equipment. Tests PNP, NPN, Power, Diodes, Rectifiers, Semi-Conductors on open or short test, ICO leakage, BETA gain, in-circuit or out-circuit measurements. As a Signal Generator, it emits a 400 C.P.S. audio signal for AF or RF, IF frequencies with variable output level. Use it as a Power Supply—Battery Eliminator at 100 MA continuous use, or up to 300 MA peak. The Volt Meter Milliammeter measures external DC voltage 0-24 and milliameters 0-100 without power supply. 110/115 volt AC 50-60 cycle. Weighs only 5½ lbs. Complete with 3 18" leads, 6 lead jacks, 8-foot built-in power cord, carrying case.

MODEL 36-568

DEALER NET

49<sup>50</sup>



... low cost power supply  
and battery eliminator

For extended operation without batteries at higher or lower than normal output voltage. Well filtered DC 0-24 volts checks current drain; large capacitor filter provides less than a fraction of 1% ripple. Ideal for recharging nickel cadmium batteries, and to align individual stages in transistor radios.

MODEL 36-562 DEALER NET 19<sup>95</sup>

See your GC Distributor, or write for free 16-page Test Equipment Catalog.



more new products, customer-engineered by  
**GC ELECTRONICS COMPANY**  
a division of Textron Electronics, Inc.  
400 S. WYMAN ST., ROCKFORD, ILL.

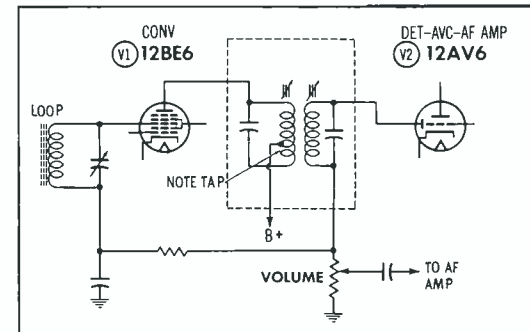

Fig. 8. Four-tube radios use special IF transformer with a tapped primary.

## Two-Way Radio

(Continued from page 43)

from the test set, the microphone can be plugged into J1, or a tone generator can be plugged into the banana jacks J2. The audio is carried into the transmitter through S3B and P1-10.

If an RCA two-way radio is to be metered, merely change switch S5 to the RCA position, and use the set as before. By studying the circuitry and the RCA-metering positions of S4 (Fig. 4B), you will see the differences involved in metering.

### Testing Other Brands of Radios

Other two-way radios can be metered with this test set through the use of adapters, which can be constructed for specific radio models by consulting their service schematics and noting the metering connections. On many two-way radios, no additional multiplier resistors are needed. By referring to the alignment instructions for the set, the maximum readings expected at various test points can be found. If these are about the same as Motorola or RCA readings, you can wire your adapters directly. However, if multiplier resistors are needed to keep the readings on scale, they should be placed in the adapter cables. When making adapter cables, be careful to maintain a common ground between radio and test set.

Fig. 5 is a simplified schematic depicting the wiring of test-set adapters for use with Bendix two-way radios. One adapter is for use with the transmitter, and the other is for the receiver. When these

adapters are in use, S5 must be kept in the RCA position.

The diagram in Fig. 6 shows an adapter for converting the test set into a voltmeter having full-scale ranges of 0-20V and 0-800V DC. By using this adapter, you can meter radios equipped with banana-jack metering points. B+ can be measured with the 0-800V DC probe. For use of the 0-20V DC range, S4 must be in position -4; for 0-800V DC, S4 must be placed in position 7. For both measurements, switch S5 is left in the MOTOROLA position.

It is easy to see the versatility of this test set, since it can take the place of a regular VOM, meter many radios automatically, and substitute for the vehicle-mounted control head of most radios.

Another handy feature included in this test set is a field-strength meter (FSM), actuated by plugging a special phone plug, with antenna attached, into FSM phone jack J3. The antenna should be small and collapsible—12" to 18" when fully extended—and should be connected to the ring terminal of the three-circuit phone plug. If a collapsible

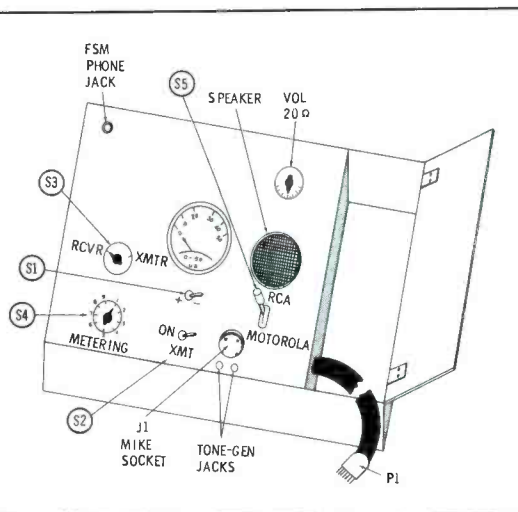

Fig. 3. Suggested front-panel layout for a two-way test set you can build.

# Trust your

# 24 HR SERVICE

## VHF or UHF-All Makes

# TV TUNER REPAIR and ALIGNMENT to

# Personal Service

EACH TUNER COMPLETELY SERVICED BY AN EXPERIENCED TECHNICIAN

VHF TUNERS . . . . .	<b>\$9<sup>50</sup></b>	Prices are for service and un mutilated units. Missing, broken and damaged parts, defective tubes charged extra at LOW net prices. We ship C.O.D.
UHF TUNERS . . . . .		
UHF CONVERTERS . . . . .		
UHF-VHF COMBINATIONS . . . . .	NET	\$17.95

OUR GUARANTEED SERVICE INCLUDES:

1. All tuners mechanically and electronically inspected.
2. All necessary parts replaced.
3. Contact surfaces correctly cleaned and lubricated.
4. First test run for intermittents and drift indication.
5. Fine tuning range checked on all channels.
6. Local osc aligned to correct frequency all channels—XTAL controlled.
7. RF alignment—all channels—XTAL controlled.
8. AGC check, all channels—cut off of RF amp checked.
9. Overall response all channels, shield covers in position.
10. Quality control FINAL CHECK ALL UNITS, UHF-VHF.

IMPORTANT:

Ship complete. Include all broken parts. State model and complaint. Package well to avoid transit damage.

ELECTRONICS

Phone: EDison 2-0665

P.O. BOX 51 • BLOOMINGTON, INDIANA

# SAMS BOOKS

TO HELP YOU ENLARGE  
YOUR SERVICE BUSINESS



available from your Sams Distributor



**Two-Way Mobile Radio Maintenance.** Jack Darr's practical guidebook on maintenance and installation for 2-way radio technicians. You get field-tested methods, service hints and test procedures. Chapters include: Planning a 2-Way Radio Installation; Receivers; Transmitters; Remote Controls; Towers; Installation of Mobile Units; Noise Elimination; Test Equipment; FCC Tests and Measurements. Includes charts to help you make required calculations without using math. Only book of its kind. 224 pages; 5½ x 8½". No. TWD-1. Only ..... **\$4.95**

**Electronic Organ Handbook.** By H. Emerson Anderson. Twelve factual chapters present pertinent specifications, schematics, and servicing information on these representative organs: Baldwin, Conn, Gulbrandsen, Hammond, Kinsman, Lowrey, Thomas, and Wurlitzer; plus Leslie speakers and the Conn Strobotuner. Over 140 illustrations. 272 pages, 5½ x 8½". No. EOA-1. ..... **\$4.95**

**ABC's of Radar.** By Alan Andrews. A comprehensive, yet simple-to-follow, explanation of radar—how it works, principles, types of radar systems, microwave transmission, antenna systems, receivers, indicating systems, etc. Helpful to anyone preparing for the FCC Radar Endorsement Exam. 112 pages, 5½ x 8½". No. ABR-1. Only ..... **\$1.95**

**Marine Electronics Handbook.** Leo G. Sands' comprehensive book describes the various types of marine electronic equipment available, what each does and how to perform repairs. Includes detailed data on circuitry used, as well as installation and maintenance. Special foldouts at back of book include full schematics. 264 pages; 5½ x 8½". No. MES-1. Only ..... **\$3.95**



**Experiments in Industrial Electronics.** By Melvin Whitmer. Learn about this growing field by actually building such typical devices as: a photoelectric doorbell ringer; garage-door opener; burglar alarm; proximity detector; electronic oven; electronic timer; measurement transducer; DC motor control; and others. 96 pages; 5½ x 8½". No. IEW-1. Only ..... **\$1.95**

**How To Repair Small Appliances** by Jack Darr. Tells how 15 everyday home appliances work, describes their most common defects, and shows how to fix them. Covers toasters, skillets, irons, shavers, coffee makers, mixers, fans, electric blankets, rotisseries, sewing machine foot controls, plus others. Includes valuable tips about line cords and plugs, heating elements, electric motors, thermostats, and switches, etc. 128 pages, 5½ x 8½". ..... **\$2.50**  
No. APP-1. Only.....

**Citizens Band Radio Handbook.** By David E. Hicks. A thorough introduction to the growing Citizens Band radio service, plus a discussion of Citizens Band equipment for all types of applications. Covers circuitry, antennas, installation, troubleshooting and repairs, service adjustments and measurements, and operating procedures. A must for technicians who install and service this equipment. 192 pages, 5½ x 8½". ..... **\$2.95**  
No. CBH-1. Only.....

FREE SAMS BOOKLIST AVAILABLE—  
ask your Distributor or write us direct

**HOWARD W. SAMS & CO., INC.**  
1720 E. 38th St., Indianapolis 6, Ind.  
In Canada: A. C. Simmonds & Sons, Ltd., Toronto 7

## A. MOTOROLA METERING PLUGS

### TRANSMITTER

1. Blank
2. Fundamental Oscillator
3. Tripler Grid
4. 2nd Doubler Grid
5. Doubler-Driver Grid
6. Power Amplifier Grid
7. High B+
8. (with 7) PA Plate Current
9. Push-to-talk
10. Audio Input
11. Ground

### RECEIVER

1. Low IF, 3rd Amp Grid
2. 1st Limiter Grid
3. 2nd Limiter Grid (not all sets)
4. Discriminator Output
5. Discriminator Input
6. Local Oscillator
7. B+ (200 volts)
8. Blank
9. Audio (Hi)
10. Audio (Lo)
11. Ground

## B. RCA METERING PLUGS

### TRANSMITTER

1. 1st Doubler Grid
2. 1st Tripler Grid
3. 2nd Tripler Grid
4. Driver Grid
5. Final Grid and DC Bias
6. Final Ip
7. Final Ep
8. Spare
9. Transmit—Receive Relay
10. Audio Input
11. Ground

### RECEIVER

1. 4th IF Grid
2. 1st Limiter Grid
3. 2nd Limiter Grid
4. Discriminator Input
5. Discriminator Output
6. Ground
7. B+ (105 volts)
8. Local Osc.
9. Audio (Hi)
10. Audio (Lo)
11. Ground

Fig. 4. Motorola and RCA circuit connections to the 11-pin metering plugs.

antenna is not available, use a length of stiff wire. However, when a wire is used, the signal energy picked up by the test set cannot be reduced if the needle starts to peg. This could cause the needle to be damaged, or fuse F1 to blow. Therefore, for safe operation with the wire, the test set must be moved farther away from the transmitting antenna. But running back and forth to the test set could be tiring, so it is better to use

a collapsible antenna.

When the phone plug is inserted into J3, the associated contacts are transferred. This action removes S4A and S4B from the meter circuit and inserts diode M3, along with its companion components, R1 and C1. Incoming signal energy is rectified by M3. R1 serves as a ground return path for M3, while C1 acts as a filter for the rectifier output. The resulting DC voltage is applied to

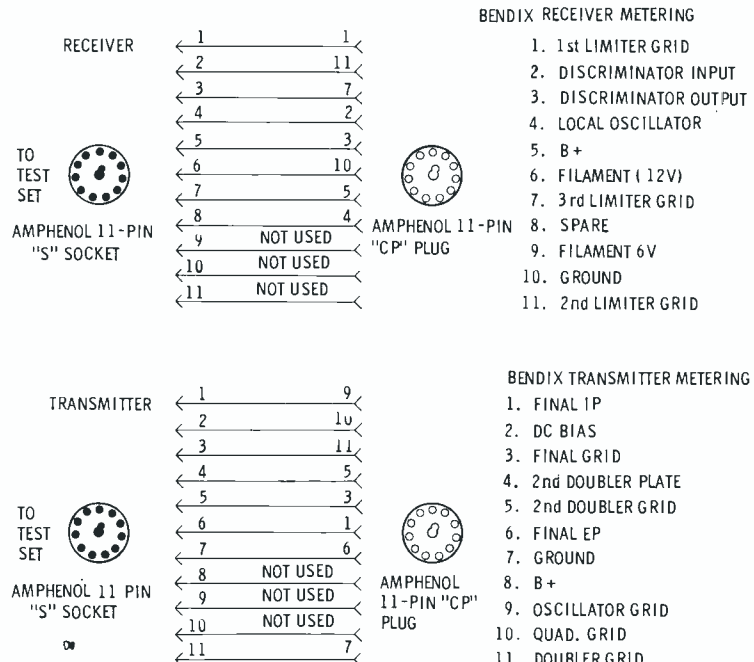

NOTE: KEEP S5 ON TEST SET IN "RCA" POSITION

Fig. 5. Wiring diagram of adapter for metering Bendix radios with test set.

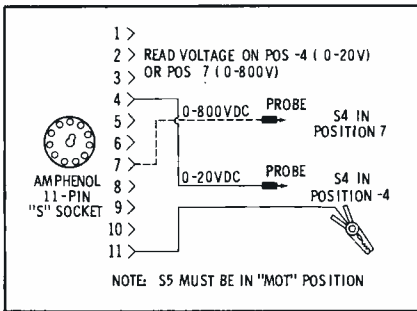

Fig. 6. This adapter is for measuring voltages at banana jacks with test set.

the negative terminal of M1 through the contacts of J3 and S1; the positive terminal of M1 is returned to ground via S1 and J3.

The construction of this test-set circuit is not at all critical. The only component which requires any special care is the meter itself. There should be no current-carrying wires passing so close to the meter coil as to cause an error in readings. The meter should be mounted securely, with no strain on the case. A large capacitor (.01 mfd) should be shunted across the meter terminals to bypass any stray audio or RF which might wander into the circuit. Naturally, proper polarity must be observed in the various diode connections. The cable connecting P1 and the test set should be at least 3' long, and lengths up to 10' are quite satisfactory. This longer cable permits the test set to be placed at a sufficient distance from the radio to allow some working space for the technician.

A metal, wooden, or plastic box can be used to house the instrument. If metal is used, circuits may be grounded to chassis. In wood- or plastic-cased instruments, however, a bus bar must be used for ground.

If field-strength measurements are not desired, M1 can be connected as shown by the dotted lines in Fig. 2,

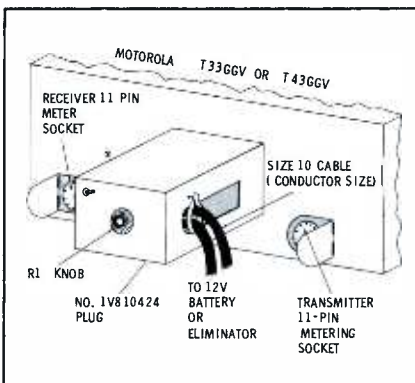

Fig. 7. Special plug and power cable for bench-servicing Motorola radios.

★ EARN MORE MONEY

★ BUILD A BETTER FUTURE

# NOW you can learn 2-way radio servicing at home from Motorola

NOW, for the first time, a home study course devoted exclusively to 2-way FM radio servicing.

The MOTOROLA TRAINING INSTITUTE trains you for a professional career with unlimited potential. The booming 2-way radio market should triple in the next 10 years. Qualified servicemen are urgently needed!

The Motorola Training Institute course covers everything in 2-way radio from basic principles to system analysis and troubleshooting the latest transistorized equipment.

### Course Includes:

- 38 STUDY LESSONS WITH COMPLETE SECTION ON TRANSISTORS
- 9 UP-TO-DATE TEXTS
- MORE THAN 20 TECHNICAL ARTICLES

### HERE'S WHAT STUDENTS SAY ABOUT THE MOTOROLA TRAINING INSTITUTE COURSE

"The section on transistors alone is more than worth the price of the full course." (K. F.—Illinois)

"Although I have an FCC license and some experience as a technician, I did not have a good working knowledge of the squelch circuit. Now, through my Motorola Training Institute training, I am able to do a decent troubleshooting job." (P. C.—Indiana)

"Personally, I think any technician that does not sign up for this course is missing a good opportunity to ease his servicing problems." (N. V.—New Jersey)

Write Today for Complete Information

**NO OBLIGATION AND NO SALESMAN WILL CALL**



**NEW TECHNICIANS:** Learn in just a few months what could take years. Course prepared by experienced faculty and highly skilled technicians. Easy-to-grasp lessons—reference library—individualized instruction.



**TV-RADIO SERVICE MANAGERS:** Here's a great growth opportunity for you and your technicians. The Motorola Training Institute home study course teaches your technicians the right way to do 2-way radio servicing and enables you to expand your range of services.



**EXPERIENCED TECHNICIANS:** Learn advanced servicing techniques and technological improvements. Get new information and know how on all the new transistorized equipment. An excellent "brush-up" course.

**MOTOROLA TRAINING INSTITUTE**

4501 Augusta Blvd., Chicago 51, Ill.

Please send me complete information on the MOTOROLA TRAINING INSTITUTE APF-198.

(please print)

NAME \_\_\_\_\_

ADDRESS \_\_\_\_\_

CITY \_\_\_\_\_ ZONE \_\_\_\_\_ STATE \_\_\_\_\_

every standard electronic part you'll ever need is pictured and described in the

# 1962 RADIO ELECTRONIC MASTER

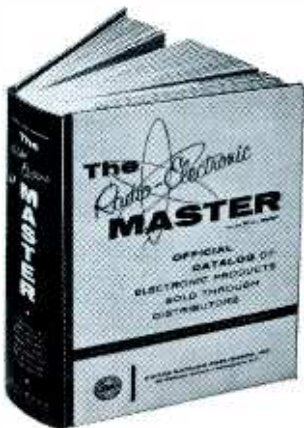

**1600 PAGES**  
world's largest electronic catalog

It's new! Covers all the latest electronic components and equipment to keep production and R & D projects on schedule.

It's the world's biggest electronics purchasing guide! 1600 pages, more than 175,000 items — with descriptions, specs, illustrations and prices.

It's easy to use! organized in 32 product sections for rapid references; fully indexed to save you time. At parts distributors.

**THE RADIO-ELECTRONIC MASTER**  
60 Madison Ave., Hempstead, N.Y.

and J3 with its associated circuitry can be omitted. The speaker can be a 4-ohm PM miniature type, in keeping with space requirements. P1 is an 11-pin plug of the Amphenol "S" type which fits Motorola, RCA, Bendix, and several other metering sockets.

### Bench Power Supplies

Servicing a two-way radio in the vehicle can be rough work, as you may know. It is much better to service the radio on the test bench whenever possible. In order to set it up on the bench, you must connect it to a power source. Since most two-way radios today are operated from 12-volt supplies, a 12-volt battery or a heavy-duty battery eliminator is used as a power source. Two 3' lengths of #8 or #10 electrical cable are used to connect the source to the control plug. In Fig. 7, note the power cables entering an opening at the side of the plug. These are held in place by a clamp. The special plug can be purchased from Motorola; on ordering, specify part number 1V810424.

The wiring of the plug is shown in Fig. 8. In the schematic, squelch control R1 is a standard 10K-ohm potentiometer. Switch S1 serves to select the operating frequency in models incorporating two-frequency operation. It is convenient to include these two controls in the power hook-up, since they are not provided in the test sets.

The location of the switches or controls on the plug case is unimportant, but they should be mounted for easy access. When constructing the power hook-up shown in Fig. 7, you should remove the knurled knob and shaft from the center of the plug. You can cover the hole with a small metal plate, and mount the squelch control on it. This method of hooking up power is effective and neat. The plug is sturdy and, with reasonable care, can be used for a long time.

In using this hook-up with a Motorola radio of the T43 or T33 series, battery polarity is not important, since these models have vibrator power supplies. To hook up a U43 or U33, on the other hand, the negative terminal of the power source must go to chassis ground. If proper polarity is not observed, either or both power transistors may

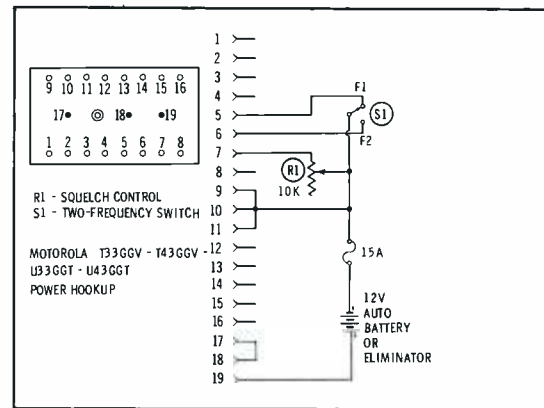

**Fig. 8. Diagram of power hook-up for the Motorola T33, T43, U33, and U43.**

be damaged. On some Motorola radios with transistorized power supplies, you will find a polarity-reversing plug beneath the chassis. With this arrangement, polarity can be easily reversed if necessary.

Fig. 9 shows the power-cable hook-up for the RCA Model 40A1, -A2, -A3, and -A4 series. Source polarity is not important with these radios. If it is necessary to change from 12 to 6 volts, look for a red plug and a black plug on top of the radio power supply, and follow the instructions stamped on these plugs. The vibrator also has instructions stamped on it for changing from 12 to 6 volts.

The cable diagrammed in Fig. 10 is for RCA Models CMC 25A2 and -A4. This two-way radio is suitable for 12-volt operation only, since it has a transistorized power supply. The source polarity for these radios is important; the power supply has a 7-pin plug and socket for polarity reversal.

Fig. 11 presents the power hook-up to the General Electric FT-33 and MT-33 equipment. Both 12-

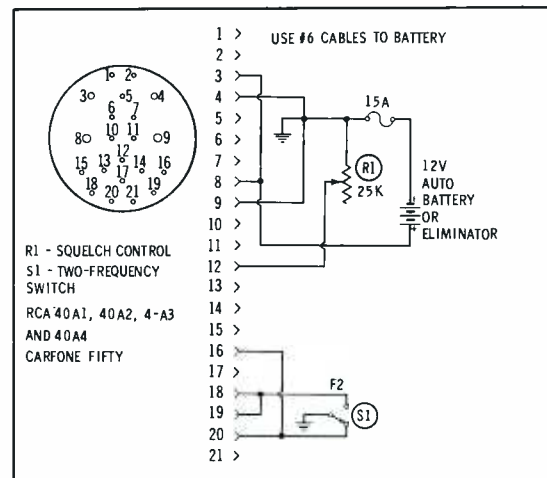

**Fig. 9. Power-cable hook-up for RCA 40A2, -3, and -4 Car-Fone Fifty radios.**



those who  
Serve Best  
Use  
**QUIETROLE**



There's never any doubt with QUIETROLE... it always says "Sh, Sh" to noisy controls and switches on TV, radio and electronics instruments. Now, Quietrole is even easier to use... has FREE EXTENDER TUBE that hits those hard to reach places right on the button. It's Quality Quietrole that makes those once pesty repairs easier than ever. See how Quietrole can ease the jangled nerves of even your hardest to please customers. Quietrole, helps the serviceman serve better than ever.

6 oz. SPRAY PACK CAN  
(with FREE Extender Tube)

2, 4, 8 oz. Bottles  
(with dropper)

Product of  
**QUIETROLE**  
COMPANY

Spartanburg, South Carolina  
in Canada: CROSS CANADA ELECTRONICS  
12 Laurel Street, Waterloo, Ontario



**New BERN'S Perfect Pin Crimper**

**Picture-Tube Repair Tool**  
Also for—5U4, 6SN7, 6BQ6, etc.

Eliminates that hard soldering job  
only \$1.25 each

Fix loose pin connections in seconds. Pays for itself in time saved on first job. 3" long.

Patented  
Intermittent operation of picture tubes due to defective solder connections easily corrected. Provides solid electrical connections, can also be used as channel-selector wrench and screwdriver. Pin keeps its original form. A 3-in-1 tool.

**3 MODELS ELIMINATE SOLDERING**  
Makes Solid Electrical Connections  
**Phono Pin-Plug Crimper**

Slip wire in "pin plug," insert in tool, and squeeze job is done.

Use end of tool to push on C-ring for ground connection.

Ant. plugs, hi-fi, multiple plugs, public address, radio and TV tubes, radar, speakers, and loop connections. Many, many more uses.

**Model LC-3 for 5/32" pin diameter**  
At your parts distributor or write us

**BERN'S** Mfg. Co.  
9853 Chalmers,  
Detroit 13, Mich.

**FM Stereo**

(Continued from page 38)

generate a 38-kc sine wave, locked in frequency and phase with the subcarrier at the transmitter. To minimize interference, the pilot is transmitted at exactly one-half the frequency of the subcarrier (19 kc). As Fig. 2 illustrates, this frequency falls within an unoccupied band between the L + R and L - R modulation components. The 38-kc reinsertion signal is developed from the pilot by a simple frequency-doubler circuit.

**Circuit Paths**

The operation of the circuits in Fig. 1 can now be explained in terms of their signal-handling functions. Stereo circuits typically are divided into three parallel signal channels, respectively carrying the L + R, L - R, and pilot signals. A major distinguishing feature of stereo tuners and adapters is the large number of tuned coils employed to shape the correct frequency responses of the various signal paths. Every component in the stereo circuitry contributes in some way to one of two basic functions — demodulating the L - R signal, or mixing it with L + R in the correct proportions to re-create the left- and right-channel audio signals.

The input to the stereo circuit is taken from the output side of the detector stage in the FM tuner. To prevent attenuation of supersonic frequencies in the demodulated stereo signal, the take-off point is located ahead of any de-emphasis network or other low-pass filter which may be present at the detector output.

The first stage in most stereo

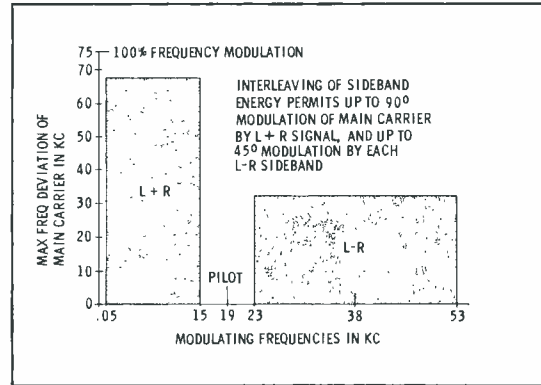

Fig. 2. In stereo broadcasting, three different signals modulate the carrier.

adapters is a preamp with a high-impedance input. In some units, a two-stage preamplifier is used. The circuit is arranged so that the amplified output is divided into L + R, L - R, and pilot components. All three portions may be tapped off from the plate circuit, as in Fig. 1; on the other hand, some models of equipment have a split-load circuit which functions as a cathode follower for one or more of the three outputs.

The L + R channel must pass the entire audio-frequency range from about 50 cps to 15 kc without significant phase or frequency distortion. A 2- to 4-mfd electrolytic coupling capacitor is often used to maintain good low-frequency response. A low-pass filter, including tunable coil A1, blocks frequencies above approximately 18 kc; in addition, it slightly delays the phase of the L + R signal, to match the delay suffered by the L - R signal in passing through the L - R detector. (The phase relationship between these two signals must be kept correct within a few degrees for accurate matrixing.) Another common feature of the L + R channel

**MERCURY TV TUNER SERVICE**  
890-1 River Ave., Bronx 51, N.Y.  
"Largest in the East"

**VHF-UHF TUNERS**  
7 Months Warranty  
Price Includes Labor & Minor Parts  
TUBES & MAJOR PARTS AT NET PRICES

When Shipping Tuner: Include Tubes, Shields and Damaged Parts.  
Give Model Number and State Complaint  
PACK WELL AND INSURE  
24 HOURS ON POPULAR TYPES

**ALL MAKES ONE PRICE!**  
**\$9.50**



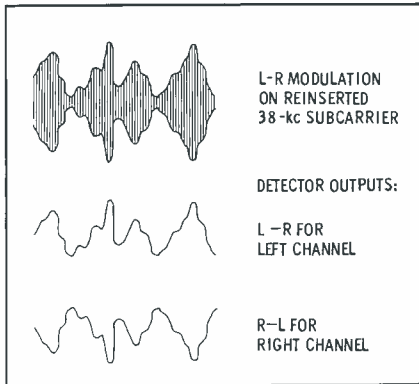

Fig. 3. Input and output signals of L - R detector in circuit of Fig. 1.

is a control (variously called MATRIX, BALANCE, or SEPARATION), with which the L + R input to the matrix can be set at the proper amplitude to produce normal stereo separation.

The L - R channel generally includes a 23-53 kc bandpass filter (note A2 and A3 in Fig. 1). An important frequency - response requirement of this channel is rejection of supersonic signals in the vicinity of 67 kc, which are present when the receiver is tuned in to an FM station that transmits subsidiary communications authorization (SCA) programs in addition to stereo. The sideband signals at the output of the L - R filter are applied to the L - R detector, where they are mixed with the 38-kc signal from the pilot channel.

In some stereo tuners and adapters, the pilot circuit consists of an oscillator-doubler stage similar to V1B in Fig. 1, with the grid tank tuned to the incoming 19-kc signal, and the plate circuit tuned to 38 kc. Oscillation of this stage follows the phase as well as the frequency of the pilot signal. Other pieces of equipment simply use a 19-kc amp followed by a frequency doubler. Either one or two stages may be included in the pilot circuit, but there are always at least two tank circuits. These must be properly peaked to insure correct phasing of the output.

At the input side of the L - R detector, the 38-kc subcarrier and L - R sidebands combine to form a conventional AM signal envelope (Fig. 3), with identical modulation on both positive and negative peaks of the 38-kc signal. In circuits of the type shown in Fig. 1, both halves of the envelope are separately detected, producing two signals 180°

# Quality you can count on EVERY SINGLE TIME!

Profit Building...Time Saving...Handy...

## AEROVOX CAPACITOR KITS

CONTAINING ONLY THE MOST POPULAR TYPES AND VALUES

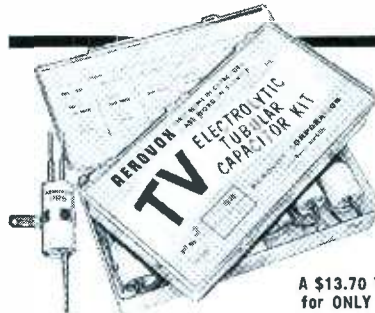

A \$13.70 VALUE  
for ONLY \$8.22

**KIT AK-500** 6 Type PRS electrolytic tubulars for repair of AC-DC table radios and series-string TV sets. Packaged in reusable plastic boxes.



A \$23.65 VALUE  
for ONLY \$14.20

**KIT AK-510** 18 Type PTT-PWE miniature 'lytics for trouble-free replacements in all transistorized radios, portable TV, and all space-tight applications. Sold in reusable plastic boxes.

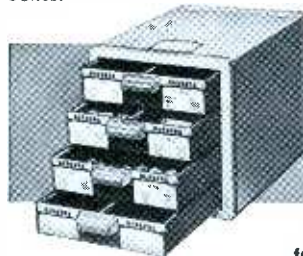

A COMBINED  
\$49.90 VALUE  
for ONLY \$29.94

**KITS AK-100 and AK-101HS** Two stacking four-drawer cabinets containing a total of 151 Type V84C trouble-free ceramic-cased Mylar\* tubulars.

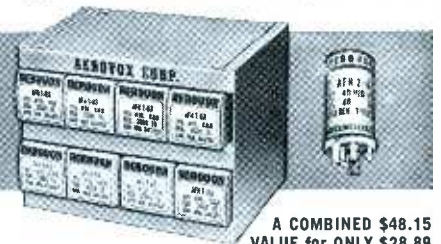

A COMBINED \$48.15  
VALUE for ONLY \$28.89

**KITS AK-400 and AK-401** Stacking metal cabinets containing a total of 16 AFH electrolytic capacitors for radio, TV, auto radio, and printed circuits.

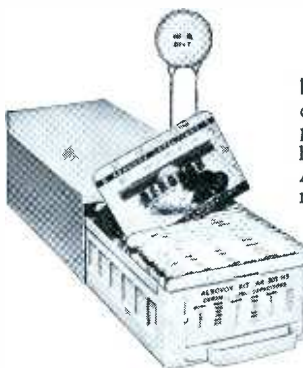

A \$23.20 VALUE  
for ONLY \$13.92

**KIT AK-300HS** 50 Type ADM dipped-mica units in 10 values, packaged in Vue-Packs and housed in 3x5 metal file drawer. A must for critical TV circuit replacements.



**KITS AK-200 and AK-201HS** A total of 230 general purpose ceramic discs packaged in Aerovox Vue-Packs, housed in stacking drawers for expanding your selections.  
A COMBINED \$58.50 VALUE for ONLY \$35.10

**FREE** The high-quality Aerovox capacitors contained in these money-saving, easy-to-inventory kits were selected on the basis of the Howard W. Sams "Stock Guide for Popular Replace-

ment Parts." For complete details and prices see your local Aerovox Distributor salesman... or write today for a free copy of the Aerovox Kit Catalog Sheet.

\*Registered DuPont Trademark



**AEROVOX CORPORATION**  
DISTRIBUTOR DIVISION  
NEW BEDFORD, MASS.

Technical Leadership - Manufacturing Excellence

out of phase. (These can be conveniently described as L-R and R-L.) Some adapters have only a single detector, followed by a phase-inverter stage to produce two outputs of opposite polarities.

Following the detector section is the matrix, which mixes the L-R and R-L outputs with equal amounts of the L+R signal. In one side of the matrix, the L components of the two signals reinforce each other, and the R components cancel; the result is a left-channel audio signal. The opposite action occurs in the right-channel side of the matrix.

### Installation Tips

It should be obvious by now that FM stereo is more critical than monophonic FM reception. The "audio" range extends all the way to 53 kc, and the frequency response of the receiving setup must be practically flat over this entire band. Freedom from phase distortion is equally important for good results with stereo. Therefore, conversions of existing FM receiving systems to

stereo will require careful planning.

Among other things, a better antenna may have to be chosen. Trailing wires, line-cord pickups, and rabbit ears often fail to deliver a satisfactory stereo signal, even where they have been giving acceptable monophonic results. These indoor antennas are prone to pick up many reflected signals, which can be fairly well tolerated in monophonic FM reception, but which raise havoc with stereo because of selective cancellation at different modulating frequencies. A reasonably directive outdoor antenna should usually give adequate performance, although some outdoor installations in problem areas will need upgrading to a higher-gain, more sharply directional type of antenna such as a multielement yagi. The more elaborate antenna may be needed either to screen out reflections, or to compensate for the poorer performance of stereo signals as compared to monophonic signals in fringe areas.

Many manufacturers discourage the use of FM stereo adapters, or

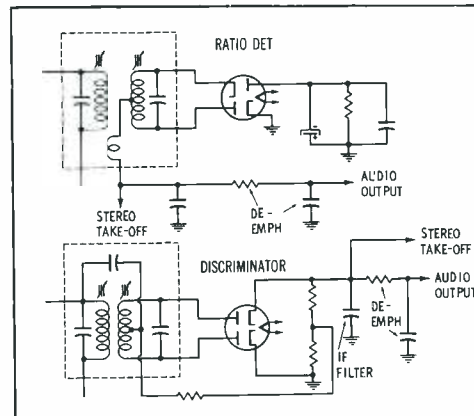

Fig. 4. Stereo signals are taken from detector output without de-emphasis.

specify using them only with certain models of tuners. These words of caution are intended to spare the public considerable disappointment with ill-advised conversions, which can lead to several knotty problems. Some of the more common difficulties, with possible solutions, are listed below:

**RF-IF bandwidth** of the tuner may be adequate for monophonic reception, but the response may not be linear over a wide enough range to avoid distortion of the stereo-subcarrier sidebands. If this deficiency is due to poor tuner alignment, it can be remedied with sweep alignment; however, simply readjusting the tuned circuits will not broaden the bandpass of a tuner which has a "designed-in" narrow response.

**Multiplex jacks** on tuners do not necessarily supply the correct input to present adapters. Before the FCC officially okayed a stereo system, it was generally believed that the L+R signal would not be fed into the adapter along with the stereo modulation. Thus, the multiplex take-off circuits of many tuners include small-value coupling capacitors (often under 1000 mmf!) that block the lower frequencies in the L+R signal.

A change to a larger capacitor may solve the problem. If the adapter already has an input coupling capacitor, it may be better to short out the one leading to the multiplex jack in the tuner.

If no multiplex jack is provided, a complete input to the adapter can usually be obtained by tapping into the output of the FM detector just ahead of the deemphasis network (Fig. 4).

*Matching of tuner and adapter*

**THE NEW DYNAMIC RAPID TROUBLE SHOOTER**  
**METREX GENIE** POCKET-SIZED — TRANSISTORIZED SIGNAL GENERATOR  
 Tunable 50 cy. to 3.3 mc.  
**7 INSTRUMENTS IN ONE!** FUNCTIONS AS • RF • IF • AUDIO VIDEO • PULSE • BAR GENERATOR & VOLTAGE CALIBRATOR

Services — RADIO, TV, HI-FI, RECORDERS, PHONES AND INTERCOMS  
 The GENIE has a tunable range of 50 cycles to 3.3 mc. Output variable from zero to 9 volts peak to peak. The uniquely designed circuitry makes possible unusually stable operation and extremely low battery drain. The rugged diecast housing insures extreme durability and perfect shielding. 2 3/4" x 3 1/2" x 2" size is ideal for shop, lab, and field use.

**1495** less Batt.  
 WRITE TODAY FOR FREE TROUBLE SHOOTING GUIDE

Pat. Pend.  
**METREX** 519 HENDRIX ST., BKLYN 7, N. Y.

**Western T.V. Tuner Rebuilders**  
**VHF or UHF ALL MAKES**  
**\$9.95** Including all parts and labor  
 major parts extra at (low) net price.  
**UHF-VHF COMB. \$17.50**  
**90 Days Guarantee — 24 Hour Service**

All tuners are thoroughly cleaned, mechanically and electrically overhauled, aligned with crystal-controlled equipment, and finally given air check for sensitivity with TV transmitters located in Los Angeles at 5,000 feet height and 120 mile distance from us.

**TUNERS ENVIADOS POR CORREO DE LA REPUBLICA MEXICANA SERAN RECOGIDOS Y ENVIADOS CON TODOS LOS REQUISITOS ADUANALES.**

**WESTERN TUNER REBUILDERS**  
 4130 El Cajon Blvd. San Diego 5, Calif.  
 ATwater 4-2733

involves two considerations — impedance and voltage.

A ratio detector is relatively easy to use as a stereo-signal source, because of its low impedance. A reasonably long connecting cable (up to about 3' of low-capacitance coax) can be run between tuner and adapter without objectionable loss of high frequencies. On the other hand, the higher-impedance discriminator circuit must be much more carefully hooked up to an adapter, since even a short length of cable can introduce a severe capacitive shunting effect. Stereo reception may not even be possible without modifying the discriminator to use smaller values for the load resistors and IF filter.

Since both tuners and adapters vary widely in signal-strength characteristics, it is important to make sure the tuner can supply enough input voltage to the adapter—or, for that matter, a small enough voltage to avoid overloading the adapter preamp stage.

### Tests and Adjustments

Really accurate work on stereo tuners and adapters will call for special test signals that duplicate the complex FM stereo signal. A new type of generator, already in use for production-line testing, provides a complete multiplex signal with modulation on the left or right channel only. With this instrument, FM stereo receiving apparatus can be checked to see if the outputs in each channel are free from distortion and cross talk.

These special generators will be hard to come by, at least for a while. Stereo-equipped FM stations will partially fill the gap by periodically transmitting special test signals, but it will still be helpful to know what tests can be made by using presently-available equipment and techniques.

Accurately-calibrated signal generators with 19- and 38-kc outputs can be used to some extent in signal-tracing. For example, the serviceman can check continuity through signal paths, stage gain of preamps, and functioning of the pilot-carrier circuit.

The potentiometer in the L + R channel can be adjusted fairly well "by ear" after a little practice. The

audio-amplifier section of the stereo system is first checked for proper balance between left and right channels; then a stereo FM program is tuned in, and the L + R control is adjusted for an adequate *but not unnatural* degree of stereo separation.

In early field experience with FM stereo equipment, it has been found that touching up the subcarrier-phasing adjustments A4 and A5 is sometimes helpful when no other cause can be found for distortion or loss of channel separation on stereo programs. In some units, the adjustments can be peaked by feeding in a signal at precisely 19 kc and checking for a steady maximum VTVM reading at the output of the 38-kc tank circuit. One manufacturer suggests an aural adjustment method, performed during a stereo broadcast. The L + R control is turned all the way down, so that only the L - R portion of the signal is heard. When the subcarrier adjustments are properly peaked, the audio has a clear (though ghostly) sound; at wrong settings, distortion

is noticeable.

The slugs corresponding to A1, A2, and A3 in Fig. 1 should not be adjusted except with a special test-equipment setup. The effect of re-setting these adjustments is not readily noticed by the ear, even when they are detuned enough to cause seriously distorted frequency response in the L + R and L - R channels. ▲

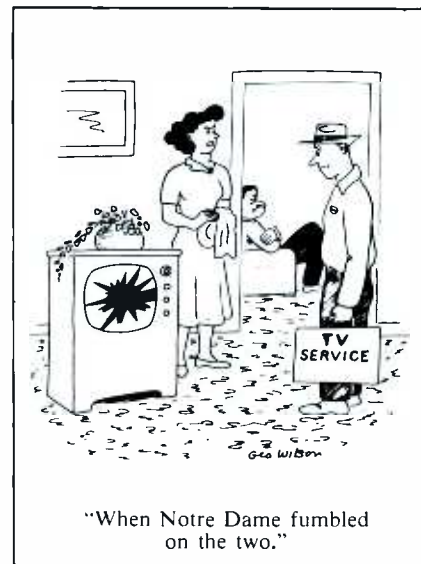

### SHORT CUTS FOR SERVICE PROFITS!

**FONO-MAGIC**—a liquid compound of Special Rubber and precious carbide particles forms a live rubber coating on metal phono drive parts . . . stops slipping and dragging caused by crystallized rubber drive wheels. Contents are equivalent to the replacement of 100 idler wheels; will not wear off. dealer net . . . **\$1.95**

**STRAPLESS CHIMNEY MOUNT**—saves 90% of the time required for antenna installations . . . outlasts stainless type mounts. No chimney too large; installs on corner of buildings too. dealer net . . . **\$1.75**

**MAGNA-LITE**—superpowerful magnet clamps light to chassis, transformers, brackets, etc. Does away with flashlight servicing. 3-way swivel action puts light exactly where needed. net . . . **\$5.95**

**HUMI-KUP 2 SET COUPLERS**—hermetically sealed for outdoor installation; all inductive circuitry; skin packaged for self service sales. List **\$3.95**. dealer net . . . **\$1.95**

**KLEENTROL MAGIC SOLVENT**—approved by C.A.A.; contains no Carbon-Tet; non-flammable; will not harm finishes of wood, metal, or acetate parts. net (5 oz. spray can incl. injector tube) **\$1.25**; pint size **\$1.95 net**.

**CARDIO MASTER**—super powerful magnetic device designed to hold a portable transistor radio in the area of a car's windshield and make it operate as a car radio. List Price **\$4.95** dealer net . . . **\$2.97**

**METAL STROBE**—handy all metal speed determining tool that lasts a lifetime; 4 speed design. dealer net . . . **.99**

**KLEENTROL TAPE**—cleans oxide from heads of tape recorders without dismantling housing which surrounds heads. Process takes 2 min. List **\$2.69**. net **\$1.88**

Sold at better jobbers everywhere—Detailed literature upon request. Write Dept. P 12

**R-COLUMBIA PROD. CO., INC.** 2008 St. Johns Ave. Highland Park, Ill.



# PRODUCT report

For further information on any of the following items, circle the associated number on the Catalog & Literature Card.

## Phono Cartridges (431)



The Shure M33 and M77 "Dynetic Stereo" cartridges both feature a convenient "pull-out" stylus housing. An optional accessory which fits both these cartridges is a new N78 diamond stylus for playing 78-rpm records. The M33 series, for arms with a tracking force below 3 gm, is offered with either 5- or 7-mil LP styli. Output is 6 mv; recommended load resistance is 47K ohms; retail price is \$36.50. The M77, for tracking forces above 3 gm, has a 9-mv output; its price is \$27.50.

## UHF TV Translator (441)



A 20-watt translator has been developed by **Adler** for extending TV coverage beyond the range possible with existing 10-watt units. Known as the UST-20, this automatic heterodyne repeater receives both color and monochrome VHF TV signals off the air and converts them to a UHF channel between 70 and 83 for rebroadcast. There is no need for an operator; the unit is turned on and off by signals from the originating station.

## Selenium Power Rectifiers (451)



Heat is conducted away from **Radio Receptor** "power flats" through the chassis or other heat sink; these units do not employ air-cooling fins, as on conventional selenium rectifiers. The bridge rectifier shown in the photo has an input rating of 26V rms and a rated output of 10 amps DC. Other bridges, half-wave rectifiers, and voltage doublers are available with input ratings as high as 130V rms. All types are epoxy-sealed.

## Two-Way Radio (461)



New trunk-mounted two-way radios in the **General Electric** "Transistorized Progress" line have a dash-mounted, transistorized control head 2 $\frac{3}{4}$ " high x 4 $\frac{5}{8}$ " wide x 2 $\frac{1}{4}$ " deep. In standby operation, ready to receive messages, the unit draws 40 ma from the vehicle battery. Models are available for operation on 25-54 or 130-174 mc. Power outputs up to 100 watts are available for certain operating frequencies.

## Flyback Transformers (471)

Several new flyback transformers are offered by **Merit** for replacement use. HVO-179 replaces Zenith S-46592 and S-47071; HVO-184 is used to replace Zenith S-47662; HVO-185 is the replacement for Admiral 79E77-8 (79D77-8); Zenith S-49918 is replaced by HVO-187 and S50095 by HVO-188; HVO-189 is used to replace Sylvania 241-0049 (50-95934-3); RCA 107698 (907251-2) is replaced by HVO-190.

## Novar Tubes (481)

Three Novar beam-power tubes, differing only in heater voltage and current ratings, have been introduced by **RCA**. For use in horizontal output circuits, the 6GT5, 12GT5, and 17GT5 can deliver 390 ma of plate current with zero bias and 60 volts on the plate. Enclosed in T-12 bulbs, these tubes are assured of firm retention in the socket by long pin length.



## Vacuum-Tube Voltmeter (491)

Available in both kit and wired form, the Model 222 VTVM by **EICO** is capable of direct-reading measurements of AC and DC voltages to 1500 volts in five ranges. Resistance values from .2 ohm to 100 meg-ohms can be measured. A 1 $\frac{1}{2}$ -volt battery is used on the lower ranges (Rx1, 10, and 1K) thereby minimizing the risk of danger to delicate apparatus. Another feature allows the unit to be calibrated without removal from its cabinet. Price is \$27.95 in kit form and \$42.95 wired.



## Line-Matching Transformers (501)

Two new line-matching transformers for public-address use are available from **Stancor**. A-8099 (for 25-volt line) is tapped for primary impedances of 312.5, 625, and 1250 ohms. A-8109 (for 70.7-volt line) has primary impedance taps for 2500, 5000, and 10K ohms. Both units have output impedances of 4 and 8 ohms. Each transformer measures 1 $\frac{1}{4}$ " high with a base area of 2 $\frac{1}{8}$ " x 1 $\frac{3}{8}$ ", and lists for \$4.17.



## DC-to-AC Converters (511)

Using a 12-volt car or boat electrical system as a source, the **Terado** Model 50-196 "Dynamo" power converter produces 110-volt, 60-cps AC. Maximum power output is about 25 watts — sufficient to operate a home-type radio. The 2" x 2" x 3 $\frac{3}{4}$ " device has a dealer net price of \$8.62, and is furnished complete with generator condenser and ignition-noise suppressor.



## Waterless Hand Cleaner (521)

When a serviceman finishes a house call and wants to wash up before making his next stop, **Chemtronics'** "Wipe-A-Way" is a handy item to have along. Containing activated lanolin and available in an aerosol can, "Wipe-A-Way" is rubbed into the hands, which are then wiped clean. Since furniture and other household possessions must often be moved in order for a set to be serviced, clean hands are always appreciated by a customer.



### Silicon Rectifiers (53I)

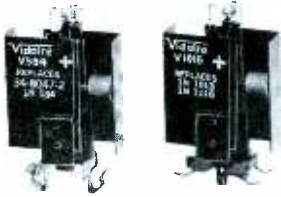

Two types of silicon voltage-doubler stacks with built-in heat sinks have been announced by Vidaire. Part V-584 is an exact replacement for Philco part no. 34-8047-2, and also replaces type 1N584 units in DuMont receivers. Part V-1016 is a replacement for the 1N1013 or 1N1016 used by General Electric, Hotpoint, and Sylvania.

### Six-Transistor Portable (54I)



Batteries can be replaced in the Hitachi Model TH-660 portable transistor radio without the need for opening the case. A "quick action" button on the bottom of the case releases the old batteries so they can be slid out. The six-transistor TH-660, sold by The Sampson Co. in a gift-presentation case, measures 2½" x 3 11/16" x 1 1/8" and retails for \$24.95.

### Mike Desk Stand (55I)



Designed to accommodate any microphone or accessory with 5/8" -27 NPSM thread, the DS-10 desk stand by University can be used with both the SSP10 and SA10 stand adapters. The stand, a solid casting, is designed to resist accidental tipping. A bottom covering of anti-skid sponge rubber prevents marring of the surface on which the stand is used. Price is \$7.95.

### Fuse Assortments (56I)



255 fuses in 30 different sizes are included in one of two assortments offered to servicemen by Bussmann. The second assortment contains 130 fuses of 26 different sizes. A metal service stand, supplied with each assortment, holds boxes which have imprinted tabs showing the size and type of fuse contained. When a box is emptied and removed, the tab shows what item needs to be reordered.

### Antenna Mounts (57I)



Mounts molded of "Tenite" butyrate plastic are provided with Mark Mobile's two-way radio antennas for securing them to fenders or rear decks of automobiles. Highly resistant to impact and weathering, the butyrate components envelop the antenna swivel joint and the fitting which secures the antenna to the vehicle body. Another feature of these mounts is their high insulation resistance.

### Stereo Receiver (58I)

Dual amplifiers with input facilities and controls for all stereo functions characterize the "Stereo Festival II" by Harman-Kardon. With the addition of an MX600 Multiplex Adapter, the unit can be used for FM stereo reception. Featuring four 7355 output tubes, the "Stereo Festival II" is capable of 120 watts of peak power. A special connector powers the MX600 Multiplex Adapter, which snaps on the rear of the chassis. Price of the receiver/amplifier is \$299.95; the adapter is \$49.95.

## \$25<sup>35</sup> puts you in the TV KNOB BUSINESS

- Dealers Exact replacement TV Knob Deal
- Helps build extra profits
- Knobs same as original
- pre-packaged and clean
- free display merchandiser
- pre-priced for full profit

ZENITH DEAL NO.  
**49-596**  
DEALER NET  
**25.35**

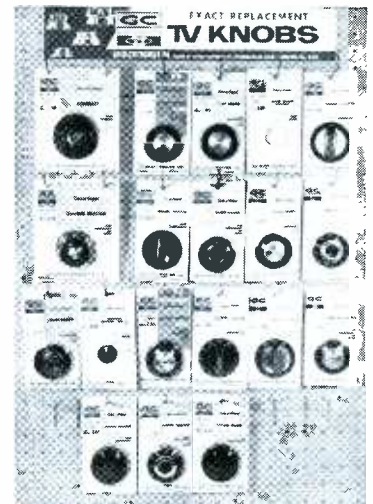

Here's immediate availability of the most popular exact replacement TV knobs, each individually skin-packed and priced. Shown are Zenith knobs, but exact replacement knobs are available for all seven leading TV manufacturers. Complete model number to GC number cross reference guide with each display order.

See your GC Electronics Distributor, or write.



**GC ELECTRONICS COMPANY**  
a division of Textron Electronics, Inc.  
400 S. WYMAN ST., ROCKFORD, ILLINOIS

## A Virtual Encyclopedia On Servicing

... available to you in back issues of PF REPORTER

### Available Back Issues

... and they're yours for just 50c a copy.

1956  
all except  
Jan-Oct

1957  
all except  
Mar, Aug, Oct,  
Nov, and Dec

1958  
all except Jan,  
Feb, Mar, Apr,  
and June

1959  
all except Dec

1960  
all except Jan  
and Dec

1961  
all except Feb

Special!! Order 6 issues or more and save 10c a copy. Sorry—no C.O.D. orders.

	JAN.	FEB.	MAR.	APR.	MAY	JUNE	JULY	AUG.	SEPT.	OCT.	NOV.	DEC.
1952												
1954												
1956												
1957												
1958												
1959												
1960												
1961												

Enclosed please find \$\_\_\_\_\_ for back issues checked above.

Mail to: Circulation Dept., PF REPORTER  
2201 E. 46th St., Indianapolis 6, Ind.

NAME \_\_\_\_\_

STREET \_\_\_\_\_

CITY \_\_\_\_\_

ZONE \_\_\_\_\_ STATE \_\_\_\_\_

1261

December, 1961

Admiral Corp. 39  
 Aerovox Corp. 95  
 ATR Electronics 21  
 B & K Mfg. Co. 25, 27  
 Belden Mfg. Co. 65  
 Berns Mfg. Co. 94  
 Bussmann Mfg. Div. 79  
 Castle TV Tuner Service 53  
 Centralab, A Div. of Globe-Union, Inc. 61  
 Chemtronics, Inc. 84  
 EICO 60  
 GC Electronics 88, 99  
 General Electric Co. Dealer Distributor—Capacitor 81, 83, 85  
 Grantham Schools, Inc. 29  
 Harman-Kardon, Inc. 64  
 JFD Electronics Corp. 11-16  
 JW Electronics 89  
 Jackson Electrical Instrument Co. 100  
 Littelfuse, Inc. 4th cover  
 Los Angeles Tuner Exchange 68  
 Mallory & Co., Inc., P. R. 30-31  
 Mercury TV Tuner Service 94  
 Merit Coil & Transformer Corp. 77  
 METREX 96  
 Miller Co., J. W. 68  
 Mosley Electronics, Inc. 24  
 Motorola, Inc. Communications & Electronics Div. 91  
 Perma-Power Co. 78  
 Precision Tuner Service 72  
 Quietrole Co. 94  
 RCA Electron Tube Div. 58-59, 63, 73, 3rd cover  
 RCA Parts & Accessories Div. 75  
 RCA Semiconductor Div. 67  
 R-Columbia Products Co., Inc. 97  
 Raytheon Co. 57  
 Sams & Co., Inc., Howard W. 69, 72, 90  
 Sargent-Gerke Co. (Electronics Div.) 82  
 Sarkes Tarzian, Inc. Semiconductor Div. 76  
 Tuner Service 17  
 Seco Electronics, Inc. 93  
 Sencore, Inc. 33-36  
 Sprague Products Co. 19, 20  
 Stancor Electronics, Inc. 28  
 Standard Kollsman Industries, Inc. 2nd cover  
 Switchcraft, Inc. 86  
 Sylvania Electric Products, Inc. Electronic Tube Div. 55  
 Technical Appliance Corp. (TACO) 22-23  
 Triplett Electrical Instrument Co. 1-2  
 Tung-Sol Electric, Inc. 71  
 United Catalog Publishers 92  
 Weller Electric Corp. 87  
 Western Tuner Rebuilders 96  
 Westinghouse Electric Corp. Electron Tube Div. 49-52  
 Winegard Co. 46-47, 48, 54  
 Xcelite, Inc. 70

ANTENNAS AND ACCESSORIES

- 11. **JERSEY SPECIALTY**—Catalog listing all types of transmission lines; includes information on display stands and custom marking of most twin leads.
- 21. **JFD**—Descriptive and promotional literature and sales aids for new "Transis-Tennas"; also complete set of specifications for outdoor and indoor TV antennas and accessories, including exact replacement antenna data. See ad insert pages 11-16.
- 31. **MOSLEY**—Latest catalog, describing complete line of television-antenna and audio accessories. See ad page 24.
- 41. **WINEGARD**—Literature on new MA-300 Tenna Boost transistorized amplifier which mounts on any antenna; also folder "How to Wire Homes for TV the Easy Winegard Way." See ads pages 46-47, 48, 54.

AUDIO AND HI-FI

- 51. **CENTRALAB**—Information on miniature L and T pad attenuators rated at 20 watts, but having the same physical size as standard 10-14 watt units. See ad page 61.
- 61. **CLAROSTAT**—Pocket-size brochure describing and giving applications and wiring diagrams for sound system controls.
- 71. **DUOTONE**—Sheet describing new diamond needle dispenser which hangs on wall, stands on counter or lies flat in display case.
- 81. **GRANCO**—Pocket-size brochure describing FM and Stereo-Multiplex operation; includes listing of receivers equipped to receive stereo broadcasts.
- 91. **HARMAN-KARDON**—Catalog including specifications and prices on full line of new Commander series of public-address amplifier. See ad page 64.
- 101. **ROBINS**—16-page catalog, RMM-3, "Tape Recording Head Reference Guide," giving cross references for replacement of old heads with M/M types.
- 111. **R-COLUMBIA**—Bulletin #34 describing Fono-Magic, a liquid compound of rubber and carbide particles used to prevent phono changer and turntable drive mechanisms from slipping. See ad page 97.
- 121. **SOUNDOLIER**—New catalog showing complete line of architectural loudspeaker baffles and furnishing technical data to aid in their selection and placement.
- 131. **SWITCHCRAFT**—Bulletin No. 116 furnishing information on new universal headphone cords to fit most monaural headphones, and exact-replacement cord for Brush BA-200, BA-205, BA-206 and RCA MI-38107B headsets. See ad page 86.

COMMUNICATIONS RADIO

- 141. **COMCO**—Catalog sheets and price lists for Models 580 and 680 two-way VHF-FM radio communications equipment providing 25- to 100-watt outputs in the HF and VHF bands.
- 151. **RAY JEFFERSON**—Information sheet, including list of typical applications, on Model 700 Spokesman transistorized portable CB transceiver.

COMPONENTS

- 161. **BUSSMANN**—Compact new 64-page BUSS Television Fuse List, Form TVC, giving serviceman a quick reference for fuse replacement in old and new TV sets; includes fuse information for car and truck radios, and for Christmas-tree lights. See ad page 79.
- 171. **LITTELFUSE**—Illustrated catalog for TV servicemen, covering complete line of fuses, fuse holders, and fuse mountings. See ad 4th cover.
- 181. **MERIT**—Catalog sheet giving specifications and prices for new line of input, interstage, and output transformers for transistor circuits. See ad page 77.
- 191. **SONOTONE**—14-page catalog BA-73 giving details on sintered-plate, nickel-cadmium cells; includes 13 individual spec sheets.
- 201. **SPRAGUE**—Chart C-457 showing all popular TV-radio-hi-fi service items (designed to hang on wall). See ads pages 19, 20.
- 211. **TRIAD**—Catalog TV-62 listing replacement transformers; also TR-62 transformer catalog including industrial types.

SERVICE AIDS

- 221. **BERNS**—Data on 3-in-1 picture-tube repair tools, on Audio Pin-Plug Crimper that lets you make pin-plug and ground

- connections for shielded cable without soldering, and on ION adjustable beam bender. See ad page 94.
- 231. **CASTLE**—Leaflet describing fast overhauling service on television tuners of all makes and models. See ad page 53.
- 241. **LUXO LAMP**—Catalog sheets giving description and price list on desk and workbench lamps which can be raised, lowered, tilted, or turned to any angle.
- 251. **MERCURY TV TUNER**—Information sheet describing immediate tuner-exchange service, 24- to 48-hour tuner repairs, and additional services; states prices and announces new seven-month warranty. See ad page 94.
- 261. **PRECISION TUNER**—Information on repair and alignment service available for any TV tuner. See ad page 72.
- 271. **SARGENT-GERKE**—Catalog of service chemicals in aerosol spray cans; also spray-paint color cards. See ad page 82.
- 281. **RCA**—Form TK-130, "RCA Color Parts & Accessories for Installation & Service." listing replacement parts and service aids for all RCA color TV receivers. Also Form TK-292, 28-page "TV Knob Directory," listing part numbers for all knobs used on 1955 through 1961 RCA TV receivers. See ad page 75.

TECHNICAL PUBLICATIONS

- 291. **GENERAL ELECTRIC**—Publication, "Techni-Talk," listing service hints, aids, and technical data for radio and television service technicians. See ads pages 81, 83, 85.
- 301. **GRANTHAM**—Booklet entitled, "Careers in Electronics," outlining training courses available. See ad page 29.
- 311. **METREX**—Serviceman's guide, "Cram-full of Shortcuts," dealing with troubleshooting, alignment, and calibration of radio, TV, hi-fi and related equipment; also manual for operation of new Genie pocket-size signal generator. See ad page 96.
- 321. **HOWARD W. SAMS**—Literature describing all current publications on radio, TV, communications, audio and hi-fi, and industrial electronics servicing. See ads pages 69, 72, 90.

TEST EQUIPMENT

- 331. **ATR**—Literature on "A" Battery Eliminators for operating and testing transistorized or vibrator-operated radios directly from 110-volt AC line. See ad page 21.
- 341. **B & K**—Catalog AP18-R, giving data and information on Model 960 Transistor Radio Analyst, Model 1076 Television Analyst, Dynamatic 375 VTVM, V O Matic 360, Models 700 and 600 Dyna-Quik tube testers, Models 440 and 420 CRT Cathode Rejuvenator Testers, Model 160 Transistor Tester, Model 1070 Dyna-Sweep Circuit Analyzer, and B & K Service Shop. See ads pages 25, 27.
- 351. **EICO**—New 32-page catalog of test equipment, kits and wired equipment for stereo and monophonic hi-fi, Citizens band transceivers, ham gear, and transistor radios. Also, "Stereo Hi-Fi Guide," and "Short Course for Novice License." See ad page 60.
- 361. **RCA**—Folder 1Q1031 giving full details on WV-120A Power Line Monitor. See ad page 73.
- 371. **SECO**—Literature on test equipment, featuring complete Model 107 tube tester which meets specifications for Federal Stock Classification; also, booklet, "Selling and Servicing Citizens Band Equipment." See ad page 93.
- 381. **SENCORE**—New booklet, How to Use the SS105 Sweep Circuit Troubleshooter, plus brochure on complete line of time-saver instruments. See ads pages 33-36.
- 391. **TRIPLETT**—Catalog sheet giving full details on Model 800 Volt-Ohm-Milliammeter. See ad insert pages 1, 2.
- 401. **WINTRONIX**—Catalog sheets listing features and specs for hi-fi—stereo, AGC-circuit, sweep-circuit, transistor, induced-waveform, and intermittent-condition analyzers. Also includes information on Model 250 Color Convergence Dot Generator.

TOOLS

- 411. **TWIRL-CON**—Literature describing new tool used for making quick, neat, and secure connections; used for installing resistors, capacitors, pin plugs, wire ends, etc.
- 421. **XCELITE**—Descriptive folder on Seizer—forceps-style pliers with jaws that lock shut. See ad page 70.

Latest Jackson Tube Test Data

Tube Type	MODEL 648					MODEL 598					Grid Test	Meter Current	
	F1	D	E	A	B	C	D	E	F	G			
3058	3.0	A1249	315	45 X2	3.0	4	3	8	472	2	40		
4847	4.2	1216	8379	17 WX	4.2	1	5	7	2	87	43		
4848	4.2	1216	8379	17 WX	4.2	1	5	7	2	87	43		
4849	4.2	1216	8379	17 WX	4.2	1	5	7	2	87	43		
6108	6.3	A124	A35	28 X2	6.3	4V	3	5	9	8	39		
6109	6.3	A124	A35	28 X2	6.3	4V	3	5	9	8	39		
6108	6.3	A124	A35	28 X2	6.3	4V	3	5	9	8	39		
6109	6.3	A124	A35	28 X2	6.3	4V	3	5	9	8	39		

Tube Type	Sec. Heater Pk	P-G	Grid Test		Meter Current
			Grid	Test	
3058	7.0P	1249	45X2	3.0	4
4847	4.0N	1246	8379	17WX	4.2
4848	4.0N	1246	8379	17WX	4.2
4849	4.0N	1246	8379	17WX	4.2
6108	6.4J	124	A35	28X2	6.3
6109	6.4J	124	A35	28X2	6.3

Supplies: Latest, Inc. Chgo. Ill. 60612. SUPPLIES, LATEST, INC., CHGO. ILL. 60612.  
 \*For further information, see Tube Test Data in PHOTOFACT Number No. 100



## “BUSINESS END” of a NOVAR tube

You're looking at the base of one of RCA's remarkable new novar tubes... the first in a new family of tubes that will mean better business for you through reduced call backs.

This new base—with 9 widely-spaced, heavy-gauge pins—characterizes novar, RCA's line of large all-glass integral base tubes designed to do the work of conventional tubes with molded bases. Because novars *outperform* these con-



ventional types, they are being selected for use in more and more radio and TV receivers as well as hi-fi equipment. From present indications, novar should become the standard of the industry.

Look for novar, RCA's latest contribution to electron tube design. Your Authorized RCA Electron Tube Distributor now has RCA-7868 novar and will soon have many other types to support your servicing business.

RCA ELECTRON TUBE DIVISION, HARRISON, N.J.



The Most Trusted Name in Electronics

In Electronic Circuits . . .

**ALL AROUND PROTECTION**

**NEW MICROFUSE**  
 THE PIGTAIL VARIETY (278000) SERIES  
 THE PLUG-IN VARIETY (272000) SERIES  
 THE SUB-MINIATURE FUSE HOLDER (No. 281001)

**New Indicating 3AG Fuse Posts**

It GLOWS when the FUSE BLOWS

Labels around the circle include: SOLDER TERMINAL MOUNTING, 4AG FINGER OPERATED POST, TERMINAL CLIP, FUSE CLIP EARLESS, FUSE CLIP, LC BASE HOLDERS, MOUNTINGS FOR RECTIFIERS, 3AG FUSES, 3AG SLO-BLO, 3AG FUSE U/L, LC FUSES 250V TYPE G, LC FUSES 125V TYPE C, LC SLO-BLO 125V TYPE N, 8AG INSTRUMENT FUSES, 8AG U/L FUSES, AIRCRAFT FUSES, 4AG SLO-BLO, IN LINE FUSE RETAINERS, 3AG POST SCREWDRIVER OPERATED, 3AG POST FINGER OPERATED, 3AG POST MINIATURE, CAN COVER MOUNTING, THROUGH PANEL MOUNTING, SCREW TERMINAL MOUNTING.

It's **LITTELFUSE** First!  
 DES PLAINES, ILLINOIS