

OCTOBER, 1960

35 CENTS



# PHOTOFACT REPORTER

## Including Electronic Servicing

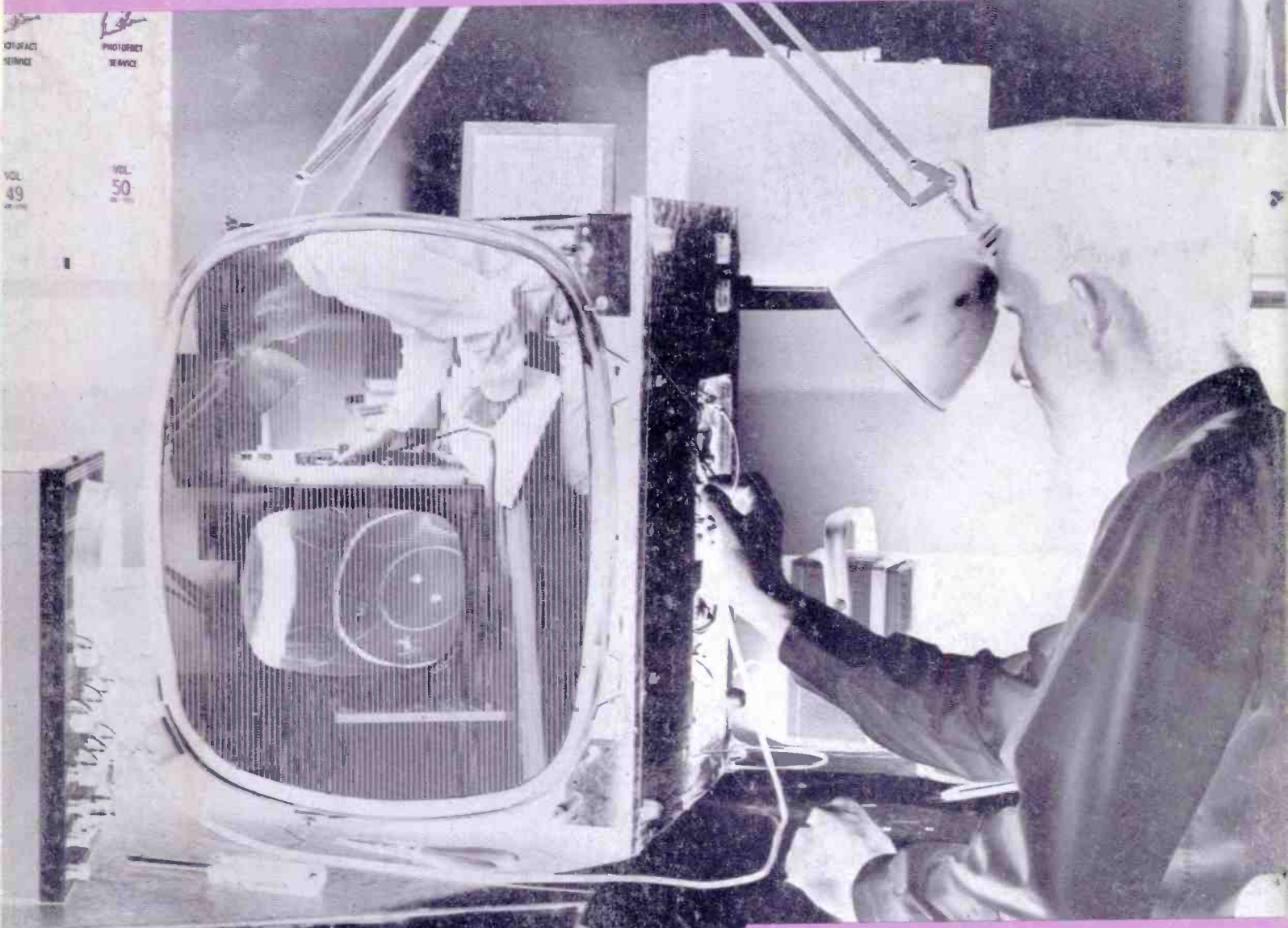

**Causes and Cures for Negative Pictures**

**Before You Touch That Chassis - - - THINK**

**Hints on Making Control Replacements**

**Facts About Tube Substitution**

W. M. DAVIS  
RADIO & TV. SEC.  
118 RIVERSIDE AVE.  
CANCN CITY, COLORADO





# PUZZLED

*...no need to be*

## look to this sign of assurance!

The Distributor displaying this sign will solve your tuner problems at a profit to you.

He has available the New Standard Tuner Replacement Guide, including replacement parts listings. This is the only Guide of its kind in the world. Covers all Standard tuners produced through 1959. Includes replacements for many tuners not produced by Standard. He handles our 48-hour Factory Guaranteed Repair Service and Trade-In Allowance on unrepairable Standard tuners.

*See This Authorized Distributor Today*



### **standard kollman**

INDUSTRIES INC. *Formerly Standard Coil Products Co., Inc.*  
2085 N. HAWTHORNE AVENUE, MELROSE PARK, ILLINOIS



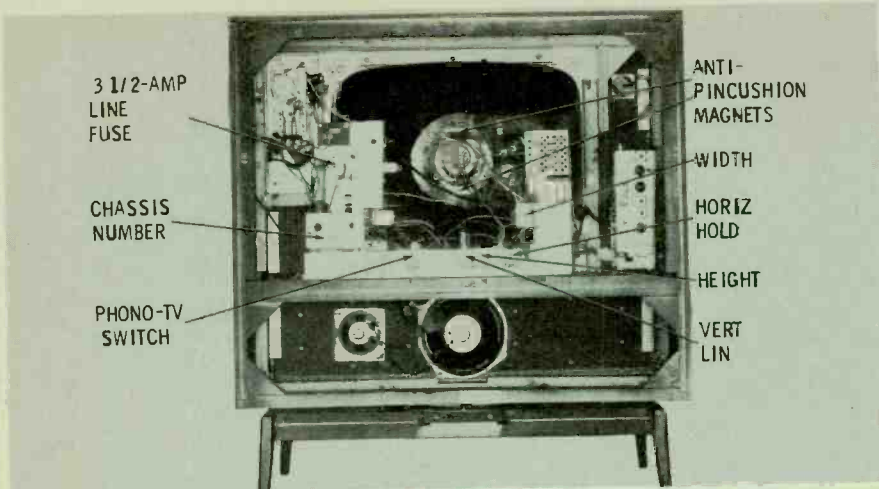

## General Electric Model R740VWD Chassis M6

All of GE's 1961 television sets use one of two chassis. This model uses the smaller of the two — the M6. The new line includes 61 different models with 17", 21", and 23" picture tube sizes. All are 110° tubes without the bonded safety shield. To clean the tube and safety glass, the mask retainer can be removed by taking four bolts out of its lower edge.

Adhering to the layout of previous versions, the "U"-shaped chassis is designed with serviceability in mind. A new innovation in anti-pincushion magnets is used; the magnets (top and bottom) are encased in a rectangular plastic holder that snaps into either the front or back of the yoke flange. (They may be omitted from some models if not needed.)

The left "chimney" of the chassis, which mounts on a bracket over the power transformer, contains the power supply and main printed board. The rather rare 6CX8 video output-sync separator, 6FM8 ratio detector-audio amplifier, and 6DN7 vertical multivibrator-vertical output (on the base part of the chassis) are carry-overs from last year's line. In addition, a 6EV5 serves as the RF amplifier in all of the tuners used with this chassis.

The remote control receiver used with this chassis incorporates three 6GH8 tubes and its own power supply with a germanium rectifier. A sensitivity control is connected in the bias network, and should be adjusted to provide the proper operation of each function at the normal installation site. This compensates for any change in "normal" noise levels. To adjust the control, connect a VTVM to the grid of either relay-control tube and set the voltage at  $-6.5$  to  $-8$  volts. Both unidirectional channel selection and four-step volume control (including a mute position) are controlled by a remote transmitter using two transistors to produce supersonic signals.

Following last year's style, wiring paths and other pertinent information are marked on the printed boards. A notable improvement is that the markings are larger and brighter, making them easier to follow. The 3/8-amp pigtail fuse used for sweep protection is mounted at the right side of the board, as is the horizontal ringing coil, which requires a hex-head alignment tool for adjustment.

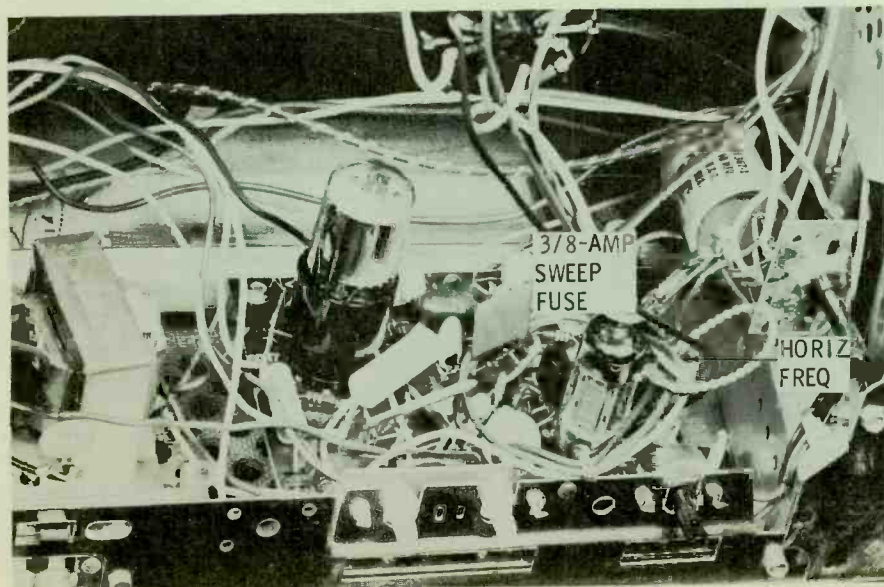
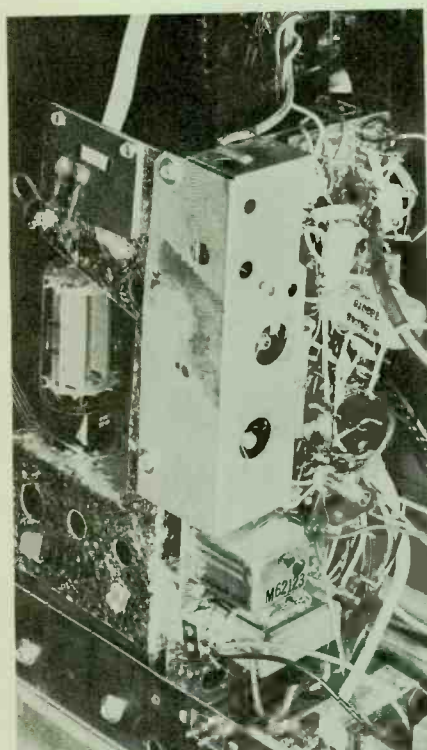



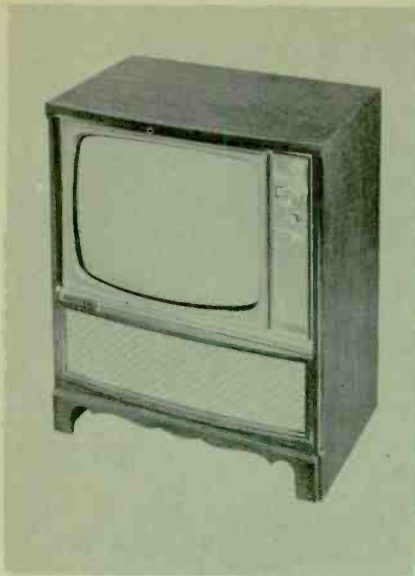

**Motorola Model 23K30M  
Chassis TS-568**

Next to the largest chassis in the 1961 Motorola line is used in this 90°, 23" model — one of 54 in the "Deluxe 23" Series. Four different chassis variations are available, providing manual, remote control, VHF, or UHF-VHF operation. All models use a 23TP4 picture tube with bonded safety shield.

Chassis layout is typically Motorola, with all of the setup controls and a service test receptacle on the rear apron of the 16-tube receiver. The conventionally-wired chassis uses modules in the horizontal and vertical deflection circuits, as did its 1960 predecessor. Also, two sets of tubes (the 1st and 2nd video IF's, and the AGC-sync separator and sound IF) have their filaments wired in series. A noise gate control has been added to regulate the bias on the No. 1 control grid of the 3BU8 AGC keyer-noise limiter-sync separator.

The transformer-powered chassis employs the full range of protective devices. These include the *Tube Sentry* thermal switch to prevent the application of B+ before tube filaments have heated, a 1½" length of #26 copper wire for filament protection, a 5-amp line fuse, and a ½-amp type-N fuse for the sweep circuits.

A brand new video output tube makes its debut in these chassis — a 6GK6 high-gain pentode with a gain of about 40 for normal operation. Just in front of the 6GK6 is the video-IF output transformer with its "gold hat" removed to expose the snap-in video detector diode. At the rear of the chassis (next to the horizontal AFC diode) there are three terminal connections provided to obtain focusing potentials of ground, 255 volts, and B+ boost.

Although the brightness and vertical hold knobs are captive, removing two screws from the control panel in the TS series permits the controls to slip out of the knobs easily. The control panel for the RTS chassis can be removed by rotating the assembly 90° counterclockwise. All chassis provide a slotted bracket on the left side of the chassis frame for mounting the tuner and control assemblies if it's necessary to transport the chassis without the cabinet.

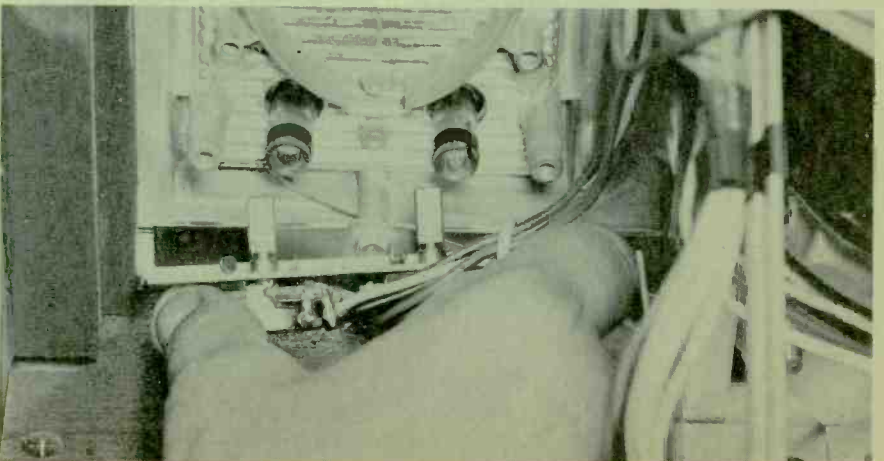
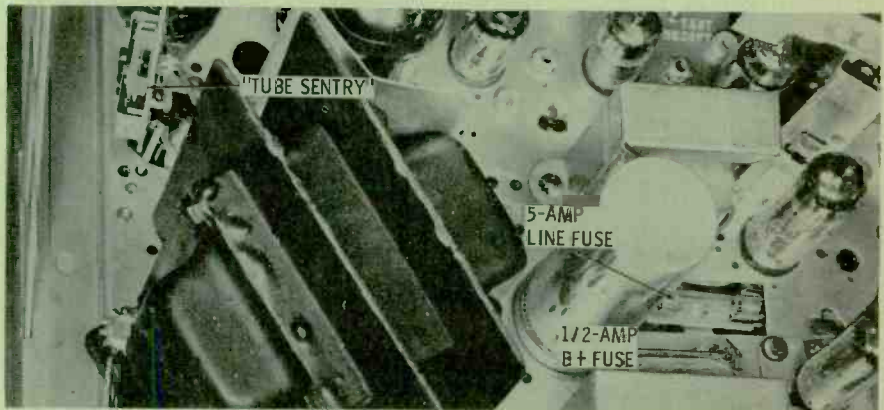
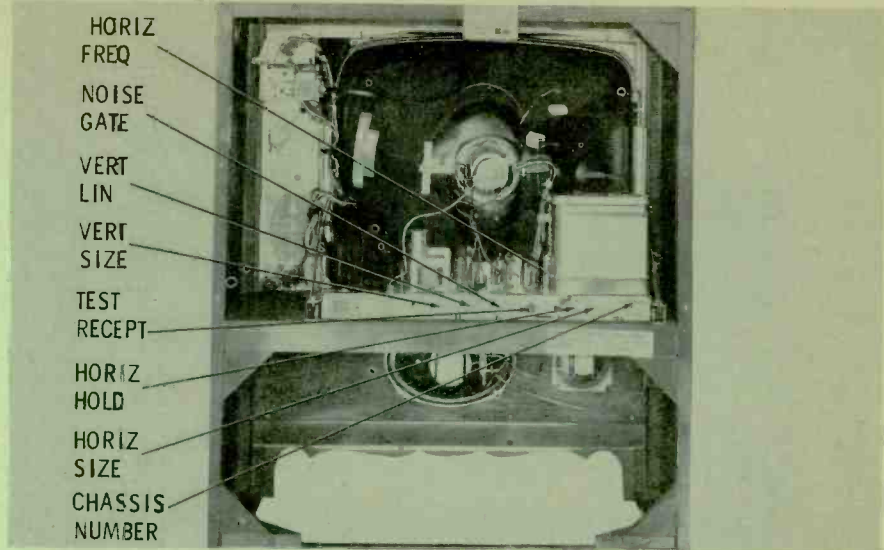



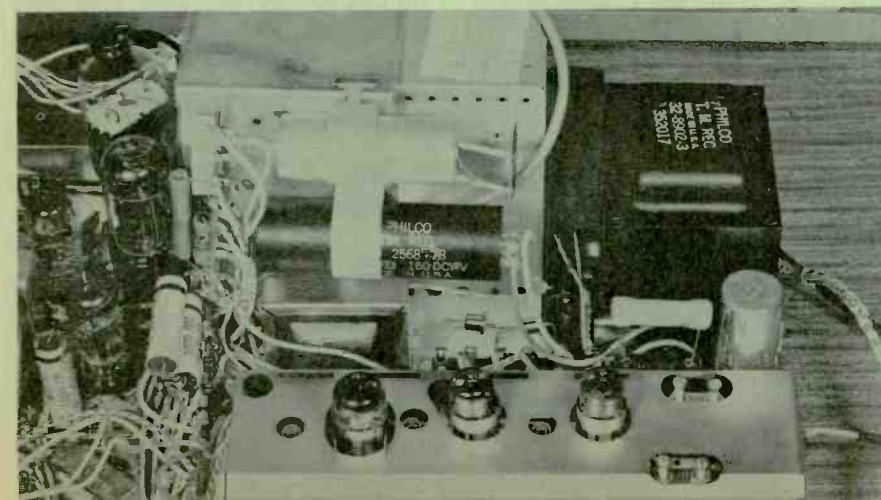
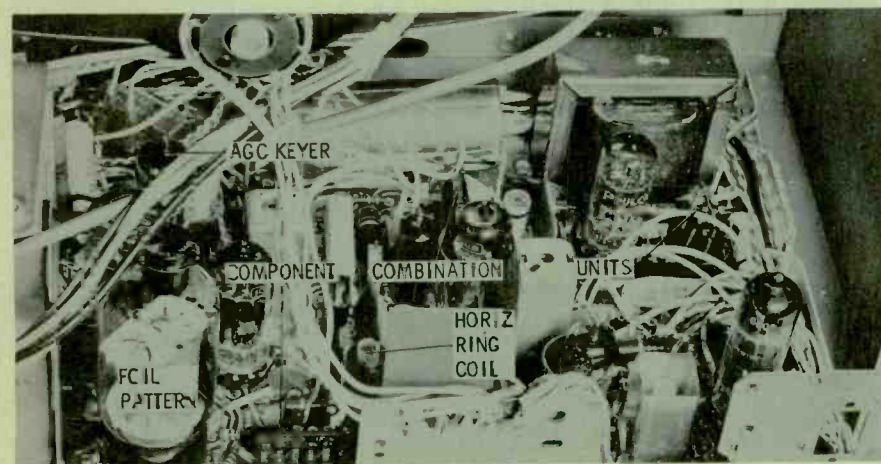
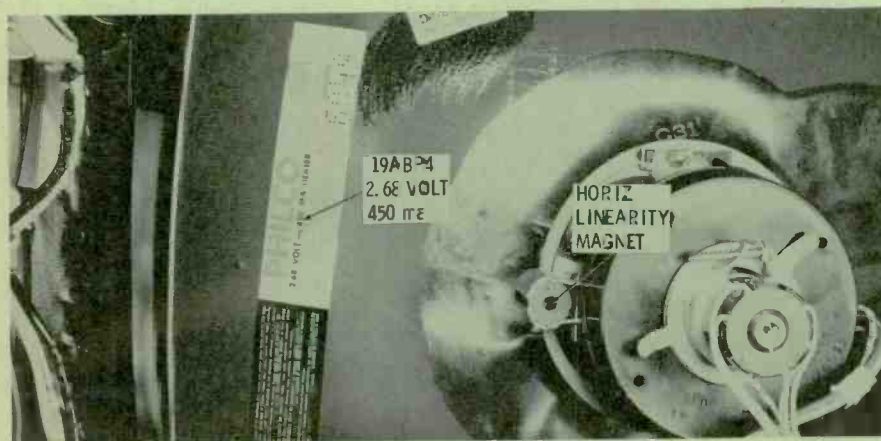
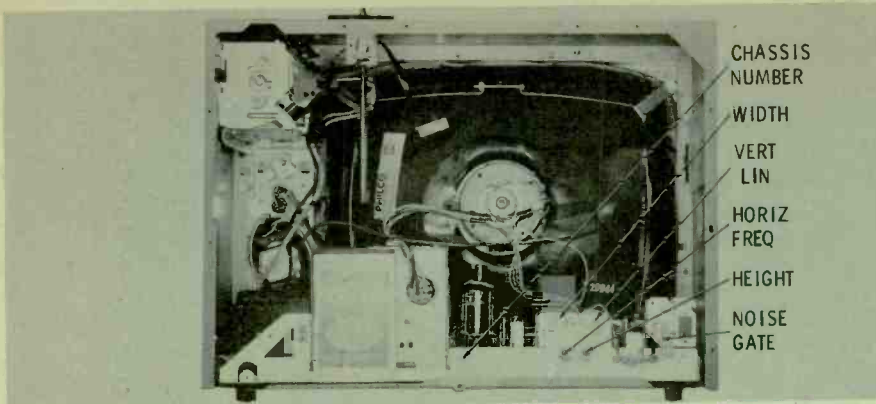

### Philco Model J-3702L Chassis 11N51

This 19", 110° model is one of 12 using the same basic chassis. While it looks like the picture tube has a bonded safety shield, it's really a tinted plastic shield covering a conventional CRT faceplate. In order to clean the CRT, the chassis and tube must be removed from the cabinet. Caution! The manufacturer advises use of only mild soap and water — no detergent or abrasive cleaner.)

Nearly all of the 16-tube chassis is contained on 2 printed boards; high- and low-voltage power supplies are the only exceptions. Philco introduces a 6HJ8 high-gain, pentode-diode tube in the 3rd video IF and detector circuits of this chassis. Setup controls are conveniently grouped on the rear apron. The noise gate is used to vary the cathode bias of a noise-inverter stage in the sync circuits.

Back to the picture tube for a moment, this new 19ABP4 has a filament rating of 2.68 volts at 450 ma, so watch it when you're testing tubes. Notice the horizontal linearity magnet carried over from previous Philco models. Although it isn't evident from the photo, the connecting wires for the picture tube socket are of solid wire — not the normal stranded type. A little thought when removing the picture tube socket will prevent undue strain on these wires where they enter the socket.

A new-type component combination is used in this chassis, consisting of a phenolic board to which a number of components are clip-mounted. The values are stamped on the reverse side of the board. In the event one of the components fail, the faulty part can be removed and a conventional replacement installed in its place. The foil pattern of the printed board is shown in the same manner as for earlier versions. One of the notable differences in this chassis, compared to former versions, is the adoption of a 6BY8 pentode AGC keyer and clamper.

The front view of the chassis shows the parts hidden by the cage. The chassis is transformer-powered, using a pair of silicon rectifiers connected in a full-wave, voltage-doubler configuration. A 5.6-ohm, plug-in fusible resistor safeguards the rectifiers, and tube filaments other than for the CRT are protected by a length of #26 fuse wire.



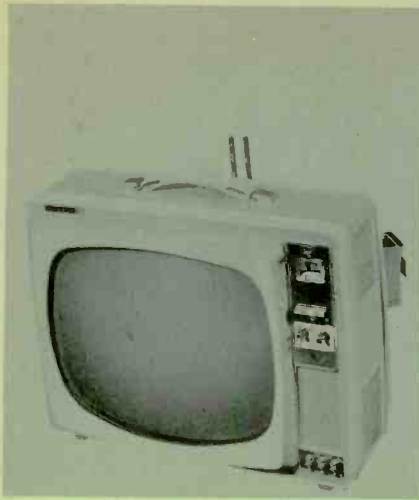

**RCA Victor  
Model 171-AR-067  
Chassis KCS130M**

This 17", remotely-controlled portable in RCA's 1961 line can make a fool of you if you don't know how to turn it on. It's quite simple if you know that you need only to depress the channel selector bar. Only three of the 19" portable models are equipped with the remote feature, so your first encounter will probably be with one having a conventional off-on switch attached to the volume control.

Newest of the 16 tubes used in this 110° chassis is the 6GM6 second video IF; one tuner uses a 6FH5 RF amplifier, and the versions with single function remote control have a 6EV7 in the remote receiver. All TV circuits, except those for horizontal deflection and the power supply, are contained on two printed boards forming the left side of the chassis.

The transformer-powered chassis has a pair of silicon rectifiers mounted on the wiring side in a full-wave, voltage-doubler configuration. A surge-limiting resistor protects the sweep circuits, two lengths of #28 fusible wire protect the tube filaments, and a thermistor (rated at 120 ohms cold) controls tube warmup.

A 14-position tuner and pneumatic switch are used in the peculiar off-on circuit. If the tuner is allowed to stay in the 14th position for over 5 seconds, the internal bellows of the pneumatic switch actuates the power switch and turns off the receiver. Programming adjustments can be made from the front after removing the fine tuning knob and top escutcheon. Turning a cam to its maximum clockwise position stops the tuner, turning it counterclockwise causes the channel to be skipped, and setting the slot to point toward the shaft puts the unit on standby (that is, on channel but with video and sound muted).

As in RCA's '60 line, the AGC, height, and linearity controls are a part of a single control pack which includes some of the circuit's resistors. Also, the same dot pattern is used on the top side of the board to show the printed conductor connections. Chassis with remote control use either a three- or four-tube remote receiver for the off-on operation described above, and unidirectional channel selection. The larger receiver also incorporates a step volume control.

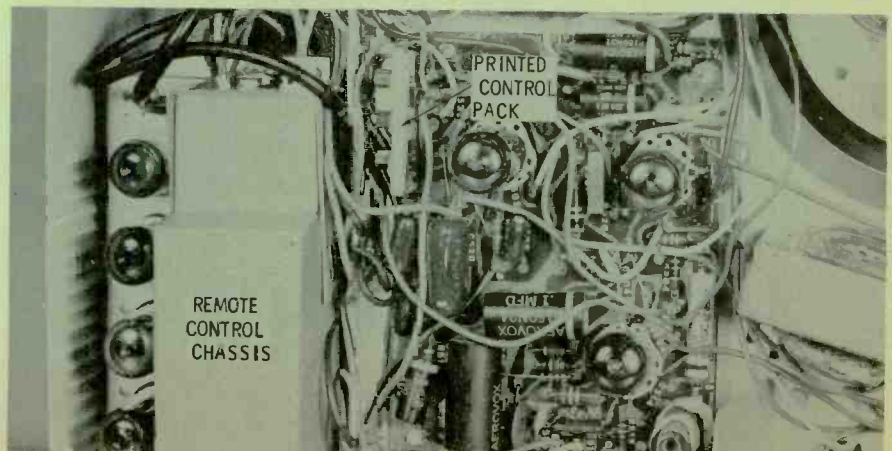
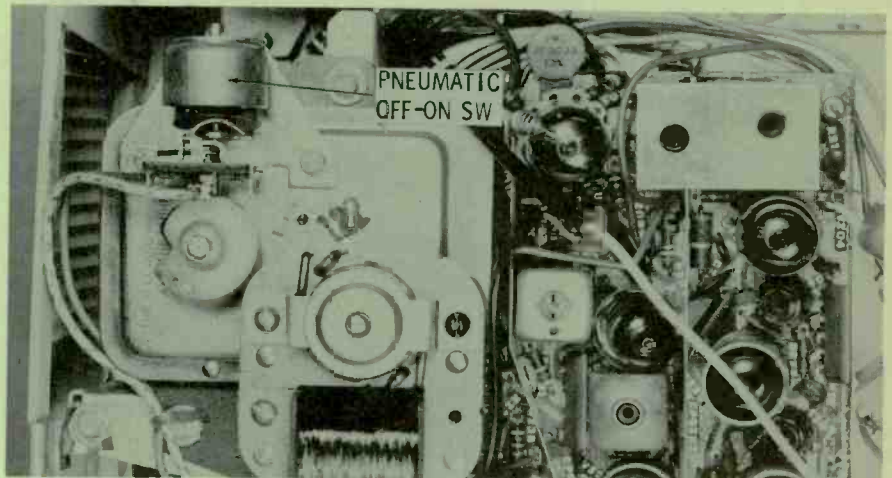
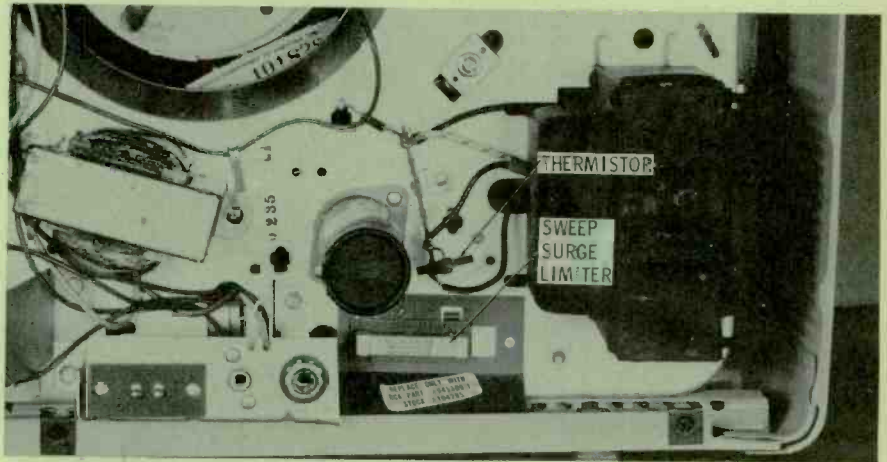
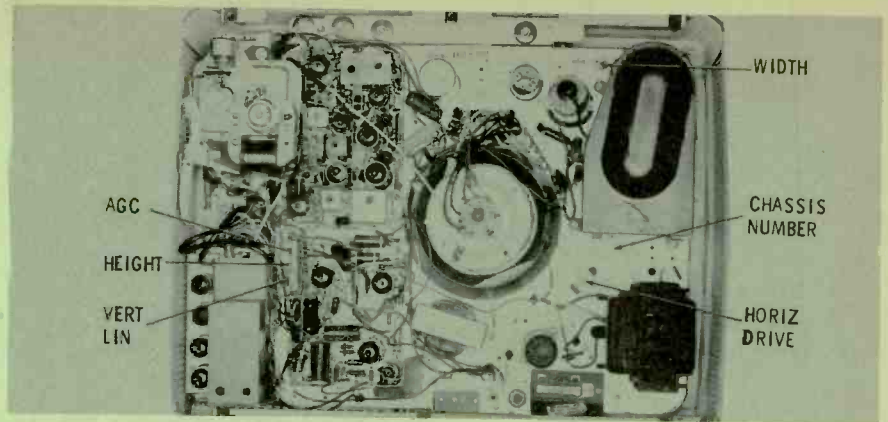



See PHOTOFAC Set 480, Folder 1

Mfr: Admiral Chassis No. 20S6

Card No: AD 20S6-1

Section Affected: Raster.

Symptoms: Insufficient vertical sweep after set has played for about half an hour.

Cause: Plate load resistor of vertical multivibrator changes in value.

What To Do: Replace R65 (2.2 meg).

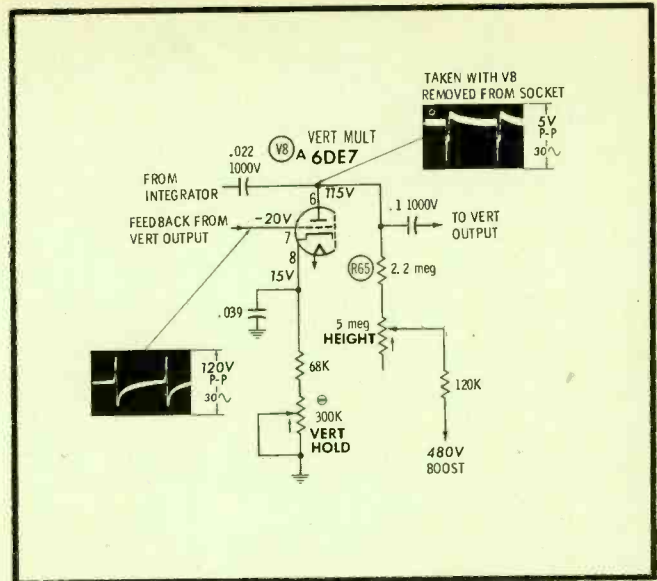

Mfr: Admiral Chassis No. 20S6

Card No: AD 20S6-2

Section Affected: Raster.

Symptoms: CRT screen dark except for bright horizontal line (no vertical sweep).

Cause: Shorted capacitor in cathode circuit of vertical output stage.

What To Do: Replace C2 (50 mfd—350V).

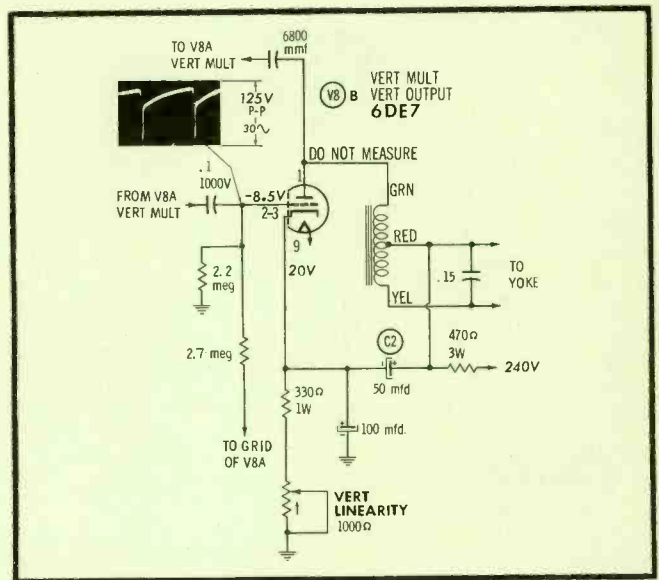

Mfr: Admiral Chassis No. 20S6

Card No: AD 20S6-3

Section Affected: Pix.

Symptoms: Contrast level fluctuates.

Cause: Video-output screen resistors are overheating and changing value.

What To Do: Replace R32 (18K) and R33 (47K—1W).

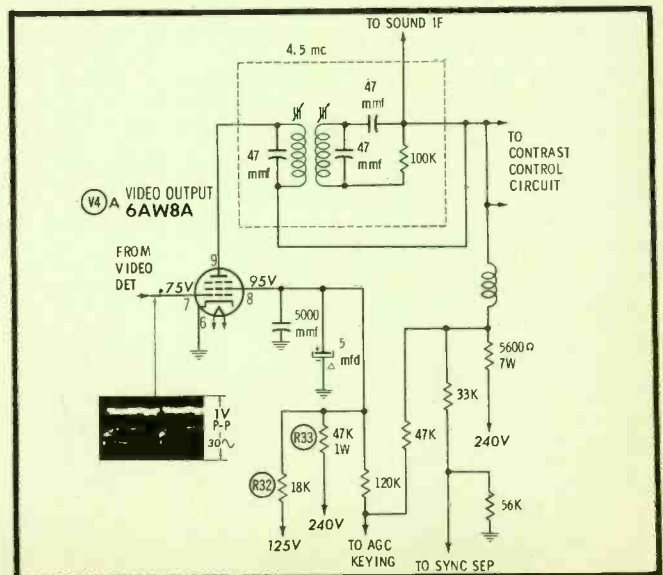



See PHOTOFACT Set 480, Folder 1

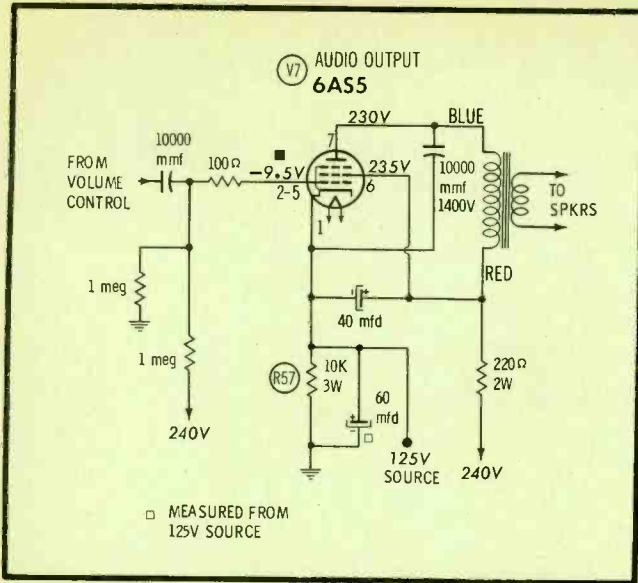

See PHOTOFACT Set 480, Folder 1

Mfr: Admiral Chassis No. 20S6

Card No: AD 20S6-4

Section Affected: Sound.

Symptoms: Distorted sound.

Cause: Resistor in cathode circuit of audio output stage has decreased in value.

What To Do: Replace R57 (10K—3W).

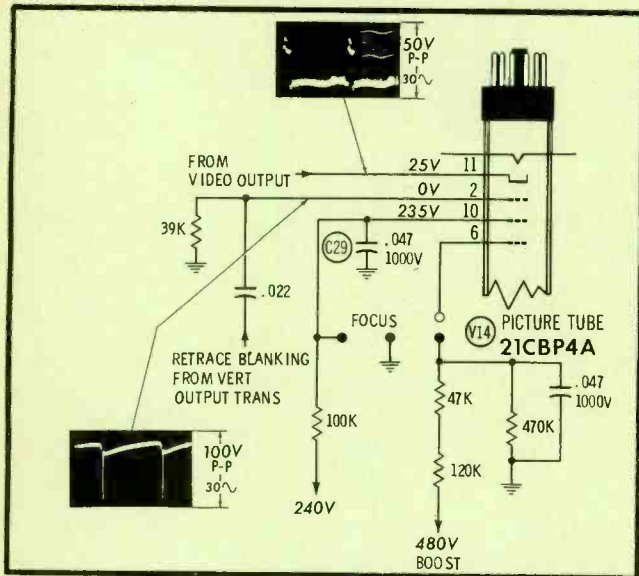

Mfr: Admiral

Chassis No. 20S6

Card No: AD 20S6-5

Section Affected: Raster.

Symptoms: No light on screen, regardless of brightness-control setting.

Cause: Shorted bypass capacitor at accelerating anode of picture tube.

What To Do: Replace C29 (.047 mfd—1000V).

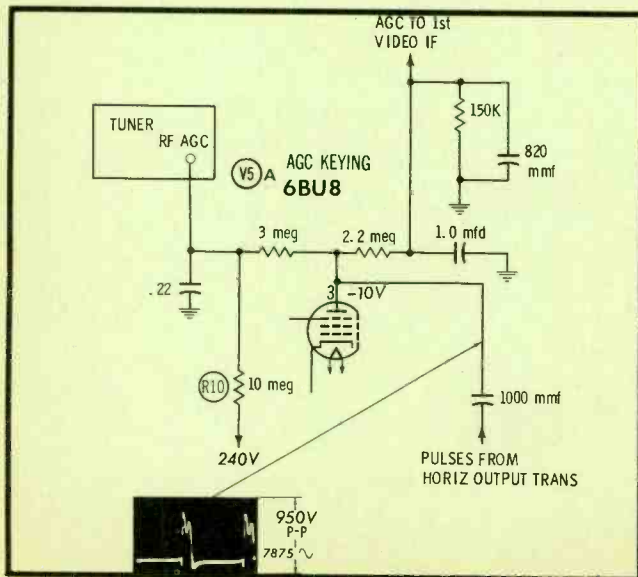

Mfr: Admiral

Chassis No. 20S6

Card No: AD 20S6-6

Section Affected: Pix.

Symptoms: Snowy picture.

Cause: Open resistor in RF-AGC delay network.

What To Do: Replace R10 (10 meg).



See PHOTOFACT Set 478, Folder 2

**Mfr:** Hoffman **Chassis No.** 426  
**Card No:** HO 426-1  
**Section Affected:** Sync.  
**Symptoms:** Poor horizontal hold.  
**Cause:** Resistor in horizontal AFC stage burned and reduced in value.  
**What To Do:** Replace R82 (15 ohms—2W) and check C68 (.068 mfd).

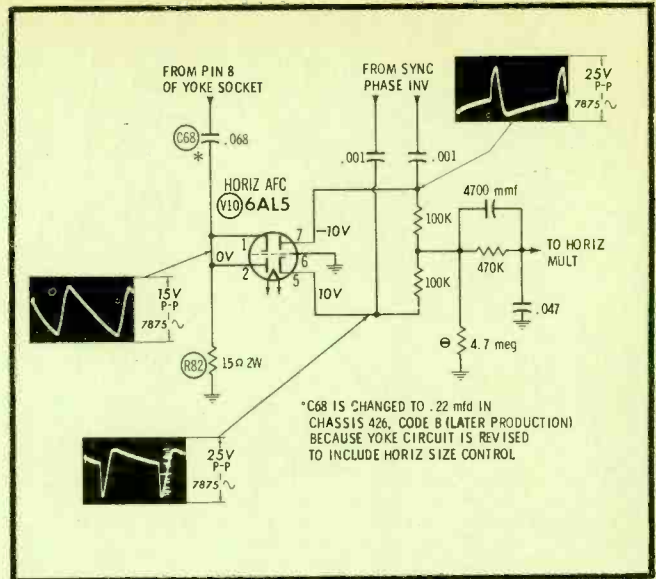

See PHOTOFACT Set 478, Folder 2

**Mfr:** Hoffman **Chassis No.** 426  
**Card No:** HO 426-2  
**Section Affected:** Sync.  
**Symptoms:** Complete loss of horizontal sync.  
**Cause:** Leaky coupling capacitor between sync phase inverter and horizontal AFC.  
**What To Do:** Replace C46 (.001 mfd).

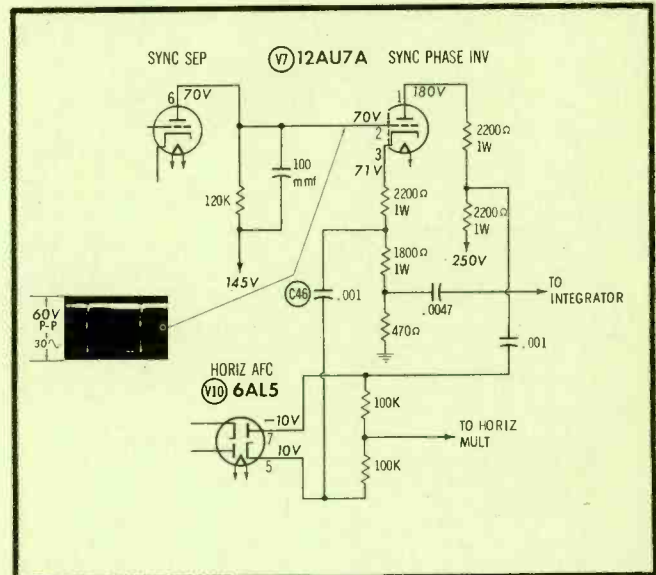

**Mfr:** Hoffman **Chassis No.** 426  
**Card No:** HO 426-3  
**Section Affected:** Pix.  
**Symptoms:** Video overloading.  
**Cause:** Grid-to-cathode resistor in keyed AGC stage burned and reduced in value.  
**What To Do:** Check V4 (6AW8A) and replace R43 (820 ohms).

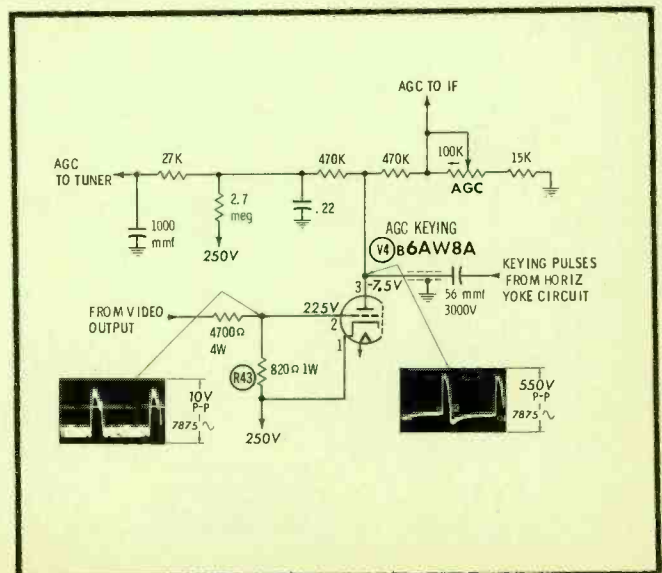



See PHOTOFACT Set 478, Folder 2

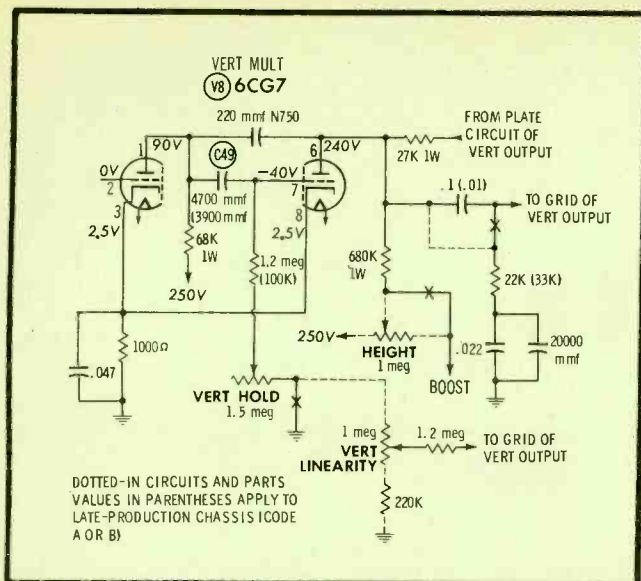

See PHOTOFACT Set 478, Folder 2

Mfr: Hoffman

Chassis No. 426

Card No: HO 426-4

Section Affected: Sync.

Symptoms: Vertical oscillator frequency drifts out of "hold-in" range.

Cause: Leaky coupling capacitor in vertical multivibrator.

What To Do: Replace C49 (.0047 mfd). On schematic, note alternate value (.0039 mfd) used with modified circuit in later production.

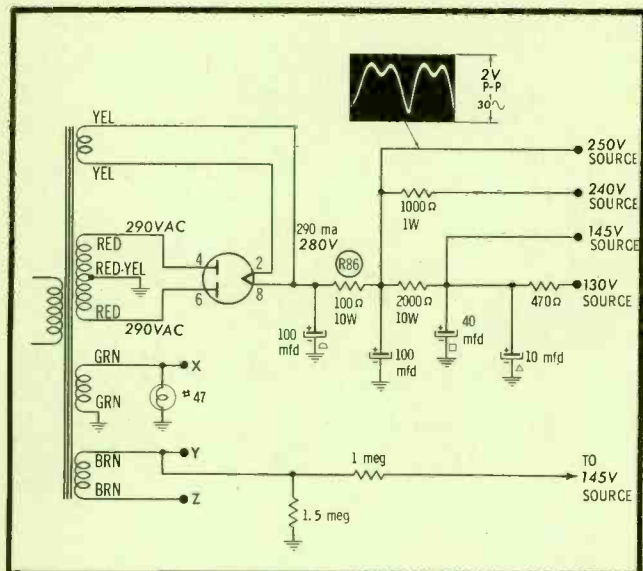

Mfr: Hoffman

Chassis No. 426

Card No: HO 426-5

Section Affected: Raster and sound.

Symptoms: Intermittent failure of sound; also, no raster when receiver is first turned on.

Cause: Intermittently open filter resistor in low-voltage rectifier circuit.

What To Do: Replace R86 (100 ohms—10W, wire-wound).

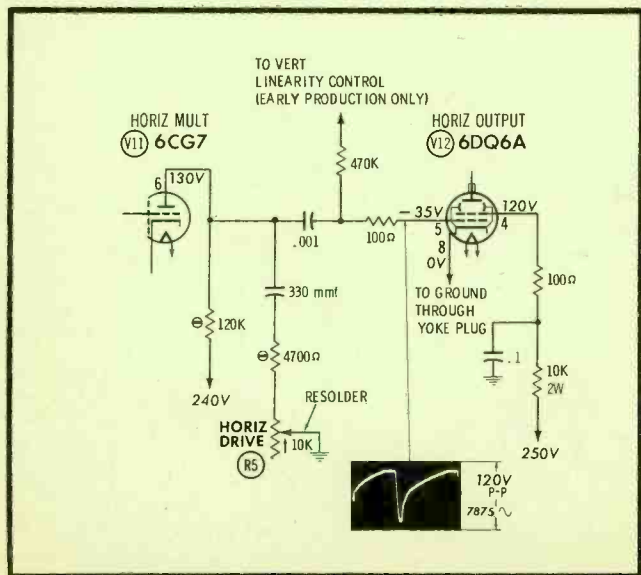

Mfr: Hoffman

Chassis No. 426

Card No: HO 426-6

Section Affected: Raster.

Symptoms: Intermittent loss of raster.

Cause: Bad ground connection to horizontal drive control.

What To Do: Resolder ground connection of R5.



# DOUBLES YOUR EFFECTIVE MANPOWER

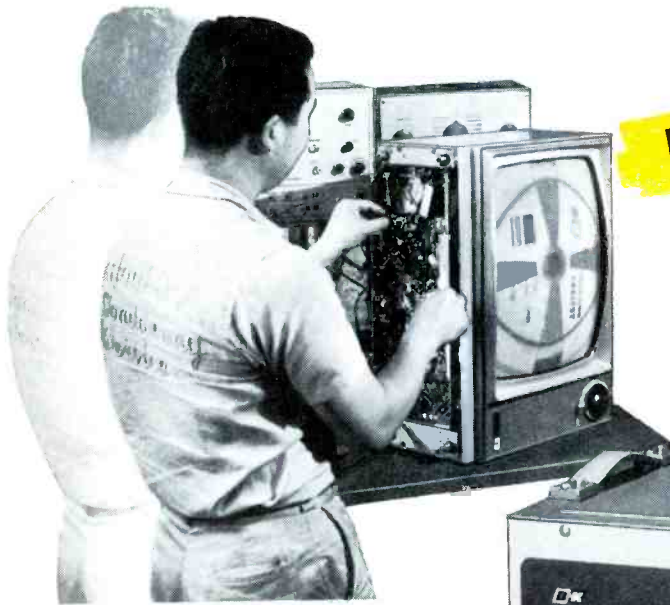

Fix "Tough Dogs" Fast!

Save Half Your Time!

Step Up Your Profit!

**B&K** NEW  
MODEL 1076

## TELEVISION ANALYST

for Black & White and Color



Check all circuits—Pinpoint any TV trouble...in minutes

**By Easy Point-to-Point Signal Injection,  
You See the Trouble on the TV Screen and  
Correct it—Twice as Fast and Easy!**

There's no longer any need to "lose your shirt" (and customers)—and worry about the lost hours you never recover—on "tough dogs" or even intermittents. *The remarkable B&K Analyst* enables you to inject your own TV signal at any point and watch the resulting test pattern on the picture tube itself. *Makes it quick and easy to isolate, pinpoint, and correct TV trouble in any stage* throughout the video, audio, r.f., i.f., sync, and sweep sections of black & white and color television sets—including intermittents. Makes external scope or wave-form interpretation unnecessary. Most useful instrument in TV servicing! Its basic technique has been proved by thousands of successful servicemen the world over.

The Analyst enables any serviceman to cut servicing time in half, service more TV sets in less time, really satisfy more customers, and make more money.

Model 1076. Net, \$29995

Available on Budget Terms. As low as \$30.00 down.

Combines all the features of both  
the Model 1075 and Model A107

COMPLETE R.F. and I.F.

VIDEO TEST PATTERN

COMPOSITE SYNC

FM MODULATED AUDIO

COLOR PATTERNS

HORIZONTAL and VERTICAL  
PLATE and GRID DRIVE

B+ BOOST INDICATOR

HI-VOLT INDICATOR

YOKE and HI-VOLTAGE  
TRANSFORMER TEST

**Also Now Provides:**

SWITCH-TYPE TUNER

NEGATIVE BIAS SUPPLY

AGC KEYING PULSE

PICTURE TUBE MODULATION



**B & K MANUFACTURING CO.**  
1801 W. BELLE PLAINE AVE • CHICAGO 13, ILL.  
Canada: Atlas Radio Corp., 50 Wingold, Toronto 19, Ont.  
Export: Empire Exporters, 277 Broadway, New York 7, U.S.A.

See Your B&K Distributor or Write for Bulletin AP16-R



# 2 great **SPRAGUE DIFILM**® tubulars are tops in their field . . . take your choice!

For maximum reliability  
and performance  
under toughest conditions

## **SPRAGUE DIFILM**® **BLACK BEAUTY**®



For extremely small  
size and exact  
original replacement

## **SPRAGUE DIFILM**® **ORANGE DROP**®



Sprague Black Beauty tubulars are missile-type capacitors. Actually, they are low cost versions of the famous Sprague capacitors now being used in every modern military missile. Where positive reliability is important, make no mistake, use Black Beauty Difilm Molded Capacitors! You get the most for the least with Black Beauties!

Difilm Black Beauties are engineered to withstand the hottest temperatures to be found in TV or auto radio sets—in the most humid climates. Further, unlike straight polyester film tubulars, these capacitors operate in a 105°C environment—without derating!

Black Beauty tubulars are tough units, too—no fragile shell to break—you can't damage them in soldering. For your convenience, every capacitor is marked twice . . . no need to twist capacitor around to read rating.

*The heart of these Sprague Difilm Capacitors can't be beat! It's a dual dielectric combination of Mylar® polyester film and special capacitor tissue—resulting in capacitors which are superior to all other comparable tubulars. Sprague's rock-hard solid HCX® impregnant fills voids and pin holes in the film. Difilm capacitors have high insulation resistance, low power factor, and excellent capacitance stability and retrace under temperature cycling!*

Sprague Difilm "Orange Drops" are a "must" for your service kit where only an exact replacement will fit. They are the perfect replacement for dipped capacitors now used by leading manufacturers in many popular television receivers. And when a dipped tubular is called for, you'll find that Orange Drops outperform all others, safeguarding your work and reputation for quality service.

Orange Drops are specially designed for easiest possible installation. Radial leads are crimped to assure neat mounting parallel to printed wiring boards . . . extremely small size makes them fit handily in tight spots. They'll beat heat and humidity because the solid, rock-hard capacitor section, double-dipped in bright orange epoxy resin, is well protected against moisture. A perfect team-mate for Black Beauty.

**±10% CAPACITANCE TOLERANCE IS STANDARD AT NO EXTRA COST**

Difilm Black Beauty and Difilm Orange Drops are packaged in sturdy, reusable rigid plastic Kleeer-Pak® boxes. Your distributor is stocked in all the popular ratings. Order some today. You can count on Difilm.

**SPRAGUE**®  
THE MARK OF RELIABILITY



**publisher**  
Howard W. Sams

**general manager**  
Mal Parks, Jr.

**editor**  
Verne M. Ray

**associate editors**  
Leslie D. Deane  
Thomas A. Lesh  
Joe A. Graves

**consulting editors**  
William E. Burke  
Robert B. Dunham  
George B. Mann  
C. P. Oliphant  
Paul C. Smith

**art director**  
Don W. Bradley

**advertising & editorial assistants**  
Georgeanna Caldwell  
Paula Haffner  
Jean Sekulski

**production manager**  
Robert N. Rippy

**circulation fulfillment**  
Pat Tidd, Mgr.  
Constance McCawley, Ass't.

**photography**  
Robert W. Reed

**advertising sales offices**  
midwestern

John Groce, PF REPORTER  
2201 East 46th Street, Indianapolis 6, Ind.  
Clifford 3-6441

eastern

Howard W. Sams & Co., Inc.  
Corning Glass Building,  
717 Fifth Ave., New York 22, N. Y.  
Murray Hill 8-6350

western

The Maurice A. Kimball Co., Inc.  
2550 Beverly Blvd., Los Angeles 57, Calif.  
Dunkirk 8-6178; and 681 Market Street,  
San Francisco 5, Calif. Exbrook 2-3365

Address all correspondence to  
PF REPORTER, 2201 East 46th Street,  
Indianapolis 6, Indiana



Copyright © 1960 by Howard W. Sams & Co., Inc. PF REPORTER is a trademark of Howard W. Sams & Co., Inc. No part of PF REPORTER may be reproduced without written permission. No patent liability is assumed with respect to use of information herein. Acceptance of advertising does not in any manner signify the products, policies and services so advertised have been approved, endorsed or recommended by this magazine.

Indexed in *Electronic Guide* and *Lectrodex*.  
Printed by the Waldemar Press Div.  
of Howard W. Sams & Co., Inc.



# PF REPORTER

including **Electronic Servicing**

VOLUME 10, No. 10

OCTOBER, 1960

## CONTENTS

|   |    |
|---|----|
| <b>Previews of New Sets</b><br>General Electric R740VWD (Chassis M6), Motorola 23K30M (Chassis TS-568), Philco J-3702L (Chassis 11N51), RCA 171-AR-067 (Chassis KCS130M).           | 1  |
| <b>Video Speed Servicing</b><br>Service hints on the Admiral Chassis 2056 and Hoffman Chassis 426.  | 5  |
| <b>Letters to the Editor</b>  | 14 |
| <b>Before You Touch That Chassis—THINK!</b> Andrew J. Olsen<br>Choosing the best troubleshooting approach requires proper interpretation of all the clues.                          | 28 |
| <b>Causes &amp; Cures for Negative Picture</b> Joe A. Graves<br>Never-before-published facts about a symptom that has baffled even the best TV servicemen.                          | 30 |
| <b>High, Wide, and Handsome</b> Stan Prentiss<br>Across the Bench — A report on an experience with DuMont's 35-tube RA-109 chassis.   | 32 |
| <b>Hints on Making Control Replacements</b>   | 34 |
| <b>AC Outlet Voltages</b> F. J. Stephens<br>Customers plagued with repeated set failures may be victims of too much "housepower."   | 36 |
| <b>Single-Sideband Adapters</b> Edward M. Noll<br>How to convert standard communications receivers for SSB operation.   | 38 |
| <b>Stock Guide for TV Tubes</b>   | 42 |
| <b>The Electronic Scanner</b>   | 44 |
| <b>Facts About Tube Substitution</b><br>With a handy chart listing 167 substitutes for 86 of the most widely used tubes.  | 46 |
| <b>Does High Fidelity Demand High Power?</b> Thomas A. Lesh<br>Audio Facts—The truth about hi-fi power requirements, and the meanings of power specifications.                      | 48 |
| <b>Dollar &amp; Sense Servicing</b>   | 52 |
| <b>Fixed At Last — Oops!</b> Calvin C. Young, Jr.<br>Quicker Servicing—Some unusual techniques used on a set that didn't want to stay fixed.  | 54 |
| <b>"Squeeze Bottles" as Insulators</b> Paul Boller  | 60 |
| <b>Notes on Test Equipment</b> Les Deane<br>Lab reports on the Hickok Model 870 transistor tester, Seco Model 500 communications radio tester, and Shell Model TC-1B "Cadi-Tester." | 62 |
| <b>The Troubleshooter</b>   | 70 |
| <b>Product Report</b>   | 92 |
| <b>Free Catalog &amp; Literature Service</b>  | 96 |

### ABOUT THE COVER

Confusing, isn't it? But that's what happens when you become involved with negative pictures. Sometimes they look negative when they really aren't; other times they are negative but don't look it. Anyway, we thought you'd get a kick out of seeing a negative picture of a technician servicing a set with a negative picture of a technician servicing a set with a negative picture. See the feature article on page 30.





# Why are more Service-Dealers Switching to **JFD** EXACT REPLACEMENT TV ANTENNAS?



## because

50 per cent of all TV sets made in the last 4 years are portables—sending *more* antenna replacement business to service-dealers every day.

## because

with the JFD PA500 and PA515 Exact Replacement Kits, dealers are ready and able to service 90% of antenna replacements for portables and tote-ables.

## because

as JFD Exact Replacement Specialists, service-dealers can get out of the unprofitable “rabbit-ear” business—earn a *profit* on the antenna sale (at full mark-up) *and* on the *installation*.

## because

with JFD guides, streamers, and sales helps, service-dealers get the merchandising *know-how* that nets them a bigger slice of the 3,500,000 dollar portable antenna replacement market.

***NOW IS THE TIME TO WRITE JFD OR ASK YOUR JFD DISTRIBUTOR FOR YOUR EXACT REPLACEMENT PROFIT PLAN PORTFOLIO!***



Check Sams Photofact folders for JFD Exact Replacement information. Only JFD keeps you up-dated with the 1960 Portable TV Antenna Guide covering every portable TV set made since 1956 (compiled and edited by Howard W. Sams & Co., Inc.)



THE BRAND THAT PUTS YOU

# JFD

JFD ELECTRONICS CORPORATION BROOKLYN 4, NEW YORK  
 JFD International, 15 Moore Street, New York, New York • JFD Canada, Ltd., 51 McCormack Street, Toronto, Ont., Canada IN COMMAND OF THE MARKET



# Why are more Service-Dealers Switching to **JFD HI-FI TV ANTENNAS?**



The *Businessman in the Serviceman* suit knows five million TV antennas are in need of replacement. For his installations he relies on the superior performance and quality of JFD Hi-Fi Colorennas to guarantee complete customer satisfaction... guard his reputation.

**JFD**  
THE BRAND THAT PUTS YOU

HI-FI HELIX HI-FI BANSHEE HI-FI FIREBALL



## because

they know *5 million* antennas need replacement—that *JFD HI-FI TV antennas* assure them a *bigger* share of this profitable market.

## because

JFD all-out advertising *sells* for them in powerful national mass media—such as *Look, TV Guide, Successful Farming, Farm Journal, Progressive Farmer.*

## because

JFD is the *total* antenna line with the *right* model, at the *right* price for every location—does the *most* for them in mile-shrinking *performance* and customer *confidence.*

## because

JFD sales stimulators such as cloth patches, decals, mobiles, banners, displays and direct mail give them the *complete* package to *sell* new customers.

**HOW MUCH INSTALLATION BUSINESS ARE YOU LOSING BY NOT SWITCHING TO JFD? THE TV ANTENNA LINE AMERICA KNOWS BEST!**

HI-FI HELIX  
Silver or Gold Anodized

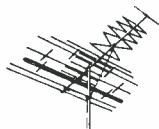

HI-FI BANSHEE  
Silver or Gold Anodized

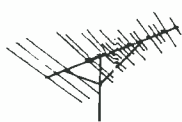

HI-FI FIREBALL  
Silver or Gold Anodized

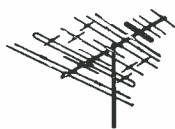

THE BRAND THAT PUTS YOU

# JFD

IN COMMAND OF THE MARKET

JFD ELECTRONICS CORPORATION, Brooklyn 4, New York  
JFD International, 15 Moore Street, New York, New York • JFD Canada, Ltd., 51 McCormack Street, Toronto, Ont., Canada

# ATR PRODUCTS FOR MODERN LIVING



## ATR PLUG-IN TYPE PORTABLE INVERTERS\*

A.C. HOUSEHOLD ELECTRICITY Anywhere... in your own car!

- Operates Standard A.C.
  - Record Players
  - Dictating Machines
  - Small Radios
  - Electric Shavers
  - Heating Pads, etc.

In your own car or boat!

**MODELS**  
 6-RMF (6 volts) 60 to 80 watts. Shipping weight 12 lbs. DEALER NET PRICE \$33.00  
 12T-RME (12 volts) 90 to 125 watts. Shipping weight 12 lbs. DEALER NET PRICE \$33.00  
 \*Additional Models Available



## ATR "A" Battery ELIMINATOR

For Demonstrating and Testing Auto Radios—TRANSISTOR or VIBRATOR OPERATED!  
 Designed for testing D.C. Electrical Apparatus on Regular A.C. Lines—Equipped with Full-Wave Dry Disc-Type Rectifier, assuring noiseless, interference-free operation and extreme long life and reliability.

MAY ALSO BE USED AS A BATTERY CHARGER  
**MODEL 610C-ELIF** 6 volts at 10 amps. or 12 volts at 6 amps. Shipping weight 22 lbs. DEALER NET PRICE \$49.95  
**MODEL 620C-ELIT** . . . 6 volts at 20 amps. or 12 volts at 10 amps. Shipping weight 33 lbs. DEALER NET PRICE \$66.95

## AUTO-RADIO VIBRATORS



By every test ATR Auto-Radio Vibrators are best! and feature Ceramic Stack Spacers, Instant Starting, Large Oversized Tungsten Contacts, Perforated Reed, plus Highest Precision Construction and Workmanship and Quiet Operation!  
 There is an ATR VIBRATOR for every make of car!  
 Ask your distributor for ATR's Low Priced type 1400, 6 volt 4-prong Vibrator; and 1843, 12 volt 3-prong; or 1840, 12 volt 4-prong Vibrator. THE WORLD'S FINEST!

There is a trim plate kit for YOUR CAR!

## ATR CUSTOMIZED KARADIO



Vibrator-Operated with Tone Control  
 ATR KARADIO is ideal for small import cars or compact American cars! Unit is completely self-contained—extremely compact! Powerful 8-tube performance provides remarkable freedom from engine, static, and road noises. The ATR Customized Karadio comes complete with speaker and ready to install. Can be mounted in-dash or under-dash—wherever space permits! No polarity problem. Neutral Gray-Tan, baked enamel finish. Overall size, 7" deep, 4" high, and 6 1/2" wide. Shipping weight, radio set, 7 lbs. Model K-1279—12 for 12V Dealer Net Price \$33.57 Model K-1279—6 for 6V Dealer Net Price \$33.57

Airplane Style Overhead Mounting under Cab Roof

NO PRINTED CIRCUITRY

## ATR TRUCK KARADIO



Excellent Tone, Volume, and Sensitivity!  
 Compact, yet powerful. Fits all trucks, station wagons, most cars and boats. Just drill a 3/8 inch hole in roof and suspend the one-piece unit (aerial, chassis and speaker) in minutes. Watertight mounting assembly holds antenna upright. Yoke-type bracket lets you tilt radio to any angle.  
 Extra-sensitive radio has 6 tubes (2 double-purpose), over-size Alnico 5 PM speaker for full, rich tone. Big easy-to-read illuminated dial. Fingertip tuning control. Volume and tone controls, 33-in. stainless steel antenna. Neutral gray-tan enameled metal cabinet, 7 x 6 1/2 x 4 in. high over-all. Shipping weight 10 1/2 lbs. Model TR-1279—12 A for 12V Dealer Net Price \$41.96 Model TR-1279—6 A for 6V Dealer Net Price \$41.96

SEE YOUR ELECTRONIC PARTS DISTRIBUTOR WRITE FACTORY FOR FREE LITERATURE . . .  
**ATR AMERICAN TELEVISION & RADIO CO.**  
 Quality Products Since 1931  
 SAINT PAUL 1, MINNESOTA—U.S.A.

# Letters to the EDITOR

Dear Editor:

The industrial article describing the "little black box" in the May issue is very well done, but he did not go far enough. After repairs are made on the Brown amplifier and associated parts, adjustments must be made, just as on any TV set. Examples are the gain control, clamp adjust, span adjust, bridge adjust, dead-load adjust, and balance adjust. There's also the problem of testing for a "ground loop" caused by defective shielding in some remote location; this can cause hum because of line-frequency currents out of phase with another source.

A VOM with 5000-ohm AC impedance and an output-voltage jack is fine for in-circuit testing. Also, a megohmmeter for checking high-resistance leaks of shielding, and a high-sensitivity scope for checking spurious signals mixed in with AC input signals, are "life-savers" at times.

FRED PARKER

Milwaukee, Wis.

Dear Editor:

After reading the article about the *ElectroniK* continuous-control system in the May issue, I have a few comments and additions as follows:

In working on the input circuit, remember that the red wire in the thermocouple lead is negative and the other color (which varies according to type of unit) is positive.

The thermocouple output is rated in millivolts, not microvolts.

The balancing motor, according to Honeywell, is a two-phase motor.

Fig. 5 of the article shows a 1.5-volt standard cell. Actually, this is a regular No. 6 dry cell. The instrument does use a standard cell, but the voltage is 1.08 volts.

In an emergency, the unit will operate on one 12AU7 with less sensitivity.

The unit has a cold junction in the cabinet, which is shown in Fig. 2 but does not appear on your print. Also omitted was the standardization circuit (which is very important).

We have about 70 or 75 of these units in our plant, some controlling gas furnaces and others controlling electric furnaces.

G. E. TAYLOR

Sheffield, Ala.

Thank you both for the additional details. From your comments, we assume our TV expert did a pretty fair job on his first industrial electronics unit—Ed.

Dear Editor:

I have a suggestion for John R. Zanath of Aliquippa, Pa., regarding his recent technical question ("Skinny Admiral" on page 87 of the May issue). He doesn't need a width control. If he will change the 82K resistor going to pin 6 of the

horizontal multivibrator tube to a 68K, he will have what he needs.

This circuit is also found in the 16CU1 chassis.

EARL A. HAMILTON

Oklahoma City, Okla.

We're sure John has his "tough dog" licked by this time, Earl, but there must be others who will benefit from your experience. Thanks.—Ed.

Dear Editor:

I have two Citizens band transceivers similar to those described in the article "Inside CB Radios" in your May issue. Some of the circuits have improvements I would like to include in my models. Are complete schematics available for the models described in the May article?

LEWIS HAWKINS

Hawkins Radio & TV  
 Dallas, Texas

Circuits shown in the article were composites of typical transceivers, and were not intended to describe any specific brand. You'll be happy to learn, however, that complete PHOTOFACT Folders are now being produced for Citizens band units.

Incidentally, don't forget that you must hold at least a second-class radio telephone license to perform any service that would affect the transmitting frequencies of such equipment.—Ed.

Dear Editor:

You must have wanted some mail when you published the striking August cover.

I've had many customers nearly as attractive as your model, and I give them all the same shuffle — into the back seat, or "It's much cooler in the shop — would you call me if the phone rings?"

At first look, I saw "Setting Up for Auto Radio Service," but the thought came out, "Setting Up for a Bruised Noggin." Of course, the dog won't tell her husband or your wife, but there's no insurance against passersby.

L. E. TRUAX

Lawton, Okla.

At risk of a stampede on Indianapolis, we'll let you in on a little secret: Our August cover girl is single, and works in our circulation department (get in line for your subscription, fellows), so there's no husband trouble this time. As for wife trouble, you know your wife better than we do!—Ed.

Dear Editor:

On page 37 of your August issue is an item about servicemen marking unknown TV sets. I've been doing that for two years, relying on my knowledge of TV sets and the pictures in PHOTOFACTS as guides.

RICHARD W. RUBIN

The Fixit Shop  
 Chicago, Ill.

We always knew our readers were intelligent and progressive, Dick, but you're the first to indicate capabilities as a telepathist!—Ed.

• Please turn to page 20



# NOW

# A HOME TV ACCESSORY WITH MASS CONSUMER APPEAL

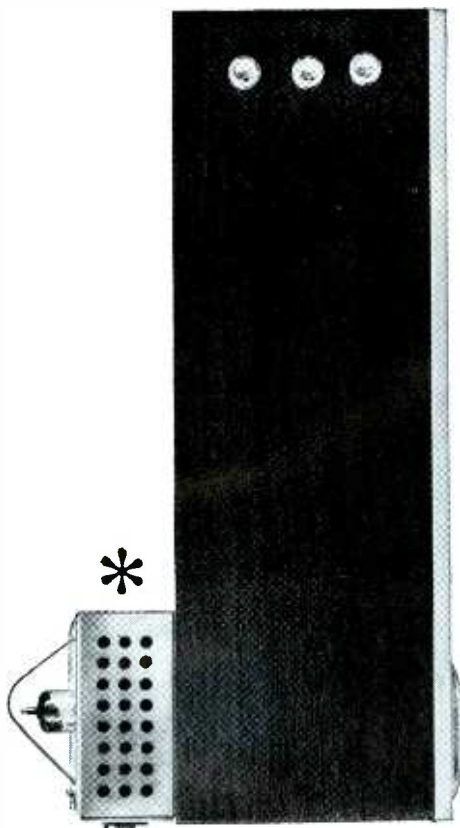

## **NEW** Blonder-Tongue TV/FM POWER BOOSTER\* Model BTA... only \$18.95

OFFERS MORE GAIN THAN EVER BEFORE POSSIBLE AT SUCH A LOW PRICE

### MASS CONSUMER APPEAL

■ Sells in volume in small town, big city, prime or weak signal areas ■ Improves TV (black & white or color) and FM reception by boosting signal strength. (7 to 9 db, channels 2-13; 4 to 8 db FM) ■ Installs in seconds with only a screwdriver ■ Features stripless 300 ohm terminals and "on/off" switch ■ Employs low-noise frame-grid tube ■ Works with indoor or outdoor antennas ■ Improves performance of 2, 3 and 4-set installations

### SELLS ON SIGHT—TAKE IT ALONG ON SERVICE CALLS

Sell it on house calls, or over-the-counter. It's easy to demonstrate the dramatic improvement it provides.

### EFFECTIVE NATIONAL ADVERTISING

☆ TV Guide ☆ Electronics World ☆ Radio-Electronics ☆ Popular Electronics ☆ Electronic Technician ☆ PF Reporter ☆ Home Furnishings Daily ☆ Electrical Merchandising Week ☆ Radio & Television Weekly . . . plus a host of sales aids.

Spark your fall sales drive with the BTA—Contact your Blonder-Tongue distributor, or wire, phone, write for details. Dept. PF-10

engineered and manufactured by **BLONDER-TONGUE**, 9 Alling Street, Newark 2, N. J. Export: Morhan Export Corp., New York 3, N. Y.

The growth of the entire Electronic

in famous

# PHILCO Industry Firsts

THIRTY YEARS AGO PHILCO REVOLUTIONIZED THE RADIO INDUSTRY WITH THE FAMOUS "BABY GRAND" . . . the first reliable quality table model to be mass-produced in America. From that day forward, table model radios became big business!

Think back . . . think how much this one Philco development has contributed to the growth of your service business. Yet it's just one example among many, many Philco "Firsts" that have resulted in increased profit opportunities for you. Similarly, the proven reliability of Philco parts, tubes and accessories protects your profits, and builds good will.

For all your servicing needs, look to

**PHILCO** THE FIRST NAME IN ELECTRONICS  
...THE LAST WORD IN **QUALITY**



SEE YOUR PHILCO DISTRIBUTOR



# Service Business is reflected



st  
—

**Here's Just One  
Example... the Famous Philco  
"Baby Grand" Introduced by  
Philco in 1930**

With the "Baby Grand", Philco solved the problem of building a quality radio in compact size that could be mass-produced at a price millions could afford. It started a whole new phase of the radio business, and in the same year—1930—Philco also introduced the

**FIRST TONE CONTROL**  
—another famous Philco first!

## **PHILCO Accessory Division**

*WORLD-WIDE DISTRIBUTION*

Service Parts • Power-Packed Batteries • Universal Components • Long-Life Tubes • Heavy-Duty Rotors • Star-Bright 20/20 Picture Tubes • Long-Distance Antennas • Appliance Parts • Laundry Parts • Universal Parts and Accessories

# **PHILCO**

 *Famous for Quality the World Over*



clear  
as  
a  
"bell"...

**CDE rotors get**



# the biggest customer reception!

CD Rotors have the power to end your service problems . . . because they are designed with a direct line of power that out performs them all. Even in the stormiest, snowiest areas, you can just install them and forget them. CD Rotors give clear-as-a-"bell" reception that's trouble-free, longer lasting, require no call-backs. So order your CD Rotors today . . . you'll shout their praises from the roof-tops! Write for Catalog #1630 to Cornell-Dubilier, South Plainfield, New Jersey.

**CORNELL-DUBILIER  
ELECTRONICS DIVISION**  
Federal Pacific Electric Company



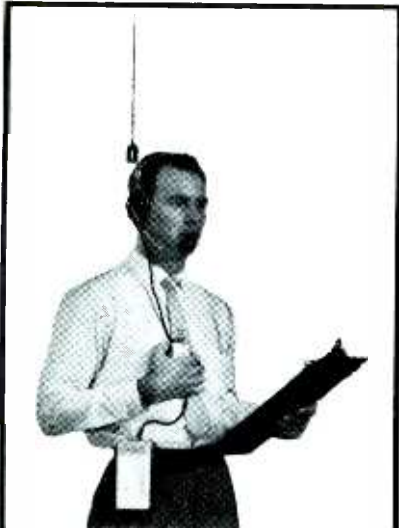

## MINIATURE 2-WAY RADIO SYSTEM Keeps YOU in CONTACT in ANY Situation; ANY TIME, ANYWHERE!

### the SEISCOR TELEPATH

... is a portable industrial quality communications system that becomes a part of your wearing apparel. It is engineered for short-range applications where dependability and convenience of use are essential. Precision circuit and durable construction provide extremely low maintenance and trouble-free operation!

- Fully transistorized printed circuit
- Crystal-controlled superheterodyne receiver
- Crystal-controlled transmitter
- Long battery life
- For any single frequency between 20-55 mc., A.M.
- No license required on 27 mc. units.

Let Seiscor Engineers analyze your short-range communications problems. Example: Special units have been designed into protective clothing for crash-crew fire fighters.

### FIND OUT TODAY HOW TELEPATH CAN IMPROVE YOUR SHORT RANGE COMMUNICATIONS!

Write for name of nearest TELEPATH dealer, and complete information on versatile TELEPATH communications.

**SEISCOR**  
A DIVISION OF SEISMOGRAPH SERVICE CORPORATION  
BOX 1590, TULSA, OKLAHOMA



**MODEL HR**  
Hardhat with built-in transceiver, antenna, earphones and mike. High and low noise level models available.



**MODEL BR**  
Belt clip transceiver and headset with built-in antenna, earphones and mike. High and low noise level models available.

## Letters

(Continued from page 14)

Dear Editor:

Glancing through the August issue, I stopped to read the item, "Nerves of Steel," in the *Dollar and Sense Servicing* column. I must say I read this with some slight amazement, if not downright amusement. No offense meant, but apparently Mr. Groves hasn't been around much, especially out in the small towns. Just ask any of the thousands of servicemen who run one-man shops in the small towns scattered over the nation, and they'll tell you what I mean.

I have been in this game for about 35 years, and have serviced radios and TV's in cities like Chicago and all the way on down to small country villages. I have yet to find any place where a service bench can be put so that some "helpful" customer won't get to it while you are working on his set. This is especially true in small towns where everybody knows everybody else.

I have tried signs, gates, counters, brick walls, barbed-wire barricades, etc., all to no avail. Sometimes they come through torn and bleeding, but come through they will! Yesterday, while checking the tubes in a man's set as he stood between the set and the tube checker, I deliberately stepped on his feet eight different times. Did he move? He did not. He didn't even pull his feet back.

Of course, the old trick of a charged filter left "accidentally" lying on the corner of the bench sometimes deters them for a few minutes, but not for long. They crawl off into a corner somewhere and lick their wounds like an injured pup, and then they come right back for more—never even realizing what hit them in the first place.

We love it, though, and after the first hundred years you get used to it. Also, I have found that the ones who are allowed to hang their chins over your shoulder while you work on their sets never complain about the bill.

M. D. CUMMINS

Cummins Radio & TV Service  
Neosho, Mo.

*Here's Joe's answer: "I practiced what I preached — and quite successfully — in a small town for a number of years. My only barricade was a four-foot opening with a hunk of chain from which was hung a "Danger — High Voltage" sign. My bench ran at 90° from the counter and practically touched it. Don't know if it was the layout, the ease with which customers could observe me working without standing over my shoulder, or what — but we made it."—Ed.*

Dear Editor:

Like most TV technicians, I'm usually "too busy eating the soup to praise the cook." But keep up the good work!

I'd like to comment about Joe A. Groves' article on *Voltage Analysis of Transistor Circuits* in the August issue. I get the feeling that Mr. Groves is among the authors who believe television technicians are having tremendous difficulties with the understanding of transis-

tors! Personally, I find them fascinating and easy to understand (as compared with some vacuum-tube circuits!), and feel that inferences should lean toward their simplicity rather than suggesting that they are confoundingly complex.

Second, it *seems* as though Mr. Groves is suggesting to ignore all other test equipment in transistor troubleshooting. A scope may not have beat him to the ultimate solution, but a dead oscillator or an improper bias causing distortion would be spotted with a scope very easily. I am a scope advocate, as is obvious, but I never fail to call on my VTVM, sig-gen, or screwdriver when the situation warrants. So, while all points are well taken concerning VTVM use, I do feel that other test equipment should not be ignored—either on the bench or in instructive articles.

Nevertheless it was an excellent article, and I'm sure many of your readers will be helped by it.

JAMES W. BURLINGAME

Pawn Television  
Tacoma, Wash.

*Surprisingly, there are still many servicemen who need to be coaxed to "get their feet wet" in transistor work. We're delighted to hear from a deep-water swimmer!—Ed.*

Dear Editor:

Ordinarily I am just an easy-going serviceman, trying to do a good job and get along with everybody. But Robert W. McAloan's letter in the April *Letters to the Editor* column got me a little bit worked up. When he described how he fixed a TV set that none of the full-time fellows could fix, he gave a prime example of the type of service rendered by some part-time "experts."

He mentioned that he found the fine-tuning belt of the set lying on the bottom of the cabinet, and went on to say that it was fixed simply with rubber cement and shoemaker's thread. I nearly laughed myself sick at this. It reminded me of the old farmer who kept his Model T running by tying it together with baling wire and pasting it with spit. I would call this the shoddiest kind of workmanship, and if I couldn't go to the simple expedient of getting a new belt for the customer, I would get out of the service business!

R. W. OSTERLAND

Service Manager

A and H Radio-TV-Electronics

"Ask Your Neighbor, We Repaired His"  
Aurora, Ill.

*You have a good point, Ronnie, but it still doesn't explain why the previous servicemen didn't find the trouble! Furthermore, Mr. McAloan assures us his customer is well satisfied with the results—and, after all, isn't that the important thing?—Ed.*

Dear Editor:

I enjoy PF REPORTER very much, and would like to see an article explaining all about delay lines and their uses in industrial electronics.

ANTHONY RUOPPOLO

New Haven, Conn.

*Anyone second the motion?—Ed.*



**NEW**

*Need to  
know more about  
TRANSISTORS?*

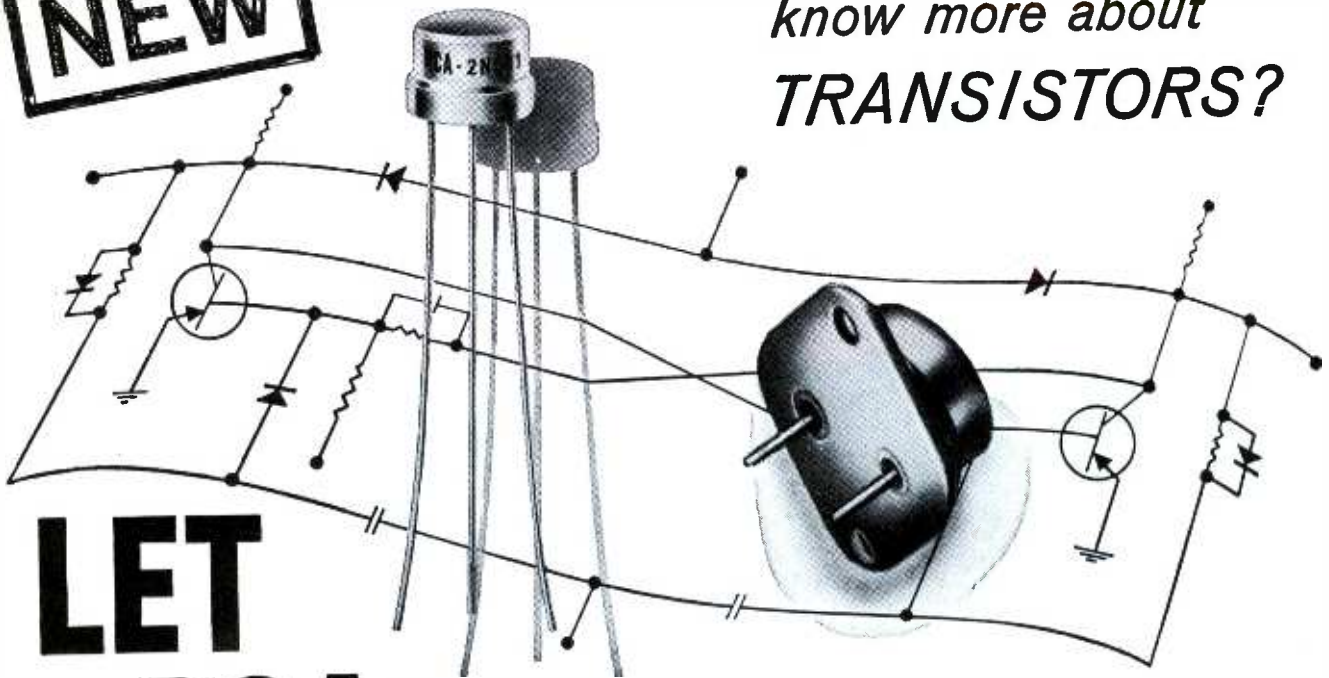

# LET RCA TRAIN YOU AT HOME

in semiconductor physics and transistor applications

RCA Institutes Home Study School now has a new course created for men and women in the field of electronics who realize the growing importance of semiconductor technology. The new course covers transistor characteristics and testing methods... prepares you to move up in your job as you increase your knowledge and skills. RCA's liberal Pay-As-You-Learn Plan is the

most economical possible home study method *because you never pay for lessons that you do not receive!* You pay for your next study group only when you order it! Should you drop out at any time, you do not owe RCA Institutes one penny.

Courses also available in Electronic Fundamentals, TV Servicing, Color TV, and Electronics for Automation.

**SEND FOR THIS  
FREE 64-PAGE  
CAREER BOOK  
TODAY!**



**RCA INSTITUTES, INC.**  
A Service of Radio Corporation of America

The Most Trusted Name in Electronics



LICENSED BY THE UNIVERSITY OF THE STATE OF NEW YORK

RCA Institutes, Inc., Home Study School Dept. PF-XO  
350 West Fourth Street, New York 14, New York

Please rush me your FREE illustrated 64-page book "Your Career in Electronics", describing your home training programs, including complete information on the new Transistor course. No obligation. No salesman will call.

Name \_\_\_\_\_ Age \_\_\_\_\_  
(please print)

Address \_\_\_\_\_

City \_\_\_\_\_ Zone \_\_\_\_\_ State \_\_\_\_\_

Korean Vets: Enter discharge date \_\_\_\_\_

**CANADIANS**—Take advantage of these same RCA Institutes courses at no additional cost. No postage, no customs, no delay. Send coupon to: RCA Victor Company, Ltd., 5581 Royalmount Ave., Montreal 9, Quebec

*TV Shop Owners AL GOGEL and TOM WALSH Say:*

# “Performance and flexibility why we prefer

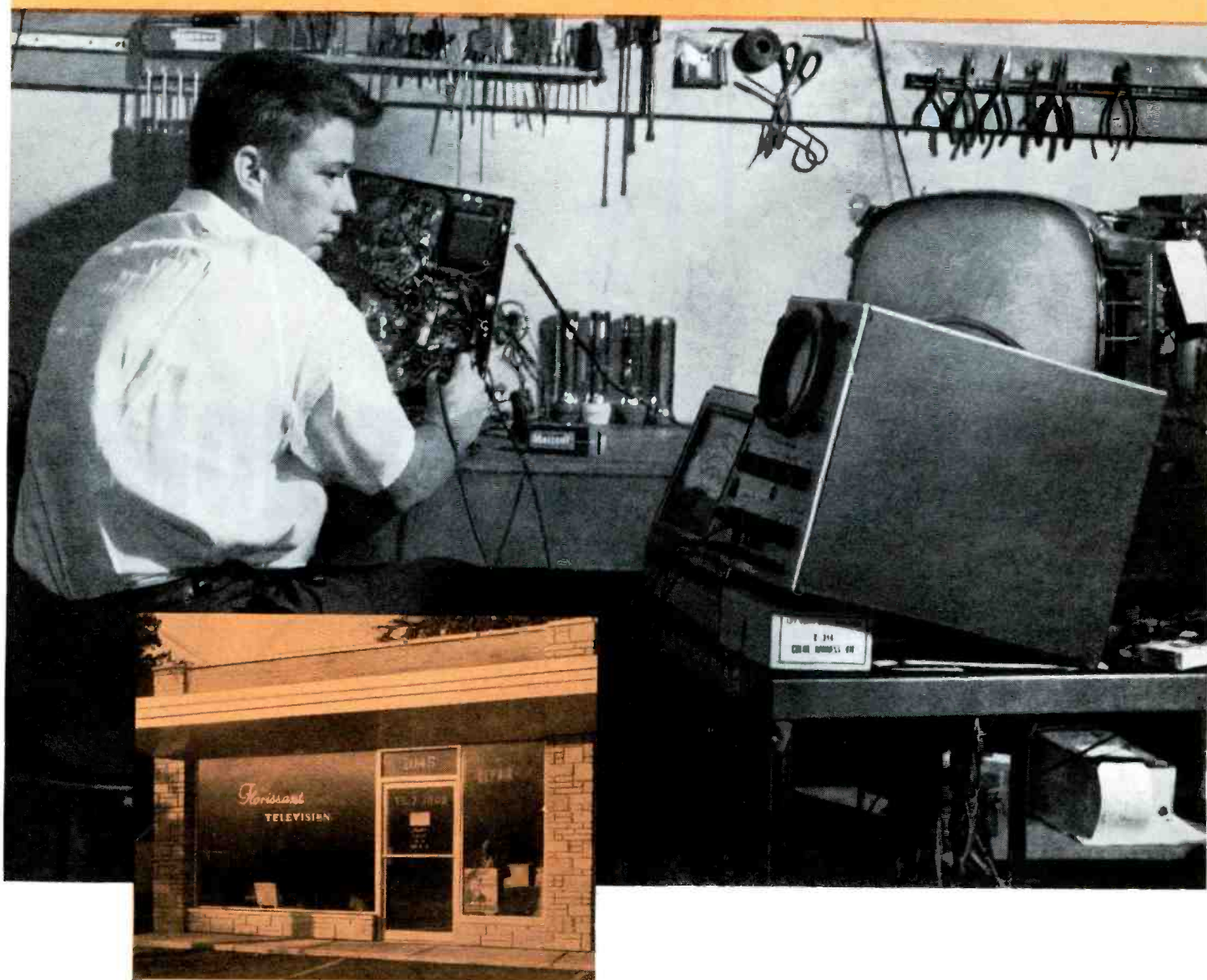

Al Gogel is a co-owner of Ferguson Television Sales and Service Company, Ferguson, Missouri, and Florissant Television, Florissant, Missouri, suburbs of St. Louis. After training at the American Television School, he started his own service shop.

Nine years ago, Al teamed up with Tom Walsh

and opened the store in Ferguson. They recently expanded into a new store in adjoining Florissant, and now employ one bench technician and three servicemen, with three trucks making 25 to 30 calls a day. They handle the warranty work on auto radios for the area's four major new car dealers, plus repair work for other dealers and used car lots.



# ...two good reasons MALLORY components"

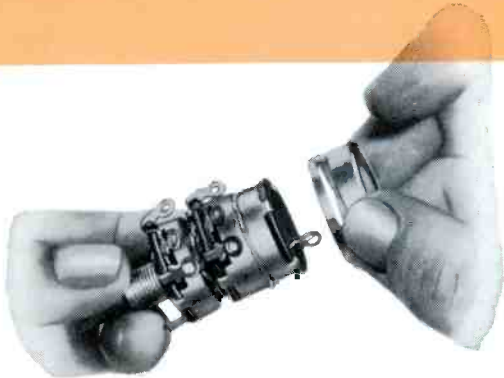

"In our business, using quality replacement parts is as important to steady growth as fast, courteous service is. That's why we use Mallory parts whenever we can; we know we can depend on their quality. We particularly like the Gem tubular capacitors and Sta-Loc® controls.

"There are two good reasons why we prefer Sta-Loc: first, naturally, is performance. There's never a call-back on these controls. Second, there's their flexibility. We can get any control we need with Sta-Loc—immediately—without having to check every distributor in town."

Stop Callbacks with These  
Quality Mallory Products . . .

Thousands of technicians have discovered that the flexibility of Mallory Sta-Loc controls spells real convenience. You can get any of over 38,000 types of single or dual controls—even the hard-to-find ones—made to order by your distributor in just 30 seconds. No more shopping, no more waiting. Convenient, too, because you can replace the line switch by itself, without unsoldering the control connections. As for dependability, you can always depend on Sta-Loc controls to work long and quietly.

Whatever your component needs, your best bet is your Mallory distributor. He has the widest line of Mallory quality products at sensible prices.

Distributor Division

P. R. MALLORY & CO. Inc.  
**MALLORY**

P. R. MALLORY & CO., Inc., INDIANAPOLIS 6, INDIANA



#### FP ELECTROLYTICS

The original 85°C capacitor. Etched cathode construction—standard in FP's at no extra cost—assures hum-free performance. High ripple current ratings.



#### GEMS

5 rugged, moisture-proof Mallory "Gem" tubular capacitors in a handy dispenser that keeps your stock fresh, clean, easy to find; prevents kinks in lead wires.



#### RMC DISCAPS\*

Made by the world's largest producer of ceramic disc capacitors. Long the original equipment standard. Supplied in a handy 3x5" file card package.



#### TC TUBULAR ELECTROLYTICS

Economically priced filter capacitors. Top performance proved in service and backed by years of Mallory experience. Hermetically sealed.

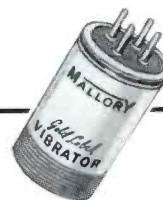

#### GOLD LABEL® VIBRATORS

The quietest vibrator ever made . . . for the best in radio servicing. Buttonless contact design gives longest life, sure starts for sure customer satisfaction.



#### MALLORY MERCURY BATTERIES

Unequaled for transistor radios . . . last several times longer, give steady power, stay "live" for years when idle. "First in space" in U. S. satellites.

\*Trademark of Radio Materials Company.  
A Division of P. R. Mallory & Co. Inc.

**Your votes made these Raytheon tubes**

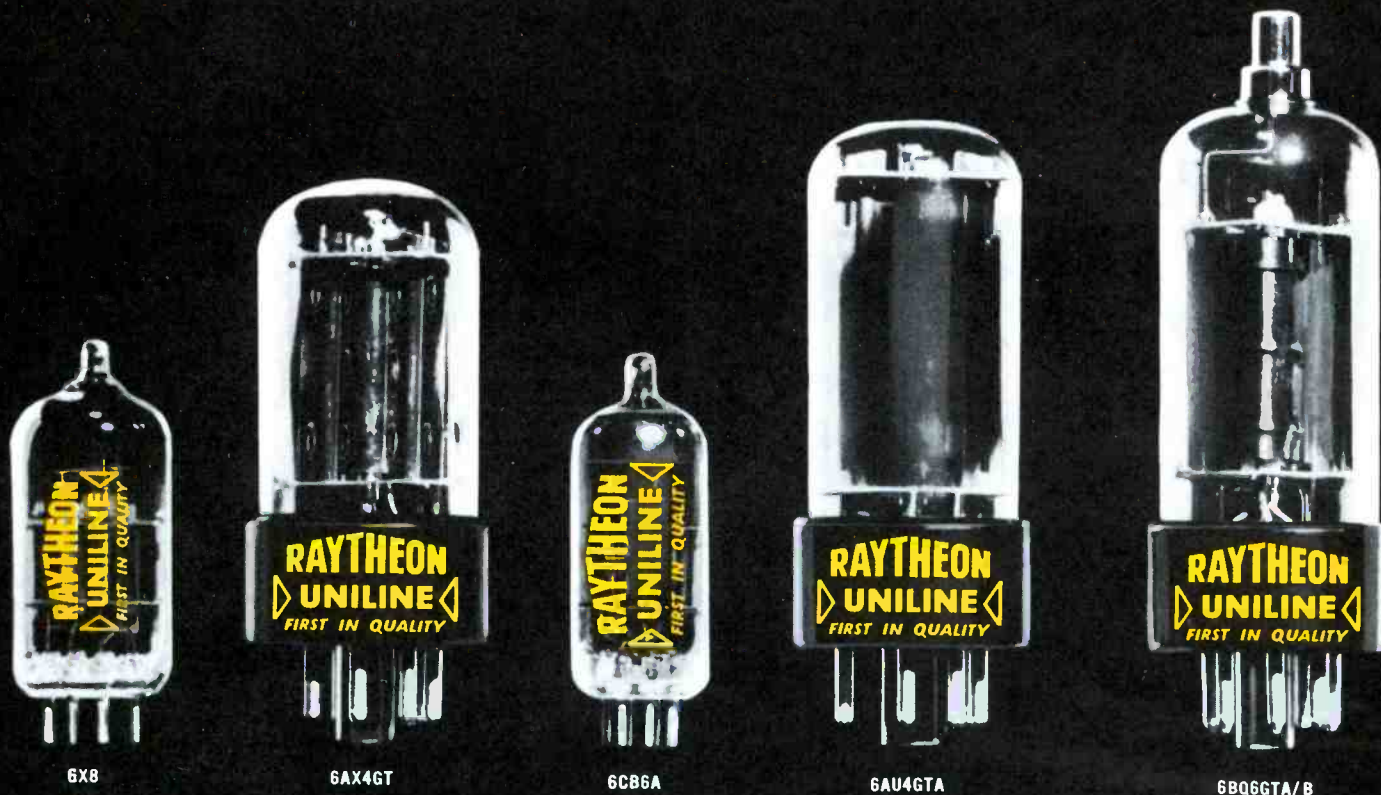

# THE TEN MOST

**UNILINE**—Raytheon's new standard of receiving tube quality is the result of your votes in our **Crusade Against Call-Backs.**

Raytheon took the ten tube types you voted to be the greatest troublemakers (regardless of brand) and made them the front-runners in our new line of tubes—UNILINE. With new improvements, new packaging, and a unique sampler "Ten-Pack," these tubes were introduced to the market only three months ago. Result? Tremendous acclaim from every section of the industry!

UNILINE receiving tubes give you trouble-free performance, highest quality in the industry, happy service customers . . . minimum call-backs.\* You can prove UNILINE superiority to yourself . . . simply call your Raytheon distributor today!

*\*See your distributor for literature describing unique Uniline features.*





6CG7

12A7

1X2A/B

1B3GT

6SN7GTB

# WANTED!

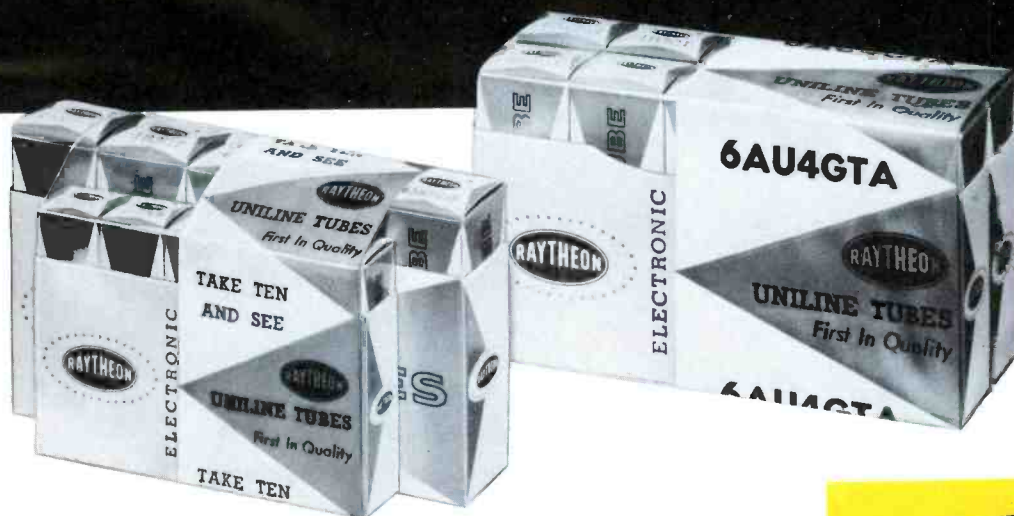

*“Take  
10  
and  
See”*

**RAYTHEON COMPANY**

DISTRIBUTOR PRODUCTS DIVISION

WESTWOOD, MASSACHUSETTS

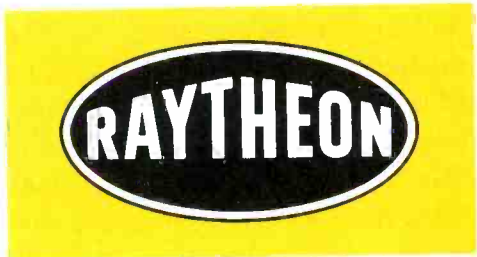

# GIVE YOUR STORE THE WITH NEW EYE-



PROSPECTS WILL STOP...LOOK...ENTER YOUR STORE  
when they see this attractive full-color window exhibit.

## PUT YOUR WINDOWS, COUNTERS, CORNER AREAS TO WORK SELLING TV SERVICE! LET PROFESSIONAL-DECORATOR SKILL INCREASE YOUR CUSTOMER LIST!

**T**HIRTY-FOUR display pieces are included in this year-round General Electric program to build customer traffic for your store or shop. All displays are handsomely processed in full colors. Many are reversible, with a different message and color treatment on either side. The range of decorative combinations that can be made up for window, counter, wall, or corner is almost unlimited. You can have a new display treatment every week in the year, if desired!

Easy-to-follow instructions show you how to create a number of attractive effects. Every grouping will be modern, lively, interesting—sure to draw attention, packed with “sell” that pays off in more service, tube, and parts business. Now—at low, low cost—step out ahead of other shops that don’t advertise! See your G-E tube distributor! Or use the coupon to order direct! *Distributor Sales, Electronic Components Division, General Electric Co., Owensboro, Ky.*

## PROFIT BY SERVICING PORTABLES!

Use this kit of full-color stand-up displays—one large, three small—to draw customers who want good service fast!

## SELL MORE TUBES AND MORE SERVICE!

Four colorful die-cut cards feature the importance of tubes and tube testing... with you as the expert to consult.

## THERE'S MONEY IN HI-FI SERVICE!

You want your share, and these full-color displays will help you get it. All are keyed to music and your audio facilities.

## GET THOSE AUTO-RADIO DOLLARS!

Keep them from rolling on by! Motorists will pull up at your shop when they see these effective service reminders.



# LOOK OF TOMORROW CATCHING G-E DISPLAYS!

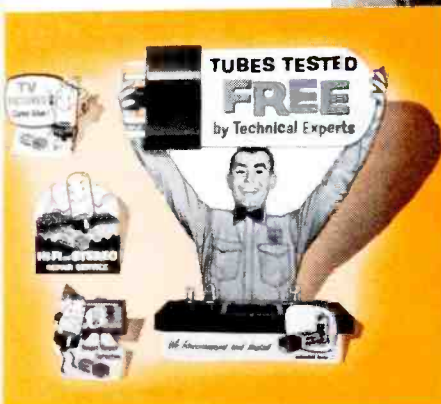

THAT "DRESS-UP" LOOK INSIDE! Mount a full-color interior display to tell your service story!

## \$8.00 DECORATES YOUR STORE FOR A WHOLE YEAR!

That's the bargain combination offer on both packages below! Mail coupon at right to the Chicago warehouse address given. Individual display-package costs are:

**ETR-2244.** "Dress-up" decorator package for store window and interior, 18 pieces in all, as shown in two large pictures across top. \$5.00

**ETR-2313.** "Self-Merchandiser" package of service-specialty kits, each with four stand-up cards, as shown in vertical illustrations at left. 16 pieces in all. \$5.00

General Electric Company, Dept. B  
3800 N. Milwaukee Ave.  
Chicago 41, Illinois

Kindly ship me prepaid:

- ETR-2244 at price of \$5.00 each.
- ETR-2313 at price of \$5.00 each.
- Combinations (both the above) at \$8.00 per pair.

My check money order is enclosed for the required amount plus any sales or use tax applicable in my area.

MY NAME \_\_\_\_\_

STREET ADDRESS \_\_\_\_\_

CITY AND STATE \_\_\_\_\_

*Progress Is Our Most Important Product*

**GENERAL**  **ELECTRIC**

311-404

# BEFORE YOU TOUCH THAT CHASSIS . . .

# THINK

DON'T THINK—  
**WORK**  
LET THE BOSS  
DO THE THINKING

Here's a sign that should *never* hang in a TV service shop. It naturally doesn't make sense in a one-man shop where the serviceman is his own boss, and it doesn't apply any better to technicians employed by a larger shop. The boss isn't interested in doing the thinking for his men; when it comes to troubleshoot-

ing TV sets, a serviceman earns his pay mostly by being able to reason out problems for himself.

Yet, many inexperienced servicemen are so anxious to begin working on a set that they leap to conclusions about where the source of the trouble might be. Once this snap judgment is made, they stick doggedly to it, working on the suspected circuit until they become discouraged. Men with more experience have generally learned to sit back and size up the situation more carefully before taking action. This involves many steps—critically looking at the picture, carefully adjusting various controls,

studying the schematic, recalling similar past experiences, and perhaps turning to reference books if needed to "get the wheels turning." This approach seems complicated, but it takes only a short while and enables you to begin working much closer to the seat of the trouble than you might believe possible.

I can recall many instances where I was able to save time by mulling over the problem before plunging into activity. For example, we once had a split-chassis Philco set in the shop for repairs to the horizontal circuit. While "cooking" the receiver

• Please turn to page 86

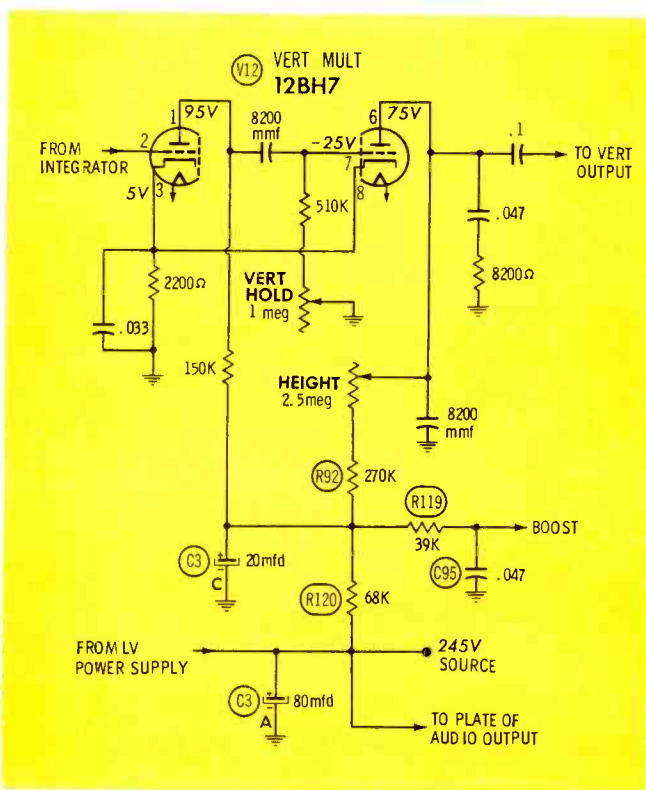

Fig. 1. Poor filtering of B+ supply to vertical multi-vibrator caused tunable hum to appear in audio output.

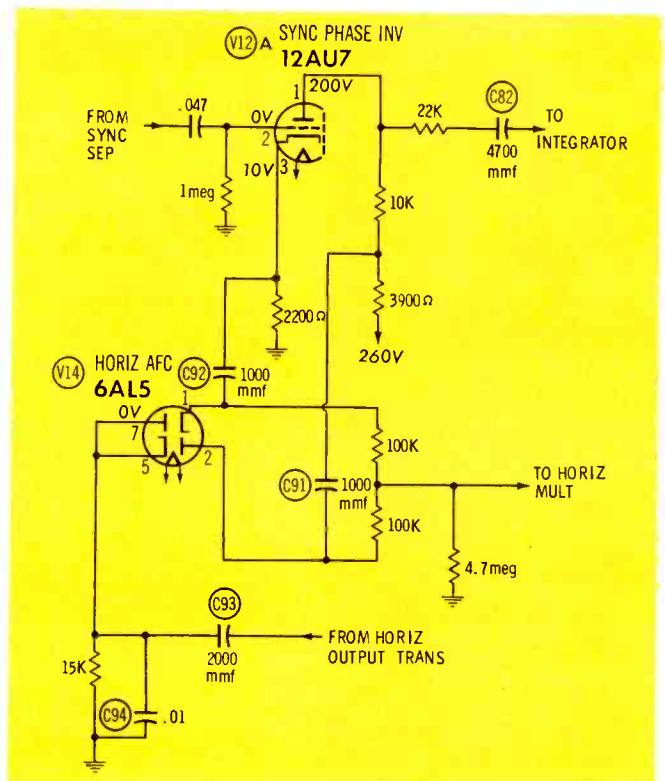
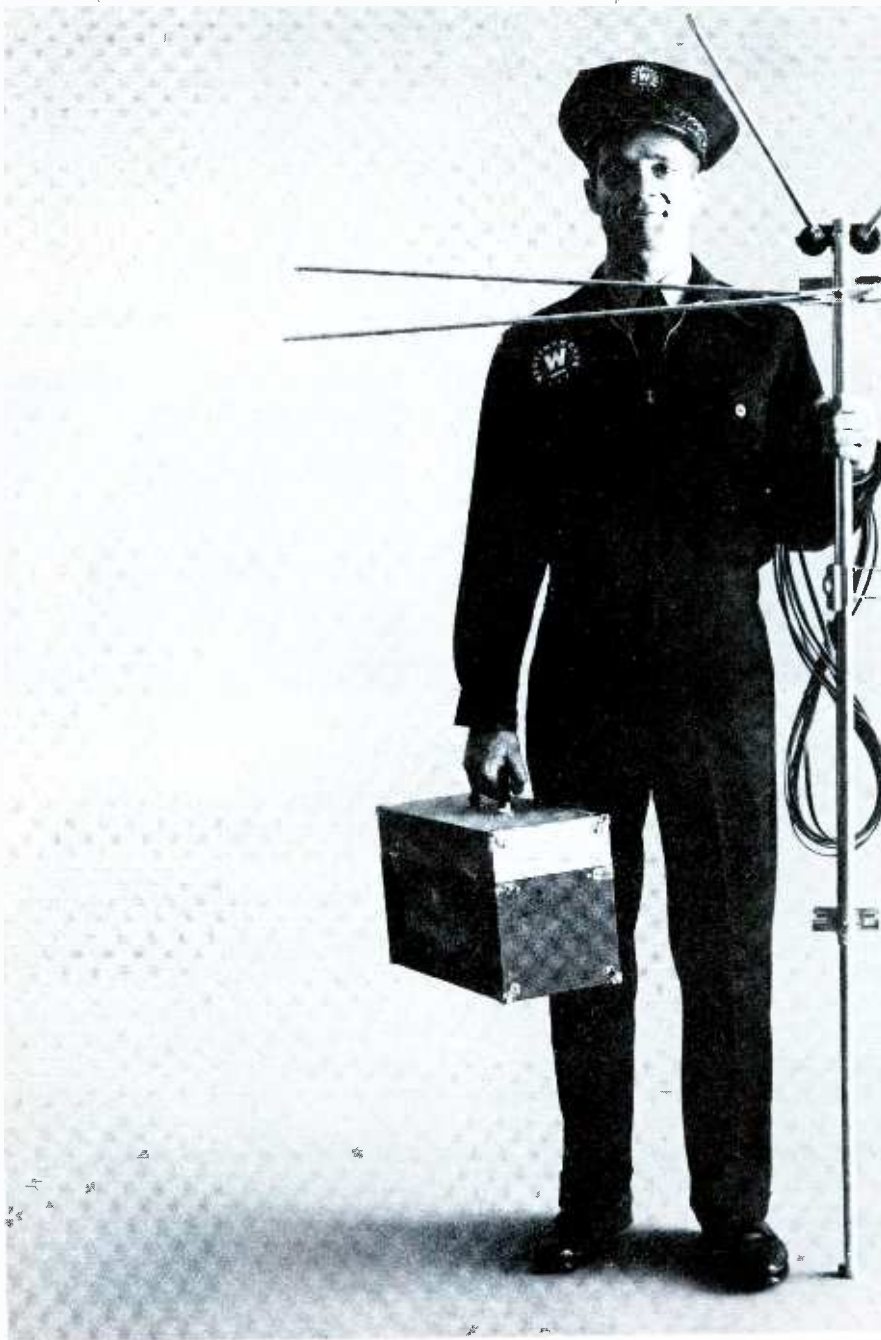

Fig. 2. Which component would be most likely to cause vertical roll, followed by severe unbalancing of AFC?





## The hardest thing to repair is your reputation

Your reputation is the difference between success and failure in your business. Westinghouse helps you maintain your reputation by designing its chassis with you, the service technician, in mind.

When our engineers put a chassis together, a member of the factory service department represents you. He looks at the design from your point of view. He sees to it that the components are arranged to make it easy for you to give maximum service to your customers.

Examine a Westinghouse chassis. One large PC board—the exclusive Westinghouse See-Matic—contains 80% of all circuits, with all component information on the

working side of the board for easy reference. There are B+ jumpers for easy isolation of shorts. All high-voltage transformer connections are clearly marked and are accessible outside of the cage.

The easier Westinghouse chassis are to repair, the better your reputation will be...and ours, too.

For complete information about Westinghouse Tech-Lit Factory Direct Mailing Service, write to Service Dept., Westinghouse Electric Corp., Metuchen, N. J., or your Westinghouse distributor.

**YOU CAN BE SURE...IF IT'S Westinghouse**

# Westinghouse Furniture TV & Stereo

Westinghouse Electric Corp., TV-Radio Division, Metuchen, N. J.

# causes and cures for

How to pinpoint defects that produce this

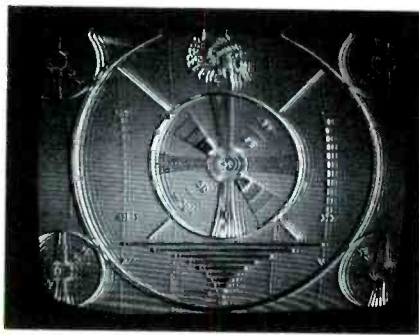

(A) Mild "gray-out" is false negative.

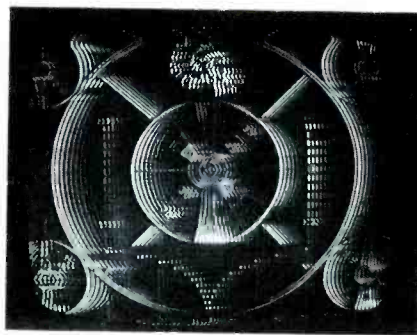

(B) Stronger "gray-out" shows ringing.

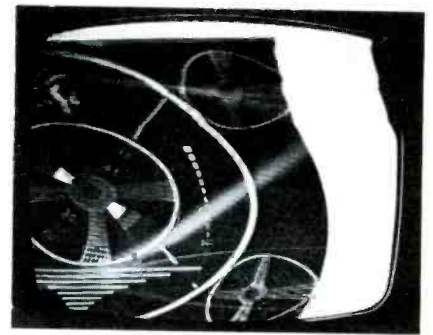

(C) True negative picture is reversed.

Fig. 1. Three picture symptoms commonly described as being negative.

Negative pictures have long plagued novice technicians and "old pros" alike. When a set comes into the shop with this trouble, some consider it a "dog" from the start. This attitude stems from a lack of understanding of the fundamental principles involved, as well as from a misinterpretation of the visual symptom.

Quite often the trouble symptom shown in parts A and B of Fig. 1 is misnamed a "negative picture," although it is definitely not the same

as a true negative image. Notice that the original black tones are still present, but the whites have turned to gray, and ringing within the circuit has produced "trailing whites" that give the picture a negative appearance. On the other hand, a true negative picture (Fig. 1C) is formed by a simple reversal of dark and light tones, with ringing usually slight or absent. True and false negative pictures may stem from somewhat related causes, but the two symptoms are different enough that

the distinction between them is important in troubleshooting.

## Understanding Symptoms

Close scrutiny of the image on the picture tube will reveal clues to the nature of the fault producing the negative picture. While this won't necessarily pin down the trouble to a specific component or stage, it will tell you what to look for in tracing the trouble to its source.

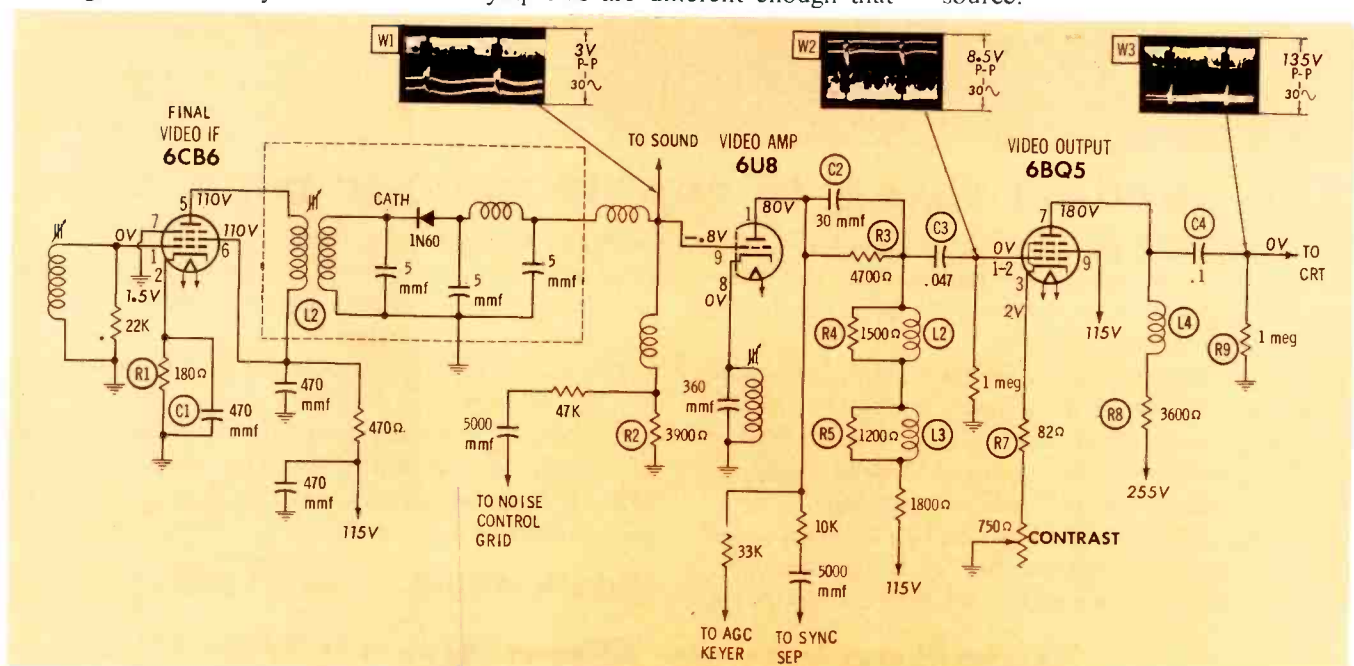

Fig. 2. Stages usually involved in tracing negative pictures to their source.



# NEGATIVE pictures

**misleading symptom . . . by Joe A. Groves**

The "gray-out" symptoms in Figs. 1A and 1B invariably point to a condition of tube saturation or excessive drive. Reducing input signal strength, adjusting the AGC control, or clamping the AGC line helps to isolate the affected stage. If any of these tests alter or remove the negative-picture symptom, the trouble is usually in the RF, IF, or AGC section. However, it is also possible for the fault to lie in a video amplifier stage.

A true negative picture (Fig. 1C) may result from signal rectification in the last IF stage, or may possibly be due to the addition or subtraction of a stage of video amplification. You may wonder how an additional stage can be created. For now, let's just say a video stage may become a *negative* amplifier. (We'll soon explain how this happens.) As for subtraction of a stage, the signal will occasionally be coupled through a dead video amplifier by means of stray capacitance; since it is not inverted in this process, a negative picture will result.

If the black and white tones in the negative picture are rich and clear, as shown in Fig. 1C, this generally points to rectification in the last IF. A very faint image — what you might call white and whiter-than-white — means the loss of a stage or a negative-amplification effect. We'd show you a picture of this last symptom, but the amount

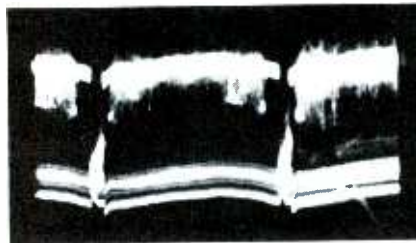

**Fig. 3. Nearness of video to blanking level in W3 indicates trouble.**

of contrast in the image is so slight as to render it practically invisible.

### Troubleshooting the Circuits

Up to this point we have considered only the general nature of the troubles which can produce certain symptoms. Before going further, let's take a brief look at the circuitry involved in tracing a negative-picture problem to its source.

The circuits chosen for this analysis are shown in Fig. 2. The two-stage video amplifier is a little unusual these days, but it presents no special troubleshooting problems; the extra stage just provides one more place for trouble to develop. (You'd follow the same general servicing procedure if the chassis had only one video amplifier and a cathode-driven picture tube.) Notice that the final video IF stage has been included in the schematic, since it plays a major role in many negative-picture troubles.

Take a critical look at waveforms W1, W2, and W3. These are your

main guideposts in analyzing negative-picture troubles. Of course, you should be quite familiar with normal composite video signals; but study them anyway. (For you fellows who haven't got around to using your scopes yet — dust 'em off and get with it! When you're tracing these troubles, voltage readings don't often mean what you might expect them to.)

See how the "blacker-than-black" sync-pulse region in W1 and W2 occupies roughly 25% of the total signal amplitude. On the other hand, W3 is an unconventional waveform with compressed sync pulses, indicating that the 6BQ5 video output tube is deliberately being driven into saturation by the sync portion of W2. This mode of operation increases the available video drive to the CRT, and yet it does not interfere with synchronization because the sync take-off point is on the input side of the 6BQ5.

Note that the black level (traced by the bases of the sync pulses) is well separated from even the "blackest" peaks of the video information. Malfunctions which produce negative pictures alter this relationship — sometimes quite drastically.

### "Gray-out"

Probably the most common symptom to be interpreted as a negative picture is the "gray-out" effect shown in Figs. 1A and 1B. This

• Please turn to page 82



(A) Scrambled video results when R8 is 56 ohms. Visual symptom is like Fig. 1B.



(B) When R8 is 10K, setting contrast at minimum produces this waveform.

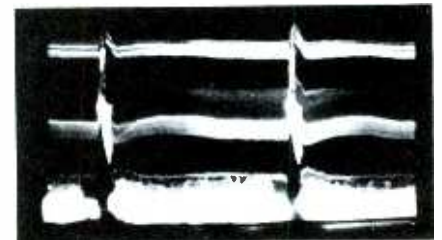

(C) The plate signal becomes inverted when the contrast control is advanced.

**Fig. 4. Waveforms produced by use of various plate-resistor values in the output stage.**

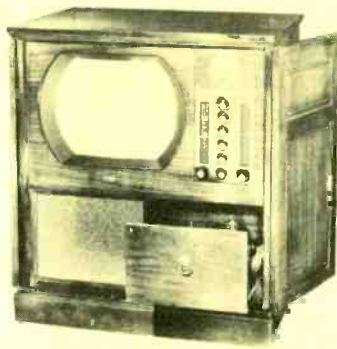

by Stan Prentiss

Wider, taller, and originally even more expensive than many of today's color receivers, the 1950-model DuMont RA-109 series gave the buyer a lot of TV set for his money. The big, L-shaped horizontal chassis has 35 tubes (including CRT, but not counting four receiving tubes in the radio tuner) — at least a dozen more than the average of its contemporaries. Dual dampers, two high- and two low-voltage rectifiers, and a pair of horizontal output tubes partially account for the "extras," but this doesn't tell the full story. These receivers also have such for-

# HIGH WIDE &

gotten luxuries as four video IF's, three sound IF's, two audio amplifiers *besides* the output stage, a separate AGC detector, and a DC restorer. The three-tube "front end" is an efficient *Inputuner* that continuously tunes all VHF TV channels and the FM radio band. A final touch of splendor is a massive power transformer with a built-in voltage-regulating feature.

Notwithstanding the great advances made in TV receiver design since 1950, this group of old DuMonts can be put back in such excellent shape that you wouldn't realize their age. True, these receivers have their weaknesses, and perhaps their problems are more numerous than those which modern sets will have 10 years from now. However, if you replace weak tubes, leaky and shorted paper tubular capacitors, off-value resistors, etc.,

many an old RA-109 will continue to render highly useful service. Of those under my wing, I have yet to see the first one sold, traded, or discarded. The same goes for the companion RA-112 and RA-113 series which were made the same year, but have "only" 26 tubes. With a little care, you can do well by these receivers, and make a solid buck in the process.

## A Typical Shop Job

I hadn't seen this particular RA-109 in almost two years. The last time, it had been in for repairs to the sound section. After I replaced several leaky bypass and coupling capacitors and one electrolytic, a good crystal-accurate IF and discriminator alignment turned the trick. Audio was pure, and the magic-eye tuning indicator on the output side of the discriminator

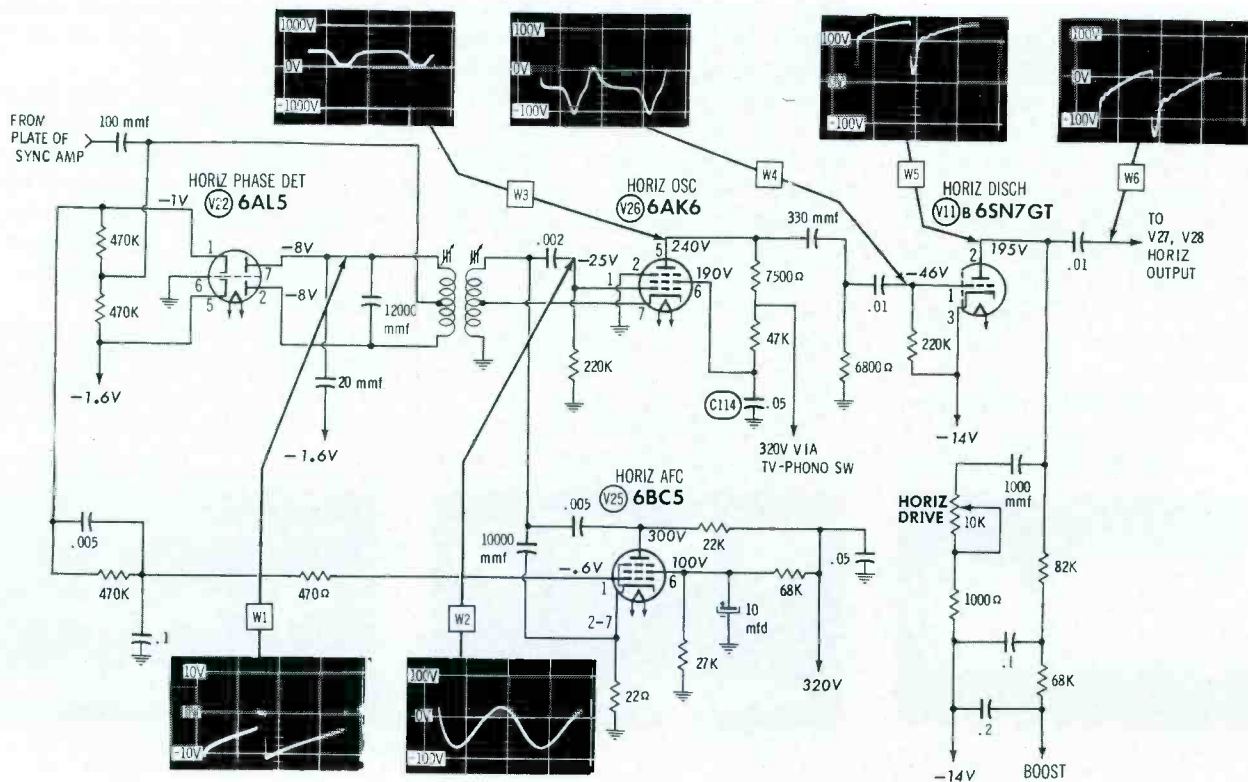
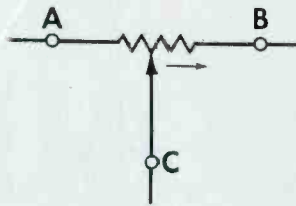
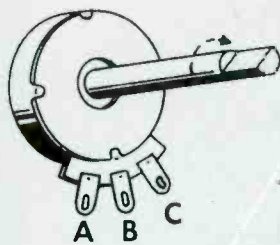

Fig. 1. Horizontal AFC and oscillator section of RA-109 Chassis, showing normal voltages and waveforms.





A control's total resistance should be measured across terminals A and C, and its taper or variable action between A and B. These points can be determined from a schematic by referring to the small arrow usually shown next to the resistive symbol. Denoting clockwise rotation, the arrow always points toward terminal C. To insure accurate resistance checks, beware of "sneak" or parallel paths through external circuits. Disconnect leads from all control terminals except one—unless, of course, leads are attached to capacitors or tube elements that provide no path for DC.



# HINTS ON MAKING CONTROL REPLACE- MENTS

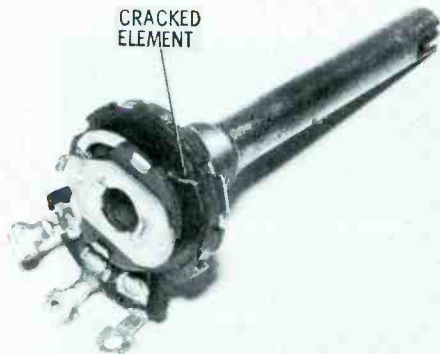

CARBON CONTROL

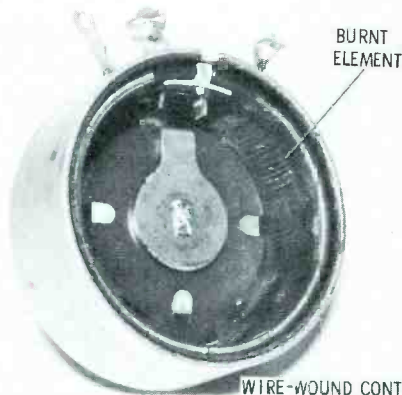

WIRE-WOUND CONTROL

A faulty control can sometimes be detected by simply rotating the shaft and noting whether or not there are any rough spots. You may even be led to the trouble by a "burnt" odor, or perhaps you'll find the shaft frozen—as is sometimes the case with wire-wound units. Occasionally a control will increase in resistance value, but this trouble is less likely to develop than an intermittent or open condition. Intermittent failure is most often caused by a cracked element, a poor internal connection at rivet points, or a dirty or bent wiper arm. When you encounter an open control, always check circuit conditions as you would before replacing a blown fuse or burnt E+ dropping resistor.

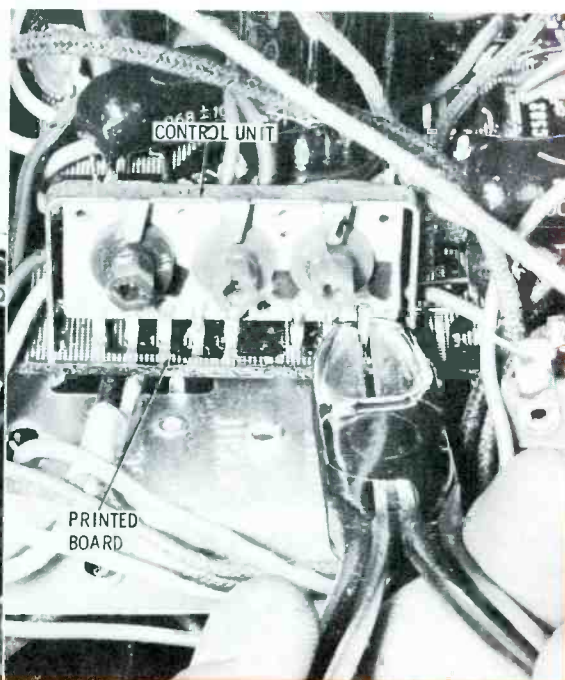
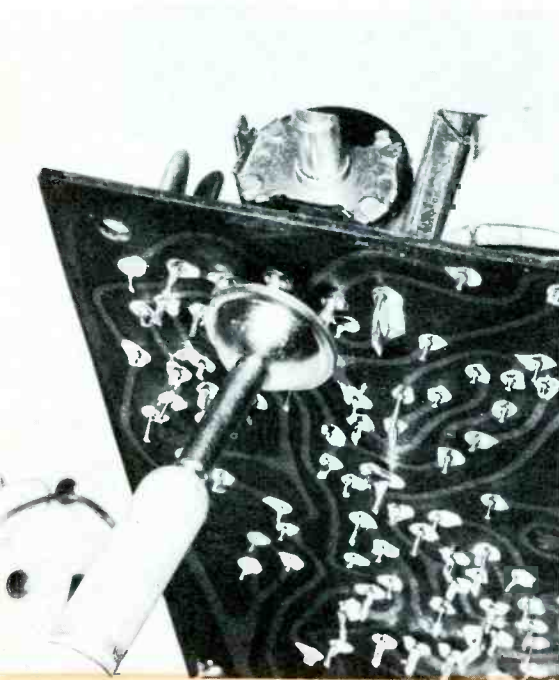

The word control naturally has a broad meaning, but to most of us who service radio and TV receivers, it takes on a very specific connotation—namely, "potentiometer." If you're having any trouble checking controls for defects, removing them from printed boards, or making them work when using other than an exact replacement or a manufacturer's original, the following tips should help you out. For additional help, refer to Volume 3 of "Replacement Guide for TV and Auto Radio Controls," just published by Howard W. Sams & Co., Inc.

Even when you've obtained an exact replacement for a control mounted on a printed wiring board, removing the old and installing the new can be a problem. Since the controls generally have a number of spear-type lugs, you'll find special soldering tips very helpful. Tips such as the one pictured, or wire loops fashioned to heat all terminals simultaneously, will help do the job in a jiffy. When a control is not entirely dependent upon its electrical connections for physical support, it may be more expedient to clip off the original terminals and solder the replacement to the remaining stubs. In the case of a multiple-control unit, the easiest procedure is to clip the pins as shown and then heat and remove them from the board individually.



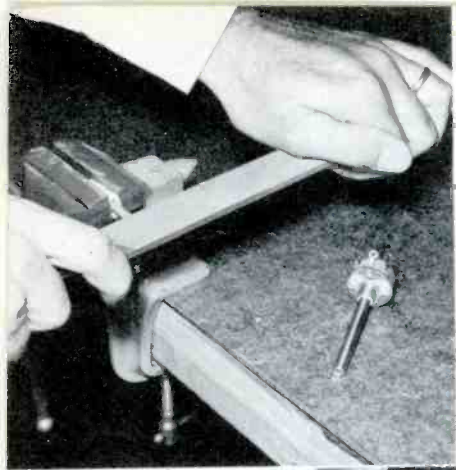

To accommodate a particular type of knob, a replacement shaft may occasionally have to be modified beyond routine alterations (such as cutting to proper length). Sometimes a "flat" must be filed on the end of a shaft or shaft extension like the round 3/16" example shown here. If convenient, position the control upside down in the vise to prevent filings from falling into the control and eventually damaging its elements.

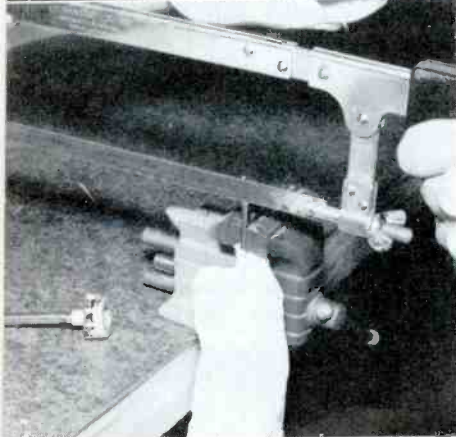

In many dual concentric controls employed in modern TV receivers, the inner shaft has a screwdriver slot accessible through the hollow outer shaft. Cut the inner shaft of the replacement unit shorter than the outer one, and file or cut a slot on the end of the inner shaft before the complete control is assembled. As shown here, a hacksaw may be used to cut the slot, after which burrs may be removed with a fine file. Note that the control element is covered during the cutting operation.

If the shaft of a replacement control is just a trifle too long, or if the bushing of a replacement must be flush with the outer mounting surface, a control can be set back from its mounting plane by using a simple spacer of some sort. Washers or a single bushing nut may be used in this application. To eliminate the possibility of the control working loose and turning, it's a good idea to place a lock washer next to the inner mounting surface as shown.

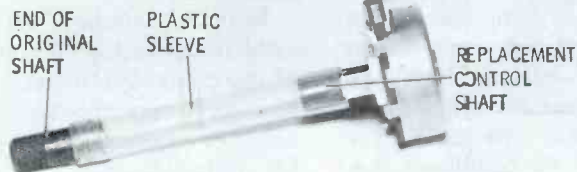
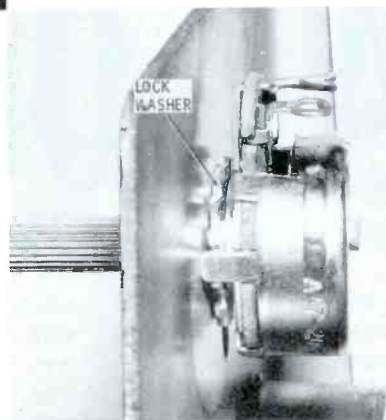

Replacement controls for TV service adjustments are sometimes designed with short, fixed shafts. When these units are used in place of a control having a longer shaft, an extension sleeve can be employed. The type shown here is a 2" hollow polyethylene tube. If the end of the original shaft has a finger-tip knurl or any other special feature, a portion of the shaft on the original control may be cut and then forced into the open end of the tube. Long pieces of similar plastic tubing are now available; you might carry a few of these in your caddy, since they are handy for the replacement of broken or damaged original plastic extensions often found on TV portables.

In many late-model TV receivers, you'll run across printed-board units which are a combination of two side-by-side controls. Provided the chassis is slotted to accommodate tab-mounted controls, single units may be used as replacements. However, cutting a dual control in two would result in a lack of physical support for the remaining half of the original unit; so both control elements generally must be replaced even if only one is found defective. If the replacements do not have spear-type terminals, lugs on the original unit may be clipped off and the replacement's terminals soldered to the remaining stubs.

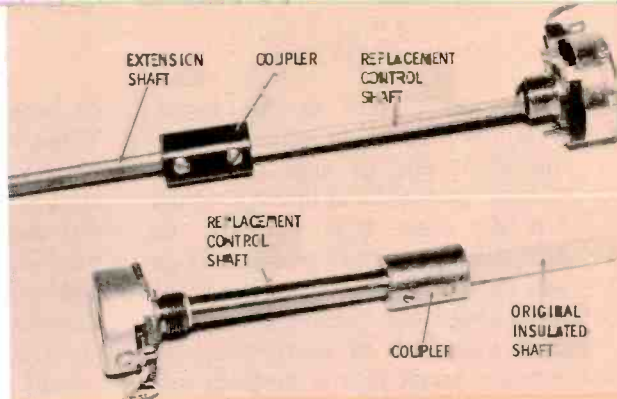

A coupler is useful for replacing a control with an exceptionally long shaft—also when you must duplicate a special insulated shaft or one with an odd diameter. In either case, a portion of the original shaft is spliced to that of the replacement.

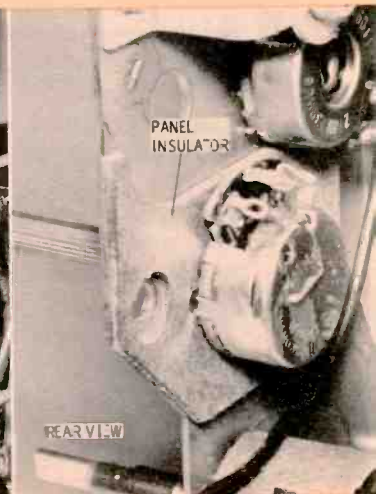

When the control being replaced has its shaft and/or case electrically isolated from chassis, always make sure the replacement is also isolated. Both surfaces of the mounting panel may be insulated as pictured here. If the fiber or other insulating material is damaged or missing, replace it before completing the job. When a metal shaft is involved, this situation becomes extremely important—especially if the receiver chassis is "hot."

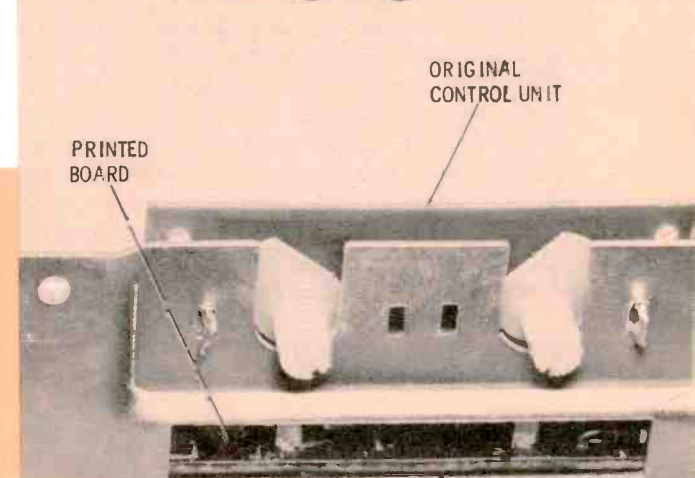
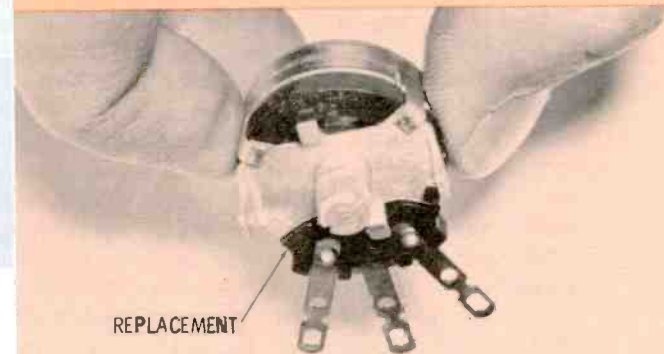

The AC outlet in the home, farm and office is an innocent looking affair, and its appearance has become standardized throughout the last fifty years. It is, however, the final delivery point of power, voltage and current and is the terminal for generating and delivery activity from thousands of sources. In the average circuit that is properly adjusted, designed and loaded, the outlet will normally deliver a 60-cycle alternating current at 117 volts. Note in the above statement that three words — *designed*, *adjusted* and *loaded* — condition the delivery of the proper voltage and current at the AC outlet.

In the design of voltage and current generating equipment, under-size generators and copper conductors as well as poorly designed line transformers and insulators have a cumulative effect on the delivered voltages.

Adjustments on generating and delivery equipment are made daily in the operation of the electric plant and in the scheduling of switching for peak and off-peak loading. Adjustments of the voltage regulation on the lines and of the taps on line transformers at the delivery points are also required.

Today only a small portion of the house and office load is permanently wired to the fuse panel — the rest might be termed migratory or mobile because it constitutes a load of the *plug-in* variety. In this last category, you will find such load items as: floor and table lamps, radio and television sets, refrigerators, deep-freeze units, electric ranges, fans, air conditioners, heaters, office calculators, small shop tools and electronic equipment. There are a number of other appliances that have the familiar AC cord with plug attached. Anyone who has tried to unravel the various line cords on his shop bench will know and understand the type of load we mean. This leads to a peculiar serviceman's disease known as "linecorditis." (Industrial loads, although a prime factor in line voltage variations, are omitted in this treatise for brevity.)

In addition to being migratory or mobile, the house and office load is a whimsical affair. It will vary with the weather, with the hours of the day, with the days of the week

or with the seasons of the year. These variations, if the line voltage regulation is poor, affect the voltages at AC outlets. It is because of this that power generation and distribution is no simple task, and elaborate devices are in use to detect changes in the load and make the necessary adjustments to keep the voltage stabilized.

At the points of delivery where the high voltage is stepped down to user level, we come to the place where the greatest compromises are required and where a great deal of damage can be done. Distribution transformers, varying in size and load capacity, can supply a single home, an office building, an apartment house, a group of homes or whole parts of a town or city. The primaries of these transformers are designed for the various standard

the delivered voltages to the outlets. Voltage regulators on the high voltage side are of some help, and properly designed distribution transformers can also minimize this variable. The big problem exists in the tap selection and the load conditions at the time of that selection. The secondary is generally set on the high side of 117 volts. This makes more power available at the consumer outlet and is satisfactory only if normal outlet voltages are not exceeded.

In a recent comparison of AC line voltage readings, a certain technician was amazed when his local power representative could not make a voltage check at a standard AC outlet. The power man's meter (a good one, by the way) had only alligator clips for attachment. The technician was curious about this

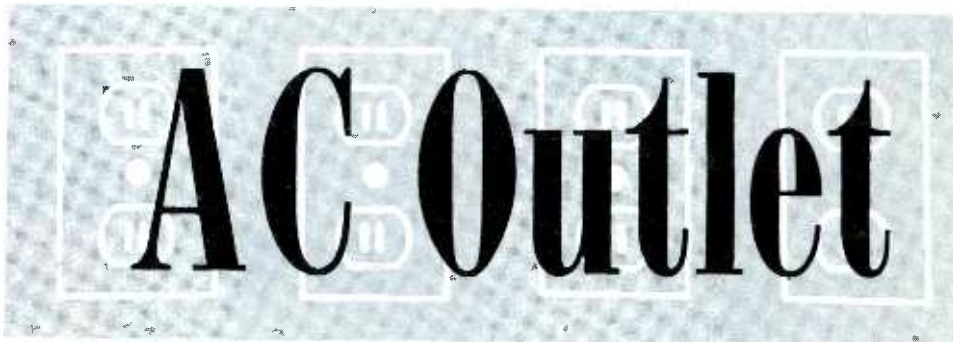

high voltages and currents that the distribution engineer selects for best delivery efficiency.

The secondaries of these units are primarily single-phase 220- or 110-volt windings with a common leg grounded and with taps which permit 3- or 4-volt incremental changes in the delivered voltages. Most of these taps are adjusted by the utility lineman and are set for a compromise of the conditions that exist at the time the lineman is at work on the pole. Some companies arbitrarily set these secondary taps at 125 volts. Other companies make a careful load appraisal and set the taps for what they feel will be best for average load conditions. Some taps are set and left undisturbed for long periods, while others may be changed frequently as load variables dictate.

At best, the selection of the tap to use on the secondary of the distribution transformer is a compromise, and the variable and mobile load previously described can alter

and asked if they had any meters with a standard AC plug. The reply was, "We set all distributed voltages from the transformer pole and need only alligator clips on our meter leads."

With a standard AC meter (which checked within one-half volt of the company's meter), a number of outlets were checked and a wide range of readings noted. A recording voltmeter plugged into a shop outlet over a long weekend showed wide swings and changes in the delivered voltage.

By this time, you are probably asking yourself what all this has to do with electronic servicing and why worry about it at all? You might even add that it's none of our concern anyway.

But, is it none of our concern?

About a year ago, a customer called at the shop with a 9-month old TV set of a good standard make and proceeded to detail the following complaints about the set's performance.



We were advised that the picture tube was still covered by the manufacturer's warranty. The principal complaint was that the set had been serviced seven times in the nine months of its use and that numerous complaints to the dealer had been of no avail — the breakdowns continued. Further questioning revealed most of the troubles had been due to tube failures for which, on the last five calls, the customer had been billed at standard rates. The customer was mad at the set, the dealer, the manufacturer and the serviceman.

On opening the back of the set, we noted that the set had a distinctive burnt odor. While the customer waited, the picture tube was tested — it proved to be a dud.

The chassis was removed, and an inspection of the cabinet revealed

added heat and lack of circulation combined with the high line voltage had caused rapid tube failure.

The customer was advised to call the service department at the power company and have them reduce the voltage and to call the shop when this had been done. The call came a couple of days later, and a check by our serviceman revealed that the voltage had been reduced — but only to 128 volts. The customer was advised that this was still too high and that it should be reduced still more. To get the power company to make this second change took a little time and some urging, but they finally adjusted the outlet voltage to 120 volts.

The television set was repaired by replacement of all obviously defective parts, together with the weak tubes and the picture tube.

appreciated when the voltages of the components of a television set are considered. For example, the picture tube of a popular make 21" television receiver requires an applied voltage of 18,000 volts at the anode to function at its normal efficiency. This means a voltage boost from the 115 volt source of supply to 18,000 volts at the picture tube anode. Now, if the voltage of the source of supply were to fluctuate widely, with a 10% to 15% drop below the normal 115 volts, then the same ratio of fluctuation will result in the voltage to the picture tube. A 15% drop in line voltage to 99 volts would result in the picture tube receiving only 15,300 volts. This is far below the engineered requirements needed for good video reception.

Over-voltage can also impair the performance and shorten the life of picture tubes. If primary voltage should increase to 130 volts, then automatically the voltage at the picture tube would proportionately increase to 20,200 volts which is more than the maximum tube rating.

All other electronic tubes are similarly affected by under-voltage or over-voltage. Whether it be for series-string circuits or conventional power transformer circuits, the heater current and heater voltage must remain within close limits to avoid tube failure from voltage surges or improper steady state voltage.

The experiences with television sets are the only ones cited here — but with high delivered voltages, other appliances are subjected to high wattage dissipations which can shorten their useful lives. High-wattage use makes for high meter readings and the customer pays in two ways — shorter equipment life and higher electric bills.

Repeated set failures have a way of reverberating against the technician who is called to get the set operating, and very few customers will patronize the same shop for seven repeat calls in nine months, even though a different failure is found each time. In this case, on the second call, the technician should have had doubts about the trouble, and the third tube replacement definitely should have made him look for something out of the ordinary. ▲

# Voltages

large spots of melted wax. A look at the chassis showed many capacitors with large wax drippings and dry casings, and wax from the horizontal-output transformer had melted in a glob at the bottom of the high voltage cage. The power transformer showed signs of overheating, and a test of the tube complement pointed out that many of the smaller tubes were defective.

Considering the service history on the set, permission was obtained to check the AC outlet voltages at the house. This check disclosed voltages ranging from 138 to 141 volts. Further questioning revealed that electric lamp failure was commonplace and that a high-wattage yard light required replacement every two or three weeks.

Additional probing revealed that with the voltage found at the house outlets, the set had been dissipating 240 watts. With normal voltage, it would have used only 175 watts. In addition, the set was located in a small cove near a gas heater. The

This experience has led us to adopt a policy of making line voltage and wattage checks whenever tube or component breakdowns occur at short intervals or callbacks for adjustment occur frequently. In some instances the meter is left connected in an outlet, out of the way of children, and mother and dad are asked to read the meter at intervals of one or two hours.

As a result of this procedure, high delivered voltages have been found more often than previously expected. We also found that where a number of houses are tapped to one transformer, the house closest to the transformer receives the highest voltages, the highest surges and the most damage to appliances. In some cases, these conditions can only be corrected with surge regulators and autotransformers for downward voltage adjustments.

The importance of having a constant voltage source of 115 to 120 volts for the operation of a television receiver may be more fully

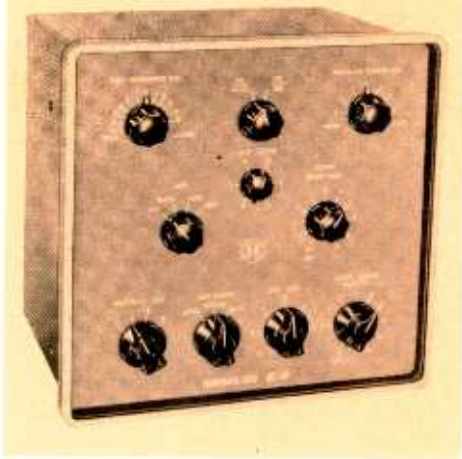

# SINGLE-SIDEBAND ADAPTERS

by Edward M. Noll

Ways of converting standard communications receivers to take advantage of SSB operations.

Single-sideband transmission is one of the more important signs of progress within the rapidly changing and expanding field of communications. On crowded communications-radio channels, the spectrum-saving feature of SSB transmission has found much favor. The reduction of carrier interference howls and squeals alone is an advantage that must be reckoned with on our nearly-saturated channels.

In short-wave communication, SSB sharply reduces the distortion caused by selective fading (attenuation of some frequencies, but not others, in a transmitted signal). The single-sideband technique also opens the door to useful new types of radio services such as two-channel multiplexing, where the upper and lower sidebands of a single RF carrier contain separate information.

The communications receiver, especially under adverse reception conditions, must offer peak performance if full benefit is to be attained from SSB transmission. Although a standard communications receiver with a stable beat-frequency oscillator can be used to demodulate an

SSB signal, some of the good characteristics of the SSB method are compromised. A better plan is to add an SSB adapter to a standard communications receiver.

The adapter obtains its signal from the IF amplifier of the receiver. Often this is accomplished by removing a plug from the adapter and inserting a plug from the receiver into the vacated socket. The tube is then plugged into the adapter. Hence, the SSB signal is removed from the regular communications receiver at the IF frequency.

As shown in the basic block diagram of an adapter (Fig. 1), the IF signal from the receiver is first applied to a mixer which converts it to a lower frequency range (generally somewhere between 50 and 150 kc). This low-frequency IF system contains a filter that permits the passage of frequencies in one sideband of the input signal but presents maximum attenuation to all other frequencies—particularly those corresponding to the undesired sideband.

This narrow-band selectivity is important in establishing a high

signal-to-noise ratio and in rejecting interference that could enter on frequencies adjacent to the desired information. Passbands are usually no more than 3 kc for voice communications. Receiver adapters with bandwidths up to 6 kc are available for systems which must convey music or other wide-range modulation. Some adapters have switching facilities that permit a choice of bandwidth.

## Choice of Sidebands

The adapter must be tuned to accept whichever incoming sideband is carrying the information. Three basic methods, as shown in Fig. 2, may be employed to select one sideband or the other. In the first plan (Fig. 2A), the frequency of the beating oscillator in the SSB mixer can be set to either side of the carrier frequency, depending on which sideband is being occupied by the incoming signal. Let us assume a condition in which the upper sideband (455-458 kc) contains all the modulation. Let us also assume that the IF bandpass of the adapter will accept only the frequencies between 100 and 103 kc. With the beating oscillator set to 355 kc, the upper sideband will be converted to the desired 100- to 103-kc range. If the modulation is on the *lower* sideband (452-455 kc), the beating oscillator must be reset to 555 kc in order to convert the input signal from the receiver to the adapter's IF passband.

In a double superheterodyne arrangement, one must keep in mind the frequency relationship between the receiver local oscillator and the incoming RF signal. When the os-

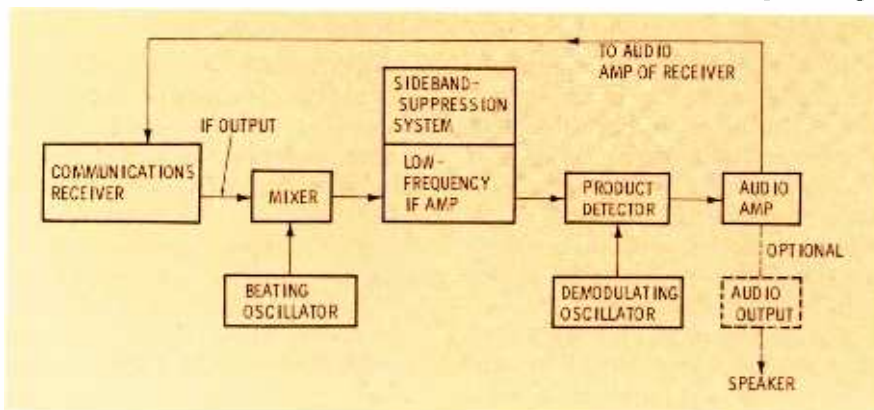

Fig. 1. Basic plan of a typical single-sideband adapter.



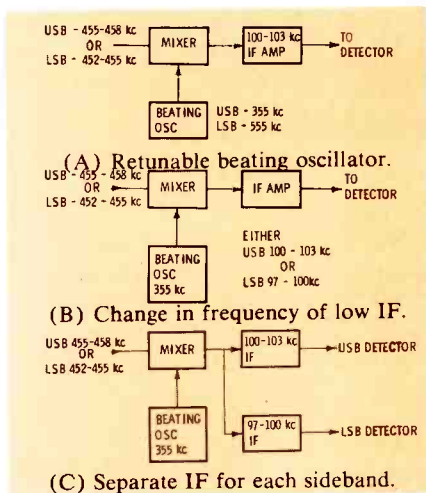

Fig. 2. Methods of sideband selection.

illator is tuned below the frequency of the input signal, the sidebands in the IF output will remain on the "same side" of the carrier as the original RF sidebands. (For example, the upper sideband of both the input and output signals will consist of frequencies higher than that of the carrier.) With the local oscillator changed over to the "high side" of the incoming signal (a common occurrence when a communications receiver is switched from one band to another), the sidebands exchange places when the signal is heterodyned. In other words, the upper sideband of an RF input signal becomes a lower sideband in the receiver IF amplifier. The SSB adapter must then be reset to pass the lower-frequency portion of its input signal, even though the upper sideband of the incoming RF signal is carrying the desired audio.

In the second method of selection (Fig. 2B), the passband of the adapter IF amplifier can be changed from 100-103 to 97-100 kc (or vice versa) by switching. The beating oscillator may then be given a fixed frequency of 355 kc, regardless of which sideband is to be passed. An incoming upper sideband beating against the 355-kc oscillator signal produces a 100- to 103-kc output; to receive the lower

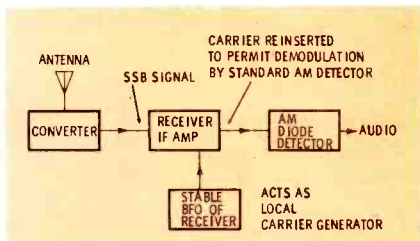

Fig. 3. How a standard communications receiver can demodulate SSB signals.

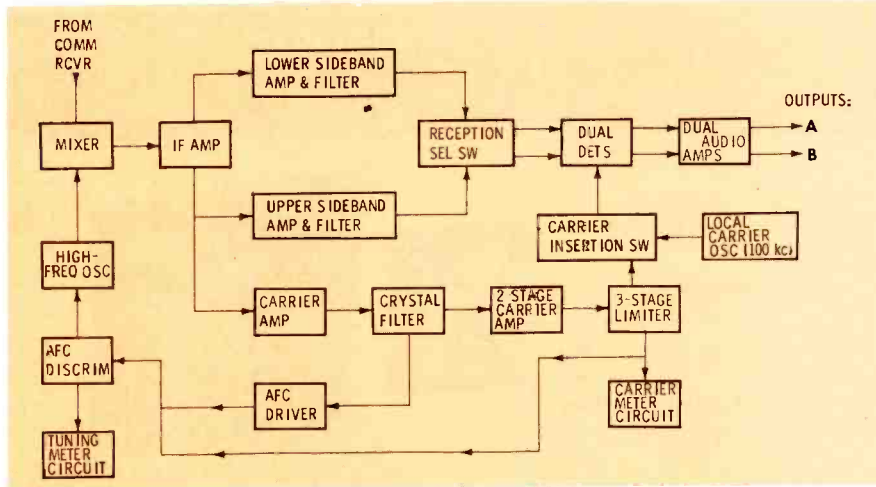

Fig. 5. Simplified block diagram of Crosby Type 51A adapter unit.

sideband, the IF acceptance range is set to 97-100 kc.

In the third method (Fig. 2C), two separate IF systems are incorporated in the adapter. One passes the upper sideband range; the other, the lower sideband spectrum. The desired sideband is chosen by selecting the output of the proper IF channel. This type of adapter is suited to multiplex reception. Both sidebands of an incoming signal could be carrying two different "streams" of information; in such instances, two separate and unrelated audio signals could be made available simultaneously at the output of the adapter.

### SSB Demodulators

The amplified SSB signal is next applied to the demodulator. In pure single-sideband systems (suppressed-carrier operation), the carrier frequency has been filtered out at the transmitter. If a substitute carrier is reinserted at the receiver, the SSB signal can be demodulated by a conventional AM detector. When a standard communications receiver is used for SSB reception, it is the BFO that reinserts the carrier. The signal can then be applied to the demodulator as shown in Fig. 3.

A standard AM detector is not the preferred circuit for SSB demodulation, because it is lacking in fidelity and noise rejection as compared to the special SSB demodulator circuit known as a synchronous detector. In this type of demodulator, a "beating" process is used to recover the original modulation. A CW oscillator reintroduces a carrier into the SSB signal at the demodulator. The output circuit is

tuned to the difference frequency between the carrier oscillator and the incoming IF signal—in other words, to the frequency range of the original audio modulation. For example, by introducing a 100- to 103-kc single-sideband signal to 0-3 kc.

Three typical demodulators are shown in Fig. 4. The one in part A of the illustration uses a multi-grid tube. The single-sideband IF signal is applied to the control grid, while carrier injection is made via the No. 3 grid. In addition to certain performance advantages, this type of demodulator requires only a very

• Please turn to page 77

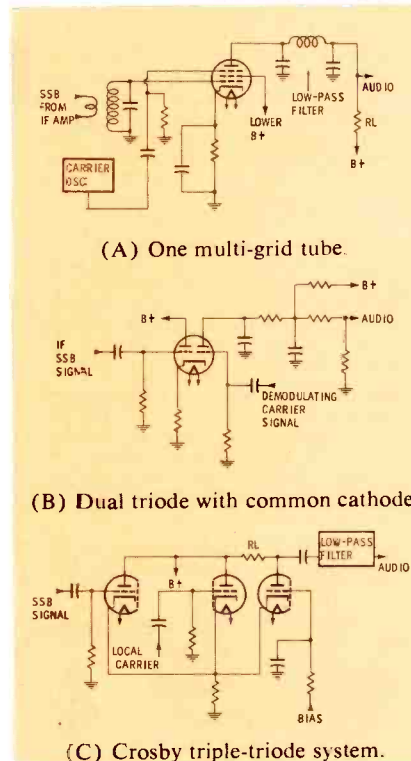

Fig. 4. Typical SSB demodulators.

# SENCORE

Most Popular Time Savers for Servicemen, Technicians, Engineers, Maintenance Men, Hobbyists!



## "MIGHTY MITE" TUBE CHECKER

Smaller than a portable typewriter . . . yet will outperform testers costing hundreds of dollars.



\$5950

A new dynamic approach to tube testing. Check over 1,300 tubes for cathode emission, grid emission, leakage, shorts and gas. A "mite" to carry but a whale of a performer that outperforms testers costing much more. New unique "stethoscope" approach tests for grid emission and leakage as high as 100 megohms yet checks cathode current at operating levels. Special short test checks for shorts between all elements. The Mighty Mite will test every radio and TV tube that you encounter (over 1,300!) plus picture tubes. Set up controls as easy as "ABC" from easy to follow tube chart. New features: • Meter glows in dark for easy reading behind TV set. • Stainless steel mirror in cover for TV adjustments. • Rugged, all steel carrying case and easy grip handle. • Smallest complete tester made. Measures only 9" x 8" x 2½" and weighs just seven pounds.

It's a real money-maker

## LC3 LEAKAGE CHECKER

Provides grid emission and leakage checks with the same sensitivity as the famous Mighty Mite but checks critical tubes only; 172 types

\$2895



Ask any serviceman who owns one . . . or try one for just one day of servicing. You'll see for yourself how much time the LC3 can save you. Checks for leakage between all elements, whether caused by gas, grid emission or foreign particles. Also checks leakage on all capacitors with voltage applied — including electrolytics. Provides instant filament checks in "Fil-Check" position—no need for a second filament checker. One spare pre-heating socket and new roll chart prevent obsolescence. New charts provided free. For 110-120 volts, 60 cycle AC.

## SENCORE SS105 SWEEP CIRCUIT TROUBLE SHOOTER

The Missing Link in TV Service . . .

**IT'S A . . . UNIVERSAL HORIZONTAL OSCILLATOR.** For direct substitution. No wires to disconnect in most cases. Traces trouble right down to the defective component. Variable output from 0-200 volts, peak-to-peak. Oscillator will sync to TV sync signal giving check on sync circuits.

**HORIZONTAL OUTPUT CATHODE CURRENT CHECKER.** A proven method that quickly checks the condition of the horizontal output tube and associated components. Adaptor socket prevents breaking wires. Easily replaceable Roll Chart gives all necessary pin, current and voltage data. New Roll Charts are Free.

**UNIVERSAL DEFLECTION YOKE.** A new, simple way to determine yoke failure accurately—without removing yoke from picture tube. Merely disconnect one yoke lead and substitute. If high voltage (also bright vertical line) is restored, TV yoke is defective.

**DYNAMIC FLYBACK TRANSFORMER CHECKER.** Merely flip switch to "Flyback Check" and meter will indicate condition of flyback transformer, in degrees of horizontal deflection. Extremely sensitive and accurate; even shows up one shorted turn on flyback.

**VOLTMETER.** For testing bootstrap, screen and other voltages. Direct-reading voltmeter. 0-1000 volts.



\$4295



|                        |                    |
|------------------------|--------------------|
| HORIZ. OSC.            | VERT. OSC.         |
| HORIZ. O.P. STAGE      | VERT. O.P. STAGE   |
| HORIZ. FLYBACK XFORMER | VERT. O.P. XFORMER |
| HORIZ. DEFLEC. YOKE    | VERT. DEFLEC. YOKE |

**UNIVERSAL VERTICAL OSCILLATOR.** Checks oscillator, output transformer and yoke. Merely touch lead to component and check picture on screen. **SS105 is completely self-contained, nothing else is needed.** New, improved Circuit.

## FC4 FILAMENT CHECKER

The ideal tool for servicing series string filaments.

\$275



Purposely works off your cheater cord to give you a positive check on line voltage. Prevents checking all tubes to find that your trouble was no line voltage. Only checker that checks all tubes automatically and has no batteries to replace. Cost half that of battery operated testers. Patented.

FC4 with test leads for checking continuity or AC or DC Voltage . . . \$295

## VB2 "VIBRA-DAPTOR"

Checks 3 and 4 prong Vibra tors Faster and Easier . . .

Plugs into any tube checker; ideal for use with LC3 or the Mighty Mite. To check 6v. vibrators, set for 6AX4 or 6SN7; for 12 v. vibrators, set for 12AX4 or 12SN7. Two No. 51 lamps indicate whether vibrator needs replacing. Instructions on front panel. Steel case.



\$275

## "FUSE-SAFE" CIRCUIT TESTER FS3

Instantly tells you whether or not it is safe to replace fuse resistors, fuses, or circuit breakers. Separate red and green scale for each commercially available fuse resistor used in radio and TV. Eliminates guesswork, wasted time. Also handy for wattage checks up to 1100 watts at 115v.

\$895



Time Savers for America's

ALL PARTS



Radio, TV and Electronic Minit-Men

MADE IN AMERICA

See your Parts Distributor Now or Mail Coupon on Opposite Page



# SENCORE *You can own all these popular Time Savers for less than some Mutual Conductance Tube Testers!*



## For TRANSISTOR RADIO SERVICING

Everything you need for less than \$50.00

**SENCORE TRC4 TRANSISTOR-RECTIFIER CHECKER**



**\$1995**

**Checks Transistors, Diodes, Rectifiers . . .**  
A transistor tester that is used by over 50,000 servicemen, engineers and experimenters from Coast to Coast. Recommended by TV and Radio manufacturers; used by such leading companies as Sears Roebuck, Bell Telephone and Commonwealth Edison. Tests indicate that the TRC4 will outperform testers costing many times more. The TRC4 tests all transistors for gain, leakage, and open or shorts. Simple to operate without set-up chart for service work and with set-up chart for more accurate checks. With batteries.

**SENCORE PS103 BATTERY ELIMINATOR & TROUBLE SHOOTER**  
**\$1995**



**Replaces Batteries During Repair . . .**  
Replaces batteries during repair time of transistor radios and helps trouble shoot, too. For transistor radio servicing, experimenting and to charge nickel cadmium batteries. Dial output voltage from 0 to 24 volts DC and read on meter. Low ripple insures no hum or feedback problem. Meter reads from 0 to 100 MA. Shorted stage will cause current to read high as indicated on PF schematics; open stage will cause current to read low. To align transistor radio, tune in station signal and adjust IF slugs for maximum current. The PS103 is the only supply that will operate radios with tapped battery supplies; such as Philco, Sylvania, Motorola, etc.

**SENCORE HG104**



**HARMONIC GENERATOR**

**\$995**

**Finds Defective Stage in a Minute . . .**  
Believe it or not. Just touch the output leads of the HG104 to inputs and outputs of transistors and a clear 1000 cycle note from speakers will tell you whether or not the stage is defective. Here is an unexcelled time saver, not a "pencil" gimmick. It actually works every time from speaker to antenna. Two leads and calibrated output (not found on pencils) are a must for speaker connection, grounding to prevent RF spray and front end checks. Also saves time when servicing HiFi, TV and radios. With life-time batteries.

**Get all 3** **COMPLETE TRANSISTOR RADIO SERVICE LAB**  
All 3 Time Savers shown above in handsome display carton carrying case

**MODEL TL107**  
**\$4985**



## For SUBSTITUTION SERVICING

Goodbye to messy parts . . . the mess of soldering and unsoldering in testing.

**SENCORE H36 "HANDY 36"**  
**\$1275**



**Substitute for Capacitors, Resistors . . .**  
Provides the 36 most often needed resistors and capacitors for experimenting, substituting or testing. Eliminates searching for replacement components, unnecessary soldering and unsoldering and the mess it creates. Says goodbye to crumpled parts. Flick of a switch instantly selects any of: 24 Resistors from 10 ohms to 5.6 megohms, 10 Capacitors from 100 mfd to .5 mfd, 2 Electrolytics, 10 mfd and 40 mfd at 450 Volts. All components are standard American brand.

**SENCORE ES102 ELECTRO-SUB**  
**\$1595**



**Substitute for Electrolytic Capacitors . . .**  
Complete, safe substitution . . . from the smallest electrolytics used in transistor radios to the largest used in costly Hi-Fi amplifiers. Contains 10 electrolytics from 4 to 350 mfd. Select correct value with the flick of a switch. Features automatic discharge, surge protector circuit. Prevents accidental "healing" of capacitor being bridged. Completely safe—no arc or spark when connecting or disconnecting. Usable from 2 to 450 volts, DC.

**SENCORE RS106 RECTIFIER TROUBLE-SHOOTER**



**\$1275**

**Locate faulty Rectifiers, Diodes . . .**  
This unique substitution unit simplifies trouble shooting rectifiers and diodes, gives you a positive check every time. Substitute for suspected rectifier or diode, watch picture or listen to sound and you'll know in seconds whether or not the rectifier or diode should be replaced. No guess work, soldering mess or time lost. The RS106 costs less than having loose rectifiers and diodes in the shop for testing and is worth many times more. A must for servicing voltage doubler circuits. Protected by a 1/2 amp. Slow Blow Fuse.

All 3 Time Savers shown above in handsome display carton carrying case **MODEL SL108 \$4145**

*See your Distributor . . . if he cannot help you, Pat will . . .*

**SENCORE BE3 "ALIGN-O-PAK"**  
Eliminates messy batteries in TV service work. Handy for alignment, AGC troubleshooting or checking gated sync circuits. Dial the voltage you need, 0-18 volts, positive or negative. Completely isolated DC supply, less than 0.1% ripple. Covers all voltages recommended by TV set manufacturers and in Photo Fact schematics. For 110-120V, 60 cycle AC.



**\$735**

**SENCORE**, ADDISON 4, ILLINOIS

Dear Pat: Will you please . . .

Send me \_\_\_\_\_ Time Savers  
(Model Numbers)

Check or M.O. enclosed (PP Prepaid.)     Send C.O.D.

Distributor's Name (if any) \_\_\_\_\_

Your Name \_\_\_\_\_

Street \_\_\_\_\_

City \_\_\_\_\_ Zone \_\_\_\_\_ State \_\_\_\_\_

ALL UNITS FULLY GUARANTEED OR MONEY BACK WITHIN 10 DAYS

# STOCK GUIDE

## for tv tubes

The tube types listed on this page should account for well over 90% of your tube stock requirements. To keep the chart down to a manageable size, about 100 of the rarest type numbers have been omitted; however, we will keep you informed on these rare types and where they are found. Look for this information in *Previews of New Sets*, and also in special coverages like the article "The 1960 Crop of TV Tubes" in the March, 1960 issue.

Two columns of figures are listed along with the type numbers in the chart. The first column is purely a matter of statistics. Here's the meaning of the figures:

If you took a cross-section sampling of 1,000 tubes from all TV sets now in service, you could expect to find the stated number of tubes of each type in this sample. (To avoid omitting many types which are only moderately popular, we have listed a figure "1" for each type with a usage frequency of at least once per 2,000 sockets.)

This column of figures, as it stands, is naturally not a suggestion to stock the exact number of tubes listed. The statistics should be combined with your own experience to produce information tailored to your own needs. Here are three factors to be considered:

1. Relatively high failure rate of certain types such as cascode RF amplifiers and power output tubes.
2. Specialization in certain makes of sets, such as regional brands. (As a national publication, PF REPORTER necessarily gives nationwide averages based on all brands of receivers.)
3. Average age of those sets which contain a particular tube type.

The second column of figures marked "Caddy Stock" is a suggested stock of 350 tubes to be carried on home calls—either in two medium-size caddies or one "king-size" caddy. This list attempts to strike a balance between having enough different types and having a sufficient stock of widely-used types to meet most contingencies.

Keep yourself informed of trends toward increased or decreased use of various tube types. This is easy to do by comparing the current *Stock Guide* with previous editions, which appear in the April and October issues.

Note: \*indicates a 450-ma series-string tube.

| PER CADDY TUBE<br>1000 STOCK TYPE |   |           | PER CADDY TUBE<br>1000 STOCK TYPE |   |          | PER CADDY TUBE<br>1000 STOCK TYPE |   |           | PER CADDY TUBE<br>1000 STOCK TYPE |   |           | PER CADDY TUBE<br>1000 STOCK TYPE |   |           |
|-----------------------------------|---|-----------|-----------------------------------|---|----------|-----------------------------------|---|-----------|-----------------------------------|---|-----------|-----------------------------------|---|-----------|
| 33                                | 5 | 1B3GT     | 1                                 | 1 | 5EA8     | 1                                 | 1 | 6BK5      | 1                                 | 1 | 6DB5      | 1                                 | 1 | *8CG7     |
| 7                                 | 2 | 1G3GT     | 1                                 | 1 | 5EU8     | 6                                 | 2 | 6BK7A/-B* | 2                                 | 2 | 6DE4      | 1                                 | 1 | 8CX8      |
| 4                                 | 1 | 1J3       | 1                                 | 1 | 5J6      | 4                                 | 2 | 6BL7GT    | 5                                 | 2 | 6DE6      | 1                                 | 1 | 8GN8/8EB8 |
| 1                                 | 1 | 1K3       | 2                                 | 1 | 5T8      | 2                                 | 2 | 6BN4      | 1                                 | 1 | 6DE7      | 1                                 | 1 | *9AU7     |
| 1                                 | 1 | 1S2A/DY87 | 37                                | 6 | 5U4GB    | 7                                 | 2 | 6BN6      | 1                                 | 1 | 6DG6GT    | 2                                 | 1 | 10DE7     |
| 8                                 | 3 | 1X2B      | 6                                 | 3 | 5U8      | 2                                 | 1 | 6BN8      | 2                                 | 1 | 6DK6      | 1                                 | 1 | 12AF3     |
| 2                                 | 1 | 2BN4      | 2                                 | 1 | 5V3      | 3                                 | 2 | 6BQ5      | 2                                 | 1 | 6DN7      | 6                                 | 3 | 12AT7     |
| 3                                 | 2 | 2CY5      | 1                                 | 1 | 5X8      | 12                                | 3 | 6BQ6GTB   | 13                                | 4 | 6DQ6B     | 21                                | 6 | 12AU7/-A  |
| 2                                 | 1 | 3A3       | 2                                 | 1 | 5Y3GT    | 12                                | 4 | 6BQ7A     | 1                                 | 1 | 6DR7      | 1                                 | 1 | 12AV5GA   |
| 2                                 | 1 | 3AL5      | 1                                 | 1 | 6AB4     | 1                                 | 1 | 6BR8A     | 1                                 | 1 | 6DS5      | 1                                 | 1 | 12AV7     |
| 4                                 | 2 | 3AU6      | 2                                 | 1 | 6AC7     | 1                                 | 1 | 6BS8      | 1                                 | 1 | 6DT5      | 8                                 | 3 | 12AX4GTB  |
| 1                                 | 1 | 3BC5      | 1                                 | 1 | 6AF3     | 4                                 | 2 | 6BU8      | 6                                 | 2 | 6DT6      | 4                                 | 3 | 12AX7     |
| 3                                 | 2 | 3BN6      | 3                                 | 2 | 6AG5     | 1                                 | 1 | 6BW8      | 1                                 | 1 | 6EA7      | 1                                 | 1 | 12AZ7A    |
| 3                                 | 2 | 3BU8      | 1                                 | 1 | 6AG7     | 1                                 | 1 | 6BX7GT    | 5                                 | 2 | 6EA8      | 1                                 | 1 | 12B4A     |
| 16                                | 4 | 3BZ6      | 2                                 | 1 | 6AH4GT   | 3                                 | 2 | 6BY6      | 1                                 | 1 | 6EM5      | 8                                 | 3 | 12BH7A    |
| 10                                | 3 | 3CB6      | 4                                 | 2 | 6AH6     | 1                                 | 1 | 6BY8      | 2                                 | 1 | 6ER5      | 1                                 | 1 | 12BQ6GTB  |
| 2                                 | 1 | 3CS6      | 1                                 | 1 | 6AK5     | 21                                | 6 | 6BZ6      | 1                                 | 1 | 6ES8      | 1                                 | 1 | 12BV7     |
| 1                                 | 1 | *3CY5     | 39                                | 4 | 6AL5     | 2                                 | 1 | 6BZ7      | 1                                 | 1 | 6E08      | 11                                | 4 | 12BY7A    |
| 2                                 | 1 | 3DK6      | 5                                 | 2 | 6AM8/-A* | 4                                 | 2 | 6C4       | 2                                 | 1 | 6EW6      | 3                                 | 2 | 12C5/-CU5 |
| 6                                 | 2 | 3DT6      | 4                                 | 2 | 6AN8/-A* | 82                                | 8 | 6CB6      | 1                                 | 1 | 6FH5      | 1                                 | 1 | 12CA5     |
| 2                                 | 2 | 4BC8      | 18                                | 4 | 6AQ5/-A* | 2                                 | 2 | 6CD6GA    | 1                                 | 1 | 6FV6      | 1                                 | 1 | 12CU6     |
| 2                                 | 1 | 4BQ7A     | 3                                 | 1 | 6AS5     | 2                                 | 1 | 6CF6      | 1                                 | 1 | *6FV8     | 2                                 | 1 | 12D4      |
| 1                                 | 1 | *4BU8     | 1                                 | 1 | 6AS8     | 30                                | 7 | 6CG7      | 1                                 | 1 | 6GH8      | 1                                 | 1 | 12DB5     |
| 2                                 | 1 | *4BZ6     | 2                                 | 1 | 6AT6     | 5                                 | 2 | 6CG8/-A*  | 3                                 | 2 | 6GN8/6EB8 | 7                                 | 3 | 12DQ6B    |
| 1                                 | 1 | *4CB6     | 2                                 | 2 | 6AT8/-A* | 2                                 | 1 | 6CL6      | 2                                 | 1 | 6J5       | 1                                 | 1 | 12DT5     |
| 1                                 | 1 | *4CS6     | 5                                 | 2 | 6AU4GTA  | 1                                 | 1 | 6CL8/-A*  | 13                                | 4 | 6J6       | 1                                 | 1 | 12ED5     |
| 1                                 | 1 | *4DE6     | 67                                | 6 | 6AU6     | 1                                 | 1 | 6CM6      | 4                                 | 2 | 6K6GT     | 3                                 | 2 | 12L6GT    |
| 1                                 | 1 | *4DT6     | 3                                 | 2 | 6AU8A    | 5                                 | 2 | 6CM7      | 1                                 | 1 | 6S4A      | 2                                 | 2 | 12SN7GTA  |
| 2                                 | 1 | 5AM8      | 2                                 | 2 | 6AV5GA   | 2                                 | 1 | 6CN7      | 1                                 | 1 | 6SL7GT    | 1                                 | 1 | 12W6GT    |
| 1                                 | 1 | 5AN8      | 10                                | 3 | 6AV6     | 2                                 | 1 | *6CQ8     | 41                                | 8 | 6SN7GTB   | 1                                 | 1 | *13DE7    |
| 6                                 | 2 | 5AQ5      | 14                                | 4 | 6AW8A    | 3                                 | 2 | 6CS6      | 2                                 | 1 | 6SQ7      | 1                                 | 1 | *13DR7    |
| 1                                 | 1 | 5AS4      | 27                                | 6 | 6AX4GTB  | 1                                 | 1 | 6CS7      | 10                                | 3 | 6T8       | 1                                 | 1 | *17D4A    |
| 2                                 | 1 | 5AT8      | 4                                 | 2 | 6BA6     | 1                                 | 1 | 6CU5      | 15                                | 5 | 6U8/-A*   | 2                                 | 1 | *17DQ6B   |
| 1                                 | 1 | 5B8       | 2                                 | 1 | 6BA8A    | 2                                 | 2 | 6CU6      | 1                                 | 1 | 6V3A      | 3                                 | 2 | 19AU4GTA  |
| 1                                 | 1 | 5BK7A     | 3                                 | 2 | 6BC5     | 1                                 | 1 | *6CU8     | 10                                | 3 | 6V6GT/-A* | 1                                 | 1 | 25AX4GT   |
| 1                                 | 1 | 5BR8      | 3                                 | 2 | 6BC8     | 1                                 | 1 | 6CX8      | 7                                 | 3 | 6W6GT     | 1                                 | 1 | 25BK5     |
| 1                                 | 1 | 5BW8      | 4                                 | 2 | 6BE6     | 2                                 | 2 | 6CY5      | 6                                 | 2 | 6X8       | 1                                 | 1 | 25BQ6GTB  |
| 3                                 | 2 | 5CG8      | 2                                 | 2 | 6BG6GA   | 1                                 | 1 | 6CY7      | 3                                 | 1 | 7AU7      | 1                                 | 1 | 25CD6GB   |
| 2                                 | 1 | 5CL8A     | 2                                 | 1 | 6BH8     | 1                                 | 1 | 6CZ5      | 1                                 | 1 | *8AW8A    | 1                                 | 1 | 25DN6     |
| 1                                 | 1 | 5CZ5      | 1                                 | 1 | 6BJ8     | 1                                 | 1 | 6DA4      | 1                                 | 1 | 8BQ5      | 2                                 | 1 | 25L6GT    |

New this issue: To make this chart easier to use, all figures are shown to LEFT of tube types.



the people who brought you the



### THE LIFETIME GUARANTEE

Utah will renew or replace **free** this loudspeaker due to **any performance failure** at any time during the lifetime of original owner. **No charge** made for handling, inspection, labor, materials or servicing for any repair or replacement. Customer pays postage only.

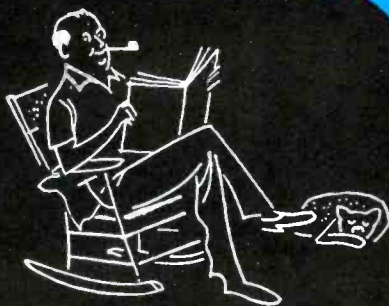

**MORE POWER**

**PER POUND**

**SPEAKER** now offer  
**MORE SOUND**  
**PER LIFE**

in the revolutionary

*utah*

# LIFETIME SPEAKER

**guaranteed**

**for the life of the owner**

24 hours a day, we lay our reputation (and our profits) on the block! We *guarantee* perfection of performance for a lifetime. To do this, we *have* to make the speakers of our lifetime . . . and we do!

Order a Utah Lifetime for your next replacement and see! (All popular sizes and shapes).

*utah*  
LIFETIME  
SPEAKERS 

Utah Radio & Electronic Corp., Huntington, Ind.

from **EICO**... a completely new  
CITIZENS BAND TRANSCEIVER

that meets  
FCC regulations\*



Model 760: 117 VAC  
Kit \$59.95 Wired \$89.95

Model 761: 117 VAC & 6 VDC (Kit \$69.95  
Model 762: 117 VAC & 12 VDC (Wired \$99.95  
incl. mtg. bracket (Pat. Pend.)

\*EICO premounts, prewires, pretunes, and seals the ENTIRE transmitter oscillator circuit to conform with FCC regulations (Section 19.71 subdivision d). EICO thus gives you the transceiver in kit form that you can build and put on the air without the supervision of a Commercial Radio-Telephone Licensee!

Highly sensitive, selective SUPERHET (not regenerative) receiver with 5½ dual function tubes and RF stage. Continuous tuning over all 23 bands. Exclusive Super-Hush® noise limiter. AVC. 3" x 5" PM speaker. Detachable ceramic mike. 5-Watt crystal-controlled transmitter. Variable "pi" network matches most popular antennas. 12-position Posi-Lock® mounting bracket. 7 tubes and 1 crystal (extra xtals \$3.95 each). Covers up to 20 miles. License available to any citizen over 18—no exams or special skills required, application form supplied free. Antennas optional.

**YOU PROFIT WITH EICO**

Everything in top-quality  
TEST EQUIPMENT for Shop  
and Field—at savings of 50%.



COLOR & Mono DC-5MC  
Lab & TV 5" Oscilloscope #460  
Kit \$79.95, Wired \$129.50  
5" Push-Pull Oscilloscope #425  
Kit \$44.95, Wired \$79.95



Peak-to-Peak VTVM #232  
Kit \$29.95, Wired \$49.95  
Vacuum Tube Voltmeter #221  
Kit \$25.95, Wired \$39.95

More typical EICO values: Signal Generators from \$19.95, Tube Testers from \$34.95, Sweep Generators from \$34.95, Power Supplies from \$19.95, VOMs from \$12.90.

Everything in CUSTOM HI-FI:  
finest quality at 1/3 the cost.



FM Tuner HFT90  
Kit \$39.95, Wired \$65.95  
Cover \$3.95. Includes FET.

AM Tuner HFT94  
Kit \$39.95, Wired \$65.95  
Includes Metal Cover and FET.

FM/AM Tuner HFT92  
Kit \$59.95, Wired \$94.95  
Includes Metal Cover and FET.



Stereo Dual Amplifier-Preamp HF81  
Kit \$69.95, Wired \$109.95  
Includes Metal Cover.

Stereo Dual Amplifier AF4  
Kit \$38.95, Wired \$64.95  
Includes Metal Cover.

Write for free catalog PF-10 and  
name of nearest distributor.  
Most EICO distributors offer budget terms.



3300 N. Blvd., L.I.C. 1, N. Y.  
Add 5% in the West

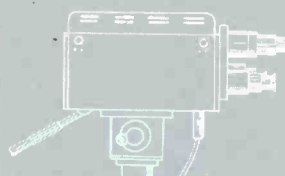

**The  
Electronic  
Scanner**

"Old Tubes Seldom Die...  
They Just Fade Away"

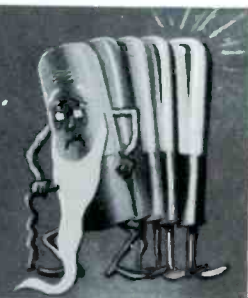

**New Film for Service Clinics**

The third in a series of slide films has just been released by Sencore for use in their "Time-Saving Service Clinics." The new film, "Old Tubes Seldom Die... They Just Fade Away," features the new **Mighty Mite** tube checker. Arrangements for its showing can be made through Sencore distributors or with the company. Incidentally, construction of a new addition to the Sencore plant, now under way, will nearly double its capacity — apparent proof that their instruments have been widely accepted by the service fraternity.

**Lion of Allentown is "Lamm"**

Winner in a "My Favorite Dealer" contest sponsored by Winegard distributor Art Peters of Allentown, Pa., was **Carl Lamm**. Details of the contest were aired over a local radio station, encouraging listeners to make a nominating statement about their favorite TV dealer. Best entries each week won a Winegard Color 'Ceptor antenna installation. Mr. Lamm's prize was a trip for him and his family to the Winegard plant in Burlington, Iowa.

**Learn by Doing Transistor Course**

A low-cost transistor home-study course which makes use of practical experiments is now available from **CBS Electronics**. Details on the cost and availability of the course can be obtained from CBS distributors.

**Help for Hi-Fi Dealers**

Hi-fi service dealers needing suggestions on what small-ticket items to carry, how to display them in building store traffic, and making the most effective use of floor and counter space will be interested in **Robins Industries'** "dealer display workshop" program. Details may be obtained through their distributors.

**Noisiest Spot in Town**

How far will a manufacturer go to improve product performance? **Shure Bros.** has recently installed a special sound room to aid in the development of microphones for use in noisy environments. In the presence of noise intensities so great a person literally cannot hear his own voice, clear and audible speech transmissions are conveyed from special microphones within the room to an outside loudspeaker.

**Expands Capacitor Line**

The latest step in **Arco Electronics'** plans for becoming a full-line capacitor supplier is the opening of an electrolytic plant in Terryville, Conn. The new "Arcolytic" line includes single and multiple section aluminum units in metal-can tubular, wax-filled tubular, and twist-prong styles.



# ADD ARTHUR GODFREY TO YOUR SALES STAFF

WITHOUT ADDING HIM TO YOUR PAYROLL!



Tie in locally with the national Sylvania Silver Screen 85 TV Tube promotion featuring you, the independent service dealer

Arthur Godfrey, America's Number One Salesman, is selling—the Sylvania Silver Screen 85 TV picture tube—and Sylvania quality small tubes—in a dynamic national advertising campaign. Just look where you're being promoted . . . twice each week on 200 CBS Radio Network stations across the country . . . *The Saturday Evening Post* . . . and lots more!



To make the most of this sales-getting promotion, be sure you use all the local tie-in aids Sylvania now offers:

**GIANT WINDOW DISPLAY**—colorful, 3-dimensional . . . features you and Arthur Godfrey. (Order #1139)

**3-PIECE DECAL KIT**—Sparkling glassine signs with Arthur Godfrey saying, "Stop Here For Quality TV Service." (Order #1138)

**GIANT WINDOW POSTER**—Big 20" x 26" poster promotes your service. (Order #2095)

Each and every promotion piece is designed to help you sell Sylvania Silver Screen 85 TV tubes plus Sylvania quality small tubes. For your supply—and helpful hints on how to make the best use of these selling aids—contact your Sylvania distributor. Do it today!

Electronic Tubes Division, Sylvania Electric Products Inc., 1740 Broadway, New York 19, New York

# SYLVANIA

Subsidiary of **GENERAL TELEPHONE & ELECTRONICS**



# FACTS

## ABOUT TUBE SUBSTITUTION

... with a chart showing which types can be replaced by others.

Why are tube-type substitutions even considered? Probably the first reason that pops into your mind is, "Because I don't have the one I need." Secondly, you may be thinking, "I sometimes use an improved version of a tube to obtain better performance." Still another reason may be, "I keep my tube inventory cleaner and smaller by substituting tubes." There may be other considerations, but these are the major ones. Just how valid are these reasons, and how can it be determined when and what to substitute?

The first reason—not having the required tube—is certainly valid enough to justify substitution. In most cases, however, the substitution should be temporary in nature; that is, it should be done only to prove a new tube is required. Of course, if the proper tube can't be obtained for a day or two, the customer should not be forced to go without TV when substituting another tube would allow him to "get by" for the time being. Be sure the customer understands the situation in such cases, and install the proper tube as soon as possible.

It takes careful consideration to deter-

mine what constitutes a proper substitution. The first thing to remember is that two given types of tubes aren't necessarily interchangeable just because they have the same base connections and are used in similar applications. Also, alternate versions of a single basic type (such as the 3-, 4-, and 6CB6), with different voltage and current requirements, normally aren't satisfactory as substitutes for each other.

Substituting an improved version or an industrial equivalent of an original radio-TV tube type is generally a good idea. However, *never go in reverse!* To give a classic example, you can use a 6AX4 to replace a 6W4, or a 6SN7GTB to replace a 6SN7GT—but not the other way around. When a "hotter" version of a tube appears on the market (for instance, a 6DQ6A as opposed to a 6BQ6), several factors must be taken into account before employing it as a substitute for an older type. Interelectrode capacitance, cathode-bias requirements, and detuning of circuits all have a bearing on RF-IF applications; and, as for power amplifiers such as the horizontal output types just cited,

there is some question as to whether or not a circuit defect is being covered up by using a "hotter" tube.

Tube substitution as a means of inventory control is a sound business practice, and—if used with discrimination—a sound technical policy. Stocking 5AR4's to replace 5V4's, and letting 6AV4's double as 6W4 replacements, are two typical examples. Extreme caution must be used, however, in determining what to stock.

The following substitution guide covering some of the more common tube types is an excerpt from the *Tube Substitution Handbook* recently published by Howard W. Sams & Co., Inc. Only tubes having similar or improved characteristics are listed as replacements for the tubes shown at the left of each column. Each tube is listed in only one filament-voltage rating, but corresponding substitutes may also be available for versions having other filament voltages. No consideration has been given to physical space limitations. This chart *does not* constitute a recommendation of such substitution by either Howard W. Sams & Co., Inc., or PF REPORTER.

| Type      | Replace with  | Type    | Replace with                     | Type       | Replace with                                    |
|-----------|---|---------|----------------------------------|------------|---|
| 1B3GT     | 1G3GT, 1J3, 1K3, 1N2  | 6BD5GT  | 6AV5GT, -GA, 6AU5GT              | 6EB8       | 6GN8, 6AU8*, -A*                                |
| 1X2       | 1X2A, -B  | 6BE6    | 6CS6, 575C‡                      | 6EF6       | 6DG6GT, 6EY6, 6EZ5, 6W6GT                       |
| 2AF4      | 2AF4A, -B   | 6BF6†   | 6BU6                             | 6ER5†      | 6ES5*, 6FH5*                                    |
| 5AW4      | 5AS4, -A, 5AU4, 5DB4, 5U4GA, -GB, 5V3                               | 6BF7†   | 6BF7A, 6BC7                      | 6ES6†      | 6ET6  |
| 5BK7A     | 4BC8, 4BQ7A, 4BS8, 4BX8, 4BZ7, 4BZ8, 4CX7                           | 6BH8    | 6BA8, -A                         | 6EW6†      | 6GM6  |
| 5U4       | 5AR4, 5AS4, -A, 5DB4, 5T4, 5931‡                                    | 6BL4    | 6AU4GT, -GTA                     | 6EY6†      | 6EF6, 6EZ5                                      |
| 5V4G      | 5AR4, 5AS4, -A, 5DB4, 5T4, 5931‡                                    | 6BL7GT  | 6BL7GTA, 6DN7, 6BX7GT            | 6FH6       | 6DQ6B   |
| 5Y3       | 5AR4, 5AX4GT, 5AZ4, 5CG4, 5R4, 5T4, 5V4, 5Z4, 6087‡, 6106‡          | 6BQ5    | 7189, -A, 7320‡                  | 6GN8       | 6EB8, 6AU8*, -A*, 6AW8*, -A*                    |
| 6AG5†     | 6AK5*, 6BC5, 6CE5, 5654‡, 6096‡                                     | 6BQ6    | 6CU6, 6DQ6, -A, -B, 6FH6         | 6SN7GTB    | 6SN7GTA*, 5692‡                                 |
| 6AK8†     | 6T8, 6T8A*  | 6BU8†   | 6GS8                             | 6U4GT      | 6AX4GT, -GTA, -GTB, 6CQ4, 6DA4, -A, 6W4GT       |
| 6AL5      | 5726‡, 6058‡, 6097‡, 6663‡  | 6BX6*†  | 6BY7*, 6EC7*                     | 6V4        | 6CA4  |
| 6AQ6†     | 6AT6*, 6AV6*, 6BK6*, 6BT6*  | 6BX7GT  | 6BL7GT, -GTA*                    | 6V6GTA†    | 6V6*, -GT*, 7408*                               |
| 6AQ8†     | 6DT8*   | 6BZ6†   | 6CB6, -A*, 6CF6, 6DE6, 6DK6      | 6W4GT      | 6AX4GT, -GTA, -GTB, 6CQ4, 6DA4, -A, 6U4GT       |
| 6AT8-*    | 6AT8A, 6CG8, -A   | 6C4     | 6100‡, 613E‡                     | 6W6GT      | 6DG6GT, 6EF6, 6EY6, 6EZ5                        |
| 6AU4GT    | 6AU4GTA, 6CQ4, 6DA4A, 6DE4  | 6CB5, A | 6CL5                             | 6X4        | 6BX4, 6AV4*                                     |
| 6AU5GT    | 6AV5GA, -GT   | 6CD6G   | 6CD6GA, 6DN6, 6EX6               | 12AD7†     | 12AX7*, -A*, 12DF7*, 12DM7*, 12DT7*, 7025*, -A* |
| 6AU6      | 6AU6A, 6BA6, 6136‡, 7543  | 6CJ6†   | 6DR6                             | 12AE6†     | 12AE6A, 12FT6                                   |
| 6AU7†     | 7AU7  | 6CM6    | 6CS6                             | 12AF6      | 12BL6   |
| 6AU8      | 6AU8A, 6AW8, -A   | 6CS6    | 6BE6                             | 12AT7†     | 12AZ7*†, -A*†, 6060‡, 6021‡, 6679‡, 7728‡       |
| 6AV4*†    | 6BX4*   | 6CU6    | 6BQ6GTB, 6DQ6, -A, -B, 6FH6      | 12AU7, A   | 6067‡, 6189‡, 6680‡, 7730‡                      |
| 6AV5GA    | 6AV5GT, 6AU5GT  | 6CX8    | 6AU8*, -A*, 6AW8*, -A*           | 12BV7†     | 12BY7, -A, 12DQ7                                |
| 6AV6      | 6AT6, 6BK6, 6BT6, 6AQ6*   | 6CY5†   | 6EA5, 6EV5                       | 12C5/12CU5 | 12C5, 12CU5, 12R5                               |
| 6AW8      | 6AW8A, 6AU8, -A, 6EB8*  | 6DA4, A | 6CQ4, 6DE4                       | 12DW7      | 7247  |
| 6AX4GT, A | 6CQ4*, 6DA4, -A, 6DE4*  | 6DA6*†  | 6DG7*                            | 12DZ6†     | 12EA6   |
| 6AX8†     | 6U8A*, 6GH8, 6EA8, 6GJ8*  | 6DC6    | 6BZ6, 6CB6, -A, 6CF6, 6DE6, 6DK6 | 12EN6†     | 12L6GT, 12W6GT                                  |
| 6BA6      | 6AU6, -A, 5749‡, 6660‡  | 6DE4    | 6AU4GT, -GTA, 6CQ4, 6DA4A        | 19T8       | 19C8  |
| 6BA8      | 6BA8A, 6BH8   | 6DG6GT  | 6W6GT, 6EF6, 6EY6, 6EZ5          | 7543       | 6AU6, -A  |
| 6BC8†     | 6BK7*, -A*, -B*, 6BQ7, -A, 6BS8, 6BX8, 6BZ7, 6BZ8, 6CH7, 6CX7, X155 | 6DJ8*†  | 6ES8, 6FW8*                      |            |   |
|           |   | 6DN6    | 6EX6, 6CD6G, -GA                 |            |   |
|           |   | 6DQ6    | 6DQ6A, -B, 6F46                  |            |   |
|           |   | 6EA7†   | 6EM7                             |            |   |

\* Parallel-filament circuits only.

† Substitutes for each other. (Excludes industrial)

‡ Industrial type.





READY  
RIGHT NOW!

ABC  
handi-  
bin

contents

|          |               |           |               |                 |         |
|----------|---------------|-----------|---------------|-----------------|---------|
| <b>A</b> |               | <b>B</b>  |               | <b>SWITCHES</b> |         |
| 4        | A47-500K-Z    | 2         | B47-5 Meg-S   | 6               | SWE-12  |
| 4        | A47-500K-S    | 2         | B47-7.5 Meg-S | 2               | SWE-20  |
| 2        | A47-1 Meg-S   | 2         | B47-2.5 Meg-S | 2               | SWE-21  |
| 2        | A47-1 Meg-Z   |           |               |                 |         |
| 2        | A47-5 Meg-S   | <b>C*</b> |               | <b>SHAFTS</b>   |         |
| 2        | A47-50K-S     | 2         | C47S-1 Meg-S  | 4               | FKS-1/4 |
| 1        | A47-2.5 Meg-S | 2         | C47S-500K-S   | 4               | FKS-1/2 |
| 1        | A47-100K-S    | 2         | C47S-1 Meg-Z  | 4               | KFS-3   |
|          |               |           |               | 4               | RS-2    |
|          |               |           |               | 4               | FS-3    |
|          |               |           |               | 4               | KSS-3   |

\*Brand-new! Pick-A-Shaft Push-Pull Switch Controls! Pick your unit—pick your shaft—Presto! The unit is ready for installation...

## The complete carbon-control servicenter

Here's the sure way to have what you need—when you need it—the Clarostat ABC Handi-Bin carbon control servicenter. And every control is ready to use as it comes from the carton—just select the appropriate shaft, tap into control, and it's ready to install...

ALL YOU PAY FOR ARE THE CONTROLS—THE STURDY, ALL-STEEL, GRAVITY-FEED CABINET IS ABSOLUTELY FREE!

ABC Handi-Bins are at your Clarostat distributor's right now—order yours today!

SIMPLE AS **ABC**

Always Buy  
Clarostat

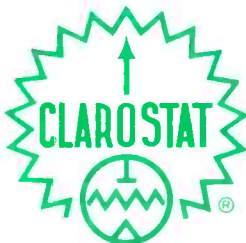

- ★ New—Pick-A-Shaft push-pull switch controls included in assortment.
- ★ Not a dog in the bin-full. Every control a popular replacement number.
- ★ Gravity-feed steel bin keeps all stock right at your fingertips—and you get it ABSOLUTELY FREE! Mounts on wall or bench.
- ★ Automatically keeps you posted on inventory—prevents running out of the fast-moving numbers.

**CLAROSTAT MFG. CO., INC.**

DOVER, NEW HAMPSHIRE

In Canada: CANADIAN MARCONI CO., LTD., Toronto 17, Ont.

# DOES HIGH FIDELITY DEMAND

# HIGH POWER ???

AUDIO  
FACTS

by Thomas A. Lesh

A recent comment by a serviceman called attention to a problem faced by technicians as well as laymen. Here's what he had to say:

"It seems to me that the facts about good high fidelity from an amplifier are becoming more confusing, what with the increasing output rating of amplifiers as of late. I would like to know what the power output of a good amplifier would have to be in order to enjoy full, undistorted high-fidelity reproduction in the average living room. I have read many articles which contradict each other on this point."

There is a great deal of room for contradiction in attempting to settle the hi-fi power question. The "right answer" depends on what you are trying to accomplish with an amplifier, and whom you are trying to please with its performance. As if this didn't create enough problems, three different power-rating standards are currently in use, so it's no wonder that this subject breeds confusion! Nevertheless, the problem of amplifier power is well worth your careful consideration, because the output wattage of an amplifier definitely affects its ability to provide faithful reproduction of music.

This fact, obvious though it may seem, is not given its full share of attention, because most people without specialized training tend to exaggerate the importance of "flat frequency response from 20 to 20,000 cps" when trying to define high fidelity. This oversimplification of the facts is just as misleading as trying to define an economical car as "one which gives good gasoline mileage." True, a wide frequency range is the most obvious feature of hi-fi equipment, but "20-20,000 cps" doesn't tell the whole story. A number of other factors are also involved in high-fidelity reproduction.

All right, then, just what *is* high fidelity? Let's get down to fundamentals. It's important to bear in mind that "hi-fi" is a relative matter, not an absolute state of perfection. If an audio amplifying system were perfect, it would reproduce sounds exactly as they would be heard during a live performance. This goal is never reached, but best practical results come close enough to perfection to be highly satisfactory, and somewhat *less* than the best results are good enough to please millions of listeners. Audio components and

systems are available to suit every taste. Since some of them introduce more "flavoring" into the sound than others, some sort of arbitrary minimum standards must be set in order to define what is "high fidelity" and what is not. In effect, this is the gist of the comment at the beginning of this article.

But the man who raised the question cannot arrive at a valid answer without taking inventory of his listening habits and standards of judgment. If he's like most of us, his tolerance of imperfections is inversely proportional to his budget! Luckily for those of us with limited means, the human imagination does very well at filling in deficiencies in the music we hear. This last statement is not intended as an excuse for maintaining low standards of music reproduction, since the listener's unconscious effort to overlook poor sound quality is known to be tiring. However, the ear's distortion tolerance helps to explain why a great deal of mediocre equipment has found acceptance as "hi-fi" simply because it is vastly better than anything previously available in a similar price class. In other words, equipment having limited capabilities is adequate for use where the demands placed on it are also limited.

## Power vs. Loudness

The most easily-made compromise with "true high fidelity" is in the realm of output power. Did you ever stop to think that a hi-fi set cannot reproduce music with *complete* realism unless the volume level is the same as for the live rendition? In case you haven't heard a live orchestra, at close range recently, you may have forgotten how loud it is — unnaturally loud for an average-sized living room. Even if you can take this much volume without flinching, your family and neighbors are likely to lay down the law and insist on moderation. Fortunately, music can still sound quite natural at less than room-shaking volume, especially when a loudness control is available to compensate for changes in the ear's frequency response at different sound intensities. (See the December, 1959 *Audio Facts*.) At a comfortable listening level, you may unconsciously adjust the loudness and tone controls so that the music seems to come from



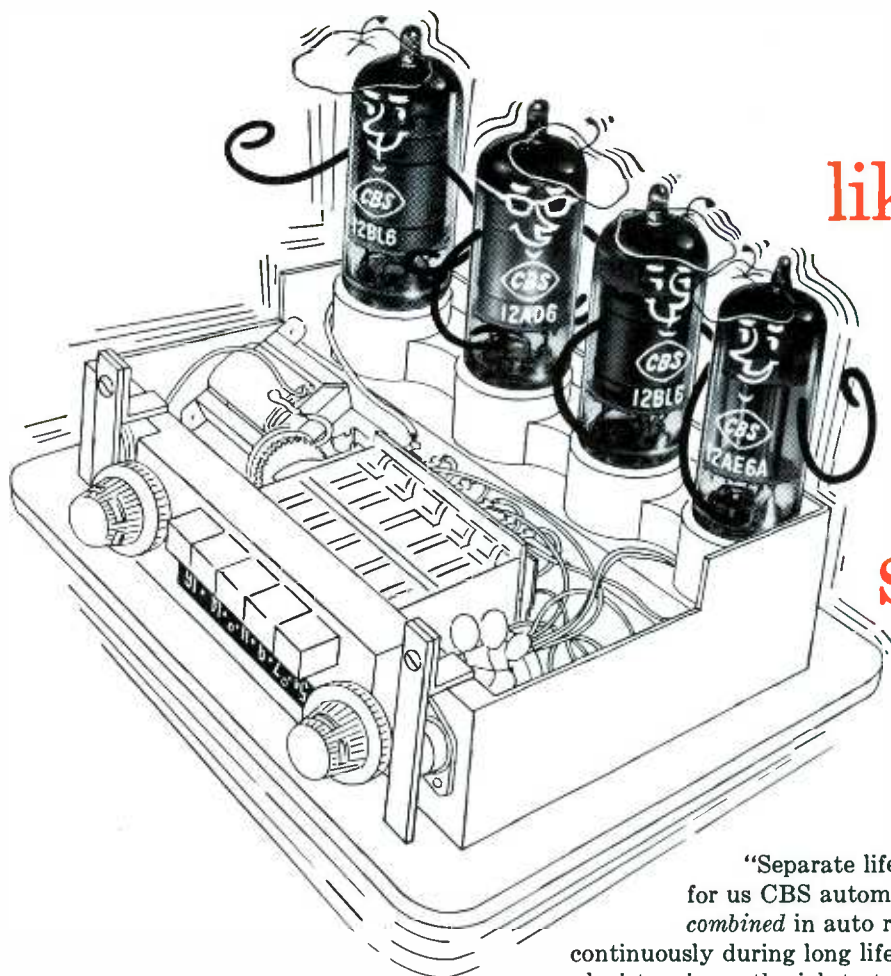

like in autos . . .  
 only more so,  
 we get  
 real  
 shock-up!

**(AND YOU GET NO  
 BURN-OUTS, SHORTS,  
 OPENS OR NOISE)**

“Separate life and vibration tests aren’t tough enough for us CBS automobile radio tubes. We have to take ‘em *combined* in auto radio chassis that are vibrated continuously during long life tests. You can imagine what happens to weak sisters in on-the-job tests like this. The causes of annoying burn-outs . . . shorts . . . opens . . . and noise just get shaken out and eliminated. And no ride is too rough for us.”

Yes, all CBS auto radio tubes offer you total reliability . . . *proved in performance* by leading radio set manufacturers. You, too, can profit from the total reliability of CBS tubes. Just make it a habit always to replace with CBS.

**NEW REVISED EDITION**

Compact, handy and up-to-date, the new revised CBS Technician’s Handbook is designed especially for the technician. Its 480 pages include, in addition to a wealth of reference material, data he needs on over 1000 receiving, picture, industrial, and European hi-fi tubes . . . transistors and diodes. Only \$1.95 now at your distributor’s.



**TOTAL RELIABILITY . . . proved in performance**



**CBS ELECTRONICS**

Danvers, Massachusetts

A Division of Columbia Broadcasting System, Inc.

Receiving, industrial and picture tubes • transistors and diodes • audio components • and phonographs

some distance away — thus “taking a back seat in the concert hall.”

Now, at last, we have reached the heart of the problem! Assuming some moderation in volume (and a normal-sized listening room), even someone with more than a passing interest in hi-fi will more than likely be satisfied with a well-designed amplifier having an output power of about 15 watts. But wait! This power figure represents a *continuous* rating, the most conservative way of expressing amplifier power. Measured with a steady sine-wave signal applied to the input, the rated watt-

age indicates the maximum audio power obtainable without going above a specified percentage of distortion in the output.

Certain hi-fi owners prefer larger amplifiers. For some, the reason may be a desire for higher volume or larger area coverage; for others, the main consideration may be an extra reserve of power to guard against distortion; and, to be frank, there are also some who are guided by the “horsepower race” instinct.

As the output rating is decreased below the 15-watt level, the maximum usable volume (without intro-

ducing distortion) becomes progressively lower — although it's still far from being a whisper! Borderline distortion isn't too easily recognized, since it occurs almost entirely on signal peaks. Most of the program material in a high-fidelity recording can be cleanly reproduced with a power of only a few watts; only an occasional sharp burst of sound would require a great deal of power. (Examples are a drum beat, a crash of cymbals, or an entire symphony orchestra rising to a crescendo.) An “almost good enough” amplifier will be overdriven on these sound peaks, but not on the rest of the signal; thus, the only complaint may be a “fuzziness” of the sound which may seem worse on some recordings than on others.

Most of the strongest peaks in a typical audio signal have a very short duration, and this fact is an important key to understanding the significance of various power ratings. An amplifier can deliver considerably more than its rated rms power for brief intervals. Accordingly, a number of audio-equipment manufacturers have rated their amplifiers according to *peak* power output, which figures out mathematically to twice the rms power. This is said to furnish a much closer index of the unit's true power capability, and it has the undeniable advantage of sounding more impressive. Output figures grow to sensational proportions when a stereo amplifier is rated according to the sum of the peak power outputs of both channels — which has been a fairly common practice in some branches of the audio field.

Just because an amplifier remains below a certain distortion level at a specified rms power rating doesn't automatically mean that the unit will be equally distortion-free during momentary signal peaks drawing twice as much power. With this limitation in mind, and hoping for an eventual end to the confusion caused by different power-rating standards, two associations of manufacturers have recently adopted and publicized a new compromise standard known as *music power output*. This specification is intended to serve as a key to the maximum *undistorted* power available on peaks of a typical audio signal.

# Transistor radio servicing

## Problem or Profit?



### You are in the transistor-age

Nearly 90% of the radios manufactured today are transistorized. Are you prepared to service this heavy volume of new business? The millions of radios now being sold means that your present customers own them and will expect you to service them . . . And, you must service them *profitably*.

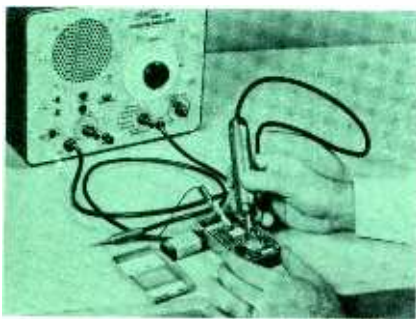

### Transistor radios can be service problems

Their compact, miniaturized components and printed circuitry are hard-to-reach for proper test • Transistors, still a little strange to many technicians, make checking difficult • Low price of sets force low servicing costs—troubles have to be spotted quickly and accurately to assure service profit • Conventional servicing techniques take too long and don't always work • Transistors and components can easily be damaged by excessive current from your VOM battery.

### Low-cost tester provides the answer

**HICKOK'S** Model 810, a new Transistor Radio Tester permits high-speed signal tracing whereby elements can be checked right in their circuit—without slow disconnecting and resoldering “Guess-and-Bogosh” servicing.

### The 810 is a THREE-IN-ONE Tester

- ★ A signal generator of RF, IF and audio.
- ★ A signal tracer covering RF, IF and audio.
- ★ A transistor tester.

### Offers many special features

The signal tracing probe has a cathode follower input . . . No detuning or loading effect. The generator output is a cathode follower . . . Means low impedance to transistor circuits. Special AC line filter . . . Limits leakage current to a safe value in preventing overload damage to transistor circuits. The 810 is ideally designed for servicing ‘hard-to-reach’ auto radios and small AC-DC portables.

### Complete . . . \$138

The 810 is everything you need for profitable transistor radio testing. The 810 is Hickok-Quality, easy-to-operate and has repeatedly proven to pay-for-itself quickly through time saved in this ‘New Business’ of Transistor Radio Servicing for Profit.

See your distributor for a Hickok-810-demonstration today! The Hickok Electrical Instrument Company, 10566 Dupont Avenue, Cleveland 8, Ohio.





The Institute of High Fidelity Manufacturers defines music power as follows for component-type equipment: "... the greatest single-frequency power obtainable without exceeding the rated total harmonic distortion (*claimed for the unit in question—Ed.*) when the amplifier is operated under standard test conditions, *except* that music power is measured immediately after the sudden application of a signal and during a time interval so short that supply voltages within the amplifier have not changed from their no-signal value."

In other words, an effort is made to measure the operating conditions within the audio output stage when a sharp signal peak is applied. If the duration of the peak is quite short, the drain on the power supply is almost negligible, and the B+ voltage to the audio output stage remains practically constant. However, a broader signal peak (such as that of an audio-frequency sine wave) could cause enough of a change in current drain to make a noticeable change in power-supply voltage. (Any fluctuations in B+ act to reduce the maximum undistorted power output.)

Literally interpreting the above instructions for measuring music power is impractical, of course, but it is possible to simulate the effect of a short-duration signal with good results. The amplifier's output stage is disconnected from the regular power supply and hooked up to an external supply having excellent voltage regulation. In this way, the supply voltages are maintained at the no-signal values regardless of how long the test signal is applied. The resultant reading of maximum undistorted output power in a typical amplifier will be about halfway between the continuous rms and peak power readings. Thus, our "average" 15-watt amplifier would probably have a music-power rating of over 20 watts. In amplifiers equipped with exceptionally well-regulated power supplies, there would be an unusually small difference between the continuous and music power ratings.

The Electronic Industries Association has adopted a very similar standard for measuring music power in "packaged" hi-fi sets, except that a maximum harmonic distortion of

5% is specified under the stated test conditions. This distortion figure is notably higher than those allowed under the stiffer IHFM standards, in line with the generally less strict interpretation of "hi-fi" from the mass-market standpoint.

If you scan the specification sheets for a number of recent-model amplifiers of many popular brands, you will notice that the music-power standard is being widely adopted. When determining whether or not a specific amplifier can handle a certain job, be sure to check and see whether music power or one of the

older standards is being specified. Also be on the lookout for other significant figures which can help you answer questions such as "Is the frequency response and distortion level the same at high power as when the power output is only moderate?" Finally, make sure the speaker system is capable of handling the full output of the amplifier without being overdriven. Used intelligently, amplifier power ratings can be a valuable tool in helping you to decide how close a given amplifier comes to "concert-hall realism." ▲



**HICKOK**

- ✓ True VTVM
- ✓ 9" Multi-Colored Meter
- ✓ Low Capacity, High Frequency Probe
- ✓ AC Response to 200 MC, RMS or Peak-to-Peak
- ✓ Capacitance Ranges: 1-10,000 $\mu$ f in 2 Ranges  
1-1,000 $\mu$ f in 8 Ranges
- ✓ Resistance Ranges: 0.1 Ohm to 10,000 Megohms  
in 8 Ranges
- ✓ Complete with AC and DC Probes and Test Leads

**See Your Distributor, Ask for a Demonstration!**

**\$157.00 net**

**The Hickok Electrical Instrument Co.**

10566 DUPONT AVENUE • CLEVELAND 8, OHIO

# NEW 4-WAY POCKET TOOL

a real "working partner"  
for removing backs of TV sets  
and installing antennas

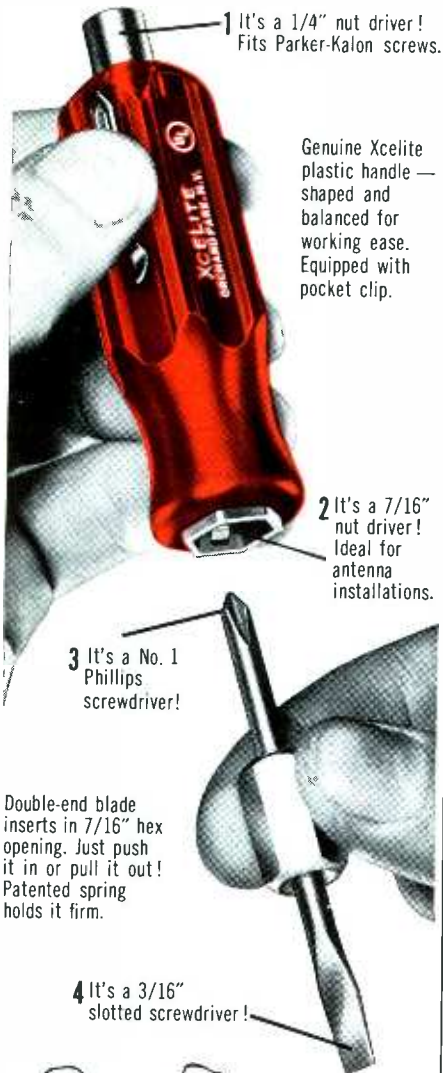

1 It's a 1/4" nut driver!  
Fits Parker-Kalon screws.

Genuine Xcelite  
plastic handle —  
shaped and  
balanced for  
working ease.  
Equipped with  
pocket clip.

2 It's a 7/16"  
nut driver!  
Ideal for  
antenna  
installations.

3 It's a No. 1  
Phillips  
screwdriver!

Double-end blade  
inserts in 7/16" hex  
opening. Just push  
it in or pull it out!  
Patented spring  
holds it firm.

4 It's a 3/16"  
slotted screwdriver!



Ask to see  
"No. 600"  
next time you  
pick up parts...

## XCELITE

XCELITE, INC. • ORCHARD PARK, N.Y.  
Canada: Charles W. Pointon, Ltd., Toronto, Ont.



**Hard-core soft sell.** Sales are the lifeblood of business; every commercial endeavor is faced with selling some service or product. Just how masterfully a firm accomplishes its sales objectives is reflected by the success of the business. Sales techniques vary between two extremes — often referred to as *hard sell* and *soft sell*. The most vivid example of hard sell is the technique used by salesmen who won't take NO for an answer. From all indications, Americans are fed up with these tactics. You may have noticed that many manufacturers are giving up hard-sell TV commercials (such as endless, loud-voiced repetition of slogans) and are turning more toward informal presentations and cartoons. However, they are retaining a hard core to their soft-sell technique.

A complete departure from the high-pressure sales approach is the soft-sell technique of a TV serviceman who, upon restoring a TV set to operation, *offers* to check all tubes in the set *if* the customer would like him to. Here the customer is offered an additional service, with no admonition of the consequences which might result if he said, "No, thanks" to the offer. Compare this with hard-sell methods, where the customer is persuasively directed into an action, and you will see the marked contrast between the two sales techniques.

Many shop owners have found it profitable to *sell* preventive maintenance as part of the repair routine. Others have gained business by simply *asking* if any other radio, phonograph, or antenna installation services are required by the customer. Some even carry phonograph needles, FM or portable radios, etc., into the home when making a TV call, to let customers know they have the item *just in case* they are interested.

It all boils down to the fact that you must sell to stay in business. In selling you must be aggressive—but not too much; make your customers

want what you have—but make them think it's their idea; offer them what their station in life permits—but in such a way that they won't be offended if it's beyond the *immediate* reach of their budget. This is applying the hard core to soft sell.

**\$ & ¢**

**Snowed under?** Has that wonderful snowfall of TV receivers needing service blanketed your shop yet? To say the very least, we'll bet your business has picked up since the beginning of the fall season.

This condition brings up many problems for set owners and technicians alike. You know John Q. Public — his set is the only one in town that needs service, and he wants it yesterday. As for yourself, you have umpteen John Q's breathing down your neck, and a time-consuming "dog" on the bench. It's a time of tried patience, mental stress, ulcer development; time to apply a little "oil" to your business operation (in the form of brain work) and get it running like a finely-tuned machine. Here are a couple of areas where you may be able to take some strain out of the rush period:

Many technicians have found it helpful to place a time limitation on each set they service — setting a "dog" aside to complete a couple of normal jobs. If you follow this approach, bear in mind that you *must* return to the "dog" in a reasonable time, and you should start on it as if it were appearing on the bench for the first time. The greatest deterrent to "whipping a dog" is going back to where you left off. You'll find it much easier to make a fresh start!

**\$ & ¢**

**Profit Builder.** Training sessions after hours and during slack periods increase efficiency and improve the profit picture.



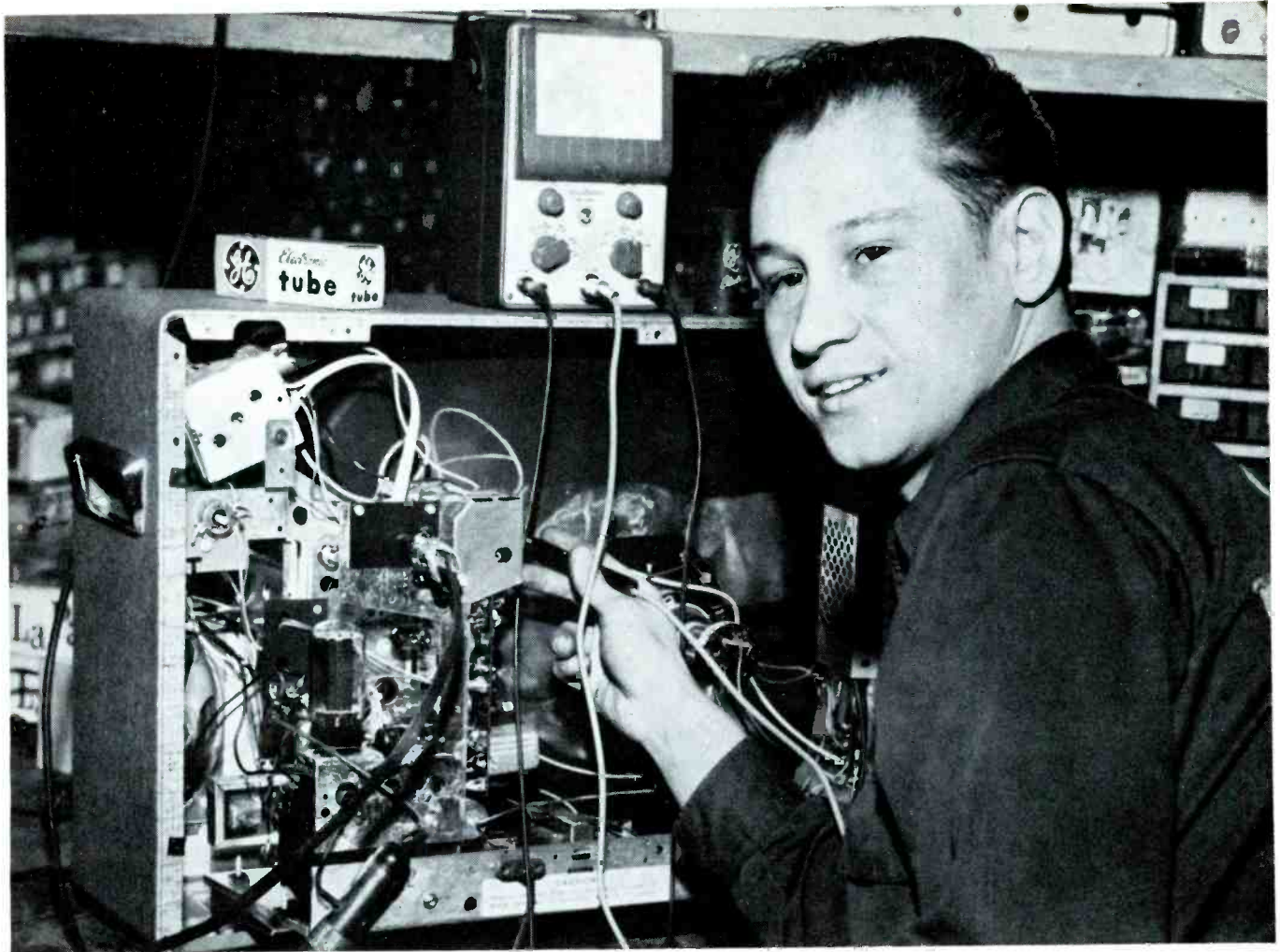

*“The ‘Designer’ is the*

# **LEAST TROUBLESOME SET**

*we have ever serviced,”*

**says Bob Wauganman of Bob’s Television,  
9518 Madison Street, Cleveland, Ohio.**

“Speaking of the General Electric ‘Designer,’” says Bob Wauganman of Bob’s Television in Cleveland, Ohio, “there probably isn’t an easier set on the market today to service.

“We can do 90% of shop work without removing the set from the cabinet, and we find that, because General Electric licked the heat dissipation problem, ‘Designers’ last longer and suffer less breakdown.

“We have very few service calls on ‘Designers’. Those that we do have are easily corrected. This gives us lots of time to get in more calls per day and,

of course, it helps us to make more money, too.”

“Designer” Tubes are directly replaceable, fuses accessible, and you easily get at the key check points. Another thing: the painted schematic on the boards helps you find your way around quickly. Again, more calls per day—and more money.

**Precision Etched Circuitry** is used in all “Designer” sets and is reliable and uniform so that when you have serviced one you will never have to puzzle over the next one.

“Designer” TV—called the easiest-to-service set in television! General Electric Company, Television Receiver Department, Syracuse 8, New York.

*Progress Is Our Most Important Product*

**GENERAL  ELECTRIC**





# fixed at last . . . OOPS!

Recently, I went through an exasperating troubleshooting bout with a Zenith Model H2438R TV receiver. Several aspects of the case were enough out of the ordinary to be worthy of interest. When first brought in, the set had only about 2" of vertical sweep. This problem wasn't difficult in itself; however, before the set could be returned to its owner, the tuner required service for a burned resistor, an arcing flyback demanded attention, the AGC circuit needed repairing, and the sound section was realigned. In order to save time on this service job, it was also necessary to figure out a way of checking the vertical yoke

circuit without observing the raster.

## Tackling the Problem

When the set was placed on the bench and power was first applied, two major symptoms were noted:

1. The raster was normal in width but extremely low in height, with compression at the bottom.
2. The flyback transformer coil was arcing to its core.

The greatly reduced and distorted appearance of the raster (unaffected by tube substitution) made me suspect that either the vertical output transformer or the deflection yoke

was defective. However, since the flyback was arcing, I didn't dare operate the set long enough to permit normal troubleshooting procedures. I was anxious to save the flyback, because the customer wouldn't stand for replacement of both the yoke and the flyback on such an old set, and also because I felt that a little corona dope and beeswax would cure the arcing condition. Red corona dope was liberally applied to the surface of the flyback coil and core. Since several minutes' time is required for the coat of corona dope to dry, and several coats were deemed necessary, I decided to proceed with troubleshooting the vertical sweep problem. The ¼-amp fuse was removed from the horizontal output stage to disable the horizontal sweep system and thus permit the corona dope to harden. Since this killed boost B+, and the vertical output stage operated from boost, a temporary connection (Fig. 1) had to be made between the vertical output stage and the regular B+ source. The voltage thus obtained was not too far below the value normally supplied from boost through the 1800-ohm dropping resistor; so, with near-normal voltage fed to the output stage, adequate troubleshooting techniques could be employed.

Operating the PICTURE CONTROL switch had failed to produce a noticeable effect on the picture, so I knew this network wasn't causing trouble. Voltage and oscilloscope checks around the vertical output

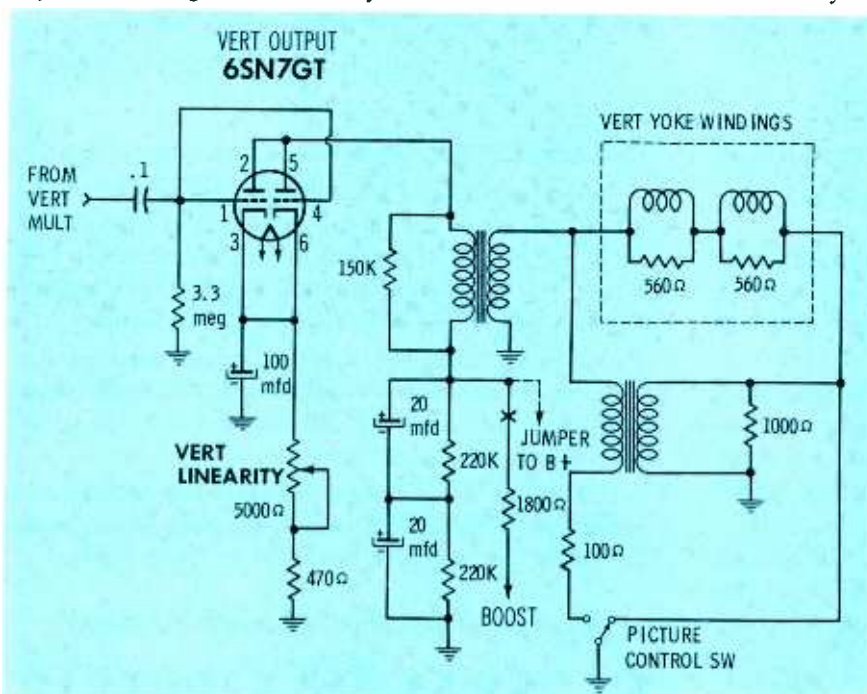

Fig. 1. Vertical sweep was powered by B+ while boost circuit was disabled.



### Transmission Line Cables



8225



8226



8230



8285

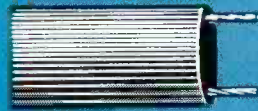

8235

### Microphone and Shielded Power Supply Cables



8410

RUBBER



8411



8413

PLASTIC



8420

# Mr. Service Technician:

Ask your Belden jobber about this complete wire and cable line

What types of wire and cable do you need? Ask your Belden electronics jobber for complete specifications on types, sizes, insulations, and convenient spooled lengths. Available from stock.

### Hi-Fi, Stereo, and Phonograph Cables



8421



8430



8419

### Rubber-Vinyl Multiconductor Portable Cordage



8462

8888

### Power Supply Cords



17106

### Antenna Rotor Cables



8464

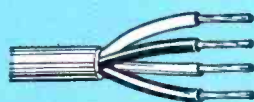

8484

### Hook-Up Wire

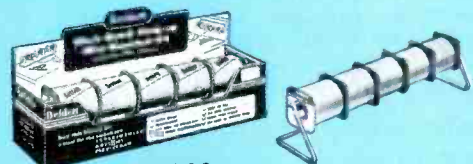

8800

### TV and Cheater Cords



8874



8875

### Aluminum Ground Wire



8018

**Belden**  
WIREMAKER FOR INDUSTRY  
SINCE 1902  
CHICAGO

power supply cords • cord sets and portable cordage •  
electrical household cords • magnet wire •  
lead wire • automotive wire and cable • aircraft  
wires • welding cable

stage revealed normal signals and voltages at the output tube, but little or no sweep-signal energy across the yoke.

### Yoke Substitution

A check of the service literature revealed that the vertical windings of the yoke should be 13 mh. An old yoke with an open horizontal coil, but with the correct vertical winding inductance, happened to be on hand. The leads of the yoke in the set were simply unsoldered and the other unit's leads soldered in place. No

attempt was made to install the test yoke on the picture tube, since the picture couldn't be viewed anyway. A scope check of the yoke signal revealed the expected sawtooth waveform, proving that the old yoke was defective. Resistance checks of the old yoke's vertical winding revealed a minor reduction in resistance, and it was assumed that a few turns had shorted.

When the correct replacement yoke had been obtained from the local parts house and installed, the yoke waveform was again checked.

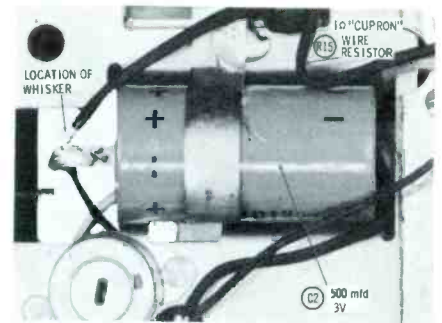

Fig. 2. Wire stub shorting to chassis caused intermittent volume changes.

No signal at all was found! Rapid voltage measurements soon revealed an open cathode resistor (Fig. 1), which had finally given up the ghost at this crucial moment. On close inspection, it turned out to be a 10-watt wire-wound unit of the wrong value. Replacing it with a 470-ohm, 1-watt composition resistor restored the yoke signal.

### Arcing Cured

During the initial troubleshooting procedure, the first application of corona dope had dried, and a second coat had been put on. Now that both coatings had set, the beeswax could be applied. It was warmed up until it reached a thick, putty-like consistency, and a layer of the warm wax was then applied over the coil surface. In about 20 minutes, when the wax had hardened, the fuse was installed and power was applied. The results obtained were rather a disappointment. The picture was upside down, the sound was full of buzz, and the sync was jittery.

### Gilding the Lily

First of all, the yoke leads were reversed to right the picture. Next, the AGC amplifier was checked and

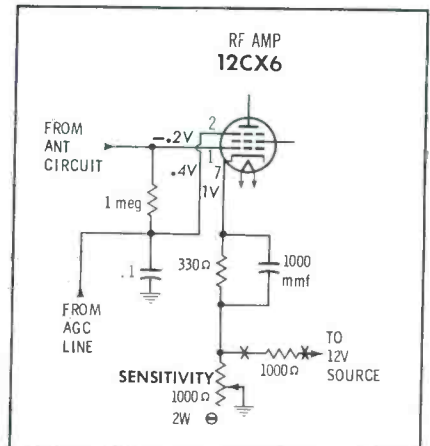

Fig. 3. Sensitivity control adjusts the cathode bias of the RF amplifier stage.



# GET MORE FOR YOUR MONEY



**SAVE CUSTOMERS**



**SELL MORE TUBES**



**B&K MODEL 550 DYNA-QUIK**  
DYNAMIC MUTUAL CONDUCTANCE TUBE TESTER

Greatest value for professional servicing! Provides 52 tube sockets to test more tubes faster, easier, with laboratory accuracy. Measures true dynamic mutual conductance. Quickly detects weak or inoperative tubes. Saves more tubes. Saves call-backs. Makes more money for you every day.

Tests Each Section of Dual-Section Tubes Separately

Completely tests each tube in seconds. Checks average TV set in a few minutes, in home or shop. Checks tubes for shorts, grid emission, gas content, and leakage. Shows tube condition on "Good-Bad" scale and in micromhos. No multiple switching. Quick-reference listings on socket panel and handy chart. New tube reference charts regularly made available. Patented automatic line voltage compensation. Phosphor bronze contacts. A real professional instrument for only **\$119<sup>95</sup> NET**

See your B&K Distributor or Send for Bulletin AP16-R

**B&K MANUFACTURING CO.**  
1801 W. BELLE PLAINE AVE • CHICAGO 13, ILL.  
Canada: Atlas Radio Corp., 50 Wingold, Toronto 10, Ont. • Export: Empire Exporters, 277 Broadway, New York 7, U.S.A.



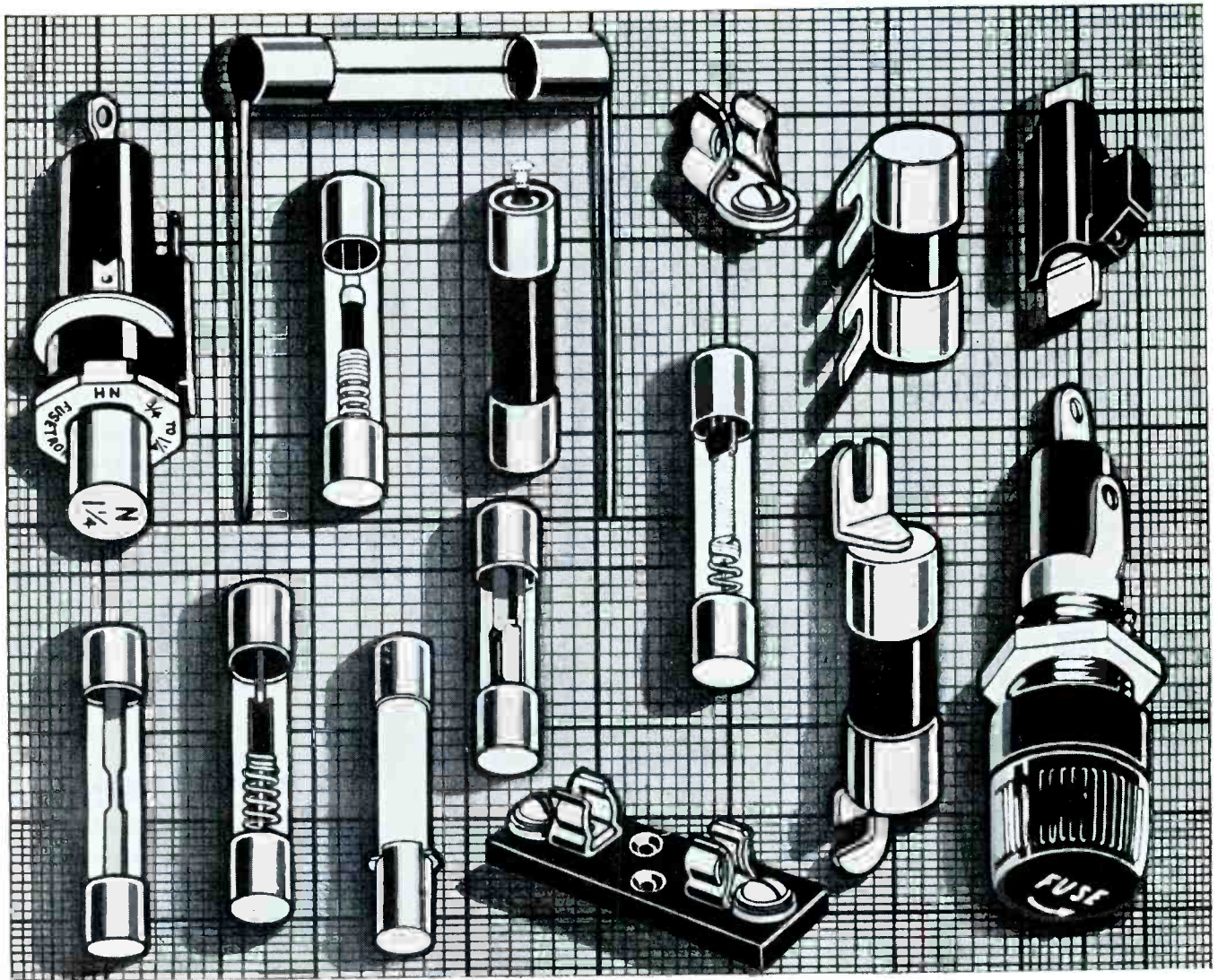

# BUSS fuses can help protect *your profits and your reputation for service*

You get double protection when you install BUSS fuses.

**First**, BUSS fuses are designed and manufactured to give maximum electrical protection.

But it doesn't stop there.

Every BUSS fuse is carefully tested in a sensitive electronic device that automatically rejects any fuse not correctly calibrated, properly constructed and right in all physical dimensions.

This is your assurance that BUSS fuses will operate as intended.

**Second**, BUSS fuses help protect your reputation for quality service. A fuse that opens prematurely causes a needless shutdown. Likewise, one that doesn't function properly may cause other components to burn out or be damaged. In either case, it's an annoying headache for your customer and it may cost you his confidence. More often than not, he will blame you for his trouble.

With dependable BUSS fuses, you need have no worries that faulty fuses will threaten your profits or your reputation. That's why it makes good sense to install BUSS fuses.

*For more information on BUSS and FUSETRON small dimension fuses and fuseholders . . . Write for bulletin SFB.*

**BUSSMANN MFG. DIVISION**

McGraw-Edison Co.

University at Jefferson, St. Louis 7, Mo.

1060

**BUSS FUSES ARE MADE TO PROTECT -  
NOT TO BLOW NEEDLESSLY**



BUSS MAKES A COMPLETE LINE OF FUSES FOR HOME, FARM, COMMERCIAL, ELECTRONIC, ELECTRICAL, AUTOMOTIVE AND INDUSTRIAL USE.





**NEW! SUPEREX SET SAVER** Model SO<sub>3</sub> List \$1.98

**STOPS HARMFUL VOLTAGE SURGE ... TRIPLES TUBE LIFE**

MINIMIZE CALL-BACKS due to tubes popping, and make more money, too! **SELL SET SAVER.** Amazing SET SAVER eliminates harmful initial voltage surge that shortens life of tubes and parts. This is the same surge that often **BLOWS OUT ELECTRIC BULBS** just as you switch it on! **SELL SET SAVER** on all your calls!

**ADDS LIFE TO TV SETS, RADIOS & HI-FI**

**PROLONGS LIFE OF tubes (incl. picture tube), capacitors, rectifiers, transformers, other parts.**



**Rx-TUNERS  
Rx-CONTROLS  
Rx-CONTACTS  
Rx-SWITCHES**

New formula Detergent-Lubricant Silicon oil

**FREE INJECTOR**

A must for all servicemen kits! Rx works wonders with tuners and controls, eliminates noise, retards corrosion, lasts longer. Recleans and re-lubricates with each rotation of tuner or control... simple to use... features a long-lasting detergent-lubricant. You can't afford to use less than the best. Insist on Rx.

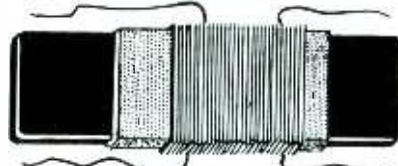

**REPLACEMENT FLAT LOOPSTICK for Japanese Transistor radios Model 2FT-397 List 2.35**

Make more money with this fabulous Flat Transistor Loopstick. Actually improves set performance by virtue of its extremely high "Q"... is adjustable to match Japanese variable capacitor. Peps up weak stations. Supplied with illustrated, installation instructions.

**NEW! REPAIR SHAFTS FOR BROKEN STUDS**



**PERFECT FOR ALL 1949-61 TV SETS** MODEL AGC DEALER NET ONLY 79c (Package of 6 most needed)

Servicemen everywhere are now repairing broken studs this easy, inexpensive way! Used on I.F. Transformers A.G.C. • Width • Horizontal Osc. and Linearity Coils. Also used as extension shaft for easier adjustment. 4-40 and 6-30 threads.

At your parts jobber. If not available, write for name of nearest supplier.



**6 Radford Pl. Yonkers, N.Y.**

found to be defective. Replacement of this dual triode cured the picture jitters, but the sound was still full of buzz. Touch-up adjustments of the quadrature coil and the buzz control remedied this situation. Just when everything seemed to be going fine, the picture went out and the tuner started to smoke. A check of the tuner tubes failed to locate any shorted or gassy tubes, so the cover was removed from the tuner chassis. Investigation here revealed a scorched 1000-ohm resistor between B+ and the mixer stage. A new resistor was installed, power was applied, and in only a second or two the new unit began to boil. Substituting a new mixer tube failed to produce a cure. A check was made for shorted bypass capacitors, but none were found.

A thorough check of the tuner failed to produce a reason for the burning resistor. Analyzing the schematic, I found that AGC voltage was applied to the mixer in this set; so I decided to check the video IF strip on the off-chance that a positive voltage was getting onto the AGC line. At the second IF stage the trouble was located; a coated resistor in the B+ circuit was leaning against a terminal lug in the AGC network. The coating had finally broken down, and the resultant plus voltage on the mixer grid caused the smoke. Dressing this part away from the lug removed this puzzling condition, and a few hours of "cooking" the receiver proved that this job was completed — at last.

### Quick Current Checks

An often-neglected task in servicing horizontal output stages is the measurement of cathode and screen currents. These tests can frequently turn up important clues to the cause of repeated tube failure, flyback failure, and width problems, but they raise a point of irritation when it comes to the unsoldering and soldering required. Often the irritation is strong enough so that the job is put off until too late.

Here's an easy way out, in the form of a simple adapter you can assemble "out of the junk box" in just a few minutes. All it takes is an octal socket and the base from any discarded octal tube. Wire all of the



**Fig. 4. Octal base adapter wired to permit in-circuit cathode-current checks.**

pins "straight through" except 3, 4, and 8. Drill 3 pairs of holes in the base, and bring out extension leads from both socket and base for each of these pins. (Photo in Fig. 4 shows only pins 3 and 8 wired.) All horizontal output tubes use either pin 3 or pin 8 for the cathode connection, and pin 4 or pin 8 for the screen grid.

Simply plugging the tube into the adapter, connecting the milliammeter to the appropriate pair of leads, and using clips to "jumper" the other leads allows you to make both cathode and screen current measurements without ever unsoldering a wire.

### CRT Test Adapter

No doubt you've realized that three different basing arrangements are being used in 110° picture tubes now on the market. This, of course, complicates testing as well as troubleshooting. However, the Anchor *Test Adapt* Model UT450 pictured in Fig. 5, manufactured by Antronic Corporation of Chicago, offers a solution to this testing problem. Equipped with sockets for both rigid-pin and wire-pin base styles used in 110° tubes, the *Test Adapt* automatically switches to the correct basing connections when you select the appropriate filament voltage (2.35, 2.68, 6.3, or 8.4 volts).

Designed to plug into any picture-tube tester, the device also has a color-CRT socket. Grid switching is provided to permit all three guns to be separately tested. ▲

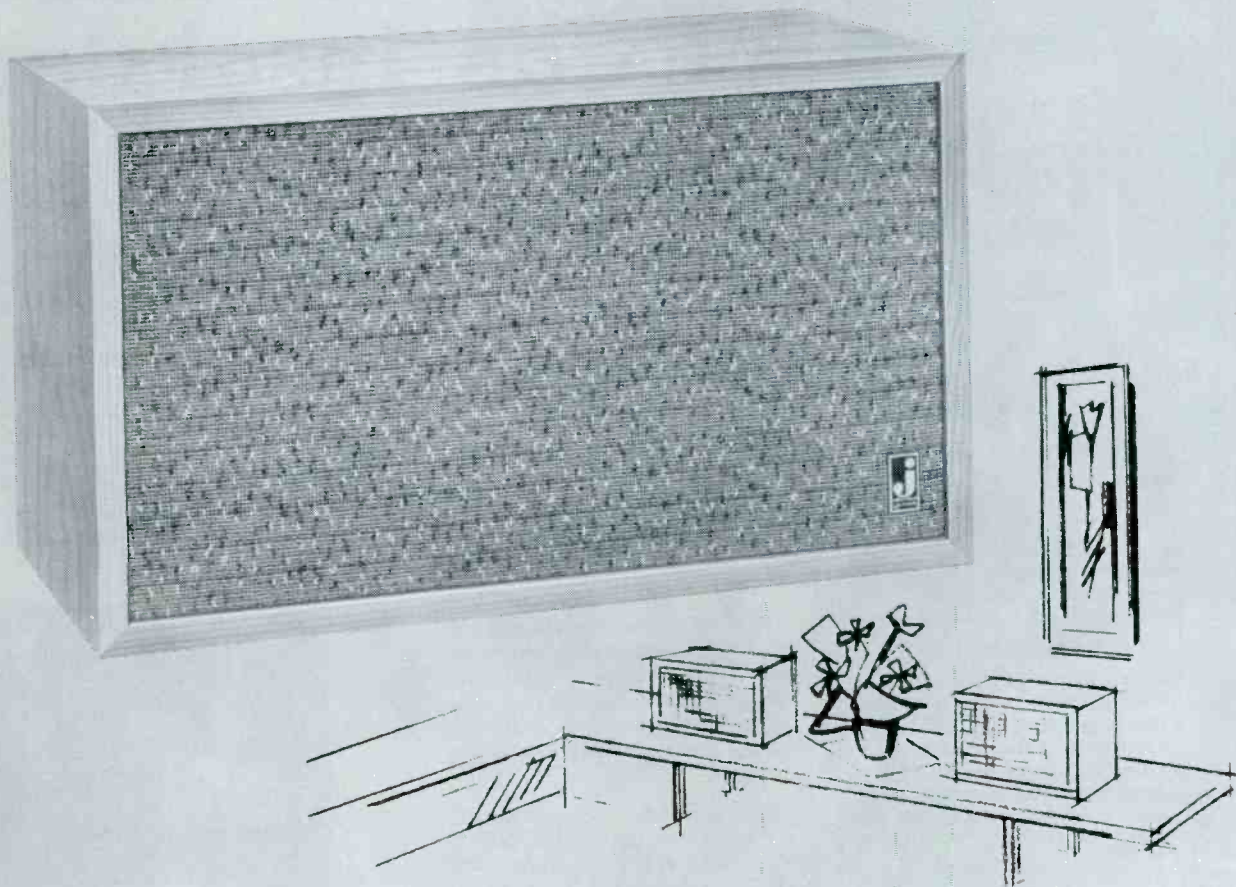

**Fig. 5. Antronic Model UT450.**



...THERE'S NO QUESTION!

# HERE'S YOUR "BEST BUY"



## The Thrifty 4-Speaker TF-3 from **jensen**



In the "budget" price range, there is no finer speaker system on the market. In fact, careful comparison proves that Jensen's beautifully balanced TF-3 is unquestionably the finest . . . not only the "best buy" . . . but point for point, the best system—and you pay much less. **Compare . . . components:** The TF-3 uses a 10" FLEXAIR\* woofer, effective from 25 cycles, two special midrange units, and the new Jensen Sono-Dome\* Ultra Tweeter. . . so brilliant a speaker, it does not even begin to operate until 10,000 cycles! **power ratings:** The TF-3 drives to full room volume with a good quality 10 watt amplifier. It does not require a 20 watt amplifier for clean performance. **enclosures:** In the Jensen TF-3 you get top quality construction 3/4" gum hardwood, rigidly built. It stains beautifully—or paint or build-in as you choose. Dimensions: 13 1/2"H., 23 2/3"W., 11 1/8"D. **Compare . . . price:** There is no real comparison. \$79.50

You are invited to make these comparisons—and any others you wish—between the Jensen TF-3 and any other "rated" speaker system on the market regardless of price. Comparison with the thrilling *sound* of the TF-3 will still further prove that . . .

\*T.M.

*there is always something better from*

# jensen

Division of The Muter Co.

MANUFACTURING COMPANY  
6601 S. Laramie Ave., Chicago 38, Illinois  
In Canada: Renfrew Electric Co., Ltd., Toronto  
In Mexico: Universal De Mexico, S. A., Mexico D.F.

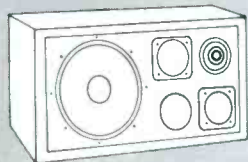

Write for Free Illustrated Brochure "KU".

**PROTECT COSTLY  
HIGH FIDELITY  
EQUIPMENT!**

**Mullard**

**GZ34/5AR4**



The Mullard GZ34 is a low impedance, indirectly heated, full-wave rectifier. Compactness and unique characteristics make the GZ34 an excellent replacement for high power rectifiers such as the 5U4G, 5U4GA, 5V4G, etc. in most amplifiers.

**CHECK THESE ADVANTAGES**

- Better voltage regulation due to lowered power supply impedance.
- Higher output voltage and cooler operation with lower voltage drop.
- Protection of costly filter condensers and power output tubes due to delayed warm-up and reduced ripple.



Trade Mark Mullard, Ltd.

**OTHER Mullard TUBES**  
designed specifically for High Fidelity:

|             |   |
|-------------|---|
| EB91/6A5    | Double Diode                              |
| ECC81/12AT7 | Low-noise medium $\mu$ dual triode        |
| ECC82/12AU7 | Low-noise low $\mu$ dual triode           |
| ECC83/12AX7 | Low-noise high $\mu$ dual triode          |
| ECC85/6AQ8  | RF Double triode                          |
| ECC88/6AQ8  | Frame grid RF Double triode               |
| ECF82/6U8   | RF triode pentode                         |
| ECL82/6BM8  | Triode with Output Pentode                |
| EF86/6267   | Low-noise input pentode                   |
| EF94/6AU6   | RF AF pentode                             |
| EL34/6CA7   | High-power pentode, 100 W PP              |
| EL37        | High-power pentode, 69 W PP               |
| EL84/6BQ5   | Miniature output pentode 20 W PP          |
| EM84/6FC6   | Miniature tuning indicator                |
| EZ80/6V4    | Miniature rectifier cathode type, 90 ma.  |
| EZ81/6CA4   | Miniature rectifier cathode type, 150 ma. |
| 7025        | AF Double Triode                          |
| 7189        | Miniature output pentode 20W PP           |

Available at all leading distributors.



NOW AVAILABLE: "Mullard Circuits for Audio Amplifiers"—136 pages of Stereophonic and Monophonic Audio Amplifiers, AM Tuners, Preamplifiers—only \$2.50 from your dealer or by mail.

For detailed technical data and application information write:

**INTERNATIONAL  
ELECTRONICS CORP.**  
81 Spring Street, New York 12, N. Y.



**"SQUEEZE  
BOTTLES"  
as Insulators**

When a polyethylene "squeeze bottle" has been emptied of its original contents (shampoo, sun-tan lotion, etc.), it has many uses around the TV service bench. The sizes holding from 3 to 7 fluid ounces are particularly useful. Refillable types, left intact, make handy containers for carrying glass cleaner or chemicals in the tube caddy. (A medium-sized bottle slips neatly into the space left by removing one 5U4GB.) Bottles can also be cut up in various ways and utilized as shown below.



With a small hole pierced in the bottom, a bottle insulates the temporary connection between a high-voltage anode lead and an extension wire used in a bench setup. The dual insulation—large air gap and plastic sheath—gives excellent protection against HV arcing.

With both ends completely cut off, the remaining polyethylene tube can be slid down over a high-voltage rectifier socket to stop corona or safeguard the technician during bench-servicing operations.



With a slit cut in the side, a bottle encloses a dangling "live wire" (such as the RCA tuner-power connector shown in the photo) and prevents accidental grounding or body contact.

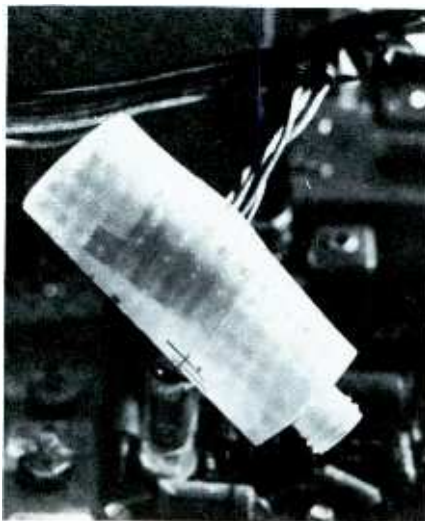

When bottles are too worn for further use as insulators, they can be cut into strips and used as wedges to hold yokes in place on the neck of an 8" check tube.

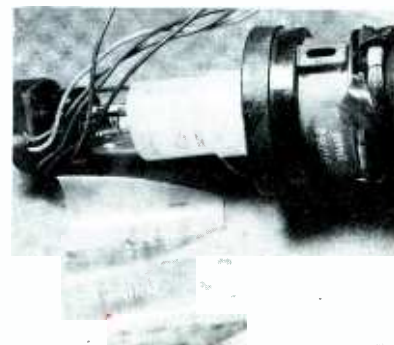



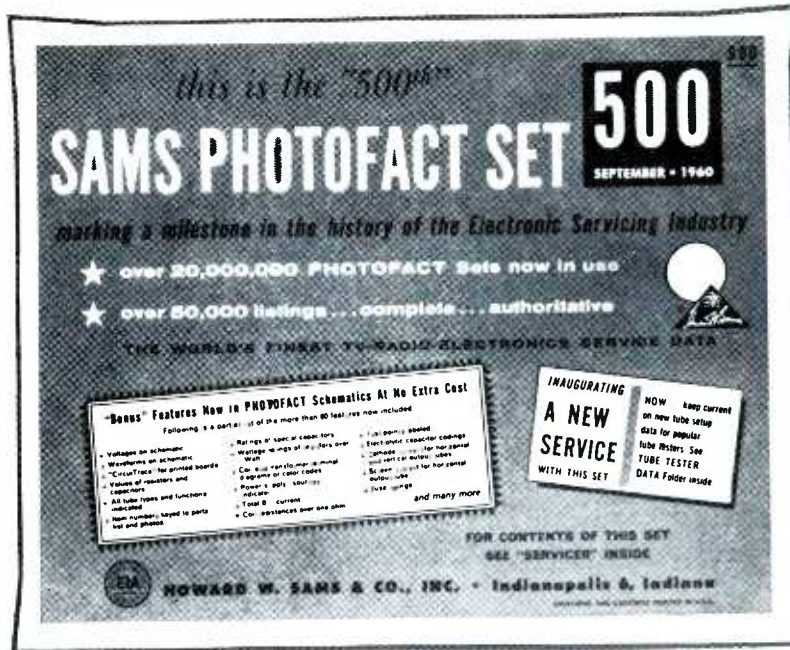

# THIS IS PHOTOFAC SET NO. 500

*truly a milestone in the history of the Electronic Servicing Industry*

over **20,000,000** PHOTOFAC Sets are now in use the world over  
 over **50,000** listings of TV, Radio and allied equipment are covered  
 over **23,000** Service Technicians subscribe to every new PHOTOFAC Set  
 over **75,000** Service Technicians refer to PHOTOFAC daily

**PLAIN FACTS:** PHOTOFAC owes its universal acceptance and success to its unquestioned ability to help *earn more money for any Service Technician.* The man

who owns a PHOTOFAC Service Data Library knows his customers' sets best. **HE EARNS MORE... HE RATES** with the public because he's **PHOTOFAC-EQUIPPED.**

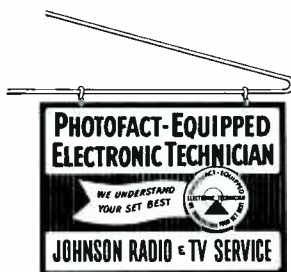

**BE AMONG THE FIRST IN YOUR COMMUNITY TO DISPLAY THIS POWERFUL SYMBOL**

If you now own a PHOTOFAC Library or plan to own one, you can apply for membership in "PEET"—the first industry program to build truly effective public acceptance for the Service Technician who qualifies. Membership helps you win public respect and confidence, builds more business for you. Benefits cost you absolutely nothing if you qualify. Ask your Sams Distributor for the "PEET" details, or mail coupon today.

**HOWARD W. SAMS & CO., INC.**

**WRITE TODAY** FOR VALUABLE INFORMATION

HOWARD W. SAMS & CO., INC.  
 1724 E. 38th St., Indianapolis 6, Ind.

Send me full details on how I can qualify for membership in the "PEET" Program. Include details of Easy-Buy Plan and Free File Cabinet offer.

I'm a Service Technician  full-time;  part-time

My distributor is \_\_\_\_\_

Shop Name \_\_\_\_\_

Attn.: \_\_\_\_\_

Address \_\_\_\_\_

City \_\_\_\_\_ Zone \_\_\_\_\_ State \_\_\_\_\_

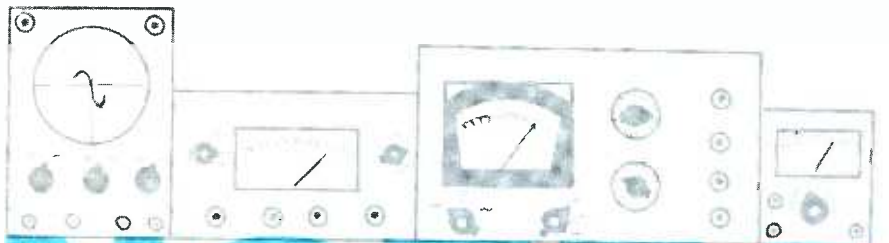

# NOTES

## ON TEST EQUIPMENT

by Les Deane

### Need a Crystal Ball?



Fig. 1. Seco's new portable unit for checking Citizens band transceivers.

Most of us at one time or another have probably wished we had one, especially when troubleshooting an unfamiliar piece of equipment; but, to be honest with ourselves, we know we can't depend on "hocus-pocus" to provide the answers. Since many of you are now, or soon will be, servicing Citizens band transceivers, you should have far greater need for a crystal checker than a crystal ball.

Seco Electronics, Inc. of Minneapolis has recently developed a combination crystal checker and multiple test instrument for servicing virtually all crystal-controlled two-way radio equipment, including Citizens band gear. The Model 500 CrystalignMeter (Fig. 1) is transistorized and completely self-powered.



Fig. 2. The 500's extension cable is helpful while making field tests.

Specifications are:

1. *Power Requirements* — two self-contained 1.5-volt "C" batteries; power-off position provided on selector switch.
2. *Crystal Checker* — determines activity of both fundamental and overtone types; test load based on good crystal having an impedance of 30 ohms; test circuit for CB types designed for 26- to 28-mc range; useful frequency range of untuned circuit from approximately 1 mc to over 20 mc; test sockets provided on panel.
3. *Field Strength Meter* — untuned meter detector circuit measures relative power output; built-in pick-up loop and remote cable supplied.
4. *Modulation Monitor* — picks up and reproduces transmitted modulation by use of auxiliary headphones or audio amplifier; meter also indicates modulation peaks.
5. *Signal Generator* — supplies low-level crystal-controlled RF output, either unmodulated or modulated by internal or external source.
6. *DC Voltmeter* — with test leads connected to proper jacks, meter movement becomes zero- to 5-volt indicator; smallest scale division .25 volts.
7. *DC Milliammeter* — during voltmeter operation, with test prods placed across 100-ohm current-sampling resistor, meter movement becomes zero- to 50-ma indicator.
8. *Frequency Comparer* — built-in germanium diode serves as heat-frequency detector; output monitored by auxiliary headphones or audio amplifier.
9. *Size and Weight* — plastic case 2" x 3 3/4" x 6 1/4", 1 1/4 lbs.

Because this instrument has so many applications, it has been identified as a two-way radio test set rather than merely a crystal checker or field-strength meter. Since the Model 500 is designed for troubleshooting equipment not altogether familiar to many of you, perhaps a full understanding of its operation will be easier to grasp if I outline how I used

the instrument in some practical applications.

Crystal testing with the unit is simple and straightforward; you first determine the type of crystal, set the slide-type selector switch to its recommended position, and plug the crystal into the test jacks provided on the panel. The meter automatically indicates the activity of the crystal on a scale which tells you whether the output is good, questionable, or poor. This output indication is based on the Q of the crystal. I found that the average good crystal will give a reading of about one-half scale, a very active one near full scale, and a weak or marginal one near the question-mark area.

For those of you not fully familiar with crystal types, it might be well to explain the meaning of the term *overtone crystal*. It is difficult to produce a crystal having a very high fundamental frequency, but the effective output frequency can be increased by forming the crystal in such a way that it vibrates in sections rather than as a single unit. To visualize this action, you might compare it to the "vibrations" set up by two people whipping a rope between them. Depending on how they maneuver the rope, they can cause a simple up-and-down motion (corresponding to a fundamental frequency), or a series of smaller motions (corresponding to a multiple or overtone frequency). As an example, a third-overtone crystal with a fundamental of 9 mc. will have an effective output of three times this fundamental, or 27 mc.

Employing the unit as a field-strength meter, I found that I could evaluate the relative power output of a transmitter by placing the back of the Model 500 at the base of the antenna. For this operation, the selector switch is placed in the OFF position and the RF signal is picked up by a loop of wire contained within the instrument. The strength of the radiated RF signal may then be noted on the meter.

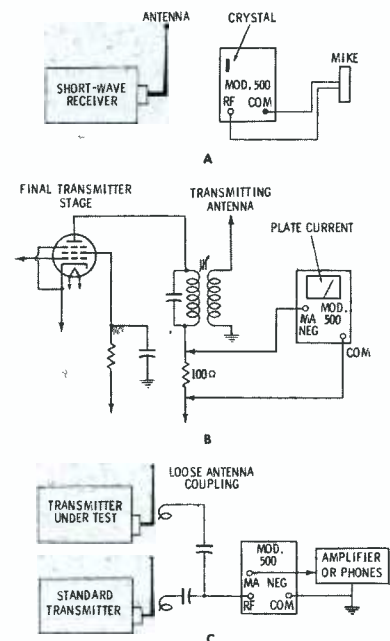
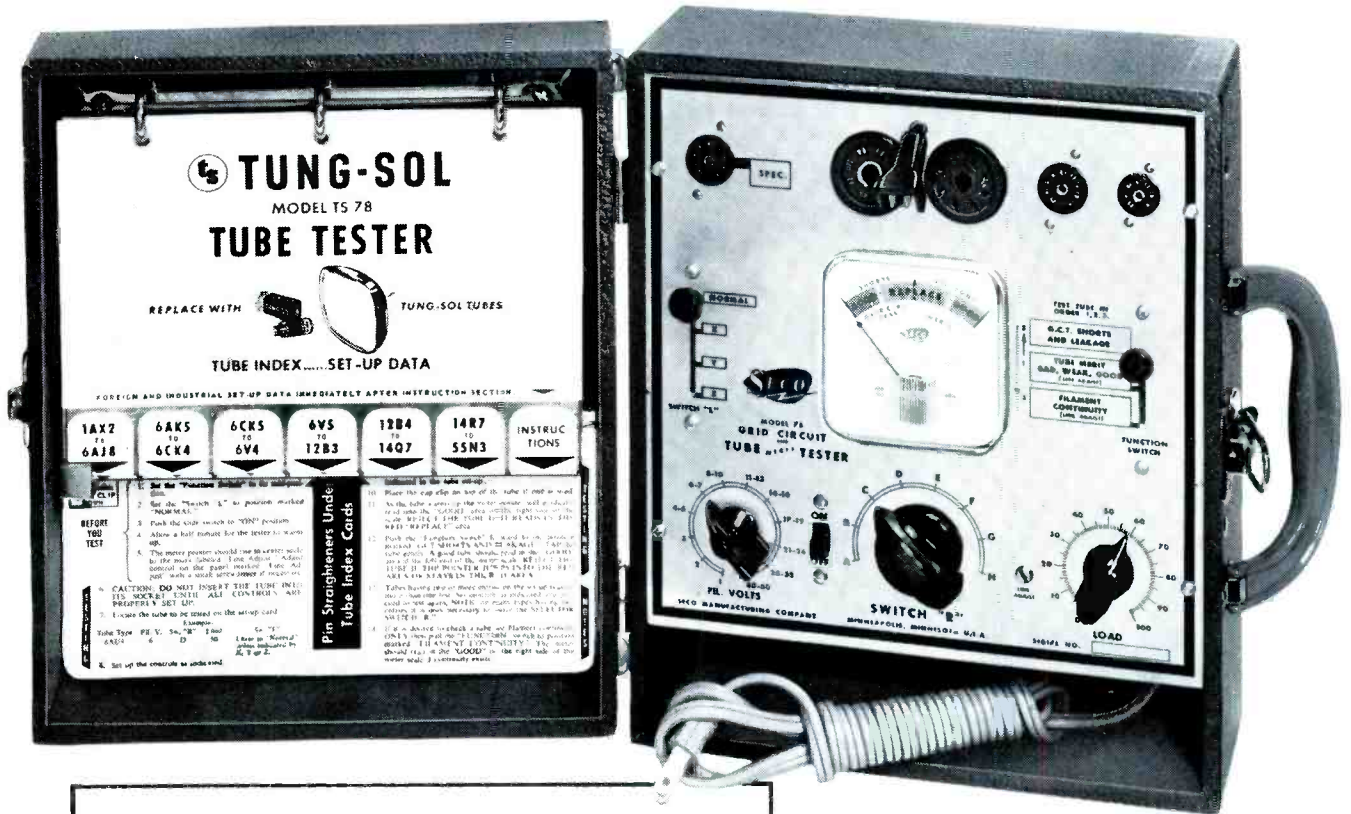

Fig. 3. Basic setups for checking CB units with the CrystalignMeter.



# Rebuild Tube Sales Volume

With the Tung-Sol "take home" tube tester plan



The Model TS-78 Tube Tester is a precision instrument, exceptionally fast and easy to use. Five sockets accommodate all tubes.

Gives results for both grid circuit and tube merit tests. Comes equipped with all instructions and complete tube reference guide.

TV servicemen now can accommodate "do-it-yourself" customers who like to test their own tubes—and at the same time regain tube sales that have been slipping away.

The low-cost Tung-Sol "Take Home" Tube Tester enables you to provide a lending service that lets customers test their radio and TV tubes right in their own home.

Here's how it works! Customer borrows the tube tester. Checks all his tubes at home.

Returns the tester and buys the new tubes he needs from you.

In addition to boosting tube sales, the Tung-Sol plan will increase traffic to your place of business. You'll gain new service customers and increase in-store sales of other products.

Your Tung-Sol tube supplier has the whole story about the Tung-Sol "take home" Tube Tester plan. Get the information at once and begin to get back the tube sales you've lost. Tung-Sol Electric Inc., Newark 4, N. J.



**TUNG-SOL**<sup>®</sup>  
ELECTRON TUBES • SEMICONDUCTORS

The instrument is also supplied with a 15' shielded cable which permits the operator to take RF measurements from a remote location. Experimenting with this procedure, I attached one end of the cable to the base of a mobile antenna and the other to the Model 500—which I observed while sitting in the vehicle. This convenient arrangement is shown in Fig. 2. Voice modulation of the transmitted signal can also be monitored by attaching a set of phones, or an audio amplifier and speaker, to the proper output jacks of the instrument.

To use the *CrystalignMeter* as an RF signal source, a crystal for the proper frequency is plugged into the appropriate panel socket and the selector switch moved to its required position. For an

internally-modulated signal, the switch is placed in position A or C, depending upon the type of crystal employed. If an unmodulated signal is desired, or you wish to use external modulation, the switch is placed in position D. To pick up this generated signal with the receiver of a two-way system, the Model 500 need only be placed within a few feet of the receiver's antenna. This application is illustrated in Fig. 3A. Although a precise frequency cannot always be assured, the test signal is satisfactory for checking squelch circuits or peaking RF and antenna coupling stages. For an accurate frequency output, special crystals can be obtained from the manufacturer.

Another handy function of the Model 500 is its use in measuring plate current

of a transmitter's final amplifier stage. Two test leads are attached to the jacks marked MA NEG and COM. These leads are then placed across the current-sampling resistor usually located in the plate supply circuit of the final transmitter stage. This resistor must have a value of 100 ohms, since the milliammeter function of the instrument is calibrated for this value. Plate current is monitored on the zero-to-50 scale of the meter. (See Fig. 3B.)

As I have shown in Fig. 3C, the *CrystalignMeter* may also be employed as a beat-frequency demodulator. Here, one transmitter of known correct frequency is being used to track or calibrate the output frequency of another. The procedure calls for coupling the "on-frequency" transmitter to the RF jack on the Model 500. The coupling should be such that only one-tenth of full-scale deflection is obtained. The output of the other transmitter is likewise coupled to the instrument and a similar reading obtained. Headphones or an audio amplifier and speaker are connected to the proper output jacks of the instrument as an audible indicator. By listening for a beat-note indication, the transmitter being tested can then be adjusted to the precise frequency of the other transmitter. In the lab, I also found an accurate signal generator useful in this tracking procedure.

Aside from its applications on Citizens band transceivers, aircraft and marine gear, and police or fleet radio equipment, the *CrystalignMeter* is also handy for troubleshooting remote-control devices such as automatic garage-door openers and industrial control apparatus. The instruction manual for the instrument incorporates several charts for Citizens band Class D transmitting and receiving crystals. Each chart lists channel number, operating frequency, and number by which the crystal is properly identified.

## Transistor Tranquilizer

The piece of equipment shown in Fig. 4 may help to relieve your anxiety about accurately checking the performance of temperamental transistors. This *Dynamic Beta Transistor Tester* was recently developed by Hickok Electrical Instrument Co. of Cleveland.

Designated as the Model 870, the unit is designed to test small-signal, medium-signal, and power-type transistors under typical operating conditions.

Specifications are:

1. *Power Requirements* — 105/125 volts, 50/70 cps, power consumption 35 watts at 115 VAC; regulated B+ supply; line fuse, ON indicator, and isolation transformer provided; two internal 6-volt nickel-cadmium batteries (with recharging circuit) employed for transistor biasing.
2. *Leakage Tests* — measures NPN and PNP transistors of either small-signal or power types for collector leakage currents ICBO, ICEO, ICES, and ICER; shorted transistors also

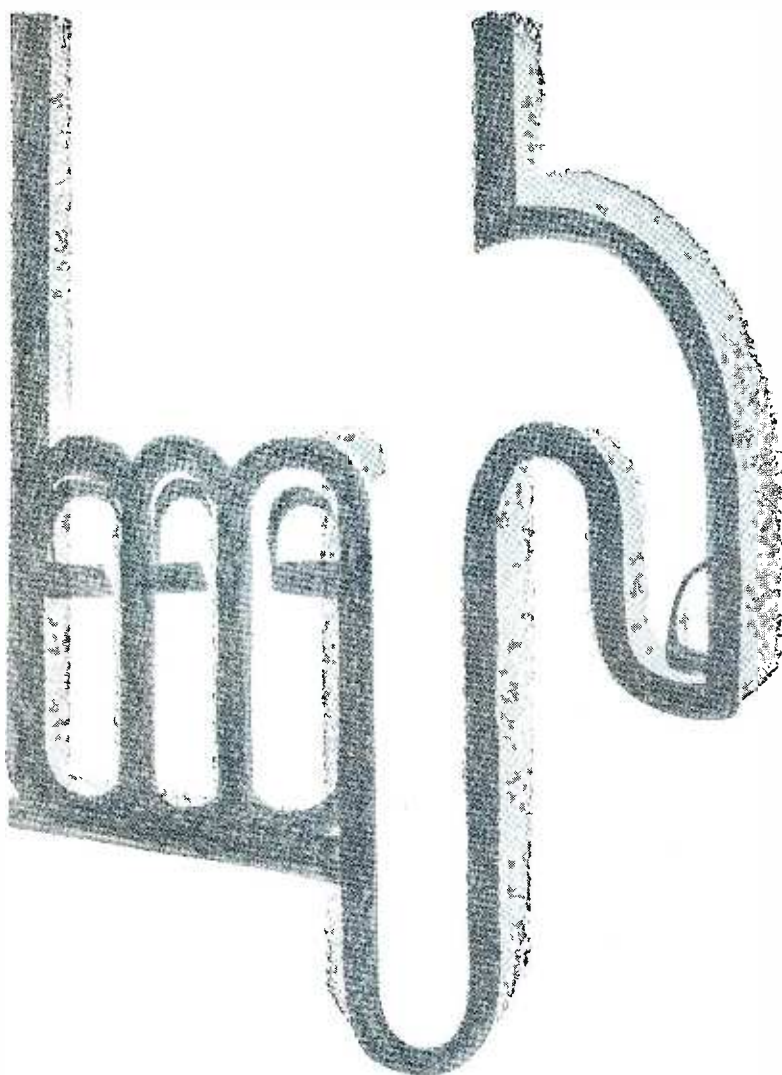

exact replacement **STANCOR TRANSFORMERS**

that do the job...and do it better

FLYBACKS • YOKES • POWER TRANSFORMERS

Your distributor has them in stock—along with many other types and the complete line of Stancor Coils. Complete replacement listings in PHOTOFACETS and COUNTERFACTS.

**CHICAGO STANDARD TRANSFORMER CORPORATION**

3501 WEST ADDISON STREET • CHICAGO 18, ILLINOIS



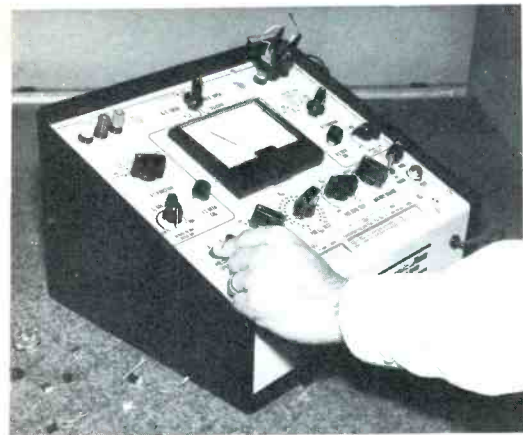

Fig. 4. Hickok's 870 offers an accurate way to check all transistor types.

- detected by test results.
3. *Gain Tests* — dynamic current-transfer ratio for small-signal transistors measured at 1000 cps (AC beta); DC current-transfer ratio also measured for power types (DC beta); reference values given in roll chart for transistors listed.
  4. *Other Tests* — AC input impedance of transistor; collector saturation voltage VCE (sat) at a given base current.
  5. *Panel Features* — 5", 100-ua meter with four individual scales providing all current, beta, and voltage readings plus a battery test indication; two sets of test receptacles, each with standard transistor socket plus individual element terminals and test leads; dual-window roll chart listing transistor test information.
  6. *Size and Weight* — 14½" x 12" x 8", 15½ lbs.

The Hickok 870 comes equipped with a roll chart, selector switches, and test buttons much the same as you would find on an elaborate dynamic tube checker. You might consider the unit as two separate testers in one, since its panel is divided into two parts — one for testing small-signal transistors and the other for power types. Basically, the sections have identical adjustments and test connections; however, the panel meter and switches located directly above the roll chart are common to both.

The housing for the instrument is designed so that the test panel slants toward the operator at an angle of about 20°, making it easy to view the roll chart, meter, and switch markings. As



Fig. 5. The tester's detachable lid is used to store manual and test leads.

pictured in Fig. 5, the detachable lid has this same angled contour, and features an elastic band which secures the instrument's instruction manual and test leads. After removing the hand-wired chassis from its case, I could plainly see that this was no simple "go—no go" transistor checker, but a complex precision instrument designed to meet high laboratory standards.

The two principal tests given a transistor are leakage current (ICBO) and beta gain (either AC or DC depending on the type under test). I have shown closeup photos of the 870's panel and roll chart in Fig. 6. If you refer to these illustrations as I explain a typical operating procedure, I'm sure you'll have a better understanding of what the instrument will do and how to operate it.

When testing a 2N35, for example, I first located this number on the roll chart. Naturally, it's impossible for the chart to include all types; therefore, manuals or manufacturers' specification sheets listing characteristics may be used equally well to determine test settings and results. Since the roll chart did list the 2N35 (Fig. 6B), I followed instructions as I would on a tube tester and placed the TYPE switch in its NPN position and the TEST SELECTOR (top center Fig. 6A) in position #1. With the selector in this first position, the left side of the panel is supposed to be used — so I connected the transistor to the test socket on this side.

To measure ICBO, which is collector current with a given reverse bias and an open emitter connection, I set the

## BUY A DOZEN VU-BRITES



...get the watch band

# FREE!

Handsome, practical Florentine expansion watch band—yours free with the purchase of 12 C401 or C402 Vu-Brites!

### WHAT A DEAL!

For a limited time, Perma-Power is offering you this wonderful gift absolutely free with the purchase of 12 Vu-Brites at the regular price. Vu-Brites are the brighteners that really do a job — on series or parallel sets (Model C401 for parallel; Model C402 for series). They come colorfully packaged in individual boxes . . . and are priced at \$9.95 the dozen, net.

Hurry—this special gift offer will end when current stocks are gone. Call your distributor today.

**Perma-Power**® COMPANY

3102 N. ELSTON AVENUE • CHICAGO 18, ILLINOIS

**HAMILTON**

**RESISTORS  
YOU  
CAN'T  
RESIST!**



Hamilton electronic components are supercharged with "SELL." When you think of resistors, think of Hamilton first because of:

- Quality Controlled Engineering
- Highest Grade Materials
- All Products 100% Guaranteed
- Sure-Fire Profits!

**FIXED COMPOSITION RESISTORS**

1/2 Watt,  
1 Watt,  
2 Watt

From 10 Ohms to 22 Megohms  
Made in U.S.A. Sold Bulk or Kits



**HAMILTON-HALL, INC.**

227 N. Water Street, Milwaukee 2, Wis. BR. 3-6460

**Picture-Tube Repair Tool**

Eliminates that hard soldering job

only \$1.25 each



Fix loose pin connections in seconds. Pays for itself in time saved on first job.

Intermittent operation of picture tubes due to defective socket connections easily corrected. Provides solid electrical connections, can also be used as channel-selector wrench and screwdriver. Pin keeps its original form.

**3 MODELS  
ELIMINATE SOLDERING**

**Pin-Plug Crimper**

Slip wire in "pin plug," insert in tool, and squeeze job is done.

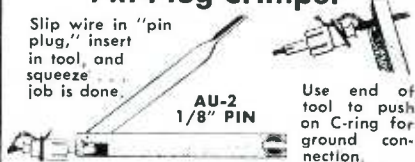

The tool that makes solid electrical pin-plug connections without soldering.

**Model LC-3 for 5/32" pin diameter**

Available at your parts distributor.

**BERNS**

Mfg. Co.  
9853 Chalmers,  
Detroit 13, Mich

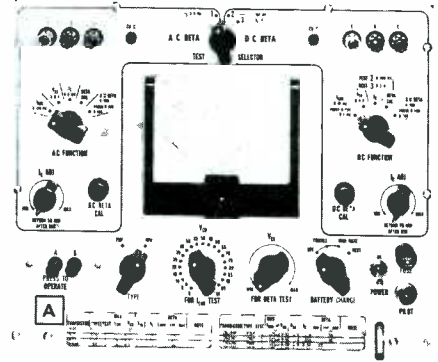

| TRANSISTOR | TYPE | TEST | MAX I <sub>EB</sub> | V <sub>CB</sub> | V <sub>CE</sub> | I <sub>C</sub> | BETA | NOTE |
|------------|------|------|---------------------|-----------------|-----------------|----------------|------|------|
| 2N34       | PNP  | 1    | 50.4                | 45              | 5.0             | 1.0ma          | 75   |      |
| 2N35       | NPN  | 1    | 50.3                | 40              | 5.0             | 1.0ma          | 75   |      |
| 2N43       | PNP  | 1    | 16.3                | 45              | 5.0             | 1.0ma          | 42   |      |
| 2N43A      | PNP  | 1    | 16.1                | 45              | 5.0             | 1.0ma          | 42   | dB   |

Fig. 6. Controls and roll chart of the 870. Note the two panel divisions.

FUNCTION switch on the left side of the panel to its first position labeled ICBO. As recommended on the chart, I then placed the VCB switch on 40, pressed the red test button A, and read leakage current on the 100-ua scale of the panel meter. This particular transistor produced an indication of 20 ua. Comparing this to the maximum (50 ua) listing on the roll chart, I knew that the transistor's base-to-collector leakage was within satisfactory limits. The preceding test might be considered similar to a preliminary shorts-leakage test for vacuum tubes; so I continued with a beta test, which can be compared to a mutual conductance measurement.

Referring again to the left side of the panel, I set the function switch to its next position (VCE). Holding test button A down, I then adjusted the VCE control so that the meter needle came to rest at the specified value listed on the roll chart — or full deflection on the 5-volt scale. Leaving this control set, I next advanced the FUNCTION switch to its IC position and, depressing the A button, rotated the IC ADJ knob until I obtained a reading of precisely 1 ma on the 5-ma scale of the meter. Note that this 1-ma value is listed under the IC column of the roll chart's beta section (Fig. 6B). Moving the FUNCTION switch one more step to the BETA CAL position and depressing button A, I proceeded by adjusting the AC BETA CAL knob until the meter needle rested directly over the CAL SET mark on the top meter scale.

With the Model 870 now set up and calibrated for a direct beta measurement, I placed the FUNCTION switch in its last position (AC BETA). After pressing the A test button, I observed a reading of slightly less than 50 on the 0-300 scale. Since this value was less than 100, I also depressed the B test button, which automatically produced a more accurate reading on the 0-100 scale. The typical value of beta listed on the roll chart is 75, but for the transistor tested I noted a reading of only 42. When a minimum acceptable figure is not given, you can usually assume it to be about 50% of the typical value. Therefore, the tran-

**WEBCOR IS BUILT  
for easy servicing**



**NEW! Technical information  
on all 1961 Webcor products  
available on subscription!**

Service Manuals and Bulletins on all current models, plus literature on new models as they are released — from July 1960 to July 1961 . . . punched for filing in Webcor folder.

only \$5.<sup>00</sup> per year's subscription

**SUBSCRIBE NOW!**

WEBCOR, INC. Service Dept., 912 W. North Ave., Chicago 22, Ill.

Enclosed is \$5.00 (by check , money order .

Please send a full year's subscription of Webcor technical literature to:

NAME \_\_\_\_\_

TITLE \_\_\_\_\_

COMPANY \_\_\_\_\_

ADDRESS \_\_\_\_\_

CITY \_\_\_\_\_ ZONE \_\_\_\_\_ STATE \_\_\_\_\_



sistor I tested should have adequate gain for most applications.

The test procedure actually requires only a fraction of the time it takes to tell about it; the steps are simpler than those necessary for many tube testers, once you get the hang of them. The instrument's manual also explains the other tests listed in the specifications. One interesting feature that I have failed to mention thus far is the unique re-charging arrangement for the instrument's batteries. Located near the power switch on the front panel, you'll find a BATTERY CHARGE selector with four positions — OFF, TRICKLE, HIGH RATE, and TEST. With this selector in the trickle position, the internal batteries are recharged at a relatively slow rate. In the high rate position, as the name implies, the batteries are recharged more rapidly. As long as power is applied to the instrument, these charging circuits are operative regardless of the position of the power switch. To test the condition of the batteries, the operator need only place this selector in its test position and note the meter indication on a special battery scale.

## Tubes, Tools, and Tester

The combination serviceman's case and tube tester pictured in Fig. 7 is a recent addition to the line of test equipment marketed by Shell Electronic Mfg. Corp., Westbury, New York. Identified as the *Tube Cadi-Tester*, the Model TC-18 features a *Test-O-Matic* chassis conveniently housed in one of the foldout compartments of a vinyl-covered tube and tool caddy.

Specifications are:

1. *Power Requirements* — 110/120 volts, 60 cps; power consumption in standby less than 5 watts; ON indicator provided in meter housing.
2. *Tube Tests* — checks more than 800 tube types; automatically indicates shorts, leakage, and gas on two panel lamps; tube emission registered on panel meter; multi-purpose tube sections tested separately; set-up data supplied.
3. *Vibrator Test*—output condition of 6- or 12-volt units indicated on matched pair of panel lamps.
4. *Other Features* — 18 individual tube-test and 3 vibrator-test sockets provided on panel; pin straighteners for both 7- and 9-pin miniature tubes; 4½" panel meter with BAD-?-GOOD scale plus linear 0-100 scale for relative indications; operating instructions printed on panel with set-up data for over 300 popular tube types furnished inside lid; case includes 19¾" x 7½" x 6¾" storage compartment in base plus fold-out section 19¾" x 6" x 4" with dividers and separate lid.
5. *Size and Weight* — portable case 20¾" x 14" x 8", 14½ lbs. complete.

If you're in need of a compact tube

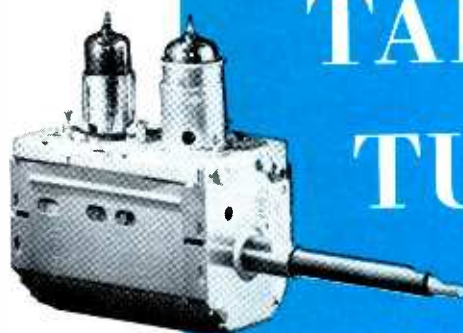

HOT ROD  
(turret-type)

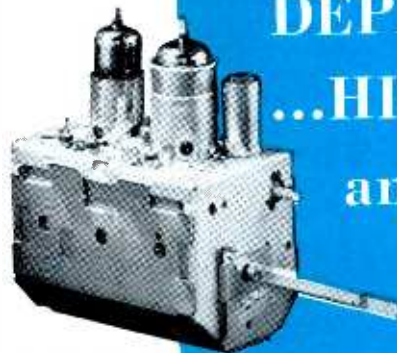

SILVER SEALED  
(switch-type)



HI FI  
(FM) Tuner

# TARZIAN TUNERS

Noted for their  
**DEPENDABILITY**  
...**HIGH QUALITY**  
and **LOW COST**

That's why the world's leading set manufacturers rely on the trouble-free TARZIAN TUNER for the excellent performance of their receivers.

Today TARZIAN TUNERS are backed up by more than 15 years of experience in the design . . . development . . . and production of more than 15 million TV Tuners.

And, Tarzian is the only commercial manufacturer offering both the HOT ROD (turret-type) and SILVER SEALED (switch-type) . . . as well as the newer Hi Fi FM Tuner. All embody the high standards of QUALITY . . . DEPENDABILITY . . . and PERFORMANCE that have made Tarzian a leader in the field.

For more information, write to: Sales Department  
Tuner Division



## SARKES TARZIAN INC

east hillside drive • bloomington, indiana

Manufacturers of Semiconductors, Air Trimmers and Broadcast Equipment

after  
**61**  
years

it's the radio-tv  
serviceman's  
"best friend"!

# KESTER SOLDER



KESTER "RESIN-FIVE" FLUX-CORE SOLDER enjoys almost 100% acceptance by the radio-television-electronics service industry. Servicemen like its fast action and easy application . . . its non-corrosive, non-conductive activated flux does a perfect job every time.

**Send** for detailed information on Kester "Resin-Five" Flux-Core Solder.

## KESTER SOLDER CO.

4228 Wrightwood Ave., Chicago 39, Illinois  
Newark 5, N. J., Anaheim, Calif.,  
Brantford, Ontario, Canada

OVER 60 YEARS' EXPERIENCE IN SOLDER AND FLUX MANUFACTURING



**RIGHT  
BEAT . . .**  
14,399,668 TIMES

That's the number of your customers hearing about Duotone replacement needles month after month in magazines such as NEW YORKER • PLAYBOY • THIS WEEK. Beating the drum for you right in your own town

**DUOTONE** DIAMOND & SAPPHIRE NEEDLES  
KEYPORT, NEW JERSEY

Makers of the first commercial diamond needle guaranteeing you the natural whole gem every time

## The LUXO MAGNIFIER . . .

IDEAL FOR VISUAL ACCURACY

ON SERVICE,  
TEST AND  
INSPECTION  
BENCHES.

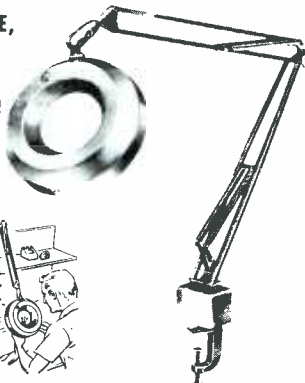

Luxo's excellent magnification and cool shadow-free light increase precision when working with miniaturized circuits and assemblies, reading parts numbers and making terminal identifications.

Built into every magnifier are the world-famous Luxo features—modern functional design, quality construction, flexibility and portability.

Luxo Lamps are also available in Incandescent, Fluorescent and Combination models.

ALL UL approved.

Order from your supplier or write:

**LUXO LAMP CORPORATION**  
San Francisco, Cal. • PORT CHESTER, N. Y. • Montreal, Que.

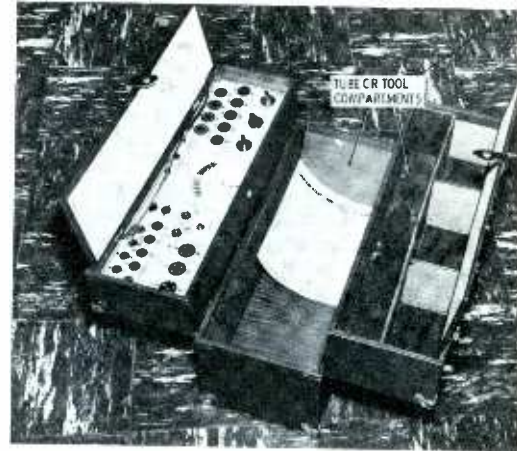

Fig. 7. Shell's Tube Cadi-Tester has storage space for tubes and tools.

tester to carry on service calls, this unit should fill the bill. The checker occupies only one tray of the caddy, and the entire tray can be lifted out easily for use at the repair bench or on a sales counter. (See Fig. 8.) Unsnapping and lifting the lid of the tray, you'll find a bright yellow panel and tube chart trimmed in red and black. The *Test-O-Matic* meter is situated in the center of the panel with two rows of tube test sockets on each side near the top. There are only three set-up adjustments, and these are in a line to the lower right of the meter. The lower left portion of the panel incorporates a tube-test button, two short indicators, and a vibrator-test section.

Making use of the Model TC-18 by testing a number of known good and bad tubes, as well as vibrators, I found its operation very simple and certainly very expedient. For an emission checker of this type, I also noted that it had reasonably good accuracy. To test a tube in the instrument, you first locate the tube type on either the chart inside the lid or a supplementary chart also furnished with the unit. The test data is contained within four individual columns — one for each knob adjustment, and the other identifying the correct test socket to be employed.

After setting up adjustments (a matter of two to four seconds) and inserting the tube into the proper socket, leakage, shorts, and gas are automatically in-

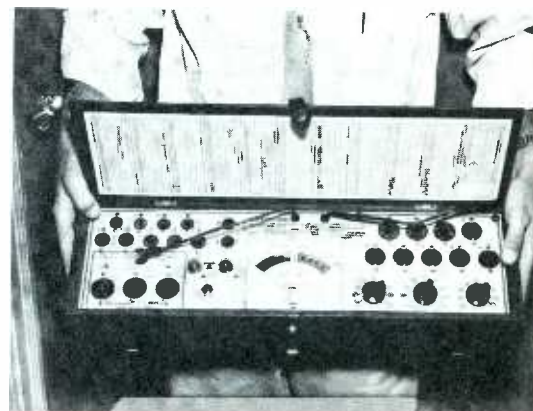

Fig. 8. The tester itself can be detached from caddy and operated anywhere.



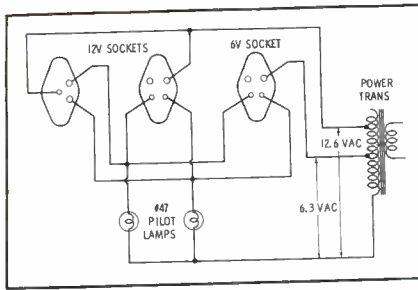

Fig. 9. The vibrator test circuit incorporated in the TC-18 Cadi-Tester.

indicated by a glow of either or both of the neon bulbs directly to the left of the meter. When I checked several known gassy tubes, I noted that these bulbs would start to flicker as soon as the tubes heated up. Those with sufficient gas to cause trouble will generally be detected in this test. Here's something you might keep in mind, however, when testing tubes in *any* checker: If you suspect certain tubes of being gassy, always give them adequate warm-up time or else preheat each one before placing it in the test socket.

To check sensitivity of the short-indicator circuit, I set up the instrument to test a number of tube types; instead of placing the tubes in the test socket, I used a resistance decade to introduce a controlled amount of leakage between certain socket connections. Varying this simulated leakage, I found the maximum resistance which would still produce a detectable glow in the neon bulbs. Overall results indicated that the sensitivity for heater-to-cathode leakage was about 500K ohms, and for grid-to-cathode leakage 1.5 megohms.

If a tube passes the initial shorts test, its emission is checked by pressing a small red button located directly below the two short lamps. The condition of the tube is then revealed on the BAD-?-GOOD scale of the panel meter. Individual sections of multipurpose tubes are checked by resetting only one of the panel knobs for each section tested. Switch z is merely positioned to the alphabetical letters designated in column z of the tube chart.

I removed the *Test-O-Matic* chassis from its caddy tray to see exactly how vibrators are tested in the instrument, and drew a schematic (Fig. 9) to help explain this relatively simple arrangement. Three panel test sockets are involved — two for 12-volt vibrators and one for 6-volt types. The input test voltage is supplied from a couple of taps on the unit's power transformer, while two #47 pilot lamps are series-connected in each branch of the vibrator's output circuit.

When the vibrator's reed makes contact with each pin, the lamp in that branch will glow or flicker at the frequency rate of vibration. If the unit under test is okay, both lamps will glow with equal brilliance; however, if a loss is present across one of the contacts, the lamp in that branch will appear dimmer. Naturally, if the vibrator is completely defective, neither lamp will light. ▲

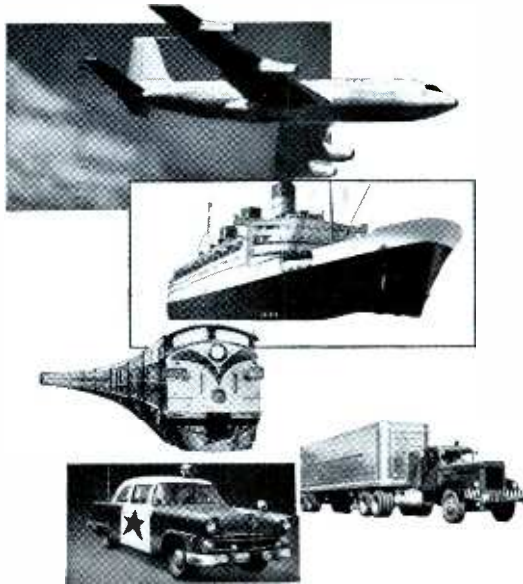

Replace  
with  
the  
best...

**RCA** POWER  
TUBES



from your RCA  
Industrial  
Tube Distributor



For reliable 2-way radio communications, always replace with RCA Power Tubes from your local RCA Industrial Tube Distributor. For more than a quarter-century RCA Power Tubes have been the standard of quality in communications equipment. Wherever you look in commercial radio, the military services or industry, you'll find RCA Power Tubes doing the critical jobs...delivering top performance. It makes sound business sense to invest in the long-life economy of RCA Power Tubes in your essential 2-way radio equipment.

Your RCA Industrial Tube Distributor carries a complete line of RCA tubes for fixed and mobile communications equipment. Give him a call whenever you need replacement tubes. He'll always give you fast, efficient service.



ANOTHER WAY RCA SERVES YOU THROUGH ELECTRONICS  
**RADIO CORPORATION OF AMERICA**  
Electron Tube Division Harrison, N. J.

# NEW and VITAL SAMS BOOKS

## 101 Key Troubleshooting Waveforms for Horizontal AFC—Oscillator Circuits

by Robert G. Middleton

First in a brand-new series by the author of the best-selling "101 Ways" books. Shows 101 abnormal waveforms (obtained when various circuit components become defective), accompanied by circuit symptoms, tests and

evaluations of results. Supplementary notes provide background information. Covers the three most popular horizontal AFC-oscillator configurations: the multivibrator and blocking oscillator with pulse-width AFC, and the multivibrator with duo-diode AFC. With this book by your side you need never be puzzled by an abnormal waveform! 150 illustrations; 128 pages; 5½ x 8½". Only... **\$200**

## Servicing Transistor TV Receivers

by Milton S. Kiver  
and Charles R. Gray

Only book of its kind on this subject, timed with the appearance of the first transistor TV models. The authors introduce you to the transistor and to basic transistor circuits. Then, you are shown, one by one, how transistors are used in the tuner, video-IF amplifier, video-detector, video-amplifier, AGC, sound, sync-separator, and horizontal and vertical deflection sections. Includes data on the application of tube-set techniques; servicing differences between tube and transistor TVs; handling, testing and replacement of transistors; checking operating points, shorted and open transistors; plus special servicing pointers on specific sections, emphasizing horizontal-deflection systems. Illustrated; 272 pages; 5½ x 8½". Only... **\$450**

## Experiments In Industrial Electronics

by Melvin Whitmer

You learn how more than a dozen industrial devices work by actually sitting down and building them—the best way to learn a new skill. Projects are simple enough to appeal to the beginner, yet meaty enough to satisfy the most bench-hardened veteran. You'll build a photoelectric doorbell ringer, garage-door

opener, burglar alarm, electronic time-welder control, electronic oven, flame detector and strain gauge, proximity detector (burglar alarm, store window novelty, thickness tester, etc.) that harnesses capacitance, DC motor control (including one for a portable turntable steady enough to satisfy even the wildest hi-fi fan) and a servo system. This valuable book can be your gateway to a profitable future in the fast-growing field of industrial electronics. 5½ x 8½". Only... **\$195**

**JUST OUT**

### HOWARD W. SAMS REPLACEMENT GUIDE FOR TV & AUTO RADIO CONTROLS

Vol. 3. Greatly expanded—covers 27,000 TV and over 1,000 auto radio models. Lists recommended replacement controls of Centralab, Clarostat, IRC and Mallory. \$100 8½ x 11". Only... **\$100**



### HOWARD W. SAMS & CO., INC.

Order from your Sams Distributor today, or mail to Howard W. Sams & Co., Inc., Dept. K-30 1720 E. 38th St., Indianapolis 6, Ind.

Send me the following books:

- "101 Key Troubleshooting Waveforms" (WFM-1)
- "Experiments In Industrial Electronics" (IEW-1)
- "Servicing Transistor TV Receivers" (KST-1)
- "Replacement Control Guide" (RGC-3)

\$.....enclosed.  Send Free Book List

Name.....

Address.....

City..... Zone..... State.....

(Outside U.S.A. priced slightly higher)



### Fusible Burnout

In the March *Troubleshooter* column, you advised Mr. R. E. Rumpf to change the 5-ohm fusible resistor in a Motorola set to 7.5 ohms when changing over from selenium to silicon rectifiers. Wouldn't the 7.5-ohm unit tend to burn out more readily than a 5-ohm one?

In past conversions, I've found that silicon rectifiers increase the B+ voltage to a considerable extent, sometimes causing flyback and associated failures. I always take care of this problem by adding a 7.5-ohm, 10-watt series resistor between the AC line and the rectifiers to reduce the DC output to the specified value.

CHARLES F. ANDREWS

Rochester, N. Y.

*The suggested 7.5-ohm fusible resistor fulfills the same electrical purpose as the 7.5-ohm, 10-watt unit you have been employing in your conversions; in addition, it provides fuse protection. It's true that an excessive failure rate has been known to result from replacing a fusible resistor with a higher-value unit, but this is likely to occur only when the rest of the rectifier circuit remains unchanged. Substituting silicon for selenium rectifiers is another story; don't forget that the currents and resistances in the circuit are significantly altered by the change in rectifier type.*

### Production Changes

Were there any production changes or vertical circuit revisions in a Philco Model 22C4113, Chassis TV-301? I have a vertical roll problem and have tried everything except juggling component values.

BEN JOSEPH

Midland, Pa.

*This chassis is covered in PHOTO-FACT Folder 276-7 and does have information available in Production Change Bulletin Folders 299-1 and 305-1. In addition, the main schematic shows a "note" symbol for the 680K resistor in series with the vertical hold control—a modification from the 470K value to provide better hold.*

*If adjustment of the vertical hold control will stop the rolling, it is safe to presume the oscillator is functioning properly and the trouble lies in the sync circuits. A critical evaluation of both*

*shape and amplitude of the waveform at the oscillator grid (with the oscillator stage disabled) will confirm any suspicions you might have in regard to the vertical sync signal at this point.*

### A Bend With Pull

Several Silvertone Model 9154 and 9156 TV sets have a common complaint: The picture pulls toward the left side of the screen. This normally happens during commercials and programs with a large amount of black information in the scene. The pulling can be reduced by backing off on the contrast and AGC controls, but we're in an area where these controls are operated at maximum settings.

I've checked the video detector, output, sync, AGC, and horizontal sections without results. The only clue I've found is "fuzz" in the separated horizontal sync pulse, evidently consisting of video information. Any help you can give will be appreciated.

EDWARD C. COOPER

Albany, Ore.

*The symptom you describe can be caused by many things. It usually results from the horizontal oscillator being on the verge of losing synchronization. From all indications, this is caused in your particular case by stray video information in the waveform presented to the horizontal AFC circuit.*

*The fact that the pulling seems more severe during commercials, and in other scenes containing a large amount of black information, again points to improper sync separation. Perhaps a review of the "Tough-Dog Sync Troubles" series appearing in our February through April issues will be of help in tracing the trouble to its source.*

*Since the trouble seems to be affected by the various settings of the contrast and AGC controls, it seems the fault may be in the RF or IF stages. Make a critical check of the waveform at the grid of the sync separator, paying particular attention to both the amplitude and shape. With a signal applied, the negative voltage at the grid should equal approximately three-fourths of the peak-to-peak amplitude of the waveform. If it does not, additional checks in the coupling and biasing networks—or in preceding stages—should*



lead to the root of the trouble.

It would be advisable to observe the waveforms at the detector and video output while varying the settings of the contrast and AGC controls. If sync-pulse compression gets worse when these controls are adjusted to provide more gain, you will have isolated the trouble to some point in the RF-IF, video, or AGC circuits, and can concentrate on troubleshooting these stages.

### Ion Glow

There's a bright blue glow in the neck of a new CRT I installed in an Emerson Chassis 120351E. It jumps around when you bring your finger near and will leave if either the accelerating or focus anode is disconnected. Of course, I can't do this to cure it. What causes the glow, and how can I stop it?

PAUL REED

Alexandria, La.

The glow is caused by a small quantity of gas within the tube ionizing from ion bombardment. The ion trap "squirts" a stream of ions with sufficient force to do the trick. There's no need to worry about it. The condition may last for the entire life of the tube, but it won't have any harmful effects.

### Sneaky Resistance Path

The resistance measurements chart for a GE MM line chassis shows 60K for the reading from pin 3 of the damper to ground. I can't get a reading that comes near this value. Also, for pin 10 of the CRT it shows 750K to pin 3 of the damper, and I get only 300K. Will you please show the correct tracing for this circuit?

J. M. McDERMOTT

Pittsburgh, Pa.

Redrawing the circuit should help clarify the parallel resistance paths.

The 60K-ohm reading from pin 3 of the 12AX4 to ground depends on the condition of the two electrolytic capacitors C7 and C3A. Any variation in the internal resistance of these components alters the value of the reading considerably. The 300K-ohm reading you obtained from pin 10 of the picture tube to the cathode of the damper seems rather low. The parallel path for this reading would be near the 750K indicated when computing the resistance of R43, C7, and C3A in parallel with R42 and R73 to ground.

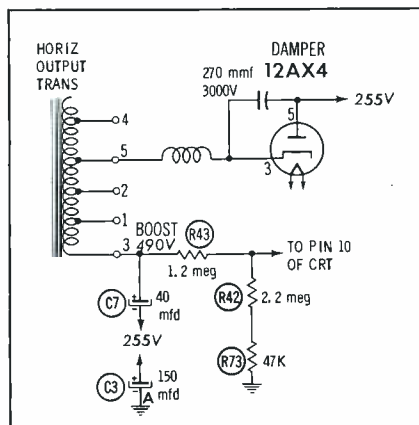

## "I've never been without PHOTOFACT.."

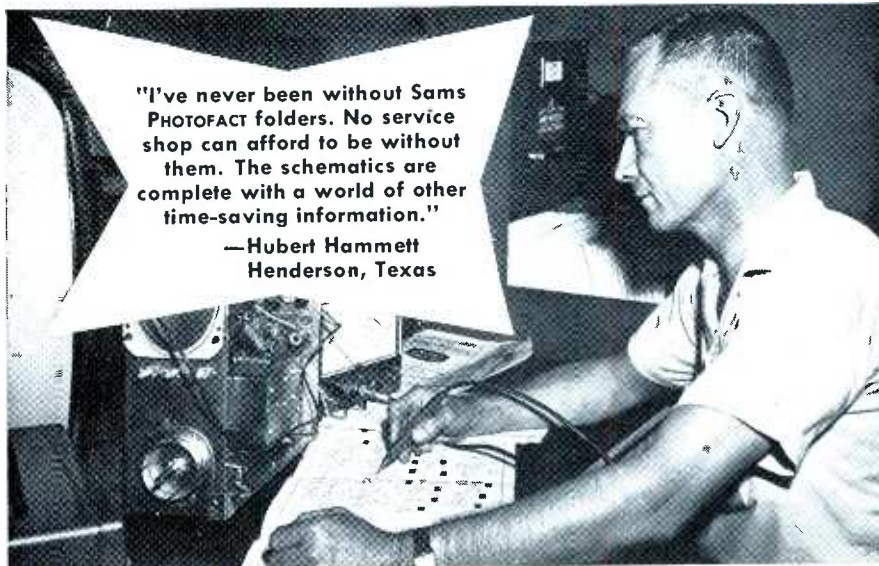

"I've never been without Sams PHOTOFACT folders. No service shop can afford to be without them. The schematics are complete with a world of other time-saving information."

—Hubert Hammett  
Henderson, Texas

## Service Technicians! YOU EARN MORE... YOU RATE with the public when you own the PHOTOFACT® service data library!

You enjoy maximum earnings as the owner of a complete PHOTOFACT Service Data Library! It's inevitable, because no matter how expert you are, you can always *save more time on any job, get more jobs done daily—EARN MORE, DAY IN AND DAY OUT...*

What's more—as the owner of a complete PHOTOFACT Library, you know your customers' sets *best*. You can actually show each customer you have the PHOTOFACT Folder covering his very own set. Result: You command public respect and acceptance which paves the way to more business and earnings for you.

### HOW TO STAY AHEAD...

Yes, the truly successful Service Technicians are those who own the complete PHOTOFACT Library, who can meet and solve any repair problem—faster and more profitably. And these men *keep ahead* because they're on a Standing Order Subscription with their Distributors to receive all new PHOTOFACTS as they are released monthly. (They're eligible for the benefits of membership in PEET, too—see below!)

**ONLY \$10 DOWN** puts the complete PHOTOFACT Library in your shop—and you have up to 30 months to pay. See your Sams Distributor today, or write to Howard W. Sams

### NOW IS THE TIME TO JOIN

## "PEET"

#### THE POWERFUL NEW PROGRAM FOR QUALIFIED TECHNICIANS

If you now own a PHOTOFACT Library or plan to own one, you can apply for membership in "PEET." It's the first industry program really designed to build powerful public acceptance for the Service Technician who qualifies. Builds enviable prestige and business for its members. Benefits cost you absolutely nothing if you qualify. Ask your Sams Distributor for the "PEET" details, or mail coupon today.

**HOWARD W. SAMS & CO., INC.**  
1728 E. 38th St., Indianapolis 6, Ind.

- Send me full details on the new "PEET" Program.
- Send full information on the Easy-Buy Plan and Free File Cabinet deal.
- I'm interested in a Standing Order Subscription.
- I'm a Service Technician  full-time;  part-time

My distributor is \_\_\_\_\_

Shop Name \_\_\_\_\_

Attn: \_\_\_\_\_

Address \_\_\_\_\_

City \_\_\_\_\_ Zone \_\_\_\_\_ State \_\_\_\_\_



## J-Tran top-tuned miniature IF transformer

by MILLER

You can align *both* tuned circuits from the top of the shield. Unit is designed with tuning cores which have hex holes extending the length of the core. This construction permits aligning tool to pass through one core and engage the other.

The J-Tran comes complete with a new style mounting clip which is part of the shield can.

### TOP-TUNED MINIATURE IF TRANSFORMERS

| Cat. No. | Item                                |
|----------|-------------------------------------|
| 14-H1    | 262 kc Input I.F.                   |
| 14-H2    | 262 kc Output I.F.                  |
| 14-H6    | 262 kc Output I.F.*                 |
| 14-C1    | 455 kc Input I.F.                   |
| 14-C2    | 455 kc Output I.F.                  |
| 14-C6    | 455 kc Output I.F.*                 |
| 14-C7    | 455 kc Input I.F. — battery radios  |
| 14-C8    | 455 kc Output I.F. — battery radios |
| 14-C9    | 455 kc Input I.F. — AC-DC radios    |
| 14-C10   | 455 kc Output I.F. — AC-DC radios   |
| 6270     | 4.5 Mc Input or Interstage          |
| 6271     | 4.5 Mc Ratio Detector               |

\*with diode filter capacitors

Size: 3/4" square x 2" high

### TOP-TUNED PRINTED CIRCUIT IF TRANSFORMERS

| Cat. No. | Item                                |
|----------|-------------------------------------|
| 16-PH1   | 262 kc Input I.F.                   |
| 16-PH2   | 262 kc Output I.F.                  |
| 16-PH6   | 262 kc Output I.F.*                 |
| 16-PC1   | 455 kc Input I.F.                   |
| 16-PC2   | 455 kc Output I.F.                  |
| 16-PC6   | 455 kc Output I.F.*                 |
| 16-PC7   | 455 kc Input — battery radios       |
| 16-PC8   | 455 kc Output I.F. — battery radios |
| 16-PC9   | 455 kc Input I.F. — AC-DC radios    |
| 16-PC10  | 455 kc Output I.F. — AC-DC radios   |
| 6270-PC  | 4.5 Mc Input or Interstage          |
| 6271-PC  | 4.5 Mc Ratio Detector               |

\*with diode filter capacitors

Size: 3/4" square x 2" high

Write for Miller general catalog, and the TV Replacement Guide, or ask for them at your distributor.



**J. W. MILLER CO.**

5917 S. Main Street  
Los Angeles 3, California

EXPORT REPRESENTATIVE:  
Roburn Agencies, Inc., N.Y. 13, N.Y.

CANADIAN REPRESENTATIVE:  
Atlas Radio Corp., Ltd., Toronto 19, Ont.

## High, Wide, and Handsome

(Continued from page 33)

normal DC level, and ripple appeared due to the removal of the filter capacitor (Fig. 2C).

Replacing C114, I watched plate waveform W3 assume its normal clipped-sinusoidal shape and 400-volt peak-to-peak amplitude. W4 at the grid of the horizontal discharge tube V11 was good, too; its amplitude was over 100 volts, and its positive tip reached more than 35 volts above the center "plateau." The DC level of approximately -50 volts also looked about right.

At the plate of the discharge tube there was a 130-volt sawtooth W5 riding somewhere above 100 volts. This DC level was somewhat low according to the tube-pin voltage chart in the service data, but this discrepancy didn't seem to hurt W5's waveshape or amplitude. Grid waveform W6 of the twin 6BG6 output tubes had pretty much the same appearance as W5. The significant thing here was the DC level, which averaged about -40 volts — as it should.

### Erasing Retrace Lines

The horizontal circuit was quickly and easily repaired this time, and the picture promptly returned; but it was marred by vertical retrace lines. I remembered that this chassis is not equipped with a retrace-blanking circuit, but depends entirely on the blanking pulses in the video signal entering the CRT grid circuit. This signal is steadied by a DC restorer diode which clamps the blanking pulses at a constant voltage level. Once the receiver is properly adjusted, the pulses will always drive the picture tube grid into cutoff during vertical retrace time—thus preventing the appearance of slanting white lines in the picture. This type of blanking is ineffective at high settings of the brightness control, when the cathode voltage is raised to such a high positive level that the blanking pulses can't achieve cutoff.

Various component failures (including changes in value) within the video output and picture-tube circuits can result in constantly visible retrace lines. In the RA-109 I was working on, I discovered that an electrolytic screen-bypass capacitor in the video output stage had

ask the  
**"Man-on-the-Roof"**  
why he prefers  
*South River*

### COMBINATION PEAK & FLAT ROOF MOUNT

MODEL PFM-30  
(Fits Masts up to 1 1/2")

MODEL PFM-30 LM  
(Fits Masts up to 2")

Features the patented South River "Walk-Up" — "Drop-Lock" mast socket for easy installation on either Peak, Flat or Pitched roofs. Heavy gauge pipe mast socket has two heavy duty screws and locknuts to secure mast. Factory assembled and supplied in a heavily plated rust resistant finish. U.S. PAT. #2734708

**SOUTH RIVER**  
METAL PRODUCTS CO., INC.  
South River, New Jersey

pioneer & outstanding producer of finest line of antenna mounts



## INJECTORALL

THE NEEDLE DOES THE JOB!



**TUNER CLEANER  
AND LUBRICANT**  
with ...  
**INJECTOR NEEDLE**

The leak-proof steel Injectorall Needle lubricates where you need it ... you can reach hard-to-get at Wafers without pulling Tuners apart, or even removing Chassis.

The BEST CLEANER on the market today!

**INJECTORALL CO.** Brooklyn 14, New York



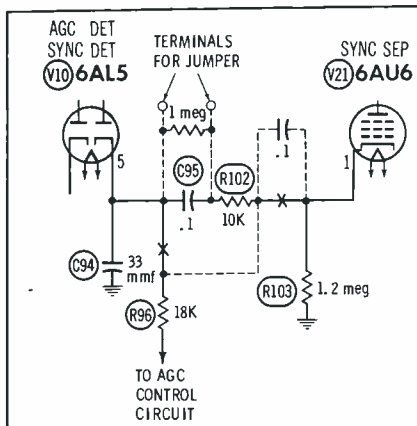

Fig. 4. Modifications to circuit connecting sync detector to separator.

opened. This defect not only lowered the gain of the stage and interfered with DC-restorer operation, but also coupled some video-signal information back into the low-voltage power-supply circuit.

Trouble in the DC restorer can also make it impossible to extinguish the retrace lines. However, the DC-restorer tube is the "other half" of a 6AL5 dual diode which also serves as a video detector; and, since complete failure of the tube is more probable than partial failure, you are more likely to lose the video signal entirely than to experience serious trouble in the DC restorer alone.

The potential on the accelerating anode (pin 10) of the CRT can be varied with a CRT SENSITIVITY potentiometer to establish the best operating range of the contrast control. This adjustment should be performed while the receiver is being set up in the customer's home.

### AGC and Sync

The input signal for the AGC and sync sections of the RA-109 is taken from the video circuits *before* detection — a most unusual arrangement. The output of the video IF strip is fed to the grid of V9, a special narrow-band IF amplifier using a remote-cutoff 6BA6 tube (see Fig. 3). The output transformer of this stage, L34, is tuned fairly sharply to the picture-carrier frequency; therefore, the signal coupled to the AGC and sync detector V10 contains mostly low-frequency video information (including sync pulses), with a minimum of high video frequencies and impulse noise. The left half of this 6AL5 rectifies the IF signal to obtain a negative DC



# The "Big Picture"

...informative shop talks

by AL MERRIAM, Sylvania Natl. Service Mgr.

No more  
"cluster  
fluster"!



WHAT a guy has to go through sometimes just to remove the chassis from a TV set! Means practically turning the set inside out—pulling control knobs or disconnecting shafts—screws, nuts, bolts and leads! I call it "cluster fluster," and I'm happy to report that Sylvania has licked it!

You don't have to crawl inside the new Sylvania TV sets to separate the chassis and controls from the cabinet. And you don't have to pull any knobs (and break or lose them), or disconnect any shafts (and worry about connecting them again). Look—

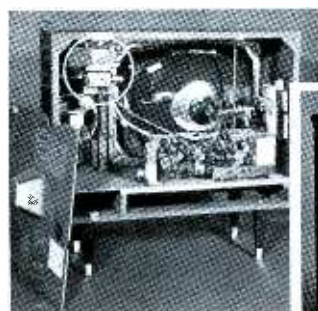

1 Just remove the two screws in the mounting bracket holding the cluster.

2 The whole control cluster slips out—complete with all the knobs and shafts!

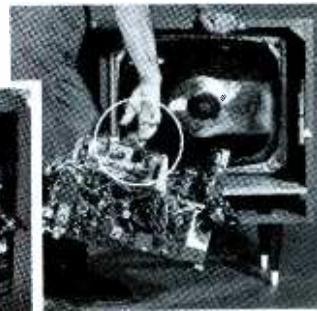
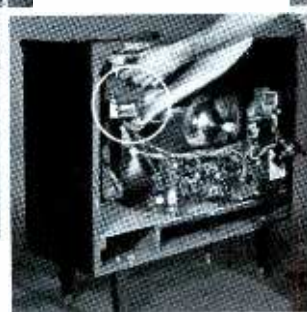

3 The cluster locks to the chassis, and the mounting bracket is a carrying handle.

How about the way the control cluster and chassis snap together into one compact unit for easy carrying and practical testing! Light, too—only 13 pounds. No loose parts or wires dangling either—even a special yoke hanger on the chassis. It's really quite a simple thing, but just typical of the thought and care that goes into Sylvania TV sets.

I believe I could go on forever giving you tips and facts about this fast-moving field of TV electronics, but the best way to keep up-to-date with the "Big Picture" is through the Sylvania Service Bulletins and the Sylvania Service Clinics. Ask your Sylvania TV distributor for details on the next clinic session in your area, or I'll be glad to fill you in — Al Merriam, Sylvania Home Electronics Corp., Batavia, New York.

# SYLVANIA

Subsidiary of GENERAL TELEPHONE & ELECTRONICS



# TV TUNERS OVERHAULED

**ALL** MAKE AND MODELS **\$9.95** NET — VHF OR UHF

UHF/VHF COMBINATION — \$19.90  
90 DAYS WARRANTY

**SAME DAY SERVICE**  
ON POPULAR TYPES—48 HOURS MOST OTHERS

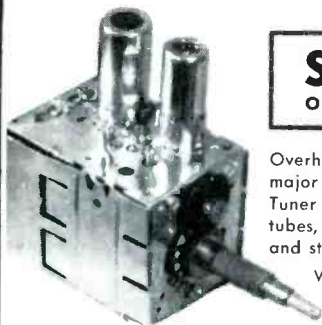

Overhaul charge includes labor and minor parts; tubes and major parts are extra at net prices. Tuner to be overhauled should be shipped complete; include tubes, shield cover and any damaged parts. Quote model and state complaint. Pack well and insure.

WE WILL SHIP C.O.D.—F.O.B. CHICAGO OR TORONTO

5710 N. WESTERN  
CHICAGO 45, ILL.

*Castle TV Tuner Service*  
U.S.A. 136 MAIN ST. TORONTO 13 CANADA

Suppliers of rebuilt TV Tuners to manufacturers, technicians & service dealers, coast to coast. Original and Only Complete TV Tuner Service covering the North American Continent.

## WILL YOU MISS OUT . . . in getting your copies of these two books?



"The Troubleshooter's Handbook,"  
a 96-page collection of questions and answers, reprinted from "The Troubleshooter" column.



"Servicing Industrial Electronics,"  
an 8½" x 11", 64-page book containing 20 industrial electronics features from past issues.

You can have one, or both — absolutely free — with your new or renewal subscription order for PF REPORTER. In addition, you'll be getting helpful and informative servicing articles on . . .

1961 TV Receiver Review  
Fundamentals of Transistors  
Phono Speed Problems  
Solid State Rectifiers in TV

Causes & Cures for Regeneration  
Magnetic Amplifier Circuits  
Servicing Synchros and Servos  
Servicing FM Radios

. . . plus many others.

Just fill out and send in the coupon below. With a 1-year order, you have your choice of either servicing book. With an order for 2 years or more, you get both. Please be sure to check your occupation, and whether this is a new subscription or an extension of your present one.

Enter my subscription to PF REPORTER  
and send me free book(s) checked.

1060

3 Years \$9.00     2 Years \$7.00     1 Year \$4.00

The Troubleshooter's Handbook

Servicing Industrial Electronics

Check only one if  
order is for one year

Bill Me

Remittance Enclosed

Extend Present Subscription

Take this coupon to your distributor, or mail to:  
Howard W. Sams & Co., Inc.  
2201 E. 46th St., Indianapolis 6, Ind.

Please Check Your  
Business Classification

Independent Radio, TV Serviceman     Owner, Mgr.

Retailer with Service Department     Service Mgr.

Industrial Electronics Service     Employee

Other (Specify occupation and title)

Name \_\_\_\_\_

Firm \_\_\_\_\_

Address \_\_\_\_\_

City \_\_\_\_\_ Zone \_\_\_\_\_ State \_\_\_\_\_

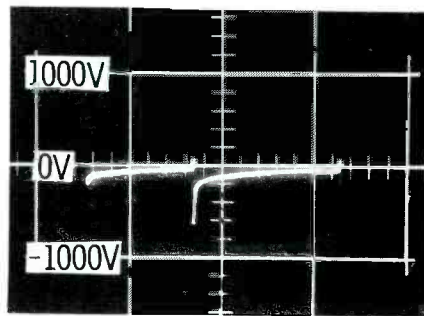

(A) Grid of blocking oscillator.

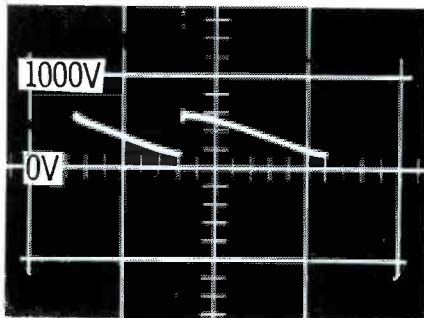

(B) Plate of vertical output.

Fig. 5. Vertical sweep waveforms.

control voltage for the first two video IF stages and the tuner. The input signal is separately detected by the right half of V10, and the output of this side is fed to sync separator V21.

Located in the cathode circuit (pins 1 and 5) of V10 is the AGC control, which permits adjustment of the bias on the AGC detector. This control has no effect on sync-detector conduction because it simultaneously varies both plate and cathode voltages of this section.

A revised version of the coupling circuit between the sync detector and sync separator was introduced some time later; for details, see the dotted-in connections in Fig. 4. Newly-added parts are a 1-megohm resistor shunting C95, an additional .1-mfd capacitor between R102 and the grid of V21, and a pair of terminals to accommodate a jumper wire for shorting out C95 and its shunt resistor. Use of the jumper (3" of #12 wire) tends to improve sync noise immunity and increase the amplitude of the sync waveform. However, horizontal sync stability is sometimes improved by omitting the jumper. If you notice an unusually great amount of horizontal bounce or pulling in one of these sets, simply check this jumper connection and remove the wire if present. Don't try to get around the problem as some shops in high-signal areas have done, by installing a weak tube in



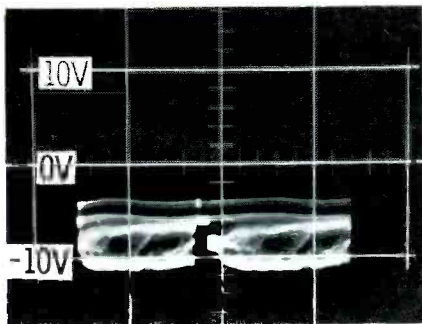

(A) At grid of video output.

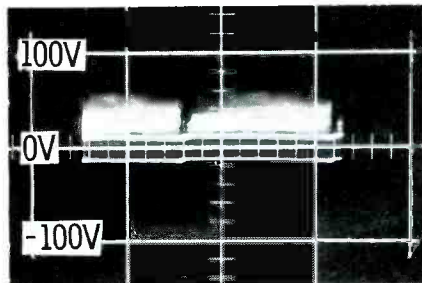

(B) At grid of picture tube.

Fig. 6. Normal video signals.

the IF strip to reduce the over-all video gain of the receiver. If removing the jumper doesn't remedy the trouble, be sure to check the various sync-coupling capacitors for value and leakage. Above all, don't try to lower the sync-signal amplitude by detuning L34. You'll merely decrease your AGC voltage, thus possibly overloading the video IF strip and adding more sync troubles to those you already have.

#### LV Power Supply

As anyone knows who has ever serviced one of these receivers, the power transformer is just about the biggest unit ever to appear in a TV set. The chief reasons for its great size are its generously high step-up voltage (almost 400 volts AC on each side of the center-tapped secondary) and the heavy current drain imposed by the many load circuits. In addition to seven DC output voltages ranging from +320 to minus 14 volts, the power supply furnishes filament voltage to all of the many TV and radio tubes except the 6W4GT damper, which is connected to a small separate transformer.

The most noteworthy feature of the RA-109's power transformer, as I mentioned earlier, is that it has automatic voltage regulation. A 2-mfd capacitor across the entire rectifier-plate winding (high-voltage secondary) forms a resonant circuit at 60 cps which produces a high circulating current in the winding.

## A perfect fit every time

## with **Centralab** Twist-Tab Controls

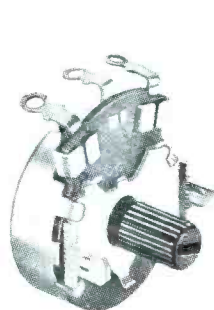

These CENTRALAB tab-mounted Radiohm® Controls are sure to suit you—because they're tailored to the minimum shaft length needed for TV set hidden controls. When you need a longer shaft, you simply use the 2" polyethylene extension packed with each unit. Nothing to saw—a snip of the scissors gives you an insulated shaft of the length you need, and the adjustment slot is still there, and still easy to get at.

CENTRALAB Twist-Tabs are available in 25 values from 200 ohms to 7.5 megohms . . . rated at ½ watt, 15/16" diameter, 1/16" deep. Ask your distributor for full details about the new fashion in controls—Model TT Radiohms.

# Centralab

B-6032

THE ELECTRONICS DIVISION OF GLOBE-UNION INC.  
942K EAST KEEFE AVENUE • MILWAUKEE 1, WIS.  
CENTRALAB CANADA LIMITED — AJAX, ONTARIO

ELECTRONIC SWITCHES • VARIABLE RESISTORS • CERAMIC CAPACITORS  
PACKAGED ELECTRONIC CIRCUITS • ENGINEERED CERAMICS

Superior's New Model 85—a DYNAMIC type **TRANS-CONDUCTANCE**

# TUBE TESTER



• **SYMBOL REFERENCES:** For the first time ever in a trans-conductance tube tester Model 85 employs time-saving symbols (★, +, ●, ▲, ■) in place of difficult-to-remember letters previously used. Repeated time studies proved to us that use of these scientifically selected symbols speeded up the element switching step. As the tube manufacturers increase the release of new tube types, this time-saving feature becomes more necessary and advantageous.

• **THE "FREE-POINT" LEVER TYPE ELEMENT SWITCH ASSEMBLY** marked according to RETMA basing, permits application of test voltages to any of the elements of a tube. The addition of an extra switch position permits the application of the necessary grid voltage needed for dynamic testing and insures against possible obsolescence due to changes in basing design.

• **NEW IMPROVED TYPE METER** with sealed air-damping chamber provides accurate, vibrationless readings.

• Employs latest improved **TRANS-CONDUCTANCE** circuit. Tests tubes under "dynamic" (simulated) operating conditions. An in-phase signal is impressed on the input section of a tube and the resultant plate current change is measured as a function of tube quality. This provides the most suitable method of simulating the manner in which tubes actually operate in radio, TV receivers, amplifiers and other circuits. Amplification factor, plate resistance and cathode emission are all correlated in one meter reading.

• **FREE FIVE (5) YEAR CHART DATA SERVICE.** The chart provided with Model 85 includes easy-to-read listings for over 1,000 modern tube types. Revised up-to-date subsequent charts will be mailed to all Model 85 purchasers at no charge for a period of five years after date of purchase.

• **SPRING RETURN SAFETY SWITCH** guards Model 85 against burn-out if tube under test is "shorted."

• **7 AND 9 PIN TUBE STRAIGHTENERS** have been included on the front panel to eliminate possibility of damaging tubes with bent or out-of-line pins.

• **AN ULTRA-SENSITIVE CIRCUIT** is used to test for shorts and leakages up to 5 megohms between all tube elements.

Model 85 comes complete, housed in a handsome portable cabinet with slip-on cover. Only **\$52.50**

Now at your radio parts jobber.

QUALITY TEST EQUIPMENT SINCE 1935

**SUPERIOR INSTRUMENTS COMPANY**

Dept. PF 2435 White Plains Road New York 67, N. Y.



**A PAGE FROM THE NEW EASTERN JEWEL CATALOG**  
**NEW SPECIAL PRODUCTS NOW**  
 THAT TV-RADIO-HI-FI SERVICEMEN NEED

SEE COMPLETE **EJ** LINE  
 AT YOUR DISTRIBUTOR

**PUSH-PUSH SWITCH**  
 Exact replacement on-off switch for Philco, Admiral, Sylvania Television Sets.  
 EJ Part No. PPS9

**CLOCK MOTOR COIL**  
 Telechron clock motor field coil. Exact replacement as used in most clock radios from Admiral to Zenith.  
 EJ Part No. CMC13

**SCHEMATIC DIAGRAM BINDER**  
 Economically holds all original mfrs. schematics or 10 H. W. Sams Photofac folders.  
 EJ Part No. SDB8

Available at Distributors EVERYWHERE  
**ASK FOR **EJ** PARTS**  
 AT YOUR DISTRIBUTOR TODAY  
 EASTERN JEWEL CORP.  
 PLAINVIEW, NEW YORK

## REPLACEMENT I. F. TRANSFORMERS

High efficient transformers for maximum gain and bandwidth. Electrostatically shielded, iron core tuned windings.

**455 KC UNIVERSAL**  
 FOR STANDARD SETS. INPUT OR OUTPUT. MOUNTING CLIPS INCLUDED. PACKED 2 BOX.  
 PT. NO. IF-455

**455 KC UNIVERSAL**  
 FOR PRINTED CIRCUIT SETS. INPUT OR OUTPUT. PACKED 2 BOX.  
 PT. NO. IF-455P

**262 KC GENERAL REPLACEMENT**  
 FOR PRINTED CIRCUIT SETS. 4 LUG INPUT. PACKED 2 BOX.  
 PT. NO. IF-262P4

**5 LUG OUTPUT W AUDIO FILTER.** PACKED 2 BOX.  
 PT. NO. IF-262P5

**455 KC FOR GE SETS**  
 EXACT REPLACEMENT. INDIVIDUALLY BOXED.  
 PT. NO. IF-455G

**455 KC FOR TRANSISTOR PRINTED CIRCUIT SETS**  
 4 LUG INPUT INDIVIDUALLY BOXED.  
 PT. NO. IF-455TP4

**5 LUG INTERSTAGE OUTPUT.** INDIVIDUALLY BOXED.  
 PT. NO. IF-455TP5

**Vidair ELECTRONICS MFG. CORP.**  
 365 BABYLON TPKE. — ROOSEVELT, N. Y.

Part of the transformer core then becomes saturated; as a result, it exerts a voltage-stabilizing effect which prevents the output from fluctuating more than  $\pm 2\%$  over a range of primary voltages from 105 to 129 volts. This feature is very advantageous in regions where the power-line voltage is greatly affected by changes in load.

The normal supply voltages and virtual absence of ripple in this particular set were convincing evidence that the entire power supply was in excellent shape, so I made no further effort to test this section of the receiver. However, before returning the set to its owner, I made the usual last-minute check of several other circuits in order to catch any additional troubles which might be lurking under the chassis.

In the vertical section, the grid waveform of the blocking oscillator (Fig. 5A) looked clean. The DC component was also normal, allowing the grid voltage to rise above zero only at the beginning of the retrace period. The plate waveform of the vertical output (Fig. 5B) also looked strong and healthy. Even in this old 70° circuit, the retrace action was accompanied by a sharp voltage spike of well over 1000 volts. (My scope and low-capacitance probe are rated to withstand this much voltage; make sure yours are, too, before trying to view this waveform.)

In the two-stage video amplifier, the grid waveform of the output stage appeared as in Fig. 6A. (Note the positive-going sync pulses.) Since fixed bias is applied to the grid, all parts of the waveform remained well below the zero-volt level. The output of this stage, after being coupled through a capacitor to the grid of the picture tube, appeared as in Fig. 6B. As illustrated here, the blanking pulses were being clamped by the DC restorer at approximately +10 volts. They remained at this level regardless of changes in the picture signal, proving that the DC restorer was functioning properly.

Try as I might, I found very few components anywhere which were in bad enough shape to need replacing. So, I readied the set for delivery, not expecting to see it again for another couple of years or more. ▲



## Single-Sideband

(Continued from page 39)

weak carrier injection signal.

Dual-grid excitation means that plate-current variations will occur at carrier, sideband, sum, and difference frequencies. The output circuit is tuned to emphasize the difference components, developing them across the load resistor. The carrier (100 kc), the sidebands (100-103 kc), and sum frequency components (200-203 kc) are removed by the low-pass filter in the output circuit.

The upper limit of this filter is in the 3-kc range, so it acts as an effective shunt to all frequencies above this point. This type of demodulator is often referred to as a product detector because the output is the product of the two input signals, carrier and single-sideband IF.

A second type of product demodulator (Fig. 4B) uses a dual triode. The SSB signal is applied to the first stage, which acts as a cathode follower to apply the signal at low impedance to the cathode of the second section. Carrier injection is made at the grid of the second stage. The difference frequency is accentuated by low-pass filtering in the plate circuit of the second triode.

Three triodes are employed in the Crosby triple-triode product detector shown in Fig 4C. The two input stages act as cathode followers for the SSB signal and the locally-inserted carrier. They share a common cathode resistor with the output triode, which is a grounded-grid amplifier. In the Crosby arrangement, each section can be biased to provide the most linear operation, as well as maximum rejection of possible interference beats and cross modulation. An audio output is obtained at the plate of the grounded-grid stage.

### SSB AVC Circuit

It is possible to use AVC circuits with SSB receivers. The AVC circuit in a conventional AM set rectifies and filters the IF output carrier, thereby developing a DC voltage that is a function of carrier strength. This DC voltage follows any change in IF output amplitude caused by fading, in addition to compensating for signal-level variations among different stations.

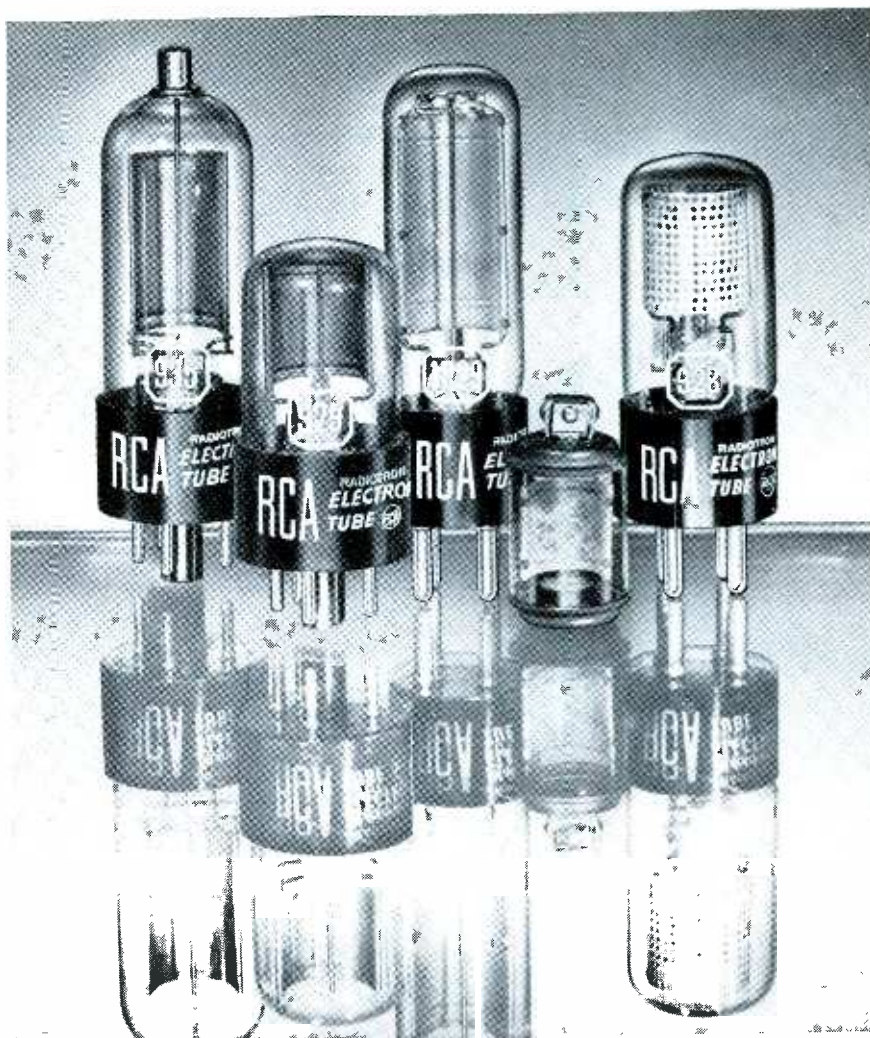

# replace with **RCA** **PHOTOTUBES** for unmatched reliability

For long life and reliable performance in light-actuated equipment, always replace with RCA Phototubes from your local RCA Industrial Tube Distributor.

There's an RCA Phototube to meet your needs in

- Counting • Sorting • Light Measurement
- Color Matching • Sound Reproduction

and a host of other industrial applications involving light sources. RCA Phototubes are available in a wide variety of spectral responses, sensitivities, and physical sizes to meet your specific needs. For immediate service, call your local RCA Industrial Tube Distributor today. *RCA Electron Tube Division, Harrison, N. J.*



The Most Trusted Name in Electronics  
RADIO CORPORATION OF AMERICA

**Double**

**effective**

**Citizens  
Band**

**Power!**



## Mosley VGR-27

Multiply your effective power by two in the forward direction! 3 db. forward gain for increased range and reliability. Constructed of rugged 61ST6 aluminum, the VGR-27 is ideal for point-to-point and is easily rotated for working mobiles. A sturdy base mount provides rigid, non-guyed support and incorporates a pre-assembled coax fitting to the unit. Antenna is 100% rust proof.

Mosley Electronics manufactures a complete line of Citizens Band Antennas... beams, ground planes and verticals. Make the Mosley Distributor in your area your source for HF and VHF communication antennas for industrial and commercial applications. Write for complete information.

**Mosley**  
Electronics, Inc.  
4610 N. Lindbergh  
Bridgeton, Missouri

In a single-sideband, suppressed-carrier system, no carrier is present; hence, the AVC system must be made to respond to the sideband amplitude. A generally conventional type of AVC circuit can be employed, but the filter has a much longer time constant than in a double-sideband receiver. The sideband amplitudes, of course, vary with the audio information carried. The time constant of the AVC network must, of necessity, be much longer than the periods of these variations. Time constants of ten seconds and upwards are employed so the AVC bias will not change in response to low-frequency modulation of the sidebands.

Some SSB AVC circuits are more complex, using a charging time constant that is substantially faster than the discharging time constant. This feature enables the AVC action to follow rather fast changes in signal level while still filtering out the slowest audio variations.

### Commercial SSB Adapter

A simplified block diagram of a commercial adapter (Crosby Type 51A) is shown in Fig. 5. This unit can be attached to any communications receiver having an IF between 440 and 510 kc. Its single-sideband filters have a frequency bandwidth of 250 to 6000 cps, and its dual-channel IF amplifier permits SSB two-channel multiplex as well as standard single-sideband suppressed-carrier reception.

The adapter can also be used to demodulate any standard double-sideband AM signal as well as various special signal types. Single-sideband demodulation is possible with no carrier present (suppressed-car-

The Modern  
"PUSH BUTTON"  
way to protect  
ELECTRONIC PARTS!



- Prevents corona in high voltage section
- Keeps lead-in connections tight
- Prevents rusting and pitting of antenna
- Goes on in seconds—DRIES IN MINUTES

**KRYLON**



## CRYSTAL CLEAR ACRYLIC SPRAY

Protect radio, TV and hi-fi equipment indefinitely against humidity and dust with Krylon Crystal-Clear, the modern "push button" acrylic spray. High dielectric strength, excellent weatherproof qualities. Available at your favorite radio-TV repair shop.

KRYLON, INC., Norristown, Pa.

Paint touch-up work easily, expertly, with  
Krylon Spray Paints—choice of 24 colors

IF YOU PRIZE IT...KRYLON-IZE IT!

**TV TUNERS** \* **REBUILT OR EXCHANGED**  
ALL TYPES

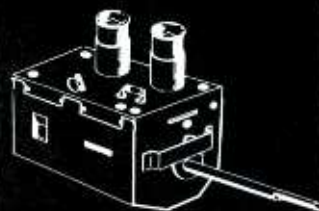

**\$9.95** including parts and labor  
(broken parts at our cost)

- Normally shipped same day received
- 90 day full guarantee
- U/V combinations \$17.95

FREE—If Mailing carton sent to you on request

Phone REpublic 3-9189

**L. A. TUNER EXCHANGE**

4611 West Jefferson Blvd.  
Los Angeles 16, California



rier operation), or at any carrier level between zero and a full amplitude-modulated carrier.

The Type 51A includes AGC and AFC circuits. AGC action (not shown in Fig. 5) can be switched to derive control from the incoming carrier (if present), the upper sideband, the lower sideband, or both sidebands and carrier combined. For operation with no carrier present, the AGC filter is set for a fast-charging and slow-discharging time constant.

An AFC system is operated off the output of a carrier filter that has a bandwidth of only 20 cycles. Hence, a high order of carrier protection from interference and jamming is attained.

In pure SSB reception (carrier completely suppressed), the incoming SSB signal is applied to the grid of the mixer tube, and the high-frequency oscillator is set to crystal control in order to bring the SSB signal exactly down to the 100-kc range.

The reception-selector switch must be set to whatever sideband is to be received (upper or lower—US or LS) in accordance with the audio channel to be used. Circuit A is tuned to the upper sideband; B is set for the lower sideband. With both channels in simultaneous operation, SSB duplex reception is possible.

Inasmuch as no carrier is present, the carrier-insertion switch must be set for local carrier (LC) injection. The 100-kc local-carrier generator is also crystal-controlled. All the various carrier-amplifier and limiter



"He's so happy to see you. This is the night that Lassie is on you know."

## STEREO QUALITY SOARS TO NEW HEIGHTS...



## THE "PROFESSIONAL QUALITY" 9T!

Now, the ceramic cartridge proved in independent A-B listening tests to perform as well as the highest-priced "professional" types. It's Sonotone's revolutionary new 9T. So superior, you can expect faithful reproduction from the most robust musical passages to the most subtle overtones. Sonotone's new 9T series stereo cartridge:

**GUARANTEES** performance equal to cartridges costing up to 3 times as much—as proven in A-B listening tests.

**GUARANTEES** highest compliance—allows major reduction of tracking force.

**GUARANTEES** more than adequate channel separation.

**GUARANTEES** crisp definition.

**GUARANTEES** superior, more compact mechanical design—including revolu-

tionary new needle design with instant "snap-in, snap-out" replacement needle feature and built-in jewel tip protector.

**ELIMINATES** distortion—incredibly flat response of  $\pm 1$  db from 20 to 17,000 cps—cuts listening fatigue.

**ELIMINATES** dust pile-up—at recent trade show the 9T ran 4 straight hours, collected no dust.

**ELIMINATES** most record groove noise or hiss—no "needle talk".

Imagine, the 9T boasts all these "professional" features...yet sells for less than half the price of the least expensive "professional" cartridge. Simplify your inventory...cut call-backs—increase sales and profits—with Sonotone's great new 9T cartridge...unsurpassed for performance—and for value.

|             |   |   |                                       |
|-------------|---|---|---------------------------------------|
| LIST PRICE: | 9T-S...\$16.50<br>(0.7-mil and 3-mil sapphires) | 9T-S77...\$16.50<br>(Two 0.7-mil sapphires) | 9T-SD...\$19.50<br>(Sapphire-Diamond) |
|-------------|---|---|---------------------------------------|

# Sonotone<sup>®</sup>

ELECTRONIC APPLICATIONS DIVISION, ELMSFORD, N. Y. DEPT. C10-100

IN CANADA, CONTACT ATLAS RADIO CORP., LTD., TORONTO

LEADING MAKERS OF

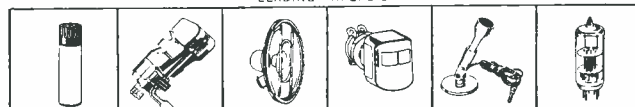

BATTERIES • CARTRIDGES • SPEAKERS • TAPE HEADS • MIKES • ELECTRONIC TUBES

**LESS CALL-BACKS**  
**...more profits!**

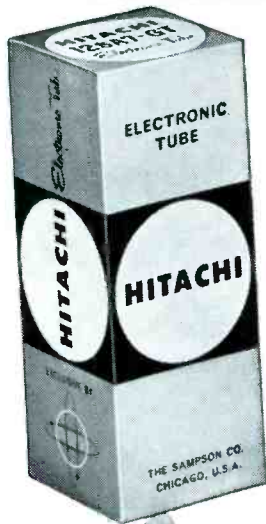

SELL—SERVICE—SATISFY

**RECEIVING TUBES**

MADE BY  
 GRAND PRIX AWARD-WINNING

**HITACHI**



Choice as original equipment by  
 manufacturers in the U. S. & abroad

From all points come good words about Hitachi tubes produced by one of the world's largest manufacturers — Hitachi, Ltd., Tokyo, Japan. Tubes that can't be beat for performance and reliability. Most popular types are available . . . each made with strict quality-control to fully meet top American standards. Yet important cost savings guarantee you extra profits. And distribution is on a localized prompt-delivery basis.

**THE SAMPSON COMPANY**

ELECTRONICS DIVISION, 2244 S. Western Ave., Chicago 8, Ill.

See your HITACHI Distributor

A COMPLETE LINE  
 OF QUALITY ELECTRONIC  
 COMPONENTS

stages are inactive when no carrier is present with the incoming signal. AFC cannot be employed under these conditions, but it is not needed because crystal control is being employed for the high-frequency oscillator.

Some single-sideband transmissions include a weak carrier component, meaning that some carrier information will be present at the mixer input. This carrier is not passed by the two single-sideband amplifier channels. However, prior to these stages, the carrier component is removed and applied to the grid of the first carrier amplifier tube. This carrier signal is built up and limited (reconditioned) in succeeding stages and is made available at the output of the first limiter stage for application to the AFC discriminator (near the lower left corner in Fig. 5). Here the signal is compared with the output of the high-frequency oscillator. The latter can then be AFC-controlled, and crystal operation is no longer required. The AFC action corrects for any frequency drift of the signal applied to the adapter.

In adjusting the receiver for reception of an SSB signal with some carrier present, the adapter is first operated with the AFC off. The signal is tuned in by adjusting the communications receiver and the adapter's high-frequency oscillator. Proper tuning is indicated when a reading appears on the carrier meter in the first limiter stage. When the AFC is turned on, the adapter oscillator is held on the correct frequency for best mixing with the incoming signal. The tuning meter indicates any frequency drift.

The reconditioned carrier output of the third limiter stage can be used

as a demodulating carrier; therefore, the crystal-controlled local carrier oscillator does not have to be employed when a carrier component is present in the incoming signal. The demodulators receive their 100-kc input through an insertion switch that permits a change-over from local-carrier (LC) to reconditioned-carrier (RC) operation. Various special types of signals, as well as phase modulation and standard AM reception, are suitable for RC demodulation. The three-stage limiter maintains the reconditioned carrier at constant

**999 ION TRAPS**



**REPLACED IN TWO YEARS!**

AMAZING? Yes! Especially when you consider they were all replaced through the efforts of just one shop — American Radio & Television Co. of Detroit.

RESULTS: Not only did they improve picture tube performance in 100% of their test cases, they took in \$7100.00 while doing it!

Are their customers happy? You bet they are, and yours will be, too, the day you begin stocking and selling ION, Berns' new beam bender.

Furthermore, with Berns' ION, there's no danger of cutting CRT necks, corner shadows are easy to eliminate, pictures are brighter, sharper. Front magnet sets rough adjustment, rear magnet used for final adjust. Gives precise magnetic strength for any CRT.

You buy it for only \$1.95, suggested list is \$7.95 . . . plenty of margin for an incentive commission to outside servicemen.

Write for free folder outlining unique sales program.

**BERNS**

Mfg. Co.

9853 Chalmers,  
 Detroit 13, Mich

**A NEW**  
**Mercury**  
**SERVICE AID**

Can be used  
 with your  
 VTVM,  
 SCOPE or  
 SIGNAL  
 TRACER

Save the  
 cost of  
 4 separate  
 probes!

Available only through parts distributors

**The versatile MULTI-PROBE  
 DOES THE WORK OF 4 PROBES!**

DC Probe

AC/Ohms Probe

RF Probe

Lo-Cap Probe

A quarter turn of the head  
 selects either DC,  
 AC/Ohms, Lo-Cap  
 or RF probe  
 positions



Model MP-1 \$975  
 Dealer Net

Now for the first time — exclusive with MERCURY — a MULTI-PROBE that does all the work of 4 different probes. Functions: DC position . . . matches VTVM input impedance • AC/Ohms position . . . for all low frequency, low impedance, voltages and wave forms • RF position . . . a demodulator for checking RF voltages, wave forms and signals and TV/radio RF and IF stages • Lo-Capacity position . . . a must for high impedance, TV sync and radio circuits where regular probes overload the circuit.

**MERCURY ELECTRONICS CORP.,**

77 SEARING AVENUE, MINEOLA, NEW YORK  
 West Coast Office: 4306 W. Victory Blvd., Burbank, Calif.



amplitude, thus overcoming the adverse influence of fading, multipath reception, and interference on the incoming signal. The above process may also be called *exalted-carrier* operation, meaning that the receiver builds up the weak incoming carrier into a strong, stable signal to assure linear demodulation and more reliable reception.

The exalted-carrier technique can be used to receive an entire conventional double-sideband AM signal, with both demodulators in operation at once. If considerable interference is present, however, only the "cleaner" of the two sidebands need be demodulated in order to recover the desired audio information. The reception-selector switch is simply set to either the LSB or USB position, whichever results in clearer output. This sideband-selection feature is highly useful in making interference-ridden signals more audible. For example, if interference is present in the upper sideband as a result of transmission on the adjacent higher channel, reception can be greatly improved by changing the selector switch to the LSB position.

This illustration goes to show that an adapter designed for ideal SSB reception can be made to render superior demodulation of other types of transmission as well—if it is equipped with a versatile switching arrangement and a few additional circuits. Single-sideband transmission and related techniques are prime examples of how much has been done in recent years to refine and improve the reliability of communications. ▲

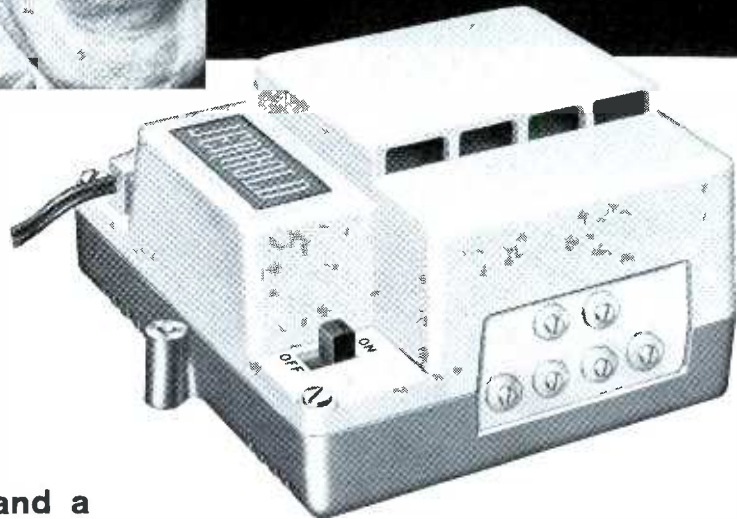

... and a **Bright Profit Outlook for YOU with**

**NEW JERROLD HSA-43**

**Amplified 3 SET COUPLER**

Here's a new precision-perfected amplifier that provides *5 DB min. gain across all TV-FM channels* on two outputs and no loss in the third output. Housed in a rugged, compact and handsome case. The HSA-43 features single tube operation (6DJ8), A.C. interlock and no-strip twin lead terminals. Its excellent isolation and match prevents set interaction and ghosting. IDEAL FOR FEEDING ONE FM AND TWO TV SETS FROM THE SAME ANTENNA.

**\$29.95 list**

**TYPICAL APPLICATIONS**

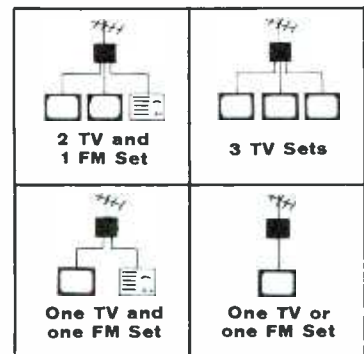

Write Jerrold today for full details on this new Profit Outlook!

**JERROLD ELECTRONICS CORPORATION, Distributor Sales Division**  
 Dept. IDS-71, Philadelphia 32, Pa.  
 Jerrold Electronics (Canada) Limited, Toronto  
 Export Representative: CBS International, New York 22, N.Y.

**LEADER AND LARGEST MANUFACTURER OF TV DISTRIBUTION SYSTEM EQUIPMENT**

**HIGH CAPACITY  
...LOW VOLTAGE  
Bakelite  
Cased  
ELECTROLYTICS**



Aerovox Type HCB units are polarized electrolytic capacitors designed especially for use in industrial applications such as battery eliminators, power supplies, electric fence controls, sound movie projectors, etc. For non-polarized applications such as welding and control equipment they are available as Type NPB electrolytics.

Both types feature heavy-duty, moisture resistant bakelite-cases which eliminates the need for outer cardboard insulating tubes. Units are high capacity etched plate, high quality electrolytics designed for trouble-free, long-life operation.

**SPECIFICATIONS**

- Operating Temperature Range:  $-40^{\circ}\text{C.}$  to  $+85^{\circ}\text{C.}$
- Capacitance Tolerance up to 150 VDCW  $-10+100\%$ , over 150 VDCW  $-10+50\%$ .
- Available in capacitance values from 15 mfd to 12,000 mfd in voltage ratings of 6, 12, 18, 25, 50 VDCW and 125, 300 and 450 VNP.
- Stacked for off-the-shelf delivery by your Aerovox Distributor.

**AEROVOX  
CORPORATION  
DISTRIBUTOR DIVISION  
NEW BEDFORD • MASSACHUSETTS**

**Negative Picture**

*(Continued from page 31)*

is true for several reasons. For one thing, this type of symptom is often noted early in the development of overdriven IF's as a result of improper AGC action, gassy RF or IF tubes, or some other trouble ahead of the video detector. This is why changing the signal level and clamping the AGC line were suggested earlier as rapid "in-the-home" checks to help pinpoint the trouble. Perhaps we should say that this trouble is often accompanied by bends, unstable sync, buzzing, etc.; however, you're probably aware of this fact already.

In tracing the trouble shown in Fig. 1A, we found that an unusually high negative clamping voltage improved the picture. However, the AGC bias voltage checked "normal for the area" even without clamping, and the picture had none of the sync instability usually associated with overloaded IF's. So, without spending additional time searching for an AGC defect, we headed our low-capacitance scope probe toward the output side of the video detector. Sure enough, W1 was a picture of health. So was W2, which indicated that the AGC and sync circuits were receiving normal inputs from the plate of the first video amplifier — thus accounting for the normal operation of these circuits.

As Fig. 3 shows, W3 presented a different story. The compression of the sync pulses was no reason for alarm, being normal in this circuit; but the black portions of the video signal were suspiciously close to the base of the vertical sync pulse, and the over-all peak-to-peak amplitude had dropped to only 40 volts. Pay dirt! With a good signal going in,

and a distorted signal coming out, the trouble had to be in the output stage. Further tests pinpointed the plate load resistor R8 as the culprit. It had changed from 3600 to only about 500 ohms.

Having solved the problem, we took a few minutes to "jumper in" a resistance decade box and try a few experiments. Lowering the value of R8 to 56 ohms produced a picture like Fig. 1B and the output waveform shown in Fig. 4A. What a mess this waveform is — 45 volts peak to peak, but indicative of complete saturation.

Deciding to go the other way, we switched in a 10K resistor for R8. This was interesting! With the contrast control set at minimum, the output waveform appeared as in Fig. 4B; with maximum contrast, it looked like Fig. 4C. As the control was advanced, the signal (starting with a 75-volt peak-to-peak amplitude at B) shrank, wrapped over, and wound up reversed with only 3.5 volts of amplitude in C. The picture had gone from a blurry positive to a very weak negative.

What happened? The answer isn't simple, so hang on — we're off on the darndest excursion into tube theory you've encountered in a long time. To begin with, plate current begins to increase as the contrast control is advanced. Then, since the plate load resistance has been raised, the plate current produces an abnormally high voltage drop across it. This, of course, reduces the plate voltage more than normal. While the plate voltage decreases, the screen voltage remains the same; so the screen is soon drawing as much current as the plate. Continued advancement of the contrast setting reduces the bias

**PHONE  
ED 9-9653**

**\$7.50**  
plus parts,  
C.O.D. and postage charges

**90 DAY  
WARRANTY**

**Precision Tuner Service**

ALL TYPES T.V. TUNERS REPAIRED AND ALIGNED TO FACTORY SPECIFICATIONS ON CRYSTAL-CONTROLLED SWEEP GENERATORS  
24-HOUR SERVICE ON MOST TUNERS  
UHF - VHF COMBINATIONS — \$13.50

See your local distributor or send to:  
P.O. Box 272, 601 N. College  
BLOOMINGTON, INDIANA

State make and model. Send all parts, tubes and shields





(A) Normal waveform obtained when probe is connected to plate of the final IF.

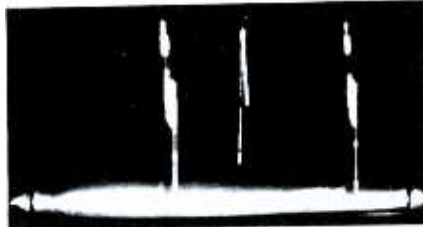

(B) With the low-capacitance probe at grid of IF, only "spike" sync is seen.

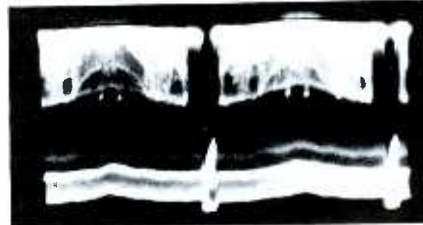

(C) Composite video at plate of final IF shows stage acting as video amplifier.



(D) Overdriven IF produced video detection at grid, as this waveform shows.  
**Fig. 5. A low-capacitance probe can be used to check the final video IF stage.**

on the tube, resulting in still more plate current and still lower plate voltage. At some critical point, the screen voltage takes over control of the tube. The screen attracts more and more electrons, and the current drawn by this element soars to 15 or 20 times its normal level. At the same critical point in the tube's operation, the plate loses control and takes on a negative-resistance characteristic normally found only in tetrodes. Influenced by the flow of electrons from the cathode, the plate itself emits electrons to the screen. Plate current thus starts to flow in the opposite direction through the load circuit, producing an output signal of the same polarity as the grid signal. (Refer once more to Fig. 4C.) This waveform produces a weak negative picture on the CRT.

In reality, the video output tube begins to function as a sort of two-stage amplifier. The first section can



# 5 ways Merit makes a better Transformer...

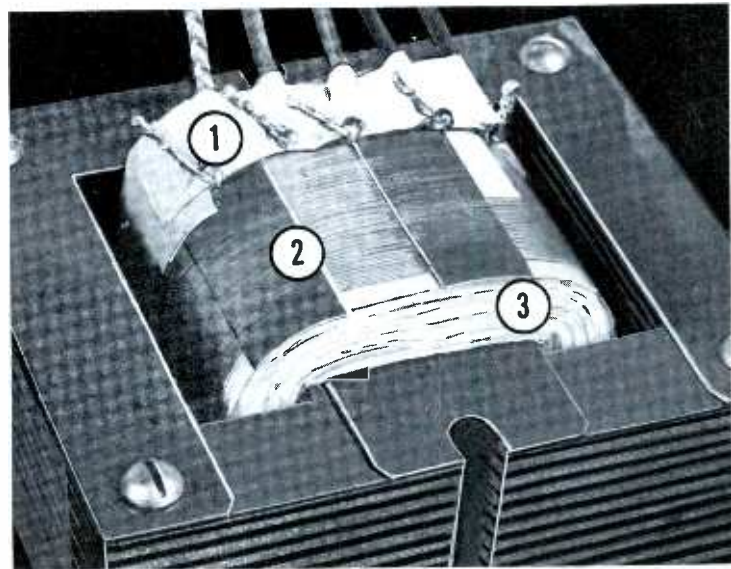

1. New type lead anchorage (saddle) eliminates metal lugs or staples which could corrode and cause ultimate transformer failures.
2. Thermal setting tapes are used instead of inferior, pressure-sensitive tapes.
3. Mylar sheets provide superior inter-winding insulation.
4. Vacuum wax (or varnish) impregnation replaces the wax dipping method to assure **thorough** impregnation throughout the winding.
5. **Individually tested under actual use conditions** to assure many years of operation without failure.



**erit**

Coil and Transformer Corporation

MERIT PLAZA HOLLYWOOD • FLORIDA

be considered to consist of the cathode, control grid, and screen, while the other section is formed by the plate, suppressor grid, and screen. The second stage inverts the signal, as in an ordinary amplifier, but it attenuates the signal instead of amplifying it. Therefore, we can say that a stage of negative amplification has been added, and the requirements for a true negative picture have been met.

#### Overdriven IF's

As mentioned earlier, excessive conduction in the RF and IF string

can produce a condition of "gray-out" by simply supplying a video-detector output signal of such great amplitude that the video amplifiers are driven into saturation. In this discussion, however, we would like to explain a condition of severe overdrive which produces the symptom in Fig. 1C.

The trouble manifests itself in the final video IF stage. This doesn't mean the source of the trouble centers in this stage; more often than not, it doesn't. Improperly operating RF, IF, and AGC circuits have already been cited as the most com-

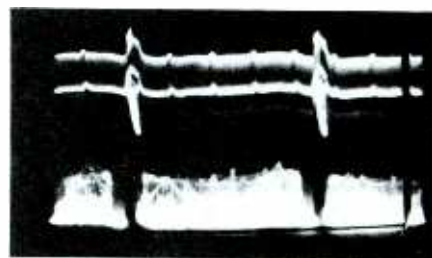

Fig. 6. Detector's output is inverted by the action of the IF stage and diode.

mon causes underlying this trouble. The final IF stage is simply the victim of circumstances, being driven into its action by a strong signal applied to its grid.

Under certain special conditions, the last IF ceases to be a stage of 40- or 20-mc amplification and turns into something more closely allied to a detector. It may surprise you to learn that your old friend, the low-capacitance probe, will permit you to spot this type of operation when it occurs. Figs. 5A and 5B show the respective waveforms of the plate and grid signals in this stage under normal operating conditions. Such tests admittedly detune the stage and kill the picture, but they permit you to find out what's going on in the final IF. To prove the point, compare Figs. 5C and 5D with parts A and B. Here you see the respective plate and grid signals of the last IF stage when driven into the condition associated with Fig. 1C. These waveforms clearly show that a composite video signal has been produced by demodulation of the IF signal.

The plate waveform of the overdriven IF stage includes not only video-frequency information, but also a distorted and rectified 40-mc component. This remnant of the IF signal can't be seen in Fig. 5C, because of the frequency limitations of a scope with a low-capacitance probe. Nevertheless, it's there; the plate circuit of the final IF stage has no filter network to remove it. Since the detector-input transformer is tuned to the 40-mc range, the signal coupled to the detector consists essentially of rectified IF—not pure video, as you might suppose from viewing Fig. 5C. The distortion in the detector-input signal is the basic cause of the negative picture on the CRT.

Checking W1 at the output of the detector, we find the signal already inverted from its normal polarity

Now . . .

Planet offers you  
exact replacement  
Twist Prong Can  
Capacitors in both  
Solder Lug and  
Printed Board  
Construction

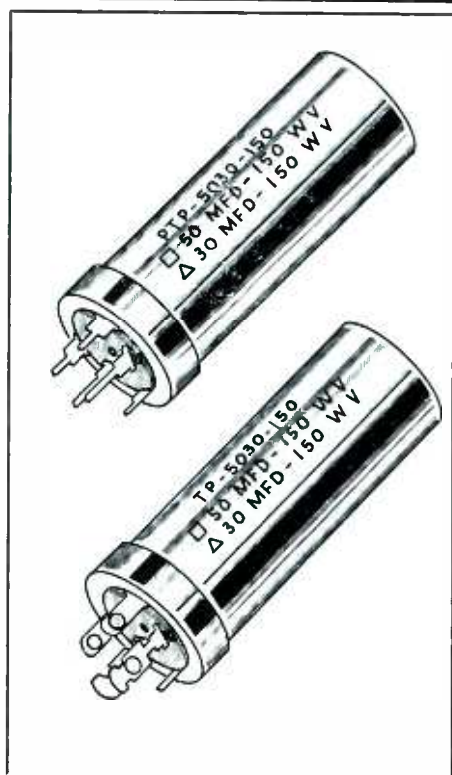

Planet Twist Prong Can Electrolytics are the choice of many top TV and electronic equipment makers. These firms use Planet "TP's" because of uniform quality, workmanlike construction and freedom from field troubles. Now Planet is making these same values and sizes available to you, the men who service this equipment. Ask for Planet "TP's" by name at your parts distributor.

We will send you our catalog listing upon request.

**PLANET SALES CORPORATION**

**BLOOMFIELD, NEW JERSEY**





Fig. 7. Theoretical waveshape of modulated IF signal applied to detector.

(see Fig. 6). To understand why this inversion takes place, let's go back to the fact that overloading of the last IF stage has caused at least partial rectification of the detector-input signal.

During normal operation, the modulated IF signal applied to the detector diode is symmetrical—with identical information in the positive and negative halves of the signal envelope (Fig. 7). The strongest peaks always correspond to the sync-pulse tips in the video-signal modulation, regardless of any signal inversion which may take place.

A typical video-detector diode of the type shown in Fig. 2 conducts on the negative swings of the input signal. The output voltage, developed by diode current flowing down through R2, fluctuates around some average negative value at a video-frequency rate. The most negative peaks (sync tips) applied to the cathode cause diode current to reach maximum, thus forming the negative peaks in the output signal W1.

When the final IF is so badly overloaded as to cause rectification of the grid signal, the 40-mc output of this stage no longer has equal positive and negative peaks. In effect, the positive half of the signal envelope is removed. If the signal is inverted in passing through the detector-input transformer, the positive peaks of the signal applied to the detector will then be normal, but the negative peaks will consist of distorted picture information. The sync tips will drive the cathode voltage of the detector in a positive direction, thereby reducing diode conduction. Minimum negative voltage will then be developed across the detector load, and "positive peaks" will appear in the output signal—just the opposite from normal. (These peaks are not positive with respect to ground. Actually, the waveform in Fig. 6 measured 5 volts peak to peak and was riding around

an abnormally high negative DC level of -15 volts.) As might be expected, the abnormal operation of the final IF stage causes distortion in the picture-signal portion of the waveform; however, the signal inversion is sufficiently clear-cut to give a true negative-picture effect.

#### Summary

While we've used only four examples in our discussion of negative pictures, every *type* of problem has been discussed except improper installation of a video detector diode. We presume you understand the

simple problem involved when diode polarity is not observed.

Waveforms have been used extensively to show what to look for when "negative picture" is the complaint. Conditions of saturation, inverted signals, overdriven IF's that become video detectors, and even dead video stages have received detailed explanations. While no attempt has been made to pinpoint specific components as frequent causes of negative pictures, we feel that a better understanding of what happens will help you immensely in your future troubleshooting operations. ▲

## Your **Amperex**<sup>®</sup> Distributor has **VALVO** TUBES *in stock*

for  
servicing

**IMPORTED RADIOS,  
HI-FI SETS,  
TAPE RECORDERS &  
DICTATING MACHINES**



To help you achieve optimum results in the repair and servicing of imported electronic equipment utilizing European-made VALVO receiving tubes, your franchised Amperex distributor now stocks the entire line of VALVO types.



**ask Amperex**

for the name and address of  
your nearest VALVO distributor

**Amperex ELECTRONIC CORP.** 230 Duffy Avenue, Hicksville, L.I., N.Y.

**RECENT and OUTSTANDING  
SAMS BOOKS**  
available from your local  
**SAMS DISTRIBUTOR**



**Tube Substitution Handbook**

Contains over **3800** direct substitutions!

Compiled by the engineering staff of Howard W. Sams & Co., Inc. Lists 2,048 receiving tube substitutions, plus 489 European and 169 industrial receiving tube substitutes. Also lists 179 European types that can be replaced by American tubes, and 799 picture tube substitutes. Includes helpful facts on tube substitution and invaluable caddy-size reference for technicians. Handy 5 1/2 x 8 1/2 size.

No. TUB-1. Only **\$1.50**

**Howard W. Sams Handbook of Electronic Tables and Formulas**

A time-saving one-source reference for all

those valuable charts, tables, formulas, and laws indispensable to the service technician. This is the reference book you'll refer to again and again. Five comprehensive sections contain most-used and most-needed information on: Formulas and Laws; Constants, Standards, Symbols, and Codes; Service and Installation

Data; Mathematical Tables and Formulas; Miscellaneous Data. Full-color six-page fold-out shows frequency spectrum chart, based on latest FCC allocations. 5 1/2" x 8 1/2", hard-bound. No. HTF-1.

Only **\$2.95**

**Radio Receiver Servicing**

All-new edition. Completely enlarged and revised edition of John T. Frye's famous best-seller,

written in his own inimitable style. Includes a brand-new chapter on how to service transistor radios and printed circuits. An understandable and valuable guide to radio servicing, based on the author's 25 years of practical experience.

Includes a separate chapter on each type of trouble, such as dead set; tubes light but no sound; noisy sets; insufficient volume; sets unable to separate stations, etc. Valuable for both the novice and the experienced technician. 208 pages; 5 1/2" x 8 1/2".

No. RS-2. Only **\$2.95**

**TV Servicing Guide**

All-time best seller! Here's the first book you'll turn to when the "usual" servicing procedures fail. Written by technicians for technicians.

Shows how to apply proper trouble-shooting techniques based on an analysis of symptoms. Trouble symptoms are illustrated by picture-tube screen photos, and possible causes for each symptom are given. First chapter covers general troubleshooting and isolating procedure; remaining chapters treat each section of the receiver separately. Each symptom illustrated, plus dozens of schematics. 132 pages, 8 1/2" x 11".

No. SGS-1. Only **\$2.00**

FREE SAMS BOOKLIST AVAILABLE—ask your Distributor or write us direct

Available from your Sams Distributor  
**HOWARD W. SAMS & CO., INC.**  
1720 E. 38th St., Indianapolis 6, Ind.

**Think**

(Continued from page 26)

after changing the CRT, we noticed a hum in the sound when the volume control was turned down. The customer hadn't complained of this, and had probably never even noticed it. Although not loud, the hum could be plainly heard without putting your ear against the speaker.

We don't take chances on minor deficiencies such as this, because they have a habit of becoming major deficiencies soon after the set is delivered. So we listened intently. The noise was neither a sync buzz nor a 60-cycle hum; however, when we turned the vertical hold control, we noticed that the hum varied in tone. The audio circuits were apparently picking up a signal from the vertical circuits.

To find out why, we turned to the schematic diagram (Fig. 1). This set (Model A-T1816) is one of the few split-chassis Philcos equipped with a multivibrator instead of a blocking oscillator in the vertical section. The DC supply voltage for both plates is picked off at the junction of R119 and R120, the midpoint of a voltage divider between the B+ and boost sources. There is a filter capacitor (C3C) at this point in the circuit, physically mounted on the sweep chassis. Bridging this filter killed the hum, which apparently had been reaching the plate of the audio output tube through the B+ wiring. Section A of C3, used to filter the main B+ source voltage, was evidently too deteriorated to do its part in suppressing the hum.

The repair was completed when we replaced the entire multi-section electrolytic can C3. We had saved considerable time because our suspicion of the vertical circuit made us

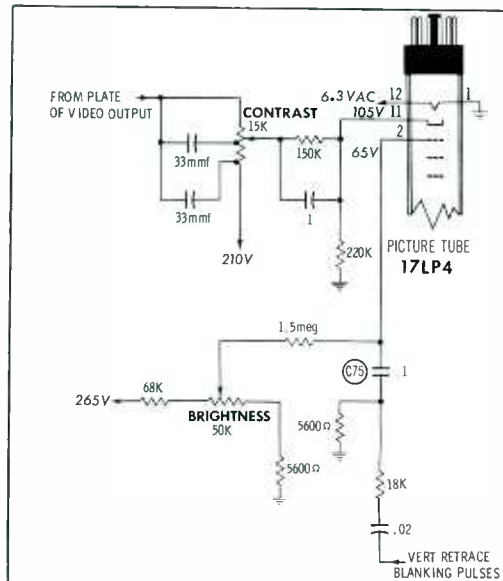

Fig. 3. Brightness control was ineffective as a result of short in C75.

proceed directly to the sweep chassis, where the bad part was mounted. If we had first tried the obvious move of checking the audio output circuit, we would have unnecessarily removed the RF chassis from the cabinet.

**More Detective Work**

Here's another illustration of finding a defective part through a process of reasoning:

The set worked well for a short while after it was turned on; then the picture would begin to roll intermittently, suggesting a momentary "drop-out" of vertical sync. After just a few minutes of this, the horizontal output transformer gave out a squeal and the brightness went off. I had the impression that the horizontal oscillator was being driven far off frequency.

We pored over the schematic (Fig. 2), trying to figure out which part could possibly cause intermit-



MODEL NO. SG-6  
INDIVIDUALLY SKIN PACKAGED

**SIL-O-LUBE**

**100% PURE SILICONE GREASE**  
IN HANDY INJECTION DISPENSER

NON-MELTING NON-FREEZING FROM -100° F TO 750° F. PREVENTS HI VOLTAGE ARCING. RUST INHIBITOR. NON-STICKY. ELIMINATES CORONA ON FLY BACK WINDING. HEAT TRANSFER BETWEEN POWER TRANSISTOR AND HEAT SYNC.

WORKMAN TV PRODUCTS, INC.  
Sarasota Florida

ONLY **75¢** DLR. NET

Available At  
YOUR FAVORITE PARTS DISTRIBUTOR



tent vertical trouble and also cause the horizontal oscillator to be detuned badly enough to kill the brightness.

It didn't seem likely that a single bad tube could cause the combination of symptoms we had observed; but on the slight chance that two or more tubes might be defective, we substituted all tubes in the affected circuits. However, this did not cure the malfunction.

If this were really a single trouble, the fault would most logically be at a point common to both vertical and horizontal circuits. Furthermore, it would have to unbalance the horizontal AFC to a great degree, or else create some serious disturbance in the horizontal oscillator circuit, to account for the extreme shift in oscillator frequency. The circuits ahead of the sync phase inverter did not seem at all likely to produce this odd result, since a failure there would be more apt to cause a simple loss of sync. Thus, we began our investigation at the phase inverter circuit.

To reduce the number of components we would actually have to check, we considered each one in turn and tried to estimate whether or not it would be likely to cause the trouble. We rejected C82 because it would probably have a much more definite effect on vertical sync than on the horizontal oscillator. C92 *could* have been at fault, but it was debatable if a fault here could cause the horizontal oscillator to change frequency enough to cut off the brightness. The other AFC-coupling capacitor C91 has quite a bit more voltage impressed across it, and would be expected to have more effect on vertical sync than C92; therefore, C91 seemed to be a more likely prospect. We also considered C93 and C94, but we couldn't see how these capacitors would be able to affect vertical stability.

After carefully considering the possibility of resistor trouble, we sidetracked this notion because we couldn't imagine any one resistor failure causing all the symptoms noted. A defective resistor in the AFC circuit would cause horizontal sync trouble, but not vertical. Any faulty resistor in the sync inverter stage would cause both vertical and horizontal sync trouble—but once again, probably not such a drastic

shift in horizontal oscillator frequency.

There was a chance of double trouble or some other odd quirk; however, when first thinking over any service problem, we believe that the best place to look for trouble is in the most obvious parts. If the problem is not thus solved, then more extensive service procedures are called for.

In the present case, C91 was the best prospect for testing. It was changed, and the set was left to run awhile. The trouble didn't reappear, so we evidently had the right part.

One end of the old capacitor was hooked to a B+ point, and a voltmeter connected to the opposite end. After a few seconds, the meter needle flicked a few times, then returned to zero for a while, and finally moved over to the 200-volt mark. Our trouble had definitely been eliminated.

This gradual breakdown, starting as an intermittent arc-through, explained the pattern of symptoms which had been observed. The horizontal oscillator had stayed in sync as long as the failure was intermittent; but when a continuous short

## Now—24-Hour Tuner Service

**Tarzian Offers 24-hour  
Direct Factory Service  
on TUNER REPAIRS  
...\$8.50**



TARZIAN tuners received one day will be repaired and shipped out the next. No increase in price: \$8.50 per unit and \$15 for UV combinations. That includes *all* replacement parts, and a 6-month warranty against defective workmanship and parts failure due to normal usage. Tuners repaired on approved, open accounts. Replacements available at low cost on tuners beyond practical repair.

Ⓢ Tarzian-made tuners easily identified by this stamping. When inquiring about service on other than Tarzian-made tuners, always give tube complement . . . shaft length . . . filament voltage . . . series or shunt heater . . . IF frequency . . . chassis identification. And, allow a little more time for service on these tuners. See your distributor, or use this address for fast, factory repair service:

SERVICE MANAGER • TUNER DIVISION • DEPT. 2A



**SARKES TARZIAN INC**

east hillside drive • bloomington, indiana  
edison 2-7251

Mfgs. of Tuners, Semiconductors, Air Trimmers, FM Radios, Audio Tape, and Broadcast Equipment

Model D-612T \$56.00 net

# Lift it...



## you can feel the extra quality in an EPL DC POWER SUPPLY!

**Powers transistor circuits,  
12/6 volt hybrid/tube  
auto, marine radios**

EPL power supplies are heavier because they're built with top quality, heavy duty components to provide unequalled durability and performance. Ample regulation for operating solenoid tuning controls in auto radios. Patented conduction cooling gives greater safety margin, longer rectifier life and higher current carrying capacity.

- out-performs all others in its price class
- lowest ripple
- costs less per output
- reserve power to handle any service job
- backed by Certified Proof-of-Performance chart
- longer life

2 ranges: 0-8 and 0-16 volts continuously variable.

Less than 0.5% ripple up to 5 amperes. 2% ripple at 10 amperes.

10 amps. at 12 v. continuous duty. 20 amperes intermittent.

**FREE BULLETIN D612T**

See the Difference at Your Jobber



**ELECTRO  
PRODUCTS  
LABORATORIES**

4501-T Ravenswood, Chicago 40  
Canada: Atlas Radio Ltd., Toronto

Name \_\_\_\_\_  
Address \_\_\_\_\_  
City \_\_\_\_\_ Zone \_\_\_\_\_ State \_\_\_\_\_

9676

developed, it totally disabled the oscillator.

### Wild Goose Chase

Now that we have seen a couple of examples of how a job can be made easier by thinking in advance, let's consider some instances where a serviceman made trouble for himself by *not* thinking.

One day I was visiting a young friend of mine who had just started in business. His practical experience was almost nil, and his servicing education consisted of a correspondence course. He told me he had a set on the bench with a raster but no picture. Starting with his scope at the input to the picture tube, he had found no signal. When he moved to the plate of the video amplifier, a waveform was barely discernible with the scope gain at maximum.

I looked at this signal and agreed it was very poor. He told me he had measured the screen voltage of the stage and found it higher than the schematic called for. He had also changed the screen resistor and bypass capacitor, and had checked around the video amplifier without any success.

I asked about the grid waveform, and he said that one was present; but when I checked it, it was almost insignificant. Unfortunately, he had "seen something" at the grid and had decided that the video amplifier was not working. Consequently, he had wasted quite a bit of time trying to find something wrong.

I asked if he had checked the AGC voltage, since I knew that many novice servicemen neglect to do this unless they see a definite indication of AGC trouble (such as overloading). He said he had not, and so I asked him to do so. Practically no AGC bias was being developed.

Next, I turned the brightness down and the contrast up, and I adjusted the fine tuning while looking at the CRT screen. A picture could just barely be seen. Since it was faintly snowy, I suspected tuner trouble, and said so.

Then my friend told me he had changed a burned part in the tuner! He showed me the component, which was badly charred but still recognizable as a capacitor. We took the tuner apart again and found a resistor which had also been dam-



## A GOLDMINE of Helpful Information Is Contained in Back Issues of PF REPORTER

The answer to that tough technical problem that's had you stumped is more than likely contained in an article which has appeared in PF REPORTER. Write today for a list of back copies available, plus annual article indexes for 1957-58-59. Back issues sell for 50c each, postpaid.

**CIRCULATION DEPT. 10  
PF REPORTER  
2201 E. 46th St.,  
Indianapolis 6, Ind.**

## SAMS PHOTOFAC INDEX

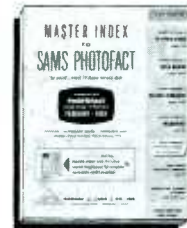

sent direct  
to your shop

# FREE

SEND FOR IT!

Yes, now you can have the valuable SAMS MASTER INDEX TO PHOTOFAC FOLDERS and Index Supplements sent direct to your shop at no cost to you! Just mail coupon below and you'll be sure to receive regularly your handy guide to the world's finest service data covering over 33,000 TV, Radio, Amplifier, Tuner Tape Recorder and Changer models. Send for it—it's FREE!

**MAIL  
COUPON**

**Howard W. Sams & Co., Inc.**  
1720 E. 38th St., Indianapolis 6, Ind.

Put me on your mailing list to receive the Sams Photofact Master Index and Supplements

I'm a Service Technician: \_\_\_\_\_ full time; \_\_\_\_\_ part time

My Distributor is: \_\_\_\_\_

Shop Name: \_\_\_\_\_

Attn: \_\_\_\_\_

Address: \_\_\_\_\_

City \_\_\_\_\_ Zone \_\_\_\_\_ State \_\_\_\_\_



aged, even though it did not look burned.

Having removed one bad part, he thought he had "fixed" the tuner trouble. Reasoning should have told him to look more carefully at the tuner when the set didn't come back to normal. Too bad—overlooking this point meant tearing *twice* into the tuner. This is what I call "servicing the hard way."

#### Is It CRT Trouble?

Jumping to conclusions about the cause of a service problem is especially risky when the picture tube is involved. It's very bad business judgment to get the customer unnecessarily worried about the prospect of a big bill for CRT replacement.

Let me tell you a couple of sad tales about incidents where a serviceman guessed wrong about the condition of a picture tube.

In the first case, I was called to the customer's home and informed that another serviceman had previously been there. The customer quoted the other man as saying the picture tube was bad and had to be changed. He had decided not to have this done without first consulting someone else about it. On operating the controls, I noted that the brightness was fairly low and the brightness control had no effect. This proved to be the cause of the original complaint. The customer said he could see no reason to change the picture tube because a control wouldn't work. I told him that the fault could possibly be in the picture tube, but I couldn't be positive without making a few checks first. No elements of the picture tube checked shorted, but voltage measurements at the tube socket clearly indicated some deficiency in the brightness-control circuit. The customer was satisfied to go ahead and have the set fixed when I reassured him that the cost of the repair would not be half that of a new picture tube.

In the shop, I analyzed the schematic of the CRT grid and cathode circuits (Fig. 3). DC coupling was employed between the video output stage and the picture-tube cathode; and, as usual for sets with this feature, the brightness control was in the CRT control-grid circuit. The grid voltage was thus supposed to change when the control was ro-

# SYLVANIA

---

# SEMICONDUCTOR

---

# DEVICES

---

... for high quality, low prices!

- *Silicon Rectifiers*
- *Power Transistors*
- *Diodes • Transistors*

Follow the leaders... the profit leaders in the electronic servicing field! When you have to replace a silicon rectifier or a power transistor, or any diode or transistor, you will find it in the Sylvania line. That's the way to save time, keep costs down and profits up.

For immediate delivery see  
your **SYLVANIA**  
**SEMICONDUCTOR**  
**DISTRIBUTOR**

NEW service-dealer's "SEMICONDUCTOR COMPLEMENT MANUAL" — only 50¢. Now at your Sylvania Distributor's. A time-saving guide to semiconductor replacements. Gives set manufacturers' parts numbers with corresponding transistor-type numbers for cross-reference. Gives U. S. equivalents of foreign transistor types. Get your copy from your local Sylvania Distributor, or from Sylvania, 1100 Main Street, Buffalo 9, N. Y.

Check your stock and fill in with quality-assured Sylvania semiconductors. Sylvania Semiconductor Division, Woburn, Mass.



# SYLVANIA

Subsidiary of **GENERAL TELEPHONE & ELECTRONICS** 

tated, but I found that it remained nearly constant at an abnormally low level. This check was made with the *socket not plugged into the picture tube*, so the CRT could not possibly have been causing the trouble.

I reasoned that the brightness control or one of its series resistors might be open, or that the retrace-blanking circuit might be defective. A fast ohmmeter check proved the latter to be correct. C75, the coupling capacitor through which the blanking pulses were fed to the CRT grid, was shorted. This failure provided a low-resistance DC path from the grid to ground, thus lowering the grid voltage and disabling the effect of the brightness control.

The first serviceman had immediately assumed a short existed in the picture tube, and did not bother to check any farther. He could have been right, but the odds were against it. His bad guess cost him a customer.

Almost as bad as immediately condemning the picture tube is the opposite error—giving the customer false hope that the tube is in good condition. My next story illustrates

this point.

The customer told the serviceman that the picture was gone. When the set (a Westinghouse Chassis V-2263-11) was turned on, it presented a very clean, bright raster with no trace of a picture. Without trying any of the controls, the serviceman started taking the back off the set. He knew the sound was perfect, and from the tube chart inside the set, he found that only one video amplifier tube is used in this chassis. "How simple this job is going to be," he thought, "just change the video amplifier tube and that will be it." As luck would have it, this *wasn't* it.

He decided to try turning up the contrast control, but this didn't help, either. "Maybe it's the AGC control," he mused—but he hit a dead end here, too.

He then advised the customer that the set would have to be taken to the shop. All customers seem to crave assurance that the picture tube isn't bad, no matter what type of trouble they are experiencing. The set owner in this case was no exception, and he questioned the serviceman along this line.

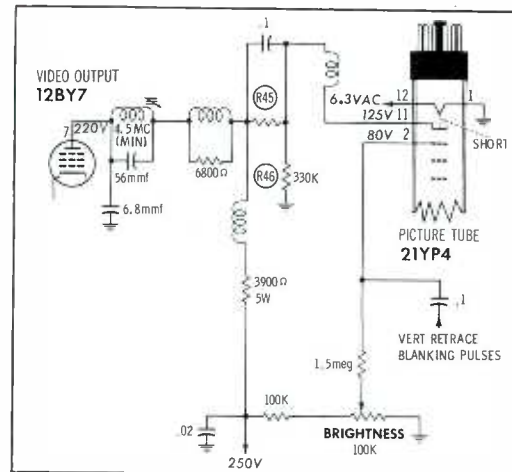



Fig. 4. Short in picture tube caused blank raster of maximum brightness.

The serviceman began to think, "Maybe something's wrong with the video amplifier or AGC circuit; most likely some small part would put it in shape again." So he proceeded to assure the customer that the picture tube was not at fault.

If he had tried out some of the other controls, he would have found a clue which would have prevented him from being so quick to give the picture tube a clean bill of health—as we'll soon see.

|       |        |  |       |       |
|-------|--------|--|-------|-------|
| 6A7   | 6AG7Y  |  <p><b>ADMIRAL</b><br/>Supertron<br/>Receiving<br/>Tubes</p> <p><b>Admiral</b><br/>ELECTRONIC TUBE<br/>MADE IN U.S.A.</p> | 5GC8  | 5EU8  |
| 6A8   | 6AH4G2 |  | 5CL8A | 5J6   |
| 6AB4  |        |  | 5CQB  | 5T8   |
| 6AC7  |        |  | 5CZ5  | 5U4JB |
| 6AC7Y |        |  |       |       |
| 6AD7G |        |  |       |       |
| 6AF3  | 6A...  |  |       |       |
| 6AF4  | 6A...  |  |       |       |
| 6AF4A | 6AK5   |  |       |       |

**483** tubes in all, and all first quality!

Fill your tube caddy with new Admiral Supertron receiving tubes. Your assurance of one call profitable service. All highest quality for all makes of TV, Hi-Fi, Stereo and radio replacement service.

**ADMIRAL** MARK OF QUALITY THROUGHOUT THE WORLD

For free literature and full details, mail this coupon.

ADMIRAL NATIONAL SERVICE DEPT.  
903 Morrisey Blvd., Bloomington, Illinois

Name \_\_\_\_\_

Address \_\_\_\_\_

City \_\_\_\_\_

P-63

**SO SAFE!**



**won't damage glass tubing let alone wire or cable!**

**ARROW STAPLE GUNS** can't damage wire or cable because driving blade automatically stops staple at right height! That's why Arrow Staple Guns are proved safer on jobs all over the country. And Arrow staples have tremendous holding power because they're rosin-coated, have diverging points that lock into wood.

**T-25** (shown) for wires up to 1/4" in diameter. (Hi-Fi wire, radiant heating, bell, thermostat, telephone, inter-com, etc.) tapered striking edge gets into tight corners. Uses 3/8", 7/16", and 1/2" staples, List \$15  
**T-25B** For burglar alarm wiring. Drives staples flush . . . List \$15  
**T-75** For non-metallic sheathed cable, Romex cable or any other object (such as copper tubing) up to 1/2" in diameter. Uses 3/8", 7/16", and 1/2" Arrow staples . . . List \$15

**ARROW FASTENER COMPANY, INC.**



At the shop, he checked the AGC voltage and found it normal. The plate voltage of the video output stage was also checked and found to be very close to what it should be (see Fig. 4). For a second, the serviceman was stumped. He turned on his scope and took a long look at the signal going into the video-output grid. To his surprise, it was perfect. Moving the scope probe to the plate, he found no video signal present, but only a humped-up line with a peak on one side. He went back to measuring voltages again, but found nothing wrong. Returning to the scope, he traced from the video-output plate toward the picture-tube input. At the junction of R45 and R46, the humped-up line disappeared. Another VTVM check revealed that there was no voltage present at this point. Neither resistor was open, so he had to conclude that the cathode of the picture tube was shorted to the heater.

If he had tried to operate the brightness control in the customer's home, he would have found that it had no effect. Note that this is another DC-coupled set, with a variable positive voltage on the grid and an even higher positive voltage on the cathode. (A "sitting duck" for a short!) When the short occurred, the video signal was grounded out; in addition, the tube was forced to operate with positive bias. This caused it to remain at maximum brightness, regardless of the setting of the brightness control. A brief check of CRT socket voltages in the home would have revealed this fault, even if the serviceman did not happen to know the exact value of voltage to expect at each element. This statement can be made because virtually all picture tubes, regardless of circuitry, carry an appreciable positive DC voltage on the cathode unless a short has occurred in the cathode circuit.

Here we have a serviceman who knows how to use his test equipment and has a fair knowledge of TV circuit operation. However, because he jumped to conclusions without making all the necessary checks, he had to make an embarrassing call to explain the picture-tube failure to the customer. A few such experiences are enough to show a serviceman the importance of taking time to THINK. ▲

## RECTIFIER PERFORMANCE THAT PLEASURES CUSTOMERS



### TARZIAN TUBE REPLACEMENT SILICON RECTIFIERS

Tarzian's 9 standard models of tube replacement rectifiers are directly interchangeable with over 95% of all popular vacuum tube rectifiers. An added plus is the new Sarkes Tarzian Full Wave Silicon Rectifier (S5347), replacing 6BW4 or 12BW4 in Citizen's Band radios where maximum performance in reception quality and range is desired.

### TARZIAN SILICON RECTIFIERS (PLUS CONVERSION KITS)

Sarkes Tarzian silicon rectifiers are made in production quantities by a special Tarzian process that provides optimum forward to reverse ratios, extremely low voltage drop, high reliability and long useful life. Compact conversion kits are available for both the M-150 and M-500 units.

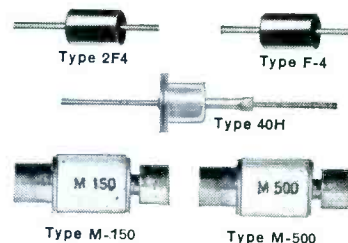

### TARZIAN "CONDENSED-STACK" SELENIUM RECTIFIERS

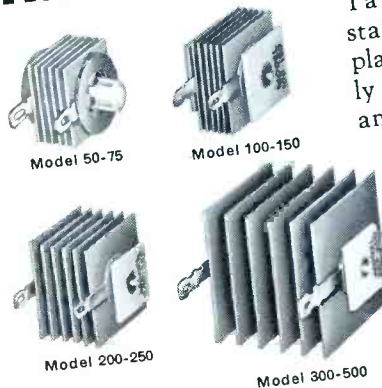

Tarzian's four "condensed-stack" selenium rectifiers—replacing the 20 types that formerly made up the 50 to 500-milliampere line—not only cover your selenium rectifier needs, but their small size eases both your application and inventory problems. Improved production processes have substantially reduced watt losses by as much as 50%.

### Tarzian "Distributor Line" Rectifier Catalog

• The new "Distributor Line" Rectifier Catalog is now available on request. It contains complete details on ratings, dimensions, electrical specifications. For additional information write Section 5554B.



### SARKES TARZIAN, INC.

World's Leading Manufacturers of TV and FM Tuners • Closed Circuit TV Systems • Broadcast Equipment • Air Trimmers • FM Radios • Magnetic Recording Tape • Semiconductor Devices

SEMICONDUCTOR DIVISION • BLOOMINGTON, INDIANA  
In Canada: 700 Weston Rd., Toronto 9 • Export: Ad Auriema, Inc., New York

**CHEMTRONICS' TUN-O-LUBE**  
with MIRACLE ACTIVATED CLEANER TC-3  
cleans and lubricates all tuners and  
provides longer lasting protective film.  
FREE "Spray Aid" and "Wall Mount" with  
every 8 oz. can. See your distributor.  
CHEMTRONICS INC., Brooklyn 25, N. Y.



# PRODUCT report

For further information on any of the following items, circle the associated number on the Catalog & Literature Card.

## Plug-In Silicon Rectifiers (45U)

The Sarkes Tarzian S-5347 silicon rectifier "tube" has a standard 9-pin miniature base and is a direct plug-in replacement for type 12BW4 or 6BW4 vacuum-tube rectifiers employed in Citizens band transceivers. Its peak inverse voltage rating is 1600 volts, and maximum DC output current is 500 ma. User net price is \$13.00.



## Printed-Circuit Components (46U)

Loudness-contour networks and other high-fidelity audio circuit elements are included among the 27 new types of PEC units (numbered from PC-344 to -370) recently released by Centralab. The list also contains a number of component combinations for TV circuits—for example, a phase detector-horizontal oscillator unit.

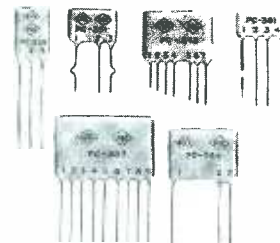

## Wire-Working Tool (47U)

The Waldom CT-3050 Universal Crimping Tool is useful for cutting and stripping wire in gauges ranging from #10 to #22, and also for crimping solderless terminals onto wires of these sizes. In addition, it can shear bolts and screws in sizes 4-40, 6-32, 8-32, 10-24, and 10-32. Price is \$4.25.

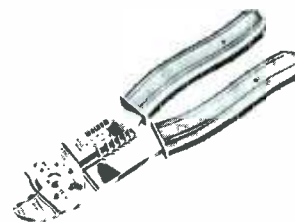

## Miniature Silvered Micas (48U)

Arco Electronics has announced the addition of miniaturized silvered mica capacitors, with dipped phenolic casings, to the Elmenco Dur-Mica line. The components in this new DM-10 series maintain capacitance tolerances as close as  $\pm 1/2\%$ . Values available range from 1-250 mmf at 500 WVDC, 1-300 mmf at 300 WVDC, and 1-360 mmf at 100 WVDC.



## Set Coupler With Amplifier (49U)

Two TV sets and one FM radio can be connected to a single antenna through the Jerrold Model HSA-43 Amplified 3-Set Coupler. A one-tube amplifier gives at least 5 db gain from each of two outputs, with unity gain from the third output. Case size of the coupler is  $4\frac{1}{2}$ " square x 3" high. Both input and output circuits have 300-ohm impedance; terminals have serrated washers which pierce insulation of twin-lead to make connections. Price is \$29.95.





**NEW!**

Only  
Grid Circuit  
Tube Tester  
with Full TV  
tube coverage!

## SECO GRID CIRCUIT TUBE TESTER

Introducing the new Seco GCT-9—the first and only Grid Circuit Tester that offers you complete coverage of all TV tube types—including voltage amplifiers, power output and heater-type diodes, hundreds of Foreign and Industrial types as well as types with Grid, Plate or Cathode caps. Quickly lets you test for Grid Emission, Leakage, Shorts and Gas in one operation—indicates results instantly, visually on a 6AF6 "Eye" Indicator. In addition to conventional tests, the GCT-9 also offers two exclusive new testing features not found on any other tester: 1. Cathode Continuity Check; and 2. Complete Inter-Element Short Test, with shorts identified to pin numbers.

The new Seco GCT-9 is available in a sturdy metal case with exposed panel (GCT-9S); or mounted in a compact, portable carrying case (GCT-9W)—complete with easy to read tube set-up data. Equipped with new "Piggy-Back" adapter so you can mount either unit right to your tube caddy—unit may be removed for use in seconds! Wired and factory tested.

MODEL **\$3295** MODEL **\$3495**  
GCT-9S NET GCT-9W NET

WRITE TODAY! New literature available on all Seco test equipment.

**SECO SECO ELECTRONICS, INC.**  
5015 Penn Ave. So. • Minneapolis 19, Minn.

EAST CANADA: Daveco Agencies, Ltd., Montreal, Quebec  
WEST CANADA: Ron Merritt Co., Vancouver 1, B.C.



### Tubes for Electronic Heaters (50U)



Amperex Types 7806 and 7807 are electrically identical high-vacuum power triodes, designed for use as oscillators at frequencies up to 30 mc in dielectric and induction heating applications. The 7806 (shown) has an integral radiator for forced-air cooling, while the 7807 is supplied with a separate jacket for water cooling. Power output of the tubes is said to remain relatively constant in the presence of impedance variations experienced in industrial electronic heating operations.

### Capacitor Kit (51U)



A stock of 15 miniature tubular electrolytic capacitors for servicing transistor radios is packaged in the Sprague EK-4 Littl-Lytic Assortment. Designed for extremely low leakage current and long shelf life, the capacitors all have welded, hermetically-sealed metal cases. One unit is provided in each of the 15 most frequently-needed ratings. Dealer net price of the kit is \$13.29.

### Antenna Outlets (52U)

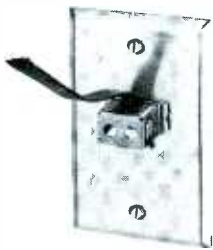

Wall outlets for plug-in antenna connections are supplied by Winegard in two styles, both for use with 300-ohm twin lead. Surface-mount outlets are available with ivory finish at a list price of \$3.00, and flush-mount wall plates are offered in brass (\$3.50), chrome (\$2.30), or ivory (\$2.10). Both styles are furnished complete with connector plugs having "no-strip" terminals.

### Dynamic Headphones (53U)



The Telex Dyna-Twin headset is equally suitable for private listening to high-fidelity music or for communications applications that demand a wide audio-frequency range (30 to 15,000 cps). If two-way communication is desired, headsets can be supplied with any type of integral boom-mounted microphone. The headband is adjustable, and the earphones are padded with air-filled neoprene. Voice-coil impedance is 6 ohms; total weight, including cord, is 9 oz.

### Ceramic Cartridge (54U)

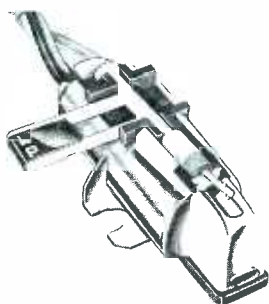

Output voltage of the Sonotone 9T ceramic cartridge is 0.4V, frequency response is flat within  $\pm 1$  db from 20-17,000 cps, and compliance is  $3.5 \times 10^{-4}$  cm/dyne (permitting tracking pressure as low as 2 gm for tone arms or 3 gm for changers). Types and list prices are: 9T-S (with 0.7- and 3-mil sapphires) or 9T-S77 (with two 0.7-mil sapphires), \$16.50; 9T-SD (with 0.7-mil diamond and 3-mil sapphire), \$19.50.

For 1960 It's ...

# "COMPACT" tools by VACO

for the Electronic Service Trade

• "Compact" in Size: they fit the pocket



HK-17 Hex Key Set \$1.00 net



ND-141 Combination Screw & Nut Driver \$2.79 net

• "Compact" in Price: they fit your pocketbook too



DE-810 Double Nut Driver \$2.79 net



SP-19 Probe \$2.96 net



AN-2 Tester \$2.79 net



A-86 Pencil Type Driver \$2.60 net



PK-8 Nut Driver \$2.48 net

Ask Your Parts Jobber or Your Jobber Salesman

## VACO PRODUCTS COMPANY

317 East Ontario Street, Chicago 11, Illinois  
In Canada: Atlas Radio Corp., Toronto 19, Ontario



**MOST COMPLETE TESTER AVAILABLE!**

### WON'T BE OBSOLETE—OFFERS EVERY IMPORTANT TEST YOU NEED!

Finest, fastest tester at a popular price—and here's why! Dynamic Mutual Conductance Test on pre-wired chassis—best method for testing high transconductance amplifiers! Cathode Emission Test by free point selector system—best method for testing power output, pulse amplifiers, and damper tubes! Nationally accepted Grid Circuit Test patented by Seco—up to 11 simultaneous checks for leakage, shorts and grid emission. In carrying case with handy flip chart for tube set-up data.

**MODEL 107—Wired and Tested . . . . \$139.50 NET**

**NEW!**

**PIGGY-BACK ADAPTER**

for tube caddies!

Developed by Seco to save you steps! Free with Seco tube testers or by enclosing 25¢ with coupon.

**SECO SECO ELECTRONICS, INC.**  
5015 Penn. Ave. So.—Minneapolis 19, Minn.

Please send free literature on all Seco Test Equipment.  
 I have enclosed \_\_\_\_\_ Please send \_\_\_\_\_  
Seco "Piggy-Back" Adapters. (25¢ each.)

NAME \_\_\_\_\_

ADDRESS \_\_\_\_\_

CITY \_\_\_\_\_ STATE \_\_\_\_\_

**EAST CANADA: Daveco Agencies, Ltd., Montreal, Quebec  
WEST CANADA: Ron Merritt Co., Vancouver 1, B. C.**

# BUY PYRAMID! GET MORE!



Only Pyramid offers you so much! Only Pyramid gives you highest quality capacitors plus so many "all new" extras.

## THE VU-PAK

An entirely new way to package capacitors... clear plastic tubes, plainly labeled and packed with the highest quality electrolytic twist-mount capacitors. Each re-usable Vu-Pak comes with a blank label, ideal for storing small parts and tools on your bench or in your tool kit.

## EXTRA OFFER!

Save 50 Vu-Pak labels and get the fabulous new Pyramid storage rack the Capac-o-mat, at tremendous savings from your authorized Pyramid distributor. The Capac-o-mat fits right on your shelf, is dust free and holds 54 Vu-Paks.

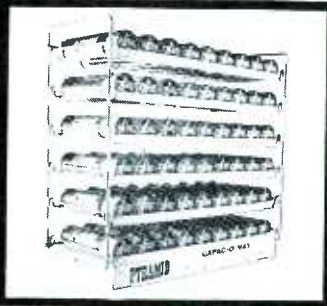

## JEWEL BOX

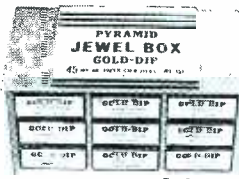

Handsome tan plastic, high impact cabinet with 9 drawers, contains 45 assorted Mylar\* paper Gold Dip capacitors, type 151. Practical... convenient... for storage in your shop, or home. Actual value of the Jewel Box with 45 Gold Dip capacitors—\$19.50, dealer net only \$9.25.

Gold Dip capacitors are also available in Clear-Vu paks... 5 to a package. Find them on Pyramid's new Whirl-o-mat on your favorite parts distributor counter.

## "GOLD STANDARD" 111 KIT

Clear lucite hinged box containing 75 Pyramid's popular assorted Gold Standard Mylar\* capacitors. You'll find so many uses for the Gold Standard 111 Kit. Actual value is \$26.00, dealer net only \$13.00.

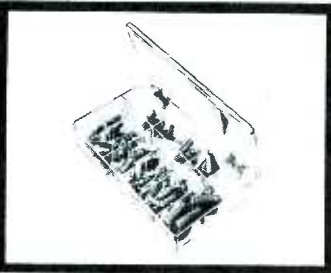

## 515 LYTIK-KIT

Hinged cover, clear lucite box with 15 assorted miniature low voltage electrolytic capacitors for transistorized circuit replacements, type MLV. This Kit is a constant companion to any busy serviceman. Actual value, \$20.60, dealer net only \$10.30.



# PYRAMID ELECTRIC COMPANY

DISTRIBUTOR DIVISION: UNION CITY, NEW JERSEY

Factories: Gastonia, North Carolina • Darlington, South Carolina  
In Canada: Wm. Cohen, Limited, 8900 Tanguay Street, Montreal  
Export: Morhan Exporting Co., 485 Broadway, New York 13, N. Y.

## UHF Translator Antennas (55U)

Cardioid - shaped dipoles are used in JFD's new series of antennas for TV translator reception, to provide more uniform response over the frequency band covering channels 70-83. The dipoles are made of solid aluminum rod, while the screen is of galvanized, welded heavy-gauge wire. Available models and list prices are as follows: TR604 (4-bay), \$8.75; TR606 (6-bay), \$10.95; and TR612 (12-bay), \$24.95.

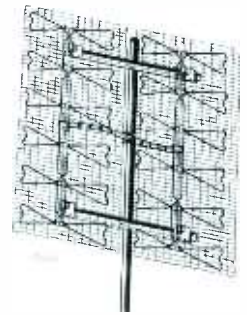

## Wall Baffles (56U)

A foam plastic material called Expanded Dylite forms the 5/8"-thick walls of the Waterson Model 888 speaker baffle (made by J. W. Davis & Co.). Designed to accommodate an 8" speaker, the enclosure measures 11" wide x 11 1/8" tall x 6 3/4" deep (at top). A choice of blond - or mahogany - colored finish is offered. Necessary hardware for wall mounting is furnished with each unit.



## FM Tuner for Autos (57U)

Utilizing the audio circuits and antenna of an existing auto radio, the Granco FM Car Converter provides all additional circuits needed for FM radio reception. The coaxial-type RF tuner is equipped with AFC. Operating voltages are taken directly from a 12-volt source. The converter, 1 1/4" thick, mounts under the dash with two screws. Price is \$49.95.

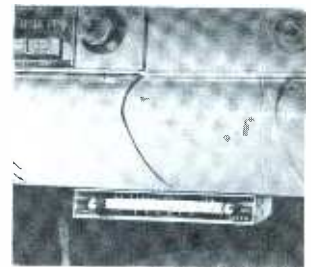

## Germanium Diodes (58U)

Semi-Elements, Inc., has in stock 151 different types of 1N-series germanium crystal diodes, including many which find use in radio and TV receivers. For example, all popular types of video detector diodes such as the 1N60, 1N64, and 1N295 are available. The company also manufactures other semiconductor products.

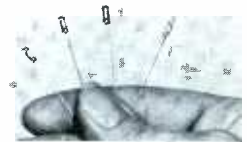

## CRT Reactivator (59U)

The Vis-U-All Model V300 Tester-Reactivator, successor to the Model V200, has a built-in filament-voltage selector switch to permit testing and "shooting" picture tubes with 2.3- and 8.4-volt filaments, as well as conventional 6.3-volt types. A color CRT adapter is also provided. Like the V200, the V300 features a "magic eye" indicator. The unit has a 10" x 6" x 5" steel case with carrying handle. Price is \$74.95.



## Laboratory Standard Cartridge (60U)

"Cross-checking" and calibration of high-fidelity components, laboratory measurements, and checking master recordings are examples of applications for the new laboratory-standard version of the Shure Stereo Professional Dynetic phono cartridge (Model M3LS). Each unit carries a 3-year guarantee, is serially numbered and registered, and is individually calibrated—with the actual response curve furnished to the owner. Net price is \$75.



### Industrial Tube (61U)



A new 9-pin miniature beam pentode, designed for use in high-voltage pulse amplifiers and shunt regulators, is now available from **General Electric**. This tube, designated as Type 7239, has a 9KH base configuration and a T-6½ envelope. Plate dissipation is rated at 4 watts, peak cathode current is 85 ma, and maximum plate voltage is 2200 volts.

### Line-Voltage Adjuster (62U)



The **Vidaire Model LR-10** Voltage Regulator compensates for high or low power-line voltage when series-connected between the AC receptacle and any load drawing 350 watts or less. Using the 4-position switch on the regulator, the supply voltage can be raised by 12 volts, lowered by the same amount, fed through with no change, or shut off. The device is priced at \$4.95 (dealer net).

### Specialized Electrolytics (63U)

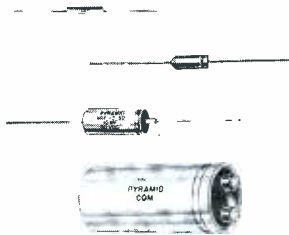

The following four series of capacitors have been introduced by **Pyramid**: MLE subminiature electrolytics for operation in very critical circuits; CQM (enclosed in high-purity aluminum containers) for computers and related applications; TAK-H wet-electrolytic tantalum units; and TAD solid tantalum capacitors featuring long shelf and operating life.

### Electronic Chemicals (64U)



The 3-oz. aerosol spray can of **Injectorall No. 250** Tape Cleaner has a long, slender plastic applicator nozzle which pinpoints the spray directly on the tape-recorder head for removal of accumulated oxide. Another new product, No. 101 Speaker Cement, is packaged in a 2-oz. plastic squeeze bottle with an applicator spout. The tape cleaner is \$1.19 (net); the cement is 51c.

### Horn-Loaded Tweeter (65U)



The modified hyperbolic horn design of the **Oxford Tempo** tweeter is said to result in a wide-angle sound dispersion pattern. Other features are a completely shielded, short-path magnetic circuit and a spherical, molded phenolic diaphragm with impregnated Egyptian cotton base. The unit may be used with either an enclosed or an open baffle.

### Heavy-Duty Yagis (66U)

The **TACO Y-54** series of antennas comprises 14 models covering the frequency band from 30 to 88 mc (including TV channels 2 - 6). Each model is a 5-element Yagi with two folded-dipole driven elements connected to a 50-ohm coaxial down-lead. Impedance can be changed to 72 ohms by adding an optional matching transformer. The elements are constructed of ¾" OD aluminum-alloy tubing, reinforced with ⅞" OD sleeves; the cross arm has a 2" square cross-section. Power capacity ranges from 960 to 1900 watts, depending on frequency.

## A.C. to D.C. POWER SUPPLY



## ... just what you need FOR TESTING TRANSISTORS

Plug this instrument into any 60 cps, 95/130 volt circuit and get a stabilized source of direct current, adjustable over a range from 0 to 45 volts DC, with current output 0/2.5 amperes. Filtered direct current output range 0/45 volts 0/2.5 amperes is continuously adjustable and stabilized ±1% at any setting regardless of alternating current fluctuation. Voltage regulation is approximately 5% between full load and no load at full voltage setting.

This DC Power Supply instrument is ideal for use in transistor testing, circuit testing, to provide regulated voltage for light testing, eliminates the need of batteries by supplying exact DC voltage required.

Write for Bulletin 17-B101 which gives full details and models available.

SAE 3402-1850

## ACME ELECTRIC CORPORATION

9410 WATER STREET

CUBA, N. Y.



Cut servicing and installation time on crystal-controlled 2-WAY RADIO equipment!

## SECO 2-WAY RADIO TEST SET

Compact, portable, use it anywhere. Designed to assist you in the following applications:

- CHECKS WIDE RANGE OF CRYSTAL TYPES! Checks fundamental types at fundamental frequency—5th and 7th overtone types at fundamental frequency—3rd overtone types in 25-30 mc range in special overtone circuit.
- RF POWER INDICATOR FOR DIRECT OR REMOTE METERING! Simply place next to antenna or use 15 ft. remote metering cable furnished with unit.
- MODULATED RF CRYSTAL-CONTROLLED SIGNAL GENERATOR!
- MODULATION CHECKER! • BEAT FREQUENCY DEMODULATOR!
- PLATE MILLIAMMETER FOR RF TUNING! • AUDIO FREQUENCY SIGNAL GENERATOR!

MODEL 500—Fully transistorized—the perfect "assist" instrument even for the fully equipped shop. . . . . **\$29.95 NET**

**NEW!** R-6

**PIGGY-BACK ADAPTER**

for tube caddies!  
Developed by Seco to save you steps! Free with Seco tube testers or by enclosing 25c with coupon.

**SECO ELECTRONICS, INC.**  
5015 Penn Ave. So.—Minneapolis 19, Minn.

Please send free literature on all Seco Test Equipment  
 I have enclosed \_\_\_\_\_ Please send \_\_\_\_\_  
Seco "Piggy-Back" Adapters. (25c each.)

NAME \_\_\_\_\_

ADDRESS \_\_\_\_\_

CITY \_\_\_\_\_

STATE \_\_\_\_\_

**EAST CANADA:** Davco Agencies, Ltd., Montreal, Quebec  
**WEST CANADA:** Ren Merritt Co., Vancouver 1, B. C.





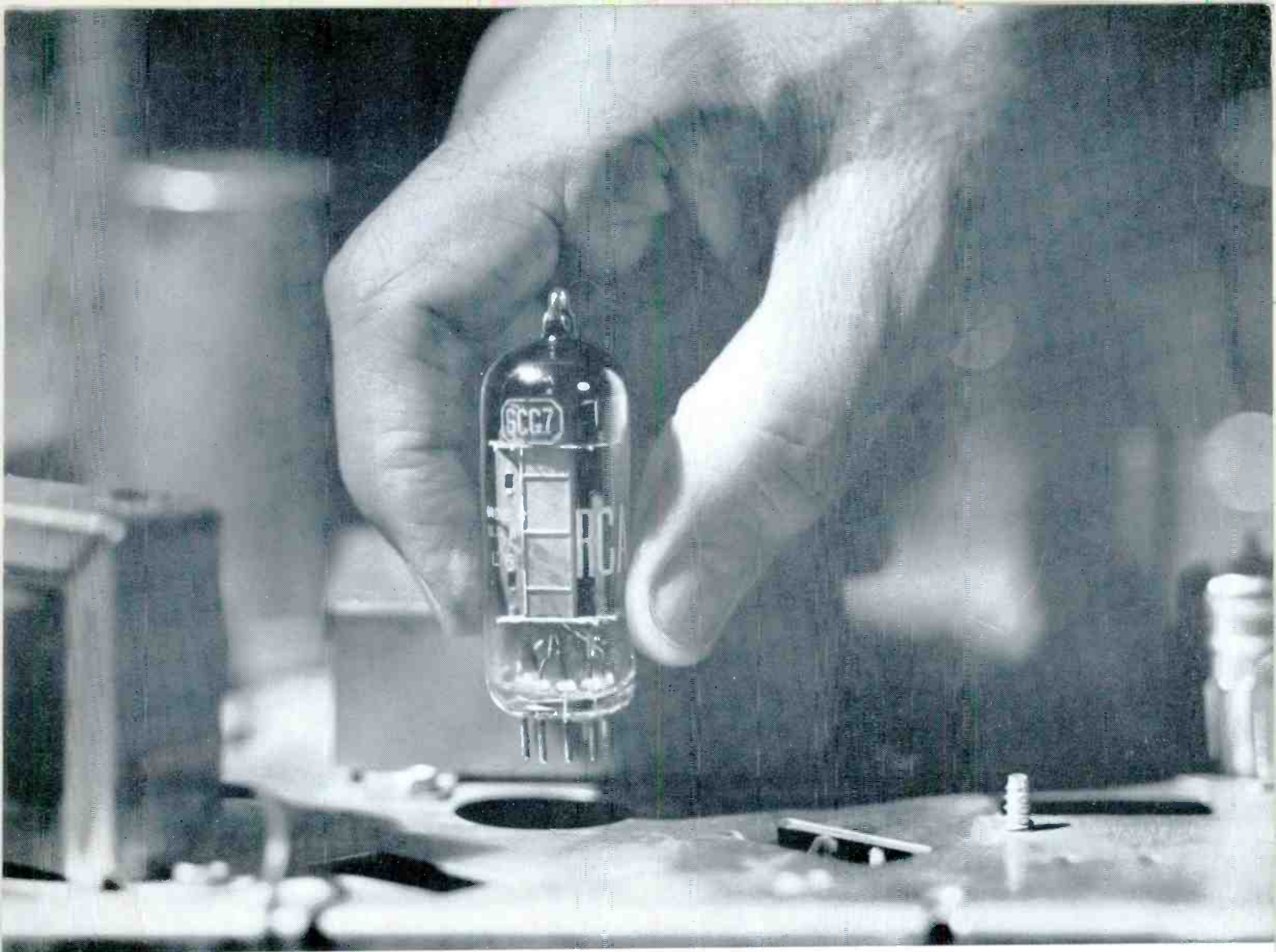

## WHEN YOU REPLACE A TUBE . . .

You have a lot at stake each time you replace a receiving tube in a customer's set. Your professional reputation, your customer's confidence, your day's profits—even future business—all depend on the quality of that replacement tube.

It is RCA's constant aim to provide receiving tubes you can install with confidence. To this end, RCA carefully controls every step of the tube making process from initial design to final test.

**QUALITY BY DESIGN**—Some of the foremost tube experts in the industry collaborate on each new RCA tube design. Engineers, chemists, physicists, metallurgists, production specialists, field representatives, all contribute their own skills and knowledge before a new RCA tube design ever leaves the drafting board.

**IMPROVED QUALITY FROM NEW AND IMPROVED MATERIALS**—All parts and materials in RCA tubes are either *produced* or *processed* by RCA under strictest quality control. Moreover, RCA scientists search constantly for new and better materials which will still further improve performance of RCA tubes. Many tube types you install today benefit from new cathode and plate materials developed in RCA labs.

**QUALITY IN MANUFACTURING**—Because tube construction is just as important as design and materials, RCA maintains a system of supervisory microscopic inspection at key points on every production line to detect any flaw in assembly. And to minimize the chance of human error, RCA has automated certain critical steps in tube production.

**QUALITY BY TESTING AND CONTROL**—Before shipment, *every single RCA receiving tube* is factory-tested for every significant characteristic. *A tube that fails one single test is rejected and destroyed. So there is no such thing as a "second" when you buy RCA.* In addition, thorough aging of tubes and rating-lab tests assure strict adherence to performance specifications.

This is why **YOU CAN REPLACE WITH CONFIDENCE** with RCA tubes . . . and why RCA tubes give you an extra advantage on every service job. Electron Tube Division, Harrison, N. J.



The Most Trusted Name in Electronics  
RADIO CORPORATION OF AMERICA



In Electronic Circuits . . .

BURTON BROWNE ADVERTISING

**ALL AROUND**

**NEW MICROFUSE**  
THE PI-TAIL VARIETY  
(278000) SERIES

THE PLUG-IN VARIETY  
(272000) SERIES

THE SUB-MINIATURE FUSE  
HOLDER (No. 281001)

**New Indicating 3AG Fuse Posts**



It **GLOWS**  
when the **FUSE BLOWS**

**PROTECTION**

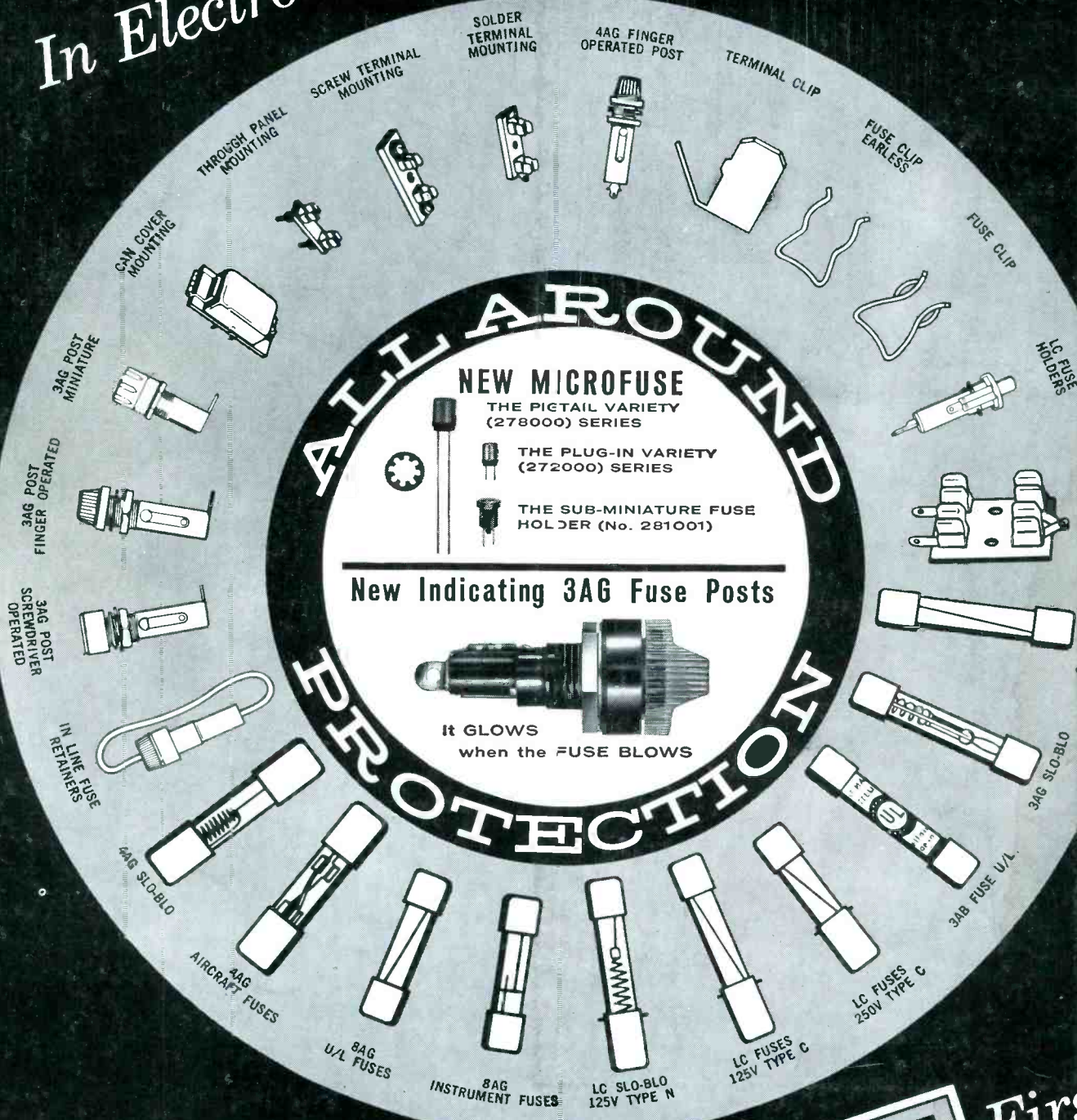

It's **LITTELFUSE** First!  
DES PLAINES, ILLINOIS