

JULY, 1960

35 CENTS



RF REPORTER

PHOTOGRAPH

including **Electronic Servicing**

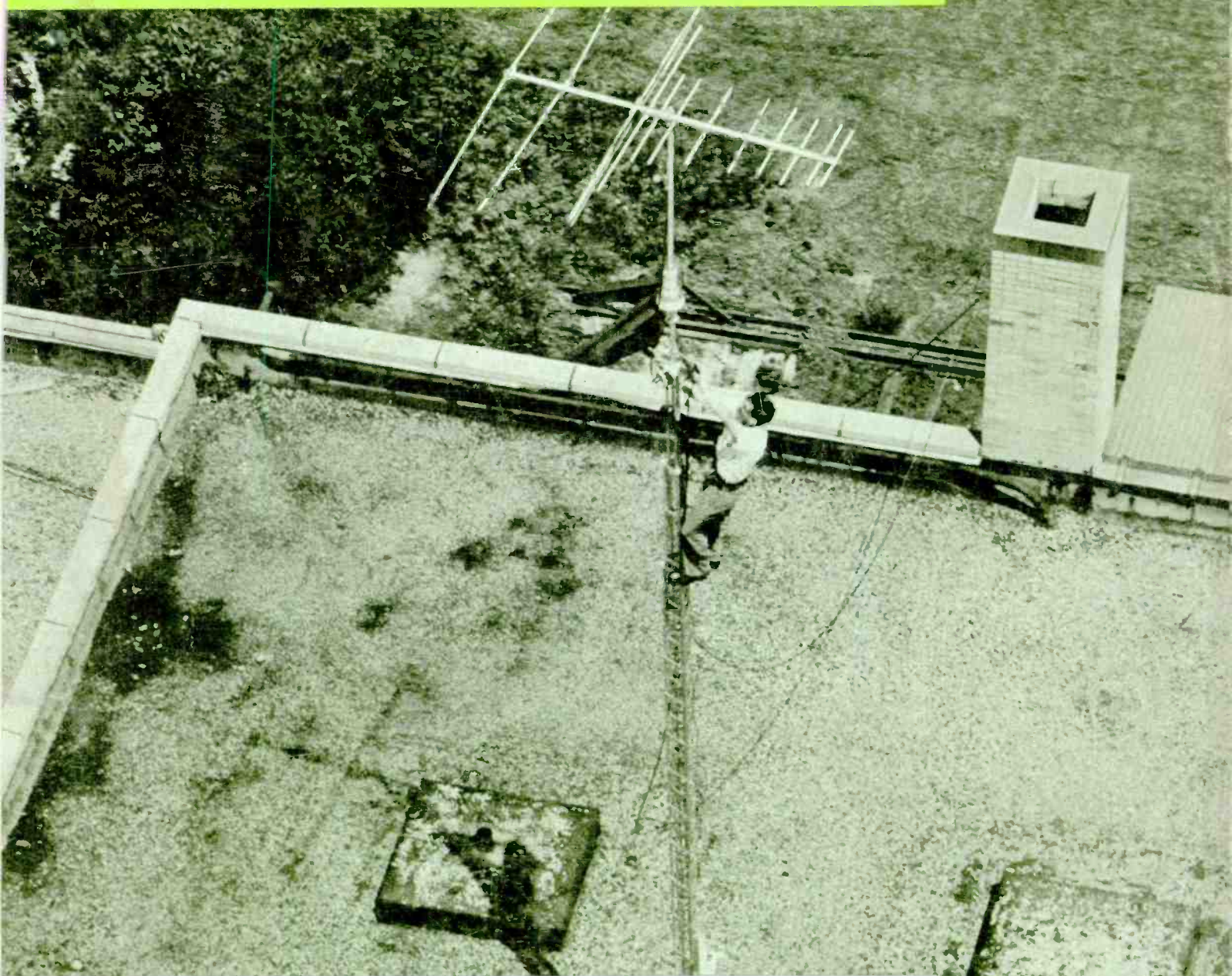

Let's Talk Antennas

Radio and Hi-Fi Tube Guide

Automatic Filling Device

Troubleshooting Color Sync

DAVIS, H. P.
1222 4th St.
M. Davis
RADIO & TV. SVC.
118 RIVERSIDE AVE.
GANNON CITY, COLORADO

EASY... PRESS THE BUTTON



Best And Easiest To Use Control Cleaner!



**FASTER ACTING TV
TUNER CLEANER**

NEW AND IMPROVED FORMULA

Stop radio and television control noises with the easiest-to-use, greatest time and money saver ever developed for the serviceman. Cleans and lubricates with one lasting p-o-o-f. It's the genuine and original G-C SPRA-KLEEN, sold by jobbers everywhere.

No. 8666 6 oz.

99¢

Dealer Net

GC ELECTRONICS COMPANY

division of Textron Electronics, Inc.

West Plant: Los Angeles 18, California

Main Plant: ROCKFORD, ILL., U.S.A.

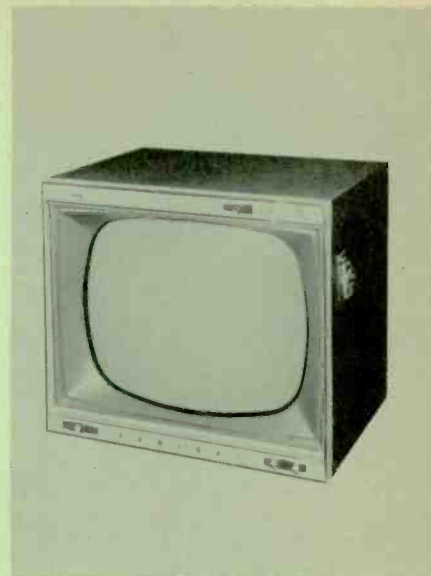
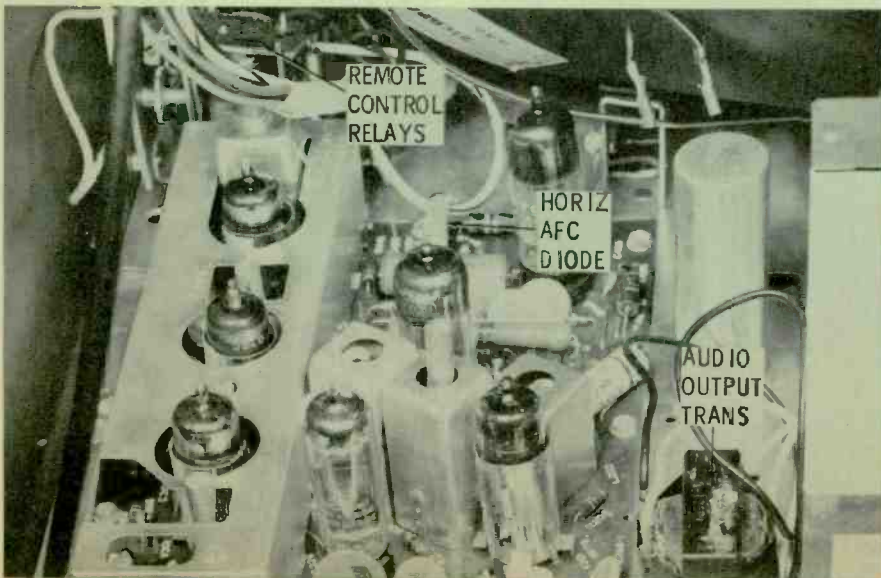
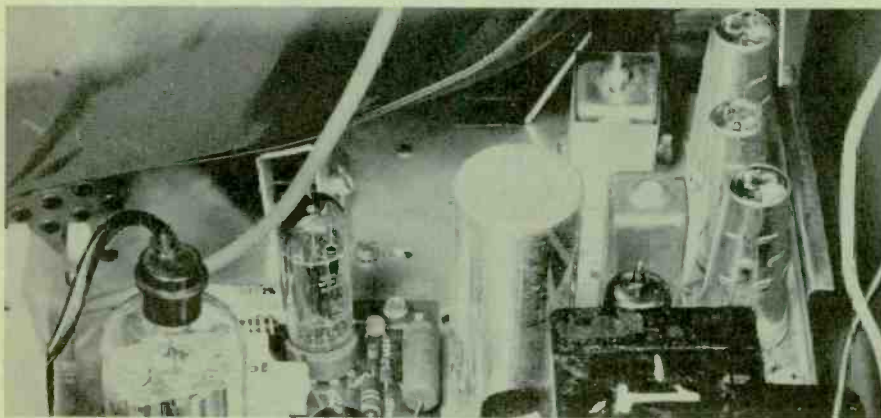
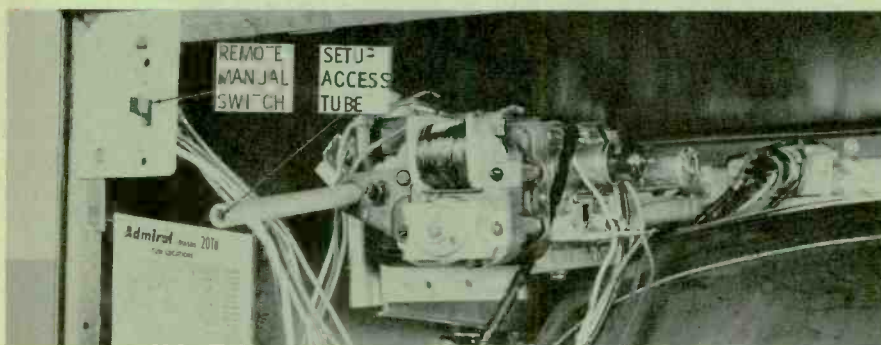
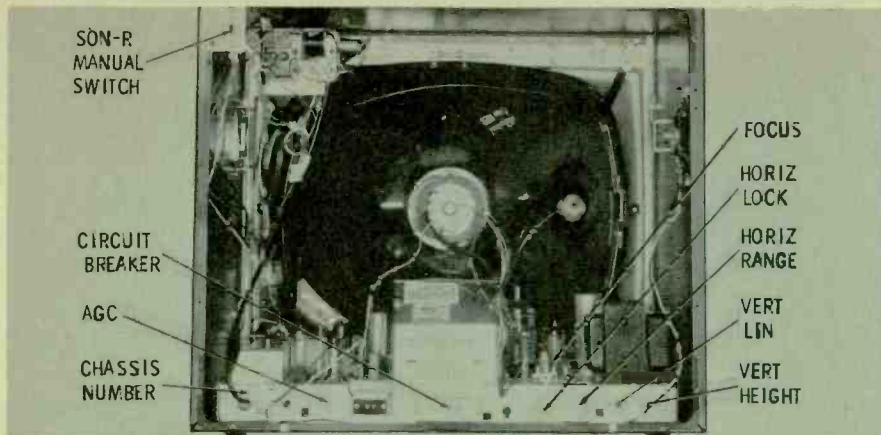

**Admiral Model TS-22M41
Chassis 20T6**

This metal 21" table model represents eleven models which use the same chassis. It's equipped with *Son-R* remote control—a supersonic signal system for turning the set on and off, selecting one of three volume ranges, and changing channels. Manual operating controls are located to the right of center, both above and below the screen. When not in use, the remote control transmitter is stored in a recessed cavity on the right side of the cabinet. The safety glass can be removed for cleaning after removal of the four screws holding the trim strip along its top edge.

Available as a VHF version only, the 19-tube chassis is equipped with a power transformer, circuit breaker (protecting the B+ supply), and a 1 3/4" length of #26 wire (protecting all tube filaments except those of the remote tuning unit). All setup controls are mounted on the rear apron of the chassis, and are clearly marked for easy identification.

A fairly long screwdriver, having a thin shank and narrow blade, is required for making the channel-programming adjustments. An access tube guides the screwdriver to the cam for the channel to which the set is tuned. Rotating a cam counterclockwise will cause the tuner to stop on the associated channel; rotating it clockwise will allow the channel to be skipped.

The major difference between this chassis and other new Admirals is the substitution of selenium rectifiers for a 5U4. (See photo of the right side of the chassis.) Also note the addition of remote-control receiver circuits in front of the transformer. The 6BJ8 triple diode in the remote control circuit is the only uncommon tube in the receiver. The printed board shown in this same photo contains all of the deflection circuits except the AFC and damper stages.

The printed board on the left side contains the remaining stages, including the horizontal AFC dual selenium diode. The board itself has no foil pattern shown on the top side, as do those in some other new Admiral sets. The audio output transformer has socket-type terminals to receive the plug ends of the speaker leads, thereby simplifying chassis removal.



**Andrea Model 2LBVS-323-1
Chassis VS-323-1**

Here's one of ten models using the same chassis and a 23", 110° Pan-O-Ramic picture tube with bonded safety shield. Operational controls (including bass and treble) are mounted to the left and right of the tube, above the speaker baffles.

Spacious is the word that best describes the inside of the cabinet. All setup controls are easily accessible, but unmarked. A phono jack and switch are provided on the rear of the chassis, permitting the audio and power-supply sections to serve as one channel of a stereo system. When removing the chassis, it's necessary to remove both control panels from the inside of the cabinet. In addition, don't forget the two screws at the top of the picture tube, which secure it to the front of the cabinet. In order to make it easier to transport the chassis, the right control panel can be held by the two screws on the right side of the high-voltage cage, while the left panel will fit under two screws along the top left edge of the chassis. When the panels are thus secured, the chassis rests easily on its right side for servicing.

The three-speaker sound system employs low-, mid-, and high-frequency speakers with a crossover network for full-range sound output. Each speaker has its terminals identified by a colored paint dot as a guide for proper phasing, should it become necessary to disconnect the original circuit.

The horizontal sweep circuits are all concentrated in the left rear section of the chassis. A 6CG7 is used in the pulse-width AFC-oscillator circuit. The horizontal drive-control circuit is a little unusual in that it varies the signal division of two series-connected capacitors which form the coupling circuit to the horizontal output stage. The only fuse used, a 1/4-amp, slow-blow type located inside the high-voltage cage, protects the sweep circuits.

The 18-tube, transformer-powered, conventionally-wired chassis is as spacious in layout as the cabinet. The only servicing problem you're likely to encounter stems from the location of the tubes used in the video IF, video output, keyed AGC, and vertical stages. These are located beneath the picture tube and directly in front of the cage, making it difficult to find their locating guides.

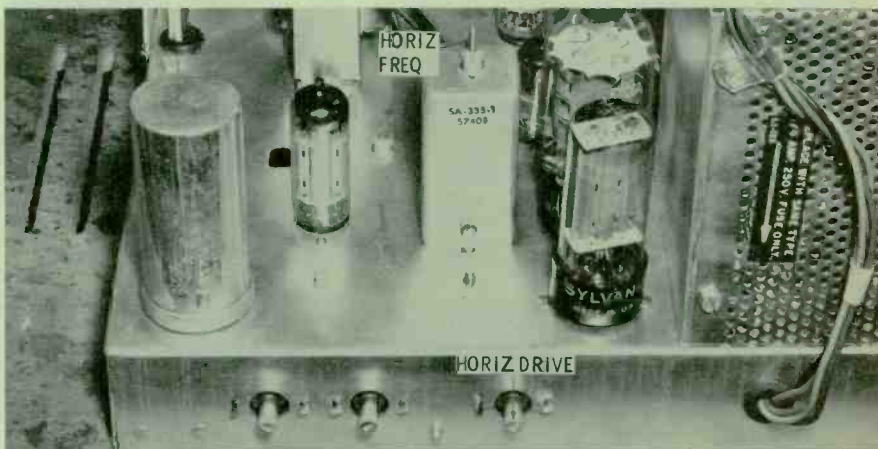
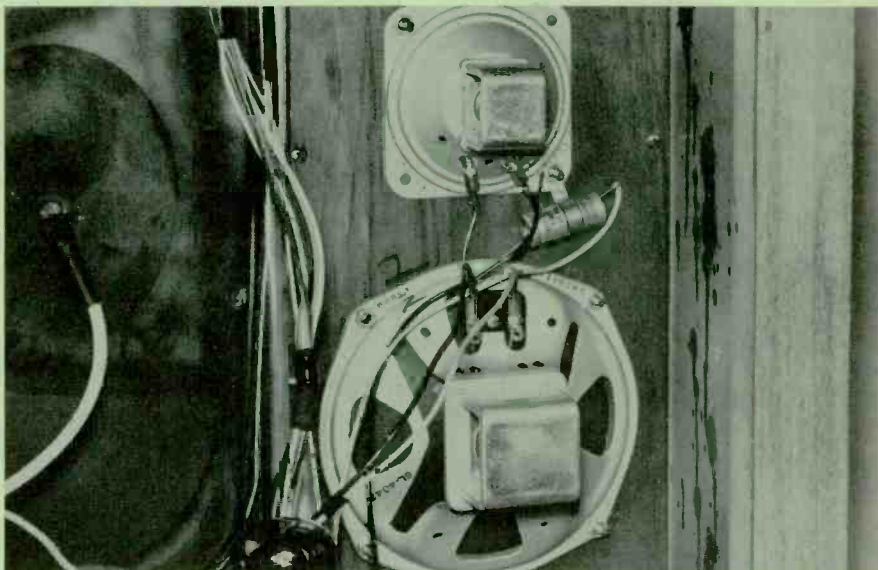
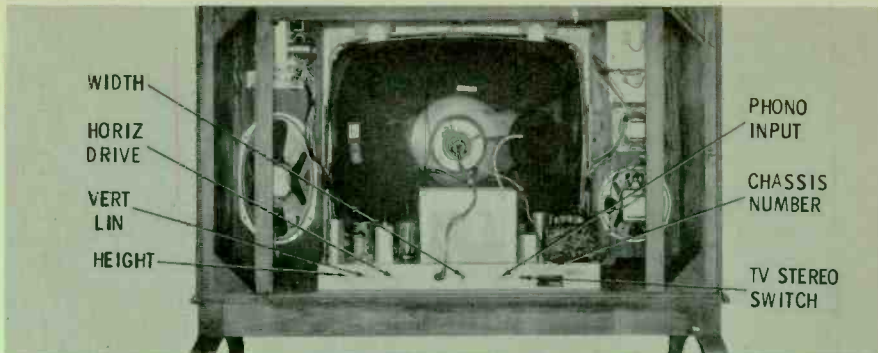

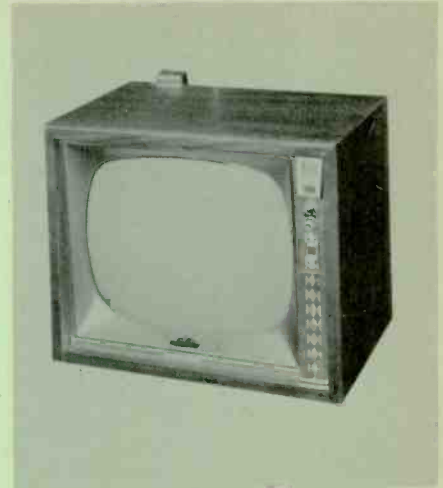
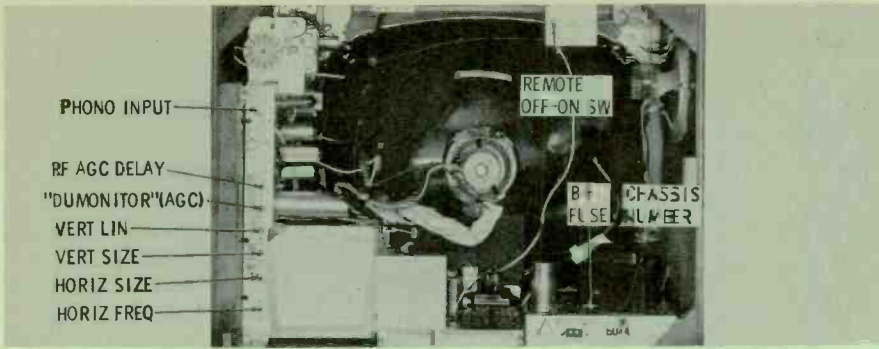

DuMont Model "Colony" Chassis RA-601A

This 21" model is one of 12 which use a 21" or 24", 90° picture tube and either the RA-600A or RA-601A chassis. The RA-601A chassis incorporates *DuMatic* wireless remote control, while the RA-600A employs a wired system. Exposed controls include a power-tuning push-button, "do-it-yourself" fine tuning (*Perma-tune*), and volume control with push-pull off-on switch. A control-panel door hides the bass, treble, brightness, contrast, fringe-lock, vertical hold, and horizontal hold controls as well as the TV-phonos switch.

The rear view of the set reveals a two-piece, 18-tube TV chassis separated by the 7-tube remote control chassis. The AGC delay control varies fixed RF bias, while the *Dumonitor* acts as a conventional AGC control. The horizontal size control, in the horizontal output tube's screen-grid circuit, varies the gain of the stage.

The remote control and TV chassis are both transformer-powered, conventionally-wired units. The TV power supply is a little unusual in that the filament circuit of the 5U4 is protected by a length of #26 wire. Other protective devices include the normal filament fuse wire, an N-type 7/10-amp B+ fuse, and a 3/10-amp sweep-circuit fuse (inside the cage). The only uncommon tube used is the EZ81/6CA4 rectifier in the remote receiver chassis. The battery-powered remote transmitter uses a transistorized RF oscillator to drive a transducer, which converts the RF signal into supersonic sound waves and radiates them to the receiver.

Except for the power supply, all the TV and power-tuning circuitry is located on the vertical chassis. The silicon rectifier pointed out is used to supply direct current for the remote volume-control motor. Program indexing is accomplished by a series of adjustable nylon cams that can be rotated to lock in either of two positions 180° apart.

Due to the compact mounting of the vertical chassis, it's virtually impossible to change tubes in the horizontal sweep circuit, since they are located in front of the high-voltage cage. Don't overlook the spring clip holding the horizontal output tube base. The shaftless control in the right front corner is the direct-coupled, motor-driven remote volume control.

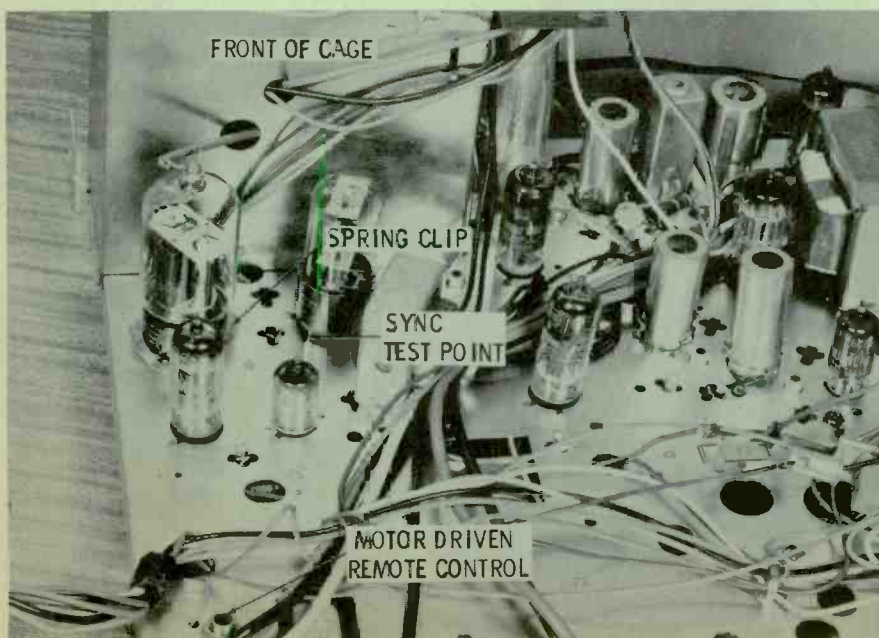



**Packard-Bell Model 23DK1
Chassis 98D8**

Here's a 53" piece of home entertainment that falls into the "has everything" class. The 23", 110° picture tube with bonded safety shield may be hidden behind a sliding, roll-up door the first time you encounter this set. All controls are located in a wired remote control unit. The function selector, audio controls, and master off-on switch are a part of the AM-FM radio chassis housed under the left lid; the record-changer compartment is on the right side.

From the back, you'll see a vertically-mounted chassis loaded with controls. While they aren't identified on the chassis itself, a guide to their functions and locations is given on the tube placement chart glued to the high-voltage cage. The picture fidelity control varies the high-frequency attenuation of the video signal, and the ANI (automatic noise inversion) control regulates the bias on a noise-inverter stage. Note the reversed position of the tuner and the location of the oscillator adjustment hole.

The 21-tube, conventionally-wired TV chassis is transformer-powered and uses a circuit breaker in series with the AC line. A 5V3 is used as the low-voltage rectifier. The 6V6 audio output tube supplies signal only to the remote-control unit speaker and an external speaker jack. Except during remote listening, all sound is fed equally to both stereo preamps. In the event the chassis is taken to the shop for service, it is advisable to take the amplifier and radio chassis also, due to the numerous circuits affected by the interconnecting leads.

The radio chassis is an 8-tube AM-FM unit which receives its power from the amplifier chassis. In addition to the radio circuits, it contains all tone-compensation networks and a pair of stereo preamps. (Incidentally, a cathode follower is employed as a final stage in each of the preamp circuits.) The FM section uses a matched pair of 1N541 crystal diodes in the discriminator stage.

The amplifier contains a healthy power supply and both audio channels. Each channel has two stages of amplification and a push-pull output stage using either EL84 or 6BQ5 tubes to power two 4" speakers and a 10" woofer.

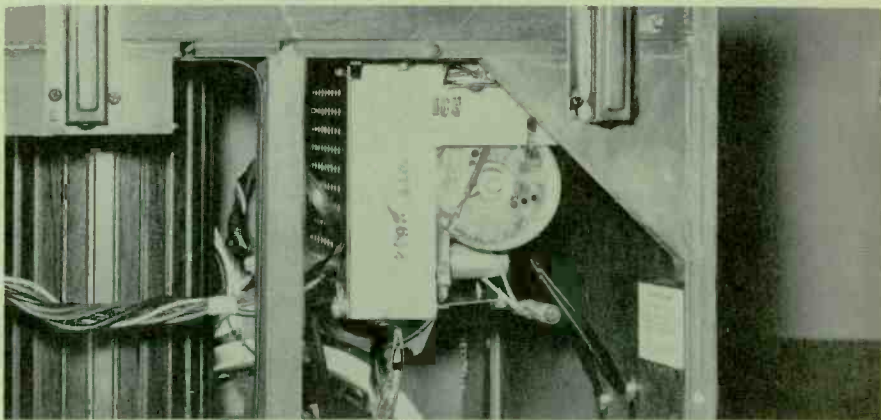
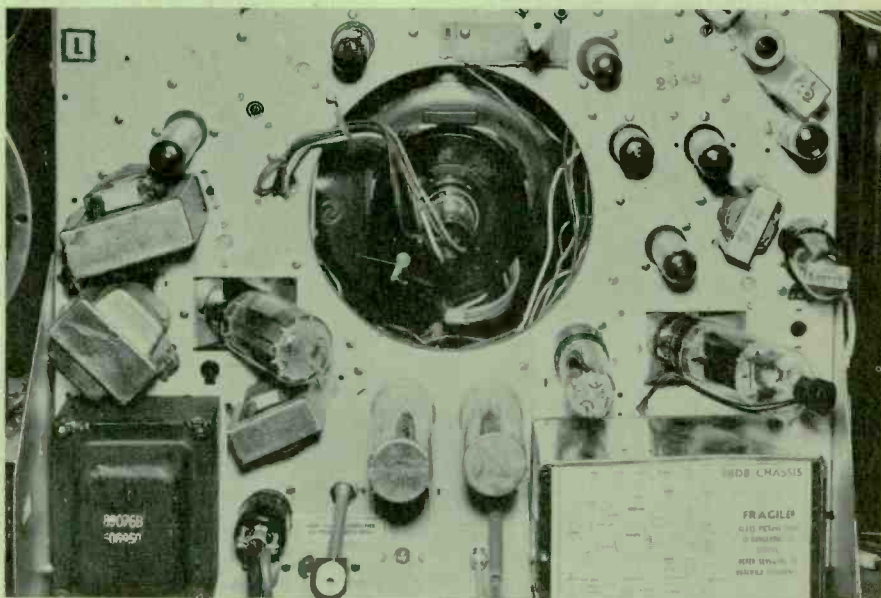
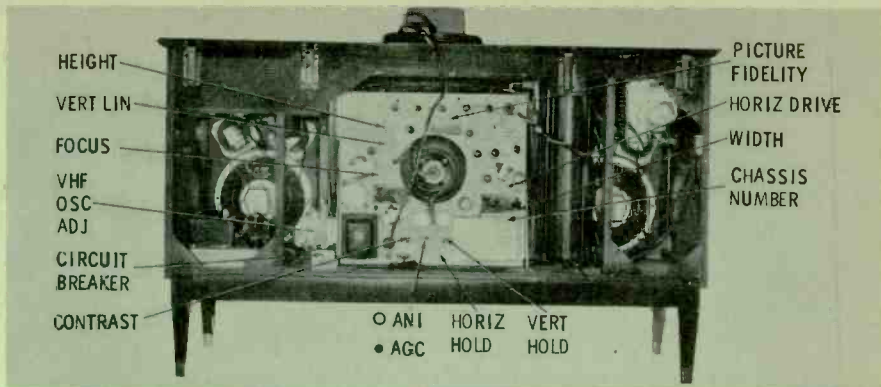

See PHOTOFACT Set 470, Folder 2

Mfr: Motorola **Chassis No.** TS-558
Card No: MO 558-1
Section Affected: Raster.
Symptoms: Flashes and streaks.
Cause: Defective horizontal size control.
What To Do: Replace R8 (5000 ohms—2W).

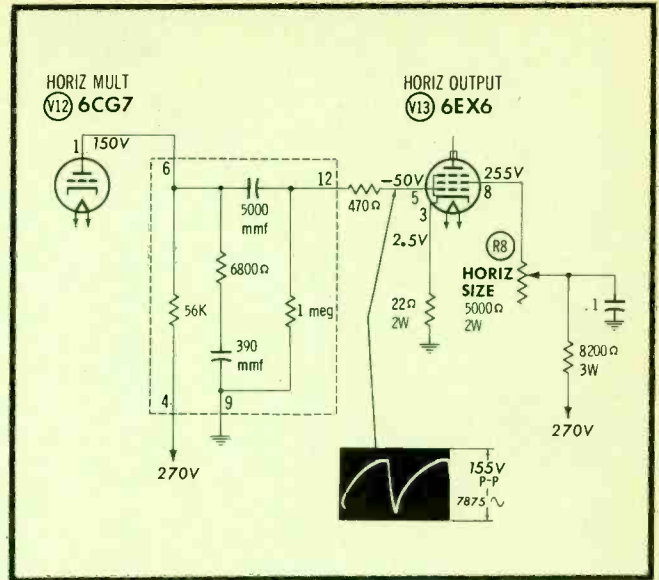

Mfr: Motorola **Chassis No.** TS-558
Card No: MO 558-2
Section Affected: Raster.
Symptoms: No vertical sweep.
Cause: Shorted feedback capacitor in vertical multivibrator.
What To Do: Replace C54 (.01 mfd—600V).

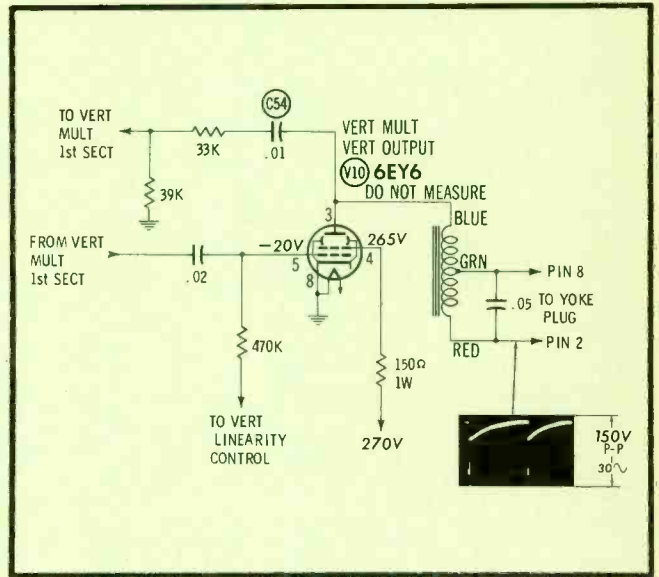

Mfr: Motorola **Chassis No.** TS-558
Card No: MO 558-3
Section Affected: Pix.
Symptoms: Contrast gradually becomes poorer.
Cause: Voltage-divider resistor in screen-grid circuit of video output tube slowly decreases in value.
What To Do: Replace R30 (47K—2W).

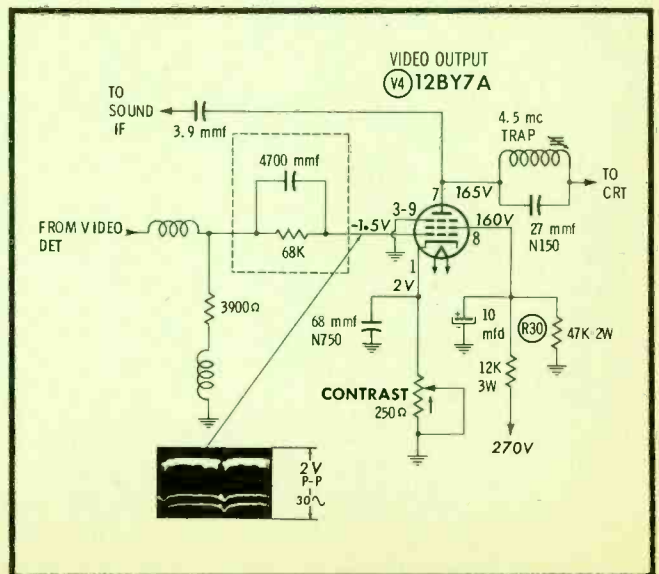

See PHOTOFACT Set 470, Folder 2

See PHOTOFACT Set 470, Folder 2

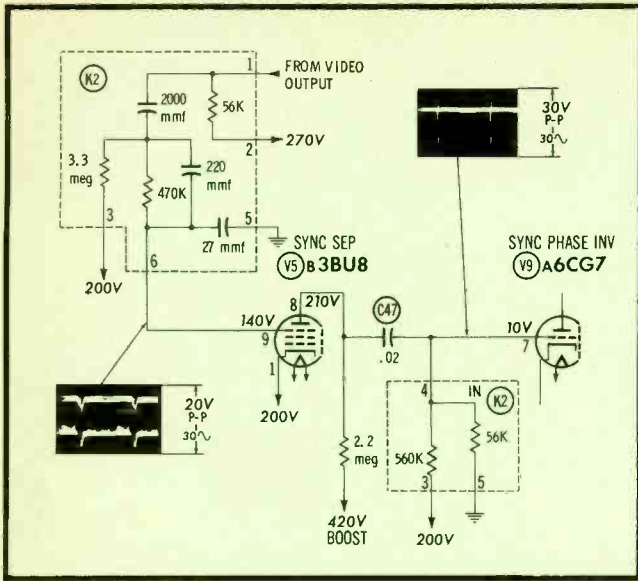

See PHOTOFACT Set 470, Folder 2

Mfr: Motorola Chassis No. TS-558

Card No: MO 558-4

Section Affected: Sync.

Symptoms: Horizontal tearing and vertical rolling.

Cause: Leaky coupling capacitor between sync separator and sync phase inverter.

What To Do: Replace C47 (.02 mfd—600V).

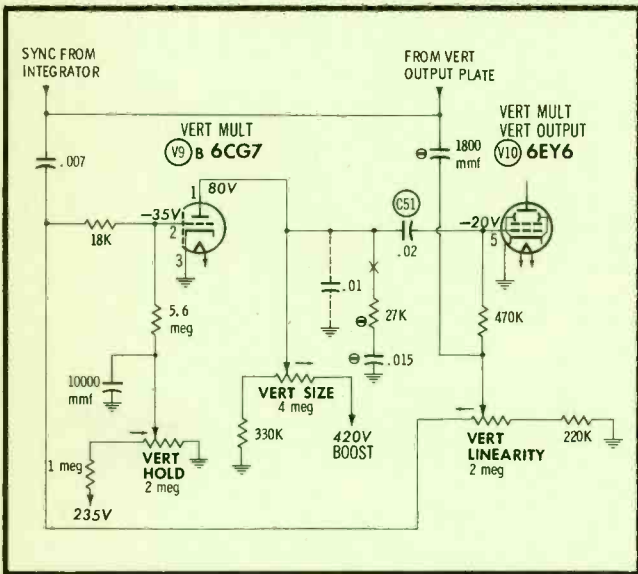

Mfr: Motorola Chassis No. TS-558

Card No: MO 558-5

Section Affected: Raster.

Symptoms: Foldover at bottom of screen.

Cause: Leaky coupling capacitor in vertical multivibrator.

What To Do: Replace C51 (.02 mfd—600V).

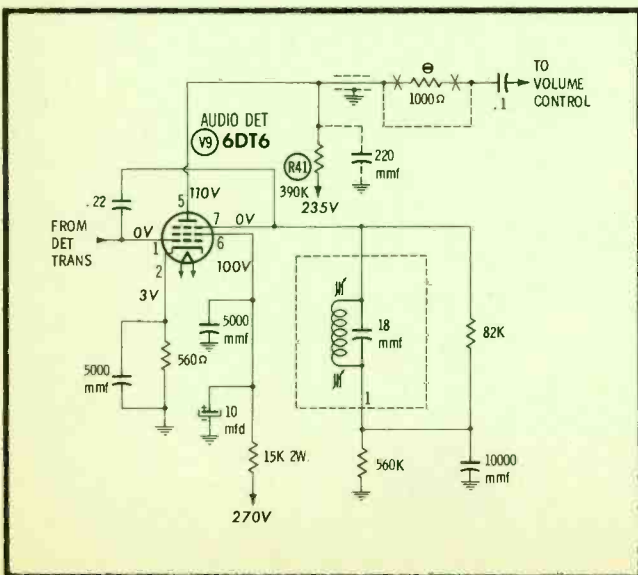

Mfr: Motorola Chassis No. TS-558

Card No: MO 558-6

Section Affected: Sound.

Symptoms: Weak and distorted sound.

Cause: Audio detector load resistor has changed value.

What To Do: Replace R41 (390K).

See PHOTOFACT Set 471, Folder 2

Mfr: Setchell-Carlson Chassis No. 259

Card No: SC 259-1

Section Affected: Raster.

Symptoms: No vertical sweep.

Cause: Shorted cathode capacitor in vertical multivibrator.

What To Do: Replace C41 (30000 mmf).

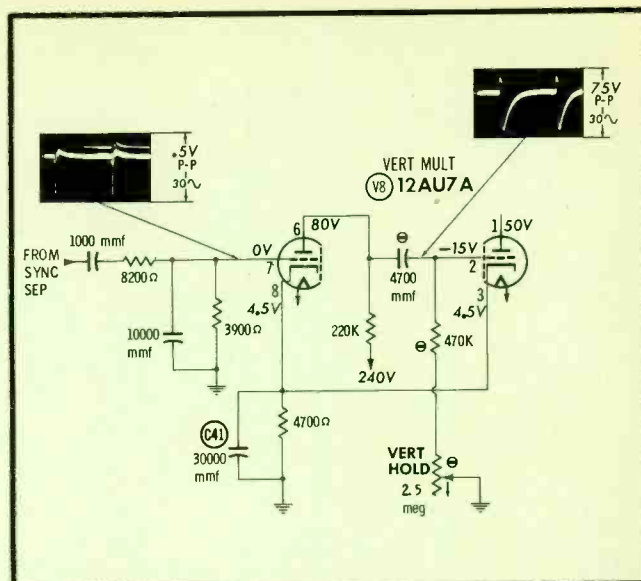

Mfr: Setchell-Carlson Chassis No. 259

Card No: SC 259-2

Section Affected: Raster.

Symptoms: Frequent failure of 6DQ6A horizontal output tube.

Cause: Screen resistors have decreased in value.

What To Do: Replace R67 and R68 (each 33K—2W).

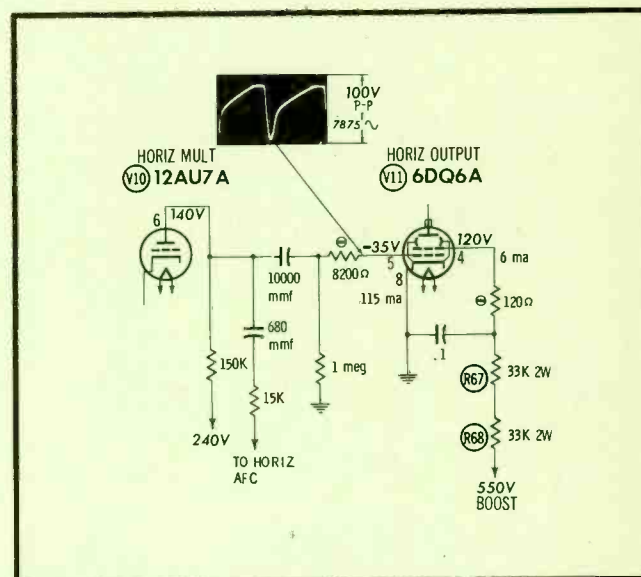

Mfr: Setchell-Carlson Chassis No. 259

Card No: SC 259-3

Section Affected: Pix.

Symptoms: Video overloading.

Cause: Shorted cathode-bypass capacitor in keyed AGC circuit.

What To Do: Replace C3 (5 mfd—150V).

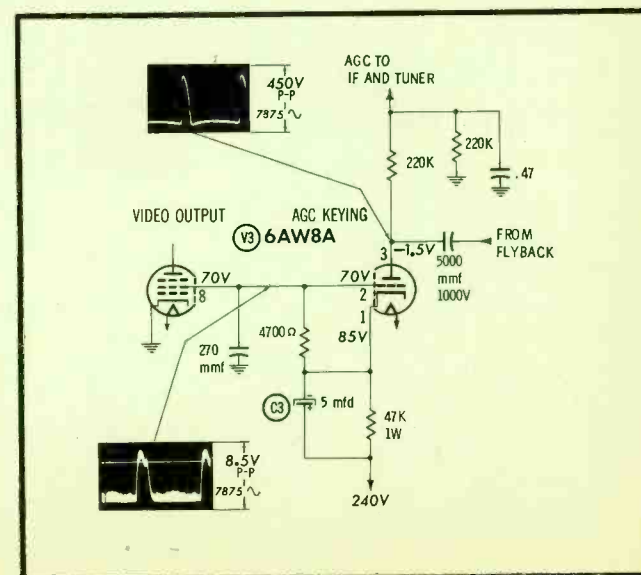

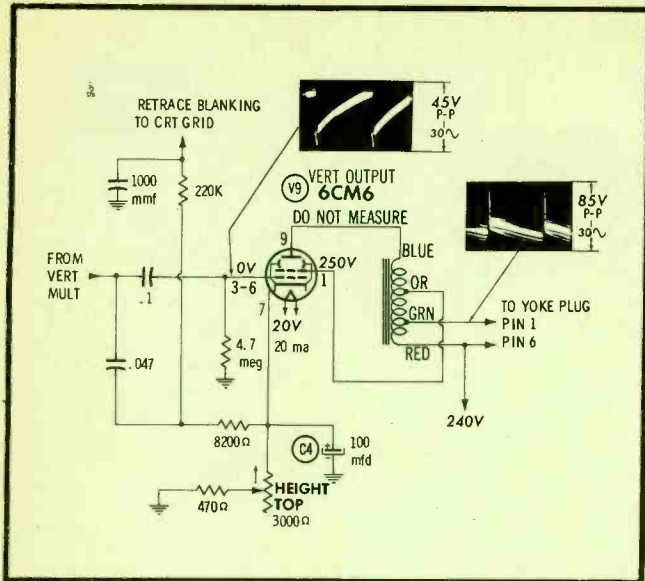

See PHOTOFACT Set 471, Folder 2

Mfr: Setchell-Carlson Chassis No. 259

Card No: SC 259-4

Section Affected: Raster.

Symptoms: Poor vertical linearity.

Cause: Open cathode-bypass capacitor in vertical output stage.

What To Do: Replace C4 (100 mfd—50V).

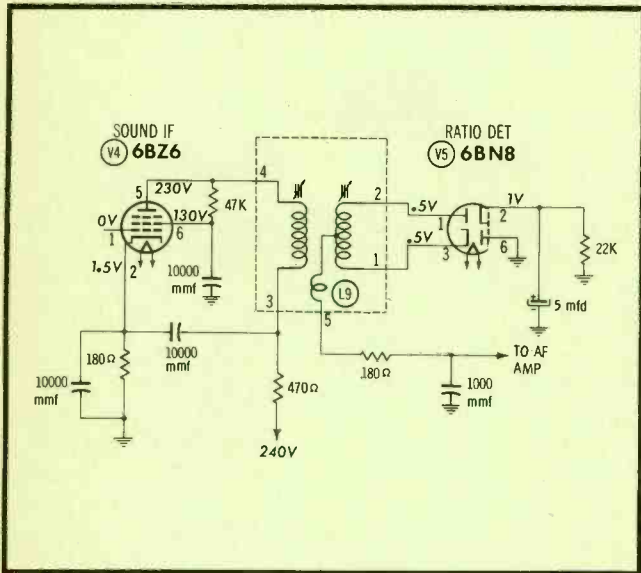

Mfr: Setchell-Carlson

Chassis No. 259

Card No: SC 259-5

Section Affected: Sound.

Symptoms: Intermittent loss of audio.

Cause: Defective ratio-detector transformer.

What To Do: Replace L9.

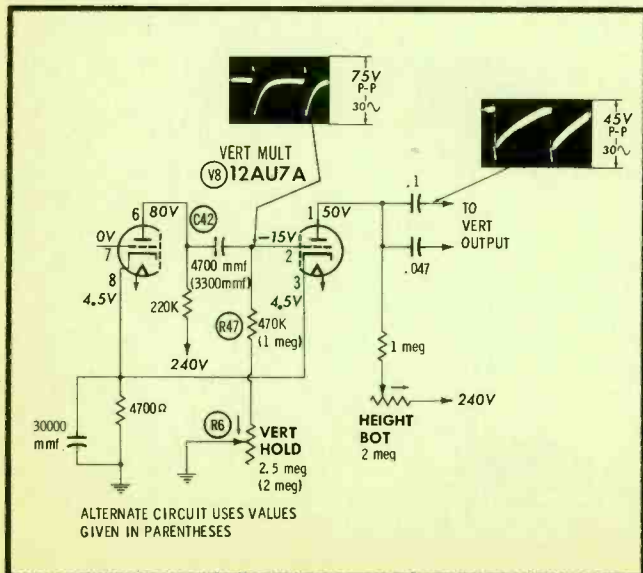

Mfr: Setchell-Carlson

Chassis No. 259

Card No: SC 259-6

Section Affected: Sync.

Symptoms: Vertical frequency drift.

Cause: Leaky coupling capacitor in vertical multivibrator.

What To Do: Replace C42 with same value as original (may be either 4700 or 3300 mmf). Check R47 and R6 to make sure they have not changed value.



Here is the new Standard Coil Tuner Replacement and Repair Program that enables you to offer better service to your customers at greater profit. Now Standard Coil Products provides the tools that will enable you to cash in on the profitable tuner repair and replacement market.

TUNER REPLACEMENT LISTING IN SAMS PHOTOFAC

Starting in January, Standard Coil tuner replacement listings will appear in all Sams TV Photofact. Tuner replacement information will be right at your finger tips. Standard Coil is the *only* manufacturer ever to provide this service.

NEW TV TUNER REPLACEMENT GUIDE

Lists original equipment TV tuners with the Standard Coil equivalent replacement for each. Also includes major mechanical replacement parts for all Standard Coil Tuners—those used in original equipment as well as the universal replacement. Eliminates all guesswork—minimizes your tuner repair and replacement problems.

48 HOUR FACTORY GUARANTEED REPAIR SERVICE

Standard Coil's special service department set-up assures factory guaranteed repairs—*on a 48 hour in-plant cycle!* All repaired tuners carry a *six month warranty* on defective workmanship and parts failure (excluding tubes). Gives you more time for additional service calls—promptly returns your customer's set to like new operating condition.

DEFECTIVE TUNER TRADE-IN ALLOWANCE

Tuners which can *not* be repaired can be traded in against a new replacement tuner which carries a *full twelve month factory guarantee*. See your Standard Coil Distributor for complete details on how trade-ins can increase your tuner sales and profits—create greater customer satisfaction.

JUMP ON THE STANDARD COIL PROFIT WAGON TODAY!

For additional details, see your authorized Standard Coil Distributor or write to:

Standard

Coil Products Co., Inc.

2085 North Hawthorne Avenue, Melrose Park, Illinois

July, 1960/PF REPORTER 9

Send 10c to Sprague
for window-size blow-
ups of this message.



EVERY DAY IS INDEPENDENCE DAY



FOR YOU AND YOUR
★ INDEPENDENT ★ ★
TV SERVICE DEALER



Your independent TV Service Dealer is in business for himself because he too wants to exercise his independence just as you do. You purchased your TV or radio set where you wanted to . . . when you wanted to . . . and at the price you decided was right.

Your TV service dealer is also an independent in the things he buys in his day-to-day work. He buys his repair parts where he can get the highest quality and the best service. And, he trained himself in his own way, on his own time, at his own expense to be able to do this in the very best way for YOU.

He stands or falls on what you think of him and his work. He has to do good work to keep your business . . . and he knows it!

We're lucky in these United States that every day is Independence Day. Independent buying, selling, and servicing is the very lifeblood of American business. Let's keep it that way.

**THIS MESSAGE WAS PREPARED BY SPRAGUE PRODUCTS COMPANY,
DISTRIBUTORS' SUPPLY SUBSIDIARY OF SPRAGUE ELECTRIC CO., NORTH ADAMS, MASS. FOR**

YOUR INDEPENDENT TV-RADIO TECHNICIAN

publisher
Howard W. Sams

general manager
Mal Parks, Jr.

editor
Verne M. Ray

associate editors
Leslie D. Deane
Thomas A. Lesh
Joe A. Groves

consulting editors
William E. Burke
Robert B. Dunham
George B. Mann
C. P. Oliphant
Paul C. Smith

art director
Don W. Bradley

advertising & editorial assistants
Georgeanna Caldwell
Marjorie Spiegel
Jean Sekulski

production manager
Robert N. Rippy

circulation fulfillment
Pat Tidd, Mgr.
Constance McCawley, Ass't.

photography
Robert W. Reed

advertising sales offices
midwestern

John Groce, PF REPORTER
2201 East 46th Street, Indianapolis 6, Ind.
Clifford 3-6441

eastern

Howard W. Sams & Co., Inc.
Corning Glass Building,
717 Fifth Ave., New York 22, N. Y.
MUrray Hill 8-6350

western

The Maurice A. Kimball Co., Inc.
2550 Beverly Blvd., Los Angeles 57, Calif.
Dunkirk 8-6178; and 681 Market Street,
San Francisco 5, Calif. Exbrook 2-3365

Address all correspondence to
PF REPORTER, 2201 East 46th Street,
Indianapolis 6, Indiana



Copyright © 1960 by Howard W. Sams & Co., Inc. PF REPORTER is a trademark of Howard W. Sams & Co., Inc. No part of PF REPORTER may be reproduced without written permission. No patent liability is assumed with respect to use of information herein. Acceptance of advertising does not in any manner signify the products, policies and services so advertised have been approved, endorsed or recommended by this magazine.

Indexed in *Electronic Guide* and *Lectrodex*.

Printed by the Waldemar Press Div.
of Howard W. Sams & Co., Inc.

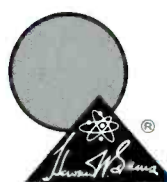

PF REPORTER

including **Electronic Servicing**

VOLUME 10, No. 7

JULY, 1960

Previews of New Sets Admiral Model TS-22M41, Andrea Model 2LBVS 323-1, DuMont "Colony," Packard-Bell Model 23DK1.	1
Video Speed Servicing Service hints on the Motorola TS-558 and Setchell-Carlson 259 Chassis.	5
Letters to the Editor	16
The Electronic Scanner	22
Servicing the Big Loop Milton S. Kiver Shop Talk—RF, IF, and AGC troubles won't lead you around in circles if you use a systematic servicing approach.	24
Let's Talk Antennas Les Deane Success as an antenna installer depends on your ability to plan the best system for each location.	26
Another Sine-Wave Horizontal Oscillator Thomas A. Lesh Servicing New Designs—Get acquainted with this new Motorola circuit now, and you'll know what to do when one comes in for service.	28
Regular Recorder-Repair Routines The mechanical section of a tape recorder needs a periodic eight-point checkup to insure tip-top operation.	30
Dollar and Sense Servicing	32
Radio and Hi-Fi Tube Guide Joe A. Groves A stock of 77 types used in radios, phonos, and audio amplifiers during the last 20 years.	34
Troubleshooting Color Sync Quicker Servicing—Some tips for turning a fuzzy rainbow back into a normal color picture.	36
Automatic Filling Device "Says When" Jack Darr There's no crying over spilt milk when dairymen use an electronic timer to control the pouring.	40
Tips for Techs	46
Notes on Test Equipment Lab reports on the EMC Model 109 VOM and RCA Model WO-33A oscilloscope.	48
The Troubleshooter	54
Product Report	70
Free Catalog and Literature Service	72

ABOUT THE COVER

No, our photographer wasn't hanging
from a "skyhook," but he had a
good substitute—as you can see.

Our good friends at Indiana Gear
Works were kind enough to place both
their whirlybird and pilot, Max Jobst,
at our disposal. Terrific
attic fan, eh?



Another bold step in Raytheon's Crusade Against Call-Backs

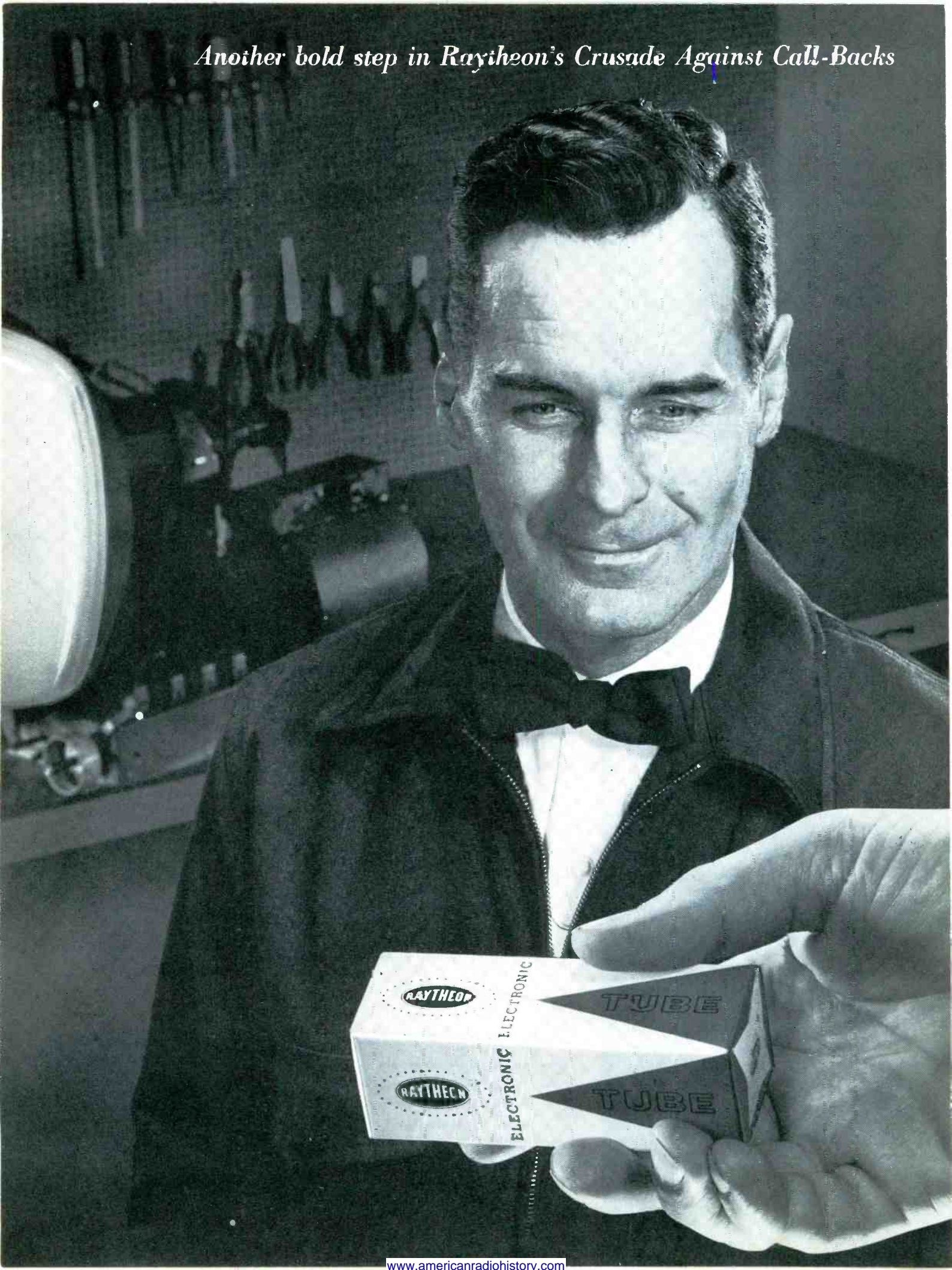



Raytheon Announces

UNILINE

The new standard of receiving tube quality...
backed by an extraordinary guarantee
against call-back loss.

Now, for the first time, a tube manufacturer offers you a new "tough-type-tested" tube line to protect you against call-backs... UNILINE... built to an entirely new standard of quality and covering the ten types you voted the most troublesome in Raytheon's recent nationwide poll.

We believe the quality of Raytheon's Uniline tubes is so superior that they will become the most trusted and talked about receiving tubes in the industry.

Now... "TAKE TEN AND SEE"!



Your Raytheon Distributor now has in stock specially prepared get-acquainted "Ten-Packs" consisting of one each of the ten Uniline types (1B3GT, 6AU4GTA, 6AX4GT, 6BQ6GTA/B, 6SN7GTB, 1X2A/B, 6CB6A, 6CG7, 6X8, 12AT7). We invite you to "Take Ten and See" if these are not the most trouble-free tubes you have ever used.

To back our complete confidence in Uniline, Raytheon is prepared to make a guarantee never before offered. Your Raytheon Distributor has full details. Prove it to yourself. Start your own Crusade Against Call-Backs today by ordering your Raytheon Uniline "Ten-Pack" in the distinctive new cartons.

RAYTHEON COMPANY

DISTRIBUTOR PRODUCTS DIVISION • WESTWOOD, MASS.

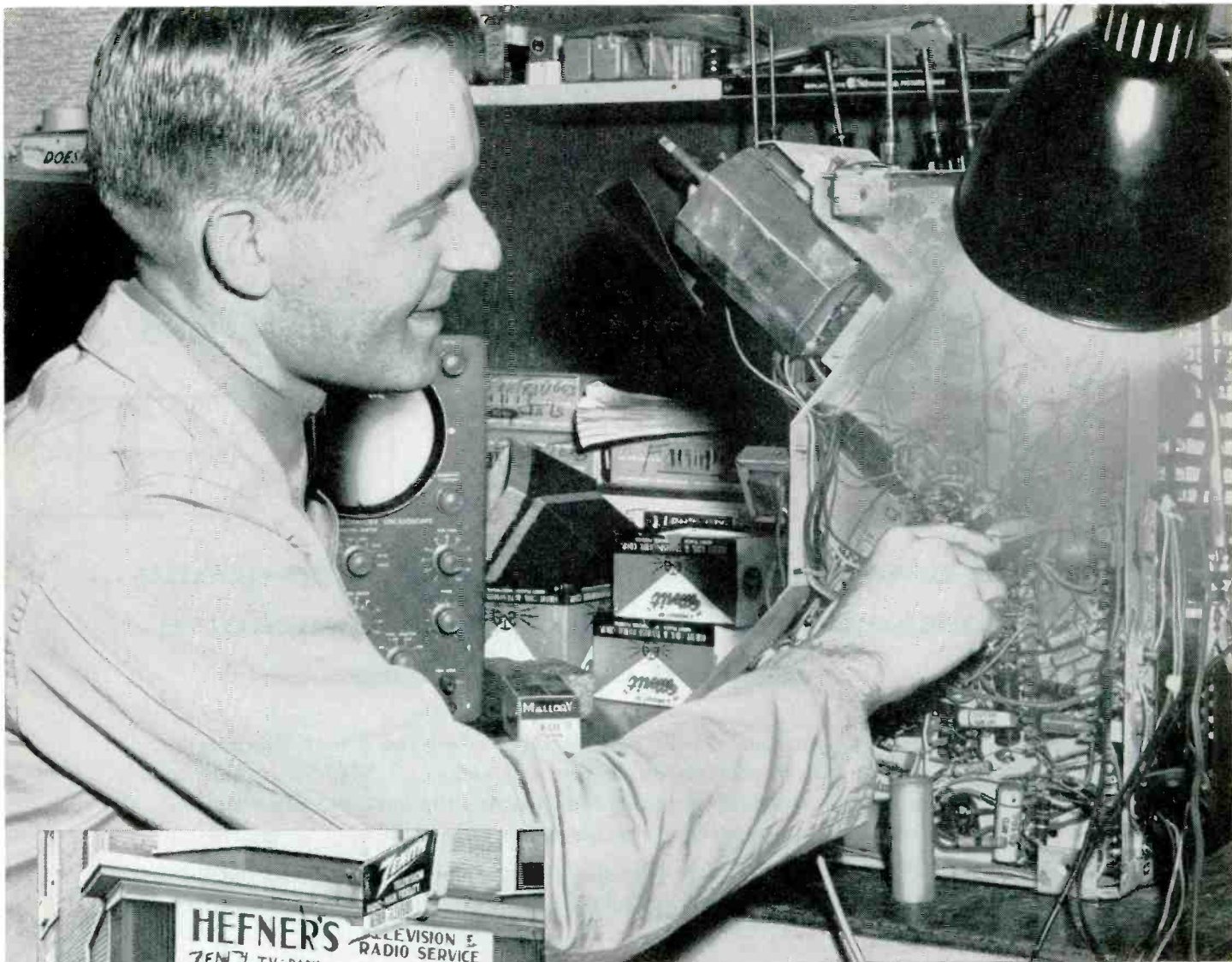

Roger Hefner owns and operates Hefner Television & Radio Service in Lima, Ohio. He attended DeVry School in Chicago, then furthered his electronics training by working with a major radio-TV manufacturer. He returned to Lima five years ago to go into business for himself. Roger now has two technicians helping him with sales and service on home and auto radio, TV and hi-fi. He credits his business success to prompt, courteous attention to service calls, careful, thorough workmanship and the use of only quality products.

STOP CALL-BACKS WITH THESE QUALITY MALLORY COMPONENTS



GEMS

Five rugged, moistureproof Mallory "Gem" tubular capacitors in an easy-to-use dispenser that keeps stock fresh, clean, easy to use . . . arc prevents kinks in lead wires. They're your best bet for prize performance in buffer, by-pass or coupling applications.



GOLD LABEL® VIBRATORS

Sell the best in auto radio servicing; use Mallory Gold Label Vibrators for every job. Exclusive buttonless contact design gives longest, trouble-free service. The quietest vibrator ever made.

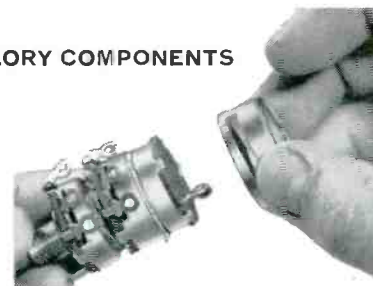

STA-LOC® CONTROLS

No more waiting for out-of-stock controls. Your distributor can custom-build in just 30 seconds, any of over 38,000 single or dual controls. You can replace the line switch by itself, without unsoldering control connections.

Radio-TV Serviceman Roger Hefner explains why:

"Mallory Quality Components

protect my reputation for quality service"



"I use only first quality components for replacement. My reputation for quality service has been built on a firm

foundation of quality products combined with quality workmanship . . . and I'll never jeopardize it by using cheap 'specials' that are sold as 'just as good'. I always choose Mallory. No substitutes for me!"

For replacing ceramic capacitors in TV tuners

and other precision circuitry, Roger Hefner, like thousands of other technicians, has discovered that Mallory RMC Discaps* are the surest step to customer satisfaction. The quality built into every Discap ends call-backs . . . provides the margin between just *service* and genuine *quality service*. Discaps—for years the standard of quality in original equipment—come packaged for replacement in handy 3 x 5" file card five-packs.

Whatever your component needs, look to Mallory for the highest quality parts . . . sensibly priced . . . and the widest selection in the industry. See your Mallory distributor soon.

*Registered Trademark of Radio Materials Company
A Division of P. R. Mallory & Co. Inc.

Distributor Division

P. R. MALLORY & CO. Inc.
MALLORY

P. R. MALLORY & CO. Inc., INDIANAPOLIS 6, INDIANA



TC TUBULAR ELECTROLYTICS

Economically priced filter capacitors with a reputation for doing an excellent job. Performance proved and backed by years of Mallory experience. Also special TCX type available for 55°C.



MERCURY BATTERIES

Unequaled for long, fade-free life in transistor radios . . . and virtually unlimited shelf-life. Chosen as the "power package" in U.S. satellites. Made by the world's largest manufacturer of mercury batteries.



FP ELECTROLYTICS

The original 85°C capacitor. New shock-resistant construction with leakproof seal. Etched cathode—standard at no extra cost only in FP's—gives hum-free performance. High ripple current ratings fit the toughest filter circuits.

Introducing ATR CUSTOMIZED Karadio



Can be installed
in dash or under
dash as desired!

for
small import cars
and
compact U.S. cars

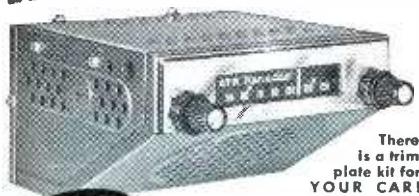

There
is a trim
plate kit for
YOUR CAR!

ATR CUSTOMIZED Karadio

• VIBRATOR-OPERATED with Tone Control

The ATR Customized Karadio is a compact, new, self-contained airplane-styled radio for small import and compact American cars. This economical unit is perfect for all small cars because it can be easily and inexpensively installed in-dash or under-dash on most any make or model automobile—and its powerful 8-tube performance provides remarkable freedom from engine, static, and road noises. ATR Karadios are built to look and fit like original equipment with sleek, modern styling and solid, single-unit construction. They offer many customized features and provide highest quality fidelity—yet cost far less than comparably designed units. The ATR Customized Karadio comes complete with speaker and ready to install... and is the ideal way to add fun and value to your small import or American automobile!



ATR KARADIO
... is ideal
for small import
cars or com-
pact American
cars! Unit is

completely self-contained—extremely compact! Can be mounted in-dash or under-dash—wherever space permits! For 6 volt or 12 volt!

SEE YOUR JOBBER OR WRITE FACTORY

• "A" Battery Eliminators • DC-AC Inverters • Auto Radio Vibrators



AMERICAN TELEVISION & RADIO CO.
Quality Products Since 1931
SAINT PAUL 1, MINNESOTA, U. S. A.

Letters to the

EDITOR

Dear Editor:

On page 74 of your June issue, the first item in "Product Report," titled *Antenna Distribution Amplifier*, illustrates an Ohmite "Little Devil" cabinet...

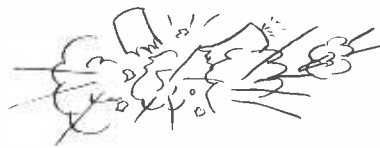

Sorry, guess I was drowned out by the hundreds of other letters being dropped on your desk, concerning the same thing—

BOB HOLT

Birmingham, Ala.

You'll find the correct pictures with the correct copy on both the *Winegard Antenna distribution amplifier* and the *Ohmite cabinet* on page 70 of this issue.

—Ed.

Dear Editor:

My copy for June just received, and, as usual, I read the "Letters to the Editor" first.

I was thrown for a curve in this month's parcel, though. I began one letter on page 14, turned over to page 16, and started finishing the letter. The two parts seemed to match until I suddenly realized that the two letters did not begin and end on the same subject!

Wot happened?

I agree with R. C. Tidwell, of Santa Barbara, that a complete file of PF REPORTER is a collector's item! I very often get down my older copies and do a little browsing! It works wonders, and I always learn something.

Tip to Mr. Osler Schuler of Dumont, Iowa: A single-edge razor blade comes in handy for removing pages from bound magazines. A straight-edge steel ruler helps out, too! Most magazines have enough "white space" between the printing and the point where the staples are inserted to permit easy removal of pages.

However, if you really want to remove the entire page, a pocket knife, a pair of needle-nose pliers, and a little patience is all you need. With a little effort, the magazine can be put back into original condition by re-inserting the removed staple, or replacing it with another.

I am a regular page-remover, and have the procedure licked! Articles on similar subjects from different magazines can be placed in a large manila envelope for future reference. I use the 9 x 12 size heavy manila envelopes, which slip right into my file drawers.

Oh! I forgot! When removing pages with a razor blade, place a stiff piece of cardboard between the pages to be

cut and the remaining pages of the magazine.

A Long-Time Booster of PF REPORTER.
HORACE D. WESTBROOKS

Griffin, Ga.

The two letters involved in last month's mix-up are printed below—in full! (For sale: One human head, left by owner who had no use for it anyway. Suitable for mounting; rolls nice. Quiet companion.)—Ed.

Dear Editor:

My hat is off to Mullard of London for their design of the ECC40 eight-pin miniature tube. It has a "bump" at one point on the base, and a special socket which enables the "bump" to be used as a keyway in seating the tube. If only other tube manufacturers could tear themselves away from the pin-game type of miniature glass tube, where one has to feel, twist, turn, and curse in order to match the pins with the socket—! Even when you finally pull the chassis out of the cabinet for a more direct view of the socket, it's still a case of twisting and fumbling to align the pins.

Let's put up a howl for tubes like the ECC40! It guides itself into place easier than the octal and loctal types; yet, it is a miniature-base, all-glass tube with evenly-spaced pins all around.

ERNEST LUKIS

Tyler Electronics Co.
Bronx, N.Y.

You should have howled years ago! This European "Rimlock" design now appears to be on its way out—not in. Like the loctal tube, it seems to be dropping by the wayside because of a worldwide trend toward standardizing tube-base designs. Examine recent models of foreign radio and hi-fi equipment, and you'll find the familiar octal or 7- and 9-pin miniature sockets almost everywhere.

Therefore, it looks as if we'll have to keep on handling miniature tubes. But at least we won't have any new sockets to add to our tube testers!—Ed

Dear Editor:

In my opinion, your magazine is tops in the electronics field; my only complaint has to do with your method of presenting *Previews of New Sets*. Since two completely different makes of receivers are described on opposite sides of each page, I haven't been able to figure out a filing system that will allow me to file the material alphabetically or with the proper PHOTOFACT Folders. Surely I'm not the only one who makes it a practice to cut out these items and file them for future reference. Can you figure out a form of presentation that will be more convenient for this purpose?

ARTHUR GLANZER

Boynton Beach, Fla.

Why don't you just file the pages in the order of publication and refer to our annual indexes? You could make a small index to cover the current year to date. Or for that matter, you could compile our contents listings into one complete index.—Ed.

52,745,000
IN
OPERATION



Actual
Size
.05
±10%
600WV

ELMENCO

**MYLAR* - PAPER
DIPPED
CAPACITORS**

RELIABILITY

Elmenco dp Mylar* - Paper Capacitors have achieved a reliability that meet missile and computer requirements. They are thoroughly and continually tested during production to insure outstanding performance. For example a 0.1 mfd. dp capacitor operated at full rated voltage and at 105° C will have a life expectancy of more than 7,168,000 unit hours.

MOISTURE-PROOF

Elmenco dp Capacitors are specially processed and vacuum dipped to obtain solid impregnation and a rugged moisture-proof coat designed to withstand 4 times more humidity than the best molded capacitors used in the past.

MINIATURIZED

These capacitors are up to 50% smaller than other brands and can be used in printed circuit and transistor applications.

*DuPont Reg. Trademark

Write for catalog dp 110.

the

**BIG
SWITCH**

is to

MINIATURIZED

ELMENCO
capacitors

AVAILABLE AT ARCO
DISTRIBUTORS EVERYWHERE



ARCO
electronics inc.

64 WHITE ST., NEW YORK 13, N. Y.
Branches: Dallas 19, Los Angeles 35



Actual
Size
.01
±10%
1000WV

ELMENCO

**CERAMIC
DISC
CAPACITORS**

RELIABILITY

The use of special ceramic materials in Elmenco Disc Ceramic capacitors impart longer life and greater stability. Higher voltage ratings greatly improve reliability by providing extra reserve for resistance to surges and temporary overloads.

MOISTURE RESISTANT

Elmenco Disc Ceramics are processed with a rugged phenolic coating and high temperature wax impregnation which gives them a superior moisture resistance and physical strength.

SPACE SAVERS

Elmenco Disc Ceramics are smaller than comparable capacitors of the same value. The miniature size is designed to offer greater service convenience with complete safety of operation.

Write for catalog CC115.

NEW WAYS RCA CAN HELP YOU

set up for greater profits

RCA's big continuing program to improve your business is now bigger than ever!

Today you'll find available to you through your Authorized RCA Electron Tube Distributor a variety of new methods, means and materials to help you SET UP FOR GREATER PROFITS. These new aids and services represent the latest phase of RCA's tailor-made program to help you build your business. They include:

- **New equipment** for store improvement—to bring added attractiveness to your sales area and greater efficiency to your service area;
- **New ideas** for successfully selling your service;
- **New informative material** to help you open up a whole new area of business: COLOR TV SERVICING.
- **New conveniences** to speed home service calls;

Check with your Authorized RCA Electron Tube Distributor today. Find out how you can get in on these new aids and services to improve your business, build your position in the community, and increase your profits.

RCA Electron Tube Division, Harrison, N. J.



The Most Trusted Name in Electronics
RADIO CORPORATION OF AMERICA

improve YOUR PLACE OF BUSINESS



Attractive sales and service areas are invaluable business assets. Plan yours with components from the RCA Store Improvement Program—all available through your RCA Distributor.

NEW Space-Saving Shelving Units help you make use of space over doors & windows, under counters.

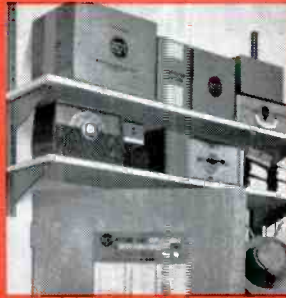

NEW RCA Accessory Bar Kit attaches to wall or shelf-unit standards. Movable hooks support anything from wire spools and tools to test instruments.

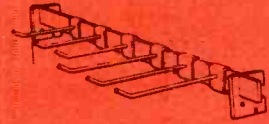

NEW RCA Special Drawer Unit provides a three-way benefit. Attaches under counter as utility drawer in service shop, cash drawer in sales area; or several drawers can be stacked together as a separate stand-up unit.



strengthen YOUR SALESMANSHIP

Here for the first time on a convenient 12" LP record are proven ideas on how to sell your services more effectively. Just sit and listen. Discover how you can apply successful selling techniques to the every-day aspects of your business.

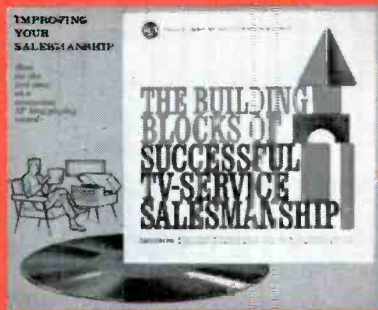

Down-to-earth tips on: ● Your Store ● Handling Store Customers ● Telephone Techniques ● Home Service Calls ● Advertising—and much more.

develop NEW BUSINESS

Profitable new business awaits you in **COLOR TV SERVICING**—provided you're ready to take advantage of it. Now RCA—world's foremost color TV authority—offers you a **FULL 11-LESSON HOME STUDY COURSE** to make you the color TV expert of your community. Prepared by RCA Institutes, it's a complete education in principles and practices of color TV servicing. **ACT NOW**; the course is a limited-time offer through your RCA Tube Distributor.



And to supplement the course, the famous **RCA COLOR TV PICT-O-GUIDE** makes an ideal refresher and quick reference on color-TV problems and how to correct them.



speed YOUR SERVICE

Make your home service calls faster, easier. This new lightweight, compact "Quick Call" Tube Caddy has a rugged wooden construction with two-color leatherette covering. This perfect mate to the big RCA "Treasure Chest" is just the thing for service calls that don't require a full tube complement.



Newlightweight "Quick Call" Tube Caddy



Standard "Treasure Chest" Tube Caddy

ALL NEW! JUST OFF THE PRESS!

Zenith Parts, Tubes and

ZENITH
"ORIGINALS" - FOR QUALITY REPLACEMENTS

ZENITH VIBRATORS
"ORIGINALS" - FOR QUALITY REPLACEMENTS

ZENITH T.V. SPACE COMMAND
HAND CONTROL UNITS
"ORIGINALS" - FOR QUALITY REPLACEMENTS

ZENITH T.V. CONTROLS
"ORIGINALS" - FOR QUALITY REPLACEMENTS

ZENITH HORIZONTAL SWEEP
TRANSFORMERS
"ORIGINALS" - FOR QUALITY REPLACEMENTS

ZENITH POWER
FILTERS
"ORIGINALS" - FOR QUALITY REPLACEMENTS

ZENITH TELEVISION KNOBS
"ORIGINALS" - FOR QUALITY REPLACEMENTS

ZENITH
"ORIGINALS" FOR QUALITY REPLACEMENTS

ZENITH
PARTS · TUBES
and ACCESSORIES
MANUAL

PRICE \$4.00



ZENITH RADIO CORPORATION, CHICAGO 39, ILLINOIS. IN CANADA: ZENITH RADIO CORPORATION OF CANADA LTD., TORONTO, ONTARIO. The Royalty of television, stereophonic high fidelity instruments, phonographs, radios and hearing aids. 42 years of leadership in radionics exclusively.

Accessories Manual

Over 375 pages of electrical and mechanical specifications! More than 400 large illustrations and charts! More than 20 sections—each tabbed and clearly indexed for fast reference—many conveniently cross referenced! Suggested retail price lists—complete information on interchange and substitution! All in a heavy-duty vinyl plastic loose leaf binder!

COMPLETE INFORMATION ON ZENITH:

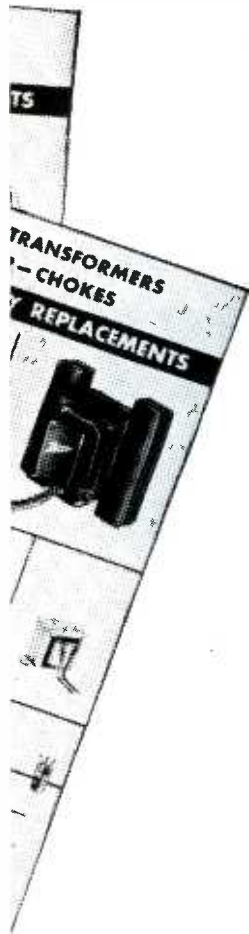

Antennas	Earphones	Stands
Batteries	Fuses	Transformers
Cabinets	Knobs	Transistors
Clocks	Lamps	Tubes
Condensers	Rectifiers	Tuners
Controls	Resistors	Wrenches
Cartridges	Speakers	

A must for every Service Dealer and Serviceman!

**CONTACT YOUR ZENITH PARTS DISTRIBUTOR
FOR SPECIAL INTRODUCTORY OFFER!**

ZENITH®

*The quality goes in
before the name goes on*

Coverage in depth



with
Centralab



Packaged Circuits

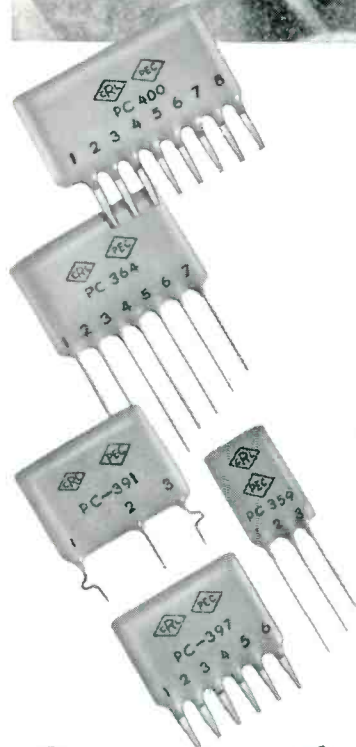

You're in the swim with CENTRALAB 's —the packaged electronic circuits from the first company to dive in and originate, develop, and manufacture them.

With the electronics industry submerged in packaged circuits (well over one hundred million CENTRALAB units are already in the field), you'll have lots of calls for replacement units —and CENTRALAB has them available . . . well over 150 different circuits, with new ones being added all the time.

The new CENTRALAB  Guide #6 tells you how to select, and replace packaged circuits—and it's available free from your distributor or by writing direct to CENTRALAB. Spear yourself a copy right away!

Centralab 

Y-6029

THE ELECTRONICS DIVISION OF GLOBE-UNION INC.
9426 EAST KEEFE AVENUE • MILWAUKEE 1, WISCONSIN
CENTRALAB CANADA LIMITED—AJAX, ONTARIO



The
**Electronic
Scanner**

Promote, promote, promote!

... was the theme of Sylvania's Little Theater musical comedy, "Has Anyone Seen My Profits," staged during the



recent May Parts Show in Chicago. Shown here are two of the Broadway performers who successfully got across the point that you don't have to cut prices to meet competition if you do a good job of promoting your services.

"Cool," Man!

That's the word for the "Cool Deal" assortment of Mallory parts being offered in connection with the company's "Dream Vacation for Two" contest. A variety of popular replacement components come packed in a "Voodoo Cooler," a plastic thermal carrier that can be re-used on picnics, trips, etc. Each package contains an official entry blank for the "Cool Deal" contest, in which the winning serviceman receives a 5-day, all-expense trip to Montego Bay, Jamaica.



So That's How It Works!

Recent "Time-Saving Clinics," which SENCORE has been conducting all over the country during the past two years, were held in Brooklyn and Long Island, N. Y., where over 300 servicemen viewed a 45-minute film and took part in a question-and-answer forum on test equipment. Company executives say the demand for these clinics is such that they are being held almost daily somewhere in the U. S.

Steps to Success

Another milestone was reached during the recent May Parts Show, where South River sold their 50,000th magnesium ladder. The company is the only one marketing this type of ladder through electronic parts distributors for use by antenna installers and servicemen.

Crusade Against Callbacks

Raytheon's new "uniline" tubes, now available in the ten types voted by servicemen as causing the greatest number of callbacks, are backed by a "money-on-the-line" guarantee. In every "Take Ten and See" package is a certificate good for \$1.00, in addition to the regular replacement tube, if any of the 10 fail within the warranty period.

*From Winegard—26 DB gain—
covers TV and FM bands
only \$79.95*



Remarkable New Precision Amplifier A-400

DRIVES 1 to 30 TV SETS

Performance and features never before available—Uses four of the new 6FY5 Neutro-electrode tubes (transconductance 13,000 MHOS). These new tubes have the extreme low noise characteristics of the latest triode RF tuner tubes with extra gain and stability normally obtained only with pentodes. Dual 75 ohm outputs, allows you to use two trunk lines right off amplifier if desired. 300 ohm balanced input with no strip disconnect plug and 75 ohm coaxial input. All parts operated well below maximum ratings for long, trouble-free life. Heavy-duty AC power transformer. Unit completely fused. Operates on 117 volt AC. 20 gauge cadmium luster plated chassis, blue-grey baked enamel, perforated steel cover. \$79.95 list.

Try one, see the difference for yourself. Other amplifiers available for 1 to 4 sets, and up to 150 sets for Master System.

FROM WINEGARD—Get complete components, quality-built advanced Line Taps, Splitters, Couplers, Disconnects, Antennas, everything for complete **MATCHED** top-performance systems. **MADE BY THE ORIGINATORS OF THE WORLD-FAMOUS COLOR'CEPTOR ANTENNA.** Winegard Co., Burlington, Iowa.

Winegard  **ANTENNA SYSTEMS**

Everything from the Antenna to the Set

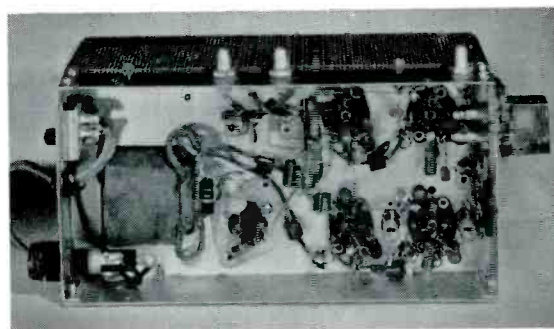

Wired like a Laboratory Instrument

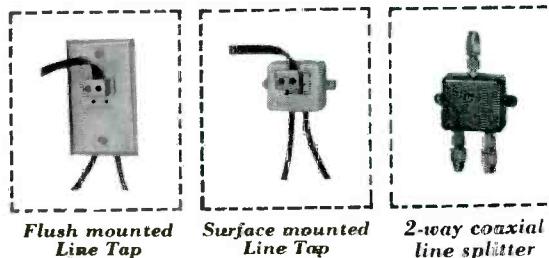

Flush mounted
Line Tap

Surface mounted
Line Tap

2-way coaxial
line splitter

SERVICING THE BIG LOOP

RF

IF

AGC

The tuner, IF strip, and AGC system of a TV set are best treated as a single functional unit for troubleshooting purposes. Defects in any of these circuits can produce almost identical trouble symptoms, and matters are complicated by the feedback loop formed by the AGC circuit. This means the serviceman must take a half-dozen or more stages into consideration when analyzing a service problem involving both picture and sound. The sooner he can localize a malfunction to some specific portion of the RF-IF-AGC loop, the sooner he will find the component causing the trouble.

A defect can often be fairly well localized during the initial home call by careful observation of the TV picture. For example, a handy criterion for analyzing the common "weak picture" symptom is the amount of snow present in the picture background. Snow normally appears when the incoming RF signal is too weak to override electrical noise (which is constantly being picked up on the antenna and is also being generated by the various receiver circuits — especially the mixer). If a faint, snowy picture is obtained in a location where signal strength is known to be adequate, a defective antenna or tuner should be suspected. The plentiful snow is a clue that the IF strip is operating in normal fashion, greatly amplifying the noise produced in the mixer. On the other hand, a weak picture with little or no snow is typically a sign of insufficient gain in the IF strip — or perhaps in the video amplifier.

Although AGC trouble can masquerade as an ordinary RF-IF defect, it often reveals itself by presenting an unusually wide range of symptoms on different channels. A loss of AGC bias voltage sometimes

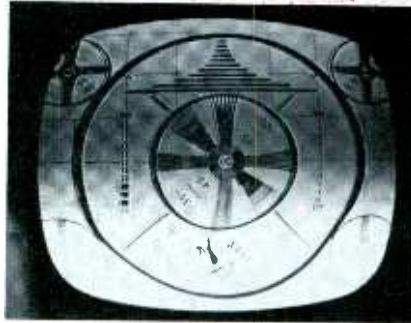

Fig. 1. Hum bars and pulling due to heater-cathode leakage in an IF tube.

results in a situation wherein the observed symptoms are not the same on any two stations. For instance, the strongest available signal might produce a negative-picture effect, while a slightly weaker signal might merely produce excessive contrast and picture bending—and the picture on the weakest channel might display no visible defects.

Unfortunately, the picture doesn't always furnish clear-cut clues to troubles ahead of the video detector, and a bench session is sometimes the only way to solve a particular problem. But, before pulling the chassis, you should check all tubes in the RF-IF-AGC loop by substitution or careful testing. It's best to substitute the tubes all at the same time, rather than changing them one by one; by so doing, you're less likely to run into trouble in cases where there are two or more bad tubes in the tuner or IF strip.

Caution: Check the video ampli-

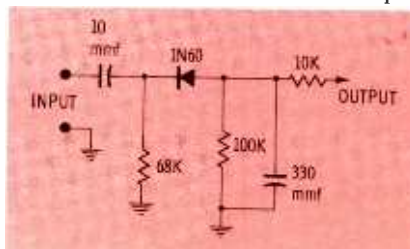

Fig. 2. Circuit diagram of a typical demodulator probe for use with scope.

fier, too! If faulty, it can cause the same picture symptoms as a defective IF amplifier; in some sets, it can also affect sound reproduction. Furthermore, it's a vital part of the AGC feedback loop in most sets equipped with keyed AGC.

Shop Analysis

Let's suppose you have a chassis propped up on your bench, and you suspect RF-IF trouble. If the picture symptoms give you some idea of where to start looking for the defect, go ahead. Otherwise, make a few quick checks to help in localization. See if the output waveform of the video detector is normal, as described in the January, 1960 column. If it is, give the RF-IF circuits a clean bill of health; if not, you can only conclude that the trouble area is still very broad. The problem could be in any circuit ahead of the detector, or could even be a video-amplifier fault affecting the RF-IF stages through an amplified or keyed AGC circuit.

To see if the problem has anything to do with AGC, temporarily "clamp" the AGC line with a negative DC voltage to take the place of the bias regularly applied to the RF-IF stages. If applying a reasonably normal level of bias restores the set to proper operation, immediately turn your attention to the AGC circuit.

IF Strip

This section is generally one of the easiest to service, because of the straightforwardness with which it usually reveals its trouble. The most common fault, of course, is a bad tube—however, several other distinct types of failures can occur. By the time an RF or IF tube deterior-

• Please turn to page 60

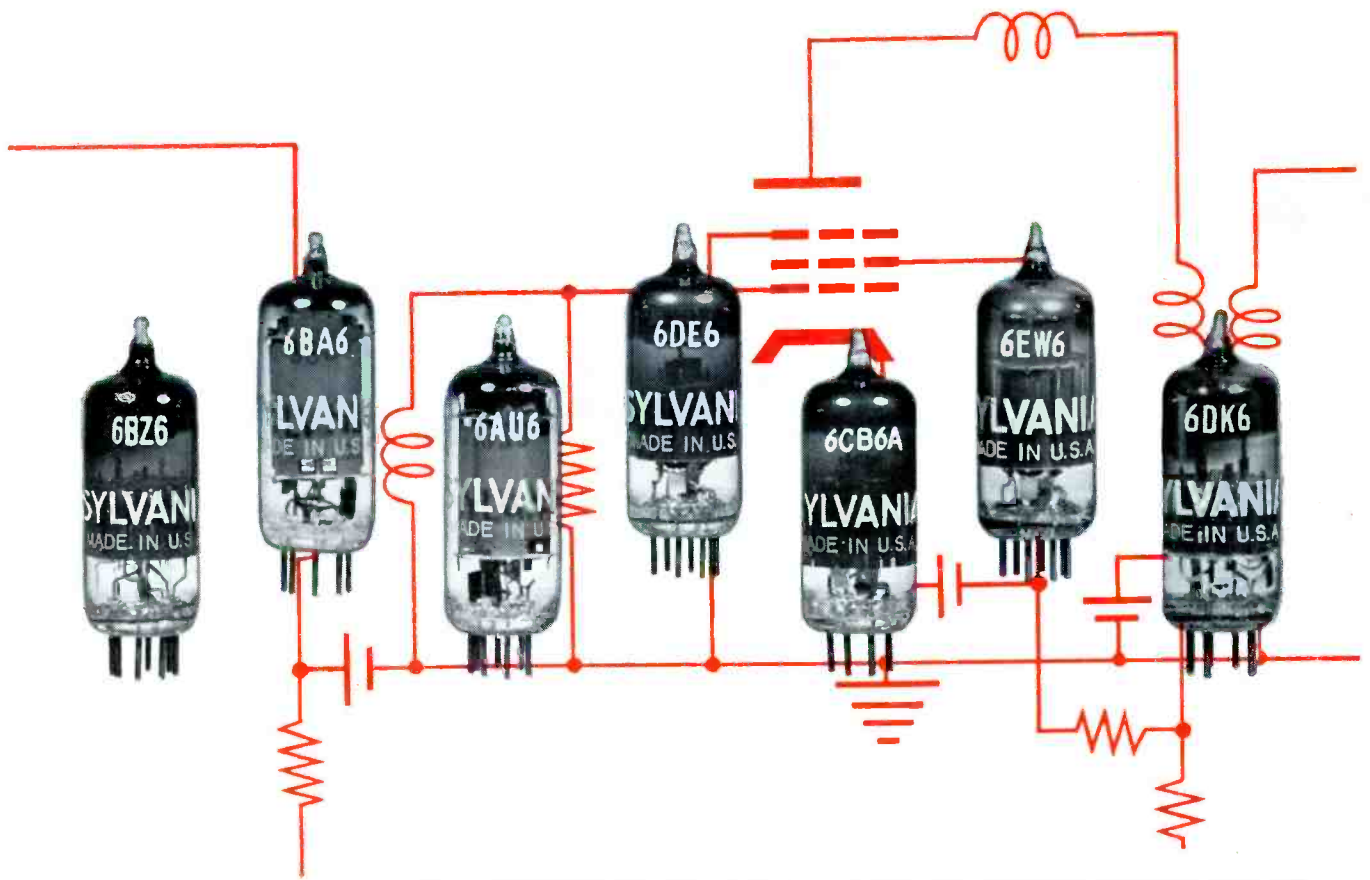

Why are SYLVANIA PENTODES so popular in TV sets?

Why, for example, are they so popular in video-if stages?

Video-if stages are critical with respect to over-all set performance. Must develop sufficient gain to "drive" the picture tube and to give effective agc. Have to deliver "clean" signals, free of hum modulation. When a TV set goes into quantity production, tubes used must be uniform in performance in their specific circuits. Tubes that are sent to the service dealer for that eventual replacement job must be just as good as those supplied to the set manufacturer. Those are some of the reasons why you see SYLVANIA pentodes such as 6BZ6, 6BA6, 6AU6,

6DE6, 6CB6A, 6EW6, 6DK6 in TV set after TV set. They're reliable. And, because of the unique, automated techniques used by SYLVANIA in manufacturing those types, they feature exceptional uniformity from tube to tube, minimum interelectrode leakage and gas, thus a longer life expectancy.

Those are some of the same reasons why, for *original design* and for *replacement*, the popular tubes are SYLVANIA TUBES! Electronic Tubes Division, Sylvania Electric Products Inc., 1740 Broadway, New York 19, N. Y.

SYLVANIA

Subsidiary of **GENERAL TELEPHONE & ELECTRONICS** 

LET'S TALK ANTENNAS

by Les Deane

How to plan an installation to suit the site.

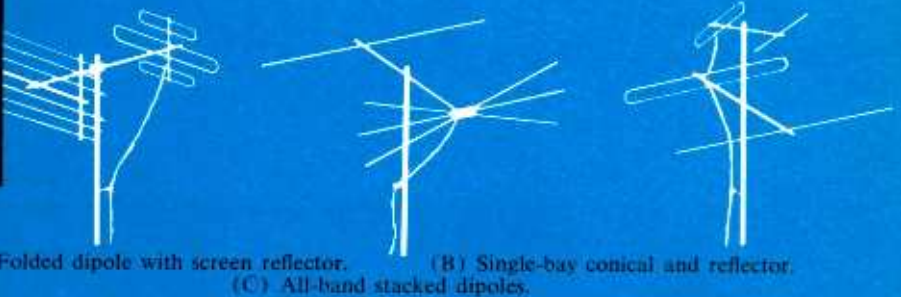

(A) Folded dipole with screen reflector. (B) Single-bay conical and reflector. (C) All-band stacked dipoles.

Fig. 2. Three antenna designs for urban, suburban, and near-fringe zones.

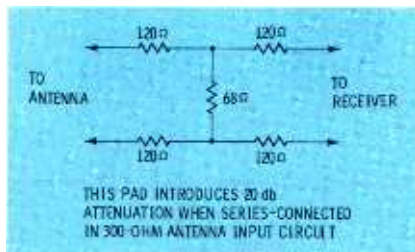

Fig. 1. Pad for attenuating signal from outdoor antenna in urban location.

Pic-N-Win!

Pick the right antenna and win customer satisfaction—the one goal we must all strive for in order to maintain a successful business. In gaining a reputation for quality antenna work, you'll find there's more to an installation than just sticking some metal rods up in the air and facing them in a certain direction. Input signal power is as important to the operation of a TV receiver as AC line power. Therefore, your first concern should be that of selecting the proper antenna for a particular job—even before troubling yourself with the steepness of the customer's roof!

The following discussion will give you an over-all picture of the various points to consider when choosing an antenna for best reception of VHF signals. It is a practical treat-

ment, purposely omitting mathematical formulas, response lobes, and complex charts dealing with wave propagation and db figures.

The Urban Site

The outdoor antenna is far from becoming obsolete even in metropolitan areas; quite the contrary, in fact, for investigations show that reception can be improved considerably in many urban areas with the installation of a suitable outdoor (or attic) antenna. Of course, signal strength is generally abundant in these localities; therefore, high-gain antenna systems are not normally called for.

Since rabbit ears and other types of indoor antennas usually work reasonably well at these sites (especially when only one or two local stations are involved), outdoor installations will be confined mainly to certain problem areas troubled by interference or ghost reflections. In many cases, an inexpensive dipole cut for a single channel and positioned in a certain manner will do the trick. In other instances, you may eliminate a ghost condition but find that other local signals cause overloading. Here, it may be necessary to attenuate the input signal to the tuner by employing a series resistive pad on the order of the one shown in Fig. 1.

If ghosts or other interfering signals are being picked up from a different direction than the desired signal, you might try installing a dipole antenna with a screen reflector as pictured in Fig. 2A. This design has an excellent front-to-back ratio and will lock out practically everything trying to sneak in

the back door. Of course, if there are two or more stations in the area, and their signals arrive from different directions, a rotator may also be called for.

Ghosts reflected from tall buildings and the like can sometimes develop more signal strength at the receiver location than the primary or direct signal. Although ghost images normally have less contrast than the desired image, and appear to the right of it, an unusually strong ghost may produce a darker image than the direct signal. In this case, the latter will look like a weak image displaced to the left (see Fig. 3). Proper orientation of the antenna will usually cure this ailment; nevertheless, you may find it more desirable at times to "home in" on the ghost instead of the direct signal-transmission path. In so doing, however, you are taking a chance on the reflected signal strength remaining relatively constant — and this is usually not the case.

In urban areas having two or more local channels, you will often run into difficulty when using a directional or single-channel type of antenna. This trouble is most likely to arise when the transmitting towers are in different directions

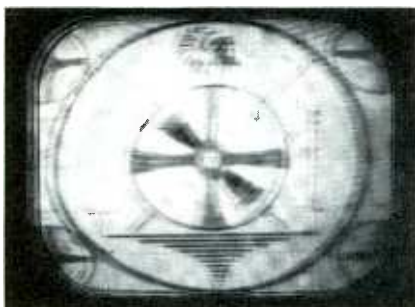

Fig. 3. Ghosts produced by strong reflected signal reaching the antenna.



Fig. 5. "Herringbone" patterns usually indicate adjacent-channel interference.



(A) Single-channel Yagi.



(B) Vee antenna (angled dipole).

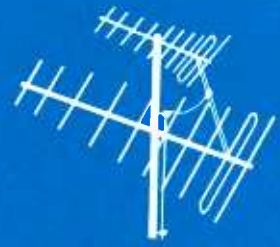

(C) All-band stacked Yagis.

Fig. 4. Three basic arrays often used in fringe and deep-fringe locations.

from the receiver, or when the stations are on widely separated channels. With gain of no prime importance, a multidirectional all-channel antenna such as the one illustrated in Fig. 2B is very popular. Many variations of this basic conical design are now commercially available.

If you prefer to use a dipole configuration for all-channel reception, a system such as that pictured in Fig. 2C is one solution. This is basically a stacked assembly with a high-band VHF element at the top, matched to a low-band section below. The two separate antennas may be connected with a phasing harness and faced in different directions in order to cover a wide angle of reception.

Regardless of the number of active TV stations in a large city, there will still be a surprising number of set owners who want that extra channel from a station as far as 60 to 80 miles away. In this situation, the serviceman must come up with a versatile system calling for high gain and directivity on one hand and a nondirectional all-band design on the other. This will most often demand the use of either a stacked and matched array or two

separate antennas with a switching arrangement. If an indoor type seems adequate for all local stations, the simplest solution is to install a high-gain directional outdoor type and an indoor unit with, of course, an antenna-selector switch. A narrow-band single-channel antenna is about the best choice for the outdoor unit (see Figs. 4A and 4B); some installations, on the other hand, may call for a high-gain, all-channel antenna designed for fringe-area service.

Although not readily apparent, the scene displayed on the TV screen in Fig. 5 is an airplane in flight over a metropolitan area. The distortion present is due to a "herringbone" pattern superimposed over the entire picture. This beat-frequency interference is generally produced by a signal from an adjacent channel; for example, if the sound carrier of the next lower channel is strong enough, it will heterodyne with the video carrier of the desired channel and will produce a pattern of lines on the screen.

This symptom might occur if the viewer were attempting to watch a distant station on a channel adjacent to one of the stronger local stations. If orientation of a unidirectional-type antenna won't clear up this condition, the next best bet is to install either an adjustable trap between the lead-in and the antenna terminals on the set or a frequency-selective device that mounts between antenna and down-lead.

After only a few installations where you have taken the time to analyze signal conditions and select the right antenna, you should know approximately what it's going to

take to satisfy all customers in an urban community—even in those touchy problem areas.

The Suburban Site

We might define "suburban" as being a near-fringe location approximately 20 to 40 miles from the transmitter, although the great variety in terrain over the country makes it impractical to place a strict distance limitation on this type of reception area.

With only one station to consider at a suburban site, it would be advisable to select a directional single-channel antenna with reasonable gain. The 5- to 10-element Yagi type (Fig. 4A) fills this bill very nicely. With two or more stations in one general direction, the antenna should take on more of a broadband design (incorporating extra elements cut for multichannel reception). Incidentally, the basic types shown in Fig. 2 will also work satisfactorily in many suburban areas.

When picking up stations from different directions at a suburban location, you must use either a system with a broad angle of reception or a more directional antenna with a rotator. If no interference is

• Please turn to page 56



Fig. 6. White and black dashes across screen caused by ignition interference.

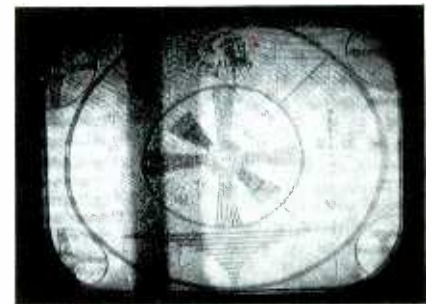

Fig. 7. Co-channel interference resulting from reception of two signals.

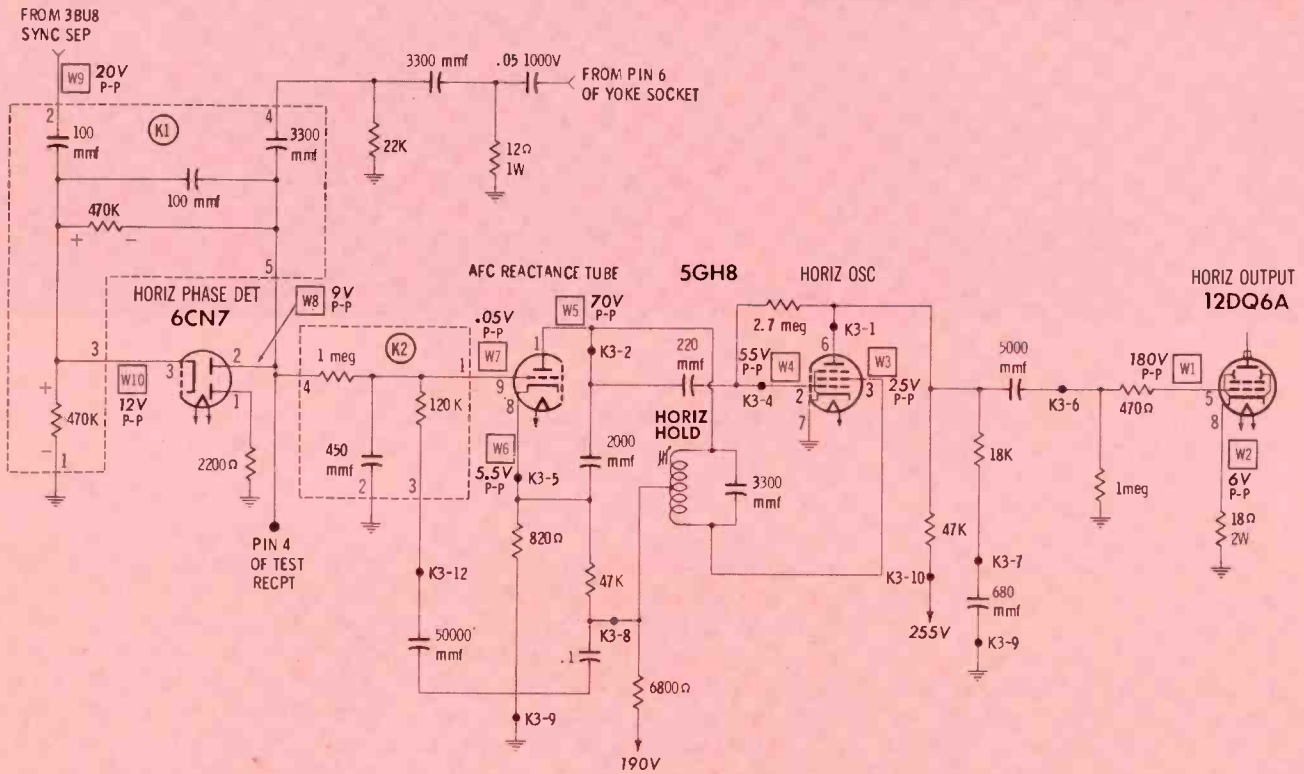

Fig. 1. Horizontal oscillator and frequency-control circuits of Motorola Chassis TS-567.

another sine-wave

Most TV receivers use either a cathode-coupled multivibrator or a *Synchroguide* blocking oscillator in the horizontal sweep section, and the serviceman is able to develop well-practiced troubleshooting procedures for these circuits through frequent encounters with them. However, when a set with a lesser-known type of horizontal circuit shows up on his bench, he's likely to be thrown for a loss. How can he do an efficient job of curing a fault in the circuit, if he's not even sure how it should normally behave? The usual tube-pin voltage readings and

key waveform checks are adequate for pinpointing severe troubles such as a completely dead oscillator — but they're of only limited usefulness when the oscillator just seems abnormally critical or unstable in its operation. In these more uncertain cases, it is helpful to be familiar with such things as the normal range of the hold control, the permissible tolerances on voltage readings, and the circuit functions of various components.

To provide some pertinent facts about nonstandard horizontal AFC-oscillator circuits, two recently-in-

troduced types have been described in this column. (See "The Gruen Circuit Goes Modern" in the July, 1959 issue, and "A Streamlined *Synchroguide*" in November, 1959.) This month's story will introduce you to still another system in current production — a Motorola circuit employing a sine-wave Hartley oscillator controlled by a reactance tube and phase detector. This hookup (Fig. 1) has a lot in common with the Zenith circuit we described last July, and yet it has plenty of distinctive features all its own.

The schematic shows the circuit

as used in Chassis TS-567 of the 1961 line. A very similar setup was employed last season in the TS-556 chassis, and a modified version of the same circuit (with semiconductor diodes in place of the 6CN7 tube) is also being used in the TS-433 series of slim 17" portables.

Basically, the sine-wave horizontal oscillator is nothing new; this design feature was in fairly wide use about 10 years ago! However, since the early versions of this circuit were relatively complex, they were almost completely abandoned during the middle 1950's in favor of multivibrators. Now, in revised and simplified form, they are staging a comeback.

Puzzle: How is it possible to use a sine-wave generator to supply a sawtooth-shaped driving signal to the horizontal output tube? The answer is simple if you're familiar with basic sweep theory. In any deflection circuit, the sawtooth wave is not generated by the oscillator itself, but is developed by the linear charging of a capacitor in a sawtooth-forming RC network. (Note the 680-mmf capacitor and associated resistors in the oscillator-plate circuit of Fig. 1.) The oscillator, regardless of type, always operates as a simple

on-off switch — conducting heavily for a small portion of each cycle in order to discharge the sawtooth-forming capacitor, but remaining in cutoff the rest of the time.

A Hartley oscillator is able to perform this switching function, since it operates class C and will conduct only for a short time on positive peaks of the sinusoidal grid signal. There's only one catch: If the sawtooth-forming circuit is connected directly to the oscillator plate, a husky sawtooth signal will appear there. The resulting fluctuations in plate voltage could interfere with proper operation of the oscillator. To avoid this problem, the old-time sine-wave circuits had an extra stage (called a discharge tube) to act as a sort of buffer between the oscillator and output circuits. Here is where simplification has entered the picture. The discharge tube has been omitted, and the plate current of the oscillator tube is utilized directly for discharging the sawtooth capacitor. However, a pentode-type oscillator tube is used in order to minimize interaction between the plate circuit and the oscillator proper. (The latter includes only the cathode, grid, and screen circuits.)

The waveforms in Fig. 2 reveal what goes on in the circuit of Fig. 1 during normal operation. All were taken with a low-capacitance probe, and external sync was applied to the scope to maintain a constant phase relationship among all the waveforms. (The necessary synchronizing signal was obtained by attaching a clip lead to the insulation of one of the horizontal yoke leads.) The right edge of each pattern represents the beginning of horizontal retrace, and the short white bar above the middle of each waveform indicates the conduction period of the oscillator tube. Note that the beginning and end of conduction are marked by distinct pips or rough spots in many of the waveforms; this can help you in analyzing the signals.

Let's begin by examining the horizontal drive signal W1 at the grid of the output tube. The unusually wide, flat-bottomed negative pulse in this waveform is a normal characteristic of the sine-wave type of horizontal circuit, even though it may look strange in comparison with the narrower, sharper-pointed pulse we are accustomed to finding in multivibrator circuits. It looks as if the rise in grid voltage is *anything but*

• Please turn to page 65

horizontal oscillator

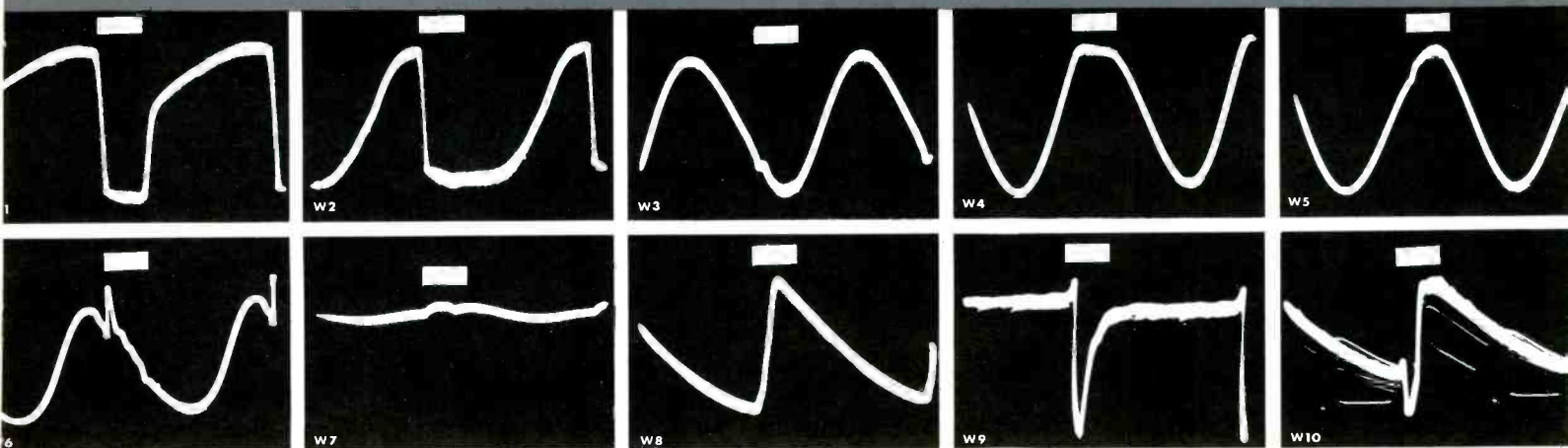
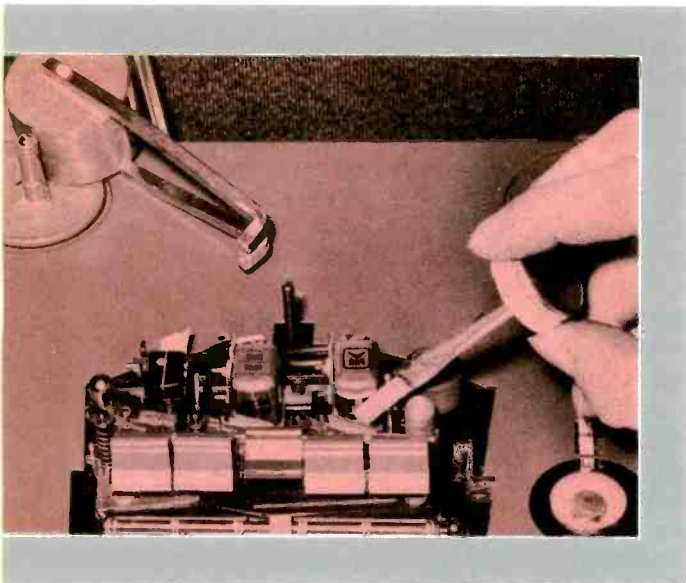
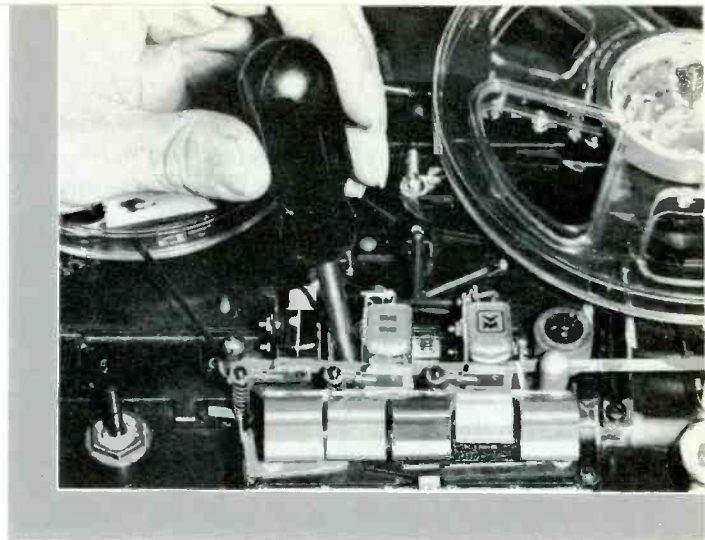

Fig. 2. Waveforms for Fig. 1. White bar above each trace indicates conduction period of oscillator.



Head cleaning and demagnetization, the top-ranking service requirements, should become a part of every service job. Repeated use of the recorder causes the oxide coating from the tape to rub off on the heads, reducing sensitivity and affecting both recording and playback quality. A cloth or brush dampened with denatured alcohol or a special tape cleaner can be used to quickly remove this oxide. Residual magnetism in a head—which increases background noise in recordings and reduces over-all frequency response—can be removed with a special demagnetizer such as the unit shown at top left in the photo.



Height and azimuth adjustments are important factors in these days of four-track stereo reproduction. Improper height produces cross talk between tracks, while an azimuth error (head-magnet gap not precisely at right angles to direction of tape travel) causes a loss of high-frequency response. The photo shows azimuth being adjusted for maximum output during the playing of a special tape.

REGULAR RECORDER-

Tape recorders are on the move. From all indications, 1960 sales will top a half-million units. Someone is going to have to service these units, in addition to the hundreds of thousands already in the field—and it might as well be you!

In our May issue we gave you the low-down on the mechanical operation of recorders; in this article we present photos to show you the whys and wherefores of the most common service requirements. The following general hints will make it much easier for you to follow the specific procedures outlined in service manuals.

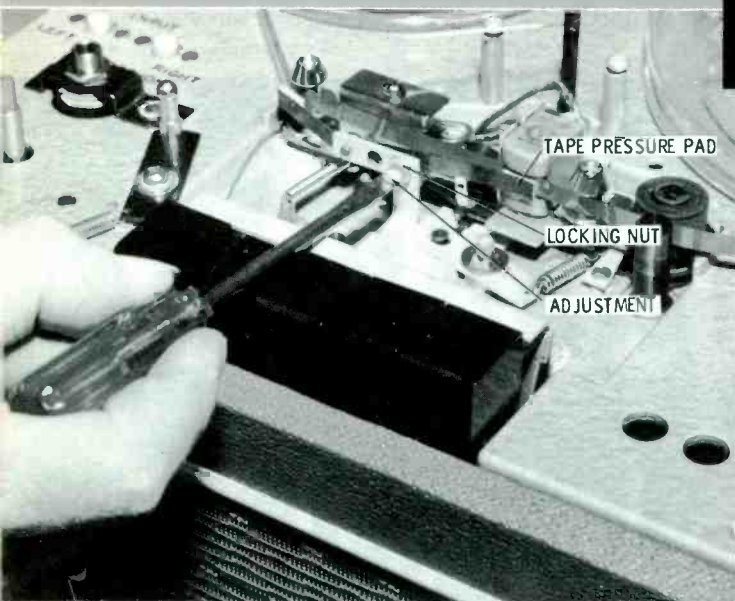

Pressure pads hold the tape in firm, flat contact with the heads. Excessive pressure increases tape wear and oxide deposit, while too little pressure causes weak output. Pads are usually tensioned to a pressure of about 15 grams (measured with a small hand scale) and can be adjusted by turning a screw or bending the supporting arm.

Most recorders use an electromagnetic erase head, fed from a bias oscillator, to "clear the track" just before recording. However, as shown here, a permanent magnet is sometimes used for this purpose. Improper height adjustment of either device fails to remove pre-recorded information from the desired track, and may erase part of an adjacent track. In this unit, the guide post is adjusted to vary the position of the tape as it passes across the magnet.

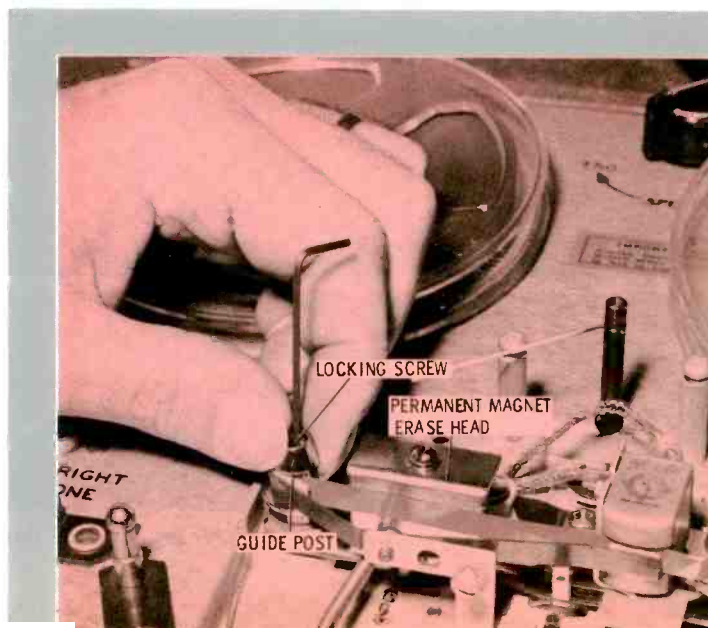

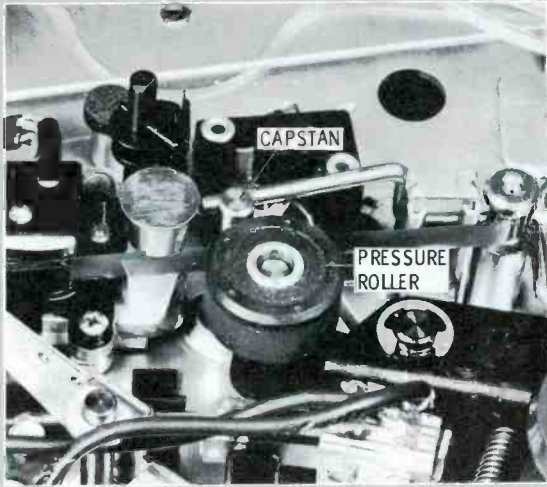

Unless the pressure roller is adjusted to exert from two to four pounds of pressure against the capstan, the tape may move at an incorrect or irregular speed. Clean surfaces and straight shafts are also necessary for proper operation. Here the keeper has been removed from the roller, the latter raised slightly, and the unit energized to see if the roller stays on its shaft. If it works off, this means the shaft is bent and the tape is likely to crawl out from between the roller and capstan. To cure this condition, the shaft must be carefully bent back to an upright position.

Take-up and rewind torque are easily checked by using small hand-held scales to make measurements at some specific distance from the hub. Improper torque results in spilled tape or improper operation during rapid tape transport. Some units have adjustments, but in others, torque is a matter of drive-surface cleanliness and quality of belts, discs, etc.

REPAIR ROUTINES

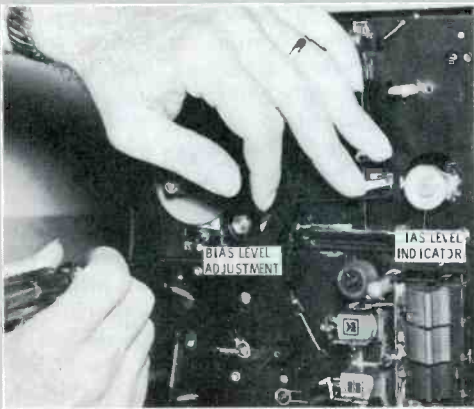
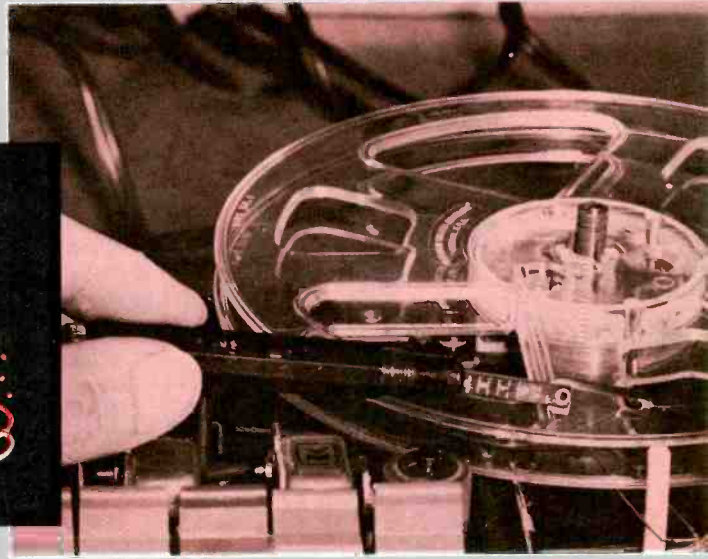

Precise adjustment and diligent observance of recording-level indicators is a basic prerequisite for good recording. The photo shows a recording-level eye being adjusted in accordance with service data. Bias adjustments are equally critical, and must be set exactly as recommended. Because these adjustments are sometimes accessible to the customer, both should be checked during service.

Improper braking can result in spilled or broken tape, incorrect tape speed, and a host of other troubles. In this photo, the brake is being adjusted in accordance with the instructions given in the service manual. You'll have to depend on service data to tell you about this adjustment, since it differs from one recorder to another. Other important factors in proper braking are cleanliness of brake shoes and the surfaces they contact, as well as freely operating linkages.

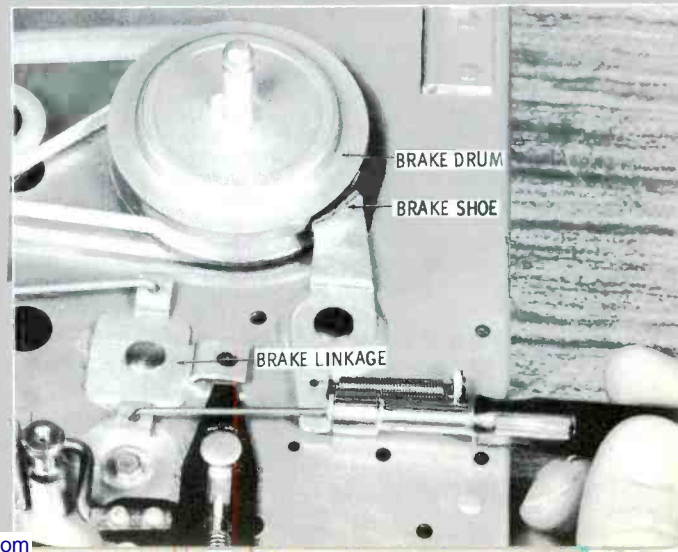

MORE PROFIT

per call... satisfaction for all!

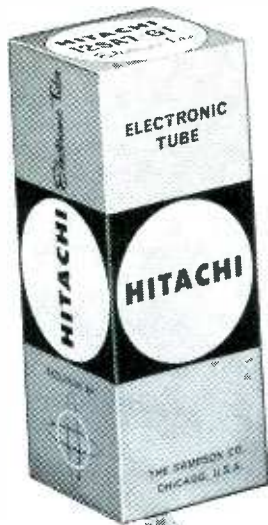

SELL—SERVICE—SATISFY

RECEIVING TUBES

MADE BY
GRAND PRIX AWARD-WINNING

HITACHI



Choice as original equipment by
manufacturers in the U. S. & abroad

From all points come good words about Hitachi tubes produced by one of the world's largest manufacturers — Hitachi, Ltd., Tokyo, Japan. Tubes that can't be beat for performance and reliability. Most popular types are available . . . each made with strict quality-control to fully meet top American standards. Yet important cost savings guarantee you extra profits. And distribution is on a localized prompt-delivery basis.

THE SAMPSON COMPANY

ELECTRONICS DIVISION, 2244 S. Western Ave., Chicago 8, Ill.

See your HITACHI Distributor
—or write for CATALOG 558-R

A COMPLETE LINE
OF QUALITY ELECTRONIC
COMPONENTS



Keep it Clean. Summer sunshine is going to be hard on window displays. In addition, displays must be bright, well-organized, and clean to attract attention away from summer daydreams, and toward the fleeting message your window brings.

Dirty windows, faded displays, bug-covered items, and a generally deteriorated window decoration may simply fail to attract attention; even if people do take notice, their impressions will be favorable only to your competitors. Make it a point to change your displays often, clean them once or twice a week, and really keep them attractive.

\$ & ¢

Half Gone. Well, 1960 is half-way through. What have you done with it — or what has it done to you?

It's time to get some factual information on what's happening to your business. It may not be the most enjoyable thing to do, but it's a definite *must* if we want to succeed. There are many who run their business "by the seat of their pants," guessing this year's progress, sales, work load, and even profit on what they *think*. No business was ever permanently successful with this type of management. True, some businesses *exist* over a period of years with this haphazard direction, but they never gain a status of soundness.

What does your balance sheet look like when compared to the one at the beginning of the year? (For those of you who can't compare the two because you don't have the first one — *make* one and see where you stand now.) How does *Net Worth* June 30, 1960 compare to that of January 1, 1960? A quick glance at these two figures gives you a good mid-year report on your progress. If you don't show a nice increase, what is the reason? One of the most likely is the item of *Profit* January 1 to June 30. If this appears low, find out why.

Going back to your profit-and-

loss statement will point out where the lowered profit originated. What has been your total *Sales* for the year to date (the amount of business including income and additional accounts receivable)? Does it reflect a healthy level? (If possible, compare it with the past few years.) If the level is below normal expectations, it's time to survey your advertising and merchandising program.

Perhaps inventory has crept up. If so, see if the increase has come from seasonable items such as batteries, TV installation supplies, etc. An increase because of such items as these is to be expected, but if the increase is from normal stock items, it would be wise to look into your purchasing practices. Don't forget that it's possible for purchasing costs to go up without increasing the volume. Failure to take advantage of the discounts allowed for prompt payment to suppliers can make a sizeable figure over a six-month period.

Wages, taxes, and normal overhead expenses all hold important clues in analyzing what happened to profits. Perhaps that raise you gave yourself is eating into the profits. Knowing your reluctance to take a pay cut, it may be desirable to re-evaluate your sales income to see if it can't be increased to compensate for the raise.

While a six-month review of your records will tell you how you're doing and help you make future plans, a monthly analysis will permit you to keep a tighter rein on the business. Here's hoping your review speaks well of itself in this first half-year of "the surging sixties."

\$ & ¢

Off to School. Just a reminder that now is the time to lay the groundwork for August promotions keyed to those young folks headed for college this fall.

A few advance thoughts about clock radios, personal portables with earphones, pillow speakers, and car radios can jell into a well-planned merchandising program for you.

NUMBER 4 IN A SERIES OF **CDE** 50th ANNIVERSARY SPECIALS!

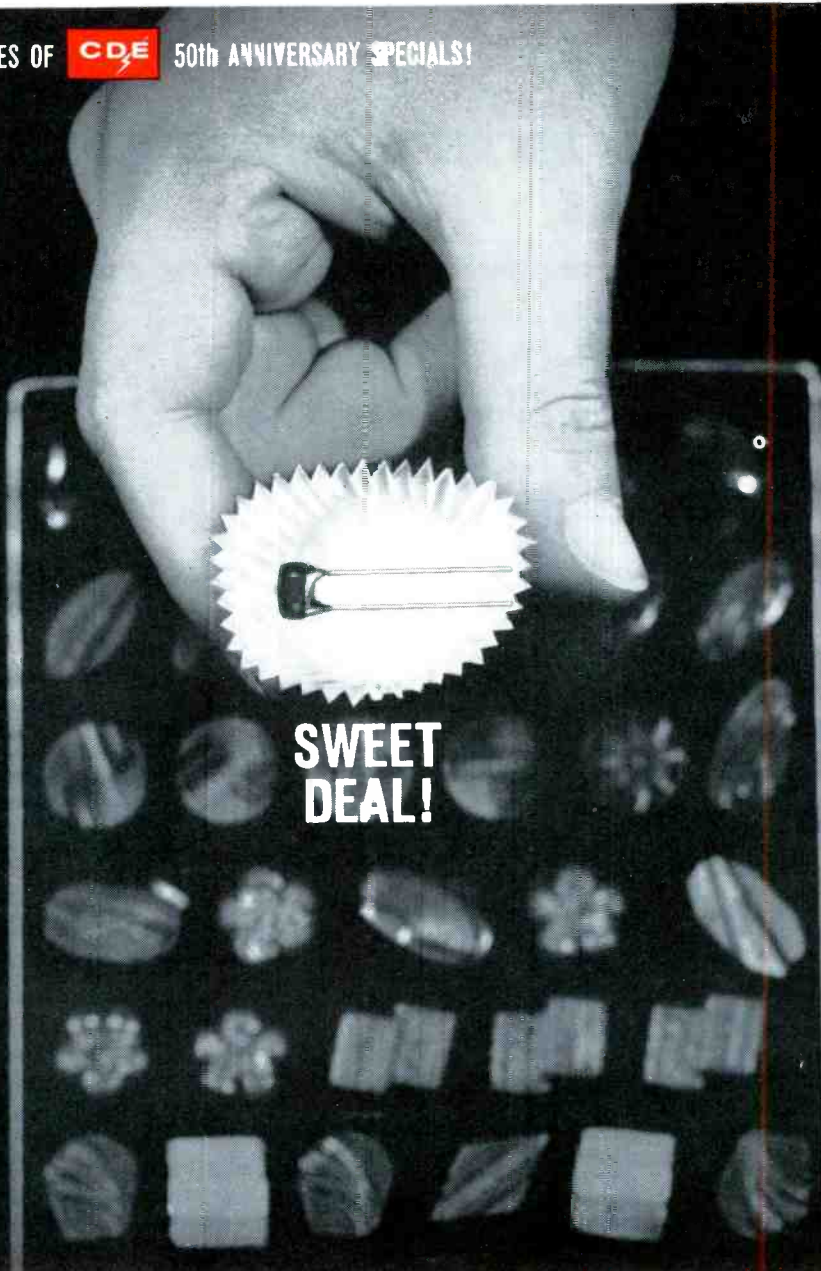

**SWEET
DEAL!**

CDE'S NEW MINIATURIZED DIPPED MICAS

Here's a SWEET DEAL from CDE to add dollars to your bank account and time to your crowded day. CDE dipped silver micas save you dollars because they cost less. They perform as well as the best molded silver micas at a fraction of the price; and they STAY dependable too, because their rock-hard phenolic coating effectively seals out humidity.

YOU GET . . .

... ALL 500V. 5%	Five CD15-5T22 220 mmfd.
Five CD15-5Q56 56 mmfd.	Five CD15-5T33 330 mmfd.
Five CD15-5Q82 82 mmfd.	Five CD15-5T39 390 mmfd.
Five CD15-5T1 100 mmfd.	Five CD15-5T47 470 mmfd.
Five CD15-5T18 180 mmfd.	Five CD19-5T68 680 mmfd.

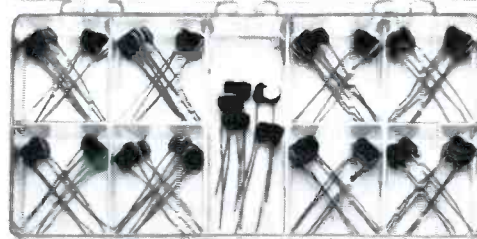

CDE dipped micas save you time because they're TINY. They'll slip into a tight chassis or crowded printed board with ease. They replace ANY mica or ceramic capacitor—and you get all 45 of these 500V., 5%, dipped micas, in a convenient clear plastic box, for only \$10.20. Call or write your distributor. CDE *Distributor Division, South Plainfield, N. J.*



CORNELL-DUBILIER ELECTRONICS DIVISION
Federal Pacific Electric Company

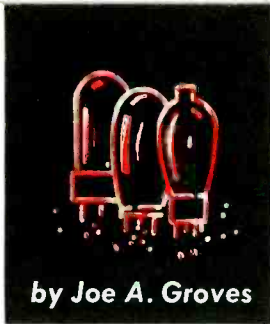

RADIO and HI-FI TUBE GUIDE

A survey of tube types you'll find in equipment now in service.

If you have never operated a radio or hi-fi service department in conjunction with your TV service, and you're thinking of starting one, what tubes should you stock? Or, if you have collected a miscellaneous stock of radio tubes over the years, and have decided to clear your shelves of all slow-moving types, what will be left? The answers to these questions will vary from one area to another, and will depend on the type of service to be rendered, as well as on the expected volume of business. To help you anticipate your stock requirements, we offer this brief resume of tube use in the radio and audio fields over the past two decades.

To begin with, let's take the simple 5-tube AC-DC receiver. These series-string units first came out in the early 40's, and were equipped with tubes having filament characteristics different from the more popular tubes of the day. The tube line-up consisting of a 12SA7, 12SK7, 12SQ7, 35- or 50L6, and 35Z5 became the standard for millions of receivers. A 14-volt series of loctal-base tubes competed, but were never as successful as the 12-volt line.

In the early 50's there was a transition to the 7-pin miniature series of 12BE6, 12BA6, 12AT6 (or 12AV6), 35- or 50C5, and 35W4. Tens of thousands of sets using these tubes were produced, resulting in a standardization of this line-up among practically all manufacturers. A four-tube circuit—employing a 12AU6 to replace both the 12BE6 and 12BA6—kindled a little fire, but never really caught on.

Now, at the beginning of the 60's, these standard 7-pin miniature tubes still constitute the big volume of radio tubes used in new set production. However,

another new series with lower filament current has been developed and is now making its appearance. (Initial types in the new group are the 18FX6, 18FW6, 18FY6, 32ET5, and 36AM3.) It will be some time before these tubes replace today's standards, but they're on their way.

During the past 20 years, transformer-powered home radios and auto receivers used basically the same tubes as their AC-DC counterparts, except for differences in filament voltage. However, notable exceptions were to be found in the tubes used in audio output and rectifier circuits. Output stages concentrated on 6V6's, with a smattering of 6L6's and 6K6's. From the mid-50's on, the 6AQ5 came to be the most common output tube in these sets. Rectifier usage centered around 5Y3's in home receivers. Some auto radios used an 0Z4; others a 6X5 (later replaced by the 6- and 12X4 miniatures).

The middle 50's saw the auto industry switch over to a 12-volt electrical system, with a consequent shift from 6- to 12-volt tube filaments. At nearly the same time, a new type of auto receiver appeared and was tabbed "hybrid." The audio output stage was transistorized, and tubes were designed to operate from a 12-volt B+ supply (directly from the car's electrical system). The new series of hybrid tubes hasn't yet become standardized, due to continual design improvements; the only tube approaching "universal" use is the 12AD6 converter.

FM and combination AM-FM receivers were developed during the 50's, and are now attaining an appreciable portion of the market. Most tube types used in these sets are also found in conventional AM or TV receivers. A couple

of exceptions must be noted, however—namely, the 19T8 and 6BJ6 types.

It can truly be said that portable radios began to make their mark in the 50's. Although a few had been introduced prior to that time, sales didn't reach major proportions until some time in the mid-50's. By that time, the tubes used had passed through designs using octal, loctal, miniature, and hearing-aid types. Miniatures account for the greatest percentage of tubes used during this period. A nearly standard circuit using the 1R5, 1S5, 1T4, and 3V4 evolved, although 1U4's, 1U5's, and 3Q4's still had a fair popularity when the whole tube concept was virtually dropped in favor of transistors. It's interesting to note that, by the end of 1959, weekly production of portables was running nearly 80,000 transistor sets as compared to less than 200 tubed units.

The hi-fi boom came along in the late 50's, featuring units ranging from so-called "hi-fi" chassis using only a 25L6 tube to sets with true high-fidelity circuitry. In current production, 12AX7 (ECC83), 6BQ5 (EL84), and 7025 tubes are probably the predominant ones not used in regular radios. It must be noted, however, there are several other types used in varying quantities—many of them brand-new designs that may largely replace existing types within a few years.

Now that you have a pretty good idea of when the various types of radio and hi-fi tubes were introduced and how they are used, take a close look at the chart on this page. Listing 77 common tube types used within the past 20 years, it will serve as a handy guide in meeting your service needs.

Radio and Hi-Fi Tube Usage Chart

*0Z4	6AQ8 (ECC85)	6EZ8	*12AD6	12BE6	32ET5
†1R5	6AT6	6L6	*12AE6	12BH7	35C5
†1S5	6AU6	6SA7	*12AF6	*12BL6	35L6
†1T4	6AV6	6SK7	*12AJ6	*12DL8	35W4
†1U4	6BA6	6SN7	*12AL8	*12EG6	35Z5
†1U5	6BE6	6SQ7	*12AQ5	12SA7	36AM3
†3Q4	6BJ6	6T8	12AT6	12SK7	50C5
†3V4	6BK5	6U8	▲12AT7 (ECC81)	12SQ7	50EH5
5AR4 (GZ34)	▲6BQ5 (EL84)	▲6V4 (EZ80)	12AU6	18FW6	50L6
5U4	6CA4 (EZ81)	6V6	▲12AU7 (ECC82)	18FX6	▲6267 (EF86)
5Y3	▲6CA7 (EL34)	*6X4	12AV6	18FY6	▲7025
6AL5	6CB6	*6X5	▲12AX7 (ECC83)	19T8	▲7199
6AQ5	*6CR6	*12AB5	12BA6	25L6	

* predominantly used in auto radios

† predominantly used in portable radios

▲ predominantly used in hi-fi equipment



Leading set manufacturers RATE CBS RECEIVING TUBES TOPS

... IN VENDOR RATINGS
Set Manufacturer X — 30 Tube Types

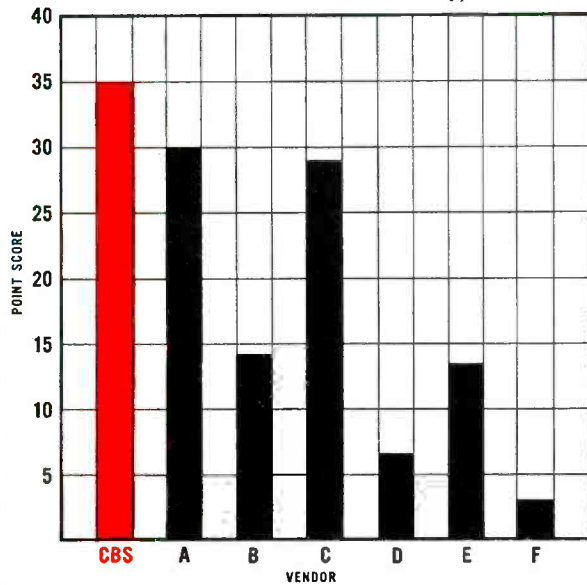

... IN LOTS ACCEPTED
Set Manufacturer Z

Tube Type	Lots Received	Lots Accepted	Lots Rejected	Rating*
A	5	5	0	Preferred
B	2	2	0	Preferred
C	1	1	0	Preferred
D	10	10	0	Preferred
E	3	3	0	Preferred
F	4	4	0	Preferred
G	1	1	0	Preferred
H	6	5	1	Fair
I	5	5	0	Preferred
J	2	2	0	Preferred
K	1	1	0	Preferred
L	7	7	0	Preferred
M	1	1	0	Preferred
N	4	4	0	Preferred
O	1	1	0	Preferred
P	12	12	0	Preferred
Total	65	64	1	

*Ratings: Preferred, Excellent, Good, Fair, Poor, Unsatisfactory

... IN LOWEST FIELD REJECTS
Set Manufacturer Z

Tube Type	Per Cent Rejects	
	All Venders	CBS
1	.7	.3
2	.8	0
3	.9	1.0
4	.5	.5
5	.8	.3
6	1.6	1.1
7	.4	.1
8	.8	.8
9	.5	.5
10	1.7	.8

... IN LOWEST LINE REJECTS
Set Manufacturer Y

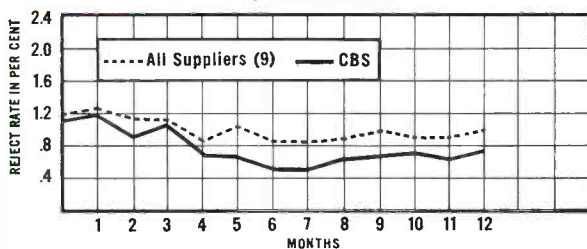

**TOTAL RELIABILITY . . .
proved in performance**



Receiving, industrial and picture tubes • transistors
and diodes • audio components • and phonographs

Yes, CBS receiving tubes are rated tops by leading TV and radio set manufacturers. Any way you want to look at it — vendor ratings . . . lots accepted . . . lowest line rejects . . . lowest field rejects — during 1959 these facts as reported by leading set manufacturers proved CBS tubes superior. This same total reliability . . . continually proved *in performance* by set manufacturers can be yours for the asking. Just ask for CBS tubes . . . always.

CBS ELECTRONICS

Danvers, Massachusetts

A Division of Columbia Broadcasting System, Inc.

troubleshooting COLOR SYNC

Tips for turning a fuzzy rainbow back into a normal color picture.

"Look, Mom! See the rainbow on the screen!"

And with these words, another color-TV owner finds out that her set has lost color sync. While the rainbow may be pretty, it's a sure bet this customer would rather see color programs—so there's a pot of gold at the end of this rainbow for the serviceman who knows what to do about it.

Isolating the Trouble

By the time the technician arrives

on the scene to begin troubleshooting, the color program may be over; but one or more stations may be transmitting a color-stripe test signal as an aid in setting up color receivers. This consists of several cycles of 3.58-mc subcarrier oscillation injected into the video signal just before and after each horizontal blanking period. The test signal has the same phase as the color-burst signal; therefore, if applied to a normally-operating color set, it will produce narrow bands of uni-

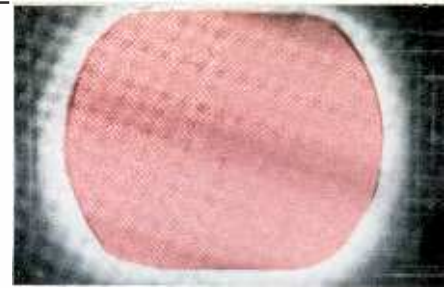

Fig. 1. Color-sync loss reduces rainbow-generator pattern to slanting lines.

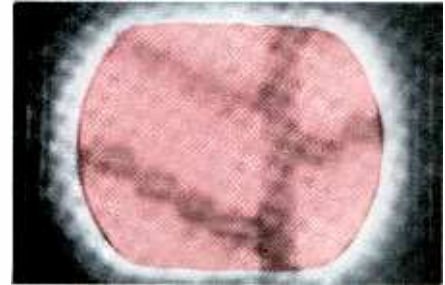

Fig. 2. Jagged splottes in NTSC bar pattern mean color sync is absent.

form greenish-yellow color along the side borders of the picture. Shifting streaks of various hues indicate a loss of color sync.

If the stripe signal isn't immediately seen, it may be off the edge of the screen because of horizontal overscan. In this case, one of the two test stripes can often be brought into view by carefully tuning the horizontal hold control to shift the raster sidewise.

In order to check color sync when no transmitted color signals are available, it is necessary to connect some type of color-signal generator to the receiver. Fig. 1 shows the completely out-of-sync pattern that appears on the screen when the output of a color simulator or rainbow generator is fed to a set with faulty color sync; Fig. 2 is the pattern developed under the same conditions from the output of a standard NTSC color-bar generator. Notice that the latter display still contains a bar pattern, even though the colors have been scrambled into a stair-step design.

Loss of color sync can be caused by many things. If reception of a regular black-and-white image gives no evidence of snow or any other abnormality, it can be presumed the trouble exists somewhere in the color sync section (Fig. 3). The prime cause is tube failure; therefore, substitution of V18, V19, and V20 is the first order of business. If new tubes don't eliminate the shifting-color symptom, a logical troubleshooting sequence must then be followed in order to find any

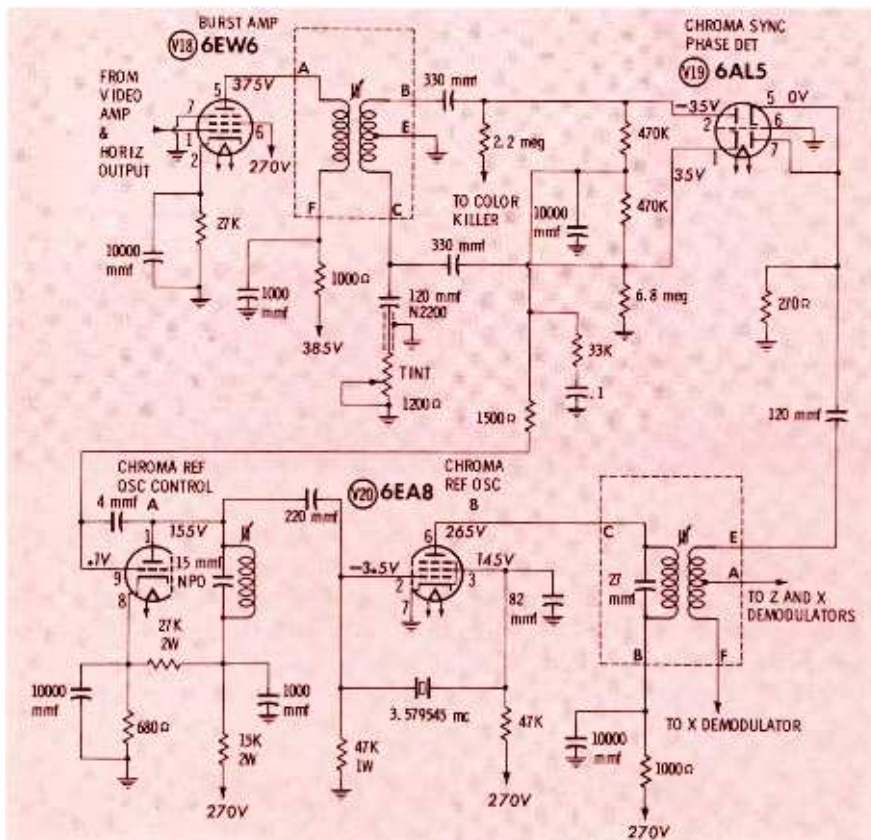
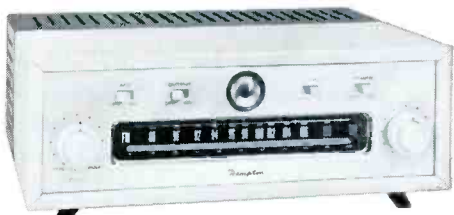
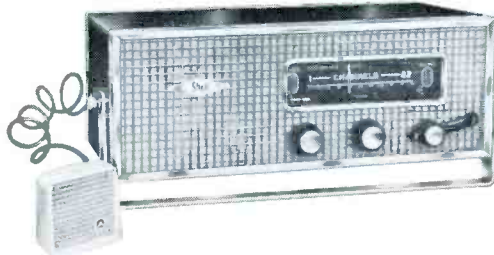

Fig. 3. Chroma oscillator and sync circuits of current-model color set.

Shell keeps on growing!



1



2



3



4



5

① HAMPTON FM TUNER

Sensitivity: 1.5 microvolts for 20 db quieting, Freq. Resp: 20 to 20,000 cycles ± 1 db, Distortion: less than 1%, IF Bandwidth: 270kc at 6db down, Hum Level: 70db below 1 volt output, Outputs: dual (2) cathode follower (1) FM multiplex, AFC Pull In: 200kc ± 15 kc, 1 volt at detector, Drift: zero with AFC on.

audiophile net \$79.95

② CB-12 CITIZEN BAND

Power input 5 watts to class C RF amplifier, Oscillator: plug in 3Rd. overtone crystal .005% accuracy, AM plate modulation with automatic limiting for less than 100% mod. High impedance input microphone. Super regen receiver with RF amplifier, Sensitivity: 1 microvolt useable signal, Tuning range 26.965MC to 27.255MC, Audio output 2 watts.

dealer net \$79.95

③ DUAL 20 WATT AMPLIFIER

Power output 40 watts (20 watts each), Peak 80 watts, Binaural 2 volts rms, 4 volts combined, Tape (recorder outputs) 2 volts each, Distortion less than 2%, Freq. Resp. ± 1 db 30 to 20,000 cps @ rated output, Inputs: tape head, mag., phono, ceramic phono, tuner, auxiliary, Tone balance signal.

audiophile net \$129.95

④ DUAL 30 WATT AMPLIFIER

Power output 60 watts (30 watts each), Peak 120 watts, Binaural 2 volts rms, 4 volts combined, Tape (recorder outputs) 2 volts each, Distortion less than 2%, Freq. Resp. ± 1 db 30 to 20,000 cps @ rated output, Inputs: tape head, mag. phono, ceramic phono, tuner, auxiliary, Tone balance signal.

⑤ AM-FM STEREO TUNER

Sensitivity: FM 1.2 microvolts for 20db quieting, AM 3 microvolts for 20db S/N Ratio, Freq. Resp. FM 20 to 20,000 cycles ± 1 db, AM 20 to 5. kc ± 1 db, Hum Level: FM-AM -70 db below 1 volt output, 7 Outputs: FM 2 dual cathode followers, 1 Multiplex, AM 2 dual cathode followers, AM FM 2 monaural, Automatic frequency control, Drift: FM zero with AFC on, AM negligible.

⑥ 102 TUBE TESTER

Vibrator tester-checks 6 and 12 volt vibrators, Engineered to accommodate new tube types, Lists and checks more tubes than any other self-service tube tester, 102 sockets, Easy-to-operate 1 knob control, Tumble lock compartment stores over 400 tubes, Complete emission tester, Checks each section of multi-purpose tubes.

dealer net \$199.95

⑦ S-18 TUBE TESTER

Tests each side of multi-purpose tubes, Tests 6 and 12 volt vibrators, Emission tests all tubes, Uses just 18 sockets, New sockets conform to MIL spec, assures positive contacts and longer wear, Tests more than 800 tube types, Foolproof test meter, Holds 400 tubes in sliding shelves, 110-120 volt AC.

dealer net \$149.95

⑧ TM-18 TUBE TESTER

Same panel and performing qualities as the S-18. Perfect for counter use in service shop. Available with legs as L-18. dealer net \$91.85

⑨ V-18 PORTABLE

Same performing qualities as the S-18. Compact and conveniently encased in attractive vinyl covered carrying case. dealer net \$59.60

⑩ TC-18 CADI-TESTER

Same performing qualities as the S-18. A handy and convenient service man's dream. The accurate, dependable built-in Test-O-Matic tube tester will increase tube sales on the job. Ample tube and tool storage. Ruggedly constructed with durable black vinyl and reinforced outside trim.

dealer net \$69.95

Shell

ELECTRONICS MFG. CORP.
112 State St., Westbury, N. Y.



6

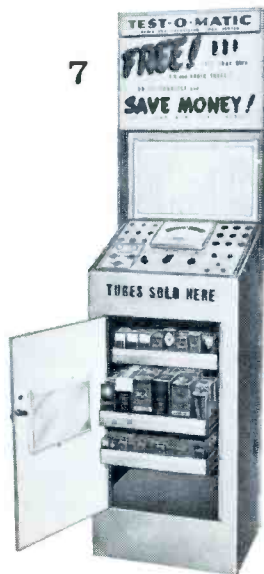

7



8

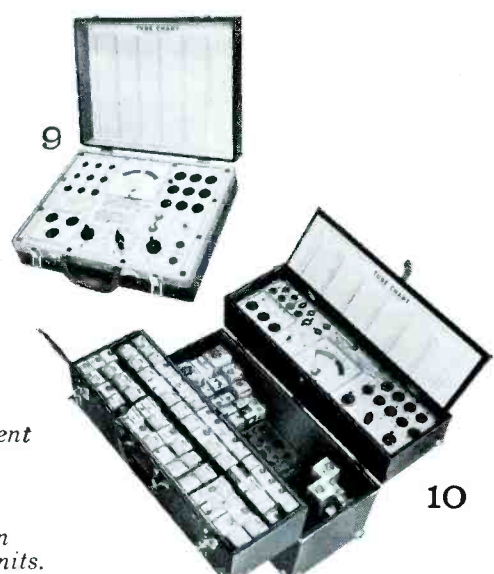

10

the most diversified line of tube testing equipment on the market.

write for complete information on these and other units.

This new
BOGEN
GUIDE-BOOK
 tells you how
 to cash in on the
 profitable commercial
 sound market in
 PA and INTERCOM



"GETTING STARTED IN SOUND"

16 pages, packed with valuable information, advice, answers to all your questions—discusses qualifications required—how much capital it takes—costs of operation—and, most important, how to get started on a modest investment. This guide book also tells you how to obtain...

VALUABLE FREE SALES KIT TO HELP YOU IN THE FAST GROWING SOUND BUSINESS

FREE sound sales kit contains sales literature—sample solicitation letters—job quotation forms—technical and installation data—product specification sheets—merchandising ideas.

You will also receive additional free material from time to time. And if you are not already dealing with a Bogen Sound Distributor we will also put you in touch with one to serve as your local supply source.

This valuable sales kit will be furnished to you when you send in the special card included in each copy of "Getting Started in Sound."



THIS MAY BE the very opportunity you have been waiting for. Don't miss it! Visit your local Bogen Sound Distributor for your copy of "Getting Started in Sound." It will be the best 25c investment you ever made. If your distributor has not yet received his supply or is sold out, use this convenient coupon. Enclose 25c in coin, and a copy will be mailed to you directly.

BOGEN-PRESTO, PARAMUS, NEW JERSEY PF-7
 Yes, I am interested in earning more money in sound systems, so please send me "Getting Started In Sound" by return mail. I enclose 25c in coin.

NAME _____
 ADDRESS _____
 CITY _____ ZONE _____ STATE _____

Look to Bogen-Presto for the big profit opportunities in sound

BOGEN-PRESTO, PARAMUS, NEW JERSEY
 A Division of the Siegler Corporation

component defects or misadjustments which may exist in the color-sync stages.

Random "tweaking" of the tuned circuits in these stages is *not* the way to overcome sync problems! Realignment may be necessary after components have been replaced, but this should be done in strict adherence to the procedure outlined in the service data.

The trouble area can be generally localized by simply grounding the grid of V20A, the reactance tube which controls the chroma reference oscillator. If the pattern on the screen changes, the trouble is thus shown to be in the circuits of the color-sync phase detector (V19) or burst amplifier (V18), or possibly in some preceding circuit. No change in the pattern indicates trouble in either the oscillator or the reactance-tube control circuit.

Color AFC Tests

The best way to hunt for trouble in the burst and phase-detector circuits is to check waveforms with a *wide-band* scope and low-capacitance probe. With a color signal applied to the receiver, check at the burst-transformer side of the phase detector (pins 1 and 2 of V19 in Fig. 3) for two color-burst waveforms of nearly equal amplitudes. Rotating the tint (hue) control should affect the appearance of the waveform at pin 1. If no burst signals are present, go to the grid of the burst amplifier. In the circuit of Fig. 3, the waveform at that point should be a combination of a strong keying pulse (from the horizontal output stage) and a relatively low-amplitude 3.58-mc burst signal. It may be necessary to disconnect or disable the inputs one at a time in order to obtain a clear view of both signal components. In some color sets, these inputs are received on separate elements of the burst-amplifier tube—so there is no problem of analyzing a composite-type signal.

Besides checking the incoming burst signal, see if a feedback signal from the oscillator is present at the other side of the phase detector (pins 5 and 7 of V19). Pay particular attention to the required

peak-to-peak amplitude—about 10 volts in the circuit of Fig. 3.

After the trouble area has been narrowed by waveform checks, a VTVM can be put to work finding the exact location of a suspected defect.

Oscillator

Reach for the VTVM if the trouble has been localized to the reactance-tube and oscillator circuits. First of all, is the plate voltage of the reactance tube normal? If not, some defect in this tube's plate circuit may be causing it to throw the oscillator off frequency.

If the grid voltage of the oscillator is incorrect, this can mean either weak oscillations or an incorrect operating frequency. Be sure to check the plate and screen voltages of the oscillator stage for possible clues to trouble on the output side of the circuit.

Intermittents

A condition occasionally seen in color sets is a loss of color sync after a long initial period of normal operation—usually an hour or more. This intermittent defect is often found to be the result of a gradual change in bias on the reference-oscillator control stage. A change in value of a cathode-circuit component, or grid current due to a gassy tube or a leaky grid-plate capacitor, is most likely to be the actual source of the trouble. It is characteristic of these defects to cure themselves each time the set is turned off and then on again. Monitoring the voltages in the circuit of V20A is the best way to trace this particular problem.

Another fault which may be diagnosed as intermittent is an unstable, or touchy, sync circuit. This behavior is usually caused by leaky capacitors, and the trouble can be readily traced by making voltage measurements. As a rule, the defect is found in the circuit feeding the grid of the control tube. Open capacitors in this same circuit cause violent, uncontrollable disturbances in color sync.

Of course, there are other possible causes of color-sync loss; but following the procedure just outlined will direct you to most trouble sources via the fastest route. ▲

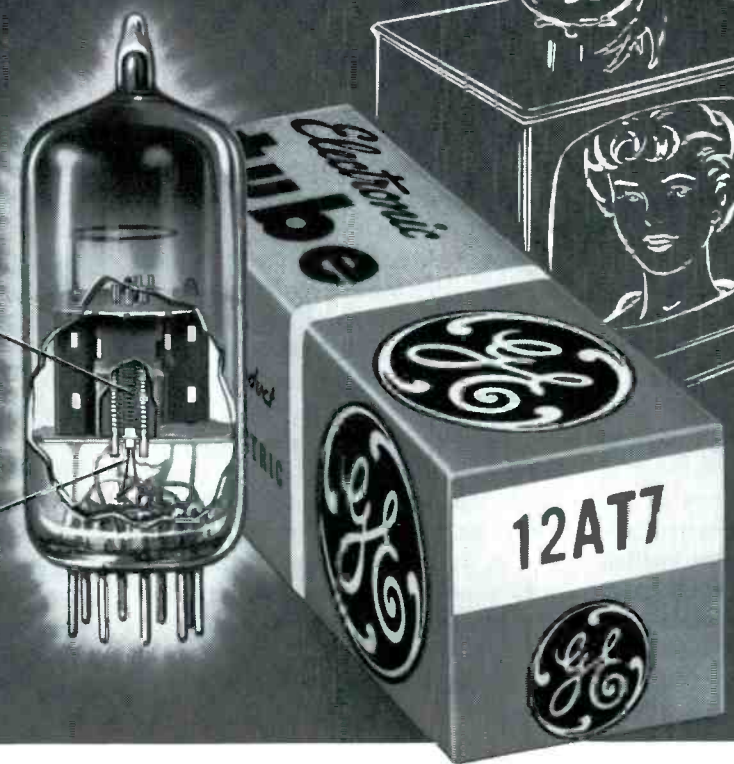
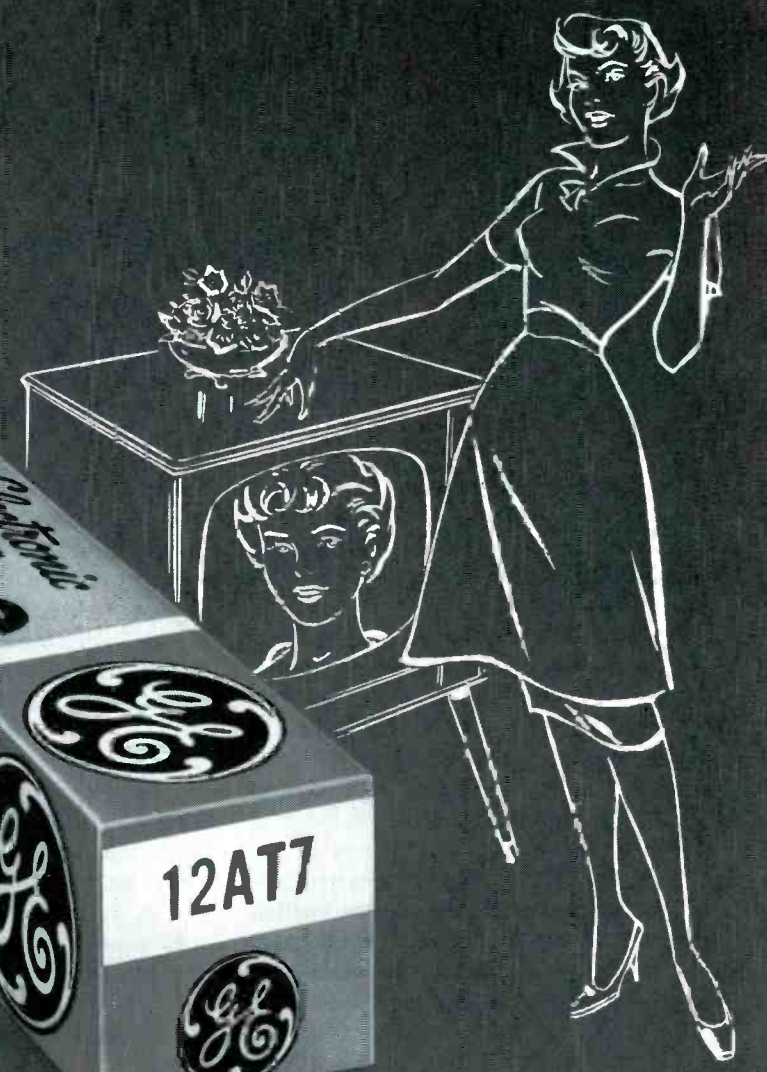

MICRO-MEASURED CATHODE COATING is applied by latest General Electric techniques which assure uniformity. Result: greater emission capability for the 12AT7, and a more responsive tube.

PRECISION-CENTERED HEATERS. General Electric heaters match in length, and are aligned with the full coated area of the cathode, for top emissive efficiency.

TWO big markets await super-sensitive G-E 12AT7!

Superior mobile reception, more dependable home TV:
now you can provide both... profitably!

Highest sensitivity of any 12AT7, especially at low voltages! Puts General Electric's twin triode in a class by itself. You can offer improved reception to police, ambulance, other FM mobile-radio users with a battery or generator power source. Also, you can install the tube to help set owners ward off faulty home-television performance when line voltages drop.

Plenty of sockets for the Service-Designed 12AT7! Make new friends with this fine tube.. make money, too! With its close inter-element spacings, Type 12AT7 must be built *right* - as General Electric builds it. Get the full quality story from your G-E tube distributor! *Distributor Sales, Electronic Components Division, General Electric Company, Owensboro, Kentucky.*

Progress Is Our Most Important Product

GENERAL  ELECTRIC

311-304



INDUSTRIAL
ELECTRONICS

by Jack Darr

automatic filling device

“SAYS WHEN”

Dairies fill milk cartons with the aid of an electronic timer.

Electronic timers, with their great accuracy and adaptability, lend themselves to all sorts of uses in industrial process control.

One important application is in the automatic filling of opaque containers with liquids or very finely ground powders. Transparent containers can be filled by photoelectric cell devices, which cut off the flow when a beam of light is blocked as the contents reach the prescribed height. Obviously, this method would not work for opaque containers, such as the waxed paper cartons which have virtually replaced glass milk bottles. Instead, a solenoid-controlled valve on the filling apparatus is held open for a predetermined length of time. Split-second timing allows the containers to be filled to a uniform level.

In the timer-controlled unit used in dairies for filling waxed paper cartons (Fig. 1), the milk supply is poured into a large stainless-steel vessel mounted above the filling

Editor's Note: Material in this article has been excerpted from the new Howard W. Sams book, *Servicing Unique Electronic Apparatus*, by Jack Darr.

table. A solenoid and valve assembly is below the supply vessel. Metal tracks guide the paper cartons into position. When the open top of the carton is directly beneath the spout, a trip arm closes a microswitch (a small snap-action switch operated by a tiny movement of its actuating arm). The microswitch “kicks off” the timer, which opens the valve and holds it open for the predetermined length of time. If the timing is correct, the carton will be filled with the exact quantity desired.

Fig. 2 is a photograph of the timer circuit with the cover removed and the principal components labeled.

Timer Circuitry

Fig. 3 shows the schematic for the timing unit. The timing depends upon the charging rate of capacitors C1 and C2, which controls the conduction of tube V1.

In the standby position at the beginning of the cycle, the armatures on relays RL1 and RL2 are positioned as shown by the solid lines in Fig. 3. That is, RL1 is activated and RL2 is not. Notice that the junction of R1 and R3 receives a positive

voltage from B+ through R5 and section A of RL2. This voltage provides the proper bias for V1, since the cathode is connected to B+ through a portion of R4; it also discharges timing capacitors C1 and C2, since the opposite ends of these capacitors are likewise connected to B+. Tube V1 is conducting and plate relay RL1 is energized (shown by the solid bar for relay RL1 in Fig. 3) in the standby position.

At the beginning of the cycle, the carton on the filling table strikes the microswitch, which closes momentarily and thus completes the circuit between terminals 3 and 4 of the control-head socket. At this time, a return path is provided for AC relay RL2. As a result, armatures on RL2 move to the positions shown by the dotted lines in Fig. 3. With RL2 in this position, a path has now been provided through section A of RL2 and section B of RL1, from B+ to terminal 3 of the control-head socket. Hence, RL2 is held in the position shown by the dotted lines, after the microswitch opens, by the connections through RL2 and RL1.

The solenoid, which operates the

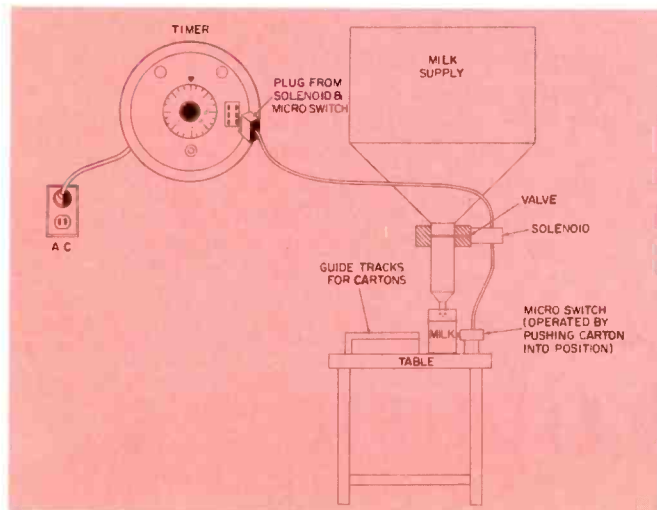

Fig. 1. Sketch of timer-controlled equipment for pouring milk into cartons.

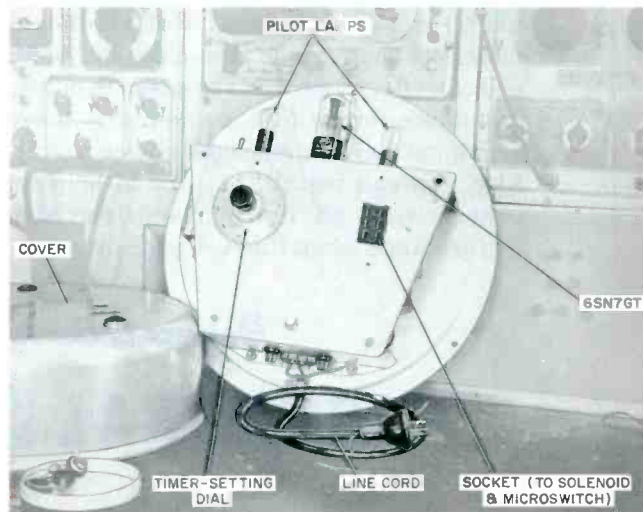
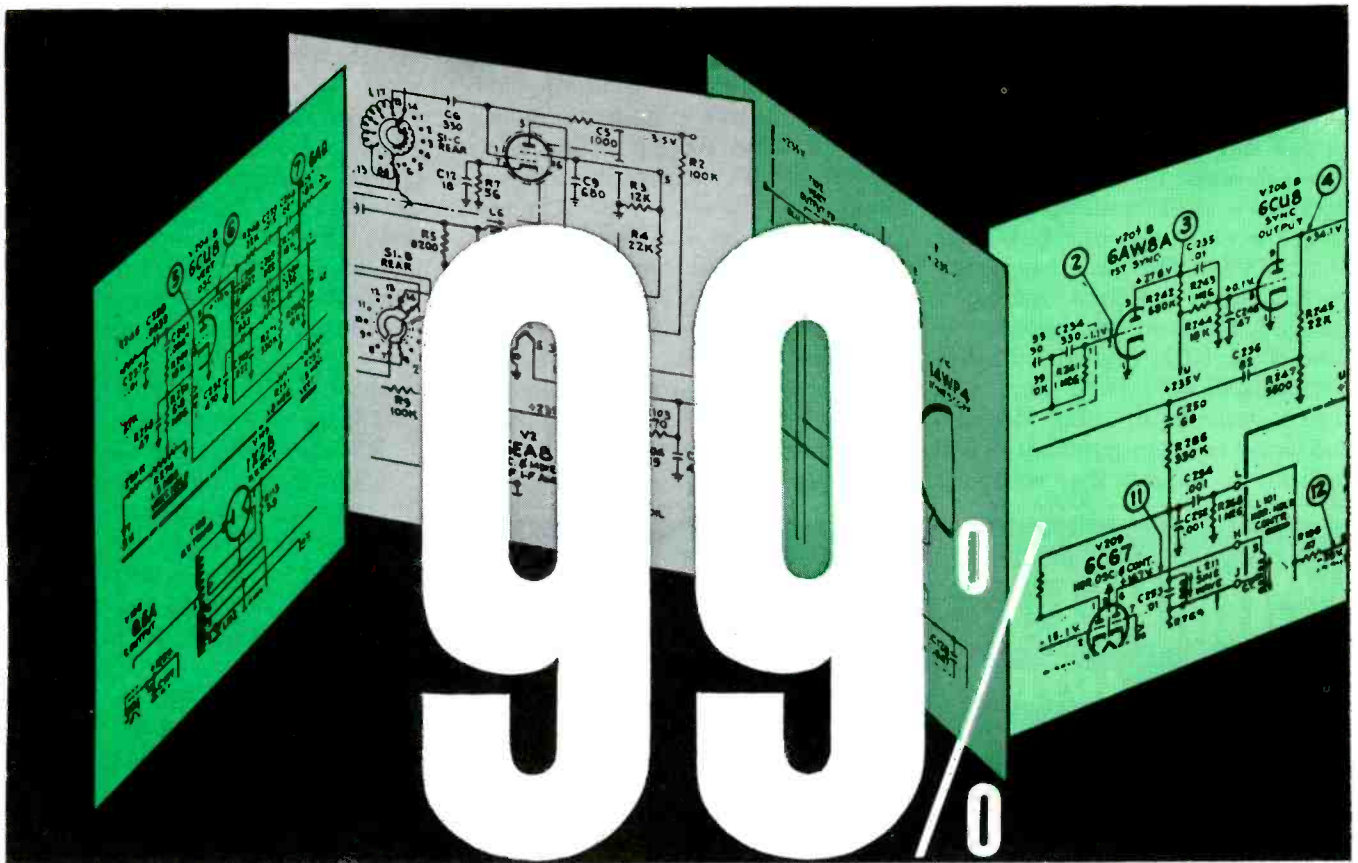

Fig. 2. Photo of actual timer unit with cover removed to show components.



OF
ALL YOUR
REPLACEMENT
CONTROL NEEDS

CLAROSTAT *READY-TO-USE CONTROLS!!*

RTV CONTROLS

Ready for use right from the carton — the right one right in every respect for practically every TV and radio receiver . . . No assembly — factory-made to work right!

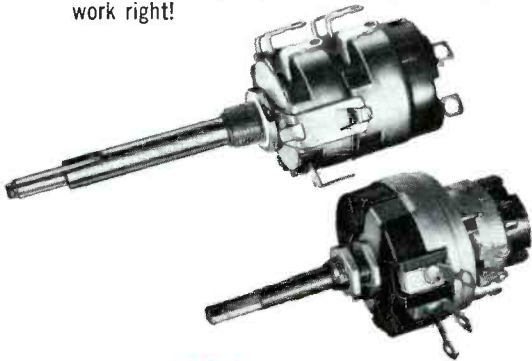

STANDARD CONTROLS

Wire-wound and carbon controls in every popular value. Also duals. Pick-A-Shaft permits right selection — snaps right into place. Ad-A-Switch snaps on with no fuss, no muss.



valve controlling the flow of milk into the carton, is connected across terminals 5 and 6 of the control-head socket. Terminal 5 is connected to one side of the AC line. Therefore, in order for the solenoid to operate, a path must be provided from the other side of the AC line to terminal 6. This path is furnished by RL2 when energized. Starting at fuse M2, the path runs through section B of RL2 (dotted lines) to section A of RL1 (solid line), and then to terminal 6. Lamp M6, also connected between terminals 5 and 6, lights to indicate that voltage is

being applied to the solenoid and that milk is flowing into the carton.

Now, while milk is flowing into the carton, let's examine the timing circuit! When relay RL1 was energized, the B+ voltage through section A of the relay (and R5) was removed. (This was the voltage provided for biasing the grid and discharging C1 and C2. Remember that C1 and C2 were *discharged* by the B+ voltage, since both sides of these capacitors were connected to B+. Although a positive potential did exist on both plates of the capacitors, there was no potential dif-

ference across the plates.) With the discharging voltage removed, capacitors C1 and C2 charge through resistors R1 and R2 and the power supply. However, the capacitors cannot charge instantaneously because R1 and R2 limit the current flow. The time required for a capacitor to reach 63% of the applied voltage is known as the *time constant* of the circuit. It is equal to:

$$T = RC$$

where

T is the time in seconds,

R is the resistance in ohms,

C is the capacitance in farads.

During each time-constant period following the first one, the capacitors charge to 63% of the remaining voltage. Fig. 4 shows the resultant decrease in voltage at the junction of R1 and R3.

The charging rate can be controlled by varying either the resistance or the capacitance in the circuit. For example, when switch S1 is closed, both C1 and C2 are in the circuit; when S1 is open, only C2 is in the circuit, and the charging time is much less. Likewise, the resistance is changed by moving the arm of potentiometer R1. When the arm is at the bottom of the drawing, the entire 1-meg resistance is in the circuit; when the arm is at the top, all the resistance of R1 is shunted out of the circuit. Thus, R1 serves as a fine adjustment of the charging time of capacitors C1 and C2. The duration of a time constant (indicated by 1, 2, 3, and 4 along the bottom of Fig. 4) can be varied over a wide range by proper adjustment of S1 and R1.

By resetting R4, the cathode voltage on V1 can be varied so that V1 can be cut off at almost any desired point on the curve in Fig. 4. When



COMPLETELY RELIABLE

AUTOMATIC MONEY-MAKER



B&K

MODEL 675

AUTOMATIC

DYNA-QUIK

DYNAMIC MUTUAL CONDUCTANCE

TUBE AND TRANSISTOR TESTER

Here is automation that combines both speed and accuracy for profitable professional servicing. Pre-tested and field proved. Keeps paying you dividends day after day. *Measures true dynamic mutual conductance.* Makes complete tube test in seconds under actual operating conditions of the set. Checks average set in a few minutes. Provides instantaneous heater continuity test. Shows true tube condition on "Good-Bad" scale and in micromhos. Patented automatic line compensation. Tests transistors, diodes, and rectifiers, too. Net, **\$169.95**

See Your B&K Distributor or Send for Bulletin AP15-R

SIMPLIFIED AUTOMATIC

DYNA-CARD SYSTEM

Only 60 indexed phenolic Dyna-Cards test over 600 tube types. Dyna-Card automatically sets socket connections.

MORE ACCURATE TESTS FOR

PROFESSIONAL SERVICING

Tests each section of multiple tubes separately for true Gm, Shorts, Gas, Grid Emission and Life.

MINIMIZES OBSOLESCENCE

Easily kept up-to-date with extra cards and punch supplied with every unit.

By checking all tubes

in the set, you can

Sell More Tubes Per Call

INCREASE YOUR INCOME

Save Call-Backs and Satisfy More Customers.

B&K MANUFACTURING CO.

1801 W. BELLE PLAINE AVE • CHICAGO 13, ILL.

Canada: Atlas Radio Corp., 50 Wingold, Toronto 10, Ont.

Export: Empire Exporters, 277 Broadway, New York 7, U.S.A.



plate current stops flowing, RL1 is deactivated, and the armature moves to the position shown by the dotted lines. This action opens the solenoid circuit (through section A of RL1), stopping the flow of milk. At the same time, the connection through section B of RL1 to the winding of RL2 also opens. RL2 is then deactivated, the B+ connection is restored to the junction of R1 and R3, and capacitors C1 and C2 are discharged. V1 starts conducting, and plate relay RL1 is again energized.

Now, conditions are the same as they were at the beginning of the cycle. When the next carton strikes the microswitch, the cycle will be repeated.

Manual-fill switch S2, when depressed, applies the line voltage directly to the solenoid, bypassing the timing and relay circuits. Hence, this switch can be used during servicing as a check on the solenoid and valve.

Operating power is supplied by a pair of selenium rectifiers in a half-wave doubler circuit. Lamp M5 indicates that the device is turned on and ready for operation. The filament voltage for the 6SN7GTA tube is supplied by a small transformer (not shown). The 0C3 voltage regulator holds the supply voltage constant to insure accurate timing. R1, a high-quality linear potentiometer, has a planetary drive instead of the standard direct drive. This, together with the very large dial scale, permits a highly accurate setting of this control.

Timing capacitors of 0.5 and 4 mfd were used in this unit. Other units will use different values, depending upon the length of charging time required. With both capacitors in the circuit (Fig. 3), times of up to three or four minutes are possible. The shortest possible time is in the neighborhood of one to two seconds. Accuracy in setting the controls is on the order of one-tenth of a second or less.

Servicing

Environment causes most of the troubles in these units. Because they are operated in the humid atmosphere of dairies, moisture can enter them and cause leakage and short circuits between elements. The case has a rubber gasket to keep out

moisture. Be sure to replace this gasket, and check it for any leaks or breaks whenever the unit is serviced. (It is not at all unlikely, every now and then, for the whole unit to get doused by a stream of water from a cleanup hose!)

Even though an AC-DC "floating ground" or B-minus circuit is used in this system, an extremely high shock hazard still exists—especially for operating personnel, who might use this equipment while wading in water or walking around on an always wet floor. To prevent shock,

heavily rubber-jacketed cables and moisture-sealed plugs are used; and a special grounding conductor, connected to terminals 1 and 2, is provided in the interconnecting cable. Be absolutely sure the whole unit is firmly connected to an actual earth ground by running a heavy ground wire to a cold-water pipe. If this wire is missing when a unit is to be serviced, install it before attempting to operate the equipment. Carefully check the cable and all plugs and sockets for weaknesses caused by steam or water. If the outer jacket

Now Completely SELF-CONTAINED

For Testing & Rejuvenating



BLACK AND WHITE



and COLOR



including 110° TUBES

NEW CRT 440





CATHODE REJUVENATOR TESTER

B&K



TESTS AND REJUVENATES
all black & white and color picture tubes at correct filament voltage from 1 to 12 V.

TESTS AND REJUVENATES
110° tubes with 2.34, 2.68, 6.3 and 8.4 volt filaments.

TESTS AND REJUVENATES
color picture tubes. Checks each color gun separately same as black & white tubes.

*Used by Thousands of Professional Servicemen
MAKES NEW PICTURE TUBE SALES EASIER*

Gives you more value than ever—all-in-one. Quickly checks and corrects most TV picture tube troubles in a few minutes right in the home without removing tube from set. Gives new useful life to weak or inoperative tubes. Checks leakage. Restores emission and brightness. Repairs inter-element shorts and open circuits. Life test checks gas content and predicts remaining useful life of picture tube. Completely self-contained in leatherette-covered carrying case. Net, **\$74.95**

ACCESSORIES for USE ONLY with FORMER B&K Models 400 and 350 CRT



Model C40 Adapter. For use only with all previous B&K Model 400 and 350 CRT's. Tests and rejuvenates TV color picture tubes and 6.3 volt 110° picture tubes. Net, **\$9.95**



Model CR48 Adapter. For use only with all previous B&K Model 400 and 350 CRT's. Tests and rejuvenates 110° picture tubes with 2.34, 2.68, and 8.4 volt filaments. Net, **\$4.95**

See your **B&K Distributor**
or Send now for Bulletin AP15-R

B&K MANUFACTURING CO.
1801 W. BELLE PLAINE AVE • CHICAGO 13, ILL.
Canada: Atlas Radio Corp., 50 Wingold, Toronto 10, Ont.
Export: Empire Exporters, 277 Broadway, New York 7, U.S.A.

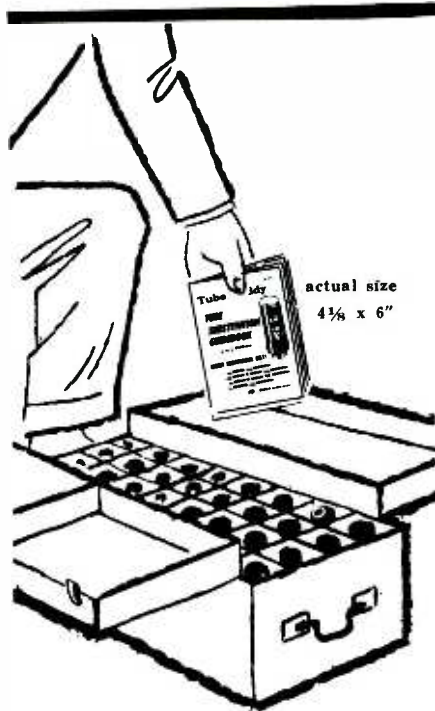

take this new
'tool' on every
service call...

especially designed
for your tube caddy

TUBE CADDY-TUBE SUBSTITUTION GUIDEBOOK

by H. A. MIDDLETON
(direct replacements only)

This guidebook is the answer to the many requests by service-technicians for an efficient direct substitution guide which can be carried in the tube caddy. It contains only direct substitutions which can be made without modification of the wiring. All substitutions listed will yield good or excellent results as indicated in the guidebook.

this guidebook will:

- save you time • eliminate carrying needless tube types • enable you to select the best substitution • minimize sales losses because you don't have the right tube.

It will pay for itself on the first service call!

Contains more than 2,400 substitutions:

Receiving tubes 1819
Ruggedized tubes 75
European-to-American 219
American-to-European 297
#272, (actual size 4 3/8 x 6") \$3.90

Order this indispensable 'tool' today at
your distributor or from: Dept. PF-7

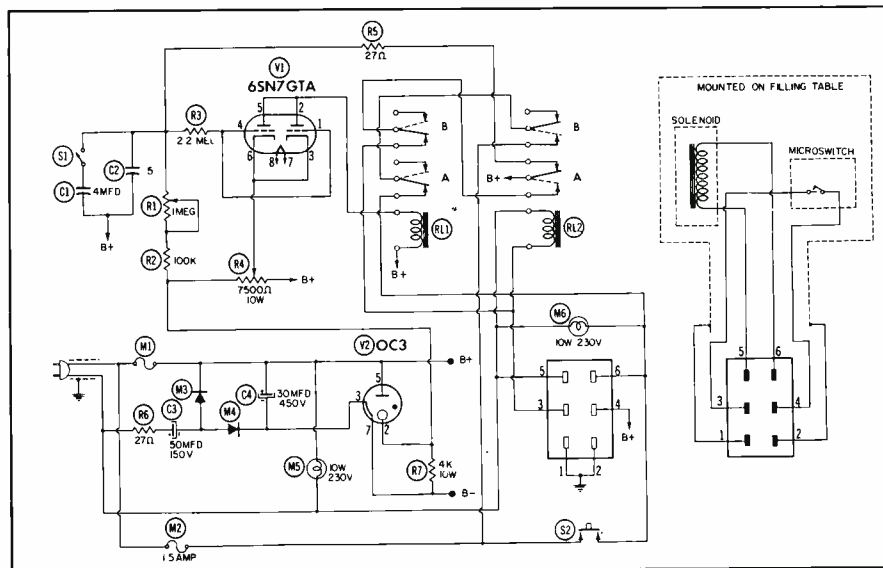

Fig. 3. Complete schematic of circuits used in the electronic timing unit.

of the interconnecting cable appears to have been weakened by steam cleaning, replace the whole cable.

Aside from these precautions, maintenance on the unit consists mainly of cleaning relay contacts and checking tubes and operating voltages. The output voltage of the selenium rectifiers should be at least 250 volts. A partially open filter or doubler capacitor, or one with a high power factor, can cause a lower voltage. Weak rectifiers can also cause low output voltage.

To clean the relay contacts, draw a strip of cardboard (cut a strip off a postal card or similar stock) between the contacts. If the contacts have burned or are badly pitted, disassemble the relay and smooth them down, using jeweler's rouge for the final polishing. Apply a thin film of contact lubricant, to help keep down future corrosion. Check the springs for positive action on the relays. These can be replaced by dial-drive springs (like those used in

radios) if they are badly stretched.

The timing pot, R1, is a precision unit; it should never be replaced by a standard radio or TV unit, but only with a duplicate. If the main timing dial is removed for any reason, carefully note and mark its position, so it can be replaced in the exact position. When the unit is first installed, the timing of the unit should be checked with a very accurate watch having a large sweep-second hand, and notes made of the dial-scale markings corresponding to different times—1, 5, 60 seconds, etc. This will make maintenance and checking easier in the future. ▲

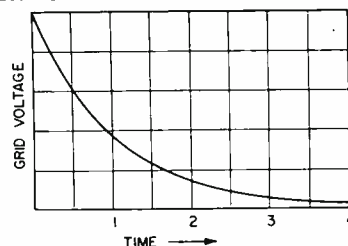

Fig. 4. Effect of RC charging network on grid voltage of control tube V1.

TV TUNERS OVERHAULED

ALL MAKES AND MODELS **\$9.95** NET 90 DAYS WARRANTY UHF/VHF \$19.90

SAME DAY SERVICE

ON POPULAR TYPES—48 HOURS ALL OTHERS

Overhaul charge includes labor and minor parts; tubes and major parts are extra at net prices. Tuner to be overhauled should be shipped complete; include tubes, shield cover and any damaged parts. Quote model and state complaint. Pack well and insure.

WE WILL SHIP C.O.D.—F.O.B. CHICAGO OR TORONTO

Castle TV Tuner Service

5710 N. WESTERN CHICAGO 45, ILL. U.S.A. • TORONTO 13 CANADA



Why "Experiment"...

with electrical protective devices

when BUSS fuses have proven their dependability?

With the many types of electrical protective devices on the market, perhaps you have asked yourself, "Which line is best for me?"

It doesn't pay to "experiment".

Protective devices that fail to protect or that open needlessly often require a time-consuming call-back that can mean loss of full profit. Your reputation for service and reliability also may suffer.

BUSS and FUSETRON fuses, on

the other hand, do provide dependable electrical protection under all service conditions . . . and have for the last 45 years in the home, in industry and on the farm.

Electronic testing assures dependability.

Every BUSS and FUSETRON fuse is tested in a sensitive electronic device that automatically rejects any fuse not correctly calibrated, properly constructed and right in all physical dimensions.

The time you save, the trouble you avoid, the satisfied customers you keep and the full profit you make are why it's just good business to standardize on BUSS.

For more information on BUSS and FUSETRON Small Dimension fuses and fuseholders, write TODAY for Bulletin SFB.

BUSSMANN MFG. DIVISION

McGraw-Edison Co.

University at Jefferson, St. Louis 7, Mo.

760

BUSS fuses are made to protect - not to blow, needlessly.

BUSS makes a complete line of fuses for home, farm, commercial, electronic, electrical, automotive and industrial use.



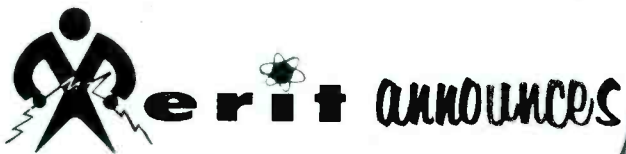

ANOTHER ADDITION TO ITS BIG FAMILY
OF TESTED ELECTRONIC COMPONENTS...

BC-424

262 K.C. Output I.F. Transformer
(Printed Circuit)

EXACT REPLACEMENT FOR
DELCD 1221253, 1221255

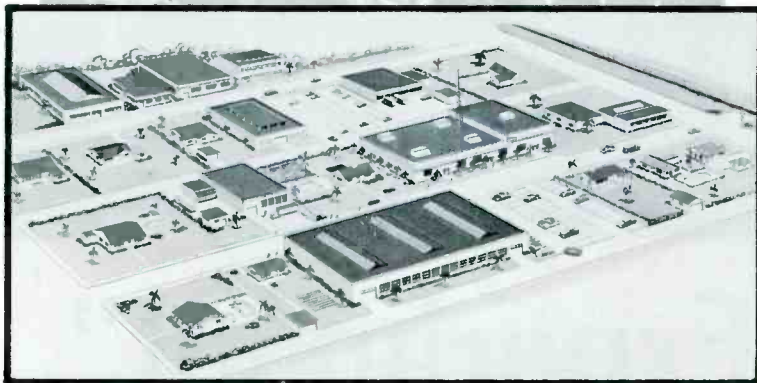
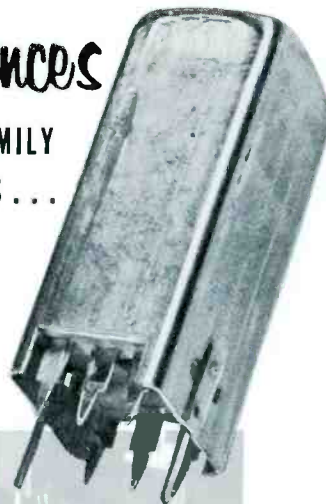

Merit does not employ the prevalent "spot check" system. Every unit in the Merit line is individually tested — subjected to *grueling* tests far beyond ordinary usage. Which accounts for an almost unbelievably low percentage of returns. And explains why so many thousands of service technicians all over the world use and

recommend Merit *tested* Electronic Components.



Coil and Transformer Corporation

MERIT PLAZA HOLLYWOOD • FLORIDA

TIPS for TECHS

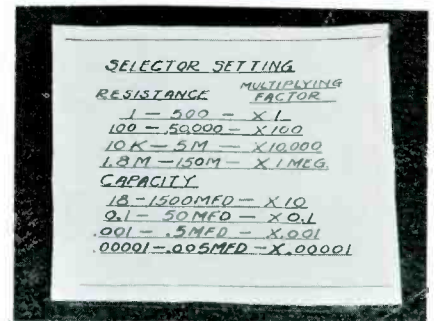

Reference Card for Instrument Settings

Instead of checking the instruction sheet or booklet for ranges and multipliers of instruments such as resistance-capacitance bridges, you'll save much time by pasting a card with this information on the top of the instrument as shown.



Illuminated Magnifier Aids in Component Identification

Illuminated magnifiers — which are available in various sizes and styles — are helpful in reading dim markings on capacitors, resistors, and other electronic components.

The magnifier shown measures about 7" in over-all length, uses medium flash lamp batteries, and magnifies five times.

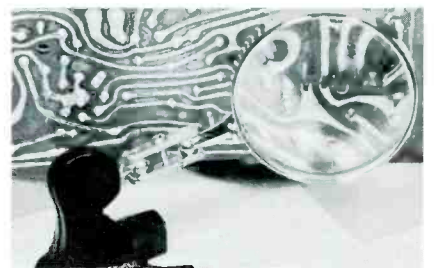

Magnifier for Printed Board Work

When looking for breaks or other defects on printed boards, try using a magnifying glass like the one shown.

The lens is about 2½" in diameter, while the base is slightly over 2" in both length and height, and is heavy enough to stay where placed.



Use Crochet Needle On Printed Boards

An ordinary crochet needle becomes a handy tool when searching for broken or loose conductors on printed boards. The small hook on the needle permits prying with a light touch, making it easier to probe without introducing new troubles.



Tape Patches Punctured Cone

Punctured or torn speaker cones can be patched quickly and easily with plastic electrical tape. The tape will adhere well and form a long-lasting repair if you wipe the cone clean of all dust beforehand.



Snout for Service Syringe

When applying control cleaner, simplify your job of reaching those noisy controls which are located in almost inaccessible places. Use a length of plastic spaghetti slipped over the syringe—in the form of a flexible "snout."

NEW!

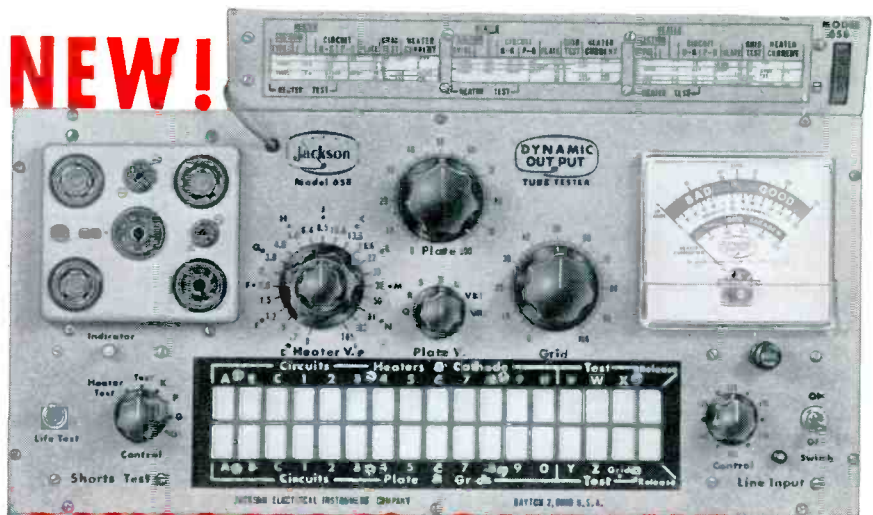

DYNAMIC® OUTPUT 658 TUBE TESTER BY JACKSON

*Makes More . . . and more accurate tests
Than Any Service Tube Tester Ever Made!*

At last, here is a tube tester that will test practically every tube the average serviceman will ever encounter. Faster, more versatile, more accurate for more types, the new 658 is the ideal choice for service, laboratory, and engineering applications.

DYNAMIC OUTPUT PRINCIPLE—8 voltage positions for plate, screen and voltage regulators. Variable DC voltage, plus variable AC signal voltage is applied to control grid. The meter then reads only the AC component in the plate circuit. A much more valid test than mutual conductance, because it considers the entire output curve of the tube, not just a small portion.

TESTS NEW 12-VOLT PLATE HYBRID TUBES—Ample current capacity for even high current space charge grid tubes. The 658 is the only tester made with this capability.

TRUE RECTIFIER TESTS—AC voltages are applied to diodes and rectifiers. Meter then reads plate current—the only valid test for rectifiers. Easily handles even high current rectifiers up to 250 ma.

GRID LEAKAGE TESTS—Highly sensitive grid leakage test indicated directly on special meter scale. Sensitivity of 15 megohms.

TESTS "EYE" TUBES UNDER DYNAMIC CONDITIONS—Eye can be opened and closed to determine accurately its operating limits.

HEATER-CURRENT TESTS ON SERIES STRING TUBES—Actual current is read directly on meter scale.

HEATER CONTINUITY CHECK WITHOUT WARM-UP—No wasted time if the heater is burned out.

TESTS ALL VOLTAGE REGULATOR AND REFERENCE TUBES—Actually indicates striking voltage and control voltage range.

PLUS THESE AND MANY MORE FEATURES

Famous Jackson Push-Button Sequence Switching
New Silicon-Rectifier Balanced double-bridge circuit
Triple Shorts Sensitivity Tests to suit each tube
231 Heater voltage combinations from 0.6 to 120 volts
Fused line for overload protection. Panel mounted fuse

Famous Jackson Life-Line Test Grouped tube sockets for easy accessibility
Complete data for testing more than 1,200 types
Compact portable case—21" l. x 13 3/4" w. x 7" d.
Sockets for 4, 5, 6, 10ktal, octal, miniature 7 and 9 pin tubes plus two for sub-miniatures

SEE IT AT YOUR DISTRIBUTORS OR WRITE TODAY FOR LITERATURE

\$189.95



THE JACKSON ELECTRICAL
INSTRUMENT CO.
124 McDonough St., Dayton 2, Ohio
In Canada: The Canadian Marconi Company

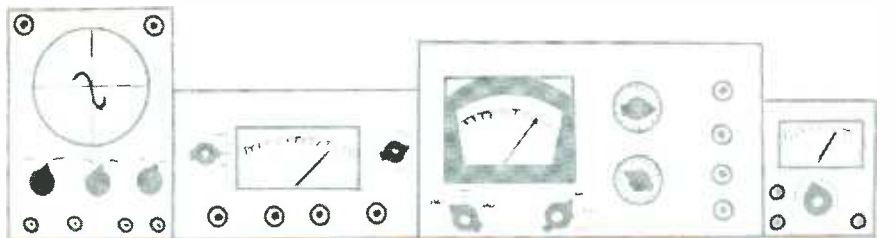

NOTES ON TEST EQUIPMENT

by Les Deane

AC-DC All the Way

A new VOM that measures AC or DC voltages and currents, resistance, and decibels has recently been introduced by Electronic Measurements Corp. of New York. The front panel of the self-powered, lightweight Model 109 is pictured in Fig. 1. It's supplied with batteries, carrying handle, and operating instructions, but not with test leads.

Specifications are:

1. Power Requirements—three series-connected 1.5-volt penlite cells; standard replacements available.
2. DC Voltmeter—five ranges of 6, 60, 300, 600, and 3000 volts; sensitivity 20,000 ohms/volt; separate jack provided for 3000-volt range.
3. Ohmmeter—0 to 20 megohms in three ranges of Rx1, x10, and x1K; center-scale indications of 70, 700, and 70K ohms; zero-ohms adjustment and separate jack provided on panel; circuit operates from 4.5-volt battery supply.
4. AC Voltmeter—five rms ranges of 12, 120, 600, 1200, and 3000 volts; sensitivity 10,000 ohms/volt; full-wave rectification employed.
5. DC Ammeter—three ranges of 6, 60, and 600 ma; all readings indicated on one scale.

6. AC Ammeter—three rms ranges of 30 ma, 300 ma, and 3 amps; AC-DC selector switch provided on panel.
7. DB Meter—five usable ranges corresponding to AC voltage range selected; readings from -4 to +64 db obtainable; direct-scale reading from -4 to +16; zero db equals 6 milliwatts of AC power across 500-ohm load.
8. Panel Meter—4½" clear plastic front, 40-ua movement with knife-edge pointer; five separate scale arcs provided, red for AC functions and black for DC, ohms, and db.
9. Size and Weight—case 5¼" x 6¾" x 6 3/4" x 2 1/4"; 1 lb., 14 ozs.

From Fig. 1 you can see that the meter face occupies most of the front panel with range selector, AC-DC switch, ohms-adjust control, and test jacks all across the bottom section. An unusual feature of the 109 is that it offers AC current measurements in addition to conventional VOM functions. This, of course, can come in handy for checking line current to various pieces of equipment, and for testing or attempting to regulate tube filament circuits.

Opening the instrument by removing four screws from the front panel, I found the three penlite cells housed in a small plastic box, which in turn is cemented to the case back (see Fig. 2). With the lid of the box open, the batteries can be removed as one pack since they are soldered together in a series arrangement.

An output jack is not provided on the meter, and the AC input circuit does not incorporate a DC blocking capacitor; therefore, audio signal voltages or db levels should not be measured with DC voltage present. At relatively high frequencies, however, a .5-mfd capacitor can be connected in series with one of the test leads to eliminate the DC component without affecting AC accuracy.

Judging from my mail, some of you seem to be having trouble in trying to figure out what the term *meter sensitivity* actually means. Generally speaking, the input resistance of a VOM should be higher than the resistance of the circuit



Fig. 2. The 109 has a sealed meter movement and three-cell power pack.

under test. This minimizes power drawn from the circuit by the instrument, and thus lessens the effect on circuit operation. Indirectly, then, the accuracy of the meter readings is increased. A high input resistance is obtained by using high-value series resistors in the meter circuitry. The combined value of these resistors or multipliers is limited, however, by the amount of current needed for the meter movement itself. Therefore, in meters with high input resistance we generally find very sensitive microamp movements. Since series multipliers must change for each voltage range selected, the input meter resistance is expressed as a ratio of resistance to voltage, or so many "ohms-per-volt."

You can check the AC or DC sensitivity of a voltmeter in the following manner: Use either an AC or DC voltage source, and obtain a near full-scale reading by selecting the appropriate meter function and range (see Fig. 3A). Next, select a resistance equal in value to the ohms-per-volt rating of the meter times the full-scale indication of the voltage range, and connect it in series with the source. Measure the voltage as illustrated in Fig. 3B; it should now be exactly one half that of the original, provided that a precision resistor is used and the meter is correctly rated.

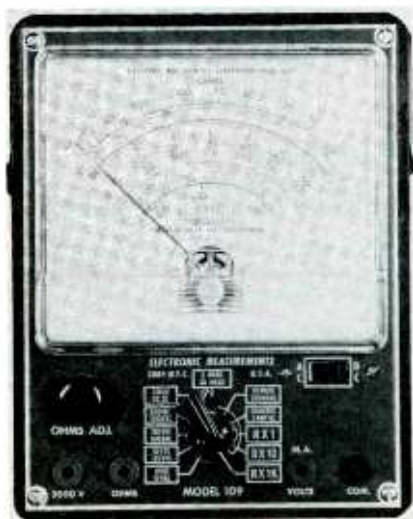

Fig. 1. Functions of the EMC Model 109 include AC current measurements.

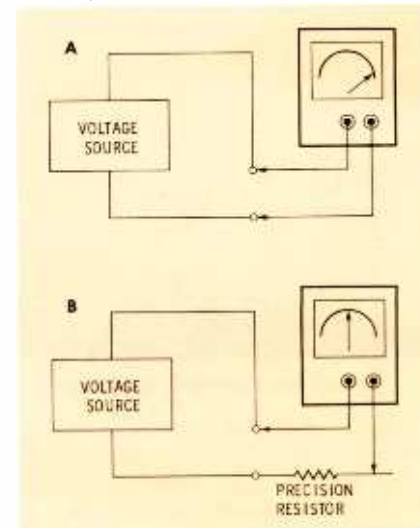

Fig. 3. Diagram showing how to check sensitivity rating of a VOM (see text).

**There's a better way
to cut off callbacks**



Your choice of the parts you use has a lot to do with the number of calls you get that become callbacks. When it comes to tubes, Tung-Sol Blue Chip quality is practically built-in callback insurance. Tung-Sol tubes are made to set manufacturers highest standards. They're best for every set — radio, tv or hi-fi. Use them. They'll keep the line clear for money-making service calls. Tung-Sol Electric Inc., Newark 4, N. J.

Tell your jobber you'd rather have

ts TUNG-SOL®

Blue Chip Quality

TUBES • TRANSISTORS • DIODES

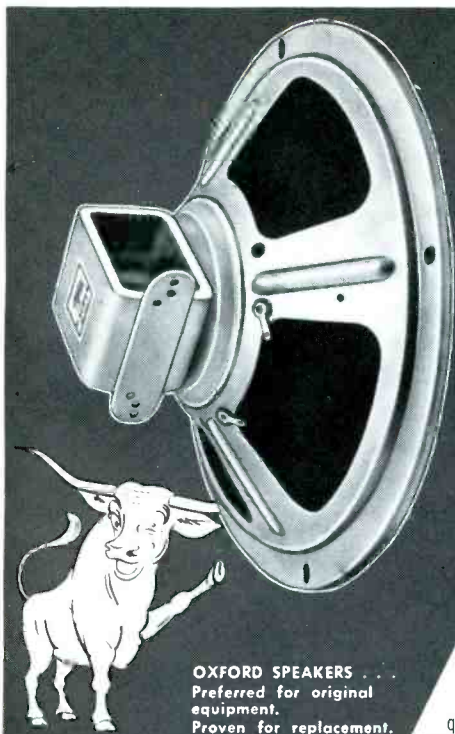

OXFORD

-the
Leader

Largest exclusive
SPEAKER manufacturer
in the world
6 factories located
throughout the U.S.A.

ONCE MORE UNTO THE BREACH,
DEAR FRIENDS! When you are
looking for replacement speakers
on a par with original equipment,
the prime source is Oxford. Oxford
is the foremost name in original
equipment speakers specified by
manufacturers. We can supply you
with exact replacement speakers
which will be of the same high
quality as that originally supplied.
Oxford has a complete line for any
and every application.

OXFORD SPEAKERS . . .
Preferred for original
equipment.
Proven for replacement.

Our catalog is available upon request.

OXFORD Components,
A Division of Oxford Electric Corp.
556 West Monroe St., Chicago 6, Illinois

Oxford Speakers are available from
recognized electronic parts distributors.

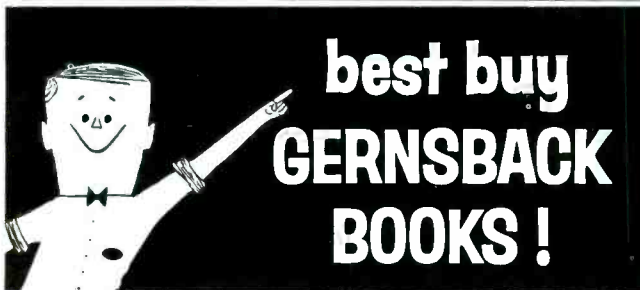
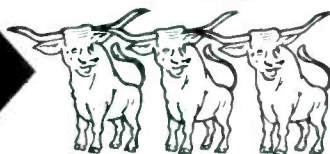

best buy GERNSBACK BOOKS!



SERVICING

- No. 85—How to Get the Most Out of Your VOM— \$2.90
- No. 81—Printed Circuits. \$2.90
- No. 78—Rapid Radio Repair. \$2.90
- No. 76—Servicing Transistor Radios. \$2.90
- No. 72—Oscilloscope Techniques. \$2.90
- No. 68—TV and Radio Tube Troubles. \$2.90
- No. 65—Servicing Color TV— \$2.90
- No. 60—Rapid TV Repair. \$2.90
- No. 59—Servicing Record Changers. \$2.90
- No. 57—The VTVM. \$2.50
- No. 55—Sweep and Marker Generators for TV and Radio— \$2.50
- No. 54—Probes. \$2.50
- No. 52—The Oscilloscope. \$2.25
- No. 50—TV Repair Techniques— \$1.50
- No. 49—Radio & TV Test Instruments. \$1.50

SEMICONDUCTORS

- No. 92—Fundamentals of Semiconductors— \$2.95
- No. 89—Transistor Projects. \$2.90
- No. 63—Transistor Circuits. \$2.75
- No. 61—Transistor Techniques. \$1.50
- No. 75—Transistors Theory & Practice. \$2.95

HIGH FIDELITY

- No. 90—Hi-Fi Made Easy. \$2.90
- No. 80—Stereo—How It Works. \$2.90
- No. 79—Designing and Building Hi-Fi Furniture. \$2.90
- No. 73—Audio Measurements. \$2.90
- No. 71—Audio Design Handbook. \$2.90
- No. 67—Elements of Tape Recorder Circuits. \$2.90
- No. 66—Basic Audio Course. \$2.75
- No. 64—Understanding Hi-Fi Circuits. \$2.90
- No. 58—Maintaining Hi-Fi Equipment. \$2.90
- No. 56—High-Fidelity Circuit Design. (Cloth bound.) \$5.95

- No. 48—High Fidelity—Design, Construction, Measurements. \$1.50

HOBBIES

- No. 74—Model Radio Control. \$2.65
- No. 70—Electronic Puzzles and Games. \$1.95
- No. 69—Electronic Hobbyists' Handbook. \$2.50
- No. 53—Radio Control Handbook. \$2.25

FUNDAMENTALS— MISCELLANEOUS

- No. 84—Marine Radio for Pleasure Craft. \$2.95
- No. 77—Guide to Mobile Radio. \$2.85
- No. 62—TV—It's a Cinch. \$2.90
- No. 47—Radio & TV Hints. \$1.00
- No. 45—Radio Tube Fundamentals. \$1.00
- No. 44—Basic Radio Course. (Cloth bound.) \$2.25

Books paper bound unless otherwise noted.

AT YOUR DISTRIBUTOR OR
ORDER DIRECT.

If exact resistances are available, each voltage range can be checked in a like manner. When you have no idea of the ohms-per-volt rating of an instrument, you can first employ a non-precision potentiometer to get a rough idea of its designed rating.

Checking sensitivity of the DC ranges for the Model 109, I employed a DC power supply with a variable output of 0 to 100 volts DC. Since the two lower ranges of the EMC meter had calibrations of 6 and 60 volts full-scale, I obtained two precision resistors with values equal to 120K and 1.2 meg, respectively. After taking the required measurements, I found that the second reading equalled exactly half that of the first in each case.

Portable CRO

No, the strange-looking object pictured in Fig. 4 is not a three-legged ant eater nor a creature from Mars; it's a new combination probe supplied with the most recent test instrument developed by RCA of Camden, N.J.

On the other end of the probe's cable you'll find the Model WO-33A oscilloscope (Fig. 5). The compact design of this instrument makes it ready to go anywhere, while wide bandpass characteristics classify it as an accurate troubleshooting tool for both black-and-white and color TV. The WO-33A comes complete with calibrated graph screen, probe, and instruction manual in either kit or factory-wired form.

Specifications are:

1. Power Requirements — 105/125 volts, 50/60 cps; average power consumption 50 watts; line-isolated supply; "on" indicator provided on panel.
2. Vertical System — wide-band response 5.5 cps to 5.5 mc within -3 db, sensitivity 100 mv (rms) / inch, five attenuation positions provided; narrow-band response 20 cps to 150 kc within -3 db, sensitivity 3 mv (rms) / inch, three attenuation positions provided; high-frequency rise time .1 microsecond; input impedance 1 megohm shunted by 90 mmf, with low-capacitance probe 10 megohms shunted by 10 mmf; maximum peak-to-peak input with 10:1 probe attenuation, 600 volts in presence of 400 volts DC.
3. Horizontal System — amplifier response 3.5 cps to 350 kc within -6 db; sensitivity 900 mv (rms) / inch; input resistance 10 megohms; gain control provided on panel.

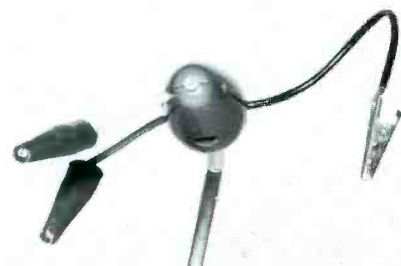

Fig. 4. No, it's not a man from outer space. It's a probe for new RCA scope.



GERNSBACK LIBRARY, INC., 154 West 14th St.
New York 11, N.Y.



Fig. 5. RCA's new "baby" oscilloscope does man-size job in shop or field.

4. *Internal Sweep System* — frequency continuously variable in four ranges from 15 cps to 75 kc; \pm internal and line sync with amplitude and phase controls provided; external sync input resistance 250K to 55K ohms.
5. *Voltage Measurements* — built-in calibration control and scaled graph screen provide peak-to-peak readings directly in volts.
6. *Size and Weight* — 8 $\frac{3}{4}$ " x 6 $\frac{1}{2}$ " x 10 $\frac{1}{2}$ ", 14 lbs.

With a front panel about the size of a meter, and case depth only twice that of a standard VTVM, I would certainly call the new RCA scope a portable instrument. In addition to a carrying handle, you'll find a bracket assembly on top of the case which serves as a line cord retainer when the instrument is not in use.

The screen bezel and all control knobs on the upper half of the front panel are made of a soft black rubber, while the vertical-range and sweep-selector switches use larger, blue plastic knobs. There are only three terminals across the bottom of the panel—vertical input, ground, and a dual-purpose input jack for external sync or external sweep signals.

One of the instrument's design features which particularly captured my interest is the unusual input attenuator circuit and voltage measurement system. The *V RANGE* switch is not calibrated in specific attenuation factors, but in eight individual multiples of either 2 or 6 — corresponding to two separate scales marked off on a graduated lens over the CRT. The first three positions of the range switch—.02, .06, and .2—are narrow-band, while the remaining five—.6, 2, 6, 20, and 60—are wide-band positions. The changeover from high sensitivity to increased frequency response is automatically accomplished when the switch is moved from .2 to .6.

In the extreme counterclockwise position of this same switch, labeled *CAL*, the vertical amplifier is disconnected from the input circuit and a calibrating voltage is applied. Using the *V CAL* control, vertical deflection is then adjusted until the voltage waveform occupies a certain height marked on the screen.



replace with **RCA** **POWER TRIODES**

for long life in industrial RF power applications

For reliability, high efficiency and long life in electronic heating and other industrial radio frequency power applications, make it a point to replace with RCA RF Power Triodes available from your local RCA Industrial Tube Distributor.

RCA Power Triodes are conservatively designed to provide efficient operation and long life under industrial conditions. This means less downtime as well as lower tube cost per hour of operation.

Your RCA Industrial Tube Distributor carries a complete line of RCA Power Tubes in a wide range of power and frequency ratings. Call him for immediate service on all your industrial tube needs.



RADIO CORPORATION OF AMERICA
Electron Tube Division
Harrison, N. J.

Designed with the Serviceman in Mind!



JERROLD magic carpet* antenna

NEW TV-FM Indoor antenna with outdoor performance . . .
NEW profitable business for you . . .

Servicemen everywhere are discovering a whole new market with this revolutionary new indoor TV-FM antenna. Now for the first time you can obtain signal gain across all frequencies, within 30 miles of the transmitter, that is comparable to that of a standard conical antenna.

In addition to strong gain characteristics, the Magic Carpet Antenna has an exceptionally low V.S.W.R. (Impedance Match) that assures maximum transfer of signal to the viewer without ghosting or smearing. Your customer avoids the expense and unsightliness of a rooftop antenna and the nuisance of ugly "rabbit ears"—you save time, trouble, and eliminate rooftop hazards with the quality-engineered, and profitable Jerrold "Magic Carpet" antenna. Get the details today!



In the Attic
Garage or Utility
Room Ceiling
In the Closet



For full information and samples of selling promotional material prepared specifically for you see your Jerrold Distributor or write



ELECTRONICS CORPORATION, Distributor Sales Division

Dept. IDS-43 The Jerrold Building, Philadelphia 32, Pa.

Jerrold Electronics (Canada) Limited, Toronto

Export Representative: CBS International, New York 22, N.Y.

*Trademark Patent Pending

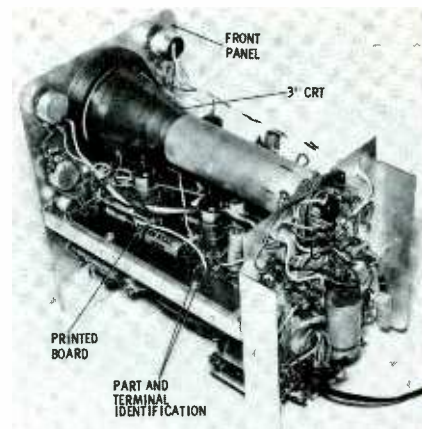

Fig. 6. The compact chassis of the Model WO-33A also comes in kit form.

After this simple calibration step, the input attenuator can be placed in any of its positions and the input signal read directly in peak-to-peak volts on one of the two graph scales.

Using direct input, with the vertical system properly calibrated, I discovered that a 60-volt peak-to-peak signal produced maximum viewable deflection. By using the instrument's low-capacitance probe, the peak-to-peak limitation is extended to 600 volts. Employing the V CAL adjustment as a gain control, peak-to-peak signals of approximately 200 volts can be applied directly without resulting in overscan. Under this condition, of course, the scope will not be calibrated for direct voltage measurements.

The probe and cable referred to earlier is the RCA Type WG-349A, which incorporates both direct and low-capacitance units. The probe head features three *Minigator* clip leads—black for ground connections, blue for direct inputs, and yellow for high-impedance inputs. The high-impedance or low-capacitance circuit incorporates a 9-megohm resistor in parallel with a 12-mmf capacitor. This network offers an attenuation factor of 10 to 1, which must be taken into account when measuring peak-to-peak signal amplitudes. A Type WG-350A demodulator probe for RF applications from 500 kc to 250 mc is also available as an accessory.

Although the Model WO-33A displays its waveforms on a relatively small 3-inch screen, I found the patterns to be sharp, bright, and of sufficient size for comparison with those given in service literature. Checking out the frequency response of the instrument, I took a look at a composite color waveform produced by an NTSC-type generator. The reproduction was excellent; I could see every detail of the complex signal including the color burst.

For those of you interested in kit construction of this scope, a view of the chassis is shown in Fig. 6. The instrument employs six vacuum tubes plus a 3AQP1 CRT. The electrostatically-focused CRT has a medium green phosphor, and the neck of the tube is completely protected by an external metal shield.



...this precision indoor-outdoor thermometer

tells indoor and outdoor temperature from the comfort of indoors, features an easy-to-read magnifying case, and can be installed easily—anywhere. Offer for limited time with an order for 100 fast-moving Westinghouse receiving tubes. Order one, or several, today! Call your Westinghouse Distributor.

WESTINGHOUSE BUYS BIGGEST POLITICAL CAMPAIGN PACKAGE

Every day during both political conventions Betty Furness will go on the air with the biggest, most pow-

erful Westinghouse TV and Radio Tube Promotion ever for Service Dealers. She'll blanket the country over a 204 station CBS-Radio network reaching more than 11 million listeners per broadcast. Get ready for this big profit opportunity. Place your tube order right away! You're going to need a lot!

YOU CAN BE SURE...IF IT'S Westinghouse

Westinghouse Electronic Tube Division, Elmira, N. Y. • Tune in Westinghouse—CBS TV-Radio Coverage, Presidential Conventions, July 10-29.

4 GREAT NEW SAMS BOOKS

"Tube Substitution Handbook"

Compiled by the engineering staff of Howard W. Sams & Co., Inc. Lists over 1500 American receiving tubes, including more than 300 which can be replaced by European receiving tube types. Also lists 400 picture tubes; 179 European types that can be replaced by American tubes, and 78 receiving tubes replaceable by industrial types. Includes helpful facts on tube substitution. Invaluable reference for technicians. Handy 5½ x 8½" size. Only.....



\$1.50

"Practical Transistor Servicing"

by William C. Caldwell

The latest word on how transistors and transistor circuits operate—shows how to signal-trace and diagnose portable and auto-radio troubles. Tried and tested procedures are based on the premise that "time saved is money earned." Concentrates on the practical in 8 fact-filled chapters; tells clearly how transistors work; describes circuit components and their functions; shows how to isolate troubles; indicates normal transistor voltages and explains meanings of defective voltages; tells how to test transistors; shows how to troubleshoot auto radios; gives actual case histories. Profusely illustrated; 5½x8½" \$2.95 Only.....



\$2.95

"Rapid Printed Circuit Repair"

by G. Warren Heath

Printed circuit boards, now being used in more and more electronic devices, can be a headache to the technician unless he understands their function and how to repair them. This practical book avoids complicated theory; it clearly describes and illustrates the fundamentals of printed circuitry and the components used by various manufacturers. Servicing and repair techniques and the various types of defects likely to be encountered are listed in alphabetical order for easy reference. 5½ x 8½". Only.....



\$1.95

"Electronic Tips and Timesavers"

by John Comstock

Includes over 300 ingenious time- and money-saving tips—solving just about any problem the technician, engineer, builder or experimenter might face. Simply written and supported by illustrations, these bench-tested hints will save you much effort and frustration. You'll want to keep this book handy for constant reference use. Eight sections include tips on bench and field servicing, shop and truck equipment, soldering, tools, test equipment, construction and experimentation. 5½ x 8½". Only.....



\$1.50

HOWARD W. SAMS & CO., INC.

Order from your Sams Distributor today, or mail to Howard W. Sams & Co., Inc., Dept. G-30 1720 E. 38th St., Indianapolis 6, Ind.

Send me the following books:

- "Tube Substitution Handbook" (TUB-1)
- "Practical Transistor Servicing" (PTC-1)
- "Rapid Printed Circuit Repair" (PC-2)
- "Electronic Tips and Timesavers" (TSC-1)

\$..... enclosed. Send Free Book List

Name.....

Address.....

City..... Zone..... State.....

..... (outside U.S.A. priced slightly higher)



Roll or Two

A Zenith Model Z2223R has the "rolls." When I can get it stopped, there are two pictures on the screen — one at the top and another at the bottom. There is also a small amount of foldover at the bottom. Information concerning this trouble will be appreciated.

JOHNSON WILSON

Pageton, W. Va.

This oscillator is running closer to 30 cps than the required 60 cps. See if it is possible to adjust the controls to obtain the voltages shown on the schematic; perhaps the control settings are so far off that it's impossible for the multivibrator to operate at the correct frequency. For a clue to frequency troubles, check the grid voltages — which are controlled by RC networks C59-R60-R5 and C58-R64.

If the voltage at pin 7 of V10 is incorrect and C59, R60, and R5 are good, substitute for C60, R61, R62 and K2 in the feedback circuit. (The latter combination of parts determines the amount of signal coupled back to the first stage from the output.)

You can check the approximate value

of this feedback signal by measuring the peak-to-peak amplitude of the pulse fed to the yoke. Even if it is impossible to synchronize the oscillator, you can still measure the amplitude of the yoke signal to get an idea of how well the output stage is doing its job.

Critical Vertical

A Crosley Chassis 431-3 has to be adjusted just right to hold vertically — then it jitters. At times it's impossible to get it to lock at all. Substitution of all the capacitors and resistors in the vertical circuit hasn't solved the problem. I've also replaced the integrator and the oscillator transformer. We sure need help.

T. PASTIGLIONE

Chicago, Ill.

First be certain the trouble is in the vertical stage and not due to the influence of the vertical sync signal. Our recent series on "Tough Dog Sync Troubles" will help you on this point.

If the sync signal is clean, refer to the production changes shown in PHOTO-FACT Folders 297-1 and 317-1; several changes have been made in the original design to improve vertical stability.

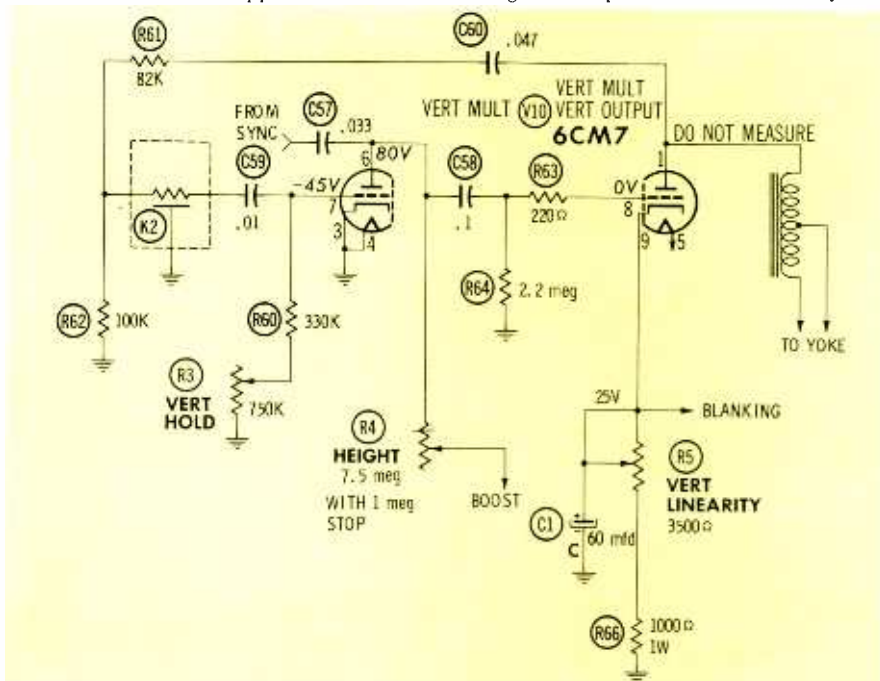

"PHOTOFACTS...most complete..."

"I have found PHOTOFACTS to be the most complete service information available on all makes and models of radios and television."

— Aaron F. Triplett
Flint, Michigan

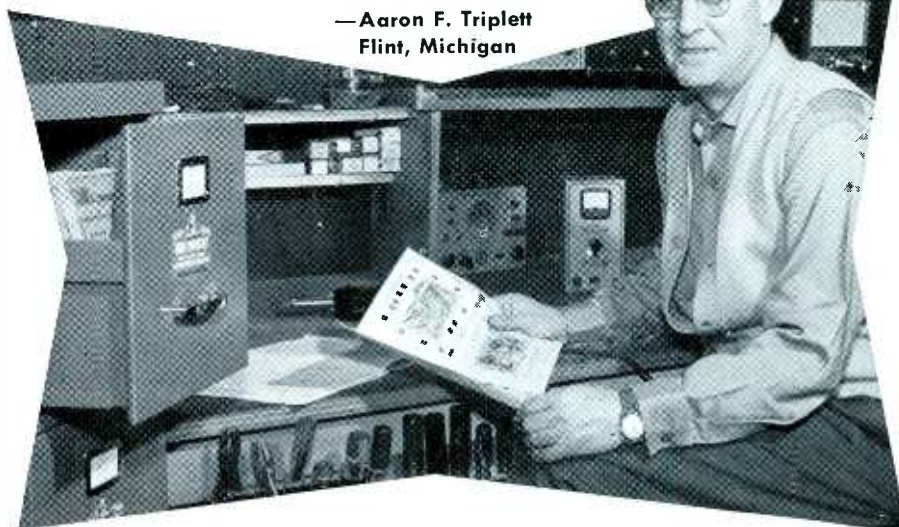

Service Technicians! YOU EARN MORE... YOU RATE with the public when you own the PHOTOFACT® service data library!

You enjoy maximum earnings as the owner of a complete PHOTOFACT Service Data Library! It's inevitable, because no matter how expert you are, you can always *save more time on any job, get more jobs done daily*—EARN MORE, DAY IN AND DAY OUT...

What's more—as the owner of a complete PHOTOFACT Library, you know your customers' sets *best*. You can actually show each customer you have the PHOTOFACT Folder covering his very own set. Result: You command public respect and acceptance which paves the way to more business and earnings for you.

HOW TO STAY AHEAD...

Yes, the truly successful Service Technicians are those who own the complete PHOTOFACT Library, who can meet and solve any repair problem—faster and more profitably. And these men *keep ahead* because they're on a Standing Order Subscription with their Distributors to receive all new PHOTOFACTS as they are released monthly. (They're eligible for the benefits of membership in PEET, too—see below!)

ONLY \$10 DOWN puts the complete PHOTOFACT Library in your shop—and you have up to 30 months to pay. See your Sams Distributor today, or write to Howard W. Sams

NOW IS THE TIME TO JOIN

"PEET"

THE POWERFUL NEW PROGRAM FOR QUALIFIED TECHNICIANS

If you now own a PHOTOFACT Library or plan to own one, you can apply for membership in "PEET." It's the first industry program really designed to build powerful public acceptance for the Service Technician who qualifies. Builds enviable prestige and business for its members. Benefits cost you absolutely nothing if you qualify. Ask your Sams Distributor for the "PEET" details, or mail coupon today.

HOWARD W. SAMS & CO., INC.
1728 E. 38th St., Indianapolis 6, Ind.

- Send me full details on the new "PEET" Program.
 - Send full information on the Easy-Buy Plan and Free File Cabinet deal.
 - I'm interested in a Standing Order Subscription.
 - I'm a Service Technician full-time; part-time
- My distributor is _____
- Shop Name _____
- Attn: _____
- Address _____
- City _____ Zone _____ State _____

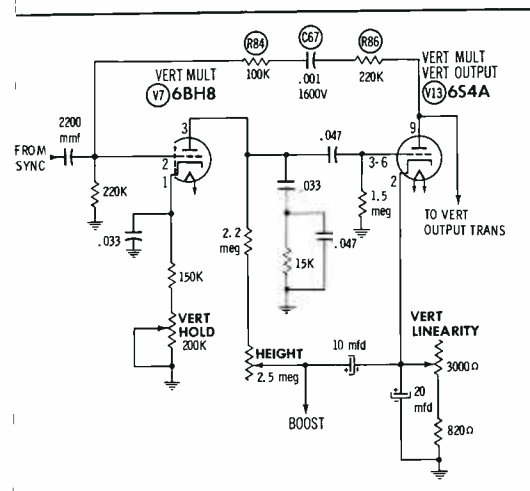

Keyed Vertical

An Admiral Chassis 20Y4E comes on with just a thin vertical line, then snaps into full deflection. When the set is switched off channel, the line returns; however, it works fine all the time it's on channel. Why does the vertical deflection conk out with no signal?

FRANCIS P. DOHERTY

Dorchester, Mass.

There is no doubt that the vertical sync pulse is keying the multivibrator into conduction and producing deflection when on channel. Since the multivibrator does operate when keyed, the apparent trouble seems to be in the feedback circuit. Substituting for C67, R84, and R86 should eliminate the trouble.

Spark Plates

Would you please give me some information about spark plates? I'd like to know why they are used, how to check them, and if there is a suitable substitute for replacements.

C. P. O'SULLIVAN

Chula Vista, Calif.

A spark plate in an auto radio is merely a bypass capacitor that uses the chassis as one of its plates. It consists of a piece of tin or brass and a thin sheet of insulating material (generally mica or fish paper). This assembly is usually riveted or bolted together, with the plates and fasteners separated by insulating washers.

The physical design forms a capacitor with a low-inductive characteristic, which is highly desirable for eliminating vibrator and ignition interference. Incoming leads are usually soldered to one end of the ungrounded plate and outgoing leads to chassis of something between 10 to 200 mmf (depending on physical size and material).

These components can be tested for shorts or leakage in the same manner as any other capacitor; however, measuring their value may be a problem because the entire area of the ungrounded plate must be considered. Although the low-inductive feature is important, I've found in most cases that a spark plate can be replaced with ceramic disc or feed-through capacitors.

SUPERIOR SERVICE

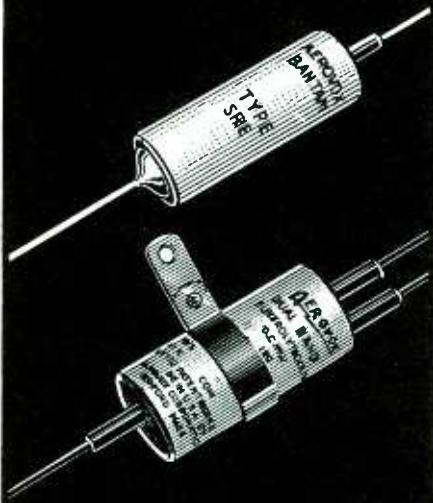

AEROVOX TUBULAR ELECTROLYTICS

The most popular 'lytics used in TV and radio service. Long established favorites with all service-technicians, Aerovox electrolytic capacitors can be counted on for dependable performance.

PRS DANDEES . . . compact tubular units in aluminum cans with cardboard insulating sleeves. Available in singles, duals, triples and quads as well as AC rated and non-polarized units. Multiple units are furnished with insulated stranded wire leads 5" long. Available in a wide range of capacity and voltage combinations.

SRE BANTAMS . . . smaller than the PRS type but perfectly capable of handling full size loads. Hermetically-sealed in aluminum cans and furnished with cardboard insulating sleeve. Available in voltages of 3, 6, 12, 15, 25, 50, 70 and 150 VDCW in all popular capacities.

For "Off-the-shelf" delivery on these and other Aerovox capacitors see your local Aerovox Distributor.

AEROVOX CORPORATION
DISTRIBUTOR DIVISION
NEW BEDFORD, MASS.

Let's Talk Antennas

(Continued from page 27)

present, a stationary conical will generally work well. When interference is a problem, you're more likely to obtain better reception by going to a stacked arrangement as shown in Fig. 2C. To improve directivity and gain, however, you might choose a more elaborate array (Fig. 4C).

As the signal fans out into suburban areas, antenna height becomes more important—not necessarily for increased gain, but to overcome ground-level interference. Position of the antenna is equally important; for example, you may find that you can eliminate a complaint of power-line interference by merely moving an antenna from the back of a house to the front. Conversely, by repositioning the installation from the front of a lot to the rear, you may find that disturbances caused from automobile ignition are considerably reduced. The photo in Fig. 6 illustrates the type of interference often encountered when an antenna installation is too close to a thoroughfare.

Here is a point often ignored by servicemen: Not only must the antenna be isolated as far from the interference source as possible, but the lead-in must also reject these unwanted signals. The best bet in really noisy locations is to use coaxial cable or shielded twin-lead. Signal losses in this type of transmission line are greater than in conventional 300-ohm ribbon, so when ridding an installation of noise pickup, remember that you may also be curtailing reception of the weaker stations in the area. One solution to this problem is to install a line amplifier—preferably one that will handle all TV signals contemplated for the area.

No single antenna type will always be right for every suburban installation; the only way you can successfully decide is to perform on-the-spot trials. Here, a simple test rig is the thing to use. You should have several basic antenna types available for quick mounting on a temporary portable mast. You might also consider the possibility of making up a universal test rig, where the antenna design can be altered by merely adding or removing certain elements or by changing their positions. You should monitor reception

on the customer's set rather than on one of your own, since receiver sensitivity varies for different makes and models.

The Rural Site

Let's consider a rural installation as being in the fringe and deep-fringe reception zones—like "way out"! However, we needn't think of it only as "down on the farm;" fringe areas also include many people in resort areas and small country communities, plus cities and towns without local telecasting facilities. If you're capable of choosing the right antenna and installing it properly, you can expect to obtain consistently good reception from stations located 100 miles from these sites. In some instances, viewable but somewhat snowy reception will also be possible up to 200 miles from the transmitter. (Again, line amplifiers will do much to improve the signal-to-noise ratio.)

Customer understanding is half the battle in a weak signal area. The serviceman must first acquaint himself with the particular reception problems and then be able to explain the situation so his customer can understand it. Remember, the customer is probably expecting excellent performance under extremely unfavorable conditions. You must present the facts in a diplomatic manner—not guaranteeing, but only predicting, that reception will be such and such if a certain antenna system is installed. It's not a bad idea to give the customer an option pricewise, naturally pointing out that if the least expensive system is employed, reception will be more limited.

Although gain is a prime factor in selecting an antenna for rural installations, directivity and front-to-back ratios are also of concern, especially where interference is a problem. Just because a manufacturer states that a certain antenna has exceptional gain, and that it will pull in signals from 200 miles away, doesn't mean that it will give good clear reception at all locations within this boundary. Some of the factors that might cause the manufacturer to qualify his statements are station power and height of transmitting towers, intervening terrain, height of receiving antenna,

losses introduced by system, and sensitivity of the receiver itself—not to mention bandwidth requirements or the directional problems that could be involved. The sensible way to choose an antenna is to pick up all possible data on the basic types you think the area calls for, and evaluate their gain figures and response characteristics. Even then, actual tryouts of two or three types may be the only way you can be assured you have given the customer the best possible antenna for the job.

A high-gain directional antenna with rotator is most desirable in the rural areas; however, if you're after only one or two stations in one general direction, a fixed installation may suffice. As a rule, a multiple-element Yagi will provide the gain needed. Variations of this design are available in all-band as well as single-channel models.

One method of increasing gain is to stack a Yagi or conical array. Theoretically, when antennas are paralleled, signal strength will increase to about 1.56 times that of an individual unit. To insure a reasonably close practical approach to this figure, consult the manufacturer's data for impedance figures and obtain details on spacing and matching techniques from a reliable book on antennas.* Stacking will generally narrow the bandwidth; therefore, if more than one channel is to be received, the use of a broadband antenna will probably be necessary. Accessories such as boosters, extra tall towers, and rotators can also prove very helpful in making a fringe installation successful.

Even though it may be a balmy spring day when you're called out on a job, keep in mind the year-around weather conditions of the area. If the weather is severe for several months out of the year, select an antenna with low wind resistance and suitable mechanical balance. A unit with small-diameter elements positioned in a horizontal plane is about the best for overcoming *Mother Nature's* punishment.

Since signal conditions are usually poor at rural sites, interference can be a major problem. These areas,

**Television Antenna Handbook*, by Jack Darr, published by Howard W. Sams & Co., Inc.

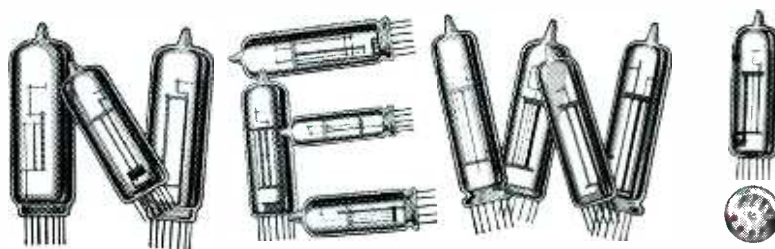

More top-quality tubes from Sonotone

- Complete line of miniature and subminiature tubes for all purposes.
- Featuring many hard-to-get European types!
- Each tube tested and guaranteed for highest quality by Sonotone!
- Sonotone tube production has qualified for the U.S. Signal Corps Reduced Inspection Quality Assurance Program (RIQAP).
- Feature Sonotone for customer satisfaction, top profits!

CHECK THE BIG SONOTONE SELECTION NOW

1AB6	6AJ8	6BY7	6U8	35W4	EABC80/6T8	EF85/6BY7
1AH5	6AL5	6BZ7	6V4	50BM8	EBC90/6AT6	EF86/5928-6267
1AJ4	6AM6	6CA4	6V6GT	50C5	EBC91/6AV6	EF89/6DA6
1B3GT	6AN8	*6CA7	6W4GT	50EH5	EBF80/6N8	EF91/6AM6
1L4	6AQ4	6CB6	6X4	5928-6267	EBF89/6DC8	*EL34/6CA7
1M3	6AQ5	6CG7	6X8	60EH5	EC91/6AQ4	*EL84/6BQ5
1S5	6AQ8	6CG7	9AQ8	60Z6	EC92/6AB4	EL90/6AQ5
1T4	6AT6	6DA5	12AT7	70Z5	ECC81/12AT7	EL95
2AF4A	6AU6	6DA6	12AU7	DAF91/1S5	ECC82/12AU7	EM71
2AF4B	6AV6	6DC8	12AU7A	DAF96/1AH5	ECC83/12AX7	EM80/6BR5
3AF4A	6AX4GT	6DJ8	12AX7	DC90	ECC84	EM81/6DA5
3C4	6BG6GA	6E58	12AX7A	DF91/1T4	ECC85/6AQ8	EM84/6F66
3V4	6BL7GTA	6FG6	12BA6	DF96/1AJ4	ECC88/6DJ8	EZ81/6CA4
5AR4	6BL8	6J6	12BE6	DK92/1L4	ECF80/6BL8	EZ90/6X4
5J6	6BM8	6J6A	12SN7GT	DK96/1AB6	ECF82/6U8	GCC34/5AR4
5U4GB	*6BQ5	6K6GT	0Z4	DL94/3V4	ECH81/6AJ8	PCC85/9AQ8
5Y3GT	6BQ6GTB/	6L6GC	16A8	DL96/3C4	ECL80/6AB8	PCL82/16A8
6AB4	6CU6	6N8	18DZ8	DM70/1M3	ECL82/6BM8	UCL82/50BM8
6AB8	6BQ7A	6SN7GTB	35DZ8	EAA-EB91/	EF80/6BX6	
6AF4	6BR5	6S4A	35EH5	6AL5		
6AF4A	6BX6	6T8				

*Available in Matched Pairs

Sonotone[®]

CORP.

ELECTRONIC APPLICATIONS DIVISION, ELMSFORD, N. Y., DEPT. T10-70
IN CANADA, CONTACT ATLAS RADIO CORP., LTD., TORONTO

LEADING MAKERS OF

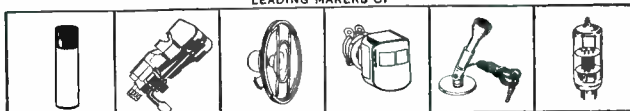

BATTERIES • CARTRIDGES • SPEAKERS • TAPE HEADS • MIKES • ELECTRONIC TUBES

AMPHENOL TV PRODUCTS

help you serve your market better!

ANTENNAS

Complete line of VHF, UHF, VHF/UHF and FM antennas. Famous Inline (re-issue U.S. Pat. 23,273) is considered by impartial authorities as the finest broadband VHF antenna ever built.

ACCESSORIES

Antenna or set couplers, arrestors, other important products—all carefully engineered to highest quality standards.

TWIN LEAD

Both receiving and transmitting types are made by AMPHENOL, including the "hot-test" twin lead on the market—AMPHENOL MARINE CORE, super low-loss Polyfoam.

COAXIAL CABLES

AMPHENOL's Cable-bility is famous: More types of RG-/U (Polyethylene and Teflon), more experienced engineering, most modern production facilities.



-INLINE*

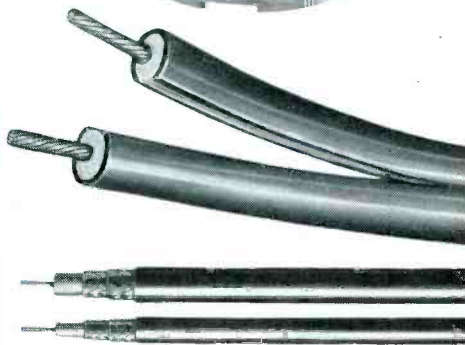

stock the finest—stock

AMPHENOL!

AMPHENOL

DISTRIBUTOR DIVISION

BROADVIEW, ILLINOIS

Amphenol-Borg Electronics Corporation

www.americanradiohistory.com

for instance, are more prone to such troubles as co-channel and adjacent-channel interference. A typical example of co-channel reception is shown in Fig. 7. This symptom is often referred to as "windshield-wiper" effect because the horizontal blanking bar of the weaker station tends to sweep back and forth across the stationary pattern produced by the stronger station. At other times, this condition will cause multiple horizontal lines across the desired picture — the so-called "Venetian blind" effect.

Either of these two co-channel symptoms may result when two stations operating on the same channel are received simultaneously. If re-orientation of the antenna won't eliminate this type of interference, you may have to resort to a special screen reflector or go to an array with a higher front-to-back ratio. The same suggestions hold true for adjacent-channel interference as mentioned in conjunction with Fig. 5.

As recommended for suburban areas, a test rig should also be used when surveying rural installations. In addition to a taller mast, your test setup should also include a fairly accurate field-strength meter. The meter readings can give you a good idea of what you can expect at a certain site, thus saving you from going too far with an expensive and time-consuming installation on the chance that it might work.

Ain't It A Site?

You'll run into a surprising number of "DX" fans in every reception area. These individuals are not likely to be as interested in actual program material as in the hobby of momentarily monitoring distant stations. They get most of their satisfaction out of being able to tell

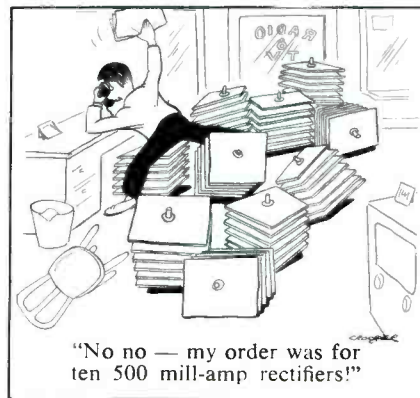

their friends and neighbors how they picked up "East Podunk" loud and clear the other night!

This sort of a job is a real challenge; it calls for a high-gain, all-channel directional antenna and special considerations to minimize overall losses in the system. In planning the system, initial consideration should be given to using a stacked broadband array and a rotator. Some type of Yagi is again a good choice, but since antennas have improved tremendously in the last few years, it will pay you to investigate the more modern designs as well. One I have in mind, for example, looks like a complex conical of some sort with an array of multilateral elements. Since this antenna is designed to receive all channels from all directions, it's considered to be a universal type well suited for "DX-ing." The lead-in used with this antenna has four wires, and a multiple-position switch is located at the receiver for matching purposes.

Booster amplifiers are also popular items for "DX" installations. There are two basic all-channel types—those that mount on the antenna mast and those that operate near the TV set. Several new types introduced during the past year have a higher signal-to-noise ratio than most existing TV tuners, so it would be worth your while to investigate "sounding up" existing installations. Mast-mounted units are recommended in cases where matching networks or transmission lines introduce excessive signal attenuation.

Summary

From the installation sites discussed here, you can see that there can be no hard and fast rules to dictate the exact type of antenna to use.

In making your final selection, you will undoubtedly have to accept a compromise among such characteristics as gain, directivity, front-to-back ratio, and frequency response. The choice rests with you; so make an earnest attempt to acquaint yourself with the latest commercial antennas and their accessories, evaluate their specifications, and try out the most desirable ones with a test rig. Never take another person's word for performance—see the results for yourself. ▲

Citizen's Band Radio Operators!



For improved reception, quality and range, use

Sarkes Tarzian Full Wave Silicon Rectifiers

\$13.00
user's price

S5347—replaces 6BW4 or 12BW4
S5017—replaces OZ4

Tarzian silicon rectifiers are available to replace over 95% of all popular vacuum tube rectifiers

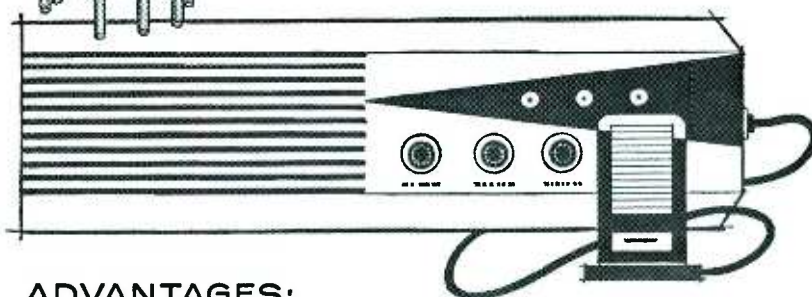

ADVANTAGES:

- Improved performance
- Cooler operation
- More reliability
- Less power drain (batteries last longer)
- Longer life for components
- Better regulation

Sarkes Tarzian's new Full Wave Silicon Rectifiers are ultra-high performance replacement tubes that give you the very maximum in reception, quality and range. Cool operation improves reliability and long life of all components.

Ask your repairman for a Sarkes Tarzian Full Wave Rectifier replacement, or see your nearest Sarkes Tarzian distributor. For additional information about Sarkes Tarzian tube replacement silicon rectifiers, write Section 5102C.



SARKES TARZIAN, INC.

World's Leading Manufacturers of TV and FM Tuners • Closed Circuit TV Systems • Broadcast Equipment • Air Trimmers • FM Radios • Magnetic Recording Tape • Semiconductor Devices

SEMICONDUCTOR DIVISION • BLOOMINGTON, INDIANA

In Canada: 700 Weston Rd., Toronto 9 • Export: Ad Auriema, Inc., New York

**NEWEST
BEST BUYS FROM**

EICO®

ripple
at full load
is only
0.005%



with new
**Model 1020
POWER &
BIAS SUPPLY
FOR**

TRANSISTORIZED EQUIPMENT

Wired \$27.95 Kit \$19.95

- Checks All transistor radios.
- includes power transformer, full-wave silicon diode rectifier circuit, electrolytic capacitor input filter followed by a two-power transistor (2-2N256) cascaded filter circuit providing extraordinary ripple rejection.
- output voltage: 0-30 VDC continuously variable, monitored by dual-range voltmeter (0-6, 0-30 VDC).
- continuous output current capacity: 150 ma @ 0-12 V; 200 ma @ 12-24 V; 300 ma @ 24-30 V.
- 0.5A fuse protects against short circuit.
- comparable in purity of output and in voltage & current capacity to transistorized supplies selling for several hundred dollars.
- ideal for laboratory, development & service work on transistors & transistorized equipment.
- rugged grey wrinkle steel case 5" x 4" x 5 1/2".

**SERIES/PARALLEL
R-C COMBINATION
BOX #1140**

Wired \$19.95
Kit \$13.95

Exclusive with EICO—1350 possible combinations! Switching facilities permit selection of any resistance or capacitance alone, or 1350 combinations of same in series or parallel. Standard EIA resistance values (1W) from 15 ohms to 10 megohms in decade multiples of 15, 22, 33, 47, 68, 100; standard EIA capacitance values (most 600V) from 0.0001 to 0.22 mfd. All 10% accuracy. Open & short circuit positions provided. Convenient jack-top binding posts. Compact: 6 1/4" h, 5 1/2" w, 2 3/8" d.

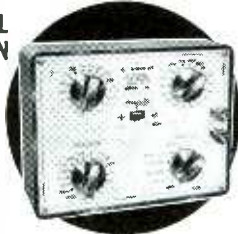

**FAST
TUBE & CRT
FILAMENT
TESTER #612**

Wired \$5.95
Kit \$3.95

Includes batteries

Fast filament checking of series string & all other TV & radio tubes (9-pin, octal, loctal, 7-pin); 14-pin, 12-pin, 8-pin CRTs; bayonet & screw-type pilot lamps; cartridge fuses. Just plug tube into tester socket, observe indicator lamp—no fiddling with controls or switches. Self-powered for convenience & safety. 7-pin & 9-pin miniature tube pin straighteners provided. Compact: 6 1/4" h, 3 3/4" w, 2" d.

Compare these best buys at your neighborhood EICO distributor. For free catalog on 65 models of EICO test instruments, hi-fi & "ham" gear, write to Dept. PF-7

EICO® Electronic Instrument Co., Inc.
33-00 Northern Boulevard
Long Island City 1, N. Y.

Servicing the "Big Loop"

(Continued from page 24)

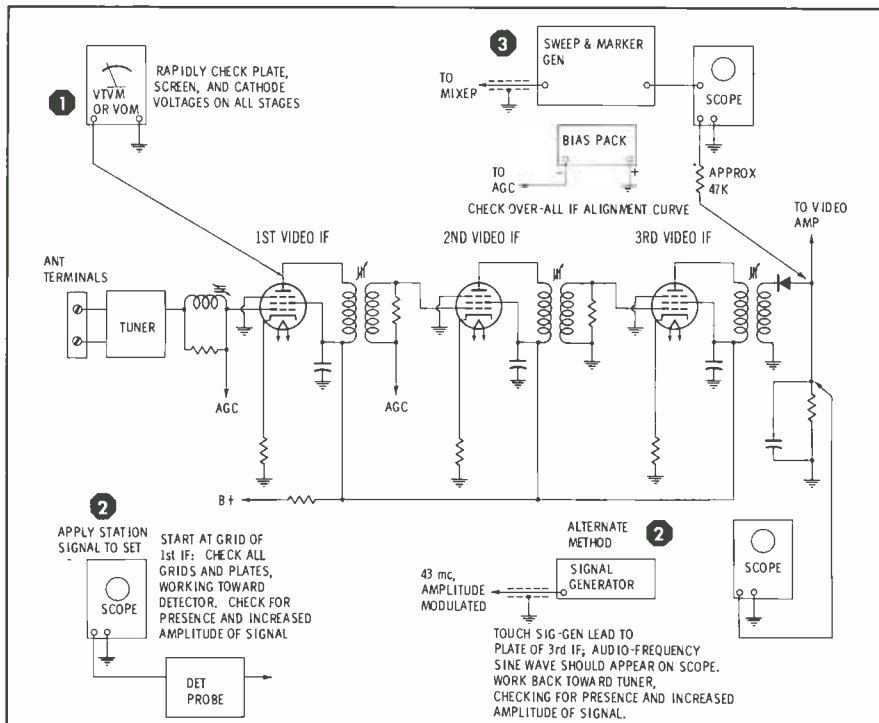

Fig. 3. Pointers for finding defect, once it has been isolated to IF strip.

rates enough to burn out or become "weak," it is also likely to develop other, more troublesome defects. One of these is leakage between cathode and heater, which leads to 60-cps hum modulation of the signal. If sufficient AC voltage is introduced, the picture will have a tendency to bend; in addition, sync stability will be affected, and light and dark bars (Fig. 1) are likely to appear in the picture.

Leakage also tends to develop between cathode and control grid after several years' service. The most serious effect of this condition in RF and IF amplifiers is a reduction in grid-bias voltage, which gives much the same results as a partial loss of AGC. Gas and grid emission are two

other troubles which yield similar symptoms. These grid troubles produce a variety of effects which can be summed up in the description "overloading." When an RF or IF stage operates at higher-than-normal gain because of insufficient bias, some succeeding stage is overloaded by receiving an input signal of too great an amplitude. Sync pulses are then either depressed or clipped off entirely, and the picture is likely to lose synchronization. In extreme cases of overloading, the signal may be partly inverted, thereby reversing tonal values in the image so that it resembles a photo negative.

Voltage measurements will uncover almost everything but open bypass capacitors, shorted coils,

TV TUNERS * REBUILT OR EXCHANGED

ALL TYPES

\$9.95

including parts and labor
(broken parts at our cost!)

- Normally shipped same day
- 90 day full guarantee
- U/V combinations \$17.95

FREE—If Mailing carton sent to you on request

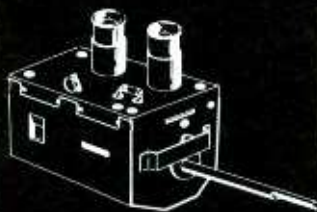

Phone REpublic 3-9189

L. A. TUNER EXCHANGE

4611 West Jefferson Blvd.
Los Angeles 16, California

shorted trimmer capacitors (if used), or misalignment. Usually, an open bypass capacitor will sharply reduce stage gain. This fault may be uncovered by signal tracing or signal injection. For tracing, a detector probe (Fig. 2) and a fairly sensitive oscilloscope are required. The input signal—either a local broadcast station or an amplitude-modulated RF test signal—is fed in at the antenna terminals. Various points in the video IF system are then checked to locate the point where the signal disappears or changes character.

If you prefer to use the signal-injection method, an AM signal generator tuned to the center of the video IF range (generally 43 mc or so) can be used to feed a signal voltage directly into various points in the IF strip. With the amplitude modulation turned on, an audio-frequency sine wave should be observed on an oscilloscope connected across the video-detector load resistor. Starting with the generator lead at the control grid of the final video IF stage, and working back toward the IF input, you can readily locate any stage where the signal is not being normally amplified or where it is being blocked altogether.

In some cases, the IF strip will pass the above test, and yet the receiver will not produce a satisfactory picture. When this happens, it is advisable to inspect the over-all IF alignment curve for discrepancies. A sweep generator, marker generator, and scope are employed in the usual manner to obtain this curve; refer to alignment instructions for the set concerned.

Fig. 3 summarizes the procedures to be followed in making a systematic check of a typical video IF strip, after you have assured yourself that all tubes are good and that the AGC circuit is not at fault.

AGC Circuit

The AGC circuit is so closely tied in with the video IF system that AGC trouble is often mistaken for an ordinary case of IF-amplifier trouble. Fortunately, there is a very simple way of determining whether or not the AGC line is at fault. Because of its very high impedance, the line can be rendered inoperative by simply connecting a small battery (or bias pack with low internal impedance) between it and the chassis

REMEMBER WHEN ...
-other guy wire SNARLED

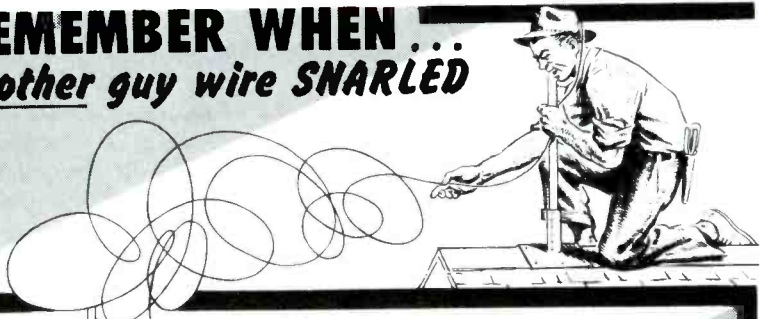

WRIGHT TV GUY WIRE
never did!



WRIGHT TV GUY WIRE ...

- Comes in 50' connected coils
- Has bright, long-lasting galvanized finish

Four strand No. 20 • Six strand No. 20 • Six strand No. 18 • No. 3—Cushion center
Seven strand—No. 18 Aluminum • All in 50' connected coils

Also on metal
and wooden reels

Wholesalers—
Stocks nearby

G. F. WRIGHT

STEEL & WIRE COMPANY

WORCESTER, MASS.

all new edition

up-to-date
component prices

PLUS

the quick easy way
to figure service charges

EQUALS



Dave Riee's

OFFICIAL PRICING DIGEST

VOL. 4, NO. 1



Flat rate and hourly service charges, based on and showing regional and national averages, plus up-to-date list or resale prices on over 63,000 components. Arranged alphabetically by manufacturers and products, numerically by part number. Compact, convenient size fits in tube caddy, toolbox or pocket. \$2.50 per copy from your distributor.

ELECTRONIC PUBLISHING COMPANY, INC.
180 N. WACKER DRIVE, CHICAGO 6, ILL.

3¢ will start you
on a new road to
additional profits
and happy customers
with speaker repair.

**WALDOM
RECONING**

Attach this coupon to
a Post Card and mail.
We will send you the
complete story.

Your Name _____
Company _____
Street _____
City _____
Send to **WALDOM ELECTRONICS INC.**
4625 WEST 53RD STREET, CHICAGO 32, ILL

as shown in Fig. 4. (This process is called "clamping" the line.) The negative terminal of the battery connects to the AGC line, while the positive terminal goes to ground. A bias value of -3 to -4.5 volts is considered normal, but will vary according to the set and the reception area. If set behavior returns to normal with the battery in use, the trouble lies in the AGC circuit. If the symptoms remain, the signal circuits should be checked.

When a troublesome case of hum, jitter, or tearing is encountered, and none of the usual service methods

resolve the trouble, you might try scoping the AGC line. If you find anything other than DC, chances are one of the components in the AGC filter network is defective. Any undesired AC voltages or pulses which manage to reach this line will find easy access to the tuner or IF stages, where they can distort the signal as it passes through. It takes very little extraneous voltage to upset the precise, split-second operation of a television receiver, so be especially watchful of the AGC network.

The most common trouble in the AGC line is an open or leaky bypass

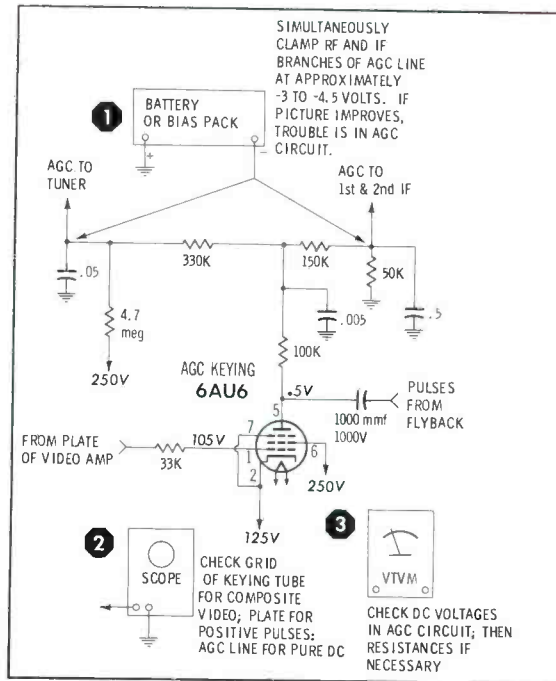

Fig. 4. Systematic troubleshooting procedure for typical keyed AGC circuit.

capacitor; in keyed systems, also be on the lookout for a defective keying tube. Furthermore, remember that keyed AGC circuits depend on a high-amplitude triggering pulse from the horizontal output transformer. Anything which affects the timing or strength of this pulse will affect the amount of AGC voltage developed. A scope is very useful for checking the keying pulse, as well as the AGC tube's grid signal. DC voltage measurements in the keying-tube circuit also are frequently helpful in leading you to the trouble source.

The RF Tuner

Troubles in the tuner fall into two categories—electrical and mechanical. The latter almost always stem from poor contact between the rotating and stationary parts of the turret or switch assembly. Once in a while, contact trouble is serious

Table I. Test Methods Applicable to IF, AGC, and Tuner

SECTION	TEST METHODS		
	PRIMARY	SECONDARY	
		1.	2.
VIDEO IF	VTVM	SIGNAL TRACING & INJECTION	ALIGNMENT CHECK
AGC	BIAS SUPPLY	SCOPE	VTVM
TUNER	VTVM	SIGNAL INJECTION	ALIGNMENT CHECK

LIFE'S "LITTLE" PROBLEMS

ARE EASILY SOLVED WITH

LITTLE SPACE

QUAM has a full line of shallow speakers, covering all popular applications.

LITTLE TIME

QUAM speakers mount quickly and easily in the most difficult installations because of QUAM's unusual mounting bracket.

LITTLE MONEY

QUAM speakers cost no more—and frequently cost less—than other speakers of the same size and magnet weight.

QUAM
Adjust-a-Cone
SPEAKERS

ask for QUAM, the quality line for all your speaker needs

A FREE copy of the latest QUAM catalog, listing over 100 replacement speakers, is available from your distributor, or from the Quam-Nichols Company.

Quam speakers are listed in Photofact Folders, Counter-facts, File-O-Matic, and Radio's Master.

QUAM-NICHOLS COMPANY

234 East Marquette Road Chicago 37, Illinois

enough to result in a complete loss of picture and sound on one or more channels; however, it's much more common to find such symptoms as streaks in the picture, noisy sound, intermittent snowy reception, etc., as a result of dirty or loose switch contacts. The solution to this type of problem may be as simple as cleaning tuner contacts, or as time-consuming as changing one or more mechanical components. Trouble of this sort is usually uncovered by observation and rotation of the channel-selector mechanism; electrical test instruments can generally contribute very little to localizing the defect.

Electrical troubles in the tuner can give rise to a host of symptoms, such as:

1. Picture snowy; sound volume much below normal.
2. No sound, no picture, and snowy raster.
3. Intermittent loss of picture and sound.
4. Inability to find any setting of the fine-tuning control where picture and sound both come in clearly.
5. Hum bars in picture, accompanied by horizontal pulling or other sync defects.

In the tuner, as in other sections of the TV receiver, tube checking is the initial step. Leakage and gas can be highly detrimental here, as well as in the IF; so it's best to depend on tube substitution instead of relying wholly on a conventional "value" test.

The next step is voltage measurement. If both picture and sound are absent or very weak, concentrate first on the B+ supply voltage entering the tuner. Also use a VTVM to check the voltage at the mixer-grid test point (see Fig. 5), which is usually in an easy-to-reach location on the top or side of the tuner. A reading on the order of -1 to -2 volts is normal in most cases, although the exact value will vary from one tuner to another. Insufficient negative voltage may be a sign that the local oscillator is not operating, or perhaps that not enough signal is being coupled from the oscillator into the mixer.

If the mixer-grid check leaves you in doubt as to whether the oscillator is in working order, you might try a direct measurement of the oscillator

grid voltage. The tuner cover does not necessarily have to be removed for this purpose. In some tuners, all tube-pin voltages and resistances can be conveniently measured at the test lugs of a socket adapter temporarily inserted between each tube and its socket. However, there are a couple of limitations on the use of these adapters. Many of the later-model tuners have captive tube shields which prevent access to the sockets, and even when an adapter can be inserted, you will sometimes find that it introduces enough added capacitance to detune the circuits or

even to kill the oscillator. If you run into trouble, it's worth the effort to take off the shield or bottom cover of the tuner so that you can reach the tube pins from below.

The foregoing procedures will uncover nearly all of the common troubles which beset TV tuners. The remaining troubles include open bypass capacitors, leaky capacitors of all types, and poor electrical contact caused by cold-soldered joints. The latter condition, a common cause of intermittent operation, is best remedied by touching a hot soldering iron to any connections which appear

Transistor Radio Servicing CAN be Highly Profitable



The ONLY Complete Transistor Radio Service Lab

Everything you need for less than \$50

Check Transistors, Diodes, Rectifiers . . .

SENCORE TRC4 TRANSISTOR CHECKER

Accurately checks all transistors in hearing aids, radios and power transistors in auto radios. Tests for opens, shorts, leakage, current gain. Measures forward-reverse current ratio on all crystal diodes. Measures forward and reverse currents on selenium rectifiers. With set-up chart for accurate checking of each transistor. Size, 5x4½x2½". With batteries. DEALER NET..... **19⁹⁵**



Replace Batteries During Repair . . .

SENCORE PS103 BATTERY ELIMINATOR

All-new "Transi-Pak," twin to TRC4 Checker above. Provides variable DC voltage to 24 volts; 1.5-volt biasing tap (a "must" for servicing Philco and Sylvania radios). Metered current output, to 100 ma. Handles 200-ma peaks. Two 200-mfd electrolytics provide proper filtering and low output impedance. No hum or feedback problems. Ideal for alignment using station signal; adjust IF slugs for max. current, also ideal for charging nickel-cadmium batteries. Size, 5x4½x2½". DEALER NET..... **19⁹⁵**



Find Defective Stage in a Minute . . .

SENCORE HG104 HARMONIC GENERATOR

New signal generator designed primarily for fast signal-tracing of transistor radio circuits. No need to unsolder all transistors. Provides RF, IF and audio signals *simultaneously*, drastically cutting service time. Traces from speaker to antenna. Clear 1000 cycle note signal is heard in speaker from all good stages. Signal weakens or stops at defective stage. Equally as effective for testing TV, hi-fi and other audio circuits also. Size, 3½x4½x1¾". With batteries. DEALER NET..... **9⁹⁵**



Turn page for other



SENCORE

ADDISON 2, ILLINOIS

ALL PARTS



MADE IN AMERICA

SENCORE

ADDISON 2, ILLINOIS

doubtful.

A signal-injection technique can frequently be used to advantage in locating intermittent troubles. Apply an amplitude-modulated RF signal to the mixer, either through the grid test point or by connecting the "hot" lead of the generator to an ungrounded shield slipped over the mixer tube. Tune the generator to one of the local TV channel frequencies, and adjust the receiver to obtain a series of black and white horizontal bars on the screen. Switch the tuner to this same channel, so that a picture appears on the screen

together with the bars. Let the receiver operate until the intermittent trouble occurs. If both signals disappear, the intermittent is somewhere in the mixer-oscillator (or a later stage); if only the station signal is lost, the intermittent is evidently in the RF amplifier circuit.

Open bypass capacitors in the tuner usually cause a sharp reduction in stage gain, often to the point where no signal can get through. Another fairly common fault is a crack in the outer casing of a feed-through capacitor, due to stresses and strains that take place during

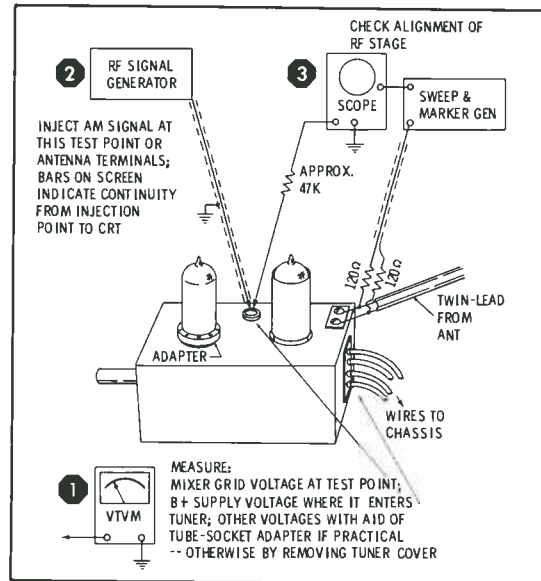

Fig. 5. What to do when you suspect an electrical defect in a TV tuner.

normal tuner operation. Possible symptoms of this trouble include lowered gain, frequency drift, intermittent operation, or no operation at all. Sometimes the cracks can be spotted visually; at other times, each unit has to be individually tested before the failure is brought to light.

Misalignment of the RF stage is occasionally the root of poor tuner performance — especially when the trouble is worse on some specific channel or group of channels. An alignment touch-up can be performed by feeding a VHF signal from a sweep generator into the antenna terminals, connecting a scope to the mixer-grid test point, and following the alignment instructions given.

In summary, RF tuners lend themselves to essentially the same troubleshooting methods as video IF amplifiers, but produce added difficulties because of their compact, precisely-arranged layout. In addition, the movable parts of the channel-switching mechanism are a further source of possible trouble.

Table I is a condensed guide to aid you in choosing test instruments for troubleshooting electrical faults in video IF, AGC, and tuner circuits. In each case, it is assumed that tubes are in good condition and the chassis has been inspected for defects of a purely mechanical nature. ▲

Editor's note: The September "Shop Talk" column will wind up the series on service techniques for TV circuits. It will include troubleshooting procedures for sound IF and sync sections.

YOUR CUSTOMERS SPEND OVER \$2200 A YEAR ON AUTOMOBILE AERIALS

The figures show that the customer served by the average radio-television shop spent over \$2200.00 per year on automobile aerials. This is business that is getting away from most service shops. The same man who saw you a few days ago when you repaired his television set, is an automobile aerial customer. He is not a potential customer but is an actual customer. This market requires no additional selling on your part. **ARE YOU GETTING HIS AUTOMOBILE AERIAL BUSINESS?**

Why not? It's so easy. Installing an automobile aerial is one of the simplest things imaginable. Ward Products makes all their aerials so that they mount completely from the top through one hole. They need merely be plugged into the input jack of the auto radio.

THERE IS ALMOST NEVER A CALL BACK ON AN AERIAL INSTALLATION. Ward Products furnishes with each aerial an exclusive, life-time guarantee. No other manufacturer offers this Warranty.*

Now how do you get into the automobile aerial business? Simple, Ward Products will furnish you at no charge a complete merchandising kit including window banners, counter display, and folder "How to Install Auto Aerials" complete with illustrated photographs to show you the easiest and fastest way to install aerials.

Can you afford any longer to ignore the automatic profits your existing customers are giving to other dealers?

LIFETIME GUARANTEE

*Guaranteed in normal use against defective manufacturing, shorted leads, peeling of chrome, loose elements, etc.

For complete information and a look at our Merchandising Package — Please fill in the coupon below

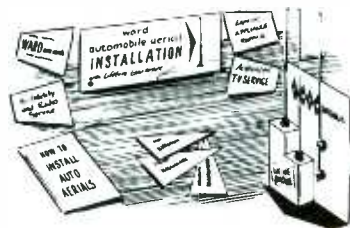

MAIL TO:

WARD PRODUCTS CORPORATION
AMSTERDAM, NEW YORK

STORE NAME
NAME
STREET
CITY ZONE STATE

Sine-Wave Oscillator

(Continued from page 29)

linear during the first half of the scanning cycle! However, this non-linearity causes no trouble, since the output tube doesn't even begin conducting until the electron beam has traveled almost halfway across the screen. (Remember, the yoke current is being supplied entirely by the damper circuit during this period.)

The conduction pattern of the output stage is clearly shown by W2, the signal developed across the 18-ohm cathode resistor. The cathode current is zero during the early part of the scanning cycle, but rapidly rises to a peak as the cycle approaches its end. Both W1 and W2 normally show a slight flattening at the positive peak, indicating that the output tube is being driven briefly into saturation and is drawing enough grid current to replenish the grid-leak bias on the stage.

No separate waveform photo has been shown for pin 6 of the 5GH8, since the signal at this point is virtually the same as W1 in both waveshape and amplitude.

Now let's look at the oscillator. Being a Hartley circuit, it has a center-tapped inductor in its tuned tank. A connection through a .1-mfd capacitor places the tap at AC ground potential, and the screen and control grids of the oscillator tube are connected to opposite ends of the tank. The signal voltages on these tube elements — W3 and W4 — are sinusoidal and 180° out of phase. The notched negative peak of screen waveform W3, and the flat

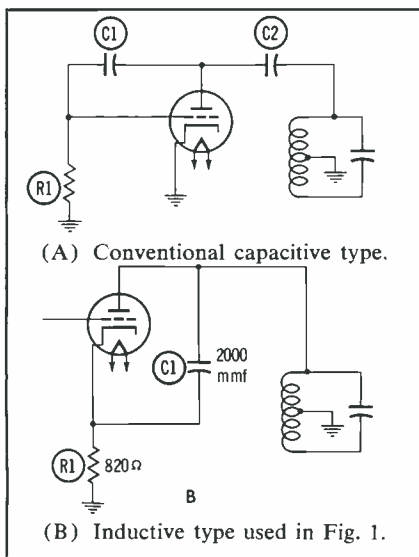

Fig. 3. Simplified schematics of two basic types of reactance-tube circuits.

spot on the positive peak of grid waveform W4, plainly show the duration of tube conduction for each cycle.

Reactance Tube

The grid end of the oscillator tank is directly coupled to the plate of the reactance tube, and plate waveform W5 corresponds fairly closely to W4. In terms of practical results, the operation of the reactance tube is very simple — any increase or decrease in its plate current will cause a corresponding increase or decrease in oscillator frequency.

However, this action is accomplished in an unconventional way in the Motorola circuit, and the operating theory of the reactance tube deserves closer scrutiny.

By way of introduction, let's briefly review the more common type of circuit shown in Fig. 3A. This is the arrangement used in the AFC circuits of many FM radio receivers, as well as in the horizontal sweep section of recent-model Zenith TV sets. C1 is a very small capacitor, sometimes consisting only of the internal grid-to-plate capacitance of the tube; therefore, its ca-



SENCORE SS105 SWEEP CIRCUIT TROUBLE SHOOTER

IT'S A ... **UNIVERSAL HORIZONTAL OSCILLATOR.** For direct substitution. No wires to disconnect in most cases. Traces trouble right down to the defective component. Variable output from 0-200 volts, peak-to-peak. Oscillator will sync to TV sync signal giving check on sync circuits.

HORIZONTAL OUTPUT CATHODE CURRENT CHECKER. A proven method that quickly checks the condition of the horizontal output tube and associated components. Adaptor socket prevents breaking wires. Easily replaceable Roll Chart gives all necessary pin, current and voltage data. New Roll Charts are Free.

UNIVERSAL DEFLECTION YOKE. A new, simple way to determine yoke failure accurately—without removing yoke from picture tube. Merely disconnect one yoke lead and substitute. If high voltage (also bright vertical line) is restored, TV yoke is defective.

DYNAMIC FLYBACK TRANSFORMER CHECKER. Merely flip switch to "Flyback Check" and meter will indicate condition of flyback transformer, in degrees of horizontal deflection. Extremely sensitive and accurate; even shows up one shorted turn on flyback.

VOLTMETER. For testing bootstrap, screen and other voltages. Direct-reading voltmeter, 0-1000 volts.

UNIVERSAL VERTICAL OSCILLATOR. Checks oscillator, output transformer and yoke. Merely touch lead to component and check picture on screen.

SS105 is completely self-contained, nothing else is needed. New Improved Circuit... DEALER NET 42⁹⁵



HORIZ. OSC.	VERT. OSC.
HORIZ. O.P. STAGE	VERT. O.P. STAGE
HORIZ. FLYBACK XFORMER	VERT. O.P. XFORMER
HORIZ. DEFLEC. YOKE	VERT. DEFLEC. YOKE

ALL PARTS
SENCORE
MADE IN AMERICA

SENCORE
ADDISON 2, ILLINOIS



for Private Conversations...

... you can't beat the flexibility of FANON-FONE telephone intercoms. Whether your neighborhood customer wants a 2-station system in his house or business or many extensions for offices and factories, FANON will help you profit on the sale and installation. Homes, restaurants, bars... many of your present customers need a FANON Intercom. Are you getting your share of the business?



"85" SERIES FANON-FONE — Telephone Intercom.

Smartly styled and suitable for wall or desk use. Provides selective ringing with common talk-line. High impact polystyrene in grey, black and ivory. From 2 to 11 phones per system. Phones start at \$34.95 list.

Stop looking and act now! We'll send you sample folders, specs, displays, etc., plus a BIG glossy photo of our girl, Jayne.

FANON

FANON Electronic Industries, Inc.
Dept. PF-7 98 Berriman St., Brooklyn 8, N. Y.

Name _____
Firm Name _____
Address _____
City _____ State _____



(A) At "slow" end of range.

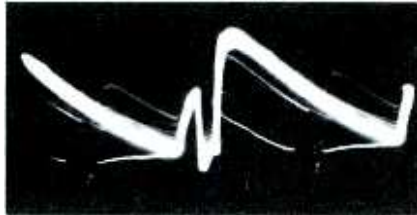

(B) At "fast" end of range.

Fig. 4. W10 changes shape as control is turned through hold-in range.

capacitive reactance at the operating frequency is much greater than the resistance of R1. When the oscillator signal is coupled back from plate to grid, the highly capacitive coupling circuit causes an advance in its phase so that the grid-signal voltage leads the plate-signal voltage by nearly 90°. Since the plate current of the tube rises and falls in phase with the grid voltage, the plate current therefore leads the plate voltage by 90°.

This means the reactance tube will act as though it were a variable capacitor connected across the oscillator tank. Whenever the reactance-tube current increases, more shunt capacitance is added, and the oscillator frequency is lowered. On the other hand, reducing the reactance-tube current decreases the apparent capacitance and thus speeds up the oscillator.

The Motorola circuit (see simplified diagram, Fig. 3B) also employs an RC feedback network which advances the phase of the signal by 90°; however, the signal is injected into the cathode of the

reactance tube instead of the grid. Cathode waveform W6 shows evidence of the leading phase angle between the cathode and plate voltages. Note that the positive peak of the sine wave (feedback signal) occurs well ahead of the pulses which mark the oscillator-conduction period (positive peak of the plate signal). This "leading" signal voltage on the cathode has an effect just opposite to that of a "leading" voltage on the grid. As a result, the plate current lags the plate voltage by 90°, and the reactance tube behaves as a variable inductance instead of a

TARZIAN Offers 48-Hour, Direct Factory Service on Tuner Repairs

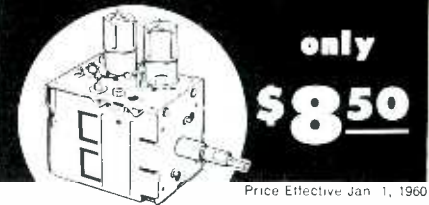

only
\$8.50

Price Effective Jan. 1, 1960

That's right. Net, \$8.50 per unit and \$15 for UV combinations, including ALL replacement parts. 90-day warranty against defective workmanship and parts failure. Tuners repaired on approved, open accounts. Replacements offered at these prices* on tuners not repairable:

VHF 12 position tuner	\$22.00
VHF 13 or 16 position	23.00
VHF/UHF combination	25.00
UHF only	15.50

*Subject to change



Tarzian-made tuners are easily identified by this stamping on the unit. When inquiring about service or replacements for other than Tarzian-made tuners, always give tube complement . . . shaft length . . . filament voltage . . . series or shunt heater . . . IF frequency, chassis identification and allow a little more time for service. Contact your local distributor or use this address for fast, 48-hour service:

SARKES TARZIAN, Inc.

Att.: Service Mgr., Tuner Division
East Hillside Drive
Bloomington, Indiana



QUIETROLE

LUBRI-CLEANER

The first of its kind and still best for silencing noisy controls and switches in TV, Radio & all Electronic Equipment.

Spray it or Drop it

Just Press and whoosh . . . aerosol QUIETROLE quickly and easily cleans as it lubricates.

Or, if you prefer, use this handy eye-dropper and just a drop or two of quality QUIETROLE does the job perfectly.

Either way, make sure it's QUIETROLE

QUIETROLE

Company, Inc.

Spartanburg, South Carolina



In Canada:
CROSS CANADA ELECTRONICS
67 Ontario St., Kitchener, Ont.

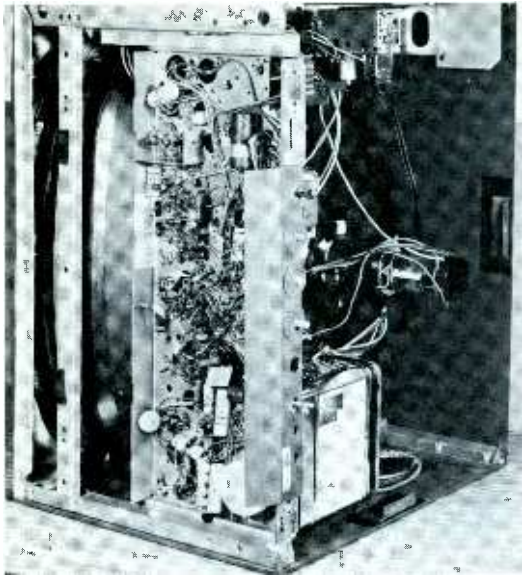

Fig. 5. In some Motorola table models, the bottom of the cabinet is removable.

variable capacitance.

This inductance is in parallel with the portion of the tuned tank between the oscillator control grid and the center tap. An increase in reactance-tube current decreases the value of this added inductance, thereby raising the resonant frequency of the tank. Similarly, a decrease in tube current lowers the frequency.

Phase Detector

No signal voltage is normally present at the grid of the reactance tube; a filter circuit removes all but a tiny ripple voltage (W7). However, a variable DC voltage is fed to the grid from the dual-diode phase detector. If the oscillator attempts to operate at a frequency higher than 15,750 cps, the diodes develop a negative output voltage which decreases the plate current of the reactance tube. When the oscillator frequency is too low, the phase-detector output is positive, and the reactance tube is driven into heavier conduction. This control-voltage polarity is just the opposite of that required by a cathode-coupled multivibrator.

Except for the reversal in output polarity, the phase detector in Fig. 1 is identical to the circuit used by Motorola to control multivibrators in other recent-model sets. Here is a summary of its operation:

The actual sweep frequency is indicated by sawtooth signal W8, which is fed back from the yoke circuit and developed across both

diodes in series. Only one sync signal is required; it consists of negative pulses (W9) fed to the common cathode of the dual diodes. The combined cathode signal appears as shown in W10.

An average cathode voltage of approximately +5 volts is developed in the course of normal operation, thus biasing the diodes so that they conduct mainly on the negative peaks of W10 (sync pulses). If the oscillator frequency is correct, W8 will be midway through its retrace period (steep positive-going slope) when the sync pulse arrives.

The net value of the sawtooth-signal voltage during sync time will then be zero, and W8 will have no biasing effect on the diodes. The sync pulse applied to the common cathode will cause equal conduction of both diode sections, resulting in equal but opposite voltages across the two 470K-ohm load resistors. (Note the polarity markings in Fig. 1.) The output, taken from across these two resistors in series, will be zero.

Whenever the oscillator tends to drift off frequency, the biasing action of W8 comes into play. A "slowdown" of the oscillator causes



SENCORE RS106 RECTIFIER TROUBLE-SHOOTER

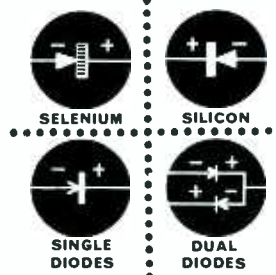

Instant, Direct Substitution for . . .

SELENIUM RECTIFIERS. Substitutes for all types used in Radio, TV and other electronic devices up to 500 ma.

SILICON RECTIFIERS. Types found in many new TV sets.

SINGLE DIODES. With exception of some used in high frequency circuits.

DUAL DIODES. Types used in sync Discriminator circuits. Third test lead is provided for center connection.

Sencore has simplified trouble shooting rectifiers and diodes with this unique substitution unit. The RS106 gives you a positive check everytime . . . Substitute for suspected rectifier or diode . . . watch picture or listen to sound and you'll know in seconds whether or not the rectifier or diode should be replaced. No guess work, no soldering mess, no time lost. The RS106 actually costs less than having loose rectifiers and diodes in the shop for testing and is worth many times more.

- Rectifiers & Diodes at your finger tips for fast substitution
- Protected by 1/2 amp. Slow Blow Fuse.

RS 106
DEALER NET. . . 12⁷⁵

Ask your Distributor to show you the RS106.

ALL PARTS
SENCORE
MADE IN AMERICA

SENCORE
ADDISON 2, ILLINOIS

VALUABLE **SAMS** BOOKS ON
TEST EQUIPMENT
available from your local
SAMS DISTRIBUTOR

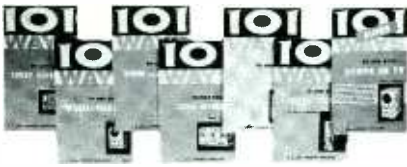

FAMOUS "101 WAYS" SERIES
BY BOB MIDDLETON

These wonderfully practical books will help you put your test equipment to work more frequently and profitably. Bob Middleton shows you simply and clearly how to apply each instrument, how to make proper connections, what added equipment is needed, proper test procedure and evaluation of results. Each book is handy 5 1/2" x 8 1/2" size and fully illustrated.

- 101 Ways To Use Your Sweep Generator.** 138 pages. No. TEM-1. Only.....\$2.00
- 101 Ways To Use Your Oscilloscope.** 180 pages. No. TEM-2. Only.....\$2.50
- 101 Ways To Use Your VOM & VTVM.** 116 pages. No. TEM-3. Only.....\$2.00
- 101 Ways To Use Your Signal Generator.** 124 pages. No. TEM-4. Only.....\$2.00
- 101 Ways To Use Your Audio Test Equipment.** 136 pages. No. TEM-5. Only.....\$2.00
- 101 Ways To Use Your Ham Test Equipment.** 168 pages. No. TEM-6. Only.....\$2.50
- 101 More Ways To Use Your Scope in TV.** 160 pages. No. TEM-7. Only.....\$2.50



Know Your Oscilloscope. The very latest information on this important test instrument — covers the circuitry, operation, adjustments, servicing and applications of oscilloscopes. Twelve chapters include: General Information; Power Supplies; Sweep systems; Synchronization; Amplifiers; Special Features; Accessories; Adjusting and Servicing the Oscilloscope; Frequency and Phase Measurements; Amplifier Testing with Square Waves and Sweep Signals; Radio and TV Alignment; Practical Applications and Servicing Procedures. 160 pages, 5 1/2" x 8 1/2". No. KOS-1. **\$2.00 Only.**

How To Understand and Use TV Test Instruments. Completely revised and enlarged to include latest data on instruments used for Color TV Servicing. Tells how each instrument operates, how to use and get the most from it in actual servicing. Covers: Vacuum Tube VM's, Signal Generators, Sweep Signal Generators, Scopes, Video Signal Generators, Field Intensity Meters and Voltage Calibrators. 176 pages, 8 1/2" x 11". No. TN-1 (Revised). **\$3.50 Only.**

Servicing and Calibrating Test Equipment. Shows you how to keep your test instruments in reliable working order. Explains proper operation of instruments, calibration procedures, simple ways to check instrument accuracy, how to service test equipment; includes many valuable time-saving tips. 184 pages, 5 1/2" x 8 1/2", illustrated. No. TEK-1. **\$2.75 Only.**

FREE SAMS BOOKLIST AVAILABLE—ask your Distributor or write us direct

Available from your Sams Distributor
HOWARD W. SAMS & CO., INC.
1720 E. 38th St., Indianapolis 6, Ind.

the feedback signal to lag behind the sync signal. W10 then looks like Fig. 4A, with the sync pulse appearing before W8 has completed its negative half-cycle. W8 then tends to make the plate of the upper diode negative with respect to the cathode, and also makes the cathode negative with respect to the lower diode plate. This added bias tends to increase the conduction of the lower diode, while decreasing that of the upper one. The positive voltage across the lower load resistor then exceeds the negative voltage across the upper resistor, and the resultant DC output is positive.

If the oscillator speeds up, the sync pulse does not arrive until after W8 has passed through zero and is approaching its positive peak (see Fig. 4B). The diodes are then biased so that the upper section conducts more heavily than the lower one, with the result that a negative output voltage is produced.

Service Observations

When bench-servicing a table model equipped with Chassis TS-556 or -567, don't worry about pulling the chassis. The bottom panel of the cabinet is completely removable, as demonstrated in Fig. 5. In addition, the side and top panels can be individually replaced if damaged.

The new sine-wave horizontal circuit uses a 5GH8 tube—the latest type in a series which also includes the 5EA8 and 5U8. Either of the latter two can be used as a temporary substitute in a pinch, but the 5GH8 is designed to be more stable and reliable in this application.

As you may have noticed in Fig. 1, nearly all parts in the horizontal

circuit are grouped into three component combinations. This results in the simplified chassis layout evident in Fig. 6. Should trouble develop within one of the multiple units, the defective section can often be cut out of the circuit and replaced with a conventional component. Detailed instruction in this technique is given in "Modular Component Replacement," in the January, 1960 issue.

Also visible in Fig. 6 is the rear-panel horizontal hold control, a slender plastic "quill" attached to the slug in the oscillator coil. Once

Picture-Tube Repair Tool

Eliminates that hard soldering job

only \$1.25 each

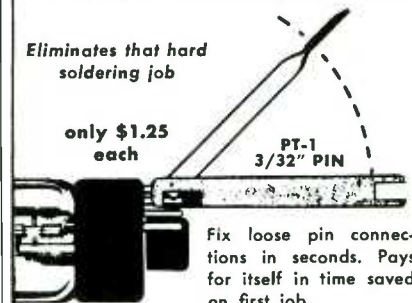

Fix loose pin connections in seconds. Pays for itself in time saved on first job.

Intermittent operation of picture tubes due to defective socket connections easily corrected. Provides solid electrical connections, can also be used as channel-selector wrench and screwdriver. Pin keeps its original form.

3 MODELS
ELIMINATE SOLDERING

Pin-Plug Crimper

Slip wire in "pin plug," insert in tool, and squeeze — job is done.



Use end of tool to push on C-ring

The tool that makes solid electrical pin-plug connections without soldering.

Model LC-3 for 5/32" pin diameter

Available at your parts distributor.

BERNS Mfg. Co.
9853 Chalmers,
Detroit 13, Mich

PHONE
ED 9-9653

\$7.50

plus parts,
C.O.D. and postage charges

Precision Tuner Service

ALL TYPES T.V. TUNERS REPAIRED AND ALIGNED TO FACTORY SPECIFICATIONS ON CRYSTAL-CONTROLLED SWEEP GENERATORS

24-HOUR SERVICE ON MOST TUNERS

UHF - VHF COMBINATIONS — \$13.50

See your local distributor or send to:
P.O. Box 272, 601 N. College
BLOOMINGTON, INDIANA

State make and model. Send all parts, tubes and shields

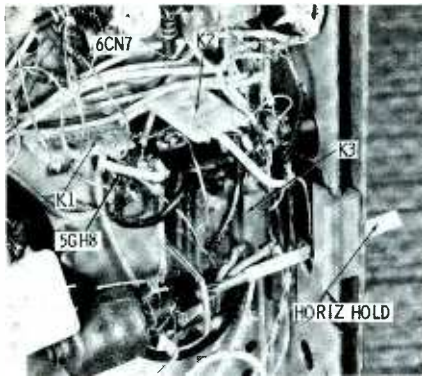

Fig. 6. New circuit makes extensive use of component-combination units.

the picture has been synchronized, it will remain in sync through several turns of this control . . . but be careful! Unless the slug is very close to the center of the hold-in range, the picture is likely to drop out of sync when the signal is interrupted. To prevent this annoyance, a rather critical slug adjustment is necessary; a half-turn either way makes the difference between *too fast* and *too slow*. However, the oscillator is highly stable when properly aligned. The most effective test of horizontal lock-in is to switch off channel and back again. If the picture is in sync when it reappears, the slug setting is correct.

It's important to remember that a fairly critical horizontal hold adjustment is perfectly normal for this circuit, just as it is for many of Motorola's multivibrators. A limited hold-in range should thus be no cause for worry. However, a need for frequent readjustment of the control is a significant trouble symptom, indicating that the oscillator frequency is drifting to an abnormal degree.

The phase-detector output voltage, measured at the rear-panel test receptacle or reactance-tube grid,

Table I. Typical Voltages in Motorola T5-567 Horizontal Section.

TUBE & PIN	NORMAL VOLTAGE	HOLD-IN RANGE	PULL-IN RANGE
6CN7-3	+5	3.2 to 6.8	4.6 to 5.4
6CN7-2 5GH8-9	+0.1	3 to -4.5	+0.7 to -0.7
5GH8-8	+4.3	3.2 to 5.8	4.0 to 4.6
5GH8-1 5GH8-3	+135	122 to 145	132 to 138
5GH8-2	-25	*	*
5GH8-6	+145	*	*
12DQ6A-5	-50	*	*
12DQ6A-8	+1.9	*	*

* Slight or no change as hold control is turned.

should vary from approximately +3 to -4.5 volts as the control is slowly rotated through its hold-in range. Once sync is lost, the control voltage must be brought within the relatively narrow range of +0.7 to -0.7 volts in order to pull the oscillator back into synchronization.

For optimum operation, the test-point voltage is only about a tenth of a volt more positive than ground—and this brings up an important troubleshooting hint! Grounding the AFC test receptacle is an effective method of checking the free-running frequency of the oscillator-reactance

tube combination. With the phase detector thus disabled, you should almost (but not quite) be able to lock in the picture by careful manipulation of the hold adjustment. It should be possible to induce a slow horizontal rolling of the picture in either direction, before it breaks up into diagonal lines on either side of the correct frequency.

In closing, a number of typical voltage observations for the circuit in Fig. 1 have been summarized in Table I for your convenience in analyzing a similar circuit's performance. ▲

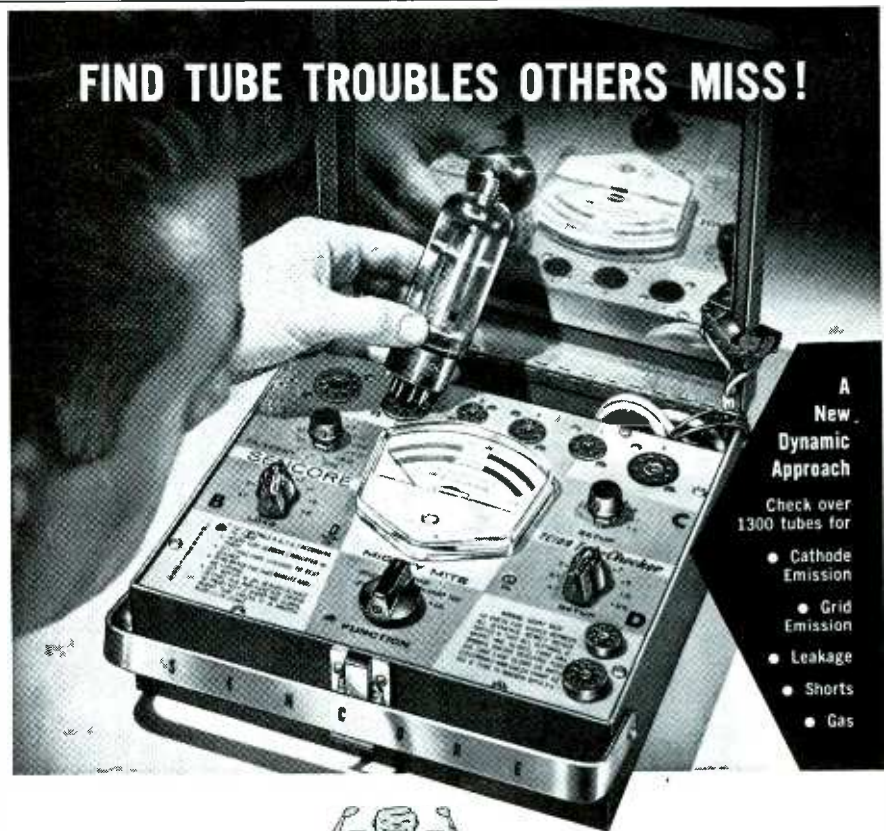

FIND TUBE TROUBLES OTHERS MISS!

A New Dynamic Approach

- Check over 1300 tubes for
- Cathode Emission
 - Grid Emission
 - Leakage
 - Shorts
 - Gas

SENCORE "MIGHTY MITE" TUBE CHECKER

Answers the needs of the fast moving, profit minded serviceman who hates time consuming call backs. A "mite" to carry but a whale of a performer that spots bad tubes missed by large mutual conductance testers.

New unique "stethoscope" approach tests for grid emission and leakage as high as 100 megohms, yet checks cathode current at operating levels. Special short test checks for shorts between all elements. The MIGHTY MITE will test every radio and TV tube that you encounter (over 1300!) plus picture tubes, foreign, five star and auto radio tubes (without damage). As easy to set up as a "speedy tester" from easy to follow tube booklet. New tube charts free of charge.

AND check these added Sencore servicing features: • Meter glows in dark for easy reading behind TV set • Stainless steel mirror in cover for TV adjustments • Rugged, all steel carrying case and easy grip handle • Smallest complete tester made.

Model TC109.....DEALER NET \$59.50

Ask your distributor for the "MIGHTY MITE" with the mirror in the cover



Use it everyday in every way. Especially designed so you can transfer into your tube caddy, bench or counter. Only 9" x 8" x 2 1/2".



SENCORE
ADDISON 2, ILLINOIS

SAVES
your back...
SAVES
your time...

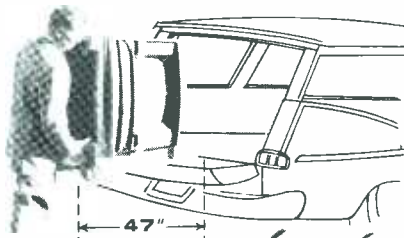

YEATS

SHORTY DOLLY
for
RADIO and TV

just 47 inches high for STATION WAGONS
and PANEL PICK-UPS

Designed for TV, radio and appliance men who make deliveries by station wagon or panel truck... the short 47 inch length saves detaching the set for loading into the "wagon" or pick up. Tough, yet featherlight aluminum alloy frame has padded felt front, fast (30 second) web strap ratchet fastener and two endless rubber belt step glides. New folding platform attachment, at left, saves your back handling large TV chassis or table models. Call your YEATS dealer or write direct today!

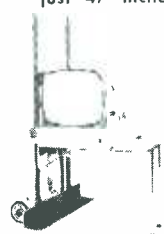

FOLDING PLATFORM
15 1/4" x 24 1/2" top.
Snaps on or off.
(Platform only)
\$11.95

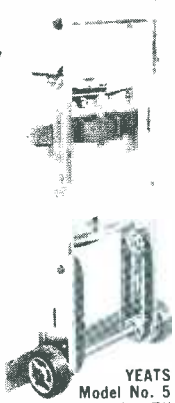

YEATS
Model No. 5
Height 47"
Weight 32 lbs.



FURNITURE PAD

"Everlast" COVER AND PADS

YEATS semi fitted covers are made of tough water repellent fabric with adjustable web straps and soft, scratchless white flannel liners. All shapes and sizes — Write



TV COVER

YEATS

APPLIANCE DOLLY SALES COMPANY

2103 N. 12th STREET MILWAUKEE WISCONSIN

PRODUCT REPORT

For further information on any of the following items, circle the associated number on the Catalog & Literature Card.

Antenna Distribution Amplifier (39R)

An all-channel VHF amplifier, using a low-noise ECC88 frame-grid tube, is incorporated in the Winegard WBC-4 *Amplified Booster-Coupler*. This unit feeds signals to as many as four TV or FM receivers from one antenna, providing 6 db gain in each signal channel; in addition, it can be used as a one-set booster to achieve a gain of up to 12.5 db. The WBC-4 can be mounted in any indoor location where it can be plugged into a 117-volt AC supply. List price is \$27.50.

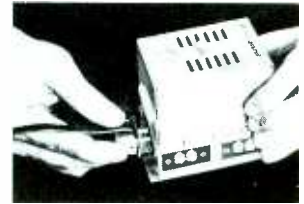

Resistor Assortment (40R)

Ohmite's new CAB-4 assortment of 1/4-watt *Little Devil* molded composition resistors contains 150 units in 37 different values, all packaged in a five-drawer plastic cabinet. These quarter-watt, .250" long and .090" in diameter, are especially suited for compact circuitry of the type found in pocket transistor radios.



Kit of Electrolytics (41R)

The Sprague EK-3 *Atom Assortment* consists of 15 tubular electrolytic capacitors in the 12 most-often-needed ratings, packaged in a 9" x 6" x 1 1/2" breakage-resistant plastic tray. The manufacturer points out that the reusable "job tray" is handy for keeping parts from a specific repair job together in one place. Price of the complete kit is \$14.91.



Public Address Equipment (42R)

Concealed, tamper-proof connectors, a choice of high- or low-impedance inputs, and convenient provisions for attaching a phonograph are among the features of Fanon's new "3300" series of PA amplifiers. Model 3320 (shown) is one of seven new types in the line, which includes 10-, 20-, 35-, 45-, and 70-watt AC-powered amplifiers as well as 10- and 25-watt fully-transistorized mobile units.



Yoke Loosener (43R)

A yoke stuck to the neck of a picture tube can be freed, without damage to either component, by applying Superex *Yoke-Off*. When the chemical is sprayed on and allowed to penetrate the area of contact for three to five minutes, the yoke can be slid off the tube neck in the usual manner. Dealer net price is \$1.19 for a 3-oz. aerosol can.

SAMS PHOTOFAC INDEX



sent direct
to your shop

FREE

SEND FOR IT!

Yes, now you can have the valuable SAMS MASTER INDEX TO PHOTOFAC FOLDERS and Index Supplements sent direct to your shop at no cost to you! Just mail coupon below and you'll be sure to receive regularly your handy guide to the world's finest service data covering over 33,000 TV, Radio, Amplifier, Tuner Tape Recorder and Changer models. Send for it—it's FREE!

MAIL COUPON

Howard W. Sams & Co., Inc.
1720 E. 38th St., Indianapolis 6, Ind.

Put me on your mailing list to receive the Sams Photofact Master Index and Supplements

I'm a Service Technician: full time; part time

My Distributor is:

Shop Name: _____

Attn: _____

Address: _____

City _____ Zone _____ State _____

23-Piece Tool Kit (44R)



Contents of the Xcelite Model 99SM *Service Master* tool kit are as follows: 12 nut-driver bits, three screwdriver bits, two reamers, a 1" extension blade, two plastic handles with a "snap-in" feature for use with the above interchangeable bits, long-nose and diagonal pliers with plastic-coated handles, and an adjustable 6" thin-pattern wrench.

Control and Switch Assortment (45R)



The Clarostat *Handi-Bin* assortment consists of a steel cabinet for wall mounting or bench-top use, packed with the following items: 18 *Pick-A-Shaft* Series A47 half-watt carbon controls in eight values; six tab-mounted Series B47 controls in three values; six Series C47S controls, each with push-pull switch attached; 10 Series SWE switches of three types; and 24 assorted shafts to fit A47 controls.

Screwdriver Flashlight (46R)

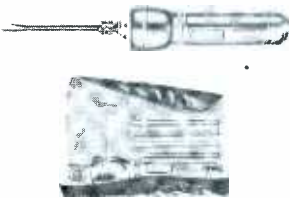

The *Light Driver*, made by I. H. Mfg. Co., combines a lightweight flashlight with a multi-purpose screwdriver. Imbedded in the middle of the *Lucite* lens is a chuck which accepts any of four interchangeable blades (two regular and two Phillips). The body is insulated from the blade by the lens, which has a dielectric strength of about 5000 volts. List price is \$2.49.

Crystal Pickups (47R)



A simple "snap-on" stylus assembly, a terminal plug for tone-arm connections, and an all-plastic body are featured in Sonotone's new Series "12" crystal cartridges. Output is 2.5 volts for Type "12TH" or 1 volt for Type "12TL"; both styles are available with combined 0.7- and 3-mil or dual 0.7-mil sapphire styli at a list price of \$6.45.

Transistorized VHF Amplifier (48R)

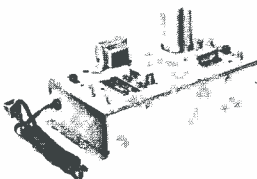

The *Blonder-Tongue* Model BT-3, a low-noise broadband TV-FM amplifier for master antenna systems and fringe-area installations, is completely transistorized. Power may be obtained from either an AC line or a 22-volt DC source. In locations where power lines are inaccessible, a Model MDX-75 *Duplexer* can be utilized to feed power to the amplifier through the same coaxial cables which carry the signal. The BT-3 has a list price of \$99.50.

200 va model suitable for 24" television receivers and many electronic type controls.

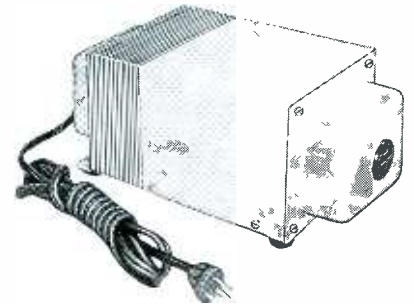

**THIS
AUTOMATIC VOLTAGE STABILIZER
makes fluctuating voltage
level-off to normal**

When fluctuating voltage causes operating problems with electronic equipment your quickest, most practical solution is an Acme Electric automatic voltage stabilizer. Compact in size, attractive in appearance. Automatically corrects fluctuating voltage over a range of 95 to 130 volts, to 115 volts $\pm 2\%$, within 2 cycles. Operation is completely noise-free. When connected equipment is not in operation, the primary circuit of the stabilizer is automatically disconnected by a built-in relay, thus stopping coil magnetism.

200 va unit illustrated is furnished complete with primary cord, built in secondary plug-in receptacle. Other units from 25 to 2000 va. Write for Bulletin.

ACME ELECTRIC CORPORATION

947 Water Street Cuba, N. Y. SAA3433/1894



6A7	6AG7Y		ADMIRAL <i>Supertron</i> <i>Receiving</i> <i>Tubes</i>	
6A8	6AH4G2		5GC8	5EU8
6AB4	6AL5		5CL8A	5J6
6AC7			5CQB	5T8
6AC7Y			5CZ5	5U4JB
6AD7G				
6AF3	6.			
6AF4	6AHc			
6AF4A	6AK5			

483 tubes in all, and all first quality!

Fill your tube caddy with new Admiral Supertron receiving tubes. Your assurance of one call profitable service. All highest quality for all makes of TV, Hi-Fi, Stereo and radio replacement service.

ADMIRAL MARK OF QUALITY THROUGHOUT THE WORLD

For free literature and full details, mail this coupon.

ADMIRAL NATIONAL SERVICE DEPT.
903 Morrisey Blvd., Bloomington, Illinois

Name _____

Address _____

City _____

P-61

JULY, 1960

Acme Electric Corp. 71
 Admiral Corp. 71
 Aerovox Corp. 56
 American Television & Radio Co. (ATR) 16
 Amphenol-Borg Electronic Corp. 58
 Arco Electronics 17
 B & K Mfg. Co. 42, 43
 Berns Mfg. Co. 68
 Bogen-Presto 38
 Bussmann Mfg. Co. 45
 CBS Electronics 35
 Castle TV Tuner Service 44
 Centralab, A Div. of Globe-Union, Inc. 22
 Clarostat Mfg. Co., Inc. 41
 Cornell-Dubilier Electric Corp. 33
 EICO 60
 Electronic Publishing Co. 61
 Fanon Electronic Industries, Inc. 66
 General Cement Mfg. Co. 2nd cover
 General Electric Co. Receiving Tube Dept. 39
 Gernsback Publications 50
 Jackson Electrical Instrument Co. 47, 72
 Jerrold Electronics Corp. 52
 Littelfuse, Inc. 4th cover
 Los Angeles Tuner Exchange 60
 Mallory & Co. Inc., P. R. 14-15
 Merit Coil & Transformer Corp. 46
 Oxford Components, Inc. 50
 Precision Tuner Service 68
 Quam-Nichols Co. 62
 Quietrole Co. 66
 RCA Electron Tube Div. 18-19, 51, 3rd cover
 Raytheon Co. 12-13
 Rider Publisher, Inc., John F. 44
 Sampson Co., The 32
 Sams & Co., Inc., Howard W. 54, 55, 68, 70
 Sarkes Tarzian, Inc. Semiconductor Div. 59
 Tuner Div. 66
 SENCORE 63, 65, 67, 69
 Shell Electronics Mfg. Co. 37
 Sonotone Corp. 57
 Sprague Products Co. 10
 Standard Coil Products Co. 9
 Sylvania Electric Products, Inc. 25
 Tung-Sol Electric, Inc. 49
 Wald Electronics, Inc. 61
 Ward Products Corp. 64
 Westinghouse Electric Co. Electron Tube Div. 53
 Winegard Co. 23
 Wright Steel & Wire Co., G. F. 61
 Yeats Appliance Dolly Sales Co. 70
 Zenith Radio Corp. 20-21

ANTENNAS & ACCESSORIES

- 1R. CORNELL-DUBILIER — Catalog No. 1630 describing all CDR rotators for TV and ham antennas. See ad page 33.
 2R. G-C ELECTRONICS — 8-page Catalog AN-61 covering Citizens band antennas and various accessories. See ad 2nd cover.
 3R. JFD—1960 Exact Replacement Antenna Guide for Portable and Toteable TV Sets (20 pages), compiled and edited by Howard W. Sams & Co., Inc. Gives TV receiver model number, manufacturer's antenna part number, and model number of corresponding JFD exact-replacement antenna. Also Form No. 71 brochure illustrating and describing 1960 line of natural silver and gold anodized Hi-Fi Helix antennas, and Form No. 66 covering 1960 series of natural silver and gold anodized Hi-Fi Fireball antennas.
 4R. JERROLD — Technical publications CSMMKI and MCA-21 on new Magic-Carpet antenna, the out-of-sight device with performance characteristics of an outdoor VHF antenna. See ad page 52.
 5R. WARD PRODUCTS—Booklet on how to install auto antennas; also new merchandising kit including antenna display placard, window banners, etc., for service shops. See ad page 64.
 6R. WINEGARD — Literature on Model WBC-4 Booster Coupler, which amplifies TV and FM radio signals for operation of one to four receivers. See ad page 23.

AUDIO & HI-FI

- 7R. ASTATIC — Catalogs M10 on microphones; 33-4 on cartridges, pickups, and needles; CRC-60 pickup cartridge cross-reference guide; and N-61 on needles and accessories.
 8R. EICO—20-page catalog of kits and wired equipment for stereo and monophonic hi-fi, test instruments, "ham" gear, Citizens band transceivers, and transistor radios. Also, "Stereo Hi-Fi Guide" and "Short Course for Novice License." See ad page 60.
 9R. FANON—Data on new line of public-address equipment, including 10- and 20-watt transistorized mobile amplifiers as well as various other systems (both fixed and portable) rated at 10, 20, 35, 45, and 70 watts. See ad page 66.
 10R. QUAM-NICHOLS—New 8-page catalog covering entire line of speakers for replacement, public-address, sound-system, and hi-fi applications. See ad page 62.
 11R. SONOTONE—Flyer SAH-31 describing Ceramike CM-12 low-impedance ceramic microphone with push-button interrupter (\$29.50 list); also data on ceramic microphone with 13" flexible arm and screw-down mounting plate for permanent installation in schoolrooms, etc. See ad page 57.
 12R. SWITCHCRAFT — Catalogs S-590 on molded cable assemblies, adapters, connectors, and signal mixers; A-403 on controls, switches, and related audio accessories; C-501 on jacks, plugs, and microphone connectors. Also condensed catalog CS-60.

BATTERIES

- 13R. B & K—Bulletin ST9-R on the "PONY" Model PB9 Rechargeable Battery and Plug-in Charger for long-life replacement in transistor radios using 9-volt batteries. See ads pages 42, 43.

COMPONENTS

- 14R. BUSSMANN — Three-color bulletin on Stak-Pak fuse assortment, showing how new packing idea can help TV servicemen on home calls. See ad page 45.
 15R. CENTRALAB—Catalog sheet on 46 new push-pull and push-push switches with controls for radio, TV, and hi-fi use—with complete specifications and list prices. See ad page 22.
 16R. CHICAGO STANDARD — Pocket-size cross-reference guide for transformers, showing original-equipment manufacturers' part numbers and correct Stancor replacements; also 28-page catalog describing full line of coils.
 17R. MERIT—New 30-page 1960 catalog of replacement transformers and components for radio and TV. See ad page 46.

- 18R. SAMPSON—Catalog No. 558 of Hitachi components; full-color folder describing line of Hitachi radios. See ad page 32.
 19R. SARKES TARZIAN (Tuner Div.)—Informative literature on TV and FM tuners. See ad page 66.
 20R. SPRAGUE—36-page Catalog No. C-613 of service-type capacitors, transistors, and test equipment. See ad page 10.

SEMICONDUCTORS

- 21R. SARKES TARZIAN (Semiconductor Div.)—4-page brochure of technical data on distributor line of silicon and selenium rectifiers, including tube-replacement types and conversion kits. See ad page 59.
 22R. SYLVANIA — Pamphlet (Form SD-2) featuring data and applicable circuits for eight "hobbyist" transistors. See ad page 25.

SERVICE AIDS

- 23R. CASTLE TUNER — Leaflet describing fast overhauling service on television tuners of all makes and models. See ad page 44.
 24R. PRECISION TUNER — Information on repair and alignment service available for any type of TV tuner. See ad page 68.
 25R. WALDOM—Informative bulletin on the economies and advantages of speaker re-coning; referral to a local re-coning station on request. See ad page 61.
 26R. YEATS—Data on hand truck for moving appliances up and down stairs and in or out of service trucks; also information on padded appliance covers. See ad page 70.

SPECIAL EQUIPMENT

- 27R. ACME ELECTRIC — Catalog 091-BL01 giving detailed information on automatic voltage stabilizers and manual voltage adjusters for TV receivers and other electronic applications. See ad page 71.
 28R. ATR — Complete information on emergency lighting and power units which automatically switch on within 1/20 second after a commercial power-line failure. See ad page 16.

TECHNICAL PUBLICATIONS

- 29R. GENERAL ELECTRIC — Registration card ETR-2223 for receiving bimonthly Techni-Talk bulletin. See ad page 39.
 30R. GERNSBACK—Descriptive literature on Gernsback Library books. See ad page 50.
 31R. HOWARD W. SAMS — Literature describing all current publications on radio, TV, amateur radio, communications, audio and hi-fi, and industrial electronics servicing. See ads pages 54, 55, 68, 70.

TEST EQUIPMENT

- 32R. B & K—Bulletin ST25-R, digest of information on Model 1075 Television Analyst, Models 1070 and A107 Dyna-Sweep circuit analyzers, Models 550, 650 and automatic 675 Dyna-Quik mutual conductance tube and transistor testers, and Model 440 CRT rejuvenator-tester. See ads pages 42, 43.
 33R. CLAROSTAT — Description of Model 240C power-resistor decade box with range of 1 to 999 ohms in 1-ohm steps, at 225 watts. See ad page 41.
 34R. JACKSON — Information on complete line of Service-Engineered test equipment. See ads pages 47, 72.
 35R. RCA—New brochure 1Q1003 on line of electronic instruments. See ads pages 18-19, 51, 3rd cover.
 36R. SENCORE — 4-page brochure on complete line of time-saver instruments, plus information on the TC109 Mighty-Mite tube tester. See ads pages 63, 65, 67, 69.

TOOLS

- 37R. BERNs—Data on 3-in-1 picture-tube repair tool, Audio Pin-Plug Crimper, and Ion adjustable beam bender. See ad page 68.
 38R. CBS—Colorful folder PF 349 describing complete line of tools and service aids for faster and easier servicing. See ad page 35.



TUBE TYPE	MODEL 648 CIRCUIT FIL.		MODEL 588 FIL.		A.	B.	C.	CONT.	D.	E.	F.	G.
	D.	E. TEST	1, 4	12649								
1H2	1, 4	0	48YX	5	0	0	0	0	0	0	0	0
6EJ7	6, 3	1256	R378* 32X2	5	6, 3	4	12649	5	0	2	8V	70
6EJ7	6, 3	1256	R378* 16WX	1	5	7	2	89Y	50	0	0	0
6FE8	6, 3	127	A89	18Y2	6, 3	4	1	5	6	7	4	48
35GL6	6, 3	123	A45	18Y2	6, 3	4	1	5	1	2	Y	48
	35GL6	35	C123	457	272	35	3	6	4	7	2	5

TUBE TYPE	SEC.	HEATER	MODEL 658		GRID	HEATER CURRENT
			H-K	P-G PLATE TEST		
1H2	D	1.5J	12	0	18U	VX
6EJ7	P	6.4J	1246	6579	22R	10WY.
6EJ7	P	6.4J	1246	6579	26R	10WY.
6FE8	P	6.4C	127	889	20R	15WY.
			123	445	30R	15WY.
35GL6	P	38F	120	457	32R	60VY.

Latest Chart Form 648-23, 598-2, 698-3

NOW'S THE TIME TO GET IN ON

RCA's giant new sales promotion program for SILVERAMA PICTURE TUBES

THE BIGGEST, MOST COMPREHENSIVE PICTURE TUBE PROMOTION IN THE INDUSTRY!

Here at last is the all-in-one picture tube promotion program you have been waiting for! Five strong sales-building elements in a single package put you ahead of competition, help you reap greater profits by selling RCA Silverama Picture Tubes.

Silverama, as you know, is RCA's all-new premium tube that can command premium price and profit on every sale!

PROMOTE YOUR SERVICES BY ANY MEDIUM YOU CHOOSE--



1
BILLBOARD POSTERS

2
FILMED TV COMMERCIALS

3
RECORDED RADIO COMMERCIALS

4
NEWSPAPER AD MATS

5
PROMOTION AND DIRECT MAIL

Full-color billboard posters in 6- or 24-sheet size with space for your imprint to link your name with the most trusted name in television: RCA.

30- and 50-second spots with open end for your name. The first filmed TV commercials by a major manufacturer designed for dealer use.

Pre-recorded 30-second and 60-second open-ended spots let you reach your customers at home, out-of-doors, in cars, everywhere!

Seven different mats with space for your name allow you to take advantage of a consistent, well integrated newspaper advertising campaign.

Window streamers, sales promotional postcards, miniature billboards, consumer literature, all to augment your other promotion activities.

ALL BACKED BY RCA'S HEAVY NATIONAL ADVERTISING CAMPAIGN IN TV GUIDE AND ON NETWORK TV

Check with your Authorized RCA Tube Distributor NOW for full facts on this exciting new program.
RCA Electron Tube Division, Harrison, N. J.



The Most Trusted Name in Television
RADIO CORPORATION OF AMERICA



