

APRIL, 1960

35 CENTS

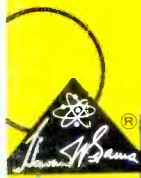

PHOTOFACT RF REPORTER

including **Electronic Servicing**

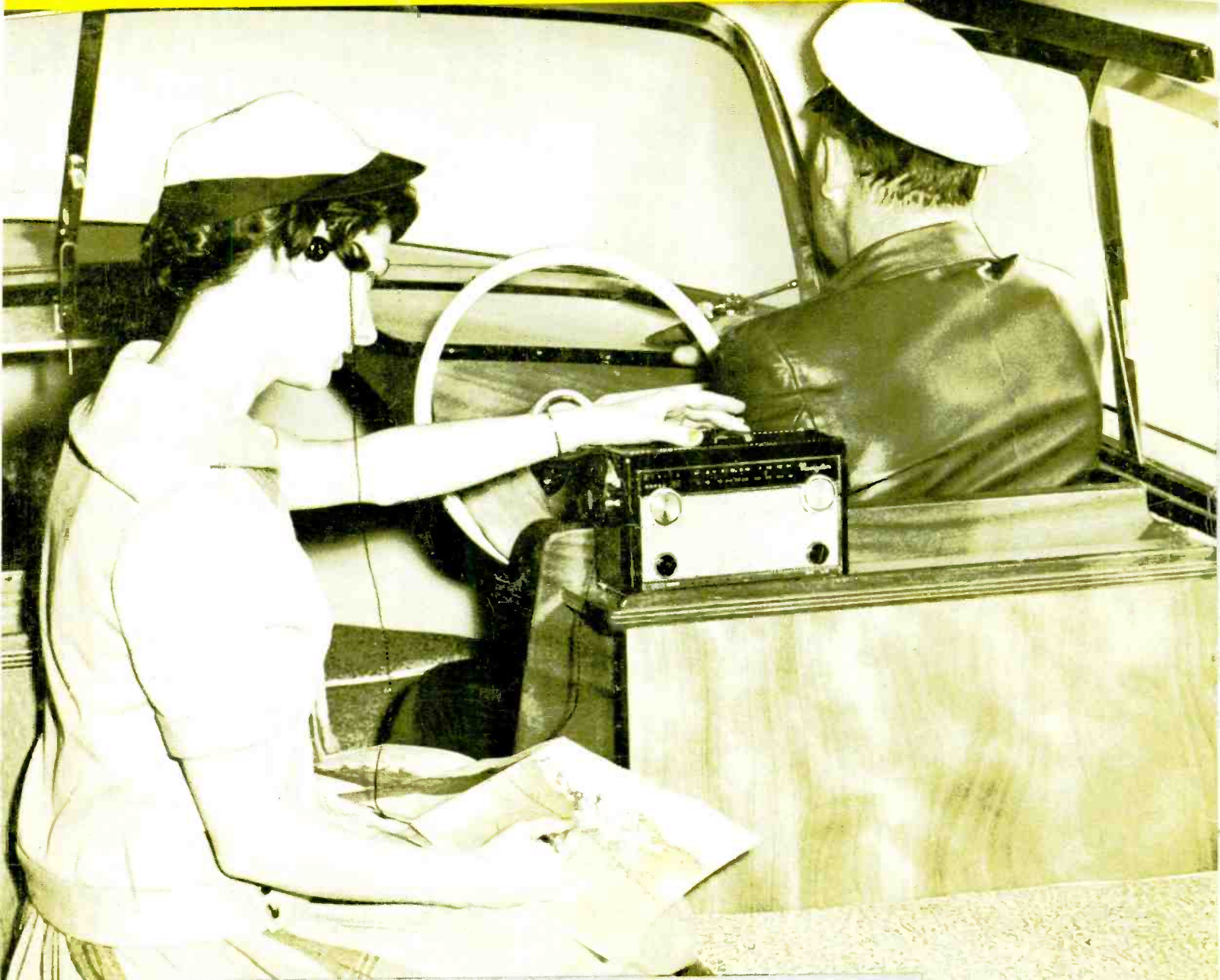

Radio Direction Finders for Boats

•
Batteries Today

•
"Tough-Dog" Sync Troubles

•
**What You Should Know
About Tube Changing**

IA OA 442 1262
WM. M. DAVIS
RADIO & TV, SFC.
118 RIVERSIDE AVE
CANNON CITY, COLORADO

Free

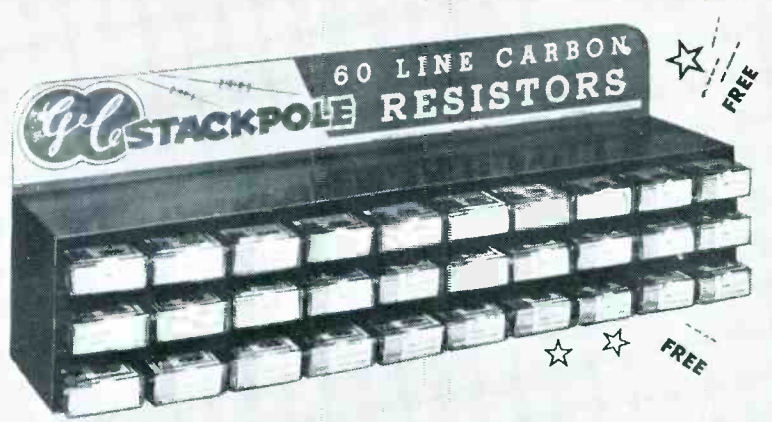

STORAGE RACK KEEPS ALL YOUR RESISTORS FOR EASY USE!

Get any one of these 7 deals on famous

GC STACKPOLE FIXED COMPOSITION RESISTORS

For a limited time only, you can stock up on the resistors you need at a real saving . . . get a handy metal storage rack free. Choose any one of these GC special assortments of top quality resistors in the exclusive-with-GC color-coded plastic boxes. Take advantage of this special sale now . . . see it at your GC jobber.

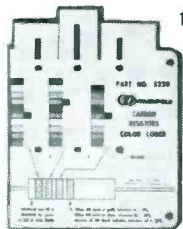

FREE COLOR-CODER included with each deal.

✓ Scientifically packaged to prevent bent soldering leads

✓ Boxes color-coded to make identification positive

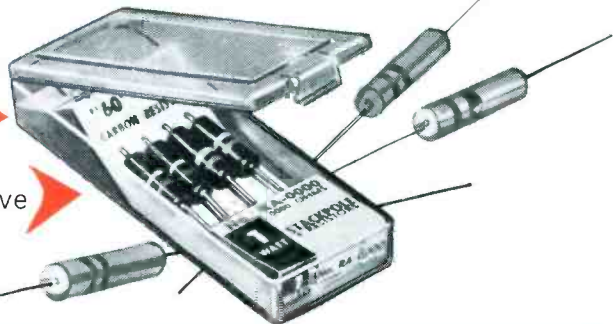

- ### HERE'S WHAT YOU GET!
- No. 3994-1— $\frac{1}{2}$ Watt—6 per box—30 boxes
 - No. 3994-2—One-half of above
 - No. 3994-3—1 Watt—4 per box—30 boxes
 - No. 3994-4—One-half of above
 - No. 3994-5—2 Watt—3 per box—30 boxes
 - No. 3994-6—One-half of above
 - No. 3994-7— $\frac{1}{2}$, 1 and 2 Watts—10 boxes of each value

SEE YOUR JOBBER! He now has these special resistor deals . . . or can get them for you.



Resistor and Knob Division of
GC Electronics Co.

Division of Textron Electronics, Inc.
Western Plant: Los Angeles 18, California • Main Plant: **ROCKFORD, ILLINOIS, U.S.A.**

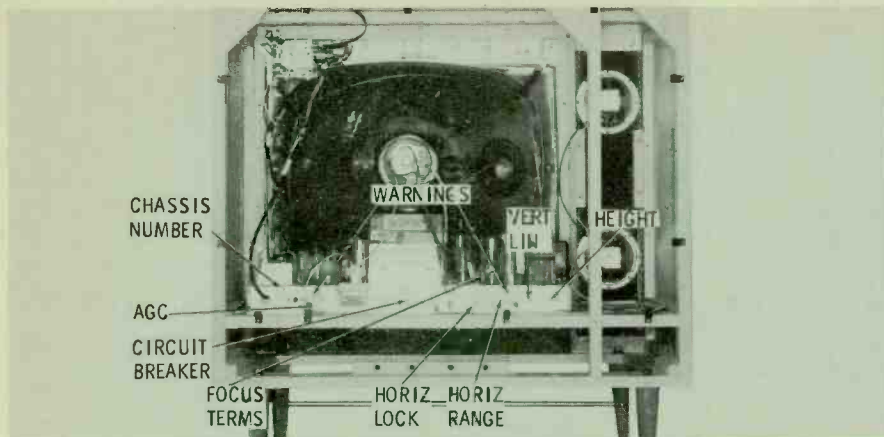

**Admiral L22M23
Chassis 2056**

The *Super ADMIRAL*—that's what it says on the front of this cabinet—is a 16-tube VHF chassis with a 21", 90° picture tube. Front-operated controls are located above and below the right side of the screen—push-pull on/off switch, volume, channel selector, and fine tuning at the top; brightness, contrast, tone, and vertical-hold controls at the bottom. RF oscillator adjustments are accessible after the channel-selector and fine-tuning knobs are removed and the hole in the fine-tuning disc is lined up with the slug for the desired channel.

All setup controls are located on the rear apron of the chassis; two are covered with warning labels. The chassis is transformer-powered, and protected by a circuit breaker in series with the center lead of the transformer secondary. The filament circuit is protected by a 1½" length of #26 fuse wire. All except the low-voltage supply, damper, and high-voltage circuits are located on two printed boards.

The left-hand board contains the IF, AGC, and sync circuits, while the sweep stages are on the right. It's a little unusual to see the AFC circuit so far removed from the oscillator — so watch it. Foil patterns are shown on top of the board to make servicing easier. The proper adjustment of the AGC control (shown covered by notice) is as follows: Tune in the strongest station in the area. Set brightness at maximum and contrast for a normal picture. Make sure the hold controls are properly adjusted; then rotate the AGC control until either sound or picture begins to distort. Retard the setting 10° from this point and check operation on all channels.

We removed the 5U4 in the photo of the right-hand board so the two test points for horizontal circuit adjustment would be visible. To properly adjust the circuit, tune in a weak signal and set brightness and contrast for a normal picture. Make sure the AGC control is properly adjusted. Short point "R" to chassis, and connect a .22-mfd, 400-volt capacitor from point "S" to chassis (CAUTION, B+). Adjust the horizontal range control for a near in-sync condition. Remove the capacitor and adjust the horizontal lock to synchronize the picture. Remove the short from point "R" and readjust the horizontal lock if necessary.

In removing the chassis, a long-handled nut driver must be used because of the cross-brace across the rear of the cabinet.

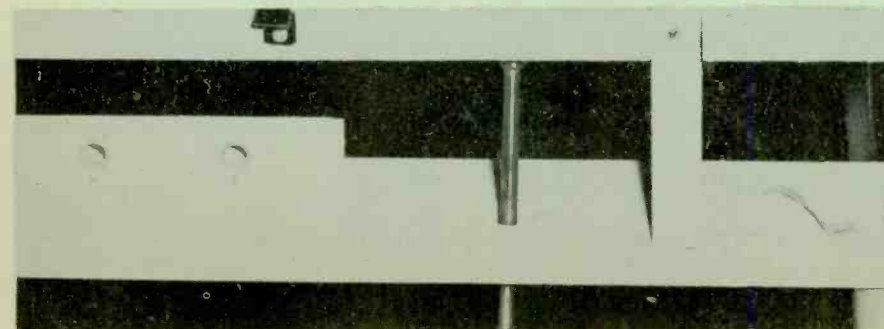
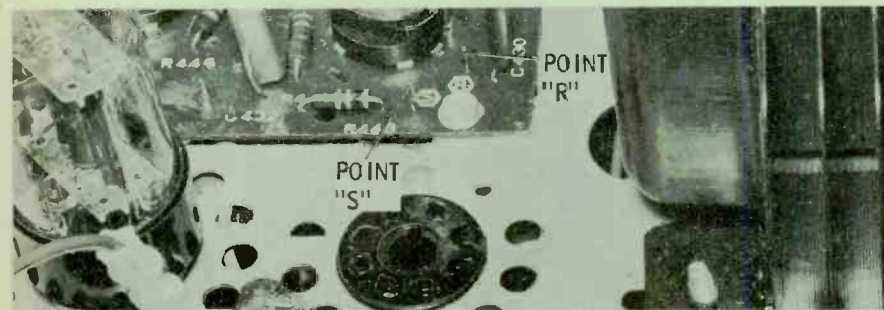
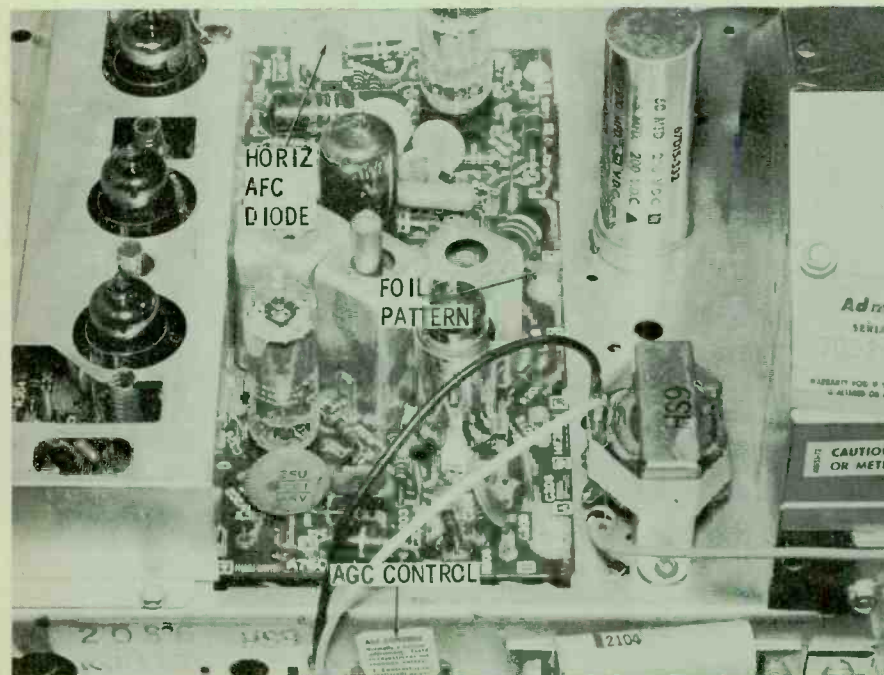

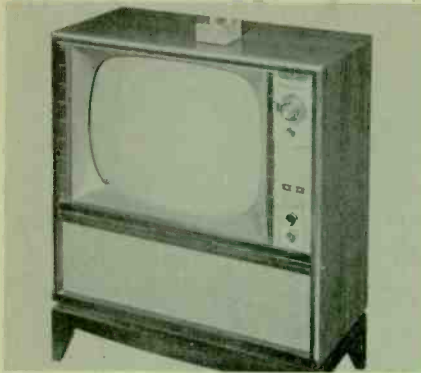

**Olympic TRW203M
Chassis JRW**

Here's Olympic's 1960 entry in the field of remotely tuned TV's. It's a 90°, 21" transformer-powered set containing a 15-tube VHF chassis and a 4-tube remote-control subchassis. Horizontal and vertical hold controls are actuated with thumbwheel knobs protruding from the bottom edge of the channel selector escutcheon. The remote transmitter (chassis JTR) uses a transistor (Olympic part no. TN-26912) as an RF oscillator: it produces one of two pretuned RF frequencies for remote control of off-on, volume, and channel selection.

From the back, you can see that the conventionally-wired chassis mounts vertically on the left, while the remote receiver chassis mounts horizontally on the right. The triple speaker system is also shown. Programming adjustments on the power tuning unit are made by inserting a screwdriver into the cam slot for each channel. For unused channels, the cam is rotated one-half turn clockwise (until a stop is reached). A range switch, which controls attenuation in the antenna lead, provides for either local or distant reception. The adjustment labeled horizontal size is in reality a drive control in the grid circuit of the horizontal-output tube.

Located on the high voltage cage is a focus terminal strip (providing two different B+ voltages plus a ground connection); a 3-amp, pigtail-type fuse which protects the power supply; two silicon rectifiers; and a 3" length of #26 fuse wire which protects the filament circuit. The rectifiers, incidentally, are connected in a full-wave, voltage-doubler configuration.

A ½-amp, type "C" fuse protects the horizontal circuit. Located just above this fuse is the horizontal frequency coil. The *sound clarifier* is an adjustment for the quadrature-grid coil of the audio detector.

One Phillips-head screw is all that holds the channel-selector escutcheon in place after the tuner knobs have been removed. The channel indicator then slips off to provide access to the VHF oscillator, height, and vertical-linearity adjustments.

In the close-up of the remote receiver chassis, the raised "hood" lets you see the channel-selector relay, and the step relay which provides the control for off-on and three levels of volume. The filaments of the remote receiver are energized whenever the main and remote off-on switches are both in the "on" position.

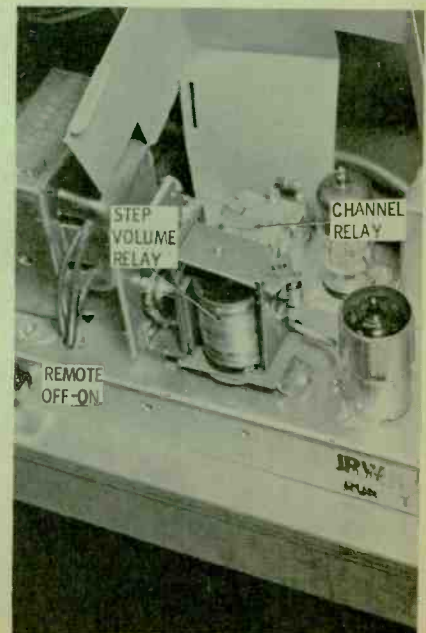
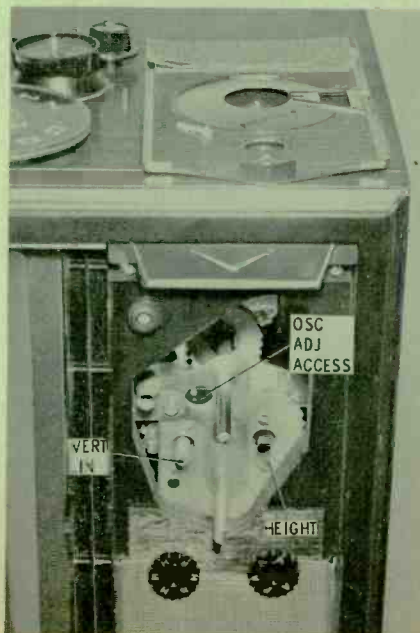
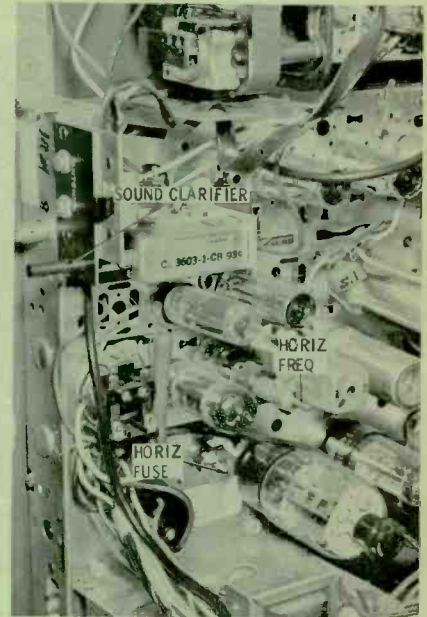
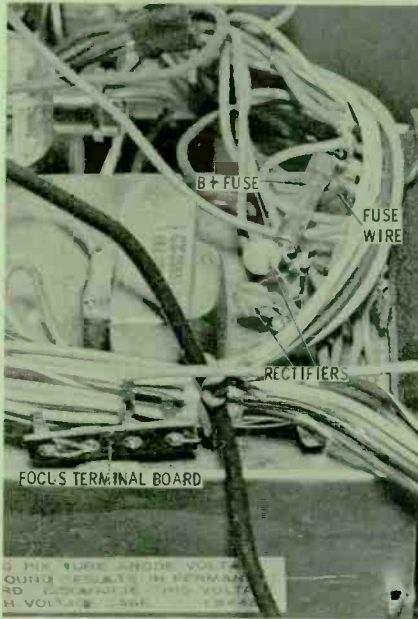
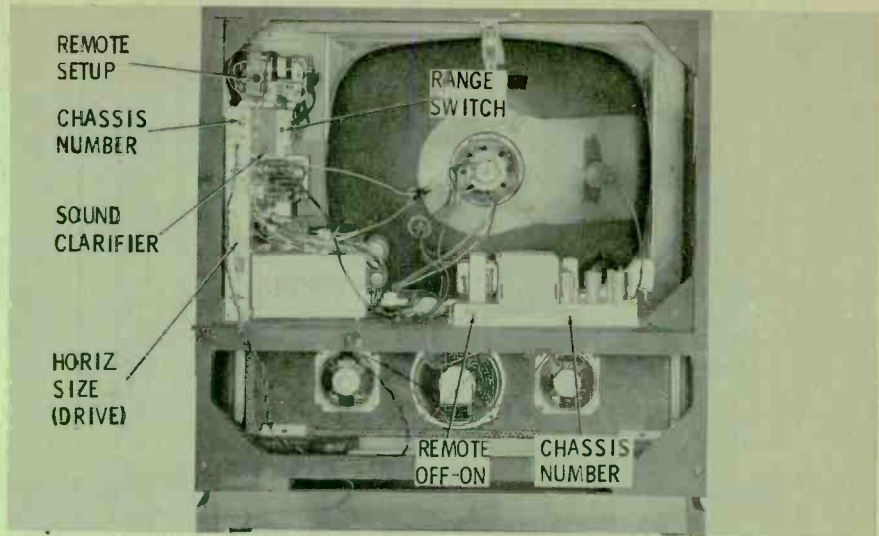

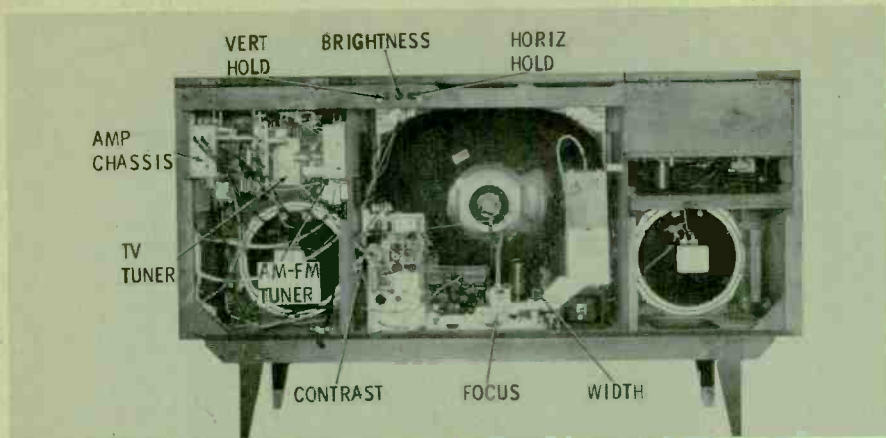

RCA Model 240-KV-775SU Chassis KCS127AE

This wall of entertainment is one model in RCA's line of "has everything" receivers. The 24", 110° picture tube is centered between two speaker baffles which house the stereo speaker system and amplifier, AM-FM tuner, 4-speed stereo record changer, and TV tuner. Many modes of operation are available: AM, FM, AM-FM, TV, TV-FM, tape, and mono or stereo phono. Controls for these function, as well as some of the other operational controls, are under the right-hand lid. Exceptions are those for horizontal hold, brightness, and vertical hold, which are located on the back.

The rear-view photo shows the positions of the various units in the system. All chassis have their own transformer power supplies; however, the transformer for the AM-FM chassis (RC1192B) is for isolation only. Its tubes are connected in a series-string arrangement. IF, video and sound circuits are on the printed board at the left. The audio detector circuit is as far as the TV chassis goes in the sound section. The detected signal is fed to the two channels of the stereo amplifier, where it is amplified and used to drive all speakers. The printed board along the bottom of the TV chassis contains both deflection oscillators, as well as the AGC, sync, and vertical output stages. The conventionally-wired part of the chassis consists of the power supply, horizontal output, damper, and high voltage circuits.

The horizontal deflection circuits are protected by a fusible resistor (part #104295) rated at 300 ma; its DC resistance is about 9 ohms. Horizontal-drive and width adjustments are both located on the flat part of the chassis between the rectifier and output tubes; the focus control is just below the AC interlock.

A current-limiting resistor, connected in series with the AC line as a tube saving feature, has 120-ohms resistance when cold. As in other 1960 RCA sets, a multiple-control assembly is used; it contains three controls and six printed resistors for the vertical linearity, height, and AGC circuits.

There's more to the last picture than just the maze of wires required for such an elaborate system of electronic equipment. A closer look would disclose the use of the new *Guided Grid* TV tuner, quite an innovation for RCA.

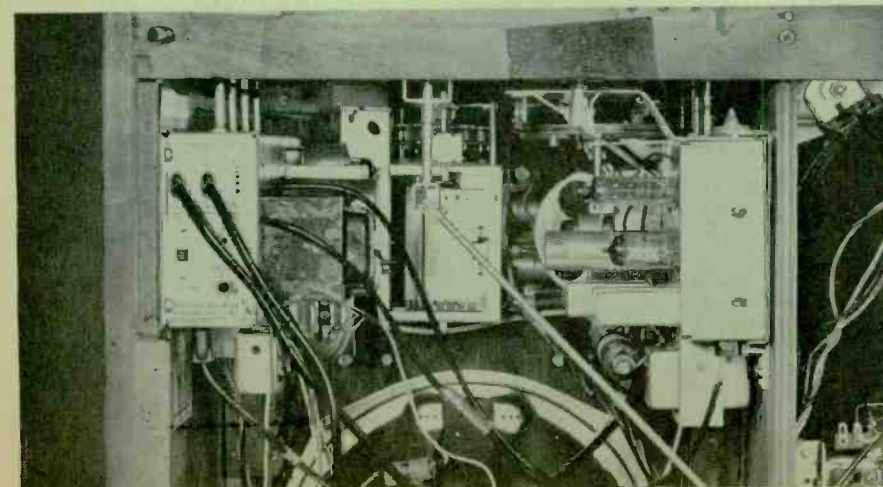
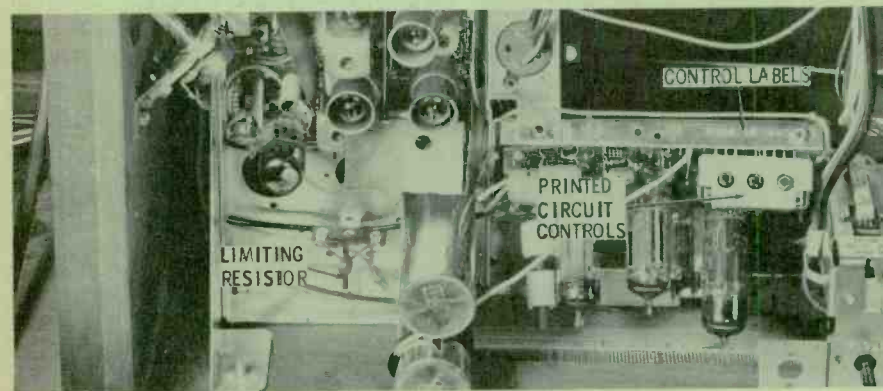
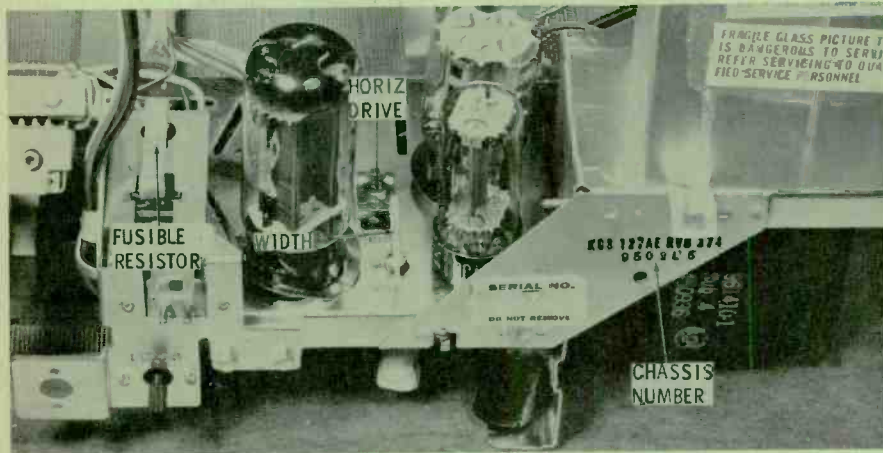



**Westinghouse Md. H-K4600
Chassis V-2378-6**

This 21", 110° chassis, shown here in the *American Contemporary* model, features a *Remote Director* control system. The remote transmitter (chassis V-2387-1) uses a transistor oscillator (10027 or 2N402) to develop a modulated RF signal for controlling functions of on-off, volume, and channel selection in either direction. Power for the transmitter is supplied by a 6.5-volt mercury battery (Eveready E-165 or Mallory TR-165R).

The TV chassis itself is an 18-tube, transformer-powered unit with a conveniently located 3.5-amp, slow-blow fuse connected in the AC line. The newest tube types you'll encounter are two 6FV8's, a 6EB8, and a 6ER5 or 6EA5 (depending on the tuner used). The major portion of the circuitry is contained on a single printed board nestled between a power-supply chassis on the left, and the horizontal-deflection chassis on the right. The remote receiver (Chassis V-2386-1) is housed in the speaker compartment.

The control panel contains a push-pull switch for remote receiver power, two channel selector bars for power tuning, plus controls for off/on volume, brightness, contrast, vertical and horizontal hold, and the setup knob for *Memory Tuning* (fine tuning). The lower right side of the speaker compartment houses the remote-receiver microphone; also located in this area are indicator lamps which show when power is supplied to both the remote receiver and the main chassis.

Power-tuning programming cams are accessible through a large tube in the rear cover. Each cam is located to the left of its respective channel number, and has two positions. The *in* position causes the channel to be skipped; the *out* position is used for active channels in the area.

The tuner, power-tuning mechanism, and control panel are held to the cabinet by five 1/4" metal screws. A 5/16" nut driver is required to remove the two front chassis bolts and the two nuts holding the speaker leads, while a 3/8" driver is required for the two chassis bolts at the rear.

Upon removal of the chassis, you'll notice the approach this manufacturer has taken to make printed-board servicing easier. Termed the *See-Matic* board, it provides a schematic representation of the components, which simplifies circuit-tracing considerably. The protruding leads are also helpful in making test equipment connections.

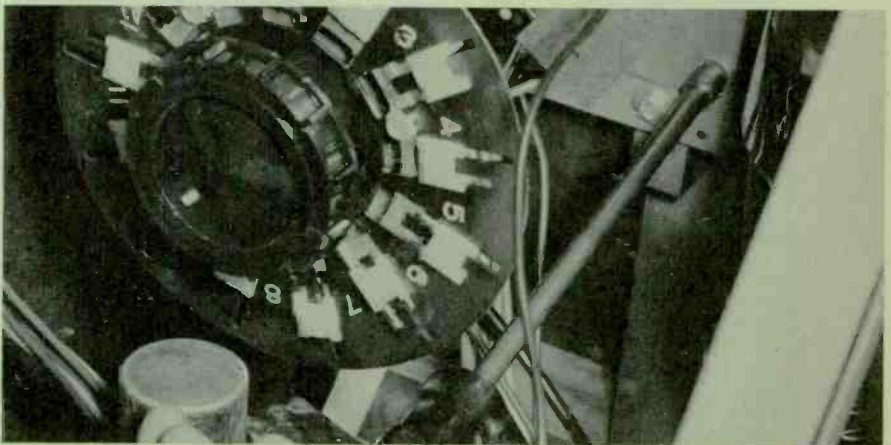
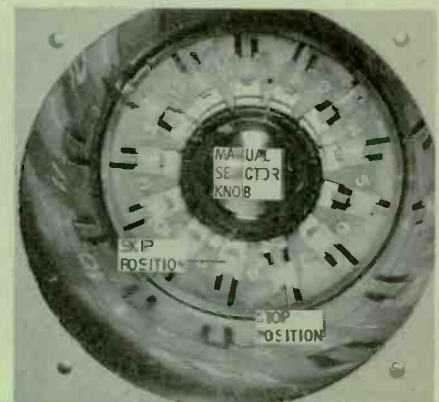
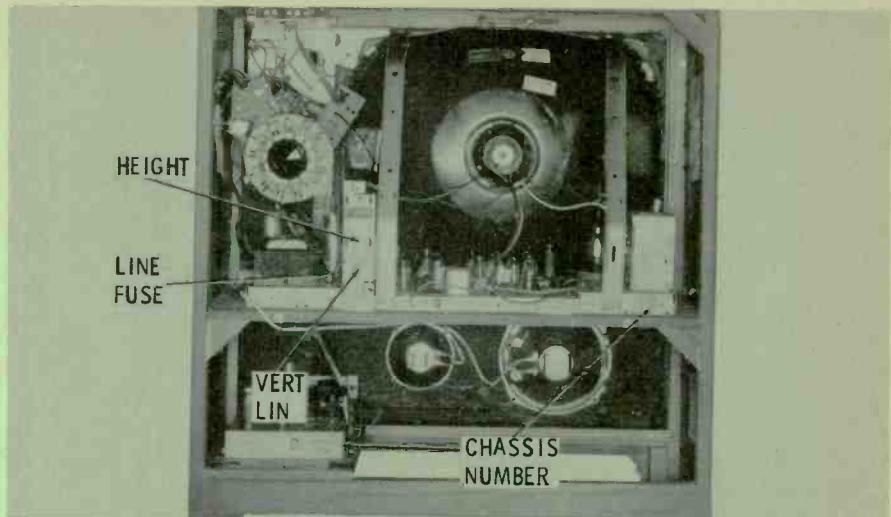

ELECT PROFITS: VOTE AGAINST CALL-BACK LOSSES

1960 is the big election year! And the *biggest* campaign in the industry is Raytheon's "Crusade Against Call-backs." It's designed to put the finger on the 10 tube types that cause you the greatest profit loss. Once the votes are in, we'll announce the top ten and at the same time introduce our platform to stop profit loss.

VOTING DATES!

Now . . . through May 15, 1960.

CAST YOUR BALLOT!

See your Raytheon Distributor, or vote when his representative calls at your place of business.

ELECT!

Vote for the ten tube types that cause you the greatest loss through Call-backs.

ANNOUNCEMENT DATE!

Raytheon will announce the ten tubes that give you the most trouble — and introduce our new candidate for top profits — on June 1, 1960.

The time for **ACTION** is now! There have been enough promises on what to do about Call-backs. Raytheon guarantees action! Get ready for great profit news to come! And don't forget to vote!



VOTE NO TO PROFIT
LOSS in the
RAYTHEON CRUSADE
AGAINST CALL-BACKS



RAYTHEON COMPANY

Distributor Products Division • Westwood, Massachusetts

Vote at your Distributor's place of business, or when his representative calls on you.



NEW

ORANGE-DROP®

DIPPED DIFILM® CAPACITORS FOR EXACT ORIGINAL REPLACEMENT

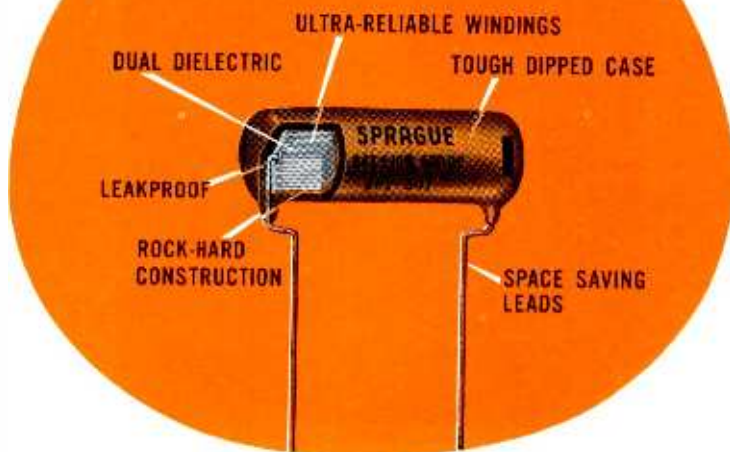

THIS NEW . . . MINIATURE . . . DIFILM
CAPACITOR OUTPERFORMS ALL
OTHER DIPPED TUBULAR CAPACITORS!

SPRAGUE DIFILM *does it again!* First to give you at regular prices the finest molded tubular capacitor made—the DIFILM BLACK BEAUTY . . . and now the newest DIFILM capacitor—the ORANGE-DROP dipped capacitor.

◆ SPRAGUE ORANGE-DROP CAPACITORS are especially made for easy installation in tight spots . . . where only an exact replacement will fit. They are the exact same dipped capacitors used by leading manufacturers in many TV sets.

WHY ORANGE-DROPS BEAT HEAT AND HUMIDITY

Sprague Orange-Drop Mylar* Paper Dipped Capacitors combine the proven long life of paper capacitors with the effective moisture resistance of film capacitors. Their duplex dielectric of kraft paper and polyester film is impregnated with HCX®, Sprague's exclusive hydrocarbon material which saturates the paper and fills voids and pinholes in the film before the HCX polymerizes. The result is a solid, rock-hard capacitor section which is then double-dipped in bright orange epoxy resin for moisture protection. Leads are neatly crimped for easy installation on printed wiring boards.

◆ SPRAGUE ORANGE-DROP CAPACITORS are a natural teammate for the molded Difilm Black Beauty®. Black Beauties, born out of engineering to tough missile standards, are still far and away the best replacement capacitors—better than any other molded or dipped . . . paper, film, or film-paper combination . . . capacitor made for entertainment electronics.

◆ Where a dipped capacitor is called for, no other dipped unit can match the ORANGE-DROP. Your distributor is stocked with all popular ratings in 200, 400, 600, and 1000 volts in handy Sprague Kleer-Paks. Order some today.

*Du Pont Trademark

don't be vague—insist on

SPRAGUE®

 the mark of reliability

ANOTHER TESTED RELIABLE PRODUCT BY THE WORLD'S
LARGEST CAPACITOR MANUFACTURER

publisher
Howard W. Sams

general manager
Mal Parks, Jr.

editor
Verne M. Ray

associate editors
Leslie D. Deane
Thomas A. Lesh
Joe A. Groves

consulting editors
William E. Burke
Robert B. Dunham
George B. Mann
C. P. Oliphant
Paul C. Smith

art director
Don W. Bradley

advertising & editorial assistants
Georgeanna Caldwell
Marjorie Spiegel

production manager
Robert N. Rippy

circulation fulfillment
Pat Tidd, Mgr.
Constance McCawley, Ass't.

photography
Robert W. Reed

advertising sales offices
midwestern
John Grace, PF REPORTER
2201 East 46th Street, Indianapolis 6, Ind.
Clifford 3-6441

eastern
Cliff Landis
Corning Glass Building,
717 Fifth Ave., New York 22, N. Y.
MUrray Hill 8-6350

western
The Maurice A. Kimball Co., Inc.
2550 Beverly Blvd., Los Angeles 57, Calif.
Dunkirk 8-6178; and 681 Market Street,
San Francisco 5, Calif. Exbrook 2-3365

Address all correspondence to
PF REPORTER, 2201 East 46th Street,
Indianapolis 6, Indiana



Copyright © 1960 by Howard W. Sams & Co., Inc. PF REPORTER is a trademark of Howard W. Sams & Co., Inc. No part of PF REPORTER may be reproduced without written permission. No patent liability is assumed with respect to use of information herein. Acceptance of advertising does not in any manner signify the products, policies and services so advertised have been approved, endorsed or recommended by this magazine.

Indexed in *Electronic Guide* and *Lectrodex*.
Printed by the Waldemar Press Div.
of Howard W. Sams & Co., Inc.



PF REPORTER

including **Electronic Servicing**

VOLUME 10, No. 4

APRIL, 1960

Previews of New Sets Admiral Model L22M23, Olympic Model TRW203M, RCA Model 240-KV-775SU, Westinghouse Model H-K4600.	1
Video Speed Servicing Service hints on the Magnavox 30 Series chassis and Westinghouse Chassis V-2366-1.	5
Letters to the Editor	16
The Electronic Scanner	20
Batteries Today Thomas A. Lesh News about rechargeable batteries for portable radio and TV sets, followed by helpful pointers for testing and stocking radio batteries.	24
What You Should Know About Tube Changing Calvin C. Young, Jr. Quicker Servicing—Why replacement of TV tubes may necessitate resetting of service controls.	26
G-E's Frisky 10-Year-Olds Stan Prentiss Across the Bench—With proper care, the surviving members of this clan might last another decade.	28
Circuit Safety Devices Overload protectors, surge limiters, and other devices to safeguard TV circuits.	30
Testing Hi-Fi Amplifiers for Distortion Alan Andrews Audio Facts—How to test hi-fi units to see if they are living up to their exacting standards of performance.	32
Dealing With "Tough Dog" Sync Troubles Joe A. Groves Part 3—A step-by-step analysis of a vertical integrator, and some waveform clues to faulty sync separation.	34
Stock Guide for TV Tubes Includes a suggested 350-tube caddy inventory.	38
Dollar and Sense Servicing	40
Tips for Techs	42
Radio Direction Finders for Boats Allan Lytel Uses, special circuit features, and servicing hints for these handy navigational aids.	44
Notes on Test Equipment Les Deane Lab reports on the Hickok 850 transistor analyzer, RCA WV-38A VOM, and Triplett 3444 tube analyzer.	50
The Troubleshooter	60
Product Report	85
Free Catalog & Literature Service	88

ABOUT THE COVER

"Sailing, sailing . . ." or some such carefree theme will soon be in the minds of thousands of boat owners during the next few months. Mariners who venture beyond the sight of land depend on radio direction-finding equipment to help them determine exactly where they are. For a complete feature article on the subject, turn to page 44.



HUBERT LINDSEY WINS 'GO PLACES' CONTEST

Special Report on Radio and TV Servicing in Mexico

C. A. Zinser

MEXICO, D. F.—Mexican radio and TV servicing is similar in most ways to that in the United States, but with some interesting variations. The first variation has to do with the method of new set distribution.

In the U. S., the three-step distribution system is the general rule (manufacturer to distributor to dealer to consumer). In Mexico, the two-step system is used (manufacturer to distributor to consumer). There is no intermediate dealer. But there is a further difference; the distributor is often a sort of manufacturer in his own right. He will often purchase "kits," assemble them, and sell them directly to the consumer. This type of activity is naturally confined to those distributors with rather substantial capital, but it is still a factor in the market.

As in the case of his American counterpart, the Mexican distributor is also a parts distributor. He sells electronic parts to service technicians. But, he almost always operates a service organization of his own. In general, this poses no particular problem, for the Mexican method of doing business is based on a definite personal relationship. Once the typical Mexican has established a business relationship, he maintains it on a lifetime basis.

The Mexican service technician faces most of the same technical

(Continued on page 2)

Lindseys Fly to Mexico City in January

STATESVILLE, N. C.—Mr. and Mrs. Hubert Lindsey will fly to Mexico City Jan. 7. Mr. Lindsey's winning entry in the "Go Places With Mallory" contest resulted in the trip. The Lindseys will be joined by Mr. and Mrs. Joe Harris of Charlotte. Mr. Harris was responsible for Mr. Lindsey's entry in the contest and is thereby eligible for duplicate prize.

The two couples will fly to Dallas via Delta Airlines, and from there to Mexico City via American Airlines. They will stay at the Continental Hilton Hotel and plan to take several tours to historic sites in and around the Mexican capital. The couples will return on Jan. 11.

LATE FLASH

INDIANAPOLIS, IND.—J. E. Templeton, General Manager, P. R. Mallory & Co. Inc., Distributor Division, announced today that there would be a 1960 "Go Places with Mallory" contest. Mr. Templeton said, "The success of the 1959 contest proves that Service Technicians are interested in 'Going Places.' In fact, they go places three ways: by using quality Mallory products, getting a bargain on popular parts, and winning a free trip." Exact details of the 1960 contest will be announced at the NEDA Parts Show in Chicago, May 16-18, 1960.

TODAY'S DAFFYNITION
CUSTOMER—The guy who puts off going to the dentist for weeks but needs his television set fixed TODAY.



Winner Congratulated CHARLOTTE, N. C.—Hubert Lindsey is shown being presented with two tickets to Mexico City by J. E. Templeton, General Manager, Distributor Division of P. R. Mallory & Co. Inc. Joining the ceremony are: left to right, Grady Duckett, Mr. Templeton, Mr. Lindsey, Joe Harris and Wm. Fanning. (Photo by Haviland Smith.)

Hubert A. Lindsey, Service Manager, Curlee Tire & Appliance, Statesville, N. C., was named today as the winner of the 1959 "Go Places with Mallory" contest. The contest was sponsored by the Distributor Division, P. R. Mallory & Co. Inc., Indianapolis, Ind.

Mr. Lindsey won the contest by submitting the best statement on which line of Mallory replacement parts he liked the most. His purchase of a flight bag containing an assortment of parts from the

complete Mallory line gave him his basis for comparison.

The grand prize of the contest is an all-expense week-end for two at the Continental Hilton Hotel in Mexico City. The trip will be via American Airlines and will feature tours to scenic and historic points in and around the Mexican capital.

Mr. Lindsey, 34, is a native of Statesville, attended high school there, is married, and has two children. He is a Marine Corps veteran of World War II.

Dixie Radio Salesman Named Co-Winner

CHARLOTTE, N. C.—Joe Harris, a salesman for Dixie Radio Supply, was named co-winner of the "Go Places With Mallory" Contest.

Mr. Harris sold Mr. Lindsey, the actual winner of the contest, his Mallory flight bag assortment of parts. Under the rules of the

contest, Mr. Harris is to receive a duplicate grand prize, an all-expense week-end for two in Mexico City.

Mr. Harris, who now resides in Charlotte, was born in Mooresville, N. C. He is married and has two children. He is a Navy veteran of World War II.

(Continued from page 1)

problems as does his American counterpart, but has some to be found only in Mexico.

Mexico City power is 115 volts, 50 cycles, and because of serious fluctuations, voltage regulators are a "must" on TV sets. Power in the remainder of Mexico is 115 volts, 60 cycle, so his problems start with two power standards. But this is only the beginning, his most serious problem stems from parts availability.

Sources of parts in Mexico are literally world-wide. Some are made in Mexico (capacitors, coils, speakers, tubes, and transformers), but not in sufficient quantity to satisfy the demand. Other sources include the United States, Japan, and Europe. Exact replacement parts are often difficult to obtain or require long delays. Because of this, the Mexican service technician must be a "master substitutor." His customers are not going to wait 4 to 6 weeks for their TV sets to be repaired any more than would an American viewer.

The Mexican service technician operates his business mostly on a credit basis. His customers generally bring the sets to his shop and he usually delivers them when repairs are completed.

Mexican or American, service technicians face many of the same problems, but on one point there is no difference—all customers want the job done *today*—not "manana."



First Plane Trip for Mrs. Lindsey Mr. and Mrs. Joe Harris and Mr. and Mrs. Hubert Lindsey are shown with Delta Airline stewardess Norma Smith as they prepare to take off for a five day vacation in Mexico City. (Haviland Smith photo.)

Tours Feature of Trip

MEXICO CITY, D. F.—Interesting tours in and around Mexico City were arranged for the Lindseys and Harris' on their recent visit here.

The first day found our visitors touring the metropolitan area with a special stop at University City. Like thousands before them, they marvelled at the blend of ancient Aztec and ultra-modern architecture. The sight of the beautiful mosaic murals by Diego Rivera and Juap O'German on the buildings quickly brought cameras into action.

On the second day, the tour proceeded to the Pyramids of Teotihuacan and then on to the shrine of Guadalupe where, in 1531, the Virgin of Guadalupe appeared to the Indian Juan Diego.

The gardens of Xochimilco were a feature of the third day's tour. Here, they were treated to the beautiful display of flowers at the floating gardens and visited the displays of pottery and flowers at the market. An afternoon at the bull fights came as a fitting climax to a whirlwind tour of the continent's oldest city.

STA-10* SOLVES CONTROL PROBLEMS

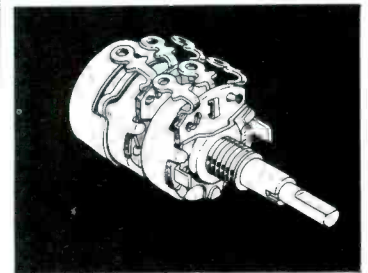

**No Waiting
No Shopping
Any of over 38,000
types of
single or dual controls
custom-built in just
30 seconds by
your distributor.**

*Trademark



Narciso Garcia, Mallory's Mexican representative, explains south-of-the-border TV servicing to Msrs. Harris and Lindsey as Cecilio Martin, Manager, Electronica Geyen, S. A. looks on.



This photo was taken during a visit to one of Mexico City's largest distributors, El Centro Comercial, S. A. Left to right: Diego J. Garrido (General Manager), the Harris' and Lindseys, Narciso Garcia, and Romulo Garcia (President).

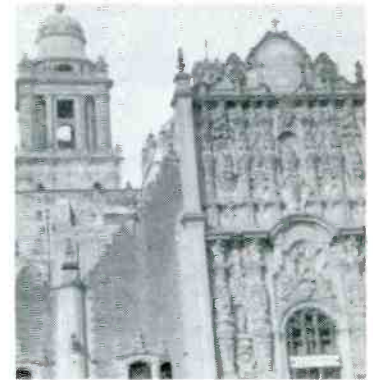
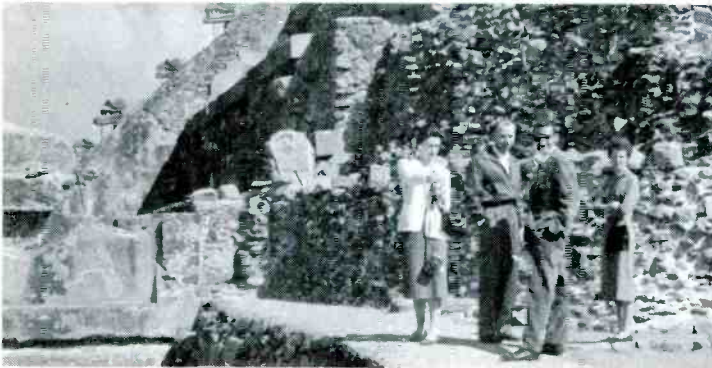
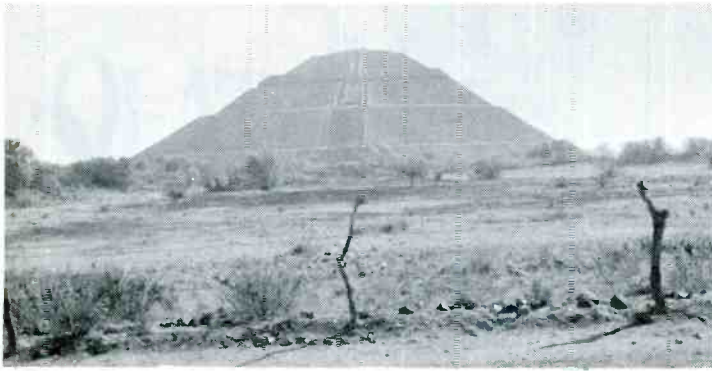

Teotihuacan

The Pyramids of Teotihuacan were constructed in 300 A.D. and are classic examples of ancient architecture. The pyramid of the Sun is larger at its base than any in Egypt. There is also a perfectly preserved temple and an archeological museum.



Study in Contrasts — Mexico City Architecture

Picture Page

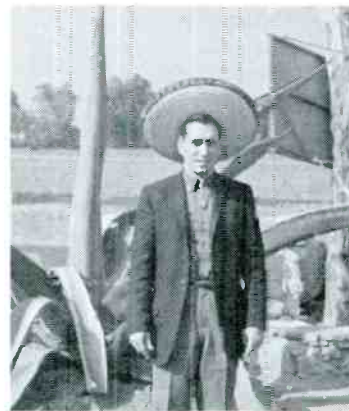

Norte Americanos y los sombreros — Joe and Hubert in Mexican disguises — ¡Viva Villa!

Photos on this page by Joe Harris



Xochimilco

The floating gardens had their origin in the tenth century when flowers and vegetables were planted on floating rafts to be used as tribute to the Aztecs. The rafts were later enlarged and poplar trees were planted with the roots growing through the bottom into the canal bed.



• • • only flat on one side

Oh! My achin' arches



"Tired — But Happy!"

STATESVILLE, N. C.—A "tired — but happy" Mrs. Lindsey returned home after a five day vacation to Mexico City.

Mrs. Lindsey said, "I'm sure glad to be home so I can catch my breath and rest my feet. We had a wonderful time and especially enjoyed the pyramids and the floating gardens. There were so many things to see and do. At first, I was a little afraid to leave the children, but I'm glad we had a chance to make the trip. It was a wonderful experience."

"Ready to Go Again"

CHARLOTTE, N. C.—Mrs. Joe Harris is home again after an exciting five day stay in Mexico City. She and her husband took several tours in and around the Mexican capital.

Mrs. Harris described Mexico as a "never to be forgotten experience. We saw so many things and went so many places. The pyramids were tremendous and the floating gardens very beautiful. Another impressive sight was the Shrine of Guadalupe. We just had a wonderful time and I'm ready to go back again."

Electronic Brain Speeds Orders

INDIANAPOLIS, Indiana — A new wonder of the electronic age has been installed by the Distributor Division of P. R. Mallory & Co. Inc. It's a business machine called RAMAC. This machine is a whopper — 20 feet long, 18 feet wide, and 6 feet tall. Its lair is a specially air-conditioned room to keep it from developing heat exhaustion.

RAMAC is more than a mere machine, it's a whole accounting system. It performs, in seconds, functions which formerly took hours of tedious record searching. It magnetically records millions of tiny bits of stock control and order information and spits them out at an awesome rate in the form of printed invoices and shipping orders.

RAMAC makes it possible for Mallory to ship parts to its distributors quickly and accurately so that they may keep pace with the accelerating demands of modern electronic business.



Lindsey Opens New Service Shop

STATESVILLE, N. C. — Hubert Lindsey, winner of the 1959 "Go Places With Mallory" Contest, has announced the opening of the Forrest Heights T.V. Center at 825F North Center Street, Statesville. He will feature guaranteed service on all types of radio, TV, and hi-fi equipment.

ence in radio and TV repair. He received his technical education at the Southern Vocational Institute in Hickory, N. C., and was formerly Service Manager of Curlee Tire & Appliance.

The most modern electronic test equipment has been installed in the shop, and pick-up and delivery service is offered. (Photo by Tom Franklin.)

Mr. Lindsey is a native of Statesville and has fifteen years experi-

Mallory to Build New Plant

LEXINGTON, N. C.—P. R. Mallory & Co. Inc. has acquired a 17-acre tract here and will build a 60,000 sq. ft. plant. Inc., which has headquarters in Cleveland and manufacturing facilities in Cleveland and North Tarrytown, N. Y.

The new plant is part of Mallory's program to expand its facilities in anticipation of 1960 and future sales gains. It will be occupied by the Mallory Battery Co., a division of P. R. Mallory & Co. The new plant will be used to manufacture advanced dry battery systems. These systems will be used to power hundreds of consumer, industrial, and military products.



Salesman at Work

Joe Harris, salesman for Dixie Radio, Charlotte, is explaining the contents of the Mallory flight bag to Bobby Jenkins, one of the many service technicians Joe calls on. Joe's territory includes southern North Carolina. (Photo by Tom Franklin.)

"Look Ma — No Wires"

The appliance cord may soon join the ranks of the dodo. A host of battery-powered personal appliances are on the market. clock, and now the transistor TV. What next?

First it was the tiny transistor radio, then the cordless electric power utility's loss would be the battery dealer's gain.

GEMS MOLDED TUBULAR PAPER CAPACITORS

Rugged Dependable All-purpose Capacitors in the HANDY FIVE-PACK!

Your best bet for outstanding service in buffer, by-pass, or coupling applications.



Operate your...

- tape recorder
- P. A. system
- portable TV set
- hand tools

FROM YOUR CAR, Boat or Plane!

with

ATR

INVERTERS

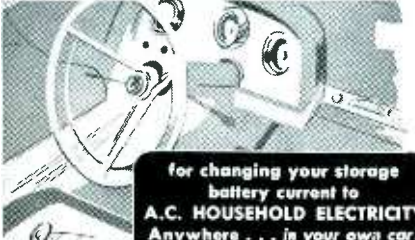

for changing your storage battery current to A.C. HOUSEHOLD ELECTRICITY Anywhere... in your own car!

OPERATES PORTABLE TV SET directly from your car!

OPERATES

- RADIOS
 - RECORD PLAYERS
 - MIXMASTERS, ETC.
- directly from your car!



MAKE YOUR CAR, BOAT OR PLANE "A ROLLING OFFICE!"

OPERATES

- TAPE RECORDERS
 - DICTATING MACHINES
 - PUBLIC ADDRESS SYSTEMS
 - ELECTRIC SHAVERS
- directly from your car!



mounted out of sight under dash or in trunk compartment

ATR UNIVERSAL INVERTERS

Especially designed to change 6 or 12 volt D.C. to 110 volt A.C. 60 cycles. for...

- EXECUTIVES
- SALESMEN
- OUTDOOR MEN
- POLICEMEN
- REPORTERS
- FIREMEN
- PUBLIC OFFICIALS

MODELS 6U-RHG (6 volts) 125 to 150 watts. Shipping weight 27 lbs. List price... \$99.50
DEALER NET PRICE... \$66.34
 12U-RHG (12 volts) 150 to 175 watts. Shipping weight 27 lbs. List price... \$99.50
DEALER NET PRICE... \$66.34

Write for literature on other Sizes and Models of ATR INVERTERS, priced as low as \$11.95 list.

SEE YOUR JOBBER OR WRITE FACTORY

- ✓ NEW MODELS
- ✓ NEW DESIGNS
- ✓ NEW LITERATURE
- "A" Battery Eliminators
- DC-AC Inverters
- Auto Radio Vibrators



AMERICAN TELEVISION & RADIO CO.

Quality Products Since 1931

SAINT PAUL 1, MINNESOTA, U. S. A.

Letters to the

EDITOR

Dear Editor:

For only a few brief months, I have used Sams service literature, and I find it keynoted by quality. Please continue as you are, no matter what difficulties may arise. In quality lies the sound recovery of our economy, which is now sick from the lack of it.

With reference to the recent part-vs. full-timer debate in your columns, all of us "pots" should stop calling all of us "kettles" black so we can get down to the business of working on the basic problem—the cause rather than the effects. Do great numbers of Americans feel they must indulge in price-gouging, or work at two jobs (taking a chance on letting their children become delinquent), in order to eat? Or do they think they are deprived if they do not have everything possible?

Our economy needs to be refined gradually and rationally toward the conclusion that quality construction in all fields, honest selling, honest prices (even when high), and fair wages (ditto) are the hope of America. We need calm, considered, and considerate criticism, too!

A. McMANUS

Trenton, N. J.

Dear Editor:

In the debate between part-time and full-time servicemen, there are two points which, in my opinion, might well be discussed.

First, whose condition is it that needs to be improved—that of the pros, the part-timers, or the public? Are those who object to part-timers concerned with better service, reasonable prices, courtesy, etc., or are they thinking primarily of maintaining a select service group? This unfortunate attitude, more than anything else, antagonizes the set owner and heads him toward the part-timer. When he feels he's at the mercy of one serviceman, can you blame him for feeling trapped when they seem to gang up against him?

The second point I want to raise is this: Does the term "professional full-timer" include servicemen who spend most of their time and effort in selling new sets? Nearly every recognized full-timer in my area is a dealer. True, all advertise their service facilities and perform some service work; but, from what I am told by customers, they would rather sell a new receiver than try to repair an old one.

This was decisively illustrated to me just a few years ago on the very first job I did for a customer who was neither a close friend nor a member of my family. Three servicemen had previously looked at this set. One had installed a new tube; the other two had

made no attempt whatsoever to repair it. All three had agreed that it should be traded in on a new one.

Still lacking in experience at that time, I tackled the job with misgivings. After all, if three real servicemen—! But what a boost that job gave my morale! I found the fabric belt that drives the fine-tuning control lying on the bottom of the cabinet. When this was repaired (a simple matter with rubber cement and shoemaker's thread), normal fine tuning was restored—and the picture was as clear as ever.

Similarly to Mr. C. H. Bond (January Letters), I have run into numerous sets that full-timers have diagnosed as needing new picture tubes or other extensive (and expensive) work; yet many of these were readily cured by minor parts replacements. By fixing these sets, I undoubtedly "do" someone out of numerous sales. On the other hand, the customer gets what he wants and is very willing to pay for the satisfaction he receives.

I have no personal grievance against any of these salesmen-servicemen. After all, they have aided me immeasurably in establishing my full-time business, and as long as they operate as they do, I will be a happy full-timer kept busy by their customers who prefer my methods. But they should stop and appraise their problems open-mindedly before blaming all of their ills on conscientious part-timers.

ROBERT W. McALOAN

Lambertville, N. J.



Dear Editor:

This humorous sign, placed on the back of a service truck, is an excellent business-getter for Planet and Audio Television Co. of 569 Third Avenue, New York City.

DAVID DEUTSCH

Brooklyn, N. Y.

Yes, and it probably saves a few dented fenders, too—especially on the truck!—Ed.

Dear Editor:

Please enter my subscription to PF REPORTER for two years.

In the past 12 years I have subscribed to other magazines in the electronics field, and it wasn't until recently that I became thoroughly convinced of how you people really help the electronic service technician. Your articles are thorough, easy to read, and to the point; your various "tips" and aids such as *Video Speed Servicing* and *Previews of New Sets* are of incalculable help to the serviceman in the field. I certainly hope



Vertical Non-Linearity



Horizontal Non-Linearity



Smeared Picture



Loss of Vertical Sync



Heater-Cathode Leakage

PINPOINT TV TROUBLES



Video I.F. Overload



60-Cycle Hum in Picture

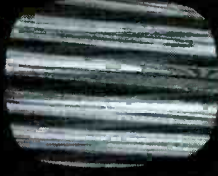

Loss of Horizontal Sync



Loss of Vertical Sweep

IN 1/2 THE TIME

B&K TELEVISION ANALYST

**By Easy Point-to-Point Signal Injection,
You See the Trouble on the TV Screen and
Correct it—Faster and More Profitably!**

Most useful instrument in TV servicing today! Enables you to inject your own TV signal at any point and watch the resulting test pattern on the picture tube itself. Makes it quick and easy to isolate, pinpoint, and correct TV trouble in any stage throughout the video, audio, r.f., i.f., sync, and sweep sections of black & white and color television sets—including intermittents. Makes external scope or wave-form interpretation unnecessary. Enables any serviceman to cut servicing time in half, service more TV sets in less time, really satisfy more customers, and make more money. Color generator provides both rainbow pattern and color bars. Net \$279⁹⁵

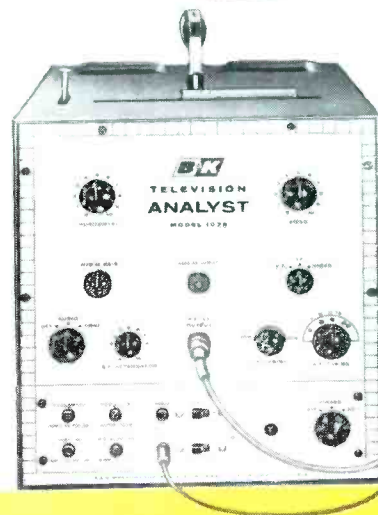

Solve Rough Sweep Output Problems with **DYNA-SWEEP CIRCUIT ANALYZER**

Saves many hours of service work. Provides vertical and horizontal sync and driving pulses that enable you more easily and quickly to check out every stage in the sync and sweep sections of a television receiver. Tracks down troubles in the horizontal and vertical output circuit including defective output transformer and yoke; checks for shorted turns, leakage, opens, short circuits, and continuity. Includes unique high-voltage indication. Eliminates trial and error replacements.

Model A107 Dyna-Sweep. Companion unit for use only with B&K Model 1075 Television Analyst for driving source. Net, \$54.95

Model 1070 Dyna-Sweep. Same as Model A107 but has its own horizontal and vertical driving pulse, and is used independently of the Model 1075 Television Analyst, for separate testing. Net, \$74.95

MODEL 1075 TELEVISION ANALYST
Makes Money for Thousands of Service Technicians



See Your B&K Distributor
or Write for Bulletin ST25-R

B&K MANUFACTURING CO.
1801 W. BELLE PLAINE AVE • CHICAGO 13, ILL.

Canada: Atlas Radio Corp., 50 Wingold, Toronto 10, Ont.
Export: Empire Exporters, 277 Broadway, New York 7, U.S.A.

Centralab has the answer

to your dual control problems

dual

FASTATCH Dual Radiohms®



No need to fence with dual concentric replacements . . . your problems are solved with CENTRALAB Model F and R controls. Just match front and rear units with proper resistance and taper—cut shafts to length (it's easy with the CENTRALAB SK-2 precision Shaft-Kut Tool)—snap together, and *ouche*, you're ready to go.

You won't be foiled by switch problems, either. Just parry them by snapping on a Fastatch KR line switch if needed.

Fastatch Radiohms enable you to meet the demand for an immense variety of dual concentrics with a minimum of components. (The handy FDK-100 Kit provides coverage of 90% of your dual control requirements.) Ask your distributor for full information about CENTRALAB Model F & R controls.

CENTRALAB products are listed in PHOTOFACTS, COUNTERFACTS, and THE RADIO-ELECTRONIC MASTER.

Centralab

B 4002 RL®

ELECTRONICS DIVISION OF GLOBE-UNION INC.
942D E. KEEFE AVE. • MILWAUKEE 1, WIS.
IN CANADA: P. O. Box 400, Ajax, Ontario

CONTROLS • ROTARY SWITCHES • CERAMIC CAPACITORS
PACKAGED ELECTRONIC CIRCUITS • ENGINEERED CERAMICS

you continue as you are and improve as the years go on, since I expect to be a member of your family of subscribers for years to come.

ANTHONY C. ROMEO
West Hempstead, N. Y.

Dear Editor:

I am a faithful reader of your fine magazine and find it very helpful. Your article on printed-board servicing in the January issue just fixed a set for me—thanks!

DON DIXON

San Leandro, Calif.

Dear Editor:

I have been reading your magazine thoroughly for the past five years and think it is the best in the electronics field.

We have also signed up for the PEET program. I believe it is the best thing the Howard W. Sams Co. has done yet.

HERMAN A. ARROWOOD
Arrowood TV & Radio
Charlotte, N. C.

Dear Editor:

Kindly send two copies of your Annual Subject Reference Index for 1959, and two for 1958. One set is for the file we maintain in the shop, and I will use the other at home for reference during "bug and dog brushup."

Your periodical is, in my opinion, essential to the service industry, excellent in quality, and very current.

R. A. BACON
Dick's TV & Appliance Co.
Portageville, Mo.

Dear Editor:

We clip and file all your *Video Speed Servicing* items, and we have found so many other interesting and educational articles in the magazine that we have begun filing the contents page of each issue in the front of our VSS notebook. We want to pass this idea along to others who need help in locating valuable articles they remember seeing in PF REPORTER.

EDGAR L. LEES

Ed Lees Television
Youngstown, Ohio

Dear Editor:

Let me join the growing number of readers who have shown their appreciation for your fine technical publication by dropping a line to say, "Thank you." You and your competent staff are to be congratulated for the manner in which articles are presented and for your wide coverage of the electronics field.

Sometime I would like to see an article on Zener diodes and their use as regulators, since these components seem to be used a great deal in commercial applications.

WILLIAM H. FOSTER

Tacoma, Wash.

Many thanks to you all for the bouquets, as well as your comments and suggestions. Specific subject ideas are always welcome; others are invited to let us know what they'd like to see in future issues.—Ed.

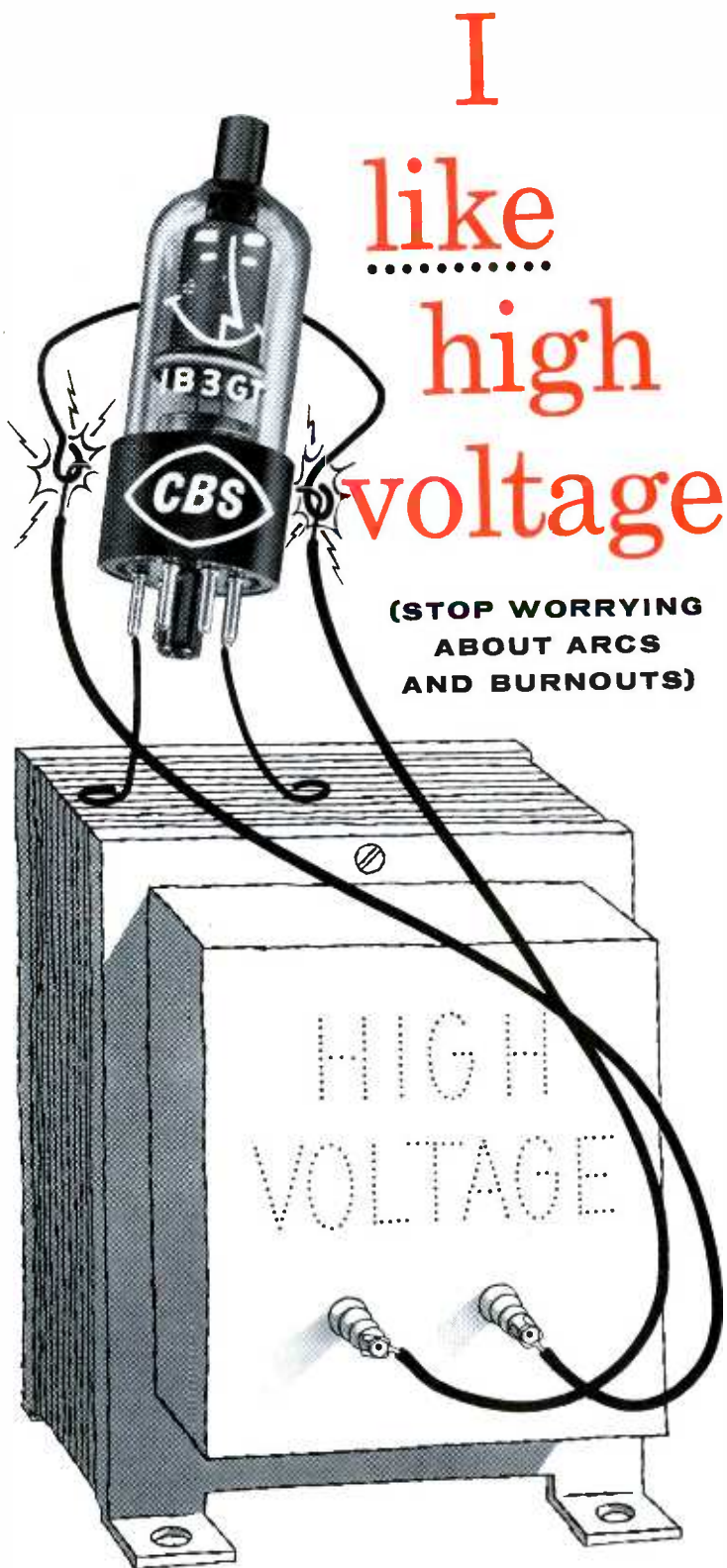

I like high voltage

**(STOP WORRYING
ABOUT ARCS
AND BURNOUTS)**

"I'm clean as a whistle inside . . . no loose particles make me get grouchy and sputter. My filament coating stays put. My filament and anode keep a respectful and arcproof distance. You can depend upon me to take high voltage and like it."

Yes, the whole family of CBS high-voltage rectifiers offers you *total reliability* . . . proved in performance by leading TV and radio set manufacturers. Profit from the *total reliability* of CBS tubes. Use them yourself.

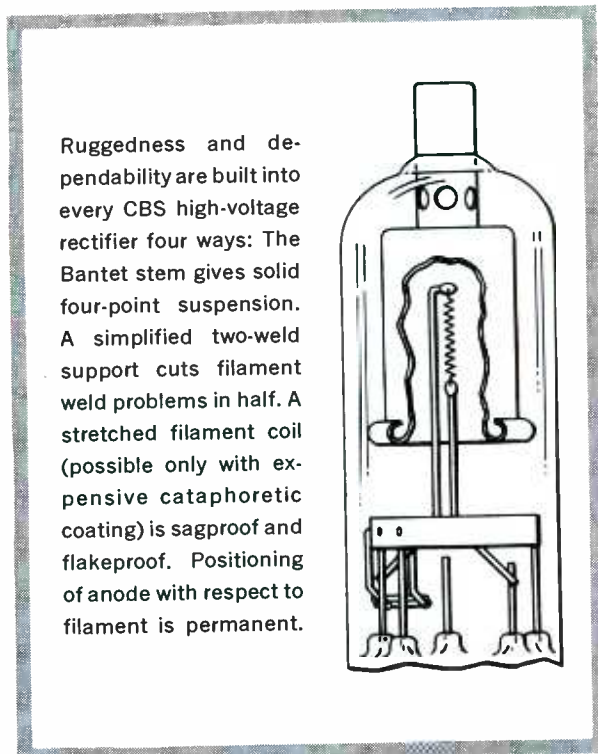

Ruggedness and dependability are built into every CBS high-voltage rectifier four ways: The Bantet stem gives solid four-point suspension. A simplified two-weld support cuts filament weld problems in half. A stretched filament coil (possible only with expensive cataphoretic coating) is sagproof and flakeproof. Positioning of anode with respect to filament is permanent.

TOTAL RELIABILITY . . . proved in performance



CBS ELECTRONICS

Danvers, Massachusetts

A Division of Columbia Broadcasting System, Inc.

Receiving, industrial and picture tubes • transistors and diodes • audio components • and phonographs

TARZIAN

Silicon Rectifiers do more than replace these 40 tube types



5AU4	5AW4	5AZ4	5T4
5U4	5V4	5Y4	5W4
5Y3	5Z4	6X4	6063
6202	80	82	83
83V	5Z3	0Z4	5X4
6AX5	6X5	5AU4	5931
6087	6106	5R4	6AU4
6AX4	6BL4	6U4	6W4
12AX4	17AX4	25W4	816
836	3B28	866	866A

Some common vacuum rectifier types that Tarzian silicon rectifiers replace

THEY ALSO PROVIDE:

1. Higher current ratings
2. Inherently rugged construction
3. Instant operation; no warmup
4. Greater electrical stability
5. Improved voltage regulation

Tarzian tube replacement silicon rectifiers combine the advantages of solid state rectification and direct interchangeability with over 95% of all popular rectifier tube types. Although the silicon units are generally smaller than the tubes they replace, their dc current ratings are substantially higher, as much as three times as great in some ratings.

If you have a rectifier application requiring high efficiency, long life, rugged construction, or wide temperature range, Tarzian tube replacement silicon rectifiers may solve your problem. They are available in nine standard models. Special designs and modifications can be worked out on request.

For specifications and prices of tube replacement silicon rectifiers, contact your Sarkes Tarzian sales representative or distributor, or write to Section 4615C Sarkes Tarzian, Inc., Semiconductor Division, Bloomington, Indiana.



SARKES TARZIAN, INC.

SEMICONDUCTOR DIVISION
BLOOMINGTON, INDIANA

In Canada: 700 Weston Rd., Toronto 9, Ontario
Export: Ad Auriema, Inc., New York City



The Electronic Scanner

If you're looking for a way to recapture tube sales lost to the corner drugstore, and have thought of offering your customers some form of tube-testing program, Seco's "Take-A-Tube-Tester-Home" plan may be just the answer. The program centers around their portable Model 78 *Grid Circuit and Tube Merit tester*, which is especially designed for loaning to your customers. When they return the unit, they also buy the tubes they need — but from you instead of the corner druggist!

Perma-Power gave away so many cigarette lighters in their last "Vu-Brite" promotion that they're making another offer this spring. By buying "VuBrite" picture tube brighteners a dozen at a time, you also get an unbreakable polystyrene flashlight at no extra cost.

If you're looking for more premium deals, you can still earn your choice of a portable tube and tool case, ¼ H.P. electric tool set, pocket-size volt-ohmmeter, or any one of four other worthwhile items, with purchases of Motorola "Golden M" premium-rated tubes.

For shipping defective tuners to the factory, Standard Coil distributors will stock specially-designed cartons which can be instantly recognized and routed to a special service department. These repair jobs will be handled on a 48-hour in-plant cycle. To help their customers choose replacement units, the company will maintain an up-to-date Tuner Replacement Guide, as well as list recommended replacements in PHOTOFACT Folders.

The BIG Picture

According to EIA, over 5.7 million TV receivers were sold during 1959, an increase of 600,000 units over 1958. The public also bought nearly 8.9 million radios, as well as 1.6 million monophonic and 2.7 million stereophonic phonograph units (packaged units only) — almost a million more packaged phono units than were even produced in 1958! So if you're concerned about your future in the radio-TV-electronic business, you can cross one worry off your list — someone is using all this equipment, and *someone* has to repair it!

Starting April 20th, Dave Garroway encourages "Today" show viewers to ask for G-E's "BLACK-DAYLITE" picture tube when they need a replacement. Newspaper mats, recordings, and other promotional material will be made available for use by independent service dealers during the nation-wide campaign.

B & K's new 65,000 square foot plant at 1801 W. Belle Plaine, Chicago, has enlarged facilities for laboratory research, engineering, and manufacturing, fortifying the firm's planned program of expansion through development of new products and acquisition of other companies.

GET THAT SYLVANIA SIGN UP TODAY!

ARTHUR GODFREY IS SELLING YOU!

Now sponsored by Sylvania Silver Screen 85 picture tubes, Arthur Godfrey is selling America on you — the independent TV service dealer!

He's telling millions — on the CBS Radio network — coast-to-coast — that you are the man to see for the finest TV service. Millions more are reading about you in *The Saturday Evening Post*. When Arthur Godfrey tells folks to "look for the Sylvania decal in the window of your local independent TV service dealer's shop," make sure you're with it.

See your Sylvania distributor for Sylvania Silver Screen 85 picture tubes and Sylvania quality receiving tubes. Get your display kit of window streamers and posters. Get that sign up today!

*Electronic Tubes Division, Sylvania Electric Products Inc.,
1740 Broadway, N. Y. 19, N. Y.*

**SYLVANIA
SILVER SCREEN 85
4 WAYS BETTER**

- * Sharper focus
- * Clearer picture
- * Greater contrast
- * More light output



See your local paper for time and station

"IT'S ARTHUR GODFREY TIME" — brought to you by

 **SYLVANIA**

Subsidiary of **GENERAL TELEPHONE & ELECTRONICS** 

Only Simpson's 260[®] VOM Converts into 7 Different Testers

NEW Simpson "Add-A-Tester" Adapters



Add-A-Tester Adapters for 260 VOM

TRANSISTOR TESTER, Model 650... \$25.95

Beta Ranges: 0-10, 0-50, 0-250, (F.S.)
Beta Accuracy: $\pm 3\%$, with 260 $\pm 5\%$ nominal
Ico Range: 0-100 μ a
Ico Accuracy: $\pm 1\%$, with 260 $\pm 3\%$ (F.S.)

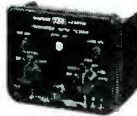

DC VTVM, Model 651... \$32.95

Voltage Ranges: 0-.5/1.0/2.5/5.0/10/25/
50/100/250/500
Accuracy: $\pm 1\%$, with 260 $\pm 3\%$ (F.S.)
Input Impedance: greater than 10 megs at
all ranges



TEMPERATURE TESTER, Model 652.. \$38.95

Temperature Range: -50°F to $+250^{\circ}\text{F}$
Accuracy: with 260 $\pm 2^{\circ}$ (nominal)
Three lead positions provided
Sensing Element: thermistor



AC AMMETER, Model 653... \$18.95

Ranges: 0-0.25/1/2.5/12.5/25 amps
Accuracy: $\pm 2\%$, with 260 $\pm 3\%$ nominal
Frequency Range: 50 cycles to 3000 cycles



AUDIO WATTMETER, Model 654... \$18.95

Load Ranges: 4, 8, 16, 600 ohms
Wattage: Continuous 25 watts (8,600 ohms)
50 watts (4,16 ohms)
Intermittent 50 watts (8,600 ohms)
100 watts (4,16 ohms)



Accuracy: $\pm 5\%$, with 260 $\pm 10\%$ nominal
Direct reading scale from 17 microwatts to
100 watts

MICROVOLT ATTENUATOR, Model 655... \$18.95

Ranges: 2.5 microvolts to 250,000 microvolts
continuously variable in decade steps
Frequency: DC to 20 KC
Accuracy: ± 1 db, with 260



BATTERY TESTER, Model 656... \$19.95

Checks all radio and hearing aid batteries
up to 90 volts at the manufacturer's recom-
mended load, or any external load.



Note: All Simpson 260[®] Adapters provide for
normal usage without disconnecting the adapter.

World's Largest Manufacturer of Electronic Test Equipment



**EXPANDS
the Famous 260®
As the Need Arises**

Before you buy a VOM, consider your future needs in test equipment. Will you require a transistor tester . . . or a DC VTVM . . . possibly a temperature tester . . . or maybe an AC ammeter? If so, you can use Simpson's world-famous 260® VOM as the basis for these, as well as a whole "test bench" of high-quality instruments. All you do is plug in "Add-A-Tester" adapters. As each new test need arises, you buy only an adapter; you save the cost of duplicate meters and circuitry necessary for single-purpose testers. Currently available are the seven adapters shown at left. Additional Add-A-Tester adapters will be announced in future months.



See these adapters on display now showing at better distributors across the Nation.

Simpson

SIMPSON ELECTRIC COMPANY

5209 West Kinzie Street, Chicago 44, Illinois
Phone: EStEbrook 9-1121

In Canada: Bach-Simpson Ltd., London, Ont.

BATTERIES TODAY

Fig. 1. In Philco 10AT10 TV set, battery is recharged from rectifier.

With portable radios reaching new heights of popularity, and transistorized portable TV sets also beginning to appear on the market, the serviceman needs to know more about batteries than ever before. Testing and stocking conventional "dry cells" is an increasingly important part of his business, and he will also be expected to service equipment powered by other, less familiar types of batteries.

Rechargeable Battery Packs

Transistorized TV sets require considerably more power than radios because of the greater number of transistors and the added load imposed by the picture tube. If ordinary radio batteries of any reasonable size were used as a power source, they would be exhausted and ready for replacement after only about a half-dozen hours of operation. The most practical way of overcoming this obvious disadvantage is to use *rechargeable* batteries.

The Philco Chassis 10AT10 transistorized portable TV set, introduced last fall, uses a relatively low-cost Everready alkaline battery. This unit's individual cells, consisting of manganese dioxide and zinc electrodes with a potassium hydroxide electrolyte, are hermetically sealed; thus, the battery can be operated in any position without risk of leakage. Five cells are connected

in series to obtain a total potential of 7.5 volts.

Since the battery has a rated capacity of 2 ampere-hours, and the current requirement of the TV receiver approaches 500 ma for battery operation, both the set and battery manufacturers recommend a maximum of four hours' playing time per charge cycle. This limitation is extremely important to remember, because an excessively heavy discharge results in a chemical reaction which permanently destroys the battery's rechargeability. Even moderately exceeding the unit's rated current capacity will materially shorten its life.

After a normal four-hour cycle of operation, the charge is replenished by flipping the function switch to the CHARGE position and plugging the receiver into the AC line. As Fig. 1 indicates, the battery is thereby connected across the output terminals of a full-wave silicon-rectifier circuit—the same one that supplies DC power to the receiver for "off-the-line" operation. A 5.6-ohm, 1-watt resistor limits the charging current to a safe level. Since the alkaline battery must be charged much more slowly than it is discharged, the circuit of Fig. 1 must be left in position for 20 hours in order to restore a full charge. Moderate overcharging will not damage the battery, as long as current is not applied at a higher-than-normal rate. One exception to this

statement is a new battery, which must first be discharged to some extent before recharging is attempted. A brand-new unit in shelf storage will hold its initial charge as long as a conventional dry battery; therefore, it is neither necessary nor desirable to "trickle-charge" these alkaline units as you would a lead-acid battery.

Nickel-Cadmium Type

Several experimental models of transistorized TV sets have included nickel-cadmium batteries; this type of power source is expected to appear in some future production models. The nickel-cadmium formula for batteries is not new—but its application to commercial units, suitably sized and priced for use in the radio-TV field, is a very recent development. Like the alkaline rechargeable battery, the latest-type nickel-cadmium units are hermetically sealed to prevent evaporation and leakage of the electrolyte.

Since small voltaic cells of any type have a limited current capacity, nickel-cadmium batteries do not provide significantly more playing time per charge cycle than alkaline units. Their chief advantage is in their ability to survive an almost unlimited number of recharging cycles. With proper care, they can conceivably last as long as the equipment in which they are used.

• Please turn to page 81



9-volt rechargeable battery marketed by B&K Mfg. for transistor portables.



Sonotone's nickel-cadmium rechargeable unit replaces two "D" size standard cells.



Burgess rechargeable batteries are made up of 1.25-volt nickel-cadmium cells.

Just off the press.... your “PROFIT BOOK” for 1960



Coil and Transformer Corporation
MERIT PLAZA HOLLYWOOD • FLORIDA



What you should know about **TUBE CHANGING**

Professional-grade TV service work practically always involves something more than just tube changing. Few, if any, of the tubes in a television receiver can be replaced without producing some effect on the operation of one or more service controls; so, if you aim to restore the receiver to peak performance, you must give some thought to checking these adjustments. Sometimes, it's even advisable to make further operational checks beyond resetting service controls, as extra insurance against callbacks.

Fig. 1 sums up a number of basic facts about the service adjustments typically found in TV receivers. This information is a key to understanding how tube changing is likely to affect the various service controls.

Tube-by-Tube Analysis

Low-Voltage Rectifier

After a B+ circuit has been repaired, circuit adjustments are definitely necessary even if no service controls are located directly in the

low-voltage power-supply section. Actually, there aren't many controls in the whole set that *won't* require readjustment after a feeble rectifier circuit has been brought back to normal.

The vertical and horizontal output amplifiers operate less efficiently at low supply voltages than at higher voltages, and if the various controls in these circuits were adjusted before the B+ circuit was restored to full output, the rise in supply voltage would make the picture oversized both horizontally and vertically. Therefore, the vertical size and linearity controls should be readjusted for an undistorted raster which "overscans" the screen by not more than 5%. This keeps most of the picture in sight, while still leaving a small margin of reserve sweep to compensate for tube aging.

Horizontal drive, width, and linearity, if adjustable, should also undergo a touch-up. For best results in checking linearity, use a pattern generator or a transmitted test pattern. It would also be wise to check the operating voltages of the hori-

zontal output tube for any discrepancies; a tube-socket adapter comes in handy here.

Unless the set employs an automatically - focused picture tube, checking the focus adjustment wouldn't be a bad idea. In sets with permanent-magnet focusing assemblies, try changing the physical position of the focus unit. Also check the voltages at the various elements of the CRT, since these will affect focusing as well as brightness and contrast. As a final touch, the ion-trap magnet may need a slight readjustment for peak brightness and best focus.

Picture Tube

An old CRT with a remaining cathode-current capacity of under 100 microamps cannot place more than a 100-microamp load on the high-voltage supply. A weak high-voltage rectifier, even if nearly dead, may be able to hold up under this limited load; but when confronted with a new CRT's demand for 200 or more microamps, it will last for only a very short time. Whenever I replace a picture tube, I also install a new high-voltage rectifier—unless I am certain the existing tube is in like-new condition.

Naturally, such items as picture centering, focus, and ion-trap placement must be adjusted for optimum performance. In addition, it is a good policy to adjust vertical and horizontal size, and to reset AGC and sync controls for best operation.

Vertical Oscillator and Output

Since the vertical size and line-

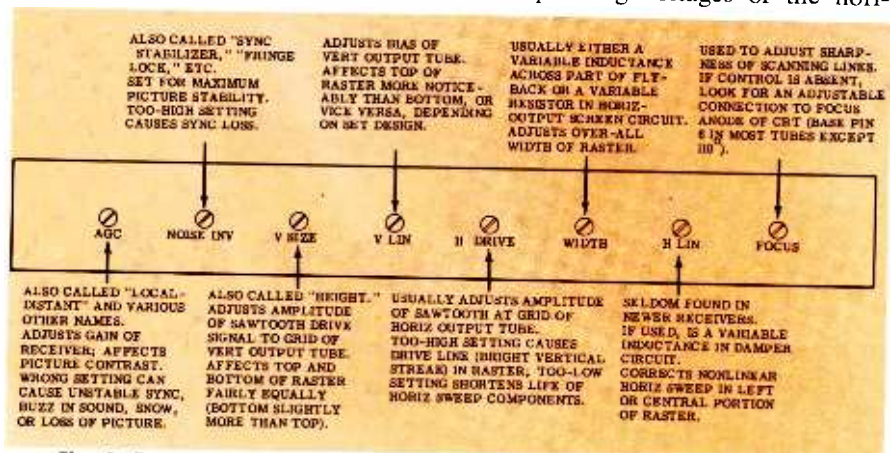

Fig. 1. Facts to keep in mind about the service adjustments of a TV set.

50% OF ALL TV SETS MADE TODAY ARE PORTABLE AND TOTE-ABLE TYPES. THIS WILL ADD UP TO \$3,500,000 IN EXACT REPLACEMENT ANTENNA VOLUME IN 1960 FOR FORWARD-THINKING DISTRIBUTORS AND DEALERS WHO PREPARE FOR IT TODAY! . . . WITH THE JFD EXACT REPLACEMENT ANTENNA MERCHANDISING PLAN.



Model TA359 List, \$4.50
Exact Replacement for RCA,
Motorola, Magnavox, 1956-7-8
Portable TV Sets



Model TA362 List, \$9.75
Exact Replacement for GE
Designer and Hotpoint "Flair"
1958 Portable TV Sets

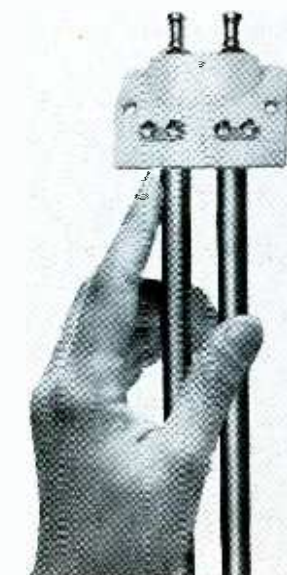

Model TA369 List, \$8.25
Exact Replacement for RCA
1960 Portable TV Sets

WHERE WOULD YOU GET ANY
AND EVERY ANTENNA REPLACEMENT
FOR PORTABLE AND TOTEABLE SETS?

JFD*

OF COURSE!

Only when you buy a JFD Exact Replacement Antenna do you get the original unit that JFD supplies to manufacturers for their TV portable or "tote-able" sets. And when you install a JFD Exact Replacement Antenna *you* make a *full* profit on the sale and the installation—bring customers back to *your* shop because only you are equipped to replace a broken antenna.

Only \$11.95 puts you back in profitable indoor antenna business. That's all it costs for the No. PA500 JFD Exact Replacement Antenna Merchandising Kit that gets you started in this new multi-million dollar service market.

Remember, next to receiving tubes, the antennas of portable and "tote-able" sets require the most frequent replacement.

See your JFD distributor today for your PA 500 kit and any and every antenna replacement need.

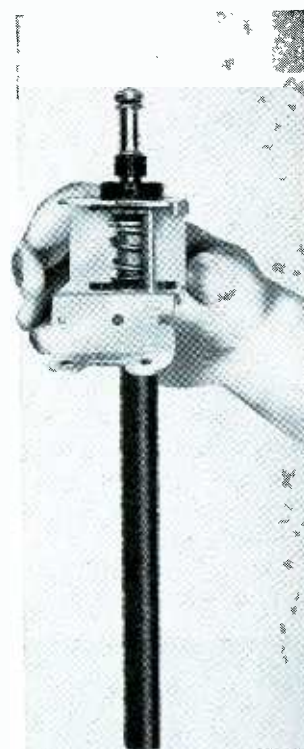

Model TA370 List, \$6.25
Exact Replacement for
Admiral 1959-6C Portable
TV Sets



Model TA360 List, \$7.65
Exact Replacement for GE,
Hoffman, Hotpoint & Emerson
1957-8 Portable TV Sets

*Beginning with set 467 in December, JFD Exact Replacement Antennas will be listed in SAMS PHOTOFACT folders for your service reference.

Pioneers in electronics since 1929
JFD ELECTRONICS CORPORATION

6101 Sixteenth Avenue Brooklyn 4, New York

JFD CANADA LTD.
51 McCormack Street
Toronto, Ontario, Canada

JFD INTERNATIONAL
15 Moore Street
New York, N.Y.

G.E.'S FRISKY

We've been hearing a chorus of distress signals lately from technicians who have been trying, with varying success, to service a batch of General Electric TV receivers made in the early 1950's. So, I have dug into this problem and have come up with some information to help you keep these unusually long-lived sets on their feet a while longer.

One particularly popular series of G-E models, all using the same

basic chassis design, first appeared in mid-1950 and continued in production through 1951. Unlike today's TV chassis units, this old-timer did not carry a special chassis number to aid in identification. However, you will be able to recognize "it" if you remember that it appeared in all the models listed in Table I. Although the early- and late-production receivers in this series were covered in separate PHOTOFAC Folders, there are only

minor differences between the two. Both have the same tube complement, virtually identical circuitry, and a very similar physical layout.

Up-to-date service information on this "Chassis X" wouldn't be complete without waveform data, so scope patterns at eight key test points in a normally-operating receiver are shown in Fig. 1. All waveforms were viewed with the contrast control adjusted to produce a composite-video signal amplitude of 1 volt peak to peak across the 3600-ohm video-detector load resistor.

Table II, a detailed troubleshooting chart, will help you to locate the causes of many common trouble symptoms in old General Electric receivers. Due to their age, these sets are likely to develop double troubles, triple troubles, or even more—but you can take care of such problems by attacking the symptoms *one at a time*, with the aid of the chart. In compiling these troubleshooting suggestions, I've tried to emphasize those failures which have actually been known to occur — neglecting the more improbable troubles.

Although references to certain electrolytic capacitors are included, I haven't run into trouble with them myself (except for the usual few failures of power-supply fil-

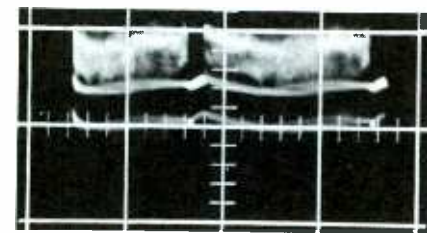

(A) Grid of video amplifier
—pin 2 of V7—1V p-p.

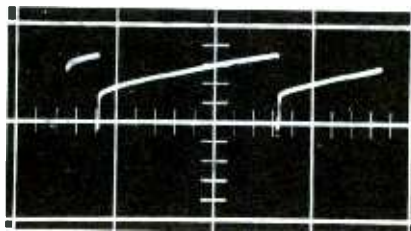

(E) Grid of vertical output
—pin 2 of V15—80V p-p.

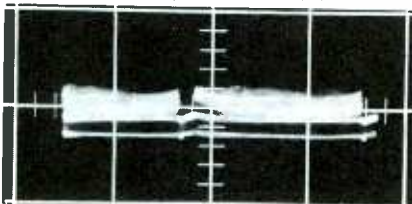

(B) Plate of video output
—pin 6 of V7—50V p-p.

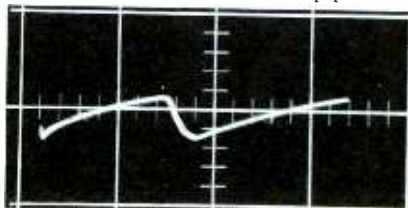

(F) Feedback of horizontal AFC
—pin 2 of V16—40V p-p.



(C) Plate of sync amplifier
—pin 5 of V13—50V p-p.

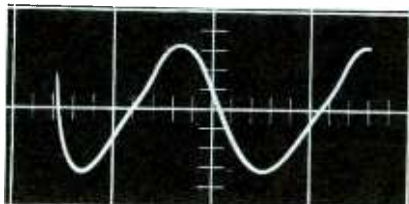

(G) High side of horizontal
frequency coil—150V p-p.

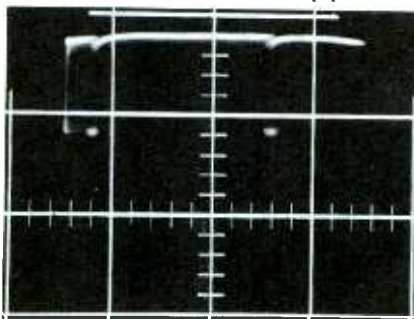

(D) Plate of sync separator
—pin 2 of V13—100V p-p.

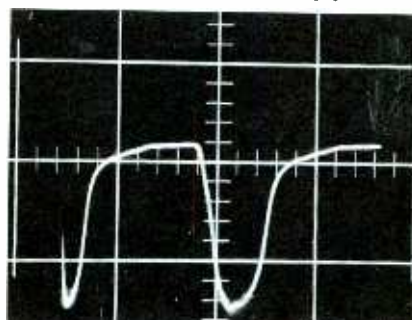

(H) Grid of horizontal output
—pin 5 of V18—180V p-p.

Fig. 1. Key waveforms in normally-operating '50 General Electric receiver.

Table I—Models Discussed in This Article

1950 GROUP -- COVERED IN PHOTOFAC FOLDER 123-4	
Consoles	Table Models
14C105, 14C103	14T3, 14T3
*16C110, 16C111, 16C115	*16T1, 16T2
16C103, 16C104, 16C113, 16C116, 16C117, 17C104, 17C102	16T3, 16T4, 16T5, 16T6
1951 GROUP -- COVERED IN PHOTOFAC FOLDER 141-6	
Consoles	Table Models
17C103, 17C104, 17C105, 17C107, 17C108, 17C109	17T1, 17T2, 17T3
17C112, 17C114	17T4, 17T5, 17T6
* Have "stacked IF's" (second and third stages series-connected across B \neq source). This alternate circuit is shown in dotted lines in PHOTOFAC schematic.	
† Include production changes covered in PHOTOFAC Folder 158-1.	

10 YEAR OLDS

ters). Neither have I had appreciable trouble with bad mica capacitors. But half-watt controls, half-watt resistors, and wax-impregnated tubular capacitors are a constant headache. Go after those wax-dribblers, and you will be well on your way to unraveling many a puzzle. If in doubt about their condition, throw 'em out.

Circuit Features and Troubleshooting Hints

These early G-E's were considered "hot" sets in several ways when they were introduced. For their day, they had a number of advanced features—some of which later became more-or-less standard practice in TV design.

RF-IF Section

One "different" feature of these sets, even by present-day standards, is the tuner circuitry. Two stages of RF amplification are used. The signal is coupled from the antenna into the cathode circuit of a grounded-grid 6AB4 triode, which in turn drives a partially AGC-controlled 6BC5 pentode. The mixer-oscillator is a 12AT7 — not too unusual in earlier tuners. However, its output is tuned to the 40-mc IF band, and this feature was "news" back in the days when the 20-mc IF strip was standard.

The IF strip includes three impedance-coupled, stagger-tuned stages employing 6BC5 pentodes. AGC bias voltage is fed equally to all three tubes (except in sets having "stacked IF's"), and the cathode resistor of the third IF stage is unbypassed to provide a small amount of degeneration for greater stability.

Contrast-Control Circuit

The contrast control in this chassis does not regulate the gain of the video amplifier, as in most other

• Please turn to page 64

Table II—Troubleshooting Chart for G-E Models Listed in Table I

SYMPTOM	LIKELY CAUSE	REMEDY
No AC voltage to set	Bad AC plug, cord or on-off switch Open thermal cutout	Replace Attempt to reset. If it "blows" again, check for short in set—especially in filters C1, C2, C3, C4A. Cutout may also be defective.
No DC output voltage from B+ rectifier	Open selenium rectifier, filter choke, or input electrolytic	Replace M1 ('50) — M2 ('51)* Substitute or check L1, C1
Tubes do not light	Open negative-temperature-coefficient dropping resistor in series string Open picture-tube filament	Replace R120 ('50) — R121 ('51) Resolder filament pins or replace tube
Tubes V1 through V8, V12, V11, and V15 do not light (see Fig. 7).	Open tube filament or heater choke	Replace defective tube; replace L25, L27, L29, or L35 ('50) — L33 ('51)
Tubes V9, V10, V11, V13, and V16 through V19 do not light	Open tube filament or heater choke	Replace defective tube; replace L44
Abnormally long warm-up time (over 15 sec.)	Filament-dropping resistance too high Slow warm-up, interelectrode leakage, or short in some tube	Replace R120 ('50) — R121 ('51) Check tubes
Raster normal; no pix or sound	Defective RF, IF, video-amp, or pix tube Open video detector diode	Substitute or check V1 through V7; also V21 Substitute or check M5
Excessively bright pix containing black lines	Leaky or shorted coupling capacitor from video output stage to grid of CRT	Check for positive voltage on grid or CRT. If present, replace C53
No raster; all tube filaments lit	Defective tubes in horizontal sweep and high-voltage section Defective components in screen circuit of horizontal output Defective components in AFC, oscillator, or output stages	Substitute or check V16 through V20 Replace or check R113, R114, C106 Check for normal waveform at grid of horizontal output (see Fig. 1); if absent, troubleshoot oscillator and AFC
Hum (S-curve) in pix; may also be in raster	Heater-to-cathode leakage in video, sync, AFC or horizontal oscillator tube Defective boost filter capacitor	Substitute V7, V13, V16, V17 Substitute C5A, C5B ('50) — C6A, C6B, ('51). Replace entire capacitor if one section is bad
Above symptom, plus strong black bar across pix	Heater-to-cathode leakage in RF, IF or video tube Bad filter capacitors in B+ or video-amplifier circuit	Substitute V1 through V7 Substitute C2, C3, and C5C ('50) — C6C ('51)
Excessive contrast or bending in pix; may not be affected by changing contrast setting	Shorted or gassy IF or video tube Excessive RF input signal Defective contrast control Defective capacitors in AGC, sync or video circuits	Substitute V4 through V7 Insert attenuator pad in series with antenna Replace R1A Replace capacitors, especially paper tubular types, in circuits mentioned
Pix "pulls," but does not fall out of sync at max. contrast setting; fades abnormally at lower contrast	Defective electrolytic filter capacitor in boost circuit	Substitute C5A ('50) — C6A ('51). If defective, replace entire capacitor
Vertical lines at left side of pix	Open or missing bypass capacitor across 240-volt B+ source	Replace or add C108 ('50) — C75 ('51)
Insufficient horizontal deflection	Defective tubes Resistor increased in value Leaky capacitor	Substitute or check V17, V18, V19 Check R107, R108, R113, ('50) — R104, R105, R113 ('51) Substitute C98, C99, C100, C106, C109, C110 ('50) — C101, C99, C102, C106, C112, C113, ('51)
Dull pix, but normal high voltage	Weak picture tube Resistor increased in value Leaky capacitor	Check or replace V21 Check R48, R49, R3B ('50) — R51, R48, R3B ('51) Substitute C53, C54
Retrace lines visible	Vertical blanking amplifier tube not conducting (see Fig. 4) Defective resistor or capacitor	Substitute or check V14 Substitute or check R96, R83, C83 ('50) — R83, R90, C88 ('51)
Poor vertical hold	Defective video, sync or vertical tube Leaky or shorted bypass or coupling capacitor somewhere between video and vertical stage	Substitute or check V7, V13, V14, V15 Substitute capacitors, especially paper tubular units, in video, sync and vertical stages
No vertical deflection	Bad vertical oscillator or output tube Open vertical output transformer Open or shorted yoke winding Shorted capacitor in vertical multi-vibrator or output stage	Substitute or check V14, V15 Check T2 Substitute or check yoke Substitute capacitors, starting with C87, C86, C84, C82 ('50) — C88, C87, C85, C82 ('51)
Insufficient height	Low emission, leakage, or gas in vertical output tube Leaky capacitor	Substitute or check V15 Substitute C87, C88, C4C ('50) — C86, C87, C5C ('51) Check T2 Check for adequate voltage from boost source
Poor vertical linearity	Defective vertical output transformer Insufficient plate voltage on vertical sweep tubes Plate load resistance increased in value	Check height control R5; also R91, R95 ('50) — R86, R89 ('51)
	Defective vertical output tube Capacitor leaky or changed value Resistor changed in value	Substitute or check V15 Substitute C4C, C81; also C87, C88 ('50) — C86, C87 ('51) Check linearity control R6; also R94, R93 ('50) — R88, R87 ('51)

*Since these receivers were covered in two separate Photofact Folders, two different item numbers have been applied to some components. In this chart, the designation ('50) is used for part numbers of receivers covered in Photofact Folder 123-4; ('51) indicates coverage in Folder 141-6.

CIRCUIT SAFETY DEVICES

Modern television receivers are sprouting several new signs of safety. In addition to one or two special fuse types, you're also apt to run across small thermal switches and odd-looking resistors. If you're not fully acquainted with these circuit-protecting components, you may find them a real troubleshooting bottleneck. Here are some you'll be seeing.

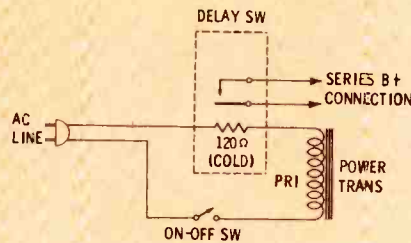
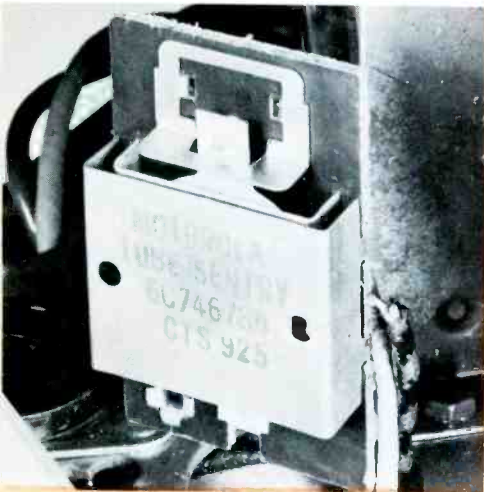

If all tubes light, yet the set doesn't operate, see if a thermal delay switch is used. This unit consists of a resistive element and bimetallic switch usually housed in a small shielded assembly as pictured. The resistor may be located in the primary circuit of the power transformer, while the bimetallic switch acts as a series connection in the B+ line. Thus, tube filaments are permitted to warm up prior to the application of B+. If the unit is working, you should be able to hear it click several seconds after the set is turned on. Some of these assemblies may have a small adjustment screw; however, these are preset at the factory and, barring physical damage, should not require adjustment in the field.

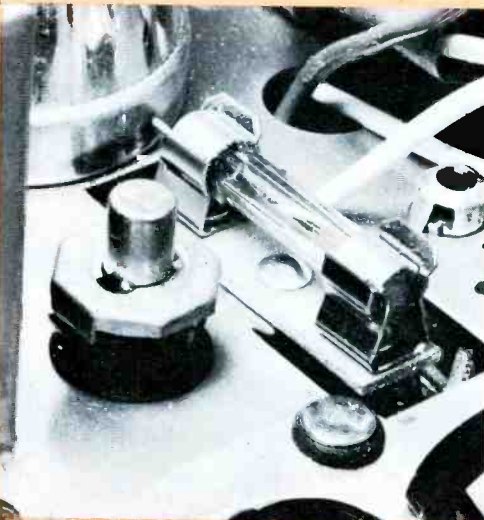
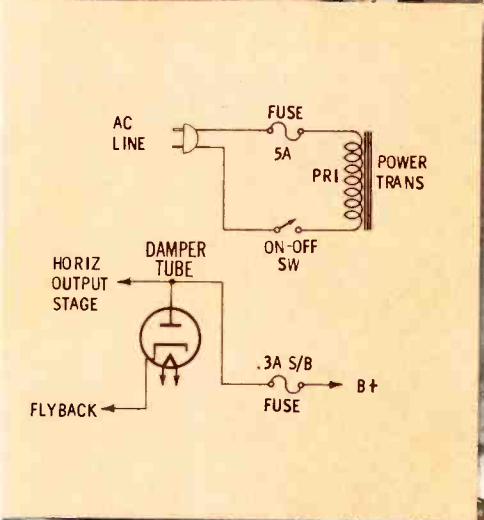

In our investigation of protection devices, we mustn't overlook fuses. You will still find cartridge and pigtail fuses used in both instant and slow-blow varieties. Shown here are a cartridge-type fuse, connected in series with the primary of a set's power transformer, and an "N" type unit protecting the horizontal sweep-circuit components. The newer "N" style fits into a special holder that prevents installing a fuse of the wrong type or rating. Straight wire fuses are being used to a greater extent these days, in both series and parallel filament circuits. These are generally pieces of #24 to #28 copper wire, ranging in length from 1" to 3". Remember, never replace fuses indiscriminately, without regard for ratings and characteristics.

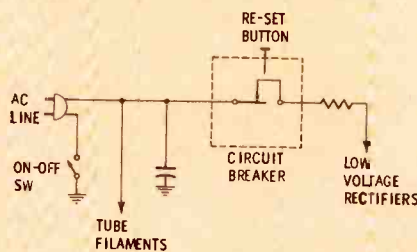
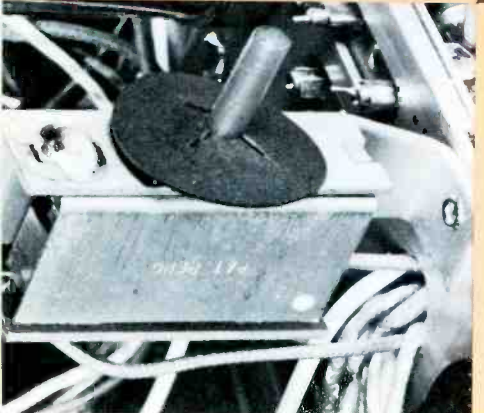

Here's another safety device you see a lot of these days. It's a thermal cut-out or circuit breaker equipped with a manual reset button which is accessible from the rear of the chassis as pictured. A typical application is shown in the partial schematic; heat due to excessive current drawn by the B+ supply will cause the breaker to open, thus safeguarding rectifiers and other series components. If this unit opens, tube filaments will remain lighted, but B+ will not be applied and the receiver will not operate.

SLOW The power-consuming fixed resistor, used for years to protect components against initial surge current, is now being replaced by something a little different—a combination resistor and thermal switch. A wirewound resistor (having a value of about 100 ohms cold) is placed in close proximity to a bimetallic strip which, in turn, acts as a shorting switch across the resistor. The resistor limits the initial current and, after a few seconds' delay, closes the switch with the heat it generates. Even many sets with power transformers are now using this form of surge protection to control warm-up.

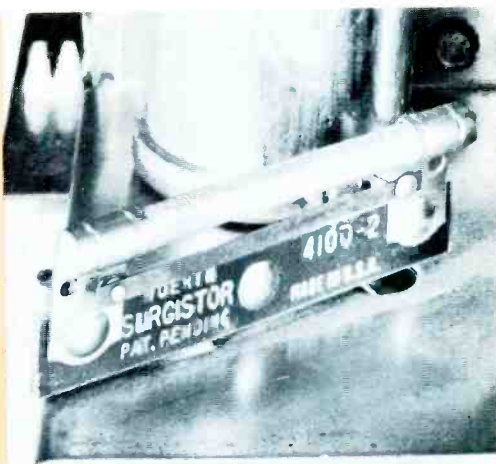
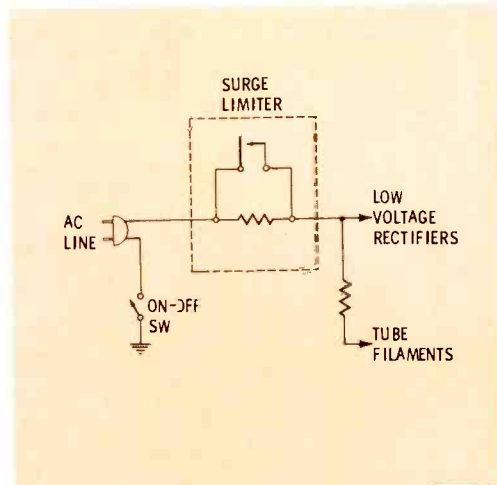

STOP Fusible resistors fall into the category of protective devices, and are especially popular in today's TV portables. Illustrated here is a typical plug-in unit rated at 5.6 ohms, 5 watts. The "sugar-coated" component plugs into a pair of banana-type connectors on a terminal board. Actually, the *fusistor* serves two purposes: It limits surge current when power is first applied, and it protects the B+ rectifier circuit against overloads. Both resistance value and wattage rating are important. If you install one of equal wattage, but of lower resistance, the fuse feature may be impaired ($P=I^2R$). If, on the other hand, you install one with a higher resistance, it will overheat and open more readily.

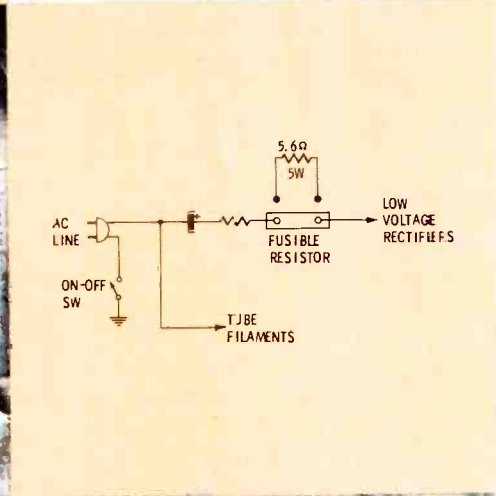

SPEED UP *Thermistors*, or temperature-compensating resistors, are employed to prolong the lives of tubes and other components. As shown, they are shaped like a large disc capacitor. By decreasing in value as they heat up, they provide automatic control of surge current. You'll often find thermistors employed in series filament circuits as shown in the schematic. When measuring the resistance of a thermistor, remember that its value depends on temperature. The rated resistance of the unit shown here is 200 ohms cold and 6 ohms hot. In many 110° receivers, you'll find thermistors used in the vertical deflection circuit. Here, however, they compensate for changing resistances in the yoke winding as the set warms up.

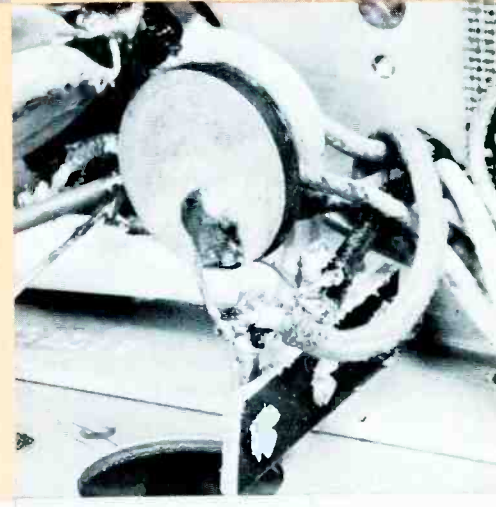
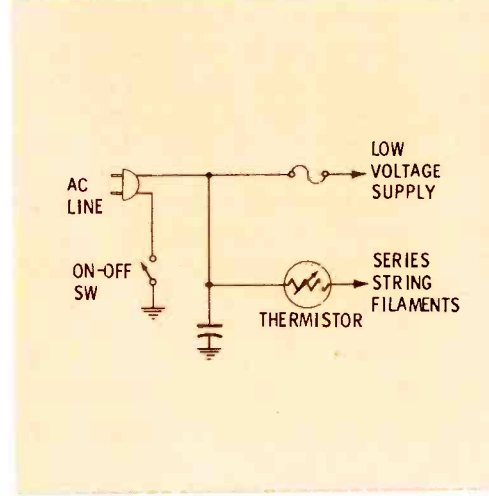

STOP If you have a customer complaining about too many tubes going out, or other repeated failures which are apparently due to high line voltage at certain times of the day, you'll want to consider installing one of the universal-type regulators now available. Here are just a couple of the surge-limiting devices which can be used on about any receiver. The smaller unit is a surge resistor paralleled by a bimetallic shorting switch; it's designed for chassis mounting and should be connected in series with either side of the input power line. The other unit is similar electrically, but is housed in a plastic case for external use.



testing HI-FI

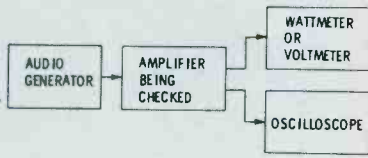

Fig. 1. Basic test setup for checking frequency response of an amplifier.

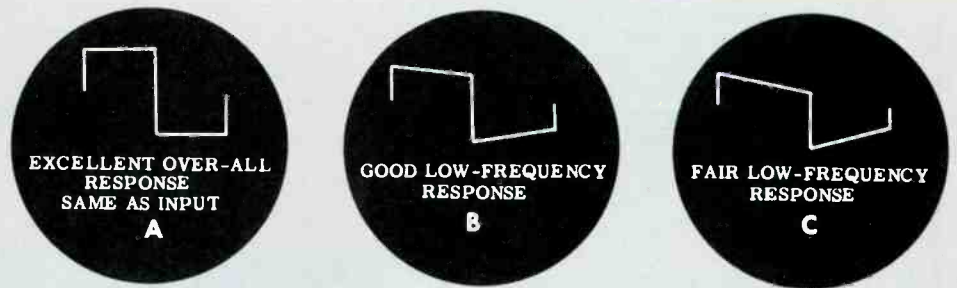

Fig. 2. Square-wave patterns due to

Hi-fi circuitry is less complex than that of TV—but, to offset this advantage, operational standards for hi-fi equipment are more stringent. Circuit performance which would be considered normal in radio or TV might easily be below par by hi-fi standards. It is nearly impossible to pinpoint minor faults in an audio system simply by listening to it, so hi-fi servicing requires more objective tests and measurements than TV servicing.

Much specialized audio test equipment is available for the technician's use in determining whether or not the operation of a circuit is up to true hi-fi standards. The most important instruments for this work are the audio signal generator, audio VTVM, harmonic distortion analyzer, and intermodulation distortion analyzer. Somewhat less essential—but still very helpful—are the audio wattmeter, wow and flutter meter, decade attenuator, stro-

boscope disc, and various types of test records and tapes.

This special equipment is not absolutely essential for performing a high percentage of hi-fi repairs, since most troubles such as bad tubes, loose connections, and outright component failures can be detected with the same equipment available in the average TV shop. However, there are a significant number of occasions when test equipment designed specifically for audio work must be used to achieve proper results. Even when it does not enter into the actual repair procedure, it can be utilized to advantage for checking the final results of service work. Your public relations are immeasurably improved if you can demonstrate to customers precisely how well their equipment is working. Just after a hi-fi rig has been serviced, the owner is likely to worry about every little flaw (real or imagined) in its

performance—unless he can be convinced that his unit is performing strictly according to specifications. The necessary reassurance can be provided by routinely making a series of precise distortion and frequency-response measurements on instruments brought to the shop, and reporting results in writing.

The most-often-heard complaint about hi-fi performance, other than actual failure of the equipment, involves some type of distortion. If a trouble cannot be localized and repaired in the home, and the unit is brought to the shop for further examination, time is often saved by making routine distortion checks before attempting to isolate the exact source of the trouble.

Analyzing Frequency Distortion

Frequency distortion, defined as the inability of a hi-fi system to handle all audio frequencies equally well, is often the underlying cause of a customer complaint. Hence, one of the following checks of frequency response is helpful in pinning down the nature of the defect.

Sine-Wave Response

The basic test setup of Fig. 1 provides one means of measuring the extent of frequency distortion. An audio generator supplies a clean sine-wave signal to the amplifier being checked. The output level of the amplifier is read by a wattmeter or a voltmeter, connected across a dummy load resistor with value equal in ohms to the impedance of the speaker system. A scope is used

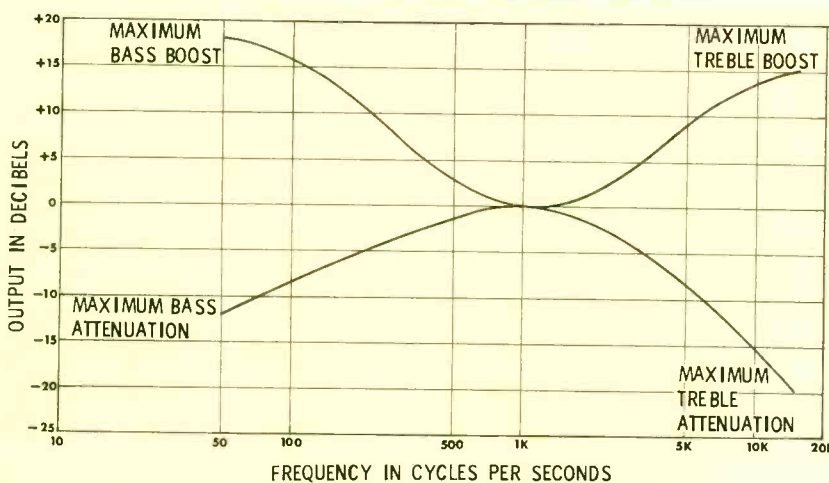

Fig. 3. Tone controls can vary amplifier response within these limits.

amplifiers for distortion



different types of frequency distortion.

to indicate whether or not the output signal is still a pure sine wave or is distorted. If the scope is calibrated so that the AC voltage amplitude of the signal can be determined from the pattern height, no separate meter is required for measuring the output level.

The generator is first tuned to about 1000 cps, and the amplifier controls are adjusted to their normal operating positions. If a pure sine-wave output can be obtained, similar tests are repeated at a number of other frequencies across the audio band. The generator output level should be kept constant at all times. If the frequency response of the amplifier is normal, the amplitude of the sine wave should remain constant, and no clipping of peaks or similar distortion should be noticed at any audio frequency.

With the gain control of the amplifier turned to maximum, clipping of the sine wave may be noted. If so, the gain setting should be reduced until the waveform assumes a normal shape. The audio power output at this gain setting represents the *maximum undistorted* power available from the unit, sometimes a key to the condition of the amplifier. If rated power output cannot be obtained, trouble in the unit is indicated.

The tone controls should be set to the "flat" position to insure uniform frequency response. If a satisfactory response cannot be obtained under these conditions, nothing more serious than a slight miscalibration of the tone-control dial markings may be indicated. Of

course, any more than a slight discrepancy in frequency response suggests trouble in the amplifier.

When looking for reasons why a frequency-response check gives unsatisfactory results, don't forget the test setup itself! Just as in TV alignment, testing can be affected by uneven or distorted output from the generator, or by improper connections between the generator and the amplifier. The operating manual of the generator should be checked for suggestions regarding hook-up to various types of amplifier input circuits.

Square-Wave Response

A square-wave input signal can also be used to advantage in checking amplifiers. In addition to giving information on frequency response, this method indicates phase distortion and shows the response of the amplifier to transients (sudden changes in signal voltage). The

equipment setup is the same as in Fig. 1, except that a square-wave generator is used instead of a sine-wave unit. A few commercially-available audio generators provide both sine- and square-wave signals.

A square wave of signal voltage (Fig. 2A) is composed of a fundamental frequency plus odd-numbered harmonics. For example, a 400-cps square wave contains components of 400, 1200, 2000, and 2800 cps. Even-numbered harmonics (80, 1600, and 2400 cps, etc.) are missing. So, when we apply a square-wave signal to an audio system, we are applying a number of different frequencies at the same time. The output waveform then shows the response of the amplifier to the whole combination of frequencies — a much better indication of amplifier performance than a response to a single-frequency sine wave.

• Please turn to page 77

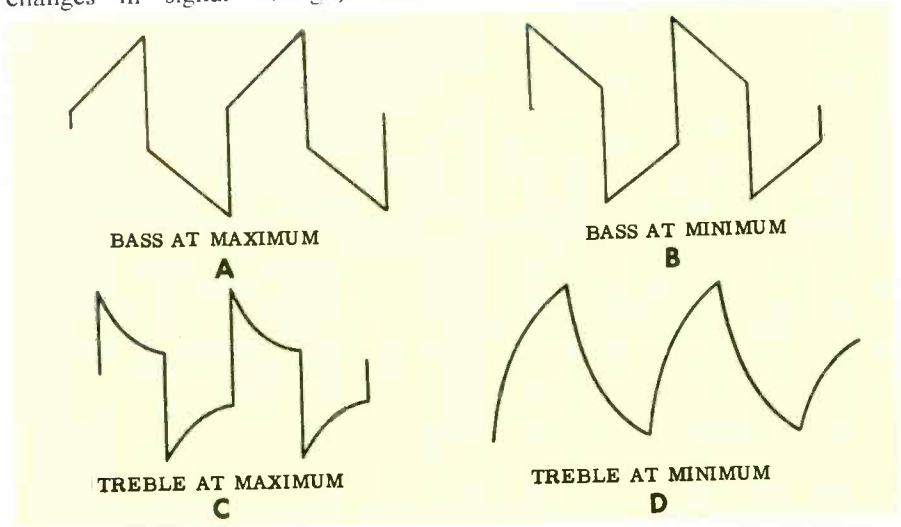
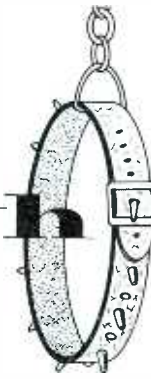
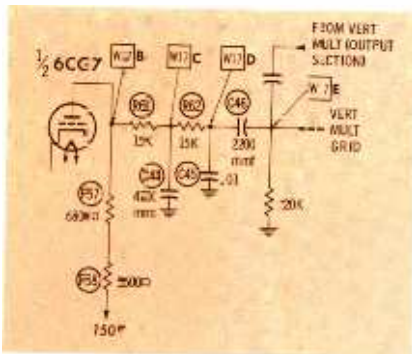

Fig. 4. Rotating bass and treble controls affects square wave response.

Tough Dog



JOE A. GROVES



(A) Schematic of integrator circuit.



(B) Phase-inverter plate waveform.

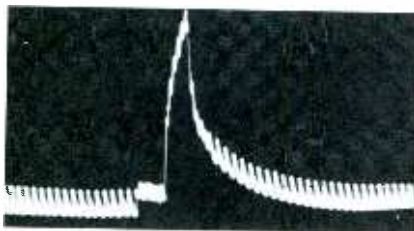

(C) Waveform at junction R61-C44.

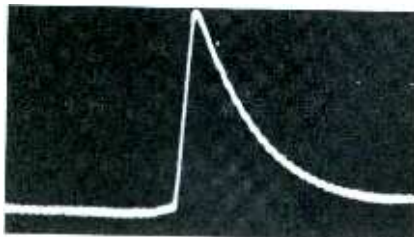

(D) Pulse at junction R62-C45.

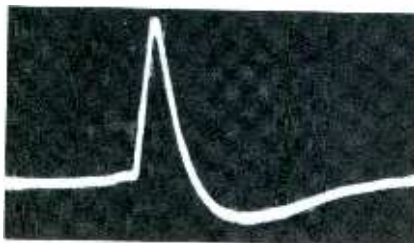

(E) Input to multivibrator grid.

Fig. 17. Vertical sync pulse is gradually reshaped by integrator network.

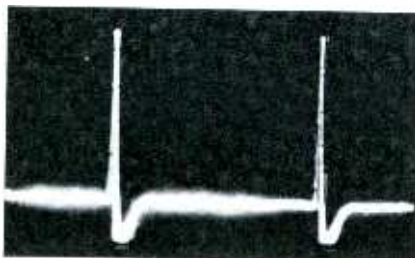

Fig. 18. Integrator output (horizontal gain of scope returned to normal).

Integration

In the last installment of this series, we saw how sync pulses were applied to the horizontal AFC stage. Now let's take a look into the integrating network which interconnects the sync amplifier and the vertical sweep circuits. Remember that the longer time interval and duration of the vertical pulse is what makes it easy to direct the horizontal and equalizing pulses into the horizontal circuit, and the vertical pulses to the vertical network.

Fig. 17A shows the vertical sync path through a typical integrator. Only identification numbers have been shown for the waveforms, providing a key to an analysis using expanded waveform presentations.

Fig. 17B is an expanded view of the vertical sync pulse at the plate of the sync phase inverter. Notice that the vertical pulses are already beginning to build up to a higher amplitude (to form the one pulse which will be present at the integrator output), while the horizontal pulses in the signal maintain a constant amplitude.

Going into the first stage of integration, the vertical pulses (Fig. 17C) continue to be accentuated as the charge on C44 builds up. While the horizontal pulses are still present, their amplitude has been greatly reduced due to the time constant of R61 and C44.

Fig. 17D shows the charge built up across C45, filtering the individual vertical-pulse segments into

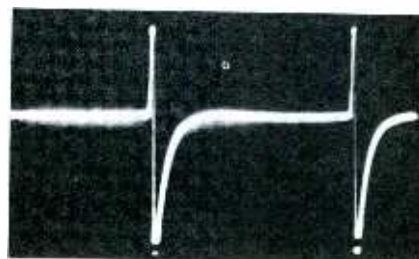

Fig. 19. Multivibrator grid waveform with circuit oscillating and in sync.

one pulse. R62 and C45 have completely eliminated whatever remained of the horizontal pulses.

Fig. 17E is the final output of the integrator as the vertical sync pulse is fed to the grid of the vertical multivibrator (which has been disabled to view this series of waveforms). Fig. 18 shows two of the pulses as they would normally be viewed with the multivibrator disabled (no horizontal expansion). The original amplitude of the vertical sync pulses at the plate of the phase inverter was about 40 volts (the same as the horizontal pulses). Now the horizontal pulses have been completely eliminated from the integrator output, and the remaining vertical sync-pulse spike has an amplitude of only 5 volts.

Fig. 19 shows the normal waveform viewed at the multivibrator grid with the multivibrator running and locked in by the applied sync pulse; the amplitude of the entire signal is 140 volts. To show the relative amplitudes of the small vertical sync pulse and the large multivibrator feedback pulse, the vertical oscillator was thrown out of sync and the waveform in Fig. 20 photographed. As you can see, it is imperative that you disable the multivibrator when checking the vertical integrator circuit.

More Dog Food

In Part 1 of this series, we demonstrated the effect of heater-cathode leakage on the sync separator



Fig. 20. Same as Fig. 19, but with multivibrator detuned to show pulses.

Sync Troubles

Part 3—A step-by-step analysis of vertical integrator action, followed by waveform clues to faulty sync separation.

output—but we didn't pursue the subject to show how vertical oscillator stability was affected. Fig. 21 shows the distorted output of the integrator when hum modulation is introduced by heater-cathode leakage in the video output stage. Although the problem is one of stability, and sync-circuit operation has been affected, we again must realize that the real trouble was in a stage preceding the sync circuits.

Fig. 10 showed the effect of a leaky coupling capacitor in a 3BU8-type separator circuit. This waveform is presented again for comparison with Fig. 22, to show how much more sensitive the triode-type circuit is to this defect. The small amount of composite video in Fig. 10, due to 100K-ohm leakage in C41 of Fig. 12 (see "repeat" of this schematic), contrasts sharply with the large amount of video present in Fig. 22 due to 1.5-megohm leakage in C22 of the triode circuit in Fig. 4 (also repeated).

This same triode circuit contains another component connected in series with the regular coupling capacitor C22. Printed-circuit network K2, consisting of a 1500-mmf capacitor paralleled by a 270K-ohm resistor, increases the sync pulse amplitude in relation to video information. Fig. 23 shows the normal output of the sync amplifier, while Fig. 24 shows the effect of a leaky capacitor or reduced series resistance in K2. Notice the presence of video information in the sync-

output signal, and the vertical sync pulse compression.

Still another cause of what appears to be sync-circuit trouble is poor low-frequency response somewhere in the video circuit. Normally, this causes picture smear; it's possible, however, for a set to produce an acceptable picture and still have poor vertical stability. The reason is that the video frequencies for most picture elements are well above the 60-cps repetition rate of the vertical sync pulses. If the brightness is turned up until details of vertical-blanking bar reproduction are visible, the pulse will appear smeared. Another indication is readily noted in the waveform at the plate of the sync separator. Fig. 25 shows fairly normal horizontal pulses in the separated output signal, while a gap in the waveform indicates almost complete compression of the vertical pulses. The trouble producing this particular symptom was a decrease in value of the coupling capacitor between the video detector and amplifier stages.

Although there are many other troubles which can appear to be sync defects, the foregoing problems should provide a sufficient sampling to prove that a sync circuit's operation can be accurately analyzed through proper use of a scope. Voltage readings simply do not provide a positive indication of what is going on in pulse-operated circuits; therefore, checking sync-stage volt-

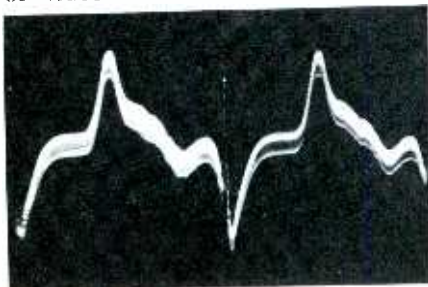

Fig. 21. Output of integrator when sync-input signal contains 60-cps hum.

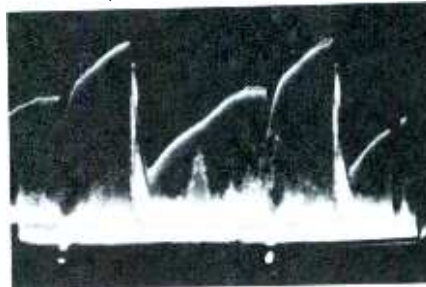

Fig. 22. Leaky grid capacitor in triode separator greatly distorts output.

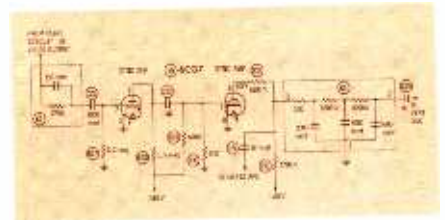

Fig. 4. This widely-used sync circuit is composed of two triode stages.

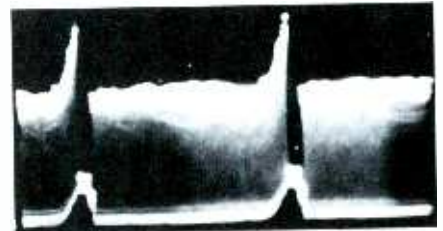

Fig. 10. With leaky input capacitor, video reaches separator plate (30 cps).

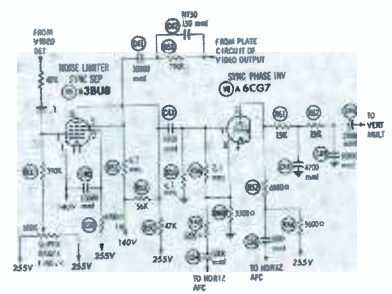

Fig. 12. The 3BU8 sync separator contains a built-in noise-limiting feature.

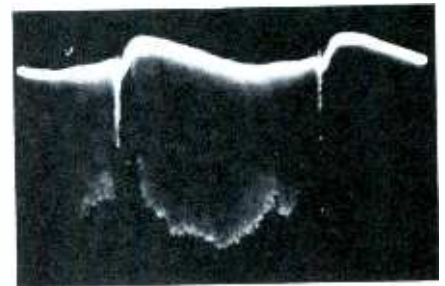

Fig. 25. Poor low-frequency response totally destroys vertical sync pulses.

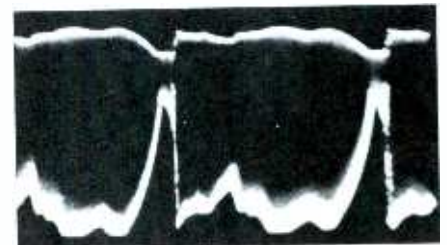

Fig. 24. Output is distorted due to decreased series resistance in K2.

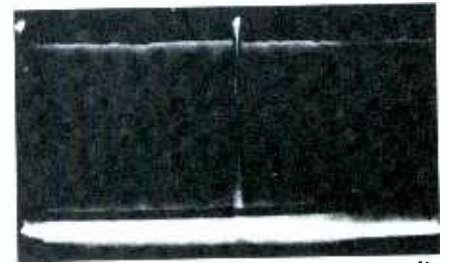

Fig. 23. Normal output of sync amplifier in dual-triode circuit of Fig. 4.

**IMPORTANT
SAMS BOOKS**
available from your local
SAMS DISTRIBUTOR



**NEW VOLUME 10!
"Auto Radio Service Manual"**



Covers 31 auto radio models produced in 1959-60: American Motors, Automatic, Buick, Cadillac, Chevrolet, Edsel, Ford, Gonset, International, Mopar, Motorola, Oldsmobile, Pontiac, Riverside, Vauxhall. Gives complete, accurate service data, including schematics, chassis photos, alignment, pushbutton ad-

justments, parts lists and replacement data. 160 p.; 8 1/2 x 11". No. AR-10. **\$2.95**
Only.....

"Auto Radio Service Manuals", Volumes 4 through 9, are available at your Sams Distributor (coverage from 1953).

Valuable Books You'll Want to Own



"Howard W. Sams Handbook of Electronic Tables and Formulas." Specially prepared for electronic technicians, junior engineers and students. A valuable compilation of tables, charts, formulas and laws useful to all who work in electronics. Five comprehensive sections include: Formulas and Laws of Electronics; Constants, Standards, Symbols, Codes; Service and Installation Data; Mathematical Tables and Formulas; Miscellaneous. Features full-color frequency spectrum chart based on latest 1959 FCC allocations. 134 pages; 5 1/2 x 8 1/2"; hard-cover. No. HTF-1. **\$2.95**
Only.....

"Radio Receiver Servicing." Latest enlarged edition of John T. Frye's famous best-seller. Includes new chapter on how to service transistor radios and printed circuits. The most understandable and valuable guide to radio servicing; based on the author's 25 years of practical experience. Includes a separate chapter on each type of trouble, such as the dead set; tubes light but no sound; noisy sets; weak sets; sets unable to separate stations, etc. 224 pages, 5 1/2 x 8 1/2". No. RS-2 **\$2.95**
Only.....

"From Tin Foil to Stereo." The whole fascinating history of the phonograph. Covers everything: man's earliest dreams of imitating sound; the Edison tinfoil phonograph; earliest prototypes; the patent struggles; cylinders and discs; the coin phonograph; the internal horn; contributions of radio and sound pictures; war of the record speeds; component systems; tape vs. discs — right down to stereo. A wonderful book for every audiophile and phonograph connoisseur. 576 pages; 6 x 9"; hundreds of rare photos. No. EPR-1. **\$9.95**
Only.....

"TV Servicing Guide." A quick-reference guide showing how to use proper troubleshooting techniques based on an analysis of the symptoms shown by the receiver. Includes troubleshooting and servicing hints that lead you right to the trouble source in each section of a TV set. 132 pages; 8 1/2 x 11". No. SGS-1. **\$2.00**
Only.....

Available from your Sams Distributor

HOWARD W. SAMS & CO., INC.

1720 E. 38th St., Indianapolis 6, Ind.



(A) Sweep energy in composite video.

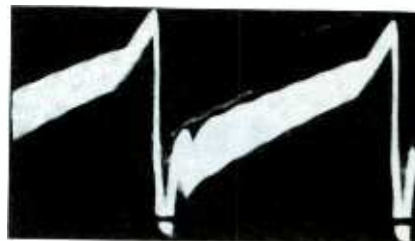

(B) Hum in sawtooth wave.

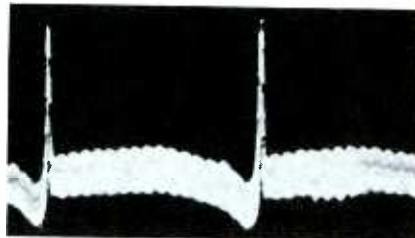

(C) Hum in separated pulse signal.

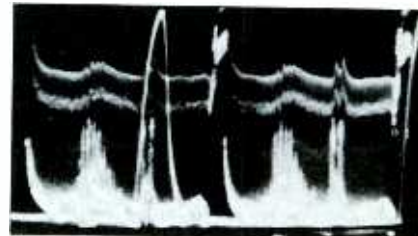

(D) Leaky capacitor across input.

Fig. 26. Waveforms misrepresented because of hook-up or probe deficiencies.

ages is a very limited means of troubleshooting.

Lies! Lies! Lies!

While scope-waveform analysis is the best way to troubleshoot sync problems, you may be confronted with a lie at times. The scope itself isn't lying; it shows exactly what goes on in the circuit. It is possible, however, for the scope connection to upset the operation of the circuit and lead to a wild-goose chase. If one isn't aware of this danger, and fails to guard against it, a dog will be born.

Fig. 26 shows four different waveforms depicting erroneous indications caused by overloading of circuits, introduction of hum modulation, or deficiencies in the scope probe. With the high-voltage cage left off the receiver of Fig. 12, sufficient horizontal-sweep radiation is picked up at pin 9 of the 3BU8 to produce the distortion evident in Fig. 26A. Different types of hum resulting from poor ground connections to the scope are illustrated in Figs. 26B and 26C. Lastly, Fig. 26D shows how a technician booby-trapped himself by temporarily connecting a small-value capacitor across the scope terminals to "clean up" a noisy waveform at the grid of a sync-separator stage. The capacitor turned out to be leaky, and the composite video signal became badly distorted because of the low-resistance shunt placed across the grid-leak resistor of the sync separator.

Know what to expect from your particular scope from first-hand knowledge gained through regular use. Most of the waveforms used in this analysis were viewed using a low-capacitance probe. All were taken from a standard service scope, similar to those used by many of you in your daily work on TV sets. Happy dog catching! ▲

Review Questions For Complete "Tough-Dog" Series

1. What does "sync separation" mean?
2. The height of a vertical blanking pedestal equals what percentage of the total amplitude of the composite video signal?
3. What determines the amount of grid bias on a sync separator?
4. How does 60-cps hum distort a sync-separator plate waveform viewed at a scope sweep rate of 30 cps? At a rate of 7875 cps?
5. How is the separated vertical sync pulse usually affected by a leaky capacitor in the separator's grid circuit?
6. Does a pentagrid or -BU8 type sync separator require an amplifier stage following it? Why?
7. What is an average amount of plate current for a triode-type sync separator with no input signal applied?
8. What action must you usually take before you can view a correct vertical-pulse waveform at the output of the integrator?
9. Describe the two sync pulses fed to a phase-detector horizontal AFC stage.



**Really dresses up
your service work**

Reliable Tung-Sol tubes add real class to every service job — radio, tv, or hi-fi. Made to set manufacturers most exacting specifications, Tung-Sol Tubes are best for all replacements. Reduce your callbacks to new lows and keep your profitable new business rolling in high style. Tung-Sol Electric Inc., Newark 4, N. J.

Tell your jobber you'd rather have

ts TUNG-SOL[®]

Blue Chip Quality TUBES • TRANSISTORS • DIODES

STOCK GUIDE

for tv tubes

The tube types listed on this page should account for well over 90% of your tube stock requirements. To keep the chart down to a manageable size, about 100 of the rarest type numbers have been omitted; however, we will keep you informed on these rare types and where they are found. Look for this information in *Previews of New Sets*, and also in special coverages like the article "The 1960 Crop of TV Tubes" in the March, 1960 issue.

Two columns of figures are listed along with the type numbers in the chart. The first column is purely a matter of statistics. Here's the meaning of the

figures: If you took a cross-section sampling of 1,000 tubes from all TV sets now in service, you could expect to find the stated number of tubes of each type in this sample. (To avoid omitting many types which are only moderately popular, we have listed a figure "1" for each type with a usage frequency of at least once per 2,000 sockets.)

This column of figures, as it stands, is naturally not a suggestion to stock the exact number of tubes listed. The statistics should be combined with your own experience to produce information tailor-made to your own needs. Here are three factors to be considered:

1. Relatively high failure rate of certain types such as cascode RF amplifiers and power output tubes.

2. Specialization in certain makes of sets, such as regional brands. (As a national publication, PF REPORTER necessarily gives nationwide averages based on all brands of receivers.)

3. Average age of those sets which contain a particular tube type.

The second column of figures marked "Caddy Stock" is a suggested stock of 350 tubes to be carried on home calls—either in two medium-size caddies or one "king-size" caddy. This list attempts to strike a balance between having enough different types and having a sufficient stock of widely-used types to meet most contingencies.

Keep yourself informed of trends toward increased or decreased use of various tube types. This is easy to do by comparing the current *Stock Guide* with previous editions, which appear in the April and October issues.

Note: *indicates a 450-ma series-string tube.

TUBE TYPE	USE PER 1,000	CADDY STOCK	TUBE TYPE	USE PER 1,000	CADDY STOCK	TUBE TYPE	USE PER 1,000	CADDY STOCK	TUBE TYPE	USE PER 1,000	CADDY STOCK	TUBE TYPE	USE PER 1,000	CADDY STOCK
1AX2	1	1	5CQ8	1	1	6BH8	2	1	6CY7	1	1	8BQ5	1	1
1B3GT	35	5	5CZ5	1	1	6BK5	2	1	6CZ5	1	1	*8CG7	1	1
1G3GT	5	2	5EA8	1	1	6BK7A/-B*	6	2	6DA4	1	1	8CX8	1	1
1J3	3	1	5J6	1	1	6BL7GT	4	2	6DB5	1	1	8EB8	1	1
1K3	1	1	5T8	2	1	6BN4	2	1	6DE4	1	1	*9AU7	1	1
1S2A/DY87	1	1	5U4GB	38	6	6BN6	7	2	6DE6	4	1	9BR7	1	1
1V2	1	1	5U8	6	3	6BN8	1	1	6DE7	1	1	10DE7	2	1
1X2A/-B	8	3	5V3	2	1	6BQ5	2	2	6DG6GT	1	1	12AF3	1	1
2BN4	2	1	5X8	1	1	6BQ6GTB	13	4	6DK6	2	1	12AT7	6	4
2CY5	3	1	5Y3GT	2	2	6BQ7A	12	4	6DN7	1	1	12AU7/-A	22	6
2ER5	1	1	6AB4	1	1	6BR8A	1	1	6DQ6B	11	4	12AV5GA	1	1
3A3	1	1	6AC7	3	1	6BS8	1	1	6DR7	1	1	12AV7	1	1
3AL5	1	1	6AF3	1	1	6BU8	4	2	6DS5	1	1	12AX4GTA	8	3
3AU6	4	1	6AG5	3	2	6BW8	1	1	6DT5	1	1	12AX7	4	2
3BC5	1	1	6AG7	1	1	6BX7GT	1	1	6DT6	5	2	12AZ7A	1	1
3BN6	4	2	6AH4GT	2	1	6BY6	3	2	6EA7	1	1	12B4A	1	1
3BU8	3	2	6AH6	4	2	6BY8	1	1	6EA8	5	1	12BH7A	9	3
3BZ6	17	4	6AK5	2	2	6BZ6	17	5	6EB8	2	1	12BQ6GTB	1	1
3CB6	10	3	6AL5	41	4	6BZ7	3	2	6EM5	1	1	12BR7	1	1
3CS6	2	2	6AM8/-A*	4	1	6C4	5	2	6ER5	1	1	12BY7A	11	4
3CY5	1	1	6AN8/-A	5	2	6CB6	88	8	6ES5	1	1	12C5/-CU5	3	1
3DK6	2	1	6AQ5/-A*	18	4	6CD6GA	2	2	6EW6	1	1	12CA5	1	1
3DT6	5	2	6AS5	3	1	6CF6	2	1	6FV6	1	1	12CU6	1	1
4BC8	2	2	6AS8	1	1	6CG7	28	6	6GH8	1	1	12D4	2	1
4BQ7A	2	2	6AT6	2	1	6CG8/-A*	3	2	6J5	2	1	12DB5	1	1
4BU8	1	1	6AT8/-A	2	2	6CH8	1	1	6J6	14	4	12DQ6A	8	4
*4BZ6	1	1	6AU4GTA	6	2	6CK4	1	1	6K6GT	5	2	12DT5	1	1
*4CB6	1	1	6AU6	70	6	6CL6	2	1	6S4A	1	1	12L6GT	3	2
4CS6	1	1	6AU8A	3	2	6CL8/-A	1	1	6SL7GT	1	1	12SN7GTA	2	2
*4DT6	1	1	6AV5GA	2	2	6CM6	1	1	6SN7GTB	45	8	12W6GT	1	1
5AM8	2	1	6AV6	10	3	6CM7	4	2	6SQ7	2	1	*13DE7	1	1
5AN8	1	1	6AW8A	12	4	6CN7	3	1	6T8	10	3	*17AX4GT	1	1
5AQ5	6	2	6AX4GTB	15	6	*6CQ8	2	1	6U8/-A*	15	6	*17D4A	1	1
5AS4	1	1	6AX5GT	1	1	6CS6	3	2	6V3A	1	1	*17DQ6A	1	1
5AT8	2	1	6BA6	5	2	6CS7	1	1	6V6GT/-A*	11	3	19AU4GTA	2	2
5B8	1	1	6BA8A	2	2	6CU5	1	1	6W4GT	12	1	25AX4GT	1	1
5BK7A	1	1	6BC5	4	2	6CU6	2	2	6W6GT	7	3	25BQ6GTB	2	2
5BR8	1	1	6BC8	2	2	*6CU8	1	1	6X8	6	2	25CD6GB	1	1
5CG8	3	2	6BE6	4	2	6CX8	1	1	7AU7	3	1	25DN6	1	1
5CL8A	2	1	6BG6GA	2	2	6CY5	1	1	*8AW8A	1	1	25L6GT	3	2

FREE TO TECHNICIANS!



Makes every working hour PAY OFF in PROFITS!

General Electric's Techni-Talk Magazine sums up for you the job experience of expert TV technicians. It shows you fast, sure ways to eliminate television performance faults—explains work-saving shortcuts that will increase your net income. New circuits are described well ahead of time, so you can be ready to service late-model television sets from the start.

125,000 readers employ Techni-Talk as a working tool. Are you a subscriber? Remember, this

10-page guide to profitable TV servicing comes to you *free*. See your G-E tube distributor to receive Techni-Talk regularly, or fill out, clip, and mail the convenient coupon below! *Distributor Sales, Electronic Components Division, General Electric Company, Owensboro, Kentucky.*

Progress Is Our Most Important Product

GENERAL  ELECTRIC

311-303

Distributor Sales, Electronic Components Division
General Electric Company, Owensboro, Kentucky

Please send Techni-Talk regularly, free of charge, to:

NAME _____

ADDRESS _____

CITY _____ STATE _____

My occupation is (please check only one):

- | | | |
|--|--|------------------------------------|
| <input type="checkbox"/> TV-Radio Service Technician (full-time). | <input type="checkbox"/> TV-Radio Service Dealer. | <input type="checkbox"/> Engineer. |
| <input type="checkbox"/> TV-Radio Service Technician (part-time). | <input type="checkbox"/> Laboratory Technician. | <input type="checkbox"/> Student. |
| <input type="checkbox"/> Industrial Electronic Service Technician. | <input type="checkbox"/> Other (please explain): _____ | |

PRECISION PERFORMERS



carbon-deposited RESISTORS

When the application calls for accuracy and stability you'll find Aerovox Precision ($\pm 1\%$) Carbon-Deposited Resistors fill the bill perfectly. Manufactured under exacting quality control specifications to assure excellent performance even under adverse operating conditions.

CARBOFILM RESISTORS . . . for wide use in circuits where accuracy and economy are factors. Units are protected by a specially formulated Aerovox coating against environmental conditions. Stocked in 300 values in following ratings:

Type	Size	Min. Ohms	Max. Meg-ohms
CPS- $\frac{1}{2}$ watt	0.162D x $\frac{1}{2}$ L	7	2
CP- $\frac{1}{2}$ watt	0.230D x $\frac{1}{4}$ L	3	5
CPL- $\frac{1}{2}$ watt	0.230D x $\frac{3}{4}$ L	5,100,000	7.5
CP-1 watt	0.293D x $\frac{1}{2}$ L	10	15
CP-2 watt	0.293D x $2\frac{1}{4}$ L	50	100

CARBOMOLD RESISTORS . . . encapsulated in a strong reinforced moisture and heat resistant plastic these units offer new standards of reliability. Over 500 standard values available from stock as follows:

Type	Size	Std. Min. Ohms	Std. Max. Meg.
CPM- $\frac{1}{4}$	$\frac{1}{8}$ x .735	10	2.49
CPM-1	$\frac{3}{8}$ x $1\frac{1}{2}$	10	5.11
CPM-2	$\frac{5}{8}$ x $2\frac{1}{4}$	30	10

All units marked with type number, RN Number, value and tolerance. Available for "off-the-shelf" delivery from your local Aerovox Distributor.

AEROVOX CORPORATION
DISTRIBUTOR DIVISION
NEW BEDFORD, MASS.

Trademark

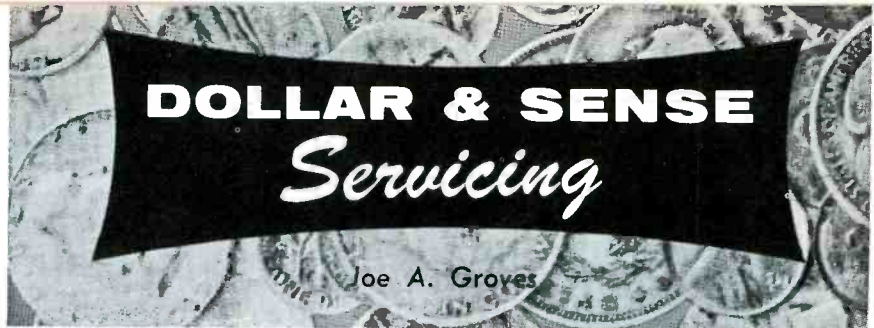

Work Standards. You can profit by taking advantage of some of the thinking of big business, especially along the line of improving efficiency to increase profits. Large companies increase their operating efficiency by employing trained time-study personnel to set "work standards"—that is, to determine the most efficient manner of doing every job. This, of course, is out of the question for small business—but the concept isn't.

Take a few minutes to think about improving efficiency in your own servicing operation. Time is money; minutes saved produce profits, while those wasted represent a loss. How many dollars does it cost you each week to look for misplaced hand tools, walk several steps for a replacement part not at your fingertips, unsolder connections that could be clipped, use an improper wrench or tool because the correct one isn't available, and on and on? Taken one at a time, the individual improvements seem negligible; but when added together, a considerable saving in time will result from closely studying work standards and making suitable improvements.



Where's the Break? Like a giant snowball plummeting down a mountainside, an entirely new type of business has been expanding at a phenomenal rate during the past 18 months. A large segment of the American public is now able to obtain service on anything and everything through central service-brokerage offices.

The amazing success of these "Service Clubs" proves that a fair percentage of the public is dissatisfied enough with present servicing arrangements to pay \$5-\$12 yearly for an assurance of satisfactory service, at a reasonable price, whenever needed.

It is of particular concern to the electronic service industry that a national poll showed calls for radio and television service ranking first in one out of five service clubs. To this industry's credit, however, it

should be noted that it ranked "least-in-demand" in two-thirds of the reports.

The particular effect of such clubs on you depends strictly upon the relationship now existing between you and your customers. If this relationship is good, you have no need to fear the growth of service clubs; in fact, you yourself may become a contractor for one of them. On the other hand, if all isn't rosy in the customer-loyalty department, the appearance of one of these clubs in your area may well be cause for consternation.

What has led to the quick acceptance of the service-club idea? Could it be a misunderstanding within the industry as to what the customer expects when he asks for service? The dictionary definition of *service* — "work performed for another"—is too simple to be of much help in answering this question, although the key words "for another" do provide some clue.

Since you're in a service business, you're bound to think of service mainly in terms of profit and loss. Thus, when the word "service" is mentioned, the phrase "service charge" quickly comes to mind. However, the customer places a different emphasis on this phrase, transposing the words to make it read, "charge for service." To him, "service" means not only the repair, but also the personal contact involved in the service job.

As soon as this contact has been established, you become the customer's servant! Then your courtesy, thoughtfulness, and appearance, as well as your professional skill, are subjected to his closest scrutiny. Satisfying all of the psychological whims of each customer's family (including treatment of children and pets!) makes your service satisfactory; anything less makes the customer reluctant to call you again or recommend you to his friends.

Evidently, the new service clubs are doing an effective job of catering to people's personal needs. So can you, if you constantly try to please.

More Applied Psych. A customer service-record file placed near the phone can come in handy when a call is received. If you learn the customer's name first thing, you can pull out his record while listening to the complaint—then you can reply with, "Is that the same Brand X we serviced last June? Do you still live at 233 Elm?" This cements your relations with the customer by showing that you have taken a personal interest in him.

If the call concerns a recent job, it's especially important to let the customer know you remember the details of the service you performed on his equipment. Nothing is more irritating than calling about a just-completed job and getting only pat answers of a completely impersonal nature—or, worse still, an attitude of "I don't know anything about that."

In addition to helping you create good will, a record file reminds you of special tube and tool requirements, correct service data to use, and other information you need for planning the call.



Phony Business. If you operate a small shop, who answers the phone when you're out to lunch or gone for the day? No one? Then you're losing business! Most people, when they want service, will keep trying to get in touch with someone. If your phone isn't answered during certain hours, chances are potential customers will try to reach one of your competitors.

The funny thing is, once they get to talk to someone, they're often willing to place an order for service — even if they're told it won't be handled until the next day!

What's the solution? A telephone answering service costs only around \$20.00 a month — or, for about \$12.50 a month, you can have the telephone company install a device to answer and record incoming calls. By pre-recording your voice, you can greet callers electronically, and ask them leave their name, address, and phone number so you can call them back at a specified time. While you can't be assured of 100% effectiveness, it's better than nothing at all — and the profit from three or four extra calls a month may easily cover the added expense.

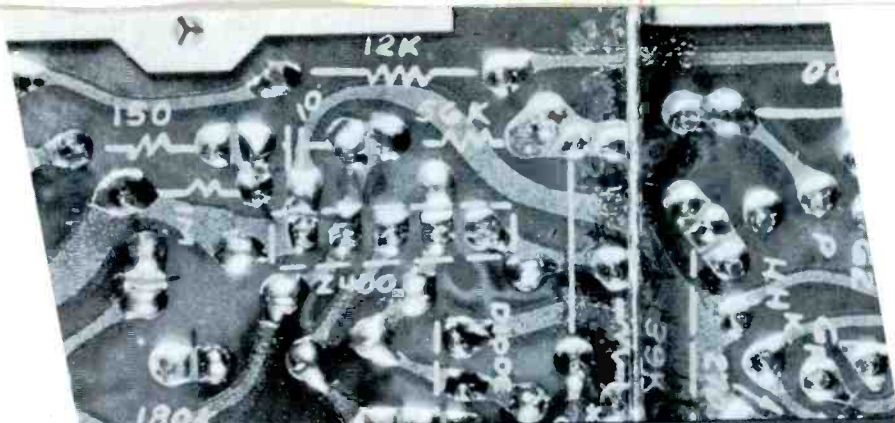

COMING NEXT MONTH

"Painted" Wiring—New Circuit-Tracing Aids

Descriptions of the many versions of printed boards, and how you can use the manufacturers circuit-tracing aids to best advantage.

Citizen Band Design

For those of you going after the service work, here's a run-down on typical transmitter and receiver circuits used for the Class-D Citizens band.

That's the Way the Horizontal Sweeps

A component-by-component analysis of horizontal output, damper, flyback, and yoke circuits — how they work, and how to pinpoint troubles quickly.

Examining an Industrial Control Device

A serviceman's analysis of a closed-loop system for controlling heat within a furnace used to temper steel.

Other informative and helpful articles include:

- Have HV, No Raster
- Care of Tape-Transport Mechanisms
- Stabilizing Horizontal Sync
- Fine Points of Radio Servicing
- Installing Intercom Systems

... plus all the other regular PF REPORTER departments, to make it the ONE magazine especially prepared for the palates of electronic servicemen.

TO ENTER A NEW OR RENEWAL SUBSCRIPTION, SIMPLY FILL IN AND MAIL THE COUPON BELOW.

Please enter my subscription for:

1 Year \$4.00 2 Years \$7.00 3 Years \$9.00
Above rates apply only in U.S.A., its possessions, and Canada, All other countries: 1 year \$5.00, 2 years \$9.00, 3 years \$12.00

Bill Me Remittance Enclosed Extend Present Subscription

Give to your parts distributor or mail to PF REPORTER,
2201 E. 46th St., Indianapolis 6, Ind.
Please Check Your Business Classification

Name _____ Independent Radio, TV Serviceman Service Mgr.
Firm _____ Retailer with Service Department Employee
Address _____ Industrial Electronics Service Owner, Mgr.
City _____ Zone _____ State _____ Other (Specify occupation and title)

Model D-612T \$49.95 net

Lift it...



**you can feel
the extra quality
in an EPL
DC POWER SUPPLY!**

**Powers transistor circuits,
12/6 volt hybrid/tube
auto, marine radios**

EPL power supplies are heavier because they're built with top quality, heavy duty components to provide unequalled durability and performance. Ample regulation for operating solenoid tuning controls in auto radios. Patented conduction cooling gives greater safety margin, longer rectifier life and higher current carrying capacity.

- out-performs all others in its price class
- lowest ripple
- costs less per output
- reserve power to handle any service job
- backed by Certified Proof-of-Performance chart
- longer life

2 ranges: 0-8 and 0-16 volts continuously variable.

Less than 0.5% ripple up to 5 amperes. 2% ripple at 10 amperes.

10 amps. at 12 v. continuous duty. 20 amperes intermittent.

FREE BULLETIN D612T

See the Difference at Your Jobber



**ELECTRO
PRODUCTS
LABORATORIES**

4501-T Ravenswood, Chicago 40
Canada: Atlas Radio Ltd., Toronto

Name _____

Address _____

City _____ Zone _____ State _____

9676

TIPS

for TECHS

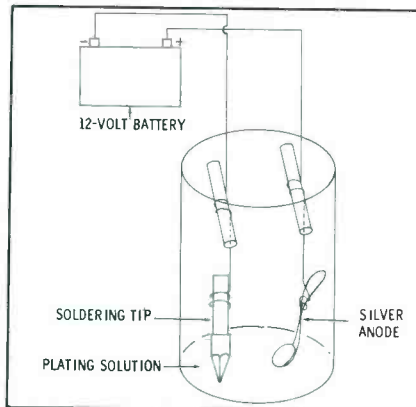

Save Soldering Iron Tip

Do your soldering-iron tips corrode and pit when the iron is left on for a long period of time? Here's how you can permanently tin them and thus prolong their usefulness indefinitely.

Dissolve one ounce of potassium silver cyanide in a pint of water contained in a small plating tank or jar. Connect the copper tip and any silver object (such as a spoon or fork) to a 12-volt battery as shown in the drawing. Allow the current to flow overnight. This will not discharge the average battery, because current drain quickly tapers from about 300 ma to approximately 5 ma.

By electrolysis, silver will be transferred through the solution to form a smooth, heavy coating on the soldering tip. In use, a quick wipe with a clean cloth will remove any residue which may form—and you'll never again have to re-tin the tip.

CAUTION: Cyanides are deadly poisons and must be handled carefully. The above operation should be carried out in a well-ventilated room or outdoors. Use rubber gloves in handling the solution and plating equipment. Wash the tank, soldering tip, etc. in running water.

Hex Driver Removes Tube From Shield

To remove miniature tubes from tight tube shields, use a 1/4" or 3/16" hex-head driver to gently push the tube while holding the shield. The end of the driver fits nicely over the nipple of miniature tubes, and distributes the pressure evenly, thereby minimizing the chances of breaking the tube.

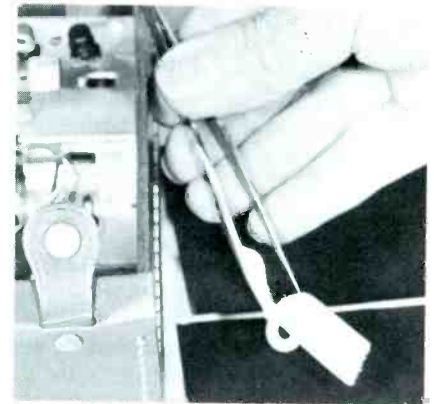

Tape Retrieves Washer

Space is at a premium inside transistor-type and other small radios, and there is not enough room to manipulate parts with regular tools.

To remove small items like washers from such receivers, attach a piece of adhesive tape to one prong of a pair of tweezers, and press the sticky side onto the part.

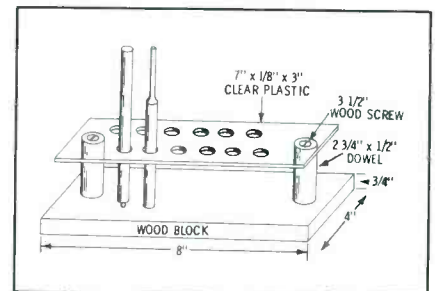

Alignment Tool Stand

It's much easier to select an alignment tool of a particular type if all of them are stored in a handy stand on the bench. You can easily make yourself such a stand from a piece of clear plastic about 1/8" x 3" x 7", a piece of wood 3/4" x 4" x 8", a couple of lengths of 1/2" x 2 3/4" dowel or broom handle, and two wood screws. First, drill holes in the plastic sheet to accept the shanks of your alignment tools. Add an extra hole near each end to accept the two wood screws, as shown in the drawing. Drill a hole down through each upright dowel for these screws. Finally, fasten the plastic top deck to the wood base, using the two dowels as vertical separators. The clear plastic top of the stand lets you view both ends of your alignment tools for effortless selection.

Look for the label that looks out for you

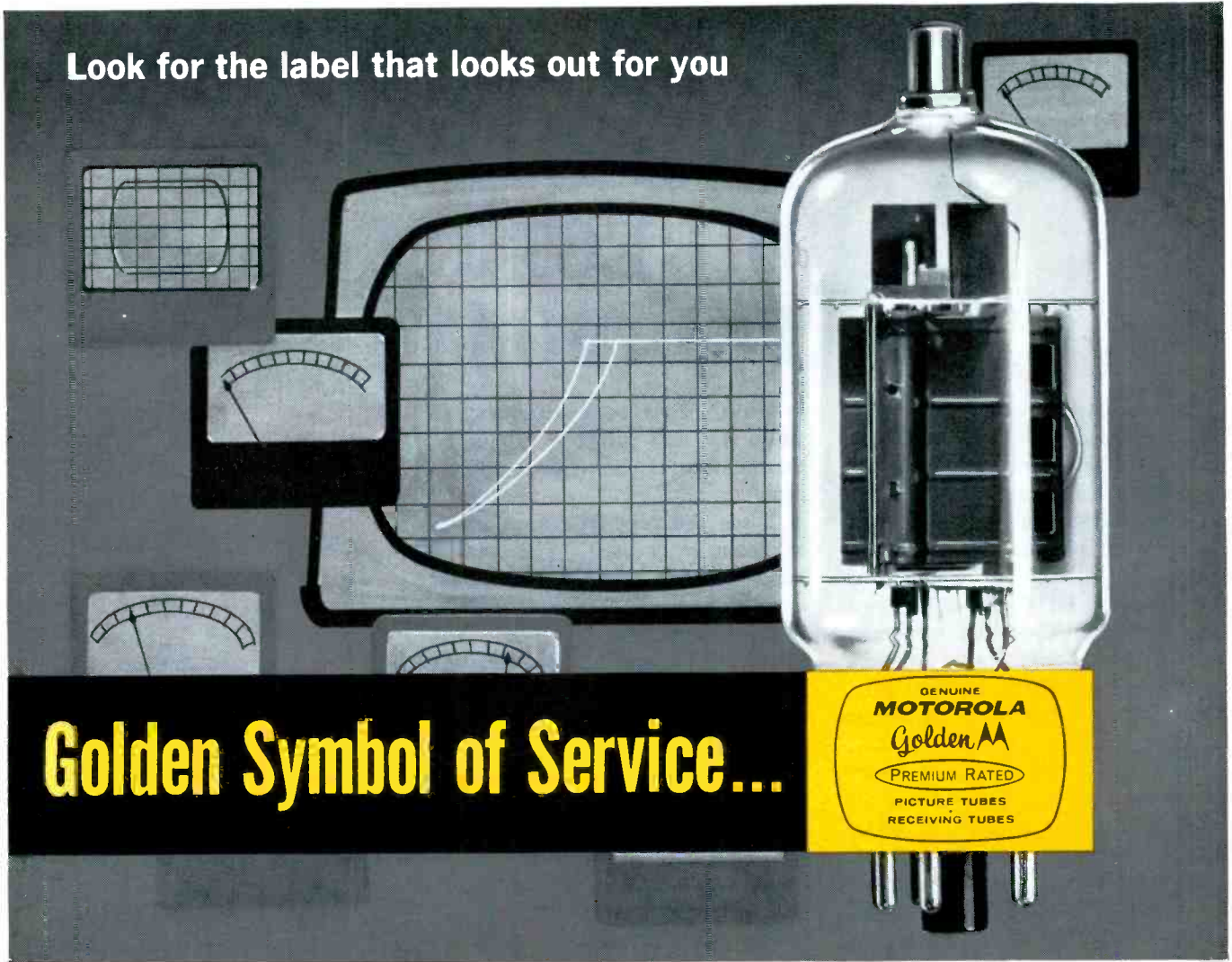

Golden Symbol of Service...

Now you can sell tubes tested to twice maximum ratings ...the most reliable tubes ever!

MOTOVAC, a Motorola-created electronic brain, torture-tests Golden "M"® Tubes to specifications that are the highest in the entertainment-type tube industry.

Result? The most reliable tubes you can buy! So do yourself a real service . . . specify Motorola Golden "M" Tubes for more customer satisfaction and more *profit!*

Contact your Motorola distributor today for further details on fabulous Golden "M" Receiver Tubes . . . and Golden "M" Picture Tubes as well.

SPECIAL "PORTABLE PRIZE" OFFER!
FOR A LIMITED TIME ONLY

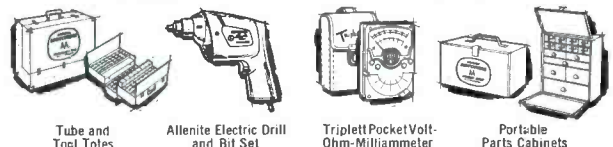

Time-saving service tools and cases can be yours with purchase of Motorola Golden "M" Picture Tubes/Receiving Tubes. Call your Motorola Distributor today for details!

MOTOROLA



PARTS AND ACCESSORIES, FRANKLIN PARK, ILLINOIS

Uses, special circuit features,
and general servicing hints for these
handy navigation aids—by Allen Lytel

RADIO DIRECTION FINDERS FOR BOATS

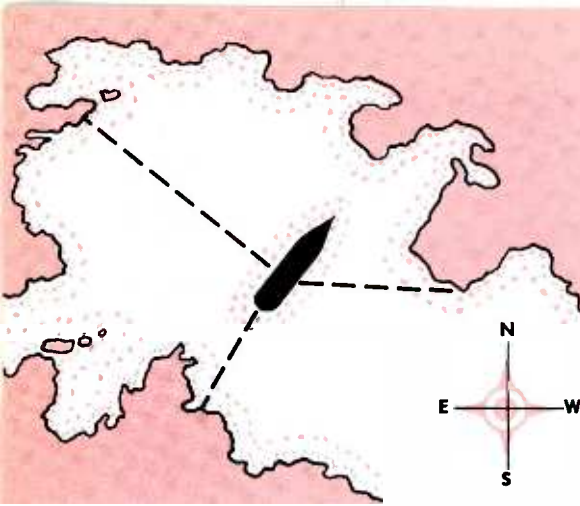

Thousands of small boats are now equipped with radio direction finders (RDF), since many simple and inexpensive versions of these valuable navigation aids have been made available to the weekend sailor.

In essence, RDF's are little more than ordinary AM radio receivers, with a few modifications for improving their ability to determine the direction from which a signal is being received. A loop antenna is used because of its highly directional characteristics. Operating an RDF is a simple process of rotating the antenna and using a *null indicator* (such as a meter, headset, or speaker) to find the point of minimum signal pickup. As shown in Fig. 1, this null point occurs when the loop is turned with its broad side toward the oncoming signal. RDF's are tuned to nulls

rather than to peak readings because the null provides a sharper, more accurate directional indication.

Three different frequency bands are commonly used. The beacon band (150 to 500 kc) includes weather navigation stations, marine beacons, and aircraft ranges. The broadcast band (550 to 1600 kc) allows utilizing local AM radio stations when their locations, frequencies, and call letters are known. The marine band (1.6 to 5.0 mc) includes Coast Guard stations and other boat transmissions. Generally speaking, it is advisable to use the lowest available frequencies for direction-finding purposes.

Not all RDF receivers tune to all the above-mentioned bands, nor are the individual bands covered to exactly the same extent by all receivers. Some units which include the broadcast band also double as regular portable radios.

Plotting a "Fix"

From the RDF user's point of view, this term implies nothing shady; it's just a means of finding out where he is. A "fix" is obtained by taking RDF bearings of at least two (preferably more) transmitting stations whose locations are known, and plotting these on a chart. The *magnetic bearing* of each received station is found by determining the angle between the signal source and magnetic north, as indicated by checking the RDF reading against the boat's compass. Lines are then drawn at the correct angles through the transmitter sites on the chart, and their intersection represents the boat's position. Fig. 2 illustrates a typical fix using three AM broadcast stations as signal sources.

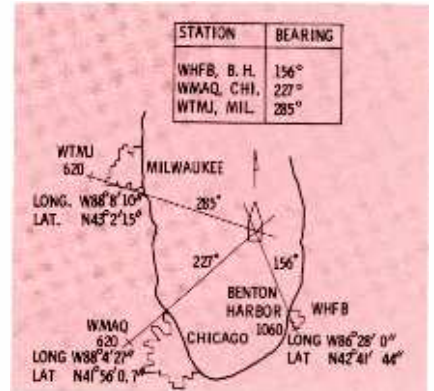

Fig. 2. Bearings from three stations fix boat's position on Lake Michigan.

Bearings must be taken from stations separated by more than 30° in order to establish an accurate fix. Fig. 3 demonstrates how a slight error in detecting null points can lead to a misjudgment of the boat's position when the signal sources are clustered too close together.

In addition to magnetic bearings, *relative bearings* (the angle between RDF indications and the prow of the boat) are of some advantage in helping the RDF user to set his

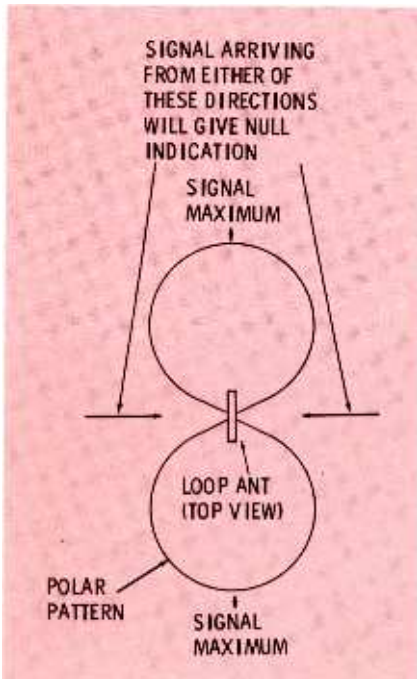

Fig. 1. Loop antenna has suitable polar pattern for direction finding.

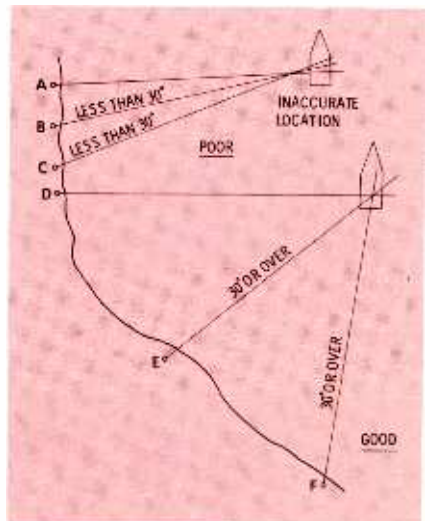

Fig. 3. Stations must be at least 30° apart to plot position accurately.

See What's **NEW FOR YOU**

IN THE **BURGESS**

1960 PORTABLE RADIO BATTERY PROMOTION

Brand New

DRAMATIC MERCHANDISERS

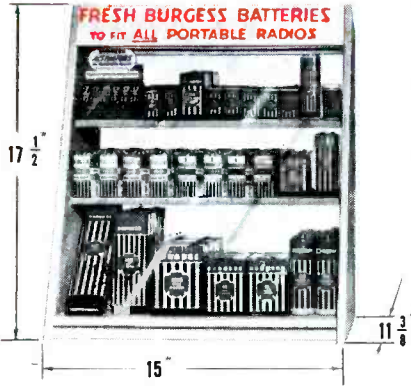

No. 601 Glass Front Counter Fixture Display

Attractive display fits needs of all types of dealers. Glass front, wood sides, open in back. Three sturdy shelves display large selection of batteries. Encourages fast buying action in heavy traffic spots in your store. Height 17 1/2"; Width 15"; Depth 11 3/8". Counter fixture included with No. 601 Portable Radio Battery Assortment.

No. 604 Counter Merchandiser

One compact display-packaged assortment sells the most popular battery types for all makes of transistor and tube type portable radios. Compartmentalized plastic tray displays batteries most effectively and shows exactly how many of each type of battery has been sold. Makes re-ordering a "snap." Complete display assortment attracts customers, shows type of batteries required for all makes and models, lists retail prices, and makes it easy to sell batteries. Counter Display is FREE with the No. 604 Assortment.



No. 602 Store Fixture Floor Display

Standard half-gondola store fixture displays complete line of portable radio batteries, flashlights, lanterns and their batteries. Beautiful merchandiser sets up easily; glass binned shelving is pre-assembled. Shelves are adjustable. It takes full advantage of your store traffic to build impulse sales. 30" wide; 50" high (60" with sign); and 23" deep. Floor display included with No. 602 Store Fixture Assortment.

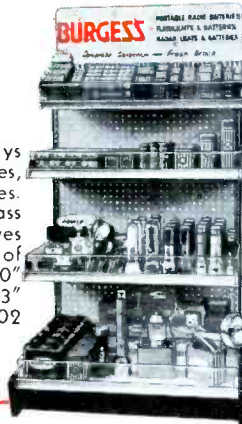

Space For Back-Up Stock

Additional quantities of the most popular batteries included with No. 604 Assortment display. Compartment for this back-up stock is in rear of display.

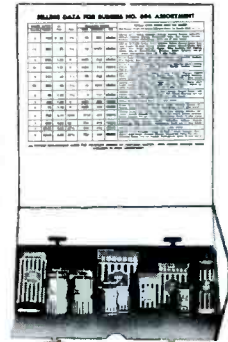

FREE! DYNAMIC NEW POINT-OF-PURCHASE SALES AIDS!



Customers will sell themselves with Burgess' complete and up-to-date sales aids! Ask us how you can get special point-of-purchase sales aids to build volume impulse sales during the 3 big holiday week-ends in 1960.

OTHER POINT-OF-PURCHASE AIDS!



No. 591 Attention-Compelling Motion Display

No. 592 Compact All-Metal Counter Display



No. 379 Simpson Battery Tester



No. 581 Corrugated Floor Stand Display

No. 42A Sterling Battery Tester



Contact Your **BURGESS** Distributor for full Information **Now!**

BURGESS BATTERIES

BURGESS BATTERY COMPANY
FREEPORT, DIVISION OF SERVEL, INC. ILLINOIS

course. It is also possible to navigate a boat by "homing" on a signal, if a usable signal source happens to be directly in line with the desired heading.

Special Receiver Features

The main difference between an RDF and an ordinary radio receiver is that the former must be very sensitive to fluctuations in received-signal strength, while the latter is designed to *override* such variations as much as possible. Therefore, if the audio output of the RDF receiver is to be used as

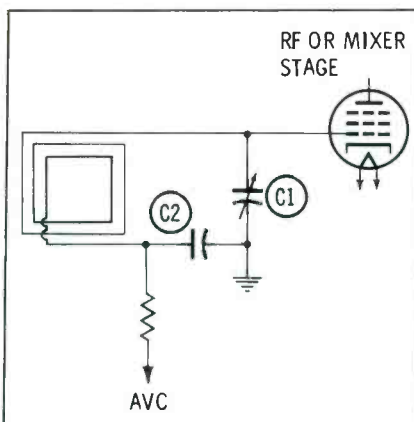

Fig. 4. Ordinary radio's loop antenna is unbalanced with respect to ground.

a null indicator, AVC is a drawback rather than a desirable feature. Many RDF units are equipped with a switch that grounds the AVC line while taking bearings; this insures constant operation of the receiver at full RF-IF sensitivity, and thus provides sharp null indications. Of course, it is also possible to leave the AVC system in operation and use the level of the AVC voltage as a null indicator.

Some sets have a BEARING WIDTH potentiometer which allows the user to vary sharpness of the null indication by regulating RF-IF gain. In units without AVC, this control often adjusts the cathode bias on the RF and IF amplifiers; in other sets, it provides for a greater or lesser extent of AVC action.

Random noise interference may make it impossible to determine the exact point of minimum-signal reception, especially when a bearing is being taken on a weak station. Some of the more elaborate RDF receivers employ a beat-frequency oscillator to overcome this problem. As long as the carrier of the desired station can be picked up at all, the beat frequency between it and the BFO signal provides a steady tone. This tone is much more reliable than ordinary program material for accurately detecting null points.

Several forms of null indicators — meters, loudspeakers, headsets, etc.—were mentioned in the introduction. Meters or tuning eyes give more accurate results than the simple aural indication provided by speakers or headsets. A voltmeter may be used to indicate the amplitude of the rectified RF signal at the output of the detector; this is

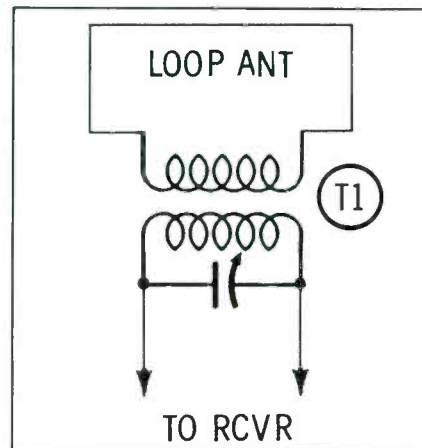

Fig. 5. Transformer-coupled antenna is balanced, thus better for RDF use.

yes

STANCOR[®]

has a complete line of
RF-IF COILS

The Stancor name is a synonym for quality and dependability. Just as you rely on Stancor for the best in exact replacement flybacks and yokes, so you can expect the highest standard of performance from Stancor coils. Your parts distributor has them in stock.

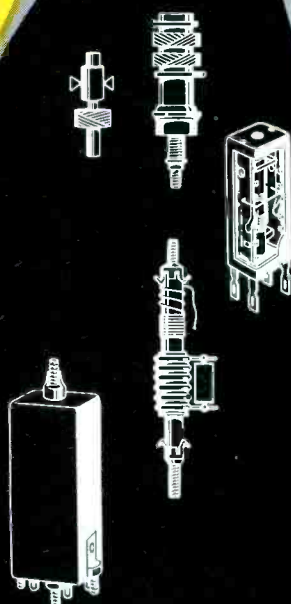

CHICAGO STANDARD TRANSFORMER CORPORATION
1581 ADDISON STREET • CHICAGO 18, ILLINOIS

almost the same thing as monitoring the AVC voltage. Another method of measurement is to insert a milliammeter in the plate circuit of some amplifier whose level of conduction is proportional to signal amplitude.

Loop Antennas

An ordinary radio receiver seldom operates as an accurate direction finder, since its loop antenna is not balanced to ground, and its loop is not as critically bidirectional as one designed especially for direction finding. In fact, its two null points are likely to be less than 180° apart.

In a typical home radio (Fig. 4), one leg of the loop is grounded

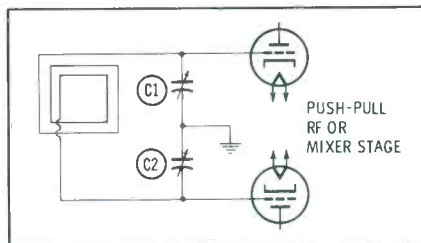

Fig. 6. This loop can be balanced by proper adjustment of both C1 and C2. through capacitor C2 and the other through variable capacitor C1. These units are so unequal in value that an unbalanced condition is produced. On the other hand, the loop in Fig. 5 is balanced because T1 isolates it from ground. Another type of balanced loop is shown in Fig. 6. Capacitors C1 and C2 tune the loop to resonance, and the ca-

pacitance ratio between them can be varied to compensate for any dissymmetry in the loop.

As an RDF loop is turned, the capacitance between its various parts and ground may also vary. This effect can be offset by an electrostatic shield placed around the loop (Fig. 7). The device clamped onto the shield at the top of the loop is simply an insulated section which breaks the continuity of the shield and prevents it from behaving like a shorted turn.

Some loops are wound on a ferrite core and are very small. Fig. 8 shows such a loop installed in a pointer-type knob. Notice that the loops in both Figs. 7 and 8 are equipped with an azimuth card, or

Which TV Antenna can do the most for you?

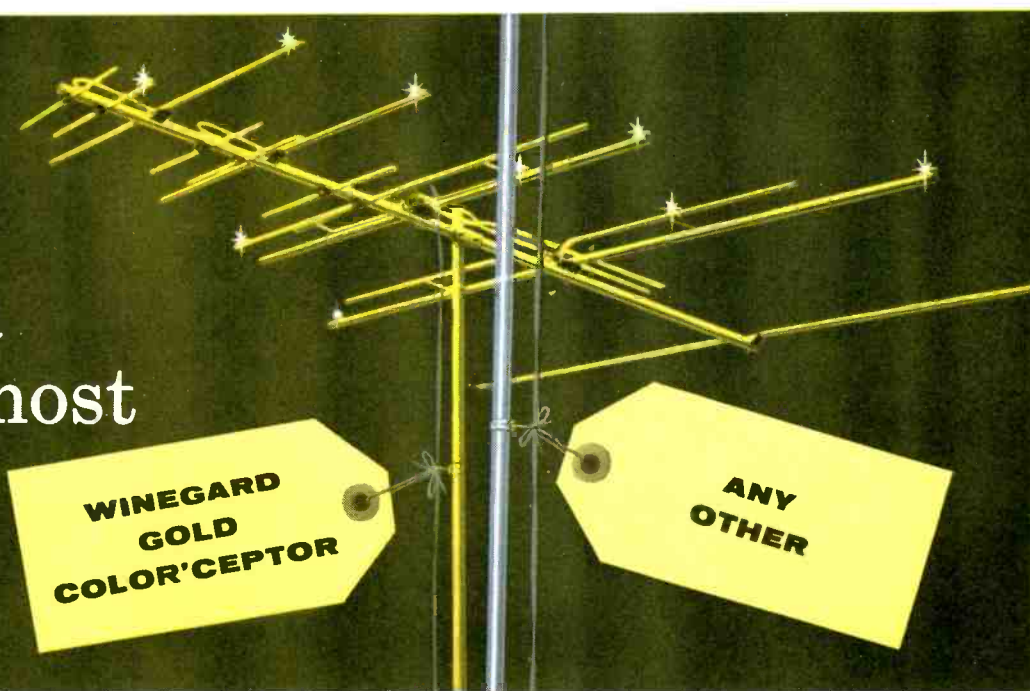

Remember when everybody lit cigarettes with matches that sold for a penny a box? Then along came a lighter at 500 times the cost of matches. Lighters, today, sell by the millions . . . making bigger profits for dealers than matches ever did!

You get the idea. People do have the money . . . and when they have a choice, they invariably buy the best . . . even if it costs more. The widespread acceptance of our patented Color'Ceptor proves that people also want the best antenna. Dealers who offer it to them are the ones who make the most money. In fact, Color'Ceptor has gained such tremendous popularity that eleven imitations are now masquerading as substitutes!

Now Know This and Make More Money Color'Ceptor outsells others for many reasons: PERFORMANCE—uniform high gain over all channels, sharp directivity, no suck-outs, no gain roll-off on end channels, no spurious side lobes, uniform high front-to-back ratio on all channels. A HIGH QUALITY OF CONSTRUCTION not found in any other antenna—rides out winds up to 100 mph, yet weighs less, installs quicker and easier. Elements lay flat and neat. Has exclusive non-crush mast clamp and Winegard's 7-cycle bright gold anodizing that doesn't turn green . . . defies salt spray, fuel acids, corrosion. Three models to meet most needs. Has the

most attractive package, best dealer sales aids, by far the strongest national consumer advertising. Has what dealers and their customers both want. So good you could build a retail business on Color'Ceptor alone—and that's been done!

Any dealer who can sell imitations and other "second-best" antennas will do far better selling the Color'Ceptor. WHY SELL PENNY MATCHES? Get OUT all that's IN this business. Feature Color'Ceptor! Speak to your Winegard distributor or mail the coupon now.



Winegard
ANTENNA SYSTEMS

WINEGARD CO. 3009-4 Scotten, Burlington, Ia.

Send me full Color'Ceptor details.

Name _____

Address _____

City _____ Zone _____

State _____

NEW 4-WAY POCKET TOOL

a real "working partner"
for removing backs of TV sets
and installing antennas



1 It's a 1/4" nut driver!
Fits Parker-Kalon screws.

Genuine Xcelite
plastic handle —
shaped and
balanced for
working ease.
Equipped with
pocket clip.

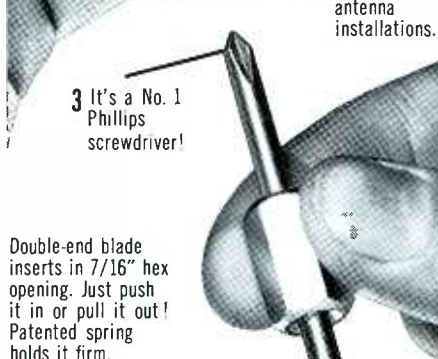

2 It's a 7/16"
nut driver!
Ideal for
antenna
installations.

3 It's a No. 1
Phillips
screwdriver!

Double-end blade
inserts in 7/16" hex
opening. Just push
it in or pull it out!
Patented spring
holds it firm.

4 It's a 3/16"
slotted screwdriver!



Ask to see
"No. 600"
next time you
pick up parts...



XCELITE, INC. • ORCHARD PARK, N.Y.
Canada: Charles W. Pointon, Ltd., Toronto, Ont.



Fig. 7. Electrostatic shield on loop is broken by insulated collar at top.

compass rose, to indicate orientation.

Sense Antennas

It was pointed out in Fig. 1 that a null indication can be obtained with the loop in either of two positions which differ by 180°. Unless the RDF user knows his approximate heading and the general location of stations being received, there is always the danger of tuning the receiver to the wrong null point. To overcome this problem, some direction finders employ a vertical *sense antenna* that enables the user to determine which null indication is the correct one. In Fig. 9, the sense antenna is connected to one side of the main loop by closing S1. R1 eliminates certain resonant effects of the sense antenna.

With the extra antenna connected, one edge of the loop will pick up a stronger signal than the other edge; thus, the signal from the sense antenna will increase the output voltage of the loop for signals coming from one direction only. To take a bearing, the user leaves S1 open while he finds two null points 180° apart. Next, he closes S1 and adjusts the loop to the position which gives maximum signal. This maximum indication tells him the general direction of the incoming signal, and the null read-



Fig. 8. Compact ferrite-core loop is often used in portable RDF equipment.

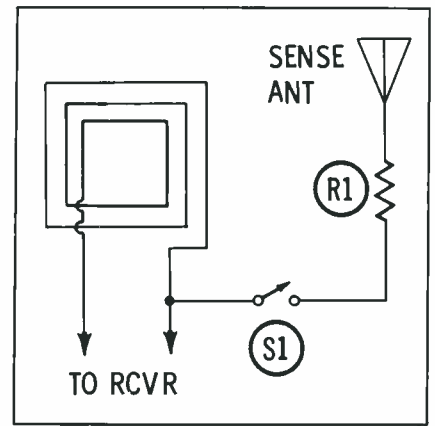

Fig. 9. Sense antenna determines which of two nulls is the correct one.

ing indicates the exact bearing of the signal source (within the accuracy limitations of the instrument).

Servicing

Since RDF's differ from typical AM receivers in only minor circuit variations, they will present very few unfamiliar service problems. The most common types of RDF's brought into regular radio-TV shops for servicing will be portable, and these can be shop-serviced using standard test equipment.

Special emphasis should be placed on alignment, however, since good reception under adverse conditions may be required. If the unit is used in one of the larger classes of boats, it may be advisable to wait and put the finishing touches on antenna, RF and mixer alignment with the unit installed in the location where it will be used. Error introduced through nearby metal objects can affect the loop antenna enough to provide inaccurate bearings, with resulting complaints of malfunction in the receiver.

Tubes should be checked very carefully. Remember — the user may be staking his life (maybe unconsciously) on the reliability of a direction finder. Therefore, it demands a rigidly high standard of servicing. Dirt, moisture, and corrosion are some of the greatest enemies of this equipment—so be on guard against them. ▲

Editor's Note: For readers desiring a more comprehensive treatment on Radio Direction Finders, as well as other marine electronic equipment, we suggest Howard W. Sams "Marine Electronics Handbook," available through electronics parts distributors.

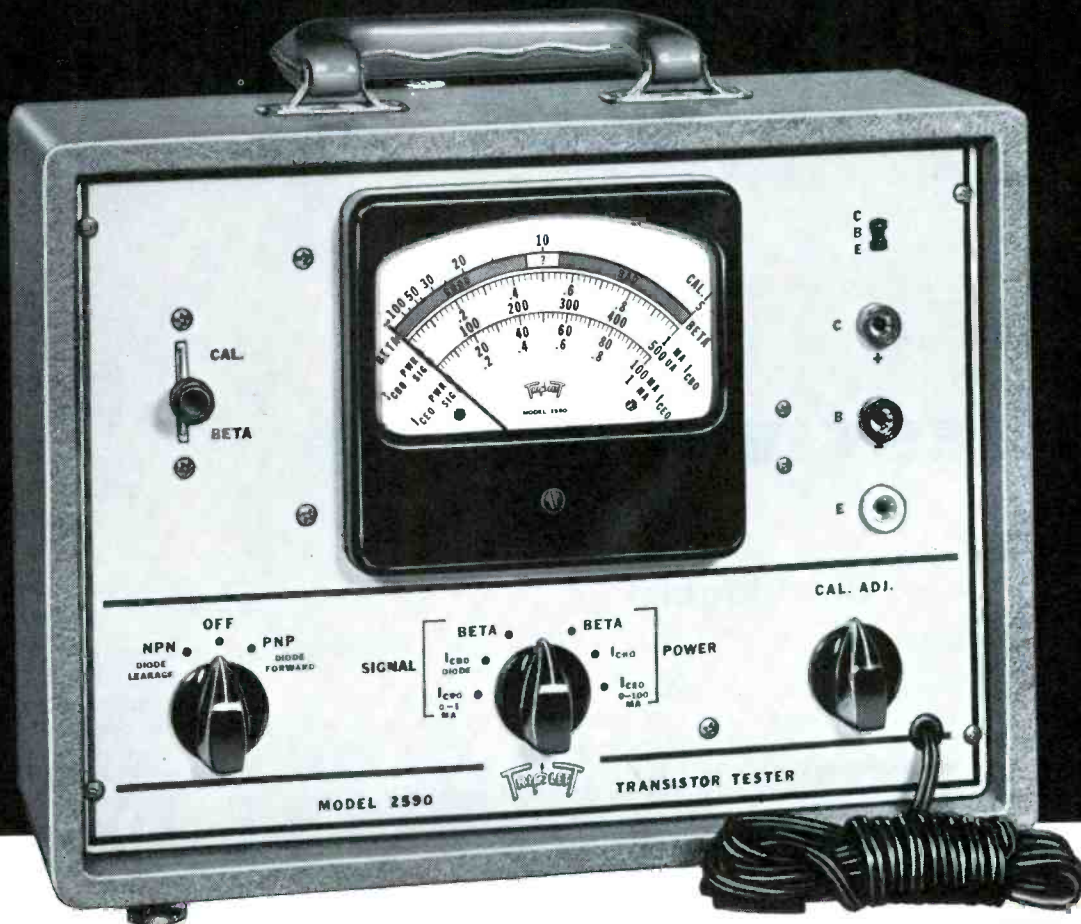

Now you can test transistors under simulated operating conditions . . .
With the NEW Triplet Model 2590 Transistor Tester
Simple to Operate—Versatile—Always Up-to-Date

Simple to Operate—The new Triplet Model 2590 Transistor Tester quickly, easily and accurately tests all power and signal transistors under simulated operating conditions. Only 3 switches and 1 control knob.

Versatile—Has provisions for testing I_{CEO} (at 9.5V), I_{CBO} (at 9.5V) and Beta Amplification (at 3V) on both NPN and PNP transistors. Also checks leakage and forward current of diodes.

Always Up-to-Date—No roll chart, specifications, or special data necessary. All you need know is the transistor type (NPN or PNP and Signal or Power type).

Transistor Socket and External Leads—Allows use with any type basing arrangement.

Accuracy—The Model 2590 is accurate to within $\pm 2\%$ of full scale reading on 0-100 D. C. Ua.

Selector Switch—Provides selection of NPN, OFF or PNP positions.

Function Switch—Provides selection of I_{CBO} Leakage, I_{CEO} Leakage and Beta Gain position for both power and signal transistors.

Beta Switch—Is in the calibrate position normally and is in the Beta test position when pulled down.

Calibrate Adjustment Control—Adjusts for full scale calibration after transistor has been inserted.

Power—115 volts, 50-60 cycle, A.C.

Scales—There are 5 scales on the meter: 0-1 ma. for signal transistor I_{CEO} ; 0-100 ma. for power transistor I_{CEO} ; 0-500 ua. for signal transistor I_{CBO} , also diode leakage and forward current; 0-1 ma. for power I_{CBO} ; 5-100 Beta range also shown as the "GOOD ? BAD" scale.

Case—Handsome gray leatherette case, 11 $\frac{1}{2}$ " x 8 $\frac{3}{8}$ " x 5 $\frac{1}{8}$ "; has recessed panel.

MODEL 2590 TRANSISTOR TESTER—U.S.A. Dealer Net Price \$49.50

MODEL 690-A PORTABLE TRANSISTOR TESTER



Triplet Model 690-A Transistor Tester is a rugged, small, easily portable unit. Battery operated.

It provides Leakage and Gain tests for all low and medium power PNP and NPN type transistors. Also checks diodes for forward and leakage current.

A single switch is provided for simplicity in selecting transistor type settings. The OFF position prevents drain on the batteries in case of accidentally shorting the leads. Another operating feature is the use of separate "Calibrate" and "Gain" buttons to eliminate errors.

A transistor socket and a set of external leads are provided for use with any basing arrangement.

MODEL 690-A PORTABLE TRANSISTOR TESTER—U.S.A. Dealer Net Price \$29.50

All Triplet instruments are available nationally through authorized Triplet distributors. A list of the Triplet distributors in your area is available upon request. Write to:



TRIPLET ELECTRICAL INSTRUMENT COMPANY, BLUFFTON, OHIO

Manufacturers of Panel and Portable Instruments, Electrical and Electronic Test Equipment

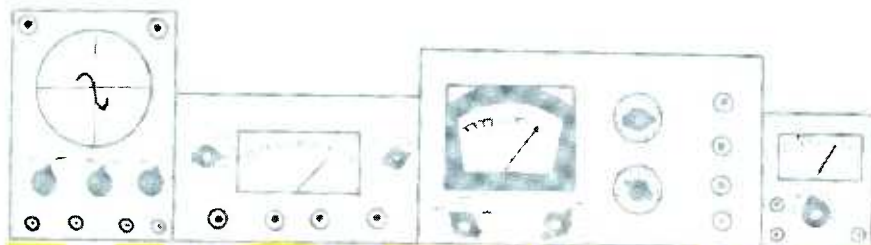

NOTES ON TEST EQUIPMENT

by Les Deane

Breadboard

The instrument pictured in Fig. 1 is the Model 850 Transistor Analyzer manufactured by Hickok Electrical Instrument Co. of Cleveland. This unit is designed primarily to enable radio and TV servicemen to check transistors simply and accurately; however, its usefulness also extends to the laboratory for applications in the design and study of transistor circuits. Since dynamic transistor tests can be performed in simple breadboard fashion, the instrument is useful to the engineer, experimenter, student, and serviceman alike.

Specifications are:

1. **Power Requirements** — ten self-contained 1.5-volt batteries, replaceable with standard size "D" cells; spring-return power switch provided; input supply variable from 0 to 2.75 volts with source resistance of .5 ohms; regulated output supply variable from 0 to 12 volts in 1.5-volt steps, source resistance .5 ohms; input and output circuits provided with panel binding posts for externally-applied power.
2. **Transistor Tests**—checks NPN and PNP transistors of either low-signal or power types for: collector leakage in common base or common emitter circuits, current gain (beta), alpha,

input resistance, output resistance, power gain, and linearity.

3. **Design Applications** — breadboard configurations of common-emitter, common-base, or common-collector circuits for both NPN and PNP types; 6-position selector automatically provides diagram of configuration; input-circuit resistance variable from 0 to 1 megohm; output circuit variable from 0 to 100K ohms; input and output circuits provided with built-in meters and panel binding posts for external signal use.
4. **Panel Meters** — 3½" direct-current instruments connected in both input and output circuits; 5 ranges of 100 ua, 1 ma, 10 ma, 100 ma, and 1 amp full scale, with meter resistance given for each range; over-all accuracy ±2%; silicon diodes provide overload protection.
5. **Other Features**—standard transistor socket plus 4 individual test jacks (with clip leads) provided on front panel; transistor reference charts supplied in manual.
6. **Size and Weight**—metal case 13" x 16¾" x 7"; 13 lbs. (less batteries).

Taking notes on the Model 850 in the lab, I discovered that the instrument is something more than an ordinary transistor checker. As its name implies, it is a complete dynamic analyzer. Not only is it capable of performing all tests necessary for accurately evaluating transistor characteristics, but its flexible circuitry also permits the operator to study or construct various transistor-circuit configurations. This feature has a sort of hidden value in that, by working with the instrument, the user continually increases his understanding of transistor theory and circuit operation.

The most impressive physical feature of the instrument is its breadboard-like panel and configuration selector, providing a schematic presentation of the way the transistor is actually connected in the system. The selector switch, located just above the center of the panel, has six individual positions; these correspond to common-emitter, -collector, and -base configurations for either PNP

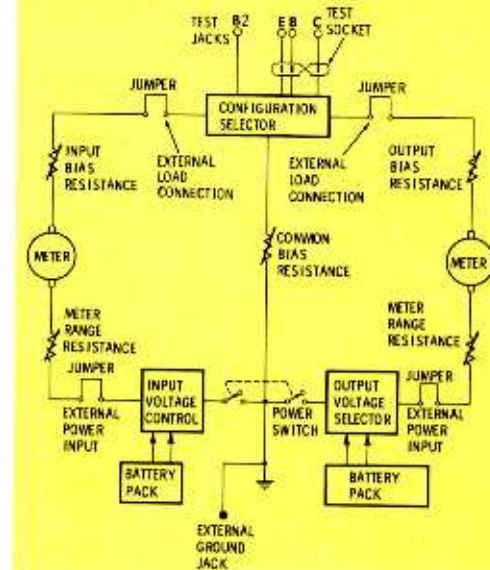

Fig. 2. Diagram showing the basic circuitry of the Model 850 Analyzer.

or NPN transistors. Through a small panel cutout directly above this selector, the transistor connections are shown for each switch position.

A diagram of the Hickok Analyzer is shown in Fig. 2, which is a slight elaboration of the breadboard circuitry imprinted on the front panel. Basically, it consists of input, output, and common-return circuits. The battery packs (batteries not supplied with the unit) consist of two regular 1.5-volt flashlight cells for the input section and eight for the output section. Individual battery holders are mounted on a panel which, in turn, is held to the back of the case by six ¼" metal screws. To install or remove the batteries, the panel is merely tilted back as shown in Fig. 3.

Both input and output voltages are variable; also, by removal of a single jumper (Fig. 2), an external voltage source can be used for either circuit. Internal meter resistance will change for the current range selected; therefore, the range-selector switches are calibrated not only in full-scale current, but also in ohms of series resistance. Both ends of the panel knobs are used to indicate these values.

Variable bias resistance is accomplished by use of 11-position switches in both input and output branches. Open and short positions are also included for certain configurations. Resistance values other than those provided by the bias switches may be inserted in place of the jumpers connected between the battery supplies and the switches.

The Model 850 is usable up to 5 mc for breadboard design applications, which is more than adequate for general transistor circuit work. In the manual, I noticed that circulating collector current should not exceed 5 ma for low or medium power transistors, and 500 ma for power types. This caution also applies to measurements of beta (the current amplification factor of a transistor). When experimenting with the test functions, I found that the instrument could immediately detect shorted or open transistors as well as indicate the two most important evaluation characteristics —

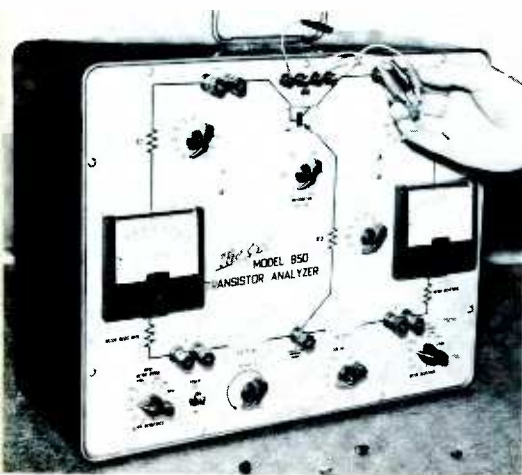
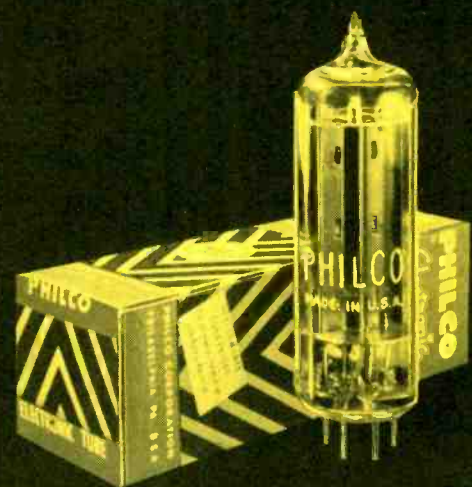
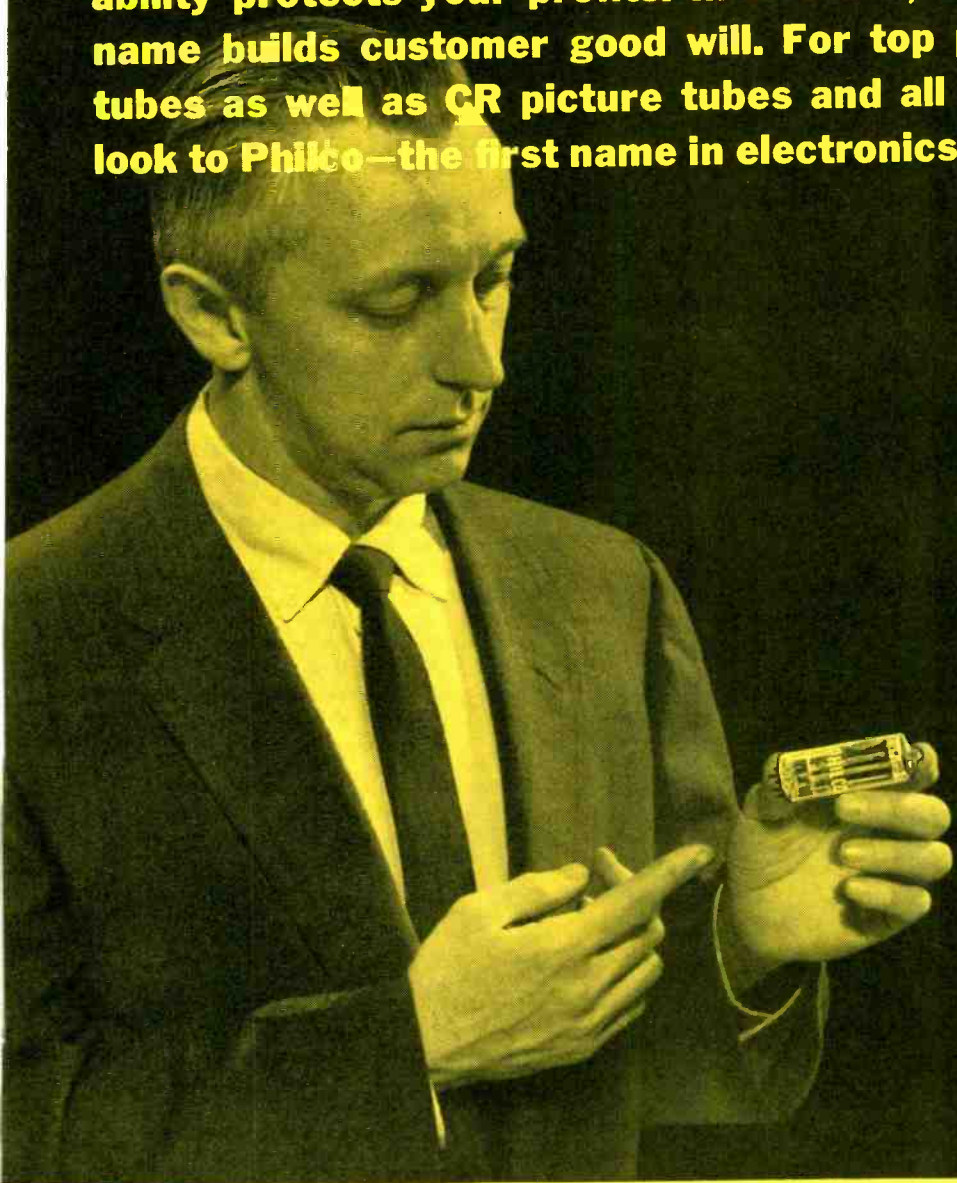

Fig. 1. Front panel of Hickok's Transistor Analyzer shows circuit hook-up.

PHILCO[®] THE FIRST NAME IN ELECTRONICS

...THE LAST WORD IN QUALITY

Because the Philco name is symbolic of quality, long-life Philco tubes are the **FIRST CHOICE** of quality-wise technicians. It will pay you to use them for all replacements—TV, radio and hi-fi. Their proven reliability protects your profits. In addition, the prestige of the Philco name builds customer good will. For top performance in receiving tubes as well as CR picture tubes and all other replacement parts, look to Philco—the first name in electronics...the last word in quality!



SEE YOUR PHILCO DISTRIBUTOR TODAY!
Get the facts about the Spring "Free-for-All".
Easter Gifts! Mother's Day Gifts! Service Aids!



PHILCO ACCESSORY DIVISION

WORLD-WIDE DISTRIBUTION

Service Parts • Power-Packed Batteries • Universal Components • Long-Life Tubes • Heavy-Duty Rotors • Star Bright 20/20 Picture Tubes • Long Distance Antennas • Appliance Parts • Laundry Parts • Universal Parts and Accessories

PHILCO CORPORATION ACCESSORY DIVISION
ATTN. Carl Areschoug
P. O. Box 3635
Philadelphia 25, Pa.

If you service television and radio receivers and would like to receive the Philco Giant Banner Sales Mailers, attach this coupon to your Company letterhead and forward to above address.

NAME _____
ADDRESS _____
CITY _____ ZONE _____ STATE _____



The "Big Picture"

... informative shop talks

by AL MERRIAM

My name is Al—what's yours?

This is my first column, so let me introduce myself.

Al Merriam is the name, Sylvania National Service Manager is my job. I guess you could call me a technician's technician. At any rate, the point of this column is to help you get your job done a little faster, a little easier and a little more profitably.

Frankly, I'm more at home working over a TV chassis than I am working over a typewriter. So the writing may not be fancy. But I promise you'll get the straight facts and plenty of 'em.

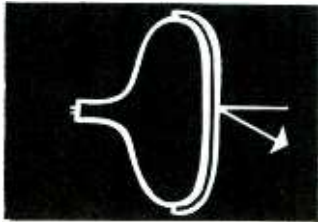

For example, in the next few columns, I'll give you some valuable tips on the new Bonded Shield 23" tube, the new Sylvania control cluster and our new simplified back cover.

Let me hear from you

This column is for you. I want to talk about things that will help you. So if you have any ideas about what topics I should cover, shoot 'em along. The address is below.

Get in on our bulletins and service clinics, too

TV electronics is a fast-moving field, and I'd like to invite all TV service dealers—and hams and hobbyists—to keep up-to-date with the "Big Picture" by subscribing to the Sylvania Service Literature and attending the Sylvania Service Clinics. I know you'll find the clinics an easy way to keep up with the latest in TV and find out what's new with other TV service dealers. Ask your Sylvania television distributor for details on the next clinic session in your area, or write me—Al Merriam, Sylvania Home Electronics Corp., Batavia, N. Y.



SYLVANIA

Subsidiary of **GENERAL TELEPHONE & ELECTRONICS**

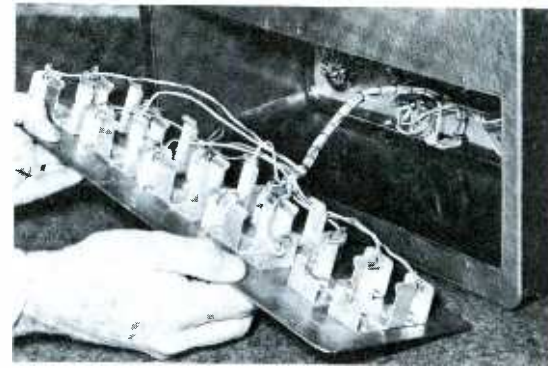

Fig. 3. Ten-cell battery panel removed from the Hickok Transistor Analyzer.

leakage and gain. These exacting tests are particularly suitable for checking transistor interchangeability and for matching pairs in push-pull applications.

Check DC from 5 mv to 5 kv

The volt-ohm-milliammeter pictured in Fig. 4 is the second test instrument to be marketed by RCA Electron Tube Division of Harrison, N. J. in both kit and factory-wired form. (The first, a *Volt-ohmyst* Model WV-77E, was covered in this column for August, 1959.)

This new VOM, Model WV-38A, features two extra-low DC ranges for voltage measurements in transistor circuits, and comes complete with test leads, batteries and manual. Kit versions also include simple step-by-step assembly instructions and large, easy-to-follow drawings.

Specifications are:

1. *Power Requirements*—five self-contained 1.5-volt batteries, one size "D" and four penlite cells.
2. *DC Voltmeter*—eight ranges of 0 to .25, 1, 2.5, 10, 50, 250, 1000, and 5000 volts; sensitivity 20,000 ohms/volt; accuracy $\pm 3\%$; polarity switch provided.
3. *AC Voltmeter*—six rms ranges of 0 to 2.5, 10, 50, 250, 1000, and 5000 volts; sensitivity 5000 ohms/volt; accuracy $\pm 5\%$; frequency response within .5 db from 10 cps to 50 kc for all ranges up to 50 volts full-scale.
4. *Ohmmeter*—0 to 20 megohms in three ranges of R x 1 (center scale 12), R x



Fig. 4. RCA's new VOM features .25- and 1-volt full-scale DC ranges.

NUMBER 3 IN A SERIES OF



50th ANNIVERSARY SPECIALS!

You asked for it!

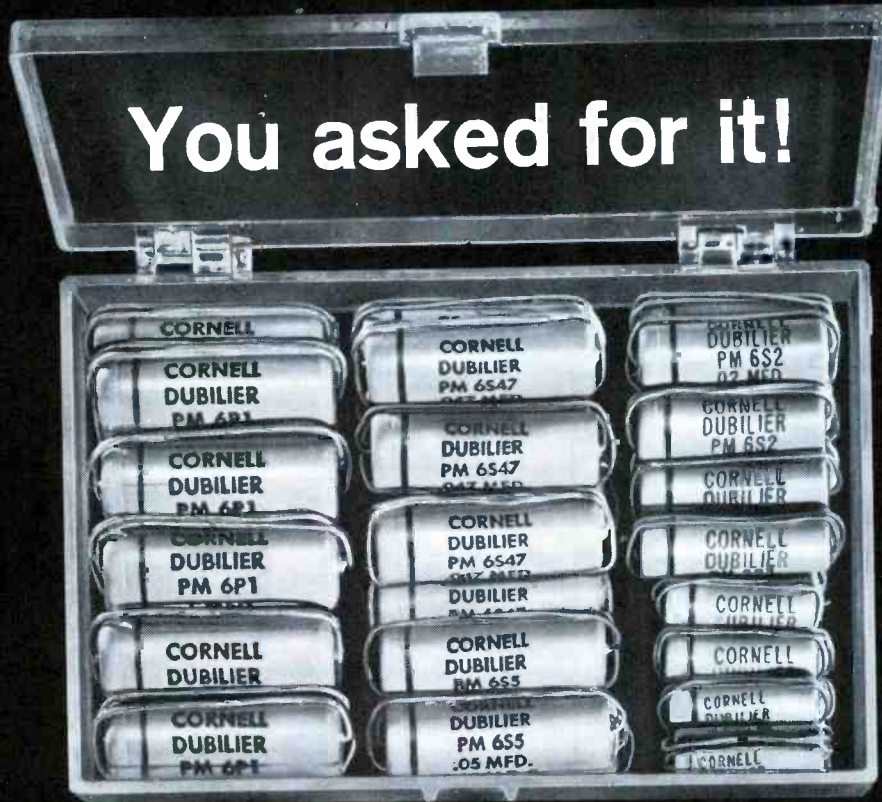

HIT KIT

35 POPULAR CDE MOLDED MYLAR TUBULARS

NOW — just in time for baseball TV-viewing (and TV-servicing) CDE has the Hit Capacitor Kit *you* asked for: 35 popular molded Mylar* tubulars that “shortstop” call-backs! Quality-proven by two years of consistently dependable replacement service, these high temperature, moisture-resistant “PMs” are the values you need and use every day. And now you can have this convenient assortment—plus a sturdy, plastic parts-or-jewel box—all for the price of the capacitors alone! A real “double-header.” Get *two* “PM Kits” today—one for your shop, another for your service bag—from your CDE Distributor. Cornell-Dubilier Electric Corp., South Plainfield, N. J.

HERE'S THE BOX SCORE

No.	Item	Mfd.
3	PM 6D2	.002
5	PM 6D5	.005
6	PM 6S1	.01
5	PM 6S2	.02
5	PM 6S47	.047
6	PM 6S5	.05
5	PM 6P1	.10

Voltage: 600 VDCW

ALL FOR ONLY \$6.87

Pick the four teams in each major league that you think will be standing in 1, 2, 3, 4-order as of midnight, May 31, 1960 and win \$100 worth of *any* CDE merchandise if the sequence you pick is closest to the actual order. See full contest details in kit.

*DuPont T.M.



CORNELL-DUBILIER ELECTRIC CORPORATION

AFFILIATED WITH FEDERAL PACIFIC ELECTRIC COMPANY

100, and $R \times 10,000$; accuracy $\pm 3^\circ$ of pointer position on scale arc; zero-ohms adjust provided on panel; 1.5-volt potential applied on $R \times 1$ and $R \times 100$ ranges, 7.5 volts on $R \times 10,000$ range.

5. *AF/db Meter*—output ranges 0 to 2.5, 10, 50, and 250 volts; power levels from -20 to +50 db; zero db = 1 milliwatt of AC power across a 600-ohm load; output jack with DC blocking capacitor provided.
6. *DC Ammeter*—six ranges of 0 to 50 μ a, 1 ma, 10 ma, 100 ma, 500 ma, and 10 amps; accuracy $\pm 3\%$; insertion loss .25 volts; separate jacks provided for 50- μ a and 10-amp ranges.
7. *Panel Meter* — 5¼" extended-view unit with clear plastic front; 50 μ a

sealed movement; five individual scales plus db chart provided on face.

8. *Accessories*—two high-voltage probes available, one for measurements up to 25 kv and one for 50 kv.
9. *Size and Weight*—6⅞" x 5¼" x 3⅛" (excluding handle), 3½ lbs.

When I removed the instrument chassis from its plastic case, I could see that almost all of its chassis wiring was confined to a single printed board. (See Fig. 5.) Components and certain connection points are located and identified by numbers on the top side of the board, while the etched wiring itself is confined to the back. The range-selector switch, mounted near the center of the board, can be rotated in either direction through all of its 12 positions.

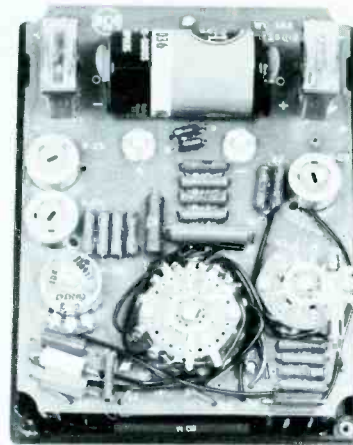

Fig. 5. Kit or factory-wired, the WV-38A utilizes a one-piece printed board.

The battery pack is made up of a single size "D" cell, mounted between two spring clips near the top center of the board, plus four smaller *penlite* cells vertically positioned in pairs to the right and left of the larger battery. Each pair of *penlite* cells is held in by a U-shaped spring clip; to replace, the sides of the holder are merely pressed in and the clip is removed as shown in Fig. 6.

The pigtail fuse lying across the AC-DC function switch (lower right of Fig. 5) is a 1-amp, 250-volt unit connected in series with the common test jack; it protects the multiplier resistors against overloads during ohmmeter and milliammeter applications. If this fuse blows, the meter will be inoperative on all functions in which the common jack is employed.

Uses for this VOM are, of course, evident from its list of specifications. I found it particularly useful for checking bias potentials in transistor radios, especially on the two lowest full-scale ranges of .25 and 1 volt. These low ranges are also handy for measuring critical AGC voltages and checking for slight bias changes on an amplifier or oscillator grid.

As with most VOM's, placing the test leads across a high-impedance circuit may cause loading problems. To overcome this condition, additional resistance can be placed in series with the "hot"



Fig. 6. Spring clips hold small batteries and serve as electrical contacts.

COMPLETELY RELIABLE AUTOMATIC MONEY-MAKER



B&K MODEL 675 AUTOMATIC DYNA-QUIK

DYNAMIC MUTUAL CONDUCTANCE TUBE AND TRANSISTOR TESTER

Here is automation that combines both speed and accuracy for profitable professional servicing. Pre-tested and field proved. Keeps paying you dividends day after day. Measures true dynamic mutual conductance. Makes complete tube test in seconds under actual operating conditions of the set. Checks average set in a few minutes. Provides instantaneous heater continuity test. Shows true tube condition on "Good-Bad" scale and in micromhos. Patented automatic line compensation. Tests transistors, diodes, and rectifiers, too. Net, **\$169.95**

See Your B&K Distributor or Send for Bulletin ST24-R

B&K MANUFACTURING CO.
1801 W. BELLE PLAINE AVE • CHICAGO 13, ILL.

Canada: Atlas Radio Corp., 50 Wingold, Toronto 10, Ont.
Export: Empire Exporters, 277 Broadway, New York 7, U.S.A.

SIMPLIFIED AUTOMATIC DYNA-CARD SYSTEM

Only 60 indexed phenolic Dyna-Cards test over 600 tube types. Dyna-Card automatically sets socket connections.

MORE ACCURATE TESTS FOR PROFESSIONAL SERVICING

Tests each section of multiple tubes separately for true Gm, Shorts, Gas, Grid Emission and Life.

MINIMIZES OBSOLESCENCE

Easily kept up-to-date with extra cards and punch supplied with every unit.

By checking all tubes in the set, you can Sell More Tubes Per Call INCREASE YOUR INCOME Save Call-Backs and Satisfy More Customers.



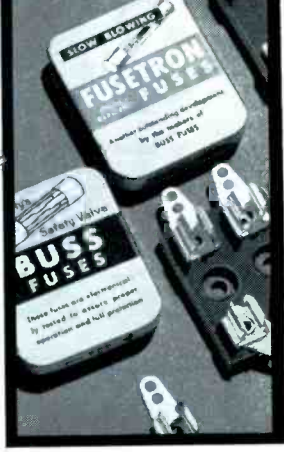
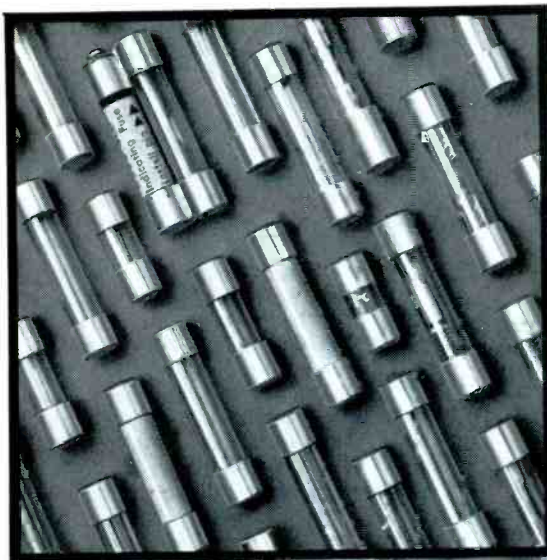

Here are the plain facts!

... why it pays to standardize on BUSS FUSES

IT'S A FACT! BUSS fuses have provided dependable electrical protection under all service conditions for over 45 years in the home, in industry and on the farm.

IT'S A FACT! You never have to stop and explain why you carry BUSS fuses because your customers accept them as the finest available.

IT'S A FACT! Every BUSS fuse you sell or install is tested in a sensitive electronic device that automatically rejects any fuse not correctly calibrated, properly constructed and right in all physical dimensions.

IT'S A FACT! When you sell or install BUSS

fuses, you avoid complaints that your fuses failed to protect or that they opened needlessly.

IT'S A FACT! Selling and installing BUSS fuses saves you time and trouble by avoiding call-backs . . . you keep your full profit and create satisfied customers.

IN SHORT . . . why take a chance with your good name by carrying fuses that might be faulty? Standardize NOW on genuine BUSS fuses. They help you protect your profits and your reputation for service and reliability.

For more information on BUSS and FUSETRON Small Dimension fuses and fuseholders, write TODAY for Bulletin SFB.

BUSSMANN MFG. DIVISION, McGraw-Edison Co. University at Jefferson, St. Louis 7, Mo.

460

BUSS fuses are made to protect - not to blow, needlessly.

BUSS makes a complete line of fuses for home, farm, commercial, electronic, electrical, automotive and industrial use.



after
61
years

it's the radio-tv
serviceman's
"best friend"!

KESTER SOLDER



KESTER "RESIN-FIVE" FLUX-CORE SOLDER enjoys almost 100% acceptance by the radio-television-electronics service industry. Servicemen like its fast action and easy application . . . its non-corrosive, non-conductive activated flux does a perfect job every time.

Send for detailed information on Kester "Resin-Five" Flux-Core Solder.

KESTER SOLDER CO.

4228 Wrightwood Ave., Chicago 39, Illinois
Newark 5, N.J., Anaheim, Calif., Brantford, Canada

OVER 60 YEARS' EXPERIENCE IN SOLDER AND FLUX MANUFACTURING

PROFESSIONAL
technicians

USE

Dave Rice's

OFFICIAL
ORDER BOOKS

for every
TV-RADIO
service
call

This is the businesslike approach to service record keeping. TriPLICATE forms serve as order form, invoice and office record, with spaces for complete information on every job. Separate listings for receiving tubes, pix tube, parts, serial numbers, labor and tax charges, signatures, etc. 75c a book, \$6.50 for dust-proof box of 10. In stock at your distributor.

Write for your free folder describing Dave Rice's OFFICIAL ORDER BOOKS, including an actual size sample copy of the handy order form.

For customer's prices on every replacement part, plus flat rate and hourly service charge data, regional and national, Dave Rice's OFFICIAL PRICING DIGEST, listing over 63,000 items. \$2.50.

ELECTRONIC
PUBLISHING CO., INC.
180 N. WACKER DRIVE
CHICAGO 6, ILLINOIS



BERNS PERFECT PIN-CRIMPER

Picture-Tube Repair Tool

Eliminates that hard
soldering job.

only \$1.25



Fix loose pin connections in seconds. Pays for itself in time saved on one job alone. 3" long.

U. S. Pat. 2,878,698
Canadian Pat. 592,702

Intermittent operation of picture tubes due to defective solder connections at socket pins is easily corrected through the use of the Berns Perfect Pin Crimper. Actually a 3-in-1 tool that can also be used as a channel-selector wrench and screwdriver, it serves to notch pins and element leads to provide solid electrical connections. Pin keeps its original form.

3 models: PT-1 for 3/32" pin diameter; AU-2 for 1/8" pin diameter and installing C rings; LC-3 for 5/32" pin diameter.

Available at your parts distributor.
Another fine product from:

BERNS Mfg. Co.
9853 Chalmers,
Detroit 13, Mich

lead, using a value higher than the impedance of the circuit under test. If you use just any value for the isolating resistor, however, the readings obtained will be only relative and not at all accurate. To help you make exact measurements under these conditions, the RCA manual goes a step farther, listing specific resistor values to be used with various scales.

For example, suppose you wanted to take a low-voltage grid measurement using the 2.5 volt range, but found that the instrument loaded the circuit so that an accurate reading was virtually impossible. In this case, you could either add a series resistor of 50K ohms, refer to the 5-volt scale and multiply by 2, or use 150K ohms and multiply the reading obtained on the 10-volt scale by 4. Multiplication factors and resistance values are also listed for use on the meter's 50- and 250-volt ranges.

Lab Tester for Shop

If you're in the market for a tube checker and want one that will test all types with a high degree of accuracy, you'll be interested in Triplett's new Model 3444 *Laboratory Tube Analyzer*. This unit is designed to measure vacuum-tube characteristics using applied potentials and signal amplitudes resembling those found in standard laboratory equipment. Although the instrument is fairly large in size, it is portable and comes complete with up-to-date tube listings, grid- and plate-cap leads, detachable lid, and instruction manual.

Specifications are:

1. *Power Requirements*—105/127 volts, 50/60 cps; power consumption less than 20 watts in standby; line adjustment, overload indicator, and line fuse provided.
2. *Short Test*—shorts and leakage between tube elements checked with application of 85 volts DC in accordance with EIA standards; leakage sensitivity 10 megohms; measurements indicated directly on panel meter.
3. *Dynamic Tests*—mutual conductance indicated in 4 micromho ranges on panel meter; regulated plate, screen, and bias potentials plus 5-kc test signal employed; VTVM circuit detects only AC component of plate voltage; special gas/grid-current test and cutoff/plate-current measurements provided.
4. *Emission Test*—cathode emission for diodes and rectifiers measured under load and indicated on DC milliammeter.
5. *Other Tests*—measurement of firing voltage and control range for regular and reference tubes; tuning-eye tubes checked for shadow reaction; thyatrons tested for cutoff characteristics; special panel jacks provided for noise test; picture tubes tested through use of accessory adapters.



Fig. 7. *Dim, Dim the Lights*—Triplett's new tester has its own "glow" power.

6. *Panel Features*—200-ua meter with 4" scale and knife-edge pointer; storage compartment beneath removable triple-window roll chart; special socket adapter for acorn-type tubes; filament-voltage selector providing 23 different potentials from .6 to 117 volts; 8 test sockets, including one combination unit that accommodates 4, 5, and 6 prong tubes; 7- and 9-pin straighteners on panel.
7. *Size and Weight*—leatherette-covered case 15 3/16" x 18 13/16" x 7 3/4", 24 lbs.

Fig. 7 pictures the instrument in operation on the bench; lab lighting was purposely dimmed to better illustrate those portions of the panel illuminated by concealed pilot lamps. Two bulbs light the face of the meter, while the roll chart is lighted by three individual bulbs—one for each window.

Basically, testing with the Model 3444 is accomplished through manipulation of various rotary switches. Don't let the number of controls shown in Fig. 8 give you the impression that this piece of equipment is too complex for speedy testing; actually, the operating procedures are fairly simple and straightforward. The instrument panel slopes toward the front of the case so that you will have little difficulty viewing the meter face at the top, even though it is positioned about 1/2" below its protective guard.

Of the test sockets lined across the top of the panel, the three on the right (Fig. 8) feature special "socket savers." Since the octal and both 7- and 9-pin miniatures are the most frequently used,

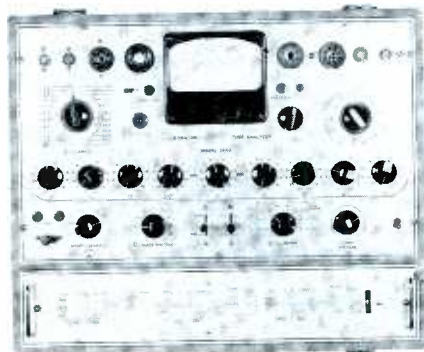

Fig. 8. View of the Model 3444 panel showing array of sockets and controls.

What's the latest score on cartridges?

✓	1ST	ceramic cartridge was invented by Sonotone ...
✓	13	years ago. Today, over ...
✓	65	different manufacturers have specified Sonotone for ...
✓	662	models of high-quality phonographs. Altogether over ...
✓	9,000,000	Sonotone Ceramic Cartridges have been used for original and replacement purposes. ('Nuff said!)

Sonotone [®] PROC.

Electronic Applications Division, Dept. C10-40

ELMSFORD, NEW YORK

In Canada, contact Atlas Radio Corp., Ltd., Toronto

Leading makers of fine ceramic cartridges, speakers, microphones, electronic tubes.

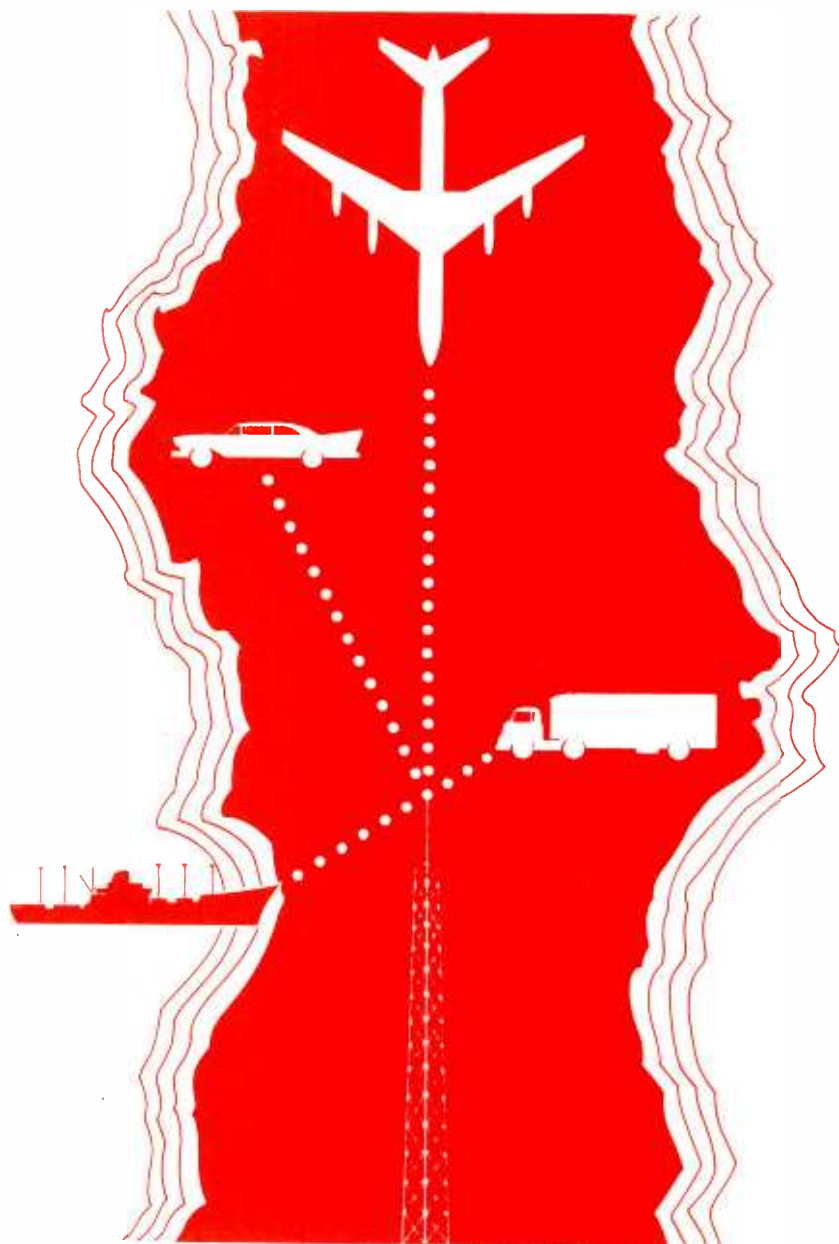

SUREST DISTANCE BETWEEN ANY 2 POINTS

RCA "PREMIUM" TUBES

Protect your essential radio communications with the tested reliability of RCA "Premium" Tubes. Designed to give you the utmost in dependable service, these premium-quality tubes can pay for themselves many times in added hours of uninterrupted communications...and they're available locally through your RCA Industrial Tube Distributor.

RCA "Premium" Tubes are subjected to a continuous and exhaustive testing program, and rigorous quality control in the selection of materials and parts is maintained. The net result to you is a line of quality tubes of exceptional performance and reliability.

Your RCA Industrial Tube Distributor is headquarters for a complete line of RCA "Premium" Tubes as well as all other RCA tubes for fixed and mobile communications equipment. Get the full "Premium" Tube story from him today—and call him for all your replacement tube needs. He'll give you fast, complete service.



RCA RADIO CORPORATION OF AMERICA
 Electron Tube Division
 Harrison, N. J.

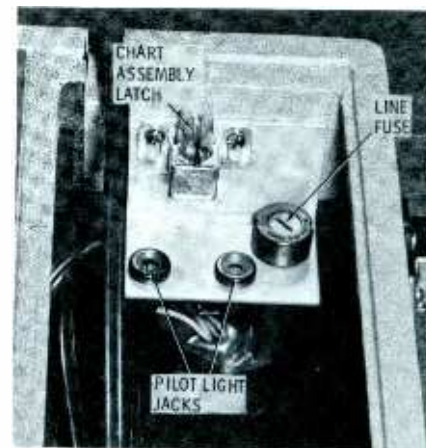
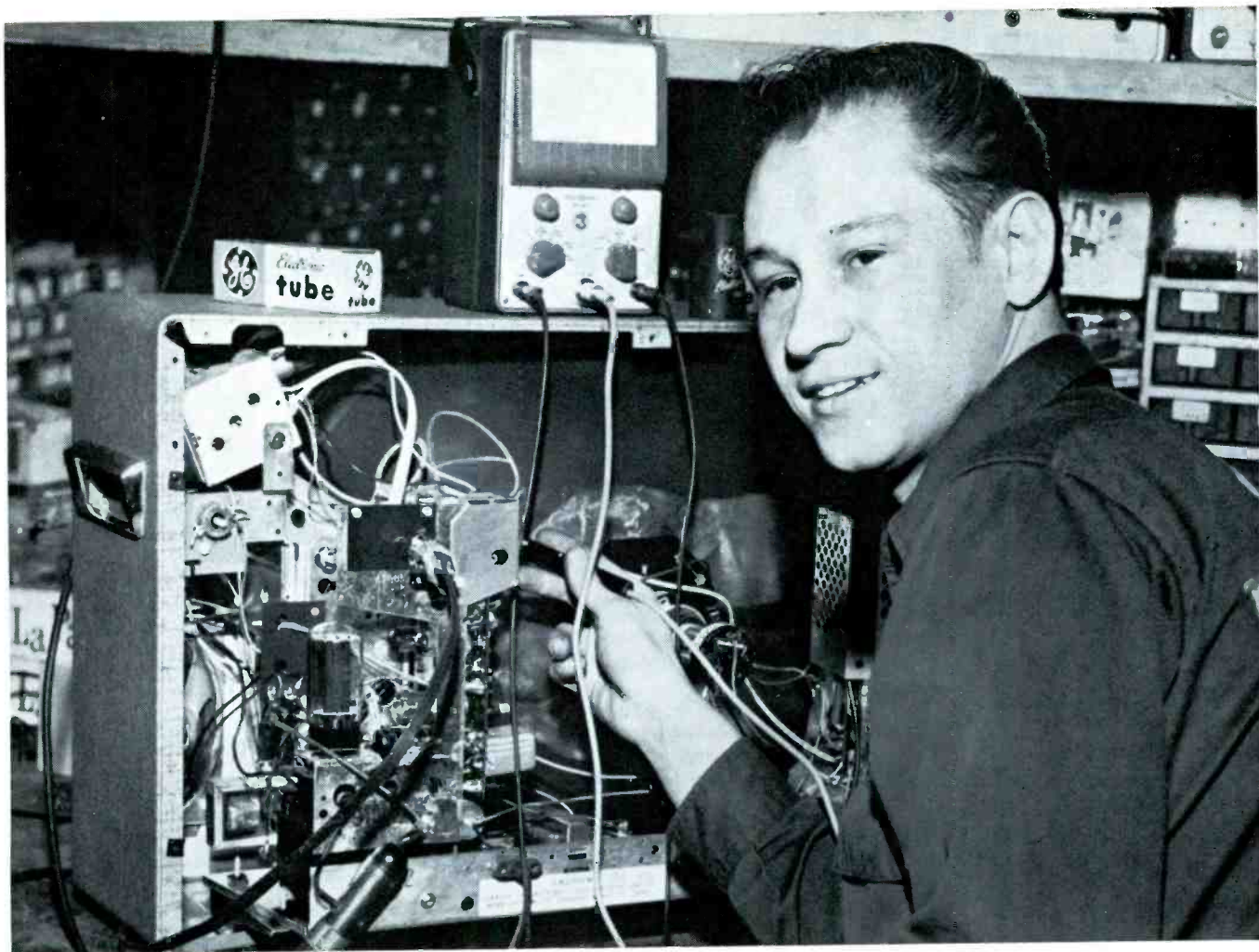

Fig. 9. Corner view of compartment in Triplett's Laboratory Tube Analyzer.

they are not permanently wired, but make use of throw-away adapters which are easily replaced when they become worn. After removal of the two screws holding the top metal plate, the socket or sockets can be unplugged and new ones inserted. Replacements are available from the manufacturer.

Another interesting feature of this tester is the provision made for checking and calibrating the 5-kc test signal and micromho indications. This is accomplished through the use of the adjustment labeled Gm CHECK. The knob, located to the right of the meter and directly below the PLATE CAP jack, controls a combination push-button switch and potentiometer. In its normal position, the knob is free to turn, but has absolutely no effect. Adjustment is made by turning the knob until it engages a small slot in the control shaft; then, as the knob is pressed down, a switch is actuated, connecting the potentiometer into the circuit. With the *Tube Analyzer* on, the "D" selector in one of its four Gm positions, and the SHORT-LEAKAGE switch set to VALUE, a balance between test signal and micromho reading can be obtained by holding the VALUE lever down and adjusting the Gm CHECK control for a full-scale indication on the meter. This calibration is necessary only periodically, but it must always be performed under exact line-voltage conditions.

As with many Triplett testers, the Model 3444 has a storage compartment under the roll-chart panel. This space is essentially reserved for the AC line cord, plate- and grid-cap leads, plus accessories such as the acorn tube-socket adapter furnished with the unit. The entire roll-chart assembly snaps into the top section of the compartment and is held stationary by a latch at each end. Items pointed out in Fig. 9 are found in the lower left-hand corner, mounted to one of the latch brackets. The fuse is a 3-amp unit connected in series with the primary winding of the power transformer, thus offering over-all protection to the instrument. Since the removable chart assembly is equipped with three pilot lights, two banana jacks are used for making electrical connections to the bulbs mounted under the roll chart. ▲



"The 'Designer' is the

LEAST TROUBLESOME SET

we have ever serviced,"

**says Bob Wauganman of Bob's Television,
9518 Madison Street, Cleveland, Ohio.**

"Speaking of the General Electric 'Designer,'" says Bob Wauganman of Bob's Television in Cleveland, Ohio, "there probably isn't an easier set on the market today to service.

"We can do 90% of shop work without removing the set from the cabinet, and we find that, because General Electric licked the heat dissipation problem, 'Designers' last longer and suffer less breakdown.

"We have very few service calls on 'Designers'. Those that we do have are easily corrected. This gives us lots of time to get in more calls per day and,

of course, it helps us to make more money, too."

"Designer" Tubes are directly replaceable, fuses accessible, and you easily get at the key check points. Another thing: the painted schematic on the boards helps you find your way around quickly. Again, more calls per day—and more money.

Precision Etched Circuitry is used in all "Designer" sets and is reliable and uniform so that when you have serviced one you will never have to puzzle over the next one.

"Designer" TV—called the easiest-to-service set in television! General Electric Company, Television Receiver Department, Syracuse 8, New York.

Progress Is Our Most Important Product

GENERAL  ELECTRIC



IMPORTANT NEW SAMS BOOKS

"101 More Ways to Use Your Scope in TV"



Here is the sequel to Bob Middleton's first book on the subject, prompted by the insistent demand of readers for still more of the unique and practical help found in the popular "101 Ways" series. This working guidebook for the service technician or for any scope user, stresses the proper interpretation of observed waveforms. Specifies equipment needed, connections required, procedure and evaluation of results for each use. Special notes supplement the uses described. Profusely illustrated. \$250

180 pages; 5 1/2 x 8 1/2". Only.....

"Electronics For The Beginner"

This book derives from the author's own experiences in helping his teenage son understand this fascinating subject and rewarding hobby. (Jay Stanley, the writer, is a frequent contributor to leading electronics magazines.) Profusely illustrated, the book includes 15 chapters which progressively introduce the newcomer to the basic fundamentals of constructing electronic devices, such as a "one-hour radio," a pocket radio, a home broadcaster, short-wave tuner, etc. The book is unique in that all the projects described make use of transistors rather than vacuum tubes. This is without doubt the most readable, up-to-date and best book of its type available. 192 pages; 5 1/2 x 8 1/2", hard-bound. \$395



Only.....

"Servicing Transistor Radios" Vol. 5



The latest volume in this best-selling series; complete data on popular transistor model radios produced in 1958-59. You get the famous Sams Standard Notation Schematics, with CircuTrace used throughout; full photo views of each chassis; complete alignment data; full replacement parts data—everything you need to be successful in fast-growing transistorized radio servicing. Includes

valuable section on special techniques for servicing transistor circuits. With cumulative index for all volumes in the series. 160 pages; 8 1/2 x 11". Only..... \$295

"Video Speed Servicing" Vol. 4

Newest volume in Sam Marshall's valuable series. Consists of 456 practical troubleshooting hints for solving hard-to-find faults in many late model TV receivers. All models are indexed by brand name, model and chassis number for quick reference. Each hint is accompanied by an explanatory diagram or schematic. An invaluable shop reference; a real time-saver. 160 pages; 8 1/2 x 11". Only..... \$295



HOWARD W. SAMS & CO., INC.

Order from your Sams Distributor today, or mail to Howard W. Sams & Co., Inc., Dept. D-30 1720 E. 38th St., Indianapolis 6, Ind.

Send me the following books;

- "101 More Ways To Use Your Scope" (TEM-7)
- "Electronics For The Beginner" (BHJ-1)
- "Servicing Transistor Radios" Vol. 5 (TSM-5)
- "Video Speed Servicing" Vol. 4 (VSM-4)

\$..... enclosed. Send Free Book List

Name.....

Address.....

City..... Zone..... State.....

(outside U.S.A. priced slightly higher)



ANSWERS YOUR SERVICE PROBLEMS

Surg-ury

In a Canadian TV with a voltage-doubler power supply, the 7.5-ohm fusible resistor burns out every two or three months. Surge current is around 500 ma, but normal drain is 300 ma. Can you help me find the reason why the resistor keeps blowing out?

GERARD LEBOEUF

Rimouski, P. Q., Canada

Your measured currents seem normal; a 500-ma surge is not uncommon. Try changing both rectifiers (especially if they are selenium units). Line-voltage fluctuations are a highly probable cause of this trouble. Another possibility is an intermittent short in the set—most likely in the damper tube.

Video Response

How can I use regular shop equipment to check the frequency response of video circuits?

J. R. SIMONIN

Detroit, Mich.

A marker generator, sweep generator, and scope can be used to check the frequency response of these circuits. Connect the outputs of both generators to the input of the video detector (across the secondary of the last video IF transformer). The cables should be properly terminated with resistance values equal to generator-output impedance—usually

75 ohms. Set the marker at 100 mc and the sweep to 106 mc with a 6-mc sweep width. The two signals will heterodyne in the detector, providing a "video sweep" difference signal which ranges from about 40 kc to 6 mc. A demodulator probe can be used with the scope to observe the familiar response-curve pattern; or, if you prefer, a low-capacitance probe and wide-band scope can be used to view the actual video-frequency waveform (see schematic and waveform drawings).

To determine what frequencies are being either attenuated or accentuated, increase the marker frequency so that part of the response runs off the base line. The reading on the generator dial can then be used to determine which portion of the response is being affected.

Shrinkin' Philco

A Philco Chassis TV-354 has a raster that shrinks about 4" over-all whenever channels are changed. I've checked all resistors and capacitors in the vertical circuit and substituted different makes of new tubes. The output waveform decreases in amplitude, too. I've changed the output transformer and tried the circuit alteration shown on the enclosed schematic.

PETER GUTIERREZ

Topeka, Kan.

I see you've modified the circuit in accordance to a suggestion in "Video

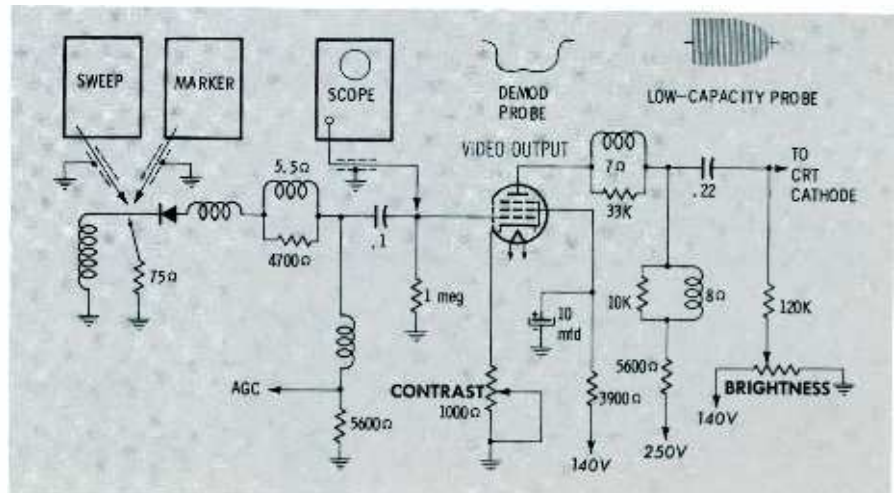

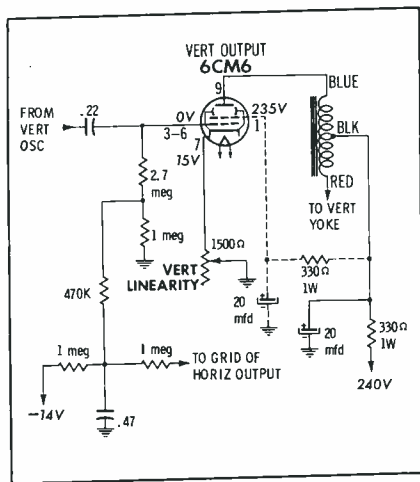

Speed Servicing," Vol. 2. The dotted portion is also suggested. Try it. Another tip: Check the waveform at the grid to see if it changes appreciably when the raster shrinks.

The set may have a poorly-regulated power supply. Monitor the fixed negative-voltage source and boost line, as well as B+; fluctuations of any of these supply voltages could cause your trouble. If poor voltage regulation isn't corrected by two new 5U4's, increased power-supply filter capacitance may be called for. Actually, a partially open capacitor would probably be at the root of such a trouble.

Real Gone

The picture and sound intermittently cut off in a Stromberg-Carlson Chassis 622 Series, and the AGC line develops -150 volts. Switching to VHF and back to UHF restores normal operation, and touching the grid of the third video IF slowly returns the set to normal. The condition pops up at any time and without warning.

J. M. THURSTON

Ft. Wayne, Ind.

The highly negative AGC holds the clue to this one. Evidently the third video IF is going into oscillation because of improper alignment, an open bypass capacitor, or some other reason. Placing a probe or finger on the grid of this stage introduces enough capacitance to stop the oscillation, and the picture and sound reappear as soon as the charge on the AGC filter capacitor bleeds off to a nearly normal level.

Runnin' Wild

I'm having sync troubles in an RCA Chassis KCS117A. The picture runs wild, but can be stopped momentarily with the hold controls. All components in the sync circuits have been checked and tubes substituted. Voltages in these stages are all normal.

AUGUST P. RONDINELLI

Trenton, N. J.

"Video Speed Servicing," Vol. 3, shows two common causes for sync loss in this chassis—a defective cathode resistor in the video output stage, or a bad coupling capacitor between sync stages.

"PHOTOFACTS are the backbone of my business—

I believe without them I would be unable to operate. When it comes to repairs and ordering parts, I can find no quicker reference."

—Robert W. Whited
Herndon, Va.

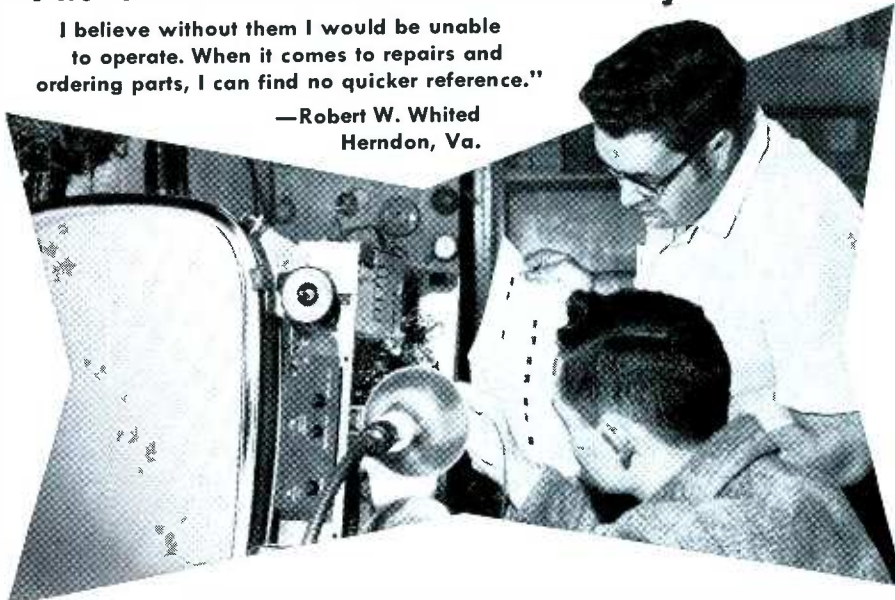

Service Technicians! YOU EARN MORE... YOU RATE with the public when you own the PHOTOFACT® service data library!

You enjoy maximum earnings as the owner of a complete PHOTOFACT Service Data Library! It's inevitable, because no matter how expert you are, you can always *save more time on any job, get more jobs done daily—EARN MORE, DAY IN AND DAY OUT...*

What's more—as the owner of a complete PHOTOFACT Library, you know your customers' sets best. You can actually show each customer you have the PHOTOFACT Folder covering his very own set. Result: You command public respect and acceptance which paves the way to more business and earnings for you.

HOW TO STAY AHEAD...

Yes, the truly successful Service Technicians are those who own the complete PHOTOFACT Library, who can meet and solve any repair problem—faster and more profitably. And these men *keep ahead* because they're on a Standing Order Subscription with their Distributors to receive all new PHOTOFACTS as they are released monthly. (They're eligible for the benefits of membership in PEET, too—see below!)

For PHOTOFACT Library Easy-Buy Plan details and Standing Order Subscription, see your Sams Distributor today, or write to Howard W. Sams...

"PEET"
PROGRAM

BIG NEW PLUS!
get the details

If you now own a PHOTOFACT Library, you can apply for membership in the powerful new "PEET" program, designed to build prestige and business for the Service Technician who qualifies. Ask your Sams Distributor for the "PEET" details, or mail coupon today!

HOWARD W. SAMS & CO., INC.
1728 E. 38th St., Indianapolis 6, Ind.

Send me full details on the new "PEET" Program. Include full information on the Easy-Buy Plan and Free File Cabinet deal.

I'm a Service Technician full-time; part-time

My distributor is _____

Shop Name _____

Attn: _____

Address _____

City _____ Zone _____ State _____

the modern approach to **HI-FI STEREO** servicing



AUDIO SYSTEM ANALYZER "800"

Here is a Complete Audio Laboratory of six instruments in one package! Our engineers have designed the "800" to save your time and to simplify the operational procedure of your shop. We know your time is your most valuable inventory. The "800" Analyzer is equally effective for monaural and stereo servicing problems. Look at the individual services the "800" performs at a fraction of the cost for all six instruments! \$169.95

- it's an AUDIO OUTPUT WATT METER
- it's an AUDIO VTVM
- it's an AUDIO-SIGNAL GENERATOR
- it's an INTERMODULATION DISTORTION METER
- it's a HARMONIC DISTORTION METER
- it's a DB and NOISE METER and it's EASY to use

SEE YOUR PARTS DISTRIBUTOR OR WRITE:

WINSTON ELECTRONICS



4000 N. W. 28th STREET • MIAMI, FLORIDA

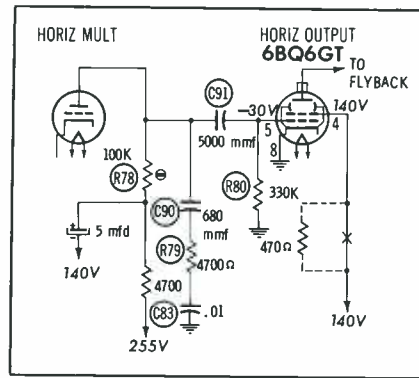

If substituting for these parts doesn't solve the problem, forget your VTVM and grab your scope to trace the defect to its source. Review the series, "Tough-Dog Sync Troubles," in the February through April issues for advice in analyzing this type of symptom.

Overdrive

I have a Motorola Model 21T4AC with a bright line from top to bottom through the center of the screen. Waveforms, voltages, and components have been checked, and I give up. The line disappears if a substitute input signal is applied to the flyback, but not if a signal is injected at the output-tube grid.

F. B. GUTHRIE

Drexel Hill, Pa.

Sounds like a drive line. Its normal cause is an overdriven horizontal output-tube grid, providing excessive DC bias. The result is a rough transition between damper and horizontal output-tube conduction near the middle of each horizontal sweep cycle. This momentarily slows the scan and produces the bright line.

Be very critical of all components and voltages in the accompanying schematic. Substitute in question, rather than depending on a checker. Note that some versions use 120K ohms for R78; also, a revision in later production changed R79 to 6800 ohms to reduce foldover. Make certain the output-tube cathode is properly grounded, and scope the screen grid to be sure the supply voltage is properly filtered. Try connecting the 470-ohm resistor in the screen circuit if not already installed.

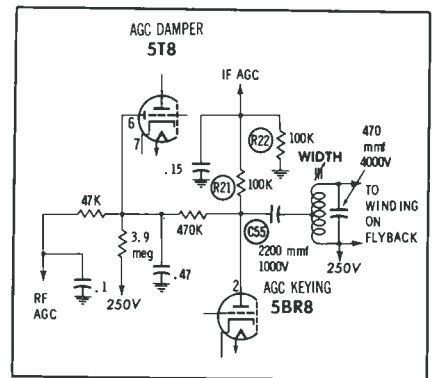

Why Plus?

I've got an RCA TV Chassis 5377 with 250 volts on the grid of the first IF. The set is drawing excessive current, but I can't pin down the cause.

RUSSELL FREESTONE

Glasgow, Mont.

I'd bet on C55, which couples the keying pulses from the horizontal output circuit to the plate of the AGC tube. If this capacitor became shorted, at least 250 volts would appear on the AGC line. Since you say the first-IF grid voltage is a full 250 volts, and not some lower value, I have an idea that R22 has become open or greatly increased in resistance. Other AGC-circuit components may also have been damaged—so I'd recommend a thorough analysis of voltages and resistances on and around the AGC network.



TEST ADAPT
MODEL UT450

Fits ALL 110° RCA type picture tubes

Fits ALL 110° Sylvania type picture tubes

Selects ALL picture tube filament voltages: 2.35, 2.68, 6.3 and 8.4

Selects individual color guns for ALL color picture tubes

Fits duo-decal socket of ALL CRT test instruments

Socket on back fits ALL color picture tubes

all THIS IN ONE UNIT FOR \$12.95 ONLY...\$12.95 DLR. NT.



WRITE FOR FURTHER INFORMATION

ANTRONIC CORPORATION
2712 WEST MONTROSE CHICAGO
DESIGNERS AND MANUFACTURERS
anchor ELECTRONIC PRODUCTS

PHONE ED 9-9653

\$7.50

plus parts, C.O.D. and postage charges

Precision Tuner Service

ALL TYPES T.V. TUNERS REPAIRED AND ALIGNED TO FACTORY SPECIFICATIONS ON CRYSTAL-CONTROLLED SWEEP GENERATORS
24-HOUR SERVICE ON MOST TUNERS
UHF - VHF COMBINATIONS — \$13.50

See your local distributor or send to:

P.O. Box 272, 601 N. College
BLOOMINGTON, INDIANA

State make and model. Send all parts, tubes and shields

Partial Cure Kills

An Admiral Chassis 24D1 has a severe case of horizontal jitters. I've found a bad output filter in the power supply, but when I replace it I lose all brightness. Can you give me a lead to the trouble?

CHELICIE HOSKINSON

West Hamlin, W. Va.

Here's a good case of multiple problems. Since you've discovered the bad filter, replace it with one of correct rating. Apparently, the restored B+ is killing the horizontal oscillator. This sounds like AFC trouble—so remove the AFC tube to see if the raster is restored. You'll probably find that the increased B+ voltage is causing the AFC to disable the oscillator as a result of a leaky capacitor. Checking the AFC and oscillator circuits with a VTVM and scope should lead to the solution of the remaining problem.

Organ to Juke

I want to connect a Lowrey Model LS organ to a Wurlitzer Model 50 juke-box amplifier. Making the connection from the output jack of the organ won't work. Can you give me advice about the hookup, and can I use the juke-box speaker?

JOHN J. ZEDER

Williamsville, N. Y.

The signal at the organ's output jack is strong enough to drive an external speaker, so you're overdriving the amplifier. An output taken from pin 1 of the socket going to the "swell" pedal will give you better results, but the amplifier still may distort the signal because of its uneven response. The juke-box speaker should work all right with the amplifier; however, you might do better to disconnect it and attach it directly to the output jack of the organ.

Converts With Ease

I have an RCA Chassis KCS47C I want to convert into a 21" set. A composite video signal of 100 volts peak to peak is available to drive the new tube. I'm figuring on using a 21FP4C to replace the 17CP4. Mechanics of the conversion offer no problem. Do you have any suggestions in regard to circuit changes?

TALMAGE ALLEN

Los Angeles, Calif.

Deflection angle is the same; you have plenty of signal (72 volts of bias will produce visual cutoff on the 21FP4C); you'll increase the high voltage when you ground the outer coating of the new tube; so you have a clear track for this conversion.

The only unsolved problem is to pick up a focusing voltage somewhere to connect to pin 6 of the new tube. Experiment with applying various voltages from either ground or B+ to find which gives best results. Caution! DON'T use boost voltage to focus this tube.

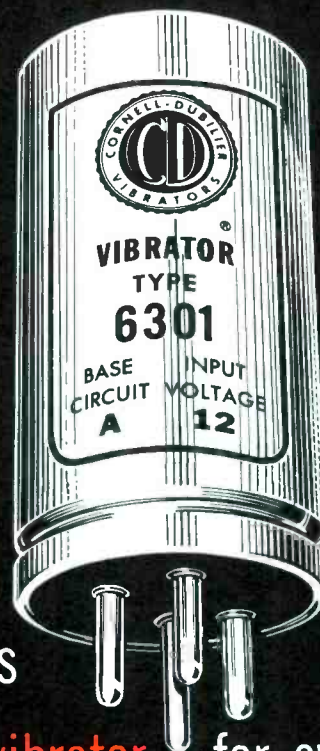

there's
a C-D vibrator for every
make and model
car

The C-D brand name on a vibrator is your guarantee of dependable performance, long trouble-free service. Because C-D vibrators are built to last, you can use them with full confidence. That's why it pays to reach for a C-D when a vibrator replacement is called for.

Remember, too, that there's a C-D vibrator type for every make and model car on the road. And the C-D VIBRATOR REPLACEMENT GUIDE makes it quick and easy for you to select the exact type required. Ask your local C-D distributor for a free copy of VIB-3, or write to Cornell-Dubilier Electric Corp., S. Plainfield, N. J.



CORNELL-DUBILIER ELECTRIC CORPORATION
Affiliated with Federal Pacific Electric Company

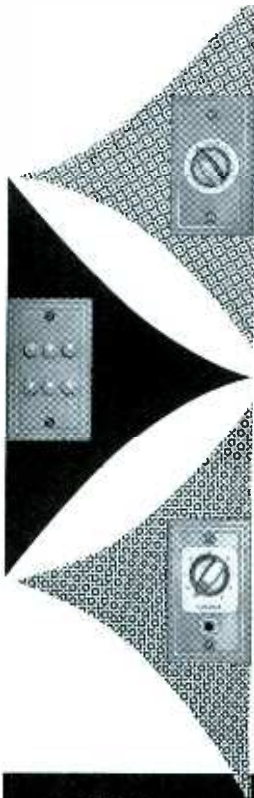

NEW! NOW!

MOSLEY Hi-Fi Accessories

Cash in on Hi-Fi and Stereo accessory sales with Mosley audio accessories. Long identified as the producer of premium quality television antenna accessories, Mosley now offers a full line of speaker switches, attenuator plates and speaker wall outlets.

A ready-made and profitable market for you through Mosley advertising in leading high fidelity and electronic enthusiast magazines.

Ask your Mosley Distributor for full details or write

Mosley Electronics, Inc.

"The
Deluxe
Touch"

4610 N. Lindbergh Blvd. • Bridgeton, Missouri

DON'T GUESS...

KNOW THE TEMPERATURE OF YOUR SOLDERING GUN BEFORE TOUCHING PRINTED CIRCUITS AND LAMINATED WIRING BOARDS!



ESICO GUNCHOKE®

REDUCES TEMPERATURE OF YOUR SOLDERING GUN TO TWO CONSTANT HEATS - 500° OR 600°

- Assures correct temperature for soldering printed circuits and laminated wiring boards.
- No need to wait for a slow-heating iron — and still have doubtful temperature.
- Just plug into GUNCHOKE and GUNCHOKE into outlet.
- Small, compact, to fit in your tool kit.

FOR ALL WIDELY USED GUNS
Get GUNCHOKE from your distributor



ESICO

LUGER GUN

Perfect balance permits delicate touch for most intricate work. Transformer built in handle eliminates tip heaviness. Long, thin tips simplify soldering connections inaccessible with other guns. LUGER is 150-watt capacity.

ELECTRIC SOLDERING IRON CO., INC.
560 W. Elm Street DEEP RIVER, CONN.



"You're a very lucky parent, Mrs. Filstrup. I've located your JENSEN CARTRIDGE!"

G.E.'s 10 Year Olds

(Continued from page 29)

sets; instead, it adjusts the RF-IF gain by varying the AGC bias voltage. The control range is relatively small, and AGC is never completely removed from the controlled stages.

Fig. 2, a schematic of the contrast-control circuit, shows that the lower end of this control is connected to the grid of the sync separator. At first, it might appear that the separator is receiving bias voltage from the AGC circuit, but just the opposite is true; the AGC voltage is being partially derived from the separator grid voltage. The contrast-control circuit forms part of the grid-leak resistance in the sync-separator stage; therefore, a negative DC voltage—which increases in direct proportion to the strength of the sync-input signal—appears at the "lower" end of the contrast control. At the same time, operation of the video detector generates a negative DC voltage across the detector-load resistor, also in direct proportion to input-signal strength. This detector voltage adds to the voltage generated by the sync separator; however, the signals which produce these two aiding DC voltages are opposite in polarity. (The sync pulses are negative-going in the video-detector output signal, but positive-going in the separator-input signal.) Consequently, the signals' AC components tend to cancel each other, while the DC components reinforce each other—and a minimum of filtering is required to obtain a pure DC voltage for the AGC line.

A number of other receivers, including G-E's later models, also feature an interconnection between the AGC and sync-separator circuits. However, this network seldom contains a potentiometer.

Is it any wonder that anything which interferes with the satisfactory operation of any video IF, detector, video amplifier or sync stage will produce a chain reaction leading to a pitiful picture? Shorted and gassy tubes are prime suspects when you have this type of trouble. Next in line are leaky bypass and coupling capacitors, resistors that have changed value, and faulty electrolytics, in that order. When resistors in the contrast-control circuit

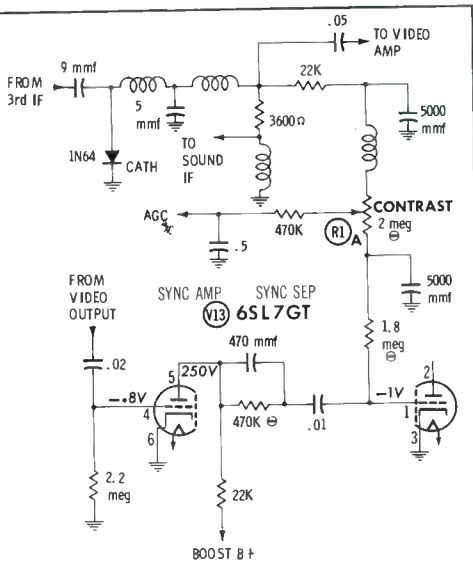

Fig. 2. Contrast control regulates AGC voltage; ties into sync separator.

change value, or leakage develops in one of the AGC filter capacitors, these receivers will overload at normal to high contrast settings and will produce very dark pictures. In addition, sync pulses in the video-output signal may be compressed, as in Fig. 3; if so, the receiver will probably lose either vertical or horizontal sync, or both. Most certainly, the picture will at least be distorted to some extent by horizontal pulling. In this series of receivers, advancing the contrast control should not cause sync compression, except perhaps at the very highest settings.

The best way to check for squashed pulses is to connect your scope through a low-capacitance probe to the grid of the sync amplifier, and then vary the contrast control over its range. If overloading occurs at normal signal levels with RI at a low or medium setting, you definitely have trouble in the stages ahead of the sync amplifier. Otherwise, look to the sync section for the reason behind any synchronization problems you may have.

Sweep-Circuit Features

Looking at the sweep section

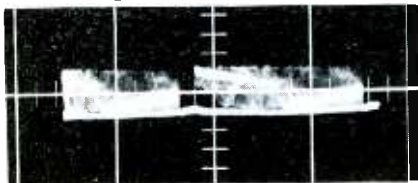

Fig. 3. Sync-pulse compression in video signal (compare with Fig. 1B).

NEW FROM SECO
DYNAMIC TRANSISTOR CHECKER



MODEL 100

DYNAMICALLY CHECKS WIDE RANGE OF TRANSISTOR TYPES EITHER "IN OR OUT" OF CIRCUIT!

This new low-cost checker uses an entirely new approach but a proven DYNAMIC principle for checking transistors. safely tests PNP and NPN transistors either "in or out" of the circuit. Covers wide range of types: small signal including "drift" types, medium power; and power types. Provides positive check for "opens," shorts, and gain—condition indicated by means of a visual indicator plus jacks for meter or scope. Also provides GO-NO-GO test at practical currents—and permits matching of similar transistor types. No set-up required—no further leakage tests necessary. Model 100 is compact, lightweight, complete, and ready-to-use . . . helps you cash-in on the big profits in the fast growing transistorized equipment servicing field!

MODEL 100—Wired and factory tested . . . \$19.95 NET

NEW FROM SECO
LOW COST, COMPLETE TUBE TESTER



MODEL 78

GRID CIRCUIT and TUBE MERIT TESTER

Complete test coverage of all modern TV tube types as well as all heater type radio tubes including hybrid types, using only 5 sockets. Incorporates patented Seco GRID CIRCUIT TEST plus a reliable CATHODE EMISSION test using new low impedance low test voltage circuit—also checks filament continuity and provides open element test. One easy-to-read meter indicates results for both Grid Circuit and Tube Merit Tests. Two-stage dc amplifier isolates meter from tube under test to protect meter—and makes it possible to achieve a wide range of load currents and test conditions. Complete with portable carrying case, pin straighteners, and slip-chart for quick set-up data.

MODEL 78—Wired and factory tested . . . \$69.50 NET



MODEL 107
TUBE
TESTER

outstanding reliability, accuracy

Provides 3 important tests: amplifier types tested for gain by Dynamic Mutual Conductance method—power types tested for cathode current by Cathode Emission method—all types tested for shorts and grid error by Grid Circuit Test developed and patented by Seco. Dynamic Mutual Conductance Test pre-wired to eliminate elaborate set-up. Cathode Emission Test done by free point pin-selector method—will not be obsolete. Completely self-contained in portable carrying case.

MODEL 107—Wired and factory tested \$139.50 NET



MODEL HC-6
IN-CIRCUIT
CURRENT
CHECKER

positive, on-the-spot check of horizontal output current!

This new, low-cost current checker provides simple means for making a positive on-the-spot check of TV horizontal circuits. Can be placed into the circuit in seconds—no unsoldering of circuit wiring—immediately indicates whether horizontal tube cathode current is within manufacturer's recommended limits. Valuable as a fast, accurate indicating device when adjusting horizontal drive and linearity. Eliminates one of the most common causes of callbacks. Compact, inexpensive, easy to use.

MODEL HC-6—Wired and factory tested \$12.95 NET



MODEL GCT-8
GRID CIRCUIT
TESTER

fast check of critical "control grid" conditions

Model GCT-8 checks "control grid" condition of vacuum tubes faster, more accurately than any other tester! As many as eleven simultaneous checks—automatically! Quickly spots grid errors and leakage—stops guessing, substitution checking, and costly rechecks. Electron-Eye tube indicates faults at a glance. Truly portable. The perfect companion to any tester that employs only conventional gas and shorts test. Carry it on all calls.

MODEL GCT-8 Complete kit . . . \$19.95 NET

MODEL GCT-8 Wired and tested . \$29.95 NET

SEND FOR COMPLETE SECO STORY ON . . .

Three Tube Testers

VTVM

Dynamic Transistor Checker

In-Circuit Current Checker

100% Accurate Flyback Checker

Battery Eliminator

SECO **SECO MANUFACTURING CO.**
5015 Penn. Ave. So., Minneapolis, Minn.

NAME _____

ADDRESS _____

CITY _____ ZONE _____ STATE _____

Sold Only Thru Electronics Parts Distributors

OUTSTANDING RELIABILITY—TOP DOLLAR VALUE!

The Modern "PUSH BUTTON" way to protect ELECTRONIC PARTS!



- Prevents corona in high voltage section
- Keeps lead-in connections tight
- Prevents rusting and pitting of antenna
- Goes on in seconds—DRIES IN MINUTES



CRYSTAL CLEAR ACRYLIC SPRAY

Protect radio, TV and hi-fi equipment indefinitely against humidity and dust with Krylon Crystal-Clear, the modern "push button" acrylic spray. High dielectric strength, excellent weatherproof qualities. Available at your favorite radio-TV repair shop.

KRYLON, INC., Norristown, Pa.

Paint touch-up work easily, expertly, with Krylon Spray Paints—choice of 24 colors

IF YOU PRIZE IT...KRYLON-IZE IT!

(Fig. 4), we find that the vertical output tube also acts as one section of the vertical multivibrator. Some of us will remember the perplexity we felt a number of years ago when we first encountered this type of circuit, but it has become too commonplace by now to excite much comment. The most surprising feature of this old G-E circuit, to the eyes of today's technicians, is the use of a 12AU7 as a vertical output tube. Hardly considered a power amplifier by ordinary standards, this dual triode has both its sections connected in parallel to supply sufficient current for producing vertical sweep.

The vertical retrace-blanking circuit of G-E's '50 and '51 sets is unusual, to say the least. The positive "kickback" pulses present at the top of the vertical output transformer are applied to a vertical blanking amplifier (half of a 12SN7GT in Fig. 4) which inverts them. The resulting negative-pulse signal is fed to the accelerating anode of the picture tube in order to cut off beam current during vertical retrace time.

In the horizontal sweep section (not shown), you'll find a sine-wave oscillator circuit controlled by a dual-diode phase detector through a reactance tube. This layout appears strange after years of seeing little else but *Synchroguide* and multivibrator-type horizontal oscillators; however, it is almost a direct ancestor of the up-to-date Zenith circuit described in the July, 1959 *Servicing New Designs* column.

The sound circuits give a telltale clue to the age of this G-E chassis series. Did it ever occur to you

"Eliminates Soldering"

PERFECT *Audio*

"PIN-PLUG" CRIMPER

SLIP WIRE IN "PIN-PLUG,"
INSERT IN TOOL, AND SQUEEZE
...JOB IS DONE.



U. S. Pat. 2,878,698
Canadian Pat. 592,702

USE END OF TOOL TO
PUSH ON GROUND CONNECTOR

Useful in making hi-fi, audio and sound, radio, phono, and TV equipment connections.

only **\$1.25**

C-rings 1c each

Get the tool that makes solid electrical pin-plug connections without soldering or destroying pin form. Use one end for pin crimping, the other to push on C-ring clamp for braided-shield ground connection. Nothing like it anywhere.

3 models: PT-1 for 3/32" pin diameter; AU-2 for 1/8" pin diameter and installing C rings; LC-3 for 5/32" pin diameter.

Available at your parts distributor.

Another fine product from:

BERNS

Mfg. Co.

9853 Chalmers,
Detroit 13, Mich

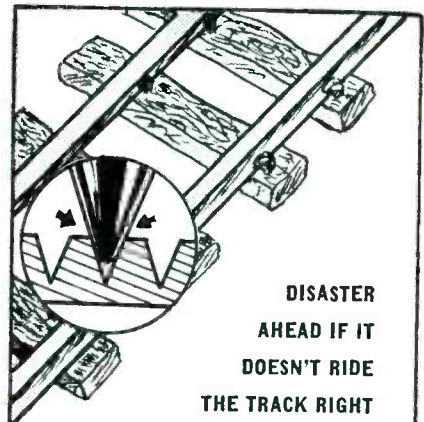

Perfect smoothness and very close tolerance in the radius of a phonograph needle is absolutely essential for a stereo or hi-fi record track. A tip too big or too small invites musical disaster. Many needles vary as much as $\pm .0007$ from the perfect radius. The hand constructed Duotone Needle, hand set, hand polished and microscope-inspected, guarantees you no more than $\pm .0001$ deviation in the radius to insure the closest tolerance and safety.

DUOTONE

DIAMOND NEEDLE

Keyport, New Jersey

In Canada: Chas. W. Pointon, Ltd., Toronto

TV TUNERS REBUILT

ALL MAKES & MODELS VHF OR UHF

EXCHANGED OR REPAIRED **\$8.95**

COMBINATION UHF/VHF UNITS **\$19.90**

Price includes labor and minor parts only, defective tubes and damaged major parts are extra at net prices.

Forward tuner complete with tubes, shield cover and any damaged parts. Quote make and model.

Include \$8.95 plus 95c handling and return transportation or include 25% deposit and we will ship C.O.D.

GLENN R. UERTZ CO.

TUNER DEPT. PF

28 AUBURN AVE., UTICA, N. Y.

PHONE — RE. 5-8726

"SERVICE-ENGINEERED"

TEST EQUIPMENT

helps you make more profit



All Jackson test equipment is "Service-Engineered" for service work. It is designed to give you the accuracy you need, combined with speedy, profitable operation. That's why smart servicemen are switching to Jackson. Your distributor will be glad to demonstrate Jackson equipment to you to prove the point.

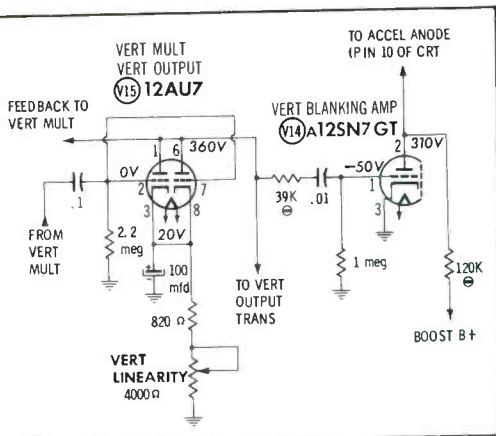

Fig. 4. Vertical blanking pulses are amplified and fed to pin 10 of CRT.

that proper focusing of the picture might be dependent upon audio-output tube conduction? Take a good look at Fig. 5, and note that the magnetic focus coil and its control are connected in the cathode circuit of the audio output stage. Therefore, a decrease in cathode current will cause not only blurred sound, but also a blurred picture.

Early Series String

TV sets with series-connected tube filaments and no power transformer are commonplace today, but they were the exception to the rule a decade ago. At that time, tubes especially designed for TV series-string applications (with 600-ma filaments having controlled warm-up time) were not yet available; so G-E used two paralleled strings of 300-ma tubes (Fig. 6) in their early receivers. This explains why about half of the tubes in the set will go dark whenever one tube burns out. The picture tube, which requires 600 ma of filament current, is the only tube common to both strings.

Although not equipped with an isolation transformer of any kind, this G-E chassis does not fall strict-

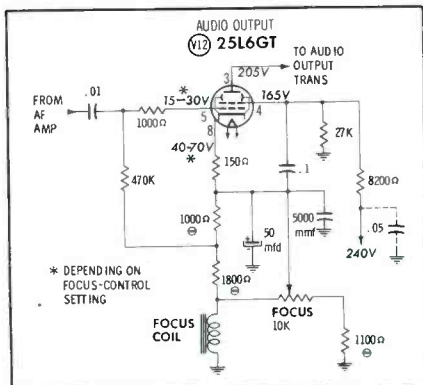
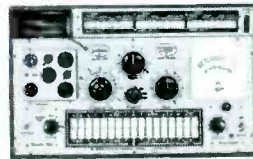
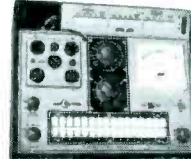

Fig. 5. Cathode current of audio output tube passes through focus coil.

DYNAMIC® TUBE TESTING



Model 658—Finest service tube tester made. Makes more tests, more accurately and faster.



Model 648R—Combines sequence switching with time-proved Jackson Dynamic testing technique.



Model 598—Low cost Dynamic circuit with convenient Lever Switching. Many features.

Power Chart Available for Any of These Tube Testers

ALIGNMENT



Model TVG-2—Combination Sweep-Marker Generator for TV or FM servicing.



Model CRO-2—Finest service 'scope made. Wide band and high sensitivity. Flat to 4.5 MC.

TEST AND MEASURING



Model 590—Accurate 7" VTVM. Fast warm-up. Measures AC and DC Volts and Ohms.



Model 591—Wide Range Capacitance Checker. Checks capacity from 10 uuf to 1000 uf.



Model 655—Wide Range Audio Oscillator. Sine wave output 20 cycles to 200,000 cycles.

See your distributor or write: **THE JACKSON ELECTRICAL INSTRUMENT COMPANY**

124 McDonough Street, Dayton 2, Ohio

In Canada: The Canadian Marconi Co.



ly into the "hot" category. The low side of the AC line is connected to a common or B-minus network, which is isolated from the metal chassis by resistors and capacitors. Nevertheless, since B-minus must serve as a ground point for test equipment, you need to classify the old G-E as a "hot" set for servicing purposes. I strongly recommend an isolation transformer between you and oblivion.

The location of the on-off switch in the low side of the AC input circuit presents an added hazard. If the AC power cord is plugged in

so that the ungrounded side of the power line is connected to the thermal cutout, there will be no difference in potential between B-minus and earth ground—as long as the on-off switch is closed! But if you cut the power off and *then* measure between B-minus and an external ground with an AC voltmeter, you will find 117 deadly volts on the B-minus network. Reversing the line plug in the wall socket doesn't solve the problem; this protects you while the set is turned off, but places 117 volts AC on the B-minus wiring when the set is on.

Now . . .

Planet offers you
exact replacement
Twist Prong Can
Capacitors in both
Solder Lug and
Printed Board
Construction

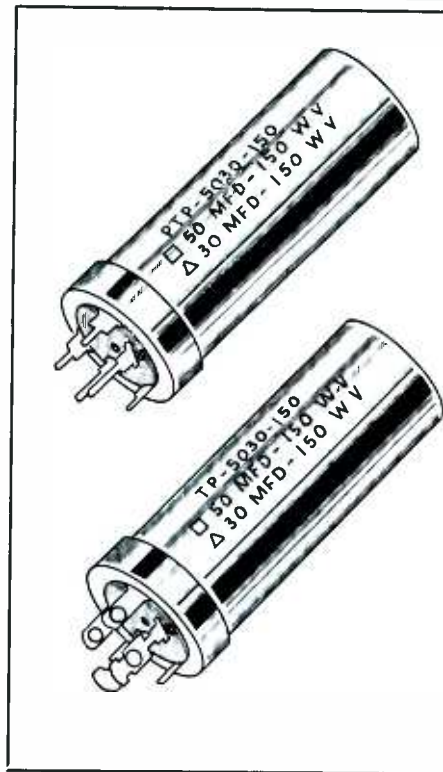

Planet Twist Prong Can Electrolytics are the choice of many top TV and electronic equipment makers. These firms use Planet "TP's" because of uniform quality, workmanlike construction and freedom from field troubles. Now Planet is making these same values and sizes available to you, the men who service this equipment. Ask for Planet "TP's" by name at your parts distributor.

We will send you our catalog listing upon request.

PLANET SALES CORPORATION

BLOOMFIELD, NEW JERSEY

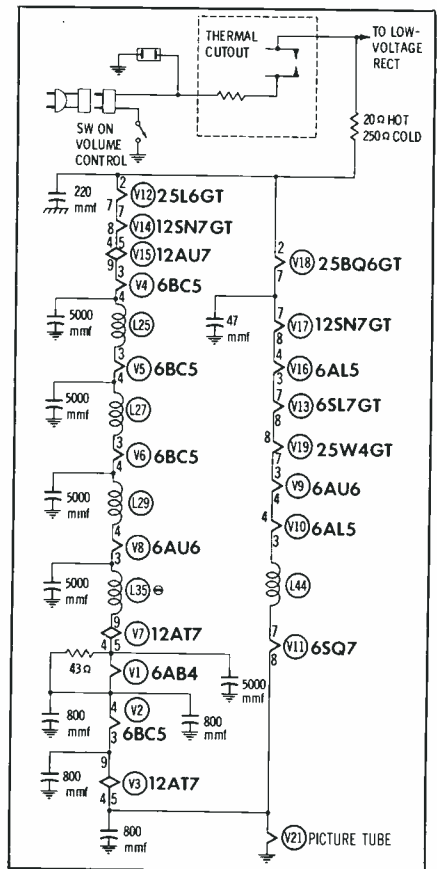

Fig. 6. Guide to series-parallel filament circuit of early G-E TV receivers.

Another reminder: Don't absent-mindedly clip the ground leads of your test instruments to chassis, or you will pick up enough hum to make measurements meaningless. Fig. 7 shows the sad results of attempting to view a waveform with the ground lead isolated from B-minus.

The low-voltage power supply of these receivers uses two selenium rectifiers in an entirely conventional half-wave voltage-doubler circuit. The bimetallic thermal cutout in series with the input lead is a type of circuit breaker which serves the same protective function as a fusible resistor, and also protects the filament circuit. If it opens, you can reset it by pressing a red button on the rear of the chassis. Resetting should be delayed at least several seconds, to allow the metal elements to cool.

As insurance against future complaints of hum or picture bending, check the low-voltage power supply for adequate filtering as well as normal DC output voltage. The scope waveform across the input filter capacitor should measure no more than approximately 25 volts peak to peak, as shown in Fig. 8A. Only

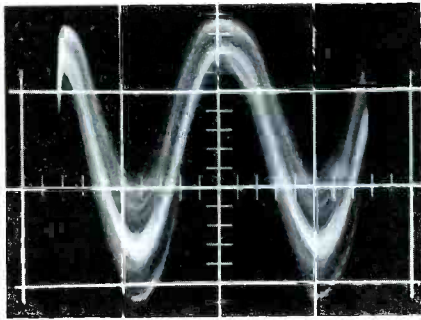

Fig. 7. Severe hum distorts waveform when scope is grounded to chassis.

about 1.5 volts of ripple should be seen at the positive terminal of the output capacitor (Fig. 8B).

Service Calls

A frequent complaint from owners of old G-E receivers is, "The set's dead," since a burned-out tube in the right-hand series string (Fig. 6) will disable both high voltage and sound. An open condition in the other series string will also result in loss of sound, and the raster will collapse to a bright line because vertical sweep will be disabled.

If all tubes are lit, and you don't have a tube checker, voltmeter, filament-dropping resistor, and a pair of selenium rectifiers with you on the home call, you can figure on a shop job. Once you have the set on the bench, go to work with the aid of the troubleshooting chart, your scope, and your voltmeter. Take a little extra time to do the job right; the results will be delightful. These receivers can still give darned good pictures. ▲

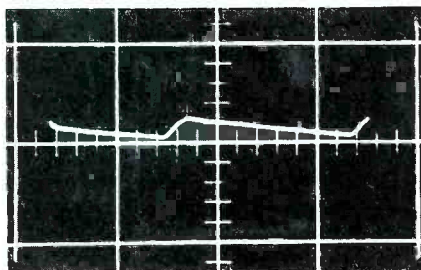

(A) Across input filter; 25V p-p.

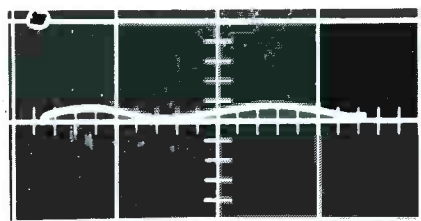

(B) Across output filter; 1.5V p-p.

Fig. 8. Normal power-supply ripple.

A TUBE TESTER FOR EVERY PURPOSE

Here's how easy it is to test all tube types with a **MERCURY TUBE TESTER** — completely, accurately — **IN JUST SECONDS**
**JUST SET FILAMENT AND LOAD CONTROLS...INSERT TUBE...
 PRESS QUALITY BUTTON AND READ EMISSION ON METER**

IMPORTANT! Mercury Tube Testers positively cannot become obsolete as they are engineered to accommodate all new tube types as introduced. New tube listings are furnished periodically to all registered owners.

Model 101 Portable Tube Tester THE SPEED AND ACCURACY OF A MULTIPLE SOCKET TUBE TESTER AT A FABULOUSLY LOW PRICE

Checks emission of over 700 tube types... Checks inter-element shorts, leakage and gas content... Checks all sections of multi-purpose tubes... Housed in sturdy gray hammertone steel case... Handy tube chart contained in special back compartment...
 Size, 9 x 8½ x 2¾".
 Model 101 **\$39⁹⁵**
 Dealer Net...



Model 102-P Portable Tube Tester A DELUXE TESTER AT A SENSIBLE PRICE

Checks emission of over 700 tube types... Checks inter-element shorts, leakage and gas content... Checks all sections of multi-purpose tubes... Checks diodes, filament and external continuity, power rectifiers, pilot lamps, auto and TV fuses... Housed in handsome oak carrying case with compartment for all test leads... Size, 11¼ x 12 x 4½".

Model 102-P **\$59⁵⁰**
 Dealer Net...

Model 102-C Caddy Tube Tester A TUBE TESTER AND TUBE CADDY 'ALL IN ONE'

Includes the specifications of the Model 102-P above... Tester fits securely on guiders but can easily be removed... Tube caddy will hold over 125 tubes... Convenient drawer stores tools and test leads. Size, 9¾ x 16 x 13⅞".

Model 102-C **\$74⁵⁰**
 Dealer Net...

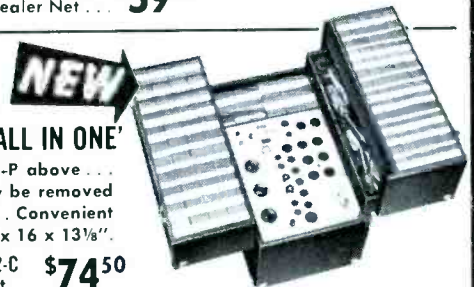

Model AD-1 CRT Adapter available... makes Mercury Tube Testers highly accurate picture tube testers of all black and white picture tubes (including the new **\$3⁹⁵** short neck 110 degree RCA type) for emission, shorts and gas content. Dealer Net...

Model 201 Self-Service Tube Tester A VALUABLE MONEY-MAKING ASSISTANT IN YOUR SHOP

Checks quality (emission, shorts and gas) of over 800 tube types... Checks each section of multi-purpose tubes... Tests all 6 and 12 volt standard auto radio vibrators... Handy push button fuse can be reset manually—never needs replacement... Tube compartment with own lock holds over 400 tubes... Tube storage drawers with tube carton dividers and drawer sheets provide for automatic inventory control... Etched aluminum panel always retains its handsome appearance... Takes only 19" x 19" of floor space. Stands 6'1" high... Illuminated colorful plastic display tops the cabinet... Colorful window streamers supplied with each tester to attract customers.

Model 201-F (Floor Model) **\$158⁵⁰**
 Dealer Net...

Model 201-C (Counter Model) **\$109⁵⁰**
 Dealer Net...



SEE YOUR LOCAL ELECTRONICS PARTS DISTRIBUTOR



ELECTRONICS CORP.
 manufacturers of quality electronic products

77 Searing Ave., Mineola, N. Y.

Tube Changing

(Continued from page 26)

arity controls are likely to have been adjusted to compensate for a weak oscillator or output tube, replacement of either of these tubes may call for resetting both controls. Before proceeding with final adjustment, it is my usual practice to turn both these controls to minimum as a check on vertical centering. The black areas above and below the resulting vertical scan line should be equal if centering is correct. Recenter the line vertically, if necessary, before adjusting the size

and linearity controls to fill the screen.

The size (height) control is most often located in the plate circuit of the vertical oscillator, where it can most effectively regulate the amplitude of the drive signal fed to the grid of the vertical output tube. Replacing the oscillator tube may increase the peak-to-peak value of the sawtooth signal, and installing a new output tube will generally result in more deflection for a given drive-signal amplitude. As a rule, then, the height setting must be slightly reduced after replacement

of either tube.

Don't worry about faulty linearity until after the height control has been reset, since reducing the height to a near-normal level may automatically restore good linearity. The simplified diagrams in Fig. 2 show why this is so. For the purpose of this illustration, we will assume that linear plate current in the output tube will result in linear yoke current. With excessive drive-signal strength (Fig. 2A), negative swings of the signal bring the output-tube grid voltage to (or beyond) cutoff. The negative peaks of the plate-current signal waveform are then flattened, and the top portion of the raster is compressed. In Fig. 2B, the lower peak-to-peak amplitude of the input signal allows it to appear entirely on the linear portion of the tube's characteristic curve. (In a large percentage of sets, an automatic reduction in grid-leak bias helps this action along.) Consequently, the output-current signal becomes linear. In case the



"Yep! — We gotta get one of those new Oelrich Counter Trays for our forms and a couple of those aluminum holders for our outside men."



#224 TRAY
for #120 form
\$4.40

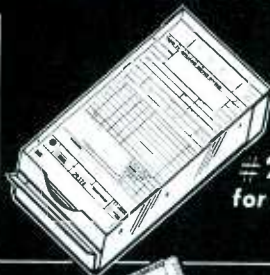

#223 TRAY
for #125 form
\$4.75



#122 HOLDER
for #120 form
\$3.50



#222 HOLDER
for #125 form
\$4.50

AT YOUR PARTS JOBBER NOW!

Yessir! If you, too, are going to get organized tomorrow why not stop in at your parts distributor and ask him to show you the Oelrich Business Items that can help you make more profit, save time, and build valuable customer goodwill. Or send for the FREE Oelrich Catalog and select the items that can help you get started tomorrow.

Succes seldoman accid ent! Star tbuild ding you rstoday!

OELRICH
PUBLICATIONS
4308 Milwaukee Ave.
Chicago 41, Illinois

Please send FREE catalog and name of my distributor

NAME

ADDRESS

CITY

COUNTY

STATE

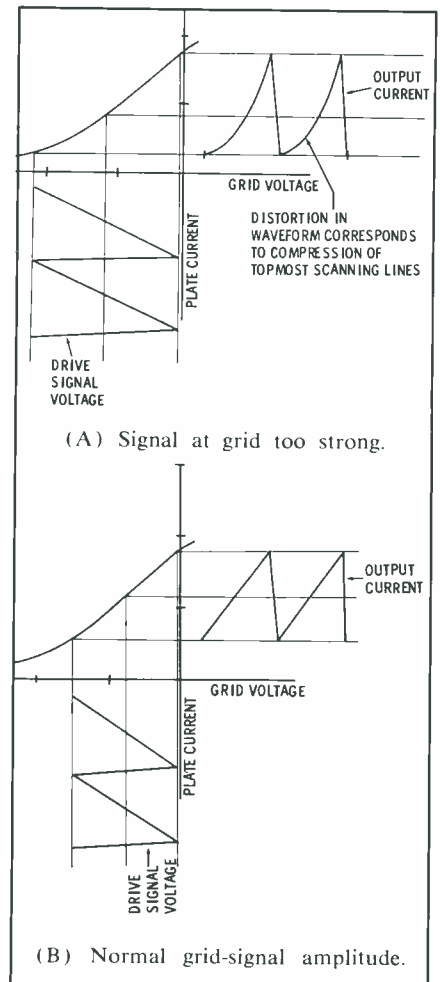

Fig. 2. Excessive drive-signal amplitude tends to compress top of raster.

scanning lines are still unevenly spaced after height has been adjusted, the linearity control must be reset in order to restore the correct operating bias on the output tube. As a final check for proper linearity, set the vertical hold control to produce a "slow roll" condition, and see if the thickness of the vertical blanking bar remains fairly constant as it travels down the screen.

Be sure to check the range of the hold control if the oscillator tube has been replaced. The picture should roll both ways. If it won't, look out for further trouble in the oscillator circuit.

Horizontal Oscillator and Output

The horizontal oscillator tube is generally a dual triode (usually a 6CG7, 6SN7 or 12AU7). Since interelectrode capacitance (including that between tube sections) may vary quite a bit among individual tubes, it is advisable to readjust the oscillator circuit each time the tube is replaced.

This alignment is usually nothing more than a simple touch-up of the horizontal frequency slug, except in some sets that employ a standard type of *Synchroguide* circuit containing two slugs. In the latter case, knowing which slug to turn can be a problem. To avoid an unnecessary trip to the shop, just remember this: Reset *only* the frequency slug, never the waveform slug, unless you have a scope hooked up to the circuit. If you don't know which is which, give each slug one turn and then bring it back to its exact original setting. The one that most noticeably shifts the picture is the frequency slug. Adjust it for proper lock-in at the center of the hold-adjustment range.

The horizontal output tube, in spite of its special operating conditions, is still basically a power amplifier. Its primary purpose is to raise the grid signal to a high enough power level for driving the horizontal yoke coils. In any amplifier stage, gain depends on tube Gm, circuit operating voltages, and load impedance. The least constant of all these factors is Gm, which can vary over a great latitude according to the condition of the tube. If you install a "hot" new horizon-

tal output tube in a set to correct for a slight lack of width, you can expect the width trouble to return long before your guarantee period runs out. The Gm decreases slightly during the first 100 hours or so of tube operation, and the tube then settles down to delivering its normal work load for the rest of its useful life. For this reason, you should allow a brand-new horizontal output tube to overscan the CRT screen to a slight degree.

If width, drive, or horizontal linearity controls were previously advanced to make up for a weak

horizontal output tube, it will be necessary to change their settings back to the original level when a new tube is installed. In case a receiver lacks these controls, and a known good horizontal output tube does not provide satisfactory sweep, you have no recourse except to troubleshoot the circuit. Due to the use of grid-leak bias on the output stage, insufficient drive-signal strength results in excessive tube current. This shortens output-tube life and may also contribute to the early demise of the damper tube and output transformer. Therefore,

AVR



the
NEW
PERMA-POWER

Model D-200

Automatic Voltage Regulator

will make you money and save you grief

It's easy to sell. There have been units similar to this on the market before—at prices upwards of \$75.00. The new PERMA-POWER Automatic Voltage Regulator has a list price of \$9.95—so *any* TV set owner can afford it . . . and any customer plagued by picture flutter, shrinking, flop-over, loss of brightness, and other similar disturbances will *want* it.

It's easy to use. This new unit insures top performance of TV sets by *automatically* returning full height and width to pictures when distorted by low line voltage. Whenever the line falls below 110 volts, it *automatically* boosts line voltage 10 volts—and it *automatically* feeds the line direct for normal voltages. *You don't have to worry about the customer's forgetting to switch the voltage regulator when the line is normal; this new PERMA-POWER unit switches automatically!*

It's easy to install. You plug it in, and it's ready to work; goes on and off with TV set. Compact and lightweight, it has no tubes, ballasts, relays, or other moving parts to fail; and it's fully guaranteed for one year. Can be used on any TV set or appliance rated up to 300 watts. See it at your distributor today.

Perma-Power COMPANY

3102 N. ELSTON AVE.
CHICAGO 18, ILLINOIS

it is a general practice to adjust a drive control for maximum signal voltage, and then reduce the signal amplitude just enough to remove any folds or wrinkles from the picture. This results in a condition of minimum circuit current, usually accompanied by acceptable width and linearity.

The drive control is often a small trimmer capacitor connected as shown in Fig. 3. Signalwise, the trimmer is in series with fixed capacitor C2, and the two components form an AC voltage divider. As the trimmer is tightened, its capacitance

increases, and a smaller proportion of the total available signal is applied to the output-tube grid. Caution: Some sets have a *series* trimmer (in place of C2), and tightening this adjustment will cause an *increase* in drive-signal strength. Observe the effect on the raster, or consult service data, to determine which way the trimmer adjustment of a particular set should be turned to obtain greater drive.

A number of receivers have potentiometer-type drive controls. These are usually located in the oscillator plate circuit, and their

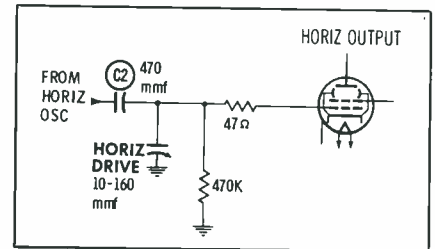

Fig. 3. Drive trimmer forms AC voltage divider with fixed capacitor C2.

effect on the sawtooth signal is comparable to that of the height control in the vertical section. You may also find the term "drive control" applied to a potentiometer that varies the output-tube screen voltage, but this adjustment is more often called a width control.

A more widely-used type of width control is a variable inductor connected across a portion of the flyback transformer to reduce yoke current. When you don't find any width adjustment on the back panel of the receiver, check to see if the flyback has an adjustable core gap, or if a metallic *width sleeve* is inserted into the center hole of the yoke to reduce the strength of the magnetic field surrounding the electron beam.

Many older sets have a horizontal linearity coil connected in series with the damper plate (or cathode) lead. The main function of this variable inductor is to assure a smooth changeover from damper conduction to output-tube conduction during the early part of each horizontal sweep cycle. Replacement of either the damper or output tube may necessitate a touch-up of the linearity adjustment; if in doubt about the correct setting, tune the slug for a compromise between minimum output-tube cathode current and acceptable horizontal linearity.

Since there is considerable current through the linearity coil, it often changes value to such an extent that a linear picture cannot be obtained. The only cure is to replace the defective coil.

Sync Separator and Amplifier

For our present purposes, "amplifier" means any sync tube other than the separator—including clipppers, phase inverters, and noise cancellers. Replacement of tubes in the sync section should naturally be

You have a ready-made market among over 6,000,000 CBS-Ronette cartridges used in American phonographs. One of 27 CBS-Ronette models will make each phonograph sound like new.

These same jeweled-styli cartridges will replace over 500 other models . . . and actually improve the performance of most phonographs.

Ask for the CBS-Ronette Catalog and Cross Reference Chart, PF-285. It makes your job fast, easy, and profitable. Tell your distributor you want CBS-Ronette, the world's most popular quality cartridge.

Exact Replacements for 6,000,000

CBS Ronette CARTRIDGES

ALSO REPLACE
OVER 500 OTHER MODELS

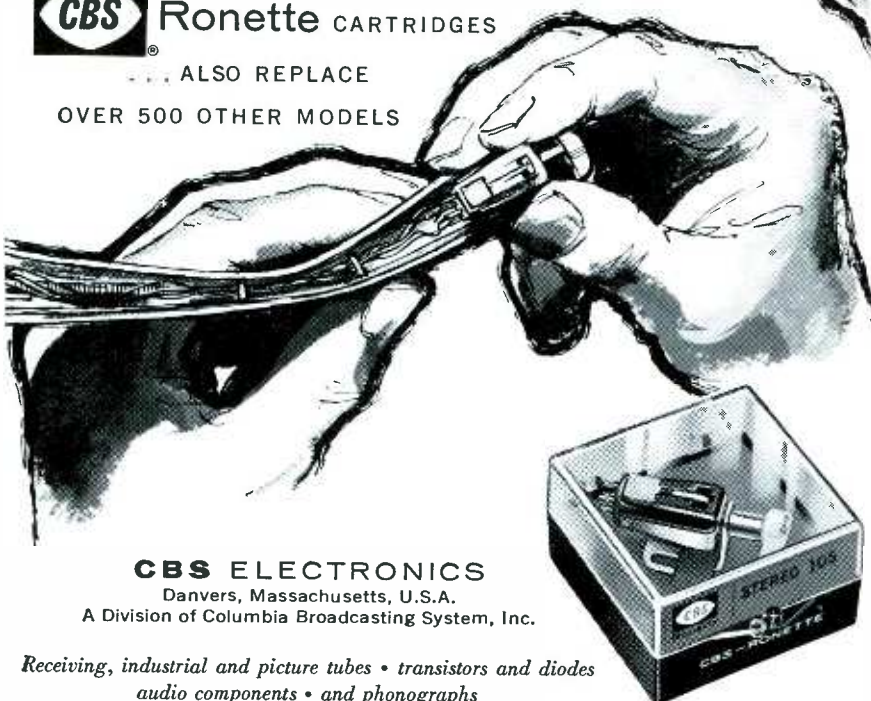

CBS ELECTRONICS

Danvers, Massachusetts, U.S.A.
A Division of Columbia Broadcasting System, Inc.

Receiving, industrial and picture tubes • transistors and diodes
audio components • and phonographs

followed by adjustment of any noise-inverter or similar controls.

The major consideration in adjusting *any* sync control, regardless of its name, is to set the operating point of some stage for maximum sync stability on all received channels. Noise-inverting features come into play only when the noise level approaches the level of the sync signal. For this reason, a noise-inverter control should always be adjusted on the weakest or most noise-influenced station received in your area. The general practice is to preset the control to its farthest counterclockwise position, and then to turn it clockwise until the picture just begins to be unstable. The control is then backed off until a steady picture is restored. Following this, the picture from the strongest station should be checked for stability, and the sync control turned farther counterclockwise if necessary to insure good lock-in on all received channels.

New sync tubes often mean a boost in sync amplitude. This could cause the horizontal oscillator to shift frequency enough to affect the range of the horizontal hold control; therefore, be sure to check this control's action, and readjust the horizontal-frequency slug if required. A check of vertical-hold range is also a good preventive measure. Perhaps the vertical oscillator is on the verge of drifting off frequency, and the customer won't be able to distinguish this trouble from the sync trouble you just finished repairing. Whenever a vertical oscillator circuit seems overly critical to adjust, replacing the oscillator tube could save you from making a free callback.

Sound IF and Detector

Tubes used in these stages may vary enough in internal capacitance to cause mild detuning. A slight touch-up of alignment may be the difference between clean sound and an irritating trace of buzz. Gated-beam (6BN6) and locked-oscillator (6DT6) detectors, along with their associated sound IF's, can often be repeaked in the home by using regular station signals as an indicator. For accurate results, the signal strength must be held down to an extremely low level (except in the

JERROLD

MF-2

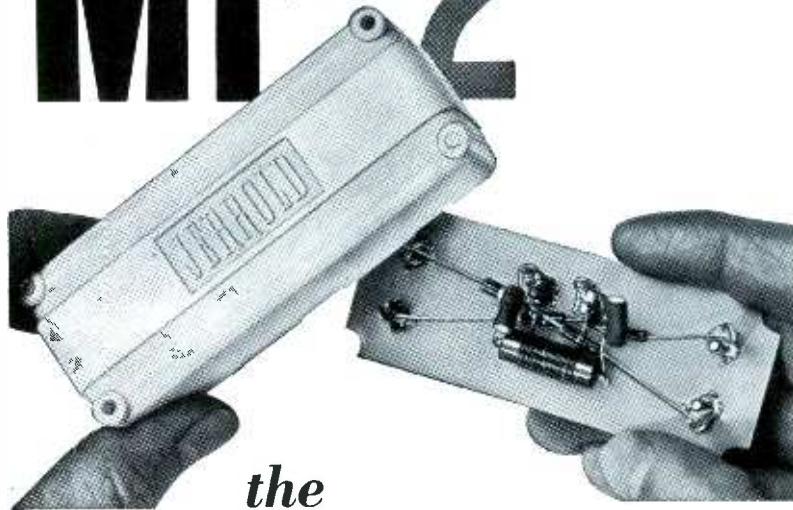

the
2 Set Coupler with GUTS...
now has
TEETH!



The famous MF-2 TV-FM Coupler with its specially engineered circuitry making it the first choice of servicemen everywhere, now requires no wire stripping!

Features Include • Extremely low forward loss • Positive matching • Complete isolation between receivers • Isolates AC from antenna • No twin-lead stripping • Permanent connections • Universal mounting • Attractive unbreakable case.

**Mounts
anywhere**

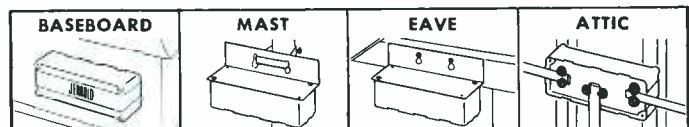

Two additional models available — the M-2 (recommended for UHF). The MF-4 (for 3 or 4 TV-FM sets fed from single antenna).

JERROLD

Order from your Jerrold distributor or write
ELECTRONICS CORPORATION, Distributor Sales Division
 Dept. IDS-20 The Jerrold Building, Philadelphia 32, Pa.

Jerrold Electronics (Canada) Ltd., Toronto

Export Representative: CBS International, N. Y. 22, N. Y.

quadrature-coil circuit of the 6DT6, where a strong signal is needed for proper adjustment). Each slug is tuned for maximum audio with minimum hiss and buzz. In the 6BN6 circuit, don't forget the rear-panel *buzz control*, which adjusts the DC bias on the detector tube for optimum limiting and clearest sound.

Ratio-detector and discriminator circuits can also be slightly re-adjusted in the field, but be very careful to turn only the *secondary* slug of the detector transformer. Rotate it no more than one-half

turn in either direction to determine the point of clearest audio. If any more adjustment than this is required, it will be necessary to shop-align the circuit with a signal generator and scope.

Video and AGC Tubes

The sync take-off point is usually on the output side of the video amplifier, so replacement of the video tube is likely to increase the amplitude of the signal applied to the first sync stage. This may create a need for readjustment of the noise-inverter control.

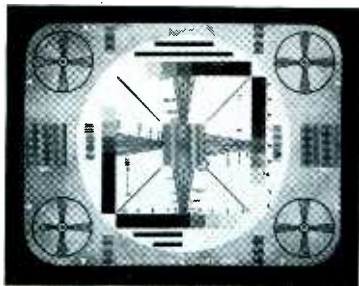

TV TIPS FROM TRIAD

NO. 7 IN A SERIES

SENIOR PTM: "The squawk on this one was that it would operate for several hours, then lose vertical. What puzzled me was that even when it was running it didn't quite fill vertically; and when I cranked up the height and vertical linearity—it started cramping on the bottom. Well, when the raster collapsed I subbed in the big 18:1 from the shelf and it restored the vertical, but the picture was just the same size as before. I could just see the customer's face if I told her that she would have to have a new vertical, plus new rectifiers, filter capacitors, output tube, and coupling; needless to say, I wasn't too happy."

JUNIOR PTM: "What causes that?"

SENIOR PTM: "I expect it's just old age on a set with very little vertical reserve. When B+ drops a little, couplers and bypasses lose a little, the picture shortens up. Since the customer is very sensitive to black area on top and bottom—it has to be fixed."

JUNIOR PTM: "What happened on this one?"

SENIOR PTM: "My sub unit was too big so I ordered one of those new small transformers. After I installed it I suddenly realized I could crank down on lin and still have a better than full picture. The vertical output cooled off a little from the lower plate current, so I was off the hook."

JUNIOR PTM: "It's hard to believe that a little job would do better than a big one."

SENIOR PTM: "Well, seeing is believing, isn't it? I've heard that the Triple-X steel they use in those new transformers makes the difference, and it certainly does."

* * *

MORAL: Triple-X steel will not cure leaky couplers or bad rectifiers, but it can provide an extra reserve to offset component aging. Not all Triad components use Triple-X yet, but the new, small vertical outputs and powers do, and you can find your requirements in TV-60, available from your Triad Distributor or by writing to us. **Triad Transformer Corporation**, 4055 Redwood Avenue, Venice, California.

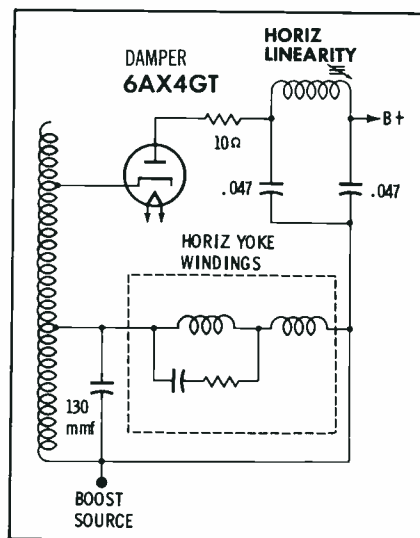

Fig. 4. Typical location of horizontal linearity coil at plate of damper.

The video amplifier also furnishes an input signal to the grid of the keying tube in sets having keyed AGC systems. Therefore, if an AGC level control has been advanced to compensate for a weak video amplifier, inserting a new video tube may cause excessive AGC voltage to be developed. Likewise, replacement of a weak keying tube will probably increase the AGC bias level. Once again, the remedy is to reduce the setting of any AGC control that may be present.

Misadjustment of this control can cause troubles varying from complete "white-out" of the picture to strong overloading. In every case, the AGC control should be adjusted while the set is receiving the strongest available signal. The contrast control should be adjusted to maximum, the fine-tuning control set for best reception, and the AGC control adjusted for as dark a picture as can be obtained without sync buzz in the sound or bends in the image. To provide a margin of safety, back off the control about 1/8 turn from the "best" setting. If turning down the contrast control provides a picture of proper contrast ratio, the AGC adjustment has been correctly set.

When a simple FRINGE-LOCAL switch is employed instead of an AGC potentiometer, customers in some areas will have to be taught how to set the switch for best performance on all channels.

RF and IF Amplifiers

Since the over-all gain of a TV

set is largely dependent on the amplification factor of the IF strip, replacing just one tube in this section can cause a marked rise in gain. If either the AGC or sync adjustments had been reset when bad IF tubes were present, you might end up with overloading or sync instability on strong signals after tube replacement. For your own benefit as well as the customer's, check operating conditions on all channels *in the home* after making any RF, IF, video, AGC, or sync repairs.

The RF amplifier is a primary factor in determining the signal-to-noise ratio of the receiver. Under certain conditions, this tube could furnish plenty of gain but suffer from a very poor noise characteristic. If the sync-stability control had been adjusted with the old tube in use, installing a new RF tube would make it necessary to touch up the sync adjustment.

Oscillator-Mixer Tube

Internal capacitances of different individual tubes vary to such a degree (even in good, new stock) that oscillator tuning is bound to be changed when the oscillator-mixer tube is replaced. This change is more noticeable on high- than on low-band channels. Checking the oscillator slug adjustments (often accessible from front of cabinet) is usually a sufficient corrective measure. On incremental-inductance (switch-type) tuners, don't forget to start with the highest active channel and proceed to lower channels in descending order. In most turret tuners, the order of adjustment doesn't matter.

It is always a good idea to make a mechanical check of tuner condition if you suspect that the set owner, or others of dubious technical background, have been tinkering with the oscillator adjustments. Switch wafers, pivoting contact strips, wafer-type fine-tuning assemblies, and paper coil forms are too delicate to take much punishment, and the average "screwdriver jockey" can completely ruin a tuner before he even knows something is wrong.

A Final Word

A thorough "follow-up" on every

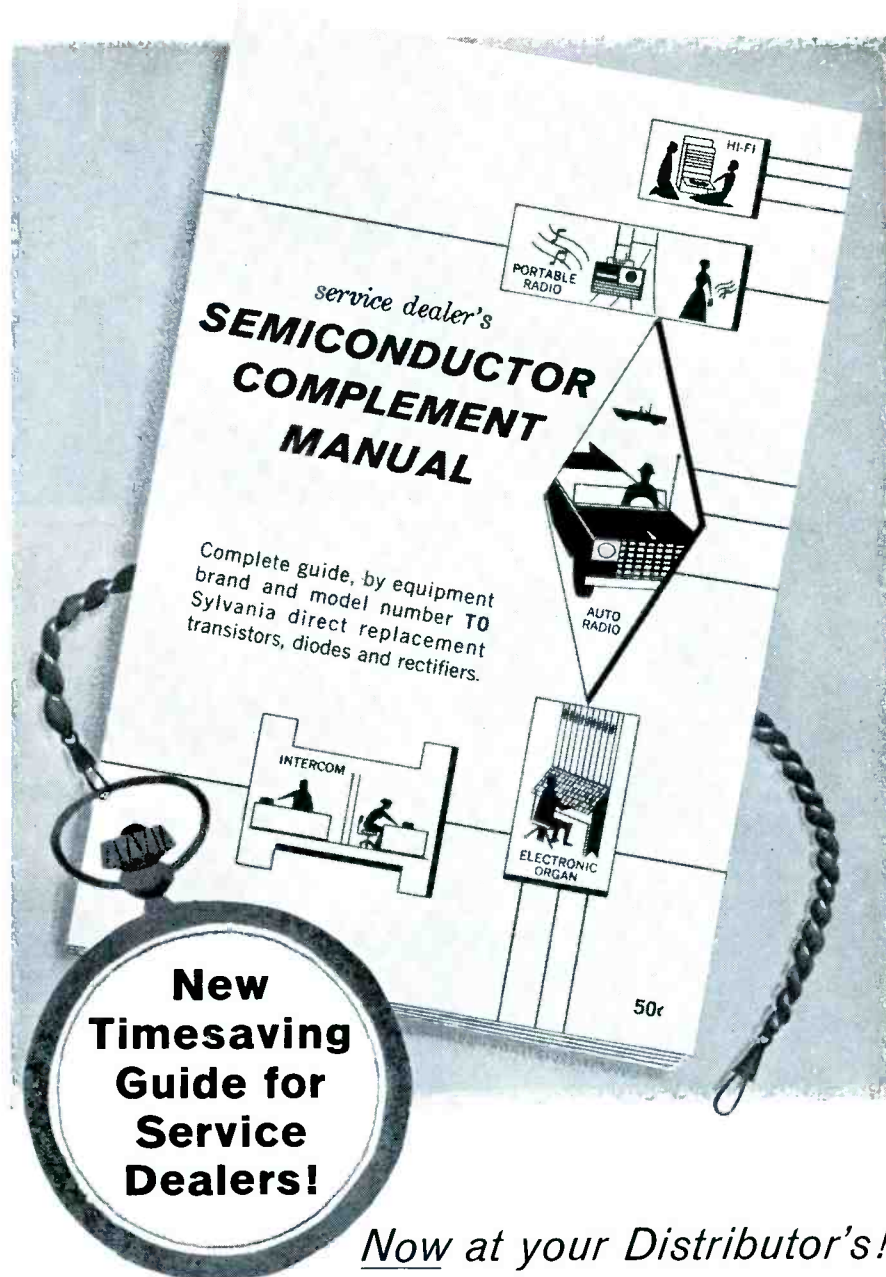

Now at your Distributor's!

A complete guide, by equipment brand and model number, to Sylvania direct replacement transistors and diodes. Interchangeability information is included for rectifiers, too. Gives Sylvania equivalents of foreign transistor-types. Helps you find the right replacement unit . . . *fast!* Get your copy from your SYLVANIA SEMICONDUCTOR DISTRIBUTOR or write Sylvania, P. O. Box 37, Buffalo 9, N. Y. Only 50¢ for this valuable booklet!

Check your semiconductor stock. Fill in with top-quality Sylvania transistors, diodes and rectifiers. Your Sylvania distributor has the best! *Sylvania Semiconductor Division, Woburn, Mass.*

SYLVANIA

Subsidiary of GENERAL TELEPHONE & ELECTRONICS



tube replacement takes a little extra time, but it pays off because it can only help you forge your chain of customer good will.

Handy Gadget

Did you ever wish you had some convenient means of checking phono speed in a customer's home? Here's a "natural" to have in your tube caddy if you're wanting to build your business in the hi-fi and phono fields. It's the *Strobolamp* by Switchcraft. The kit contains a 4¼" disc with dot pattern for checking all four record speeds;



also supplied is a 6' cord with a neon lamp to provide the required light for a stroboscopic test of turntable rpm.

When you use this device on a home call to check your customer's platter-spinner, the "visual-aid" clarity of the demonstration implants in his mind that you're the one to call the next time service is required—even if everything is fine when you make the check.

Packaged in a clear plastic bag, the \$1.95 kit contains operating instructions for the "do-it-yourselfer" — so you can include it in your record-accessory display.

Control Soldering Temperature

If you're the kind of serviceman who prefers to use a soldering gun instead of an iron, but you find the wattage of your present gun unsuitable for printed-board work, you should know about *Gunchoke*. Recently introduced to the market by Electric Soldering Iron Co., Inc. (ESICO) of Deep River, Conn., *Gunchoke* limits gun-tip temperature to a specified maximum.

As shown in the photo, the unit is inserted between the gun's AC plug and the 117-volt outlet. Note the three-prong receptacle, which permits inserting the plug either of two ways to provide a choice of 500° or 600° tip temperature.

Six different *Gunchoke* models are available. W4 is for use with Weller S400 and D440 models and the Wen 288; W5 is designed for Weller's S500 and D550, as well as Wen's 250; the Weller 8100 takes W8; WE1 is for the Wen 199; and Esico's Model "C" Luger gun uses the L1 with all AB tips, or L2 for C tips. ▲

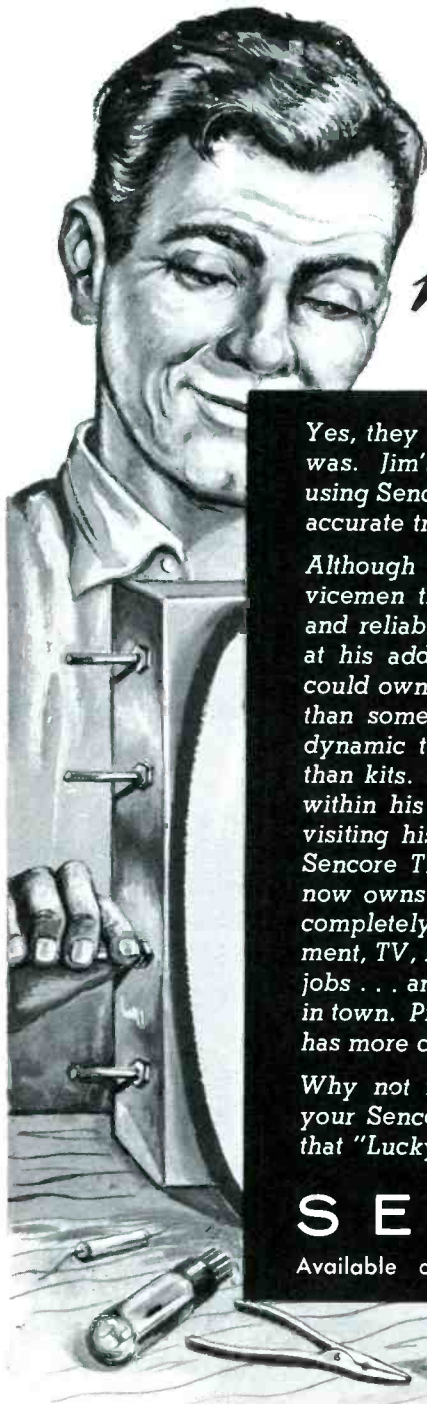
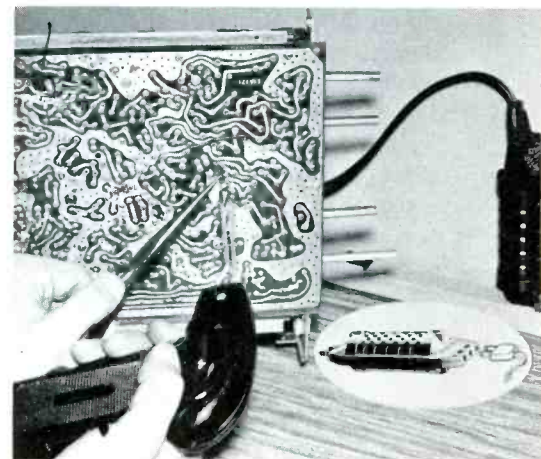

They called him "Lucky"

Yes, they called him "Lucky" . . . and he was. Jim's luck started the day he began using Sencore Time Savers for faster, more accurate trouble shooting.

Although Jim had heard from other servicemen that Sencore units were unique and reliable, he hesitated until a moment at his adding machine told him that he could own the entire Sencore line for less than some other manufacturers offered a dynamic tube tester . . . yes, even less than kits. Now that Jim knew it was well within his budget, he wasted no time in visiting his distributor. Jim bought three Sencore Time Savers that same day and now owns most of the Sencore line. He completely services transistorized equipment, TV, HiFi, radio and even most color jobs . . . and in less time than other shops in town. Profits have jumped and "Lucky" has more customers than he can handle.

Why not follow Jim's example and see your Sencore distributor . . . oh yes, say that "Lucky" sent you.

SENCORE

Available only thru your parts distributor.

Testing Hi-Fi Amplifiers

(Continued from page 33)

It would seem that the response of an amplifier would be adequate if it extended down to just beneath the lowest frequency, or fundamental, of the square wave. But this is not the case. Poor response to lower frequencies causes a shift in the *phase* of the fundamental-frequency component — even though the *amplitude* may remain unchanged. At the same time, the higher harmonics do not undergo this phase shift. The phase relationship between different components of the square wave is thus destroyed, and the waveform is distorted.

As a rule of thumb, adequate response of an amplifier to a square wave generally means the frequency response of that amplifier is linear throughout a range extending from about one-tenth to ten times the fundamental frequency. For example, adequate reproduction of a 400-cps square wave would indicate "flat-topped" amplifier response from about 40 to 4000 cps.

Following this rule, a good idea of an audio amplifier's over-all response can be obtained by applying only two square-wave frequencies to the unit. To be more exact, tests at 200 and 2000 cps serve to check the amplifier over a total frequency range of about 20 to 20,000 cps.

Fig. 2 shows several different types of square-wave distortion which can result from nonlinear frequency characteristics of amplifiers. Fig. 2A shows a practically perfect square-wave output, indicating excellent over-all response. B, C, and D show progressively worse attenuation of low frequencies only. E shows a slight, but not serious, loss of high-frequency response, while F illustrates a serious deficiency in gain at higher audio frequencies. Don't look for absolute perfection during square-wave tests, because

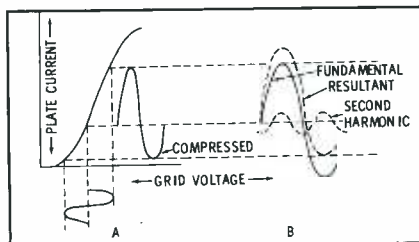

Fig. 5. Output-waveform compression is a symptom of harmonic distortion.

any amplifier — even the best — will show some drop-off in gain at both extremes of the audio spectrum.

One restriction on the use of a square-wave test is its unsuitability for checking equalized preamp stages. Misleading indications are produced because the equalization network is purposely designed to alter the frequency response of a signal applied to it.

Tone-Control Action

The same tests used for measuring frequency response can also be

used to examine tone-control action. The basic setup in Fig. 1 is again employed for these tests, but instead of setting the tone controls at "flat" and checking for level response, the technician seeks to measure the variation in amplifier response as the tone controls are rotated through their full range. Published specifications on the unit under test provide the most reliable indications of what to expect. In most data sheets, the range of tone controls is stated in terms of the maximum boost and attenuation obtainable for two frequencies (one

Transistor Radio Servicing CAN be Highly Profitable



The ONLY Complete Transistor Radio Service Lab
Everything you need for less than \$50



Check Transistors, Diodes, Rectifiers . . .

SENCORE TRC4 TRANSISTOR CHECKER

Accurately checks all transistors in hearing aids, radios and power transistors in auto radios. Tests for opens, shorts, leakage, current gain. Measures forward-reverse current ratio on all crystal diodes. Measures forward and reverse currents on selenium rectifiers. With set-up chart for accurate checking of each transistor. Size, 5x4 1/2 x 2 1/2". With batteries. DEALER NET. 1795



Replace Batteries During Repair . . .

SENCORE PS103 BATTERY ELIMINATOR

All-new "Transi-Pak," twin to TRC4 Checker above. Provides variable DC voltage to 24 volts; 1.5-volt biasing tap (a "must" for servicing Philco and Sylvania radios). Metered current output, to 100 ma. Handles 200-ma peaks. Two 200-mfd electrolytics provide proper filtering and low output impedance. No hum or feedback problems. Ideal for alignment using station signal; adjust IF slugs for max. current, also ideal for charging nickel-cadmium batteries. Size, 5x4 1/2 x 2 1/2". DEALER NET. 1795



Find Defective Stage in a Minute . . .

SENCORE HG104 HARMONIC GENERATOR

New signal generator designed primarily for fast signal-tracing of transistor radio circuits. No need to unsolder all transistors. Provides RF, IF and audio signals *simultaneously*, drastically cutting service time. Traces from speaker to antenna. Clear 1000 cycle note signal is heard in speaker from all good stages. Signal weakens or stops at defective stage. Equally as effective for testing TV, hi-fi and other audio circuits also. Size, 3 1/2 x 4 1/2 x 1 3/4". With batteries. DEALER NET. 995



Turn page for other
SENCORE
Time Savers

See your Parts
Distributor
NOW!

SENCORE
ADDISON 2, ILLINOIS

low, one high). For example, the output-signal level of a certain amplifier at 15,000 cps can be boosted by as much as 15 db or attenuated by 20 db from the "flat" level, for a total range of 35 db. The bass response of the same unit (at 50 cps) can be varied over a 30-db range—from 18 db of boost to 12 db of attenuation. These variations are shown graphically in Fig. 3. Although the actual maximum and minimum db values will vary from one amplifier design to another, the general shape of these curves remains the same. The values given

here are fairly typical of most hi-fi tone control circuits.

To check separate bass and treble controls, 50- and 15,000-cps sine waves are applied in sequence to the input of the amplifier. With the 50-cps signal applied, the audio output is measured at both extremes of the bass-control setting. The treble control is checked using a 15,000-cps input, again measuring the output-signal level at maximum and minimum control settings.

To compare these readings to the published specifications, the voltage

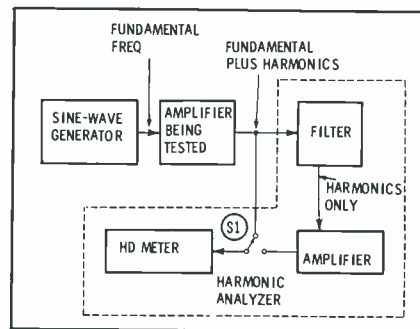

Fig. 6. Test setup for measuring harmonic distortion in an amplifier.

or wattage readings must be converted to decibels (db). If output voltage is being read, the following equation may be used:

$$\text{db} = 20 \log \frac{E_1}{E_2}$$

where E1 is the voltage output at the maximum boost setting (either for bass or treble), and E2 is the voltage at the maximum attenuation setting. If a wattmeter is being used for direct measurement of power output, the equation becomes

$$\text{db} = 10 \log \frac{P_1}{P_2}$$

Output meters employed in hi-fi service work are often equipped with db scales, thus eliminating the need for calculations. While the test results need not correspond exactly to figures in published data, they should be reasonably similar.

Square waves can also be used in checking tone controls, unless an equalization network is associated with the tone-control circuit. This test is performed by injecting a square wave (at about 1000 cps) and adjusting the controls so that a good square wave is visible on the scope. As a rule, the treble control chiefly affects the leading and

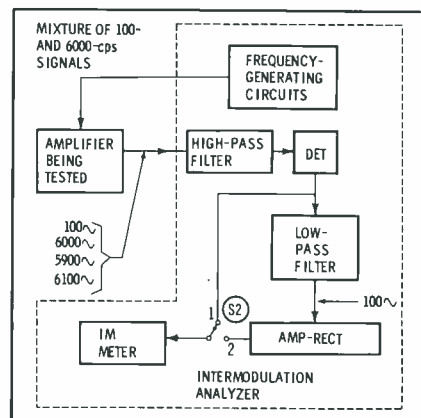

Fig. 7. Intermodulation-distortion analyzer supplies its own test signals.

Servicemen! SAVE TIME...SUBSTITUTE THE SENCORE WAY
The Fastest, Surest Method Known!

Substitute for Capacitors, Resistors
SENCORE H-36—THE "HANDY 36"
 36 most-often-needed resistors and capacitors, for fast, easy, direct substitution in all circuits. ● Eliminates searching for replacement components for test purposes. ● Avoids unnecessary unsoldering and soldering—no more solder mess. ● Pays for itself the first month in time saved. ● Flick of a switch instantly selects any one of...
 24 RESISTORS from 10 ohms to 5.6 megohms
 10 CAPACITORS from 100 mmfd to .5 mfd
 2 ELECTROLYTICS, 10 mfd and 40 mfd
DEALER NET... 1275

Substitute for Electrolytic Capacitors
SENCORE ES102 ELECTRO-SUB
 Usable from 2 to 450 volts, D.C.
 Contains 10 electrolytics from 4 to 350 mfd. Select the correct value with the flick of a switch. Features automatic discharge, surge protector circuit. Prevents accidental "healing" of capacitor being bridged. Completely safe—no arc or spark when connecting or disconnecting. **DEALER NET... 1595**

Substitute for Fuse Resistors During Repair
SENCORE FS3 "FUSE-SAFE" CIRCUIT TESTER
 Instantly tells you whether or not it is safe to replace fuse resistors, fuses, or circuit breakers. Separate red and green scale for each commercially available fuse resistor used in radio and TV. Eliminates guesswork and wasted time. Also handy for wattage checks up to 1100 watts. **DEALER NET... 895**

Substitute for Bias Batteries During Repair
SENCORE BE3 "ALIGN-O-PAK"
 Completely isolated DC supply, with less than 0.1% ripple. Eliminates messy batteries in TV service work. Handy for alignment, AGC trouble-shooting, or checking gated sync circuits. Just dial the voltage you need, 0-18 volts, positive or negative. Covers all voltages recommended by TV set manufacturers. Size, 3½x4½x1¾". For 110-120 volts, 60 cycle AC. **785 DEALER NET...**

UNIVERSAL TV JUMPER CORD
 Fits any set from back to chassis. Box has male and female plugs for additional power source, soldering, etc. **DEALER NET 195**

Turn page for other
SENCORE
 Time Savers

See your Parts Distributor Now!
SENCORE
 ADDISON 2, ILLINOIS

trailing edges of the waveform, while the bass control determines the degree of slant across the top and bottom. Waveforms like those in Fig. 4 are developed by most amplifiers at extreme settings of tone controls. Assuming a good square-wave output is achieved when both controls are at their "flat" settings, the waveforms of Figs. 4A and 4B will result from maximum and minimum bass boost, while Figs. 4C and 4D correspond to maximum and minimum treble settings. Although this method does not reveal the exact amount of boost and attenuation available, it does serve as a fast over-all check of tone-control action.

Harmonic and IM Distortion

Uneven response to various frequency components of the input signal plays a definite part in causing distorted output from hi-fi amplifiers. However, more severe effects (and more difficult service problems) are created when frequencies *in addition to those contained in the input signal* are generated within the amplifier itself. This type of spurious-signal distortion originates in two ways, both caused by nonlinear operation of some portion of the amplifier circuitry. In harmonic distortion, applying a certain frequency component of the input signal to a stage causes one or more harmonics of that frequency to be added to the signal. Intermodulation distortion occurs when various signal components are heterodyned to form new frequencies *not* harmonically related to the original signal.

Incorrect circuit characteristics

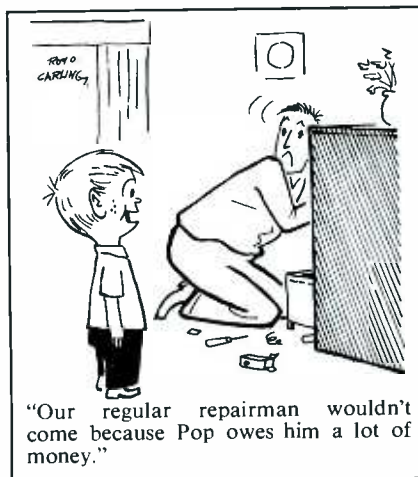

often lead to distortion. For example, if an amplifier stage is biased too close to cutoff, the resultant plate-current waveform will be as shown in Fig. 5A. The distorted plate waveform can be shown to contain both fundamental and second-harmonic components (Fig. 5B); this will serve to illustrate how a harmonic which was not a part of the original signal can be added in the amplifying process.

Although harmonic and IM distortion often occur together in the same amplifier, they are measured individually with highly specialized

instruments — or by two separate sections of a multipurpose instrument.

A typical arrangement for analyzing harmonic distortion is shown in block-diagram form in Fig. 6. An external audio generator supplies a sine-wave signal to the amplifier at some frequency such as 1000 cps. The output of the amplifier is fed to the harmonic-distortion analyzer, where a filter removes the fundamental frequency and leaves only the harmonics generated in the amplifier. Switch S1 is set to position 1, and the amplitude of the

Check TUBES, VIBRATORS THE SENCORE WAY

**FAST
ACCURATE
TROUBLE
SHOOTING**



America's Most Popular Tube Tester
more than 25,000 now in use

SENCORE LC3 LEAKAGE CHECKER
Whips those "tough dog" tube troubles . . .

Ask any serviceman who owns one . . . or try one for just one day of servicing in your shop. You'll see for yourself how much time the LC3 can save you. Checks for leakage between all elements, whether caused by gas, grid emission or foreign particles. Also checks leakage on all capacitors with voltage applied—including electrolytics. Provides instant filament checks in "Fil-Check" position—no need for a second filament checker. One spare pre-heating socket and new roll chart prevent obsolescence. New charts provided—no charge. Leakage sensitivity, 100 megohms, control grid to all other elements; 50,000 ohms, heater to cathode. Size, 7x6x3 1/2". Wt., 3 lbs. For 110-120 volts, 60 cycle AC. DEALER NET **28⁹⁵**

NEW . . . checks 172 tube types—more than any other checker of this type.

NEW . . . replaceable Roll Chart prevents obsolescence.

Check Filaments of All Receiving Tubes and Picture Tubes



FC4 FILAMENT CHECKER

For fast, easy checking of all tube filaments, without pulling chassis. Neon light goes out if tube filament is good. Also acts as continuity and voltage tester. Neon lamp glows when 115 v. AC is applied by cheater cord, providing a check on power to TV set. Size, 3 1/8 x 4 x 1". **2⁹⁵** With leads. DEALER NET.....

Check 3- and 4-Prong Vibrators . . . Faster, Easier



VB2 "VIBRA-DAPTOR"

Plugs into any tube checker; ideal for use with LC3 above. To check 6-v. vibrators, set for 6AX4 or 6SN7; for 12-v. vibrators, set for 12AX4 or 12SN7. Two No. 51 lamps indicate whether vibrator needs replacing. Instructions on front panel. Steel case. Size, 1 1/2 x 1 1/2 x 3". **2⁷⁵** DEALER NET.....

See your Parts Distributor NOW!

Turn page for other



Time Savers

SENCORE

ADDISON 2, ILLINOIS

total output signal from the amplifier is measured in order to set a reference level on the harmonic-distortion meter. Then the switch is thrown to position 2, and the amplitude of the harmonics alone is compared to that of the entire signal. The reading is obtained in terms of "percentage of harmonic distortion." In many high-quality amplifiers, this reading is below 1%.

The intermodulation analyzer (Fig. 7) differs from the harmonic-distortion analyzer in that it supplies its own amplifier-input signal for the test. This signal consists of

a mixture of two different frequencies — say, 100 and 6000 cps. If intermodulation occurs in the amplifier, the output of this unit contains sum and difference frequencies (5900 and 6100 cps) in addition to the original signals. The composite signal is fed through a high-pass filter to remove the 100-cps component, and the remaining frequencies are passed through a detector. In the latter stage, a 100-cps component is returned to the signal as a result of heterodyning between the other signals — and the strength of this new 100-cps

signal is proportional to the amount of IM distortion which occurred.

The actual reading is taken in almost the same way as for harmonic distortion. First, the composite signal amplitude is measured (with S2 in position 1), and then the 100-cps component of the detector-output signal is measured alone (with S2 in position 2). The ratio between the two readings determines the "percentage of intermodulation distortion" — which should be less than 3 to 5% for quality reproduction, and even less in top-grade hi-fi instruments.

Trouble Isolation

Of course, the test equipment used in making the aforementioned over-all checks can be used just as well in isolating trouble to a specific stage. Either a signal-tracing or signal-injection procedure can be employed; the setup would still be similar to Fig. 1, except that the indicating instrument or the signal generator (or both) would be connected to some intermediate point in the amplifier circuit. Once localized to a specific stage, a defect can often be found by usual troubleshooting procedures, including visual, voltage, resistance, and component-value checks.

Miracles shouldn't be expected from distortion-analyzing test equipment. It isn't designed to do all the work in pinpointing a trouble — just to supply a signal or measure some characteristic of operation. The rest is up to the serviceman. ▲



The missing link in TV service ...

SENCORE SS105 SWEEP CIRCUIT TROUBLE SHOOTER

IT'S A ... UNIVERSAL HORIZONTAL OSCILLATOR. For direct substitution. No wires to disconnect in most cases. Traces trouble right down to the defective component. Variable output from 0-200 volts, peak-to-peak. Oscillator will sync to TV sync signal giving check on sync circuits.

HORIZONTAL OUTPUT CATHODE CURRENT CHECKER. A proven method that quickly checks the condition of the horizontal output tube and associated components. Adaptor socket prevents breaking wires. Easily replaceable Roll Chart gives all necessary pin, current and voltage data. New Roll Charts are Free.

UNIVERSAL DEFLECTION YOKE. A new, simple way to determine yoke failure accurately—without removing yoke from picture tube. Merely disconnect one yoke lead and substitute. If high voltage (also bright vertical line) is restored, TV yoke is defective.

DYNAMIC FLYBACK TRANSFORMER CHECKER. Merely flip switch to "Flyback Check" and meter will indicate condition of flyback transformer, in degrees of horizontal deflection. Extremely sensitive and accurate; even shows up one shorted turn on flyback.

VOLTMETER. For testing bootstrap, screen and other voltages. Direct-reading voltmeter, 0-1000 volts.

UNIVERSAL VERTICAL OSCILLATOR. Checks oscillator, output transformer and yoke. Merely touch lead to component and check picture on screen.

SS105 is completely self-contained, nothing else is needed. New Improved Circuit... DEALER NET 42⁹⁵



See Your Parts
Distributor
NOW!

SENCORE
ADDISON 2, ILLINOIS

Batteries Today

(Continued from page 24)

This extremely long life compensates for their price, which is several times the cost of nonrechargeable types.

In addition to their use in transistor radio and TV sets, sealed nickel-cadmium units have also become available in various small cell sizes for operating flashlights and other low-current electrical devices. (See photos above.) Some have a built-in recharging circuit which is activated by merely plugging the cartridge into an AC wall socket; others require an external DC charging source, usually a rectifier circuit of the type shown in Fig. 1. The battery manufacturer can furnish specific information about the correct value of supply current, which varies according to the storage capacity of the cell; typical values range from 10 to 90 ma. In general, a proper charging rate is one which will restore a fully depleted battery to full charge in 14-16 hours. Considerable overcharging can be tolerated if current is not applied at an excessively high rate.

Care of Zinc-Carbon Batteries

In spite of all the new developments of the past several years, the low-cost, nonrechargeable zinc-carbon battery is still the bread-and-butter of the radio-battery replacement business. To help you get the best possible service out of these staple items, here is a review of some basic facts about their storage and testing requirements.

Voltage Tests

Checking the actual voltage of a radio battery by the "open-circuit" method—i.e., measuring the potential across the terminals after removal from the radio—is generally not recommended, because this check doesn't tell you whether or not the battery will hold up satisfactorily under a load. However, such a test is of some worth in a negative sense; if the open-circuit voltage is definitely lower than normal, the battery should be discarded. The normal potential of a new battery of the conventional zinc-carbon type is about 1.6 volts per cell. This voltage gradually tapers off during

use or with age, and the battery is usually ready to be junked by the time the potential under load declines to about 1.0 volt per cell. Of course, the main criterion for judging the condition of a battery is whether or not it still satisfactorily operates the equipment. However, if it shows signs of going bad, it should be promptly removed from service. Even a modern, sealed-type cell, when worn out, can leak or swell enough to damage the equipment in which it is used.

The mercury batteries used in some transistor radios have a nom-

inal open-circuit voltage of 1.345 volts per cell when new. Here's a fact about these units that may surprise you: Only a slight decrease in output voltage is sufficient to indicate that the battery is getting close to the end of its life. This small change is highly significant because the output potential of a mercury cell is extremely stable throughout practically all of its useful life span.

Why do some batteries check OK in an open-circuit test and then turn out to be pitifully weak when connected to a load? The answer lies in the internal resistance that tends to



SENCORE RS106 RECTIFIER TROUBLE-SHOOTER

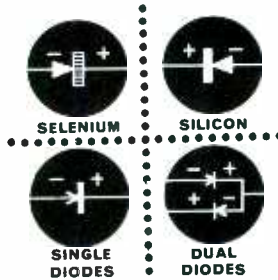

Instant, Direct Substitution for . . .

SELENIUM RECTIFIERS. Substitutes for all types used in Radio, TV and other electronic devices up to 500 ma.

SILICON RECTIFIERS. Types found in many new TV sets.

SINGLE DIODES. With exception of some used in high frequency circuits.

DUAL DIODES. Types used in sync Discriminator circuits. Third test lead is provided for center connection.

Sencore has simplified trouble shooting rectifiers and diodes with this unique substitution unit. The RS106 gives you a positive check everytime . . . Substitute for suspected rectifier or diode . . . watch picture or listen to sound and you'll know in seconds whether or not the rectifier or diode should be replaced. No guess work, no soldering mess, no time lost. The RS106 actually costs less than having loose rectifiers and diodes in the shop for testing and is worth many times more.

- Rectifiers & Diodes at your finger tips for fast substitution
- Protected by 1/2 amp. Slow Blow Fuse.

RS 106
DEALER NET . . . 12⁷⁵

Ask your Distributor to show you the RS106.



SENCORE
ADDISON 2, ILLINOIS

TV TUNERS REBUILT

All MAKES & MODELS

VHF
or
UHF



VHF or UHF
TUNER
OVERHAULED

\$9.95
NET

90 DAYS
WARRANTY

COMBINATION
UHF/VHF
UNITS
\$19.90

Fast Service, 48 hours on many types

Prices include labor and minor parts only, defective tubes and damaged major parts are extra at net prices.

Forward tuner complete with tubes, shield cover and any damaged parts. State fault.
QUOTE MAKE AND MODEL

F.O.B. CHICAGO OR TORONTO
We will ship C.O.D.

CASTLE TV TUNER SERVICE

5710 N. WESTERN
CHICAGO 45, ILL.

136 MAIN ST.
TORONTO 13

U.S.A.

CANADA

3¢

*will start you
on a new road to
additional profits
and happy customers
with speaker repair.*

**WALDOM
RECONING**

*Attach this coupon to
a Post Card and mail.
We will send you the
complete story.*

Your Name _____

Company _____

Street _____

City _____

Send to **WALDOM ELECTRONICS INC.**
4625 WEST 53RD STREET, CHICAGO 32, ILL

build up in a dry cell with age. This does not affect the cell's output voltage until a heavy current drain is imposed, and then it causes a considerable voltage drop within the battery. Result: Low operating voltage.

Thus, the most dependable way of checking the condition of a battery is to leave it in the radio, turn the switch on, and measure the voltage across the terminal connections. You can expect the normal output voltage of any battery under load to be somewhat less than in the open-circuit test. Unfortunately, it's impossible to set an arbitrary minimum value below which a battery should be considered weak. The measured operating-voltage value will depend on whether the current drain of the load is relatively high or low in comparison with the capacity of the battery. If in doubt, compare the performance of the battery being tested with that of a new unit installed in the same receiver. It helps to be familiar with typical supply voltages in properly operating receivers of various makes.

No presently-known test gives a reliable prediction of a battery's future life expectancy. The checks just described merely let you know what shape the battery is in at the time you test it.

Storage and Shelf Life

When stored at ordinary room temperature under conditions of moderate humidity, zinc-carbon batteries have a shelf life of one to two years. (When planning your stock, don't forget to include the time on the distributor's shelves in this figure!) A battery gradually deteriorates in storage, but it should retain as much as 70% of its original ca-

capacity even after a couple of years on the shelf. Mercury batteries have even greater longevity.

To insure keeping your stock as fresh as possible, don't forget to "rotate it" — just as food markets do with their produce, meats and other perishables. This procedure is as simple as can be: Just put the newest stock at the back of the shelf and use up the oldest units first.

Special storage arrangements are not essential for keeping a battery stock. However, the familiar admonition, "Store in a cool dry place," emphasizes the fact that extremes of temperature and humidity must be avoided. Just about the worst place for batteries is near a steam radiator, where their life is shortened because the increased heat speeds up chemical action within the cells, and the extremely low humidity tends to dry them out. True, modern batteries are generally sealed for protection against drying and leakage; nevertheless, a certain amount of water vapor can escape through the seal, which is never absolutely 100% tight.

Very high humidity, such as is found in many basements and other storage areas, can damage batteries. The effect is usually external rather than being the result of any chemical action within the cell. In other words, moist air simply promotes corrosion of the outer shell of the battery.

If the humidity becomes so high that moisture condenses on the battery, a conductive leakage path may form between the terminals and permit the unit to discharge as it sits on the shelf. This action is especially likely to occur in "B" batteries,

NEW!



RESIST-O-RACK

FREE! with any 4
Handy-Pak Carbon Resistor
Assortments • 77 Values

\$5⁴⁴ to **\$110⁸⁸** Dealer Net

All-metal • Can also be wall mounted



Order from
your IRC
Distributor

INTERNATIONAL RESISTANCE COMPANY
DISTRIBUTOR SALES DIVISION
414 N. 13th STREET • PHILADELPHIA 8, PA.

BEST BUYS IN TEST INSTRUMENTS



- Praised by the experts
- Lifetime service guarantee
- Ruggedized mechanical design for utmost accuracy & stability
- Only the latest, finest quality parts used



Color & Monochrome • DC to 5 MC Lab & TV 5" Oscilloscope #460
 Wired \$129.50 Kit \$79.95
 Features DC amplifiers; flat from DC to 4.5 mc, usable to 10 mc.



TV-FM Sweep Generator & Marker #368
 Wired \$119.95 Kit \$69.95

Entirely electronic sweep circuit with accurately biased inductor for excellent linearity. Extremely flat RF output.

Dynamic Conductance Tube & Transistor Tester #666
 Wired \$109.95 Kit \$69.95

Tests all receiving tubes (picture tubes with adapter), n-p-n and p-n-p transistors.



Add 5% in the West

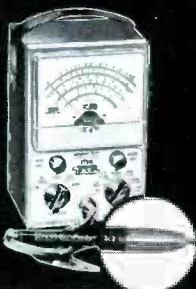

Peak-to-Peak VTVM #232 & Uni-Probe (pat. pend.)
 Wired \$49.95 Kit \$29.95

Uni-Probe — exclusive with EICO — only 1 probe performs all functions: half-turn of probe tip selects DC or AC-Ohms.

In stock at over 1500 distributors in the U.S. and Canada

IMPORTANT NOTE: All EICO kits built according to our instructions, and all EICO factory-assembled equipment, conform to the high standards and specifications published in EICO literature and advertisements. All EICO factory-assembled equipment is completely and meticulously hand-wired throughout — no printed circuitry, each factory-assembled unit is 100% final-tested throughout for each feature and function — no "spot" or "partial" checking. In EICO's finest test techniques, nothing is left to chance.

EICO, 33-00 Northern Blvd., L.I.C. 1, N. Y.

whose high potential can force current more easily through the relatively high resistance of the leakage path.

You increase the risk of accidental discharge if you leave batteries in close-fitting cardboard cartons that touch both positive and negative terminals, or if you jumble them in a heap.

Freezing is one type of extreme condition that does not seem to hurt batteries permanently. Some units have been frozen solid at temperatures far below zero, and then have worked normally after being completely thawed out again. Of course, a battery's operating efficiency would not be up to par if it were put into service at abnormally low temperatures.

As for deliberately giving batteries the "deep-freeze" treatment to prolong their life—why not? Slowing stock items could be stored at about 0°F, if wrapped in polyethylene film to prevent condensation of moisture on the battery surface. The covering should be left on while the battery is being warmed up for use.

Corrosion

It was mentioned that humid air will often cause a battery case to corrode. This effect is often mistaken by laymen for a different condition — internally-caused corrosion of the zinc case—which has been known to occur near the end of the battery's service life. The case is the negative terminal of the cell, and zinc is eaten away from it during the normal process of discharging. Holes will appear in the case if this chemical action goes too far. Perforation of the case seldom occurs nowadays because modern batteries are made with extra zinc to give ample thickness to the case. As an added protection, some batteries are sealed in a steel jacket; therefore, most corrosion in today's batteries is not a sign of disintegration of the cell, but is due either to a surface condition or to a slight leakage of the electrolyte. The latter in particular is an uncommon occurrence.

Rejuvenation?

Many readers have undoubtedly had an experience similar to the following: A customer brings in a portable radio for new batteries, saying

BEST BUYS IN CUSTOM

STEREO HI-FI...



- Praised by the experts
- Lifetime service guarantee
- Modern "low silhouette" horizontal chassis
- Easy console installation



FM Tuner HFT90 Wired \$65.95* Kit \$39.95*
 Cover \$3.95. *Less cover, FET included. "One of the best buys." — AUDIOCRAFT

AM Tuner HFT94 Wired \$65.95 Kit \$39.95
 Includes cover & FET. "One of the best... ideal for those wishing to add AM to their systems." — HI-FI SYSTEMS

FM/AM Tuner HFT 92 Wired \$94.95
 Kit \$59.95 Includes cover & FET



Stereo Dual Amplifier — Preamplifier HF81
 Wired \$109.95 Kit \$69.95
 "Outstanding quality... extremely versatile." — ELECTRONICS WORLD LAB TESTED



Stereo Dual Preamplifier HF85
 Wired \$64.95 Kit \$39.95
 "Outstanding buy." — THE AMERICAN RECORD GUIDE

Stereo Dual Power Amps
 28-Watt Model HF86 70-Watt Model HF87
 Wired \$74.95 Kit \$43.95 Wired \$114.95 Kit \$74.95



3-Way High Fidelity Speaker System Semi-Kits HFS-3 & HFS-5

- Complete with factory-constructed enclosure
- Easy to assemble — no gluing or woodworking
- HFS-3 unfinished birch, \$72.50; walnut, mahogany or teak, \$87.50
- HFS-5 unfinished birch, \$47.50; walnut, mahogany or teak, \$59.50.
- Other speaker system semi-kits from \$39.95.

In stock at over 1500 distributors in the U.S. and Canada

EICO, 33-00 Northern Blvd., L.I.C. 1, N. Y. PF-4
 Show me how to save 50% on top quality: Hi-Fi
 Test Instruments Ham Gear. Send free catalog and name of neighborhood EICO supplier.
 Send free STEREO Hi-Fi Guide.

Name.....
 Address.....
 City..... Zone..... State.....
 Add 5% in the West



do your service calls MEASURE UP . . .

. . . to the amount of time you spend on them?" Every call could mean the sale of a dependable, high-styled FANON Intercom in addition to service business. Priced for every purse, FANON Intercom systems are ideal for your residential homes and restaurants, bars, stores, etc., in your own neighborhood. 55% of service dealers are doing it . . . are you getting your share of these new profits?

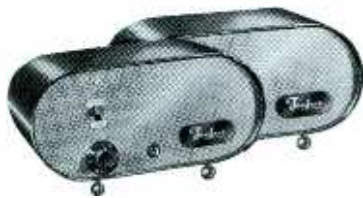

FX-2, TWO STATION SET.

Ultra-sensitive system with 50 feet of cable as low as \$29.95 list. Extra remote units can be added — \$12.50 list.

FX-6 and FX-12 multi-station systems for up to 6 or 12 units interconnected for larger installations. Masters start at \$34.95; FC remote station, \$13.25.

Let FANON give you full measure! Send for samples of folders, specs, displays . . . and a BIG Glossy photo of our girl, Jayne!

FANNON

PF-4
ELECTRONIC INDUSTRIES, INC.
98 Berriman St., Brooklyn 8, N. Y.

Name _____
Firm Name _____
Address _____
City _____ State _____

that the sound became extremely weak (or faded out entirely) after the radio had been played for several hours. You turn it on, and find that the output has come back up to normal. Did the battery rejuvenate itself? Your suspicions are aroused—is the recovery permanent, or just a dying gasp?

In order to explain how a battery can recover after being apparently exhausted by an overload, we need to take into account an action called "polarization." In a dry cell, the materials in the electrolyte break up into positively- and negatively-charged ions which are attracted to the electrodes of the cell during operation. Hydrogen ions go to the carbon electrode; if discharge is rapid, they form hydrogen gas bubbles which cluster around the electrode and reduce cell activity.

To hold gassing to a minimum, a material rich in oxygen is included in the cell as a "depolarizer." (A chemical generally used for this purpose is manganese dioxide.) This compound gives up some of its oxygen, which combines with the hydrogen to form water. An alkali is employed as an electrolyte in some recently-developed batteries (e.g., the alkaline cell and the mercury battery) partly for the purpose of making depolarization more efficient.

During prolonged, continuous use of the battery, polarization produces an unbalanced condition in the cell and provides a barrier to current flow between the electrodes. When the battery is disconnected from its load and allowed to rest, it is gradually restored to its original condition by diffusion and depolarization. After "recovery," the battery usually has lost only a small portion of its total energy capacity and should continue to provide normal service for a moderately long period. (Of course, repeated overloads will shorten its life.)

If a battery is going to recover at all, it will begin to do so immediately after the load is removed—so it's worth waiting awhile to see if recovery will take place. Zinc-carbon cells will "spring back" to a great degree after several hours' rest, and mercury cells (which have much less tendency toward gassing in the first place) will show improvement within a few minutes. ▲

**TARZIAN Offers 48-Hour,
Direct Factory Service
on Tuner Repairs**

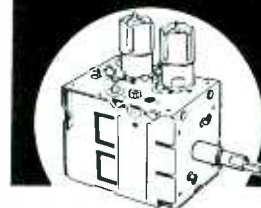

only
\$8.50

Price Effective Jan. 1, 1960

That's right. Net, \$8.50 per unit and \$15 for UV combinations, including ALL replacement parts. 90-day warranty against defective workmanship and parts failure. Tuners repaired on approved, open accounts. Replacements offered at these prices* on tuners not repairable:

VHF 12 position tuner \$22.00
VHF 13 or 16 position 23.00
VHF/UHF combination 25.00
UHF only 15.50

*Subject to change



Tarzian-made tuners are easily identified by this stamping on the unit.

When inquiring about service or replacements for other than Tarzian-made tuners, always give tube complement . . . shaft length . . . filament voltage . . . series or shunt heater . . . IF frequency, chassis identification and allow a little more time for service. Contact your local distributor or use this address for fast, 48-hour service:

SARKES TARZIAN, Inc.

Att.: Service Mgr., Tuner Division
East Hillside Drive
Bloomington, Indiana



*"He got the idea from
a science fiction movie."*

for power tools to your liking



ONLY
\$44.95

**1/2 H.P. SOUPED-UP SABRE SAW
MODEL 909 ONLY**

Only portable electric saw that can cut 4x4's at 45°, 6" board or log, yet cut any pattern, too! Cuts up to 1/2" steel, 2" pipe. Complete with rip guide, circle cutter, 45° tilting base plate and 7 blades.

Say WEN for Drills, Solder Guns, Sanders
5810 NORTHWEST HIGHWAY, CHICAGO 31

PRODUCT report

For further information on any of the following items, circle the associated number on the Catalog & Literature Card.

Marine Radio (420)



All circuits in the Kaar Marlin marine radiotelephone are transistorized, except the oscillator and power amplifier in the transmitter. Power input to the latter circuit is 65 watts. The unit operates from a 12-volt DC source only. Standard models have a frequency range of 2 to 3 mc, but an optional 2- to 4-mc version is also available. The receiver includes a series-impulse type of noise limiter. Price is \$399.00.

AGC For Master Amplifier (430)



Automatic gain control for amplifiers in master antenna systems is provided by the Blonder-Tongue Model MAC. When connected to an amplifier having at least 16 db gain and an output of 0.6 to 2.5 volts, the control device functions over a range of input-signal levels from 1900 to 100,000 microvolts. The unit is available to master-antenna contractors at \$121.50.

High-Fidelity Cartridges (440)



A *Collectors' Series* of cartridge-stylus combinations, based on the Model 380 *Stanton Stereo Fluxvalve* magnetic pickup, has been announced by Pickering. The Model 380E *Collectors' Ensemble* (\$60), for use with transcription tone arms, includes three easily-interchanged *V-Guard* styli with 0.7-, 1-, and 3-mil tips. Models 380A (for transcription arms; \$34.50) and 380C (for changer arms; \$29.85) are each equipped with a single 0.7-mil stereo stylus.

Short-Range Transceiver (450)



The transistorized Model 4303 transceiver (RME div. of Electro-Voice, Inc.) is designed for limited-range communications according to Part 15 of FCC rules; as such, it requires no license for the prescribed type of operation. Maximum RF output is less than 100 mw. The low-power channels largely overlap with Class D Citizens band frequencies; therefore, the 4303 can also be used to communicate with regular Class D stations if a license is obtained for this purpose.

Stereo-Playback Tape Recorder (460)

Either two- or four-track stereo tapes can be played on the Recordio Model 692 with no need for switching or adjusting tape heads. Retail price of the recorder, including microphone, is \$239.50. Accessories obtainable are a radio tuner (for installation in the recorder's storage compartment) and a separate, matching record changer; both play through the amplifier of the recorder.



Connecting Cable (470)

Connections between a stereo tone arm and a dual-channel preamp can be made quickly and neatly with the Rek-O-Kut *Stereo Connector Kit* No. KK-1. Four color-coded wires, enclosed in an outer sleeve for most of their length, are terminated in twin phono plugs at one end, and in four separate spade lugs at the other. A counter display offered to dealers holds 18 cables. Net price is \$2.49 each.



Dual "L" Pads (480)

Ganged pairs of constant-impedance "L" pads, for varying the output of stereo speaker systems from a remote location, are available from Audiotex in brass housings designed for surface mounting. Power rating of each pad is 10 watts (continuous) or 20 watts (peak). Controls are available for either 8- or 16-ohm systems at a list price of \$10.50. Also obtainable are single "L" pads for in-cabinet mounting, priced at \$3.50 each.



Anti-Slip Chemical (490)

Slip Stop, a liquid dressing developed by Colman Electronic Products for use on phono-drive components and dial-cord pulleys, increases friction and prevents slippage. As it dries, it forms a hard-surfaced coating with no tendency to become either sticky or slippery. An applicator is attached to the lid of the 2-oz. bottle.



Plug In and Talk (500)

Signal connections between Vocaline Model CC-60 *Vocatron* intercom stations are completed through the AC power wiring, thus eliminating the need for additional wires. The "press to talk" switch includes a *talk-lock* position for the user's convenience when delivering long messages. Bursts of noise between transmissions are silenced by a squelch circuit. Units are priced at \$109 per pair.



**Designed
to Burn
for Only
15 Seconds!**



This miniature lamp has a planned life of only a quarter of a minute, but its brief existence is truly spectacular! For in those few seconds it pours forth all the light normally emitted during the entire lifetime of an ordinary lamp!

Designed to provide a point of intense light for the tracking apparatus that determines the accuracy of a missile's course in the first few seconds of flight, this lamp is typical of many specially engineered lamps Chicago Miniature is called upon to produce.

Be assured that the Chicago Miniature Lamps your jobber offers will burn longer than 15 seconds! The same experienced, precision engineering that designed and produced this special lamp is producing long lasting, standard miniature lamps for your use.

Always ask for *Chicago Miniature Lamps!*

CHICAGO MINIATURE LAMP WORKS

1518 No. Ogden Ave., Chicago 10, Ill.

Miniature Lamps for every requirement



Preassembled TV Antennas (510)

JFD *Quik-Rig Banshee* broadband antennas are similar in design to the standard *Banshee* series, but are fully preassembled and have other new features such as a heavy-walled, 1"-diameter boom with a square cross section. 9-, 11-, 15-, and 18-element models are available in a price range of \$22.00 to \$39.30 (with gold anodized finish) or \$19.30 to \$31.50 (in aluminum finish).

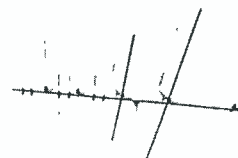

Capacitor Substitution Box (520)

The Cornell-Dubilier Model CDE *Electrolytic Capacitor Substitution Box* has four front panel toggle switches that can be arranged in various combinations to provide 15 values of capacitance, ranging from 10 to 150 mfd in 10-mfd steps. Maximum voltage rating for any combination is 450 WVDC. Net price of the unit is \$12.50.



Miniature Signal Injector (530)

The transistorized *Mosquito* signal generator, manufactured by Don Bosco Electronics, is useful for signal-substitution tests. The output of this pen-sized unit consists of a basic audio-frequency tone (approximately 1.5 kc) and many harmonics extending well up into the RF range.



Speaker-Matching Device (540)

Argos high-fidelity speaker enclosures are equipped with a *Tuning Tube* so that the resonant frequency of the enclosure can be adjusted to match that of any desired bass speaker. Besides increasing system efficiency at low frequencies, matching eliminates "bass boom." When installing the speaker, the tube is trimmed to the recommended length.

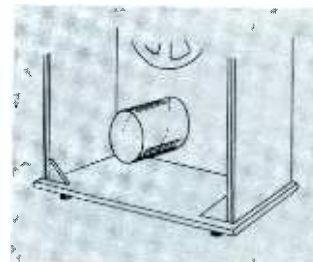

Class "D" Transceiver (550)

The Shell Model CB-12 Citizens band transceiver incorporates a continuously-tunable superregenerative receiver plus a transmitter that can be operated on any of the 22 Class "D" channels (using proper crystal). Power requirement is 1.9 amp at 12 VDC or 37 watts at 105-125 VAC. The unit costs \$79.95 wired and is also supplied in kit form.



Replacement Tubes for TV (560)

Sylvania has added the following tube types to its renewal line; 2- and 6FH5 *Guided Grid* RF amplifiers for operation at a plate potential of 135 volts; 6AX4GTB, 6DE4, and 17DE4 damper diodes with higher electrical ratings than type 6AX4GTA; 6- and 8GN8 miniature triode-pentodes for video-amplifier and sync-separator service; 4EW6 high-Gm, sharp-cutoff pentode for video IF amplifiers not controlled by AGC; 12BZ6 semiremote-cutoff pentode; 10DR7 dissimilar double triode, a series-string version of 6DR7; and 10EG7 octal-based dissimilar double triode for use as vertical oscillator and output tube.

SAMS PHOTOFAC INDEX



sent direct
to your shop

FREE

SEND FOR IT!

Yes, now you can have the valuable SAMS MASTER INDEX TO PHOTOFAC FOLDERS and Index Supplements sent direct to your shop at no cost to you! Just mail coupon below and you'll be sure to receive regularly your handy guide to the world's finest service data covering over 33,000 TV, Radio, Amplifier, Tuner Tape Recorder and Changer models. Send for it—it's FREE!

MAIL COUPON Howard W. Sams & Co., Inc.

Put me on your mailing list to receive the Sams Photofact Master Index and Supplements

I'm a Service Technician: _____ full time; _____ part time

My Distributor is:

Shop Name: _____

Attn: _____

Address: _____

City _____ Zone _____ State _____

Professional Tape Recorder (570)



The Crown Model 714C Stereo X tape recorder, manufactured by International Radio & Electronics Corp., records and plays four-track stereo, or two-track monophonic tapes. It is also capable of playing back two-track stereo tapes recorded on other machines. The standard model has three tape speeds (15, 7½ and 3¾ ips), accepts 10" or smaller reels, and can mix stereo inputs from two pairs of microphones. Price is \$730.

Ceramic Mikes in Pairs (580)



Acoustically-matched pairs of Sonotone *Ceramikes* are available for making stereo tape recordings. Set No. CM-T10 consists of two wide-range microphones with a frequency response of 50-13,000 cps and sensitivity of -62 db; Set CM-T11 offers more sensitive units (rated at -55 db), with a narrower frequency response (50-8000 cps). Each pair has a list price of \$36.75; table stands are \$5 each.

Prealigned Tuner Kit (590)



All tuned circuits of the PACO Model ST-45FA AM-FM tuner kit are preassembled on printed-wiring boards and prealigned; therefore, no touch-up adjustments are needed after completion. AM and FM circuits are entirely separate to permit reception of stereo simulcasts. In addition to this "semi-kit" at \$99.95, identical tuners are obtainable in regular kit form (\$84.95) or wired and tested (\$134.95).

Replacement Needle Line (600)



More than 250 types of replacement phono needles are now available from Electro-Voice. All are individually packaged in plastic cases with a protective padding of plastic foam. A black and gold package is used for diamond needles; blue and silver for sapphire types. A currently-available catalog gives needle-replacement information for practically all types of cartridges and specific stereo-phonograph models.

Soldering Irons (610)



The *Trig-R-Heat* soldering gun, made by P. Wall Mfg. Co., operates on either AC or DC. Squeezing the trigger for a few seconds causes the copper tip to heat up to normal soldering temperature. The trigger is then released, and the tip remains hot enough to melt solder for a minute or two. The work is illuminated by a recessed 7-watt lamp, which has its own "push-push" switch. A 40-watt pencil-type iron is also available.

For 1960 It's ...

"COMPACT"

tools by

VACO®

for the Electronic Service Trade

• "Compact" in Size: they fit the pocket



HK-17 Hex Key Set \$1.00 net



ND-141 Combination Screw & Nut Driver \$.79 net

• "Compact" in Price: they fit your pocketbook too



DE-810 Double Nut Driver \$.79 net



SP-19 Probe \$.96 net



AN-2 Tester \$.79 net



PK-8 Nut Driver \$.48 net

A-86 Pencil Type Driver \$.60 net

Ask Your Parts Jobber or Your Jobber Salesman

VACO PRODUCTS COMPANY

317 East Ontario Street, Chicago 11, Illinois
In Canada: Atlas Radio Corp., Toronto 19, Ontario

FOR TECHNICIANS,
SERVICE MEN, HI-FI, STEREO
HOBBYISTS

SWITCHCRAFT COMPONENTS

2 NEW PHONO JACK

- Eliminate rivet mounting.
- Convenient replacement for old style Jacks.

No. 3501FP—Lock Nut back of panel, requires only ¼" hole.



No. 3501FR—For front of panel mounting, where necessary to assemble Jack through the panel from the back due to lack of space.



NEW PHONO PLUG

No. 3502—Removable handle—exposed terminals. Nickel plated brass body and handle. Can be used in multiples even where Jacks are on ¼" centers.



NEW PHONO EXTENSION JACK

No. 3503—Removable handle. Cable clamp. Shielded. Nickel plated brass.



Send for NEW Catalog C-501 on complete line of SWITCHCRAFT CONNECTORS.

SWITCHCRAFT®

5573 N. Elston,
Chicago 30, Ill.

APRIL, 1960

Aerovox Corp. 40
 Anchor Electronic Products—
 Div. of Antronix Corp. 62
 American Television & Radio Co.
 (ATR) 16
 B & K Mfg. Co. 17, 54
 Berns Mfg. Co. 56, 66
 Burgess Battery Co. 45
 Bussmann Mfg. Co. 55
 CBS Electronics 19, 72
 Castle TV Tuner Service 82
 Centralab, A Div. of Globe-Union, Inc. 18
 Chicago Miniature Lamp Works 86
 Chicago Standard Transformer Corp. 46
 Cornell-Dubilier Electric Corp. 53, 63
 Duotone Co., Inc. 66
 EICO 83
 Electric Soldering Iron Co. (ESICO) 64
 Electro Products Laboratories, Inc. 42
 Electronic Publishing Co. 56
 Fanon Electric Co., Inc. 84
 General Cement Mfg. Co. 2nd Cover
 General Electric Co.—
 Receiving Tube Dept. 39
 Television Receiver Div. 59
 International Resistance Co. 82
 JFD Electronics Corp. 27
 Jackson Electrical Instrument Co. 67, 88
 Jensen Industries, Inc. 64
 Jerrold Electronic Corp. 73
 Kester Solder Co. 56
 Krylon, Inc. 66
 Littelfuse, Inc. 4th Cover
 Mallory & Co., Inc., P. R. 12-13, 14-15
 Mercury Electronics Corp. 69
 Merit Coil & Transformer Corp. 25
 Mosley Electronics, Inc. 64
 Motorola, Inc. 43
 Oelrich Publications 70
 Perma-Power Co. 71
 Philco Corp.—Accessories Div. 51
 Planet Sales Corp. 68
 Precision Tuner Service 62
 RCA Electron Tube Div. 58, 3rd Cover
 Raytheon Co. 9
 Sams & Co., Inc., Howard W. 36, 60, 61, 86
 Sarkes Tarzian, Inc. 20
 Semiconductor Div. 84
 Tuner Div. 65
 Seco Mfg. Co. 76, 77, 78, 79, 80, 81
 SENCORE 22-23
 Simpson Electric Co. 57
 Sonotone Corp. 10
 Sprague Products Co. 87
 Switchcraft, Inc. 52
 Sylvania Electric Products, Inc.
 Home Electronics Div. 75
 Semiconductor Div. 21
 Electronic Tubes Div. 74
 Triad Transformer Corp. 49
 Triplett Electrical Instrument Co. 37
 Tung-Sol Electric, Inc. 66
 Uertz Co., Glenn R. 87
 Vaco Products Co. 82
 Waldom Electronics, Inc. 84
 Wen Products, Inc. 47
 Winegard Co. 62
 Winston Electronics—
 Div. of Jetronic Industries, Inc. 48
 Xcelite, Inc. 8

Latest Jackson Tube Test Data

TUBE TYPE	MODEL 648 CIRCUIT PLATE		MODEL 598 C. CONT. D. E. F. G.	
	FILE	E. TEST	A. B.	C. CONT. D. E. F. G.
6FH8	6.3	A12	6.3	5 - 4Y 9.6 7 60
	6.3	A12	6.3	5 - 4Y 8.6 7 85
	6.3	A12	6.3	5 - 4Y 1.6 7 95
	6.3	A12	6.3	5 - 4Y 3.3 2Y 70
	6.3	12M	6.3	9A - 5Y 7.32 2Y 75
7360	6.3	12M	6.3	49 - 5 7.32 2Y 75
	7.5	12.6	12.6	4 18.5 6.2 3 20
	7.5	12.6	12.6	4 18.5 6.2 3 20

TUBE TYPE	MODEL 658 HEATER H-R		MODEL 658 GRID PLATE TEST	
	SEC.	HEATER H-R	P-G	HEATER CURRENT
6FH8	P	13.6D	A1247 a889 32Q	15WV.
	P	13.6D	A1246 a789 55Q	15WV.
	P	13.6D	A1267 a889 55Q	15WV.
	P	6.4J	12467 b359 48Q	35WV.
7360	B	6.4J	12467 b358 48Q	35WV.
	B	6.4J	12467 b358 48Q	35WV.
7581	P	13.6K	1249 ab358 20Q	60VY.
7588	P	6.4L	1249 ab358 20Q	60VY.

Latest Chart Form 618-22, 598-1, 658-2

ANTENNAS & ACCESSORIES

10. CLEAR BEAM—Flyer on three-way Miracle Mount do-it-yourself kit.
 20. JFD—20-page Exact Replacement Antenna Guide for portable and towable TV sets, compiled and edited by Howard W. Sams & Co., Inc. Gives TV receiver model number, manufacturer's antenna part number, and model number of corresponding JFD Exact Replacement Antenna. See ad page 27.
 30. JERROLD—Data sheet on TX series of antenna mixing networks for combining signals from several antennas, mixing or splitting VHF-UHF or TV-FM signals, and related applications. See ad page 73.
 40. WINEGARD—Information on precise-match, coil-type TV-FM antenna coupler that provides positive signal isolation and minimum insertion loss. See ad page 47.

AUDIO & HI-FI

50. CBS—Pocket-sized retail price list and cross-reference chart for CBS-Ronette and Columbia CD cartridges. See ads pages 19, 72.
 60. DUOTONE—Leaflets describing the "how" of needle replacement; wall chart with reference data on replacement needles; catalog of phono needles and accessories. See ad page 66.
 70. EICO—20-page catalog of kits and wired equipment for stereo and monophonic hi-fi, test instruments, "ham" gear, Citizens band transceivers, and transistor radios. Also "stereo Hi-Fi Guide" and "Short Course for Novice License." See ads page 83.
 80. JENSEN INDUSTRIES—Information on latest innovation in stereo cartridges. See ad page 64.
 90. PARKWAY SPECIALTIES—Catalog of Aud-O-Grill speaker systems and audio accessories, including enclosures, grille panels, stereo adapters and controls, crossover networks, etc.
 100. SWITCHCRAFT—Illustrated folder describing lines of "Mini-Mix" audio mixers. Also Catalogs S590 and C501 on connectors, including adapters, connectors, and plugs. See ad page 87.

COMPONENTS

110. AUDIO DEVELOPMENT—Catalog TF, featuring audio and power transformers; also catalog supplement describing line of communications-type plugs, jacks and patch cords.
 120. BUSSMANN—Three-color bulletin on Stak-Pak fuse assortment, showing how new packing idea can help TV servicemen on home calls. See ad page 55.
 130. CORNELL-DUBILIER—56-page TV Capacitor Replacement Guide gives TV-set manufacturers' original part numbers, rating information, and replacement recommendations for electrolytic capacitors in over 3500 applications. See ads pages 53, 63.
 140. IRC—Revised numerical listing of CTS-IRC exact duplicate controls, showing Concentrikit equivalent as well as original "trade-name" part number for each type of control. See ad page 82.
 150. MERIT—Exact Replacement Guide, covering 6,000 exact replacement parts for TV sets. See ad page 25.
 160. SAMPSON—12-page catalog, "Important Electronic Components Economize Through Import," with complete listings on tubes, transistors, resistors, capacitors, tone arms, cartridges, etc., imported from Japan.
 170. SPRAGUE—6-page bulletin describing Difilm molded and dipped tubular capacitors with combination plastic-film and paper dielectric. See ad page 10.

SERVICE AIDS

180. CASTLE TUNER—Leaflet describing service for all makes and models of TV tuners. See ad page 82.
 190. GENERAL ELECTRIC—Cross-reference of General Electric and Hotpoint TV model numbers, listing chassis designations and applicable service manuals. See ads pages 39, 59.
 200. KESTER—Technical literature on Resin-Five flux-core solder; booklet, "Soldering Simplified"; 78-page advanced training manual for service-supervisory and production personnel, "Solder—Its Fundamentals and Usage." See ad page 56.
 210. 3M ELECTRICAL PRODUCTS—Technical data on Scotch Brand No. 33 stretchable plastic insulating tape in 3/8" width for radio, TV, and hi-fi applications.

220. WALDOM—Informative bulletin on the economics and advantages of speaker re-coning; referral to a local re-coning station on request. See ad page 82.

SPECIAL EQUIPMENT

230. LAMPKIN LABS—Literature on new PPM Package (incorporating frequency meter and crystal calibrator) for accurately adjusting transmitter frequency of VHF-UHF mobile radio equipment to comply with FCC split-channel regulations.
 240. PERMA-POWER—New flyer illustrating and describing latest model radio-controlled garage-door opener with transistorized transmitter. See ad page 71.

TECHNICAL PUBLICATIONS

250. HOWARD W. SAMs—Literature describing all current publications on radio, TV, and hi-fi servicing. See ads pages 36, 60, 61, 86.

TEST EQUIPMENT

260. ANCHOR—Catalog sheet on Model UT450 Test-Adapt for equipping any CRT tester to handle 110² tubes, non-standard filament voltages (2.34, 2.68, and 8.4 volts), and color picture tubes. See ad page 62.
 270. B & K—Bulletin ST24-R, digest of information on Model 1075 Television Analyst, Models 1070 and A107 Dyna-Sweep circuit analyzers, Models 550, 650 and automatic 675 Dyna-Quik dynamic mutual conductance tube and transistor testers, and Model 440 CRT rejuvenator-tester. See ads pages 17, 54.
 280. CENTRAL ELECTRONICS—Descriptive folder on Model RE-2 Rejuva-Tube CRT rejuvenator, with instructions for use.
 290. ELECTRO PRODUCTS—Bulletin D612T describing DC power supply for transistor circuits, hybrid auto radios, and marine radio equipment. See ad page 42.
 300. JACKSON—Two-color flyer describing complete line of Service-Engineered test equipment. See ads pages 67, 88.
 310. RCA ELECTRON TUBE DIV.—Flyer on line of electronic test instruments. See ads pages 58, 3rd cover.
 320. SECO—Article reprint of "Take a Tube Tester Home" plan; two-color folder describing full line of test equipment and servicing aids; also information on dynamic tube checking and troubleshooting TV deflection circuits. See ad page 65.
 330. SENCORE—4-page brochure on complete line of time-saver instruments. See ads pages 76, 77, 78, 79, 80, 81.
 340. SIMPSON—Brochure describing VOM's, DC VTVM, color-bar generator, and many other types of radio and TV test equipment. See ad pages 22-23.
 350. TRIPLETT—Technical data on new Model 2590 transistor tester. See ad page 49.

TOOLS

360. BERNS—Data on 3-in-1 picture-tube repair tool, Audio Pin-Plug Crimper, and Ion adjustable beam bender. See ads pages 56, 66.
 370. ESICO—Information on the GUN-CHOKE, a simple and inexpensive device that controls tip temperature for soldering on printed-circuit or laminated boards. See ad page 64.
 380. VACO—New catalog sheets on Compact tools for the electronic serviceman, including glow-type voltage testers, hex key wrench sets, pocket-sized Phillips screwdrivers, thin-jawed adjustable wrenches, and reversible screwdrivers. See ad page 87.
 390. XCELITE—Bulletin 360 on new four-way pocket tool with 1/4" and 7/16" nut-driver, No. 1 Phillips, and conventional slot-type bits, designed for removing back covers of TV sets and installing antennas. See ad page 48.

TRANSISTORS

400. TUNG-SOL—Similar-Type Transistor Reference Guide, available as wall chart or booklet; Transistor Replacement Guide; data booklet on recommended circuits for transistorized radios. See ad page 37.

TUBES

410. RAYTHEON—Reliable Tube Replacement Guide, printed on heavy 8 1/2 x 11 stock, lists Raytheon Reliable replacements for standard tubes in communications equipment. See ad page 9.

FACTS



to help you sell more
RCA Silverama Picture Tubes

... the All-New replacement picture tubes that command premium price and profits.

Here are the facts—proof that RCA Silverama is your customers' best picture tube buy.

1
FREE OF GLASS DEFECTS. Glass cord lines, scratches, chips, or buffed faceplates are common defects found in many brands of tubes made with used glass. Surest way to avoid these defects and also obtain the latest optical advances in faceplate engineering: an All-New RCA Silverama!

2
ALL-NEW. Of the three largest-selling brands of replacement TV picture tubes, only RCA Silverama is guaranteed 100% all-new—new glass, new gun, new phosphor, new everything! You'll get written proof—right on the warranty card.

3
FINEST SCREEN QUALITY. Advanced screen coating and bonding processes combined with RCA's giant vibration-free screen settling machines assure the maximum in picture screen quality and uniformity.

4
RCA "KNOW-HOW". RCA's continuous product research and advanced design engineering have resulted in RCA Silverama picture tubes being steps ahead of all other brands.

5
WORLD'S FINEST. RCA Silverama is manufactured in the world's most modern manufacturing plant using all-new premium-quality materials. Result? RCA Silverama is the world's finest picture tube. © Silverama



RADIO CORPORATION OF AMERICA

Electron Tube Division

Harrison, N. J.

Visit RCA at the Electronic Parts Distributor Show.
Our Booth is North Exhibit Hall #874; and our display
rooms, 659-661.

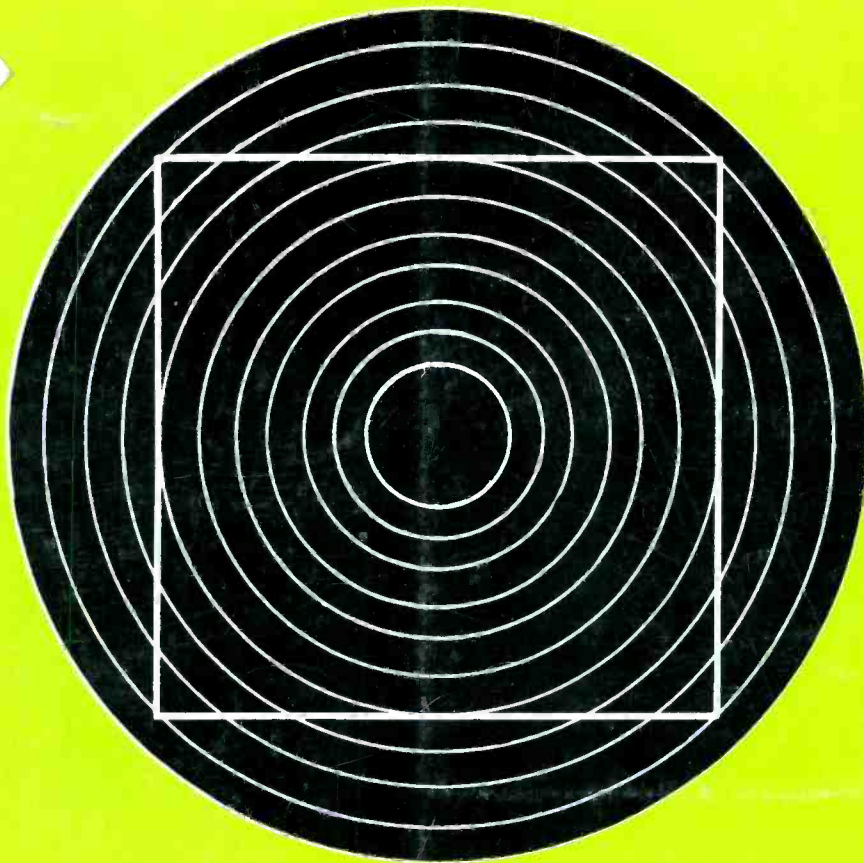

things are NOT as they seem . . .

This is a perfect square within the circle
—it is an optical illusion that the sides bend.



Things are not as they seem . . .
These two fuses look alike . . .
But they are not.



This fuse may burn out anywhere along the length of the filament even in the cap—this blown fuse is impossible to detect visually.



This Littelfuse has a controlled blowing point—the filament is plated throughout its length except in the very center—the fuse will always blow here. A blown Littelfuse can be detected immediately—a Littelfuse feature.

Littelfuse holds more design patents on fuses than all other manufacturers combined.

LITTELFUSE

DES PLAINES, ILLINOIS