



*Relaying*

JANUARY • 1958 25 CENTS

**PHOTOFACT**

# REPORTER

FOR THE ELECTRONIC SERVICE INDUSTRY



## This Month's Highlights

Troubleshooting With the Scope—Page 14

Suffering From the Bends—Page 16

Selection and Use of Hand Tools—Page 40

Keeping Up with Vertical Sweep—Page 18

PLUS JANUARY SUPPLEMENT TO SAMS MASTER INDEX

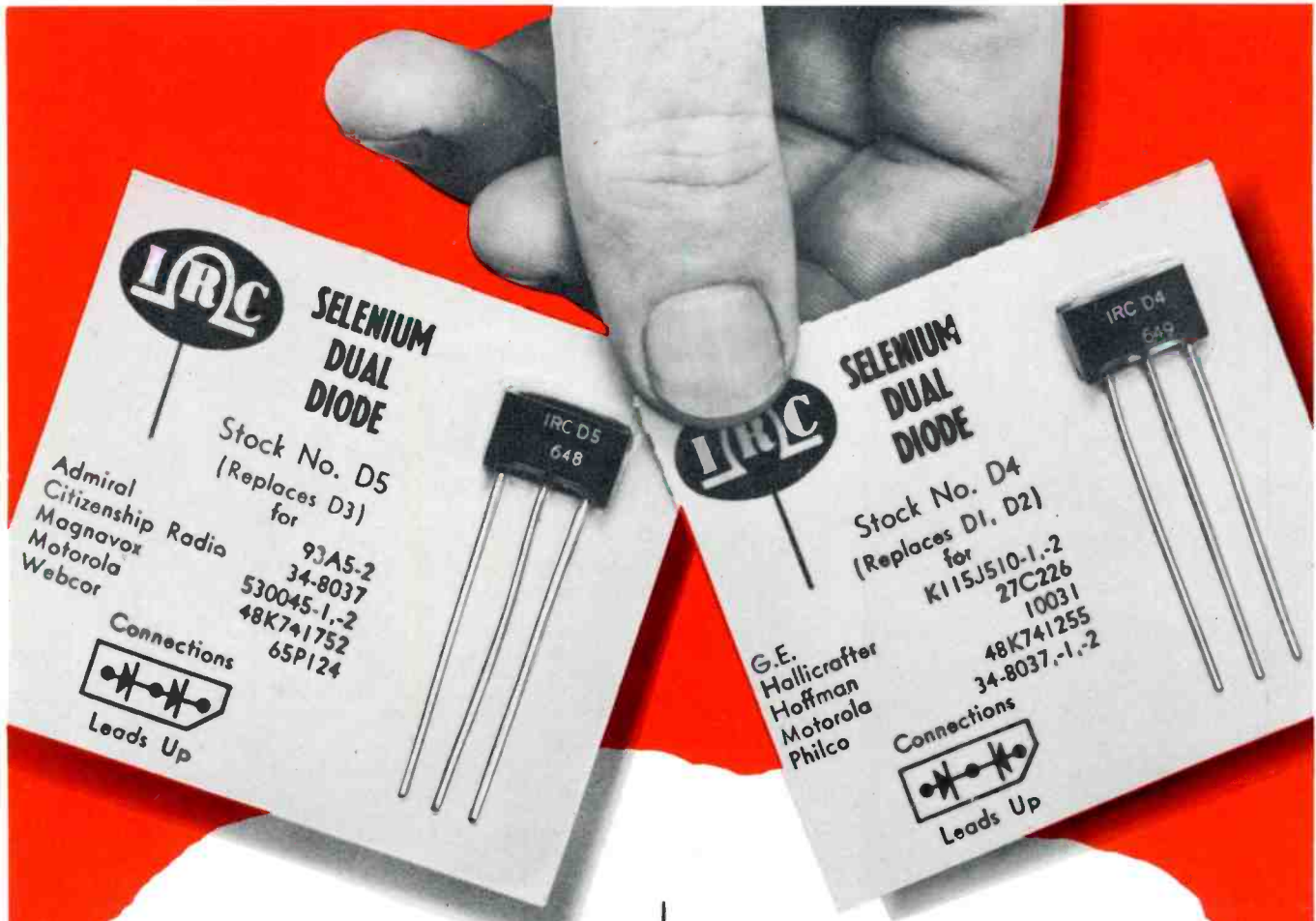

#### TYPE D5 SERIES CONNECTED DIODE

Universal replacement for following Manufacturers' Parts: Admiral (93A5-2, 93B5-3, 93B5-4 and 93B5-5), Citizen (34-8037), Emerson (817062), Magnavox (530045-1 and 530045-2), Motorola (48K741752, 48B742698), Silvertone (B48-110), Webcor (65P124), Zenith (63-3977).  
New Type D5 takes place of IRC Type D3.

#### TYPE D4 COMMON CATHODE DIODE

Universal replacement for following Manufacturers' Parts: G. E. (K115J510-1 and K115J510-2), Hallicrafter (27C226), (027-300-226), Hoffman (10031), (744002), Motorola (48K741255), Philco (34-8037, 34-8037-1, 34-8037-2 and 34-8037-3), Muntz ([2] SR-0004, SR-0006).  
Type D4 takes place of IRC Types D1 and D2.

**NEW IRC® DUAL DIODES**  
meet replacement requirements  
of 24 manufacturers' parts

- Only two IRC Universal Selenium Dual Diodes are now necessary to meet the replacement requirements of most big name TV sets, phonographs, hi-fi sets, plus model airplane radio controls and other circuits.
- Mounted on cards with a special plastic "skin" that seals out dust, dirt and handling . . . peels off quickly, easily and neatly.

ORDER FROM YOUR IRC DISTRIBUTOR



INTERNATIONAL RESISTANCE CO., Dept. 364, 401 N. Broad St., Phila. 8, Pa.

The foremost  
name in  
automotive  
loudspeakers!

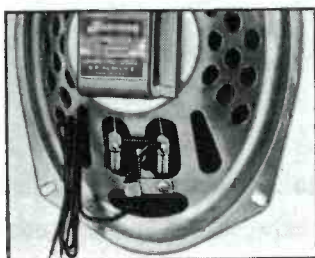

Three-way universal terminal-lead arrangement is especially convenient. Tip jacks fit Ford-Lincoln-Mercury rear seat pin terminals; twin lead for splicing to front seat plug cable; solder lugs for general use.

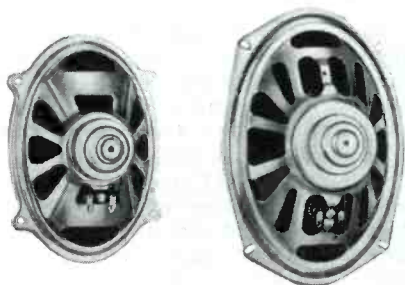

BURTON BROWNE ADVERTISING

PROVED IN **10,000,000**  
CARS AND TRUCKS!

**Jensen** WORLD'S MOST RUGGED  
AUTOMOTIVE SPEAKERS

## CONCERT SPECIAL OVAL GROUP

Jensen designed this extra ruggedized Special Oval Group at the request of one of the largest automobile manufacturers. Millions of units with years of service in truck and passenger vehicles have established the complete dependability of these speakers for use as replacements wherever 6 x 9 and 5 x 7 units are required. Not to be compared with conventional ovals, they are up to 3 times as resistant to housing distortion due to mounting strains and vehicle vibration, maintain alignment indefinitely in specially oversized gaps, withstand severe overloads, are immune to weather and temperature changes. Efficient magnetic structure design, using DP-Alnico 5 magnets, has made possible shallow construction, virtually universal in complying with crowded installation conditions.

*New high fidelity models* will give superior wide range performance and added power handling capacity for a noticeable improvement in auto radio sound quality.

## VIKING

For lowest cost, combined with rugged compactness, Jensen VIKING Series ovals fill the bill in automotive and other replacement services. Features include a completely enclosed magnetic structure, with precision locked-in alignment and new high efficiency DP-Alnico-5 magnet. Heavy gauge rigid housing. Solder lug terminals. One model in each 5" x 7" and 6" x 9" sizes handles 90% of your oval speaker requirements.

### CONCERT SERIES—SPECIAL OVAL GROUP

Nominal Size Inches	Model No.	Magnet Weight* Ounces	Voice Coil			Dimensions, Inches			List Price
			Imped. Ohms	Power Watts	Dia. Inches	H. & W.	Depth	Baffle Opening	
5 x 7	P57-U	1.73†	3.2	8.0	1	5 x 7 1/4	2 1/2	4 1/4 x 6 1/2	\$7.20
5 x 7	P57-TX§	2.5‡	3.2	9.0	1	5 x 7 1/4	2 1/8	4 1/4 x 6 1/2	8.35
6 x 9	P69-U	1.73†	3.2	9.0	1	6 3/8 x 9 1/8	3 1/8	5 1/4 x 8 1/8	7.80
6 x 9	P69-T	2.5‡	3.2	10.0	1	6 3/8 x 9 1/8	3 3/8	5 1/4 x 8 1/8	8.65
6 x 9	P69-TX§	2.5‡	3.2	10.0	1	6 3/8 x 9 1/8	3 3/8	5 1/4 x 8 1/8	8.95
VIKING SERIES									
5 x 7	57-J9	1.47	3.2	6.0	3/4	5 x 7 1/4	2 1/8	4 1/4 x 6 1/4	5.85
6 x 9	69-J9	1.47	3.2	7.5	3/4	6 3/8 x 9 1/8	2 1/8	5 1/4 x 8 1/8	6.50

§High Fidelity Model. \*All Magnets DP Alnico 5.

†Performance Equivalent to RETMA 2.15 oz. ‡Performance Equivalent to RETMA 3.16 oz.



Send for your  
free copy of  
Data Sheet 167.

**Jensen** MANUFACTURING COMPANY  
6601 South Laramie Ave., Chicago 38, Illinois

In Canada: J. R. Longstaffe Co., Ltd., Toronto  
In Mexico: Radios Y Television, S.A., Mexico D.F.

*Reputation Builder #5: it pays to charge a reasonable price*



- Two very easy ways to go broke... charge too little, or charge too much.

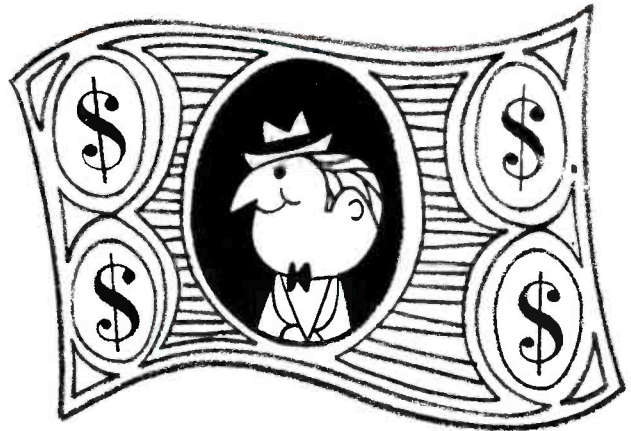

- But...you'll continue to do business when you keep your basic service charge between five and seven dollars.

*it pays to use the New To-5 Tel-Ohmike Capacitor Analyzer*

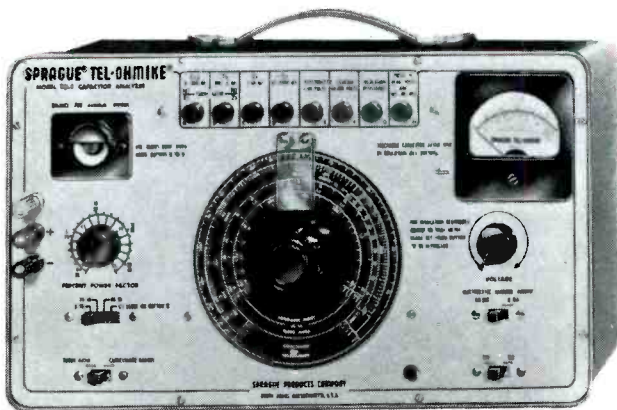

- Another way to build and hold a reputation is to insist on top quality test equipment. Callbacks due to inadequate or incorrect testing not only cost you *money* . . . they also cost you customers! Use less than the best service equipment and you place your reputation at stake. In capacitor analyzers, the best is *Sprague*.
- The NEW TO-5 TEL-OHMIKE Capacitor Analyzer gives quick and dependable measurements of capacitance, power factor, leakage current, and insulation resistance. It is compact, highly accurate, and easy to use. Outstanding features of this indispensable instrument include . . . improved accuracy, jumbo dial for easy reading, special color-keyed push buttons for instant range selection, automatic release for added safety, magic-eye tube for simplified bridge balancing. An added feature is a turns-ratio bridge circuit for audio and power transformers. Complete price, only \$83.90 net.
- For a more complete description and demonstration, see your distributor today. Or write for your free copy of Sprague's latest radio and TV service catalog, C-612. Address request to Sprague Products Co., Distributors' Division of Sprague Electric Company, 105 Marshall Street, North Adams, Massachusetts.

**don't be vague . . . insist on**

**SPRAGUE®**

*world's largest capacitor manufacturer*

**SPRAGUE RESEARCH IS CONSTANTLY PRODUCING NEW AND BETTER CAPACITORS FOR YOU**

PUBLISHER  
Howard W. Sams  
GENERAL MANAGER  
Mal Parks, Jr.

EDITOR  
Verne M. Ray

ASSOCIATE EDITORS  
Leslie D. Deane  
Thomas A. Lesh  
Calvin C. Young, Jr.

CONSULTING EDITORS  
William E. Burke C. P. Oliphant  
Robert B. Dunham George B. Mann  
Paul C. Smith

ART DIRECTOR EDITORIAL ASSISTANT  
Don W. Bradley Judy Ann Hurley

PHOTOGRAPHY CIRCULATION  
Robert W. Reed Pat Tidd

ADVG. PRODUCTION ART ASSISTANT  
Carol B. Gadbury Phillip W. Lee

ADVERTISING SALES OFFICES

MIDWESTERN  
PF REPORTER,  
2201 East 46th Street, Indianapolis 5, Ind.  
Clifford 1-4531  
EASTERN  
Paul S. Weil and Donald C. Weil,  
39-01 Main Street, Flushing 54, New York.  
Independence 3-9098.  
WESTERN  
The Maurice A. Kimball Co., Inc.  
2550 Beverly Blvd., Los Angeles 57, Calif.  
Dunkirk 8-6178; and 681 Market Street,  
San Francisco 5, Calif. EXbrook 2-3365.

Published monthly by Howard W. Sams & Co., Inc., at Indianapolis 5, Indiana.  
Entered as second class matter October 11, 1954, at the Post Office at Indianapolis, Indiana, under the Act of March 3, 1879.

Copyright 1957 by Howard W. Sams & Co., Inc. No part of the PF REPORTER may be reproduced without written permission. No patent liability is assumed with respect to the use of information contained herein.

Subscription prices in U.S.A. and possessions: 1 yr., \$3.00; 2 yrs., \$5.00; 3 yrs., \$7.00. In Canada and Pan America: 1 yr., \$3.60; 2 yrs., \$6.00; 3 yrs., \$8.50. Foreign subscriptions: 1 yr., \$6.00; 2 yrs., \$11.00; 3 yrs., \$15.00. A limited quantity of back issues are available at 35c per copy.

**next month**

**WIRE & ITS USES**

Offhand, wire may seem to be a rather simple product—until you stop to think of all its various forms and applications in this modern electronic world. To help the service technician in choosing the right type of wire for the right application, this article, in picture story form, will describe the designs and explain the uses for the many types of wires and cables used in the radio and TV field.

**REGENERATION**

This, the first of a series of three articles on the use of oscilloscopes, covers the use of a scope and a sweep generator in isolating regeneration problems in the RF, IF and video circuits of a TV receiver.

**AUDIO FACTS**

You asked for it, so starting next month, "Audio Facts" will be back to renew old acquaintances, presenting a theoretical discussion of equalizing networks—what they are, why they are needed, some typical circuits and how they work. In addition, practical information will be included to help the serviceman isolate troubles in packaged hi-fi units and some of the new products in the audio field will be described and pictured.

VOLUME 8, No. 1



JANUARY, 1958

**PF REPORTER**

FOR THE ELECTRONIC SERVICE INDUSTRY

**CONTENTS**

<b>This Month's Cover</b> .....	55
<b>Letters to the Editor</b> .....	8
<b>Shop Talk</b> .....	12
How to decipher multiple scale graphs such as tube and semiconductor charts or nomograms. <i>Milton S. Kiver</i>	
<b>Troubleshooting With the Scope</b> .....	14
An analysis of 8 key waveforms associated with typical TV circuits.	
<b>Suffering From the Bends?</b> .....	16
Read this one if you're interested in isolating causes for bending TV pictures. <i>Les Deane</i>	
<b>Keeping Up With Vertical Sweep</b> .....	18
Have you seen this newly-popular blocking oscillator-output circuit? Here's how it works. <i>Calvin C. Young, Jr.</i>	
<b>Quicker Servicing</b> .....	22
Lubricating Magnavox tuner detent; scope locates cause of negative picture; fusible resistors; increasing service business; motorized Westinghouse tuner. <i>Calvin C. Young, Jr.</i>	
<b>The Troubleshooter</b> .....	26
These reader's problems may coincide with yours—try our solutions.	
<b>Dollar &amp; Sense Servicing</b> .....	28
<i>John Markus</i>	
<b>Notes on Test Equipment</b> .....	30
Alignment generator, dot-bar/crosshatch generator, DC power supply, and signal-tracing probe. <i>Les Deane</i>	
<b>Selection and Use of Hand Tools</b> .....	40
Part 1 — Don't be a "screwdriver mechanic" — use the hand driver designed for the job.	
<b>Stock Guide for TV Tubes</b> .....	47
<b>Servicing Industrial Electronics—Part 5</b> .....	48
Electronic sensors to determine the level, viscosity and density of liquids. <i>Melvin Whitmer</i>	
<b>Product Report</b> .....	62
<b>Free Catalog &amp; Literature Service</b> .....	64
<b>Supplement to SAMS Master Index</b> .....	69

**SUBJECT REFERENCE INDEX**

ANTENNAS	Vertical oscillator-output .....	21
Amphenol "Vi-Fi" indoor type....	Waveform analysis .....	14, 15
AUDIO	TOOLS	
Hi-Fi performance appreciation... 28	Allen-head drivers .....	45
Record brush .....	Clutch-head drivers .....	45
BUSINESS	Cross-slot drivers .....	43
Increasing service income..... 24	Frearson drivers .....	43
Rural TV sales..... 28	Hex-nut drivers .....	45
TV rentals .....	Phillips screwdrivers .....	44
Window advertising .....	Reed and Prince drivers .....	44
Women technicians .....	Screwdrivers, standard & screw-holding .....	42, 43
CIRCUITS	TEST EQUIPMENT	
AGC, Motorola chassis TS-292C... 26	ATR DC Power supply..... 35	
Capacitance-bridge liquid level sensor .....	Bendix Ultra Viscoson viscosity-measuring device .....	50
Fluid-density control .....	Clarostat power resistor decade box .....	63
Photoelectric density sensor..... 51	EICO sweep & marker generator.. 32	
Resistance-bridge liquid level sensor .....	Kingston "Probe-Master" .....	36
Vertical blocking oscillator-output .....	Win-Tronix dot-bar/crosshatch generator .....	33
Video output, GE model 21C137... 22	THEORY	
COMPONENTS	Blocking oscillator-output .....	18
Fusible resistors .....	Graph forms, interpreting multiple-scale types .....	12
Newly introduced .....	Liquid-sensing techniques .....	48
SERVICING	TV servicing .....	26
Bending picture .....	Waveform analysis .....	14, 15
Fusible resistor replacement..... 22	TUBES	
Hum isolation .....	TV, stock guide for.....	47
Industrial .....		
Problems and their solutions..... 26		
Tuner detent lubrication..... 22		

USE HANDY CARD AT BACK TO ENTER YOUR SUBSCRIPTION

# PLUG-IN PROTECTION

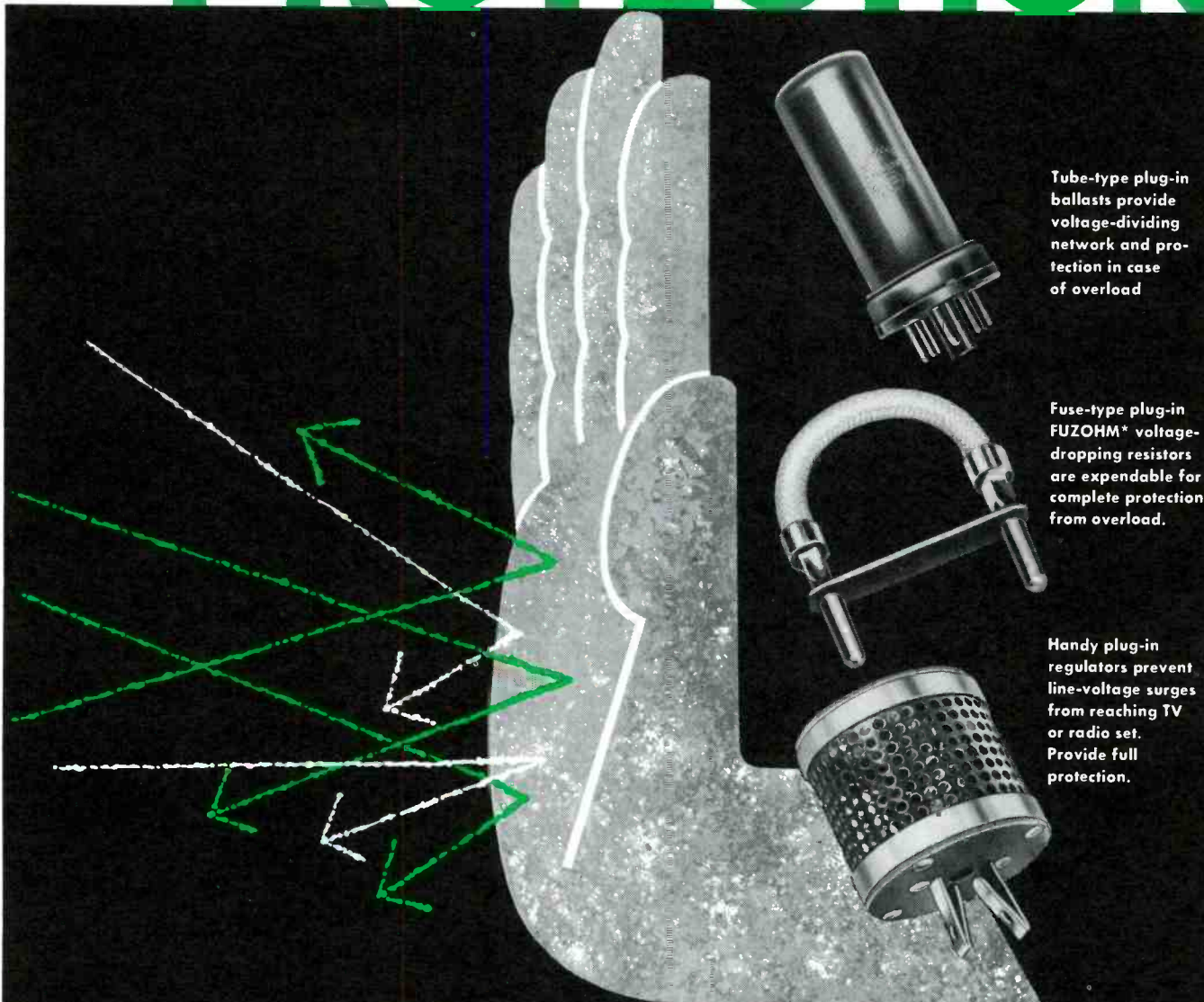

Tube-type plug-in ballasts provide voltage-dividing network and protection in case of overload

Fuse-type plug-in FUZOHM\* voltage-dropping resistors are expendable for complete protection from overload.

Handy plug-in regulators prevent line-voltage surges from reaching TV or radio set. Provide full protection.

## CLAROSTAT PROTECTIVE DEVICES

# FIT RIGHT! WORK RIGHT!



*Controls and Resistors*

**CLAROSTAT MFG. CO., INC., DOVER, NEW HAMPSHIRE**  
In Canada: CANADIAN MARCONI CO., LTD., TORONTO 17, ONT.

\*Reg. U.S. Pat. Off.

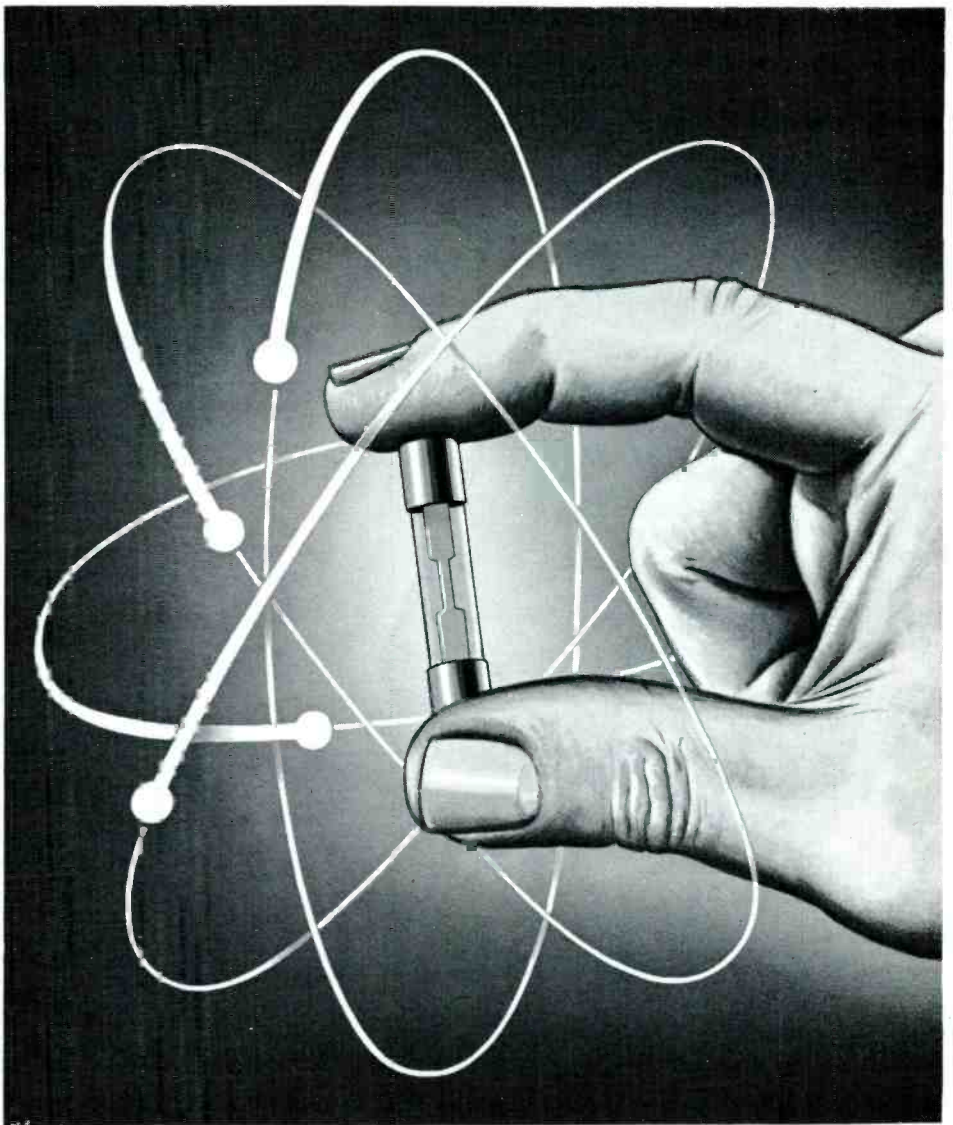

## ELECTRONICALLY TESTED BUSS FUSES *can help safeguard you against troubles and complaints*

With BUSS fuses, dependable electrical protection is not left to chance. Every BUSS fuse is tested in a sensitive electronic device that automatically rejects any fuse not correctly calibrated, properly constructed and right in all physical dimensions.

As a result, when you sell or install BUSS fuses you are sure the fuses will operate properly under all service conditions. You avoid 'kicks' or complaints from customers about faulty

fuses failing to protect or causing needless shutdowns.

By their unfailing dependability, BUSS fuses can help you safeguard your reputation for quality and service.

### **BUSS fuses have ready customer acceptance**

The universal acceptance of BUSS fuses is based on the millions upon millions of BUSS fuses used in homes on farms and in industry over the past

43 years. This means sales are easier to make because BUSS quality is never questioned.

For more information on BUSS and FUSETRON Small Dimension fuses and fuseholders . . . Write for bulletin SFB. Bussmann Mfg. Division McGraw-Edison Co., University at Jefferson, St. Louis 7, Mo.

*BUSS fuses are made to protect - not to blow, needlessly*



MAKERS OF A COMPLETE LINE OF FUSES FOR HOME, FARM, COMMERCIAL, ELECTRONIC, AUTOMOTIVE AND INDUSTRIAL USE.



**You need HICKOK quality  
for profitable color work**

**100% FULLY SATURATED NTSC\* STANDARD  
COLOR BAR — WHITE DOT - BAR  
TV Generator**

\*National Television  
Systems Committee as  
approved by Federal  
Communications Com-  
mission.



**\$495** Net

**Model 656XC**

Model 656XC: Matched to the other HICKOK instruments, housed in a handy portable detachable cover carrying case attractively covered with durable black leatherette. 16 3/4" W., 18 3/4" L., 7 1/2" D. 34 Lbs. net; 42 Lbs. shipping.

**DESIGN FEATURES**

Produces a standard 100% fully saturated NTSC color bar pattern on color TV sets. This is a must for non-obsolescence. Regardless of future color television receiver design this HICKOK color bar generator will be compatible. This is the type of signal that is transmitted over the air. All literature and alignment data are published around this standard NTSC signal. The Model 656XC provides signal for complete color alignment. Produces color bars on TV screen in the following order from left to right: green, yellow, red, magenta, white, cyan, blue and black. Phase of colors produced is accurately set with precision delay lines. The amplitude of sub-carrier and the amplitude of the brightness component are accurately set with precision resistive Networks. This results in the high stability required for proper alignment. Proper colors are generated within 30 seconds after warmup. In addition to color bar patterns, the 656XC produces: White Dot Crosshatch (20 vertical and 15 horizontal, less those in blanking); Vertical Lines only; Horizontal Lines only; and small size WHITE DOTS are "locked" to assure stability. This "locking" is achieved through the self generated 60 cycle and 15,750 cycle sync pulses. The white dots are of perfect size (approx. 2 lines thick) to permit accurate convergence adjustments. 300 dots are present in each raster, less those in the blanking region.

- Designed for use with all TV color systems approved by F.C.C.
- Precisely crystal controlled: Sub carrier and horizontal framing. Produces clearly defined wave forms to provide ease of alignment and assure minimum possible error.
- NTSC standard phase and brightness: This NTSC standard signal was used in designing all color TV receivers and is now used by TV manufacturers.
- Self Checking: Assures operator that generator is producing accurate NTSC standard signal at all times.
- Generates 3 primaries, 3 complements plus black and white. (An essential feature of this equipment is that white is produced by adding the 3 primaries.)
- The Model 656XC is preferred for its accuracy, stability and long trouble-free operation. This instrument was designed and built in cooperation with leading color TV receiver manufacturers and is specified by them for their field service engineers.
- Output is either R.F. or Video. Video: 0-2 volts peak-to-peak open circuit. 0-1 volt peak-to-peak across 100 ohms with positive or negative output. RF: Modulated output modulated through color bar pattern—channels 2 thru 6. A sound carrier is also provided for accurate setting of local oscillator in TV receivers.
- Generator is self-contained... no complicated external synchronizing connections. Equivalent vestigial side band modulation. Avoids overloading of chroma channels.
- In addition to color bars, this instrument generates the necessary signals to align R-Y, B-Y or I and Q type demodulators. These signals appear at black level with equal amplitudes.
- Produces: White Dot-Crosshatch (20 vertical and 15 horizontal, less those in blanking); Vertical Lines only; Horizontal Lines only; and small size white dots which are "locked" to assure stability. This "locking" is achieved through the extremely stable (crystal controlled) timer circuit. White dots are of perfect size (approx. 2 lines thick) to permit accurate convergence adjustments. 300 dots are present in each raster, less those in the blanking region.

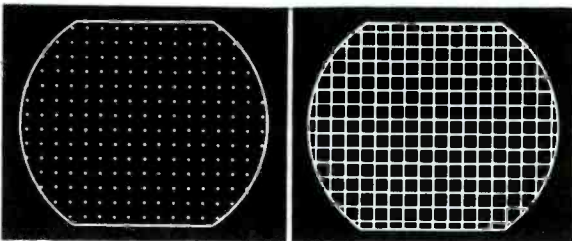

Small size white dot pattern. 300 white dots, less those in blanking.

White line cross-hatch pattern. 20 vertical and 15 horizontal, less those in blanking.

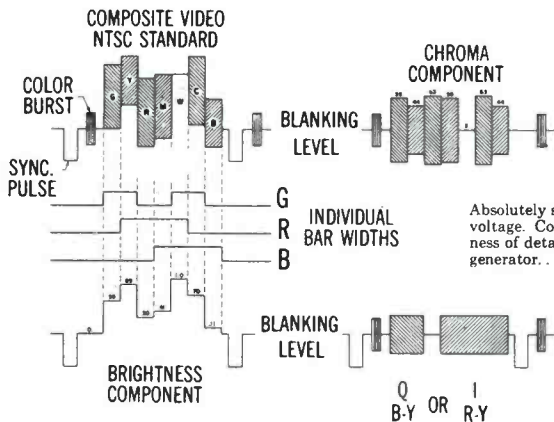

Absolutely stable. Entirely independent of changes in line voltage. Compare the wave form information and sharpness of detail of the 656XC with any other TV color bar generator. . . . You'll pick the HICKOK immediately.

**This NTSC standard waveform is to precise scale and is accurately produced in detail by the 656XC when viewed on a high quality wide-band scope (At least 4.5 MC).**

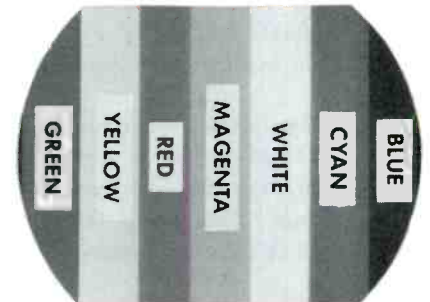

Generates color bars on the screen of any Color TV receiver in the following order from left to right: Green, Yellow, Red, Magenta, White, Cyan, Blue and Black. (All literature and alignment data published is based on this standard NTSC signal.)

**THE HICKOK ELECTRICAL INSTRUMENT CO. 10566 Dupont Avenue • Cleveland 8, Ohio**



NOW IS THE TIME TO... TRADE UP TO A HICKOK

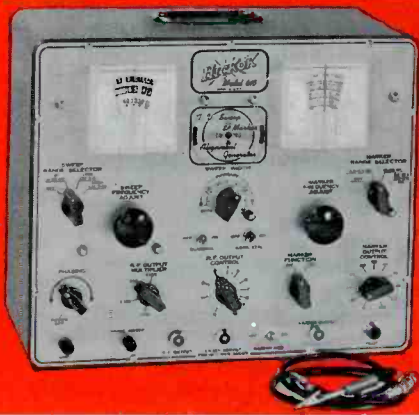

## VHF-UHF Sweep-Marker-Alignment DUAL MARKERS . . . ALL ELECTRONIC SWEEP

**Model 615:** A complete, single unit TV sweep and marker generator specifically engineered to provide all the necessary features and ranges required for visual alignment of modern TV receivers. Permits complete television IF and RF alignment. Provides harmonic output on UHF. Both marker and sweep have excellent attenuation (due to the high sensitivity of today's TV receivers, alignment equipment must have good attenuation to achieve required results). HICKOK All-Electronic Sweep features no moving parts to wear out or become inoperative. In the Model 615, amplitude modulation is less than 0.1 db per megacycle. Marker frequency accuracy is at least .5% at any setting. Non-Parallax knife edge pointers practically eliminate reading errors.

**\$299<sup>00</sup> Net**



## VHF-UHF Marker Generator 4.25 to 225 MC . . . All on Fundamentals

**Model 690:** Crystal controlled. High .25 volt RF output. Provides dual markers with any TV sweep generator. Features another HICKOK First—a Non-Parallax shadow type dial. Conventional dials introduce error unless viewed at exact right-angle, since hairline indicator is always a slight distance from the scale . . . The HICKOK Non-Parallax dial can be viewed from any angle without introducing error. The 45 inches of dial can be self-calibrated to within .05% accuracy with self-contained crystal calibrator. Complete RF coverage channels 2 thru 83. Also, 3.58 mc crystal (color burst frequency) is available. You need the 690 for VHF or UHF black and white or color alignment.

**\$362<sup>00</sup> Net**



## VHF-UHF Sweep Alignment Generator

**Model 695:** Here is a completely new generator with ALL-ELECTRONIC Sweep. It will exactly fill top requirements of the professional TV serviceman. Features a high .3 volt output. Triple shielded. Signal can be attenuated from 3 to 300,000 microvolts. 0-12 volts variable bias voltage with continuous tuning allows set alignment to more sensitive for "fringe areas", or less sensitive for "prime areas" to prevent overloading. Continuous tuning and easy-to-read scales provide foolproof method of alignment. Three RF oscillators provide complete VHF coverage on fundamentals and heterodyned output IF 0 to 50 mc. Assures the strong signal necessary for alignment front-ends.

**\$391<sup>00</sup> Net**



## PROFESSIONAL ENGINEER'S TV Service Oscilloscope

**Model 675A:** A versatile oscilloscope incorporating the latest engineering features to provide ease of use and fine accuracy.

The illuminated calibrated screen is backed with a green filter to reduce reflections caused by incidental illumination. The illumination brightness is adjustable. An astigmatic focus control provides a new standard in undistorted trace detail.

This equipment features a vertical wide band frequency response flat from 1 cycle through 3.58 megacycles, and to 4.5 megacycles (within 3 db) at a 20 millivolt RMS per inch sensitivity. A new type circuit design has replaced the need for dual sensitivity. The wide band response is not achieved at the expense of sensitivity, therefore, the need for band width switching has been eliminated.

A minimum of full screen deflection is provided without low or high frequency distortion. The vertical attenuator is frequency compensated in decode steps from 1 to 1 through 1000 to 1.

The recurrent sweep has a frequency coverage from 10 to 100,000 cycles in four calibrated decade ranges. These ranges have a vernier control of 10 to 1.

**\$278<sup>25</sup> Net**

Complete with low capacity probe.

*You get \**

# SR

*(and a whole lot more)*

## with this new mike!

ACTUAL SIZE

\* **Selective Recording**, (editing sound as you record), is easy with American's new TRC model. Push-button control at the mike can be locked "on" whenever wanted. You'd expect to pay much more for SR\* and other superb engineering features that let you take full advantage of your tape recorder range—wide frequency response, omnidirectional pickup, faithful audio reproduction. Note the sleek styling in polished chromeplate. Weighs a mere 9 oz.

Choose from three types: Dynamic—80-8500 c.p.s., low or high impedance, Ceramic—80-7500 c.p.s., high impedance, Crystal—80-9500 c.p.s., high impedance.

Use three ways—as a hand mike, table mike (stand included), or wear as a lavalier for p.a. use. You get a lot of microphone at low cost in American's TRC . . . complete specifications on request.

Choose the mike with SR\* Lists from \$11.50 to \$17.85

# American Microphone

ELGIN

A DEPARTMENT OF ELGIN NATIONAL WATCH COMPANY  
366 BLUFF CITY BOULEVARD, ELGIN, ILLINOIS

## Letters to the EDITOR

Dear Editor:

The CRT emission indicator on page 82 of the October issue is a good one to carry on service calls, but I have been using only a neon lamp (90 V to 550 V AC-DC) for the same purpose. When the lamp is placed between the control grid (Pin 2 of 12-pin socket) and ground, the light should vary with the setting of the brightness control. To check the contrast control in the same way, the lamp is placed between the cathode (pin 11) and ground. With the lamp across pins 2 and 11, rotation of either the contrast or brightness control should vary the brilliance of the lamp. When the lamp is put between grid No. 2 (pin 10) and ground, the lamp lights if the circuit is good; and contrast and brightness should have no effect on the brilliance. To see whether the CRT is getting filament voltage, I check the socket by plugging in a 6SN7 with all pins cut off except 7 and 8, and see if it lights up.

Ed J. CUFFE

Chicago, Ill.

*One more test: Place the lamp between second anode and ground, and see if the technician lights up.—Editor*

Dear Editor:

I have just finished your article on test equipment in the October PF REPORTER and am interested in the probes by Futuramic Co. of Chicago. What is their address?

B. T. HARTRY

Chestnut, Ill.

915 S. Broadway, Park Ridge, Ill.  
—Editor

Dear Editor:

With the increasing numbers of transistors in all types of electronic equipment, I would like to suggest that you complete a cross-reference which would show interchangeability and similar types of transistors made by different manufacturers.

T. W. HOPKINSON

Charlottesville, Va.

*Your suggestion directly supports an idea which we have been anxious to carry out for some time; however, a number of problems are involved. There are very few cases where different transistor types are freely interchangeable! One type can be made to replace another in many instances, but some change in circuit component values often must be made also. In addition, the technician may have to try several transistors of a substitute type before*

# Cut testing time in half— DOUBLE TUBE SALES



## **B&K** **DYNA-QUIK**

*Makes Money for  
Servicemen Everywhere*

**NEW  
MODEL  
650**

### *Fastest, Most Complete, Portable* **DYNAMIC MUTUAL CONDUCTANCE TUBE & TRANSISTOR TESTER**

Checks over 99% of the tubes most widely used in television receivers, plus popular home and portable radio tubes. Tests over 500 tube types. Lists over 125 tube types, with settings, on socket panels for maximum operating speed. Complete listing in fast telephone-index type selector. Includes 16 spare sockets and sufficient filament voltages for future new tube types. Tests each section of multiple tubes separately for Gm—Shorts—Grid Emission—Gas Content—and Life. Provides instantaneous Heater Continuity check. Shows tube condition on "Good-Bad" scale and in micromhos. Special bridge assures automatic line compensation. No multiple switching—No roll chart. Includes pin straighteners. Transistor Tester checks junction, point contact and barrier transistors, germanium and silicon diodes, selenium and silicon rectifiers.

Net, **\$169<sup>95</sup>**

- Each Dyna-Quik Tube Tester completely tests each tube in seconds
- Eliminates substitution testing
- Shows customer true condition and life expectancy of tubes
- Sells more tubes right on-the-spot
- Cuts servicing time, wins customer confidence
- Saves costly call-backs, brings more profit

One extra tube sale on each of 5 calls a day pays for the Dyna-Quik in a few weeks.

### *Famous MODEL 500 Money-Making Portable* **DYNAMIC MUTUAL CONDUCTANCE TUBE TESTER**

Servicemen say: "Best tube tester I've ever owned for speed and dependability!" "Makes money. Paid for itself several times. Really indispensable!" "Have two...one for the shop and one for house calls!" "Adds income and saves unprofitable call-backs!" That is why thousands of the Model 500 are now in profitable use all over the nation. Tests tubes for Shorts, Grid Emission, Gas Content, Leakage, and Dynamic Mutual Conductance—in a matter of seconds. Life Test detects tubes with short life expectancy. Shows tube condition on "Good-Bad" scale and in micromhos. One switch tests everything. No multiple switching—No roll chart. Special bridge maintains automatic line compensation. 7-pin and 9-pin straighteners.

Net, **\$109<sup>95</sup>**

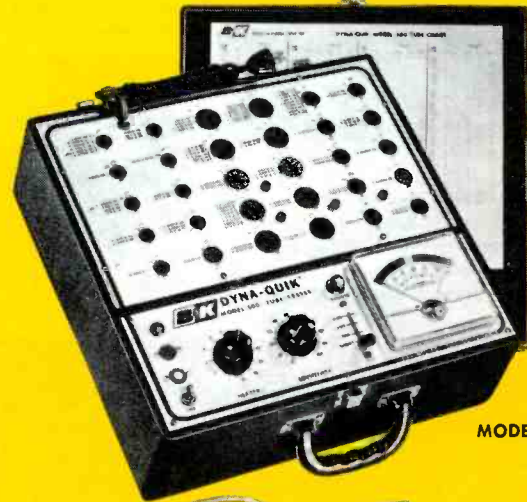

MODEL 500



MODEL 510

### **NEW MODEL 510 ACCESSORY SOCKET PANEL**

Adds over 50% more sockets to the B&K Model 500 Dyna-Quik. Enables you to quick-check many more tube types, old and new. Fits inside the cover of the Model 500. The Model 510 Accessory Socket Panel comes completely wired, ready to install and connect.

Net, **\$29<sup>95</sup>**

See your B & K Distributor,  
or write for Bulletin AP10-R

## **B&K**

**B&K MANUFACTURING CO.**  
3726 N. Southport Ave., Chicago 13, Illinois  
Canada: Atlas Radio Corp., 50 Wingold, Toronto 10, Ont.  
Export: Empire Exporters, 458 Broadway, New York 13, U.S.A.

# Weller soldering guns make safe repairs to Heat-Sensitive Components

A WELLER Soldering Gun gives you precise control of heat. This feature is especially important when replacing heat-sensitive components. Here are some typical applications:



**1 REPAIRING PLASTIC-MOUNTED I-F TRANSFORMERS.** Your Weller Gun gives you precise heat control for this delicate operation. Prevents melting of plastic sockets; enables you to repair loose contacts and hair-thin coil-winding wire without damage.

**2 SOLDERING VOICE COIL CONNECTIONS.** Heat-control characteristic of Weller Guns enables you to repair loose or broken voice coil connections on the reflecting surface of paper resonating cone. The slightest mishandling of a soldering iron would burn cone.

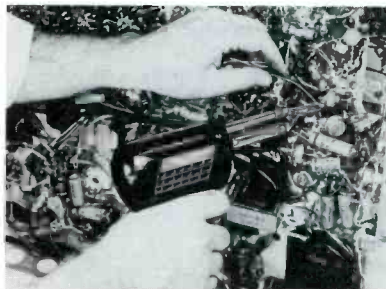

**4 REPAIRING REMOTE-CONTROL TUNING UNITS.** Your Weller Soldering Gun fits neatly into the small spaces between the terminal tabs on telephone-type relay stacks. Also, heat shut-off feature of gun prevents damage to insulation.



**3 REPLACING CRYSTAL OSCILLATOR.** Controlled heat is imperative for replacing crystal oscillator in color demodulator circuits. With a Weller Soldering Gun you get perfect heat control, thus avoid damage to delicate crystal element.

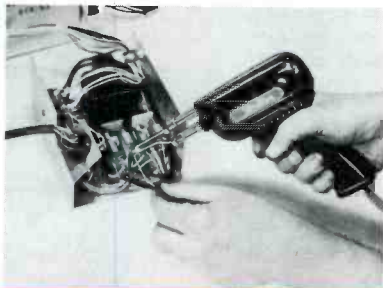

There are professional model *Weller* guns  
for every type of service work



Your choice of models . . . ranging from 100 to 250 watts single heat and 100 to 275 dual heat types. Suitable for every kind of service operation. All models heat in 5 seconds; provide instant, triggermatic control of temperature.

ORDER FROM YOUR ELECTRONIC PARTS DISTRIBUTOR

*Weller*

ELECTRIC CORP.

601 Stone's Crossing Road, Easton, Pa.

he finds one that will work properly under all conditions. At such time as a reliable chart for direct plug-in substitution becomes feasible, we shall certainly publish one. Meanwhile, technicians can avoid "cut-and-try" substitution techniques only by relying on exact replacement transistors.—Editor

Dear Editor:

Your article "Preview of 1958 TV Sets" in the November issue has a couple of errors on the Silvertone Model 8190. First, the chassis number is 528.52100, not 528.51160. Second, the trimmer capacitor mentioned is not a horizontal drive trimmer, but is the horizontal range control. This chassis uses no drive control.

CHARLES BEAMON

Goldsboro, N. C.

*We admit the error in the chassis no., but it was only off by .00940. Even the best slide rule wouldn't put you that close. We must have been living in the past, referring to the trimmer as a drive control. Hardly anyone uses it nowadays.—Editor*

Dear Editor:

Herewith, please find enclosed a clipping from your most esteemed and serious magazine.

*Our Editors are diligently at work studying WAVE (and WAC) forms, and will present their findings early next year.*

Please, explain what the "WAC" stands for in electronic language?

MAXIM TZYTOVITCH

San Francisco, Calif.

*Surely, you've come across this wave shape in your troubleshooting analyses —"Without Any Curves."—Editor*

Dear Editor:

I wish to express my appreciation for your latest series "Inside TV Tuners" and hope you continue this discussion right through the TV set. What I value most is the detailed explanation of every single part in various tuner designs. Why not go on through the IF, sync, etc.?

Now that TV sets are trimmed down at every end, would it not be the right time to show both old-timers and young technicians what a top-designed or "ideal" TV set should look like, not only on paper but also in layout and mechanical considerations?

By the way, I am looking for an IF strip with a bandwidth as close to 4.5 mc as possible. Where could I find one?

G. R. A. RANDEL

Hamilton, Ont.  
Canada

*An "ideal" TV set? Designers are still haggling over this animal. An IF strip with a bandwidth as close to 4.5 mc as possible! Why not ask for the moon? However, you might check the RCA CT-100 set, flat to over 4.0 mc.—Editor*

PF REPORTER • January, 1958

# ASTRON "Staminized" CAPACITORS ARE

## born -- protected

TO INSURE REAL STAYING-POWER  
AFTER INSTALLATION

From the first conception of design, Astron's protection insures highest capacitor quality and reliability.

Only the very finest of raw materials pass Astron's "Selected Purchasing System." Time-proven production techniques assure "surgically clean" assembly. Meticulous quality controls are strictly enforced . . . over 10 separate production line tests are performed, **plus a 100% final inspection of every unit before shipment!**

Astron's climatic protection processes are many . . . each designed to guard the quality of Astron capacitors against moisture and temperature long after installation.

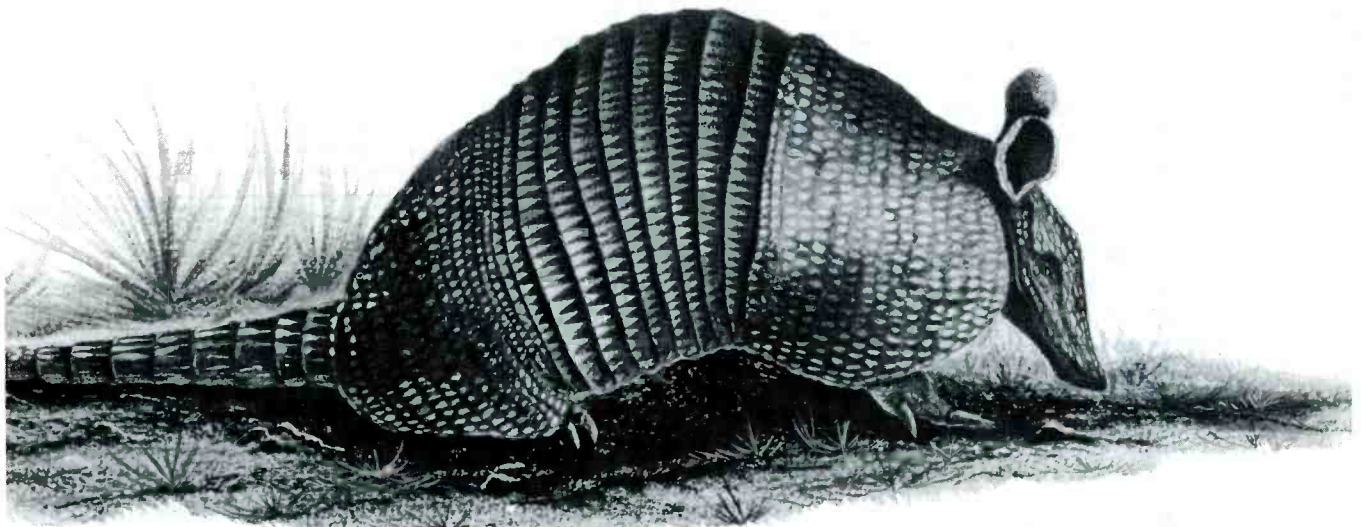

The Astron "Staminizing" method of manufacture guarantees you a "no-call-back" capacitor with real staying power!

Remember, your reputation is **our** business. Build it, guard it, protect it . . . Buy Astron Capacitors . . . they're born-protected.



FREE Servicing Aid

Save time, use handy Astron Pocket-sized Replacement Catalog and Pricing Guide (AC-4D) . . . Write today!

\*Trade-mark



Export Division: Rocke International Corp., 13 East 40th St., N. Y., N. Y.

**ASTRON**  
CORPORATION  
255 GRANT AVENUE EAST NEWARK, N. J.

In Canada: Charles W. Pointon, 6 Alcina Ave., Toronto 10, Ontario

# ShopTalk

MILTON S. KIVER

Author of . . .  
*How to Understand and Use TV Test Instruments  
and Analyzing and Tracing TV Circuits*

## Multiple Scale Graphs

For the sake of convenience, it is often desirable to chart several different quantities on the same graph. When this is done and the quantities are designated by different units, it becomes necessary to indicate these units on separate side scales. An illustration that the technician is likely to encounter is shown in Fig. 1. Here, the plate resistance ( $r_p$ ), mutual conductance ( $gm$ ), and amplification factor ( $\mu$ ), of a 6C5 is shown for a plate current range of from 0 to 15 ma. Note that while all curves use the same horizontal scale, each possesses a separate vertical scale. Furthermore, each vertical scale employs figures suited to its particular range and this means that the various graph spacings will carry different weights. For example, one spacing on the mu-

tual conductance scale is equal to 50 micromhos; on the plate resistance scale, the same spacing is equal to 500 ohms. And if we use the amplification factor scale, a single space is worth just one unit.

Once the foregoing layout is understood, use of the curves becomes quite simple. For example, at a plate current of 10 ma, tube plate resistance is 9,000 ohms, mutual conductance is 2,200 micromhos, and the amplification factor is 20. At some other plate current value, these characteristic values would change. In general, the graph shows us that plate resistance decreases with plate current, mutual conductance rises, while the amplification factor remains fairly constant.

It sometimes happens that one of the scales on a graph will abruptly change value in order to more clearly present a certain effect. Consider, for example, the characteristic curve for a germanium (or silicon) rectifier shown in Fig. 2. If we examine the right-hand side of the graph, we note that the voltage values along the horizontal axis change in steps of 1 volt. The corresponding vertical axis employs current values in amperes. Thus, with only a volt or two of applied voltage, an exceedingly high current flows through the unit.

Now, look at the left side of the graph. Here, both the current and voltage axis values have significantly different values. The current, for example, rises in steps of one ma; the voltage, along its axis, changes in steps of 100 volts. This portion of the graph represents the rectifier when it is reverse biased. Under these conditions, an exceedingly high voltage

is needed to produce any significant amount of current.

As we examine the graph, we see why the change in scale values was initiated. Without such a change, a complete picture of the forward and reverse characteristics would have necessitated either an extremely long, stretched-out curve at the left, or a tightly-compressed presentation at the right. Neither one of these representations would have been desirable. To get around this weakness, the scale values were altered. This practice is quite common for rectifiers. The technician will come across other instances where the same scale graduations will represent different values, but there should be no difficulty in arriving at the correct values if the change in scale is noted.

## Circular (Polar) Graphs

Another type of graph that the technician will see frequently is one employing circular coordi-

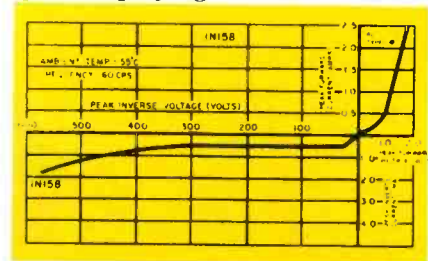

Fig. 2. Dynamic operating curves for a germanium rectifier (GE type 1N158).

nates (see Fig. 3). The main purpose here is to demonstrate how the amplitude varies as the angle changes from 0 to 360°. This type of presentation particularly lends itself to the directional response of antennas and microphones.

The number of scale graduations will depend on the graph itself and the accuracy to which the smallest angle must be shown. In the circular graph of Fig. 3, the angle covered by successive radii is 10°. This area, in turn, is further subdivided into ten minor sections, each representing 1°. The start of the circle, or the location of the 0° marker is entirely arbitrary and is chosen by the person drawing the graph. In this example, it appears at the top of the chart. The remainder of the graph then follows in sequence as we move clockwise around the circle.

• Please turn to page 53

PF REPORTER • January, 1958

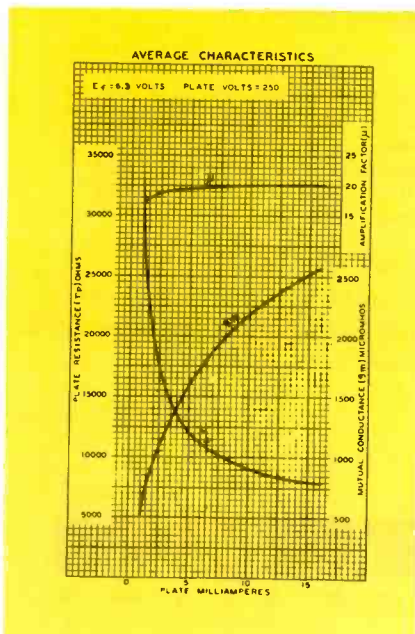
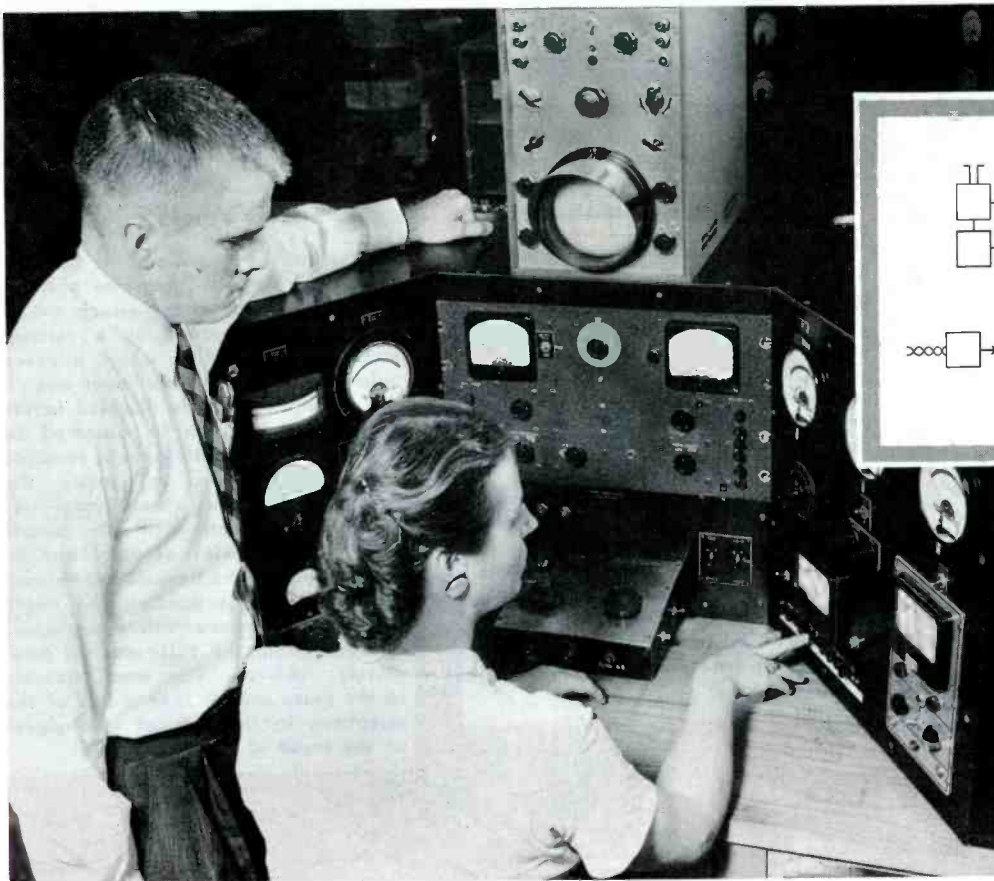

Fig. 1. Graph with 3 separate vertical scales and single horizontal scale.



◀ **G-E PROCESS ENGINEER J. N. Holeman** studies the dial reading of a 6BN6 being checked for AM rejection. When taken at intervals from their life test racks, these G-E audio tubes must continue to show an AM rejection figure that, under standard operating conditions, is at least  $-25$  decibels.

## Guard customers' sets from hum and sync buzz! Install G-E high-quality TV audio tubes!

Once you have adjusted the buzz control on a customer's TV set for noise-free audio, it is annoying . . . and costly in working time . . . to be summoned back later because the buzz has recurred.

Change in the AM-rejection characteristics of an audio tube may produce this result. In order to keep down service callbacks needed to remove buzz and hum, General Electric tests 6BN6's, 3AL5's, 5T8's, and other audio detector types under conditions which closely parallel actual operation—and over periods of time that give ample opportunity for any change in characteristics to develop.

This testing for stability of characteristics throughout tube life, supplements G-E manufacture that employs fully every modern method for building superior performance into the finished product.

A pace-setter in designing and applying audio types, General Electric brings you tubes for replacement that add real listening pleasure to customers' visual enjoyment. Install audio-tube quality you can back up . . . and which will back up *your* service reputation! Phone your G-E tube distributor! *Distributor Sales, Electronic Components Division, General Electric Company, Owensboro, Kentucky.*

*Progress Is Our Most Important Product*

**GENERAL**  **ELECTRIC**

161-1A12

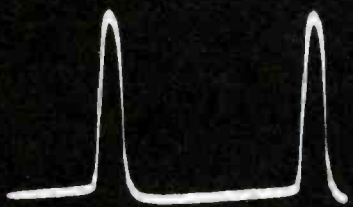

### Snow or Overloaded Picture

Trouble symptoms of this nature are often a result of improper AGC operation. One important check point in a keyed system is the plate of the AGC keying tube. Here we should find a horizontal pulse which has been derived from the flyback circuit; therefore, the scope should be set up for a sweep rate of 7,875 cycles.

Although the negative DC potential at this point will be well within the maximum input voltage rating of the scope, the amplitude of the positive-going keying pulse may be as high as 900 volts peak-to-peak. Thus, the amplitude of the pulse normally present at this point should be considered before applying it to the scope input.



### Poor Synchronization

The input signal of the sync section is composite video and will appear similar to that found at the input to the picture tube. Check sync circuit operation by monitoring the output signal of the final sync stage at a scope sweep-rate of 30 cycles. At this point, no video information should be detected and the vertical sync pulse should predominate as shown.

Check the peak-to-peak amplitude and polarity of the wave. Make sure that video has been properly removed and that no hum modulation exists. Horizontal sync is represented only by the hazy lines between vertical pulses. To view two horizontal pulses, the scope sweep rate must be increased to 7,875 cycles.



### Faulty Vertical Sync

Examine the sync signal at the output of the vertical integrator network by adjusting the scope sweep to 30 cycles. In receivers using a vertical oscillator-output stage where a sweep pulse is fed back to the input circuit, the oscillator must be disabled before the sync signal can be observed by itself. With the oscillator tube removed or its grid shorted to ground, the signal will have only a small amplitude as indicated. The oscillator control pulse at this point actually has no resemblance to the transmitted vertical sync signal. By expanding the sweep of the scope and readjusting brightness and centering, the pulse can be more closely observed. The small notches in the pulse are all that is left of the serrations in the vertical sync signal at the input of the integrator.

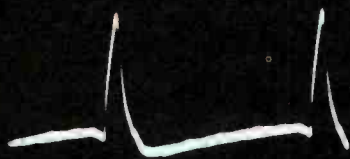

### Loss of Horizontal Sync

View the sync signal applied to the horizontal AFC circuit by adjusting the sweep rate of the scope to one-half the horizontal line frequency, or 7,875 cycles. Check, signal amplitude and shape for any distortion caused by sync clipping.

Some AFC phase-detector stages will require both positive and negative sync pulses. In this case, the amplitudes of the two signals should be equal and their peak-to-peak values should compare with those given in the service data. A check for excessive hum at this point can be accomplished by reducing the scope sweep to 30 cycles.

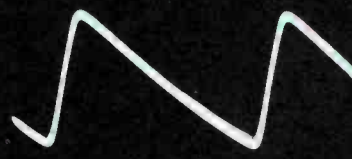

### Improper Horizontal Phasing

Horizontal AFC operation can easily be upset by the lack of proper feedback from the horizontal output circuit. Set the scope sweep rate at 7,875 cycles and observe the feedback pulse at the point of application to the AFC system. Peak-to-peak amplitude of the signal is fairly critical and should be checked against the normal value given in the service data. In some receivers, adjustment of the width coil may affect the amplitude of this pulse.

### Loss of Horizontal Sync

View the sync signal applied to the horizontal AFC circuit by adjusting the sweep rate of the scope to one-half the horizontal line frequency, or 7,875 cycles. Check, signal amplitude and shape for any distortion caused by sync clipping.

Some AFC phase-detector stages will require both positive and negative sync pulses. In this case, the amplitudes of the two signals should be equal and their peak-to-peak values should compare with those given in the service data. A check for excessive hum at this point can be accomplished by reducing the scope sweep to 30 cycles.

### Improper Horizontal Phasing

Horizontal AFC operation can easily be upset by the lack of proper feedback from the horizontal output circuit. Set the scope sweep rate at 7,875 cycles and observe the feedback pulse at the point of application to the AFC system. Peak-to-peak amplitude of the signal is fairly critical and should be checked against the normal value given in the service data. In some receivers, adjustment of the width coil may affect the amplitude of this pulse.

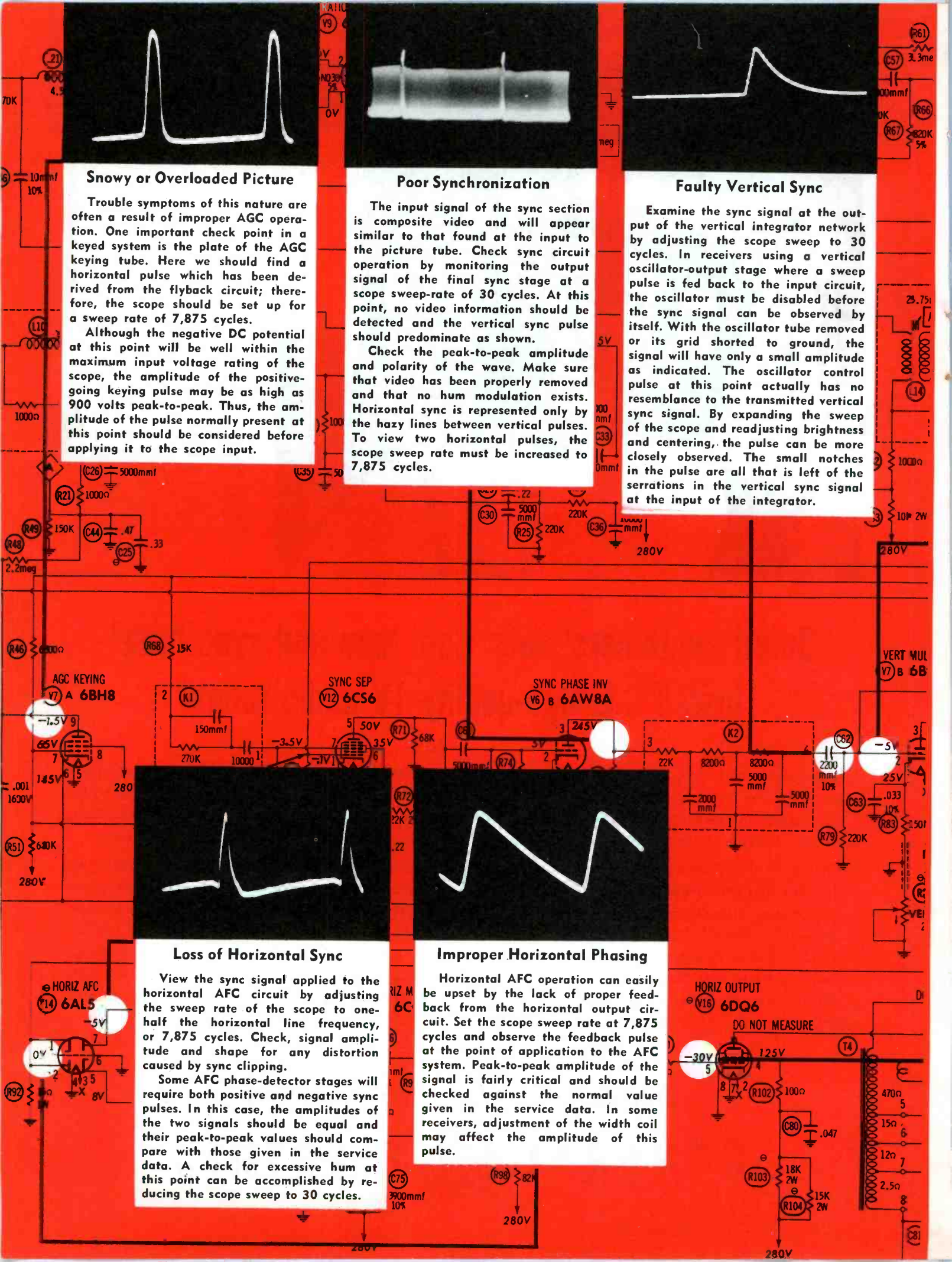



V11 6DG6GT

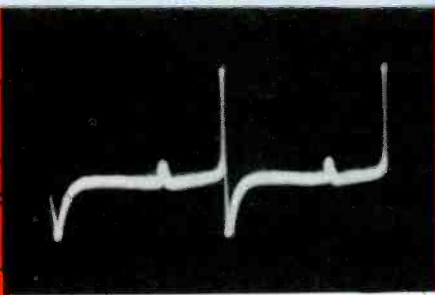

### Loss of Vertical Sweep and/or Sync

With a 30-cycle sweep rate, check the composite signal formed by the feedback pulse and the incoming sync signal at the vertical oscillator input. With the oscillator functioning, the signal may have an amplitude of from 30 to 90 volts peak-to-peak; therefore, the input attenuator of the scope must be adjusted accordingly.

When the oscillator is out of sync, the sync pulses will be in constant motion while the oscillator waveform is stabilized. When properly synchronized, however, the pulses will appear only at the points marked "S." Remember, checking the amplitude of this wave also gives an indication of the vertical sweep output signal.

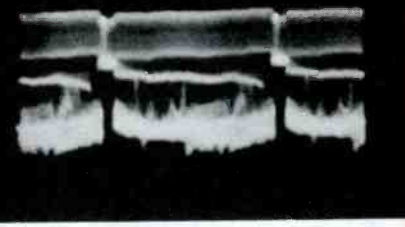

### Picture Distortion or Loss of Video

The composite video signal should be examined at the detector load, at the grid and plate of the video amp and at the picture tube input. In order to view two entire cycles of the signal, the sweep rate of the scope must be adjusted to one-half the vertical sync-pulse frequency or 30 cycles. Signal polarity may either be positive as shown or negative, depending on where the signal is sampled. Check peak-to-peak amplitudes of the wave against values given in the service data. Look for sync-pulse compression or inversion, hum modulation, ringing and interference. To observe the signal ahead of the detector stage, a demodulator probe must be used.

VIDEO DET V5 B 6AM8

VIDEO OUTPUT V6 A 6AW8A

0V 5V

0.5V 5V

5000mmf

CONTRAST 1000Ω

47K

470Ω

# troubleshooting with the.....

# SCOPE

### Introduction

The waveforms shown in this pictorial coverage of the fundamentals of troubleshooting with an oscilloscope are actual photographs taken from a typical scope screen, and represent signals found at key check points in a modern TV receiver.

Using a direct probe, the brightness of the scope was adjusted for reproduction of all portions of each desired signal—the focus control for the sharpest possible trace—and the sync selector switch in the internal sync position. For each example, centering, vertical gain, input attenuator, and horizontal gain controls were adjusted for a pattern of convenient viewing size.

Bear in mind that peak-to-peak voltage values found in service literature are generally based on certain operating conditions. Receiver controls are usually placed in their normal operating positions and a signal level of specific amplitude is maintained at the input of the picture tube.



### Horizontal Sweep Trouble

Check the horizontal drive voltage on the grid of the output tube. The scope should be adjusted for a sweep rate of 7,875 cycles and the input attenuator set to accept a signal of from 50 to 150 volts.

The signal at this point is a positive-going saw and any amplitude deficiency or nonlinearity should be readily apparent in the waveform. If the signal is very weak at this point, loss of high voltage may result. The presence of the signal itself at this point is an indication that the horizontal oscillator is operating.

- 4 5•
- 3 6•
- 2 7•
- 1 8•

HV TRANSFORMER TERMINAL BOARD



Alternate Speaker Used In Some Ver

Focus Jumper From Pins 2 Or 10 For us.



PH 13-14KV 13-5KV

DO NOT MEASURE

R106

18K 2W

R105

DO NOT MEASURE

1

RT HOLD 100K

HEIGHT 2.5meg

100V

T H8

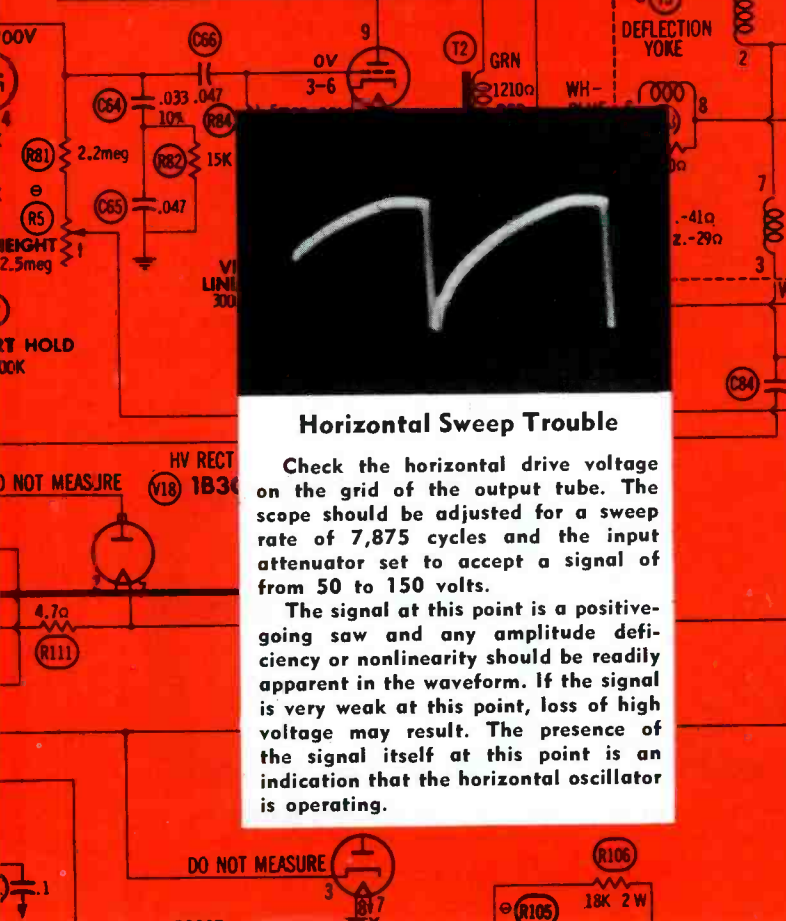
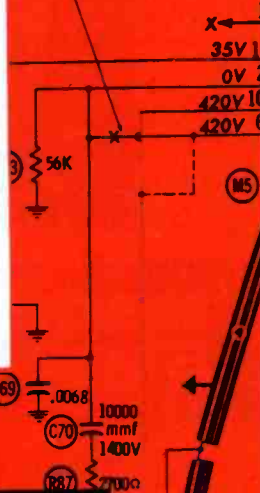
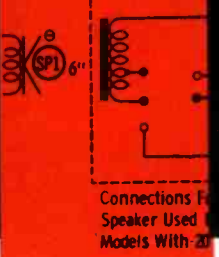
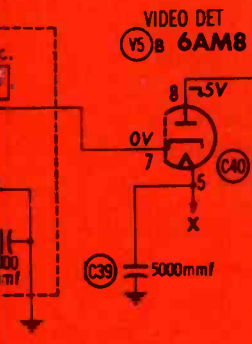
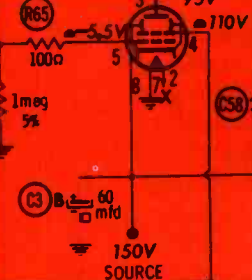

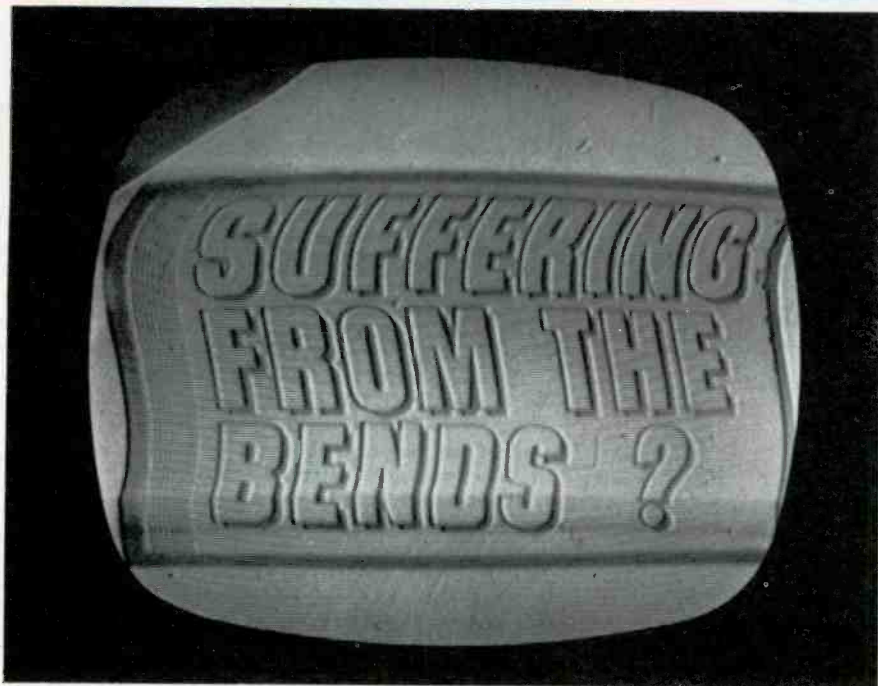

## HERE'S HOW YOU CAN GET RID OF THEM

by Leslie D. Deane

Without a doubt, one of the most exasperating complaints the TV technician has to deal with is that of a pulling, bending, wiggle, or waviness in the picture. Picture pulling is a common term used to describe horizontal distortion in the image, and indicates that the horizontal oscillator is momentarily attempting to lose synchronization with respect to the incoming signal. Picture pulling can result from trouble in various sections of the receiver, and next to loss of raster, is probably one of the most frequently encountered symptoms in TV servicing.

A common cause of picture pulling is either sync-pulse distortion or the presence of a foreign AC signal in the horizontal oscillator circuit. Sync-pulse distortion can occur from overloading, clipping, or poor low-frequency response, while the source of undesired hum

modulation will either be the 60 or 120-cycle power supply, or the vertical sweep system. Both sync distortion and hum modulation can be introduced into any stage in the signal path from the tuner to the horizontal oscillator, and in some instances, even trouble in the power supply will produce picture pulling.

The troubleshooting procedure to be followed for isolating the cause of picture pulling should start in the customer's home and should include a number of basic checks. First, the symptoms should be considered carefully. Before assuming the one obvious trouble of picture pulling, always look for other important symptoms such as brightness modulation, distorted sound, or vertical flopover. Analyzing the presence or absence of these conditions may eventually isolate the fault.

Never neglect to check the trouble symptom on all operating channels. The fault may be due to tuner trouble, station difficulties, or local interference. One should also check the effects of all operating controls upon the pulling, especially adjustments which affect stage gain such as contrast and AGC. These are sometimes overlooked when checking the set in the customer's home.

Perhaps the most frequent cause of picture pulling is heater-to-cathode leakage in an RF or video IF tube. The trouble symptom, however, may appear as shown in either Fig. 1 or Fig. 2 depending upon the extent of the leakage. A high resistance short between cathode and heater in these tubes will introduce a 60-cycle voltage from the filament supply into the video signal. If the 60-cycle modulation is of sufficient amplitude, variations in brightness will also occur on the picture tube screen. Thus, picture pulling accompanied by brightness modulation, as illustrated in Fig. 1, indicates the trouble is in the signal path somewhere between the tuner and the picture tube itself. With a symptom of this nature, the technician should substitute all tubes associated with the RF, IF and video sections of the receiver. More than one tube may be defective; therefore, it's a good idea to leave the replacements in until all substitutions have been completed.

The symptom pictured in Fig. 2 can also be caused by other defects in these same sections. A limited amount of leakage within a tube, or overloading caused by a gassy tube, will often produce picture pulling without noticeable brightness modulation. Of course, without the brightness symptom, picture pulling may also develop

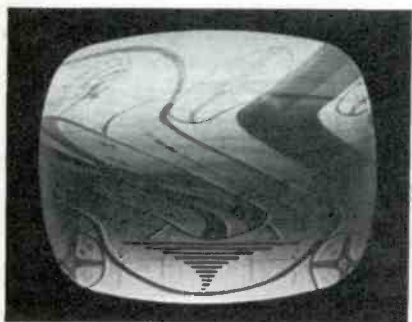

Fig. 1. Picture pulling due to hum modulation, which is also present in raster.

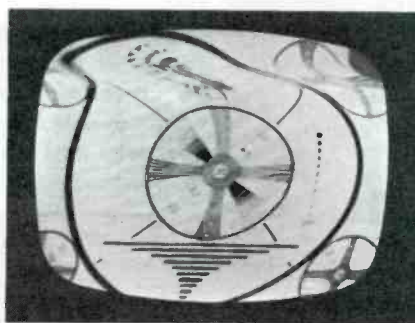

Fig. 2. Pulling produced by a fault in any stage from tuner to oscillator.

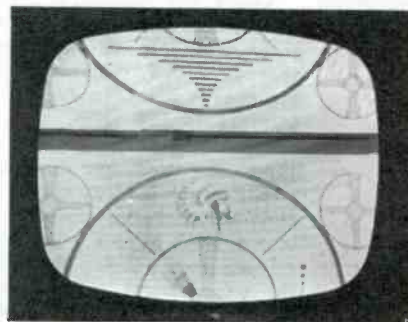

Fig. 3. Vertical blanking reproduction indicates quality of sync-pulse response.

from a faulty tube or tubes in the sync, horizontal AFC, or horizontal oscillator sections.

A simple check that is sometimes useful in isolating the trouble to a general section is to observe the pulling while varying the contrast control. In receivers where the sync take-off point is after the stage employing this control, the pulling should change slightly with its settings. For example, if pulling tends to lessen as the contrast is decreased, the trouble probably lies in one of the video IF or tuner stages, or in the AGC amplifier if one is used. If, on the other hand, the pulling tends to increase as the contrast is reduced, the trouble is most likely in a section which follows the control location—meaning that either the video, sync, AFC, or oscillator stage is at fault.

If the contrast setting seems to have little or no effect upon the symptom and the vertical sync is somewhat unstable, it may be wise to check the sync-pulse response of the receiver. This can be accomplished by viewing the vertical-blanking signal on the picture tube screen. By adjusting the vertical-hold, contrast and brightness controls, one should obtain a condition similar to that shown in Fig. 3. The gray portion of the bar represents the blanking signal and the darker portions represent the vertical sync and equalizing pulses.

If these latter areas are not darker than the darkest elements of the picture, sync amplitude is either being reduced by poor low-frequency response or by sync-limiting action in the video circuit.

To cure picture pulling in the customer's home, the technician should replace all tubes in the suspected circuits and check the settings of the horizontal frequency and AGC controls. If unable to locate the trouble, naturally, the chassis must be pulled and further investigations made in the shop.

With the ailing set on the bench, the technician might first determine whether the pulling or bending is in the video signal alone or in both video and raster. This can easily be determined by moving the picture-centering me-

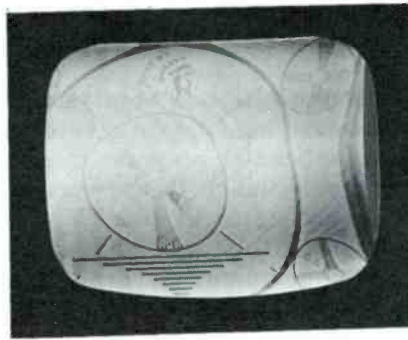

(A) Picture pulling—raster okay.

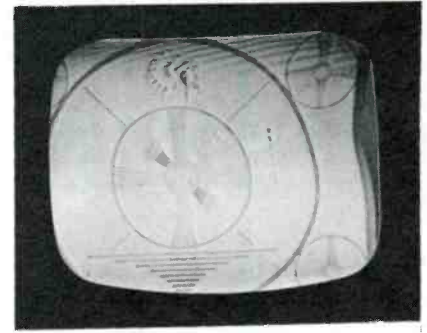

(B) Picture and raster both distorted.

Fig. 4. Picture centering adjusted to view edge of raster.

chanism until one edge of the raster becomes visible and then reducing contrast and increasing brightness until a clear division between picture information and raster appears as illustrated in Fig. 4. In some cases it may be necessary to adjust the horizontal hold or frequency control until the video moves away from the edge of the raster.

If the distortion is only in the video signal, the raster edge will remain straight while the picture pulls as shown in Fig. 4A. If the distortion is affecting the sweep, the raster edge will also have a bend as shown in Fig 4B. An undistorted raster indicates that the trouble is affecting only the horizontal oscillator bias and not the yoke driving signal. When the raster bends, however, the trouble is probably caused by a fault in the oscillator-output section or by vertical or power supply hum on the B+ line.

If the raster shows no sign of distortion, the following simple check should be made to further isolate the trouble. First, disconnect the signal input to the sync section and vary the horizontal and vertical frequency adjustments until you can momentarily observe the picture. If the pulling disappears, then the trouble is ei-

ther in the RF, IF, or video sections. If the symptom remains, reconnect the signal to the sync input and disconnect the sync signal from the horizontal AFC stage. Again adjust the horizontal frequency and check for the pulling condition. The pattern may tend to shift back and forth slowly, but only a glance at the vertical lines in the picture is needed to reveal whether the bending symptom is present or not. If the pulling is no longer noticeable, then the fault probably lies in the sync section. In this case check the sync coupling capacitors since they are the usual culprits. Naturally, if the symptom can still be detected, one should look for trouble in the horizontal AFC and oscillator input circuits.

Assuming the trouble is affecting the video signal, one might take a look at the composite waveform in the video amplifier stage. With the scope set at a 30-cycle sweep rate, you should be able to view two vertical sync pulses—see waveforms in Fig. 5. In viewing the waveforms at this point in the receiver, a check for both sync pulse distortion and hum modulation should be made. As

• Please turn to page 59

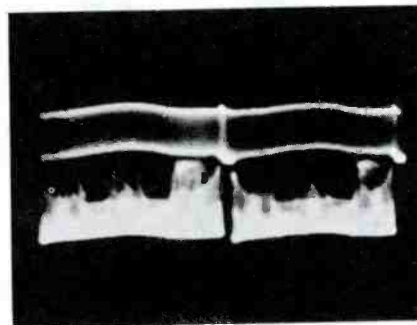

(A) Normal composition video signal.

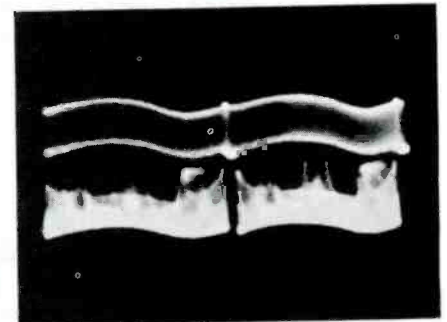

(B) Signal with 60-cycle hum.

Fig. 5. Waveforms at plate of video amplifier—sweep rate 30 cps.

# Keeping Up With Vertical Sweep

## waveform study of a newly popular blocking oscillator

by Calvin C. Young, Jr.

The requirements of the vertical sweep section in a television receiver are twofold: It must sweep the electron beam across the picture tube face in a vertical direction and it must do this in synchronization with the vertical sweep generator at the TV station.

These requirements demand a free-running oscillator that can be synchronized with a pulse signal. It must be free-running to insure that the picture tube screen will be scanned in a vertical direction even when no signal is being received.

The free-running frequency of the oscillator must be slower than its synchronized frequency so that the incoming synchronizing pulse can trigger the oscillator before it would normally trigger of its own accord. This is illustrated in Fig. 1. If the free-running frequency of the oscillator were too fast, it would trigger itself ahead of time and the sync-pulses would have little or no effect on the action. Now that we have established the basic requirements of the vertical sweep system, let's see how each part of the system works to meet these requirements.

### Grid-to-Cathode Coupled Blocking Oscillator

The first stage in the vertical sweep generator chain of a TV receiver is the oscillator. It must

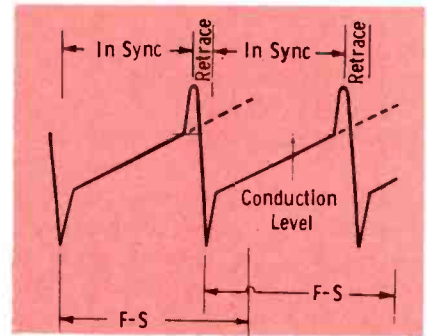

Fig. 1. Grid waveform comparison of in-sync and free-running conditions.

deliver to the vertical output stage a timed driving signal which has the proper amplitude and shape to produce a sawtooth current through the deflection yoke.

A free-running oscillator must have a feedback path so that a portion of the output signal can be used to sustain oscillations. In the circuit of Fig. 2, energy is fed back through the coupling action of transformer T2. It is interesting to note that instead of the usual plate-to-grid feedback, cathode-to-grid feedback is provided by the transformer. The action is essentially the same since the same current flows in both the cathode and plate circuits of a triode. Examination of the signal waveforms directly associated with the oscillator (W3, W4, W5, and W6) shows that the grid, cathode and plate signals are in phase and that the tube conducts for only a very short time during the retrace period.

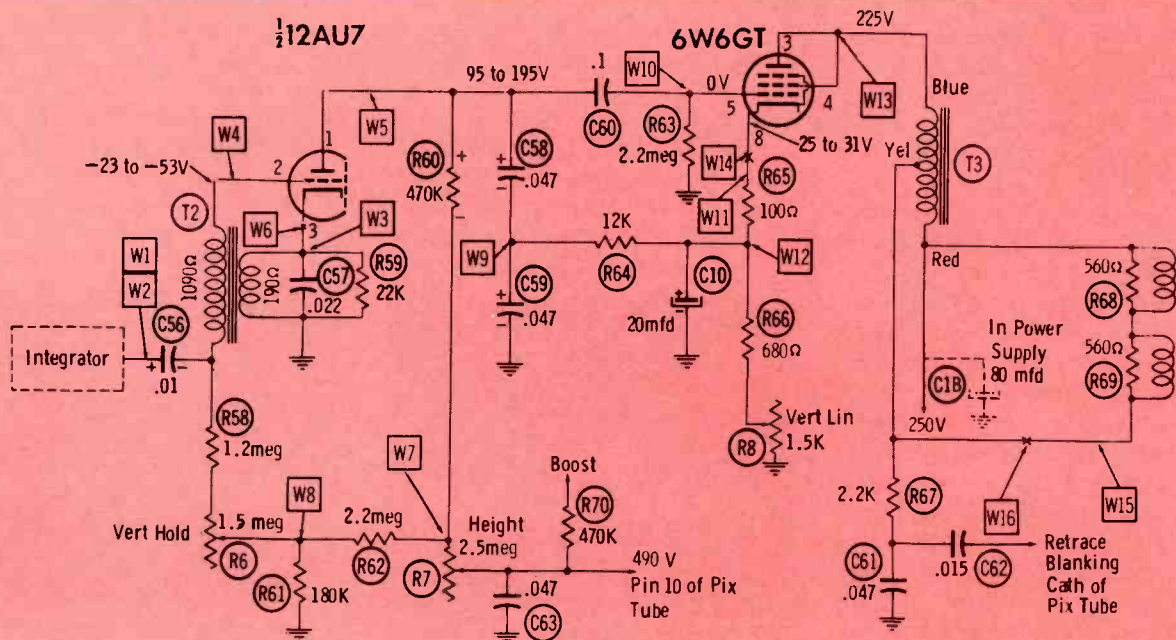
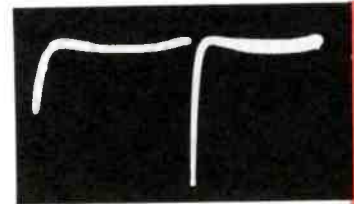

Fig. 2. Schematic of a blocking oscillator using cathode-to-grid coupling.

The plate of the tube is connected to a positive voltage source through a 470K resistor and the height control, and the cathode is connected to B— (chassis ground) through transformer T2. This means that the instant the tube heats up and starts to conduct, the rapid increase of current (W6) through T2 will induce a grid voltage (W4) that will cause the grid to draw current, charging C56 and cutting the tube off. While this is happening, the tube is conducting very heavily, which increases the voltage drop across R6 and allows C58 to discharge (W5) through the oscillator tube. The moment the oscillator tube stops conducting, the plate voltage rises toward the value of the supply voltage and C58 begins to charge. As you can see, we have a rapidly changing series of events occurring in both grid and plate circuits. So that the reader may get a clear idea of the action in each circuit, they will be dealt with separately.

#### Grid Circuit Action

Returning to the grid circuit, we find C56 gradually discharging through R58, R6 and R61, as represented by the gradual rise of the trace in W4 (from a highly negative toward a less negative potential). This point can be very confusing, but it is very important, so let's examine it again. The grid of the oscillator is driven positive by the induced signal across the transformer, causing grid current to flow. This charges C56 in the polarity shown in Fig. 2 (represented by sharp downward spike in W2) and drives the tube into cutoff. When cutoff is reached, the capacitor begins to discharge through the grid resistance to ground, reducing the bias on the tube. Before capacitor C56 discharges enough to permit the tube to conduct, a positive-going sync pulse (the sharp positive spike in W1) arrives via the integrator and drives the tube into conduction. At this point, we want to emphasize that the discharge time of C56 can be varied with the adjustment of the vertical-hold control. This control is necessary to compensate for changes in tube characteristics, resistance and capacitance values which would otherwise



W9  
45V  
p-p

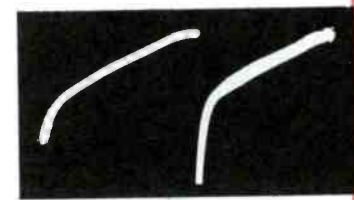

W10  
95V  
p-p

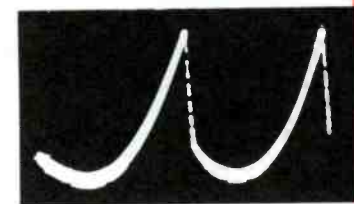

W11  
5.5V  
p-p

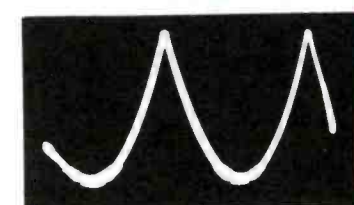

W12  
3V  
p-p

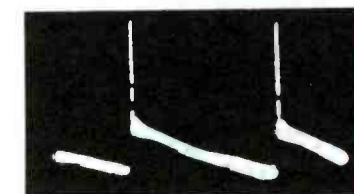

W13  
620V  
p-p

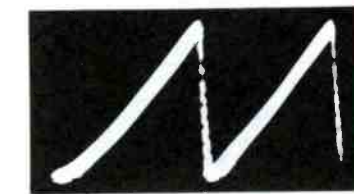

W14  
48 ma  
p-p



W15  
100V  
p-p

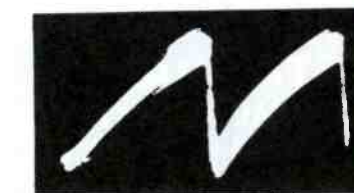

W16  
440 ma  
p-p

W1  
15V  
p-p



W2  
35V  
p-p

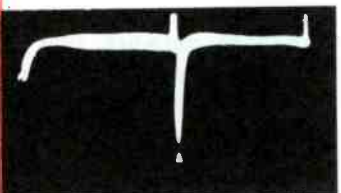

W3  
50V  
p-p

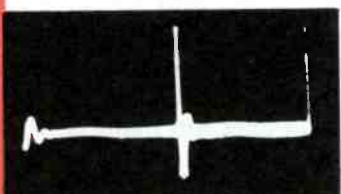

W4  
180V  
p-p



W5  
45V  
p-p

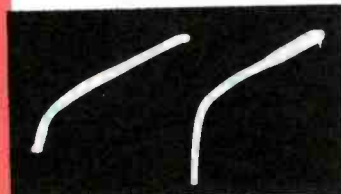

W6  
30 ma  
p-p

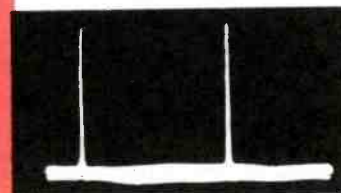

W7  
50V  
p-p



W8  
15V  
p-p

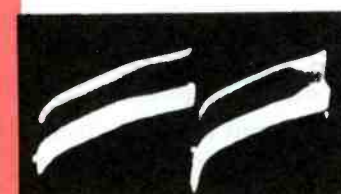

# NO CHASSIS BITES When You Use *Adjust-A-Volt*

## Variable Isolation Transformers

Combines features of both variable and isolation transformers. Drop line voltage to check faulty oscillator. Cook set to breakdown intermittent parts. Isolated primary winding eliminates chassis touching jitters. No service bench is complete without an Adjust-A-Volt!



Model	Input Volt.	Output Volt.	Amps. Max.	Net Price
LR-5	115	70-140	5.0	\$29.50
LR-10	115	70-140	10.0	57.50
LR-24	230	70-140	10.0	61.50



### METERED MODELS

Model	Input Volt.	Output Volt.	Amps. Max.	Net Price
LRL-5	115	0-140	5.0	\$41.50
LRL-10	115	0-140	10.0	69.50



**PA-1 AUTO-TRANSFORMER.** Low cost, \$13.50, small compact auto-transformer ideal for controlling soldering iron heat for repair of printed circuits.

Write for Adjust-A-Volt catalog showing complete line.

**STANDARD**  
ELECTRICAL PRODUCTS CO.  
2240 E. THIRD ST., DAYTON, OHIO

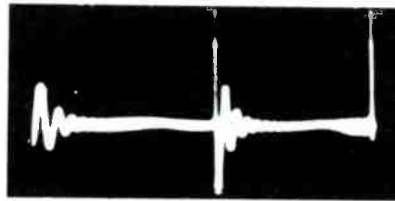

Cathode with R59 removed.

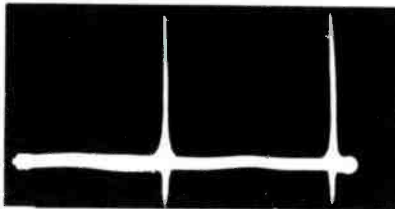

Cathode with C57 removed.

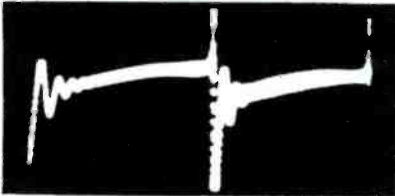

Grid with R59 removed.

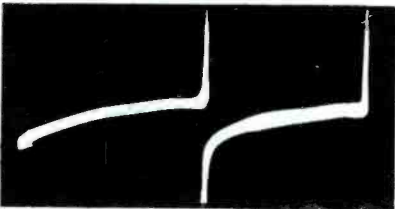

Grid with C57 removed.

Fig. 3. Oscillator cathode and grid waveforms with cathode components removed.

cause loss of synchronization.

### Plate Circuit Action

During the time that C56 is discharging, C58 is charging through R60 and R7. This provides the scan portion of the signal as indicated by the gradual rise of the trace in W5. The sudden voltage increase from the most negative point is due to current surge through the 12K resistor R64 and capacitor C59 the instant the oscillator tube is cut off, producing a voltage spike across R64. This is more readily understood when you consider that R64 is returned to chassis ground through a 20-mfd capacitor paralleled with R66 and R8 and that the impedance of a 20-mfd capacitor is only 132 ohms at 60 cps.

With these facts in mind, the charge path of C58 should be clear to all; however, since there may be some who won't see the complete path, let's follow it through. Electrons leave the top side of C58 and pass through R60, R7, R70, the power supply, and C10 and R64 in parallel with C59 to the bottom side of C58. We now

see that the charge of C58 through R60 and R7 produces the signal (W5) which is then coupled through C60 to the control grid of the output stage.

### Other Features

To complete the discussion of the oscillator stage, let's examine the feedback network that exists between the plate and control grid and the RC network in the cathode circuit. As indicated by W7, a portion of the plate signal is developed across the unbypassed part of the height control R7 and is fed to the grid circuit through a resistive divider network consisting of R61 and R62. The feedback signal stabilizes the oscillator and does not materially affect its frequency.

The capacitor and resistor across the cathode winding of T2 are not a part of the frequency-determining circuit; instead, they

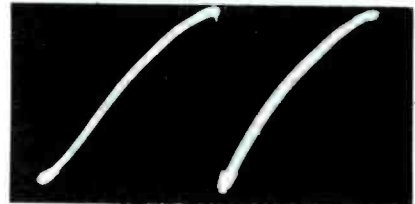

C59 shorted



C60 leaky

Fig. 4. Abnormal amplifier grid signals.

are employed to shape the pulse fed back to the grid. C57 tunes with the transformer inductance and R59 acts as a resistive damper, reducing the Q of the circuit. The waveforms in Fig. 3 show the effects on the grid and cathode signals when C57 and R59 are removed from the circuit. You will note that without these components, the signals are greater in amplitude and have much sharper spikes, which could result in less stable operation and a shorter life for T2 due to the increased peak-to-peak signal level.

### Output Amplifier Circuit

The output amplifier includes a triode-connected pentode and an autotransformer which directly

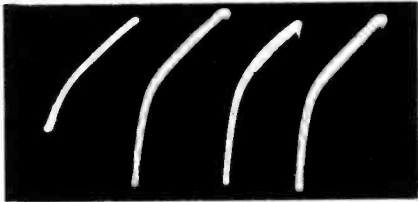

Fig. 5. Sweep signal when C56 is leaky. This drives the deflection yoke. This is a straight forward power amplifier stage with but one exception; namely, the unbypassed 100-ohm resistor in the cathode circuit. This provides degeneration as indicated by a comparison of W11 and W12, increasing the low-frequency response of the stage. With this configuration, only 20 mfd is used to bypass the remainder of the cathode load (R66 and R8) instead of the more familiar 100 or 150 mfd usually found in this application.

Current through the output tube (W14) varies in accordance with the signal on the control grid (W10). The linearity control is provided so that the bias on the stage can be adjusted and the operating point of the tube shifted up or down the characteristic curve. Notice that tube current (W14) is practically identical to the current through the deflection yoke (W16) and that the voltage waveform at the plate (W13) and at the high side of the yoke (W15) are also very similar. The small difference is due to the presence of some 15,750 cps energy in the vertical winding of the yoke.

### Troubleshooting

Troubles normally associated with the vertical sweep circuit are loss of synchronization and loss of or distortion of sweep, the symptoms of which are familiar to us all. The appearance of some of the key waveforms when operation is abnormal are not so well known. The waveforms in

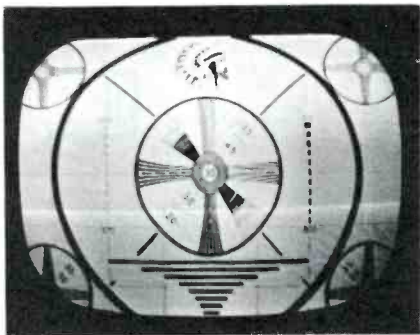

Fig. 6. Picture distortion caused by "knee" in tube curve.

Fig. 4 were taken at the amplifier grid under different trouble conditions (note the differences between these and the normal waveform W10). Fig. 5 shows the waveform present at the oscillator plate when the .01 capacitor C56 is leaky. You can see that there are now four cycles of signal, while all of the other waveforms have only two. Identical scope settings were used in obtaining all of these waveforms, so we immediately know that the oscillator is running at twice its normal speed. Realizing that the oscillator frequency is primarily a function of C56 discharge through R58, R6 and R61, the obvious procedure is to check the values of these components. As strange as it sounds, an open transformer winding can also cause a very similar symptom.

The test pattern in Fig. 6 is an

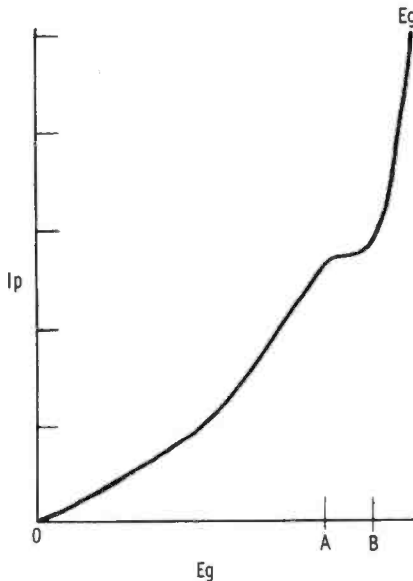

Fig. 7. Eg-Ip curve showing "knee."

example of an infrequent trouble. In this case, both oscillator and output tubes checked good in a high-quality tester, yet replacement of the output tube cured the trouble. The line across the screen and the nonlinearity are both due to a "knee" in the operating characteristic of the tube. By this we mean that instead of a linear characteristic curve, the particular tube has a curve with a bend or dip within the operating portion of its curve. (See Fig. 4.) Thus, as the grid signal swings between voltage points A and B, very little or no change in plate current takes place and the linearity of the sawtooth driving signal is affected. ▲

## TRANSFORMER NEWS FROM TRIAD

### YOKE SERVICING SIMPLIFIED

CHANGE THIS

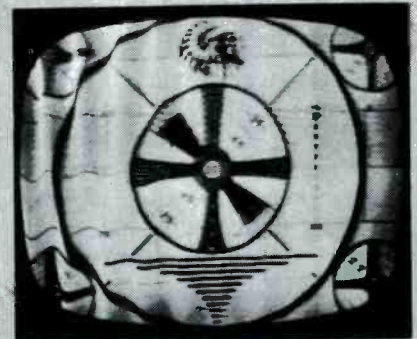

This is caused by improper value of horizontal damping network—or network mounted on wrong terminal.

TO THIS

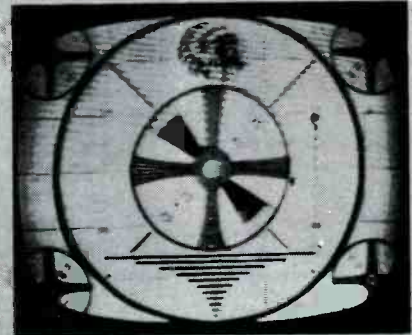

WITH THIS

FLYBACK	YOKE	NETWORK	VERT. OUT
738079 D-44	708176 Y-19(-3)	NW-1	738081 A-111X
738068 D-43	708174 Y-41(-3)	NW-1	738066 A-118X
738078 D-95	708174 Y-41(-3)	NW-4	738076 A-118
738099 D-81	Y-19(-3)	NW-1	

Correct yoke servicing\* information as listed in Triad's Television Replacement Guide TV-57. It is available at your distributor.



\*Bonus information to the PTM offered only by Triad.

4055 REDWOOD AVENUE, VENICE, CALIF.  
812 E. STATE STREET, HUNTINGTON, IND.  
A SUBSIDIARY OF LITTON INDUSTRIES.



# QUICKER SERVICING

by Calvin C. Young, Jr.

## Service Hint on Magnavox Tuner

The star gear used as a detent mechanism on 700584 and 700587 tuners (Fig. 1) can cause excessive wear on the detent spring unless proper lubrication is maintained. As indicated in the drawing, "Lubriplate" or a similar product should be applied liberally to the detent springs. In so doing, it is very important that both sides of the point of contact be lubricated.

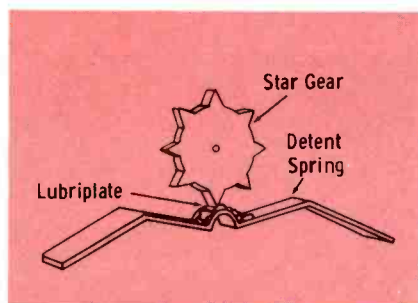

Fig. 1. Magnavox tuner, detent assembly.

Although the detent springs should last the life of the set with proper lubrication, excessively worn springs should be replaced with Magnavox part number 635580.

## Scope Locates Cause of Negative Pictures

Hal Russell of Philadelphia, Miss., reports that his oscilloscope was most valuable in finding the cause of a negative picture and weak, distorted sound in a GE Model 21C137 TV receiver. Naturally, Hal first checked by substitution all tubes that could have caused this trouble (tuner, video IF, AGC and video amplifier), but without success.

Stopping to think a moment before plunging blindly into the set, he reasoned that the signal reaching the picture tube grid would have to be inverted for blacks to

be white and whites to be black. He further reasoned that, in order to find the trouble, he had only to locate the stage where the inversion was taking place.

Using the oscilloscope, he found a negative-going signal on both the cathode of the picture tube and the grid of the video amplifier stage (Fig. 2). These signals not only had the same phase but also the same relative amplitude. Hal now knew that the video amplifier stage was causing his trouble because normal phase inversion was not taking place and the stage was not providing any gain.

The VTVM was next employed, and only 20V was found on the plate of the 6AU8. A point-to-point check of the plate load circuit of this stage showed that the 5,600-ohm, 4-watt resistor was open. Replacing the resistor with one of an identical rating and type restored both picture and sound to normal. An exact replacement was used because any change in the plate load characteristics of a video amplifier stage would materially affect frequency response and therefore picture quality.

## About That Fusible Resistor

As the name implies, a fusible resistor is both a fuse and a resistor. Both of these characteristics are very important to TV receiver operation. The fuse feature is designed to protect the receiver circuits against overloads that would damage them, and the resistance serves as a surge limiter to protect the B+ rectifiers when power is first applied.

Most technicians know that fusible resistors are available in several ohmic values and generally have a 5-watt rating, but they don't know how the value of the unit affects its operation.

In a given TV receiver, there will be a certain amount of B+ current which will flow through the fusible resistor (Fig. 3). The original resistance value was calculated so that the 5-watt unit would operate at a temperature just below the fusible point under normal conditions; thus, a large overload will blow the unit at once and a smaller overload will take longer to actuate the fuse. (This action is identical to that of a standard fuse.)

If for any reason a unit with a lower resistance value is installed in the circuit, the unit will operate cooler (since the same B+ current flowing through a lower resistance results in less wattage dissipation and the fuse action will be defeated. By the same token, the installation of a unit with a higher resistance value will cause the unit to run at a higher than normal temperature and thus tend to open too readily. Small line voltage surges, or perhaps

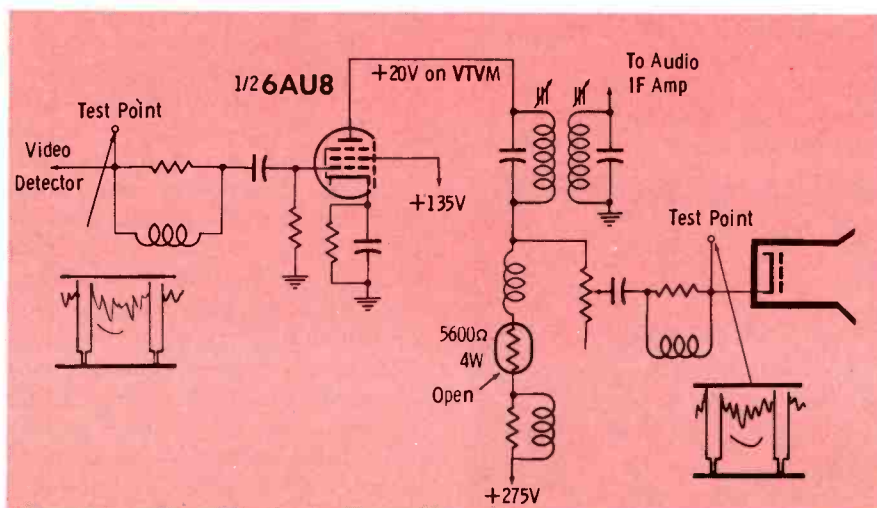

Fig. 2. Schematic of video output and picture tube circuits in GE receiver.



*Mr. Independent Service Dealer:*  
**are you helping to support  
 your "competitors"?**



Not if you buy and use Raytheon Television and Radio Tubes. Raytheon does not have a factory TV-Radio service organization — does not compete with you in any way for service business. Raytheon believes that TV-Radio service is *your* business and serving you is Raytheon's.

Every time you buy a Raytheon Tube you buy from the first tube manufacturer to help independent service dealers. For more than thirteen years Raytheon, through their Distributors, has offered independent service dealers the many benefits of the Raytheon

Bonded Dealer Program. Support through national advertising, Western Union Operator 25 service and Group Life Insurance are among other business building dealer helps that Raytheon has pioneered for "independents".

But most important of all, Raytheon makes TV and Radio Tubes that are ideal for all replacement work, because they are designed to provide quality performance in all makes and models of TV and Radio sets. Use them with complete confidence that they are best for you . . . and for your customers, too.

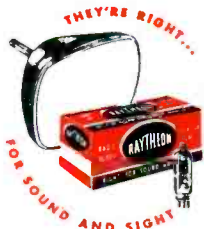

<b>RAYTHEON MANUFACTURING COMPANY</b>			
<i>Receiving and Cathode Ray Tube Operations</i>			
NEWTON 58, MASS. 55 Chapel Street	CHICAGO, ILL. 9501 Grand Ave. (Franklin Park)	ATLANTA 6, GA. 1150 Zonolite Rd. N.E.	LOS ANGELES 7, CALIF. 2419 So. Grand Ave.
Raytheon makes all these		} Receiving and Picture Tubes, Reliable Subminiature and Miniature Tubes, } Semiconductor Diodes and Transistors, Nucleonic Tubes, Microwave Tubes.	
			<i>Excellence in Electronics</i>

the specs are the proof . . .  
 the BEST BUYS are **EICO**  
 for COLOR & Monochrome TV servicing



**NEW COLOR**  
 and Monochrome  
 DC to 5 MC LAB & TV  
 5" OSCILLOSCOPE

=460  
 Factory-wired  
 and tested \$129<sup>95</sup>  
 Also available as kit \$79<sup>95</sup>

• Features DC Amplifiers!

Flat from DC-4.5 mc, usable to 10 mc. VERT. AMPL.: sens. 25 rms mv/in; input Z 3 megs; direct-coupled & push-pull thruout; K-follower coupling bet. stages; 4-step freq-compensated attenuator up to 1000:1. SWEEP: perfectly linear 10 cps-100 kc (ext. cap. for range to 1 cps); pre-set TV V & H positions (30 & 7875 cps); auto. sync. ampl. & lim. PLUS: direct or cap. coupling; bal. or unbal. inputs; edge-lit engraved lucite graph screen; dimmer; filter; bezel fits std photo equipt. High intensity trace CRT. 0.06 usec rise time. Push-pull hor. ampl., flat to 400 kc, sens. 0.6 rms mv/in. Built-in volt. calib. Z-axis mod. Sawtooth & 60 cps outputs. Astig. control. Retrace blanking. Phasing control.



**NEW TV-FM**  
 SWEEP GENERATOR  
 & MARKER

=368  
 Factory-wired  
 and tested \$119<sup>95</sup>  
 Also available \$69<sup>95</sup>  
 as kit

Entirely electronic sweep circuit (no mechanical devices) with accurately-biased inductor for excellent linearity. Extremely flat RF output: new AGC circuit automatically adjusts osc. for max. output on each band with min. ampl. variations. Exceptional accuracy: edge-lit hairlines elim. parallax. Swept Osc. Range 3-216 mc in 5 fund. bands. Variable Marker Range 2-75 mc in 3 fund. bands; 60-225 mc on harmonic band. 4.5 mc Xtal Marker Osc., xtal supplied. Ext. Marker provision. Sweep Width 0-3 mc lowest max. deviation to 0-30 mc highest max. dev. 2-way blanking. Narrow range phasing. Attenuators: Marker Size, RF Fine, RF Coarse (4-step decade). Cables: output, 'scope horiz., 'scope vertical.

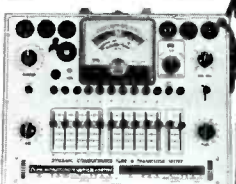

**NEW DYNAMIC**  
 CONDUCTANCE  
 Tube &  
 Transistor Tester

=666  
 Factory-wired  
 and tested \$109<sup>95</sup>  
 Also available \$69<sup>95</sup>  
 as kit

COMPLETE with steel cover and handle. SPEED, ease, unexcelled accuracy and thoroughness. Tests all receiving tubes (and picture tubes with adapter). Composite indication of Gm, Gp & peak emission. Simultaneous sel of any 1 of 4 combinations of 3 plate voltages, 3 screen voltages, 3 ranges of continuously variable grid voltage (with 5% accurate pot). New series-string voltages: for 600, 450, 300 ma types. Sensitive 200 ua meter. 5 ranges meter sensitivity (1% shunts & 5% pot). 10 SIX-position lever switches: free-point connection of each tube pin. 10 pushbuttons: rapid insert of any tube element in leakage test circuit & speedy sel. of individual sections of multi-section tubes in merit tests. Direct-reading of inter-element leakage in ohms. New gear-driven rollchart. Checks n-p-n & p-n-p transistors: separate meter readings of collector leakage current & Beta using internal dc power supply. CRA Adapter \$4.50

See the 50 EICO models IN STOCK at your neighborhood distributor. Write for FREE Catalog PF-1

Prices 5% higher on West Coast



33-00 Northern Blvd.  
 Long Island City 1, N.Y.

just normal operation over a period of time, are then sufficient to blow the unit.

In the matter of surge protection, the higher the resistance the greater the limiting of initial surge currents. However, an increased resistance produces an increased voltage drop, and the resistance value will be determined primarily by the current drain on the B+ circuit.

Cases where the fusible resistor fails repeatedly for no apparent cause can usually be traced to either high or fluctuating line voltage. If the trouble is simply high line voltage, an adjustable line transformer can be employed to reduce the voltage applied to the set. If voltage fluctuations are causing the trouble, however, a regulating type of transformer would have to be employed.

There will also be cases where repeated fusible resistor failures are due to increased current demand by one or more circuits in a receiver. The power consumption figure included in the service data can be used in conjunction with an AC wattmeter to check for this condition. Naturally, the filament circuit will consume only a certain fixed amount of power, and the balance will be used by the B+ circuit; therefore, any material increase in power consumption is an indication of excessive drain on the B+ circuit or a defect in the B+ circuit itself. The fuse is in danger of blowing if operation is continued.

**Increasing Your Business**

The best way to increase your business is to do more work on each TV set you service. The extra work, however, should improve either the set's performance or its appearance to the customer. As an example of extra work you might do on a typical call, suppose that a customer complains of excessive snow and you find in 5 minutes that a 6BQ7A cures the trouble. Instead of just putting in a tube and leaving, you also checked receiver operation and found that:

1. The contrast control was dirty,
2. the height and vertical linearity were not adjusted in proper ratio, and

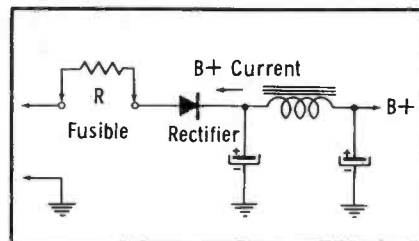

Fig. 3. B+ circuit with fusible resistor.

3. the picture tube was dirty. After informing the customer of these minor discrepancies, you proceeded to eliminate them and make a nominal charge for your services. *Net result:* One very well-satisfied customer. *Reason:* You expertly analyzed all of her troubles and made that extra effort to see that her TV was left in the best possible operating condition. *By-product:* Later on you can expect calls from neighbors wanting your expert services on their receivers.

It has been proven time and again that the best advertising for any business is a well-satisfied customer. The beauty of this idea is that satisfying a customer by the above method doesn't cost you money but earns it for you instead.

The preceding example covers only a few of the extra services that can help you to increase your business. Others are: (1) If the picture tube is bright enough and focuses well, but keeps flashing on and off because of a poor connection, solder it. Make a small charge, and tell the customer you will allow her the amount of this charge on a new picture tube if and when it is needed. (2) Re-adjust size and centering of the picture. (3) Clean the chassis (in shop). (4) Clean tuner contacts if needed. The customer usually



doesn't understand that dirty contacts cause flashing pictures. (5) Clean dirty controls. (6) Install new springs in loose knobs. Above all else, be sure the customer knows of these extra services. This is how you increase your business in the most profitable way.

### Hint on 1958 Westinghouse

If you should get a 1958 Westinghouse with a motorized tuner into your shop for service, remember that the chassis will have to be placed in its normal horizontal position in order to observe operation of the channel-changing mechanism.

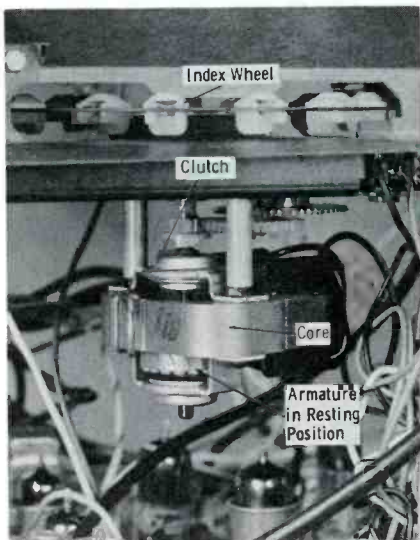

Fig. 4. Motorized drive and indexing wheel in 1958 Westinghouse receiver.

As shown in Fig. 4, the motor is disengaged from the gears in its normal resting position. Actuating the motor draws the armature up into the center of the motor core and engages the gears through a clutch. When an indexed channel is reached (index slider in outermost position), power is removed from the motor and the combination of a small spring and the weight of the armature disconnects the clutch. If the chassis is turned on its side, the armature weight is not available to help disengage the clutch and the motor will run continuously.

If it is desired to operate the chassis in any other than the normal position, do not actuate the tuning motor. Instead, change channels by manually turning the index wheel to the desired channels. ▲



**"EMERGENCY CALL GUS!—LADY SAYS THEIR HI-FI'S GONE HAYWIRE AND HER HUSBAND IS THREATENING TO FIX IT HIMSELF!"**

The lady's right Gus — her husband can't compete with a trained technician and his stock of

Webster cartridges. And the whole family will be happier with the results — the renewed life found in their records.

There's more money in it for you too

because there's never an unhappy customer.

**BUY WISELY...BUY WEBSTER!**

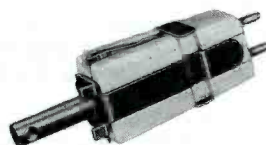

Model B202—3-speed; push-in mounting; clip-mounted needles.

Free—large print of this Lichty cartoon suitable for framing. Request on your own letterhead.

ELECTRONICS DIVISION

WEBSTER  ELECTRIC  
RACINE · WIS

# the TROUBLESHOOTER

answers to  
readers'  
service  
problems



## Long Warmup

I am servicing a Majestic Model 17C64. The set checks out all right, but it takes some time for the picture to come on—30 or 40 minutes. Sound comes on O.K. as soon as the set warms up.

MAX NEMOY

Bronx, N. Y.

Your trouble is probably due to a defective picture tube, but another possibility is trouble within the horizontal output and high voltage circuits. In order to isolate the trouble, you should check for the presence of high voltage immediately after the normal warmup period. Its absence would indicate trouble in the horizontal or high-voltage stages. If high voltage is present but still no raster is produced, check the voltages associated with the picture tube. Normal voltage variations produced by adjustment of the brightness control are an indication of a defective picture tube. Abnormal voltages point to trouble in some portion of the circuitry surrounding the picture tube.

## Puzzling Symptom

On a 17" RCA, when anything light-colored (such as a man wearing a white shirt or waving his hand) appears at the right side of the screen, a flashing or "reflection" occurs. It does not happen all the time, but occurs often enough to be annoying. An explanation of this effect would be greatly appreciated.

DANIEL P. MCCALL

Wakefield, Mass.

Although you did not supply the model number of this receiver, the horizontal sweep systems of most RCA receivers are very similar. It is possible to have a slight phasing error in the horizontal oscillator, with the result that the retrace interval in the horizontal scanning signal does not coincide exactly with the horizontal blanking

portion of the video signal. Consequently, the CRT beam is allowed to come out of cutoff during a small part of the retrace time, and "flashing" appears near light-colored objects at the left edge of the picture. You might try readjusting the frequency and phasing slugs in the horizontal oscillator circuit.

## 630 Chassis

The complaint on an RCA Model 630-TS was no raster and no high voltage. A visual inspection of the underside of the chassis was made, and a blown  $\frac{1}{4}$ -amp high voltage fuse was found. A further check revealed that the 100-ohm cathode resistor of the 6BG6G horizontal output tube was burned in half and that the 22K-ohm resistor in the screen return was severely scorched. An ohmmeter check of the latter showed it to measure only 300 ohms. Replacing the two resistors and the fuse returned the high voltage to normal.

EDWIN R. NICHOLS

Washington, D. C.

Our service records indicate that most failures of these resistors in 630-TS sets have been caused by faulty 6BG6G tubes, and that the faults do not necessarily show up when the tubes are tested. In cases of repeated resistor or fuse burnouts, it would be a good practice to replace the 6BG6G even if it does not appear defective.

## Trap those Ions!

In the October "Letters to the Editor" column, Mr. Milton E. VerDoot of Green Bay, Wis., described a problem concerning insufficient brightness, and your answer was, "Sounds like a misadjusted or defective ion trap. Suggest you substitute one having the correct magnetic strength."

How does one readily determine if an ion trap has lost its magnetic strength?

How does one know what the original magnetic strength of an ion trap was?

How does one go about ordering an

ion trap of the required magnetic strength?

ADAM ZELINSKI

Kearny, N. J.

As we said before, an ion trap is best checked by substituting a new unit of correct magnetic strength. The parts distributor can supply you with the right one if you specify the picture tube type for which the ion trap is needed. In this case, you don't really need to know the numerical value of the magnetic strength. However, the larger 21" to 27" picture tubes generally require an ion trap of 37 to 40 gauss, while most 14" to 17" tubes use a 34- to 37-gauss magnet.

## Negative Picture

I'm stumped by a Motorola Chassis TS-292C. The fault is a negative picture with loss of sync, and the horizontal frequency is off. I have checked voltages, tubes, and resistances, but before I can make a complete check the set will operate perfectly and I can't check any further.

JONES RADIO & TV REPAIR

Ft. Wayne, Ind.

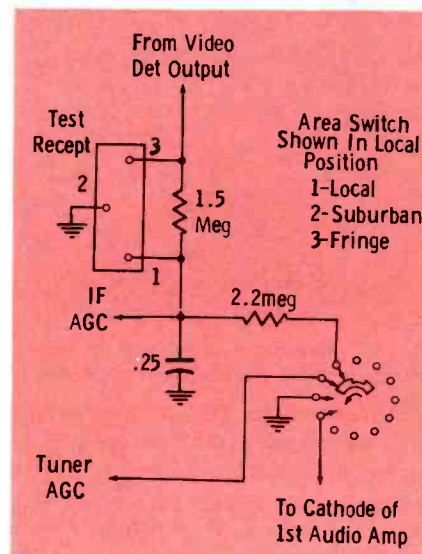

Sounds very much like AGC trouble. You could try clamping the AGC line at whatever voltage level is normal for your area. If this clears up the trouble, check for defects in the various resistors and capacitors in the AGC circuit. You might also recheck the IF amplifier tubes for such conditions as gas and leakage.

The symptoms might also be caused by a defective or misadjusted area-selector switch. As shown in the diagram, AGC is fed to the tuner through this switch when it is in the "local" position. This connection could be open because of poor contacts, thus killing the tuner AGC voltage; or the AGC line to the tuner might be mistakenly grounded by setting the switch in the "suburban" or "fringe" position. In the latter position, AGC to the IF strip is also reduced because a 2.2-meg resistor is shunted across the AGC line.

more things to sell...  
and help you sell...

# your INDEPENDENT SERVICE



NEW THREE-PIECE WINDOW DISPLAY

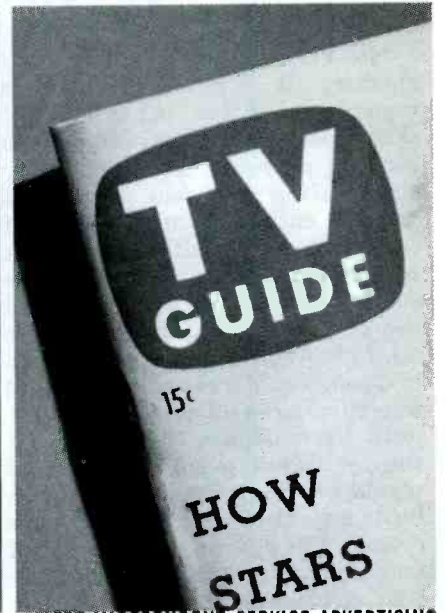

MORE INDEPENDENT SERVICE ADVERTISING

## Complete Line of Tie-in Materials

- |                       |                      |
|-----------------------|----------------------|
| "Your Future" booklet | Flange sign          |
| Window display        | Postal cards         |
| Decalcomania          | TV and radio scripts |
| Outdoor sign          | Ad mats              |
| Indoor clock-sign     | Consumer booklet     |
| Clock                 | Doorknob hangers     |

*Reliable Products  
through Advanced-  
Engineering*

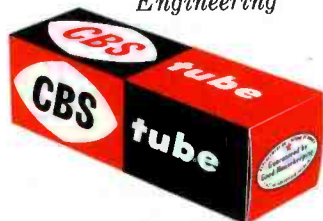

### HOW TO GET THEM

See your CBS Tube Distributor. Or write for PA-187 folder and order form illustrating all the tie-in materials for this the only *complete* program selling your Independent Service. Tie in today. And be sure to specify CBS Tubes, always. Help us help you keep your Independent Service Program growing.

**CBS-HYTRON**, Danvers, Massachusetts  
A Division of Columbia Broadcasting System, Inc.

FOR THE BEST IN ENTERTAINMENT TUNE TO CBS



BY JOHN MARKUS

**No Price.** Out in rural Colchester, Ill., Charles Hunt gets recommended list price for TV sets, plus an additional \$40 to \$170 for an antenna installation, by emphasizing the sale of a good picture rather than a piece of furniture. Any proffered payment is actually refused until after the set is operating in the home and the customer says the picture is all right. His logic, as described in *Electrical Merchandising*, is that in a rural area no sale is complete until the customer is satisfied. If the set didn't perform, a refund would be necessary just to stay in business. Turning down of cash creates the unique atmosphere of technicians seeking to provide the best possible service, rather than of merchants seeking a quick sale.

There are no price tags on display floor sets. He won't even tell the price until a home survey has been made, to determine the type of antenna needed to bring in both uhf and vhf signals from 60 to 90 miles away through hilly country. Once the customer has been classified and qualified, he gets the good-picture sales pitch, punctuated with anecdotes of picture problems solved for neighbors and other satisfied customers.

The payoff for this carefully-planned sales technique is close to one set sold per day throughout the year, at an average installed price of around \$325.

**\$ & C**

**Nellie's Intuition.** Over in England, a number of television dealers employ girls as service technicians. Experience has shown that their natural intuition is generally much faster than that of a man with an oscilloscope, when it comes to locating causes of trouble.

After serving her apprenticeship on one of these jobs, a particularly competent and comely girl

went out on her own. She fitted up a small truck as a mobile service shop, painted on its sides the slogan "Send for Telly Nellie" and toured the countryside. A mobile radiotelephone in the truck brought her the calls from customers.

When bench work was required, Nellie ran a long cable out of the truck and plugged it to an outlet in the customer's home. Only when major repairs or special parts were needed did she take the set back to her shop headquarters. Since she was an extremely attractive young lady, there was seldom a quibble from male customers over service charges. In one village particularly, many of the young lads seemed to be having constant trouble with their TV sets.

Should we be using more women in TV servicing in this country?

**\$ & C**

**Rentals.** There is much money to be made in straight rentals of TV sets. Atlas TV Center found this out in Miami Beach, where gather each winter some of the country's sharpest television customers. Most of them laugh at list prices, and many can quote wholesale prices faster than you can spin a dial. Straight rentals are the countermeasure; in winter this shop keeps about 100 sets out on rental within a 10-mile radius of their store, while in summer this drops down to about 50 units.

Rates currently are \$10 a week, \$30 a month and \$100 for four months, including an inside antenna, delivery and free service. Only 21" table models are rented, these being big enough to discourage stealing yet small enough to be installed by one man. Partners Lou Goodman and Sol Wexler found that a 17-incher was just too easy to pop into a car trunk.

Most rental customers reside in apartments, hotels or motels. An additional safeguard against theft is obtained by giving the owner, manager or custodian of the building a percentage of the rental fee for watchdog service. This man signs a receipt for each rental set installed. The customer himself signs a charge slip, along with a cognovit note form, legally binding in every state.

When a new model year begins, all rental sets are rounded up and sold at floor-sample prices, chopped low enough to clear the floor before they are obsoleted by the new models.

At peak periods when the rental stock is exhausted, rental business from private parties is turned down in preference to using new sets out of stock. On the other hand, hotel and motel rental business is never refused, for once such a customer gets a turndown, the account is lost.

**\$ & C**

**Hi-Fi Service.** To make a customer appreciate the quality of your service work on his hi-fi system, try giving free with each such repair job a record carefully selected to show off the performance of hi-fi equipment. Choose a record that has consistently clean recording quality throughout, with some highs, some lows and some loud passages. Choose a piece that almost everybody is familiar with, such as "Rhapsody in Blue," "Merry Widow Waltz," or "William Tell Overture." Once you find a suitable selection either in LP or 45, you can buy it in quantity at wholesale for this purpose. Left with the customer, this one good record becomes a long-lasting testimonial to your work.

**\$ & C**

**Reading.** Store traffic increased about 50% when Kraft and Williams in Buffalo, N. Y., plastered this sign across the entire width of their show window:

**Everything Must Be Sold  
GOING OUT for BUSINESS**

Most people misread the sign and came in looking for bargains. The explanation that the firm was going out for business generally brought a friendly laugh, to set the stage for sales talk on the bargains that actually were on the floor.

If you buy Newcomb or sell Newcomb, you profit from Newcomb's *proven* dependability. First of all, Newcomb products earn their place in the sun by their superior sound. But the quality that accounts for Newcomb's position as probably the largest independent manufacturer in the field is *dependability*. The user owns equipment that is always ready to operate, ready to go to work from the minute it is installed. The dealer is not plagued with a series of profit-eating service calls. And, he gains the invaluable asset of a satisfied customer. Newcomb dependability is the result of highly-refined conventional circuitry, quality parts, thorough testing, and meticulous reworking until Newcomb products meet Newcomb standards—the highest in the audio industry. The tried and true conventional circuitry found in Newcomb products not only adds to their dependability, but also is readily understood by the maintenance technician. "Dependability" is a characteristic that cannot be established by a simple assertion. Dependability must be proved over a period of time. In twenty years Newcomb Audio Products Co. has proved its ability to deliver maximum dependability combined with superior sound... *consistently*.

# NEWCOMB



## DEPENDABLE NEWCOMB PUBLIC ADDRESS AMPLIFIERS

are designed for continuous heavy duty, safety, simplicity of operation. Although specifically designed for use in school and civic auditoriums, their flexibility and dependability have led to an impressive variety of applications—in radio and television stations, government projects, sports events... The Newcomb Custom KX-50 shown here is the finest public address amplifier ever offered—without equal at any price. A 50 watt unit with less than 3% distortion, full remote control, double-acting separate bass and treble controls, bandwidth selector, dual electronic eye volume and overload indicator... Write for free catalog containing complete description.

# dependability



## DEPENDABLE NEWCOMB HIGH FIDELITY COMPONENTS

are noted for their exceptional, continuous reliability and brilliant performance. Newcomb has concentrated on the qualities of sound reproduction most desirable for home entertainment, reduced distortion and hum to the vanishing point, increased the flexibility of control, achieved outstanding beauty in appearance. Finest of all compact-styled units are the flexible Newcomb Compact 1020 preamplifier-control unit-power amplifier and the sensitive, stable Newcomb Compact 200 AM-FM Radio Tuner.



## DEPENDABLE NEWCOMB RECORD AND TRANSCRIPTION PLAYERS

have earned an unchallenged reputation for reliability and safety in many of the leading public school systems throughout the nation. Ruggedly built, with excellent audio quality, they represent the greatest value available in this field today. Newcomb Record Players have gained wide acceptance for church activities and Sunday schools, in dance schools, and among square dance callers. Only American made parts are used in this equipment. All Newcomb products bear the Underwriters Laboratories labels.

*Write for free catalog of products in which you are interested*

Since 1937 Hollywood's leading producer of precision products for the control and amplification of sound.

**NEWCOMB AUDIO PRODUCTS COMPANY** Department PR-1  
6824 Lexington Avenue • Hollywood 38, California

A LIMITED NUMBER OF DEALERSHIPS IN A FEW AREAS ARE OPEN. WRITE FOR DETAILS

Notes On

# TEST EQUIPMENT

Latest Information on Application,  
Maintenance and Adaptability  
of Service Instruments

by Leslie D. Deane



Fig. 1. EICO's Model 368 in action.

## New Alignment Generator

The piece of equipment pictured in Fig. 1 is the Model 368 TV-FM Sweep Generator and Marker developed by EICO (Electronic Instrument Co., Inc., Long Island City, New York). The unit is especially designed for use in servicing and aligning TV and FM receivers. As with all EICO instruments, it is available in either kit or factory wired form.

Specifications and features are:

1. Power Requirements—105 to 125 volts AC, 50/60 cps, power consumption 50 watts.
2. Sweep Output—5 frequency ranges from 3 to 216 mc on fundamentals, output .2 to .4 volts rms  $\pm 1/2$  db up to 90 mc and .1 volt rms  $\pm 1$  db from 80 to 216 mc.
3. Output Impedance—50 ohms with properly terminated cable supplied.
4. Sweep Width—continuously variable 0 to 30 mc maximum deviation.
5. Output Attenuators—4 position coarse attenuator in steps of 20 db and continuously variable fine adjustment for both sweep and marker signals.
6. Variable Marker—4 frequency ranges from 2 to 225 mc (2 to 75 mc on fundamentals and 60 to 225 mc on harmonics); separate marker size control provided.
7. Fixed Marker—built-in crystal controlled marker oscillator, 4.5-mc crystal and front panel socket provided.

8. Ext. Mark.—jack input for externally generated markers or output for internally generated markers.

9. Blanking and Phasing—internal blanking eliminates return trace and a separate control provides phase adjustment of horizontal sweep signal to scope.

I had an opportunity to use the Model 368 while performing some experimental alignment work in the lab recently. To familiarize myself with the instrument, I first read over the instruction manual, carefully noting the operating procedure. Since my work involved a check of the video response curve for a normally operating TV receiver, I set up the generator and a lab scope according to the alignment instructions given for the particular receiver.

Connecting the two EICO test leads from the generator's SCOPE HOR binding posts to the horizontal input terminals of the scope, I next attached the output cable to the RF OUTPUT jack on the front panel of the instrument. As recommended in the alignment instructions, I then placed the clip-lead end of the output cable between grid and ground of the first IF amplifier in the receiver. Using another cable supplied with the Model 368, I made a connection between the vertical input terminals of the scope and the video detector test point in the receiver.

After the equipment had warmed up, I adjusted the sweep tuning for a center frequency of 45 mc and the sweep width control for approximately a 15-mc sweep. I then set up the scope and with very little trouble obtained a satisfactory response curve.

To check sound and video carrier positions on the curve, I placed the MARKER RANGE switch in its third position and adjusted the marker tuning dial to the video carrier frequency and then to the sound carrier frequency. Adjusting marker size to a convenient level, I noted that the markers fell in at the proper points on the curve.

I next decided to use the crystal marker feature of the instrument—so I plugged the 4.5-mc crystal, which incidentally is supplied with the Model 368, into its socket (see Fig. 2). Inserting the crystal automatically throws the crystal oscillator circuit into operation and both variable and crystal outputs appear in the generated signal. The markers produced are a

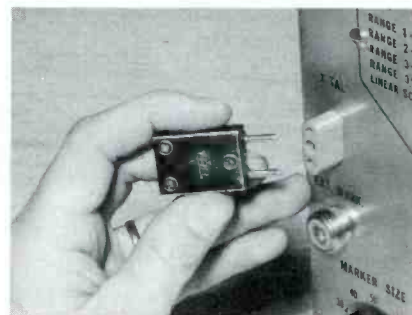
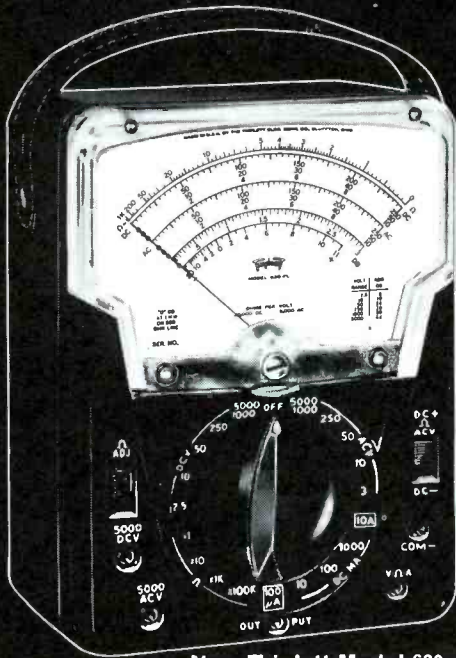

Fig. 2. Separate 4.5-mc crystal is supplied as an added marker feature.



# the mighty nine plus two!



New Triplet Model 630-PL

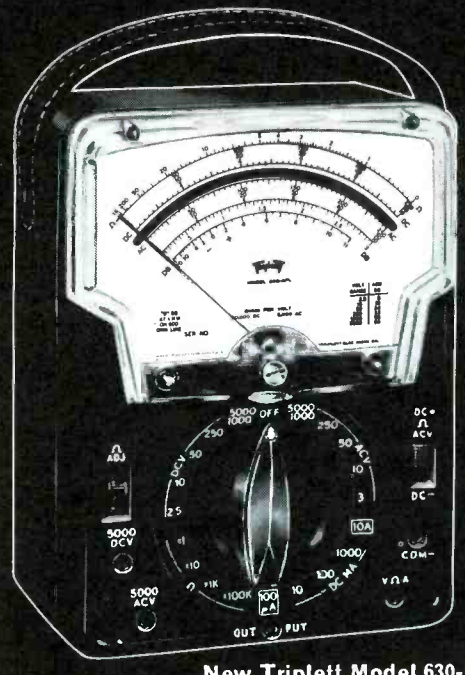

New Triplet Model 630-APL

## TWO NEW VOLT-OHM-MILLIAMMETERS

Now the Triplet Mighty Nine Has Expanded to A Line of 11 VOMs Tailored to Meet Your Preference, Purse or Purpose. Only Triplet Offers So Complete A Variety.

With the new 630-PL and 630-APL you get these important new features:

- Voltage scales for those who want ranges reading by 10's (2.5-10-50-250-1000-5000).
- Instant-vision, wider spread scales; streamlined case, handsome modern design.

- D.C. Polarity Reversing Switch.
- 5 to 500,000 Cycles per second frequency response in A.C. measurements.
- 5000 ohms per volt sensitivity in A.C. ranges; 20,000 ohms per volt D.C.

Both new testers — with the popular continued Models 630 and 630-A—offer these proved Triplet advantages:

- One switch will select any range; minimizes chance of incorrect settings and burnouts.

- Reads from .1 ohm (4.4 ohm center scale) to 100 megohms; four ranges.
- Molded circuit panel for instant component replacement.
- Models 630-APL and 630-A feature 1/2% resistors for greater accuracy; long mirrored scales to eliminate parallax in reading.
- Banana-type leads for low contact resistance at jacks.

# how do you want it?

X 3s or X 10s

Triplet Models 630 and 630-A read volts 0-3-12-60-300-1200-6000; or Triplet New Models 630-PL and 630-APL reading 2.5-10-50-250-1000-5000.

Choose your preference in range reading.

MODEL 630-PL... Dealer Net \$44.50

MODEL 630-APL... Dealer Net \$54.50

MODEL 630... Dealer Net \$44.50

MODEL 630-A... Dealer Net \$54.50

Only Triplet offers 11 VOM's — a line complete enough to give you exactly what you want.

# TRIPLET

Triplet Electrical Instrument Co.  
Bluffton, Ohio

53 Years of Experience



Triplet Model 630

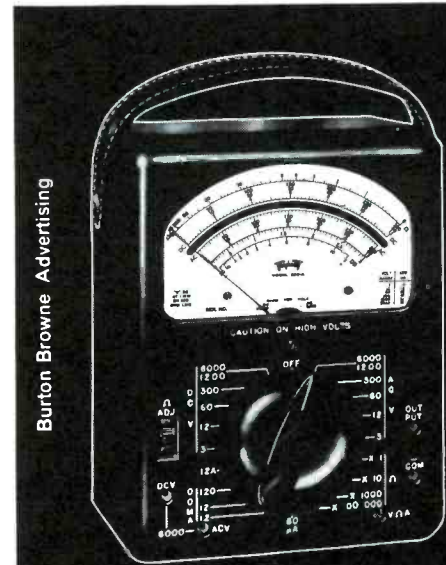

Triplet Model 630-A

Burton Browne Advertising

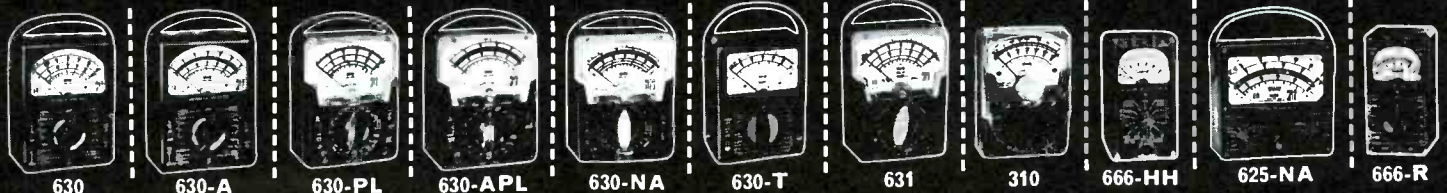

# A Faster Way to Reach the Top in TV Servicing

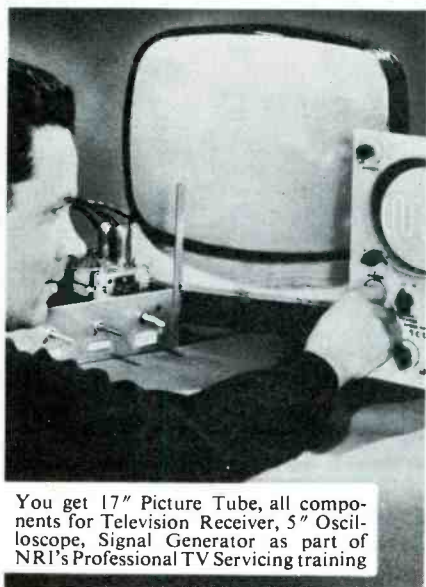

You get 17" Picture Tube, all components for Television Receiver, 5" Oscilloscope, Signal Generator as part of NRI's Professional TV Servicing training

## NRI All Practice Method Trains You in Spare Time to Fix TV Sets Quickly, Correctly, Confidently.

If you know basic theory, either from Radio or TV experience or training, NRI's Professional TV Servicing Course can train you to go places faster. This is 100% learn-by-doing, practical training. You learn how experts diagnose defects quickly. You get actual experience aligning Television receivers, discovering causes of complaints from scope patterns, learn to know the causes of defects, audio or video; accurately, easily . . . and how to fix them.

### NRI IS THE OLDEST AND LARGEST HOME STUDY TV-RADIO SCHOOL

Over 40 years' experience and the record and reputation of NRI back up this learn-by-doing Professional TV course. TV servicing has only started to grow. New sets, new developments, portables, color TV make this a golden opportunity for the man who is trained to service sets quickly and correctly.

### COLOR TV BOOK SENT EARLY

Soon after you enroll you also get color TV lesson with illustrations in full color. This course is not for beginners, but for men who realize the need for planned practical training so they can keep up with new developments—get ahead faster. Mail coupon today. NATIONAL RADIO INSTITUTE, Dept. 8AE4 T, Washington 16, D. C.

### SEND for FREE BOOK

NATIONAL RADIO INSTITUTE  
Dept. 8AE4 T, Washington 16, D. C.

Please send me FREE copy of "How to Reach the Top in TV Servicing." I understand no salesman will call.

Name \_\_\_\_\_ Age \_\_\_\_\_

Address \_\_\_\_\_

City \_\_\_\_\_ Zone \_\_\_\_\_ State \_\_\_\_\_

Accredited Member National Home Study Council



Fig. 3. Special scope-input cable with low-pass filter network termination.

result of the sum and difference frequencies of both signal fundamentals and harmonics.

For example, using the 4.5-mc crystal and setting the variable marker at 45.75 mc, marker indications will be obtained at the variable fundamental of 45.75 mc, at the sum frequency of 50.25 mc, at the difference frequency of 41.25 mc, at the sum harmonic of 54.75 mc, at the difference harmonic of 36.75 mc, and at the crystal's 5th, 6th, 7th and 8th harmonics of 22.5, 27, 31.5, and 36 mc. I found, however, that with a 15-mc sweep width, all markers below 37.5 mc and above 52.5 mc will not appear on the scope screen. By using this added marker provision, I obtained both video and sound markers on the curve simultaneously.

In my examination of the Model 368, one particular item caught my eye. It was not in the instrument itself but in the accessory cables supplied with the unit. One cable is especially designed for the vertical input of an oscilloscope and is to be used in conjunction with the generator during an alignment procedure. In series with this cable is a small plastic cylinder with two short test leads protruding from one end and the shielded cable from the other.

I disassembled the unit by merely removing a screw-type cap from the test-lead end of the plastic cylinder as pictured in Fig. 3. Inside I found a simple R-C network composed of a 68K-ohm resistor in series and a 1,000-mmf capacitor in shunt. This probe-like circuit is a low-pass filter which attenuates the higher beat frequencies produced by the marker-sweep heterodyning action. By limiting the highs, the marker indication on the scope screen is much sharper and less marker

**NEW! IMPROVED!**

**SENCORE**  
TRC4  
**TRANSISTOR CHECKER**

*Another Sencore Time-Saver*

America's newest, most popular test instruments

**NOW CHECKS:**

- ★ **Transistors** for opens, shorts, leakage and current gain. Includes new gain test on power transistors.
- ★ **Crystal Diodes** checks forward to reverse current ratio on all diodes.
- ★ **Selenium Rectifiers** checks forward and reverse currents.

Controls are accurately set for each transistor by referring to replaceable set-up chart on rear. Test leads or socket provides for fast hook-up. See your parts distributor.

**ONLY \$17.95**

Dealer Net  
Cannot become obsolete. Approved by leading manufacturers.

SIMPLE TO OPERATE

**SERVICE**  
Mfg by INSTRUMENTS CORP.  
171 OFFICIAL RD., ADDISON, ILL.

Cut out this ad now for further information

**all EYES are on MERIT**

...watch for new catalog No. 5811 it's terrific!

"COMPARE IT WITH MERIT"

MERIT COIL & TRANSFORMER CORP.  
4427 N. CLARK ST., CHICAGO 40, ILLINOIS

amplitude is required. The lower the marker output level, the less chance there is for response distortion.

The generator's RF output cable also contains a similar arrangement using a single 47-ohm resistor. This component terminates the test lead end of the cable with approximately the characteristic impedance of the instrument.

### Dot-Bar/Crosshatch Generator

An instrument designed specifically for color convergence and TV linearity testing is pictured in Fig. 4. Called the Model 250 Color Convergence Dot Generator, it is manufactured by Winston Electronics, Inc., Philadelphia, Pa.

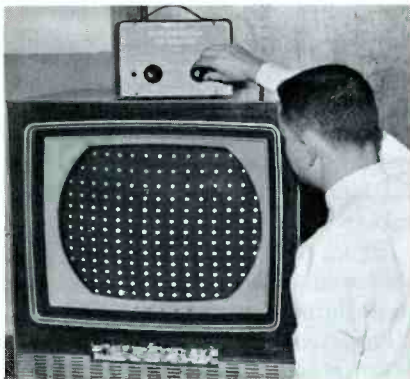

Fig. 4. Win-Tronix Model 250 Color Convergence Dot Generator.

Specifications and patterns available are:

1. Power Requirements — 105 to 125 volts, 60 cps, power consumption 30 watts.
2. RF Output — preset for TV channel 2 and tunable to channel 3, 30 db variable attenuator.
3. Output Impedance—300 ohms,

4' output lead provided.

4. Synchronization — internally generated vertical and horizontal sync signals for 30-frame, 525-line interlaced raster.
5. Dot Pattern — fixed white-dot display with 14 horizontal rows and 18 vertical rows.
6. Bar Patterns — vertical white bar display with 18 individual bars or horizontal white bar display with 14 individual bars.
7. Crosshatch Pattern—14 white horizontal and 18 white vertical bars.

When investigating the Model 250, I noticed that the instrument required no manual RF tuning and that only two adjustments, the pattern selector switch and the output attenuator, appear on the front panel. From the instruction manual I learned that the TV channel frequency is fixed and pretuned at the factory for channel 2; also that the RF oscillator can, if desired, be adjusted for channel 3 through an access hole in the rear of the unit.

Studying the schematic, my attention was drawn to the frequency-counter and AFC circuits. A block diagram of the instrument's circuitry is shown in Fig. 5. Referring to the 31.5-kc oscillator stage, you will note that it is automatically controlled by an AFC phase detector and reactance tube circuit. AFC feedback is obtained by sampling the output signal of the 60-cycle vertical sync oscillator.

Following the 31.5-kc oscillator is a triode tube acting as both a buffer and a signal-peaking circuit. A portion of the output sig-

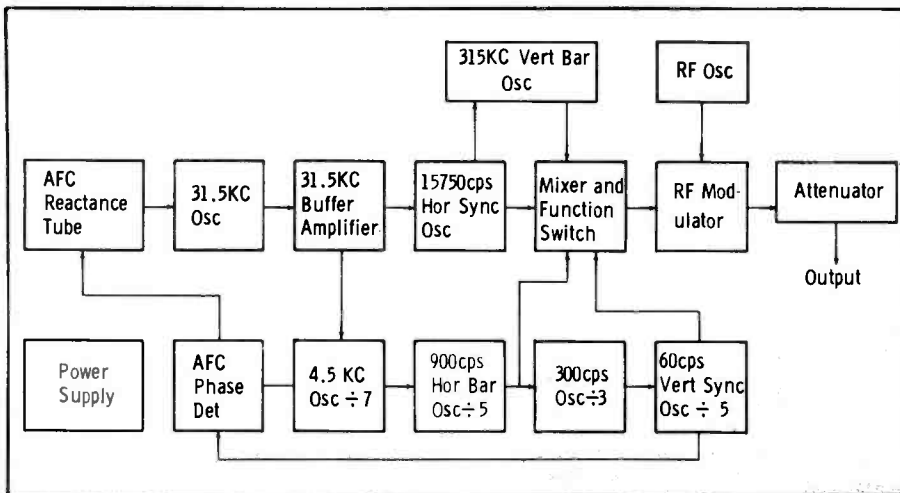
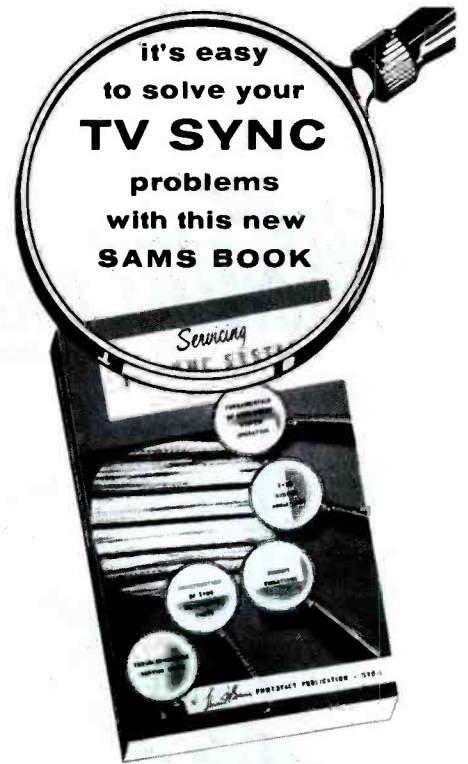

Fig. 5. Block diagram of the Model 250 shows its interlocking AFC system.



### "Servicing TV Sync Systems"

by Jesse Dines

Valuable time-saving book for Service Technicians. Covers fully the theory of operation, circuit function and circuit variations of the 18 different types of sync systems used in TV receivers. Explains various types of sync separator, horizontal and vertical oscillator, and horizontal AFC circuits used in sync systems. Methods of analyzing and troubleshooting these circuits are supported by actual picture tube photos and waveforms illustrating types of sync troubles. Includes valuable data on oscillator coils, transformers and printed electronic circuits used in sync systems. Has chapter on practical servicing hints. This book will definitely help the technician to better understand and more easily service any type of sync system trouble. Written clearly and simply for quick and easy understanding. 320 pages; 221 illustrations, 5½ x 8½".

PRICE \$3.95 ONLY

SEE THIS MONEY-EARNING BOOK AT YOUR ELECTRONIC PARTS DISTRIBUTOR OR MAIL COUPON TO HOWARD W. SAMS...

### FREE TRIAL COUPON

Howard W. Sams & Co., Inc., Dept. 3-A8  
2201 E. 46th Street  
Indianapolis 5, Indiana

Send me Jesse Dines' book "Servicing TV Sync Systems" for 10 days FREE examination. In 10 days I will pay for the book, plus small delivery cost, or return postpaid.

We pay delivery costs if you remit with this coupon. Same return privilege.

Name.....  
Address.....  
City..... Zone..... State.....  
(outside U.S.A. priced slightly higher)

... another  
**MALLORY**  
 service-engineered  
 product

*Months under Water...*



prove  
**MALLORY**  
 "GEMS"

*moisture proof*

To demonstrate how well Mallory "Gem" tubular capacitors resist moisture, we put some in plastic tubes filled with water. Months later, their internal resistance remains unchanged . . . proving there has been no moisture absorption.

Sure, you don't expect to submerge the capacitors you install. But when you're looking for top performance, even under the toughest humidity—always ask for Mallory "Gems."

Get your stock today from your Mallory distributor. He carries them in all popular ratings for by-pass and coupling applications.

P. R. MALLORY & CO. Inc  
**MALLORY**

P. R. MALLORY & CO. Inc., INDIANAPOLIS 6, INDIANA

- Capacitors
- Vibrators
- Resistors
- Power Supplies
- Mercury and Zinc-Carbon Batteries
- Controls
- Switches
- Rectifiers
- Filters

nal from this stage controls the frequency of the 15,750-cycle horizontal oscillator, which in turn couples a simulated TV sync pulse to the mixer section.

Another portion of the 31.5-kc buffer-amplifier signal is fed to a bank of four oscillators. The vertical sync signal is derived from the output of this frequency count-down bank which is comprised of 4.5-kc, 900-cps, 300-cps, and 60-cps oscillators.

For the generator to produce a vertical bar pattern, a separate 315-kc oscillator is employed. This stage is not entirely independent, for it too is controlled by the interlocking AFC arrangement through the horizontal sync oscillator. The signal responsible for the reproduction of a horizontal bar pattern is derived from the 900-cycle oscillator in the frequency count-down bank. Thus, horizontal and vertical sync together with vertical and horizontal bar signals are coupled to the mixer section.

From this point the signals selected are then fed to a crystal modulator which also receives a signal from a separate RF oscillator stage. The RF oscillator is pretuned and generates a carrier frequency for either TV channel 2 or 3. The composite signal leaving the modulator undergoes a certain amount of reduction through a variable output attenuator. Selection of the various generated patterns is accomplished by a function switch which is shown as part of the mixer section.

By following the procedures outlined in the instruction manual, I checked dot convergence of a color receiver using the Model 250. After the instrument and receiver had warmed up, I merely connected the generator output lead to the antenna terminals and switched the tuner to channel 2. The dot pattern came into synchronization as I adjusted the fine tuning and hold controls. I also found the instrument of value when signal tracing or setting up linearity on monochrome receivers.

#### Low Ripple DC Supply

The Model 610C-ELIF Rectifier Power Supply shown in Fig. 6, made by American Television and

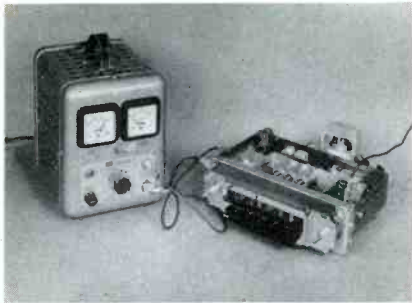

Fig. 6. ATR Power Supply has voltmeter, ammeter, and step-voltage control.

Radio Co., St. Paul, Minnesota, is especially designed for the operation of auto radios as well as other DC powered apparatus.

Specification features are:

1. Power Requirements—105 to 125 volts, 50/60 cps AC, power consumption variable with load, line fuse provided on front panel.
2. DC output—6 volts at 10 amps continuous or 20 amps intermittently, 12 volts at 6 amps continuous or 12 amps intermittently, 6-12 volt selector switch and 8 position voltage control provided.
3. Panel Meters—ammeter 0-20 amps DC, voltmeter 0-15 volts DC.

I made use of the ATR unit by checking the operation of several late-model auto radios the other day. Upon examination of the front panel adjustments, I noticed one unique feature that I had not previously encountered in equipment of this type—a toggle switch with an added locking device to prevent accidental switching from 6 to 12 volts during operation (see Fig. 7).

While powering one of the auto radios, I decided to check the AC ripple content present in the output of the supply. The radio I used for this test was a modern

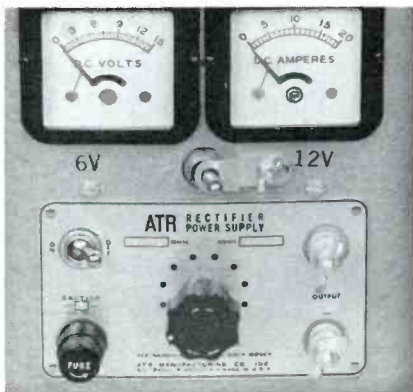

Fig. 7. Close-up of the ATR switch lock.

... another  
**MALLORY**  
 service-engineered  
 product



## New **MALLORY** Push-Pull Switch

*modernizes any set*

Put "1957-model" convenience into nearly any radio or TV set that needs a volume control replacement—by installing a Mallory control with the new push-pull line switch.

Pull the shaft—the set goes on. Push—and it's off. No more need to readjust volume every time the user turns the set on. No more accelerated wear on the low end of the control element.

Your customers will appreciate this new idea in switches that's making such a hit on the newest sets. Order now from your Mallory distributor in the ratings you need.



*Shaft adapters to fit any style knob.*



P. R. MALLORY & CO. Inc., INDIANAPOLIS 6, INDIANA

- Capacitors • Vibrators • Resistors • Controls • Switches • Filters
- Rectifiers • Power Supplies • Mercury and Zinc-Carbon Batteries

**AMPHENOL**

**STEEL**

**CORE**

**TWIN LEAD**

**TWICE AS TOUGH & FLEXIBLE**  
as stranded copper lead-in

Laboratory tests prove AMPHENOL's Steelcore Twin Lead to be twice as tough and flexible as conventional twin lead. And installers' reports from all over the country back these tests up: For long runs where adverse weather and high winds are encountered, AMPHENOL Steelcore is doing an outstanding job. Try Steelcore for your next tough installation—Steelcore can take it!

LABORATORY TEST RESULTS:		STEELCORE	Stranded Copper Lead-in
FLEXING TEST	Mechanical flexing of twin-leads in one direction through 90° from starting position, 5 pounds force at 90°—flexes before circuit interruption	7610 flexes	3175 flexes
TENSION TEST	Direct axial load applied to twin-lead—breaking points in pounds	138 lbs.	78 lbs.

**STEELCORE PUT-UPS & PRICES**

Part Number	Description	List Per 1000 Ft.
214-559-500	500 Foot Reel	\$38.00
214-559-1000	1000 Foot Reel	37.00
214-559-50	50 Foot Preassembled Hank	2.22 (each)
214-559-75	75 Foot Preassembled Hank	3.05 (each)
214-559-100	100 Foot Preassembled Hank	3.89 (each)

AMPHENOL ELECTRONICS CORPORATION  
chicago 50, illinois

**AMPHENOL**

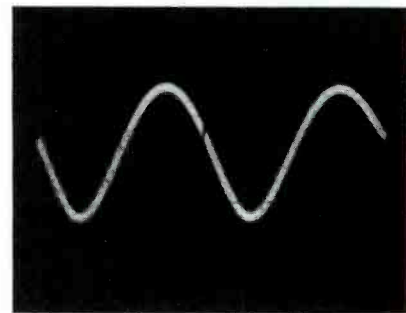

Fig. 8. Scope waveform of the small ripple voltage from the ATR power supply. transistor-operated job drawing approximately 1.5 amps. Employing a scope and voltage calibrator, I measured the peak-to-peak value of the ripple and found it to be about .2 volts (see Fig. 8). Thus, under typical operating conditions with a 12.5 volt supply, the ripple was less than .02% of the total DC output.

**Probing for Trouble?**

The unit pictured in Fig. 9 is a new product of Kingston Electronic Corp., Cambridge, Mass. It is called the "Probe-Master" and is a combination neon indicator and signal-tracing probe designed to check for the presence of signal or supply voltages as well as for testing individual components in electronic equipment.

A carefully worked-out chart supplied with the probe details over twenty troubleshooting applications pertaining to TV, radio and other electrical devices. The probe assembly actually has three available connections—the probe tip itself and two separate test leads. The leads are terminated with heavy-duty clips which are insulated and color-coded with rubber sleeves, one red and the other black. The neon indicator is located in the butt end of the unit where it is easily visible to the operator. Using the three connec-

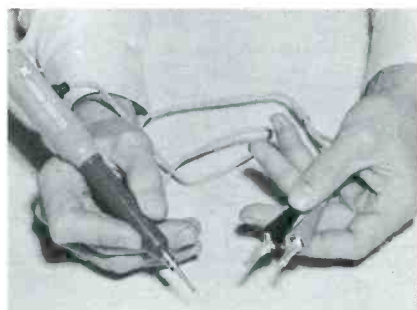
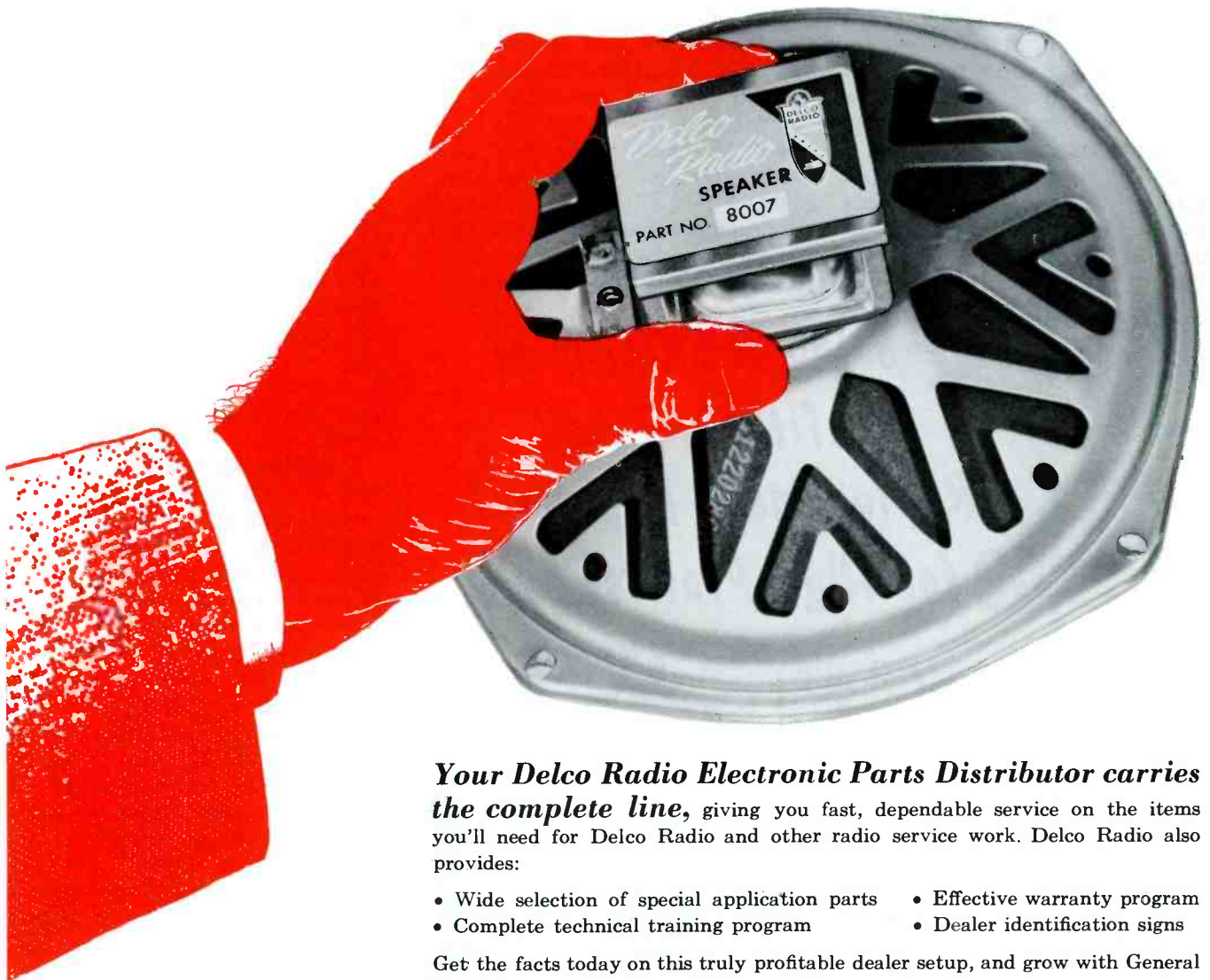

Fig. 9. The features of the Kingston "Probe Master" make it versatile in troubleshooting.

# Use Delco Radio Service Parts!

8-inch "Hi-Fi" speaker, No. 8007 offers the most highs, the most lows, the most watts in a medium-price speaker. Designed for replacement use and high fidelity audio systems.



*Your Delco Radio Electronic Parts Distributor carries the complete line*, giving you fast, dependable service on the items you'll need for Delco Radio and other radio service work. Delco Radio also provides:

- Wide selection of special application parts
- Complete technical training program
- Effective warranty program
- Dealer identification signs

Get the facts today on this truly profitable dealer setup, and grow with General Motors!

Available everywhere through Electronic Distributors associated with . . .



## DELCO RADIO

DIVISION OF GENERAL MOTORS, KOKOMO, INDIANA

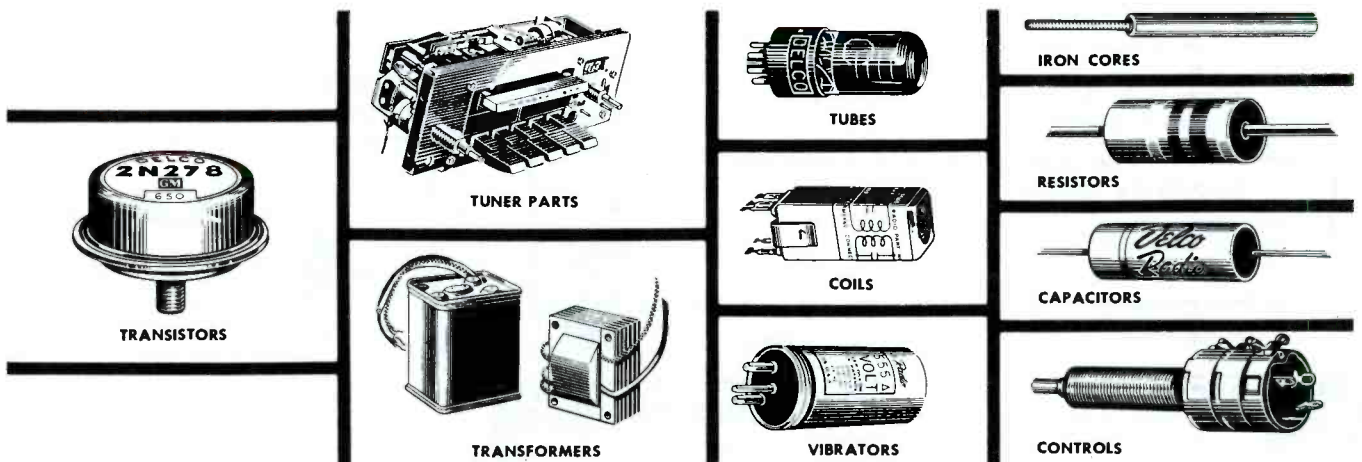

tions as recommended in the troubleshooting chart, the technician can check for a number of troubles involving signal loss, B+ failures or defective resistors and capacitors.

I noticed that the built-in capacitive network of the probe permits bypassing of certain stages within a receiver, coupling of a signal from one stage to another for signal tracing purposes and a quick substitution of bypass and coupling capacitors. To test this feature, I decided to use it to locate a defective stage in a set

which had no picture. I bypassed each of the video IF stages by placing the red clip lead of the instrument on the grid of the tube and the probe tip on the plate connection. According to the instructions, a signal should appear on the picture tube screen if the stage is defective. If video is still absent from the screen, then the signal is not being lost in the stage being bypassed. The test lead with the black clip is not used during this check. As it turned out, the trouble was quickly isolated to the 1st IF stage.

In other applications, the test procedure might involve the volume control and speaker of the faulty receiver. For instance, when I set up a condition of no high voltage and checked the output of the horizontal oscillator, I merely connected the red clip lead to the ungrounded terminal of the volume control and the probe to the grid of the horizontal output tube. In this test, rotation of the horizontal hold control should produce a whistle in the speaker—provided, of course, that the oscillator stage is operating. During this procedure, I disabled TV sound by switching off-channel. The vertical and sync sections can also be checked in this manner, but a hum or buzz will be heard from the speaker instead of a whistle.

Troubleshooting the sound section of a TV receiver, I used the probe assembly to couple a test signal from the vertical sweep system to various sound stages. When the signal path was intact, I detected the vertical buzz in the speaker. One can signal-trace clear to the speaker voice coil using this procedure.

I also found that the "Probe-Master" could be used to check for opens or value changes in plate and screen resistors under typical operating conditions. In this case, the black clip lead is connected to B- or chassis ground and the probe tip placed on the plate or screen side of the resistor. If the component is open, the neon indicator in the end of the probe will not glow. If, on the other hand, the component changes value as the equipment warms up, then brightness of the indicator should vary. The neon feature of the probe can also be used to check for the presence of AC and DC voltages, fuse and tube-filament continuity or for shorted capacitors. ▲

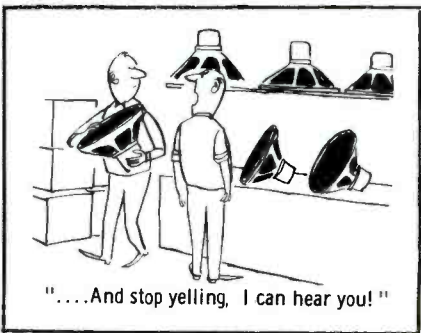

# STOP being ROBBED of Profitable Tube Replacement Business! GO for High Profits!

## U-CHECK-'EM

Pats. Pend.

The Lowest Price in the Industry

Place these profit-making tube testers in your store — A colorful and attractive point-of-sale unit that enables customers to test their own tubes. It saves you time and trouble and you sell more replacement tubes "on the spot."

## TUBE TESTERS

Table Model

Deluxe Table Model



### ✓ CHECK THESE FEATURES

- ✓ 40 long life phosphor bronze sockets guaranteed to check 99% of all standard tubes
- ✓ can never become obsolete due to its universal filament control
- ✓ all tubes checked by dynamic emission
- ✓ big 7 1/2" clear plastic meter
- ✓ built-in tube pin straighteners
- ✓ chart lists 250 of the most popular tube types. Data on 300 additional tubes is available immediately.

BEAUTIFUL WINDOW STREAMERS AND VARI-VIEW DISPLAY CARDS AVAILABLE

### REAP EXTRA PROFITS!

Place console tube testers in other locations — drug stores, auto service stations, hardware stores, etc.

- Your chance for a continuous, growing income
- Removable metal trays for easier stock control



See your local parts jobber or write for additional information



**AFFILIATED television laboratories, inc.**

112-07 FRANCIS LEWIS BLVD., QUEENS VILLAGE 29, N.Y., HOllis 5-8000





# how long would it take you to solve this service problem?

**SYMPTOM:** Smear'd Picture (showing black streaks trailing from blacks)

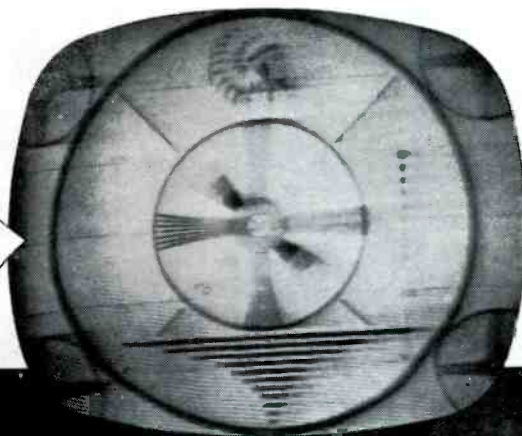

## PHOTOFACT helps you lick problems like this

in just minutes for only

\* **2½¢** per model!

Let's take a look at this problem: A smear'd picture such as illustrated above is caused by excessive low-frequency response coupled with poor high-frequency response. Look for the following possible causes:

1. Defective video amplifier, video output, or Picture tube
2. Low value of coupling capacitor C51 or C53
3. Low value of grid resistor R46 or R52
4. Open cathode bypass capacitor C50 or C52
5. Open series-peaking coil L23 or L21
6. High value of plate resistor R44, R48 or R49

With the applicable PHOTOFACT Folder at your fingertips, you trouble-shoot and solve this problem in just seconds. Here's how:

Check the Video Detector (V7) and the Video Amplifier (V8). Just refer to the Tube Placement Chart (you'll find it in every PHOTOFACT TV Folder) for quick location of these tubes.

Use the servicing method you prefer—checking of waveform, voltage or resistance—you'll find all the information you need at your finger-tips in PHOTOFACT.

For only \*2½¢ per model, PHOTOFACT helps you solve your service problems in just minutes—helps you service more sets and earn more daily!

\*Based on the average number of models covered in a single set of PHOTOFACT Folders.

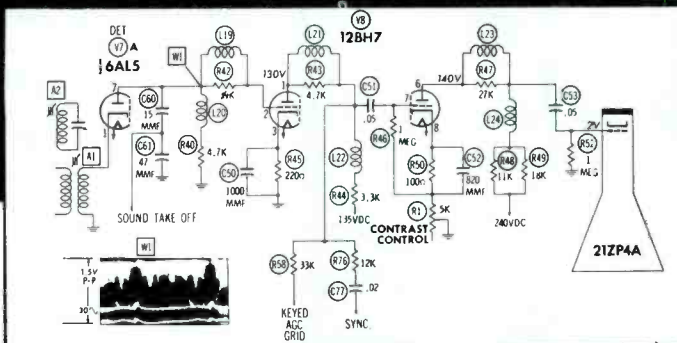

(Based on an actual case history taken from the Howard W. Sams book "TV Servicing Guide")

Tubes okay?—then: Check the waveform at pin 7 of V7. The correct waveform is shown right on the PHOTOFACT Standard Notation Schematic. Waveform correct?—then: Check the voltages in the Video amplifier and Video output stages to determine which part is defective. The correct voltages appear right on the exclusive Standard Notation Schematic, along with resistances (shown in easy-to-read chart form). Exclusive PHOTOFACT chassis photos with "call-outs" keyed to the schematic help you locate the faulty parts in just minutes.

Whatever the trouble, you'll locate it faster and easier with a PHOTOFACT Folder by your side. Be sure to use the complete Replacement Parts List to select the proper replacement for the repair.



### MONEY BACK GUARANTEE!

Got a tough repair? Try this—at Howard W. Sams' own risk: see your Parts Distributor and buy the proper PHOTOFACT Folder Set covering the receiver. Then use it on the actual repair. If PHOTOFACT doesn't save you time, doesn't make the job easier and more profitable for you, Howard W. Sams wants you to return the complete Folder Set direct to him and he'll refund your purchase price promptly. GET THE PROOF FOR YOURSELF—TRY PHOTOFACT NOW!

**FREE**



### FOR SERVICE TECHNICIANS ONLY

Fill out and mail coupon today for Free subscription to the Sams Photofact Index — your up-to-date guide to virtually any receiver model ever to come into your shop. Send coupon now.

### HOWARD W. SAMS & CO., INC.

Howard W. Sams & Co., Inc.

2201 E. 46th St., Indianapolis 5, Ind.

Put me on your mailing list to receive the Sams Photofact Index and Supplements. My (letterhead) (business card) is attached.

I'm a Service Technician:  full time;  part time

My Distributor is: \_\_\_\_\_

Shop Name \_\_\_\_\_

Attn: \_\_\_\_\_

Address: \_\_\_\_\_

City \_\_\_\_\_ Zone \_\_\_\_\_ State \_\_\_\_\_

# the selection and use of *HAND TOOLS*

by Calvin C. Young, Jr.

To perform efficient and profitable work, the electronic service technician must master not only circuit theory, customer psychology, and the use of test equipment, but also the selection and proper use of hand tools. Nothing gives a customer a less favorable impression of a technician than an improper choice of tools or improper use of the correct tool. In addition to this, a given job takes longer with the wrong tool—and the wrong tool can even “botch” a job so badly that the customer is not willing to accept the repair as having been expertly completed.

Because of the extreme importance of the correct use of hand tools, we present herewith the first of a two part series on the subject. In this part, we will cover the use of screwdrivers, cross-slot drivers, clutch-head drivers, hex-nut drivers and similar devices. The subsequent installment will feature pliers, cutters, wrenches, wire strippers, wire staplers and miscellaneous items.

## General Considerations

In a general sense, the tools covered in this article are very

much alike. They all have similar handles, and you can't distinguish one type from another, unless you see the “business end.” For this reason, let's first examine the problems that are common to all tools in the general category of hand drivers before specifically discussing a particular type of tool. The first problem encountered is how to hold a hand driver properly. If you place the tool in your hand as shown in Fig. 1 and then grasp it so that your index finger wraps around the lower end of the handle and the thumb rests as shown in Fig. 2, the tool will be gripped properly and will feel comfortable in your hand. When you hold a tool in this manner, the butt of the handle rests against the palm of the hand so that a normal amount of force will naturally be applied to keep the tip of the tool in contact with the work. Manipulation of a tool often requires the use of both hands to keep the tool engaged with the work (Fig. 3) while shifting the gripping hand back and forth to turn the handle.

The next common problem for consideration is the length of the

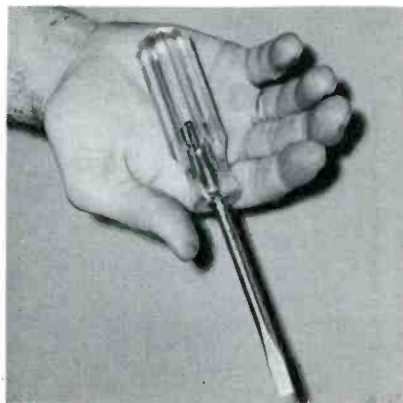

Fig. 1. How to hold a hand driver.

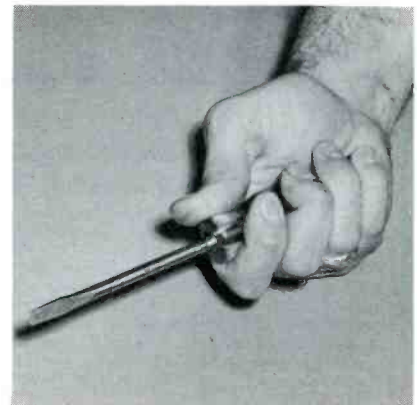

Fig. 2. Gripping the hand driver.

tool—both handle and shaft. Hand drivers are available in lengths from stubby to extra long (Fig. 4), the standard length generally being 6" to 8". Stubby tools are for use where there is limited clearance between the work and some object immediately in line with the work. For example, in some of the lowboy TV consoles which have a shelf below the main body of the TV cabinet, a standard 6" to 8" tool will not fit into the space to permit removal of the chassis hold-down bolts.

The extra-long types of tools are useful where tall objects surround the work and again make the use of standard-length tools impossible. In answer to a logical question, "Why not just have all short and long tools and forget about the standard lengths?" consider the fact that a piece of metal  $\frac{3}{16}$ " in diameter and 6" long is much more rigid than a piece of the same metal  $\frac{3}{16}$ " in diameter and 12 to 16" long. This additional rigidity in the standard shafts is often necessary in the tool's normal application. Thick-bladed screwdrivers and other tools may have a slightly longer standard length—10 to 12"; this has proved to be the most convenient for their particular conditions of usage.

The next thing to be considered is the insulating property of the handle. Although the plastic used in tool handles has a high dielectric strength, it may not offer enough insulation to anode voltages if the handle is in a beat-up condition. One common source of damage to the plastic handles on hand drivers is a soldering iron or gun—the hot tip melts the plastic very rapidly.

Another way to mistreat a driver is to use it for a hammer. This not only roughens the handle and makes it rough to the hands, but also can loosen the shaft from the handle and thus ruin the tool.

### Screwdrivers

Although the term screwdriver could be applied to any instrument used to install or extract wood or metal screws, we will consider in this discussion that the term applies only to tools for use with screws having a single slot (Fig. 5). Appearancewise, a screw-

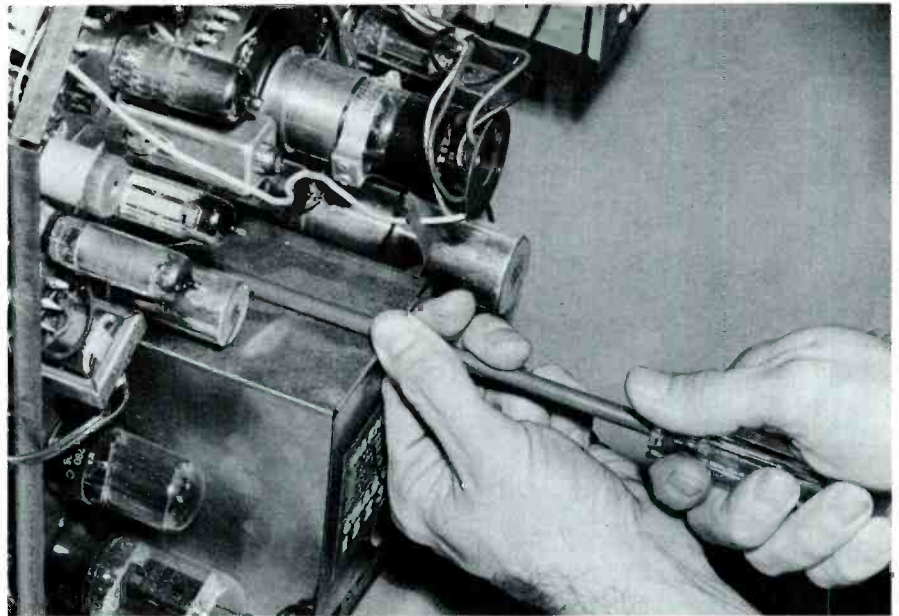

Fig. 3. Supporting the shaft of the tool with the other hand.

driver (Fig. 6) is simply a handle and a metal shaft with a ground-down tip. This gives rise to the general attitude that "a screwdriver is a screwdriver" and that the first one you pick up which will fit into the screw slot is okay for use with that screw. This attitude will result in screws with "chewed-up" heads and slots, as shown in Fig. 7. Chewed-up screw heads are marks of a novice. Not only do they degrade the appearance of equipment, but the removal and subsequent reinstallation of such screws is a difficult, if not an impossible task.

The drawing in Fig. 8 illustrates

three examples of screwdriver tips inserted in screw slots; in only one case is the match correct. In the other two cases, the screw will be damaged and there is also a good possibility of damaging the tool itself.

Four popular screw sizes (4, 6, 8 and 10) are generally used in radio and TV, and each size requires the use of a different size screwdriver. A no. 4 screw requires a screwdriver with a  $\frac{1}{8}$ " shaft diameter; no. 6 requires  $\frac{5}{32}$ " diameter; no. 8 requires  $\frac{3}{16}$ " diameter while no. 10 requires  $\frac{1}{4}$ " diameter. The selection of screwdriver size by shaft diameter

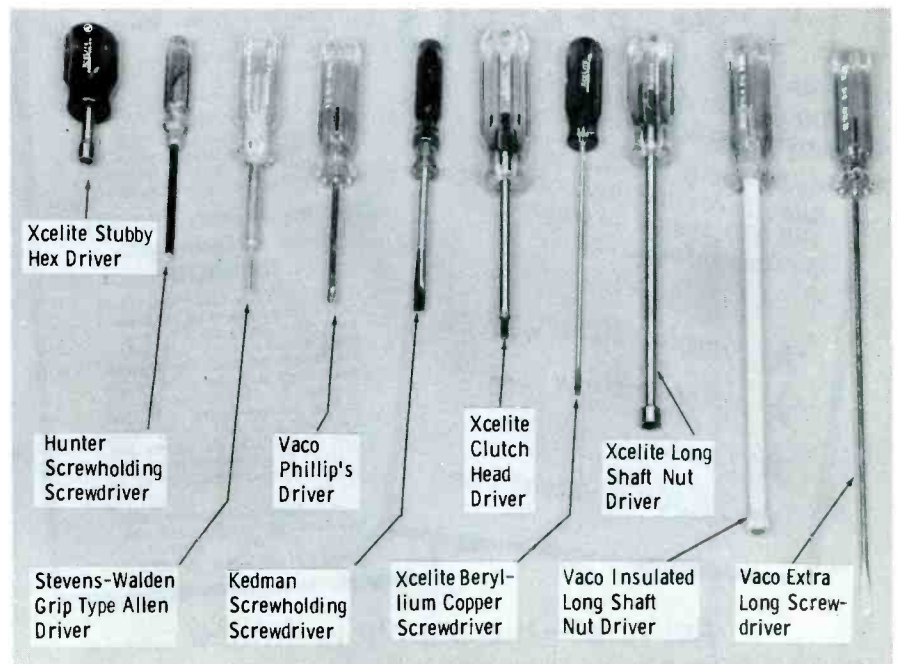

Fig. 4. Various lengths of tool shafts (stubby to extra-long).



only  
\$350  
at your distributor

...it's  
here!

# 1958 RADIO-ELECTRONIC MASTER (22nd edition)

biggest, most authoritative buying guide ever published

## TV - RADIO - AUDIO - ELECTRONICS

Completely catalogs over 150,000 standard electronic parts and equipment necessary to radio-TV-audio and industrial servicing. It places the entire electronic industry at your fingertips!

**1584 pages**  
The world's largest and most referred to electronic buying guide contains...  
direct-from-the-factory product information covering 150,000 items produced by 350 manufacturers

- ★ complete descriptions
- ★ specifications
- ★ prices
- ★ 11,500 illustrations

**When you BUY and SELL  
You can immediately find out**

What product best fills your needs?  
How does it compare with other makes?  
What does it look like?  
What does it cost?  
...because the MASTER is systematically arranged in 18 product sections with all similar products grouped together.

**You operate more efficiently,  
more profitably with  
The MASTER**

The MASTER describes, illustrates, lists specs of all items necessary to radio-TV servicing. What's more — it offers thousands of additional products that can lead to extra income in Hi-Fi, sound and industrial servicing. You can buy, sell and bill direct from The MASTER. It shows list prices! It's invaluable at the bench, over-the-counter or in the field.

Remember, no matter what product or component you require...**YOU FIND IT FASTER IN THE MASTER!**

Act now — the supply is limited

Get your 1958 MASTER today at local parts distributor or write for list.

**THE RADIO-ELECTRONIC MASTER** 60 Madison Avenue, Hempstead, N.Y.

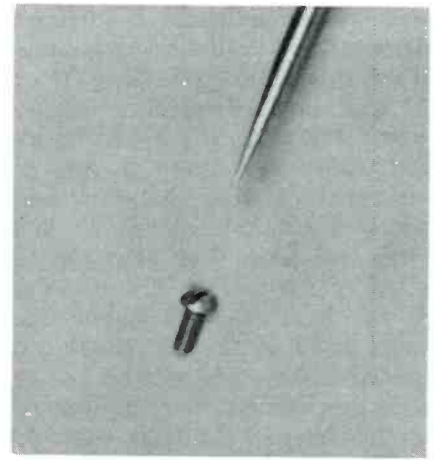

Fig. 5. Screw with single slot.

automatically insures correct fit of the tips into the screw slot, since the width of the tip varies with shaft diameter.

It was mentioned earlier that a screwdriver could be damaged by using it on a screw of the wrong size. This could happen in two ways—i. e., the tip could be burred or broken, or the shaft could become unbonded from the handle. This will be more readily understood of you consider that the handle on a screwdriver having a  $\frac{1}{8}$ " shaft diameter is required by the U. S. Standards Bureau to withstand 6 inch-pounds of torque, while a handle used with a  $\frac{3}{16}$ " shaft is required to withstand 25 inch-pounds, and a handle used with a  $\frac{1}{4}$ " shaft must permit torsional movement of 60 inch-pounds. Since it is well understood that larger screws require more torque for installation

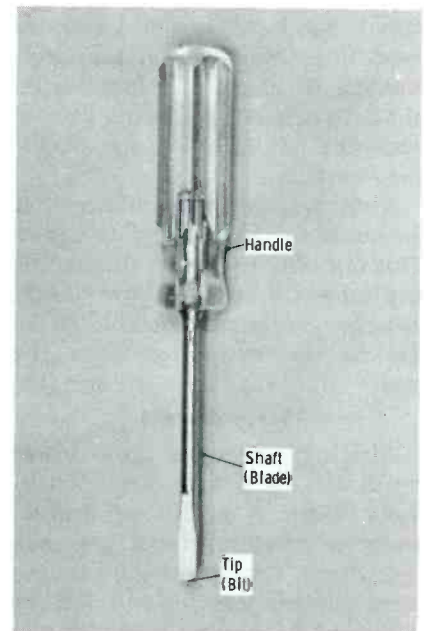

Fig. 6. Screwdriver parts identified.



Fig. 7. Examples of "chewed-up" heads.

and removal, it should follow that the rating of smaller drivers could easily be exceeded in trying to remove or install a larger screw.

Tip damage to a screwdriver is the probable result of using a driver that is too large and doesn't fit all the way into a screw slot. Choose the right screwdriver for the job and be classed as a technician instead of a "screwdriver mechanic!"

#### Screw-Holding Screwdrivers

The primary difference between a screw-holding screwdriver (several of which are shown in Fig. 9) and a standard screwdriver is that the screw-holding unit features some method of expanding the tip of the driver so as to grip the slot of the screw and hold it firmly. This permits screws to be started in places where it would be difficult or even impossible to hold the screw with one hand while turning the screwdriver with the other.

The screw-holding driver may be used until the screw is well started, but a standard driver of the correct size should be used to complete the installation. This will avoid damage to the screw-holding units, which are slightly more expensive than their standard counterparts.

#### Cross-Slot Drivers

There are two types of cross-slot screws and drivers—the Phillips or "U" recess and the Reed and Prince (Frearson) or "V" recess. Both types of screws and

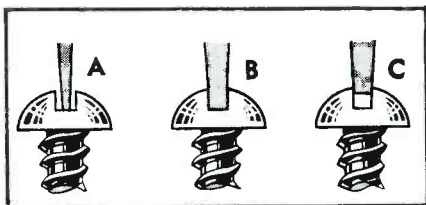

A. Bit too small. B. Bit matched to slot. C. Bit too large.

Fig. 8. Matching bit to screw slot.

# NEW improved model Simpson 260!

TRADEMARK

**RUGGED  
PRINTED  
CIRCUIT!**



**...the VOM that outsells  
all others combined**

### MANY NEW FEATURES MAKE THE 260 MORE VALUABLE THAN EVER!

- POLARITY REVERSING SWITCH
- 50 MICROAMPERE—250 MILLIVOLT RANGE
- EASIER-TO-READ SCALES
- LESS CIRCUIT LOADING
- POPULAR DBM RANGES
- FULL-WAVE BRIDGE RECTIFIER SYSTEM
- RUGGED PRINTED CIRCUIT
- ALL COMPONENTS EASILY ACCESSIBLE

- IMPROVED FREQUENCY RESPONSE IN A. C. MEASUREMENTS

See it at your Distributor, or write

### SIMPSON ELECTRIC COMPANY

5200 West Kinzie Street, Chicago 44, Illinois

Phone: EStebrook 9-1121

In Canada: Bach-Simpson Ltd., London, Ontario

WORLD'S LARGEST MANUFACTURER OF ELECTRONIC TEST EQUIPMENT



**WILL YOUR REPLACEMENT**

**FUSE-RESISTOR  
BURN OUT AGAIN?**

Another  
Sencore  
Time-  
Saver

Not if you use—  
The NEW SENCORE  
"FUSE-SAFE"  
CIRCUIT TESTER

Save costly call backs  
by testing the circuit  
before replacing  
fuse, fuse resistor or  
circuit breaker.



Individual scale for  
each value fuse re-  
sistor — no inter-  
pretation, just read  
in red or green area.

★ Measures line current  
and up to 1100 watts of  
power at 115 volts using  
line cord and socket.  
★ Two convenient current  
ranges — 0 to 2 amps and  
0 to 10 amps. Test leads  
clip in place of fuse or fuse  
resistor.

★ 5 ohm, 10 watt resistor prevents TV circuit  
damage and simulates operating conditions.

As Recommended by Leading Manufacturers

**\$8.95**  
DEALER NET

MODEL FS-3  
AC-DC or both as  
needed for Fuse  
Resistor Circuits



Mfg. by **SERVICE**  
INSTRUMENTS CORP.  
171 OFFICIAL RD., ADDISON, ILL.

Cut out this ad now for further information

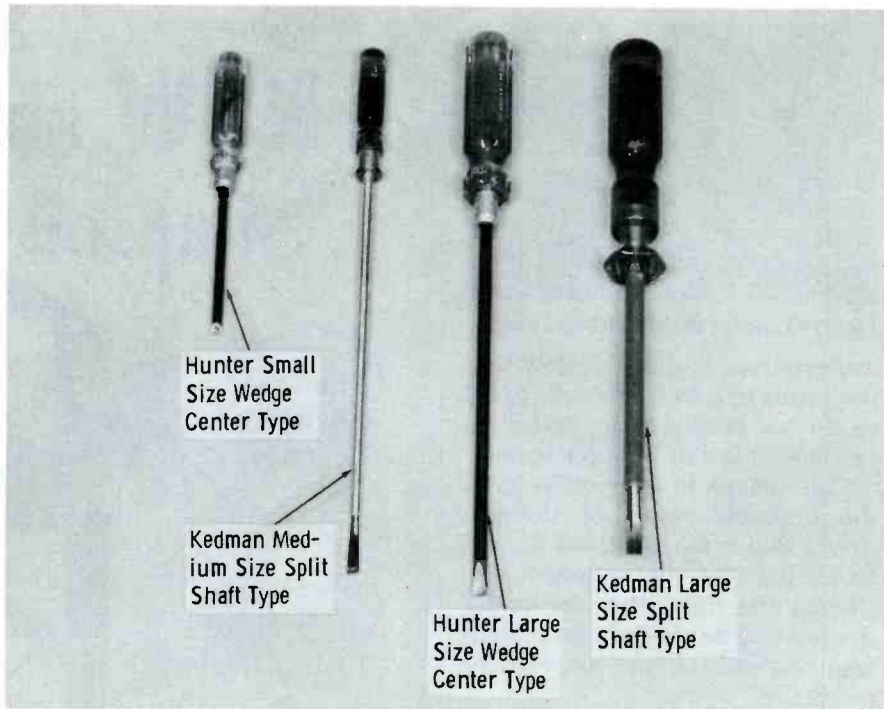

Fig. 9. Several screw-holding screwdrivers.

drivers are presented in Fig. 10 to illustrate an important point of difference between them.

Phillips drivers are available in several sizes. The 1/8" diameter is recommended for screw sizes 0 to 1, the 3/16" diameter for sizes 2 to 4, the 1/4" diameter for sizes 5 to 10, and the 5/16" diameter for sizes 12 to 16. The Reed and Prince drivers are likewise available in different shaft diameters for use with screws of different sizes.

Everyone knows that a narrow-blade standard screwdriver will fit into a cross-slot screw. Sometimes you can even manage to remove or replace a cross-slot

screw in this manner, but this is definitely the wrong procedure because it is likely to ruin both the screw and the driver. The narrow-blade screwdriver will be damaged because its torque limitation is easily exceeded by the demands of a large cross-slot screw.

In using any screwdriver, remember to always hold the driver firmly engaged and not at an angle to the screw slot. In any other than the straight-up position, the driver tip will not be properly mated to the slot and will cause damage to the screw head, or be damaged itself.

**AMAZING**

**WUERTH  
TUBE-SAVER**



**Stop Annoying Call-Backs**

By absorbing damaging in-rush current, so destructive to television, radio and Hi-Fi tubes, the Tube-Saver eliminates annoying call-backs by more than tripling the life of all tubes . . .

**PROTECTION**



Model 101-2—100-300 watts, \$1.85 List

**WUERTH SURGISTOR**

A new component easily installed by a serviceman to reduce call-backs by eliminating surge current damage to television and Hi-Fi tubes.

Servicemen can earn \$50 to \$100 extra profit per week by installing a Surgistor on every service call.

**Wuerth Tube-Saver Corp.**  
9125 Livernois Ave., Detroit 4, Mich.

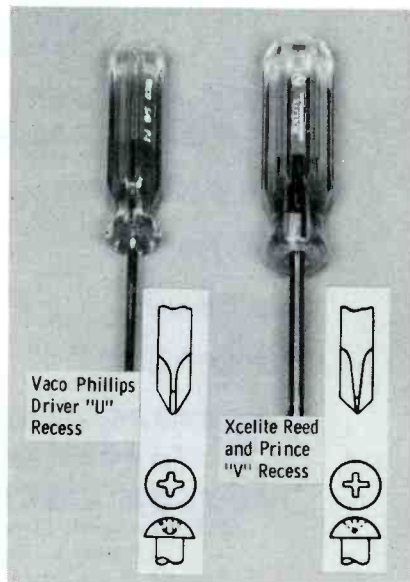

Fig. 10. Cross-slot screws and drivers.

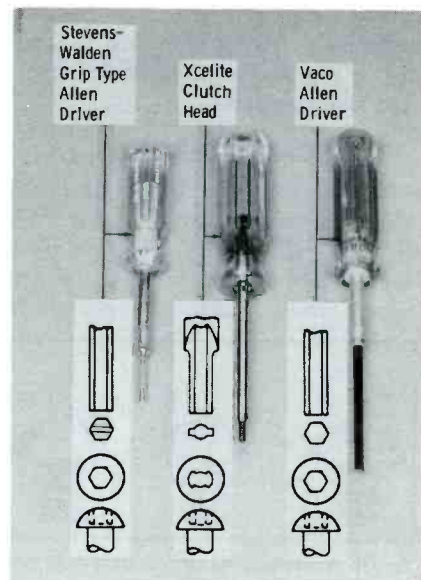

Fig. 11. Clutch-head and Allen drivers.

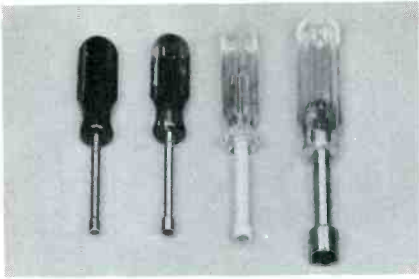

Fig. 12 Hex drivers of various sizes.

### Clutch Head and Allen Drivers

Some screws are supplied with special types of recesses known as clutch-head and Allen types, and correct drivers must be used on each. Fig. 11 illustrates both screws and drivers.

It is possible to remove a clutch-head screw with a driver that is slightly too small for an exact fit. Just as in the case of standard, Phillips, and Reed and Prince drivers, however, the correct size should *always* be used to prevent damage. The Allen recess requires an exact match between screw and driver for installing or extracting screws.

### Hex-Nut Drivers

A hex-nut driver is the screw-driver equivalent of a socket wrench and is used to drive hex-head screws and nuts. Primarily, the hex-nut driver is a low-torque tool and should not be used to loosen nuts or bolts that have been installed at relatively high

torque levels. Hex drivers are available in large sizes (Fig. 12) which are intended for removal and installation of potentiometers and switches, chassis hold-down bolts, picture-tube mounting screws and other low-torque bolts and nuts.

They are also available with short shafts, standard shafts, hollow shafts, insulated shafts, and "no-spark" nonmagnetic shafts, all of which are illustrated in Fig. 13. The nonmagnetic no-spark type is useful for industrial servicing in explosive atmospheres like those present in chemical and paint factories, in addition to being very useful in installing focalizer assemblies or other magnetic units.

This business of using the correct tool size applies doubly to hex drivers. The next larger size of driver will turn a nut or screw in many cases, but this practice rounds screw and nut corners and reams out the working edges inside the driver. This ruins the driver because it is then too large for the correct size screws.

### Plug-In Tools and Pocket Clip-On Tools.

The chief asset of both of these types of tools is their handiness and portability. A set of plug-in tools (Fig. 14) consists of one handle and an assortment of various tool shafts or blades that can plug into that handle. In addi-

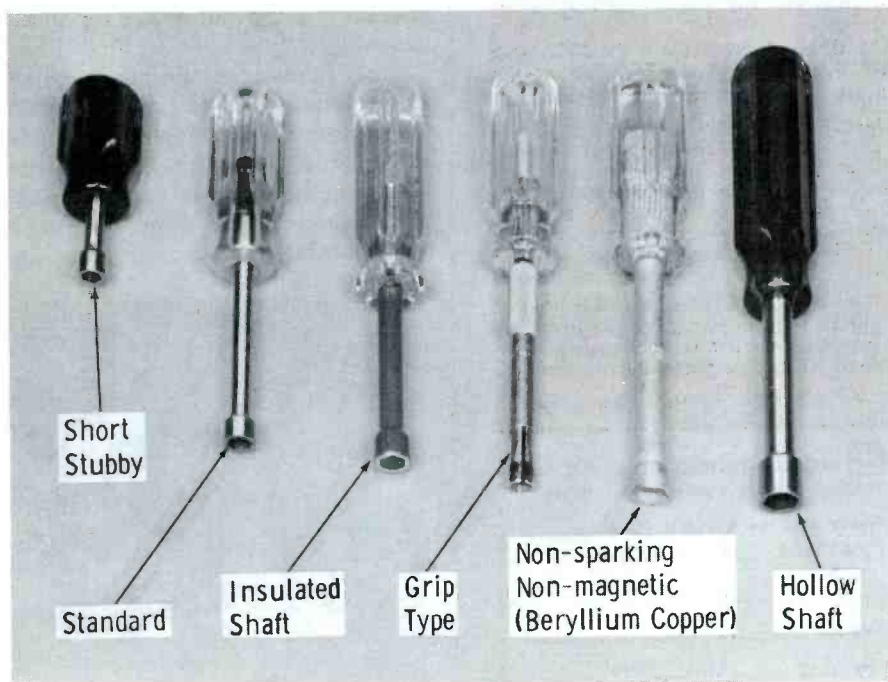
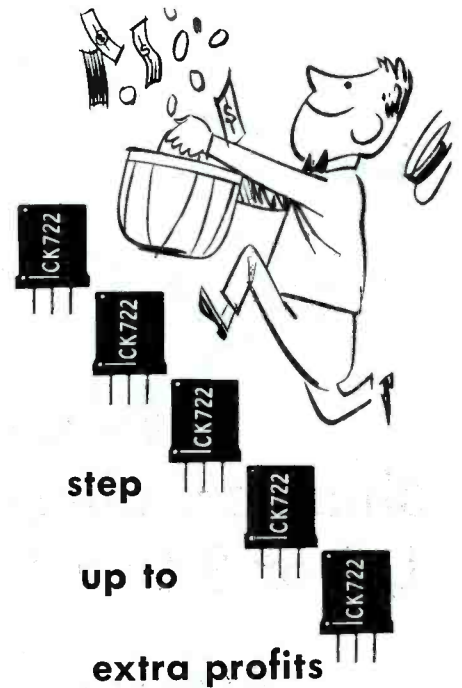

Fig. 13. Various styles of hex-nut drivers.



step  
up to  
extra profits

**STOCK and SELL**  
**RAYTHEON**  
**TRANSISTORS**

You're overlooking a good profit bet, if you are passing up the lucrative transistor receiver servicing business in your area. And the best way to get the lion's share of this good business is to stock and sell Raytheon Transistors. They are first choice of Service Dealers for this type of work because they combine dependable performance with low cost and ready availability.

What's more, hobbyists, engineers and experimenters are buying thousands and thousands of Raytheon Transistors — another source of extra profit for the transistor-wise Service Dealer. For the whole story on Raytheon Transistors call your Raytheon Tube Supplier.

### Raytheon Transistor Applications Book Vol. II

A must for Service Dealers . . . Full of practical circuit design information, transistor theory and shop practice . . . Many circuit applications including circuits for making useful transistorized shop equipment. Buy from your Raytheon Tube Supplier or send 50¢ to Department PF2.



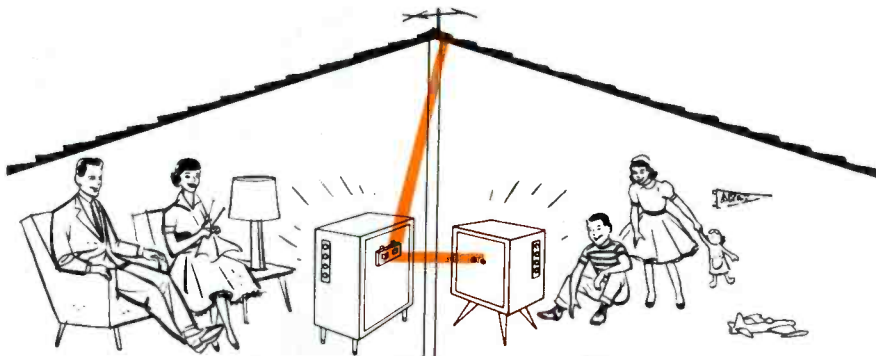

**NOW!**

sharper, clearer pictures on  
1, 2 or 3 tv sets with 1 antenna

NEW **B-T LABS** B-23

**TWO-SET BOOSTER**



ONLY \$23.95

From B-T comes the most important step forward in better TV reception for 1958—a broadband TV amplifier that boosts signal strength on all VHF channels 2-13 and operates 1 or 2 or 3 TV sets with one antenna. No tuning is required.

combines two functions in one

A single B-23—

- **BOOSTS** signal strength on 1 or 2 or 3 TV sets—up to 6 db gain operating two TV sets from one antenna.

- **COUPLES** 2 or 3 TV sets—using the present antenna. Outperforms non-powered couplers in any reception area by more than 2 to 1.

check these B-23 features:

- Ideal for color—add a color TV set and keep present black-and-white set, use the same antenna—the result, sharper, clearer pictures on both sets.
- Low noise figure—designed to work with new VHF sets.
- Reduces interference.
- Easily installed at antenna terminals of set. Can be mounted out of sight at the rear of the receiver.
- Automatically amplifies channels 2-13.
- Ideal small TV system (motels, multiple dwellings, TV showrooms).

**FOR OPERATING 3 TO 8 TV SETS, USE THE B-T LABS DA8-B—MORE THAN 10 DB GAIN ON ALL VHF CHANNELS.**

The DA8-B Distribution Amplifier is a broadband, all-channel unit that requires no tuning, impedance matching devices, pre-amps or other special fittings. Ideal for all small TV systems including garden apartments, motels, TV showrooms serving more than 3 sets. Approved for color, only \$94.50.

The B-23, the DA8-B, and a host of other B-T quality engineered products to improve television reception, are available at electronic parts distributors.

For further information, use coupon.

**B-T LABS** BLONDER-TONGUE LABS., INC.  
9 Alling Street, Newark 2, New Jersey

Please send me literature covering:

B-T B-23  B-T TV Accessories

Name \_\_\_\_\_

Address \_\_\_\_\_

City \_\_\_\_\_ Zone \_\_\_\_\_ State \_\_\_\_\_

PF-1

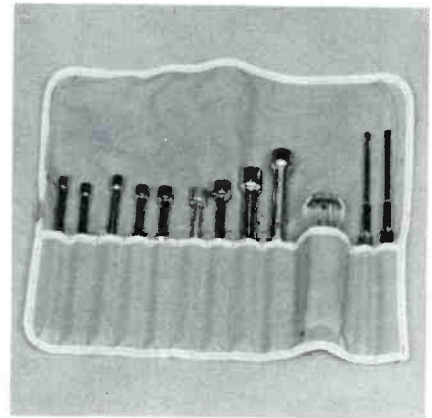

Fig. 14. Plug-in tool and handle set.

tion to the standard screwdriver blades, Phillips, Reed and Prince, clutch-head, hex-nut, hand reamer and extension shafts are available. Hex-nut drivers from the smallest to the largest sizes are obtainable in plug-in form, but the others (screwdriver, Phillips, Reed and Prince, and clutch-head) are generally available in only the most popular sizes.

The pocket clip-on tools (Fig. 15) are small in both handle and tip size and are primarily intended for use in removal of small screws and nuts. Their small size would make them easy to misplace in a tool kit—this is the main reason for the pocket clip.

The torque ratings of these tools is very low. Since the handles are also small, it is unlikely that their ratings will be easily exceeded—but don't press your luck. Remember, small points are for small screws.

This concludes the coverage of the common hand drivers that electronic service technicians use every day. The remainder of the common hand tools used by servicemen will be discussed in a forthcoming issue. ▲

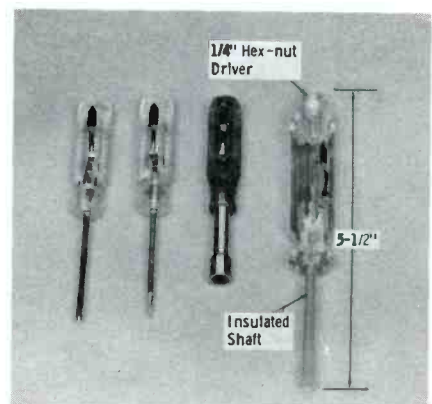

Fig. 15. Pocket clip-on tools.



# S T O C K G U I D E for TV tubes

The chart on this page is presented as a guide for the maintenance of an up-to-date stock of television receiving tubes. The figures shown are expressed as proportions based on a total of 1,000 tubes. For example, if the figure 6 is given for a particular type of tube, this means that six out of every 1,000 tubes in television receivers now in service are of that type. The minimum entry in the "No. of Units" column is 0.5 per 1,000, rounded off to 1. Tubes which are used more rarely than this are also listed but the usage figure is not given.

The listing of a large figure for a particular type of tube is not necessarily a recommendation for stocking that number of tubes, but it does indicate

that the tube is used in many circuits and should always be on hand in sufficient quantity to fill requirements between regular tube orders. Some consideration should be given to the frequency of failure of a particular tube type when stock requirements for that type are being considered.

This guide is based on all brands of TV receivers, and the frequency-of-use data for tubes represent nationwide averages; therefore, these figures should be adjusted to take into account regional and local conditions. In addition, shops which specialize in servicing particular brands of sets will need to modify their tube stocks to suit the requirements of those sets.

In most cases, combined listings are

given for redesigned "A" and "B" tube types and their prototypes. It is often practical to stock the latest version exclusively.

The figures in the Stock Guide are obtained statistically by keeping a cumulative record of the tubes used in new models of receivers. The results are adjusted to take into account the quantities of production of different models and the retirement of old sets at an estimated average age of 5 years.

Types preceded by an asterisk are 450-ma series-string tubes which were actually in use at the time the computations were made. An asterisk following an "A" or "B" suffix indicates that only the "A" or "B" version of the tube has controlled warm-up time.

TUBE TYPES	NO. OF UNITS	TUBE TYPES	NO. OF UNITS	TUBE TYPES	NO. OF UNITS	TUBE TYPES	NO. OF UNITS	TUBE TYPES	NO. OF UNITS
1AX2	—	5BK7A	1	6BC5	6	6CN7	1	12AV5GA	—
1B3GT	42	*5BQ7A	—	6BC7	—	*6CQ8	—	12AV7	2
1V2	1	5BR8	—	6BC8	1	6CS6	3	12AX4GT/-A	7
1X2A/-B	9	5BT8	—	6BD4/-A	—	6CS7	1	12AX7/ECC83	5
2BN4	1	5CG8	1	6BE6	6	6CU5	—	12AZ7	1
2CY5	—	5CL8	—	6BF5	1	6CU6	3	12B4A	2
3A2	—	5CM8	—	6BG6G	4	*6CU8	—	12BH7/-A	12
3A3	1	5J6	1	6BH8	1	6DC6	—	12BK5	1
3AL5	2	5T8	1	6BJ7	—	6DE6	2	12BQ6GA	—
3AU6	2	5U4GA/-B	43	6BJ8	—	6DG6GT	1	12BQ6GTA/-B	1
3AV6	—	5U8	5	6BK4	1	6DN6	—	12BR7	—
3B2	—	5V3	—	6BK5	2	6DQ6/-A	2	12BV7	—
3BC5	1	5V6GT	—	6BK7A/-B*	6	6DT6	1	12BY7/-A	11
3BN6	3	5X8	1	6BL4	—	6J5	3	12BZ7	—
3BU8	—	5Y3GT	2	6BL7GT	6	6J6	22	12C5	—
3BY6	—	6AB4	1	6BN4	—	6K6GT	7	12CA5	1
3BZ6	3	6AC7	4	6BN6	6	6M3	—	12CT8	—
3CB6	9	6AG5	5	6BQ6G/-A	2	6S4/-A	2	12CU5	—
3CF6	1	6AG7	2	—GTA/B	19	6SL7GT	1	12CU6	1
3CS6	1	6AH4GT	3	6BQ7A	16	6SN7GT/-B	66	12D4	—
3DT6	1	6AH6	6	6BR8	—	6SQ7	2	12DQ6/-A	3
*4AU6	—	6AK5	2	6BS8	—	6T8	13	12L6GT	2
*4BC5	—	6AK6	—	6BU8	1	6U4GT	—	12R5	—
4BC8	—	6AL5	60	6BV8	—	6U8/-A*	18	12SN7GT/-A	3
*4BN6	—	6AM8/-A*	4	6BX7GT	—	6V3A	2	12W6GT	1
4BQ7A	2	6AN8/-A*	7	6BY6	2	6V6GT/-A*	14	*17AV5GA	—
4BS8	—	6AQ5/-A*	15	6BY8	—	6W4GT	18	*17AX4GT	—
*4BU8	—	6AR5	1	6BZ6	4	6W6GT	10	*17D4/-A	—
*4BZ6	—	6AS5	3	6BZ7	4	6X8	7	*17DQ6/-A	—
4BZ7	—	6AS6	1	6BZ8/X155	1	6Y6G	1	17H3	—
*4BY6	—	6AS8	1	6C4	7	7AU7	3	18A5	—
*4CB6	—	6AT6	2	6CA7/EL84	—	*8AU8	—	19AU4/-A	1
*4CS6	—	6AT8/-A*	2	6CB5A	1	*8AW8A	—	25AV5GA	—
*4DT6	—	6AU4GT/-A	3	6CB6/-A	121	*8BH8	—	25AX4GT	1
5AM8	1	6AU6/-A	91	6CD6G/-A	2	*8BN8	—	25BK5	1
5AN8	1	6AU8	3	6CE5	—	*8CG7	—	25BQ6GA	—
5AQ5	2	6AV5GA	3	6CF6	2	*8CM7	—	25BQ6GTA/-B	3
5AS4	—	6AV6	15	6CG7	5	*8CN7	—	25C5	—
5AS8	—	6AW8A	6	6CG8	1	*8CS7	—	25CD6G/-A	—
5AT8	2	6AX4GT/-A	14	6CH8	—	*8SN7GTB	—	25CU6	—
5AV8	1	6AX5GT	1	6CL5	—	9CL8	—	25DN6	1
5AU4	—	6AX8	—	6CL6	3	9U8	—	25L6GT	4
5AW4	—	6AZ8	—	6CL8/-A*	—	10C8	—	25W4GT	1
5B8	1	6BA6	7	6CM6	1	12AT7	9		
5BE8	—	6BA8A	2	6CM7	2	12AU7/-A	31		



The proper mixing and control of fluids involves the sensing of several physical properties such as pressure, rate of flow, liquid level, viscosity and density. Pressure and rate of flow were described in the previous installment; the remaining properties will be analyzed in the following discussion.

### Level Sensing

Storage and mixing tanks require some method of liquid level measurement which will convert level changes into an electrical signal for use in actuating indicating devices or control circuits. Mechanical level sensing systems employ a float as shown in Fig. 1. As the float moves, it turns the shaft of potentiometer P1, and the resultant change in tube bias changes the conduction of the amplifier tube. Variations in plate voltage are transmitted to the control station where a pen recorder indicates the change in liquid level.

Electrical signals may be obtained directly when the liquid is either a good dielectric or a good conductor. With dielectric liquids the difference between the dielectric constants of air and the liquid may be utilized. In Fig. 2, capacitor plates are formed by placing a flat metal sheet on each side of the storage tank. As the liquid level varies, so does the capacitance between the plates and the operating frequency of the tuned circuit. At the detector the sensing signal is compared to a standard frequency, and the difference will cause a DC control voltage to be generated. The conductivity of the liquid does not

affect circuit operation because the resonant frequency of an LC circuit is not affected by shunt resistance. Oscillations are maintained by constant pulsing from a relaxation type pulse generator.

When the liquid itself is primarily a good conductor, a resistance sensing method is used. In this case, the sensing elements are rods rather than plates in order to reduce capacitive coupling effects. Fig. 3 shows that the liquid resistance is used as part of a bridge circuit to which an AC signal is applied between points C and B. The applied signal must be AC to prevent electrolysis action from forming an oxide coating on the sensing rods.

### Viscosity Sensing

Viscosity is the measurement of a fluid's resistance to flow. The greater the viscosity of a liquid, the more reluctant it is to flow. For example, thick molasses will flow much slower than water. The difference in movement is caused by the differences in viscosity. Water characteristics are used for so many standards of measure that it is not surprising to find the unit of viscosity (poise) defined as the viscosity of water at a temperature of 20.20°C. The word poise is taken from the name of the scientist Poiseuille, and the common unit of measurement is the centipoise ( $\frac{1}{100}$  of a poise). The friction of water sliding over itself at a temperature 20.20°C is called one centipoise, and subsequent viscosities are relative to this standard.

Since viscosity is a measure of a liquid's resistance to movement,

**SERVICING  
INDUSTRIAL  
ELECTRONICS**

**part - 5**

# LOOKING AT LIQUID SENSERS

by Melvin Whitmer

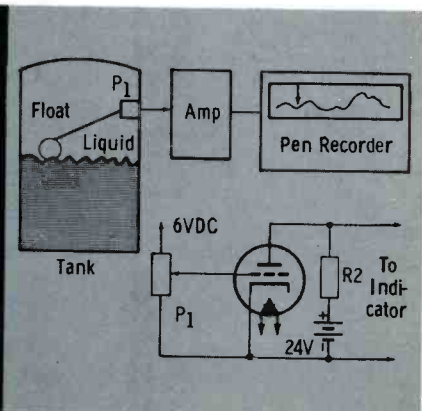

Fig. 1. Electromechanical sensor used to automatically indicate fluid level.

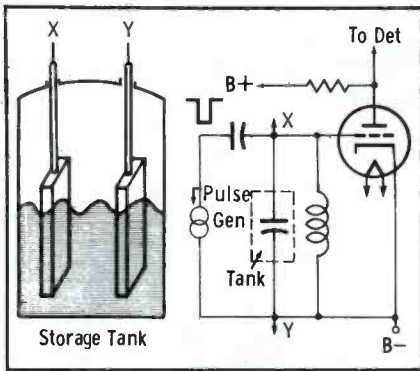

Fig. 2. Difference between dielectric constants of air and liquid are used in determining change in fluid level.

it is possible to determine viscosity by measurement of the energy required to set up vibration waves in the liquid. The Bendix Ultra Viscoson (Fig. 4) is an instrument that operates on this principle. This unit consists of an ultrasonic generator, power consumption computer, kettle or pipeline probe and a centipoise meter having several ranges. The probe (Figs. 5 and 6) houses a steel ribbon which is excited by a 28-kc generator and is constructed so that the power consumed in generating vibration waves in the liquid may be measured. Since the power consumed in generating vibrations in a liquid is a relative measure of viscosity over density, and density is a constant, the reading obtained is an indication of the viscosity in centipoise grams per cubic centimeter.

The instrument shown in Fig. 4 also provides a DC output voltage which can be used to operate chart recorders or control systems. Cable lengths up to one mile are possible without introducing an error in the resultant indication. Other viscosimeters used in

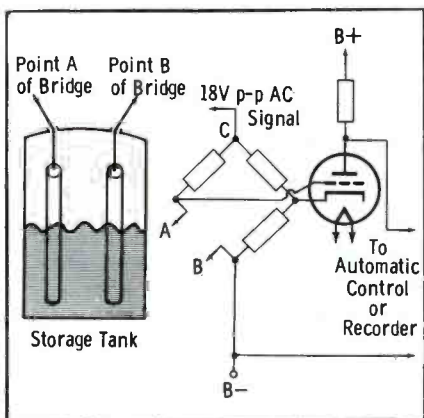

Fig. 3. Resistance between rods changes with level and unbalances bridge.

# only the MODEL 97 AEROVOX LC-CHECKER



can do SO MANY  
JOBS - SO WELL!



INDUCTANCE LOOP AND C PROBE ASSEMBLY C PROBE ASSEMBLY CLIP CORD

## THE MODEL 97 LC-CHECKER CAN DO ALL THESE JOBS!

- 1 Measure capacitance and relative "Q" of capacitors.
- 2 Measure capacitor and insulation resistance.
- 3 Align r-f and i-f circuits.
- 4 Check super-het oscillator tracking with set "hot-or-cold."
- 5 Align i-f channels in FM receivers and independent alignment of i-f transformers.
- 6 Determine resonant absorption points.
- 7 Locate resonant points in unused portions of coil assemblies in multi-range oscillators.
- 8 Align video and sound i-f systems in TV sets.
- 9 Precise alignment of 4.5 mc inter-carrier sound i-f channels.
- 10 Determine natural resonant points of r-f chokes.
- 11 Determine natural period of antennas and transmission lines.
- 12 Measure fundamental crystal frequencies and operation at harmonic levels.
- 13 Measure transmitter buffer, amplifier and tank circuits for parasitic current loops with power off.
- 14 Measure correct wave-trap and filter tuning.
- 15 With a standard plug-in crystal, can be used as an accurate signal generator for signal substitution and precise signal sources.

**\$69.95**

## AEROVOX CORPORATION

DISTRIBUTOR DIVISION

NEW BEDFORD, MASS.

don't stand  
on your  
head!

USE *Howard W. Sams*  
"AUTO RADIO REMOVAL"  
MANUALS



**THE ONLY BOOKS OF THEIR KIND**

These books really help you solve the toughest problem in auto radio servicing. They give you step-by-step instructions for the easy removal of radio, power supply and speaker units from all 1955, 1956 and 1957 standard and sports model automobiles. Complete information is provided for each car covered: tools required for removal; phantom view of dash panel with radio in place (quickly locates chassis mounting nuts, bolts, cables, antenna and speaker leads); photo showing actual removal of radio. Includes rear-deck speaker data for each model; shows if cutout is provided, speaker size, and whether speaker control is included or required. Includes summary of preliminary servicing procedures which should be performed to determine whether radio removal is required to effect repair.

- ARR-57. Covers all 1957 American stock and sports models. 120 pages, 5 1/2 x 8 1/2".
- ARR-56. Covers all 1956 American stock and sports models. 104 pages, 5 1/2 x 8 1/2".
- ARR-55. Covers all 1955 American stock and sports models. 104 pages, 5 1/2 x 8 1/2".

EACH VOLUME \$2.95  
ONLY.....

SEE THESE BOOKS AT YOUR  
ELECTRONIC PARTS DISTRIBUTOR  
OR MAIL COUPON TO  
HOWARD W. SAM'S TODAY



**FREE TRIAL COUPON**

Howard W. Sams & Co., Inc. Dept. 3-AA8  
2201 E. 46th Street  
Indianapolis 5, Ind.

Send me the book(s) checked below, for 10 days FREE examination. In 10 days, I will pay for the book(s), plus small delivery costs, or return them postpaid. (We pay delivery costs if you remit with this coupon; same return privilege.)

- ARR-57.  ARR-56.  ARR-55.

Name.....  
Address.....  
City..... Zone..... State.....  
(outside U.S.A. priced slightly higher)



Fig. 4. Dynamic viscosity is determined from the amount of power required to make the probe blade oscillate.

industry for continuous control rely on the pull exerted on an object when liquid passes over or through it. Meters of this type must have a rate of flow control preceding them to assure accuracy.

Temperatures of liquids must be controlled during viscosity measurements, otherwise considerable error will result. Crude oil, for example, changes viscosity from 400 centipoises at 0°C to 54 centipoises at 100°C. Because higher viscosity means greater resistance to movement, crude oil is heated and maintained at a constant temperature during pipeline transmission. The power saved by heating crude oil before transmission more than pays for the cost of heating the oil.

**Density**

Density is the measurement of mass for a unit volume of substance. The density units for the metric system are grams/cubic

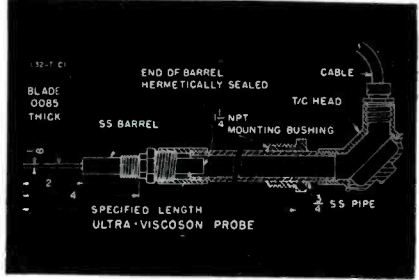
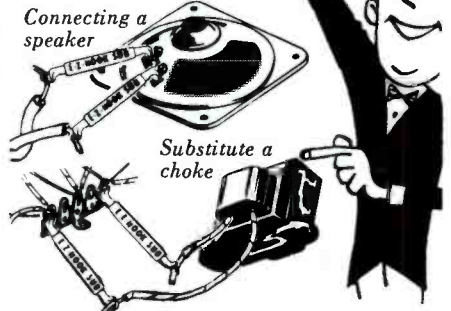

Fig. 5. Cross-sectional view of typical pipeline viscosity-measuring probe.

Now Substitute Parts  
without Soldering!

**The E-Z-HOOK "SUB" Test Connector**  
Has 1001 Uses!

Here's several uses:



plus transformers, capacitors and resistors!

- ★ Makes connections instantly!
- ★ Won't pull off!
- ★ Insures positive contact!

Saves time, money and parts in servicing, experimenting, instructing and production.



No. 71 E-Z-HOOK SUB  
IN SIX COLORS—69¢ net each

ORDER THROUGH YOUR  
PARTS DISTRIBUTOR  
E-Z-HOOK TEST PRODUCTS  
Dept. F, 1536 Woodburn Ave.  
Covington, Ky.

**Yours for the Asking**

To fill the service dealer's needs for complete, up-to-date replacement data on Global\* resistors, fused resistors and special types of wirewound resistors brought about by the ever-increasing number and variety of these components in modern TV and radio receivers, WORKMAN TV INC., Teaneck, N. J., publishes several valuable cross-reference sheets which, through your favorite parts jobber, are YOURS FOR THE ASKING!!

Designated as Forms #CS13, #CS14, #CS18 and #CS25, these reference sheets provide complete, accurate replacement data on Global\* resistors, fused resistors, and wirewound resistors for series-string TV and for portable radios, respectively.

Don't waste valuable time searching for replacement data in schematics and parts lists. Ask your favorite jobber for the WORKMAN TV cross-reference sheets! They are supplied to him free of charge so that they may be YOURS FOR THE ASKING!

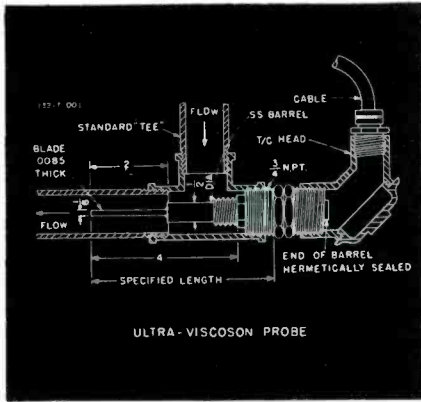

Fig. 6. Cross-sectional view of typical kettle-type viscosity-measuring probe.

centimeter, and for the English system ounces/cubic inch. In the static condition, density control is relatively simple, but industries do not like to have production halted while a chemist takes a sample and dashes to the laboratory with it. Continuous control is the objective, and the actual mechanics involved are left up to the technician or engineer. A very widely used method of determining density is to convert from density to specific gravity. In this method, the density of any liquid is compared to the density of water at 4°C.

Specific gravity can be measured by the hydrometer measuring device shown in Fig. 7. The position of the float is determined by magnetic coupling; thus, friction cannot contribute an error and accurate measurement of specific gravity is obtained. The position of the float controls the inductance of a coil which forms part of the oscillator tank circuit.

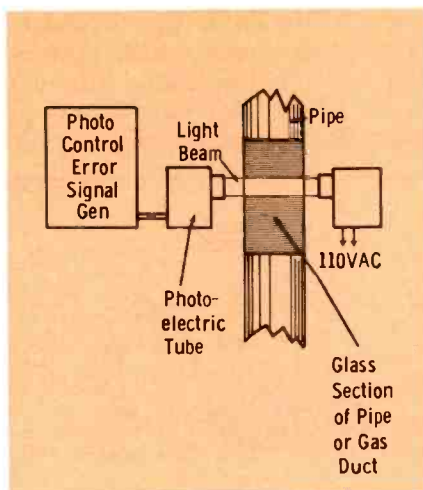

Fig. 8. Variations in density will alter amount of light reaching phototube.

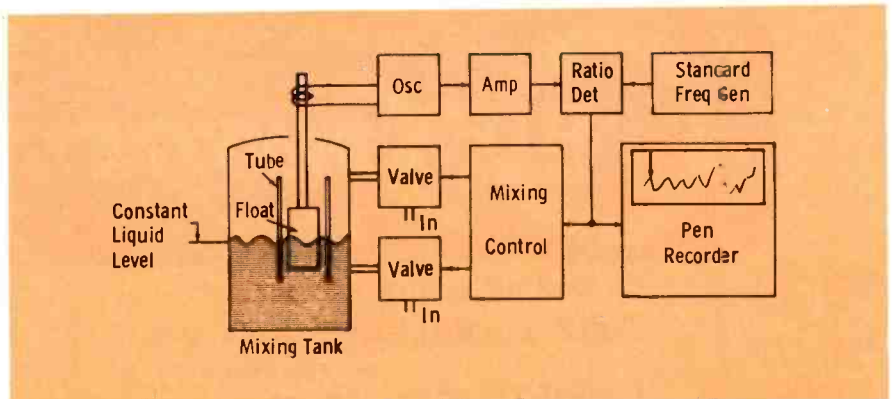

Fig. 7. Hydrometer level controls oscillator frequency which is compared with standard frequency to develop correction voltage for control of fluid density.

**For Every Serviceman ...**  
**The Dozen That Does The Most!**



## G-C

# 12 TOP TOOL KIT

**12 TOOLS FOR ONLY \$10.95 LIST**

**KIT No. 5040**

**WRITE TODAY** for free copy of illustrated G-C Catalog. Do it now! Contains thousands of useful service aids.

**HERE'S THE ALL IMPORTANT 12!**

- LONG REACH 16" ALIGNMENT TOOL  
No. 8729 List \$0.90
- NYLON .125 HEX IRON CORE TOOL  
No. 9091 List \$0.75
- "SHORTY" 2" ALIGNMENT TOOL  
No. 8289 List \$0.70
- ZENITH-ADMIRAL NYLON HEX TOOL  
No. 8606 List \$0.55
- ZENITH-RCA ALIGNMENT TOOL  
No. 9050 List \$0.30
- K-TRAN—I.F. TRAM TOOL  
No. 5097 List \$0.35
- WESTINGHOUSE ALIGNMENT TOOL  
No. 9089 List \$0.90
- HEAVY DUTY SOLDERING AID TOOL  
No. 9088 List \$1.65
- DUPLEX ALIGNMENT TOOL  
No. 8276 List \$0.80
- NYLON LONG REACH 12 1/4" ALIGNER  
No. 8607 List \$1.80
- STACKPOLE-TYPE CORE ALIGNER  
No. 8271 List \$0.90
- PLASTIC SLIM 14 1/2" SCREWDRIVER  
No. 8988 List \$1.50

**GENERAL CEMENT MFG. CO.** Division of Textron Inc.  
 400 SOUTH WYMAN STREET • ROCKFORD, ILLINOIS

# "G" PRESENTING THE *New* GRIP SPINTITE<sup>®</sup> WRENCHES

PATENTS PENDING

FINEST QUALITY  
STEEL SHANK  
AND SLEEVE  
•  
BRIGHT PLATED  
FINISH  
•  
STRONG  
PLASTIC HANDLE

WITH THE EASY "FINGER-CONTROL"  
**GRIP AND RELEASE ACTION**  
FOR THOSE  
**HARD-TO-GET-AT PLACES —**

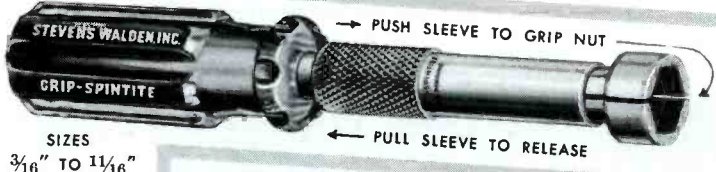

SIZES  
3/16" TO 1 1/16"

BY THE MAKERS OF  
THE ORIGINAL  
**SPINTITE**  
WRENCHES  
OVER 150 STYLES  
AND SIZES

**ONE HAND OPERATION—**

- GRIPS nuts or bolts of any material
- HOLDS firmly in any position
- TIGHTENS nut or bolt securely
- RELEASES at the pull of the fingers

**STEVENS WALDEN Inc.**  
500 SHREWSBURY STREET — WORCESTER, MASSACHUSETTS  
MAKERS OF WORLD-FAMOUS HAND TOOLS FOR OVER 50 YEARS

Write for  
catalogue

## NOW-GET TOP PERFORMANCE FROM TAPE RECORDERS

HERE'S A GLIMPSE  
AT SOME OF THE  
HIGHLIGHTS

- ELEMENTS OF A TAPE RECORDER
- CHARACTERISTICS OF A HIGH-QUALITY TAPE AMPLIFIER
- HEAD CHARACTERISTICS
- TAPE CHARACTERISTICS
- BIAS CURRENT
- EQUALIZATION REQUIREMENTS
- EQUALIZATION CIRCUITS
- OSCILLATORS
- RECORD LEVEL INDICATORS
- MINIMIZING NOISE AND HUM

### ELEMENTS OF TAPE RECORDER CIRCUITS—

By Burstein and Pollak. Gernsback Library Book No. 67. 224 Pages. Paper cover ed. \$2.90. Deluxe hard cover ed. \$5.00



Hi-fi fans! Technicians! Here's the book you asked for! **ELEMENTS OF TAPE RECORDER CIRCUITS** answers all your questions on the electronic aspects of tape recorders. Shows you what to look for when you buy—explains what various types will and will not do—gives you details on how to push the performance up to the best possible level. The authors, two of the most highly regarded experts in the industry, were commissioned to write this book in answer to the demands of our readers. They cover all the points you want to know—how tape recorders work—what to expect from inexpensive models—what the better ones will do—how to get maximum performance in any type. They even teach you basic design principles (with a minimum of simple arithmetic) so you can modify your equipment for better results. Ideal for both audiophile and technician! Use the coupon below for this and other G/L books.

**MAIL THIS COUPON TODAY—**  
**GERNSBACK LIBRARY, Inc. Dept. PR-18**  
154 West 14th Street, New York 11, N.Y.  
Here's my remittance of \$..... Please send me the books checked below.

No. 67 **ELEMENTS OF TAPE RECORDER CIRCUITS**  
 Paper cover..... \$2.90     Hard cover..... \$5.00

Paper cover editions

<input type="checkbox"/> Basic Audio Course No. 66..... \$2.75	<input type="checkbox"/> Rapid TV Repair. No. 60 \$2.90
<input type="checkbox"/> Understanding Hi-Fi Circuits. No. 64..... \$2.90	<input type="checkbox"/> High-Fidelity Circuit Design. No. 56. Deluxe hard cover ed. only..... \$5.95
<input type="checkbox"/> Transistor Circuits. No. 63..... \$2.75	<input type="checkbox"/> Transistors—Theory and Practice. No. 51..... \$2.00
<input type="checkbox"/> Transistor Techniques. No. 61..... \$1.50	<input type="checkbox"/> High-Fidelity—Design, Construction, Measurement. No. 48..... \$1.50
<input type="checkbox"/> Maintaining Hi-Fi Equipment. No. 58..... \$2.90	<input type="checkbox"/> Basic Radio Course, No. 44. Hard cover only..... \$2.25

NAME.....  
STREET.....  
CITY..... ZONE..... STATE.....

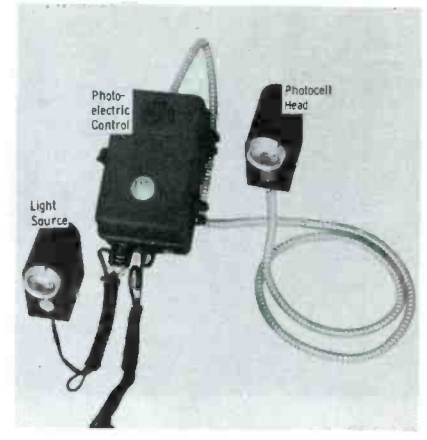
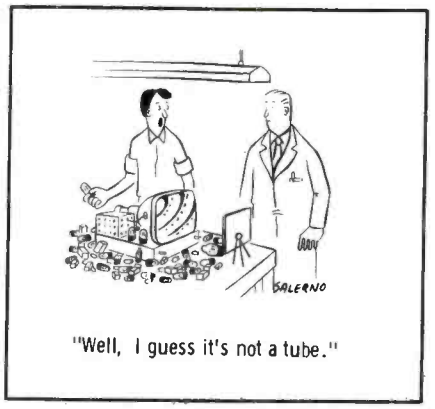

Fig. 9. Photoelectric unit controls density and warns when control is lost.

The oscillator output is amplified and applied to a ratio detector where an error signal is developed to operate a recorder or control system.

Density can also be measured by photoelectric means as shown in Fig. 8. A beam of light is directed through the substance, and the photocell conducts according to the amount of light it receives. The substance will diffuse the light in proportion to its density; thus a change in photoconduction generates a control signal to operate a valve which will increase or decrease the quantity of material. This system is used in combustion control of furnaces, safety control of air ventilators, liquid suspensions, and foreign particle detection. Fig. 9 illustrates a commercial photoelectric device which is used to control density and give a warning if control is lost.

Thus far we have discussed only physical sensing-control units, but many of the fluids used in industry are mixtures which require the use of chemical-sensing devices. These will be covered in next month's installment. ▲



**SHOP TALK**

*(Continued from page 12)*

Amplitude on a circular graph is considered to start at the very center of the chart, the origin for all of the concentric circles drawn around it. This point represents zero amplitude. Amplitude values then increase as we move away from this center along any of the radii; thus, the closest dark circle might be assigned a value of 1 or 10 or 100, or whatever is desired. The next larger heavy circle would be given a higher value and so on until the outermost circle is reached. In between each two consecutive dark circles, there are a number of lighter or minor

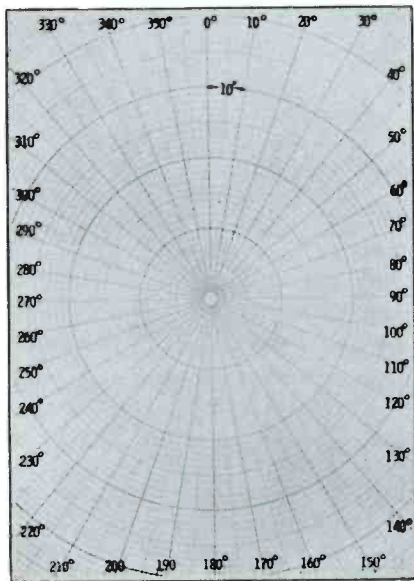

**Fig. 3. Circular coordinate graph useful for plotting directional response of antennas and microphones.**

circles. These are assigned intermediate values in exactly the same fashion as the minor divisions on a rectangular graph. Thus, if two consecutive major circles possess values of 10 and 20, and there are nine minor circles between them, each of these would possess a value one greater than the smaller circle just preceding it. This is illustrated in Fig. 4.

Now let us consider an application of the circular graph. The directional response of a certain television antenna is shown in Fig. 5. This consists of one large lobe pointed in the 0° direction and a very small lobe directed toward 180°. Consider the large lobe first. It reaches its greatest amplitude at 0°. At 10°, the point

January, 1958 • PF REPORTER

**It's no trick to save time replacing dual controls**



**with  
Centralab  
Fastatch® FR-22A  
Control Kit**

Why waste time with special trips to jobbers every time you need a dual-concentric, when — at a fraction of the cost — you can stock a complete line within arm's reach?

The handy Fastatch® FR-22A kit puts 570 dual-control variations at your fingertips — gives you the replacement you need for 85% of your TV, radio, and auto-set service calls . . . and all this for only \$28.51!

Make it a point to pick up a Fastatch® FR22A dual-control kit at your Centralab distributor the next time you need supplies.



Each Fastatch® FR-22A kit contains 22 control units, 4 Fastatch® switches, and 2 auto-adaptor bushings that you can combine to get 570 of the most popular dual controls. Each control is factory-assembled, tested, and guaranteed by Centralab.



A DIVISION OF GLOBE-UNION INC.  
942 EAST KEEFE AVENUE • MILWAUKEE 1, WISCONSIN  
IN CANADA: 804 MT. PLEASANT ROAD • TORONTO, ONTARIO

of lobe intersection is not quite as far from the center; at  $20^\circ$ , the lobe line intersects the  $20^\circ$  radius at a point even closer to the center. This trend continues until, at the  $40^\circ$  line, antenna response is practically zero.

The same behavior is exhibited to the left of the  $0^\circ$  line. We could label these items  $-10^\circ$ ,  $-20^\circ$ ,  $-30^\circ$ , etc., or we could use their rightful designation of  $350^\circ$  (just to the left of the  $0^\circ$  line),  $340^\circ$  (two lines to the left), etc. Best reception is then obtained from signals approaching the array

along the  $0^\circ$  line. Any signals arriving from points to the left or right of this line will not be as well received, and as the angle increases, the amount of signal fed to the transmission line drops off considerably. From  $40^\circ$  to  $90^\circ$ , practically no signal at all is obtained; the same is true for angles  $-40^\circ$  to  $-90^\circ$  (or from  $270^\circ$  to  $320^\circ$  if the latter notation is employed).

Now consider the smaller secondary lobe. This indicates the ability of the antenna to receive from the rear. Obviously, some

signal can be received, as evidenced by the fact that a small lobe does appear. Just as evident, however, is the fact that the reception is considerably poorer than that which can be obtained from the front.

The foregoing discussion indicates why the choice of the  $0^\circ$  line is arbitrary. Obviously, we could point the array in any desired direction, be it north, west, east or south and this direction would represent the point along which the  $0^\circ$  line would be drawn. From this line, we would start marking off the rest of the  $360^\circ$  of the circle. If the response is quite sharp, as it is in Fig. 5, it is more

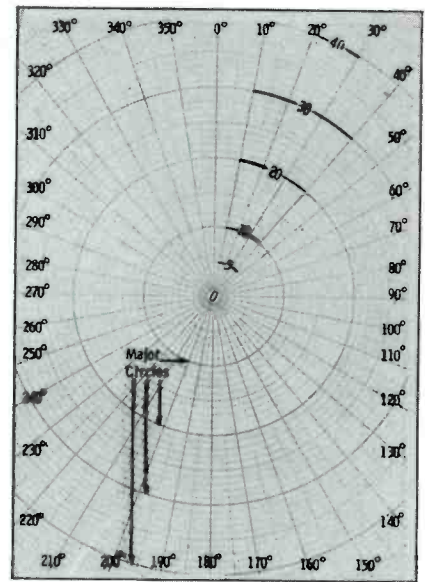

Fig. 4. The amplitude scale on a circular graph starts at the center and proceeds outward along any of the radii.

desirable to label the angles to the left of the  $0^\circ$  line (i. e., counter-clockwise) as  $-10^\circ$ ,  $-20^\circ$ ,  $-30^\circ$ , etc. This introduces no confusion and tends to simplify the angular presentation, since most of the rest of the circle is not being used.

The response curves of several different types of antennas are shown in Fig. 6. In the first illustration, Fig. 6A, the two-lobed pattern is nearly symmetrical with respect to the line running from  $90^\circ$  to  $270^\circ$ . It is assumed the array is placed with its elements running from left to right (i. e., from  $270^\circ$  to  $90^\circ$ ), with the front of the antenna pointing toward  $0^\circ$  and its rear facing  $180^\circ$ . The large extent of both lobes indicates that, for this antenna, good signal reception can be expected from both

**A**

*Always dependable...*

**B**

*Better quality and design...*

**C-D**

**VIBRATORS**

*the complete line...*

There is a CORRECT replacement C-D vibrator for every original installation...no guessing...no problems! And every C-D vibrator delivers longer service that is dependable...and quieter in operation! AND...the complete line of COMMUNICATION VIBRATORS answers every replacement problem in this important field!

It's as basic as knowing your A B C D's... that C-D vibrators are your best buys year 'round... day in and day out! Look for the famous C-D seal... it is your guarantee of quality combined with skilled engineering and controlled manufacture!



**CORNELL-DUBILIER**

Plants in South Plainfield, N. J.; New Bedford, Worcester and Cambridge, Mass.; Providence and Hope Valley, R. I.; Indianapolis, Ind.; Sanford, Varina and Fuquay Springs, N. C.; and Venice, California. Subsidiary: The Radiart Corporation, Cleveland, Ohio.





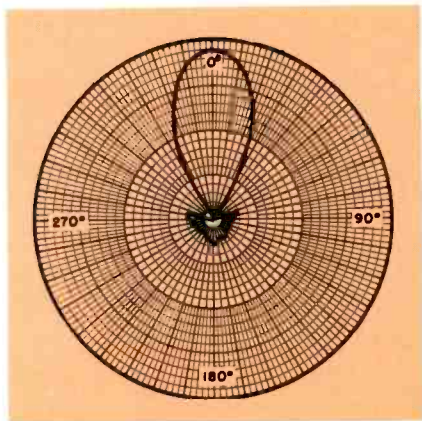

Fig. 5. Lobe pattern of yagi antenna.

front and rear. However, since the forward extent of the top lobe is greater than that of the bottom lobe, the same signal reaching the antenna from the front would develop more voltage across the antenna leads than it would coming from the rear, although the difference is very slight.

In the second pattern, Fig. 6B, we find an array that has four directions from which it can receive a signal equally well. Again, the front of the array is pointed in the 0° direction. Reception along this line is quite poor, and best reception is first encountered at 45° from the 0° line. Thus, while it is generally true that most arrays receive a good signal from their front, this need not always be true.

The final pattern, Fig. 6C contains a number of lobes, each pointing in a different direction. Some of the lobes are broad, encompassing 20° or more; others are narrow, being effective over an angular sweep of only 5 to 10°.

The foregoing circular patterns illustrate some of the antenna responses that may be encountered

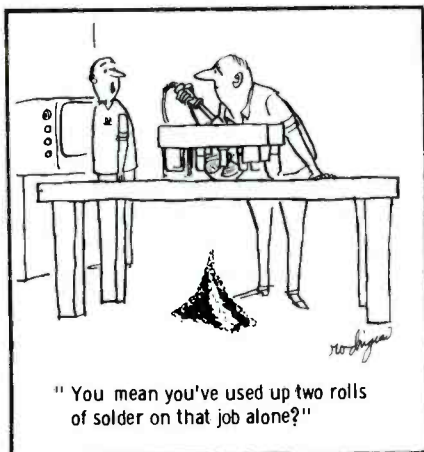

"You mean you've used up two rolls of solder on that job alone?"

## 1957 EDITORIAL INDEX

For the many PF REPORTER readers who keep a file of issues for quick reference, a 1957 Editorial Subject Reference Index has been prepared and is available without charge on request to the Editor, PF REPORTER, 2201 E. 46th St., Indianapolis 5, Indiana.

## THIS MONTH'S COVER

Let's face it men, the technician hiding behind his newspaper is going to *have* to fix the family TV set . . . or else. This was his wife's *one* New Year's resolution. Leonard Cramer, the technician, is doing his utmost to ignore the fact that his wife (Carol Gadbury) and daughter (Cindy Gadbury) want him to spend the evening on a busman's holiday. We have it on good authority that the women got their way, as usual. The camera-shy laddie is Cameron Andrews, Cindy's favorite playmate.

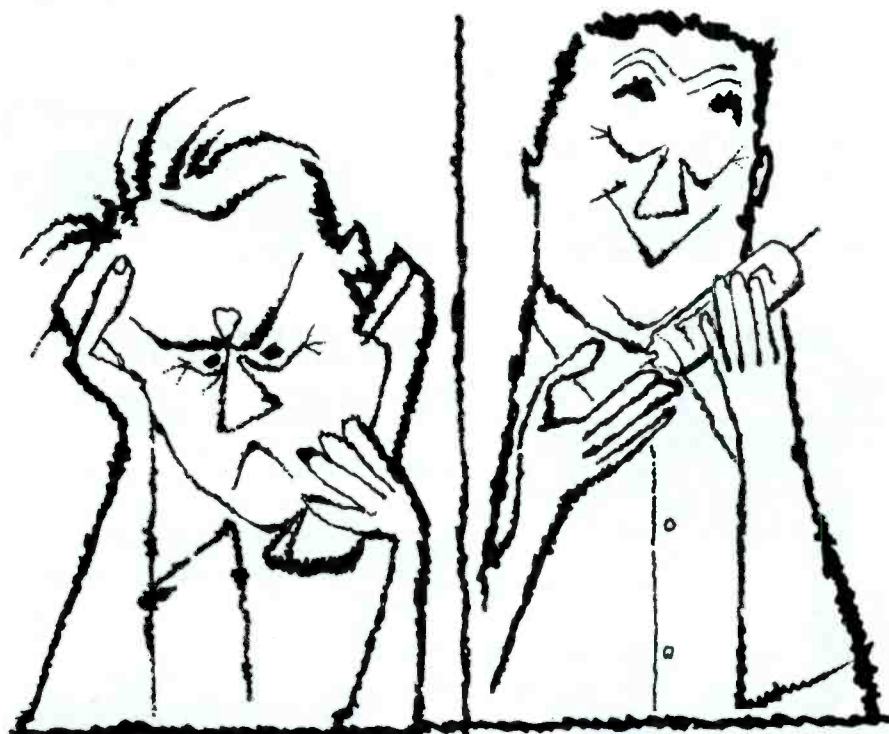

# STOP CB\* WITH C-D

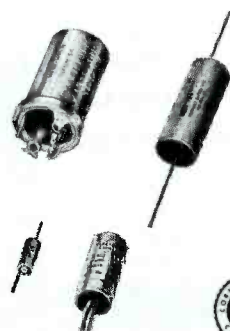

\*CALL BACKS ARE COSTLY. Cornell-Dubilier are specialists in ELECTROLYTICS for replacement service. The familiar C-D Trademark has been the mark of outstandingly superior quality for over 47 years. Every style, size, rating and characteristic of electrolytic capacitor is produced in C-D's own network of plants. From the tiny "finger-nail" size "ELECTO-MITE",<sup>®</sup> to the compact "BLUE BEAVER"<sup>®</sup>, to the long-life "UP" C-D ELECTROLYTICS have earned their great popularity because they are consistently MADE BETTER to LAST. Say C-D when you buy ELECTROLYTICS—be particular. Write for Catalog 200D-3E to Dept. Cornell-Dubilier Electric Corp., South Plainfield, New Jersey.

stop call backs...insist on  
**CORNELL-DUBILIER CAPACITORS**

SOUTH PLAINFIELD, N. J.; NEW BEDFORD, WORCESTER & CAMBRIDGE, MASS.; PROVIDENCE & HOPE VALLEY, R. I.; INDIANAPOLIS, IND.; SANFORD, FUGUAY SPRINGS & VARINA, N. C.; VENICE, CALIF.; & SUB.: THE RADIART CORP., CLEVELAND, OHIO; CORNELL-DUBILIER ELECTRIC INTERNATIONAL, N. Y.

**XCELITE Hand Tools**  
 REFERRED BY THE EXPERTS

Featuring  
**QUALITY**



**A TECHNICIAN  
 MUST HAVE PROPER  
 HAND TOOLS . . . and  
 XCELITE HAS THEM!**

XCELITE hand tools are designed and made especially for the professional Radio, T.V., and Electronic technicians . . . the screwdriver blades are skillfully forged of A.I.S.I. 6150 Chrome Vanadium steel . . . the nutdriver sockets are "precision formed". Handles are of genuine XCELITE plastic, correctly shaped, full "man" size for perfect grip and balance.

Available in a variety of regular and special types and sizes for greater utility and performance . . . remember XCELITE for the finest tools first!

*Call or see your distributor today . . . get acquainted with XCELITE quality, also check the complete line of XCELITE quality tools for new items, or replacements that will help you do your job easier and faster.*

**XCELITE, INCORPORATED**  
 Dept. Q, Orchard Park, N. Y.  
 In Canada: Charles W. Pointon, Ltd.  
 6 Alcina Ave., Toronto, Can

*For Originality*  
**LOOK TO XCELITE**



**TRANSISTOR  
 POWER SUPPLY**

MODEL A-400

Especially designed to operate, service and test transistor portable radios and low power transistor circuits.

Highest quality components combined with careful engineering make this instrument extremely reliable and useful for laboratory and service applications.

**\$64.50** from Electronic Parts Distributors only

**"TRULY A  
 VARIABLE BATTERY"**

**SPECIFICATIONS**

- Input: 115 Volts 50/60 cycles
- Output Voltage: 0-30 Volts and 0-30 Volts
- Output Current: 0-15 MA and 0-60 MA
- Accuracy: 2% on both voltage and current
- Ripple: Less than 500 microvolts (.002% at full output)
- Regulation: 1.2 Volts Maximum; Zero to full load current
- Internal Impedance: Less than 20 ohms DC to Radio Frequencies (including 7.0 ohm Meter Fuse, optionally removable)
- Terminals: 5-Way Binding Post
- Size: 10" x 6 1/2" x 5 3/4"
- Weight: 16 pounds

**FEATURES**

- Continuously adjustable output using variable autotransformer control.
- Two output voltage ranges for accurate setting of all transistor battery voltages.
- Two output current ranges monitor current for single transistor or entire set.
- Extremely low ripple for testing lowest level transistor circuits.
- Very low internal impedance providing excellent regulation.
- Precision D'Arsonval meters provide laboratory accuracy.
- Millimeter protected by front panel fuse; additional internal line fuse.
- Output isolated from line and case.
- Attractive Slope - Front, Maroon Hammerloid Cabinet - Rubber feet.

Manufactured by **Perma-Power COMPANY** 3100 N. ELSTON AVENUE CHICAGO 18, ILL.  
*There's always something new being developed by Perma-Power*

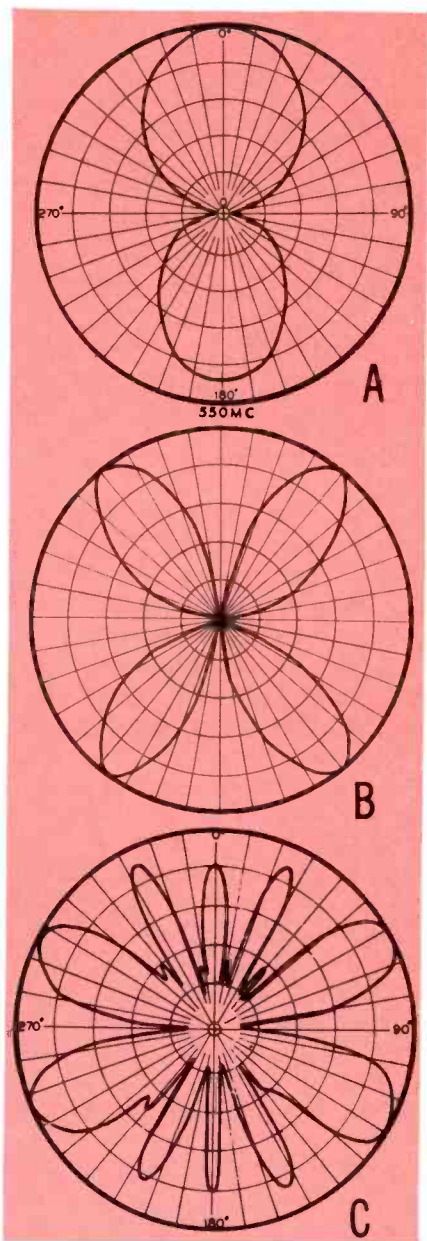

Fig. 6. Representative response patterns of 3 different antenna types.

and how they would be interpreted. If no amplitude values are assigned to the various concentric circles, then simply consider them relatively, with the largest circle (the outer one) possessing the highest amplitude. This is the form in which the television technician will usually see these response curves. In manufacturers' literature, any db gain figures given represent the highest gain which the array is capable of, conforming to the largest lobe. The more you deviate from this optimum receiving direction, the lower the gain.

**Nomograms.**

There is one type of graph that the technician has occasion to deal

with from time to time which is unlike any of the graphs shown either in this or last month's coverage. Such a graph is shown in Fig. 7 and it possesses the special name of nomogram. The various quantities which are interrelated by this graph are each represented by a straight line, and the markings on each line are governed by the relationship of the variable it stands for to the variables of the other lines. The major advantage of this type of presentation is that it enables the relationship between a number of quantities to be shown in a relatively simple manner.

The conventional graph using two axes not only is limited in the range of values which can be reasonably shown, but in attempting to include additional variables by adding more curves, the entire illustration becomes involved and difficult to deal with.

With a nomogram, we can add several parallel axes while causing only a relatively small increase in the complexity of determining an answer. Probably the best way to demonstrate this is by working several examples with the nomogram of Fig. 7. This chart shows the relationship between resistance, power, voltage and current. If two quantities are given, a single operation will reveal the answers to the other two quantities. For extended coverage, a dual numbering system is employed for all scales. When working a problem, all numbers should be read either from the black or the colored scales.

**Example 1.**

*Find the current flowing and the power dissipated in a 100,000-ohm resistor with a potential drop of 300 volts.*

Since the resistance is over



# SERVICEMEN EVERYWHERE

## choose ELMENCO CAPACITORS

For highest reliability and quality



STEATITE TUBULAR

- Complete Humidity Resistance
- High Temperature Resistance
- Longer Operating Life



- ALL Capacities Tolerance & Voltage Imprinted on each Unit
- Standard Tolerance = 5%



SEE YOUR LOCAL **ARCO** DISTRIBUTOR

**Don't Accept Imitations!  
Ask for Elmenco!**



## Suffering from Bends

(Continued from page 17)

mentioned before, insufficient sync pulse amplitude may be due to poor low-frequency response or sync clipping in the video circuit. Any condition ahead of the video amplifier that causes signal overload or any component that affects video amplifier bias can cause sync pulse clipping or distortion. However, picture pulling in such cases will usually be accompanied by unstable vertical synchronization.

The waveform of Fig. 5A represents a typical video signal containing a permissible amount of hum. This slight amount of signal distortion will not normally produce annoying symptoms, but should it reach the extent shown in Fig. 5B, picture pulling and

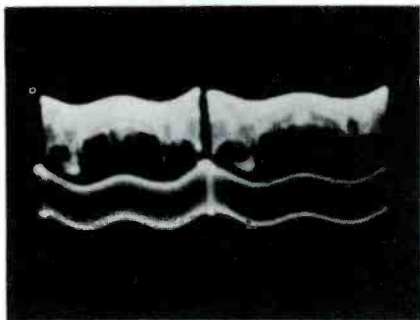

Fig. 6. Composite video signal with 120-cycle modulation—check B+ filtering.

even brightness modulation can result.

In Fig. 5, the frequency of the modulation voltage is 60-cycles. Should the modulation voltage be 120-cycles, the distortion would appear as shown in Fig. 6. The only feasible source of 120-cycle modulation is a full-wave low-voltage power supply. In receivers employing this type of supply, one should check the filtering system as well as B+ decoupling to the RF, IF, and video circuits.

If 60-cycle distortion is found in the video signal, it might pay to check the AGC line, since an open AGC filter capacitor can cause the AGC voltage to vary at the vertical sync pulse rate and thus produce picture pulling. Other sources of 60-cycle voltage are the vertical sweep signal (lack of decoupling which permits the vertical sweep signal to modulate the B+ voltage), the filament supply (heater to cathode leakage), and the ripple or hum present on

# The Case of The Serviceman WHO TOPPLED ANTENNAS!



Suburbia was a good place to live, but distant TV stations and local hills made TV reception spotty. Each neighbor tried to outdo the others with costly antennas, but nothing worked . . . until an enterprising serviceman came along.



He sold them a Jerrold "Neighborhood Cable" System that captures a clean signal at one antenna location and delivers it over shielded coax to each home . . . giving high fidelity signals on all channels . . . at all receivers . . . and eliminating ugly, hazardous rooftop antennas!

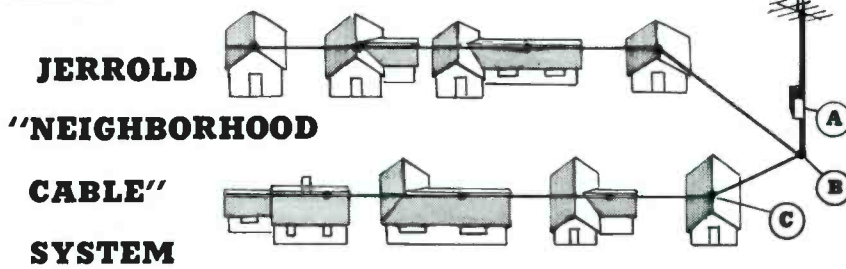

**JERROLD**

**"NEIGHBORHOOD**

**CABLE"**

**SYSTEM**

**CONSISTS OF THESE EASY TO INSTALL COMPONENTS**



**(A) AMPLIFIER**

Distributes strong, clear pictures over shielded coax cable!

**(B) SPLITTER**

Divides amplifier output up to 4 ways. No tube overload!

**(C) TAP**

"Pressure" Tap. Taps line and isolates receivers.

For complete details on "How to Sell and Install a Jerrold Neighborhood Cable System," write to: Dept. P. D. # 23

**JERROLD**  
**ELECTRONICS CORPORATION**

Philadelphia 3, Pa.

LOOK TO JERROLD FOR AIDS TO BETTER TELEVIEWING

**SENCORE**  
*Another Sencore Time-Saver*  
**Handy "36"**  
**R-C Substitution Unit**



**"36"**  
**Most Often Needed Components At YOUR Fingertips!**

3 pole, 12 position switch individually selects one of the "36" components for direct substitution.

Contains:

- ★ 12—1 watt 10% resistors from 10 ohms to 5600 ohms
- ★ 12—½ watt 10% resistors from 10K ohms to 5.6 megohms
- ★ 10—600 volt capacitors Completely isolated from 100-mmfd. to .5mfd.
- ★ 1—10mfd., 450V Electrolytic
- ★ 1—40mfd., 450V Electrolytic
- ★ For Shop, Lab, or outside service

AVAILABLE AT ALL PARTS DISTRIBUTORS!

**POPULAR SENCORE PRODUCTS**

- Transistor Tester
- Leakage Checker
- Filament Tester
- Voltage Regulator
- Bias Supply

**ONLY \$1275 DEALER NET**

**SENCORE SERVICE**  
**INSTRUMENTS CORP.**  
 171 OFFICIAL RD., ADDISON, ILL.

Cut out this ad now for further information.

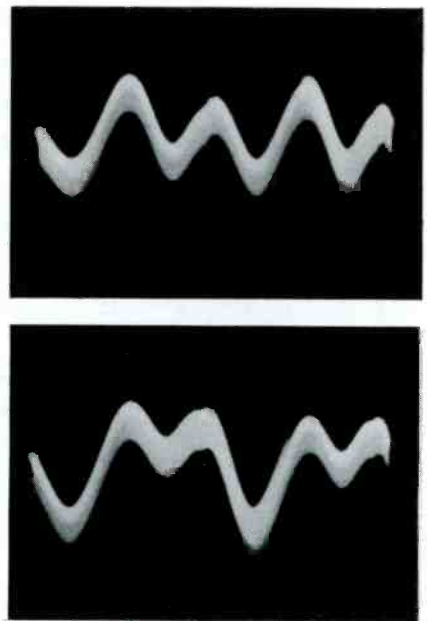

Fig. 7. Waveforms of normal AC ripple on B+ line—peak-to-peak value .5 volt.

the B+ line from a half-wave power supply.

In the majority of receivers, the AC component always found on the B+ line will be composed of both power-supply ripple and a certain amount of vertical sweep voltage. The combined peak-to-peak value, however, will seldom exceed 2 volts under normal conditions. The two waveforms seen in Fig. 7 represent normal AC ripple found on the B+ line of a typical receiver employing a full-wave rectifier system.

In waveform 7A, the sine-wave peaks of the 120-cycle ripple vary in amplitude; that is, every other peak appears either larger or smaller than the adjacent one. This condition is brought about by the fact that both vertical sweep energy and 120-cycle ripple are present on the B+ line and are not in exact synchronization. Since the vertical sweep rate is 60-cycles, every other cycle of the supply ripple is either accentuated or attenuated depending upon the phase relationship between the two AC voltages. A change in the phase relationship produces slightly different ripple patterns. One variation is shown in Fig. 7B—and is the result of merely reversing the AC line plug. Regardless of phase, however, the amplitude of the AC ripple will remain relatively low as long as adequate filtering is maintained.

If more than normal hum is found on the B+ line, one should



*"Boy! You aren't kidding. Your husband is a bear if you forget the JENSEN NEEDLES".*

*Dave Rice's*  
**OFFICIAL ORDER BOOK**  
 for every TV-Radio service call



Triplicate forms serve as order form, invoice and office record with spaces for complete information on every job. Separate listings for receiving tubes, pix tube, parts, serial numbers, labor and tax charges, signatures, etc. 75c a book, \$6.50 for dust-proof box of 10.

... and for customer's prices on every replacement part, Dave Rice's

**OFFICIAL PRICING DIGEST**  
 listing over 60,000 items. \$2.50

In stock at your distributor, or write

**ELECTRONIC PUBLISHING CO. INC.**  
 180 North Wacker Drive Chicago 6, Illinois

**HI-FI COMPONENTS**

*Dynamic*  
**ELECTRONICS**  
**ACCESSORIES**

**PRE-AMPLIFIER**



**Model PA-110... List \$12.95**

You can now convert your HI-FI amplifier or RADIO-PHONOGRAPH (with controls) for use with any VARIABLE RELUCTANCE CARTRIDGES or TAPE RECORDER. Frequency response 11-25,000 CPS ±1.5 db. Noise and hum level 60 db below 10 millivolts—overall gain 34 db.

- Shielded Cable Molded-on Pin Plug
- Phono Input Jack
- On-Off Switch
- Pilot Lite
- 110-117 volts 60 cycle AC—15 watts
- handsome Copper and Black Enclosure

**FINEST PRE-AMP MADE!**

Manufactured By  
**DYNAMIC ELECTRONICS-NEW YORK, INC.**  
 Forest Hills, Long Island N. Y.

first determine if its source is vertical energy or power supply ripple. This can be done by disabling the vertical oscillator and rechecking the hum amplitude with the scope. If the hum symptom remains, the trouble is undoubtedly excessive power supply ripple, and a check of all B+ filter capacitors should be made. If B+ ripple drops to normal with the vertical oscillator disabled, then a check of decoupling resistors and capacitors in the vertical circuit is more in order. Electrolytics associated with the vertical output stage are common offenders and should be the first components checked.

In many receivers, boost B+ from the flyback system may supply plate voltage to both vertical and horizontal oscillator circuits. With this circuit arrangement, insufficient decoupling of the vertical stage often produces hum on the boost line which in turn modulates the horizontal oscillator at the 60-cycle vertical rate. A trouble of this nature, however, will most generally result in raster distortion as well as picture pull-

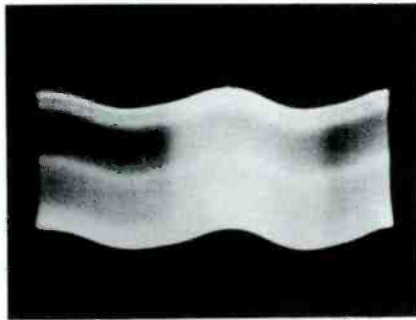

Fig. 8. Waveform of oscillator bias voltage modulated by 60-cycle hum.

ing. Normal 60-cycle ripple found on the boost line will usually be much less than 1 volt peak-to-peak.

Using the scope to trace the cause of hum modulation, one might also check the bias voltage applied to the horizontal oscillator itself. An indication of 60-cycle hum at this point will often appear as shown in Fig. 8. When checking this point, it may be necessary to place a resistor in series with the scope probe for isolation purposes. Keep in mind, however, that any AC voltage present at the oscillator input need only be of a small amplitude to

cause picture pulling.

Picture pulling caused by a fault in the horizontal AFC or oscillator stages can usually be traced to a defective tube, oscillator feedback capacitor, AFC filter component, or improper alignment of horizontal frequency and phase adjustments. Although seldom encountered, a kink or bend in one section of the picture and raster may be a direct result of an ungrounded aquadag or an undesired magnetic field positioned too near the picture tube, or it may be due to a magnetized metal picture tube. When probing for picture pulling, the technician will most likely find either a shorted or gassy tube, an open electrolytic, or a defective resistor or capacitor in the video, sync, or horizontal AFC-oscillator section.

By using the techniques outlined in this article, the serviceman should have little difficulty in isolating the cause for picture bending to a specific circuit. When this is done, locating the defective component is a straightforward troubleshooting procedure. ▲

The **NEW** **YEATS "Shorty"**  
STATION WAGON & PANEL PICK-UP  
appliance dolly



**YEATS Model No. 5**  
Aluminum alloy  
Height 47"  
Weight 32 lbs.

Only 47" tall, this new YEATS dolly is designed for TV and appliance men who make deliveries by station wagon or panel truck. No need to detach appliance for loading into the "wagon" or pick-up... the YEATS "Shorty" will slide into your vehicle with ease. Has aluminum alloy frame with padded felt front, quick fastening (30 second) strap ratchet, and endless, rubber belt step glide. New YEATS folding platform attachment, at left, saves back-breaking work handling TV chassis or table models. Call your YEATS dealer today!

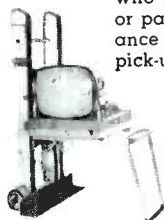

Folding platform is 13 1/2" x 24 1/2" —attaches instantly. (Platform only) \$9.95.



Furniture Pad

SEND postcard for full information on our complete line TODAY!

**YEATS** appliance dolly

2103 N. 12th St.



TV Cover

**"Everlast" COVERS & PADS**

YEATS semi-fitted covers are made of tough water repellant fabric with adjustable web straps and soft, scratchless white flannel liners. All shapes and sizes—Write.

sales co.  
Milwaukee, Wis.

IT'S NEW! IT'S A BARGAIN! IT'S "IN THE BAG"!



**VACO**<sup>®</sup>  
5-PIECE  
ALL HOLLOW SHAFT  
Nut Driver  
Kit  
No. K 505

Only  
**\$3.68**  
NET

**Convenient! Compact!**

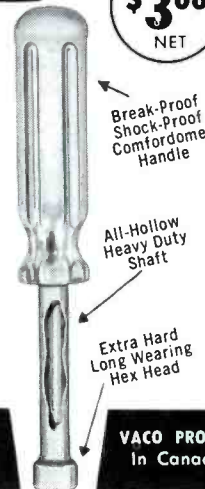

Here's a practical, quality built nut driver kit... economically priced, too! 5 popular sizes... 3/16", 1/4", 5/16", 11/32", 3/8" ideal for every service need... in one convenient plastic bag with button-down flap to keep drivers in place! Made to VACO professional quality standards throughout backed by our famous unconditional guarantee.

See Your Parts Distributor, Today!

VACO PRODUCTS CO., 317 E. Ontario St., Chicago 11, Ill.  
In Canada: ATLAS RADIO CORP., Toronto 10, Ontario

# BEST BUILT



# YET

The Tung-Sol Magic Mirror Aluminized Picture Tube captures every tone, every detail brilliantly to bring out the best in every set. It's your best insurance for loyal, satisfied customers. Tell your supplier you'd rather have Tung-Sol tubes.

*Blue Chip Quality*

**ts TUNG-SOL®**  
Magic Mirror Aluminized  
**PICTURE TUBES**

TUNG-SOL ELECTRIC INC., Newark 4, N. J. Sales Offices: Atlanta, Ga.; Columbus, Ohio; Culver City, Calif.; Dallas, Tex.; Denver, Colo.; Detroit, Mich.; Irvington, N. J.; Melrose Park, Ill.; Newark, N. J.; Seattle, Wash.

## PRODUCT report

### Surge-Limiting Resistor



The new 4000 series Surgistor manufactured by Wuerth Tube-Saver Corp., Detroit, Mich., is a negative-temperature-coefficient resistor designed to limit the current drawn by a TV receiver or other electronic device when it is first turned on. Heater and B+ currents are both reduced until the tube heaters warm up and tube damage from initial current surges is thereby minimized. The Surgistor is connected into the power-line circuit of the device being protected.

### Static Brush



Jensen Industries, Inc., Forest Park, Ill., has a new phono accessory—a silicone-treated brush designed to mount on the tone arm of a phonograph. This "Record Sweep" removes static charges as well as dust from the grooves of the record while it is being

played. The brushes, boxed in transparent plastic, are mounted on a double-faced counter-display rack that holds 5 brushes on each side.

### Low-Priced Tube Caddies

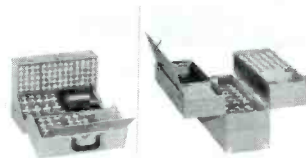

Argos Products Co., Genoa, Ill., has brought out a new economy line of tube caddies as a companion to their regular line. The "Pacemaker" Model TC-100 (right) holds 262 tubes and has a net price of \$12.35, while the "Pacemaker Jr." Model TC-200 (left) has room for 143 tubes and sells for \$8.95 net. The TC-100 and TC-200 are comparable in size to the regular "Carry-All" (\$15.95) and "Tube Caddy Jr." (\$10.50), respectively.

### Miniature Capacitors

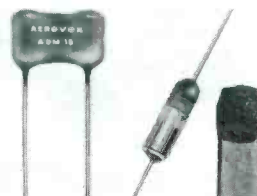

Two new types of extremely small capacitors have been announced by Aerovox Corp., New Bedford, Mass. Type ADM dipped-mica units (left) are general-purpose components that feature a plastic casing, narrow temperature coefficient and an operating temperature range of  $-55^{\circ}$  to  $125^{\circ}$  C. Type WT wire tantalum capacitors (right), specially designed for low-voltage DC applications, feature polar construction with the case forming the cathode terminal and a length of tantalum wire forming the anode.



### Power Resistor Decade Box



A power resistor decade box, already a familiar instrument in engineering, industrial and school laboratories, is being made available to service technicians through parts distributors by the manufacturer, Clarostat Mfg. Co., Inc., Dover, N. H. A resistance range of 1 to 999,999 ohms, variable in 1-ohm steps, is provided by six decade dials connected to 30 "Greenohm" power resistors. Maximum ratings of the unit are 225 watts and 1,000 volts. Among features which contribute to its high power-handling capability are glass-insulated wiring and a ventilated metal cabinet.

### Indoor TV Antenna



Amphenol Electronics Corp., Chicago, Ill. has announced a new "Vi-Fi" indoor antenna for TV sets. Features include slender modern design, collapsible dipole elements with ball-joint mountings, transmission-line type of matching transformer to couple antenna to set, tunable inductors for adjusting electrical length of elements, separate folded dipole in base for UHF reception (optional), and provisions for mounting on either top or back of receiver. Three colors are available: cloud grey, sandalwood and black marble.

### Outdoor TV-Set Couplers

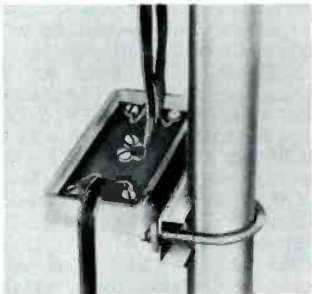

JFD Mfg. Co., Brooklyn, N. Y., has produced three models of TV-set couplers designed for outdoor mounting on the antenna mast. Outdoor location of the coupler permits shorter transmission-line runs in many cases and eliminates much interior wiring. All three types are encapsulated in plastic for weatherproofing. Model numbers and list prices are as follows: AC40, for two sets, \$3.50; AC60, for three sets, \$4.00; and AC70, for four sets, \$4.85.

### FM Antenna Kit



An outdoor antenna kit intended for use with hi-fi FM tuners is being marketed by Telco Electronics Mfg. Co. (a division of General Cement-Textron), Rockford, Ill. The kit (Cat. No. A-124) consists of an omnidirectional, turnstile-type antenna made of  $\frac{3}{8}$ " aluminum elements; a mast with self-supporting base; 60' of transmission line; and all mounting hardware required for installation. List price of the complete kit is \$16.50.

# BEST FOR



# EVERY SET

All Tung-Sol radio, TV or Hi Fi tubes are engineered to one standard of quality—Blue Chip Quality. Whether they're for famous set makers or leading service dealers, Tung-Sol Tubes are identical in design and performance. Tell your supplier you'd rather have Tung-Sol!

*Blue Chip Quality*

**TUNG-SOL<sup>®</sup>**  
**RECEIVING TUBES**

TUNG-SOL makes All-Glass Sealed Beam Lamps, Miniature Lamp Signal Flashers, Picture Tubes, Radio, TV and Special Purpose Electron Tubes and Semiconductor Products.

### INDEX TO ADVERTISERS

January, 1958

Advertisers	Page No.
Aerovox Corp.	49
Affiliated Television Labs., Inc.	38
Amphenol Electronics Corp.	36
Arco Electronics, Inc.	57
Astron Corp.	11
B & K Mfg. Co.	9
Blonder-Tongue Labs.	46
Bussmann Mfg. Co.	5
CBS-Hytron	27
Centralab, a Div. of Globe-Union, Inc.	53
Cornell-Dubilier Electric Corp.	54, 55
Clarostat Mfg. Co., Inc.	4
Delco Radio Div., General Motors Corp.	37
E-Z-Hook Test Products	50
EICO	24
Electronic Publishing Co.	60
Elgin Nat'l. Watch Co. (Electronics Div.)	8
General Cement Mfg. Co.	51
General Electric Co.	13
Gernsback Library, Inc.	52
Hickok Electrical Instrument Co.	6-7
International Resistance Co. (IRC)	2nd Cover
Jackson Electrical Instrument Co.	64
Jensen Industries, Inc.	60
Jensen Mfg. Co.	1
Jerrold Electronics Corp.	59
Littelfuse, Inc.	4th Cover
Mallory & Co., Inc., P. R.	34, 35
Merit Coil & Transformer Corp.	32
National Radio Inst.	32
Newcomb Audio Products Co.	29
Perma-Power Co.	56
RCA Electron Tube Division	3rd Cover
Raytheon Mfg. Co.	23, 45
Sams & Co., Inc., Howard W.	33, 39, 50
Seco Mfg. Co.	58
Service Instruments Corp.	32, 44, 60
Simpson Electric Co.	43
Sprague Products Co.	2
Standard Electrical Products Co.	20
Stevens-Walden, Inc.	52
Triad Transformer Corp.	21
Triplet Electrical Instrument Co.	31
Tung-Sol Electric, Inc.	62, 63
United Catalog Pubs., Inc.	42
Vaco Products Co.	61
Webster Electric Co.	25
Weller Electric Corp.	10
Workman TV, Inc.	50
Wuerth Tube-Saver Corp.	44
Xcelite, Inc.	56
Yeats Appliance Dolly Sales Co.	61

(Advertisement)

latest JACKSON tube test data

MODEL 648		MODEL 48		MODEL 48		MODEL 48		MODEL 48		MODEL 48		MODEL 48	
TUBE TYPE	FIL. D.	CIRCUIT	PLATE	FIL. D.	CIRCUIT	PLATE	FIL. D.	CIRCUIT	PLATE	FIL. D.	CIRCUIT	PLATE	FIL. D.
6DT8	6.3	A127	A89 35YZ	6.3	A127	A89 35YZ	6.3	A127	A89 35YZ	6.3	A127	A89 35YZ	6.3
12D4	12.6	234	6 15W	12.6	234	6 15W	12.6	234	6 15W	12.6	234	6 15W	12.6
12DF7	12.6	A123	A45 35WX	12.6	A123	A45 35WX	12.6	A123	A45 35WX	12.6	A123	A45 35WX	12.6
12DT8	12.6	A123	A45 35YZ	12.6	A123	A45 35YZ	12.6	A123	A45 35YZ	12.6	A123	A45 35YZ	12.6
6DT8	6.3	A127	A89 35YZ	6.3	A127	A89 35YZ	6.3	A127	A89 35YZ	6.3	A127	A89 35YZ	6.3
12D4	12.6	D	12.6 7	12.6	D	12.6 7	12.6	D	12.6 7	12.6	D	12.6 7	12.6
12DF7	12.6	T	12.6 9	12.6	T	12.6 9	12.6	T	12.6 9	12.6	T	12.6 9	12.6
12DT8	12.6	T	12.6 4	12.6	T	12.6 4	12.6	T	12.6 4	12.6	T	12.6 4	12.6

Latest Chart Form 648-19, 118/715/561-9, 49-3

### ANTENNAS

1M. TELCO—Catalog No. A-58 shows a complete range of over 100 different types of antennas.

### ANTENNA DISTRIBUTION

2M. JERROLD—New 8-page illustrated catalog on equipment for improving home TV reception, simplifying TV distribution systems and improving TV servicing. See ad page 59.

### BOOKS, TECHNICAL

3M. GERNSBACK—Descriptive literature on Gernsback library books. See ad page 52.

### BOOSTERS

4M. BLONDER - TONGUE — Form TS-107 on Model B-23 two-set booster. See ad page 46.

### BUSINESS PROMOTION

5M. WESTINGHOUSE—"This is the story of a TV set," a pamphlet which is part of a "Build Consumer Confidence" kit.

### CAPACITORS

6M. ARCO—Literature on Elmenco capacitors, steatite tubular kit #9 and silvered mica TV kit #14. See ad page 57.

7M. ASTRON — Handy pocket-sized AC4-D, Replacement Catalog and Pricing Guide for servicemen. See ad page 11.

### CHEMICALS

8M. GENERAL CEMENT—Industrial Chemical Handbook. See ad page 51.

### COMPONENTS

9M. WUERTH — Application Data Sheet AD-10 shows how surgistors are connected in TV & Hi-Fi sets to reduce call-backs due to early tube failures. See ad page 44.

### CONTROLS

10M. CLAROSTAT — Audio controls, T&L pads and outdoor theater controls are described in Sound Systems Controls Form No. 751773. See ad page 4.

11M. IRC—Form S-067 Merchandising Guide. See ad 2nd cover.

### DIAL LIGHTS

12M. UNITED CATALOG PUBLISHERS—Panel and flashlight lamp chart shows bulb type, base, volts, amps. and bead color with illustrations and physical dimensions. See ad page 42.

### FUSES

13M. BUSSMANN — Complete TV Fuse Guide, Form TVC, shows type and ampere ratings of fuses used in various TV sets. See ad page 5.

### HOME STUDY

14M. NRI — Booklets describing courses in Professional TV Servicing, Radio TV Servicing, and Communications and Electrical Appliance Servicing, plus "sample lessons" from each of the three courses. See ad page 32.

### MICROPHONES & CARTRIDGES

15M. ELECTRO-VOICE—"ABC's" of Microphones," a primer in microphone application, plus Power-Point Interchangeability Guide, a complete cross reference of hundreds of phono cartridges and their correct Power-Point replacements.

16M. ELGIN—Microphone and phono-graph cartridge catalog. See ad page 8.

### NEEDLES

17M. JENSEN INDUSTRIES — J-100 Wallchart, J-53 Catalog. See ad page 60.

### POWER SUPPLIES

18M. STANDARD ELECTRICAL — 22-page catalog describing the complete line of "Adjust-A-Volt" transformers. Also catalog sheet on PA-1 "Adjust-A-Volt." See ad page 20.

### PROBES

19M. E-Z-HOOK—A convenient reference sheet titled "How to Build the Five Most Useful Scope Probes" with schematic, mechanical component layout, etc. See ad page 50.

### SPEAKERS

20M. CLETRON—8-page catalog describes a new line comprised of 14 speakers plus one 3-speaker combination board with cross-over network.

### TEST EQUIPMENT

21M. B&K — Bulletin 1050 tells how you can transmit video and audio to any TV set with Model 1050 Dyna-Scan. Bulletin 650 describes the Model 650 Dyna-Quik portable dynamic mutual conductance tube and transistor tester. Bulletin 400-C40 describes CRT Cathode Rejuvenator Tester. See ad page 9.

22M. EICO—12 page catalog shows how to save 50% on electronic test instruments and hi-fi equipment in both kit and factory-wired form. See ad page 24.

23M. HICKOK — Descriptive 4-page brochure on new, low-priced Cardmatic portable tube tester. See ad page 6-7.

24M. JACKSON—Folder covering the entire Jackson line of "Service Engineered" test equipment. See ad page 64.

25M. PERMA-POWER—Catalog sheet describing Model A400 Transistor Power Supply and showing applications. See ad page 56.

26M. SECO—Complete data on the Seco approach to tube testing and troubleshooting TV deflection circuits. See ad page 58.

27M. SERVICE INSTRUMENTS—Literature on new transistor tester (TRC4), new Fuse Safe Checker (Model FS3) and line folder. See ads pages 32, 44, 60.

28M. SIMPSON — Catalog of panel meters (Bulletin 2057), catalog on test equipment (Bulletin 2058) and new 260 Bulletin. See ad page 43.

29M. SPRAGUE—Form No. M-737, 4-page brochure explaining the new features of the Model TO-5 Tel-ohmike capacitor analyzer. See ad page 2.

30M. TRIPLETT—Literature on new volt - ohm - milliammeter Model 630-PL. See ad page 31.

### TOOLS

31M. VACO — Catalogs on solderless terminals, crimping tools and complete line of service tools. See ad page 61.

32M. XCELITE — Illustrated catalog on full line, plus literature on new products. See ad page 56.

33M. YEATS—Four-page Catalog describing appliance dolly and padded covers for delivering TV sets. See ad page 61.

### TRANSISTORS

34M. CBS-HYTRON — Bulletin PA-176, "Know All About Transistors?" See ad page 27.



# SUPPLEMENT TO SAMS AUGUST, 1957 MASTER INDEX

## Covers PHOTOFAC Set Numbers 369 through 386 Released **SEPTEMBER through JANUARY**

This Supplement is your index to new models covered by PHOTOFAC since August 1957. For model coverage prior to this date see the Sams Master Index dated August 1957. Use this Supplement with the Sams Master Index—together they are your complete Index to PHOTOFAC coverage of over 28,000 receiver models.

Set No.	Folder No.
<b>ADMIRAL</b>	
Chassis 1B1, 1C1, 1D1	381—5
Chassis 4B2 (See Photofact Servicer)	378
Chassis 4P2	374—1
Chassis 4V1 (See Photofact Servicer)	378
Chassis 4Y1 (See Photofact Servicer)	376
Chassis 5A4 (See Photofact Servicer)	376
Chassis 5F3, A, B (See Photofact Servicer)	378
Chassis 5K3 (See Photofact Servicer)	376
Chassis 5S2 (See Photofact Servicer)	376
Chassis 5Z2 (See Photofact Servicer)	376
Chassis 6A3	384—1
Chassis 6F1 (See Photofact Servicer)	378
Chassis 7L1	375—6
Chassis 7M1	369—1
Chassis 8B1 (See Photofact Servicer)	373
● Chassis 14YP3D, DK, DM	370—1
● Chassis 17AF1	367—13—5
● Chassis 17F1	367—13—5
● Chassis 19AZ4D, DF, DT, ES	377—2
● Chassis 19R2 (See Photofact Servicer)	377
● Chassis 19S4EF, ES, LS (See Photofact Servicer)	379
● Chassis 19S24D, DF, DT, ES, FS, PS	377—2
● Chassis 20L2, Z (See Photofact Servicer)	373
● Chassis 20Z4EF, PS (Runs 10-13) (See Photofact Servicer)	377
● Chassis 20Z4EFB, FFB, PSB	380—2
● Chassis 22H3Z, 22J2Z (See Photofact Servicer)	380
● Chassis 23B1AZ (See Photofact Servicer)	374
● Chassis 23C1 (See Photofact Servicer)	380
● Chassis 23E1AZ, 23E1Z (See Photofact Servicer)	375
● Chassis 23F1 (See Photofact Servicer)	380
● Chassis 23F1Z (See Photofact Servicer)	374
● Chassis 23H1Z (See Photofact Servicer)	381
● Chassis 23HF1, B	384—1
● Chassis 29A21	383—1
● Chassis 29S21, B	383—1
● Chassis 29Z1, B	383—1
● C322C2, C322C3 (Ch. 29Z1)	383—1
● C322C16, C322C17 (Ch. 29Z1)	383—1
● C322C26, C322C27 (Ch. 29Z1)	383—1
● C2516Z, C2517Z (Ch. 23E1AZ, Z) (See Photofact Servicer)	375
● CA322C16, CA322C17 (Ch. 29A21)	383—1
● CA322C26, CA322C27 (Ch. 29A21)	383—1
● CA2236A (Ch. 20L2, Z) (See Photofact Servicer)	373
● CS23A11, CS23A12, CS23A13 (Ch. 19S24DT)	377—2
● CS23A25 (Ch. 19S24DT)	377—2
● CS23A26, CS23A27 (Ch. 19S24ES)	377—2
● CS23B16C, CS23B17C (Ch. 19S24DF)	377—2
● CS322C2, CS322C3 (Ch. 29S21)	383—1
● CS322C16, CS322C17 (Ch. 29S21)	383—1
● CS322C26, CS322C27 (Ch. 29S21)	383—1
● CS323A6, CS323A7 (Ch. 19S24ES)	377—2
● CS323A16, CS323A17, CS323A19 (Ch. 19S24ES)	377—2
● CS325A6, CS325A7 (Ch. 19S24FS)	377—2
● CU2516Z, CU2517Z (Ch. 23F1Z) (See Photofact Servicer)	374
● F2B17Z (Ch. 23B1AZ) (See Photofact Servicer)	374
● FA2226 (Ch. 20L2, Z) (See Photofact Servicer)	373
● H2516Z (Ch. 23E1AZ, Z) (See Photofact Servicer)	375

Set No.	Folder No.
<b>ADMIRAL—Cont.</b>	
● H2816Z (Ch. 23B1AZ) (See Photofact Servicer)	374
● HL323A6 (TV Ch. 23HF1 and Amp. Ch. 6A3)	384—1
● HL323A6B (TV Ch. 23HF1B and Amp. Ch. 6A3)	384—1
● HL323A7, HL323A8, HL323A9 (TV Ch. 23HF1 and Amp. Ch. 6A3)	384—1
● HU2516Z (Ch. 23F1Z) (See Photofact Servicer)	374
● LC322C36, LC322C37, LC322C39 (Ch. 29Z1B)	383—1
● LC5322C36, LC5322C37, LC5322C39 (Ch. 29S21B)	383—1
● T18A11, T18A12, T18A13 (Ch. 17F1)	367—13—5

Set No.	Folder No.
<b>ADMIRAL—Cont.</b>	
5Z22, 5Z23 (Ch. 5Z2) (See Photofact Servicer)	378
6F10, 6F11, 6F12 (Ch. 6F1) (See Photofact Servicer)	378
7C64 (Ch. 8B1) (See Photofact Servicer)	373
7L12, 7L14, 7L16, 7L18 (Ch. 7L1)	375—6
7M12, 7M14, 7M16, 7M18 (Ch. 7M1)	369—1
<b>AIRCADLE</b>	
602-170144 (See Photofact Servicer)	381
610.CE-352 (See Photofact Servicer)	381
610.PM-236 (See Photofact Servicer)	381

Set No.	Folder No.
<b>AIRLINE—Cont.</b>	
● WG-5041A	376—20—5
● WG-5051A	376—20—5
● WG-5131A, B, C, D, WG-5134A, B, C, D, WG-5136B, WG-5137B	313—2
(PCB 340-1, 378-1)	313—2
05BR-1525B, C, 05BR-1526B, C, 05BR-1531B, C, 05BR-1532B, C	384
● 05BR-3040A (See Photofact Servicer)	383
● 05BR-3044A (See Photofact Servicer)	383
05WG-2745B (See Photofact Servicer)	384
● 05WG-3032B (See Photofact Servicer)	384
● 05WG-3036C (See Photofact Servicer)	384

Set No.	Folder No.
<b>ARVIN—Cont.</b>	
Ch. 1.41700	376—7
Ch. 1.42200	386—6
Ch. 1.43000	377—6
Ch. 1.43400	384—7
<b>AUTOMATIC</b>	
CP-315B (Similar to Chassis)	298—4
<b>BRAUN</b>	
HM2, HM3	375—7
MM3	375—7
MS3	375—7
Super 99	375—7
TS2	375—7
<b>BUICK</b>	
981813	369—4
<b>BULOVA</b>	
100, 110	371—2
200 Series	382—6
220 Series	372—2
230 Series	372—2
240 Series	382—6
260 Series	376—8
270 Series	369—5
300 Series	369—6
310, 320 Series	370—2
<b>CADILLAC</b>	
7268005	370—3
7268035	370—3
<b>COLUMBIA RECORDS</b>	
512	373—1
516	383—6
517, 518	376—9
540	373—1
572	352—4
<b>CONRAC (Also See Fleetwood)</b>	
● CK14, CL14	385—1
<b>CORONADO</b>	
● TV2-9414A, B	379—2
● TV2-9414C, D, E (PCB 386-5)	379—2
● TV2-9415A, B	379—2
● TV2-9415C, D, E (PCB 386-5)	379—2
● TV2-9416A, B	379—2
● TV2-9416C, D, E (PCB 386-5)	379—2
● TV2-9417A, B	379—2
● TV2-9417C, D, E (PCB 386-5)	379—2
● TV2-9418A, B	379—2
● TV2-9418C, D, E (PCB 386-5)	379—2
● TV2-9419A, B	379—2
● TV2-9419C, D, E (PCB 386-5)	379—2
● TV2-9420A, B	379—2
● TV2-9420C, D, E (PCB 386-5)	379—2
● TV2-9421A, B	379—2
● TV2-9421C, D, E (PCB 386-5)	379—2
● TV2-9422A, TV2-9423A, TV2-9424A, TV2-9425A	384—17—5
● TV2-9470A, TV2-9471A	384—17—5
● TV2-9475A, TV2-9476A	384—17—5
● TV2-9480A, TV2-9481A	384—17—5
● TV2-9485A, TV2-9486A	380—12—5
● TV3-9395A	373—2
● TV3-9397B (PCB 385-5)	359—4
● TV3-9400B, C (PCB 384-5)	353—3
● TV3-9401A	374—3
● TV3-9402A	385—13—5
● TV3-9404A	361—4
● TV3-9408B, TV3-9409B, TV3-9410B, TV3-9411B	361—4
● TV3-9450A	382—13—5
● TV3-9455A, TV3-9456A	382—13—5
● TV3-9460A, TV3-9461A	382—13—5
<b>CRAFTSMEN (Also See Radio Craftsmen)</b>	
CP-14	369—7
CP-18, CP-19	369—7
CTA-5	369—7
<b>CRESCENT</b>	
A-699, B	384—8
A-744, A-746B, E, M	377—7

THIS IS YOUR LATEST INDEX SUPPLEMENT!

FOR COMPLETE PHOTOFAC LISTINGS

# YOU MUST

USE IT WITH THE AUGUST 1957 MASTER INDEX!

# THROW AWAY ALL OTHER SUPPLEMENTS

● T170, T171, N, T172AL, T173AL (Ch. 14YP3D)	370—1
● T323B1B (Ch. 20Z4EFB, FFB, PSB)	380—2
● T1710 (Ch. 14YP3D)	370—1
● TA1811, TA1812, TA1813 (Ch. 17AF1)	367—13—5
● TA2216A, TA2217A (Ch. 20L2, Z) (See Photofact Servicer)	373
● TS23A1, TS23A2, TS23A3 (Ch. 19S24D)	377—2
● TS23A6, TS23A7 (Ch. 19S24DT)	377—2
● TS323A1, TS323A2, BZ, TS323A3, LN (Ch. 19S24PS)	377—2
1B11, 1C12, 1C14, 1D11, 1D12, 1E13, 1E14 (Ch. 1B1, 1C1, 1D1)	381—5
4B21, 4B22, 4B24, 4B28, 4B29 (Ch. 4B2) (See Photofact Servicer)	378
4P21, 4P22, 4P24, 4P28 (Ch. 4P2)	374—1
4V12, 4V18, 4V19 (Ch. 4V1) (See Photofact Servicer)	378
4Y11, 4Y12, 4Y18, 4Y19 (Ch. 4Y1) (See Photofact Servicer)	376
5A42, 5A43, 5A44, 5A48 (Ch. 5A4) (See Photofact Servicer)	376
5F31, A, B, 5F32, A, B, 5F33, A, B, 5F34B, 5F38, A, B (Ch. 5F3, A, B) (See Photofact Servicer)	378
5K31, 5K32, 5K34, 5K38, 5K39 (Ch. 5K3) (See Photofact Servicer)	376
5S21, 5S22, 5S23 (Ch. 5S3) (See Photofact Servicer)	376

610.S551-PC (See Photofact Servicer)	383
<b>AIRLINE</b>	
GAA-861A, GAA-862A, GAA-863A	369—2
GAA-864A	374—2
GAA-975A	320—3
GAA-979A	320—3
GAA-1001A	333—2
GAA-2620A, GAA-2621A	384—6
GAA-2642A, GAA-2643A	384—6
● GRX-4030A	379—1
● GRX-4130A	379—1
● GSE-4004B, GSE-4006B (See Photofact Servicer)	382
● GSE-4017B (See Photofact Servicer)	382
● GSE-5008B, GSE-5009A (See Photofact Servicer)	382
GTM-1108A	379—5
GTM-1653A, GTM-1654A	376—6
● GTM-4031A	378—2
● GTM-4032A	377—3
● GTM-4131A	378—2
● GTM-4132A	377—3
● WG-4021A, B, C, D, E, WG-4022A, B, C, D, E, WG-4023A, B, C, D, E, WG-4024A, B, C, D, E, WG-4025A, B, C, D, E, WG-4026A, B, C, D, E, WG-4027A, B, C, D, E, WG-4028A, B, C, D, E, WG-4029A, B, C, D, E, WG-4030A, B, C, D, E, WG-4031A, B, C, D, E, WG-4032A, B, C, D, E, WG-4033A, B, C, D, E, WG-4034A, B, C, D, E, WG-4035A, B, C, D, E, WG-4036A, B, C, D, E, WG-4037A, B, C, D, E, WG-4038A, B, C, D, E, WG-4039A, B, C, D, E, WG-4040A, B, C, D, E, WG-4041A, B, C, D, E, WG-4042A, B, C, D, E, WG-4043A, B, C, D, E, WG-4044A, B, C, D, E, WG-4045A, B, C, D, E, WG-4046A, B, C, D, E, WG-4047A, B, C, D, E, WG-4048A, B, C, D, E, WG-4049A, B, C, D, E, WG-4050A, B, C, D, E, WG-4051A, B, C, D, E, WG-4052A, B, C, D, E, WG-4053A, B, C, D, E, WG-4054A, B, C, D, E, WG-4055A, B, C, D, E, WG-4056A, B, C, D, E, WG-4057A, B, C, D, E, WG-4058A, B, C, D, E, WG-4059A, B, C, D, E, WG-4060A, B, C, D, E, WG-4061A, B, C, D, E, WG-4062A, B, C, D, E, WG-4063A, B, C, D, E, WG-4064A, B, C, D, E, WG-4065A, B, C, D, E, WG-4066A, B, C, D, E, WG-4067A, B, C, D, E, WG-4068A, B, C, D, E, WG-4069A, B, C, D, E, WG-4070A, B, C, D, E, WG-4071A, B, C, D, E, WG-4072A, B, C, D, E, WG-4073A, B, C, D, E, WG-4074A, B, C, D, E, WG-4075A, B, C, D, E, WG-4076A, B, C, D, E, WG-4077A, B, C, D, E, WG-4078A, B, C, D, E, WG-4079A, B, C, D, E, WG-4080A, B, C, D, E, WG-4081A, B, C, D, E, WG-4082A, B, C, D, E, WG-4083A, B, C, D, E, WG-4084A, B, C, D, E, WG-4085A, B, C, D, E, WG-4086A, B, C, D, E, WG-4087A, B, C, D, E, WG-4088A, B, C, D, E, WG-4089A, B, C, D, E, WG-4090A, B, C, D, E, WG-4091A, B, C, D, E, WG-4092A, B, C, D, E, WG-4093A, B, C, D, E, WG-4094A, B, C, D, E, WG-4095A, B, C, D, E, WG-4096A, B, C, D, E, WG-4097A, B, C, D, E, WG-4098A, B, C, D, E, WG-4099A, B, C, D, E, WG-4100A, B, C, D, E, WG-4101A, B, C, D, E, WG-4102A, B, C, D, E, WG-4103A, B, C, D, E, WG-4104A, B, C, D, E, WG-4105A, B, C, D, E, WG-4106A, B, C, D, E, WG-4107A, B, C, D, E, WG-4108A, B, C, D, E, WG-4109A, B, C, D, E, WG-4110A, B, C, D, E, WG-4111A, B, C, D, E, WG-4112A, B, C, D, E, WG-4113A, B, C, D, E, WG-4114A, B, C, D, E, WG-4115A, B, C, D, E, WG-4116A, B, C, D, E, WG-4117A, B, C, D, E, WG-4118A, B, C, D, E, WG-4119A, B, C, D, E, WG-4120A, B, C, D, E, WG-4121A, B, C, D, E, WG-4122A, B, C, D, E, WG-4123A, B, C, D, E, WG-4124A, B, C, D, E, WG-4125A, B, C, D, E, WG-4126A, B, C, D, E, WG-4127A, B, C, D, E, WG-4128A, B, C, D, E, WG-4129A, B, C, D, E, WG-4130A, B, C, D, E, WG-4131A, B, C, D, E, WG-4132A, B, C, D, E, WG-4133A, B, C, D, E, WG-4134A, B, C, D, E, WG-4135A, B, C, D, E, WG-4136A, B, C, D, E, WG-4137A, B, C, D, E, WG-4138A, B, C, D, E, WG-4139A, B, C, D, E, WG-4140A, B, C, D, E, WG-4141A, B, C, D, E, WG-4142A, B, C, D, E, WG-4143A, B, C, D, E, WG-4144A, B, C, D, E, WG-4145A, B, C, D, E, WG-4146A, B, C, D, E, WG-4147A, B, C, D, E, WG-4148A, B, C, D, E, WG-4149A, B, C, D, E, WG-4150A, B, C, D, E, WG-4151A, B, C, D, E, WG-4152A, B, C, D, E, WG-4153A, B, C, D, E, WG-4154A, B, C, D, E, WG-4155A, B, C, D, E, WG-4156A, B, C, D, E, WG-4157A, B, C, D, E, WG-4158A, B, C, D, E, WG-4159A, B, C, D, E, WG-4160A, B, C, D, E, WG-4161A, B, C, D, E, WG-4162A, B, C, D, E, WG-4163A, B, C, D, E, WG-4164A, B, C, D, E, WG-4165A, B, C, D, E, WG-4166A, B, C, D, E, WG-4167A, B, C, D, E, WG-4168A, B, C, D, E, WG-4169A, B, C, D, E, WG-4170A, B, C, D, E, WG-4171A, B, C, D, E, WG-4172A, B, C, D, E, WG-4173A, B, C, D, E, WG-4174A, B, C, D, E, WG-4175A, B, C, D, E, WG-4176A, B, C, D, E, WG-4177A, B, C, D, E, WG-4178A, B, C, D, E, WG-4179A, B, C, D, E, WG-4180A, B, C, D, E, WG-4181A, B, C, D, E, WG-4182A, B, C, D, E, WG-4183A, B, C, D, E, WG-4184A, B, C, D, E, WG-4185A, B, C, D, E, WG-4186A, B, C, D, E, WG-4187A, B, C, D, E, WG-4188A, B, C, D, E, WG-4189A, B, C, D, E, WG-4190A, B, C, D, E, WG-4191A, B, C, D, E, WG-4192A, B, C, D, E, WG-4193A, B, C, D, E, WG-4194A, B, C, D, E, WG-4195A, B, C, D, E, WG-4196A, B, C, D, E, WG-4197A, B, C, D, E, WG-4198A, B, C, D, E, WG-4199A, B, C, D, E, WG-4200A, B, C, D, E, WG-4201A, B, C, D, E, WG-4202A, B, C, D, E, WG-4203A, B, C, D, E, WG-4204A, B, C, D, E, WG-4205A, B, C, D, E, WG-4206A, B, C, D, E, WG-4207A, B, C, D, E, WG-4208A, B, C, D, E, WG-4209A, B, C, D, E, WG-4210A, B, C, D, E, WG-4211A, B, C, D, E, WG-4212A, B, C, D, E, WG-4213A, B, C, D, E, WG-4214A, B, C, D, E, WG-4215A, B, C, D, E, WG-4216A, B, C, D, E, WG-4217A, B, C, D, E, WG-4218A, B, C, D, E, WG-4219A, B, C, D, E, WG-4220A, B, C, D, E, WG-4221A, B, C, D, E, WG-4222A, B, C, D, E, WG-4223A, B, C, D, E, WG-4224A, B, C, D, E, WG-4225A, B, C, D, E, WG-4226A, B, C, D, E, WG-4227A, B, C, D, E, WG-4228A, B, C, D, E, WG-4229A, B, C, D, E, WG-4230A, B, C, D, E, WG-4231A, B, C, D, E, WG-4232A, B, C, D, E, WG-4233A, B, C, D, E, WG-4234A, B, C, D, E, WG-4235A, B, C, D, E, WG-4236A, B, C, D, E, WG-4237A, B, C, D, E, WG-4238A, B, C, D, E, WG-4239A, B, C, D, E, WG-4240A, B, C, D, E, WG-4241A, B, C, D, E, WG-4242A, B, C, D, E, WG-4243A, B, C, D, E, WG-4244A, B, C, D, E, WG-4245A, B, C, D, E, WG-4246A, B, C, D, E, WG-4247A, B, C, D, E, WG-4248A, B, C, D, E, WG-4249A, B, C, D, E, WG-4250A, B, C, D, E, WG-4251A, B, C, D, E, WG-4252A, B, C, D, E, WG-4253A, B, C, D, E, WG-4254A, B, C, D, E, WG-4255A, B, C, D, E, WG-4256A, B, C, D, E, WG-4257A, B, C, D, E, WG-4258A, B, C, D, E, WG-4259A, B, C, D, E, WG-4260A, B, C, D, E, WG-4261A, B, C, D, E, WG-4262A, B, C, D, E, WG-4263A, B, C, D, E, WG-4264A, B, C, D, E, WG-4265A, B, C, D, E, WG-4266A, B, C, D, E, WG-4267A, B, C, D, E, WG-4268A, B, C, D, E, WG-4269A, B, C, D, E, WG-4270A, B, C, D, E, WG-4271A, B, C, D, E, WG-4272A, B, C, D, E, WG-4273A, B, C, D, E, WG-4274A, B, C, D, E, WG-4275A, B, C, D, E, WG-4276A, B, C, D, E, WG-4277A, B, C, D, E, WG-4278A, B, C, D, E, WG-4279A, B, C, D, E, WG-4280A, B, C, D, E, WG-4281A, B, C, D, E, WG-4282A, B, C, D, E, WG-4283A, B, C, D, E, WG-4284A, B, C, D, E, WG-4285A, B, C, D, E, WG	

Set No.	Folder No.	
DB115	376-10	
D070	379-6	
PR100A	381-6	
R620	380-6	
RT75	385-6	
ST-10, ST-10G	378-6	

DAVID BOGEN		
RA-378, RA-379	373-3	
RA-392, RA-393, A	373-4	
RA-394, RA-395	372-3	
RA-902	375-8	
1210	375-8	
Americano	372-3	
Balladier	373-3	
Governor Winthrop	372-3	
Minstrel	373-3	

ELECTRO-VOICE		
3303	380-7	
3304	385-7	

EMERSON		
8338 (Ch. 120267B)	381-7	
8404 (Ch. 120267B)	381-7	
8458 (Ch. 120321B)	369-8	
8488 (Ch. 120267B)	381-7	
8518 (Ch. 120327B)	372-4	
8528 (Ch. 120334B)	372-4	
8538 (Ch. 120335B)	372-4	
854A, B (Ch. 120321B)	369-8	
8658 (Ch. 120243B)	287-7	
8678 (Ch. 120349B)	370-4	
878B, 879B (Ch. 120267B)	381-7	
1212 (Ch. 120351-E, 120353-E)	384-2	
1213 (Ch. 120352-G, 120354-G)	384-2	
1228 (Ch. 120351-E, 120353-E)	384-2	
1229 (Ch. 120352-G, 120354-G)	384-2	
1238 (Ch. 120351-E, 120353-E)	384-2	
1239 (Ch. 120352-G, 120354-G)	384-2	
1244 (Ch. 120351-E, 120353-E)	384-2	
1245 (Ch. 120352-G, 120354-G)	384-2	
1246 (Ch. 120351-E, 120353-E)	384-2	
1247 (Ch. 120352-G, 120354-G)	384-2	
1254 (Ch. 120341H)	365-16-5	
1255 (Ch. 120342R)	365-16-5	
1264 (Ch. 120341H)	365-16-5	
1265 (Ch. 120342R)	365-16-5	
1272 (Ch. 120351-E, 120353-E)	384-2	
1273 (Ch. 120352-G, 120354-G)	384-2	
1274 (Ch. 120351-E, 120353-E)	384-2	
1275 (Ch. 120352-G, 120354-G)	384-2	
1280 (Ch. 120360-E)	384-2	
1281 (Ch. 120361-G)	384-2	
1282 (Ch. 120380H)	386-15-5	
1283 (Ch. 120381M)	386-15-5	
1284 (Ch. 120380H)	386-15-5	
1285 (Ch. 120381M)	386-15-5	
1286 (Ch. 120388H)	386-15-5	
1287 (Ch. 120389M)	386-15-5	
1420 (Ch. 120377C)	386-15-5	
1421 (Ch. 120377C)	386-15-5	
1424 (Ch. 120377C)	386-15-5	
1425 (Ch. 120370G)	386-15-5	
1426 (Ch. 120369C)	386-15-5	
1428 (Ch. 120369C)	386-15-5	
20345 (Ch. 120343-E, V)	383-2	
20385 (Ch. 120343-E, V)	383-2	
20405 (Ch. 120346-V)	383-2	
20425 (Ch. 120346-V)	383-2	
2056 (Ch. 120343-E)	383-2	
2057 (Ch. 120344G)	383-2	
2058 (Ch. 120343E)	383-2	
2059 (Ch. 120344G)	383-2	
2060 (Ch. 120343E)	383-2	
2061 (Ch. 120344G)	383-2	
2062 (Ch. 120343E)	383-2	
2063 (Ch. 120344-G)	383-2	
Ch. 120243B	287-7	
Ch. 120267B	381-7	
Ch. 120321B	369-8	
Ch. 120327B	372-4	
Ch. 120334B	372-4	
Ch. 120335B	372-4	
Ch. 120341H	365-16-5	
Ch. 120342R	365-16-5	
Ch. 120343-E, 120344-G	383-2	
Ch. 120345-V, 120346-V	383-2	
Ch. 120349B	370-4	
Ch. 120351-E, 120352-G	384-2	
Ch. 120353-E, 120354-G	384-2	
Ch. 120360-E, 120361-G	384-2	
Ch. 120369C, 120370G	386-15-5	
Ch. 120377C	386-15-5	
Ch. 120380H, 120381M	386-15-5	
Ch. 120388H, 120389M	386-15-5	

GRANCO		
780	350-5	

GROMMES		
LJ-5	378-8	
10PC	381-9	
15PG	379-7	
20PG	376-12	
207, 207A	382-8	
212	380-8	
221	375-10	
260	384-10	

HALLICRAFTERS		
10TS900T, 10TS901T (Ch. A2011, B2011)	381-3	
17TS740B, M (Ch. A2007)	385-2	
17TS760B (Ch. A2007)	385-2	
17TS760B (Ch. E2007)	385-2	
17TS760M (Ch. A2007)	385-2	
17TS780B, M (Ch. A2007)	385-2	
Ch. A2007	385-2	
Ch. A2011, B2011	381-3	
Ch. E2007	385-2	

HAMILTON ELECTRONICS		
W-7	375-11	

HARMAN-KARDON		
TA-1040	380-9	

HOFFMAN		
81007 (Ch. 315)	318-15-5	
81081, U (Ch. 321, U)	372-7	
81121, U (Ch. 322, U)	372-7	
81161, U (Ch. 323, U)	370-6	
81191, U (Ch. 329, U)	377-4	
81201, U (Ch. 329U, 330)	377-4	
81211, U (Ch. 3 29, U)	377-4	
82021, U (Ch. 706, U)	385-3	
83061, U (Ch. 321, U)	372-7	
83071, U (Ch. 322, U)	372-7	
83081 (Ch. 419)	321-15-5	
83101, U (Ch. 321, U)	372-7	
83114, U (Ch. 322, U)	372-7	
83151, U (Ch. 324, U)	373-8	
83191, U (Ch. 420, U)	376-2	
83201, U (Ch. 323, U)	370-6	
83214, U (Ch. 324, U)	373-8	
83234, U (Ch. 331, U)	380-3	
83241, U (Ch. 329, U)	377-4	
83251, U (Ch. 329U, 330)	377-4	
83261, U (Ch. 331, U)	380-3	
83271, U (Ch. 331, U)	380-3	
83291, U (Ch. 421, U)	378-3	
83304, U (Ch. 331, U)	380-3	
84041, U (Ch. 706, U)	385-3	
84061, U (Ch. 706, U)	385-3	
8G1151, U (Ch. 323, U)	370-6	
8T1144, U (Ch. 326, U)	371-4	
BW1144, U (Ch. 326, U)	371-4	
CT1144, U (Ch. 326, U)	371-4	
K1081, U (Ch. 321, U)	372-7	
K1151, U (Ch. 323, U)	370-6	

Set No.	Folder No.	
13-G-210 (Codes 199-6-17125B, 199-6-17125C) (PCB 383-5)	362-3	
13-G-211, 13-G-212 (Code 280-6-21T58)	369-10	
13-G-213 (Code 280-6-21T59)	369-10	
13-G-214, 13-G-215 (Code 280-6-21T58)	369-10	
13-G-216, 13-G-217 (Code 280-6-21T49)	369-10	
13-G-220, 13-G-221, 13-G-222, 13-G-223 (Codes 334-6-A62/A, 334-6-N62/A)	375-2	
13-G-225, 13-G-226 (Codes 334-6-A63/A, 334-6-N63/A)	373-5	

FIRESTONE-Cont.		
13-G-210 (Codes 199-6-17125B, 199-6-17125C) (PCB 383-5)	362-3	
13-G-211, 13-G-212 (Code 280-6-21T58)	369-10	
13-G-213 (Code 280-6-21T59)	369-10	
13-G-214, 13-G-215 (Code 280-6-21T58)	369-10	
13-G-216, 13-G-217 (Code 280-6-21T49)	369-10	
13-G-220, 13-G-221, 13-G-222, 13-G-223 (Codes 334-6-A62/A, 334-6-N62/A)	375-2	
13-G-225, 13-G-226 (Codes 334-6-A63/A, 334-6-N63/A)	373-5	

FLEETWOOD		
8108	386-1	

GENERAL ELECTRIC		
C405, C406	373-6	
P710A, B, C P711A, B, C	375-9	
P710C, P711C (PCB 385-5)	375-9	
P725, P726	378-7	
T105, T106	376-11	
9T001UHF, 9T002UHF ("T" Line)	359-7	
14P1210, 14P1211, 14P1212 ("Q2" Line)	381-2	
14T020 ("Q" Line)	310-4	
16C104	123-4	
16T6	123-4	
17P1328, 17P1329, 17P1330	383-3	
17P1331 ("M3" Line)	383-3	
17T027 ("MM" Line)	342-7	
21C142 ("ST" Line)	337-7	
21C143, 21C144 ("U" Line)	344-7	
21C158, 21C159 ("U" Line)	344-7	
21C1449, 21C1450 ("M3" Line)	383-3	
21C1550, 21C1551 ("U2" Line)	362-17-5	
21T056, 21T057 ("U" Line)	344-7	
21T1439 ("M3" Line)	383-3	
21T1540, 21T1541, 21T1542 ("U2" Line)	362-17-5	
670, 671, 672, 673	382-7	
860, 861, 862	374-5	
876, 876, 877	376-11	
91D, 91D2, 91D3, 91D4	377-8	
935, 936	373-6	
940, 941, 942	372-6	

GRANCO		
780	350-5	

GROMMES		
LJ-5	378-8	
10PC	381-9	
15PG	379-7	
20PG	376-12	
207, 207A	382-8	
212	380-8	
221	375-10	
260	384-10	

HALLICRAFTERS		
10TS900T, 10TS901T (Ch. A2011, B2011)	381-3	
17TS740B, M (Ch. A2007)	385-2	
17TS760B (Ch. A2007)	385-2	
17TS760B (Ch. E2007)	385-2	
17TS760M (Ch. A2007)	385-2	
17TS780B, M (Ch. A2007)	385-2	
Ch. A2007	385-2	
Ch. A2011, B2011	381-3	
Ch. E2007	385-2	

HAMILTON ELECTRONICS		
W-7	375-11	

HARMAN-KARDON		
TA-1040	380-9	

HOFFMAN		
81007 (Ch. 315)	318-15-5	
81081, U (Ch. 321, U)	372-7	
81121, U (Ch. 322, U)	372-7	
81161, U (Ch. 323, U)	370-6	
81191, U (Ch. 329, U)	377-4	
81201, U (Ch. 329U, 330)	377-4	
81211, U (Ch. 3 29, U)	377-4	
82021, U (Ch. 706, U)	385-3	
83061, U (Ch. 321, U)	372-7	
83071, U (Ch. 322, U)	372-7	
83081 (Ch. 419)	321-15-5	
83101, U (Ch. 321, U)	372-7	
83114, U (Ch. 322, U)	372-7	
83151, U (Ch. 324, U)	373-8	
83191, U (Ch. 420, U)	376-2	
83201, U (Ch. 323, U)	370-6	
83214, U (Ch. 324, U)	373-8	
83234, U (Ch. 331, U)	380-3	
83241, U (Ch. 329, U)	377-4	
83251, U (Ch. 329U, 330)	377-4	
83261, U (Ch. 331, U)	380-3	
83271, U (Ch. 331, U)	380-3	
83291, U (Ch. 421, U)	378-3	
83304, U (Ch. 331, U)	380-3	
84041, U (Ch. 706, U)	385-3	
84061, U (Ch. 706, U)	385-3	
8G1151, U (Ch. 323, U)	370-6	
8T1144, U (Ch. 326, U)	371-4	
BW1144, U (Ch. 326, U)	371-4	
CT1144, U (Ch. 326, U)	371-4	
K1081, U (Ch. 321, U)	372-7	
K1151, U (Ch. 323, U)	370-6	

Set No.	Folder No.	
K1191, U (Ch. 329, U)	377-4	
K1211, U (Ch. 329, U)	377-4	
M1007 (Ch. 315)	318-15-5	
M1091, U, M1111, U (Ch. 321, U)	372-7	
M1121, U (Ch. 322, U)	372-7	
M1161, U (Ch. 323, U)	370-6	
M1191, U (Ch. 329, U)	377-4	
M1201, U (Ch. 329U, 330)	377-4	
M1211, U (Ch. 329, U)	377-4	
M2021, U (Ch. 706, U)	385-3	
M3061, U (Ch. 321, U)	372-7	
M3071, U (Ch. 322, U)	372-7	
M3081 (Ch. 419)	321-15-5	
M3101, U (Ch. 321, U)	372-7	
M3114, U (Ch. 322, U)	372-7	
M3151, U (Ch. 324, U)	373-8	
M3181, U (Ch. 420, U)	376-2	
M3201 (Ch. 323, U)	370-6	
M3214, U (Ch. 324, U)	373-8	
M3234, U (Ch. 331, U)	380-3	
M3241, U (Ch. 329, U)	377-4	
M3251, U (Ch. 329U, 330)	377-4	
M3261, U (Ch. 331, U)	380-3	
M3271, U (Ch. 331, U)	380-3	
M3281, U (Ch. 421, U)	378-3	
M3304, U (Ch. 706, U)	385-3	
M4041, U (Ch. 706, U)	385-3	
M4061, U (Ch. 706, U)	385-3	
MG1151, U (Ch. 323, U)	370-6	
P410 Series, P411 Series (Ch. 1109)	381-10	
P1007 (Ch. 315)	318-15-5	
P1121, U (Ch. 322, U)	372-7	
P1151, U (Ch. 323, U)	370-6	
P1201, U (Ch. 329U, 330)	377-4	
P1211, U (Ch. 329, U)	377-4	
P3071, U (Ch. 322, U)	372-7	



Set No.	Folder No.	No.
<b>ZENITH</b>		
A400G, W, Y, A404L (Ch. 4A40, 4A42)		373-16
A402L, V, Y (Ch. 4A41)		385-12
A504F, Y (Ch. 5A41)		386-13
A510F, W, Y (Ch. 5A10)		359-17
A513F, G, R (Ch. 5A01)		386-14
A515F, L, V, W, Y (Ch. 5A06)		362-16
A600, A600L (Ch. 6A40, 6A41)		381-16
A835E, R (Ch. 8A02)		325-17
A1510L, A1511G, A1512J, A1515W (Ch. 15A25)		373-17-5
A1812R, RU (Ch. 15Z30, U)		379-4
A1817G, GU, L, LU, A1819J, JU, A1820W, WU (Ch. 15Z31, U)		376-5
A2221J, Y, A2223E, H, R, Y (Ch. 17A20)		377-19-5
A2241E, EU, M, MU, R, RU (Ch. 17Z32, U)		374-16
A2245E, R, A2250M, R, A2251E, R (Ch. 17A20)		377-19-5
A2282E, R (Ch. 17A20)		377-19-5
A2329J, A2330E, H, R (Ch. 19A20)		377-19-5
A2358E, R, A2359E, H, R, A2362M, R (Ch. 19A20)		377-19-5
A2673E, R (Ch. 17A20)		377-19-5
A3000E, R, A3001E, H, R, A3004, E, R, A3008E, R (Ch. 17A20Q, 17A21Q)		377-19-5
A3010E, H, R, A3011, E, Y, A3012H, R, A3013H, A3014H, R (Ch. 19A20Q)		377-19-5
A4007E, R (Ch. 19A20Q)		377-19-5
HF17E, H, R (Ch. 5Z21)		346-21

Set No.	Folder No.	No.
<b>ZENITH—Cont.</b>		
HF20R, HF21E (Ch. 5Z21)		346-21
HF774E, H, R (Ch. 7Z20)		360-14
HF1180R, HF1182R (Ch. 11Z20)		370-15
HF1183E, HF1185M, R (Ch. 11Z20)		370-15
HF1284, E, G, L, Y, HF1286R (Ch. 12Z20)		370-15
Z1812RZ, RZU (Ch. 15Z30, U)		379-4
Z1817GZ, GZU, LZ, LZU, Z1819JZ, JZU (Ch. 15Z31, U)		376-5
Z2221RZ, YZ, U (Ch. 17Z30, U)		372-17
Z2223CZ, CZU, EZ, EZU, RZ, RZU, YZ, YZU (Ch. 17Z31, U)		374-16
Z2229RZ, RZU, Z2230EZ, EZU, RZ, RZU (Ch. 19Z32, U)		385-4
Z2243EZ, EZU, RZ, RZU, Z2244EZ, EZU, RZ, RZU (Ch. 17Z32, U)		374-16
Z2249EZ, EZU, RZ, RZU, Z2251EZ, EZU, RZ, RZU (Ch. 17Z32, U)		374-16
Z2257EZ, EZU, MZ, MZU, RZ, RZU (Ch. 19Z32, U)		385-4
Z2282EZ, EZU, RZ, RZU (Ch. 17Z32, U)		374-16
Z2259EZ, EZU, RZ, Z, ZU, Z2260RZ, RZU (Ch. 22Z30, U)		383-4
Z2675EZ, RZ (Ch. 17Z33)		357-14-5
Z3000EZ, EZU, RZ, RZU (Ch. 17Z32Q, QU)		374-16
Z3001EZ, EZU, RZ, RZU (Ch. 17Z34Q, QU)		374-16

Set No.	Folder No.	No.
<b>ZENITH—Cont.</b>		
Z3004EZ, EZU, RZ, RZU (Ch. 17Z32Q, QU)		374-16
Z3008EZ, EZU, RZ, RZU (Ch. 17Z34Q, QU)		374-16
Z3010EZ, HZ, RZ, YZ (Ch. 19Z32Q)		385-4
Z3012HZ, RZ, Z3014HZ, RZ (Ch. 22Z30Q)		385-4
Z4000EZ, RZ (Ch. 17Z33Q)		357-14-5
Z4006EZ, RZ (Ch. 17Z33Q)		357-14-5
ZP7L		382-14
ZP8L		376-19
Ch. 4A40		373-16
Ch. 4A41		385-12
Ch. 4A42		373-16
Ch. 5A01		386-14
Ch. 5A06		362-16
Ch. 5A10		359-17
Ch. 5A41		386-13
Ch. 6A40, 6A41		381-16
Ch. 8A02		325-17
Ch. 11Z20, Z		370-15
Ch. 12Z20		370-15
Ch. 15A25		373-17-5
Ch. 15Z30, U		379-4
Ch. 15Z31, U		376-5
Ch. 17A20, Q, 17A21Q		377-19-5
Ch. 17Z30, U		372-17
Ch. 17Z31, U, 17Z32, Q, QU, U		374-16
Ch. 17Z33, Q		357-14-5
Ch. 17Z34Q, QU		374-16
Ch. 19A20, Q		377-19-5
Ch. 19Z32, Q, U		385-4
Ch. 22Z30, Q, U		383-4

Set No.	Folder No.	No.
<b>RECORD CHANGERS</b>		
<b>CRESCENT</b>		
C606, C607		374-4
C708, C709		374-4
<b>MONARCH</b>		
UA8		381-11
<b>PERPETUUM-EBNER</b>		
Rex A, Rex AA		378-10
<b>SILVERTONE</b>		
567.40010		365-13
567.40110		365-13
567.41020		365-13
567.41108		365-13
567.41120		365-13
<b>TELEFUNKEN</b>		
TW560		371-12
<b>WEBCOR</b>		
151, 152		375-17
<b>RECORDERS</b>		
<b>AMPEX</b>		
A121, A122, A124		382-5
A621, A692		382-5
<b>GELOSO</b>		
G-255-5		384-9
<b>KNIGHT</b>		
99RZ177		372-8
99RZ936		372-8

Set No.	Folder No.	No.
<b>RCA VICTOR</b>		
TR-1, TR-1A		377-15
6HFT1		377-15
7TRC1 (Ch. RS-156A)		376-17
8-STP-1, 8-STP-2 (Ch. RS-162)		370-10
Ch. RS-156A		376-17
Ch. RS-162		370-10
<b>REVERE</b>		
T11		386-8
<b>SILVERTONE</b>		
6074 (Ch. 567.34004, 567.35005)		379-12
8070, 8072 (Amp. Ch. 528.59040, 41, 60, 61, Transport Ch. 528-58010, 11, 30, 31)		380-11
Ch. 528.58010, 11, 30, 31		380-11
Ch. 528.59040, 41, 60, 61		380-11
Ch. 567.34004		379-12
Ch. 567.35005		379-12
<b>SYMPHONIC</b>		
BR-1200, R-1200		373-13
<b>TELECTRO-TAPE</b>		
1960		385-8
<b>WEBCOR</b>		
2719 (PCB 376-1)		357-11
<b>WILCOX-GAY</b>		
375		383-13
686		316-16
750		383-13

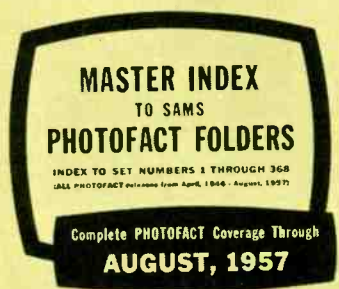

**NEW... EASY-TO-USE INDEX!**  
 Now... all information relating to any chassis or model, covered by PHOTOFACT, can be found in one easy-to-find listing. Use this Master Index with the supplements issued monthly for complete model coverage.

**HOWARD W. SAMS & CO., INC.**  
 2203 East 46th Street - Indianapolis 5, Indiana

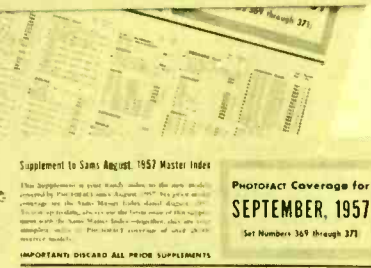

**TAKE THE RIGHT STEP TO TIME-SAVING PROFIT-BUILDING BUSINESS: Sign up with your Parts Distributor to get PHOTOFACT Folder Sets automatically each month.**

**DO IT NOW!**

**Free!**

to Service Technicians Only

**THE NEW SAMS INDEX TO PHOTOFACT FOLDERS**

it keeps you up-to-the-minute on receiver coverage

Mail coupon today for your free subscription to the Sams Photofact Index

**HOWARD W. SAMS & CO., INC.**

Howard W. Sams & Co., Inc.  
 2203 E. 46th St., Indianapolis 5, Indiana

Send me your FREE Master Index to PHOTOFACT Folders (twice yearly), and put me on your mailing list to receive all Index Supplements. My letter-head and/or business card is attached.

I am a Service Technician:  full time;  part time.

My Distributor is: \_\_\_\_\_

Shop Name \_\_\_\_\_

Attn: \_\_\_\_\_

Address \_\_\_\_\_

City \_\_\_\_\_ Zone \_\_\_\_\_ State \_\_\_\_\_

NOTE: PCB Denotes Production Change Bulletin. • Denotes Television Receiver. S Denotes Schematic Coverage Only.

When the Diagnosis is  
 "That WASHED-OUT Look"...



pep up the picture with

**RCA TUBES**

Light output is low, focus okay...but, oh, that "washed-out look"! You can fix it quick. Check the front end and video-if tubes, low- and high-voltage tubes. If new tubes are indicated, "pep up" the picture with the most dependable tubes for TV replacement—TOP QUALITY RCA TUBES.

Selected materials, advanced manufacturing processes, costly and painstaking inspection techniques, combine to give you maximum assurance of top-performance when you replace with RCA TUBES.

For the top-quality brand—always ask your tube distributor for RCA, of course!



**RECEIVING TUBES**

RADIO CORPORATION OF AMERICA  
 Electron Tube Division Harrison, N. J.



**RCA MICROSCOPIC INSPECTION  
 OF POPULAR TV RECEIVING TYPES**

*Helps Reduce Costly Callbacks!*

RCA Quality-Control Procedures include microscopic inspection of popular TV receiving types! Specially trained inspectors help reduce costly callbacks in the field. You gain the valuable assurance from this extra care that you can always service your customers with the confidence that RCA TV Receiving Types are top quality Replacement tubes.

# LITTELFUSE

*Des Plaines, Illinois*

**DRAW TO A STRAIGHT SUCCESS  
WITH ...  
LITTELFUSE**

*Quality, Service, Range, and such winning service aids as the Fuse Caddy, One-Call Kits, LC Fuse Caddy, Packaged Snap-On Holders, Fuse-Retainer Assortments, Single-Fuse Channels, participation in Howard Sams Photofact Folders.*

Burton Browne Advertising