

FEBRUARY • 1956

25 CENTS

Herbert W. Sams

RE[®] REPORTER

for the Electronic Service Industry



Audio-Facts
.....

**TEST EQUIPMENT
SERVICING
COLORBLOCK**

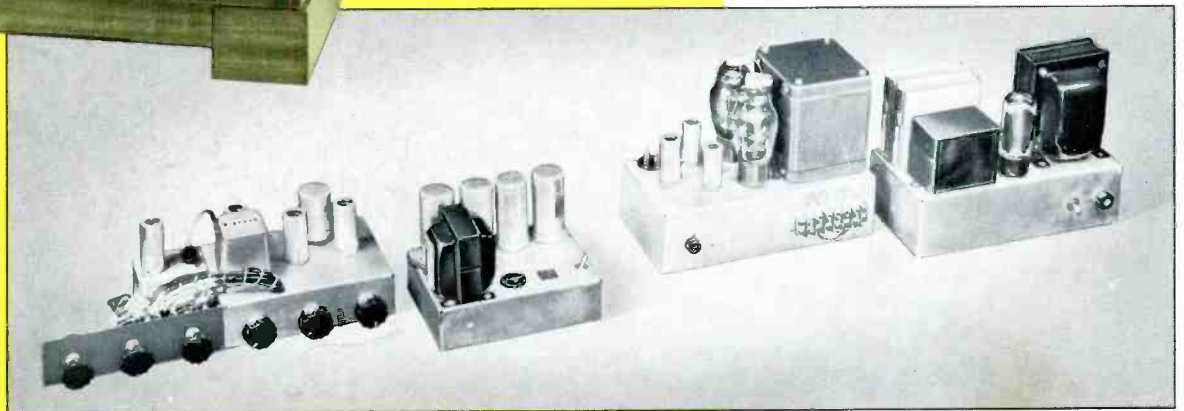
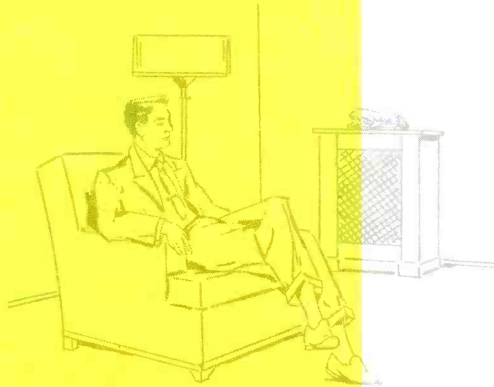

Preferred for modern set servicing

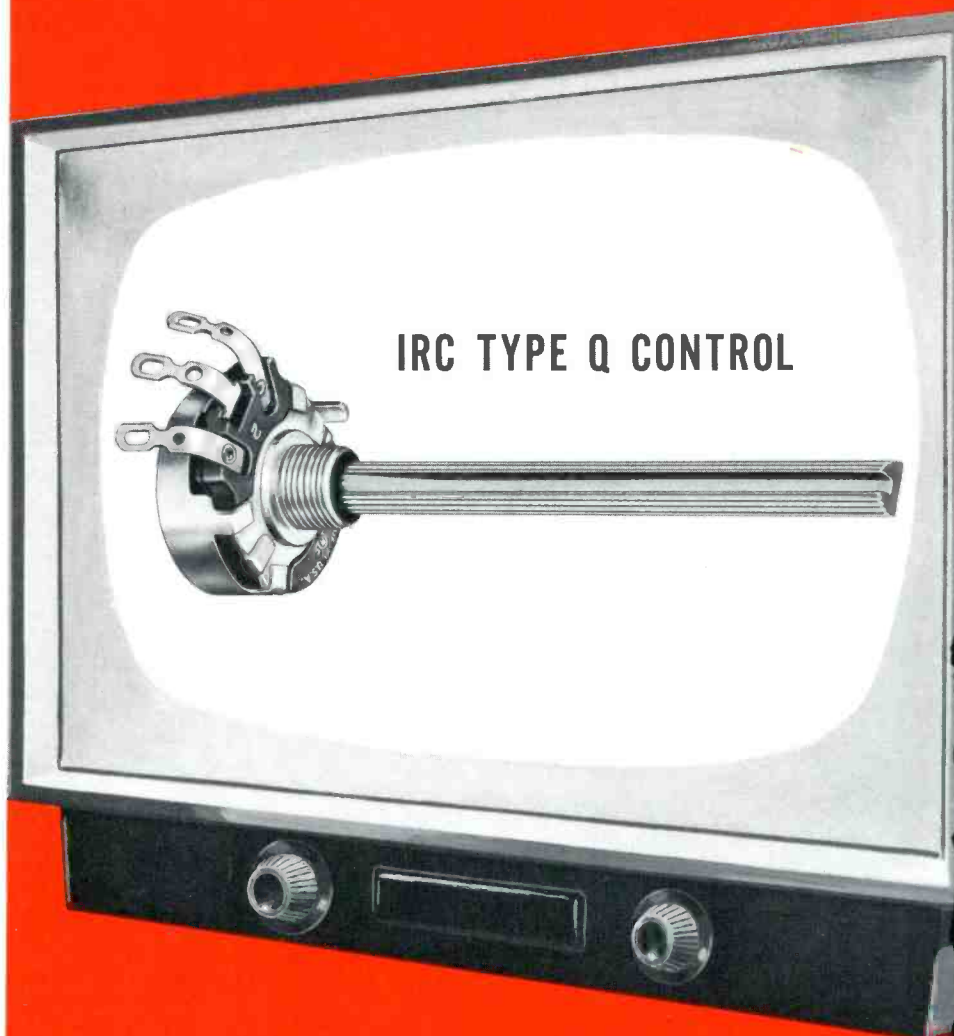

IRC TYPE Q CONTROL

Service technicians get greater coverage with less investment; more practical service features; and easier, faster installation with the IRC Type Q Control. Here's a dependable, basic control that is directly designed for modern set servicing. For appearance, performance and price . . . there's none better. So why settle for less? Tell your Distributor you want Q Controls . . . most servicemen do.



Wherever the Circuit Says 



This 8 page catalog gives you all the facts . . . Send for your free copy—

INTERNATIONAL RESISTANCE CO.

Dept. 361, 401 N. Broad St., Phila. 8, Pa.

In Canada: International Resistance Co., Ltd., Toronto, licensee

KNOBMASTER FIXED SHAFT

Q Control standard shaft is knurled, flatted and slotted — fits most knobs without alteration.

INTERCHANGEABLE FIXED SHAFTS

Exclusive IRC convenience feature — provides fast conversion to "specials", with FIXED shaft security. 15 types available.

1/4" LONG BUSHING

Accommodates all small sets, yet handles large set needs perfectly.

7 STANDARD TAPERS

Full coverage of all taper requirements is provided in the Q Control.

94 RESISTANCE VALUES

For TV, AM and FM coverage, 94 values of plain and tapped controls are furnished.

QUALITY APPEARANCE

The handsome professional appearance of IRC Q Controls lets you point to your work with pride.

CUSHIONED TURN

The smooth, quality of "feel" of a Q Control contributes to customer confidence.

TYPE 76 SWITCHES

Either of two type IRC switches attached as quickly and easily as a control cover — meets all your requirements.

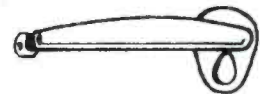
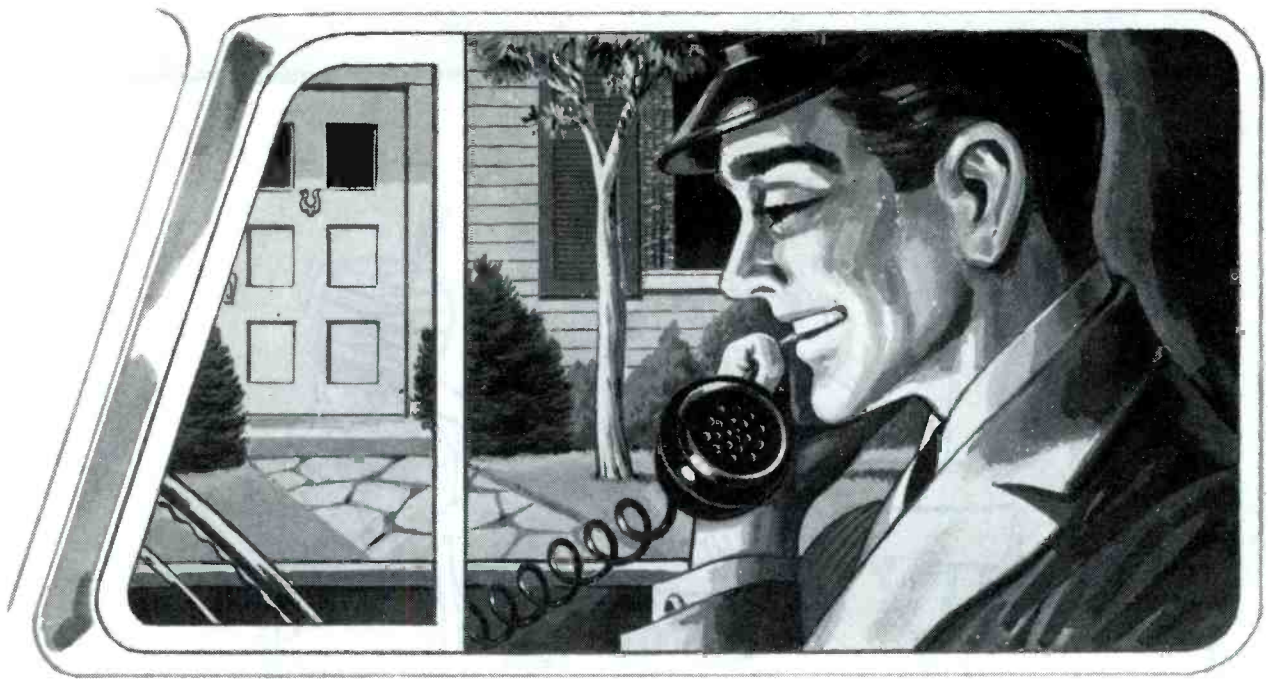

RADIART features
 the complete line of **NEW**
COMMUNICATION VIBRATORS
 in 6 Volt and 12 Volt Series
 that outlast all others

These Ten Types Offer Complete Replacement for ORIGINAL Communication Equipment.

Old No.	New No.	
	6 volt	6/12 volt
5515	5715	6715
5518	5718	6718
★	5721	6721
★	5722	6722
★	5725	6725
5605	5805	6805
5620	5820	6820
5621	5821	6821
5622	5822	6822
★	5824	6824

For Specific Applications See Latest Radiart Vibrator Guide

Again because of SUPERIOR ENGINEERING and CONSISTENTLY INCREASED QUALITY, Radiart offers you communication vibrators that are DEPENDABLE! The RIGHT vibrator... for EACH application! See for yourself... You're RIGHT WITH RADIART.

SUBSIDIARY OF



THE **RADIART** CORPORATION
 CLEVELAND 13, OHIO

TV ANTENNAS • AUTO AERIALS • VIBRATORS • ROTORS • POWER SUPPLIES



I ALWAYS USE SPRAGUE CAPACITORS TO GET CLEAR PICTURES!

Don't Be Vague... Insist on SPRAGUE

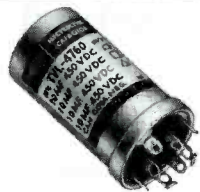

**Insist on Sprague
TWIST-LOK ☆ 'LYTICS**

Sprague TVL's fill the top performance bill in the toughest TV circuits. High temperatures, surge voltages, ripple currents won't faze them. Like all Sprague capacitors, Twist-Lok 'Lytics are your first line of defense against expensive call-backs.

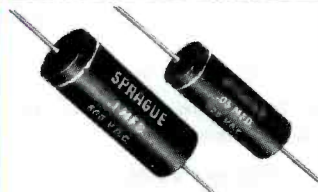

**Insist on Sprague
BLACK BEAUTY® TELECAPS®**

The most imitated capacitor Sprague ever introduced. But you get Sprague *performance* only when you insist on Sprague Telecaps. Hundreds of millions are in use today as first choice of quality conscientious manufacturers and servicemen. It's the *premium* molded tubular *at no extra cost.*



**Insist on Sprague
TEL-OHMIKE®**

This capacitor-resistor analyzer is the handiest instrument you can buy! Moderately priced for radio and TV repair shops, the Model TO-4 Tel-Ohmike offers top quality and accuracy for every service need. Priced so you can afford it at **\$73.50 NET**

Accept no substitutes. There is a Sprague Distributor in every sales area in the United States. Write for the name of your nearest source of supply today.

☆ Trademark

SPRAGUE

Get your copy of Sprague's latest radio and TV service catalog C-610. Write Sprague Products Company*, 105 Marshall St., North Adams, Mass.

*Distributors' Division of Sprague Electric Company

**WORLD'S LARGEST
CAPACITOR MANUFACTURER**

PUBLISHER
Howard W. Sams

EDITOR
Lester H. Nelson

MANAGING EDITOR
Glen E. Slutz

TECHNICAL EDITOR
William E. Burke

EDITORIAL STAFF

Leslie D. Deane	C. P. Oliphant
Robert B. Dunham	Verne M. Ray
Thomas A. Lesh	Paul C. Smith
George B. Mann	Calvin C. Young, Jr.

EDITORIAL ASSISTANTS

Phyllis J. Hurley	Evelyn S. Mouser
Margaret Neff	

ART DIRECTORS

Anthony M. Andreone	Glenn R. Smith
---------------------	----------------

PHOTOGRAPHY
Robert W. Reed

PRODUCTION
Douglas G. Bolt Charles A. Ferguson

ABOUT THE COVER

Robert B. Dunham, author of "Audio Facts," has experience and interest in audio far beyond his preparation of audio articles. A few of the components used in his home music system are shown on the cover. Each unit has had years of use and undergoes constant modification and modernization. Photographs by Robert W. Reed. Cover design by Glenn R. Smith.



BUSINESS DEPARTMENT

Donald B. Shaw, V. P.
 F. T. Dobbs, Secretary
 Joe H. Morin, Sales Mgr.
 Ann W. Jones, Advertising

ADVERTISING SALES OFFICES

Eastern: Paul S. Weil and Donald C. Weil,
 39-01 Main Street, Flushing 54, New York.
 Independence 3-9098.

Midwestern: Joe H. Morin, Sales Manager,
 2201 East 46th Street, Indianapolis 5, Ind.
 Glendale 4531

Western: Maurice A. Kimball Co., Inc.,
 2550 Beverly Blvd., Los Angeles 57, Calif.
 Dunkirk 8-6178; and 681 Market Street,
 San Francisco 5, Calif. EXbrook 2-3365.

PUBLICATION INFORMATION

Published monthly by Howard W. Sams & Co., Inc., at Indianapolis, Indiana.

Entered as second class matter October 11, 1954, at the Post Office at Indianapolis, Indiana, under the Act of March 3, 1879.

Copyright 1956 by Howard W. Sams & Co., Inc. No part of the PF REPORTER may be reproduced without written permission. No patent liability is assumed with respect to the use of information contained herein.

A limited quantity of back issues are available at 35c per copy.

CONTENTS

Shop Talk	Milton S. Kiver	9
New transistor developments		
Notes on Test Equipment	Paul C. Smith	10
Triplet Model 3438 dot generator; Win-Tronix Model 820 dynamic sweep circuit analyzer		
Using a Solder Pot	Calvin C. Young, Jr.	12
A photographic coverage		
Selecting Test Equipment for Color Servicing	Verne M. Ray	15
Suggestions for the technician who is entering the field		
Audio Facts	Robert B. Dunham	16
Different types of microphones		
Examining Design Features	Leslie D. Deane	19
New fashions in components		
In the Interest of Quicker Servicing	Calvin C. Young, Jr.	23
Discussion of a servicing experience		
Signal Tracing in Sync Separators	Thomas A. Lesh	25
Use of an oscilloscope in servicing sync-separator circuits		
Know Your Oscilloscope (Part III)	Paul C. Smith	26
Sweep systems in typical oscilloscopes		
Antenna Insurance	George B. Mann	29
Facts of interest to you and your customer		
Dollar and Sense Servicing	John Markus	31
A Stock Guide for TV Tubes		47
Product Report		66
PHOTOFACT COLORBLOCK Reference Chart No. 11	Insert	
Formation of the composite color signal		

Please enter my subscription to PF REPORTER for:

- | | | |
|--|---|---|
| <input type="checkbox"/> 1 Year \$3.00 | <input type="checkbox"/> 2 Years \$5.00 | <input type="checkbox"/> 3 Years \$7.00 |
|--|---|---|

In Canada: One Year \$3.60 Two Years \$6.20 Three Years \$8.80

- | | |
|---|----------------------------------|
| <input type="checkbox"/> Remittance Enclosed* | <input type="checkbox"/> Bill Me |
|---|----------------------------------|

*Two extra issues if remittance accompanies order.

Name _____

Firm _____

Address _____

City _____ Zone _____ State _____

- | | |
|--|---|
| 01 <input type="checkbox"/> Independent Service Man | 12 <input type="checkbox"/> Service Manager |
| 02 <input type="checkbox"/> Dealer with Service Shop | 37 <input type="checkbox"/> Student |
| 38 <input type="checkbox"/> Other _____ | |

Give to your Electronic Parts Distributor or mail, with remittance, to PF REPORTER, 2201 East 46th Street, Indianapolis 5, Indiana.

GREATEST TIME-SAVER FOR



SERVICE-DESIGNED TUBES

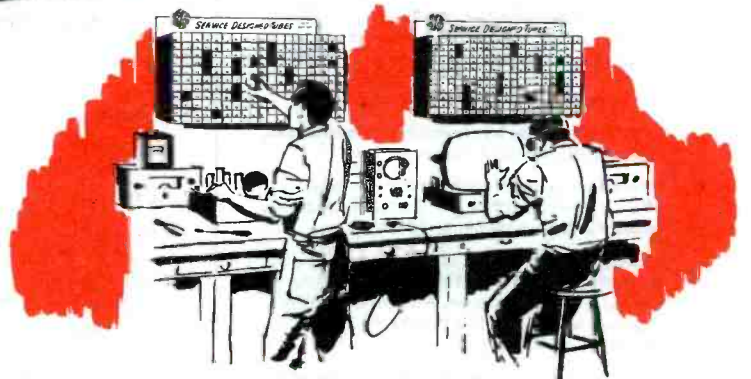
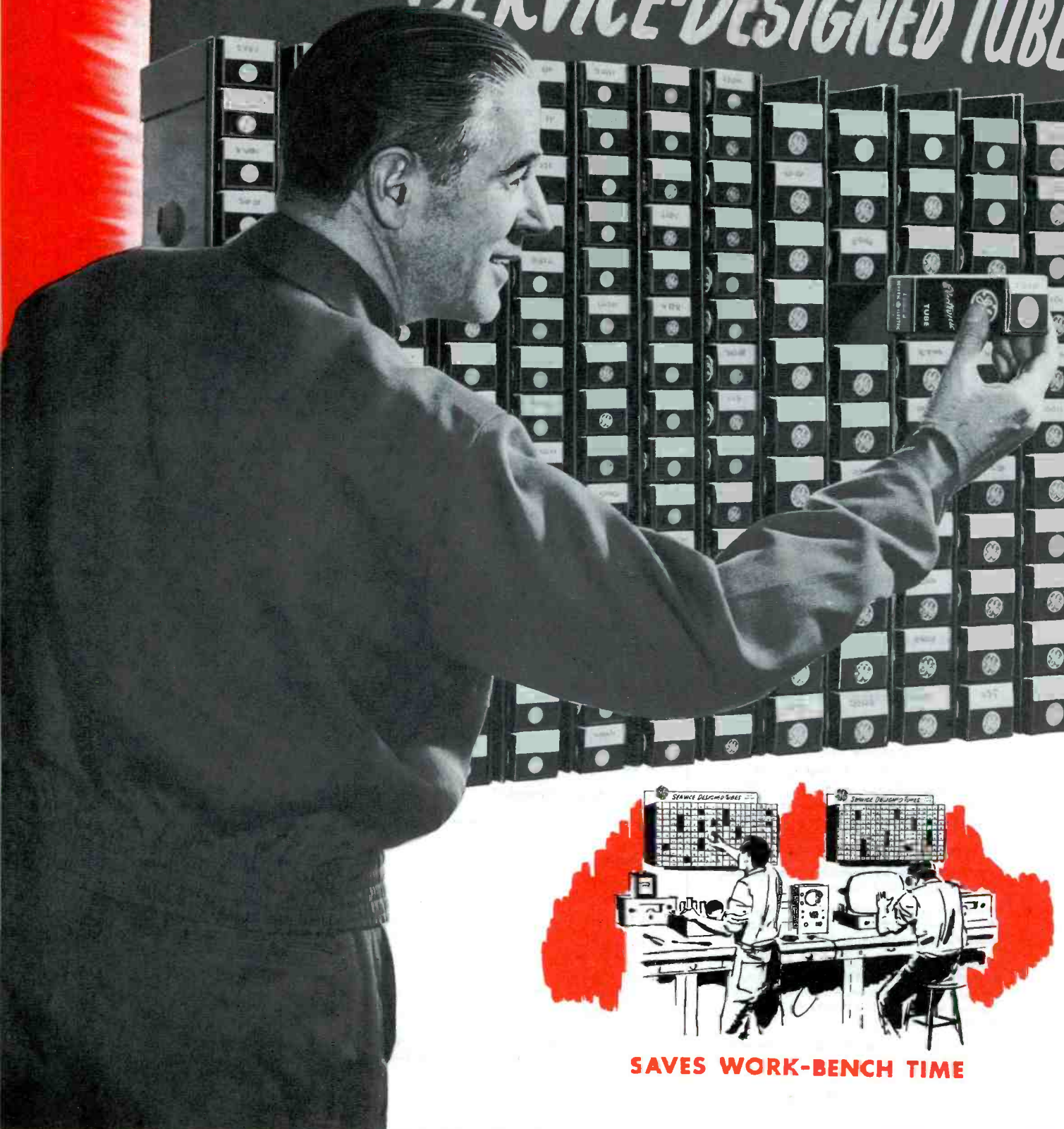

SAVES WORK-BENCH TIME

TV-RADIO SERVICE EVER OFFERED!

NEW!



Best for any set!

SEE-LECT-A-TUBE

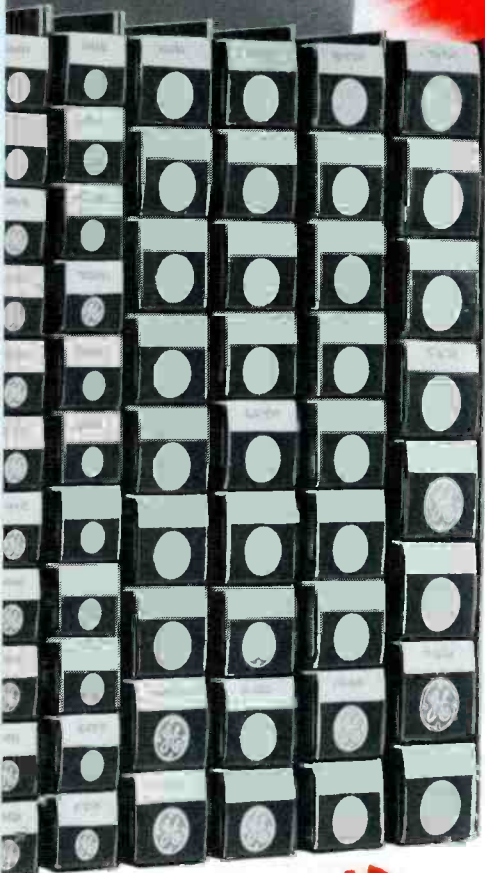

- Speeds up your counter tube sales.
- Increases work-bench efficiency.
- Makes tube selection easy, quick, sure.
- Protects tubes against breakage losses.
- Visual inventory control helps you rotate your tube stock properly.
- Saves valuable space . . . 250 tubes of all carton sizes occupy a dimension only 38" by 20 $\frac{1}{2}$ " by 6 $\frac{1}{4}$ ".

General Electric TV-radio technicians pooled their experience to help design this new SEE-LECT-A-TUBE for your TV-radio service business.

Complete flexibility in meeting your tube requirements! Rugged blue steel dispensing units, mounted side-by-side, each hold a vertical row of tubes. The types can vary with your individual needs. Six carton sizes are provided for—from miniatures to large glass types. The number of dispensers allotted to each size is scientifically based on average tube usage, but dispensers can be arranged so that they will match your special requirements.

Friction flanges hold tubes in place! When a tube is removed from a dispenser, those above it can't slide down. The tube alignment remains intact. Open spaces, therefore, indicate tubes that need to be re-ordered . . . or, as a further check, you can put back the

empty cartons in reverse position, with bottom ends forward. Thus—besides gripping the cartons for safety—the friction flange in each SEE-LECT-A-TUBE dispenser helps you determine how many tubes of any given type you have in stock.

Wall-bracket included! A bracket comes with each SEE-LECT-A-TUBE which will fasten easily to any wall, giving solid support to dispensers and tubes. The SEE-LECT-A-TUBE is shipped pre-assembled . . . just unbox the complete unit and hang it on the wall bracket.

See your G-E tube distributor for details! Right now your General Electric distributor is waiting to tell you all about the new SEE-LECT-A-TUBE, and how you can obtain one promptly. Contact him today! Don't miss this chance to modernize your tube inventory for bigger sales, improved shop efficiency! *Tube Department, General Electric Company, Schenectady 5, New York.*



SPEEDS UP TUBE SALES

Progress Is Our Most Important Product

GENERAL  **ELECTRIC**

161-1A1

The unfailing Dependability of BUSS FUSES . . .

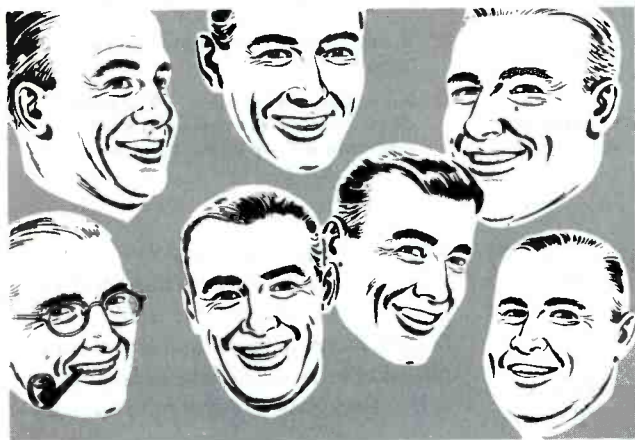
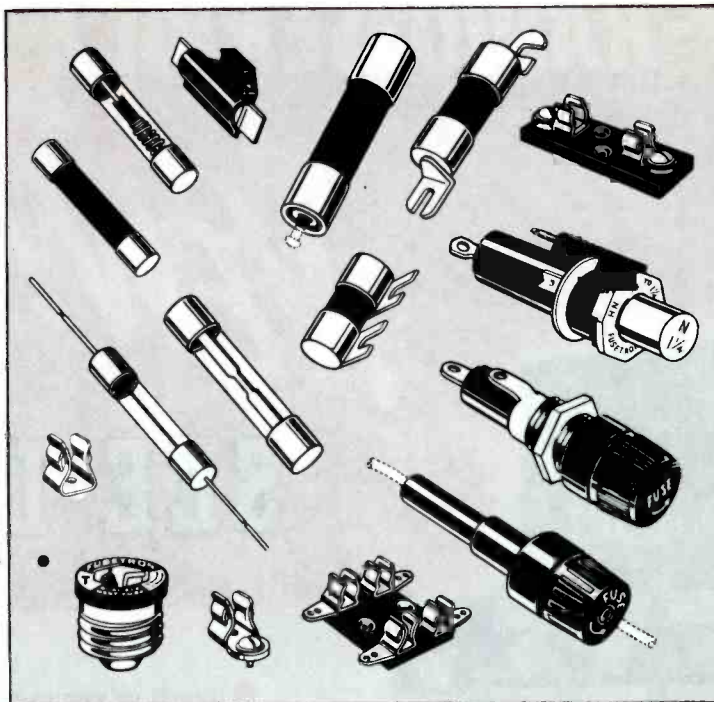

helps you keep customers satisfied!

By operating properly under all service conditions — BUSS fuses can help safeguard the reputation of your product or service against loss of customer good will.

When there is an electrical fault — BUSS fuses open and prevent further damage to equipment, saving users the expense of replacing needlessly burned out parts.

And just as important, BUSS fuses won't give a false alarm by blowing when trouble doesn't exist. Useless shutdowns caused by poor quality fuses blowing needlessly are not only irritating to customers — but customers' confidence in your product or service could be jolted.

Every BUSS fuse is electronically tested to assure "trouble-free" operation.

Every BUSS fuse normally used by the Electronic Industries is electronically tested. A

sensitive device automatically rejects any fuse not correctly calibrated, properly constructed and right in all physical dimensions.

With a complete line of fuses, fuseholders and fuse blocks available — it is just good business to standardize on BUSS.

For more information on FUSETRON and BUSS small dimension fuses and fuseholders . . . Write for bulletin SFB.

Makers of a complete line of fuses for home, farm, commercial, electronic, automotive and industrial use.



BUSSMANN MFG. CO.
(Division of McGraw Electric Co.)
UNIVERSITY AT JEFFERSON
ST. LOUIS 7, MO.

156

**BUSS FUSES ARE MADE TO PROTECT
— NOT TO BLOW**



WHY should a set owner call you instead of Joe's for TV-Radio service?

Honestly, now, what special inducement do you have that will cause customers to select you for service instead of your competitor? Men? Shop? Trucks? Test Equipment? In most cases the answer is simple — *not a single thing!*

The exceptions are service dealers who are among the select group of RAYTHEON BONDED ELECTRONIC TECHNICIANS.

Raytheon Bonded Dealers can offer the public TV-Radio service that is bonded by Raytheon through one of America's largest insurance companies. This creates customer confidence, sways potential customers, helps get more business and make more money. Yet, this tremendous selling advantage costs Bonded Dealers *not one penny.*

Why not ask your Sponsoring Raytheon Tube Distributor if you can qualify as a Raytheon Bonded Electronic Technician? If you can, we'll be happy to pay for *your* bonding.



Excellence in Electronics

RAYTHEON MANUFACTURING COMPANY

Receiving and Cathode Ray Tube Operations

Newton, Mass., Chicago, Ill., Atlanta, Ga., Los Angeles, Calif.

RAYTHEON MAKES ALL THESE:

RECEIVING AND PICTURE TUBES • RELIABLE SUBMINIATURE AND MINIATURE TUBES • SEMICONDUCTOR DIODES, POWER RECTIFIERS AND TRANSISTORS • NUCLEONIC TUBES • MICROWAVE TUBES

An open letter to all TV service-dealers

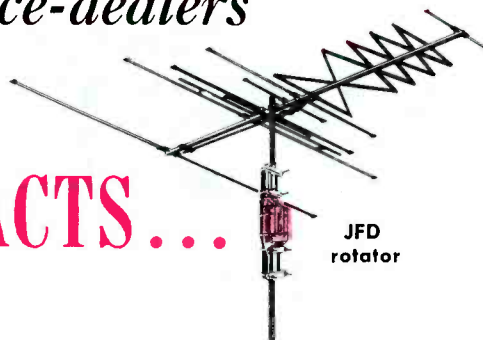

FACTS ARE FACTS...

FACTS ARE FACTS and you—as a serviceman—must be prepared to face them. All rotators eventually break down and require servicing. This usually means dismantling the antenna installation and disrupting your customer's TV enjoyment for days. It not only costs you time, effort, and money, but strained customer relations. Moreover, your cost of servicing the rotator is greater than the profit you make on the original installation.

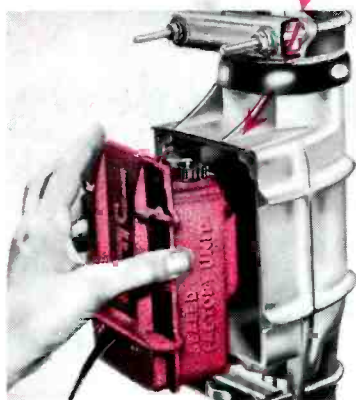

THE ANSWER MUST BE *BUILT* RIGHT INTO THE ROTATOR. The unit must be designed to give superior performance and yet be easy to service. That is why the JFD Roto-King Rotator is the solution to your problems. To service, *simply remove the old unit and replace with a new, moderately-priced factory-sealed unit.* Service is restored in a matter of *minutes*, without loss of customer goodwill.

Your nearest JFD distributor has Roto-King Rotators in stock at attractive prices, in 4 different models to suit any location requirement. Control cases can be obtained in either mahogany, ebony, or ivory. Be sure to ask for the JFD Roto-King—the *only* rotator with the *replaceable* power cartridge.



The Roto-King Rotator was designed, engineered, and manufactured in the JFD plant.



MANUFACTURING CO., Inc.

Brooklyn 4, N. Y.

Go Forward with JFD Engineering!

Shop Talk

MILTON S. KIVER

Author of *How to Understand and Use TV Test Instruments and Analyzing and Tracing TV Circuits*

Improved High-Frequency Response of Transistors

Last month, we noted some of the factors which govern (and limit) the frequency response of a junction transistor. It was apparent from the discussion that there was no simple solution to all of the problems presented. Rather, we will have to depend, as we have in other developments in the field of electronics, upon the evolution of a number of approaches and then let the industry choose from these the one or ones which will best serve the purpose. In the following, four highly promising methods of achieving improved high-frequency response will be discussed. The first is the alloy or diffused-junction transistor that RCA has developed.

The Diffused-Junction Transistor

The diffused-junction transistor is formed by diffusing indium into germanium. A small pit is drilled into a relatively thick wafer of n-germanium. (See Fig. 1.) Then a pellet of indium is placed at the bottom of this pit, another pellet is placed opposite the pit on the other side of the wafer, and heat is applied.

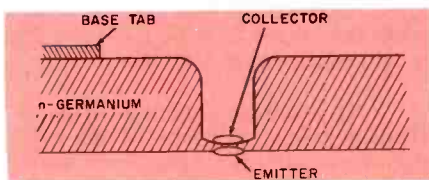

Fig. 1. A Magnified Cross Section of a Diffused-Junction Transistor.

The temperature chosen is above the melting point of indium but below that of germanium. The indium diffuses into the germanium in the regions underneath the pellets until

the two regions are separated by the required distance. The result is a p-n-p transistor because indium has an acceptor atom and forms p-regions. Connections are made by wires to the emitter and collector sections, which are the regions containing the alloy. The other ends of these wires are then spot welded to leads that make contact with the circuit in which the transistor is placed.

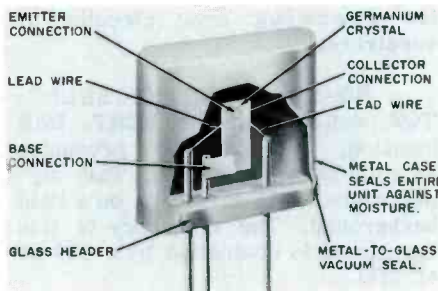

Fig. 2. Transistors Are Placed in Metal or Plastic Cases and Hermetically Sealed.

For protection, the completed assembly is placed in a metal or plastic case and is hermetically sealed. (See Fig. 2.)

With the diffusion method of construction, several things have been accomplished. First, the separation between the collector and emitter regions is only about 0.0005 inch. This permits a significant reduction in transit time. Second, the base resistance is made low by the use of a relatively thick germanium wafer at all points except in the small area between the emitter and collector. The emitter and collector diameters (which are 0.010 and 0.015 inch, respectively) are kept small, and thereby the various capacitive effects of these elements are reduced. (The sizes of the emitter and collector are not controlled by the diffusion process but do aid in improvement of

the frequency response.) The first transistors made by this diffusion process exhibited 12 decibels of gain at 10 megacycles. Oscillations could be sustained up to 75 megacycles. Still higher frequency limits will be attained with continued improvement in the techniques of making and controlling the indium junctions, with the use of germanium of lower resistivity, and with reduction in the dimensions of the elements of the transistor.

The diffusion or alloy method is feasible for both p-n-p and n-p-n junction transistors. For an n-p-n unit, p-germanium would be used and a pentavalent element would be substituted for the indium.

The Surface-Barrier Transistor

The Philco surface-barrier transistor is another high-frequency unit. The cross section of it closely

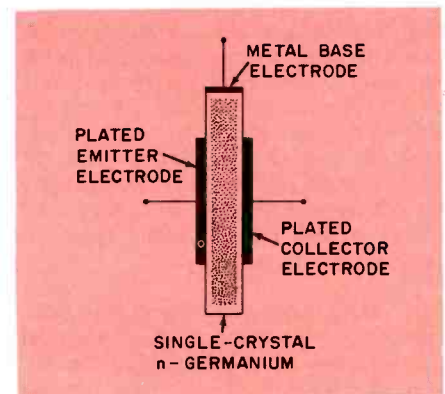

Fig. 3. A Cross Section of a Surface-Barrier Transistor.

resembles that of a junction transistor. (See Fig. 3.) In its mode of

* * Please turn to page 73 * *

Notes On TEST EQUIPMENT

Presenting Information on Application, Maintenance, and Adaptability of Service Instruments



by Paul C. Smith



Fig. 1. Triplet Model 3438 Dot Generator.

The Triplet Model 3438 dot generator is shown in Fig. 1. It provides signals suitable for checking the video, RF, IF, sync, and color circuits in black-and-white and color receivers. The signals are available in the form of modulated RF and IF, and as video signals of either positive or negative polarity. The RF signal may be tuned continuously from channel 2 through channel 6, and the IF signal may be tuned from 20 through 55 megacycles.

Separate attenuators of the continuously variable type are provided for both the video signal and the RF and IF signals. The output impedance for the video signal is 2000 ohms or less, depending upon the setting of the attenuator. The output impedance for the RF or IF signal is 200 ohms or less, also depending upon the attenuator setting.

The FUNCTION SELECTOR switch provides the following func-

tions: OFF, STANDBY, H-V SYNC., VERT. BAR, HORIZ. BAR, CROSSHATCH, and DOTS. In the H-V SYNC position, horizontal and vertical sync pulses are obtained. These signals are of the right shape and frequency for checking sync circuits in receivers.

When the FUNCTION SELECTOR switch is in the VERT. BAR position, a signal for producing vertical bars is obtained. This signal produces 11 dark bars on a light background. The frequency of this bar signal is controlled by a 189-kc crystal.

A signal for producing horizontal bars is obtained at the HORIZ. BAR position of the switch. The frequency of this signal can be varied from 480 to 600 cycles by means of the HORIZ. BAR CONTROL on the front panel of the instrument.

When the FUNCTION SELECTOR switch is in the CROSSHATCH position, both bar signals are applied to the output and a signal that will produce a crosshatch pattern on a receiver will result. The vertical-bar, horizontal-bar, and crosshatch signals are useful in making linearity checks and adjustments on black-and-white and color receivers. When the instrument is adjusted for 11 vertical and 8 horizontal bars, it will produce a crosshatch pattern of squares on a receiver that is adjusted properly.

All the bar and crosshatch signals just mentioned produce dark bars on a light background. The dot signal produces white dots on a dark back-

ground. The dots are of proper size for convergence checks and adjustments of color receivers, they have the same number as there are intersections in the crosshatch pattern, and they coincide in position with these intersections.

At any signal setting of the FUNCTION SELECTOR switch, a color signal can be added by moving the COLOR switch to the ON position. This color signal is controlled by a 3.563795-mc crystal. The color pattern is of the type in which each color is continuously blended into the next through approximately 330 degrees of the color spectrum. For example, red blends into magenta, magenta into blue, and blue into cyan through all the intermediate colors. If the FUNCTION SELECTOR switch is at the VERT. BAR position at the same time that a color pattern is being viewed, the pattern will be marked by vertical bars at 30-degree intervals; and this information can be used as the basis for identification of different sections of the pattern. This information will also be useful when the signal is used for checking or adjusting color receivers.

To avoid any confusion in identification of the sections of the color pattern and to obtain the most stable synchronization of the receiver, the technician can check the HORIZ. HOLD control of the Model 3438 generator by connecting the video output signal of the generator to an oscilloscope. Fig. 2 shows the waveform obtained from the generator. The internal sweep rate of the oscilloscope is set so that the horizontal sync pulse (which is the large pulse

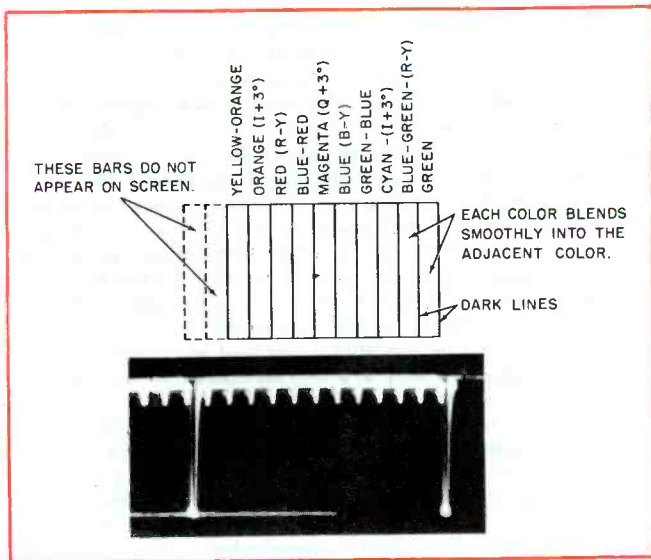

Fig. 2. The Relationship Between the Signal From the Triplet Model 3438 Dot Generator and the Color Pattern Produced on the Receiver Screen.

shown in the figure) may be viewed. The smaller pulses in the figure are the ones that produce the vertical bars in the pattern. The frequency of the vertical-bar signal is held constant by the 189-kc crystal, but the frequency of the horizontal sync pulses can be varied by the HORIZ. HOLD control of the generator. With this hold control adjusted so that 12 vertical pulses may be seen between the horizontal sync pulses, the color pattern produced by the receiver can be identified as that in the diagram above the waveform in Fig. 2. The name given to any particular bar in the pattern refers to the color represented by the average phase of the bar signal.

The use of the Triplet Model 3438 generator while checking and adjusting color receivers will be covered in more detail in another issue.

The size of the instrument is 6 1/4 by 11 1/32 by 15 11/32 inches. The weight is approximately 16 pounds.

Win-Tronix Model 820 Dynamic Sweep Circuit Analyzer

Troubles in sweep circuits have been among those more difficult to localize in a TV receiver. The nature of these circuits is such that their dynamic characteristics are very different from their static characteristics. Checks of resistances and DC voltages may uncover some troubles, but other troubles will require tests of a more dynamic nature. A defect such as a single shorted turn in a transformer may seem minor, but it may throw a high-voltage system completely out of operation. Both the DC and pulse high voltages found in a high-voltage system discourage some types of tests.

A number of yoke and transformer testers have been developed to aid in locating shorted turns and open circuits in these components. The Win-Tronix Model 810 flyback and yoke tester is an example of such a tester, and it was discussed in this column in the November 1955 issue of the PF REPORTER. In addition to the test provided for checking yokes and transformers, the Model 810 also has provisions for making certain checks of electrolytic and bypass capacitors.

The Model 820 dynamic sweep-circuit analyzer will provide the same continuity and shorts tests for yokes and flyback transformers as did the Model 810; and in addition, it furnishes several other facilities for substituting circuits and signals of known quality in place of some of those that may be suspected.

The general appearance of the instrument can be seen in Fig. 3 in which the instrument is being used to drive the flyback transformer of a TV receiver. This is one of the functions which the Model 820 provides. It can be seen that the plate cap has been removed from the horizontal output tube of the receiver and has been attached to the lead from the HORIZONTAL XFMR DRIVE jack of the Model 820. The other lead of the instrument is a ground lead which is

clipped to the receiver chassis. When the instrument is connected in this manner and when the FUNCTION switch is set at the SIGNAL SUBSTITUTE position, the flyback transformer of the receiver is driven by the horizontal output tube within the instrument. The raster obtained can be used as an indication of the condition of the circuits following the horizontal output tube.

When the substitution feature of the instrument is being used in the manner just described, the OVERLOAD lamp on the front panel serves to indicate the amount of load placed upon the instrument by the receiver circuits. If the lamp glows more brightly than normal (normal brilliance can be judged by testing a few receivers known to be in good condition), it indicates a possible short in some component of the horizontal output circuits of the receiver. In case of an extreme overload, the lamp may even burn out; thus, it serves as a protective fuse. The No. 44 pilot lamp which is used is easily replaceable from the front of the panel.

The signal from the HORIZONTAL GRID DRIVE jack can be applied to the grid of the horizontal output tube as a test for the operation of all components in that circuit. The waveform of the signal obtained at this jack is shown in Fig. 4A. The peak-to-peak amplitude of the signal is approximately 110 volts. The frequency of the signal is approximately 15,734 cps, and it can be varied slightly by means of the CAL-FREQ control.

A signal to drive the grid of the vertical output tube is available at the VERT DRIVE jack of the instrument. The waveform of this signal is shown in Fig. 4B. The peak-to-peak amplitude of the signal is approximately 180 volts, and the frequency is 60 cps (locked to the line frequency).

Both the vertical drive and horizontal grid drive signals are available at the same time and can be applied simultaneously to the output stages of a receiver. According to

* * Please turn to page 48 * *

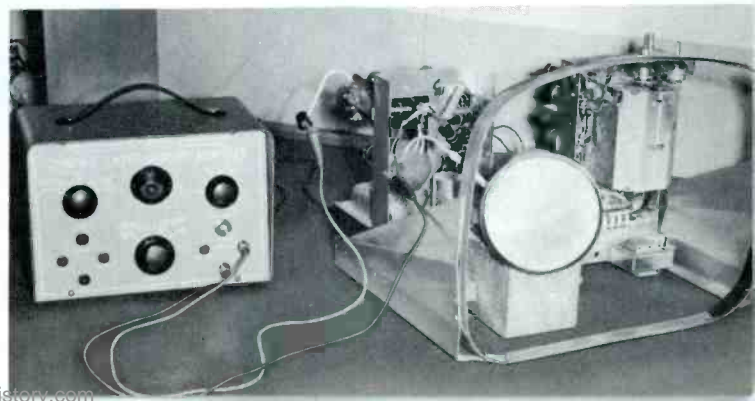
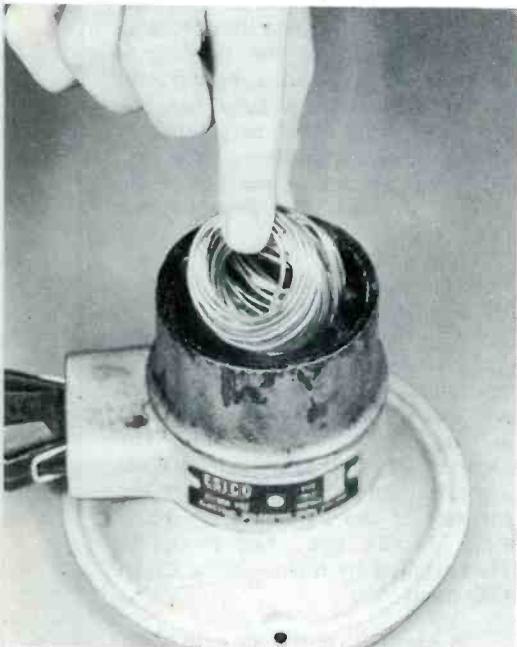

Fig. 3. Win-Tronix Model 820 Dynamic Sweep Circuit Analyzer in Use.



1. Equipment.

This is the equipment necessary for solder-pot servicing of printed boards. In the top row (from left to right) are several rags, a solder pot and AC cord, plastic spray, and solvent. In the bottom row (from left to right) are masking tape and 60/40 low-temperature solder. In addition to this equipment and material, the normal complement of pliers, cutters, screw drivers, and nut drivers are required.



2. Adding Solder to Pot.

The solder should be added to the pot in small quantities to avoid splashing until the pot is completely full. Wire solder of the rosin-core type was used to fill the solder pot because bar solder with the proper tin content of 60 per cent was unavailable from local parts distributors. About 2½ pounds was required to fill the pot to the top. Because of the danger of spilling the melted solder, the solder pot should be securely fastened to the bench in a place where it will not interfere with other service work.

3. Removing Excess Flux.

The amount of flux present in rosin-core solder is excessive for solder-pot use. This excess flux was removed from the pot by soaking it up with an absorbent rag.

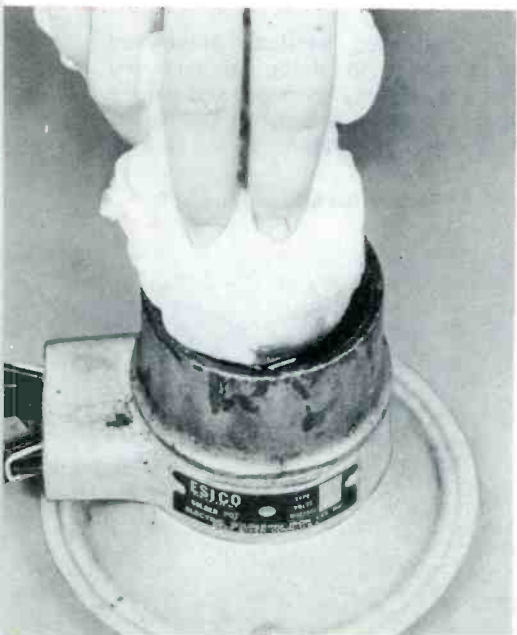

Connected to a printed board are a great many components which have from 3 to 7 or more terminals soldered to the foil. To remove one of these components, it is necessary to unsolder every terminal that secures the component to the board. These can all be unsoldered simultaneously by use of a solder pot. All of the terminals must be straight so that the component can be removed without damage to the board. Components that have their terminals bent over and soldered to the foil may usually be removed by use of a small low-bent soldering iron. One exception is a tube socket that has its center terminal soldered to the foil. In this case, the terminals should be freed and straightened; then the socket should be removed by using the solder pot.

It is very important to use the correct solder in the pot. Solder that is 60 per cent tin and 40 per cent lead has a melting temperature of approximately 370 degrees Fahrenheit and should be used for all servicing of printed boards.

The kind of solder pot is also important. It should be of the temperature-regulating type that will maintain the temperature of the solder at about 400 degrees Fahrenheit. If the pot is not of the temperature-regulating type, then it should be disconnected when the solder becomes melted. The solder will remain hot long enough to be used for several minutes after the power is turned off.

The solder may be stored in the solder pot when not in use. A heavy cover should also be made to cover the pot during its cooling-off period.

CAUTION: Always use extreme care when using a solder pot because melted solder can cause very serious and painful burns.

using a SOLDER POT

by
CALVIN C. YOUNG, JR.

4. Skimming the Pot.

The impurities that float to the top of the solder should be skimmed off before using the pot for soldering. A rolled-up coarse rag is very satisfactory for this purpose. Extreme care should be taken to guard against burning oneself with any solder that might be dragged out of the pot during this operation.



5. Removing or Replacing Component.

The portion of the printed board that has the defective component affixed to it should be lowered into the solder pot. All of the connections are heated simultaneously, and the defective component may be removed. This requires only a very few seconds, and the board should be removed from the solder at once. Replacement of components is accomplished in the reverse manner from that used when they are removed.

CAUTION: Hold the board with a heavy, folded rag to avoid getting your fingers burned.

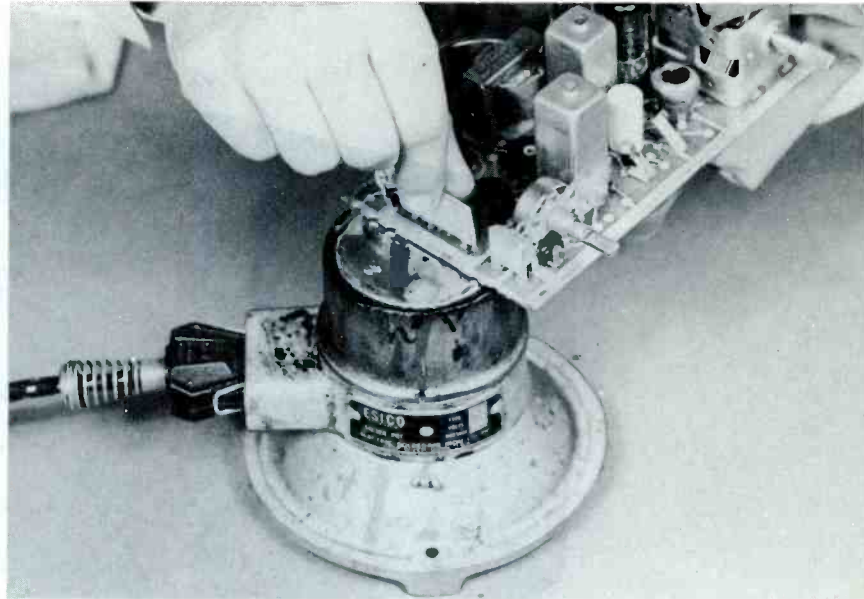
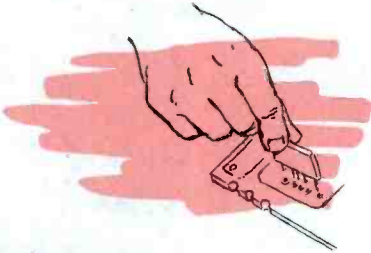

6. Inspection and Cleaning.

After the new component has been installed on the board, the foil area that has been in contact with the solder should be thoroughly inspected for shorts between the foil strips or for any other defects. After removing any shorts that might have been located, clean the area that has been subjected to the melted solder with a rag and with a suitable solvent. Denatured alcohol is usually satisfactory for this purpose.

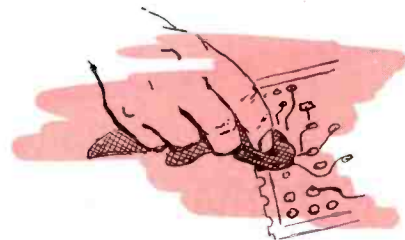

Photographs: Robert W. Reed

7. Protective Coating.

After the cleaning solvent has thoroughly dried or evaporated, coat the foil side of the printed board with a plastic spray or other material recommended by the manufacturer. Be sure that neither the edges of the board nor other surfaces that are required for electrical contact are covered with the coating. These surfaces should be covered with masking tape prior to the spraying operation.

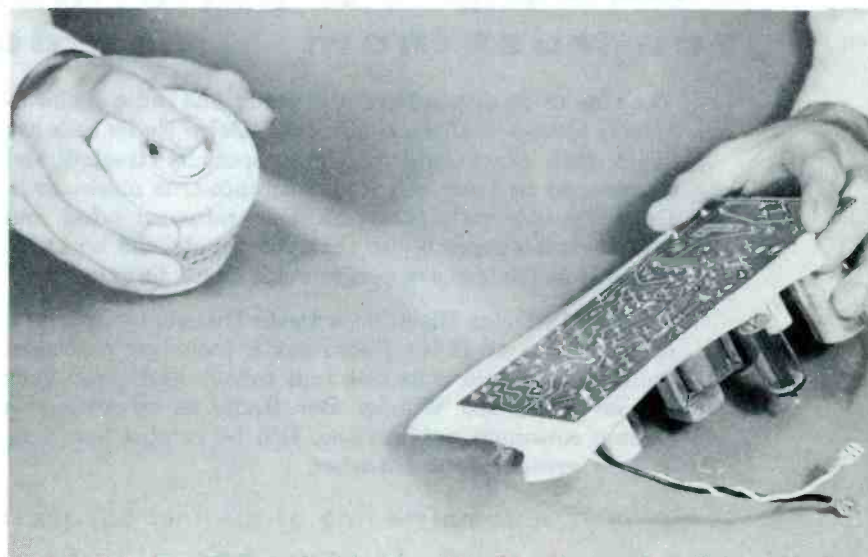
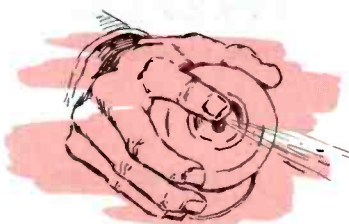



MOST ACCEPTABLE

**FROM DELCO RADIO . . .
 come the **coils**
 with highest performance.
 You trust them . . . so do your customers!**

The core of quality service and really fine radio performance is always in Delco Radio coils. Delco Radio coils are made with powdered-iron cores, specially treated and compressed to exact shape on tolerance-true machines in Delco Radio's own plant. Skilled craftsmen wind and test the entire assembly so that you can depend on Delco Radio coils for *uniform* performance characteristics.

Your UMS-Delco Electronics Parts Distributor carries a complete line of Delco Radio parts, including precision-built Delco Radio coils. See him today! And, keep your eye on the Delco Wonder Bar Radio as advertised in leading consumer publications. It'll be helping you tune in to a greater service market.

DELCO



RADIO

DIVISION OF GENERAL MOTORS, KOKOMO, INDIANA



A GENERAL MOTORS PRODUCT — A UNITED MOTORS LINE
 Distributed by Electronics Distributors Everywhere

A complete line of original equipment service parts from the
WORLD LEADER IN AUTO RADIO



SELECTING TEST EQUIPMENT FOR COLOR TV SERVICING

by Verne M. Ray

Although most technicians have not yet been called upon to service color television receivers, the chances are that they will be in the very near future. Without the proper test equipment, however, professional servicing of color receivers is next to impossible. The question is, should a service shop invest at once in test equipment for color servicing when this equipment might only be used occasionally in the coming months? Obviously, this is a question every shop owner will have to answer soon if he has not already done so.

Before deciding whether or not to buy the necessary equipment, the shop owner will have to consider how much use he can make of it. An important factor in this respect is the number of color receivers already operating in the area; another is the number of color programs which are being transmitted locally. This second factor will affect the sales volume of new color receivers.

There are a number of color receivers operating in some of the large cities, but there are also several shops which may be competing for the service business on these receivers. Shop owners have two good reasons for entering the field of color servicing. First of all, there is a certain amount of prestige to be gained from advertising the fact that you service color receivers. It not only helps to obtain service work on color receivers, but customers tend to have more confidence in your ability to service monochrome re-

ceivers. The customer feels that if you are an expert in the color-television field, you certainly should have no trouble in servicing a monochrome receiver so that optimum performance will be obtained.



The second reason for servicing color receivers as soon as possible is to gain experience. After becoming familiar with the theory of color television, a technician should use his knowledge in practice. The day will come when the servicing of color receivers will be a daily occurrence to many technicians, and the ones who gain experience now will have an advantage over those who do not.

Assuming that you have decided to invest in some test equipment for color-television servicing, we will discuss a few of the principal requirements of such equipment. Oscilloscopes, sweep and marker generators, high-voltage probes, white-dot generators, and color-bar generators, will be covered in that order.

Oscilloscope

Do you have a wide-band oscilloscope — one which has good frequency response up to at least 4 megacycles? You will need one if

you expect to make accurate observations of the waveforms of the color burst or of the chrominance portion of a composite video signal. This is not meant to imply that an oscilloscope having a frequency response which is fairly uniform up to one megacycle cannot be used to observe these waveforms. Many narrow-band oscilloscopes will pass a frequency of 3.58 megacycles, but signals having this frequency will not be amplified nearly so much as signals with frequencies below one megacycle. As a result, when the waveform of a composite video signal is observed on the screen of a narrow-band oscilloscope, the chrominance signal portion of the signal may not be seen. If only the chrominance signal were applied to the oscilloscope, however, the settings of the gain controls of the instrument may be increased to a point where the amplifier circuits would increase the signal amplitude sufficiently and cause a waveform to be produced on the screen.

Is your oscilloscope capable of developing a calibrating voltage which can be used as a standard for determining the peak-to-peak amplitude of a signal? If not, you should have a generator which will provide calibrating voltages or a meter which can be used to measure peak-to-peak voltages accurately. One or the other is necessary because the amplitudes of the signals at certain points in a color receiver are somewhat critical. The waveform of such a signal might appear to be normal, but the receiver may not operate properly if the amplitude of this signal is not correct.

Another limitation of a narrow-band oscilloscope is that the peak-to-peak amplitude of a signal having a frequency of 3.58 megacycles would be difficult to determine. The reason for this is that calibrating voltages usually have a frequency of only 60 cycles per second and would therefore receive much more amplification than signals having a frequency of 3.58 megacycles; however, if a color-bar generator which will provide a chrominance signal is available, this signal can be used as a calibrating voltage if its peak-to-peak amplitude is known. The conclusion of all this is that an oscilloscope having a narrow passband can be used in connection with the servicing of color receivers as long as the user of the instrument understands its limitations; however, in order to be entirely satisfactory for observation of the waveforms of video signals associated with color television, an oscilloscope should have a passband of at least 4 megacycles.

* * Please turn to page 61 * *

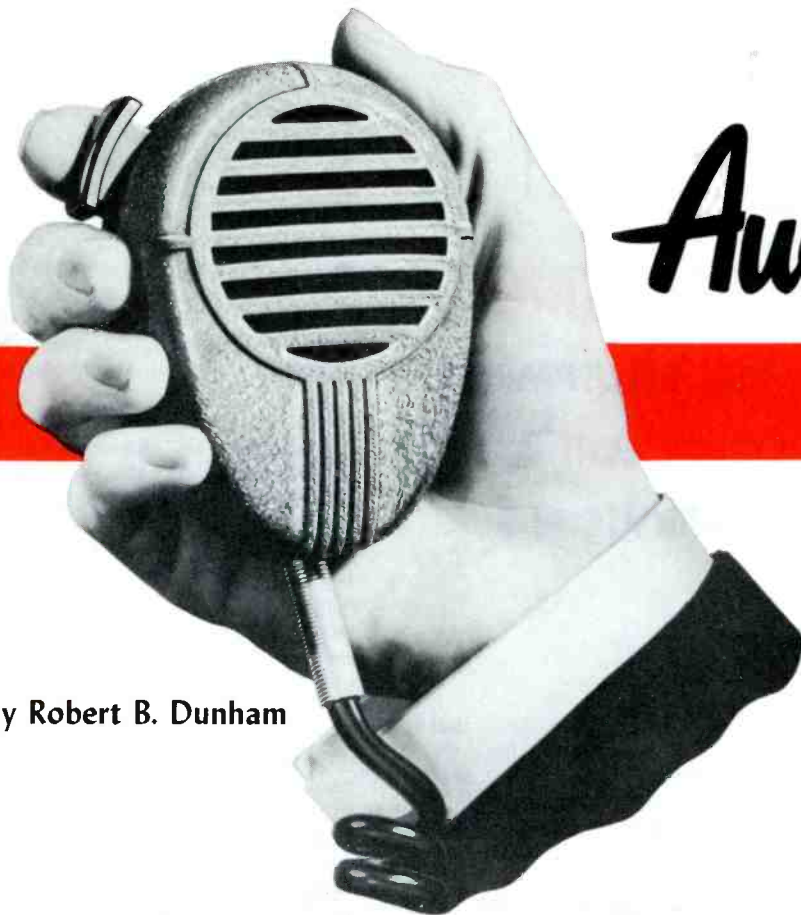

Audio-Facts

MICROPHONES

by Robert B. Dunham

The subject of microphones is one that we have considered writing about for some time but have always hesitated to start. There are so many types of microphones made for so many different applications and there are so many details about them that it is difficult to select an approach to the subject. For instance, because of the variety in types of microphones and the diversified uses made of them, the microphone with which one user is acquainted may not even resemble the one employed by another user whose microphone serves in an altogether different application.

More audio enthusiasts than ever are now interested in microphones, particularly in the higher quality units, because of the increased use of tape recorders. Sooner or later, when the enthusiast becomes more involved in recording, he wants to learn more about them and how they can be used to best advantage. Although many persons who never had anything to do with microphones before are now interested because they have tape recorders, they certainly are in the minority when compared with the number who use microphones for other purposes.

We have mentioned the fact in these columns that loudspeakers are difficult to design, test, and write

about because each is an acoustical as well as an electrical device. A microphone is also an acoustical and electrical device. Instead of changing the electrical signal into an acoustical signal as a loudspeaker does, a microphone picks up the acoustical signal and changes it into an electrical signal; consequently, since we are concerned to a great extent with acoustics or with the behavior of sound waves, the conditions under which a microphone will be used are very important. Such things as whether the microphone will be used to pick up sound from a distant source or will be used as a "close-talking mike" which the user may actually hold in contact with his lips as he speaks must be considered. Will the microphone be used to pick up sound from all directions or to pick it up only from a pin-pointed area? These considerations are important because the microphone must be designed for the specific conditions of use if satisfactory results are to be obtained.

Uses

Microphones are often placed in categories according to their intended use. The following are examples.

PA Microphones

PA microphones are generally used by speakers, announcers, bar-

kers, and demonstrators. These microphones can be classified further according to physical characteristics such as stand, hand-held, or lapel types. Distinct, clear, and intelligible reproduction of the human voice is the main objective.

Home-Recording Microphones

Home-recording microphones are usually rugged and inexpensive units that give adequate results for the user who is recording for fun.

Communication and Amateur (Ham) Microphones

Microphones for communication and for use by amateurs are often similar to the units in the PA category, but they include several types designed especially for use with portable and mobile equipment.

Professional Recording and Broadcasting Microphones

Professional microphones for recording and broadcasting include several specialized types that feature uniform wide-range response suitable for high quality pickup of music and for other critical uses.

Construction

Microphones can also be classed according to their construction or operating principles. Carbon, crystal, dynamic, condenser, and ribbon types are the chief classifications. Microphones in some of these classifications can be designed for different uses. Others find their greatest use in one particular, specialized application because they possess certain characteristics that make them suitable for the one purpose.

We could continue with classifications because microphones are also classed as being of high or low

impedance, directional or omnidirectional, pressure or velocity, and so on. It would be better, however, if we were to discuss some certain types.

Carbon Microphones

The carbon microphone can be termed the "original" microphone because it has been used for such a long time. It has been used in most telephones including the very early instruments and the modern models now in general use. The carbon microphone was almost universally used by all broadcasters during the early years of radio broadcasting.

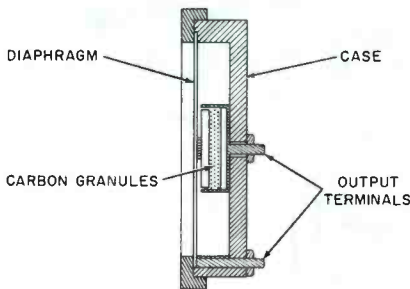

Fig. 1. Basic Construction of Single-Button Carbon Microphone.

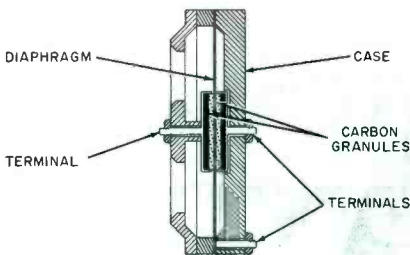
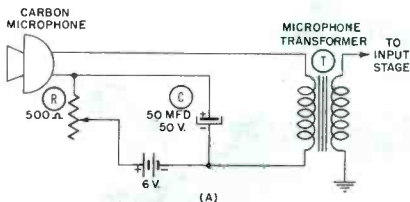
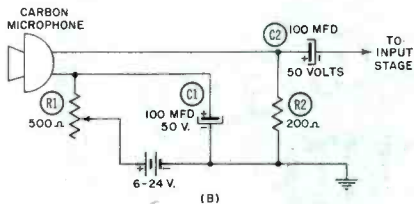

Fig. 2. Basic Construction of Double-Button Carbon Microphone.



(A) Transformer Coupled.



(B) Resistance Coupled.

Fig. 3. Typical Input Circuits Used with Single-Button Carbon Microphones.

In fact, the popular double-button microphone was seen so often either spring mounted in an open ring or mounted in its round case (with its

pattern of screened round openings) that it became the symbol of radio broadcasting in those early years.

For radio broadcasting, carbon microphones have been replaced by more suitable types; but they are still widely used in communication services. Their characteristic ruggedness and suitability for voice pickup are qualities that adapt them for use with mobile and portable equipment.

The basic construction of a single-button carbon microphone is shown in Fig. 1. The cross section in Fig. 2 of a double-button microphone illustrates how it can operate with a push-pull action. Structural details vary in different makes and models of carbon microphones, but the basic operation is the same in all units.

The typical input circuits (Figs. 3A and B) used with carbon microphones include a source of DC and an adjustable resistor by which the current flowing through the microphone can be controlled. Transformer coupling (Fig. 3A) or resistance coupling (Fig. 3B) can be employed. Each method of coupling has advantages and disadvantages.

The carbon microphone is pressure operated. The diaphragm which is moved by the varying pressure of the sound waves causes the pressure exerted on the carbon granules to change at the rate of the varying or modulating sound pressure. This change in pressure on the granules produces a change in resistance and consequently a change in the amount of current flowing through the microphone. The resultant pulsating direct current represents the audio signal because it is varying at the rate of the variations in the original sound waves.

The carbon microphone is rugged, develops a high output at voice frequencies, and is not easily affected by high temperatures or high humidity. It can take vibration and jarring without damage; in fact, a few bumps once in a while keep the carbon granules loosened and prevent them from packing or clinging together.

The flow of current through many small carbon granules that are making more or less intermittent contact with each other is responsible for the characteristic hiss and noise developed in carbon microphones. This comparatively high noise level, along with limited frequency range and high levels of distortion, limits the use of carbon microphones to the communication applications previously mentioned.

Some representative examples of current models of carbon microphones are shown in Fig. 4. These



(A) Electro-Voice Model 205.



(B) Astatic Model 10M5.



(C) Turner Model SR90-R.

Fig. 4. Carbon Microphones.

hand-held models include some that are special in that they are suitable for use in locations where noise levels are high.

Crystal Microphones

There are several types of crystal microphones. These vary in the number of crystals employed and in the methods used to obtain the desired results from the crystals.

* * Please turn to page 68 * *



Insist on the

**PERFECT
REPLACEMENT**

for "original quality" results

When it's necessary to replace the original, people naturally want something as much like the original product as possible. With picture tubes, the replacement for the original can be better! (in other words—the *perfect replacement*.) A Twin-Screen Hi-Lite[®] picture tube by Du Mont offers brightness and contrast superior to the original tube. Don't get bitten by buying inferior products. Insist on a Du Mont Twin-Screen Hi-Lite, the ultimate in aluminized picture tubes.

[®] Aluminized picture tube

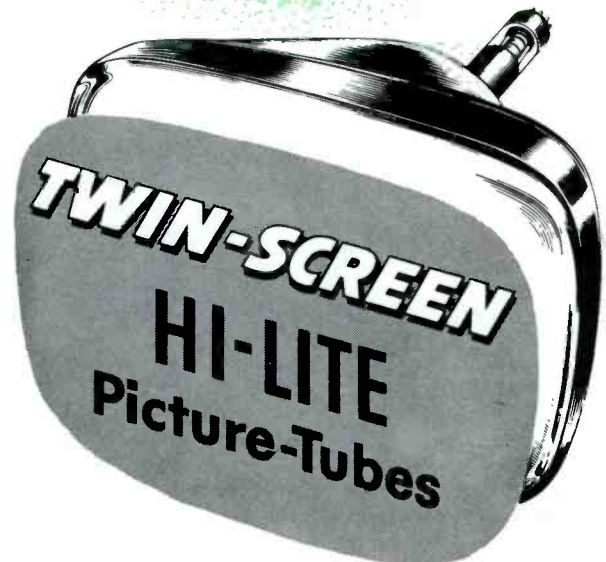

DU MONT[®]

CATHODE-RAY TUBE DIVISION, ALLEN B. DU MONT LABORATORIES, INC., CLIFTON, N. J.

Examining DESIGN Features

by Leslie D. Deane

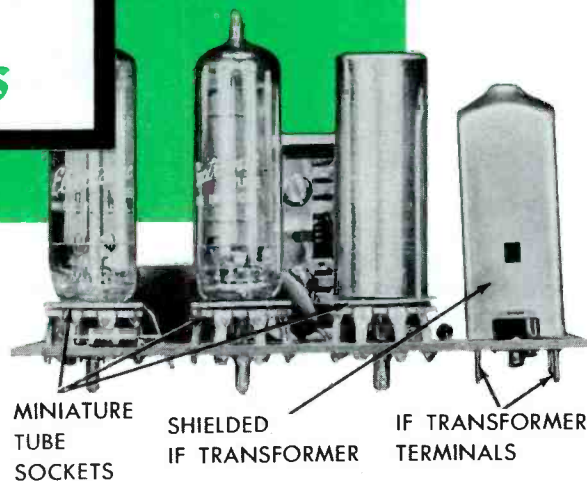

Fig. 1. Side View of the Printed-Wiring Board Employed in the General Electric Model 900 Clock Radio.

New Fashions in Component Design

The growing trend toward assembling parts automatically — now a very important production factor in the electronics industry — has brought about radical changes in the appearance of radio and television chassis and their associated parts. The acceptance of the printed-wiring board by leading radio and television manufacturers has offered a new challenge to design engineers. They are striving to produce small lightweight components which are suitable for these printed boards and for use in machines that do the assembling automatically. The purpose of this article is to acquaint the reader with a few of the many new components being developed especially for use on printed-wiring boards. Before examining the individual components, let us discuss some of the reasons for this new design trend.

The automatic methods of assembling are now commonly referred to as "automation." In the radio and television industry, it has been stimulated a great deal by the development of printed wiring.

The printed-wiring board, or subassembly, begins with pieces of laminated plastic board having a thin sheet of copper foil bonded to one side. A protective coating is then placed over the plated surface in the desired wiring pattern. The excess foil, which is not a part of the wiring pattern, is removed by an etching process. A number of holes and slots

are punched in the board for the various component leads and mounting lugs. The components are then placed in position with leads and mounting lugs inserted in their respective holes.

The wiring side of the board is then ready for the dip-soldering process and is dipped into melted solder which simultaneously makes all electrical connections and physically secures the components in their proper positions. In order to prevent dust or moisture from causing a short circuit, a coat of lacquer is applied to the printed-wiring side of the board. Improved quality, higher production rates, more uniform and compact products, and the elimination of many wiring and soldering operations are some of the advantages offered by this new method of assembling.

Earlier efforts to mechanize radio and television manufacturing reduced the cost of production considerably, but the assembling processes still required a number of manual operations together with various jigs and conveyor systems. The present-day automation program in the electronics industry was made possible, to a large degree, by parts manufacturers who recognized the need for a new line of circuit components. These components are limited in design by two major factors. The first is that the component must be adaptable to a printed-wiring board, and second is that the component must lend itself to automation.

The ideal design for components which are to be used on printed boards is that all connections should be terminated in one plane of small area. This will normally cut down the distance between contact points and reduce the over-all area required for the printed wiring. The electrical contacts of some of the lightweight components also serve as mounting supports; and in these cases, no additional lugs or tabs are necessary in their construction.

In order for a component to lend itself to automation, it must be physically designed for use in a hopper type feeding machine, but alterations to the physical form of a component must not adversely affect its electrical characteristics. Some automatic hopper-fed machines are now in use, and many more are being developed to aid in the assembling of printed-wiring boards. These automatic-insertion machines are capable of taking a component and cutting, bending, and inserting the leads into proper position on any conventional printed-wiring board. In addition to these features, some machines can inspect their own operations and reject any faulty or imperfect mounting. The machines are usually constructed so that they can be changed to handle different types of components.

With the factors governing the design of components for printed-wiring assemblies in mind, let us examine a few of the individual parts more closely. Among those components originally intended for use in chassis with conventional wiring, there are a number which can easily be installed on the printed boards. Many of these components have pig-tail leads or rigid tabs protruding from one surface in such a way that the leads or tabs may be inserted into holes or slots provided on the board. Such items as subminiature tubes, transistors, molded printed circuits, unshielded coils, ceramic-disc and tubular trimmer capacitors, crystal diodes, and the newly developed module units are suitable in their original form for printed-wiring applications.

Some manufacturers of conventional carbon type resistors and tubular capacitors are supplying their units with the leads formed and cut for automatic insertion in printed-wiring assemblies. The component leads are also crimped or flattened so that the part will be held in place on the printed-wiring board. The handling of the boards during assembly often presents a problem. If the individual components are not held in place by some means, they may be jarred out of position or fall from

the board before the dip-soldering operation is completed. Many components designed for use on printed-wiring boards now feature devices using some type of spring tension to secure the components to the board.

Some of the more familiar components which have been modified for use on printed-wiring assemblies are: tube sockets, capacitors, resistors, IF transformers, selenium rectifiers, and controls. In many cases, only the physical shape of the component or its electrical contacts required redesigning. Let us examine a few typical components which are now used in the production of radio and television receivers employing printed circuits.

Tube Sockets

One of the first newly designed components for utilization in printed-wiring assemblies was the miniature tube socket. Various styles of sockets which contributed to the success of the mass production of printed circuits were developed. The modern type of chassis shown in Fig. 1 is part of a typical AM clock radio manufactured by the General Electric Company of New York.

All components of this receiver are located on top of a square printed-wiring board. The three tube sockets indicated in the photograph are specifically designed for board mounting. Two thin pieces of Bakelite form the body of each socket, and the pin contacts fit through small holes in the circuit board. The two wafer sections are riveted together at the center and hold the contacts in position. The sockets are held away from the board by a relatively large center post which is sometimes designed with a projecting key similar to that used on an octal tube base

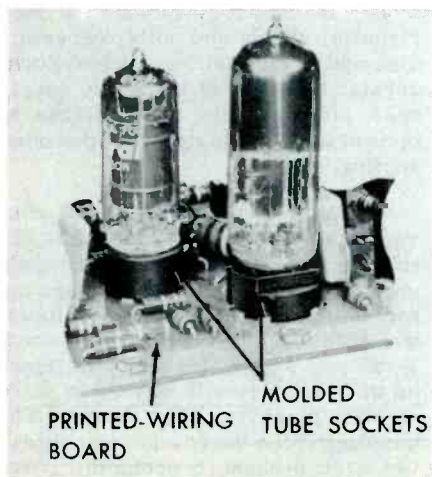
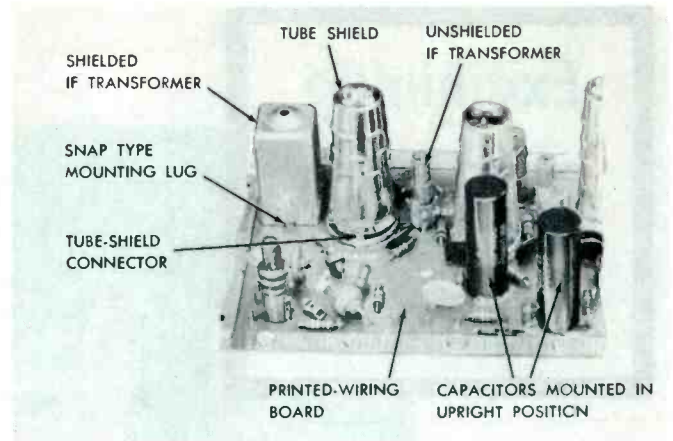

Fig. 2. Tube Sockets Utilized in the Admiral Chassis 20SY4B.

Fig. 3. A portion of the Printed-Wiring Board Used in the Video IF Section of the Admiral Chassis 20SY4B.



for proper orientation during assembly. In some receivers, this center post is soldered to the ground circuit of the chassis wiring. The printed wiring is arranged, with respect to the tube-socket connections, for the shortest possible conductor paths.

Another tube socket designed for printed boards is shown in the photograph of Fig. 2. This type is currently employed in many of the latest Admiral television chassis. These sockets are constructed of a molded plastic material which eliminates possible moisture traps and provides excellent insulation. The pin contacts extend through separate holes in the board and are bent and soldered to the printed wiring. Some of these molded type sockets provide notches to support metal tube shields. Other designs have a separate metal rim which encircles the tube socket and which is fastened to the board by two tabs. The rim has three or four metal strips extending upward to make contact with the shield. This type of arrangement is indicated on the printed-wiring board of Fig. 3.

Another type of molded socket now available to radio and television manufacturers is designed with a slot in one side to accommodate an additional strip of metal. When the strip is inserted in this slot, it serves as an orientation pin at the bottom of the socket and as a ground strap for a metal tube shield on the top.

The subassembly pictured in Fig. 4 utilizes still another style of tube socket. In this example, the pin contacts protrude upward. The socket fits into a large cutout in the laminated board, and the pin contacts are bent to make connection with the printed wiring. This particular arrangement permits the tubes to be mounted from the soldered side of the board. The majority of miniature tube sockets are designed for automatic production methods, and they

will stack for hopper type feeding machines.

Capacitors

Many of the capacitors now used in the construction of radio and television receivers have also taken on a new look. Such items as tuning capacitors, molded paper tubular capacitors, and electrolytic units have been altered so that they will be more adaptable to printed-wiring assemblies. The tuning capacitors employed in printed circuits for radios have been redesigned to some extent. Provisions have been made for the stator contacts and the mounting lugs to extend from the bottom of the unit so that the contacts and lugs can penetrate the printed-wiring board and so that they can be held in place by solder. Other tuning capacitors are obtainable in various mounting styles to suit a variety of applications on printed boards.

The conventional type of paper tubular capacitor is now being used to a great extent on printed-wiring boards, but these components have recently been redesigned to facilitate their use in such circuits. In the

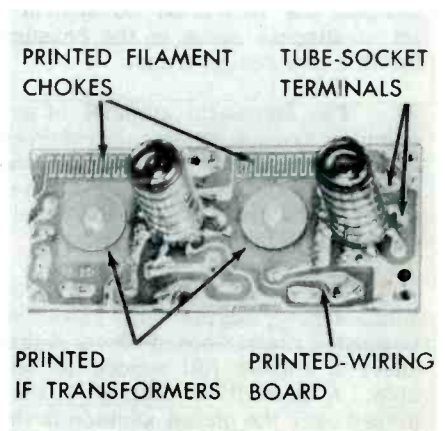

Fig. 4. A Close-up View of the Printed IF Circuitry Employed in the RCA Chassis KCS94.

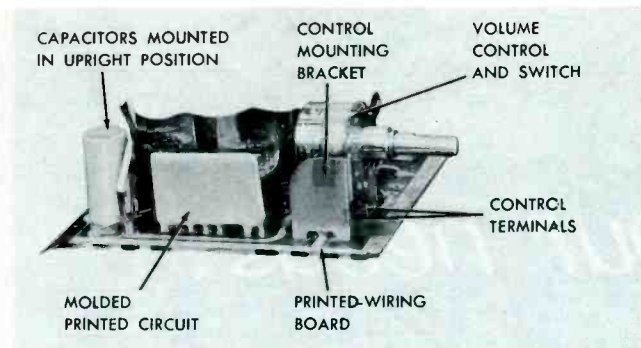

Fig. 5. Volume Control Employed in the Motorola Model 56R1 Radio.

past, the unit was usually laid flat against the board and the leads extending from each end were bent down to make contact with the wiring pattern. The component in this arrangement, however, consumes a rather large amount of space on the component side of the board and causes the contacts on the wiring side of the board to be spaced too far apart.

In order to conserve space and to promote automation, some of the capacitor manufacturers have come up with a new idea for the mounting of these paper tubular units. The photograph of Fig. 3 shows the new type of capacitor and illustrates the upright mounting feature. The close-up view pictured in Fig. 3 is a portion of the Admiral Chassis 20SY4B. This vertically mounted chassis has about 75 per cent of its total wiring located on three separate printed-wiring boards. The new capacitors are employed throughout the IF, sound, and sync circuits. The capacitors are encased in molded shells with two wire leads extending from one end. The terminals are spaced a fixed distance apart so that they may be inserted directly into holes in the board and easily secured by the dip-soldering method.

Another variety of this type of capacitor is shown mounted on a printed-wiring board in Fig. 5. The examples shown in Figs. 3 and 5 have their ends sealed with a material which will not soften or melt at soldering temperatures. The sealer not only prevents moisture seepage but also rigidly fixes the terminals in place.

Tubular electrolytic capacitors now employed on printed-wiring boards have also taken on a similar style of design. All terminals and mounting lugs have been positioned at one end so they may be inserted into the printed board. Upright mounting of the component results. These units are extensively used in modern five-tube radio receivers.

Resistors

Carbon resistors up to a rating of two watts do not need to be rede-

signed for use in printed-wiring chassis because of their small size. In the design of small pocket-sized portable radios, these units are often mounted on end because of the extremely limited space allotted the printed wiring. This may be an indication that there is a need for a new resistor design for applications in extremely compact equipment.

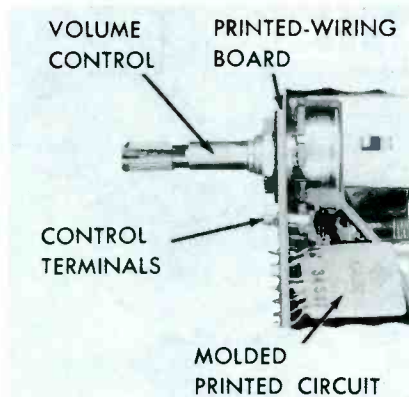

Fig. 6. Volume Control and Molded Printed Circuit Employed in the General Electric Model 905 Radio.

New designs for the larger wire-wound types of resistor have, however, appeared in recent months. These units are built with the printed-wiring board and automatic-insertion techniques in mind. Both leads extend from the same end of the resistor so that upright mounting on the board will be possible. These wire-wound resistors are also designed with some sort of a spring-clip arrangement which locks the unit into position on the board before the soldering process. Power resistors especially designed for use on printed boards are being constructed so that maximum heat will be dissipated above the wiring connections. The plated wiring and board are thus protected from excessive temperatures. A new card type resistor has been developed to reduce the space normally required for wire-wound resistors; however, these units have not as yet appeared in radio or television receivers which are known to the writer.

Molded printed circuits often house a number of resistive and capacitive elements. The molded printed circuits shown in Figs. 5 and 6 are ideal space savers for use on printed-wiring boards. The one in Fig. 5 has seven rigid terminals which provide the necessary circuit contacts and support the unit physically. The network contains eight components — three RF bypass capacitors, two audio coupling capacitors, and three resistors.

Transformers and Coils

The familiar shielded transformers employed in radio and television IF circuits have also been redesigned for mounting on printed boards. The terminals and the mounting lugs are formed to penetrate the printed board and to make contact with the wiring. Examples of these units may be seen in Figs. 1, 3, and 7. The shielded IF transformers shown in Fig. 7 have a snap-in feature incorporated in the mounting lugs to hold the units in place pending the dip-soldering operation. In the photograph of Fig. 3, there is also an unshielded type of IF transformer. This unit conserves a great deal of mounting area. The unprotected windings, however, present somewhat of a problem when the units are used in automatic feeding machines.

The photograph of Fig. 4 represents a portion of the printed-wiring board utilized in the video IF section of the RCA Chassis KCS94. The IF transformers and filament chokes identified in this illustration are actually a part of the printed-circuit pattern. The IF transformers consume little space compared to the

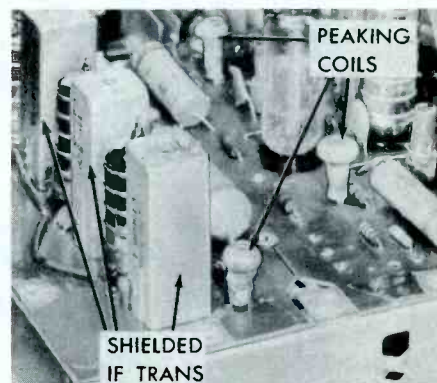

Fig. 7. Components Mounted on Printing-Wiring Board in the Westinghouse Chassis V-2342.

upright shielded units. They are constructed of flat copper inductors etched on the plated board in a rectangular pattern. A flat metal disc is mounted parallel with the windings.

* * Please turn to page 42 * *

geared

to your needs!

RTV
matched
components
by
CLAROSTAT

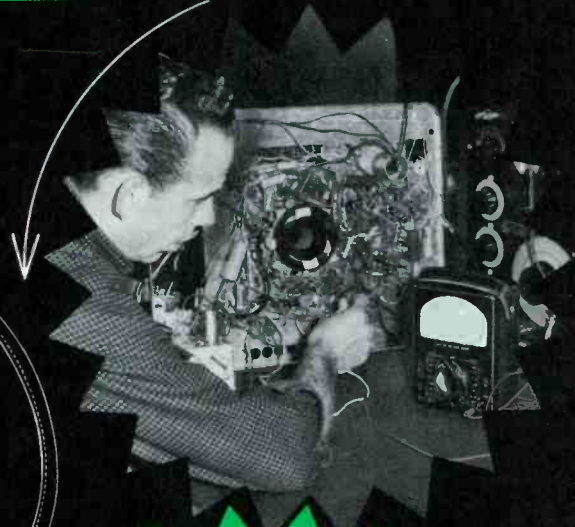

CLAROSTAT RTV replacement controls for radio and television are matched to the original components, both electrically and mechanically.

No fuss; no bother; just pull out the old control, install the CLAROSTAT RTV control called for, and the job is completed.

Ask your distributor for complete details on CLAROSTAT products geared to your needs.

CLAROSTAT MFG. CO., INC., DOVER, NEW HAMPSHIRE

In Canada: Canadian Marconi Co., Ltd., Toronto, Ont.

In the Interest of . . .

Quicker Servicing

by Calvin C. Young, Jr.

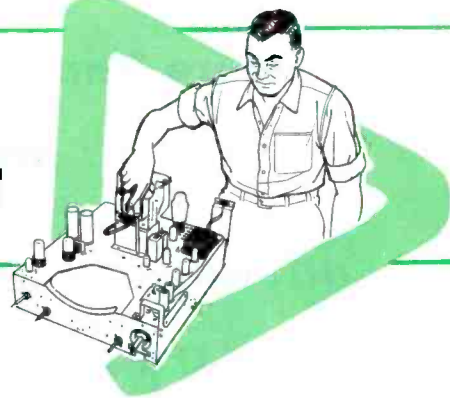

A Long and Painful Tale

The following account of a servicing experience is presented in order that the reader might have a chance to compare his own method of attacking a problem with that used by the star of our story. The experience is told step by step from symptom to cure, and the concluding summary gives some pointers which our technician could have found very helpful.

Not too long ago, a case of horizontal twitching or tearing in the picture on a TV set was encountered. This effect occurred intermittently. A symptom of the trouble is shown in Fig. 1. The trouble actually was more pronounced than is shown; but because of camera limitations, we were unable to obtain a picture showing the trouble in its most severe form.

The technician in his first analysis concluded that the trouble was caused by intermittent arcing in either the horizontal output, damper, or high-voltage stage. With this in mind, he substituted tubes in these stages. This failed to eliminate the trouble. Since some of the characteristics of a "piecrust" effect were noted in the picture, the horizontal oscillator tube was substituted. This also failed to remedy the trouble.

Since tube substitution had failed to produce any results, the technician next turned out the lights and darkened the area around the horizontal output stage as much as possible. A close visual inspection of the high-voltage section failed to reveal any evidence of corona discharge or arcing anywhere within the area. Neither could any arcing be heard. Even though arcing did not seem to be the trouble, the technician decided to spray the high-voltage transformer and wiring with an acrylic spray just to make sure that the trouble was not from a minor case of arcing that could neither be seen nor heard. When the

plastic spray had dried thoroughly, the receiver was turned on but the trouble was still there.

During the process of substituting tubes and checking for corona discharges, it was noticed that there was a considerable amount of flashing in the picture whenever the chassis was disturbed. Investigation of this effect was the next step. Tapping on the chassis with a plastic hammer showed that the flashing was the most severe when the chassis was tapped in the video IF or tuner area. A pencil with a large eraser was used to tap the tuner and IF tubes. The flashing appeared when any of these tubes were tapped; consequently, the technician simultaneously substituted new tubes for all the tuner and IF tubes. With the new tubes installed in the chassis, the tearing effect was still present. Tapping on the chassis, however, no longer seemed to affect the picture. The original tuner and IF tubes were then numbered with a grease pencil and put away. The technician felt that one or two of these tubes might be microphonic, and therefore he wished to investigate this condition later on. By marking the tubes, he made it possible to return them later to their original circuit

locations if tests should prove that these tubes were good.

After careful consideration, the technician reasoned that perhaps the sync signal was being distorted by a leaky coupling capacitor in a sync or video stage. He used a tester with which he could check for leakage with the capacitor connected in the circuit, and one leaky capacitor was detected. The replacement of this defective unit failed to cure the trouble. Since the tester was warmed up, the technician decided to test the boost B+ filter capacitors, the capacitor in series with the yoke, and other capacitors in the horizontal-sweep and high-voltage stages. No leaky units were located in these stages.

Tube substitution and a check of suspected capacitors had failed to give even a hint as to the possible source of the picture tearing; therefore, the technician decided to check the waveforms at critical points in the circuit. The twitching or tearing in the picture occurred in the horizontal direction, and therefore he checked the waveforms in the horizontal-sweep section first.

* * Please turn to page 36 * *

Fig. 1. Horizontal Tearing in a Picture.

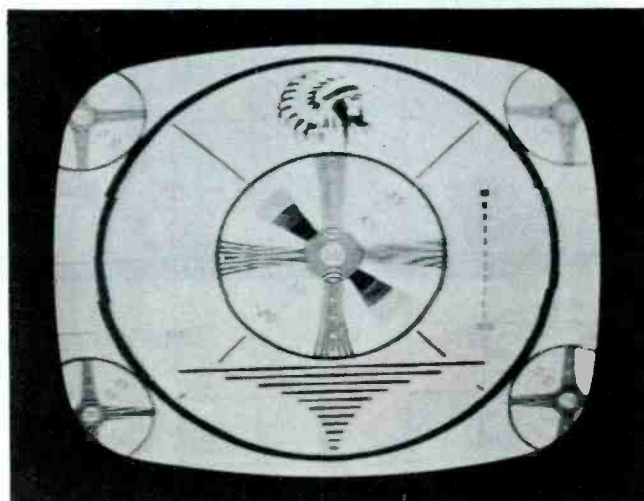

**More and More he's
pre-selling
advanced-engineered
CBS SILVER VISION
aluminized picture tubes
for you!**

Garry
Moore
famous CBS
Television Star



Garry Moore is selling Silver Vision tubes to your women customers regularly over the CBS Television Network. And, starting in March, he begins to pre-sell them also in a new series of full-page ads in Good Housekeeping Magazine.

He is not telling the ladies about the advanced-engineering of Silver Vision's aluminized screen . . . silver activated phosphors . . . and small-spot gun. *You* appreciate these things, but women don't. Garry is stressing Silver Vision's clearer, sharper, brighter pictures. And he is repeating these facts: "There are no better tubes made than CBS tubes . . . and CBS tubes have the Good Housekeeping Guaranty Seal."

Take advantage of the customer confidence CBS-Hytron is constantly building for you. You'll find the sale is ready-made when you recommend an advanced-engineered Silver Vision picture tube.

Garry Moore is selling you and your expert service.



CBS-HYTRON, Danvers, Massachusetts
A DIVISION OF COLUMBIA BROADCASTING SYSTEM, INC.

SIGNAL TRACING in SYNC SEPARATORS

by Thomas A. Lesh

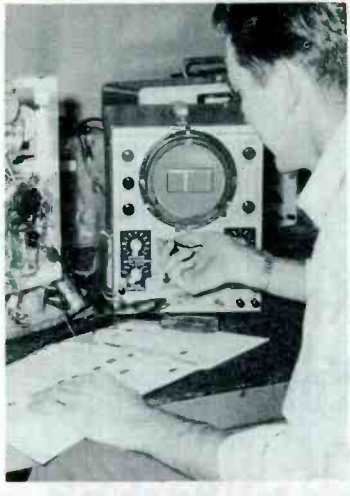

**WAVE FORM CHECKS
CAN SPEED
SERVICING**

Loss of synchronization, either vertical or horizontal or both, in a TV receiver is often caused by faulty operation of the sync separator and its associated circuits. If tube substitution does not clear up the difficulty, the use of an oscilloscope to check the signals that are present at various test points is the most convenient means by which the source of trouble can be localized. This article will discuss the waveforms which are characteristic of sync separators.

Dual-Triode Circuit

One basic circuit which is widely used as a sync separator in

present-day receivers is composed of two triode stages. A circuit of this type is used in the Olympic Model 21TC54 receiver. The sync-separator circuit in this receiver is shown in the schematic diagram of Fig. 1. A brief summary of its operation will be given first, and then a more detailed description will accompany the discussion of some waveforms from this circuit.

A composite signal containing a video signal and positive-going sync pulses is taken from the plate circuit of the video amplifier and is applied to the grid of the first triode V10A. This tube acts as a clipper and removes the video portion of the signal. The clipping action occurs because V10A is cut off by all portions of the input signal which are more negative than the blanking level. In other words, the sync pulses are the only portion of the signal which are amplified and which appear in the output.

The second triode V10B inverts and amplifies these pulses, and it tends to eliminate any irregularities which may have passed through the

sync clipper. In some receivers, the second triode is also a phase inverter which furnishes positive sync pulses from the plate circuit and negative pulses from the cathode circuit.

Before these pulses can be supplied to the vertical and horizontal oscillators, they must be separated according to their frequencies. This task is accomplished by two RC networks which directly follow the sync separator. One is an integrator circuit which responds to the vertical pulses, and the other is a differentiator circuit which responds to the horizontal pulses.

The following discussion will describe the normal and abnormal waveforms W1 through W7 observed at various points in the circuit which was selected as being typical. (See Fig. 1.) Intentional defects were introduced into the circuit, and the abnormal waveforms which were produced will be discussed. This discussion is a review of a variety of troubles that might be encountered in this type of circuit but not in all sync-separator circuits. It is intended to give the reader a general idea of the symptoms that can be produced by certain faults.

All the waveforms in this article were taken with a high-impedance probe attached to the oscilloscope. In waveforms W1, W3, W5, and W7, the oscilloscope sweep was synchronized to 30 cps; in waveforms W2, W4, and W6, the sweep was synchronized to 7,875 cps.

Grid Waveforms of Sync Separator

Fig. 2A shows W1 which was taken at the grid of V10A and at a sweep rate of 30 cps. The video portion of the signal appears as an irregular white mass which makes up the most negative portion of the waveform. The blanking level is marked by a thin white horizontal line that is traced by the pedestals of the sync pulses. This line is separated

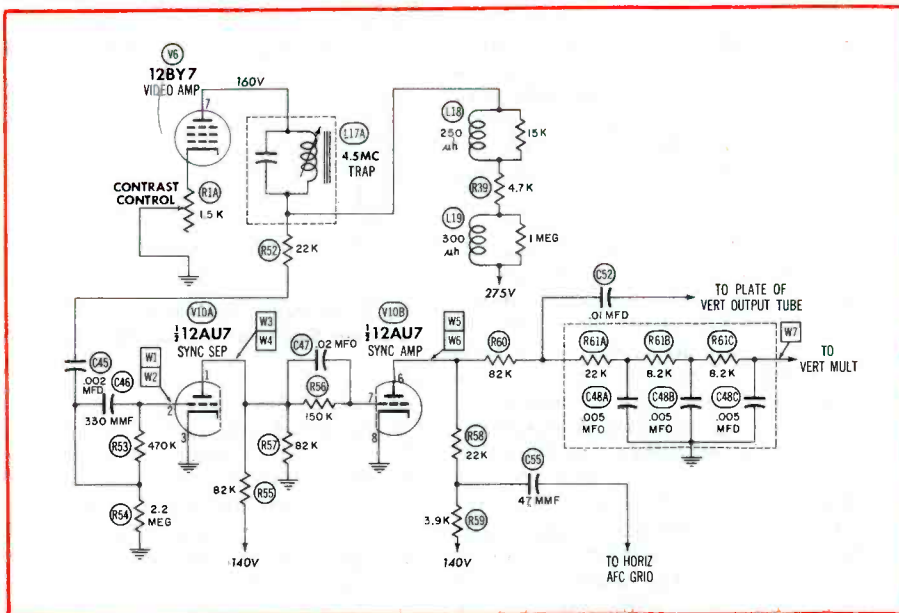
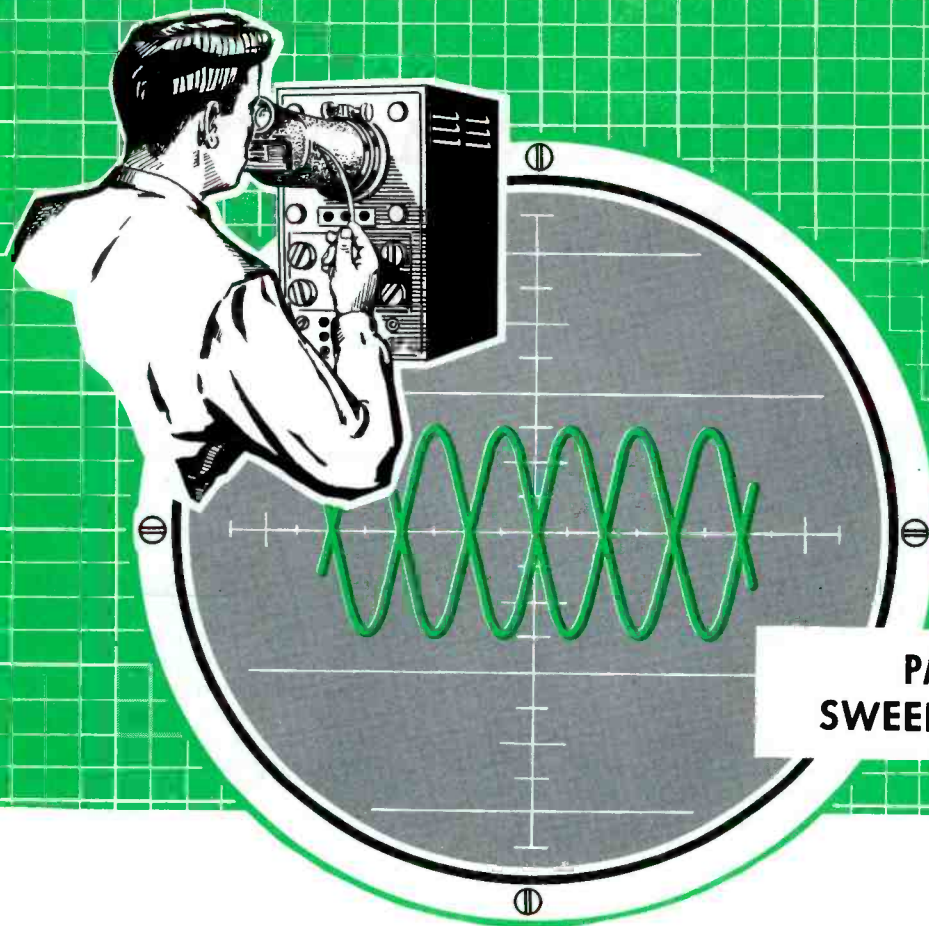

Fig. 1. Schematic Diagram of Sync Circuit in Olympic Model 21TC54 Receiver.

* * Please turn to page 51 * *



Know Your Oscilloscope

PART III SWEEP SYSTEMS

BY PAUL C. SMITH

In Part I of this series, it was mentioned that the oscilloscope will actually plot a graph of voltage with respect to time. The operator of an oscilloscope can see on its screen an indication of the way a voltage changes in amplitude from one moment to the next. The signal to be observed is normally applied to the vertical deflection system and will cause a vertical trace to appear on the screen, provided that the signal is of sufficient amplitude and that there is no AC voltage applied to the horizontal deflection plates.

Under these conditions, a change of amplitude of the signal will result in a change of the height of the vertical trace. In order that these changes in amplitude may be viewed with respect to changes in time, some type of sweep system is incorporated in the oscilloscope. The signal from the sweep system is used to drive the horizontal deflection plates of the cathode-ray tube. This provides a horizontal trace as a time reference for the signal at the vertical deflection plates. Because of this, sweep systems are sometimes called time bases. In addition to the sweep signals provided internally in the general-purpose oscilloscope, other sweep signals can usually be applied from an external source.

Oscilloscope sweeps may be classed as linear or nonlinear and as single or repetitive. Single sweeps are seldom found except in laboratory oscilloscopes. Their greatest usefulness is for viewing signals of a non-recurring nature. They are designed to sweep the beam once across the screen of the oscilloscope and must be timed very accurately so that the signal to be viewed will occur at the exact instant of the sweep. A sweep of such short duration would result in a trace which would fade very quickly on a screen of normal persistence; consequently, a screen of long persistence is used to increase the viewing time.

The majority of the signals which the service technician will encounter are of a recurring or repeating nature. They normally go through a complete cycle of variations a number of times a second. Some examples of this type of signal are: (1) the voltage supplied by the power line, (2) the AC voltages at tube filaments in a receiver; and (3) the voltages generated by the sweep circuits in a television receiver. The ideal sweep for viewing these signals is one in which the beam starts at the left-hand edge of the oscilloscope screen and moves at a uniform rate of speed in a horizontal direction to

the right-hand edge of the screen. Upon reaching the right-hand edge, it should reverse direction and return to the starting position at the left of the screen. This return sweep (called retrace) should be made in the least time possible.

Linear Sawtooth Sweep

The waveform of the voltage necessary to produce such a sweep as we have just mentioned is shown

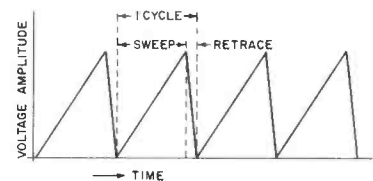

Fig. 1. Voltage Waveform Used to Produce a Linear Sweep on an Oscilloscope Screen.

in Fig. 1. Several cycles of the sawtooth waveform are shown in this figure. The voltage applied to the horizontal deflection plates is plotted in a vertical direction, and time is plotted in a horizontal direction. The sweep produced by such a waveform is called a linear sweep because the useful portion of it moves at a constant rate of speed and can be represented by a straight line on a graph.

In many oscilloscopes, the retrace is blanked out and does not appear on the screen.

There are three common circuits for producing the sawtooth voltage indicated in Fig. 1. One of these, the blocking oscillator, is used more in TV receivers than in oscilloscopes and will not be discussed here. The other two circuits require the use of a multivibrator and a thyatron oscillator, respectively. Let us first consider the circuit using the thyatron oscillator.

Thyatron As a Sweep Generator

The waveform of Fig. 1 can be approximated very closely by the voltage across a capacitor which is charged and discharged in a certain manner. Fig. 2 shows a simple arrangement for doing this. When the switch is in position A, capacitor C will be shorted and no voltage will appear across its terminals. When

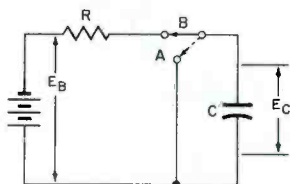

Fig. 2. A Simple Arrangement for Charging and Discharging a Capacitor.

the switch is moved from point A to B, the battery will immediately start to charge the capacitor and will continue to charge capacitor C until the voltage across the capacitor equals that across the battery. Theoretically, it would take an infinite length of time for E_C to reach the voltage E_B . For most practical purposes, E_C can be considered to equal E_B after a time equal to $5RC$ has elapsed. RC is measured in seconds and is equal to the product of the resistance in megohms times the capacitance in microfarads.

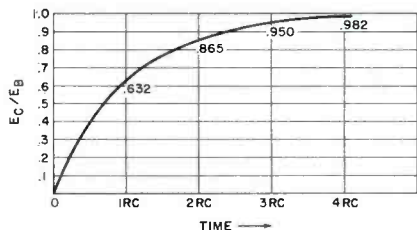

Fig. 3. Graph Showing the Rise in Voltage As a Capacitor Is Charged Through a Resistance.

Fig. 3 is a graph showing the ratio between the voltage E_C and the voltage E_B obtained with the circuit of Fig. 2. It can be seen that the

voltage E_C increases rapidly, at first, then more slowly as E_C approaches E_B . Considered as a whole, the curve of Fig. 3 appears to have a large amount of curvature; but if only a small portion of the curve is considered at one time, it appears to be

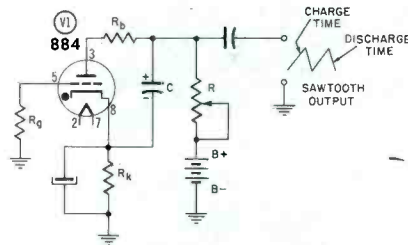

Fig. 4. Basic Thyatron Sawtooth Generator.

nearly straight, especially between points 0 and $1RC$. It would therefore be logical to use this latter portion of the curve, or a part of it, to develop the sawtooth curve diagrammed in Fig. 1. The manner in which this is done can be explained through the use of Fig. 4 which illustrates a simple sawtooth generator which uses an 884 thyatron tube.

The R and C of Fig. 4 correspond to the R and C of Fig. 2. The 884 tube $V1$ functions as a switch across capacitor C in Fig. 4. This capacitor charges through resistor R from the $B+$ supply. The voltage across this capacitor also serves as the plate-to-cathode voltage for tube $V1$; and when this voltage reaches a certain value, the gas in the tube ionizes and $V1$ conducts heavily. As $V1$ conducts, it rapidly discharges capacitor C until the voltage across this capacitor drops to a certain value called the deionization potential of $V1$. Tube $V1$ ceases to conduct at this potential, and capacitor C immediately starts recharging through resistor R . This cycle of charging and discharging is repeated over and over; and in this manner, the sawtooth waveform of Fig. 1 is developed. The amplitude of this signal is usually too small for direct application to the horizontal deflection plates; so, most oscilloscopes will have one stage or more of horizontal amplification between the generator and the deflection plates.

The frequency of operation of the sawtooth generator of Fig. 4 depends upon several factors which are: (1) the value of resistor R , (2) the value of capacitor C , (3) the $B+$ supply voltage, and (4) the bias on tube $V1$. Referring to Fig. 3, it can be seen that C will charge to .632 times the applied voltage in a time equal to $1RC$. This is true no matter what the individual values of R and C may be. For example, if

the product of R in megohms and C in microfarads equals 2, then C will charge to 63 per cent of the applied voltage in two seconds. If R times C equals 1 second, then 63 per cent of the applied voltage will be reached in one second. It would require a time of $2RC$ to reach a value of 86 1/2 per cent of the applied voltage; and these times would be 4 and 2 seconds, respectively, for the cases just mentioned.

It can be seen, therefore, that for any individual value of voltage required to fire tube $V1$ of Fig. 4, this voltage will be reached in less time if RC is reduced and in more time if RC is increased. In the first case, the frequency of the sawtooth signal will increase; and in the second case, it will decrease. The change in the RC product can be made by varying either R or C , or both. Most oscilloscopes are designed with R variable for fine or vernier control of frequency and with several different capacitors that can be connected individually by means of a switching arrangement. The switch then serves as a coarse control of the frequency. Sawtooth-frequency controls of this type are easily spotted on an oscilloscope chassis because of their characteristic appearance. They usually consist of a rotary switch surmounted by capacitors ranging in regular order from smaller to larger size. Fig. 5 shows the sweep-frequency controls of the Hickok Model 665 os-

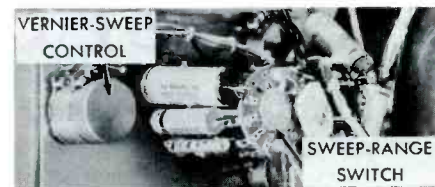

Fig. 5. The Sweep-Frequency Controls of the Hickok Model 665 Oscilloscope.

cilloscope. A five-position rotary switch is used to select the desired sweep range, and a dual potentiometer is used for fine adjustment of each range.

The effect of different values of the $B+$ voltage supplied to the sawtooth-generator stage can be illustrated by the following example. Assume that the bias of the thyatron tube of Fig. 4 has been set so that the tube fires when its anode reaches a potential of 63 volts and deionizes or stops conducting when the charge on capacitor C has fallen to 40 volts. These values are not necessarily characteristic of the 884 thyatron but are chosen arbitrarily for the purpose of illustration. Fig. 3 was

* * Please turn to page 79 * *



“Silver Screen 85’s” new barium “picture-guard” process deposits a lining of barium over the tube’s inside walls. Increased “getter” action keeps the vacuum pure, protecting the screen and electron gun from contamination. The result: Silver Screen 85 gives a brighter picture for a longer time.

“Silver Screen 85’s” new high-energy electron gun delivers 10% more light-producing electron energy to the screen. Brightness is increased an equal amount. Precision-focus keeps the picture in perfect sharpness.

SYLVANIA
SILVER SCREEN 85

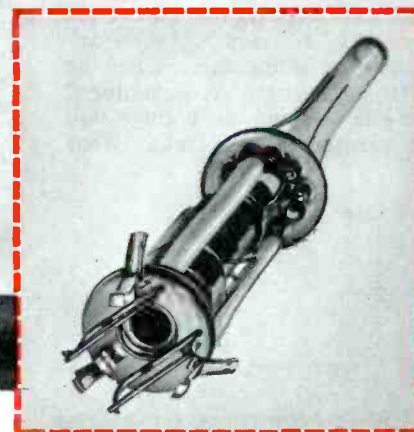

“Silver Screen 85” steals the show again

...with new “picture guard” and
new high-energy electron gun

Sylvania’s “Silver Screen 85” is now improved four ways to give brighter pictures for a longer time. New “Picture Guard” and high-energy electron gun headline these improvements. In addition, refinements have been made in the silver activated screen and super-aluminized reflector to make television’s brightest picture tube even brighter. And to make this *your* biggest year with “Silver Screen 85” Sylvania will be telling more consumers than ever about the improved “Silver Screen 85.”

In addition to “Beat the Clock” Sylvania will use Sunday Supplements to promote the “Silver Screen 85” in your own locality. Full schedules will be run in *This Week* and *American Weekly*, plus a score of independent Sunday Supplements.

A better tube, better promotion, with more tie-in material made available for your use. That means this can be your biggest picture tube year if you make it a “Silver Screen 85” year.

 **SYLVANIA**®

SYLVANIA ELECTRIC PRODUCTS INC.
1740 Broadway, New York 19, N. Y.
In Canada: Sylvania Electric (Canada) Ltd.
University Tower Bldg., Montreal

LIGHTING • RADIO • ELECTRONICS • TELEVISION • ATOMIC ENERGY

ANTENNA INSURANCE

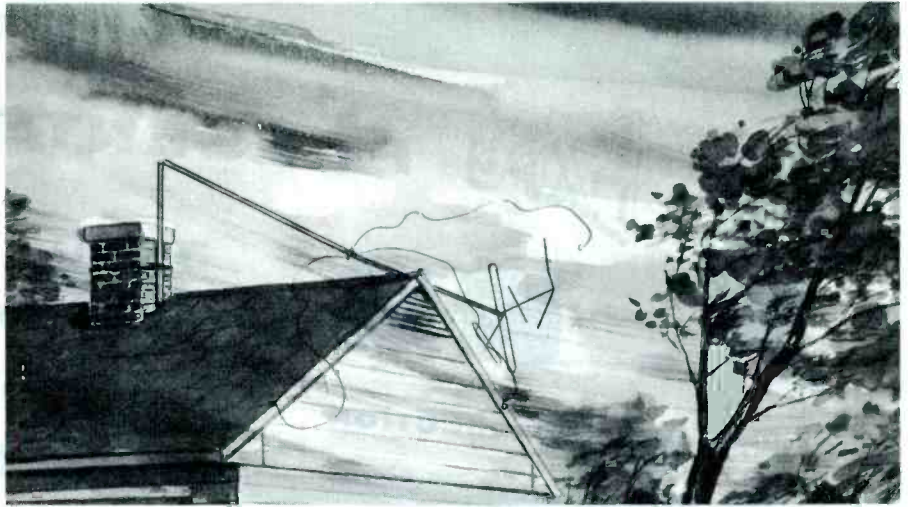

by George B. Mann

The best-installed antennas are often destroyed by wind. It is impossible to prevent entirely the destruction of antennas by high winds or hail, but the expense involved in restoring an antenna to its original operating condition can be recovered by the owner if he has previously made certain that the antenna was properly insured.

The owners of damaged antennas naturally expect their insurance companies to pay for the damages. Many of these persons submit claims for the damages and then find that the antenna value was not specifically stated in their policies, in which case the antenna was not insured against wind and hail damage. For this reason, the following information about some of the existing insurance regulations is presented to the technician as an aid to him in conducting his business and in giving better service to his customers.

There are certain technicalities involved in obtaining insurance on outside television and radio antennas, and these technicalities vary in different parts of the country. This information will be supplied by any local insurance agent.

Information about the types of insurance policies which cover antennas in the State of Indiana is given here as an example of the situations which the technician may encounter. In each of the following cases, the coverage for wind and hail damage is excluded unless the value of the antenna is specifically indicated in the policy and an additional premium is paid for this coverage.

1. If you own and occupy your home, your antenna attached to the

Facts of Importance to the Owner and the Installer of an Outside Antenna

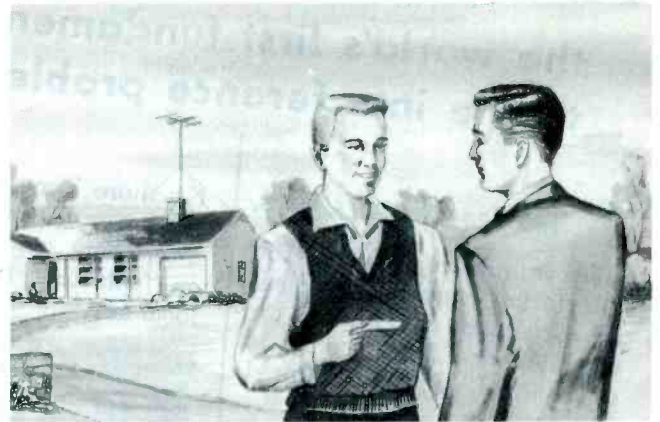

house is covered by the insurance on your household goods and not by the insurance on your home.

2. If you rent and if the antenna attached to the house is your property, it is covered by the insurance on your household goods.

3. If you rent but the antenna attached to the house belongs to the property owner, then it is covered only by the insurance on the home itself.

4. If you own and occupy the house and the antenna is not attached to the house but is set up in the open on the premises, then it is covered by the insurance on the house under the clause that applies 10 per cent of the insurance on the house to cover private structures pertaining to the house.

5. If you rent and if the antenna is not attached to the house but is your property, then it is covered by the insurance on your household goods.

All perils except wind and hail damage will be covered for the antenna automatically. Antennas damaged by wind or hail are not covered unless the value is indicated in the policy and an additional premium is

paid or unless you have a personal-property floater policy. Persons having this form of insurance do not have to pay the additional premium for antenna coverage.

The foregoing information applies to insurance policies in the State of Indiana. Regulations may be somewhat different in your locality.

A knowledge of insurance regulations can be used by the technician to provide an additional service to his customers. A large percentage of antenna installations will be made for persons who have never before had an outside antenna. These persons will greatly appreciate information about antenna insurance.

It is to the technician's advantage that his customers obtain proper antenna insurance. The customer who has it and sustains wind or hail damage to his antenna will be in a financial position to call a technician immediately and to have the antenna repaired promptly and correctly.

Again we wish to emphasize that insurance rules and regulations differ in all parts of the country. Be sure that you get the correct information for your locality by contacting a local insurance agent.

EXPO PRESENTS

I. R. I. S.*

INFINITE REJECTION INTERFERENCE SYSTEM

the world's first fundamental and complete answer to the interference problem...

* The Sensational I.R.I.S.

gives infinite rejection of the interfering signal regardless of direction or channel or whether the interference is co-channel, adjacent channel or ghosts.

The rejection of the interfering signal is accomplished by opposing the interfering signal with a signal of equal amplitude but of opposite phase, thus producing complete cancellation. Simply rotate the upper section of the antenna to a position where the interference disappears.

Can be used either in a fixed installation or with rotor. All accessories and harness furnished for quick, easy installation.

The Famous EXPO Antenna

is used in I.R.I.S. with its fundamental unlimited bandwidth characteristic, thus insuring excellent performance throughout the 82 channels.

No more Venetian blinds, or ghosts or distortion from an interfering co-channel signal or "splatter" from a strong local station.

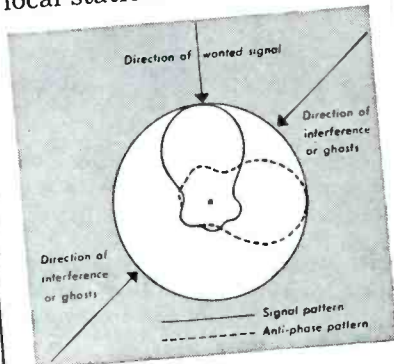

The combination of the principle of the exponential curve and the proved performance of I. R. I. S. offers an exceptional sales potential, both in antennas and TV sets. Now is the time to cash in on this exclusive opportunity.

EXPO-I.R.I.S. comes in the following models:

- XO2R6 2-bay, 6 element EXPO-I. R. I. S. List \$20.95
- XO2R8 2-bay, 8 element EXPO-I. R. I. S. List \$25.50
- XO4CR6 4-bay, 6 element colinear EXPO-I. R. I. S. List \$53.25
- XO4CR8 4-bay, 8 element colinear EXPO-I. R. I. S. List \$61.75

ORDER TODAY FROM YOUR DISTRIBUTOR

whom we will supply until official distributors are designated in your locality.

EXPO
HOLLOWAY ELECTRONICS CORP.
Fort Lauderdale, Florida

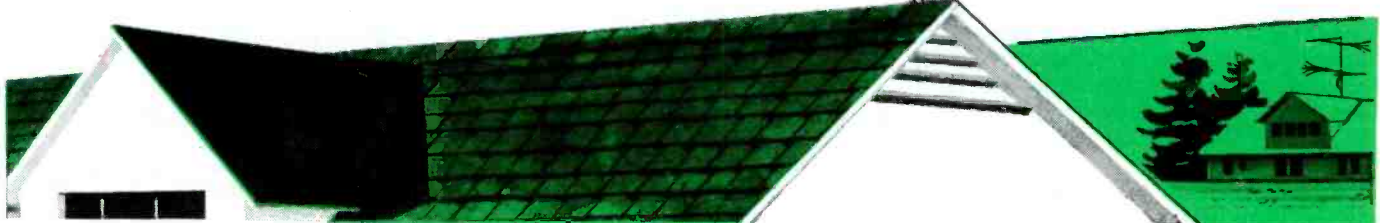
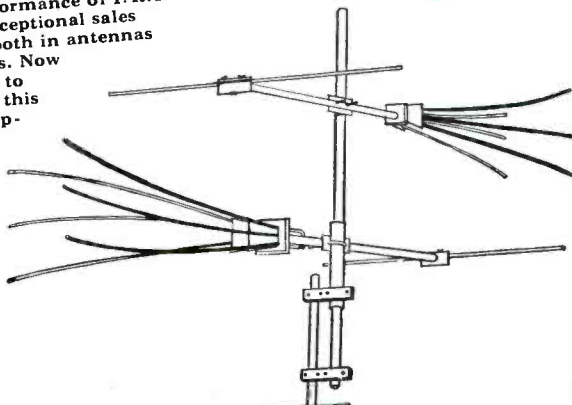

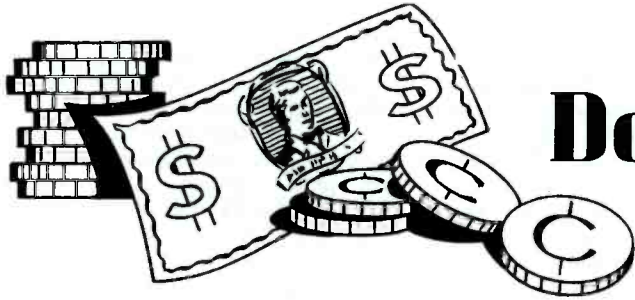

Dollar and Sense Servicing

by *John Markus*

Editor-in-Chief, McGraw-Hill Radio Servicing Library

LECTURES. For hot ideas on programs for your service technicians' organization, give serious consideration to the topics chosen by Associated Radio & Television Servicemen in Chicago for their 1955-1956 lecture series:

I. Installment financing for the small radio and television service shop — what to know about selling on credit and what to watch for. By E. J. Morris, vice-president, National Bank of Commerce of Chicago.

II. Printed circuits — how they are produced and pointers in the servicing and repair of such circuits in your shop. By Richard Harasek, Radio Division, Motorola, Inc., Chicago.

III. Introduction to credit and credit ratings — what they are and how they are obtained, what a rating means to a business man, and credit and collection advice for the small shop man. By Eugene Reichstetter, manager, Dun & Bradstreet, Chicago.

IV. Transistor story — what the transistor is, how it works, and where it may be going. By L. J. Couch, sales service engineer, Sylvania Electric Products, Inc., New York.

Additional lectures now being lined up will cover other business topics including advertising, income tax, and public relations which will be of interest and help to the small shop owner.

These are all topics that will bring a good turnout. ARTS chairman Howard Wolfson, 433 S. Wabash Ave., Chicago, and his co-officers deserve real credit for getting down to practical-advice programs that can mean extra dollars of income for the members. With these topics as a guide, a wide-awake organization in practically any other city can line up a similar program.

DEALERS. According to RETMA's annual survey, there are now over 110,000 TV and radio dealers in this country, as compared to 107,000 a year ago. Most of them (about 90,000) sell both radios and TV sets; about 20,000 sell only radios. Each TV dealer sold an average of 70 sets per month this year.

Some of 42,800 of the dealers were classified as TV-radio-appliance stores; 19,050 were furniture stores; and the rest were miscellaneous hardware stores, department stores, and other retail outlets.



JAMMING. A camouflaged battery-operated radio transmitter in a tree was tracked down by a posse of engineers in the Idaho hills after signals from the transmitter had thoroughly jammed the microwave relay channel set up by Idaho Falls station KID-TV to pick up a nationwide networking program. The owner of the jamming equipment remains a mystery — a technical "whodunit."



SHALLOW TV. New picture tubes coming in mid-1956 or earlier will have 120-degree deflection angles, as another step toward the goal of a flat tube. In the 21-inch size, the new tube will for the first time make possible a 21-inch set that is wider than it is deep.

The greater deflection angle will require higher sweep voltages, which means designing deflection components for higher voltages and redesigning receiver circuitry for proper balance with the higher voltages.

POLICE RADAR. How accurate are radar speed meters? This question is answered in detail in a feature article in the December 1955 issue of *Electronics* and is well worth looking up since you may someday be called into court as an expert witness to testify on the validity of radar speed readings. Author of the article is J. G. Brantley, Jr., consultant in the traffic department of Buffalo, N. Y.

Most of the speed radars currently in use depend upon precise measurement of the Doppler shift in signal frequency as the speeder approaches the radar car. Analysis shows that the errors in readings result from carrier-frequency shift of the transmitter, parallax when the radar car is parked off the highway, and multiple reflections from other passing cars or from nearby objects. However, all these errors usually make the radar meter read low, and hence give the speeder a break.

Lowest readings occur when two cars pass the radar car simultaneously; in one test run, when car A at 35.5 mph and car B at 21 mph passed the radar car together, the meter gave a single reading of 24 mph.

The one exception to the foregoing occurred when the engine in the radar car was idling rather than shut off. Radar meter readings increased about 5 per cent when the generator was running at idling speed, as compared to operation directly from the car storage battery.

The results were obtained by testing a single unit; hence, they cannot be applied in general. The article does serve to give a procedure for testing other such units and does tend to indicate that with properly operated and properly maintained speed radar a speeder who is caught might just as well shut up and pay up. His chances of winning a court challenge of the accuracy of the electronic equipment are pretty slim.

VIDEOTOWN. The eighth annual Cunningham & Walsh survey of Videotown (New Brunswick, N. J.), revealed in June 1955 that only 7 per cent of the homes had two TV sets. This figure is just twice as high as a national average obtained in another study.

Among the reasons given for not having a second set were: "Don't need it" or "The house is too small." Most new two-set owners plan to keep the old set until the picture tube wears out or until the set itself needs repair. With the Videotown market saturation for TV now at 87 per cent, this indicates that manufacturers can count very little on the second-set market for future sales.



WORK. Despite a seeming epidemic of heart failures these days, more and more doctors are saying that good old plain hard work will never hurt you — if you do it yourself. It's a competitor's hard work that hurts. Worrying about it can ruin your own health, and grumbling about it with jealous inaction can ruin your business.

RANGE. New Tappan electronic ranges for home kitchens will operate at 2,450 megacycles and will sell for around \$1,000. The heating unit operates on radar principles and was developed by Raytheon. General Electric, Frigidaire, and Westinghouse also intimate that they'll bring out electronic ranges soon. The obvious goal is the luxury market, where price is no objection.



CRYSTALS. Synthetic quartz grown by man is now being offered to the public for the first time by Clevite Corp., Cleveland, through permission of the Signal Corps. The price is \$52.50 per pound which is many times the current price of radio-grade natural quartz from Brazil, but developments now well in hand are expected to bring the price down considerably within the next 12 months. This may make the synthetic quartz come pretty close to competing with the natural mineral because there is very little waste when the crystals are grown to exactly the size and orientation required by the manufacturers of oscillator crystals.

APPLE. Behind the screen of a heavy-wire fence, we saw dozens of the hush-hush Philco Apple tubes cooking away on life tests; but the only details released so far are those in the recent television survey conducted by Fortune magazine. It says that Apple is a single-gun color tube without a shadow mask, using vertically arranged thin lines of the three phosphor colors. With this as a clue, we can envision precision circuitry that makes the beam vary appropriately in intensity as it passes horizontally across each vertical color line in turn. For monochrome broadcasts, the relationships between the intensities of the three primary colors would be fixed to give the visual effect of white, and the sum of the three color signals would vary in accordance with the picture signal. For color programs, both the relationships and the sum of the three color signals would vary.

Getting signal synchronization with the phosphor lines on the screen is undoubtedly the major problem to be solved before this tube can be placed on the market. If this can be licked without costly complex circuitry and if the phosphor pattern can be put on the screen economically,

(Continued on page 34)



MODEL RE-1

No Guesswork with Rejuva-Tube!

- Only Device That Meters Cathode Activity During Rejuvenation
- Tells Exactly When Rejuvenation Should Stop —
- Prevents Damage to Cathode Emitting Surface
- Built-in Current Limiter Eliminates Possibility Of Accidental Cathode Ribbon Burn-Outs



COMPARE THESE FEATURES

Tests — Repairs TV Picture Tubes Without Removing Tube From Set

- Compact, light-weight and easy to use.
- Complete Tester: detects open or shorted elements and leakage as high as 3 megohms between elements.
- Highest quality lab instrument construction.
- Special metered circuit removes "particle" shorts between heater and cathode.
- Checks cathode emission and grid cut-off characteristics.
- Predicts approximate life-expectancy of tube — identifies gassy tubes.

DEALERS! Now you can sell those "dim-out" trade-ins at a good profit, and back them up!

SERVICEMEN! Sell rejuvenation service. Fully 80% to 90% of picture tubes that have gone dim in service can be quickly reactivated to furnish up to years of "bright as new" service!

MULTIPHASE "Rejuva-Tube" CRT REJUVENATOR

Brings "Dim-Outs" Back to Life
SENSATIONAL MONEY MAKER

Complete Kit \$49.50 Factory Wired \$59.50

Condensed Instructions Printed Inside Case Lid
Write for Manual on Rejuvenation with the "Rejuva-Tube"
*Patent Pending

"Rejuva-Tube" By The Designers of



Central Electronics, Inc.

1247 W. Belmont Ave.

Chicago 13, Illinois



**WR-36A
Dot-Bar
Generator
User Price*...
\$147.50**

**WR-61A
Color-Bar
Generator
User Price*...
\$247.50**

**WO-91A 5" Scope for
Black-and-White/Color
User Price*... \$229.50**

**Stable!
Accurate!
Portable!
Easy-to-use!**

RCA TEST INSTRUMENTS FOR COLOR TV

Your shop's one of the best equipped for trouble-shooting and servicing both black-and-white and color TV when it's equipped with RCA Test Instruments...add these three RCA units to your black-and-white setup and you are ready to service *all* makes of color TV sets.

WR-61A Color-Bar Generator generates signals for producing 10 different color bars simultaneously—including bars corresponding to the R-Y, B-Y, G-Y, I, and Q signals for checking and adjusting phasing and matrixing in all makes of color sets. *Crystal-controlled oscillators insure accuracy and stability.* Luminance signals at bar edges facilitate checking color "fit" or registration. Adjustable sub-carrier amplitude permits checking color-sync action. The WR-61A is accepted as the standard for color-phasing accuracy in many TV stations and network operations.

WR-36A Dot-Bar Generator provides a pattern of small-size dots, horizontal and vertical bars and fine-line cross-hatch patterns for precise adjustment of convergence and linearity. RF output available on channels 2-6. High-impedance video output circuit with the new WG-305A Video Test Adapter (included) contributes to sharp, steady patterns. Choice of internal 60-cps vertical sync or external sync. The crosshatch pattern and the number of vertical and horizontal dots and bars is adjustable. Weighs only 13 lbs.

WO-91A 5" Oscilloscope incorporates features usually found only in much more expensive instruments. It has all the 'scope functions you need to do both black-and-white and color TV service work...speedily and with top-grade results! Some of the outstanding features are: front-panel switching of "V"-amplifier bandwidth; response flat to 4.5 Mc in wide-band position; voltage-calibrated frequency-compensated "V" amplifier step-attenuator. Simultaneous waveshape display and voltage measurement on direct-reading graph scales enable you to read peak-to-peak voltages directly. Sturdy single-unit probe with built-in switch permits instant selection of direct/or low capacitance operation.

* (optional)

SEE YOUR RCA DISTRIBUTOR
FOR DETAILS ON THESE
OUTSTANDING
RCA TEST INSTRUMENTS
FOR COLOR TV!



TEST EQUIPMENT
RADIO CORPORATION OF AMERICA
HARRISON, N. J.

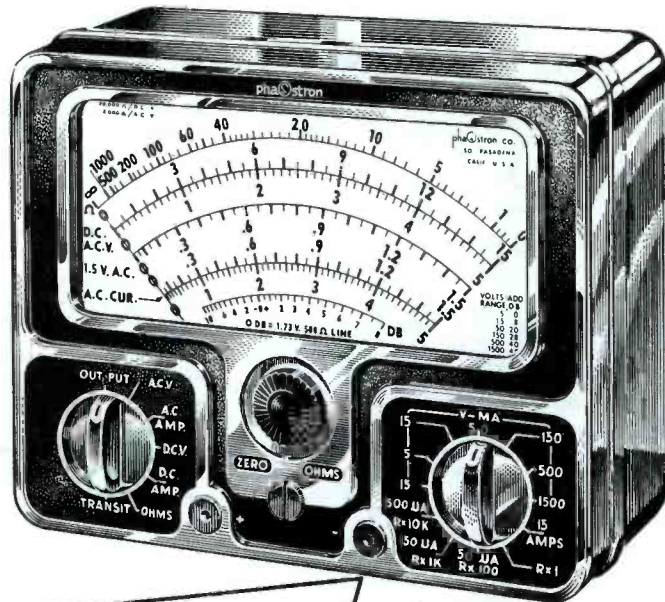

555A VOM

YOU NEED THESE FEATURES:

Meter Movement Protection up to 500 times overload is provided by a rectifier network.

The 555A Measures: AC Current, DC Current, AC Voltage, DC Voltage, Output, Resistance

43 Unduplicated Ranges

Separate Range and Function Switches

Double Magnetic Shielding

3% DC, 4% AC Permanent Accuracy

Easy to Read, Four Color Scales 4 7/8" long

Metal Case with Die Cast Bezel 6 1/8" x 4 5/8" x 2 1/8"

Sensitivity: 20,000 Ohms/Volt DC, 2000 Ohms/Volt AC

Complete with Probes and Batteries at your Parts Distributor **\$44⁵⁰**

PHASTRON INSTRUMENT AND ELECTRONIC COMPANY
151 Pasadena Avenue, South Pasadena, California

this tube could well be a winner. Apple, by the way, is just Philco's code name; the tube looks much like an ordinary black-and-white picture tube.



LIGHTNING. If you get a call from a color-set owner saying his set is giving color on black-and-white programs after lightning hit nearby, don't think he's crazy. We know from personal experience that a color TV set is supersensitive to lightning. A bolt made a direct hit on a house 200 feet from ours, and the resulting induced voltage in the power line magnetized our set thoroughly before burning out the fuse on the house circuit into which the set was plugged.

A thorough demagnetizing with a large AC coil got out most of the color, but there's still a bluish-green haze across the bottom of the screen that just won't come out. It's not objectionable on black-and-white programs and isn't even noticed on color programs, so we'll just leave it there. But remember that for color servicing, you may need a large demagnetizing coil that'll plug into a 117-volt AC outlet.



SALES. Latest RCA figure on color sets being sold is 1,000 per week, these being actual installations in homes rather than taverns. General Sarnoff estimated total industry sales of color sets next year at "more than a couple hundred thousand" which corresponds to over 4,000 per week.

There are now about 40,000 color TV sets in use, according to a Television Digest estimate. This isn't even half a set per service technician yet, so there's still plenty of time to study up on color-servicing problems.



FUTURE. Admiral announces that it's planning to bring out in 1958 a solar-powered all-transistor radio that might last a lifetime without repair. Why? Might be all right for Navajos, who're out in the sun all day anyway; but in regions other than the Southwest, the sun is mighty scarce at times.

JOHN MARKUS

this TV serviceman uses

STANCOR

EXACT REPLACEMENT TRANSFORMERS



There are now 59 Stancor exact replacement flybacks covering all major TV set manufacturers and many private label brands.

The latest units include 6 new Zenith replacements that give you

71% ZENITH EXACT REPLACEMENT FLYBACK COVERAGE

and 6 new General Electric replacements that give you

79% G. E. EXACT REPLACEMENT FLYBACK COVERAGE

You too can take life easy and have time to spare when you use Stancor exact replacements. No changing of circuits, no drilling of holes . . . you just take out the defective unit and replace it with a Stancor Transformer that exactly duplicates the original.

FREE The New Stancor TV Transformer Replacement Guide, listing accurate replacement data on almost 8500 TV models and chassis of 116 manufacturers. If you haven't received your copy see your Stancor distributor or write Chicago Standard Transformer Corporation.

CHICAGO STANDARD TRANSFORMER CORPORATION

3594 ELSTON AVENUE
CHICAGO 18, ILLINOIS

Export Sales:
Roburn Agencies, Inc.
431 Greenwich Street
New York 13, N. Y.





\$30.00 including 4-drawer metal cabinet
suggested net price

Time-saving, workbench kit of 200 new Centralab Molded Disc Capacitors

Centralab Metal Kit MDK-200 provides comprehensive assortment of 31 most generally used values

You don't have to delay a job until you get the right ceramic disc capacitor — because *you always have the right one handy* in this MDK-200 selection of 31 popular types.

It's easy to find just what you're looking for. All capacitors are packed five to a polyethylene envelope — with values, part numbers, and ratings clearly shown.

This gives you another good reason to use Centralab Molded Discs on all bypass, coupling, and general applications. You save time and money — your customer gets premium performance.

Call your Centralab distributor and have him deliver a Centralab MDK-200 Kit today.



Only Centralab Type MD Molded Discs provide all these and other advantages

Lead strength greater than the breaking strength of the wire itself.

The only truly insulated ceramic capacitor — 2500 V.D.C. breakdown to ground.

Electrical properties constant to 3,000 megacycles.

Insulation resistance of molding, 300,000 megohms.

Fungus-proof. Unaffected by ozone, salt water, or solvent at room temperature. Will not become brittle at -55° C.

Moisture absorption, .005% or less.

Centralab

**Write today for Centralab
Catalog No. 29.**

Address Centralab,

A Division of Globe-Union Inc.

942A E. Keefe Ave., Milwaukee, 1, Wisconsin

D-555

In the Interest of Quicker Servicing

(Continued from page 23)

Checks at the horizontal-output grid, horizontal-oscillator plate, horizontal oscillator grid, and in the horizontal AFC circuit failed to reveal any abnormal waveforms.

Not quite sure of just where to turn next, the technician decided to check the output signal from the video detector. A close examination of this signal revealed that a pulse was present in the video signal whenever the tearing or twitching occurred in the picture. As a result of finding this abnormal pulse in the output signal of the video detector, the technician reasoned that perhaps the large pulse voltage generated by the horizontal sweep within the receiver was being picked up in the tuner or video IF stages. In this receiver, the high-voltage transformer and the rectifier tube were not shielded by a metal cage. The locations of the transformer and rectifier are shown in Fig. 2.

The B+, filament, and AGC lines to the tuner and video IF stages were checked for the presence of a pulse signal. A large pulse seemed to be everywhere. It was found that pickup in the cable to the oscilloscope probe, even though it was a shielded cable, accounted for this and caused the checks of the B+, AGC, and filament lines to the tuner and video IF stages to be inconclusive.

The technician next reasoned that poor contact between the drum assembly and the slider contacts in the tuner could permit pickup of the spurious signal; therefore, the drum assembly was removed, and its con-

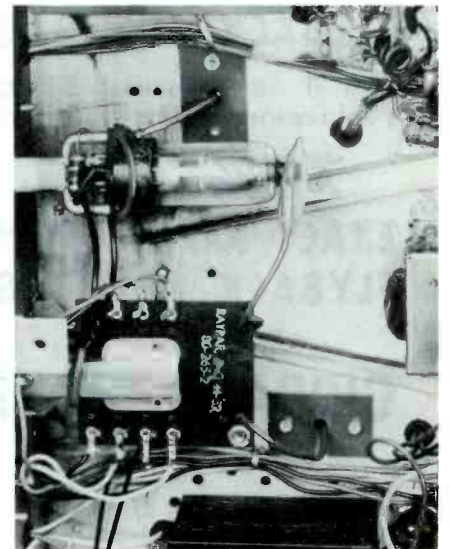

Fig. 2. Unshielded Horizontal Output Transformer and High-Voltage Rectifier.

FIRST TO BREAK THE TV RECEPTION BARRIER...

**MOST POWERFUL SUPER FRINGE
ANTENNA IN THE WORLD**

NEW WALSCO WIZARD

with exclusive **PHASE REVERSER**

Distance is no barrier to the amazing new WALSCO WIZARD. Exclusive "Phase Reverser" delivers the sharpest, crystal-clear picture ever seen in the most difficult reception areas. No other antenna like it!

New WIZARD offers highest gain and sharpest directivity possible on all VHF channels. Installation in a jiffy... without complicated harnesses, phasing stubs, or extra dipoles. Guaranteed for 3 years!

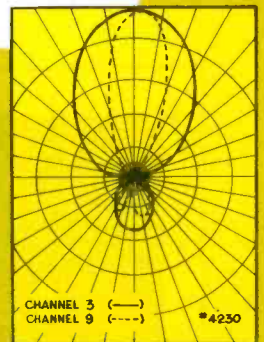

WALSCO WIZARD Imperial equals reception of 10 element yagis on low channels, and equals a three stack 10 element (30 elements) yagi on channels 7 to 13.

Actual comparison of fringe antenna performance

Channels	Gain (db) Single Bay						
	2	4	6	7	9	11	13
Walsco Wizard Imperial	6.1	6.9	8.2	11.9	11.6	10.8	12.6
Antenna "A" With 3 Phase Reversing Dipoles	6.3	6.6	8.1	10.5	10.2	10.6	12.4
Antenna "B" - Yagi Type with Phasing Loops	5.1	5.5	6.8	7.5	9.6	8.8	11.2
Antenna "C" - Yagi Type with Loading Coils	5.9	6.9	8.6	9.1	8.6	9.6	7.8



ELECTRONICS CORPORATION
A SUBSIDIARY OF *Tellutograph* CORPORATION

3602 Crenshaw Blvd.,
Los Angeles 16, California

Model
Wizardette #4210
Wizard #4220
Wizard Imperial #4230

Price
\$14.90 list
19.50 list
34.90 list

where do you find

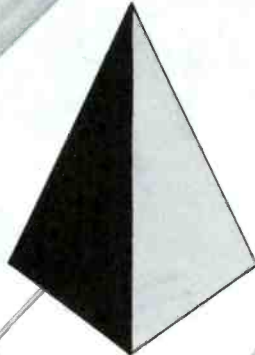

PYRAMID

CAPACITORS AND SELENIUM RECTIFIERS

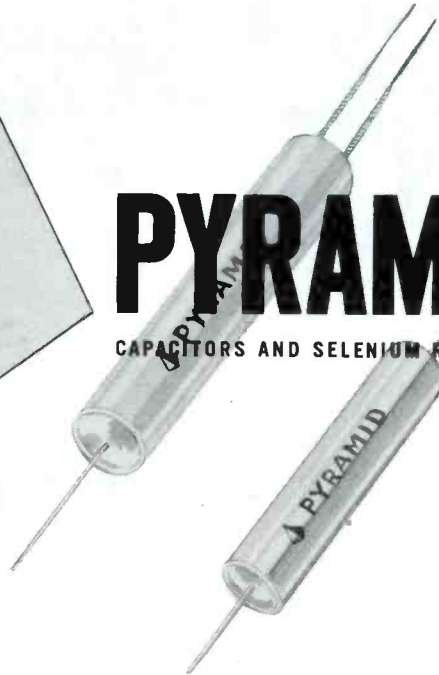

In the electronic products of all these leading brand manufacturers—where their presence testifies to PYRAMID'S high standards of quality and service.

Admiral

Magnavox



Motorola

CROSLEY

Packard-Bell

DU MONT

RAYTHEON

Emerson



SYLVANIA

hallicrafters

Westinghouse

Hoffman



Howard W. Sams

RF
PHOTOFACT



PYRAMID ELECTRIC CO.
North Bergen, New Jersey

THE BIG NAME IN CAPACITORS AND SELENIUM RECTIFIERS TODAY...

tacts were cleaned. The slider contacts were also cleaned and re-tensioned. Before replacing the drum assembly, the technician made a thorough visual inspection of the connections and components in the tuner. The B+ decoupling resistors and any other resistors that could be reached with the meter probes were all checked and found to be satisfactory. The tuner drum assembly was then reinstalled in the tuner; and as you might guess, the tearing in the picture was still present. The technician, still not completely convinced that the trouble was not in the tuner, decided to substitute another tuner since one happened to be available in the shop. The substitute tuner was installed; and as in the previous checks, the trouble was still present. The original tuner was then reinstalled in the receiver.

The technician still reasoned that the trouble was being caused by the pickup of an interfering signal; therefore, the bypass capacitors in the IF stages were checked. This check failed to uncover the source of the trouble. The B+ decoupling capacitors for the IF and tuner stages were also checked and were found to be satisfactory.

All of this testing and troubleshooting procedure had taken the largest part of the day and had produced no positive results; so, the technician decided to do some work on other receivers in the hope that a possible solution might come to him. The first thing in the morning of the next day, the technician returned to the set with the twitching picture. During his off-duty hours, he mentally reviewed the procedure that he had employed and he had also reviewed the nature of the trouble involved. He believed that the tuner and video IF stages had been eliminated as possible sources of the trouble.

A thorough check of the normal operating voltages in the video and sync sections showed that these stages were in all probability operating normally. The technician then reasoned that since the tuner, IF, video, and sync sections all seemed to be normal, the pulse that was noticed in the signal must be a result of the trouble and not the cause of it.

With this supposition in mind, he decided that the trouble just had to be in the horizontal-sweep section. A check of the signal at the horizontal-output grid had failed to reveal any distortion; and it was reasoned that the trouble was located in the horizontal output, damper, or high-voltage stages. The boost filters and other capacitors had been eliminated as sources of the trouble, and there was

no evidence of external arcing. The trouble was then thought to be from a defective flyback transformer, deflection yoke, width coil, or linearity coil. Since the width and the linearity coils were the easiest to check, they were checked first. The linearity coil was checked by shorting across its terminals with a jumper wire. This caused severe drive lines to appear in the picture, but the tearing condition was still readily apparent. The width coil was checked by disconnecting one of its lead wires from the circuit. The picture then bloomed severely, but the tearing could be seen and the width coil was therefore eliminated from suspicion.

This had narrowed the search to the yoke and the flyback transformer. The substitution of either would require some work; but since substitute units were available, it was decided to substitute each one starting with the flyback transformer. The replacement unit was installed; and as before, the tearing in the picture was still present. The flyback transformer was left in the circuit, and a new yoke was substituted; but this also failed to eliminate the trouble. The original units were then replaced in the chassis.

At this point, the technician was very discouraged, and justifiably so, since almost everything in the receiver had been checked and eliminated as a possible cause of the trouble.

After a careful study of the schematic diagram for a few minutes, the technician realized that there was still one major component that had not been checked in the horizontal-sweep section. This was the ringing coil in the horizontal oscillator stage. With the receiver turned on and operating, the ringing coil was shorted with a jumper wire as shown in Fig. 3. The picture went out of synchronization; but when it was again synchronized, there was no evidence of the tearing. The technician was amazed but also skeptical that the trouble was actually gone; therefore, the jumper wire was removed. Immediately, the tearing was again present. This was definite proof that the trouble was in the ringing network. He substituted a new 3900-mmfd capacitor across the ringing



Fig. 3. Ringing Coil Shorted With a Test Lead.

coil, but the tearing was still present. It was evident that the coil was defective even though the DC resistance of the coil was checked and was found to be correct.

The replacement of the coil remedied the trouble. In this case, the 3900-mmfd capacitor was also replaced because the replacement coil did not resonate properly with the original capacitor.

Since the entire group of tubes in the video IF strip and in the tuner had been replaced and since the technician felt that all of these tubes could not be defective, the original tubes were reinstalled in the chassis one by one. The second video IF tube proved to be defective, and its replacement eliminated the microphonic condition which had been noted earlier.

SUMMARY

In reviewing the procedures used by the technician to locate these troubles, several errors may be found. These may have caused our star to waste time looking for the possible cause of the trouble in unlikely places.

Before going into the errors made by the technician, let us set up a group of rules for trouble shooting a television receiver.

1. Carefully analyze the picture or sound, and try to locate all symptoms of the trouble.
2. Test all tubes in suspected sections by replacement with tubes of known good quality. Testing the tubes with a high quality tube tester is also satisfactory.
3. Make sure that the line voltage, power-supply voltage, and ripple content are normal.
4. Carefully analyze the edge of the raster to determine if a symptom appears in the raster.
5. Determine whether a signal analysis could help to reveal the trouble; and if it can, check critical waveforms within the suspected section.
6. Check voltages in suspected stages.
7. If erroneous voltage readings are obtained, then make resistance checks in the suspected section.
8. Substitute new components for those which were revealed by careful analysis to be possible causes of the trouble.

**Write for your copy
of Radio Receptor's NEW**

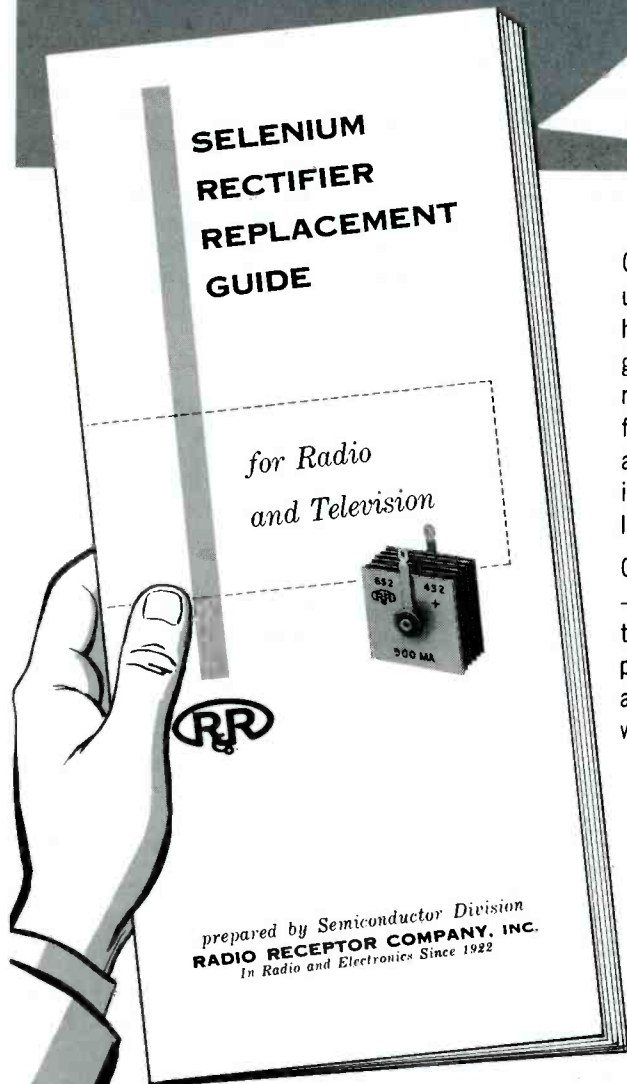

Completely revised and up-to-date, this handy 28 page guide gives the Radio Receptor rectifier replacements for every radio and TV manufacturer, including all the latest models.

Convenient in size, too — just right to slip into your pocket or tool kit, always available when you need it!



In Radio and Electronics Since 1922

When the job calls for rectifier replacements, install RRco. "Safe Center" units. You'll find the guide lists a complete range of standard sizes and types for every need—in stock at your local distributor. For your free copy fill out the coupon below and mail it to us today.

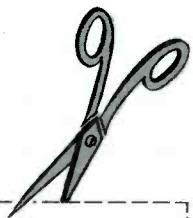

Semiconductor Division IN
RADIO RECEPTOR COMPANY, INC.
 251 West 19th St., New York 11, N. Y.

Please send me a copy of the new RRco. Selenium Rectifier Replacement Guide

Name Position

Firm

Address

City Zone State

9. Replace all defective components.

10. Give the receiver a thorough operational test after it has been repaired.

A comparison of the list of rules and the actual procedure used by the technician shows that the technician went astray on the fourth rule. If he had carefully inspected the raster, he would have found that the horizontal tearing or twitching was present in the raster. He would have known positively that the trouble was in the horizontal-sweep section. With the basic source of the trouble thus localized, the search could then have been narrowed to the suspected components within that section. Time would have been saved because the tuner, video IF, video, and sync sections would not have been searched for the source of an interfering pulse.

The fifth rule is one that may be new to some technicians. It is a very important rule, however, and has a very definite purpose. The technician in our story became involved with an analysis of the various signal waveforms in the receiver; and as a result, a considerable amount of time was spent trouble shooting in the wrong places in the receiver. When the symptom indicates that the trouble occurs only during a few horizontal scanning periods in each frame, the nature of the signal waveform at the grid of the horizontal output tube may not have any significance. A disturbance in the signal during a few periods of horizontal scanning would be hidden because of the fact that the oscilloscope combines multiple images of the signal into the one trace. The lack of displacement of just a few of the many images could not be detected.

After the trouble had been localized to the horizontal-sweep section, the technician might have applied an externally produced drive signal to the grid of the horizontal output tube. This signal could have been obtained from another TV receiver or from one of the commercially available instruments which have been designed to produce such a signal. The technician would then have had the trouble isolated to the horizontal oscillator stage. From then on, his problem of finding the defective ringing coil would not have been too difficult.

We thought that this service experience was worth telling — it's a fact that the technician involved learned something as a result of it.

CALVIN C. YOUNG, JR.



**GENERAL
CEMENT MFG. CO.**

- SERVICE AIDS
- CHEMICALS
- ALIGNMENT TOOLS



Everything you need for successful radio-television servicing is available in the big G-C line . . . at leading parts distributors everywhere.

GENERAL CEMENT MFG. CO.
919 Taylor Avenue • Rockford, Illinois



**G-C ELECTRONICS
MFG. CO.**

G-C Stackpole Carbon Resistors

Scientifically Packaged to Prevent Bent Soldering Leads

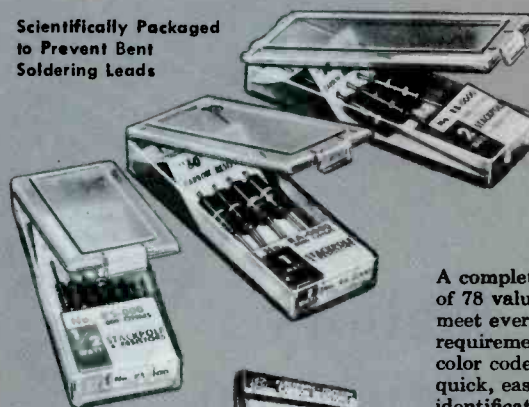

A complete line of 78 values to meet every requirement . . . color coded for quick, easy identification.

96 60 LINE
CARBON RESISTORS
ALL ONE PRICE . . .
ONE STANDARD PACKAGE
LIST \$1.00 per BOX
DEALER NET **60c**
PER BOX



**G-C ELECTRONICS
MFG. CO.**
Division of General
Cement Mfg. Co.
919 Taylor Avenue
Rockford, Illinois



**TELEVISION
HARDWARE MFG. CO.**

Headquarters for all TV Hardware

- ROOF MOUNTS
- STAND-OFFS • LIGHTNING ARRESTORS
- TOWERS • CHIMNEY MOUNTS
- WALL MOUNTS • ACCESSORIES

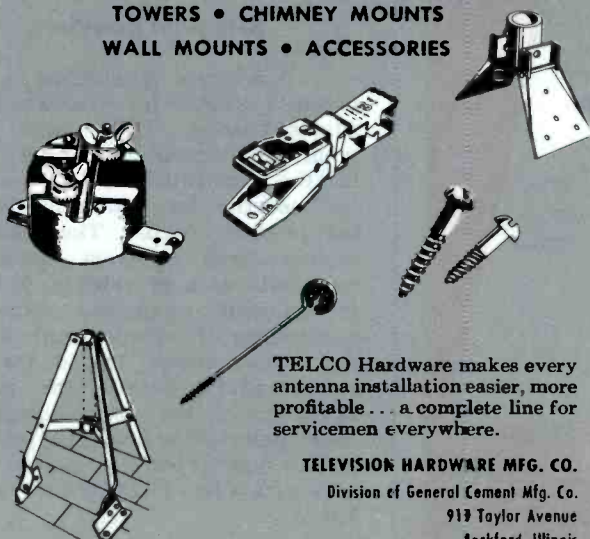

TELCO Hardware makes every antenna installation easier, more profitable . . . a complete line for servicemen everywhere.

TELEVISION HARDWARE MFG. CO.
Division of General Cement Mfg. Co.
919 Taylor Avenue
Rockford, Illinois



**TELCO ELECTRONICS
MFG. CO.**

Telco UHF-VHF Antennas

Whether it's price, distance, UHF or VHF, indoor or outdoor . . . you'll find the antenna you need at TELCO

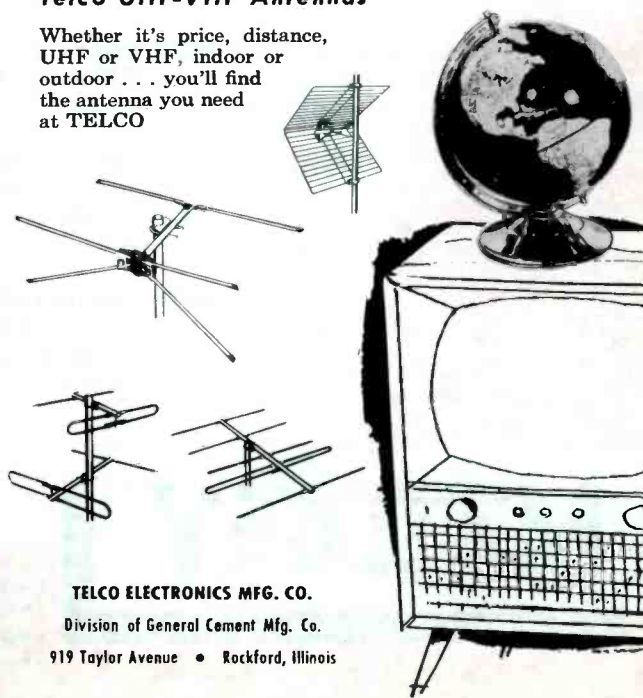

TELCO ELECTRONICS MFG. CO.
Division of General Cement Mfg. Co.
919 Taylor Avenue • Rockford, Illinois

... Another
MALLORY
service engineered
products

Mallory Selenium Rectifiers

make every
replacement sure

Made by Mallory-developed techniques unique in the industry, this new line of selenium rectifiers gives you an unequalled combination of performance and dependability.

SERVICE LIFE IS LONG—far exceeds original equipment specifications.

EFFICIENCY IS HIGH due to low forward voltage drop. Efficiency stays high throughout service life.

COUNT ON EVERY STACK for the same high quality. The new rectifiers are manufactured to standards of uniformity never before possible.

RATINGS ARE CONSERVATIVE—no need to use over-size stacks to “play safe”. Order your stock today from your Mallory distributor.

P. R. MALLORY & CO. Inc.
MALLORY

P. R. MALLORY & CO. Inc., INDIANAPOLIS 6, INDIANA

- Capacitors
- Controls
- Vibrators
- Switches
- Resistors
- Rectifiers
- Power Supplies
- Filters
- Mercury Batteries

Examining Design Features

(Continued from page 21)

The distance between the disc and the printed windings can be changed by a screw adjustment, and thus the transformer can be tuned for the desired frequencies. The filament chokes are also etched on the plated board in a zigzag pattern about 1 3/4 inches in length. In the future, components which are etched right on the printed-wiring boards will undoubtedly increase production rates and will result in more compact and lightweight chassis designs.

The new look in components for printed boards is also reflected in the video peaking coils marked on the photograph in Fig. 7. This photograph is a close-up view of one portion of the Westinghouse Chassis V-2342. The windings of each coil are located at one end of a small tubular coil form. When these units are mounted in an upright position, as shown in Fig. 7, they have a mushroom-shaped appearance. Two terminals extend from the bottom of the tubular form and pass through the board where they are soldered to the printed wiring. These terminals also support the component in an upright position. The miniature audio output transformers which are being used in small radio receivers have also been slightly altered for use in printed-wiring assemblies. The terminals have been redesigned and a lug type of mounting has been devised for easy insertion into the printed boards.

The service technician will eventually deal with these newly developed transformers and coils as printed circuitry comes into more general use throughout the industry.

Selenium Rectifiers

A new type of selenium rectifier is now available for use on printed-wiring boards. These units differ from the conventional rectifiers in that the terminals have been modified for insertion into slots provided in the printed boards. The rectifiers employ three different types of terminals each of which is designed for automatic or manual methods of assembling. The three terminal types are: the square tipped for thin printed-wiring boards, the snap in which locks the component to the board prior to the soldering process, and the tapered end designed for easy penetration into thick printed-wiring boards.

Each style of terminal has a shoulder which acts as a spacer and

keeps the terminal from being inserted too far into the slot; thus, the rectifier plates cannot come into contact with the wiring on the board. This feature improves heat dissipation and increases the area available for additional components and wiring.

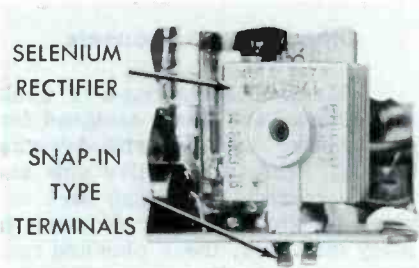

Fig. 8. Photograph of the New Terminals Used on Selenium Rectifiers Designed for Printed-Wiring Boards.

An example of one of these new units as it appears in the Philco Model 665 portable radio may be seen in Fig. 8. Selenium rectifiers designed for printed boards reduce the cost of assembling because they are more adaptable to automatic machines and because their contacts are suitable for dip soldering.

Controls

Controls with a large number of physical variations are now available for utilization on printed-wiring boards. Holes for the wiring are no longer necessary in the terminals of these components. The terminals are fashioned to penetrate the board and are terminated in one plane for connection to the printed wiring.

The volume control pictured in Fig. 6 mounts on the printed board by a threaded bushing and nut. The terminal lugs are bent in the same direction as the shaft and extend through slots provided in the board. With this arrangement, all the terminals can be fastened simultaneously by the dip-soldering process.

The control assembly shown in Fig. 5 illustrates another new mounting style designed especially for printed-wiring boards. This control employs a self-supporting, snap-in mounting bracket which permits the control to be mounted parallel with the printed board. The bracket has four mounting tabs that protrude through the board and are secured by the soldering operation. The terminals of these units are usually straight lugs which extend through the printed-wiring board.

Other new designs feature the twisted-ear method of mounting in which the control is perpendicular to the chassis board. This unit is

... another
MALLORY
service-engineered
product

Exact Duplicates

as you prefer them

Want them ready to use?
Mallory can give you completely assembled dual controls in all the styles and characteristics to fit the most popular TV and auto radio sets.

Want to assemble your own?
A small stock of Mallory factory-assembled sections, switches and shaft tips lets you make thousands of combinations to match each job. It takes you only a few minutes to complete the control you need, and you save all the time of shopping for the right combination.

**You're right either way —
with Mallory.** Mallory Dual Controls assure you of duplicating the exact characteristics you require . . . with noise-free, long-lasting, stable controls that assure customer satisfaction. Your Mallory distributor carries a full stock of both types. See him today!

P. R. MALLORY & CO. Inc.

MALLORY

P. R. MALLORY & CO. Inc., INDIANAPOLIS 6, INDIANA

- Capacitors
- Controls
- Vibrators
- Switches
- Resistors
- Rectifiers
- Power Supplies
- Filters
- Mercury Batteries

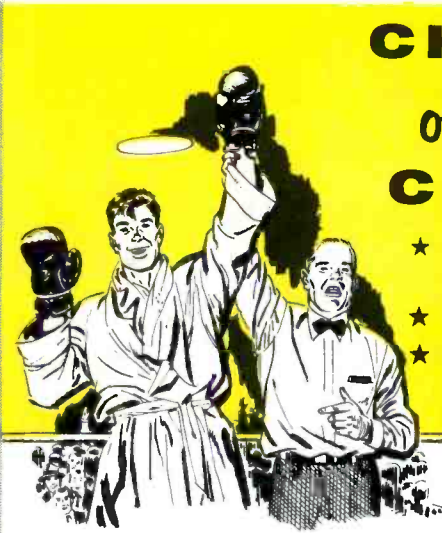

CHAMPION of all Fan-Type CONICALS

- ★ BETTER LOW BAND PERFORMANCE!
- ★ BETTER HIGH BAND PICKUP!
- ★ GUARANTEED SUPERIOR TO ANY CONICAL ON THE MARKET TODAY!

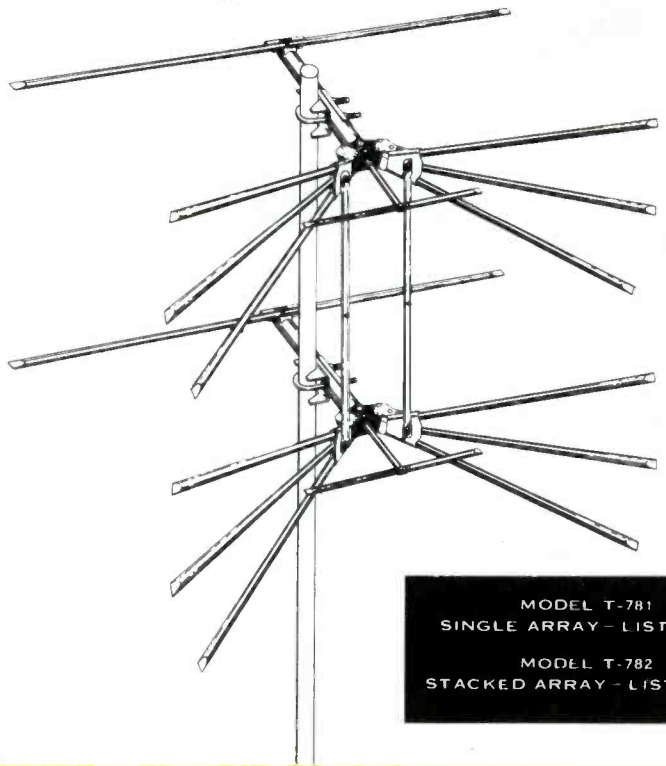

MODEL T-781
SINGLE ARRAY - LIST \$5.56

MODEL T-782
STACKED ARRAY - LIST \$11.53

An Exclusive Tenna Development

Now, Tenna has combined all of the better features of the BAR-X conical and the fan-type conical into a single model to give you the ultimate in both high band and low band performance. The NEW Tenna T-781 and T-782 are guaranteed superior to any other conicals. Try this NEW Tenna conical under the toughest reception conditions and you'll be astonished with its performance. All aluminum, full size and completely pre-assembled . . . and at a low, low price.

TENNA Manufacturing Co.

7580 GARFIELD BLVD. • CLEVELAND 25, OHIO

very similar to the one shown in Fig. 6 except that the threaded bushing is omitted. Should it become necessary to replace any one of these new components, the service technician will usually find it desirable to obtain an original replacement because of the unusual design features.

Other New Components

Many different types of cable connectors have been designed for exclusive use on printed-wiring boards. Miniature tubular pins and female contacts have also been devised for this express purpose. In many instances, these pins and contacts are supplied in a chainlike strip for automatic feeding and crimping operations. One manufacturer has developed a right-angle tube socket for use with printed-wiring assemblies. The terminals of the tube socket are inserted into the etched board in the same manner that the terminals of other components are inserted, but the socket is perpendicular to the flat surface of the board. In this design, the tubes are parallel with the board; and a very compact arrangement results.

A printed-circuit board that is folded into a three-dimensional form is a new development which may in time make necessary the redesign of other conventional components. Complete subassemblies similar to modular units and intended for use in printed circuitry are also in the process of development. These units combine two or more parts in a single molded plastic assembly which is ideal for automation.

The component modifications discussed in this article are only a part of what the future holds along these lines. It may be well for the service technician to learn about these new components because a large degree of his business in the very near future may depend upon his knowledge of them and techniques for their replacement.

LESLIE D. DEANE



If so, please notify us by the 15th of the preceding month. This will assure uninterrupted delivery of each of your copies of PF REPORTER.

Also, please include your present address. If possible, simply send the address label from one of your back issues. Mail both to:

PF REPORTER
2201 E. 46th Street • Indianapolis 5, Indiana

"5,904 HOURS WITHOUT FAILURE"



6ET-4103

YOU CAN BE SURE ... IF IT'S
Westinghouse

RELIATRON® TUBES

WESTINGHOUSE ELECTRIC CORPORATION, ELECTRONIC TUBE DIVISION, ELMIRA, N. Y.

Westinghouse Locked-TV Test* at Lew Bonn Company demonstrates how you can eliminate excessive call-backs!

ARE CALL-BACKS EATING UP YOUR PROFITS? Listen to this report from W. J. Heisel (at left in photo), General Manager, Lew Bonn Company, Minneapolis:

"We wanted to *prove* to our service dealers the outstanding dependability of Westinghouse RELIATRON Picture and Receiving Tubes. So we conducted a Westinghouse Locked-TV Test in our showroom. The set shown in the photo, completely equipped with *stock* Westinghouse RELIATRON Tubes, was turned on at two P.M. on April 25. As these words are written, this Westinghouse-equipped set has been operating continuously for 5,904 hours without a single tube failure—and it's still going strong!"

5,904 HOURS! Almost *four years* of average family viewing! This is *real* dependability. Dependability that cuts costly call-backs practically to the vanishing point. And notice . . . the tubes used in the Lew Bonn Company test were *taken right from stock*. They're the identical kinds of tubes that *you* can handle—to protect your profits, win customer confidence—simply by calling your Westinghouse Distributor. Do it today.

*This dramatic tube-endurance test was rechecked Dec. 27, 1955 when this ad went to press. On that date, the test had been operating 246 days or 5,904 hours.



look to the little Indian
to give your customers
the **BEST** in replacement
electrolytic capacitors



SANGAMO Type MT "Chieftains"

Specially designed for television and other electronic applications where operation at 85° C is required... hermetically sealed in round aluminum containers... small size makes them good for mounting in limited space... they fit anywhere and can be mounted in almost any position.

SANGAMO Type PL "Warrior"

These twist-tab electrolytics are used as original equipment by all major manufacturers... they are exact replacements... assure long life and dependable performance at 85° C and under conditions of high surge voltages and extreme ripple currents.

SANGAMO Type CS "Tomahawk"

These electrolytic capacitors are contained in wax-filled cardboard tubes with insulated leads approximately 8 inches in length extending from both ends of the unit. Each unit is supplied with a mounting strap to facilitate mounting to the chassis.

**Plug-in electrolytics
for printed circuit
replacement too!**

These dry electrolytic plug-in capacitors are exact replacements for most of the new sets with printed circuit chassis. Stock up now!

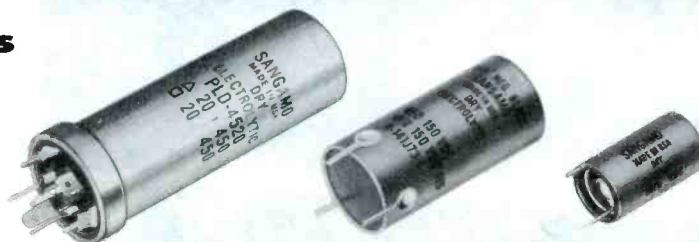

Those who know  choose Sangamo

SANGAMO ELECTRIC COMPANY
MARION, ILLINOIS

A STOCK GUIDE for TV TUBES



The following chart has been compiled to serve as a guide in the establishment of proper tube stocks for servicing TV receivers. The figures have been derived by combining: (1) a production factor based upon the number of models and upon an estimate of the total number of receivers produced by all manufacturers, and (2) a depreciation factor based upon an average life of six years for each receiver and with the figures reduced accordingly every two months.

The figures shown are based upon a total of 1,000 units. This was done in order to eliminate percentages and decimals. A listed figure of 100 would therefore imply that that particular tube type constitutes 10 per cent of all tube applications in TV receivers.

Some consideration should be given to the frequency of failure of a particular type of tube. A tube used in the horizontal output stage will fail much more frequently than one used as a video detector. As a result, even

though the same figure may be given for both tubes, more of the horizontal output tubes should be stocked.

The column headed '46-'56 is intended for use in those areas where television broadcasting was initiated prior to the frequency-allocation freeze. Entries in this column include all tubes used since 1946 except those having a figure of less than one per thousand — the minimum entry in this chart. The '52-'56 column applies to the TV areas which have been opened since the freeze. Because the majority of receivers in these areas will be of the later models, only the tubes used in these newer sets are considered in this column. The minimum figure of one per thousand also applies to this column.

The listing of a large figure for a particular type of tube is not necessarily a recommendation for stocking that number of tubes. It does indicate that this tube is used in many circuits and emphasizes the necessity for maintaining a stock sufficient to fill requirements between regular tube orders.

'46-'56 Models		'52-'56 Models		'46-'56 Models		'52-'56 Models		'46-'56 Models		'52-'56 Models		'46-'56 Models		'52-'56 Models	
c0A2	-	-		c#6AF4	3	3		c6BG6G	10	5	15	6SN7GTB	1	1	
c1AX2	-	-		#*6AF4A	-	-		6BH6	6	-	-	6SQ7	2	2	
c1B3GT	41	44		6AG5	25	7	1	c6BJ7	-	-	-	6SQ7GT	2	2	
1X2	4	1		6AG7	2	2		c6BK5	3	3	-	c#6T4	1	1	
1X2A	3	4		c6AH4GT	3	4		6BK7	2	5	1	c6T8	13	13	
c1X2B	2	2		c6AH6	6	7		c6BK7A	2	2		c6U8	10	12	
#*2AF4	-	-		6AK5	3	3		c6BL7GT	5	7		6V3	2	3	
c3A2	-	-		c6AL5	71	72		c6BN6	6	5		c6V6GT	18	17	
c3A3GT	-	-		6AL7GT	4	-		6BQ6GA	1	1		6W4GT	24	26	
*3AV6	-	-		c6AM8	1	1		6BQ6GT	17	24		6W6GT	7	11	
*3BZ6	-	-		#6AN4	-	-		*6BQ6GTA	-	-		c6X8	6	8	
3CB6	3	3		c6AN8	3	3		6BQ7	5	11		6Y6G	2	1	
*3CF6	-	-		c6AQ5	13	14		c6BQ7A	7	9		7N7	2	-	
*3CS6	-	-		6AQ7GT	2	2		c6BY6	-	-		c12AT7	13	13	
*4BQ7A	-	-		6AS5	3	3		*6BZ6	-	-		c12AU7	44	33	
*5AQ5	-	-		c6AS6	-	-		c6BZ7	8	3	2	c12AV7	2	3	
*5AT8	-	-		6AT6	4	3		c6C4	9	8		12AX4GT	2	4	
*5AU4	-	-		c6AU4GT	1	1		c6CB6	110	135		12AX4GTA	1	1	
*5BK7A	-	-		6AU5GT	3	3		c6CD6G	9	10		12AX7	4	5	
*5T8	-	-		c6AU6	118	110		6CF6	1	1		12AZ7	-	2	
c5U4G	44	46		6AV5GT	2	3		*6CG7	-	-		c12BH7	10	13	
5U4GA	1	1		c6AV6	16	17		c6CL6	1	2		*12BQ6GA	-	-	
5U8	1	1		c6AX4GT	12	11		c6CS6	3	3		*12BQ6GTB	-	-	
5V4G	6	-		6AX5GT	1	2		c6CU6	1	1		c12BY7	8	9	
*5V6GT	-	-		c6BA6	12	10		c6DC6	-	-		12BZ7	2	-	
*5X8	-	-		6BC5	9	7		6J5	3	3		12SN7GT	5	4	
5Y3GT	3	2		c6BC7	-	-		6J5GT	1	-		*19AU4	-	-	
6AB4	2	2		c6BD4A	-	-		6J6	30	27		*25BQ6GA	-	-	
6AC7	6	6		6BE6	6	7		6K6GT	14	9		25BQ6GT	3	4	
# A stock of these tubes should be maintained in UHF areas.								6S4	8	9		*25BQ6GTB	-	-	
* New tubes recently introduced.								c6S4A	-	-		*25CD6GA	-	-	
c These tubes have been used in color television receivers.								6SH7GT	1	-		25L6GT	5	5	
								6SL7GT	3	2		25W4GT	1	1	
								c6SN7GT	64	70	3	5642	1	2	
								c6SN7GTA	7	7		c6505	-	-	

Notes on Test Equipment

(Continued from page 11)

the instruction manual supplied with the instrument, the receiver should then produce a normal raster; but if the horizontal transformer drive feature is used at the same time as the vertical drive signal, the raster may be only a fourth to a third of normal height.

The drive signals represented in Figs. 4A and 4B can be changed in

amplitude and shape to forms that are suitable for signal substitution in the sync circuits ahead of the vertical and horizontal output stages of a receiver. The instruction manual contains schematic diagrams of probes which can be constructed for that purpose; or if desired, probes can be purchased from the Winston Electronics, Inc., manufacturer of the Model 820. These probes are listed as Models 915 and 960 and are shown in Fig. 5.

The Model 960 takes the signal from the VERT DRIVE jack and con-

verts it into the shapes shown by the waveforms in Figs. 6A and 6B. The reversal of polarity is accomplished by movement of the slide switch

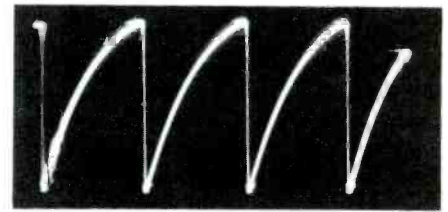

(A) Horizontal Grid Drive Signal—110 Volts Peak to Peak.

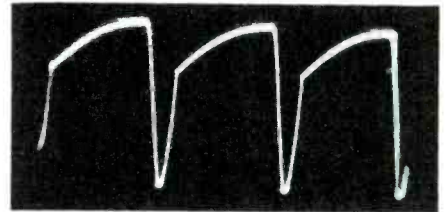

(B) Vertical Drive Signal—180 Volts Peak to Peak.

Fig. 4. Waveforms of the Drive Signals Obtained From the Win-Tronix Model 820.

which is on the probe. The Model 915 takes the signal from the HORIZONTAL GRID DRIVE jack and converts it into the shape shown by the waveform in Fig. 6C. By observing

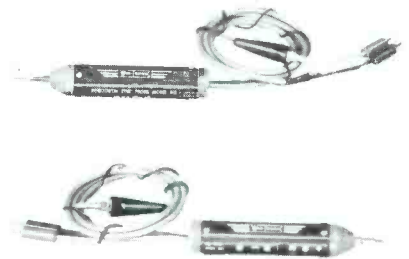

Fig. 5. Win-Tronix Model 915 and Model 960 Probes for Use With the Model 820 Dynamic Sweep Circuit Analyzer.

the manner in which the various sync circuits of the receiver respond to the converted signals, the technician can determine whether these circuits are operating properly.

The Model 820 will test flyback transformers and deflection yokes for continuity of windings or for shorted turns. The instrument is sensitive enough to detect a single shorted turn. Iron-core flybacks, air-core flybacks, and yokes for monochrome or color receivers can be tested. A neon lamp is used as the indicating device for these tests.

The continuity test can be used to check for excessive leakage be-

PAYS ITS WAY every day

**TESTS and
REPAIRS
TV PICTURE
TUBES**

**Makes Customers Happy
— Creates New Profits**

Servicemen now earn new servicing dollars in minutes and build satisfied customers—with B&K Deluxe Portable CRT 400.

Spots and corrects picture tube troubles in a few minutes, right in the home, without removing tube from set! Restores emission, stops leakage, repairs inter-element shorts and open circuits. Grid cut-off reading indicates picture quality customer can expect. Life-test checks gas content and predicts remaining useful tube life. Cuts operating costs, eliminates tube transportation. Also saves money on TV set trade-in reconditioning. Profits start the very first day.

Send for Bulletin 104-S



DELUXE CRT 400 with 4½" Plastic Meter

Weighs only 5 lbs. mounted in rugged, luggage style, carrying case covered with handsome, durable leatherette. Size: 11 x 7½ x 5". Net \$54.95

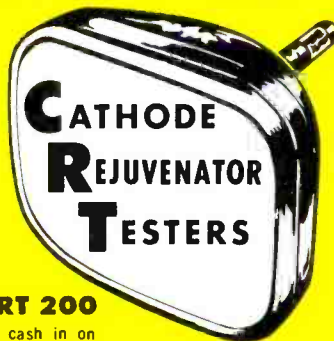

**CATHODE
REJUVENATOR
TESTERS**

ECONOMY CRT 200

Every serviceman can cash in on picture tube repairs with this low priced quick profit maker. Performs most of the functions of the CRT 400. Has 3" meter. In leatherette carrying case. Size: 11 x 7½ x 5". Weighs 5 lbs. Net \$39.95

**PROVEN IN
THE FIELD
EVERY DAY
BY OVER
20,000
SERVICEMEN**

Made by the Makers of the DYNA-QUIK Tube Tester

B & K MANUFACTURING CO.
3726 N. Southport Ave. • Chicago 13, Illinois





NOW! PHOTOFACT BRINGS YOU EXTRA SCHEMATIC COVERAGE

you get immediate coverage on leading receivers just as soon as they hit the market!

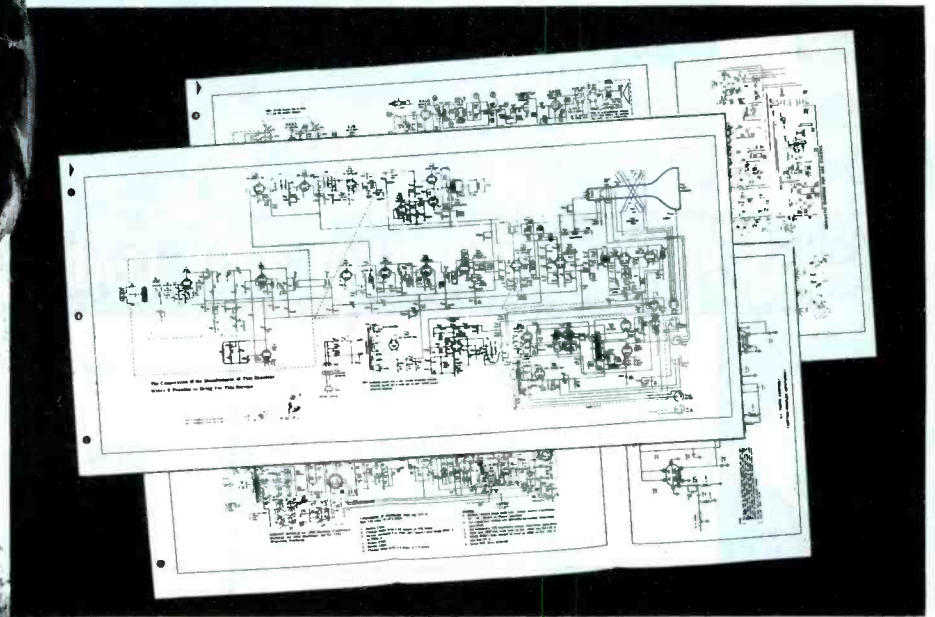

IT'S AN "EXTRA" SERVICE— IN ADDITION TO REGULAR COVERAGE— AT NO EXTRA COST TO YOU

Sams' PHOTOFACT now includes EXTRA schematic diagram coverage of the top manufacturers' new model releases. You get this up-to-the-minute EXTRA coverage at no extra cost in all current PHOTOFACT Sets. Look for them at your Parts Distributor today! See for yourself how PHOTOFACT keeps you current with the present output of new TV and Radio Models. Be sure to enter your "standing order" for each new monthly release of Sams' PHOTOFACT Sets—they'll put you out ahead in service work.

**remember—you get the world's finest service data —
you get it fastest in PHOTOFACT**

HOWARD W. SAMS & CO., INC., 2201 E. 46th St., Indianapolis 5, Indiana

OVER
5,000,000

AMPHENOL TWIN LEAD INSTALLATIONS have proved what dealers and installers have always known—with dependable AMPHENOL Twin Lead they are assured of:

TOP PERFORMANCE

electrically superior, low loss

EXCELLENT SERVICE

virgin brown polyethylene assures longer-lasting, trouble-free installations

CUSTOMER SATISFACTION

no call-backs, more referrals

FAIR PROFITS

good dealer mark-ups to fair list prices



5 POPULAR AMPHENOL TWIN LEADS

			List per 1000 Feet
	14-271 AIRCORE*	300 ohm—tubular construction contains and protects field of energy—assures lowest loss under wet or dry conditions. Excellent for fringe area installations. A must for UHF and coastal regions. *U.S. Patent 2,543,696	\$57.50
	14-056 STANDARD	300 ohm—60 mil web thickness. Standard of quality in thousands of installations.	\$36.50
	14-559 STEELCORE	300 ohm—72 mil web thickness, 7/28 copperweld conductors. Twice as tough and flexible!	\$38.50
	14-100 CENTURY	300 ohm—100 mil web thickness for applications where a strong line is needed.	\$45.00
	14-298 ROTATOR	Four conductor rotator cable with heavily ribbed virgin brown polyethylene dielectric.	\$50.50

SEE YOUR AMPHENOL DISTRIBUTOR FOR QUANTITY PRICES!



AMERICAN PHENOLIC CORPORATION *chicago 50, illinois*
AMPHENOL CANADA LIMITED *toronto 9, ontario*

tween separate windings of transformers, yokes, and coils. It can also be used to check the continuity

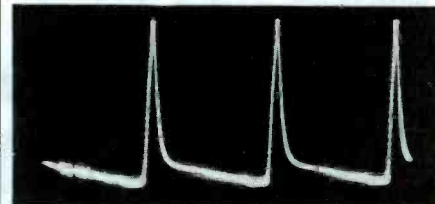

(A) Positive Vertical Sync Signal—18 Volts Peak to Peak.

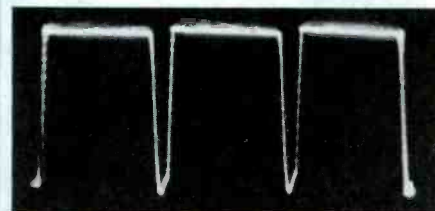

(B) Negative Vertical Sync Signal—18 Volts Peak to Peak.

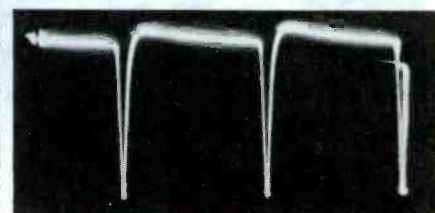

(C) Horizontal Sync Signal—12 Volts Peak to Peak.

Fig. 6. Sync Signals Obtained by Using the Win-Tronix Probes Shown in Fig. 5.

of speakers, resistors, vacuum-tube filaments, and series-filament strings.

Definitions?

In response to numerous requests for definitions of technical terms which occur commonly in electronics articles, we submit the following "daffynitions" (accuracy not guaranteed):

BANANA PLUGS — Horses raised on bananas.

CONTACT POTENTIAL — Sales enthusiasm.

RESPONSE CURVE — See Marilyn Monroe. (The connection may not be quite clear, but see Marilyn Monroe anyway.)

RISE TIME — Interval between sitting on a tack and hitting the ceiling.

STANDING WAVE — Saying good-bye from a crowded bus.

SWEEP GENERATOR — Broom factory.

PAUL C. SMITH

Signal Tracing in Sync Separators

(Continued from page 25)

from the video portion of the signal by a thin dark line. Two vertical pulses are visible, and the area between them has a filmy or ribbonlike appearance which is due to the presence of closely spaced horizontal pulses.

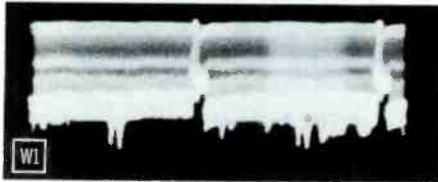

(A) Normal at 30 CPS.

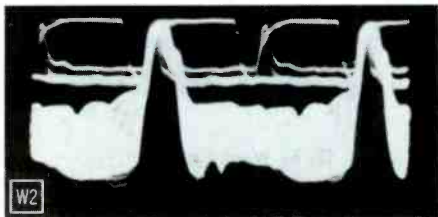

(B) Normal, at 7,875 CPS.

Fig. 2. Waveforms Observed at Grid of V10A in Circuit of Fig. 1.

These horizontal pulses are seen clearly in W2 of Fig. 2B. The greater sweep frequency of 7,875 cps in W2 gives the effect that W1 is being viewed with the horizontal gain of the oscilloscope increased to many times the original value. The amplitude of W2 is the same as that of W1. The narrow white trace above the video portion of the signal in W2 marks the blanking level.

The technician should be familiar with the characteristic differences in the appearance of 30-cps and 7,875-cps waveforms in order to prevent confusion between the two sweep rates during trouble shooting. In video circuits and sync separators, waveforms which are viewed at 30 cps will normally have the narrow pulses and filmy areas which are seen in W1.

The amplitude of a normal signal at the grid of V10A is variable and depends upon the setting of the contrast control in the cathode circuit of the video amplifier. The strength of this signal in the Olympic receiver was found to range from 10 to 80 volts peak to peak approximately.

The clipping action of V10A is consistent for wide ranges of signal amplitude because the only bias on the tube is a grid-leak bias that

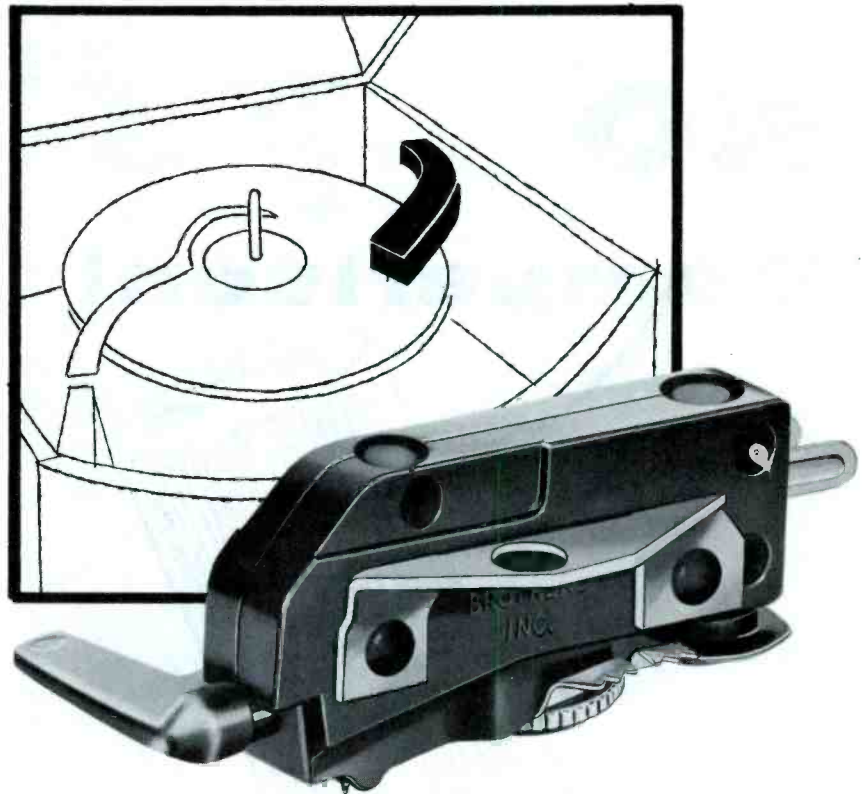

It's Dramatically New!

SHURE 'TWIN-LEVER' Ceramic Phono Cartridge

The most important advance in phono replacement cartridges since the introduction of 3 speeds!

- To improve the quality of all conventional home phonographs!
- To replace 128 3-speed, plastic-cased, ceramic and crystal, turnover and single needle cartridges!

We make these strong claims: the "Twin-Lever" is the finest replacement cartridge ever developed! It sets a new high, leaving all other replacement cartridges far behind its brilliant level of tone superiority . . . individual needle compliance for superior 78 rpm and microgroove response . . . unique needle shift design . . . amazingly simple needle replacement.

The "Twin-Lever" offers you maximum replacement coverage with minimum investment because it handles the replacements for practically all 3-speed phonos using plastic-cased cartridges. New business and greater profits can be yours — because this "Twin-Lever" cartridge costs only \$9.50 list — yet it can make conventional 3-speed phonos sound better than when they were new!

See your Shure Distributor today — he has the "Twin-Lever" in stock. And here's a tip: buy more than you think you will need — or you'll have to go back for more mighty soon. That's how good this cartridge is. And don't take our word for it — ask your first "Twin-Lever" customer what he thinks!

MODEL WC10

List Price **\$9.50**

(including two synthesized sapphire-tipped needles)

MODEL WC10D

List Price **\$34.00**

(including a 1-mil diamond-tipped needle and a 3-mil synthesized sapphire-tipped needle)



----- *The Mark of Quality*

NO Comparison!



Imperial—the golden vibrator
in the black and gold box.

Try any 12-volt replacement vibrator—none can compare with Vokar Imperial for value and performance!

Prepare now for big increase in 12-volt replacements (all '56 cars have 12-volt systems!).

Two Imperials will fill all your replacements!

- Imperials are Sahara Dry-Packed to keep points corrosion-free, provide sure starts.
- Imperials have extra-large points, Vapor-Block coated to eliminate early-life failures.
- Imperials are Whisper-Quiet to assure unequalled radio reception.



Order your supply of 12-volt Imperials now—unlimited shelf-life—unconditionally guaranteed!

VOKAR

3129—3 prongs,
12-v, base no. 9

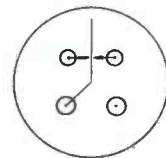
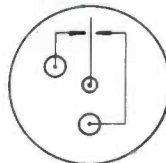

4124—4 prongs,
12-v, base no. 4

VOKAR VIBRATORS
—preferred by
leading manufacturers
of auto-radios.

VOKAR CORPORATION • Dexter 3, Michigan

automatically adjusts itself to the strength of the incoming signal. Fig. 3 illustrates the change of bias when the signal strength changes. The signal is strong in Fig. 3A and weak in Fig. 3B. The average value of the

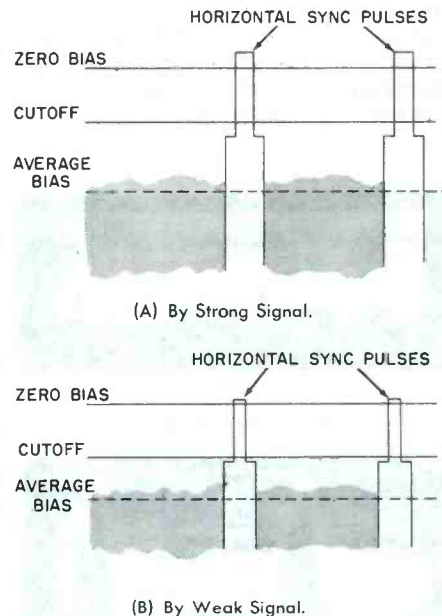

Fig. 3. Development of Grid-Leak Bias in a Sync Clipper.

bias voltage is more negative than the cutoff voltage in both cases, and the tube conducts only when a sync pulse appears on the grid. The tip of each sync pulse drives the grid voltage to a value that is slightly positive with respect to the cathode voltage, and the grid draws enough current to maintain the grid-leak bias. If the amplitude of the incoming signal decreases, the grid draws less current during each pulse and the grid-leak bias decreases. The tips of the sync pulses therefore continue to drive the grid positive even though the height of the pulses has decreased, and some grid-leak bias is maintained.

An extremely strong input signal at the antenna terminals or a lack of AGC voltage may cause the IF or video stages to become overloaded. The signal will be compressed or limited under these conditions, and it will be delivered to the sync separator with flattened sync pulses. If the sync pulses are of inadequate height in comparison with the rest of the signal, portions of the video signal or noise pulses will approach the amplitude of the sync pulses and can pass through the sync separator. False triggering of the sweep system occurs as a result. The indication on the picture tube in mild cases is a jittery horizontal sweep. More severe compression of the signal produces sidewise pulling of the picture and slow vertical rolling together with extreme contrast or excessive blackness in the picture.

Fig. 4 is a view of W2 in which the height of the horizontal sync pulses is severely limited. This waveform was produced by reducing the AGC voltage in the receiver.

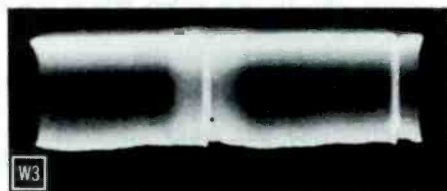

Fig. 4. Waveform Observed at Grid of V10A at 7,875 CPS and Showing Flattened Pulses Caused by Overloading of Video Amplifier.

Since the flattening of the pulses in this case was due to overloading in the video amplifier, the effect became worse as the contrast control was advanced. The amplitude of the waveform was 80 volts peak to peak regardless of the setting of the contrast control; only the shape of the waveform changed.

Plate Waveforms of Sync Separator

When the receiver is operating normally, the waveform taken at a sweep rate of 30 cps at the plate of the sync separator resembles W3 in Fig. 5A. The waveform contains



(A) Normal at 30 CPS.



(B) Normal at 7,875 CPS.

Fig. 5. Waveforms Observed at Plate of V10A.

clear-cut vertical pulses plus a hazy multitude of horizontal pulses. A very slight horizontal pulling in the picture is evident in this waveform as an uneven bottom fringe caused by variations in the heights of the horizontal pulses. The individual horizontal pulses seen at the 7,875-cps sweep rate are shown as W4 in Fig. 5B.

Sensational!

Retract-O-Matic

— the new, foolproof replacement

Pickup



Even if you drop it...or slide it...

Retract-O-Matic protects records and needles from damage!

WEBSTER ELECTRIC proudly offers the new, exclusive RETRACT-O-MATIC—the sensational crystal pickup that provides positive protection to record and needle, *even when it is dropped or slid* across the record surface.

Retract-O-Matic is priced to make it a *practical replacement* for installation on any manual record player.

THE(DOME) ABSORBS THE SHOCK

The unique spring-mounted construction gives absolute insurance against damage to cartridge, needle, or record. The slightest pressure on the arm automatically lifts the needle from the record's surface, and lets Retract-O-Matic's rounded "dome" absorb the shock.

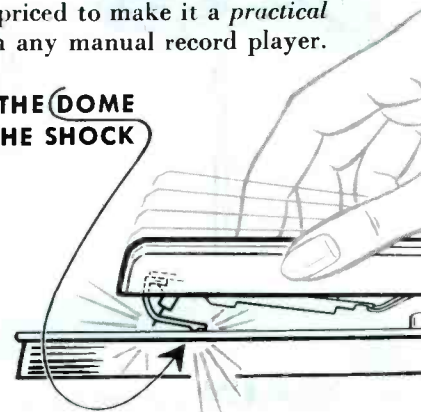

A BIG PROFITABLE MARKET

Retract-O-Matic is a "natural" as a pickup replacement for record players, children's and portable phonographs. List price of complete assembly (tone arm, cartridge, arm rest and all parts needed for installation) is only \$6.95—little more than the price of the cartridge alone. Order a stock today. Step up your sales with Retract-O-Matic!

WEBSTER  ELECTRIC
RACINE WISCONSIN

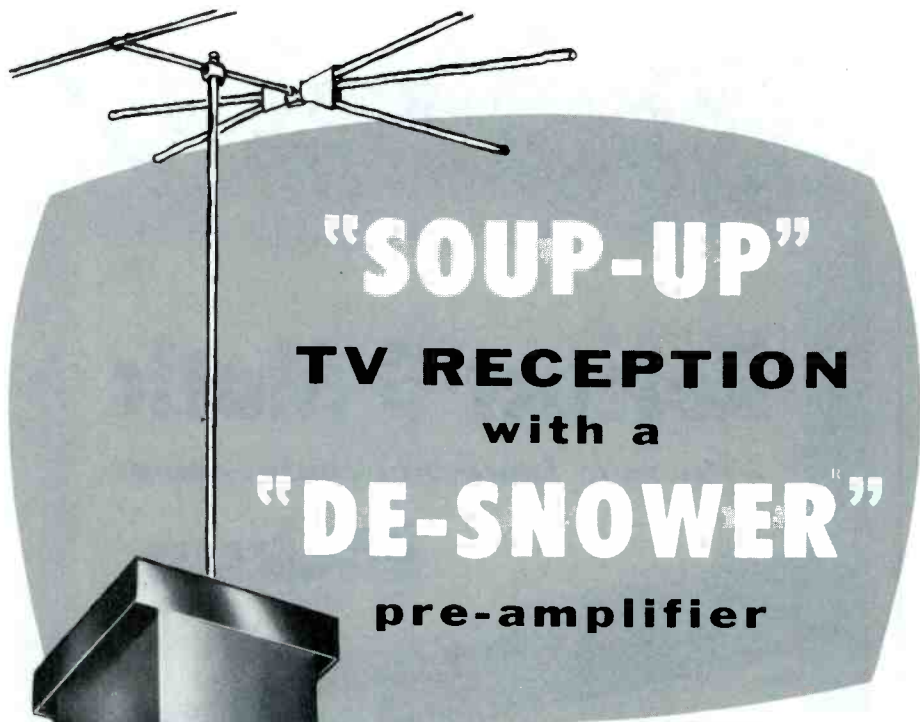

**"SOUP-UP"
TV RECEPTION
with a
"DE-SNOWER"
pre-amplifier**



IN FRINGE AREAS

the Jerrold De-Snower gives beautifully clear TV pictures where conventional boosters fail. Sensitive, noise-free, cascode front end mounts at the antenna . . . amplifies weak signals before line losses set in. Lets you run noise-reducing coax to indoor power supply where it converts back to 300 ohms for receiver.



IN METROPOLITAN AREAS

the De-Snower brings in that "extra" channel that was just out of range before. Coax lead-in cuts troublesome noise and interference pick-up on *all* channels.

- Single-channel models for any VHF channel—30 db gain.
- Broadband models for channels 2 thru 6 or 2 thru 13—25 db gain.
- Noise level approaches theoretical minimum—6 db.
- Flat response for color.

GAIN more satisfied customers and a big new source of income. Send today for full details on the Jerrold De-Snower—the preamp that's used in hundreds of community antenna systems. See your nearest Electronic Parts Distributor, or write directly to Jerrold.



JERROLD ELECTRONICS CORP.
2218 Chestnut Street • Philadelphia 3, Pa.
In Canada: Jerrold Electronics (Canada) Ltd., Toronto 17, Ont.

The amplitude of the signal at the plate of the sync clipper is approximately 35 volts peak to peak. This value is practically constant, under normal conditions, for any amplitude of incoming signal. The pulses must maintain a constant amplitude if the horizontal AFC circuit in this receiver is to operate properly. This AFC circuit is a pulse-width system which controls a blocking-oscillator type of horizontal oscillator.

If the grid-leak circuit of V10A does not develop sufficient bias to hold the video portion of the input signal below the cutoff voltage, some of the video signal will appear in the plate circuit. Fig. 6 shows W3 as it appears when contaminated by video.

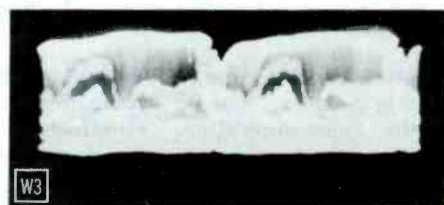

Fig. 6. Waveform Observed at 30 CPS at Plate of V10A When Capacitor C45 is Leaky.

The symptoms caused by insufficient bias were horizontal pulling and slow vertical rolling neither of which grew worse at higher settings of the contrast control. The range of contrast in the picture was normal because the IF and video stages were not overloaded.

The grid bias of V10A was too low because the input coupling capacitor C45 was leaky and could not hold a large enough charge to furnish the correct amount of grid-leak bias. Another possible cause of insufficient bias would be negative grid current caused by grid emission in the sync-separator tube. Negative grid current would change the grid voltage considerably, since there is a very high resistance path to ground in the grid circuit.

Plate Waveforms of Sync Amplifier

Waveform W5 in Fig. 7A shows the normal 30-cps waveform taken at the plate of the sync amplifier V10B. The general appearance of W5 is similar to that of W3 except that the pulses are positive and the amplitude of the waveform is 80 volts from peak to peak. The sawtooth appearance of the top of W5 is caused by feedback from the vertical oscillator through C52. (See Fig. 1.) If the oscillator were disabled, the top of the waveform would appear level except for two sharp spikes which

represent the vertical pulses. In some receivers, this flat-topped waveform is obtained at the plate of the sync amplifier without the necessity of disabling the vertical oscillator.

The normal appearance of the horizontal pulses at the plate of V10B is shown in W6 of Fig. 7B. The amplitude of this waveform is approximately 60 volts.

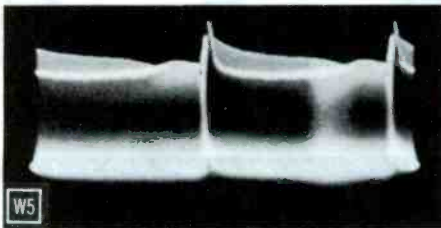

(A) Normal at 30 CPS.



(B) Normal at 7,875 CPS.

Fig. 7. Waveforms Observed at Plate of V10B.

In this particular receiver, the output of the sync separator is direct-coupled to the grid of the sync amplifier. Grid-leak bias is developed on V10B by the RC circuit composed of C47 and R56. Trouble somewhere in this RC combination or in the plate circuit of V10A should be suspected as the cause of lost synchronization if the signal is normal at the grid of V10A and defective at the grid of V10B.

If C47 were to become shorted, the negative bias would fail to develop on the grid of V10B. The amplitude of the waveform at the grid of the sync amplifier would be only a fraction of a volt, and waveform W5 at the plate of the sync amplifier would appear as it does in Fig. 8A. The sweep rate of this waveform is 30 cps, and the amplitude is only 5 volts. The feedback pulses from the vertical oscillator predominate in this waveform, because the sync-pulse signal is compressed almost to zero amplitude. The DC voltages on the various elements are of interest in this case. Measured with a VTVM, these voltages are 1.2 instead of the normal -2 on the grid of V10B and 1.2 instead of the normal 45 on the plate of V10A.



BEST FOR COLOR TEST!



**MODEL 617
3" OSCILLOSCOPE**

The most for your scope dollar. Flat-face CRT gives edge-to-edge accuracy... laboratory precision *plus* field ruggedness. And at your electronic jobber, it's just... \$269.50.

There's just one way to test the new color TV sets... WITH NTSC COLOR PATTERN. That's what Hycon's Model 616 Color Bar/Dot Generator offers... *all* standard colors, sequences and patterns easily selected and graphically shown *in actual color* right on the control panel. For color TV, get ready... GET HYCON!

"Where Accuracy Counts"
Hycon ELECTRONICS, INC.
A Subsidiary of Hycon Mfg. Company

321 SOUTH ARROYO PARKWAY
PASADENA, CALIFORNIA

**MAIL,
please,
for Catalogs
616 and 617**

HYCON ELECTRONICS, INC. Dept. P
P.O. Box 749 Pasadena, California
Please send me the new model 616 and 617 catalogs.

Name _____
Address _____
City _____ State _____

Use Your Military Training

The time was never more opportune than now for becoming associated with the field of advanced electronics. Because of military emphasis this is the most rapidly growing and promising sphere of endeavor for the young electrical engineer or physicist.

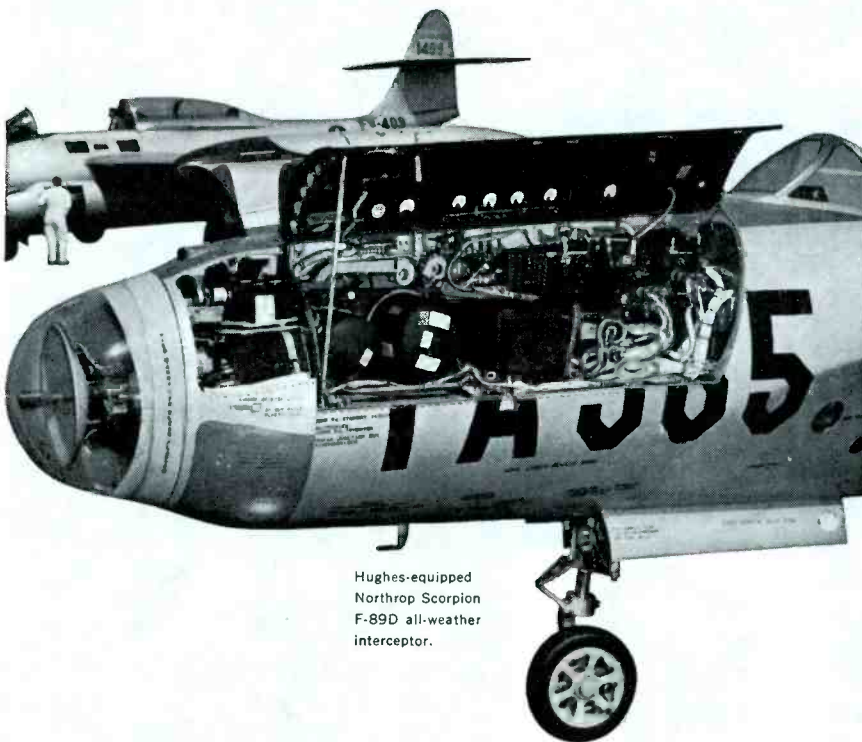

Hughes-equipped Northrop Scorpion F-89D all-weather interceptor.

Scientific Staff
Relations

Hughes

RESEARCH AND
DEVELOPMENT
LABORATORIES

Culver City
Los Angeles County
California

E.E. or PHYSICS GRADUATES
with experience in
RADAR or ELECTRONICS
or those desiring to enter these areas...

Since 1948 Hughes Research and Development Laboratories have been engaged in an expanding program for design, development and manufacture of highly complex radar fire control systems for fighter and interceptor aircraft. This requires Hughes technical advisors in the field to serve companies and military agencies employing the equipment.

As one of these field engineers you will become familiar with the entire systems involved, including the most advanced electronic computers. With this advantage you will be ideally situated to broaden your experience and learning more quickly for future application to advanced electronics activity in either the military or the commercial field.

Positions are available in the continental United States for married and single men under 35 years of age. Overseas assignments are open to single men only.

The horizontal pulses which occur at the plate of V10B when C47 is shorted are shown in waveform W6 of Fig. 8B at a sweep rate of 7,875 cps. The amplitude of this waveform is only 0.3 volt.

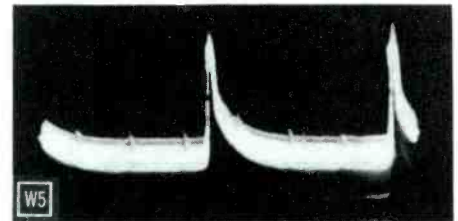

(A) At 30 CPS.

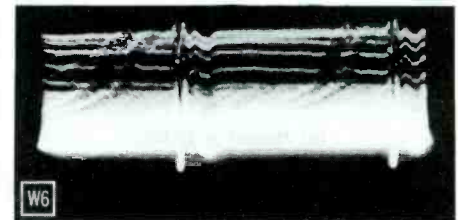

(B) At 7,875 CPS.

Fig. 8. Waveforms Observed at Plate of V10B When Capacitor C47 Is Shorted.

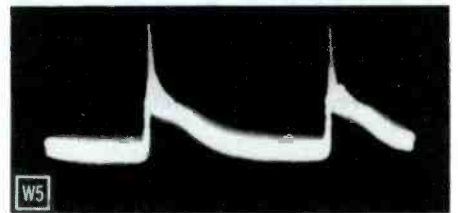

Fig. 9. Waveform Observed at 30 CPS at Plate of V10B When Resistor R56 Is Open.

An open condition in R56 increases the bias on V10B because the discharge path for the excess electrons on the grid side of C47 is broken. A waveform such as W6 in Fig. 9 can be found at the plate of the sync amplifier if R56 becomes open. The horizontal pulses which are shown are only slightly lower in amplitude than normal, but the DC voltage on the plate of V10B is about 60 volts instead of the normal value of 35 volts because the conduction of V10B is greatly reduced. A train of damped oscillations is produced by each pulse. If the contrast control is advanced, the oscillations increase in amplitude and engulf the horizontal pulses. The result is a loss of horizontal synchronization, although vertical synchronization is not greatly impaired.

The distorted waveform W5 in Fig. 10 is observed at the plate of V10B when the plate-load resistor R59 becomes open. The amplitude of the waveform is 45 volts or more.

The pulses, which have a frequency of 60 cycles, are composed principally of the feedback signal from the vertical oscillator. Synchronization is totally lost. The DC voltage on the plate is -15 volts instead of the normal value of 35 volts.

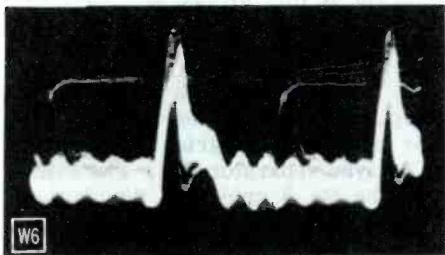

Fig. 10. Waveform Observed at 7,875 CPS at Plate of V10B When Resistor R59 Is Open.

One output of the sync amplifier is to the integrator network, which is a printed circuit made up of series resistors and shunt capacitors. The network converts the combined sync pulse signal into a series of pulses which occur at a frequency of 60 cps. These pulses are applied to the grid of the vertical oscillator. Waveform W7 (Fig. 11) is a view of the signal which normally appears at the output terminal of the integrator when the vertical oscillator is not disabled. Most of the signal is composed of feedback from the oscillator, and the amplitude of the signal is 50 volts.

The vertical oscillator in the Olympic receiver of Fig. 1 uses a multivibrator circuit which requires a positive sync pulse for its operation, but some other receivers are designed to use a negative pulse as the input to the vertical oscillator.

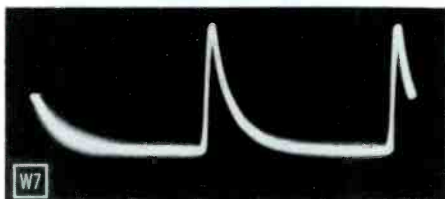
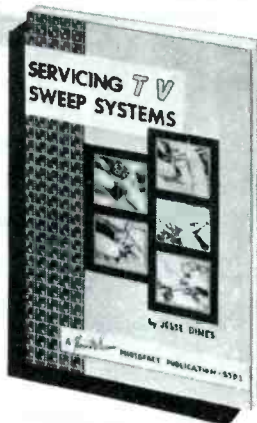

Fig. 11. Waveform Observed at Output of Integrator Circuit in Fig. 1.

The other output of the sync amplifier is by way of capacitor C55 which is part of a differentiating circuit. This output is coupled to the grid of the horizontal AFC tube, and the differentiating action is completed in the circuit of this tube. An additional function of the differentiating network is to sharpen the leading edges of the horizontal pulses.

In many older sets, additional stages were included in the section which functions as a sync separator. A noise limiter or sync amplifier



"Servicing TV Sweep Systems"

only \$2.75 ORDER TODAY

SAMS BOOKS
keep you ahead in
ELECTRONICS

Having Trouble with Sweep Systems?

This book TROUBLE-SHOOTS for you—makes you an expert on Sweep Systems

Describes the operation, circuit function and circuit variation of the different types of vertical and horizontal sweep systems common to most TV receivers. Describes best methods of analyzing circuits and trouble-shooting the vertical and horizontal sweep systems; fully supported by helpful photographs, waveforms and service hints covering specific troubles. Also discusses construction of transformers, coils and deflection yokes. 212 pages 5½ x 8½"; fully illustrated. Only \$2.75

USE HANDY ORDER FORM BELOW

Sams books cover every phase of Electronics for the service technician, engineer, student or experimenter. Listed below are a few of the many valuable Sams books available at electronic parts distributors and leading book stores.

USE THIS ORDER FORM

SERVICING TV SWEEP SYSTEMS \$2.75

- Color Television for the Service Technician. Prepares you for the day when you will be installing and servicing color TV. 116 pages, 8½ x 11". \$2.50
- Analyzing and Tracing TV Circuits. Presents a new approach to TV servicing. 168 pages, 8½ x 11". \$3.00
- TV Service Data Handbook. Most frequently needed charts, tables and formulas required in TV servicing and installation. 112 pages, 5½ x 8½". \$1.50
- TV Test Instruments. How to operate each test instrument used in TV service work. 175 pages, 8½ x 11". \$3.00
- TV Servicing Timesavers. Outlines handy service techniques gained from actual experience. Quick reference. 124 pages, 5½ x 8½". \$1.50
- Fundamentals of Color Television. Complete up-to-date explanation of Color TV. Easy to understand. 224 pages, 5½ x 8½". \$2.00
- Photofact Television Course. Gives a clear, complete understanding of TV principles, operation, practice. Used by thousands of students. 208 pages, 8½ x 11". \$3.00
- TV Servicing Short-cuts. Actual service case histories show you how to solve similar troubles in any receiver. 100 pages, 5½ x 8½". \$1.50
- UHF Antennas, Converters & Tuners. Covers all antenna types, transmission lines, matching networks. UHF converters, tuners. 136 pages, 5½ x 8½". \$1.50
- Servicing TV in the Customer's Home. Short-cut methods for repairs in the field. 128 pages, 5½ x 8½". \$1.75
- Pay As You See TV. A clear exposition of the facts. Four informative chapters present the case for this new development in TV entertainment. 96 pages, 5½ x 8½". \$1.50

- Video Handbook. Exhaustive coverage of entire subject of TV. Covers design, construction, production, installation, operation and service. 892 pages, 5 x 7". \$5.95

TV Tube Location Guides:

- Vol. 5. Shows tube positions and functions in hundreds of TV receivers; helps locate faulty tube quickly. Invaluable in service work. 200 pages, 5½ x 8½". \$2.00
- Vol. 4. Covers receivers produced in 1952-1953. 192 pages, 5½ x 8½". \$2.00
- Vol. 3. Covers receivers produced in 1951-1952. 192 pages, 5½ x 8½". \$2.00
- Vol. 2. Covers receivers produced in 1950-1951. 208 pages, 5½ x 8½". \$2.00
- Vol. 1. Covers receivers produced in 1948-49-50. 208 pages, 5½ x 8½". \$2.00

COYNE BOOKS

Distributed by Howard W. Sams & Co., Inc.

- TV Servicing Cyclopedic \$5.95
- Latest Testing Instruments for Servicing Radio-TV \$3.25
- Practical TV Servicing and Trouble-Shooting Manual \$4.25
- Technical Dictionary \$2.00
- TV and Radio Handbook \$2.75
- Bigger Profits in TV \$1.50
- Application of Radio & TV Principles \$3.25
- Radio & TV Circuits \$3.25

There is an authoritative Sams book on virtually any Electronic subject in which you're interested. Check below for FREE Book List describing all Sams books.

Send Book List



Look for
SAMS BOOKS
on the
"Book Tree"
at your Parts
Distributor

HOWARD W. SAMS & CO., INC.

Order from your Parts Jobber today, or mail to Howard W. Sams & Co., Inc., Dept. 3-B6, 2201 East 46th St., Indianapolis 5, Indiana.

Send books checked above. My (check) (money order) for \$ is enclosed.

Name

Address

City Zone State

(outside U.S.A. priced slightly higher)

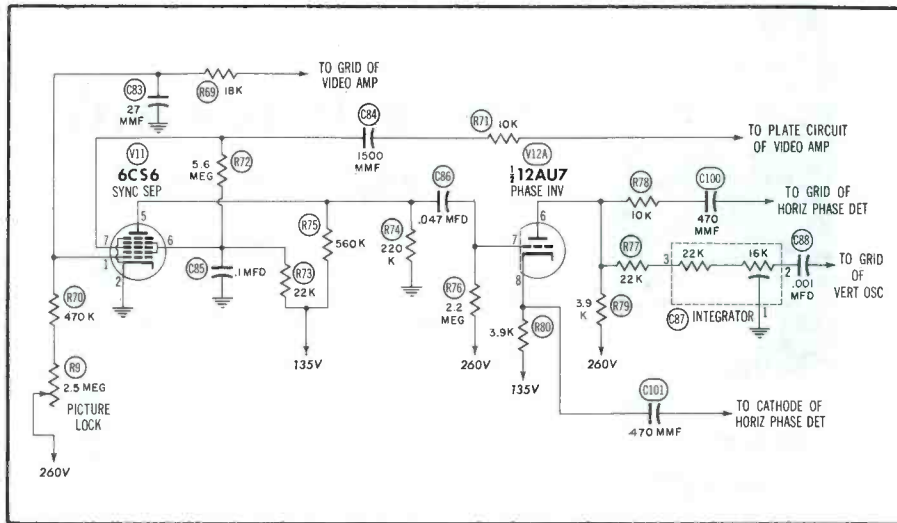

Fig. 12. Schematic Diagram of Gated Sync Separator in Capehart Chassis CX-38C.

may precede the sync clipper; and, in some cases, there may be both an amplifier and a phase inverter after the clipper stage.

Signal tracing through these more complex circuits is basically the same as in the simplest type of sync separator. The incoming signal should be checked through each stage in order to be sure that the signal is not being lost, attenuated, or distorted, and that the polarity of

the output pulses is correct according to service data.

Gated Sync Separator

Separate stages which function as extra amplifiers or noise limiters are being included in relatively few receivers today. Those sets which make special provisions for noise limiting generally do so by means of a gated sync separator. This circuit is built around a pentagrid tube

(either a 6BE6 or a 6CS6) which functions both as a sync clipper and as a limiter of noise pulses of high amplitude. A circuit which is representative of this type of sync separator is included in the Capehart Chassis CX-38C. A schematic diagram of this circuit is presented in Fig. 12.

In this circuit, a signal from the plate circuit of the video amplifier is coupled to grid No. 3 of the 6CS6 sync separator V11. The cathode, the No. 3 grid, and the plate of V11 function as a triode; and the video portion of the input signal to this sync separator is clipped in exactly the same manner as in the circuit previously described.

Negative pulses are delivered to the phase inverter V12A where they are amplified. Positive pulses from the plate of V12A are coupled to the vertical oscillator through an integrating circuit. Pulses are taken from both the plate and the cathode of V12A for application to the horizontal circuit because the control circuit for the horizontal oscillator is a phase detector and requires pulses of two polarities. The process of signal tracing through the foregoing circuitry is very similar to the

at your fingertips...

CLEAR BEAM'S

5

**"EASY WAY" ANSWERS
FOR TOUGH FRINGE
INSTALLATIONS!**

B CLEAR BEAM ANTENNA CORP.

CANOGA PARK, CALIF. • CHICAGO, ILL.

Your Clear Beam distributor has all 5 antennas — contact him today!

It's an established fact (and you know it, too) that no one antenna can lick every fringe area problem.

In view of this, Clear Beam manufactures five different types of fringe antennas — each tops in its field!

All five Clear Beam fringe antennas provide easy installation, improved picture quality and happy customers.

One of the five is the tailor-made answer to your installation headaches — and a faster way to higher profits!

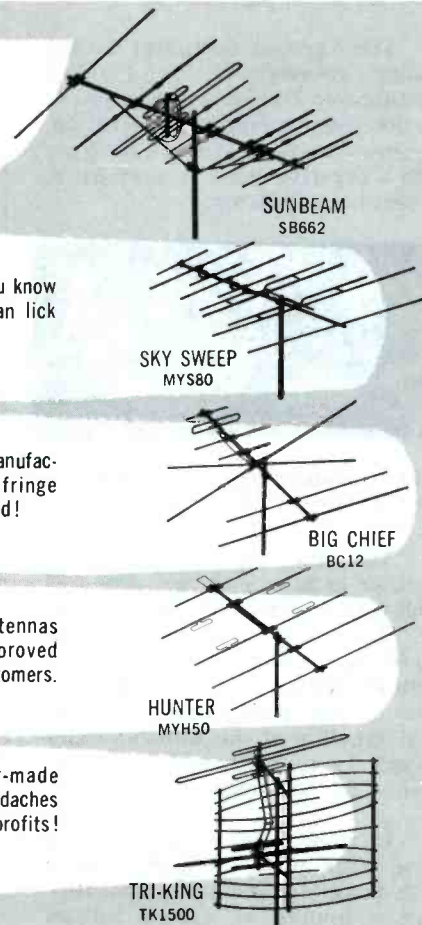

routine which was used to check the operation of the Olympic receiver.

The noise limiter is included in the circuit of V11, in Fig. 10, in an effort to remove each noise pulse which has a greater amplitude than the sync pulses. If this noise is not eliminated, it passes through the sync separator and interferes with the correct timing of the oscillators in the sweep systems.

Grid No. 1 of V11 functions as a noise-limiter grid. A signal is taken from the grid of the video amplifier and is applied to the limiter grid of V11. Since this signal has not passed through the video amplifier, it has a much smaller amplitude than the signal on grid No. 3 of V11. Its polarity will be opposite to that of the signal on grid No. 3, and therefore the noise pulses which are the most positive portion of the signal on the sync-clipper grid are the most negative part of the signal on the limiter grid.

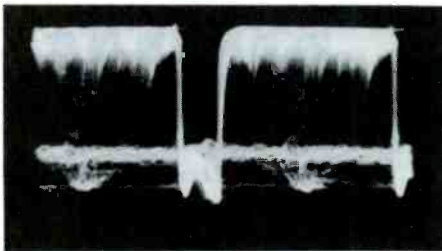
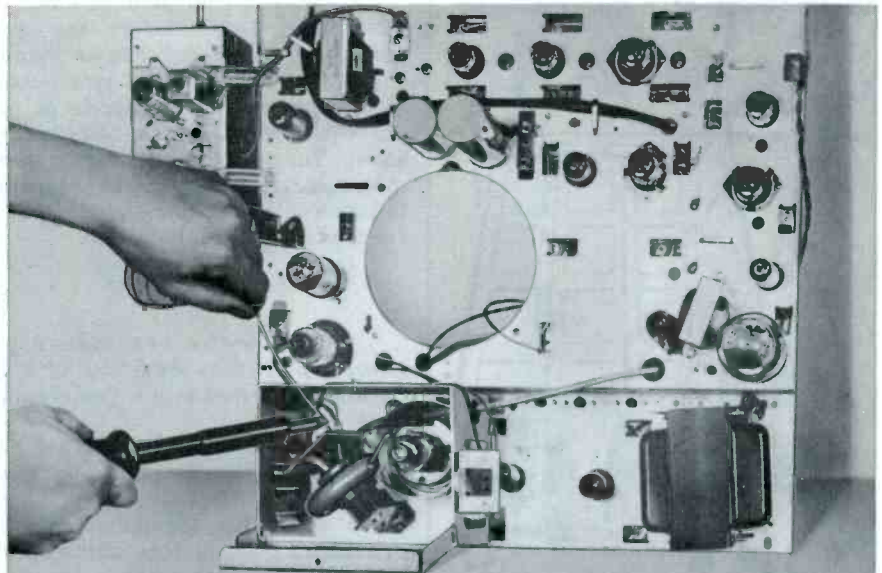

Fig. 13. Waveform of Horizontal Sync Pulses at Cathode of Phase Inverter When Picture-Lock Control Is Misadjusted.

A control is provided in the circuit of the limiter grid to permit the technician to vary the DC bias voltage on that grid. This control in the circuit of Fig. 10 is called a "picturelock," but controls of this type are also called "fringe-lock" or "noise-stabilization" controls. The control is advanced until a strong noise pulse will drive the voltage on the limiter grid to a value below cut-off. The noise pulse which occurs simultaneously at grid No. 3 is removed by the momentary interruption of conduction through the tube. An occasional sync pulse is lost, but the circuit is not disrupted nearly so much by this loss as by the presence of noise.

The picture-lock control is kept at its minimum setting unless interference from noise becomes troublesome. Even then, it must be adjusted with care. If it is set indiscriminately, trouble can be injected into the circuit. A setting that is too high would cause V11 to be cut off by the tips of all the sync pulses in the signal at grid No. 1, and synchronization would be disturbed.



keep your servicing on-the-go profitably, with **RCA SERVICE PARTS**

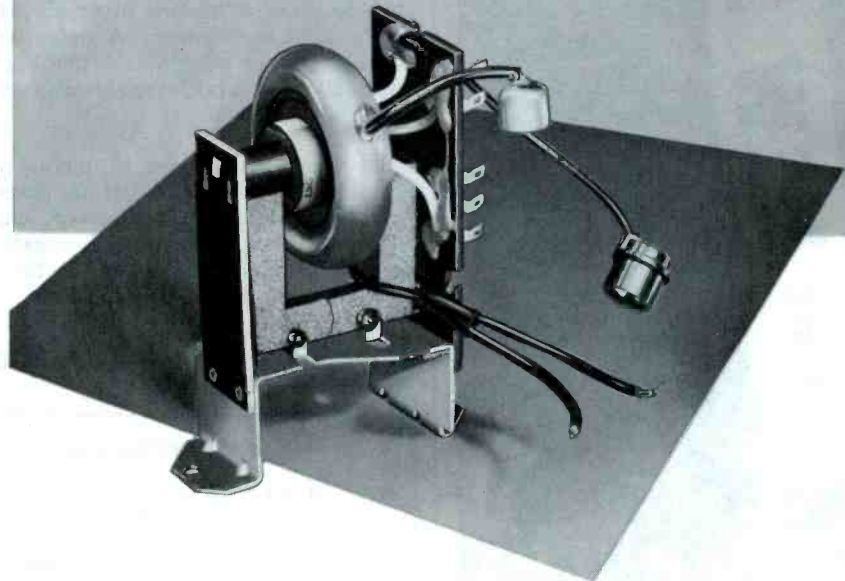

Mechanically and electrically this Horizontal-Output and High-Voltage Transformer is an exact replacement for the high-quality original used in an RCA Victor TV receiver. Like all RCA Service Parts, it is factory-tailored to cut down bench-time by fitting right, installing fast . . . without reaming, drilling, tapping, sawing, or cutting! Add outstanding performance to this ease of installation, and you'll appreciate why smart servicemen everywhere depend on RCA Service Parts to keep their servicing on-the-go profitably.

RCA Service Parts are the only genuine replacement parts for RCA Victor radios, TV receivers, and phonographs.



SERVICE PARTS

RADIO CORPORATION OF AMERICA, HARRISON, N. J.

RCA VICTOR PRODUCTS · RCA SERVICE PARTS—made for each other!



NEW DESIGN means NEW SALES

Now, the newest, finest Radio-Control Garage Door Opener, styled in a modern spun-aluminum fixture that beautifies garage interiors.

Convenience and safety features galore — New automatic shut-off, positive locking of door, FCC authorized radio frequency . . . and many more plus qualities! Write today for descriptive literature.

Perma-Power's
NEW Garage Door Opener

mfd by **Perma-Power COMPANY** 4727 N. Damen Ave., Chicago 25, Ill.
Manufacturers of electronic equipment since 1928
EXPORT: Scheel International, Chicago, Ill.

made better!

A misadjustment of the picture-lock control will distort the sync pulses, and the result can be seen in Fig. 13. The horizontal sync pulses in this signal at the cathode of the phase inverter have a dented appearance. This effect is produced when the conduction of the sync separator is interrupted each time a sync pulse reaches its peak value.

Servicing Hints

The following reminders apply generally to the servicing of sync separators by means of signal tracing.

1. If waveforms appear in service notes, observe whether they were taken at a sweep frequency of 30 or 7,875 cps. The former frequency provides a good picture of the entire signal which makes up one frame of the TV picture, but the latter frequency gives more accurate information about the condition of the individual horizontal sync pulses.

2. The input and output signals of the sync separator should be checked with an oscilloscope before extensive trouble shooting is done in the circuit of the sync separator. A defective input signal or a normal output signal point to trouble elsewhere in the receiver.

3. The oscilloscope is useful in localizing trouble to a definite stage in the sync section of a receiver, and a voltmeter or ohmmeter is usually helpful in tracing a defect to a specific fault in a component.

THOMAS A. LESH

Dollar and Sense Servicing

TOLL ROBOT. An automatic toll collector, now in operation during daylight hours at the Raritan Plaza entrance to Garden State Parkway in New Jersey, gives out a tape-recorded message when the 25-cent toll is dropped in. A typical message from the robot is, "Thank you, please drive safely." Plans call for use of different messages on special occasions such as during Christmas week. Only motorists having the exact change (any combination of pennies, nickels, and dimes, or a single quarter) can take the automatic toll lane.

If tape recorders click for toll stations, there may be new jobs for service technicians to keep the recorders running or extra work for local shops equipped with the know-how to handle the tape-transport mechanisms. From the recording head on through the speaker, the units are of course like any audio amplifier.

MARKUS . . . Dollar and Sense Servicing

Hand size ...
Voice size ...

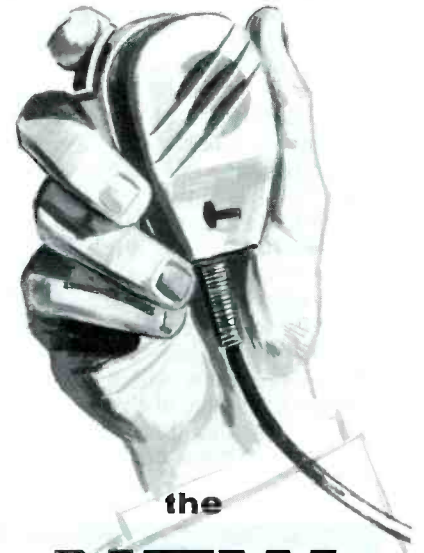

the
NEW

American "501" Series Microphones

Lightweight, rugged, easy to handle . . . true-to-life in fidelity of voice pickup. The new American "501" Series presents a complete line of dynamic or carbon hand microphones to improve all types of voice communications.

The attractive styling is completely functional . . . the gently curved case fits easily into the hand. Positive operation under all conditions is provided by a specially designed cantilever switch. The case is made of die cast aluminum to assure durability and minimum weight.

There's a model for every need:

- Mobile Communications
- Police
- Ship-to-Shore
- Aircraft
- Amateur

To be heard and understood . . . start with an American Microphone. Write for complete details and specifications today. Ask for Bulletin 501.



American
microphone
company

370 South Fair Oaks Ave., Pasadena 1, Cal.

AN ELGIN NATIONAL WATCH
COMPANY AFFILIATE

Selecting Test Equipment for Color TV Servicing

(Continued from page 15)

A good oscilloscope is one of the most versatile instruments in the television servicing business. It can



be used to observe response curves and signal waveforms, to indicate the presence or absence of a signal at any particular point in the receiver, to measure the peak-to-peak amplitudes of signals, and to determine frequency and phase differences between two signals by interpretation from Lissajous figures. In addition, when an oscilloscope is used in conjunction with an electronic switch, the waveforms of two signals may be observed simultaneously.

It should be mentioned that switches have been incorporated in some oscilloscopes so that either a high sensitivity or a wide passband can be obtained. With the switch in the high-sensitivity position, the passband of the vertical-amplifier circuits is relatively narrow. When the switch is in the side-band position, the sensitivity of the instrument may be reduced by as much as 90 per cent; however, the passband may be increased up to eight times in width.

An oscilloscope of this type obviously affords more versatility than one which does not provide a means of obtaining either optimum bandpass or maximum sensitivity. For purposes of viewing frequency-response curves, high sensitivity is desirable but a wide passband is not necessary. When the waveform of a composite signal made up of a wide range of frequencies is observed, an oscilloscope having a wide passband is desirable.

Sweep and Marker Generators

In connection with the servicing of monochrome receivers, the most useful application of a sweep generator is during the alignment of the RF and IF stages. To be of further use in connection with the servicing of color receivers, a sweep generator

should incorporate a video range which sweeps down to 50 kilocycles or below. This video range will permit the technician to check the frequency response of such circuits as the video amplifier, the bandpass amplifier, and the demodulator and matrix circuits.

When the response curve of any of these circuits is being viewed on an oscilloscope, frequency markers ranging from .5 to 4.5 megacycles are very helpful. At the present time, the marker frequencies incorporated in many sweep generators and those supplied by most marker generators

are not within this range. This presents no problem, however, since an RF signal generator will provide frequencies in the video range. The signal from such a generator can be injected, and the generator can be tuned so that a marker will appear at practically any point on the video response curve. For those who prefer, video-marker generators can be purchased at a very reasonable cost.

There is a way to check the frequency response of video circuits without using a sweep generator. This method involves the use of a signal generator and an oscilloscope.

you can
hear the
quality of
a

QUAM
Adjust-a-Cone[®]
SPEAKER

When you install a Quam speaker, listen to it carefully.

Your ears will tell you why Quam Speakers have earned the reputation of "the Quality Line."

No other replacement speaker offers you all these important quality features: patented Adjust-a-Cone[®] suspension, U-shaped pot, heavier magnetic structures, 4 threaded holes in coil pot, transformer brackets, universal mounting brackets, factory packaging, listing in Howard Sams' Photofacts.

For happier customers,

ask for QUAM, the quality line, for all your speaker needs

**QUAM-NICHOLS
COMPANY**

234 East Marquette Road
Chicago 37, Illinois

536K Multimeter Kit \$12.90
Wired \$14.90
1000 ohms/volt



425K 5" Scope
Kit \$44.95
Wired \$79.95



470K 7" Push-Pull Scope
KIT \$78.95. WIRED \$129.50.

YOU BUILD

EICO

**KITS
IN ONE
EVENING—
but they
last a lifetime...
and you
save 50%**

**38 Kits and 42 Instruments —
the Industry's most complete
line of MATCHED
TEST INSTRUMENTS**

½ - million EICO Instruments are now in use the world over! That's the proof of EICO's leadership in Value.

For latest precision engineering, finest components, smart professional appearance, lifetime performance and rock-bottom economy — see and compare the EICO line at your Jobber before you buy any higher-priced equipment! You'll agree with over 100,000 others that only EICO Kits and Instruments give you the industry's greatest values at lowest cost.

Prices 5% higher on West Coast.



221K VTA Kit \$25.95
Wired \$35.95



565K Multimeter Kit \$24.95
Wired \$29.95
20,000 ohms/volt



377K Sine & Square Wave Audio Gen.
Kit \$31.95 -Wired \$49.95



360K Sweep Gen.
Kit \$34.95 -Wired \$49.95



1050K Battery-Elim.
Kit \$29.95 -Wired \$38.95

625K Tube Tester
Kit \$34.95
Wired \$49.95



Write NOW for FREE latest Catalog PF-2

EICO
Laboratory Precision at lowest cost

©1954

ELECTRONIC INSTRUMENT CO., Inc.
84 Withers Street, Brooklyn 11, N. Y.

Suppose that a particular circuit is required to pass a signal which is comprised of frequencies ranging from a few cycles to 500 kilocycles per second. The signal generator can be connected at the input of this circuit, and the oscilloscope can be connected at the output. By varying the frequency of the signal from the generator and observing the amplitude of the signal waveform produced on the oscilloscope screen, a technician can determine if the amplification afforded by the circuit is uniform over the proper range of frequencies. As a matter of fact, a graphical representation of the frequency response can be plotted from the peak-to-peak indications obtained on the oscilloscope screen when the generator is tuned through a range of frequencies.

There are a few minor drawbacks in the use of such a procedure. First of all, it must be determined if the amplitude of the signal supplied by the generator is the same over the range of frequencies to be used. If it is not, the amplitude control of the generator may have to be readjusted each time the frequency of the signal is changed in order to keep the amplitude of the input signal uniform over the range of frequencies at which the response of the circuit is being checked. A second drawback concerns the frequency response of the oscilloscope, since this response may not be uniform over the video range.

The nonuniformity in the frequency response of the circuits in both the signal generator and the oscilloscope may be compensated for in the following manner:

1. Supply a signal from the generator to the input of the video circuit being checked, and tune the generator to the lowest frequency at which the circuit should provide maximum amplification.

2. Temporarily connect the vertical input of the oscilloscope to the output of the generator, and adjust the vertical-input controls on the oscilloscope to produce a waveform having a specific amplitude. Keep the setting of the output control on the generator as low as possible.

3. Connect the vertical input of the oscilloscope to the output of the video circuit, and note the amplitude of the waveform. If the peaks of the waveform extend beyond the edges of the screen, set the vertical-attenuator switch on the oscilloscope for greater attenuation. Do not change the setting of the vernier control.

4. Reconnect the oscilloscope to the input of the video circuit, and set

**DETERIORATION
PROOF**

"The ONLY new development in TV transmission line in 10 years"

Columbia
Permaline
ELIMINATES
RAPID
DETERIORATION

Specify

Columbia

**because it's
guaranteed up to
25 years to:**

- ★ Resist salt spray and salt air
- ★ Resist fumes from chemical plants and oil refineries
- ★ Resist severe low temperatures
- ★ Resist sunlight and ultra-violet light
- ★ Resist deterioration for countless other reasons

PERMALINE TV TRANSMISSION LINE reduces servicemen nuisance calls; means happier customers; provides better signals because of longer life.

Available at leading distributors!

Columbia
WIRE & SUPPLY CO.
2850 Irving Park Road • Chicago 18, Ill.

the frequency control of the generator to the next frequency to be used.

5. If the amplitude of the waveform is not the same as that obtained after completing step 2, adjust the output control on the generator until this condition exists.

6. Repeat steps 3, 4, and 5 until the amplitudes of the waveforms at all frequency check points have been noted. Consider the results with respect to a drawing of the desired response curve in order to determine if the video circuit has the correct frequency response.

The bandpass-amplifier stage of a color receiver is usually the only video circuit which might require alignment. Without a source for video sweep frequencies, the tuned components of this circuit are almost impossible to adjust; however, there is not much reason for these components to become misadjusted, and it may be possible to get along without a video sweep generator for a while at least.

High-Voltage Probe

A device which is necessary in connection with the servicing of many color receivers is the high-voltage probe. Since the second-anode voltage in a color receiver which utilizes a three-gun tube is regulated at a specific value, proper operation of the high-voltage circuit is most readily determined by an actual voltage measurement. This voltage in many color receivers may exceed 30 kilovolts when unregulated; therefore, a high-voltage probe which will withstand this potential and which incorporates an ample safety factor is recommended.

Probes of this type are made by several instrument manufacturers and are very inexpensive. They are usually designed to be used with a certain type of meter or with a meter which has certain voltage ranges. If the probe is to be used with a meter which you now have, make sure the probe is designed to be used with that meter or with a meter having the same voltage ranges.

White-Dot Generator

Thus far, we have discussed only those instruments which were designed to be used in connection with the servicing of monochrome receivers. In addition to these, instruments which have been specifically designed for use in the servicing of color receivers should be acquired by the technician desiring to perform such service. One such instrument is the white-dot generator.

Actually, the use of a dot generator is not new. Some of the pattern generators used to provide test signals for monochrome receivers can be adjusted to produce a pattern of black dots on a white field. Patterns consisting of white dots on dark fields are preferred in color-television servicing because these patterns can be used to check and adjust for proper static and dynamic focus and for proper convergence of the three beams in a color picture tube.

Some of the generators originally designed to provide only black-dot patterns can be converted to

provide white-dot patterns also. For a modest sum, one manufacturer will

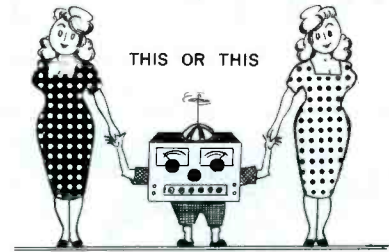

supply an adapter kit and the necessary instructions for the conversion of one of their generators. After the

C-D's CUB BEST-BAR NONE

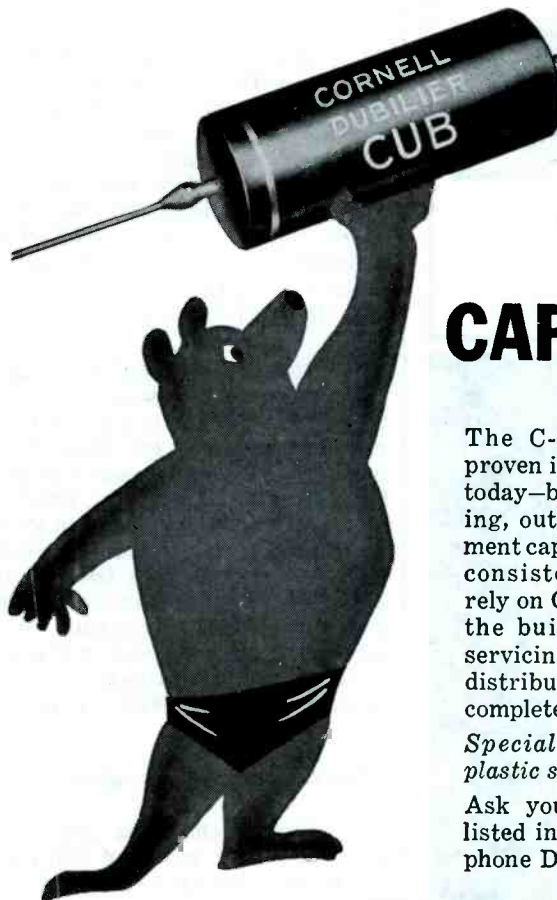

MOLDED TUBULAR CAPACITORS

The C-D "Cub" capacitor has proven itself the best on the market today—by out-lasting, out-performing, out-selling any other replacement capacitor for radio or TV. For consistent high quality—always rely on C-D, the only tubulars with the built-in extras required in servicing sets today. That's why distributors *who know*, carry the complete Cornell-Dubilier line.

Special! "Cub-Kit" with bonus plastic service dispenser.

Ask your C-D Distributor. He's listed in your local Classified Telephone Directory.

There are more C-D capacitors in use today than any other make



CONSISTENTLY DEPENDABLE
CORNELL-DUBILIER CAPACITORS

PLANTS IN SOUTH PLAINFIELD, N. J.; NEW BEDFORD, WORCESTER AND CAMBRIDGE, MASS.; PROVIDENCE AND HOPE VALLEY, R. I.; INDIANAPOLIS, IND.; SANFORD AND FLOUQUAY SPRINGS, N. C.; SUBSIDIARY: THE RADIART CORPORATION, CLEVELAND, O.

Merit

FIRST IN EXACT REPLACEMENT.

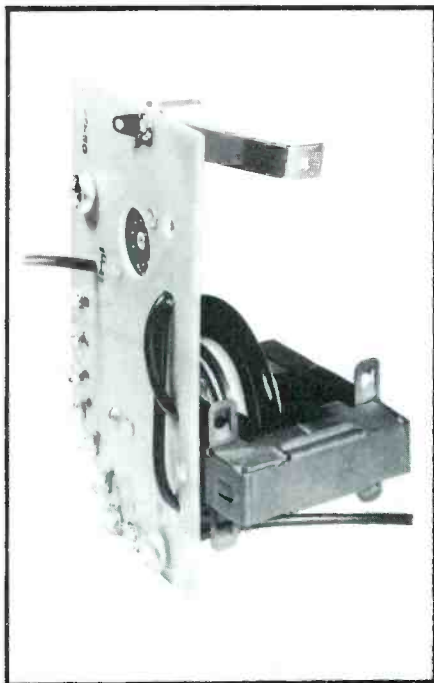

HVO-50 FOR EXACT REPLACEMENT in over 75 TRAV-LER models and chassis. Another in the complete Merit line of exact and universal transformers, yokes and coils. Merit is the only manufacturer of transformers, yokes and coils who has complete production facilities for all parts sold under their brand name.

Merit

MERIT COIL & TRANSFORMER COMPANY
4427 N. CLARK ST., CHICAGO 40, ILL.

instrument has been converted, either white dots on a dark field or black dots on a white field can be obtained by changing the position of a switch.

Color-Bar Generator

Another instrument which is specifically designed for use in the servicing of color receivers is the color-bar generator which is a necessity in checking the performance of the video circuits in a color receiver. As the name implies, this type of generator develops a signal from which bars of various colors can be produced on the screen of a color picture tube. Many generators incorporate a function switch so that different bar patterns can be produced. One position of the switch may cause a combination of primary and complementary colors to be reproduced on the screen. Other positions may result in the production of individual colors representative of I, Q, R - Y, and B - Y signals. The subcarrier oscillator in the color-bar generator is usually crystal controlled; consequently, this instrument is a reliable standard for checking the performance of the color circuits of a receiver.

Since the advent of color television, several makes of color-bar generators have been produced for commercial use. Some of these instruments are more elaborate than others in that they will provide a variety of signals in both the RF and video ranges, and naturally these instruments are more expensive than those which provide only one signal or a limited number of signals.

The prices of color-bar generators range all the way from \$49.95 to \$595.00. The less expensive models are ideal for checking the operation of a color receiver in the field because they are relatively small, compact, and light in weight. The medium-priced models are better suited for bench work because they are more accurate and have a greater variety of uses. Generators in the \$500 class are precision instruments which are particularly useful in laboratory and research work.

What Instruments Should You Buy?

Many technicians are partial to a particular brand of test equipment, and this partiality will probably be influential in the choice of a new piece of equipment. Most of the manufacturers of test instruments are now marketing color equipment. This article has pointed out the instruments which are desirable and those which are absolutely necessary in color-television servicing. We

NOW!

test, service, operate RADIO and ELECTRONIC EQUIPMENT



NEW DUAL RANGE DC POWER SUPPLY



MODEL "EF" **\$84⁵⁰**
only

continuously variable

0-28V Up to 5 Amps
0-14V Up to 5 Amps

performance chart proves

LESS THAN 1% AC HUM!
at top load

Well-known ELECTRO premium quality components and construction . . . exclusive ELECTRO cooling . . . 25% extra power capacity!

.....
: **Heavy Duty DC Power Supply** :

Less than 1% AC hum!

MODEL "NF" **\$195**

0-28 Volts Up to 15 Amps
continuously variable

Widely recognized and accepted in industry as the heavy duty unit of unmatched construction and performance at this low price.
.....

WRITE FOR BULLETINS!

ELECTRO PRODUCTS LABORATORIES

4501-PFN, Ravenswood Ave., Chicago 40, Ill.
Canada: Atlas Radio Ltd., Toronto

PF REPORTER - February, 1956

have also mentioned that a color receiver can be serviced by using a minimum number of instruments as long as the technician understands the limitations of the instruments used; however, the application of certain instruments which have not been previously used in monochrome servicing will make color servicing a lot easier.

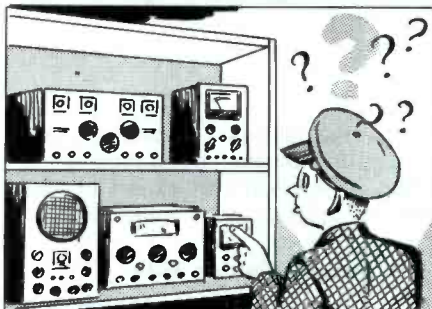

When buying new equipment, consider the following questions before completing your purchase.

1. Will the instrument do all that I want it to do?

2. Will another brand of instrument in the same price bracket do more or do the same job better?

3. Is the cost within my budget?

4. Will it help me to do the job better and with more ease?

If you can answer these questions to your satisfaction, your choice will probably be a wise one.

Anyone who works on a color receiver for the first time is in for

quite an experience. It is recommended that such service work should not be attempted by anyone who does not have a basic understanding of the theory of color television. Do not expect to make any profit on the first color receiver that you service. If possible, choose a time to work on the receiver when the customer will not mind doing without it for a few days. This might be during a period when no color programs are scheduled and also when you have some extra time. Learn all the theory you can. Study the service literature thoroughly, and then "see what makes the set tick."

Color television is here to stay, but its growth is unpredictable. Those who are planning to service color receivers will have to acquire certain instruments first. Additional equipment can be acquired as color business increases. Shops having limited budgets can purchase inexpensive instruments to be used for both bench and field work. More elaborate equipment for bench work can be obtained when there are more uses for it. Oh, yes! — to you who are about to start working with color TV — good luck!

VERNE M. RAY

(Advertisement)



MODEL 648		MODEL 715/115	
TUBE TEST	CIRCUIT D	PLATE TEST	PLATE YZ
3DT6	3.0 A2347 AC156	75XZ	3.0 - 32 21MNQ
6BH8	6.3 A128 679 A124 35	75Z 36V	6.3 - 32 770Q 20 9LR
8DT6	6.3 A2347 AC156	75XZ	6.3 - 32 21MNQ
X155	6.3 A1237 A45 A89	41V 41V	6.3 - 17 2LR 17 4NR
8662	6.3 A2347 AC156	55WZ	6.3 - 36 21MS

MODEL 49		Latest Chart Form 49-3	
TUBE TYPE	SEC.	A. E. C.	D. SHORTS
3DT6	P	3.0 3	X 1567 2 30
6BH8	P	6.3 4	X 789 6 31
	T	6.3 4	X 23 6 31

See* FOR YOURSELF . . .

★ how light
★ how beautifully balanced
★ how easy to use

is this **NEW**

▲ See it on display on your service equipment distributor's counter.

◀ See the most versatile assortment of tips ever . . . in new, handy, tubular container.

* Pick up the LUGER . . . try it for balance, ease of handling, compactness. Its twin-lamped, ventilated housing needs no stand.

No service kit complete without this fast-heating, flexible Esico LUGER . . . newest achievement in soldering guns!

FOR EVERY SERVICEMAN'S NEED . . .

Non-annealing, non-bending tip shapes and sizes for

- remote connections
- previously inaccessible chassis
- deep, confined assemblies
- long service and fast changing

See it . . . GET YOURS today!

ELECTRIC SOLDERING IRON Co., Inc.

ESICO

Famous for Quality Soldering Equipment Since 1927

5255 W. Elm Street, Deep River, Connecticut

"I NEVER HEAR COMPLAINTS..."

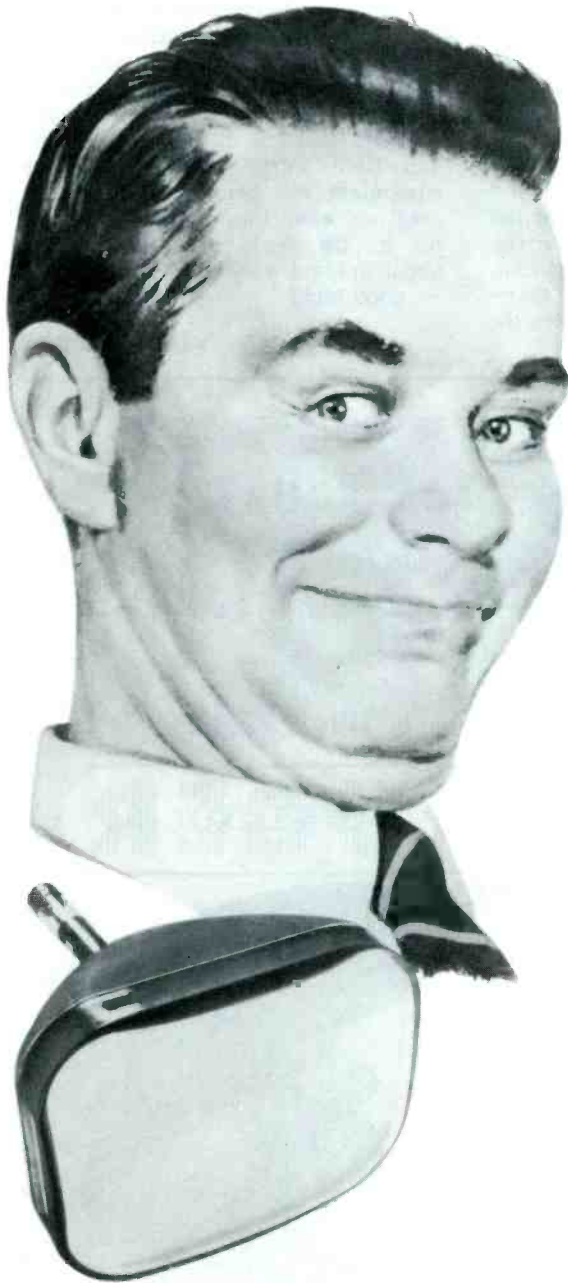

"... when I use Tung-Sol Tubes for replacement jobs! These dependable, long-lasting tubes stay put. Instead of wasting time on callbacks, I'm out servicing new business!"

 **TUNG-SOL**[®]
dependable
PICTURE TUBES

TUNG-SOL ELECTRIC INC., Newark 4, N. J. Sales Offices: Atlanta, Chicago, Columbus, Culver City, Dallas, Denver, Detroit, Newark, Seattle.

Product Report



Editor's Note:

The material appearing in this column has been taken from literature supplied by the manufacturers of the various products. The PF REPORTER cannot assume responsibility for claims of originality or application.

Featherweight Instant Solder Gun

Hexacon Electric Company, 589 W. Clay Avenue, Roselle Park, New Jersey, announces a new instant solder gun which reaches soldering temperature in a few seconds. It weighs 8 ounces; and the tip is made from a special alloy which resists wearing, corroding, or bending.

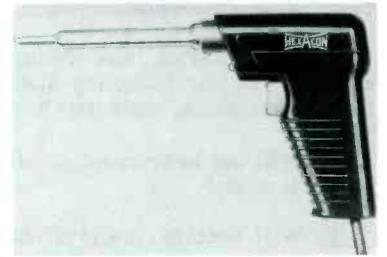

The unit features trigger control, a heater unit located in the tip, and a spotlight. The tip assembly is long and thin so that confined places can be reached. Rated at 150 watts and available for 120-volt operation, the unit operates identically on DC as well as AC, any cycle. The gun designated by catalog No. G14 is shown here, and it is listed at \$7.95.

"The Radio-Electronic Master" for 1956

Starting with the 1956 (20th) edition, the industry-wide catalog which was formerly entitled "Radio's Master" is now known as "The Radio-Electronic Master!" The publishers consider the new title more appropriate for the wider scope of coverage in the volume.

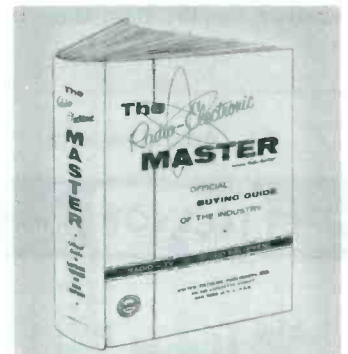

This catalog is designed for those who buy, sell, and service electronic parts and equipment. A few of the products catalogued in the 1956 edition include: tubes, capacitors, resistors, relays, coils, antennas and their accessories, transformers, test equipment, recording and PA systems, hi-fi equipment, hardware, tools, transmitters, communications receivers, wire and cable, speakers, microphones, rectifiers, converters, amateur gear, switches, volume controls, and the like. Detailed indexes help the user locate information about the products of 350 manufacturers.

"The Radio-Electronic Master" may be obtained from electronic-parts distributors whose names will be furnished on request by United Catalog Publishers, Inc., 108 Lafayette St., New York 13, N. Y.

Rotary Cable Stripper

The Model S-1 rotary stripper for coaxial cables and for other non-metallic tubing up to 1/2 inch in diameter has been announced by the Blonder-Tongue Laboratories. This tool is useful for TV, audio, industrial, and electrical installation work.

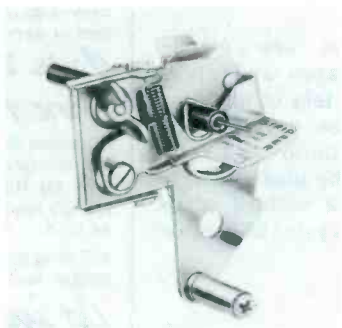

The stripper is machined from heavy-gauge steel and employs a standard single-edged razor blade for the cutting action. The depth of cut and degree of spring tension may be varied by means of simple adjustments. A measuring scale on the unit enables the user to remove the correct amount of insulation and braid.

The Blonder-Tongue Model S-1 stripper lists for \$3.75 and is available through electronic-parts distributors and dealers.

Color Alignment Generator

The General Electric Company, Syracuse, N. Y. recently announced a Type ST-16A color alignment generator which can be used as a signal source for the generation of specific color signals. These signals can be used to align sweep, color, and convergence circuits in television receivers.



The unit will deliver either a video or an RF signal which conforms to NTSC color standards. The user may also select dot or crosshatch signals. Crystal-controlled horizontal and vertical sync signals ensure a completely stable pattern with video blanking during the vertical retrace interval. RF output may be on any one channel from 2 through 5. The unit uses 28 tubes and is equipped with a blower fan for cooling. The weight of the instrument is 40 pounds, and its dimensions are 9 by 19 1/4 by 13 inches.

Transistor Kit

A kit of six p-n-p diffused-junction transistors for all types of radio receivers is now available through parts distributors. These kits are made by the General Transistor Corp., Jamaica, New York, manufacturers of transistors and germanium diodes.



Designed for experimenters, engineers, and technicians, the kit includes: one converter-oscillator transistor, two intermediate-frequency transistors, and three audio transistors. All are packaged in a functional Lucite box. Transistor kit No. 2 is shown here.

"IT SOUNDS BETTER THAN EVER..."



"...since my service man fixed it! Complicated sets are scarcely my cup of tea, but I do know this: he used Tung-Sol Tubes and my set's never worked better."

TUNG-SOL[®]
dependable
TUBES-DIAL LAMPS

TUNG-SOL makes All-Glass Sealed Beam Lamps, Miniature Lamps, Signal Flashers, Picture Tubes, Radio, TV and Special Purpose Electron Tubes and Semiconductor Products.

AMERICAN TELEVISION & RADIO CO. ST. PAUL, MINN.

introduces the new

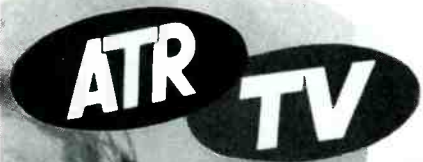

Full Door Console Receiving Sets

UNSURPASSED
IN BEAUTY

UNEQUALLED
IN PERFORMANCE

UNMATCHED IN
QUALITY
CONSTRUCTION

exclusive
profitable
dealer
franchises
now available



*designed
with the
Serviceman
in mind
... easy to
get at*



WRITE TODAY FOR COLORFUL
BROCHURE SHOWING THE
NEW LINE OF ATR TV SETS

ALSO MANUFACTURERS OF DC-AC INVERTERS,
"A" BATTERY ELIMINATORS, AUTO RADIO VIBRATORS



Audio Facts

(Continued from page 17)

Crystal microphones are manufactured in many shapes and sizes for use in a great variety of applications. All of them use crystals that are usually of Rochelle salt and operate by virtue of the piezoelectric effect which causes a voltage to be developed when the crystal is bent or twisted.

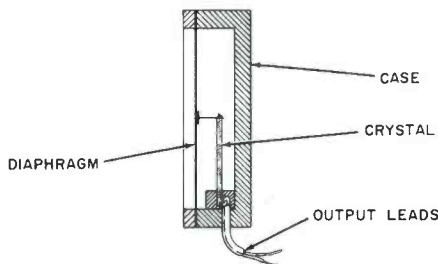

Fig. 5. Basic Construction of Crystal Microphone.

The basic construction of a simple crystal microphone is shown in Fig. 5. It is a pressure-operated device. When the varying pressures of the sound waves move the diaphragm, the crystal is bent or twisted. The voltage developed because of the piezoelectric effect varies as the sound pressure varies and therefore is the desired audio signal.

A crystal microphone has a high output impedance and can normally be connected directly to the grid of the input stage of the associated amplifier. The value of the grid or loading resistor depends upon the microphone that is being used and the purpose for which it is being used.

The high signal output and general ruggedness of crystal microphones make them suitable for various uses. They can be designed and constructed so that a wide-range response with very low percentages of distortion will be produced.

Since the piezoelectric properties of a Rochelle-salt crystal will be lost if it is subjected to temperatures above 130 degrees Fahrenheit, care must be observed to keep crystal microphones away from high temperatures.

An indication of the widespread use of crystal microphones is the fact that the neat little microphones supplied with tape recorders used in the home are of the crystal type. These comparatively inexpensive microphones give excellent results and service when they are used for the purpose for which they were intended.

1st with all prices

Pricing Digest answers a need long-felt by Servicemen—List or resale prices for every replacement part or component at your fingertips.

Over 200 pages; covers more than 60,000 items

Compiled like a telephone book (1) alphabetical by Manufacturer (2) Alphabetical by Product Category (3) Numerical by Part Number. Price and identify any replacement item in seconds—as easy as 1-2-3.

9 3/4" long by 3 3/4" wide . . . convenient for counter, pocket, tool box or tube caddy.

1st in savings

Time and money savings—no wasted effort—no calls to your distributor to check prices. No undercharges—no overcharges when you price your tubes and parts from the Official Pricing Digest.

PRICE \$2.50 PER COPY—will pay for itself many times over by giving you CORRECT PRICES where and when you need them. Publication dates are October, January, April and July. Completely revised prices will be current on each publication date.

Available exclusively thru your parts distributor.

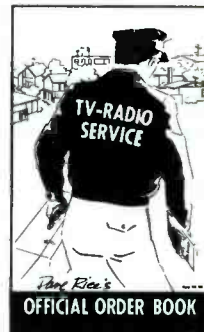
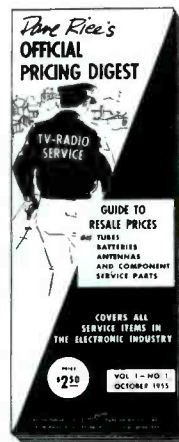

Dave Rice's OFFICIAL TV-RADIO SERVICE ORDER BOOK

Best Service Order Book because it's the only form providing for all types of service on TV-Radio, Phono or Hi-Fi equipment. Best service order book because it's the only form providing separate listings for tubes, parts and components, plus space for picture tube and serial number.

Best service order book because it's the only form clearly separating labor and parts and allowing all state and local taxes to be added.

Best Service order book because its handy size is 5 1/2" wide by 8 1/2" long. Each book contains 50 orders (in triplicate). Original white bond, duplicate yellow, triplicate pink. Numbered consecutively in sets. Two sets of carbons bound into each book. The only form packaged in dustproof boxes of ten—keeps stock clean until you need it.

Sold by parts distributors at 75c per book or \$6.50 per box of 10.

Electronic Publishing Co., Inc.
180 North Wacker Drive
Chicago 6, Illinois

As mentioned previously, crystal microphones are made in many types and models and for many special purposes. Fig. 6 shows styles furnished by some of the manufacturers. These styles include hand-held models for mobile work, lapel



(A) Astatic Model JT.



(B) American Microphone Model X-203.

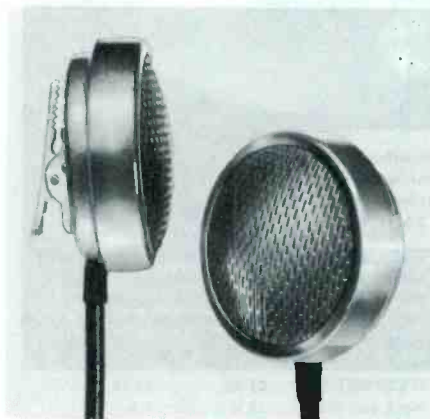

(C) Shure Model 76B (Lapel).

Fig. 6. Crystal Microphones.

microphones for lecturers and demonstrators, and contact models for use on musical instruments. In addition, microphones on table stands have been used in great numbers for

PA, recording, and broadcasting applications.

Dynamic Microphones

The dynamic or moving-coil type of microphone is basically very similar to a dynamic loudspeaker. This type of microphone could be thought of as a miniature dynamic loudspeaker used in reverse. Most of us are aware of the way the loudspeaker also serves as the microphone in most intercommunication systems. The similarity to the loudspeaker can be seen in Fig. 7 which shows the basic construction of a dynamic microphone.

This microphone is a pressure-operated device. When the varying pressures of the sound waves move the diaphragm, the coil is moved in the magnetic field. Because of the movement of the coil, a current which

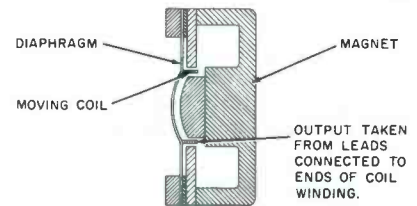

Fig. 7. Basic Construction of Dynamic Microphone.

*Sure-Cure
for
Replacement
Headaches:*



Replace with the **BEST**

**OXFORD
SPEAKERS**

"No more worrying after you've completed your replacement jobs" . . . that's the saying of more and more servicemen every day because they've switched to OXFORD REPLACEMENT SPEAKERS.

We GUARANTEE you products that are built to be replacement speakers. We stand behind each and every speaker with a 100% guarantee against any mechanical or electrical defects for one full year.

OXFORD Replacement Speakers undergo a rigid inspection to make certain that they are as good or better than the original speaker. That's why more servicemen are switching to OXFORD . . . the replacement speakers for a better job.

Illustrated literature is available without obligation.

. . . at better jobbers!



OXFORD ELECTRIC CORPORATION

DISTRIBUTOR SALES DIVISION
556 WEST MONROE ST., CHICAGO 6, ILL.
EXPORT—ROBURN AGENCIES, NEW YORK CITY
IN CANADA—ATLAS RADIO CORP. LTD., TORONTO

varies with the amplitude and frequency of the sound waves is generated and flows through the coil. Since a dynamic microphone is a low impedance device, the signal is fed through a transformer to the input of the amplifier being used.

The dynamic microphone is rugged by nature, which is a distinct advantage in a microphone. We must remember that a microphone cannot

be thrown around indiscriminately and cannot be grossly mishandled without the risk of damage. Besides being rugged, dynamic microphones are not affected by high temperatures nor high humidity. Well-designed dynamic microphones possess a high degree of sensitivity, a smooth wide-range frequency response, and an output with very low percentages of distortion. They are easy to use. No power supply and no outside cur-

rent source are required to activate the microphone; and because of their low output impedance, long cables can be employed.

Dynamic microphones provide excellent results when used in most any application where high quality results are desired. Suitable models are available for making scientific tests and measurements and for all types of communication work, PA

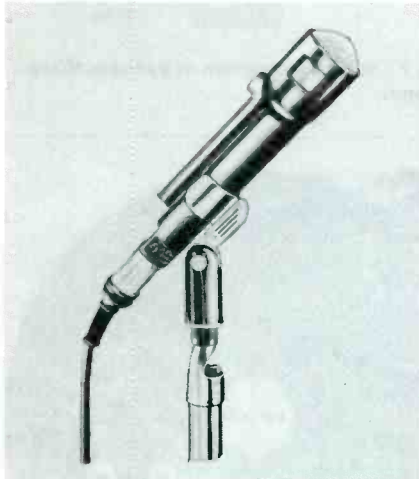

(A) Electro-Voice Model 666.



(B) Shure Model 525.



(C) Turner Model 58.

Fig. 8. Dynamic Microphones.

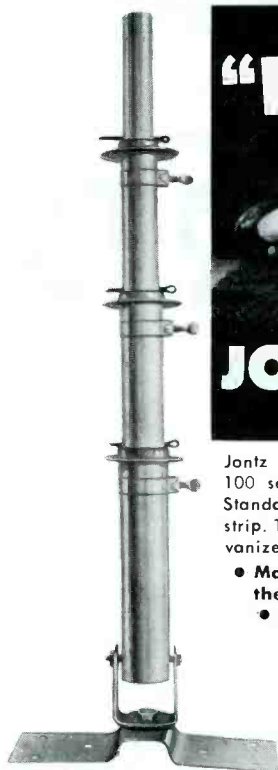

"Really Built"

JONTZ Kwick-Up Telescoping Masts

Jontz Kwick-up telescoping masts are available in 3 lines: The De Luxe 100 series, made from hot-dipped galvanized 16 gauge tubing. The Standard 200 series, made of 16 gauge tubing rolled from galvanized strip. The Standard 300 series made of 18 gauge tubing rolled from galvanized strip with 1 1/4", 16 gauge top.

- Mast sections will not pull apart with the exception of the top section which enables easier antenna mounting.
- New type locking device for faster erection and locking without tools.
- Revolutionary new guy ring eliminates all strain, tension, and friction on the next section to be erected.
- Newly designed companion base assures definite locking, will not turn in the wind.

Sell the Line that is "Really Built" to do the job Available at better jobbers everywhere



JONTZ MANUFACTURING CO.

1101 East McKinley, Mishawaka, Indiana

IN. CANADA: Active Radio & TV Distributors
60 Spadina Ave • Toronto, Canada

ATLAS Cobra-Jectors

- wide angle dispersion
- indestructible fiber-glass
- all-weather construction

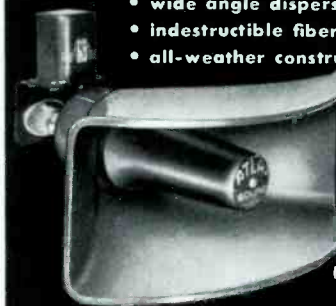

CJ-30
Net \$24.00

Weatherproof universal line transformer, \$5.10 Net.



CJ-14
Net \$16.80

Designed for wide angle coverage, paging, high efficiency intercom, sensitive talk-back. Tops in articulation. Convenient omni-directional mounting bracket. In appearance, they're "beauts".

SPECIFICATIONS	CJ-30	CJ-14
Input pwr (cont.)	15 w	5 w
Input imp.	4 or 8 Ω	4, 8 or 45 Ω
Response (cps)	250-9,000	400-10,000
Dispersion	120° x 60°	120° x 60°
Bell Size	14" x 6"	9 1/2" x 5 1/2"
Over-all length	14"	8 1/2"

Amazing "power packages"—use the Cobra-Jectors for the "tough" jobs.



WRITE FOR COMPLETE CATALOG
ATLAS SOUND CORP.
1448—39 St., Bklyn. 18, N. Y.
In Canada:
Atlas Radio Corp., Ltd., Toronto, Ont.

applications, home recording, professional recording, and broadcasting work.

Some of the various styles and models supplied by several manufacturers are shown in Fig. 8. Most manufacturers make a full line of dynamic microphones, and it is impossible to show many of them here.

One reason that these microphones are made in so many shapes and forms is that the shape and size of the case are important to the operation of the microphone just the same as the shape and size of the enclosure is important to the operation of a dynamic loudspeaker.

Condenser Microphones

Condenser microphones have been used for some time for high quality work and for critical applications. Most of them are elaborate and expensive pieces of equipment. The basic construction used in the head of a condenser microphone is shown in Fig. 9. The head is usually polarized; in other words, a source of DC voltage is connected across its two plates. As the pressure of the sound waves moves the diaphragm which is one plate of the head, the distance between the plates changes; and when this happens, the voltage across the plates changes.

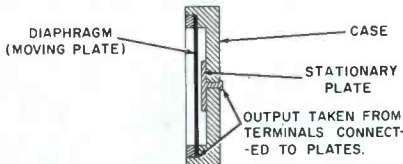

Fig. 9. Basic Construction of Condenser Microphone.

This changing or pulsating voltage, which represents the signal, is so small that it must be amplified before it can be used; therefore, an amplifier is used, and it is usually located in the case with the head because the leads from the head must be very short.

Ribbon or Velocity Microphones

The ribbon or velocity microphone is a high quality unit that has been used in great numbers in broadcasting and recording activities. Its perforated case has become as familiar as the double-button microphone was in the old days.

The basic construction of a typical ribbon microphone is shown in Fig. 10. A thin, corrugated, and very lightweight Duralumin ribbon is suspended between but does not touch the pole pieces of the magnets. It is held under practically no tension. In the first place, its lightweight construction would not stand up under tension; and in the second place,

from the VOICE OF AUTHORITY IN SWEEPS...

SPOT and FIX TV FAULTS FAST!

FREE RAM BOOK SHOWS HOW!

Typical latest field-proven servicing data you'll find in your RAM book:



FAULT - Picture compression and stretching.
CAUSE - Capacitance value of boost capacitor (connected to linearity coil) too low.



FAULT - Trapezoidal pattern.
CAUSE - Short in horizontal winding of Yoke.



FAULT - Split picture.
CAUSE - Reversed AGC winding of H. Output Transformer; insufficient AGC voltage or reversed polarity.

For over 10 years, RAM has specialized and pioneered in sweeps exclusively. RAM designs them, makes them, counsels TV set manufacturers on them, field-services them, educates Servicemen on them — leads the industry.

No one but RAM can bring you such proven data — as shown here and in the RAM Manual. In manufacturing know-how and field experience, you can depend on RAM for...

THE VOICE OF AUTHORITY IN SWEEPS

Send coupon today — get the BEST information from the FOREMOST manufacturer now!



RAM ELECTRONICS SALES CO. • Irvington, N. Y.
Canadian Sales Division: Telequipment Mfg. Co., Ltd., Ontario
Export Dept: Doge Corp., 219 E. 44 St., New York, N. Y.

Non-Snarling, Pre-Measured Wire Strand

WRIGHT Wire Strand Uncoils like this →

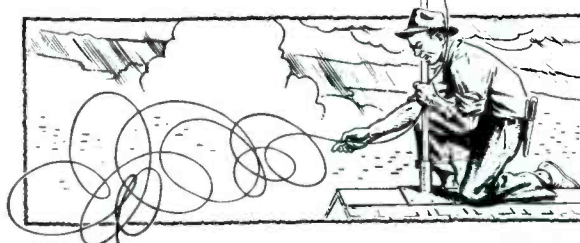

← WRIGHT unique process prevents this

Besides the important factor of no snarling, WRIGHT TV GUY WIRE is pre-measured. Every concentric coil measures two feet — time and money saver in guying antennas. WRIGHT TV GUY WIRE has great flexibility and is heavily galvanized... continuous connected coils.

Prompt deliveries from stocks in Worcester, Chicago, Atlanta, New Orleans, Houston, Dallas and Los Angeles.

G. F. WRIGHT STEEL & WIRE CO.

245 Stafford St. • Worcester, Mass.

**NOW
SEALED
IN PLASTIC**



**New, Better Way to
Stock, Sell and Service
PHONO-CARTRIDGE
REPLACEMENTS**

For greater protection and convenience, E-V replacement phono-cartridges now come in new individual sealed-in-plastic Blister-Paks—each with full model identification, interchangeability chart and instructions. This exclusive advancement in packaging makes it simpler to carry and sell phono cartridge replacements on service calls.

**New E-V Model 47 Dual-Slide
Cartridge for 78, 33 $\frac{1}{3}$, 45 RPM**

New idea in replacement phono-cartridges! The dual-slide, dual-needle Model 47 enables you to replace hundreds of different specialized types with a single general-purpose cartridge. List Price: \$9.00

**FREE NEW HANDY
INTERCHANGEABILITY
GUIDE**

Tells at a glance exact E-V replacement model for every popular crystal and ceramic phono-cartridge. Get it now from your E-V Distributor or write to Electro-Voice.



Electro-Voice
ELECTRO-VOICE, INC. • BUCHANAN, MICH.

tension is not desirable because the ribbon should almost float between the pole pieces. Because of its lightness and very low resonant frequency, the ribbon is sensitive to any sound waves that strike it on the front or rear surfaces. The ribbon responds to the velocity of the sound waves and generates a signal as it moves in the magnetic field.

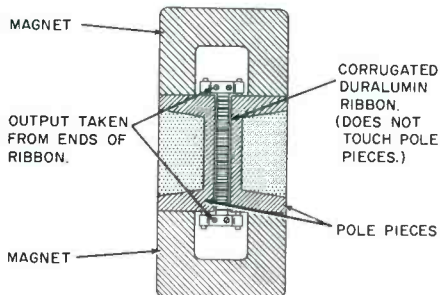

Fig. 10. Basic Construction of Ribbon Microphone.



(A) Shure Model 333. (B) American Microphone Model DR-330.

Fig. 11. Ribbon Microphones.

The ribbon microphone is not sensitive to sound waves that approach from any direction but the front or rear. This bidirectional effect is one of the important features of this microphone.

Some models of ribbon microphones are constructed with a case enclosing the back of the unit so that the microphone will respond only to sound waves striking the front of the ribbon. These are called unidirectional microphones. Two representative ribbon microphones are shown in Fig. 11.

All of this discussion can only serve as an introduction to the subject of microphones because there are so many phases which we have not covered in this article. In the near future, we hope to go into more detail concerning the microphone to use and the reasons for its use for each purpose.

ROBERT B. DUNHAM

CORNISH

The symbol of good

WIRE

TV LEAD-IN CABLES
ANTENNA CONTROL CABLES
INTERCOMMUNICATION CABLES
HOOK-UP WIRES • MICROPHONE CABLES
SHIELDED CABLES • TEST LEAD WIRES
COAXIAL CABLES • PORTABLE CORDS
REPLACEMENT CORD SETS

PREFERRED... since the earliest days of Radio... for absolute uniformity and superior quality.

CORNISH WIRE CO., INC.
50 Church Street New York 7, N. Y.

SAVE TIME...

on EVERY TELEVISION SERVICE CALL with the NEW

Senco UNIVERSAL TV Jumper Cord

Carry only one Jumper Cord for all TV Sets!

- Extends Power from back of TV Set—no more moving of furniture to get to the wall plug
- Turn set off from rear
- No more winding and unwinding cords
- Two handy power outlets for soldering iron and test equipment
- Fits many speakers, focus coils, etc.

Write for illustrated Literature...

COMPLETE \$195 DEALER NET
Available at leading jobbers

SERVICE INSTRUMENTS COMPANY
ADDISON, ILL., (Chicago Industrial Suburb)
In Canada: Emerald Television Corp., Montreal

Shop Talk

(Continued from page 9)

operation, however, it represents another approach to a solid-state amplifier (one in which the current carriers travel within a solid).

Electrodes serving as the emitter and collector are plated electrolytically on opposite faces of a germanium wafer. A metal contact is then soldered to one end of the wafer, and this serves as the base electrode. Unlike junction transistors, the emitter and collector electrodes remain as coatings on the surface of the germanium. There is no penetration of the lattice structure of the germanium by the atoms of the plated electrode.

If the operation of the surface-barrier transistor is to be understood, certain facts concerning the behavior of electrons inside a crystalline structure must be known. It has been found that electron energy levels may exist on the surface of a crystal without existing in the interior. It is believed that there is no orderly structure of energy levels on such a surface. Rather, the leftover bonds of germanium atoms together with any atoms of other substances on the surface form a two-dimensional solid with properties which are entirely different from those in the interior.

An electron can move from one level to another in surface atoms easier than in interior atoms. Because of this freedom, a number of free electrons move up to the surface and concentrate there in sufficient strength to produce a negative field which repels other free electrons of the n-germanium toward the interior; and a partially insulating region containing a strong electric field forms just beneath the surface. This is the reason that the interior of the n-germanium in Fig. 3 is shown shaded and that the narrow strips along the surfaces are left unshaded. This insulating region is referred to as a "surface barrier."

A metal electrode which is brought into contact with this germanium crystal can influence the electrons in the main body of the crystal through the surface barrier only. A negative potential applied to the metal plate will further repel the interior electrons away from the surface and cause the insulating region to become thicker. If the metal electrode is made positive, these interior electrons will be attracted and the width of the insulating region will be reduced. Current flow

between the surface electrode and the inner portion of the crystal can thus be made smaller or larger as desired.

To form a surface-barrier transistor with n-germanium, we require an appropriate distribution of holes which will travel from the emitter to the collector as they do in a comparable p-n-p junction transistor. In the surface-barrier transistor, it is found that holes are created under the germanium surface when the valence electrons that are thermally excited enough to leave their atoms move into some of the

energy levels at the surface. These electrons come from the atoms located near the surface; and for every such electron departure, a hole is created. This action is confined to a layer just below the surface; few holes are produced in the rest of the germanium interior.

Note that the valence electrons just referred to are separate and distinct from the free electrons present in the n-germanium. The latter free electrons are caused by the presence of the impurity which was added to the germanium originally in order to convert it into n-germanium.

Ask "The Man on the Roof" why he prefers

South River



How valuable is a Serviceman's time? 5¢ a minute?
... 7¢ a minute? ... 10¢ a minute?

South River's New Ratchet Type Chimney Mount Saves 10 Minutes Per Installation!

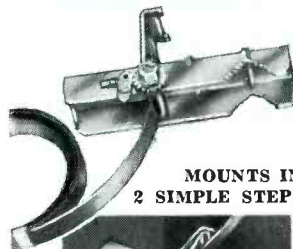

MOUNTS IN
2 SIMPLE STEPS

1. Encircle chimney with banding and thread through slotted shaft.



2. Tighten banding with wrench.



RATCHET GUY WIRE TIGHTENER

Eliminates turn-buckles! Fastens to wall or roof with screws. Extra space between tightening shaft and base permits large tightening capacity. Same sturdy construction as ratchet chimney mount.

It's the fastest, simplest, most convenient ever manufactured!

Mounting is factory assembled with band attached. No assembly of eyebolts, banding, banding clips, nuts, etc., is necessary for chimney mounting.

South River's New Ratchet Type Chimney Mount is 8 WAYS BETTER:

1. Heavy gauge steel construction.
2. Banding naturally unwinds for easy mounting. No troublesome watchspring effect!
3. Embossed and welded for extra rigidity and strength!
4. Ratchet of aircraft type aluminum, forged and heat-treated for maximum toughness and strength.
5. Fine ratchet teeth insure positive tightening of banding.
6. Banding is factory assembled to mounting.
7. Zinc plated, golden iridite finish.
8. Available with galvanized banding (Model RT) or stainless steel banding (Model RT-ST).



HIGH STRENGTH ALUMINUM GUY CABLE, HIGHLY CORROSION RESISTANT

Special 56S Alclad alloy. 7 strands, 17 gauge specially tempered and normalized. Special tight weave. Will not rust or stain. Specifically for guying use. Breaking strength: approx. 500 lbs. pull. Boxed in 100 ft. coils or ten 100 ft. coils, interconnected, 1000 ft. to box.

South River

METAL PRODUCTS CO., INC.

South River, New Jersey

PIONEER MANUFACTURER AND OUTSTANDING PRODUCER OF THE FINEST LINE OF ANTENNA MOUNTING ACCESSORIES

WRITE FOR OUR LATEST CATALOG

FIRST and FOREMOST!

The ORIGINAL and UNMATCHED

CapaciTester

The pioneer instrument for checking coupling condenser leakage in the circuit!

TeleTest anticipated your demand for a unit that would check leaky coupling condensers, under load, without removal from the circuit. With the remarkable and unparalleled CapaciTester, you not only can check any coupling condenser without clipping or unsoldering leads, but you can test for leakage between any points where it may occur! AND, with the added Wien bridge, you can measure capacities from 10 mmf. to 50 mfd.



Model CT-355

1-YEAR FACTORY SERVICE GUARANTEE

only \$44⁹⁵

- Tests all coupling condensers for leakage, regardless of type or capacity.... IN THE CIRCUIT
- Will not damage condensers
- No calibration adjustments required
- Positive indication of relative leakage amount present

TELETEST

See your local jobber, or write TODAY:

TELETEST INSTRUMENT CORP.

31-01 Linden Place, Dept. PF-2, Flushing 54, N. Y.

When one of these free electrons leaves the interior of the germanium to enter an energy level at the surface, no holes are produced. A valence electron, on the other hand, is a bound electron; and when it acquires enough energy, thermal or otherwise, to leave its atom and reach the surface, then a corresponding hole is produced. The latter holes are those referred to.

Some of the metals used for contacts produce a denser population of holes under the surface of the germanium than others produce. Among the metals found to be useful for this purpose are indium, zinc, cadmium, tin, and copper.

In review, then, we see that the surface-barrier transistor owes all of its characteristics to the special conditions which exist at the surface of a crystalline structure. The strong negative field at the surface forces free electrons to remain in the interior. Holes are found concentrated just below the surface. When a metal electrode attached to the crystal is made positive, these holes are repelled through the barrier. This electrode is the emitter. The other electrode, the collector, is reverse biased (biased negatively); and holes coming within its field after passage through the germanium will be drawn to it.

The surface-barrier transistor therefore consists of a germanium crystal, an electrode which forms the base, and two metal electrodes which are on opposite faces of the crystal and which serve as the emitter and collector electrodes.

A positive emitter will drive the holes toward the collector; but at the same time, it will attract the interior electrons. For efficient transistor action, the electron current should be reduced as much as possible. This goal was achieved by bringing the collector electrode within 0.0002 inch of the emitter. The negative charge on the collector drives the free electrons of the germanium away from the emitter; and at the same time, it presents an attractive force for the holes.

In order that the minute spacing required may be achieved, a process of electrolytic machining is employed. Two tiny jets of a solution containing a metallic salt are directed from miniature glass nozzles toward opposite faces of a germanium wafer, with the latter serving as the anode and with electrodes in the glass

WRITE FOR THIS

FREE

LIFETIME
HI-FIDELITY
Sales Kit

DEALER

SALES KIT

MAKE BIG HI-FI PROFITS

Sell the finest HI-FI Units for custom building or in BEAUTIFUL CABINETS... Sell BELOW REGULAR WHOLESALE PRICES with full dealer mark-up and with price protection.

TRANSVISION Hi-Fi Equipment is SOLD THRU SELECTED DISTRIBUTORS

TRANSVISION, INC., NEW ROCHELLE, N. Y.
In Canada: 1338 Queen St. W., Toronto 3, Ont.

TRANSVISION, INC., New Rochelle, N. Y. PF-2
Rush FREE Dealer SALES KIT on HI-FI and name of nearest distributor.

Name _____
Address _____
City _____ State _____



"Don't play it until I get back with a JENSEN NEEDLE."

nozzles serving as the cathode. A voltage is applied between the anode and the cathode. The electrolytic action etches away the germanium under each jet until the desired amount of material has been removed.

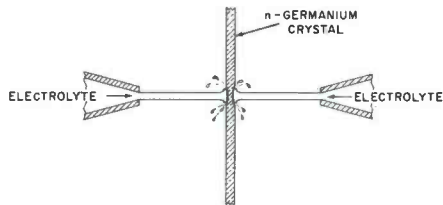

Fig. 4. Tiny Jets of a Metallic-Salt Solution Are Directed From Glass Nozzles Toward Opposite Faces of a Germanium Wafer. In This Manner, Etching and Then Surface Electroplating Are Achieved.

Then the polarity of the voltage is reversed, and the same jets are used to electroplate the metallic ions of the salt solution directly upon the freshly etched surface of the germanium. (See Fig. 4.) In this manner, the desired emitter and collector electrodes are placed on the wafer. Using the salt solution to accomplish both actions of etching and electroplating is a very efficient and ingenious method. The diameter of the

emitter electrode is 0.003 inch, and that of the collector is 0.006 inch.

Video amplifiers that have 5-mc bandwidths and tuned amplifiers that have shown stage gains of 15 decibels or more at 30 megacycles have been built with surface-barrier transistors. Reliable oscillator operation up to 70 megacycles has also been attained.

The p-n-i-p and n-p-i-n Transistors

Another transistor which holds considerable promise of raising the high-frequency limits of present-day transistors is the p-n-i-p transistor (and its complementary n-p-i-n) developed by the Bell Telephone Laboratories, Inc. An illustration of this type of transistor is shown in Fig. 5. It consists of an emitter, a base, and a collector which are smaller than those in previously described junction transistors; and it has an additional layer of pure germanium which is inserted between the base and the collector. This slab of pure germanium is almost completely free of excess electrons and holes. For this reason, it is also called intrinsic germanium; and it is from this latter

designation that the letter "i" in the name p-n-i-p is obtained.

The principal change is the insertion of the intrinsic-germanium layer; and through its presence,

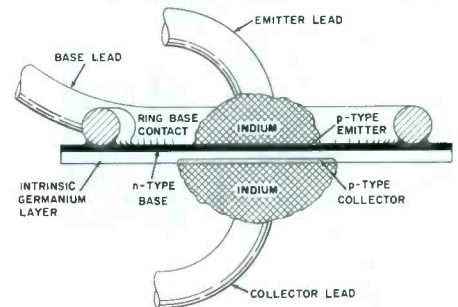

Fig. 5. A Magnified Cross Section of a p-n-i-p Transistor.

several advantages are gained. For one thing, the base and collector regions are separated by this layer; in essence, we have widened the base-to-collector junction and thereby lowered its capacitance. This lowering, of course, aids the frequency response. The slab of intrinsic germanium possesses no excess electrons or holes, and therefore it cannot provide the charges necessary

Mr. Electronic Service Technician

You have seen and will continue to see, in the chassis of TOP-NAME Radio and TV sets, an increasing number of Planet electrolytic capacitors — conspicuous because of their shiny red cardboard jackets. They are in those quality sets because components engineers have proven for themselves that PLANET condensers are "ENGINEERED FOR QUALITY".

You can take advantage of their findings by purchasing from your distributor Planet universal replacement types of the same high standard of quality. Ask for PLANET by name.

Write now for "ENGINEERED FOR QUALITY" latest FREE catalog. **GUARANTEED FOR ONE YEAR**

PLANET PLANET MANUFACTURING CORPORATION
225 BELLEVILLE AVENUE
BLOOMFIELD, N. J.

XCELITE Hand Tools

PREFERRED BY THE EXPERTS

No. 99 JUNIOR SERVICE KIT

APPROVED BY THE BEST JUDGE OF GOOD TOOLS — THE SERVICEMAN!

That's because the 99 Junior gives a serviceman what he wants — a pocket roll kit with the screwdrivers and nut drivers he needs — the big, hand-filling Xcelite handle — screwdriver points and nut driver sockets of high strength and accurate fit. And best of all, a price tag that's not hard to take. Ask your supplier today!

XCELITE INCORPORATED
Dept. Q.,
Orchard Park, N. Y.

For Originality
LOOK TO XCELITE

**New! COLOR
& BLACK & WHITE
LAB & TV SERVICE
5" SCOPE**



**KIT
\$79.95**

**Factory
Wired
\$129.50**

#460

- Flat from DC to 4.5 mc to reproduce 3.58 mc sync burst and oscillator signals in color TV sets.
- V amplifier direct-coupled and push-pull through; gradual roll-off beyond 4.5 mc, useful at 10 mc.
- High V sensitivity: 25 mv/in.
- Choice of direct coupling (DC) or capacitive coupling (AC).
- 4-step frequency-compensated attenuator in both AC and DC positions.
- Built-in calibrator permits peak-to-peak voltage measurement.
- Automatically syncs anything visible on the screen.
- Pre-set TV V & H sweep positions (30 cps & 7875 cps).
- Edge-lit lucite engraved graph screen with dimmer control; filter; standard bezel fits standard photographic equipment.
- 5UP1 CRT.

Prices 5% Higher on West Coast



Write for Name of Distributor & FREE New 1956 CATALOG PFS-2
84 Withers St. • Bklyn 11, N. Y.

NOW IN STOCK AT YOUR NEIGHBORHOOD DISTRIBUTOR—ORDER NOW!

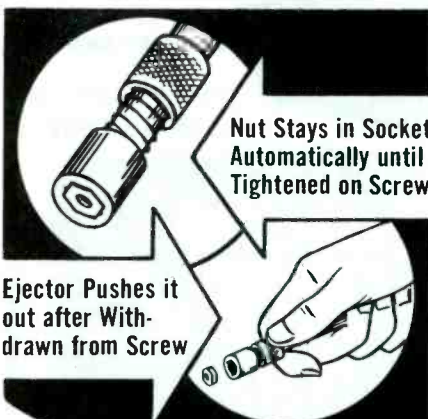

**Nut Stays in Socket
Automatically until
Tightened on Screw**

**Ejector Pushes it
out after With-
drawn from Screw**

The Radio-TV Serviceman Will Save Time and Effort with this NEW

Ejection-Grip NUT DRIVER

Eliminates lost nuts, screws or bolts. Specially designed to speed intricate assembly work. The internal tapered socket takes care of all size variations in nuts, bolts and screws. Non-magnetic. Non-jamming. Unconditionally guaranteed.

**SET YOUR
SIGHT ON**

**See Your
Jobber**

AMALITE Inc.
1884 PITKIN AVENUE, BROOKLYN 12, N. Y.

to form a p-n junction with either the base on one side or the collector on the other.

With the collector positioned at a greater distance from the base, we can make the base very thin without fear of a voltage breakdown between the emitter and the collector. Base substances of much lower resistivities may also be employed, and thus lower base resistances would be produced. Finally, to reduce the effect of the capacitance of the emitter-to-base junction, the emitter area is made smaller.

Bias voltages are applied to the p-n-i-p transistor in the same fashion that they are applied in conventional junction units — the emitter is biased in the forward direction, and the collector is biased in the reverse direction with respect to the base. The layer of intrinsic germanium is not given any external potential.

When operating biases are applied to this transistor, holes are injected by the emitter into the base region and they diffuse across this region until the intrinsic-germanium layer is reached. At this point, they travel at high velocities through the intrinsic germanium to the collector. The carriers, which are holes in this instance, travel slowest through the base region because it is practically field free. Whatever voltage is applied between the base and the emitter appears almost wholly across the junction separating these two regions. By the same token, whatever voltage is applied between the base and the collector appears across the junction separating these two regions. Carrier travel through the intrinsic germanium is much faster because there are no donor nor acceptor charges to reduce the strength of the applied voltage from the battery connected between the base and the collector.

Laboratory units have produced stable gains of 20.5 decibels at 10 megacycles. It is indicated that amplifiers may be built to operate at 1,000 megacycles with 10 decibels or more of gain.

Tetrode Transistors

All of the preceding methods of improving frequency response have dealt with what has been called the triode transistor which is so named because of its resemblance to the triode vacuum tube. Improved frequency response has also been achieved by the addition of another

connection to the triode junction transistor to form what has become known as the four-terminal or tetrode transistor. The fourth electrode, labeled b_2 , is attached to the base layer at a point which is on the side opposite the original base connection b_1 . See Figs. 6 and 7. A

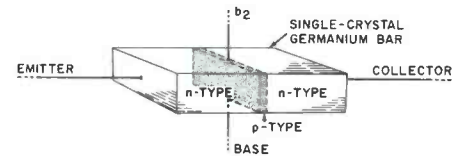

Fig. 6. The Tetrode Junction Transistor.

potential which is considerably higher than the normal emitter-to-base potential is applied to this second base lead. The emitter voltage is generally about -0.1 volt. On the other hand, b_2 is given a potential of about -6 volts. This voltage is fixed and will not vary with the signal since the latter is still applied between the emitter and base b_1 .

The bias voltage on b_2 will modify the flow of current through the transistor. In the unit shown in Fig. 7, the emitter and collector sections are formed of n-germanium and the base is formed of p-germanium.

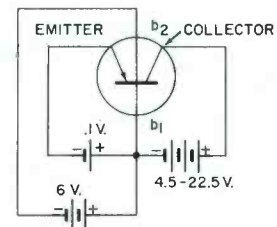

Fig. 7. The Tetrode Transistor (n-p-n Variety) With Bias Voltages Applied to All Elements.

The relatively large negative potential on b_2 serves to restrict the flow of electrons from the emitter to the collector in the base region directly underneath the field of this voltage.

It can be seen from Fig. 7 that the -6 volts are applied between b_2 and b_1 , or actually across the width of the base section. Since the base has an internal resistance, the voltage decreases uniformly from -6 volts at the top to 0 volts at the bottom. At all points except near the bottom edge of the base, the voltage is negative enough to prevent the flow of electrons from the emitter across the base to the collector. At the bottom edge, the 0.1-volt forward bias between b_1 and the emitter will

permit electrons to travel from the emitter to the collector.

The flow lines in the tetrode transistor differ from those in the conventional n-p-n transistor to the extent shown in Fig. 8. The improvement in the high-frequency operation of this transistor stems from two factors. First, the capacitance of the collector is reduced by the decreased effective area of the base-to-collector junction. This capacitance, we have seen, acts to shunt the signal at the output of the transistor and is

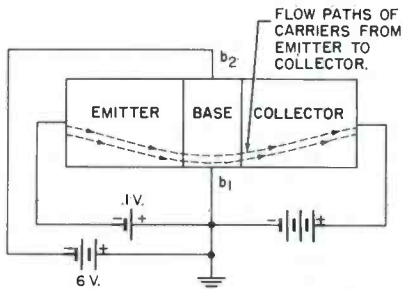

Fig. 8. The Presence of a Voltage at b_2 Modifies the Flow of Carriers From the Emitter to the Collector.

analogous to the output capacitance of a vacuum tube. The smaller the capacitance, the higher the signal

frequency can become before the shunting effect becomes important. Second, the reduced effective area of the base means that the effective base resistance is reduced. A low base resistance is also conducive to improved high-frequency operation.

A limitation of this tetrode construction is the fact that, by forcing the currents to flow in a narrow channel, we reduce the current rating and thereby the power capabilities of the unit. Fortunately, the power requirements for many of the high-frequency stages in commercial receivers are very low; therefore, this limitation is not of prime importance in many applications.

The ability of the tetrode transistor to extend the frequency range of an amplifier is demonstrated by the graphs shown in Figs. 9 and 10. The first figure shows relationships between frequency and alpha (which is representative of the current gain in the transistor). The top curve in the figure shows the variation of alpha when the second base connection is open. The transistor is functioning as a conventional n-p-n unit. When b_2 is connected and a current (in this case 1.5 milliamperes) flows through

this element, the alpha value is lower but its decrease with increasing frequency is more gradual. The curves cross over at about 30 megacycles; thereafter, the operation of the tetrode transistor is definitely superior to that of an n-p-n triode transistor.

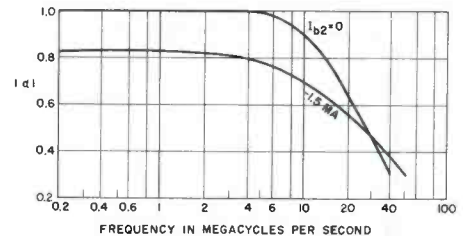

Fig. 9. Variation in Alpha (α) With Frequency When b_2 Is and Is Not Connected in a Tetrode Transistor.

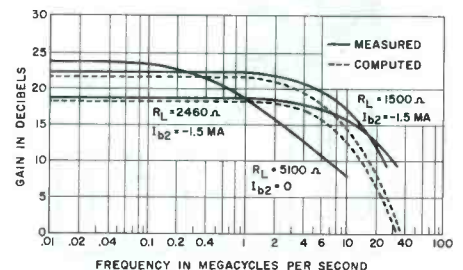

Fig. 10. Measured and Computed Gains for the Tetrode-Transistor Amplifier of Fig. 11.



FREE LAYOUT SERVICE assures better storage facilities for less money

Find out how to store more stock in less space . . . how to make maximum use of each unit to reduce equipment investment . . . how to arrange units for fastest stock handling . . . proper width of aisles, location of packing benches, and other valuable data by using Equipto's **FREE LAYOUT SERVICE**. Profit by the aggregate experience of trained Equipto engineers who have designed hundreds of layouts of every description.

For simpler layouts, or for those who wish to design their own facilities, Equipto offers a fact-cramped free booklet entitled, "How to Solve Your Storage Problems."

Write today for your copy of booklet or advise when our layout engineer should call.



Equipto

Division of Aurora Equipment Co.
830 Prairie Avenue, Aurora, Illinois

Steel Shelving...Parts Bins...Drawer Units...Lockers...Carts...Work Benches

QUIT KIDDING YOURSELF —
YOU'RE NOT GOING TO BE
SATISFIED 'TIL YOU START
SELLING WALCO NEEDLES!



FOR FREE
ILLUSTRATION
OF LILY, WRITE

Walco

TRADE NAME OF

PF-2

ELECTROVOX CO., INC.

60 Franklin St., East Orange, N. J.

KENCO KATE SAYS

"NO
INSTALLATION
PROBLEMS
when you use
KENCO
MOUNTS"



KENCO
EAVE
MOUNTS

Easily mounted on hanging
rafters or trim boards of eave.
Eliminates need for drilling
into brick or masonry walls.
Ideal for buildings with exten-
ded roofs. Hot dip galvan-
ized.

AVAILABLE IN 3 SIZES:

Model # 122 ... 22" Eave Mount
Model # 128 ... 28" Eave Mount
Model # 148 ... 48" Eave Mount

OTHER KENCO PRODUCTS:
All-Position Mounts; Parapet
Mounts; Sky Struts; "Snap-
In" Wall Brackets; "Snap-In"
Chimney Mounts; Z-Type
Chimney Mounts; Lag Screws
and Hardware.

For information on the com-
plete Kenco line write Dept. D.

KENWOOD ENGINEERING CO., INC.

Kenilworth, New Jersey

The frequency improvement produced by this new transistor is perhaps more clearly brought out in Fig. 10 in which we have the measured and computed gains for the tetrode amplifier shown in Fig. 11.

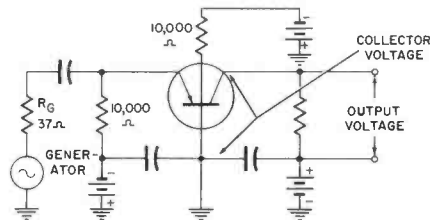
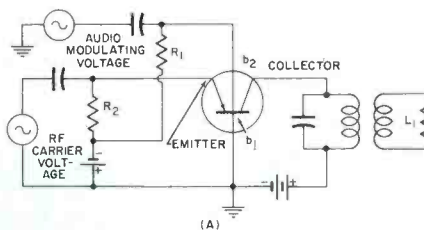
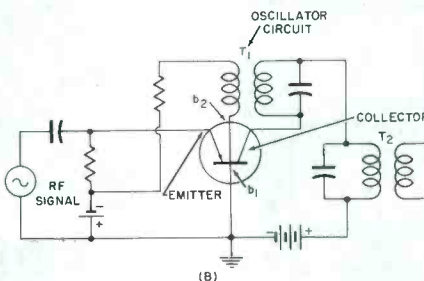

Fig. 11. The Circuit Used in Obtaining the Curves of Fig. 10.

When b_2 is left unconnected, the drop in gain starts at about 100 kilocycles and becomes appreciable above 1 megacycle. Compare this behavior with that obtained when b_2 is used. Results are given for two values of load resistors. The gain remains flat up to 1.5 megacycles when R_L equals 5,100 ohms and up to 3 megacycles when R_L equals 2,460 ohms.



(A) Modulator Circuit.



(B) Frequency Converter.

Fig. 12. Two Applications of a Tetrode Transistor in Which b_2 Is Employed as an Active Element.

The usable range greatly exceeds these frequencies; according to the graphs shown, 12 decibels of gain can be obtained at 20 megacycles. This represents a sizable step upward in frequency and would enable such tetrode transistors to be useful in the IF stages of television receivers, if this application should be desired.

Active use of b_2 , rather than the passive role indicated in the fore-

going, has also been suggested. For example, in Fig. 12A, the tetrode transistor is employed as a modulator. The RF carrier signal is applied to the emitter and the audio voltage is impressed at b_2 . The bias voltages for both the emitter and the base b_2 are obtained from the same battery although each circuit is isolated from the other by resistors R_1 and R_2 . The changing audio voltage alters the amount of RF carrier current flowing through the transistor and, in this way, modulates the RF carrier amplitude. The modulated signal appears across load L_1 for transfer to the rest of the system.

In Fig. 12B, the tetrode transistor is shown connected as a frequency converter. Transformer T_1 feeds energy back from the output or collector circuit to the base b_2 . If the polarity of the feedback voltage is correct, oscillations will occur. At the same time, the received signal is applied to the emitter. The interaction of this signal with that from the local oscillator produces sum and difference frequencies. Transformer T_2 is tuned to the IF or difference-frequency signal, and this signal is fed to several stages of amplification as in any conventional radio receiver.

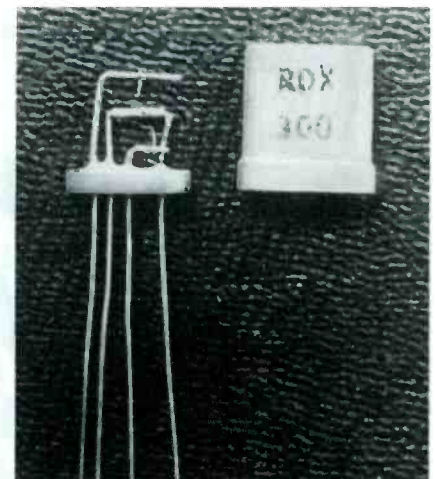

Fig. 13. Photograph of a Tetrode Transistor Commercially Produced. (Courtesy of Germanium Products Corp.)

The tetrode transistor is seen to have many possible applications, and a number of firms are beginning to manufacture such transistors in quantity. One such unit is shown in Fig. 13. Just how much actual use will be made of this transistor depends upon its cost and its ability to compete with some of the other transistor developments discussed.

MILTON S. KIVER

Harold W. Sams

PF
PUBLICATIONS

REPORTER

INDEX TO ADVERTISERS
February, 1956

Advertisers	Page No.
Amalite, Inc.	76
American Microphone Co.	60
American Phenolic Corp.	50
American Television & Radio Co.	68
Astron Corp.	Colorblock Insert
Atlas Sound Corp.	70
B & K Mfg. Co.	48
Bussmann Mfg. Co.	6
CBS-Hytron	24
Central Electronics, Inc.	32
Centralab, A Division Globe-Union, Inc.	36
Chicago Standard Transformer Corp.	35
Clarostat Mfg. Co., Inc.	22
Clear Beam Antenna Corp.	58
Columbia Wire & Supply Co.	62
Cornell-Dubilier Electric Corp.	63
Cornish Wire Co., Inc.	72
Delco Radio Div., General Motors Corp.	14
DuMont Labs., Inc., Allen B.	18
Electric Soldering Iron Co.	65
Electro Products Labs.	64
Electro-Voice, Inc.	72
Electronic Instrument Co., Inc. (EICO)	62, 76
Electronic Publishing Co.	68
Equipto Div., Aurora Equipment Co., Inc.	77
Federal Telephone & Radio Co.	Colorblock Insert
General Cement Mfg. Co.	41
General Electric Co.	4 & 5
Hexacon Electric Co.	79
Holloway Electronics	30
Hughes Aircraft Co.	56
Hycon Mfg. Co.	55
International Resistance Co.	2nd Cover
Jackson Electrical Instrument Co.	65
Jensen Industries, Inc.	74
Jerrold Electronics Corp.	54
JFD Mfg. Co.	8
Jontz Mfg. Co.	70
Kenwood Engineering Co.	78
Littelfuse, Inc.	4th Cover
Mallory & Co., Inc., P. R.	42, 43
Merit Coil & Trans Co.	64
Oxford Electric Corp.	69
Perma-Power Co.	60
Permo, Inc.	77
Phaotron Co.	34
Planet Mfg. Corp.	75
Pyramid Electric Co.	38
Quam-Nichols Co.	61
Radiart Corp. - Cornell-Dubilier Electric Corp.	1
Radio Corp. of America	33, 59, 3rd Cover
Radio Receptor Co., Inc.	40
Ram Electronics Sales Co.	71
Raytheon Mfg. Co.	7
Sams & Co., Inc., Howard W.	49, 57
Sangamo Electric Co.	46
Service Instruments Co.	72
Shure Bros. Inc.	51
South River Metal Products Co.	73
Sprague Products Co.	2
Sylvania Electric Products Inc.	28
Teletest Instr. Corp.	74
Tenna Mfg. Co.	44
Transvision, Inc.	74
Tung-Sol Electric Inc.	66, 67
Vokar Corp.	52
Walco Products Inc.	78
Walsco Electronics Corp.	37
Webster Electric Co.	53
Westinghouse Electric Corp.	45
Wright Stell & Wire Co., G. F.	71
Xcelite, Inc.	75

While every precaution is taken to insure accuracy, we cannot guarantee against the possibility of an occasional change or omission in the preparation of the REPORTER.

Know Your Oscilloscope

(Continued from page 27)

redrawn, and the sawtooth output from tube V1 has been superimposed upon it to make Fig. 6. Two conditions are pictured: one with a supply of $E_B = 100$ volts, the other with $E_B = 200$ volts. In each case, the firing potential is 63 volts and the deionization potential is 40 volts. Two effects of the higher value of E_B can be noted: a more linear sawtooth waveform and an increased frequency of the sawtooth signal. If E_B were only slightly higher than the firing potential of 63 volts, the sawtooth would shift to a position near the top of the curve; the frequency would be lowered; and the waveform would become very non-linear.

This relationship between linearity and supply voltage is a good point for the technician to keep in mind. If the sweep on his oscilloscope screen appears to be very nonlinear, it would be well to check the sawtooth generator to see that the supply voltage has not changed from its normal value. This voltage cannot be adjusted in most oscilloscopes.

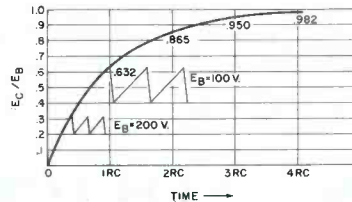

Fig. 6. Graph Showing the Effect of Different Values of E_B Applied to a Thyatron Sawtooth Generator.

The other major factor affecting the frequency of the sawtooth signal is the bias on the thyatron tube. The bias governs the firing potential of the tube. If the bias is made more negative, the tube will not fire until a higher anode potential is reached; and if it is made less negative, the tube will fire at a lower anode potential. Synchronization of the sawtooth signal with the waveform being viewed can be obtained easily if the synchronizing signal is allowed to control the bias on the grid of the thyatron. The bias for the tube shown in Fig. 4 is obtained from the cathode resistor R_K . In some cases, R_K is made a part of a bleeder network in the $B+$ supply; and it may also be made adjustable if the oscilloscope designer sees fit. In the latter case, it is not adjustable from the front panel but is preset at the factory for best results.

The effect of the bias voltage on the sawtooth frequency may be summed up as follows. The higher the bias, the higher the firing po-

tential of the tube; and this means that more time will be required for capacitor C to charge to the firing potential. The frequency of repetition will therefore be lowered. The reverse effect is true if the bias is lowered.

Multivibrator Sweep Circuits

The thyatron sawtooth generator is still used in some present-day oscilloscopes, but some form of multivibrator sweep circuit is becoming much more common. At the frequencies at which it operates, the thyatron will give a more rapid retrace; but the multivibrator is capable of generating higher sweep rates. A number of general-purpose oscilloscopes have been designed with sweep rates of several hundred kilocycles per second. The multivibrator is also widely used as a sweep generator in TV receivers, and its design differs very little for the two applications except for the greater frequency range required in the oscilloscope.

The nature of a multivibrator sweep generator is such that it can be easily designed to give either a single sweep, triggered sweeps, or free-running sweeps. A free running sweep is one that operates at its own natural frequency in the absence

NOW! INSTANT SOLDER GUN
and COMPLETE
"DO-IT-YOURSELF" KIT

FOR HUNDREDS OF RADIO, TV AND HOMECRAFT JOBS

HEXAHEXON
FEATHERWEIGHT
Instant SOLDER GUN
NO HEAVY BULKY TRANSFORMER

SOLDER GUN ONLY—MODEL G14 \$7.95
BEST KIT VALUE! MODEL G14K \$8.95

Includes:

- ✓ 150-Watt Instant Solder Gun Model G14
- ✓ Cutting Tip for plastic tile, old putty, toys, etc.
- ✓ Smoothing Tip for furniture scratches, sealing, etc.
- ✓ Famous Kester TV-Radio Resin Core Solder
- ✓ Sandpaper for cleaning parts

COMPARE THESE FEATURES WITH ORDINARY SOLDER GUNS!

POWER PACKED—150 Watts
NO HEAVY TRANSFORMER —weighs only 8 oz.
STURDY LIFETIME TIP —no soft fragile wire
HEAT RIGHT IN TIP —new unique element design
LONGER, THINNER REACH —EFFECTIVE SPOTLITE

"You'll like the way it HANDLES!"
COMBINES ALL THE ADVANTAGES OF THE SOLDER GUN AND THE CONVENTIONAL SOLDERING IRON. No waiting — press trigger and solder at once. Ideal tool for shop or home use. Takes only half the space of transformer guns in tool boxes.
120 Volts AC-DC ¼" Tip (also available ⅛" Tip)

HEXAHEXON ELECTRIC COMPANY
589 WEST CLAY AVENUE, ROSELLE PARK, NEW JERSEY

Serving Craftsmen for a Quarter of a Century

of a synchronizing signal. A triggered sweep has a natural frequency determined by its circuit components, but each cycle of sweep must be initiated or triggered by a synchronizing signal. In the absence of such a signal, no trace will be obtained with the latter type of sweep.

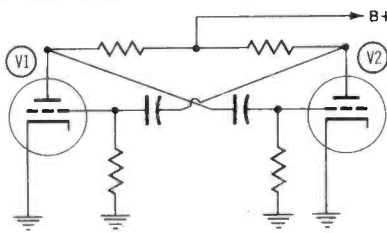

Fig. 7. Basic Multivibrator Circuit.

A basic multivibrator circuit is shown in Fig. 7. This is a free-running type and operates continuously without the necessity for a triggering signal. If both tubes have similar characteristics and the corresponding resistors and capacitors for each tube are identical, the output signal at the plate of tube V2 will be a close approximation to a symmetrical square wave. Values of the different components can be chosen so that a nonsymmetrical square wave will be obtained. One tube will conduct for a much longer period of time than the other. This signal can then be used to trigger a discharge tube

connected across a capacitor, and thus a sawtooth curve will be obtained.

It is possible by further modifications of the circuit to eliminate the discharge tube. That function would be performed by the second tube V2 in addition to its function as part of the multivibrator. Twin-triode tubes are particularly adaptable to multivibrator circuits because they contain in one envelope two triodes of identical characteristics. Common choices for this type of operation are 6J6, 12AT7, and 12AV7 tubes.

Some Refinements of Sweep Circuits

The examples given and illustrated have been kept rather basic in order to simplify the discussion. It was shown that the use of a small portion of the charging curve of a capacitor results in a sawtooth sweep which is fairly linear. Some oscilloscopes incorporate means for further linearization of the trace. With a thyratron sweep generator, this can be done by placing a pentode tube in the charging circuit of the capacitor. The pentode functions as a constant-current device and allows the capacitor to charge at a constant rate. RC networks are sometimes added to a multivibrator sweep gene-

rator to improve the shape of the sawtooth signal.

Nonlinear Sweeps

It is sometimes desirable to use sweeps other than the sawtooth sweep which is provided internally in the oscilloscope, and usually these are of a nonlinear nature. This means that the sweep does not travel at a constant rate in the horizontal direction. The majority of present-day oscilloscopes have provision for using a sine-wave sweep. This is usually obtained internally from the oscilloscope itself and can be taken from a winding on the power transformer. The 60-cycle sine wave obtained in this manner is applied to the horizontal amplifiers of the oscilloscope, and the amplified signal drives the horizontal deflection plates. The nonlinearity of a sine-wave sweep is greater at the extremes of the sweep, and response curves viewed in this manner will be compressed at these points. Another disadvantage is the fact that the sweep time and retrace time are the same, but this disadvantage is usually minimized by the use of a retrace-blanking feature.

PAUL C. SMITH

PF REPORTER

CATALOG and LITERATURE SERVICE

valuable manufacturers' data available to our readers

1P. ATLAS (Atlas Sound Corp.)

Free Catalog No. 55, covering complete Atlas public address system. See advertisement page 70.

2P. B & K (B & K Manufacturing Co.)

Informative article titled: "Profitable TV Servicing in the Home," by Henry Gronski, General Manager of Central Television Service, Chicago. Also Bulletin No. 500 on newest B&K Dynamic Mutual Conductance Tube Tester, and Bulletin No. 104 on CRT Cathode Rejuvenator Tester. See advertisement page 48.

3P. BUSSMANN (Bussmann Mfg. Co.)

Bulletin on Fusetron and Buss Small Dimension Fuses—Form SFB. See advertisement page 6.

4P. CBS (CBS-Hytron)

CBS-Hytron Business Builders Catalog, Third Edition. See advertisement page 24.

5P. CLAROSTAT (Clarostat Mfg. Co., Inc.)

Clarostat C Line Controls, Form No. 753394 1-watt composition element, 2, 3 and 4 watt wire wound controls. Deluxe controls for laboratory experimenters, equipment builder, etc. See advertisement page 22.

6P. CORNELL-DUBILIER (Cornell-Dubilier Electric Corp.)

Ceramic Catalog No. 616. See advertisement page 63.

7P. EICO (Electronic Instrument Co., Inc.)

Free 1956 Catalog of all EICO Instruments for service technicians. See advertisement pages 62 and 76.

8P. HEXACON (Hexacon Electric Co.)

Catalog No. 103, illustrating and listing complete line of Soldering Irons and replacement tips. See advertisement page 79.

9P. HYCON (Hycon Manufacturing Co.)

Catalog and specification sheets on all Hycon instruments. See advertisement page 55.

10P. IRC (International Resistance Co.)

Form S012C Replacement Manual for Trade Names and Part Numbers. See advertisement 2nd Cover.

11P. JFD (JFD Manufacturing Co.)

New 1956, 36-page TV catalog listing the most complete line of mounts, screw eyes, wire, indoor antennas, masts available in the industry. See advertisement page 8.

12P. KENWOOD (Kenwood Engineering Co., Inc.)

A new 16-page catalog listing television mounts and accessories that are available through distributors. Four pages devoted to new products. See advertisement page 78.

13P. RADIO RECEPTOR (Radio Receptor Company, Inc.)

New Radio and TV Selenium Rectifier Replacement Guide, Bulletin No. 213. See advertisement page 40.

14P. RAM (Ram Electronics Sales Co.)

Free 1956 RAM TV Service Manual PF-2 fea-

tures "PIX-A-FAULTS," "TROUBLE-FACTS," Circuit Diagrams, plus complete Cross-reference replacement listings for flybacks, yokes, vertical osc. and output xfmr's, linearity and width coils—all authentic recommendations from TV manufacturers' specifications. See advertisement page 71.

15P. TELETEST (Teletest Instrument Corp.)

Free Booklet covering Flyback Tester, Model No. 100; Rejuvenator, Model No. 203; and Capacitester, Model No. 355. See advertisement page 74.

16P. WALCO (Walco Products-Electrovox Company)

New 1956 Walco Needle Catalog; Walco Needle Cross Reference Guide; Walco Needle Wall Charts; Walco Ident-a-graf—Phonograph Needle Identification System Sheet. See advertisement page 78.

17P. WALSCO (Walsco Electronics Corp.)

Walsco Wizard—for complete information, write for brochure Form No. 210. This brochure gives the complete theory and engineering analysis of the mechanical and dielectric properties of the 3 new fringe area Walsco antennas incorporating the exclusive "Phase-reverser" principle. See advertisement page 37.

18P. WRIGHT (G. F. Wright Steel & Wire Company)

Folder giving complete information on Wright non-snarling TV Guy Wire. See advertisement page 71.

TOP performance for TV anywhere!

Federal's "ALL-STAR" LEAD-IN TEAM

*Urban, fringe or distribution system . . .
heat, rain, dust, snow, ice, salt spray,
polluted air. . . whatever the conditions
you'll find a winner in these dependable
Quality-Controlled Cables by "FTR"*

North, East, South, West . . . wherever there are TV customers . . . Federal's "All-Star" Lead-in Team can be depended upon to deliver *championship performance* . . . !

These six popular types are outstanding examples of the quality, ruggedness, efficiency and long life built into every foot of Federal Cable. Whatever the run requirements or local weather conditions the Federal "All-Stars" will score high in satisfaction . . . with you and your TV customers.

Federal lead-ins can be installed with utmost confidence, because they are engineered and manufactured by a *pioneer* cable maker . . . and "Certified by a World of Research" . . . through the International Telephone and Telegraph Corporation.

Check the high points of Federal's "All-Star" Lead-in Team . . . then get in touch with your Federal Distributor. Always specify "Federal". . . *keep those TV installation profits instead of paying them back in call-backs!*

*"America's leading producer of
solid dielectric cables"*

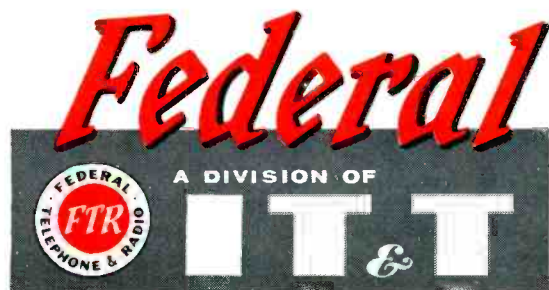

High Volume-Low Price TV Lead-in



Economical and Efficient

TV-1190—300-ohm heavy-duty lead-in with 90 mil. web. Has 7/#28 copper strands. Economical and highly efficient. Insulated with Federal-developed "silver" polyethylene for rugged service and long life.



Another Low-cost Leader

TV-2000—300-ohm dumbbell-shaped lead-in with 55 mil. web. Has 7/#30 copper strands. A high-value, low-cost type for the average installation. Cinnamon-brown color is protection against ultra-violet.

"Quality-Controlled" TV Lead-in & Cable



Heavy-duty Type

TV-1182—300-ohm deluxe type heavy-duty long life lead-in with 7/#28 copper strands, 90-100 mil. web, insulated with Federal's "silver" polyethylene. Resists weather, heat, sun. Very low line loss in fringe areas.



Quality plus Economy

TV-1184—300-ohm dumbbell-shaped, standard, economy type lead-in with 7/#28 copper strands, 70 mil. web, for urban areas with no unusual conditions. Cinnamon-brown color is highly effective in resisting ultra-violet.

Community TV Lead-in



Primary Lead-in

RG-11/U—75-ohm shielded low-loss coaxial. One of the best small-diameter cables. Tops as a Community TV primary lead-in. Also can be used with unbalanced input TV receivers in low signal strength areas.



Secondary Lead-in

59/U Type—73-ohm coaxial lead-in. Highly efficient as a Community TV pole-to-house tap-off. Meets all needs wherever a high-grade installation is a must. Ideal for use with unbalanced input TV receivers.

For data on other types, write Dept. D-4118A

Federal Telephone and Radio Company

A Division of INTERNATIONAL TELEPHONE AND TELEGRAPH CORPORATION
COMPONENTS DIVISION • 100 KINGSLAND ROAD • CLIFTON, N. J.

In Canada: Standard Telephones and Cables Mfg. Co. (Canada) Ltd., Montréal, P. Q.
Export Distributors: International Standard Electric Corp., 67 Broad St., New York

The Facts

PROVE...

"STAMINIZED" ASTRON CAPACITORS
ARE THE *toughest* EVER
DEVELOPED...

Better designs, Better materials, Better techniques
are combined to create
EXTRA-RUGGED, EXACT REPLACEMENT
capacitors for every servicing need.

Talk about performance!
Service Technicians will tell you
"Staminized" Astron Capacitors
make sets operate better-than-new.

Judge for yourself!

Install "Staminized" Astron Capacitors
-- the verdict will be in your favor.

Ask your jobber for them today.

THE BEST YET!



"SM" TWIST-PRONG



"SM" MINIMITE TUBULARS



"SM" CARDBOARD TUBULARS



BLUE-POINT®
MOLDED PLASTIC PAPER TUBULARS

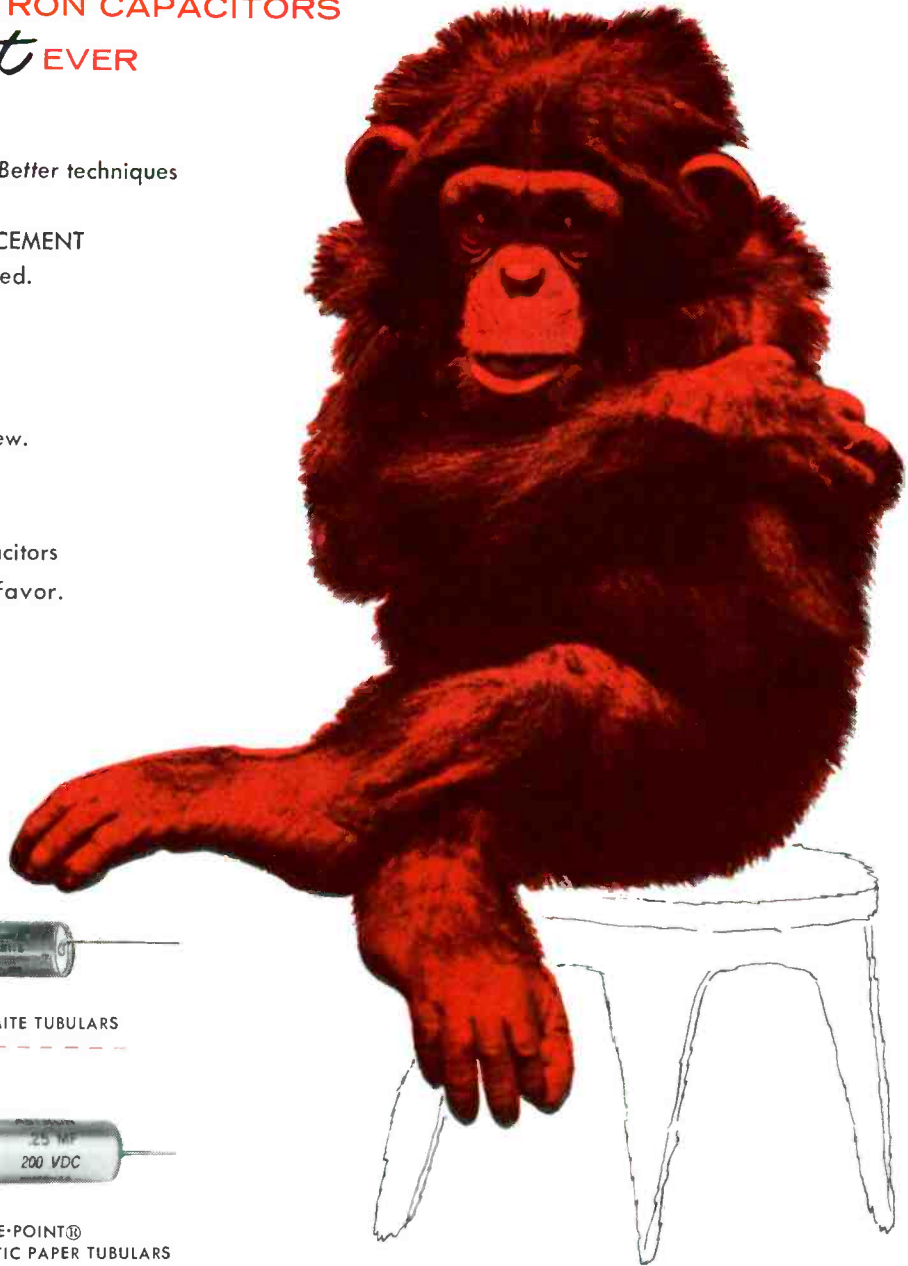

FREE... ASTRON'S NEW SERVICING AID
Replacement Catalogue AC-4D. Write for your copy — Now!

ASTRON

C O R P O R A T I O N

WEST COAST WAREHOUSE: 9041 West Pico Blvd., Los Angeles
EXPORT DIVISION: Roche International Corp., 13 East 40th St., N. Y., N. Y.
IN CANADA: Charles W. Pointon, 6 Alcina Ave., Toronto, Ontario



255 GRANT AVENUE, EAST NEWARK, N. J.

VISIT US AT
BOOTH 368 IRE SHOW
MARCH 19-22

*Safety Margin Construction — An Astron Trademark

Build bigger business through better public relations

- Tie-in with the biggest event in the TV Industry... National Television Servicemen's Week—March 5-10
- Benefit from the gigantic promotion program sponsored for you by RCA

Plan now to build greater customer confidence and lasting business success by getting on the big bandwagon—along with thousands of TV Dealers and Service Technicians from coast to coast. Bring the vital message of your "Code of Ethics" to your neighborhood customers and prospects. Just look at the tools and materials available for your use.

Our pledge for Superior TV SERVICE

CODE OF ETHICS

WE USE RCA TUBES

CODE OF ETHICS

How's your television I.Q.?

Decals

TV "I. Q." Booklets

"Code of Ethics" Plaque

WE USE RCA TUBES

TV-RADIO SERVICE

DEALER NAME

RCA salutes THE RADIO-TV TECHNICIAN

NATIONAL TELEVISION SERVICEMEN'S WEEK

MARCH 5th to 10th

Window Display

Illuminated Interior Signs

Streamers

TV Safety Glass Cleaners

Electronic Lapel Pins

Car Bumper Sign

Drop Cloths

RCA backs up this greatest promotion in TV Service history with....

Color pages in Life & TV Guide

On RCA TV Spectaculars

On Network Radio

In Local Newspapers

What a program! What an opportunity for you!

See Your RCA Distributor Today



RADIO CORPORATION of AMERICA
TUBE DIVISION
HARRISON, N. J.

WHAT'S IN A FUSE?

Only a fuse element, glass & caps?

No! Every fuse carries
with it the skill and quality of its manufacturer.

You can't reach out and touch or taste this,
you can't even be sure it will do
its job when needed except
by purchasing from a company
that has the know how of 25 years
of manufacturing fine fuses.

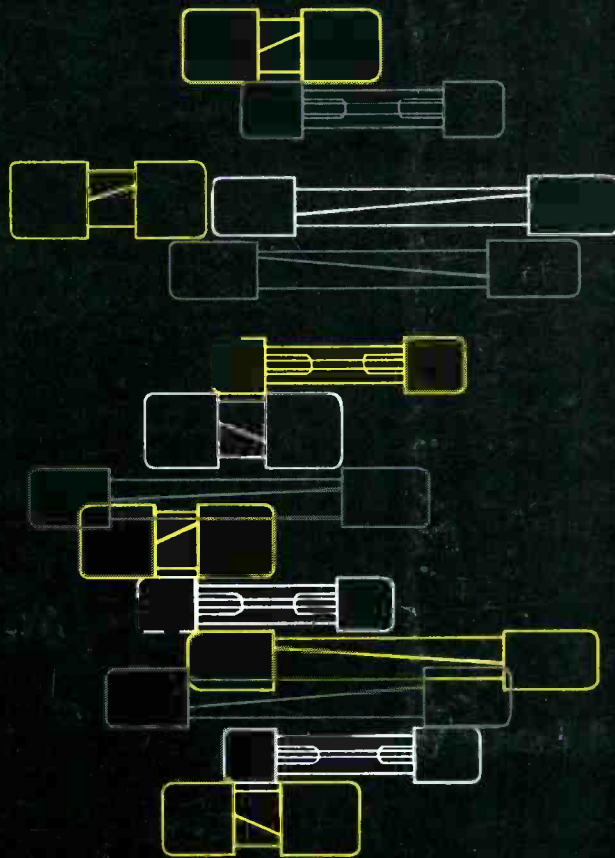

BURTON BROWNE ADVERTISING

LITTELFUSE

1865 Miner Street · Des Plaines, Illinois