

THE PROFESSIONAL MAGAZINE FOR ELECTRONICS AND COMPUTER SERVICING

ELECTRONICTM

Servicing & Technology

April 2000

Service management software

New technology update

Looking inside digital television

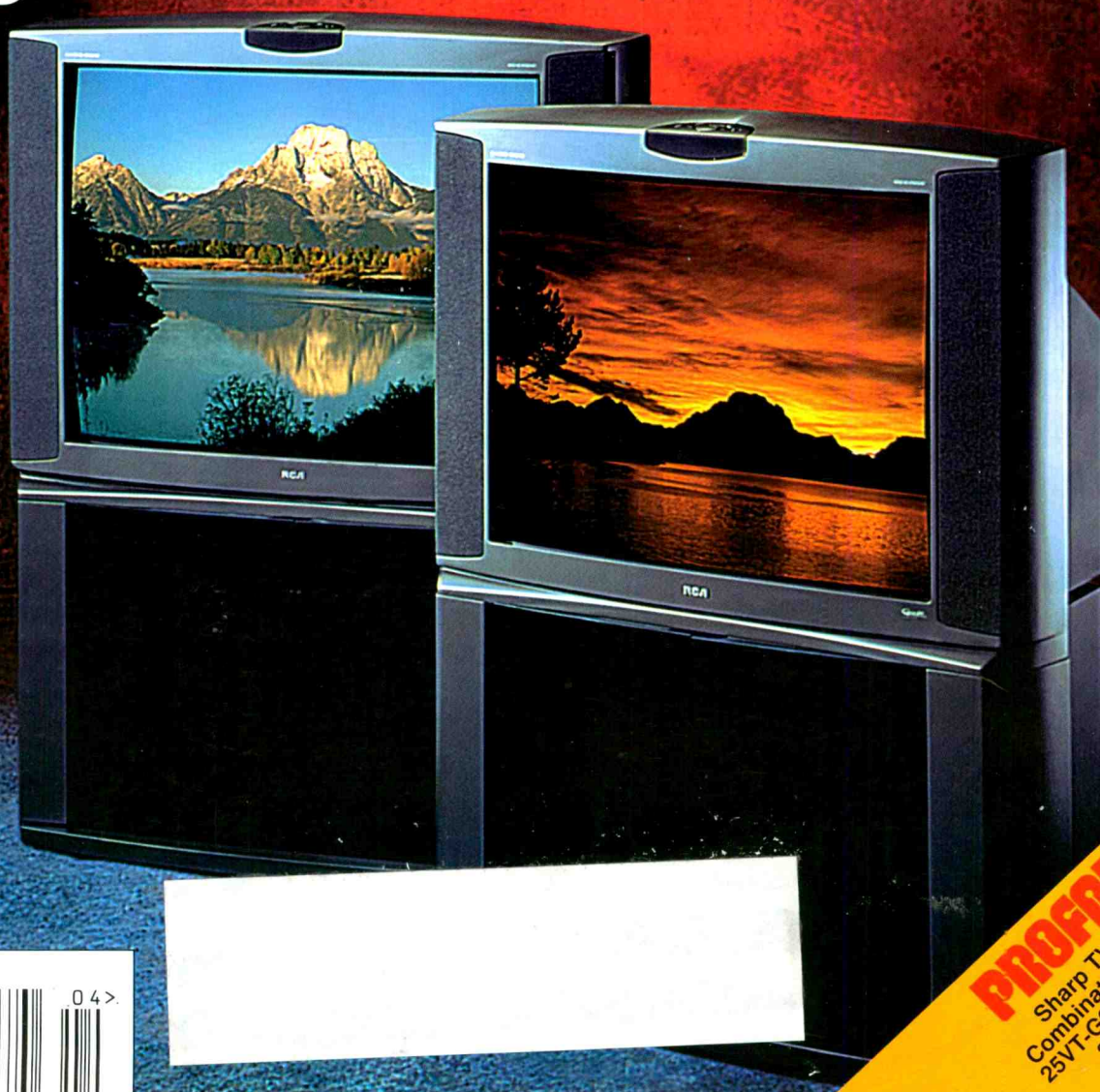

U.S. \$3.50

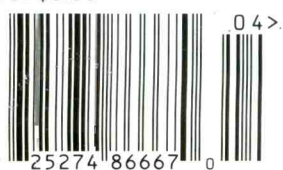

PROFAX
Sharp TV/VCR
Combination Models
25VT-G60, 25VT-G80,
27VT-G100

Big Screen

Big Profits!

Bring home the cash with in-home servicing of high-end electronics. Quickly and accurately aligning big-ticket items like projection TVs for your customer's total viewing satisfaction can be your best opportunity for profitability. Sencore offers servicing solutions for progressive servicers with portable, durable and reliable test equipment that brings the "best of the bench" to every home.

HA2500 Universal Horizontal Analyzer

Localize horizontal and B+ Supply defects in less time and more profitably than ever before!

- Exclusive "Horizontal Output Load Test" makes setup and testing a snap - even without applying AC power for faster diagnosis
- Patented "ringer" proves the condition of flybacks and yokes in seconds
- Exclusive "dynamic tests" help you analyze the horizontal circuit in powered-up conditions

VG91 Universal Video Generator

This complete all channel RF/IF/MTS Universal Video Generator performance tests and isolates defects in any NTSC video system, including big screen TV systems!

- Proof-positive tests for MTS Stereo/SAP on all channels
- Exclusive and dynamic NTSC video test signals
- Standard, Y/C, composite video, and audio line outputs

SENCORE

www.sencore.com • email:sales@sencore.com

Circle (1) on Reply Card

1-800-SENCORE

contents

FEATURES

- 6 Looking inside digital television** by John Ross
The author of this article describes some of the technology behind this hot phenomenon.
- 15 New technology update: Opportunities for service centers in installing/servicing new technologies** by Alvin Sydnor
Complete functions on an IC, fiber optics, wireless, the Internet, are changing the world of servicing.
- 21 Servicing TV circuits with the ESR meters** by Homer Davidson
An ESR meter can be used to test capacitors as well as other components/circuits.
- 52 Zenith L-Line power supply** by Steven Babbert
This article examines modes of failure, and techniques for troubleshooting problems in a power supply in a specific set, but the principles apply to the power supplies in a broad segment of the TV market.
- 57 Service management software** by the ES&T Staff
These days, service center managers need all the timesaving help they can get. A good service management software package can automate many of the service manager's routine chores, leaving him free for the creative stuff.
- 60 Video interfacing** by James Van Laarhoven
Currently, two different video information separators are being used to improve video quality: Component Video and S-Video. This article examines these formats after first considering the characteristics of the more traditional video inputs.

ADVERTISING SUPPLEMENT

With every passing year, consumer electronics products feature more and more manufacturer specific components, which means that distributors have to stock and keep track of more and more items. Sometimes finding the correct replacement party requires the best efforts of the most resourceful distributor. This showcase is designed to allow distributors to describe themselves in their own words, and to help readers make a sound decision about what distributor to do business with.

40 Distributor Showcase

DEPARTMENTS

- | | |
|--------------|-----------------------|
| 2 Editorial | 39 Books |
| 4 News | 50 Products |
| 5 Literature | 56 Photofacts |
| 14 Calendar | 62 Classified |
| 29 Profax | 64 Reader's Exchange |
| | 64 Advertisers' Index |

Distributor Showcase

40

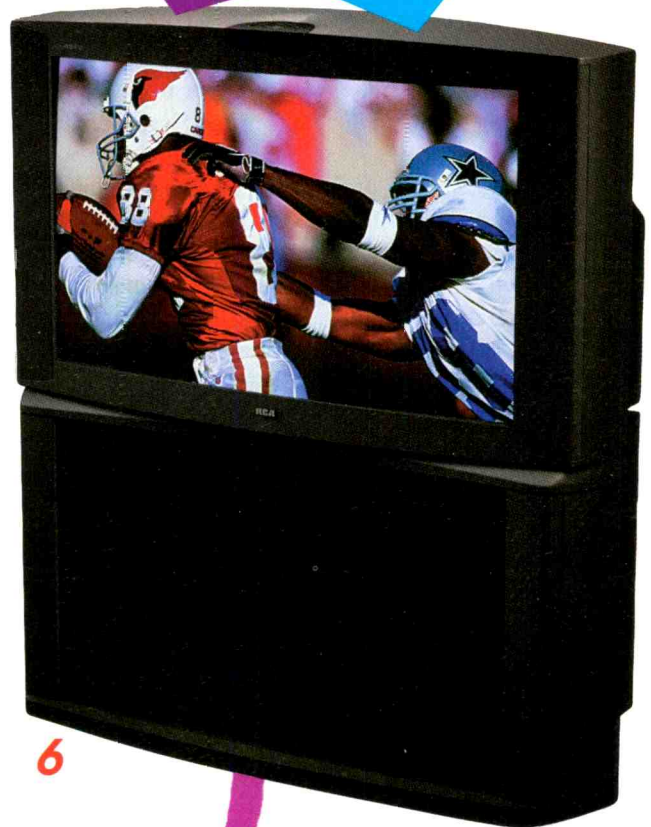

6

Service

Software

57

ON THE COVER

Digital television provides a movie theater-like experience right in the home. The picture is sharp and clear, and the sound is high-fidelity surround sound. Many of the circuits in a digital television will seem familiar to the servicing technician, but some will seem quite different. And the transmitted ATSC (Advanced Television System Committee, signal will look very different from the currently-used NTSC signal. (Photo courtesy Thomson Consumer Electronics)

Editorial

by Nils Conrad Persson

What a waste

I received a call from a reader in Oregon the other day. He owns a service business. In the past, he serviced the traditional consumer electronics products: TVs, VCRs, etc. Now he has completely switched over to servicing personal computer monitors. In fact, his business is now called Monitor Service.

This service center owner has a pretty good thing going. He is able to service monitors for about \$50.00 each. In addition, he sells monitors that customers have abandoned and that he has refurbished for about \$50.00 each. And he makes a living at it.

He could do a lot better at his business, though, if the manufacturers, or vendors, of these products would make available service manuals, schematic diagrams, replacement parts cross references, and other such service information. Unfortunately, many manufacturers or vendors of personal computers consider the monitor to be a disposable item. They make no provision for servicing them. If a monitor malfunctions during the warranty period, the company replaces it free of charge. If a monitor malfunctions beyond the warranty period, the consumer pays for a replacement.

The reason for this gentleman's call was to ask if I was aware of any cross reference that would allow him to determine if there was some specific, or generic, replacement for faulty components in monitors. I told him that I didn't know of any, but I'd do some research. I figure it's something that would be valuable to a lot of readers.

But that's not the point of this editorial. The point is, what a shame it is that discarded monitors are contributing to the filling up of our landfills at a such huge rate, when a program of servicing them could not only keep thousands of monitors out of landfills, but could save computer users a significant amount of money, and keep a lot of technicians busy servicing them.

And keep in mind, too, that the problem is not only the environmental impact of the discarded monitor. Every discarded monitor has to be replaced with a new monitor. That consumes precious resources. And the manufacturing process generates wastes that further pollute our planet.

In researching this subject, I came across the website of a company that seems to be doing their part to cut down on the environmental impact of discarded monitors. They have a recycling program. According to their website, "Experts predict that more than 150,000,000 computers are headed for our landfill sites." DMC Electronics Recycling Company is in business to prevent this waste.

"Our goal is to end the landfilling of electronics in the U.S. and abroad. We are committed to ending or substantially reduc-

ing the waste of reusable resources and the risk of contamination that currently exists with the wholesale landfilling of excess and scrap electronics." It's great that there are environmentally-conscious companies that can make a profit, while at the same time they do something to help the environment.

The Environmental Protection Agency is, of course, also trying to do something about this problem. Part of the problem with discarding monitors is that they contain lead, which, once they are discarded, is considered hazardous waste. Lead is contained not only in the solder used to connect the components to the printed circuit boards, but also in the glass of the CRTs. The fact that the lead in the glass in the CRTs makes them hazardous waste, contributes to the problem of handling them. Hazardous waste requires special handling, and documentation. Here's an excerpt from the EPA website:

A process is needed within EPA to change regulations to specifically promote responsible recycling of CRTs. If RCRA is modified as recommended, 200,000 tons per year of this glass could be recycled in a way that reduces the cost of television and computer monitor disposal and reduces solid waste generation.

Background: The CRTs in computers and televisions contain leaded glass to shield users from the radiation required to produce the image. Leaded glass recovered from used CRTs can be safely and practically used to produce new CRT glass. However, because of its lead oxide content, EPA's RCRA hazardous waste requirements could require that recycled CRT glass be transported and processed as a hazardous waste. Such a requirement would impose a significant legal and economic burden on recycling this glass.

The Computers and Electronics Sector Subcommittee proposed RCRA rule change to remove perceived federal regulatory barriers to recycling CRTs. The rule change would allow CRT glass to be recycled into new glass by defining management practices for facilities that collect, process, or transport CRTs.

Further evidence of the problem of discarding of computer monitors was found in an article that was published on the DMC website that reports that the state of Massachusetts will no longer allow CRTs to be dumped in landfills.

It's great that the federal government as represented by the EPA, state governments such as that of Massachusetts, and private recycling companies such as DMC, are doing much to alleviate the problem of computer displays in landfills. Now if only those manufacturers who consider monitors to be throw away devices, and who are largely responsible for the problem in the first place, would institute a servicing program, we might be able to stem the problem at its source. ■

THE PROFESSIONAL MAGAZINE FOR ELECTRONICS AND COMPUTER SERVICING

ELECTRONIC

Servicing & Technology

Electronic Servicing & Technology is edited for servicing professionals who service consumer electronics equipment. This includes service technicians, field service personnel and avid servicing enthusiasts who repair and maintain audio, video, computer and other consumer electronics equipment.

EDITORIAL

Nils Conrad Persson, *Editor*

(Internet e-mail: cpersedit@aol.com)

Alycia Nicholzen, *Associate Editor*

(Internet e-mail: AlyciaEST@aol.com)

Richard S. Moseson, W2VU, *On-Line Coordinator*

CONSULTING EDITORS

Homer L. Davidson, *TV Servicing Consultant*

Victor Meeldijk, *Components Consultant*

John E. Shepler, *Audio Consultant*

Sam Wilson, *Electronics Theory Consultant*

BUSINESS

Richard A. Ross, *Publisher*

Jonathan Kummer, *Associate Publisher*

Emily Leary, *Sales Assistant*

Sal Del Grosso, *Accounting Manager*

Ann Marie DeMeo, *Accounting Department*

Judith Erickson, *Office Manager*

CIRCULATION STAFF

Catherine Ross, *Circulation Manager*

Melissa Gilligan, *Operations Manager*

Denise Kells, *Data Processing*

Jennifer Cormagi, *Customer Service*

PRODUCTION

Elizabeth Ryan, *Art Director*

Barbara McGowan, *Associate Art Director*

Edmond Pesonen, *Electronic Composition Mgr.*

Dorothy Kehrwieler, *Production Manager*

Emily Leary, *Assistant Production Manager*

EDITORIAL CORRESPONDENCE:

P.O. Box 12487

Overland Park, KS 66212

913-492-4857



National Electronic Service
NESDA
Dealers Association, Inc.
Member, Electronic Servicing
Dealers Association

A publication of



CQ Communications, Inc.
25 Newbridge Road
Hicksville, NY 11801 USA.

Electronic Servicing & Technology (ISSN 0278-9922) is published 12 times a year by CQ Communications, Inc., 25 Newbridge Road, Hicksville, NY 11801. Telephone (516) 681-2922. Periodical class postage paid at Hicksville, NY and additional offices. Subscription prices (payable in US dollars only): Domestic—one year \$26.95, two years \$49.95. Canadian—one year \$36.95, two years \$69.95. Foreign Air Post—one year \$44.95, two years \$85.95. Entire contents copyright 2000 by CQ Communications, Inc. Electronic Servicing & Technology or CQ Communications, Inc. assumes no responsibility for unsolicited manuscripts. Allow six weeks for delivery of first issue and for change of address. Printed in the United States of America.

Postmaster: Please send change of address notice to Electronic Servicing & Technology, 25 Newbridge Road, Hicksville, NY 11801.



B&D

ENTERPRISES

AUTHORIZED DISTRIBUTOR FOR

NEC **Shindengen**
SANYO **SanKen** AND OTHERS

NEW

A Bell Atlantic Company

Howard W. Sams

Authorized distributor

- Photofacts • VCR facts
- Photofact of the month subscriptions
- Prompt publications • U-Can Do Videos

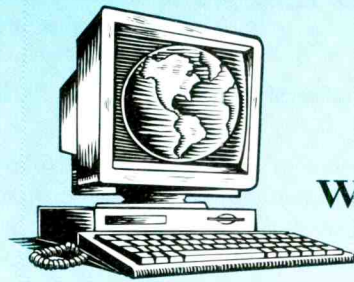

Visit our
Website at
www.bdent.com

- Secure server on-line ordering
- Manufacturers' catalogs and data sheets
- Competitive pricing with over 16,000 components in our on-line database

P.O. Box 460 Main & Liberty, Russell, PA 16345

TECH SUPPORT: 814-757-8300

FAX: 814-757-5400

Call today for your FREE Catalog

1-888-815-0508

Circle (6) on Reply Card

Video sales start off strong in 2000

Manufacturer-to-dealer sales of video products in January grew by 8 percent over the first month of 1999 and totaled nearly 3.5 million units, according to figures issued by the Consumer Electronics Association (CEA). Sales of DVD players, projection televisions, and camcorders were the major factors contributing to this growth.

Sales of analog projection televisions grew to a level of 92,000 units, 27 percent ahead of last January. Camcorders also contributed strongly to the month's growth, with shipments reaching 297,000 units, a 31 percent increase over last year.

The strongest category, however, was DVD players. Following on the heels of a record breaking 1999, DVD players opened the year 2000 with 370,000 units shipped in January, a 195 percent increase over last January's shipments. CEA estimates that DVD player sales will again be strong in 2000, reaching more than 6.5 million units.

Sales of large-screen television sets (those measuring 29" and higher) rose by 16 percent over January 1999. This sub-category represents 18 percent of the 1.36 million sets sold so far this year, and points to a continuing trend of consumers' building home theater environments.

Gary Shapiro, president and CEO of CEA, commented, "January's sales represent a great start for 2000. We look forward to a tremendous year in the video marketplace, with sales of new and exciting digital technologies such as DVD players, personal video recorders, and digital television fueling growth across the category."

Scott McNealy Presents Vision of Connectivity During CES Keynote

During the Executive Perspective Keynote at the 2000 International CES, Sun Microsystems' Chairman and CEO, Scott McNealy, outlined his vision of the networked future, in which stand-alone electronic devices give way to a fully connected universe. In this scenario, electronics devices not only work, but also work better. McNealy stated that stand-alone devices would soon be obsolete because current electronics devices cannot connect with each other, let alone human beings.

McNealy's comments were especially relevant to the CES audience, many of whom had spent the day touring the show floor stocked with just such devices, including a wide variety of integrated home systems and home networking technologies. More than 1,500 exhibitors are showcasing the latest in work-style and lifestyle technologies to more than 90,000 industry professionals here at CES.

To set the mood, the presentation opened with a brief skit in which a frustrated man attempts to return numerous holiday gifts to a retailer because of their lack of connectivity. A coffee-pot, for example, is unacceptable because it cannot recognize that the man has set his alarm clock earlier than usual, and so his coffee is not ready when he wakes. McNealy used examples like these to demonstrate the trend towards a more con-

nected future, in which consumer electronics devices are able to "talk" to each other, and as such perform better. The language these devices will use, he proposed, is Sun Microsystem's JAVA and JINI technologies.

Taking his proposition even further, McNealy proposed that the trend towards connectivity would eventually lead to devices themselves being free to consumers. Instead of paying for products, consumers would pay for the service (or usage of those products) through a third party service provider who, in essence, would lease the device to the consumer. Through this model, products would become more customized to consumers' needs.

To demonstrate his and his company's dedication to the concept, McNealy announced the formation of the "connected family," a unique business partnership between Sun, GTE, Cisco, and various device and content providers. In the "connected family," Cisco will provide the network infrastructure, GTE will be the service provider, and Sun's JAVA/JINI will be the language that the various devices use to "talk" to one another. A number of home products were demonstrated, including a refrigerator that automatically keeps track of grocery lists and a dishwasher that self-reports operational problems.

McNealy's closing remarks were words of advice to the audience. He recommended that anyone providing a product, service, or content would be well served to make that product, service, or content either Web-based, or Web-ready, because if they don't, someone else soon would. However, he also added that in this scenario, to survive, "you don't have to outrun the bear, you just have to outrun all of the other hikers."

CEA Accepts FCC Chairman's Challenge to Resolve Remaining DTV Issues

The following statement was issued by Consumer Electronics Association President and CEO Gary Shapiro in response to comments made at the 2000 International CES by Federal Communications Commission (FCC) Chairman William Kennard:

"The Consumer Electronics Association (CEA) welcomes Chairman Kennard's challenge to resolve the remaining copy protection and cable compatibility issues surrounding digital television (DTV). We have aggressively developed and presented solutions to these important issues over the past several years. As was clear in the Chairman's speech, our industry and the Commission have the same 'pro-consumer' goals. We welcome the FCC's efforts to bring these issues to resolution. We also look forward to a renewed commitment by the cable and content industries to remove the final remaining barriers to full cable compatibility and copy protection."

"The fact is, digital television is thriving. Our industry met our projections; DTV product sales since introduction will reach 120,000 units by the end of 1999. All over the exhibit floor of the 2000 International CES, new digital television products were presented in a broad variety of options. Resolution of the cable compatibility and copy protection issues will only further spur this growing market." ■

Literature

iChip brochure

Seiko Instruments announces that a free 4-page full color brochure on its iChip S-7600A is now available. The iChip is a stand-alone hardware-based Internet-ready IC. This IC allows Web browsing, e-mail, and networking to be added to consumer or commercial devices easily and inexpensively. The brochure contains information on the iChip and the just released software Development Kit (SDK). This self-contained iChip SDK contains everything a design engineer needs to quickly add Internet functionality and networking ability to any project.

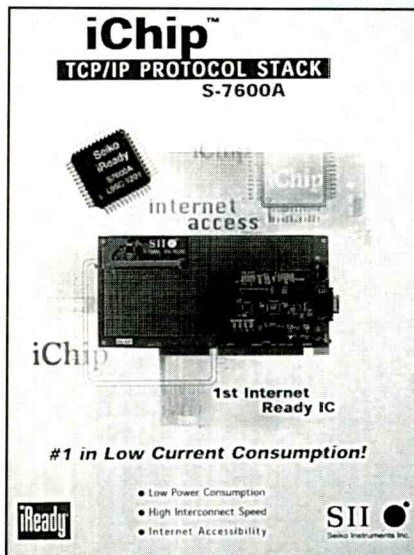

The iChip, created using the CMOS process, contains a TCP/IP Protocol Stack that acts as an accelerator between a processor and the Internet or a network that uses the TCP/IP protocol. This is a hardware solution that will provide a high interconnect speed with low power-consumption. Because the iChip acts as an accelerator, engineers aren't forced to use a specific processor. They can use any processor on the market from the PIII to a 4-bit processor.

Developed in conjunction with iReady Corporation, of Santa Clara, CA, the iChip permits users to connect to the Internet, or any other network that uses the TCP/IP protocol, using their PDAs, organizers, cell phones, or even pagers, as well as many other non-portable electronic devices. Adding Internet functionality to these types of devices is now as simple as selecting any other pre-defined component, such as a resistor or controller. The iChip runs at a speed of 256 kHz (5 MHz maximum) and consumes less than 1.5 mW in typical operation.

Seiko Instruments, 2990 West Lomita Blvd., Torrance, CA 90505, Phone: 800-934-9334, Fax: 909-975-5699, E-mail: seiko-eed@salessupport.com, Website, www.seiko-usa-eed.com

Circle (90) on Reply Card

Tools, toolcases, and test equipment

Specialized Products has released its comprehensive Fall '99 catalog. The new 400-page publication features a wide assortment of the latest products for virtually every service application in the Telecom, LAN, Fiber Optic, Wireless, Medical Electronic, and Computer industries.

Technicians, field service managers, and engineers can choose

from a complete assortment of electronic test equipment featuring component testers, digital multimeters, frequency counters, function generators, oscilloscopes, power supplies and a large selection of instrument/shipping cases. LAN test equipment choices include analyzers, Category 5 testers, and continuity testers. The telecom selection includes bit error rate testers, digit grabbers, digital butt sets, and transmission test sets. For fiber optic test equipment, choose from cleavers, light sources, optical time domain reflectometers, power meters, strippers, and more.

Specialized Products Company, 1100 South Kimball Avenue, Southlake, TX 76092, Phone: 817-329-6647, Fax: 817-329-6195, Website: www.specialized.net

Circle (91) on Reply Card

Components catalog

Jameco Electronics announces their latest catalog 994, "Your Component Path to the New Millennium."

The 150-page catalog features thousands of ICs, components, tools, test equipment, and computer products for OEMs, engineers, educators, and service repair technicians. More than 190 new products have been added including a new line of power supplies and converters by Volgen and Atmel ICs. They also have expanded lines of data acquisition products



by ComputerBoards, motors, USB products, Parallax basic controllers, SX chips, and more.

Log on to www.jameco.com and view the on-line catalog and Virtual Spec Room. It features product photos, expanded descriptions, and a secure web server.

Jameco, 1355 Shoreway Road, Belmont, CA 94002, Phone: 650-592-8097, Fax: 650-592-2503, Website: www.jameco.com

Circle (92) on Reply Card

LCR measurement primer

QuadTech, Inc. has published an LCR Measurement Primer for component test engineers, quality engineers, and users of ac impedance measuring instruments.

The LCR Primer provides detailed information on a number of topics, including complex impedance terms, series/parallel measurements, connection methods and associated errors, measuring capacitance, inductance or resistive components, and the electrical characteristics of solid and liquid materials.

QuadTech, Website: www.quadtech.com

Circle (93) on Reply Card

Looking inside digital television

by John A. Ross

In past **ES&T** articles, we've discussed the development of digital television standards by the Advanced Television Systems Committee or ATSC. Since 1987, the ATSC sorted through 23 design concepts for advanced television systems and eventually combined the four best designs into a prototype system. During this process, the ATSC settled on proposals given by the "Grand Alliance"—a consortium consisting of AT&T, David Sarnoff Research Center, General Instrument Corporation, the Massachusetts Institute of Technology, Philips Consumer Electronics, Thomson Consumer Electronics, and Zenith Electronics Corporation.

The ATSC worked with the Grand Alliance to create a system that responded to the needs and concerns of consumers, broadcasters, cable operators, computer interests, and the telecommunications industry. As the process continued, members of the Grand Alliance concentrated on providing high quality system components and support for the ATSC system. Beginning in 1996, the United States, Canada, Mexico, Taiwan, South Korea, and other nations have selected the ATSC system as the standard for digital television.

Defining the ATSC digital television standard

The ATSC digital television standard utilizes a layered digital system architec-

ture. As the OSI 7-layer model provides a basis for integrating computer networking technologies, the layered digital system architecture allows a digital television system to interface with consumer electronics, computing, and telecommunications systems at any layer. The four-layer architecture of the digital television

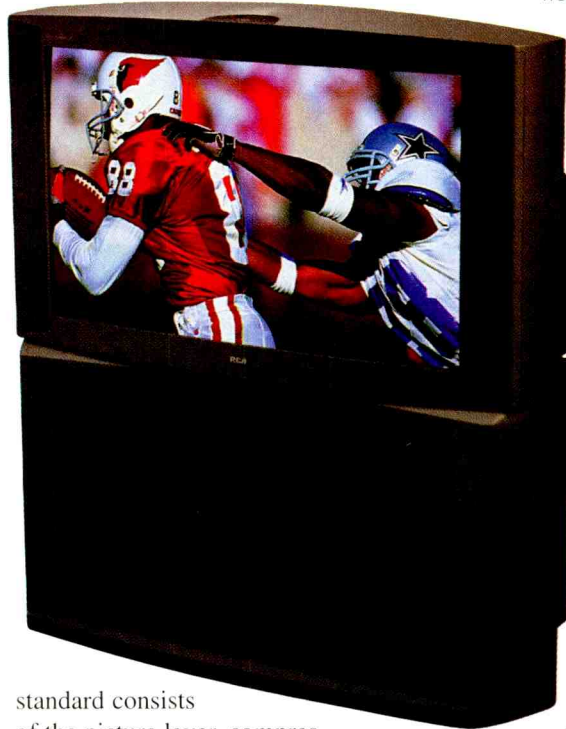

standard consists of the picture layer, compression layer, transport layer, and the transmission layer. Table 1 defines the purpose of each layer.

In addition, the DTV standard establishes interoperability with any HDTV receiver through the application of multiple formats and frame rates. The HDTV standard assembled by the Grand

Alliance takes advantage of the interlaced scanning used for television transmission and reception and the non-interlaced scanning commonly seen with computer monitors. With non-interlaced, or progressive scanning, the HDTV system provides a choice of 24-, 30-, and 60-frame-per-second scanning with a 1280 x 720 pixel dot resolution and a 24- and 30-frame-per-second scan with a 1920 x 1080 pixel dot resolution. As a whole, HDTV supports the spatial formats shown in Table 2.

Broadcasting digital television signals

As illustrated in Figure 1, the digital television transmission standard takes advantage of the 8-VSB modulation format and the MPEG-2 compression/packetization format (MPEG is the abbreviation for Moving Picture Experts Group). Both formats allow the conversion of high definition studio video into the form used for over-the-air transmission. As a result, the digital television broadcast system relies on forward error correction, an 8-VSB exciter, and an MPEG-2 encoder. Moreover, the system introduces two new broadcast standards called the Program Service and Information Protocol and the Universal Program Identification.

Ross is a technical writer and microcomputer consultant for Ft. Hays State University, Hays, KS.

Table 1. Digital television layer architecture

LAYER	PURPOSE
Picture	Provides multiple picture formats and frame rates
Compression	Uses MPEG-2 video compression and Dolby AC-3 audio compression.
Transport	Packet format that provides the flexibility to deliver a wide variety of picture sound and data services.
Transmission	Vestigial Sideband signal that delivers a net data rate of over 19Mbps in the 6MHz simulcast channel

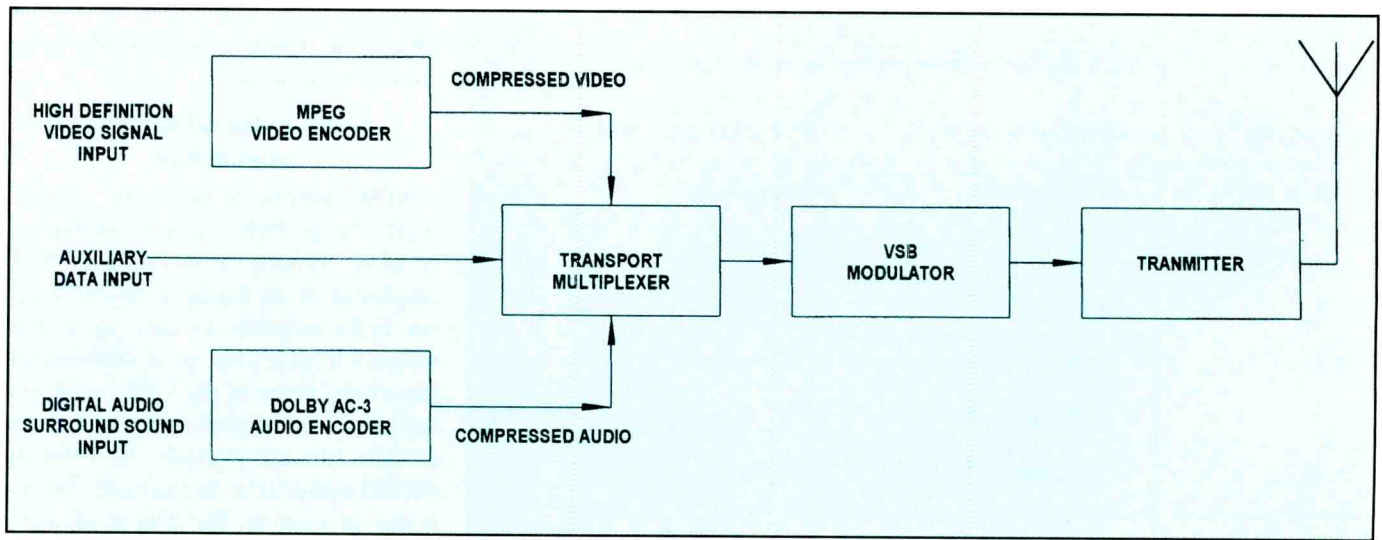

Figure 1. The digital television transmission standard takes advantage of the 8-VSB modulation format and the MPEG-2 compression/packetization format. Both formats allow the conversion of high definition studio video into the form used for over-the-air transmission.

Forward error correction

Encoding a digital signal onto an analog carrier frequency involves the breaking up of data into discrete packets, because any transponder frequency will be carrying several different data streams simultaneously. During the encoding process, the multiple streams must interleave in an organized manner so that the receiver can reproduce the data in the same form. Interleaving of data in this fashion is referred to as Multiple Channel Per Carrier, or MCPC.

The use of interleaved audio and video data requires the transmission of

additional information along with actual audio and video information. A packet identifier, or PID, fits into the data stream and informs the television receiver about the type of data. Synchronization packets keep the audio and video information synchronized while the system information packets carry other vendor-related information.

Because propagation delays and real-time transmission can cause the dropping out of packets, the compression and decompression of video and audio information relies on error correction. With each transponder capable of handling 40

megabits per second of data, two modes of error correction operation exist. While the high mode uses 30 megabits per second for information and 10 megabits per second for error correction, the low mode uses 23 megabits per second for information and 17 megabits per second for error correction. Because of the rate differences, the high error correction mode requires 3 dB more of power.

Propagation delays due to atmospheric conditions increase the attenuation of digital signal. Greater path loss causes an increase in the bit error rate of the signal and a reduction of the accuracy of the

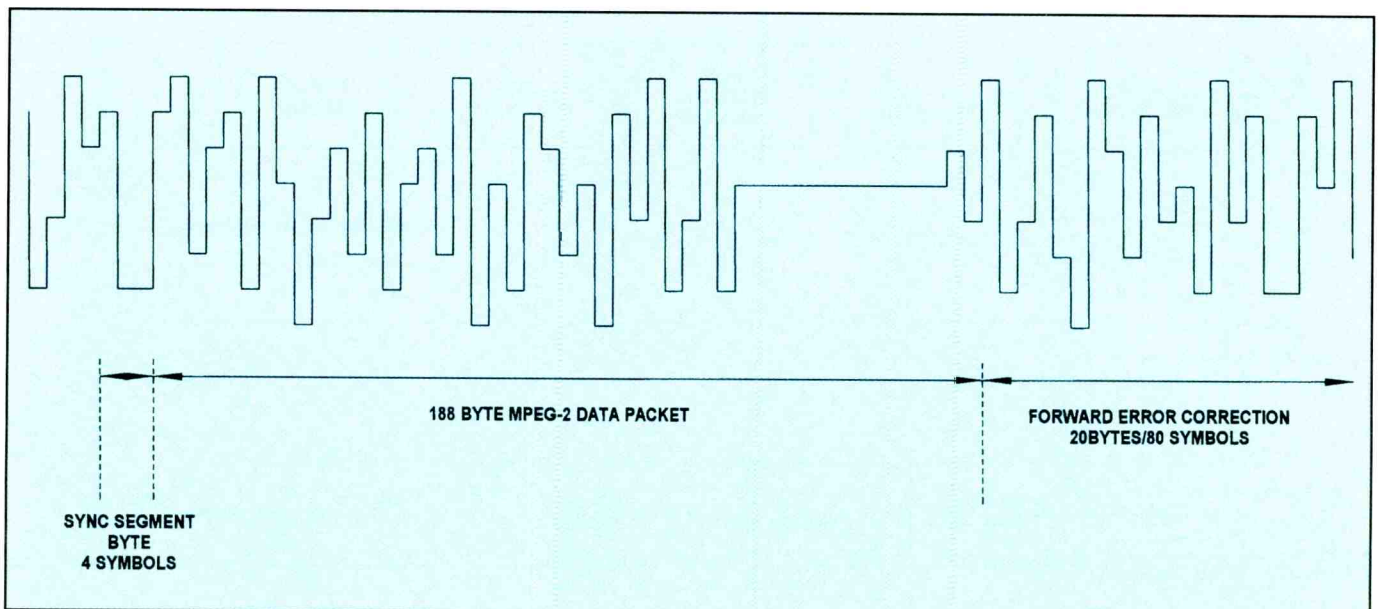

Figure 2. In HDTV transmission, the first four binary format symbols provide segment synchronization and represent the sync byte of the 188-byte MPEG-2 compatible transport packet. In turn, the remaining 828 symbols of each data segment carry the remaining 187 bytes of a transport packet along with the FEC information.

Table 2. HDTV supports these spatial formats

FORMAT	FREQUENCY	TYPE OF SCANNING
1280 x 720	23.976/24Hz	Progressive
	29.97/30Hz	Progressive
	59.94/60Hz	Progressive
1920 x 1080	23.976/24Hz	Progressive
	29.97/30Hz	Progressive
	59.94/60Hz	Interlaced
	59.94/60Hz	Interlaced

Generally, a receiver will mute both the sound and video automatically if the error correction fails.

Trellis-coded 8-VSB trellis modulation

ATSC terrestrial broadcast applications rely on Trellis Coded Modulation, or TCM. During operation, the 8-VSB single-carrier modulation system delivers 19.29 megabits of data per second within a 6 MHz channel, establishes the basic band shape of the VSB signal, and suppresses the lower sideband. The serial data stream consists of 188-byte MPEG-compatible data packets. During signal processing, the data randomizer operates on the remaining 187 data bytes of each MPEG packet after the removal of the sync byte.

Once randomization and forward error correction processing have occurred, other transmission circuitry formats the data frames for transmission and adds data segment sync and data field sync signals. Each data frame includes two data fields with each containing 313 data segments. Each data segment carries the equivalent of the data from one 188-byte transport packet.

From there, a circuit called the *Reed-Solomon encoder* operates on blocks of 187 data bytes to produce blocks of 207 data bytes. As shown in Figure 2, the first four binary format symbols provide segment synchronization and represent the

recovered received signals. In addition, the use of video compression for digital television transmissions translates large numbers of video and audio data bits into fewer numbers of video and audio data bits. Without error correction, propagation delays would cause some of the data to drop out. As a result, the reproduced video would resemble a patchwork of colored blocks or a frozen image.

Forward error correction ensures that digital television systems can function correctly without intervention from the transmission site. The generation of the FEC information-signal takes place during the actual transmission of the television signals. During this process, a com-

plex mathematical process, called a *syndrome*, produces and codes the continuously changing details of the television data signal as a separate part of each television signal.

The syndrome contains sufficient information to allow the decompression processor to correct and fully recover its own original information. At the receiver, a set of processes review the syndrome and recreate any information lost due to an error. However, an extremely high bit-error rate can cause the automatic error correction to fail and result in the reproduction of incorrectly placed small picture blocks; blocks of colored snow; or static-like clicking sounds.

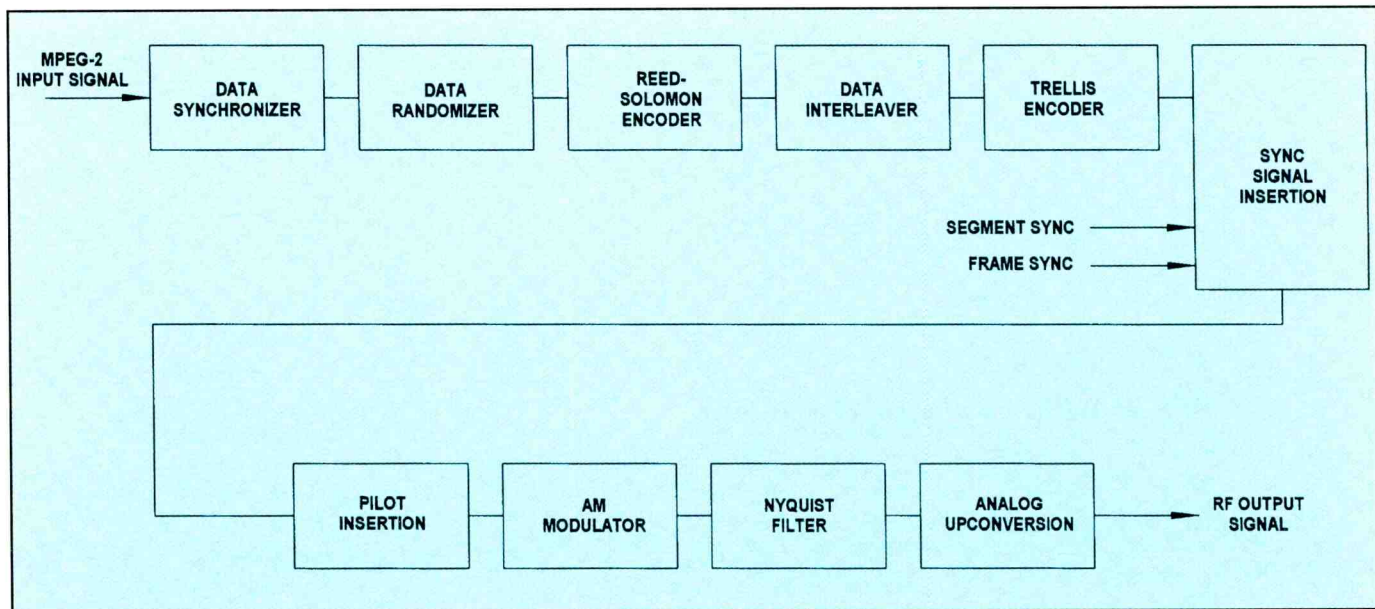

Figure 3. Block diagram of the MPEG-2 encoding sequence. During operation, the MPEG compression process examines each frame and compares the contents of the frame on a pixel by pixel basis to the previous frame. If the pixel values in the new frame match the pixel values in the original frame, the MPEG compression processor deletes the new frame.

sync byte of the 188-byte MPEG-2 compatible transport packet. In turn, the remaining 828 symbols of each data segment carry the remaining 187 bytes of a transport packet along with the FEC information. With this, we see the total of 207 data bytes seen at the encoder output.

As the data progresses through the system, the data interleaver interleaves bytes of data while the trellis encoder converts each byte to symbols. As a result, the system transmits the 828 symbols as 8-level signals that carry three bits per symbol. During transmission, the system provides a symbol rate 10.76 mega symbols per second and a data frame rate of 20.66 frames per second. Pre-coding of the data allows the use of a comb filter to reject any analog signal interference.

Pilot carrier

The insertion of a pilot carrier assists the operation of the receiver. In specific terms, the pilot-carrier is at approximately 310kHz from the lower band edge. An optional pre-equalizer removes any linear distortions of the broadcast. Bandpass filters in the transmitter output or the use of non-ideal Nyquist filters in the modulator can produce the distortions.

Digital television broadcasters take advantage of unused UHF channels and taboo NTSC channels while utilizing an ATSC system that defines two vestigial sideband, or VSB, modes. With terrestrial broadcasts, the digital television standard relies on trellis-coded 8-VSB, while cable systems use trellis-coded 16-VSB modulation. Both of these transmission modes have the same channel and excess bandwidth, symbol rate, field and segment sync rates, segment length and duration, and pilot power. The two VSB modes differ in data transfer rates and trellis coding modulation.

Trellis coding provides forward error correction by tracking a progressing stream of bits that develops through time. To accomplish this tracking, trellis coding splits each 8-bit byte into a stream of four, 2-bit words. From there, the coder compares each 2-bit word that arrives to the past history of previous 2-bit words.

Then, the coder mathematically generates a 3-bit binary code that substitutes for the 2-bit word. The broadcast system transmits the 3-bit codes over-the-air as the eight level symbols of 8-VSB. Every 3-bit code equals 23 symbols or 8 com-

binations. Because two-bit words travel into the trellis coder and three-bit codes exit, the trellis coder in the 8-VSB system operates as a 2/3 rate coder.

Because the transmitted signal relies on vestigial sideband modulation, the signal does not require equal skirt selectivity on both sides. The roll-off in the transmitter has the response of a linear-phase, root-raised cosine filter. A linear phase, flat amplitude response SAW (Surface Acoustic Wave) filter provides additional adjacent channel suppression.

MPEG-2 video compression/ packetization

During 1992, more than 200 international companies contributed to the MPEG draft development that demonstrated strong support for a new technology specification. As opposed to MPEG-1, MPEG-2 includes enhancements that cover the compression of broadcast interlaced television signals. From there, MPEG-2 has become a compression standard for digital television, DVB, digital satellite systems, and high-density compact disc technologies. When considering digital television systems, both MPEG-2 and MPEG-2 "near compliant" stand as standard approaches to video and audio signal compression.

Figure 3 shows a block diagram of the MPEG-2 encoding sequence. During operation, the MPEG compression process examines each frame and compares the contents of the frame on a pixel by pixel basis to the previous frame. If the pixel values in the new frame match the pixel values in the original frame, the MPEG compression processor deletes the new frame. In addition, the MPEG processor also examines a range of pixels for areas of identical color and tone.

When two frames match, the MPEG processor inserts a special small marker that instructs the MPEG decompression processor to restore the pixel. If frames have pixels with identical color and tone areas, the MPEG processor removes the duplicate areas and sends on only one pixel. An instruction accompanies the lone pixel and contains information needed to replicate the color and tone areas a specific number of times.

Although the MPEG compression scheme cannot condense volumes of data to a low enough level, the lossy characteristics of MPEG take advantage

of the ability of the brain and eyes to fill in any information gaps. As a result, the compression encoder can look for near matches rather than exact matches of data. Adjusting the nearness of the match also controls the amount of compression. However, compression of a file at a ratio higher than 3:1 will result in the averaging of intermediate tones and allows pixelation, or the placement of visible blocks in an image, to occur.

Digital television transmission systems not only utilize the MPEG compression scheme but also include encoder circuitry that limits the amount of data. When a large amount of activity in the reproduced picture causes the number of matches and near-matches to decrease, the encoder software responds by lowering the precision of the compression. In addition, digital television compression schemes utilize a statistical multiplexing process that multiplexes channels found on the same frequency together.

Statistical multiplexing

Statistical multiplexing gathers statistics on the amount of data in each channel and feeds the information back to the MPEG compression system for the purpose of balancing the load. If one channel has low amounts of activity in the reproduced picture and higher match rates, the system allows more precise matches to occur in the paired channel that has more activity and lower match rates. The opposite occurs for channels that have high amounts of activity in the reproduced picture. As a result, the system parameters, selected compression ratios, and the mix of channels affect the compression scheme. Frame by frame analysis, compression, and load balancing occur in real time.

MPEG encoding

During the first step of the encoding process, the encoder circuitry reduces the active area from the NTSC format of 704 x 480 down to 352 x 240. In addition, the circuitry translates the color information from the NTSC to the RGB, to the YUV format. While the translation compacts the color signal, the YUV format also separates the color information into independent brightness and hue values. When the human eye views any color, the luminance, or brightness, information exists as the dominant com-

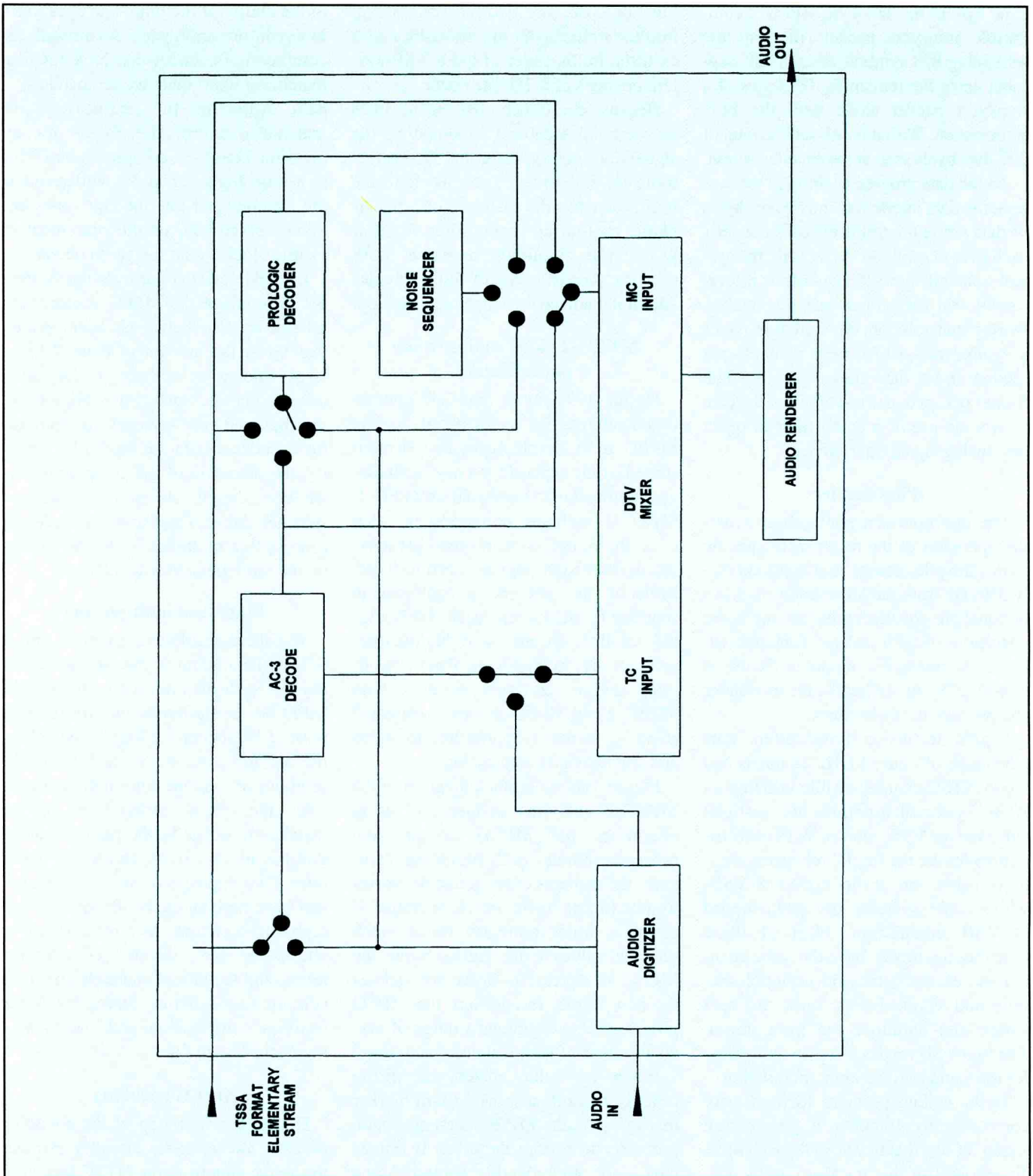

Figure 4. Digital television systems use the Dolby Digital AC-3 format. Using this scheme, it is possible to transmit 120 stereo music channels to business and commercial establishments through a single transponder.

ponent. Because hue is less significant than brightness in terms of color, the MPEG encoder eliminates 75% of the chrominance values.

During the compression process, any unneeded information is immediately

discarded. As an example, the NTSC broadcast format uses only 480 out of the possible 525 scan lines to hold image information. The additional 45 scan lines contain information needed for the analog transmission of the signal

but unnecessary for the digital transmission of the signal. Discarding the 75% of the chrominance values and the analog-only information allows the MPEG compression scheme to work with only 124 megabits of video data

per second rather than the original 162 megabits of information.

Discrete cosine transformation

The MPEG compression standard relies on discrete cosine transformation, or DCT, for the translation of 8 x 8 blocks of image pixels into sets of numbers. The DCT technique works by removing redundancies from the images. Rather than compress the image, the complex mathematical process of discrete cosine transformation changes the video signal into a form that easily compresses. During the process of compressing the NTSC signal, the video frame divides into 8,100 small individual blocks or boxes. In comparison, the compression of a PAL or HDTV signal results in more blocks. The process also groups the blocks together into five columns called macro blocks and then moves the blocks into an order that increases the efficiency of the compression.

At the beginning of the process, all information about the top left pixel in a given block is stored in its complete form. In the next step of the process, only the difference between the next pixel and the base pixel is stored. For example, the transformation of a signal that represents only the blue sky, the difference between the first pixel and the next pixel would equal zero. The zero value for the difference would continue for all the pixels in the block and only the difference values would be stored. If the televised scene includes white and gray clouds, the difference value would change. With the clouds in the lower half of the block, the bottom pixels might differ from the base pixel by changes equaling a negative one or a positive three. After the completion of the process, the values of each pixel in the block are weighted according to the specifications of the system.

Each set of pixels describes one level of detail with low detail images represented by many zero values and high detail images represented by fewer zero values. In essence, each value given through the discrete cosine transformation represents energy at a specific frequency. Rounding off the results of the transformation reduces the number of possible values and produces a better chance for identical values. Although

transformation is not the same as compression, frames that feature lower detail compress more than frames with higher levels of detail.

Adaptive quantization and variable length coding

During the compression process, the system approximates the amount of compression needed for each block. To do this, the compression system looks for long strings of zeros in the data. Rather than storing the entire string such as 00000000000000, the system stores a phrase that means "15x0."

Consequently, the more consecutive zeros contained within the data translates into saved space. Because long strings of zeros rarely occur in practice, the compression code tries to round off all values from negative one to positive one down to zero. If the data stream remains too large, the circuit will attempt to round off all values from positive two to negative two down to zero. This process continues until the proper amount of data compression results in the reproduction of only about 25 megabits per second of video.

At this point, quantization has a major impact on the size of the final encoded video stream. Larger constants offer fewer possible values and increase the compression ratio. The increased density of compression allows the loss of information and the degradation of video signal quality. Quantization ensures that the video stream data rate never exceeds the throughput of the target output device. During operation, the encoder accesses quantized and transformed values from the lowest to the highest frequencies. As a result, the quantized data becomes strings of identical values that comprise a single token. In turn, each token indicates a value and the number of times that the value repeats.

Encoding the tokens involves the assignment of the most common tokens to symbols that have the shortest possible length. With this process, further compression of the data occurs through the distribution of token frequencies. The MPEG standard further increases the compression by eliminating any redundant data that appears on more than one frame.

Throughout the encoding process, the MPEG encoder has the capability to look ahead as many frames as desired to

seek repetitive blocks. A pointer that references a single copy of the block replaces identical blocks of pixels common to two or more successive frames.

Dolby Digital AC-3 audio

As shown in Figure 4, digital television systems use the Dolby Digital AC-3 format to transmit 120 stereo music channels to business and commercial establishments through a single transponder. In comparison to the Dolby Pro Logic format, the Dolby AC-3 format takes advantage of Digital Audio Coding, a type of perceptual coding. In practice, perceptual coding seeks to eliminate the data that a human ear cannot hear while maintaining desired data. Digital Audio Coding allows the use of lower data rates with a minimum of perceived degradation of sound quality. As a result, perceptual audio coding places more information into the available spectrum. In addition, the Dolby Digital version of perceptual coding handles multi-channel audio.

While Dolby AC-3 works as a compression format, it also applies superior noise reduction techniques through the lowering of noise when no audio signal is present. With an audio signal, strong audio signals cover the noise at all frequencies through auditory masking. Generally, noise reduction occurs only at nearby frequencies. To accomplish this task, Dolby Digital AC-3 divides the audio spectrum of each channel into narrow frequency bands that correlate closely to the frequency selectivity of human hearing. As a result, coding noise is very sharply filtered and remains close in frequency to the audio signal being coded. The audio signal masks the noise and causes the noise to remain imperceptible to human hearing. With no audio signals present for masking, Dolby Digital AC-3 reduces or eliminates the coding noise.

All this occurs through the use of a "shared bitpool" arrangement where bits distribute among different narrow frequency bands. Dolby Digital AC-3 can process at least 20-bit dynamic range digital audio signals over a frequency range from 20Hz to 20,000Hz ± 0.5 . The bass effects channel covers 20Hz to 120Hz ± 0.5 dB. In addition, Dolby Digital AC-3 supports sampling rates of 32kHz, 44.1kHz, and 48kHz. To answer

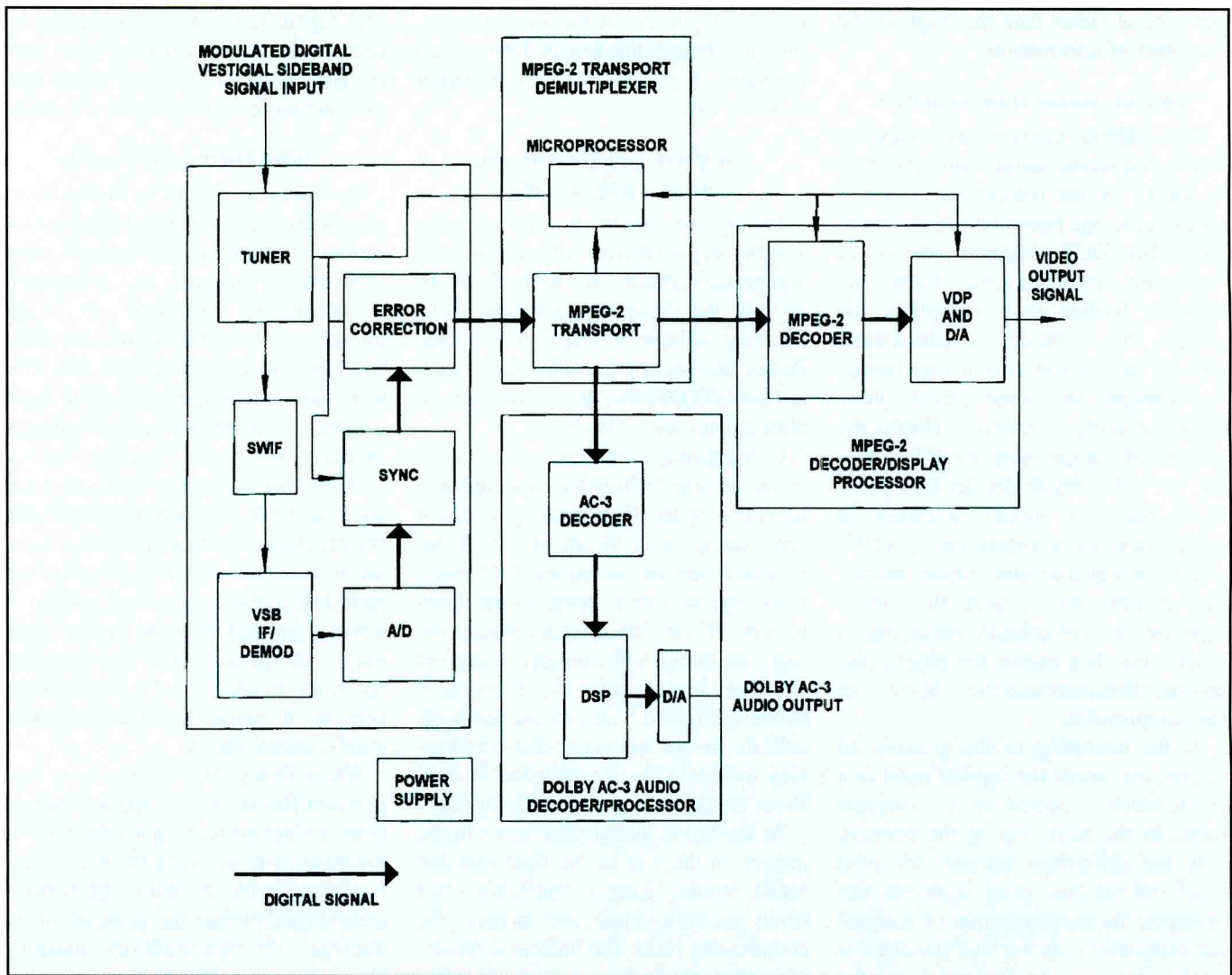

Figure 5. Block diagram of a generic digital television receiver. An inspection of the receiver diagram from left to right reveals that it is similar in many respects to traditional televisions.

the needs of a wide range of applications, data rates range from as low as 32 kilobits per second for a single monophonic audio channel to as high as 640 kilobits per second.

The distribution of bits differs according to the needs of the frequency spectrum or dynamic nature of the coded program. Auditory masking ensures the use of a sufficient number of bits to describe the audio signal in each band. In addition, bits are distributed among the various channels and allow channels with greater frequency content to demand more data than channels with less frequency content. This type of auditory masking allows the encoder to change frequency selectivity and time resolution so that a sufficient number of bits describe the audio signal in each band. Consequently, Dolby Digital AC-

3 can use proportionally more of the transmitted data to represent audio. With the Dolby Digital AC-3 standard, higher sound quality and multi-channel surround sound are encoded at a lower bit rate than required by just one channel on a compact disk.

The use of a sophisticated masking model and shared bit pool arrangement increase the spectrum efficiency of Dolby Digital AC-3. Rather than use data to carry instructions to the decoders, AC-3 can use proportionally more of the transmitted data to represent audio. As a result, AC-3 has higher sound quality delivered over six discrete channels of sound. Compared to Dolby Surround Pro Logic, AC-3 also includes Left, Center, and Right channels across the front of the room and discrete left surround and right surround channels for

the rear of the room. All five main channels have a full frequency range of 3Hz to 20,000Hz.

A sixth channel — the Low Frequency Effects channel — sometimes contains additional bass information used to increase the audio impact of scenes such as explosions and crashes. Because the sixth channel has a limited frequency response of 3Hz to 120Hz, it is sometimes referred to as the “0.1” channel. All six channels in a Dolby Digital system have a digital format that allows the transfer of data from the producer’s mixing console to a home playback system without loss.

Program service and information protocol

Along with the standards that we have discussed, the Program Service and

Information Protocol, or PSIP, affects broadcast transmissions. PSIP allows existing analog stations to retain their present analog number designation during and after the transition to digital broadcasts. The analog number remains in place even if the station has moved to a different RF channel.

The Master Guide Table, or MGT, contained within the PSIP carries references to all other tables in the digital broadcast. Tuning to a "station" using PSIP involves using a primary channel number, a separator, and a secondary channel number. While the primary number is the same as the broadcaster's present analog channel, the secondary channel number is zero for the analog broadcast and 1 through n for the digital broadcasts associated with that particular broadcaster. As an example of the syntax for primary numbers, separators, and secondary numbers, a viewer could key in "9.1" for direct access to the digital service found at channel 9.

The event tables found within PSIP offer the information needed to produce an on-screen program guide. Receivers use the PSIP data to store a table of upcoming events. In addition, the event tables allow the receiver to determine whether any of the table values required modification by local conditions such as reception on a translated frequency.

Universal program identification

Another feature of the new digital television standard is the Universal Program Identification, UPID. Universal Program Identification provides auxiliary data set used by broadcasters to identify a particular broadcast program for purposes such as verifying the airing of commercials or identifying unique versions of a production work without intervention from the home receiver. For example, an uncut movie would have a different UPID than the same edited movie. The ATSC design does not require the use of a UPID.

Receiving digital television signals

Figure 5 is a block diagram of a general digital television receiver. Progressing from left to right, the diagram of the digital television compares well with block diagrams of traditional televisions. The digital television standard relies on a

tuner that receives a 6 MHz signal and features high-side injection double-conversion. A bandpass filter located at the input limits the input frequency signals to a range of 50MHz to 810MHz. As a result, the tuner rejects all non-television signals. In addition, a broadband tracking filter eliminates any signals that may have a greater signal power than the desired signal.

Because the system establishes a first IF frequency of 920MHz, image frequencies remain above 1GHz. As a result of this design, the fixed front-end filter provides above average rejection. In addition, the use of a high first IF frequency promotes the selectivity given by the input bandpass filter. Without the selectivity, the 978MHz to 1723MHz local oscillator frequency could interfere with other UHF channels. The first IF frequency ranges low enough so that the second harmonics of the 470MHz to 806MHz UHF channels fall above the first IF bandpass.

The tuner converts the incoming RF frequency to a fixed IF frequency centered at 44MHz. Because of the use of digital technologies, however, there are a few significant differences between the traditional NTSC design and the new digital television standard. After the filtering of the tuner output and the down conversion of the IF block to a low IF frequency centered at approximately 5.28MHz, or one-half the VSB symbol rate, the low IF signal travels to an analog/digital converter.

VSB IF/demodulator

The VSB IF/Demodulator and FEC decoder provides for the reception of 8-VSB modulated signals for terrestrial and cable applications. While the integrated circuit device contains the loop components needed to recover the data from the received symbols, the system requires external loop components such as a low-speed serial D/A converter and a voltage controlled crystal oscillator (VCXO), for the symbol timing recovery. In addition, an operational amplifier functions as an integrator for the AGC. The bus controls the loop parameters of the clock and carrier recovery.

The location of the A/D converter within the fine AGC allows the system to take advantage of the full input span of

the converter. While the system can apply the AGC control output directly to the tuner, it may use the variable gain stage at the output of the IF block. After detection of the AGC output occurs after the analog-to-digital conversion, the system samples the low IF signal at a nominal rate of 21.5MHz or twice the VSB symbol frequency. The detector determines the peak level of the incoming signals.

The selectivity of the VSB IF demodulator determines the allowable analog/digital adjacent channel ratios. Without the use of a comb filter, the NTSC signal must be about 12dB below the VSB signal. The tuner and baseband filtering of the demodulated signal may provide 2dB or 3 dB attenuation each, for a total of about 55dB attenuation of the upper adjacent NTSC video carrier. A two-stage SAW filter with an intermediate amplifier stage obtains the desired out of band attenuation of 55dB with insertion loss on the order of 14dB.

Carrier recovery occurs within the IC and through the use of a digital frequency and Frequency Phase-Locked Loop, or FPLL. In addition, a half Nyquist filter shapes the data with a roll-off factor of 11.5%. The VSB IF/demodulator also performs symbol timing with the assistance of the external loop components. At this point, the field sync synchronization signals and the 8-VSB data goes through adaptive equalization.

Trellis demodulation

A trellis decoder uses a process called the *Viterbi Algorithm* (VA) to decode the information bits from the received signal. The ATSC digital television standard features two trellis decoders for full maximization of performance. When NTSC interference requires the use of the comb filter, the receiver uses the trellis decoder for the 1-D channel with 8 states.

The comb filter delays and subtracts symbols for the purpose of producing a 16-state code. Activating the comb filter results in the implementation of a standard Viterbi algorithm operating on the received signal. The structure of the trellis used for decoding depends on the state of the comb filter. With the enabling of the comb filter, the decoder processes the signal through the use of a modified trellis diagram.

An 8 VSBT receiver can utilize a comb

filter to reject NTSC co-channel interference. The comb filter must have a delay of 12 symbols in the feed forward path. Since the receiver may have 12 trellis decoders each operating on every 12th received data symbol, the comb filter can simply be viewed as 12 comb filters, each with a delay of one symbol in the feed forward path and each feeding one of the 12 trellis decoders.

When little or no NTSC interference exists, the receiver does not use the comb filter and uses the optimal trellis decoder for the AWGN channel with 4 states. Due to the structure of the code, the design can group the sixteen states into eight pairs and reduce the amount of required hardware. Not using the comb filter requires the application of a differential decoder after the Vitrebi decoder.

De-interleaving and de-randomization

Once trellis demodulation has occurred, the system de-interleaves the data stream and applies Reed Solomon error correction. A Pseudo Random Bit Sequence, or PRBS, provides de-randomization and passes the data to a First-In, First-Out, or FIFO, register so that irregular gaps will not appear in the output data.

An ATSC-compliant MPEG-2 packet stream and clock signals exist at the output of the VSB IF/Demodulator. Signal flags indicate the location of sync bytes, valid data bytes, and uncorrected blocks.

From there, the 8-bit wide MPEG-2 data stream travels to the MPEG-2 transport demultiplexer.

MPEG-2 transport

The MPEG-2 transport embedded processor contains all the hardware and software required to receive, descramble, and demultiplex MPEG-2 transport streams. To accomplish these tasks, the MPEG-2 transport processor uses a versatile stream input interface that handles byte-parallel and bit-serial streams in various formats. The MPEG-2 data streams may travel at a rate up to 13.5 megabits per second. Data from the stream moves through an on-chip descrambler that employs a DVB descrambling algorithm.

Demultiplexing separates the 32 individual data streams. Within the demultiplexer section, various functions such as clock recovery and timebase management occur. In addition, demultiplexing of the data streams establishes the Program Specific Information, or PSI, Service Information, or SI, Conditional Access, or CA, messages and private data that allow complete customer interaction with the system.

Integrated video/audio decoding

Once the demultiplexer separates the transport stream into MPEG2 video, Dolby AC-3 audio, EPG, a data services stream and program information, the

MPEG-2 source decoder applies audio decoding and video decoding as well as enhanced graphics, background display, and/or on-screen display control. Within the source decoder, a video renderer splits the closed captioning information from the MPEG2 elementary stream and sends the data to a specific closed captioning module for decoding. Audio modules cover Dolby Digital decoding into a 2-, 4-, or 6-channel digital stream, SPDIF output, conventional stereo output, Dolby Pro Logic 4-channel decoding along with audio mixing and rendering.

Conclusion

This article provides some of the background needed to work with digital television systems. Going back only a few years, digital television appeared as a far-off concept that could eventually become popular. Today, however, sales of digital televisions have begun to rise as consumer acceptance has increased. All major manufacturers have some type of digital television or set-top box in their inventories.

Next-generation digital televisions will feature even higher integration, enhanced functionality, and lower numbers of IC chips. As an example, Philips Electronics has already begun to showcase the latest addition to their TriMedia family. The programmable 32-bit NX-2700 processor offers a high-performance very-long instruction word CPU core and hosts several on-chip co-processing units designed to handle the data streams commonly found in digital television applications. Some of functions integrated into the processor include the ATSC demultiplexer functions, transport stream decoding for the 18 ATSC video formats, MPEG2 decoding, Dolby Digital AC-3 decoding, ATSC data processing, and OSD and graphics handling.

All this indicates that the business of servicing electronic products has taken a new turn. Anyone involved in this business finds themselves immersed in digital technologies and learning about processes such as compression and different types of modulation schemes. Time will show the impact of digital television technologies on our industry. As always, staying current with this and other technologies stands as the highest priority for all of us. ■

ES&T Calendar

ETA Annual Membership Meeting
May 5-6, 2000
ETA Headquarters
604 N. Jackson
Greencastle, IN 46135, and
The Walden Inn
Greencastle, IN
ETA: 765-653-8262

NESDA 50th/ISCET 30th/NIAS 8th
Annual National Professional Service
Convention and Professional Service
Trade Show
August 7-12, 2000
John Ascuaga's Nugget Hotel
Sparks (Reno) NV

NESDA
2708 W. Berry
Fort Worth, TX 76109-2356



New technology update:

Opportunities for service centers in Installing/ servicing new technologies

by Alvin G. Sydnor

Every year, some time between December and January, most of us start polishing and gazing into our crystal ball trying to see what the future has in store for us. Now it's my turn to share with you what I think I see in my crystal ball. Even though there is a lot of haze and noise, I'll try to read through that haze and noise and come up with what I think is in store for all of us in the electronic service industry.

As we have all witnessed within the past couple of years, the electronics industry has and will continue to move at the speed of light. This is particularly true for those of us who have been in this business since the vacuum tube days. Many of us in the servicing-repair segment of the electronic industry have not taken a serious look at the effect all of the consolidations, mergers, and start-up companies will have upon us. This is particularly true for the small independent service center. We must try to look and find out what direction the pace setters are going in, and from what I can see, the drive won't be as strong for PC's as some would expect, but the direction and push seems to be concentrating on communications, home appliances, and consumer products.

The Internet's instability is demanding more bandwidth, which is going to drive more development and products into broadband communications. There is a growing desire and need for, anytime, anywhere connectivity in all the modes of moving more and more data into what we know today as voice only channels. This will create more flexibility and adaptability.

This expanded bandwidth and connectivity will extend into our homes and

our cars, which will interface into the expanding intelligent highway which will help motorists get around traffic jams much more easily, and locate yellow pages for whatever you need while on the road. All of this is what is called "Smart-Systems," and the growth in smart-systems will incorporate more embedded computing systems, which in turn will keep the existing businesses alive and well. Industry analysts and trade associations predict double-digit growth for the electronics industry that will be concentrating on connecting the home and car to the Internet.

There is no doubt that all of these favorable predictions will be putting increased pressure on the job market for more highly-skilled technical personnel. My crystal ball tells me that the needs will no longer be in basic theory of electronics, but the technician must start thinking and preparing himself for dealing with putting systems together.

For example, there was a time when electronic service centers repaired TV tuners and there were some who set up facilities specializing in tuner repairing. As we all know, this is no longer economically or technically feasible and those service centers that didn't diversify or see what was happening went out of business or were out of work. Take a look at what is coming in TV tuners of the future (see the October issue of this publication; "The Worlds First TV Tuner on a Chip").

The systems approach

Lets take a look at what I mean by taking the systems approach. The TV tuner on a chip is much more than what most service technicians are familiar with when dealing with today's TV tuner. Systems-on-a-chip (SOC) will be finding their way into home appliances, comput-

ers and communications applications.

What has already started to happen is that the chip manufacturers are becoming the system designers as well as the suppliers. Years ago, a manufacturer of an electronics product had their design engineers design their product and the manufacturer would purchase all the necessary components needed to build that product. Those days are numbered because the chip manufacturers are designing the complete package and supplying an SO. All that is needed is to perform interconnections and put them in a package and off they go to be sold as a complete system. I believe that by the year 2003 the term ASIC (application specific integrated circuit) will be synonymous with SOC. As the ICs transistor count continues to double and redouble, SOC designers will be facing the task of incorporating millions of gates, and mega-bits of memory on a chip.

Just a few years ago, I could not imagine 23 million transistors, 200-billion operations per-second and operating at 350 MHz all on a single chip. That level of integration and performance are available today. A few years ago when the capability of SOC was being researched there were rumors of the death of the printed circuit board (PCB) because there were some that thought that an SOC chip could be connected to or be part of a connector or socket.

As a direct result of the growing demands, I do believe that there will be a new generation (actually fourth generation) of PCB's which you will be seeing before the end of this year. These boards will be using microvias and innovative substrates that will create smaller boards. But due to new packaging and construction techniques, it will no longer be possible to physically repair these boards using old-fashioned trou-

Sydnor is a retired consumer electronics servicing technician.

bleshooting techniques. So forget repairing anything on these new boards.

New entertainment options and connectivity

Coming soon is the intellectual-property-free enhanced-TV content protocols for analog and digital systems. I see a data-casting boom in which data carousels will allow hundreds and even thousands of virtual channels to be broadcast each minute and a number of stations will be synchronized together each second. I also see that digital subscriber lines (DSL) will be delivering synthetic phone lines on demand at a much lower cost than cable. Unless cable moves quickly, DSL will go into more homes with more sustainable bandwidth per home than cable.

Recently introduced is a chip that will support MPEG-2 video, (latest specification for multimedia PC's) Dolby Digital (formally AC-3) and MPEG audio, 3-D graphics and studio quality 2-D text and graphics for SDTV and HDTV displays. This chip can also decode multiple video streams simultaneously to enable new services such as the viewing of multiple camera angles and picture-in-picture, and it will be capable of decoding world wide analog TV formats for the seamless integration of digital and analog television from around the world.

What about antennas?

There is a lot of talk going around about the need for an outdoor antenna to handle the coming DTV. This is true, but don't plan on retiring selling and installing outdoor antennas. Today, there is a rush on to deliver new antenna-based receivers and television sets to capture this new video and data information. The challenge with indoor reception is that the primary signal may be attenuated by furniture, a wall, or a person, thus producing primary and multipath signals each having similar amplitudes and making it difficult to receive the main signal.

A chip has recently been introduced that solves the indoor reception problem by using an equalizer that can be reconfigured on the fly to optimize the recovery of the main signal. This chip is a programmable DSP (digital signal proces-

sor) that can reconfigure the parameters of the built-in demodulator, matched filter, adaptive equalizer, forward-error-correction, numerically controlled oscillator and phase-locked loop via internal registers. This will eliminate the need for an outdoor antenna.

Fiber optics and wireless

The optical devices of today are where silicon was in the 1950s and '60s. The next generation of optical devices will be so inexpensive that it will be possible to have fiber connections directly to the PC so each PC will have its own wavelength.

Tomorrow's wireless will be all sorts of equipment and the network will be all kinds of networks interconnected in a seamless fashion so it looks like one network. Lucent Technologies-Bell Laboratories has successfully combined bipolar transistors based on silicon germanium thus producing a device that has a cut-off frequency of 51GHz and a maximum oscillating frequency of 53GHz and they indicate that the cut-off frequency over 60GHz is possible for smaller transistors at currents as low as 450mA.

More chips

I look forward to seeing, before year's end, a chip that has been designed to solve the real-world fading and multipath distortion problems with emphasis on low power consumption. This highly integrated device will include an on-chip voltage controlled oscillator, fractional-N synthesizer, power amplifier, low noise amplifier, IF filters, a receiving signal strength indicator, and a bit slicer. This chip will make the receiver's sensitivity -84dBm or 20% better than today's specifications.

This chip will be selling for less than \$5.00 and it's estimated that the cost of replacing the chip would be about \$25.00, if you had the proper tools. How can anyone justify the economics of replacing this chip? There is another IC now available that will accept RF signals from 44MHz up to 870MHz and convert them to IF signals at 36MHz or 44MHz.

This IC will support all popular cable-modem industry standards including Cable Television Laboratories Inc., (Cable Labs), the Data Over Cable Service Interface Specifications (DOCSIS)1.0/1.1, the Euro DOCSIS, Digital

Video Broadcast (DVB), and Digital Audio Visual Council (DAVIC) organizations standards.

Home networks

You can look forward to seeing a home-network that will simultaneously handle many different communication devices such as set-top boxes, home security systems, and electrical appliances, as well as computers through the average home. Even today, X-based devices are inexpensive and have long been available from some major vendors. The ability to connect an X-10 controller to your home power line so that you will be able turn off the table lamp in your child's bedroom from a switch next to your bed is available today. But you will have a problem if you want to use that same connection to transmit a data stream from the multi-DVD changer in your living room to the flat panel TV in your bedroom.

There is a multimedia system known as IEEE 1394 that has the capability to smoothly transmit your DVD signals simultaneously while you're holding a video conference call. We all know that there are technologies based on "being-everywhere," such as the telephone line that transmits voice and computer data, but unfortunately the data rates are limited and this technology does not guarantee quality of service unless you throw in more electronics until you have a nineteen-inch rack from floor to ceiling. Keep an eye on IEEE-1394 (also called "firewire"); it's coming. Before the end of this year, more than 40 percent of all new PC's will include the IEEE 1394 multimedia standard. Most new camcorders will have it and a new set of peripherals, including printers, scanners, and storage devices will incorporate the 1394 standard.

Unprecedented growth

Within the next several years, we will see growth as we have never seen before. The electronics industry has just begun to exhibit it's ability to expand into areas beyond our present imagination. More new computer interface capabilities will be able to deliver more performance than the contemporary PC we know today, they will be performing real-time activities, such as digital-video record-

ing and video-conferencing. Today's hard-disc video recorders can do the job, but they are single-function devices. Over time, these new machines will take over more and more functions within the home and remotely.

Many homes today have more than one PC and there are many homes with multiple television sets. With the extra added value of the new PCs, computing technology will outstrip the TV market. As the prices start to come down, like today's PCs, we will begin to see video screens and computers wherever you now see a telephone, alarm clock, doorbell, and home security devices, not to mention the kitchen appliances.

Cable and multimedia

Where today's cable-TV system may carry 100 channels, tomorrow's cable customers will be able to share live or pre-recorded videos on a broadband equivalent of a million personal web sites. This rising tide in technology is definitely going toward heavy use in the multimedia and the home area, so this is where the action will be. Within the first

week of the 21st century open-cable specifications were released, an occurrence that has brought forth a slew of issues in regard to the future of cable television and how broadcasters will react, and the way television watching will progress in the next couple years.

Open-cable will put the decision to buy set-top boxes to watch cable programming in the hands of the consumer, which will have an impact on the market. First, it gives the consumer a choice, where before they would take the box the cable company gave them. This way, if a customer wants a set-top box that has additional features, such as a DVI player, Internet access or more features, the consumer can purchase and choose the box that provides the functions they want.

The ability to choose will free up the cable companies from having to cover the burden of developing and buying set-top boxes every year. All of this will be in the hands of the consumer. By having an open-standard, the cable provider will be able to offer more services, more channels and functions to compete with the satellite vendors, such as Direct TV and EchoStar.

Open cable will also open many doors for small businesses that want to provide features and services that the large corporations are not offering or not interested in getting involved in providing. Part of the reason that satellite broadcasting companies became so popular is that they offered features that cable providers didn't: more channels, on-screen programming guides, better reception, better service, and more.

TV sets that send and receive e-mail

Zilog Inc. in Campbell, California, has just teamed up with World-Call Net, Inc. of London to launch M@iTV, e-mail enabled TV sets that will first be available in the UK and later this year in the U.S. M@iTV will support up to five e-mail addresses per TV set and require no configuration by the set owner. The set-up will be as easy as connecting a telephone line to the M@iTV set. All systems will have the ability to send and receive e-mail via a television remote control or by an optional wireless keyboard and receiver unit.

The M@iTV user will also be able to access Internet features such as home

What's Your Best Servicing Value? The magazine that makes money for you!

THE PROFESSIONAL MAGAZINE FOR ELECTRONICS AND COMPUTER SERVICING

ELECTRONIC
Servicing & Technology

As an electronic servicing professional, it's crucial for you to keep current in an industry that's always growing and changing.

Each month, **ES&T** brings you how-to service articles on TVs...VCRs... Computers... CD players... Microwave ovens... Audio products and more. It's the information you need to do your job every day.

Regular columns and special features from experts will make you more efficient – and more profitable – in no time. Plus, our monthly PROFAX, a FREE 8-page pull-out of popular TV, VCR and computer schematics, makes **ES&T** an even greater value.

Subscribe today to the only magazine devoted to you!

SUBSCRIBE TODAY!!



8 pages of schematics FREE! each month

United States	
1-yr (12 issues).....	\$26.95
2-years (24 issues)	\$49.95
Canada/Mexico	
1-yr (12 issues).....	\$36.95
2-years (24 issues).....	\$69.95
Foreign Air Post	
1-yr (12 issues).....	\$44.95
2-years (24 issues).....	\$85.95

When ordering include: Name, address, city, state, zip. Check, money order, MasterCard, VISA, Discover, and American Express accepted. Send credit card number along with expiration date. If renewing, send a label along with your request.

Electronic Servicing & Technology

25 Newbridge Road, Hicksville, NY 11801, Ph: 516-681-2922 FAX: 516-681-2926

shopping, banking, etc. This technology was designed specifically to allow every customer to easily and inexpensively connect to the rest of the world without the need to buy any additional devices. There is no doubt that M@ilTV is a revolutionary television system that will allow customers to conduct personal communications through their television sets.

In the near future I can see television sets that will accommodate DVI playback, Internet connection, as well as digital video broadcasting. Many sets will have a variety of pixel formats which will pave the way for pixel-format converters that will convert interlaced TV screens to progressively scanned formats or to on-screens with higher pixel resolutions.

Smart appliances

There is a very big movement to embed networking capabilities into every consumer product found in and around the home which will become a major business opportunity for hardware vendors and service providers. You can look forward to being involved with many different "smart-appliance," which

will be plug-in devices as well as hard-wired that will be communicating over the ac power lines within the home, while battery-operated devices, such as smoke detectors, will communicate by way of RF devices to notify their owner of a fire or low battery voltage.

The Sunbeam Company has developed a kitchen console called "HandyHelper" which has a digital assistant, and an intelligent alarm clock that will interface with other appliances, such as the bathroom scale and a blood-pressure monitor that will maintain on going records for the owner, doctor, or others. These records can either be stored locally or transmitted to a remote location via the Internet.

General Electric has also introduced a line of smart appliances that will link to the Internet, such as refrigerators and microwave ovens, the refrigerators feature a WebPad that can be easily stored on a holder mounted to the fridge door and can share information on what foods need to be re-stocked with an online connection to a grocery store.

Sharp Corporation has demonstrated an intelligent microwave oven that can download recipes from the internet and cook food according to the instructions it receives remotely. Soon we will be seeing home control servers that will allow users to connect their kitchen appliances, cooling and heating systems, entertainment equipment, lighting and security systems either from within the house or remotely by using the Internet.

High-speed internet access

An array of techniques now exist for bringing low-cost high-speed Internet and multimedia services to the typical home. Some of these are designed to upgrade established links, while others are available for those who plan to build from scratch. These technologies, along with the high-volume opportunities they represent, are pushing the semiconductor industry and related component providers into new markets, which explains the alliances with system providers. There are a number of technologies, each with their own blend of technical advantages, cost and speed of implementation. Before this year ends, there will be a drive to using the plain old telephone line to provide different

implementations of digital subscriber lines (DSL) which will offer upstream rates in the hundreds of kilobits/sec range. Although DSL will capitalize on existing telephone lines, the telephone company central office and the home will need new line-interface cards.

But why limit all this to existing cabling? Fiber, either direct to the home or via hybrid fiber to the neighborhood system, promises to operate free from the constraints of in-place wiring. Cabling the whole country is already underway at a very high rate. Most all providers believe that the performance that they will be able to offer each home will justify the rates they will have to charge to cover the cost of fiber.

Broadband communication via satellite and microwave

The providers of direct satellite broadcast systems (satellite TV) also are beginning to see the opportunity to deliver broadband services. Geo-stationary satellites and 18-inch home dishes can provide the pipe for high-speed Internet access with relatively low infrastructure effort, much of which is already in place.

Finally, the microwave transmission industry will add to helping all this to become a reality. As an example, Local Multipoint Distribution Service (LMDS), operating in the 28-GHz band with a bandwidth of several gigahertz, can deliver broadband signals very economically to clustered homes or apartment buildings. Once these signals arrive at the home, how does it get distributed, and how do the various users in the home link together? Again, the phone line is a very strong contender because it's already there.

The suppliers of wireless RF links will be pushing to reduce their prices and power consumption while boosting their performance. Their aim will be to blanket the home with invisible, easy-to-configure, painless-to-maintain networks which will be operating in the GHz region at milliwatt power levels and free from regulatory issues.

Connecting the home will create many opportunities for the alert electronic servicing technician and the next few years will be exciting ones for the whole electronic industry. ■



**Your Ticket to
SUCCESS**

More than 40,000 technicians worldwide are Certified Electronics Technicians. IS CET offers Journeyman certification in Consumer Electronics, Industrial, Medical, Communications, Radar, Computer and Video. For more information, contact the International Society of Certified Electronics Technicians, 2708 West Berry Street, Fort Worth TX 76109; (817) 921-9101.

Name _____
 Address _____
 City _____
 State _____ ZIP _____

___ Send material about IS CET and becoming certified
 ___ Send one "Study Guide for the Associate Level CET Test." Enclosed is \$14.95 (includes postage/handling). **TX residents — include 8.25% sales tax.**

ES&T

Circle (68) on Reply Card

Serviceing TV circuits with the ESR meter

by Homer L. Davidson

Troubleshooting defective capacitors and electronic components in the low voltage power supply and scan-derived circuits of television sets can be made easier with the ESR meter. The ESR (equivalent series resistance) meter was designed to locate defective capacitors (1 μ F and up) in or out of the circuit. The ESR meter can locate a bad electrolytic when the regular capacitor tester will not. You can quickly check most electrolytic and bypass capacitors right in the power supply circuits in minutes. Besides a good or bad reading, the ESR meter sounds off when a good capacitor is located (Figure 1).

By applying the sharp test probes across each capacitor in the power supply circuits, you can save valuable service time and also eliminate suspected capacitors. If you short the test probes of the ESR meter together, you will read 0 Ω , and you'll hear a beeping sound. A good electrolytic capacitor should measure below 1 Ω . An open capacitor will measure near infinity, which will make it very easy to locate.

In addition to identifying defective capacitors, the ESR meter can locate and test other SMD (surface mount device) components, or help you locate a poor soldered connection or broken foil or trace on a printed circuit board. For example, a raspy or broken beeper sound from the meter might indicate a poor soldered connection. A completely broken trace or foil has no indication or beeping sound on the ESR meter. The ESR meter can locate a poor soldered end connection on the SMD component.

Discharge capacitors before using the ESR meter

Disconnect the TV power ac plug before checking any component with the ESR meter. Discharge each electrolytic

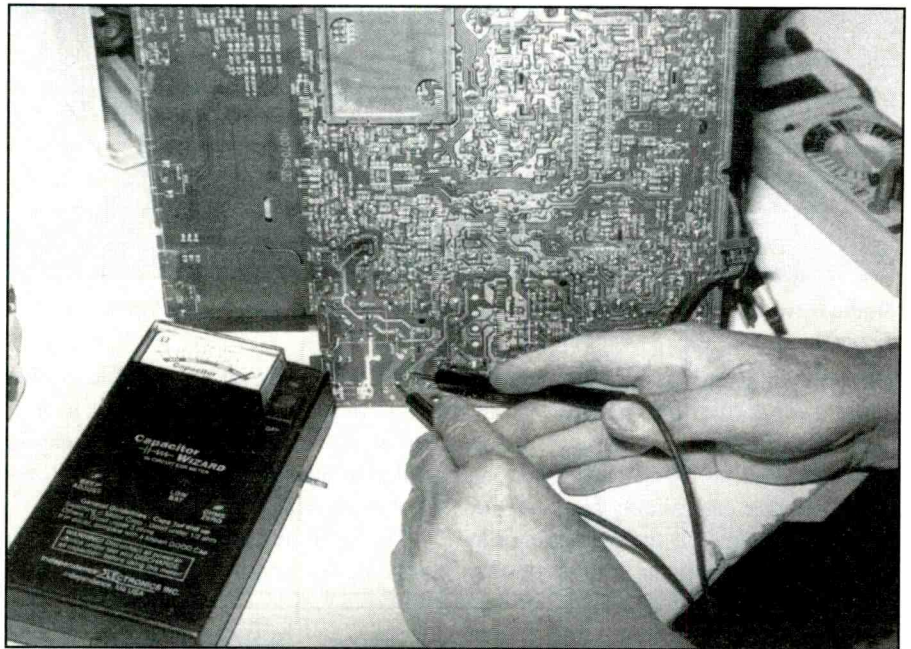

Figure 1. Checking electrolytic CP31 (330 μ F-200V) with the ESR meter.

capacitor by placing a short across the capacitor terminals. Do not discharge them to common ground. Connect the alligator lead and clips across the main filter capacitor for a few seconds. You can damage the ESR meter if you try to check a large electrolytic capacitors that is not fully discharged. Treat the ESR meter the same way you would the ohmmeter range of the ohmmeter or DMM.

Remember, when using the ESR meter in the different circuits, to use it the opposite of the way you would use a voltmeter. No voltage should be in the circuit. The ESR meter measures series resistance of a capacitor. Treat the ESR meter as you would when checking resistance in the various circuits. Discharge the voltage at the main filter capacitor and any capacitor to be tested.

Testing components other than capacitors

Besides its obvious use to check capacitors, the ESR meter can also

.047 μ F30 ohms
0.1 μ F15.9 ohms
0.22 μ F5 ohms
0.33 μ F2.2 ohms
0.47 μ F1 ohm
0.56 μ F0.8 ohm
0.68 μ F0.5 ohm

Figure 2. This table lists the correct resistances of known bypass capacitors when tested with the ESR meter.

locate shorted PC traces, small inductors or coils, shorted or leaky diodes, leaky transistors, and measure small value resistors in the circuit. Horizontal output transistors containing internal damper diodes can be tested for leakage. Extremely low value bypass capacitors from 0.047 μ F to 0.1 μ F can be tested in circuit by comparing the low ohm measurement across the capacitor terminals and using the meter reading chart in Figure 2. This means that suspected bypass capacitors in the horizontal out-

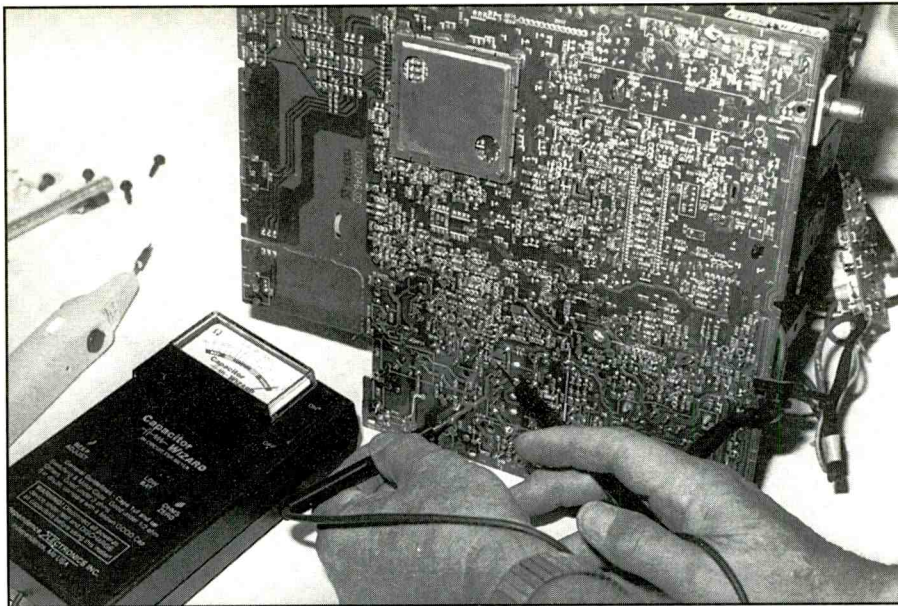

Figure 3. Normal electrolytic capacitors will read high capacitance on the ESR meter.

put and yoke circuits can be quickly checked for correct capacitance with in-circuit ESR tests.

Besides testing standard capacitors, the ESR meter can quickly test SMD or SMT components on the printed circuit wiring. The ESR meter can accurately

check the value of an SMT capacitor while in the circuit. You do not have to remove it for a good test or worry about which test probe goes where, as the ESR probes are non-polar.

The ESR meter can quickly locate a SMT tie in-circuit bar as a shorted com-

ponent. If in doubt about a certain measurement of any SMT chip, compare a component of the same value out of the parts bin with the ESR meter.

Troubleshooting low voltage circuits

Most electrolytic and bypass capacitors in the low voltage power supply and the scan-derived power supply can be checked effectively with the ESR meter (Figure 3). Discharge all electrolytic capacitors before making tests with the ESR meter. Low voltage electrolytics with lower than normal capacitance can cause very low output voltages. These types of electrolytics are frequently the cause of a power supply problem that is difficult to diagnose.

Open fuses, isolated resistors, and leaky diodes can be easily located in the low voltage power supply using an ESR meter. Large and small open electrolytic and bypass capacitors can be tested while soldered into the various circuits. Bypass capacitors with capacitance values below $0.01\mu\text{F}$ might show a nudge of the meter scale while larger ones above $0.047\mu\text{F}$ can be tested effectively.



Electronic Technicians Association - ETA

and
Satellite Dealers Association - SDA
present

The **Ultimate Customer Service Specialist Study Guide**

CSS-2

The second edition of this popular CSS Study Guide is now in print.

-  Twice the number of pages
-  Twice the chapters
-  Dozens of new practice quiz questions

Sales-marketing-service relationships; Technoliteracy; Safety; Company standards; Dependability; Teamwork; Work ethics; Problem solving; Company loyalty; Telephone techniques; Controlling your emotions; Communications; Record keeping; Safety; Decision making; Customer service techniques; Hygiene, and more

No Service Business Should be Without One of These Unique Guides to World Class Service!

to order
Call 800 288 3824

eta@indy.tdsnet

ETA-I

602 N Jackson, Greencastle, IN 46135

ES&T READER SURVEY

It's a mini survey about you.

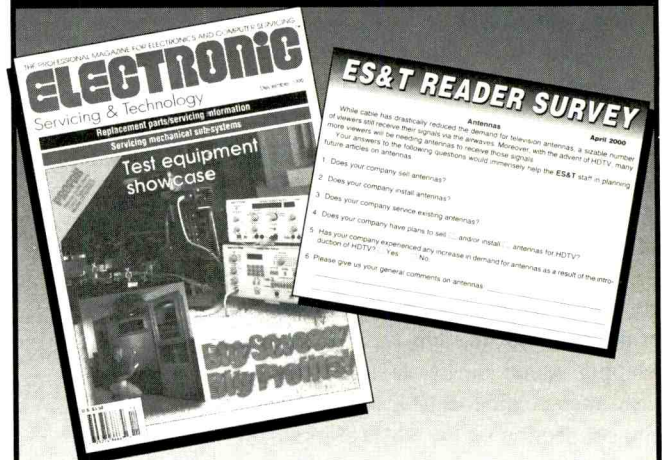

Bound into this issue is the ES&T Reader Survey card.

We would like to hear about the problems you face, the opportunities you see and the equipment you use during the course of your work day.

The postage is paid. All you have to do is fill it out and mail it.

What could be easier?

Please fill yours out and mail it today.

Circle (63) on Reply Card

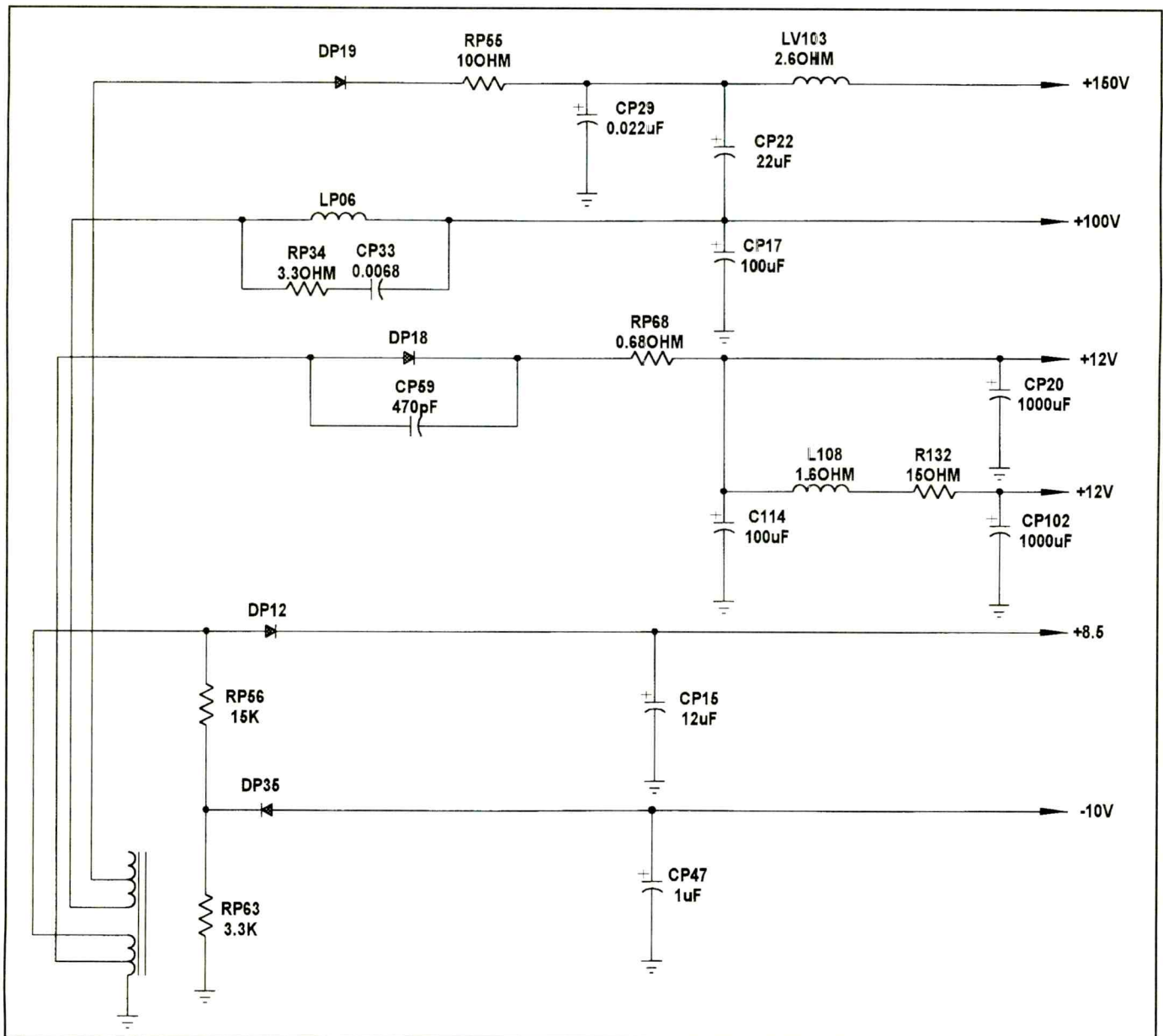

Figure 4. In addition to checking capacitors, the ESR meter can check small coils, diodes, and poor board connections with in-circuit tests.

All electrolytics in the low voltage horizontal output transformer and scan-derived circuits can be checked in-circuit with the ESR meter. Leaky transistors and diodes can easily be located with ESR tests. Small filter coils or inductors found in the low voltage circuits can be tested with the ESR meter. In Figure 4, L108 (47μH) coil should read around 30 on the ESR meter.

Bypass capacitors below 0.047μF cannot be checked with the ESR meter. If you suspect that a low value capacitor is shorted, use the ohmmeter to check it. A capacitor that has a terminal that is broken internally, and is therefore open,

can be spotted with the ESR meter. You can quickly check most capacitors in the low voltage circuits by applying the ESR test probes across the suspected component terminals, without worrying about correct meter polarity.

Testing SMD or SMT capacitors

Like their larger counterparts, SMD bypass and electrolytic chip capacitors can be quickly tested in-circuit using the ESR meter. Today, many SMD parts are found throughout the TV chassis. Most problems found with SMD parts are component breakdown, leakage, and open conditions. The SMD capacitor can

be tested accurately in-circuit with the ESR meter probes applied across the SMD end terminals.

SMDs might be faulty because of breakage or poor end connections. Sometimes when a large PC board is flexed, or the set is dropped, poor soldered connections can develop where the part ties into the PC wiring (Figure 5). Look for poor soldered end connections or broken PC traces when the TV operation is intermittent. The ESR meter can quickly locate a broken trace or poor soldered joint.

To check for a poor or broken connection, press the sharp ESR meter probes at

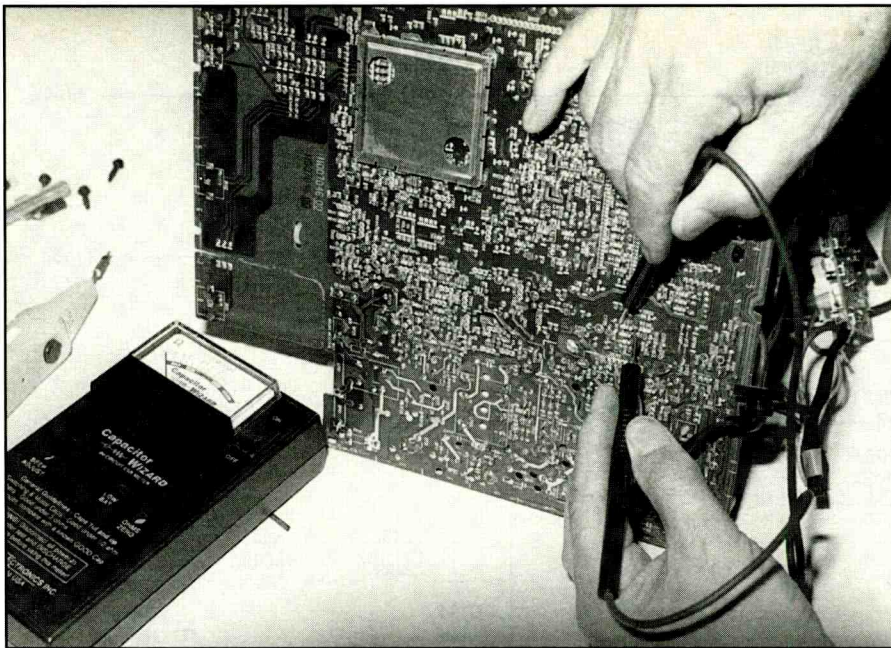

Figure 5. Check small SMD bypass capacitors and resistors under 30Ω with the ESR meter.

one end of the SMD or SMT component and the other to a connecting trace of the same part. These test probes are very sharp and can dig into the PC foil or trace for good connections. Now push up and down on the probes and notice the reading on the meter. A broken or erratic connection can show a make or break measurement with an erratic beeping sound.

Poor IC soldered connections

After locating and replacing a defective IC, microprocessor, or SMD chip, check for poor circuit connections and soldered joints. Sometimes when an IC or chip has been removed from the printed circuit board, the trace or foil might be lifted or broken resulting in a non-operating chassis.

Check each IC terminal connection, from each pin to a corresponding trace, to a connecting component with the ESR meter. Make sure that each connection pin is properly soldered with a good connection to the correct circuit. A bad connection will cause some resistance measurement with an erratic beeping sound. A good connection on the ESR meter should hit the peg at zero with no resistance measured.

Dead symptom-RCA CTC187 chassis

A customer brought in an RCA CTC187 chassis that was totally dead. There was no horizontal pulse or wave-

form at pin 24, so the technician replaced U1001. When the chassis was reconnected and turned on, the problem remained. Was it possible that the technician had caused a bad connection or trace during replacement of the sweep IC? All IC terminals were checked for good trace contacts with the ESR meter.

Transistor Q4302 was tested in-circuit and found to be normal. A quick in-circuit ESR meter test from each transistor lead to corresponding resistors, R4310

and R4304 showed that everything was normal there. When the emitter terminal was tested between the transistor leg and the 12.1V source, an open measurement was noted. A poor soldered connection between the emitter terminal of Q4302 and the supply voltage was the cause of the dead chassis (Figure 6). Resoldering of this connection returned the set to normal operation.

Shutdown in a Sanyo DS26050 TV

The B+ regulated voltage was quite high and the main filter capacitor (C042) was running extremely hot in a Sanyo DS26050 chassis that was in shutdown. The B+ voltage feeding the horizontal output transistor, which should be around +14V, was high at +162V. C042 was discharged and checked out with the ESR meter. Most normal electrolytics capacitors will operate in the *good* segment of the scale. Capacitor C042 (150μF) tested in that range.

The oscillator transistor and the switching transistor were found to be shorted and were replaced. Note that both transistors operate in the hot ground circuits. Capacitor C042 operates in the common ground circuit and Q001 and Q004 work in the positive ("Hot") ground system (Figure 7).

When the chassis was again supplied with ac power, the chassis remained in shutdown, and when the replacement

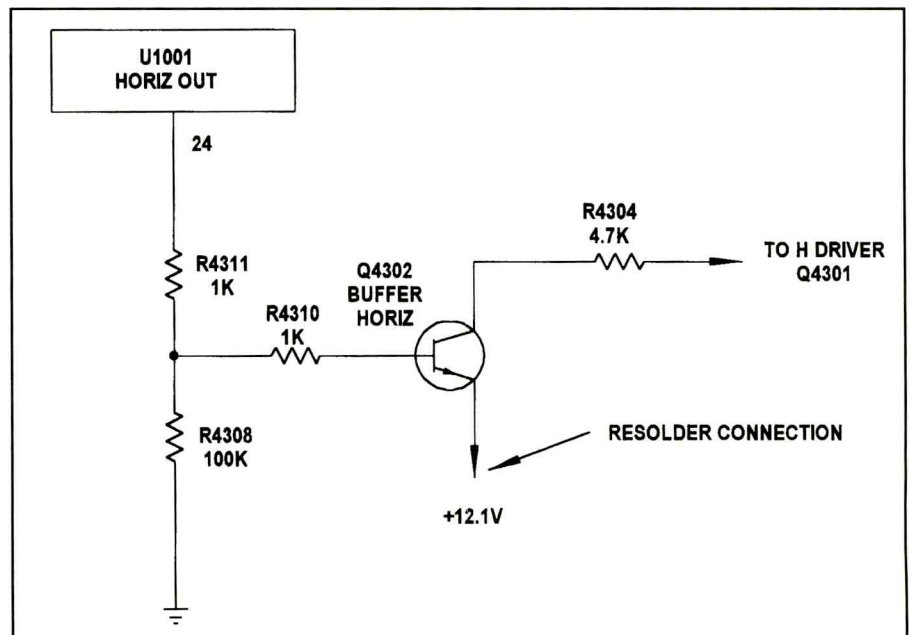

Figure 6. A poor soldered connection between emitter and trace wiring caused a dead chassis symptom in an RCA CTC187 chassis.

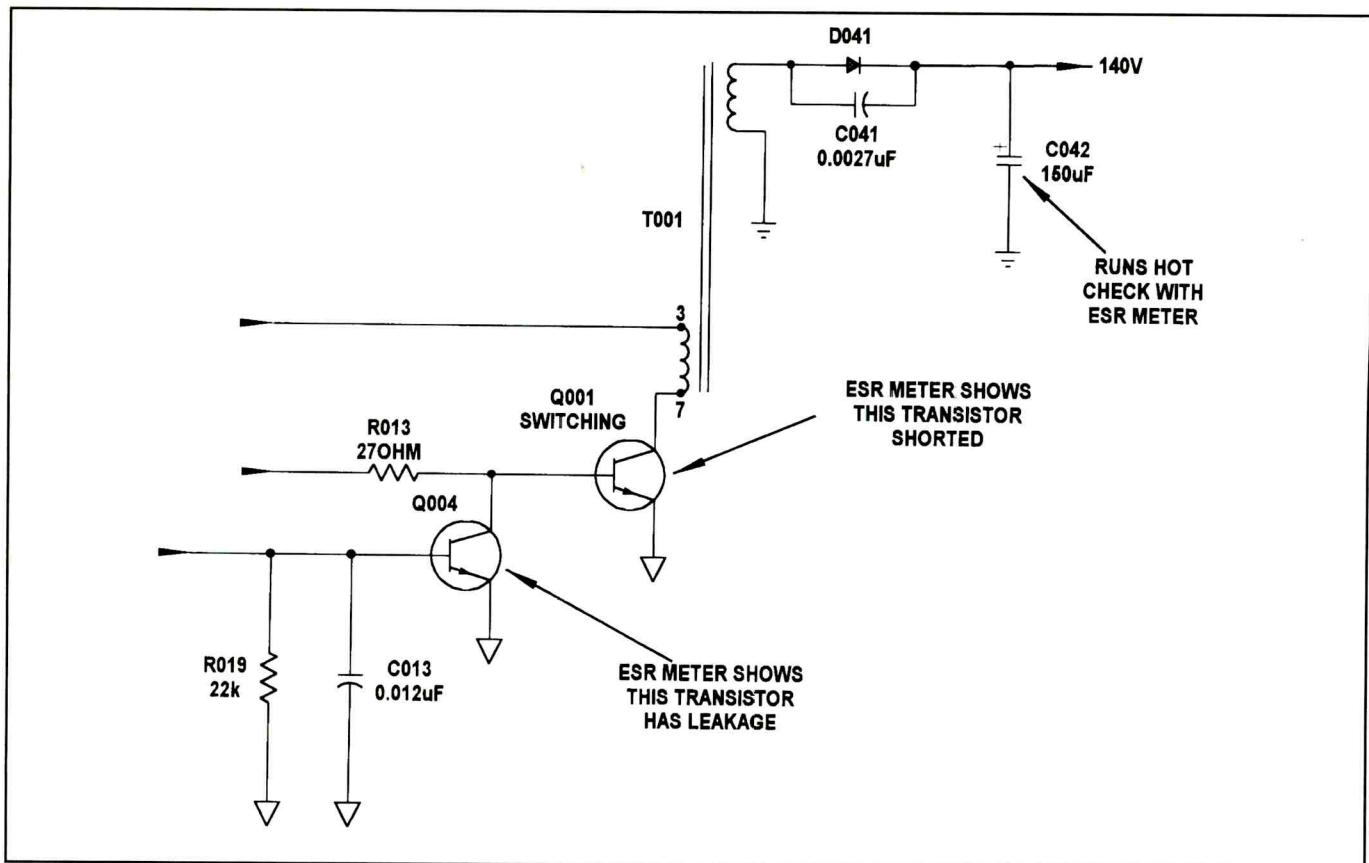

Figure 7. Replacement of Q001, Q004, C013, and C042 in a Sanyo DS2650 with shutdown problems restored the set to normal operation.

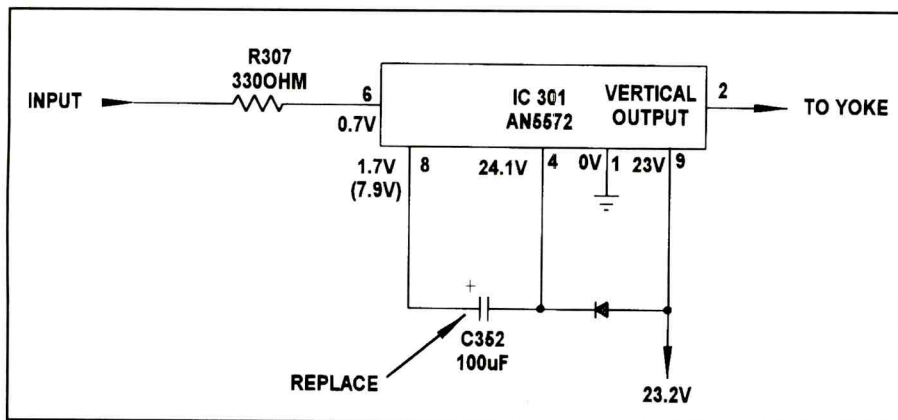

Figure 8. A quick test with the ESR meter located a leaky C352 electrolytic in a Samsung TC9865T TV.

shorted. Replacement of capacitors C013, C042 and transistor Q001 and Q004 solved the shutdown problem.

In another chassis with the same model number, C042 was running extremely hot. Replacing the switching transistor Q001, Q004, and C042, leaky diode D010, C013, and shorted error amp Q005 solved the multi-component break down problems. Although electrolytic capacitor C042 tested normal when checked with the ESR, it was running hot when power was applied to the set, so it was replaced to prevent future low voltage problems.

switching transistor (Q001) was tested, it was determined to have been destroyed. The set was again disconnected, the B+ circuits were discharged, and Q001 was again replaced. The replacement Q001 tested normal when tested in-circuit with the ESR and transistor tester. No doubt, Q004 was damaged when the chassis was powered up as a leakage was found between base and emitter terminals.

Q004 was removed and tested out of the circuit. It was found to be intact. A close examination of the chassis showed that there was a bypass capacitor between base and hot ground. The ESR meter hit the peg when the test probes were placed across C013 terminals. In normal tests, a bypass capacitor of 0.01 μ F capacitance should only nudge the ESR meter. C013 was removed from the circuit and tested. It was found to be

No vertical sweep-Samsung TC9865T TV

The ESR meter can be used to test just about any circuit in the TV chassis. When the combination of video and audio symptoms causes the technician to suspect a specific stage as defective, the ESR meter can weed out most any defective capacitor in that circuit. After discharging electrolytic capacitors in a given circuit, the ESR meter can be

To Order Back Issues



**Only
\$4.00
Per Issue**

When ordering back issues include the following information: Name, address, city, state, zip & phone. Please make a list of the issues you're requesting. When paying by credit card send the number along with the expiration date. Check, Money Order, Mastercard, VISA, Discover and AMEX accepted.

Complete your collection today!

A great way to save your issues of *Electronic Servicing & Technology* is with a case or binder. These cases or binders are manufactured by *Jesse Jones Industries* and will help keep your valuable copies from damage so they can be read time and time again.

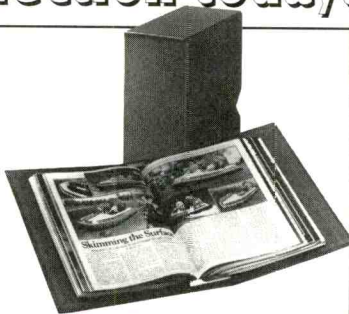

**For Binders Only. Call TOLL FREE 7 days, 24 hours
1-800-825-6690**

FOR BACK ISSUE ORDERS ONLY

For Fastest Service

Call 1-516-681-2922

Electronic Servicing & Technology

25 Newbridge Rd., Hicksville, NY 11801

Fax 1-516-681-2926

used to check each individual capacitor in the circuit.

Usually the technician checks voltage, resistance, and waveforms to help locate a defective component. When those preliminary checks have been performed, the ESR meter can be used to point out the open or leaky capacitor. If the capacitor is open or has lost capacitance, in-circuit tests with the ESR meter will confirm that the capacitor is defective and should be replaced. When checked with a capacitor tester, an electrolytic capacitor might appear to have the correct capacitance, but it might also have an ESR problem. The ESR of every capacitor in that circuit can be checked in minutes. Remember, capacitors below $0.047\mu\text{F}$ will not indicate effectively on the ESR meter.

Another Samsung problem

A Samsung TC9865T model was brought into the service center with the complaint that there was no picture. The problem was that there was no vertical sweep. After the vertical output IC (IC301) was located, voltages at all of the IC terminals were measured. The voltage at pin 8 of IC301 measured 7.8V. This voltage should be around 1.7V (Figure 8). Either IC301 was defective, or C352 was leaky, causing higher than normal voltage on pin 8. Since it was quick and easy to test $100\mu\text{F}$ C352 in-circuit, it was discharged and checked using the ESR meter.

The check indicated that the capacitor was defective. Of course, one terminal of C352 could be removed from the circuit and a voltage measurement would indicate a leaky electrolytic, but time was saved by checking the electrolytic with in-circuit tests using the ESR meter. Always, recheck the suspected component after it is removed from the PCB to confirm that it is in fact defective.

Conclusion

Always discharge capacitors before making ESR tests. The ESR meter can quickly eliminate guesswork. The ESR meter can test most capacitors with in-circuit tests. Remember the ESR meter can also test those tiny SMD parts. Besides capacitors, the ESR meter can test other electronic components. ■

Books

***Electronics Portable Handbook*, by Stan Gibilisco, Tab/McGraw-Hill, 640 pages, hardcover, \$54.95**

Electronics Portable Handbook, part of McGraw-Hill's Portable Handbook Series, features customizable, fast-access guides for everyday use on the job. This electronics problem-solver helps you design, optimize, choose, install, protect, troubleshoot, interface, and use just about anything electronic. Filled with tables, charts, and checklists, plus diagrams, formulas, and clear directions, the *Electronics Portable Handbook* shows you how to: Design equipment such as oscillators, amplifiers, and antenna systems; Optimize the performance of radio receivers, transmitters, and other electronics; Troubleshoot devices and systems; Choose communications frequencies and modes; Ensure that equipment is properly installed; Protect against costly hazards such as lightning and electric shock; Interact with technical staff or professionals in other electronics specialties.

Tab/McGraw-Hill, 877-833-5524

***Electronics Pocket Reference*, Tab/McGraw-Hill, paperback, 544 pages, \$29.95**

The third edition of *Electronics Pocket Reference* is intended to provide answers to problems most commonly encountered by engineers, technicians, students, and hobbyists in a compact format. The book covers the spectrum of modern electronics—both analog and digital. Contents provide a full theoretical background of the field along with practical applications. A unique aspect of this book is that it shows those using electronics how to solve problems with copious examples and real-world solutions. The methods provided are ideal for use in conjunction with desktop or laptop computers with calculators.

Tab/McGraw-Hill, 877-833-5524

***Novell's Introduction to Networking* by Cheryl C. Currid and Arch D. Currid, Novell Press, 328 pages, \$19.99**

Because the Internet and private intranets are becoming more and more popular, a solid understanding of networking fundamentals is now more important than ever. Learn the basics of the latest networking technology with this straightforward, no-nonsense resource guide. Discussing both Novell and non-Novell products, this book provides step-by-step instructions to implement and manage a network for any size business. Diagrams and real-world examples make it easy to understand computer networking technology.

Novell Press, 1-800-762-2974, 317-596-5530

***Video Engineering*, Tab/McGraw-Hill, \$65.00**

Video Engineering presents an overview of the fundamentals underlying video technology, and it describes current video equipment used in TV broadcasting, cable-TV, satellite broadcasting, digital cameras, home and semiprofessional video, and

video on the Internet. The third edition recognizes that video systems are undergoing a transition from analog to digital technology, and the focus of most of the presentation is on digital video.

Tab/McGraw-Hill, 877-833-5524

***CMOS Projects and Experiments*, by Newton Braga, Newnes, 352 pages, paperback, \$29.95**

CMOS Projects and Experiments includes information on audio and RF devices, lamps, LEDs, timers, alarms, inverters, and much more. This book offers hobbyists and students a satisfying, practical way of learning about most hot topics in electronics today.

Among the devices you can build using this book are a touch-controlled oscillator, a light-controlled oscillator, insect repellent, a metronome, a Morse code tone generator, a CW transmitter, a two-tone siren, a neon-lamp flasher, an auto turn-off relay, a turn-off timer, a touch-controlled motor, a bistable sonic relay, a coin tosser, a freezer alarm, an ultraviolet lamp, a simple fluorescent lamp inverter, a nerve stimulator, and an experimental high-voltage generator.

Newnes, 225 Wildwood Avenue, Woburn, MA 01801-2041, Phone: 781-904-2500

***Principles of Digital Audio*, by Ken C. Pohlmann, Tab/McGraw-Hill, paperback, 319 pages, \$54.95**

A long proven bestseller, this is the market leader in digital audio texts over three consecutive editions. The new edition will update every chapter with the many, many changes that have altered this field since 1994 and include entirely new chapters on DVD and Internet Audio.

The contents of the book are:

Preface to the Fourth Edition.

Chapter 1: Sound and Numbers.

Chapter 2: Fundamentals of Digital Audio.

Chapter 3: Digital Audio Recording.

Chapter 4: Digital Audio Reproduction.

Chapter 5: Error Correction.

Chapter 6: Magnetic Tape Storage.

Chapter 7: Digital Audio Tape (DAT).

Chapter 8: Optical Disk Storage.

Chapter 9: The Compact Disc.

Chapter 10: Perceptual Coding.

Chapter 11: DVD.

Chapter 12: The MiniDisc.

Chapter 13: Interconnection.

Chapter 14: PC Audio.

Chapter 15: Internet Audio.

Chapter 16: Digital Radio and Television Broadcasting.

Chapter 17: Digital Signal Processing.

Chapter 18: Sigma-Delta Conversion and Noise Shaping.

Tab/McGraw-Hill, 877-833-5524

When you examine the process of servicing a consumer electronics product, it's deceptively simple: evaluate the symptoms, test the suspect circuits/components, isolate the faulty component(s), replace the faulty component(s), and test the repaired product. All of the steps in this process are important. Some of the steps, however, require that the service center be dependent, to a greater or lesser degree, on something/someone outside.

For example, evaluating and testing generally imply the use of service literature and test equipment. That involves a distributor, and/or the manufacturer of the product. The step in which the faulty components are replaced requires that the service center obtain the components from a distributor. In short, the business of the consumer electronics service center is closely tied to the businesses that supply it. Of course, the converse is true: the distributors depend on the requirements of the service centers that are its clients to stay in business.

Given that interdependency, it's important that each business know as much as it can about the other. That's why it's important for a service center to do a little research before selecting a distributor. Some distributors are more efficient, and more conscientious than others. Some distributors are authorized for certain brands and have a much better likelihood of having those parts.

That's why **ES&T** presents this "Distributor Showcase" once a year. In the showcase, we give each distributor who advertises in this issue an additional amount of space equivalent to the size of their ad in which to tell readers more about their business than is possible with an ad. We hope that reading these showcase entries helps readers make a more informed decision in choosing a distributor. The following text gives service centers some suggestions on making this important decision.

Consider these variables

When choosing a distributor, consider some of the factors listed below. Some apply only to the local distributor, and some apply only to mail order, but it would be a good idea to keep them in mind any time you're thinking about

doing business with a new firm. These items are not listed in any particular order, for the simple reason that their order of priority or importance depends upon your particular wants and needs. Put them in order of importance for yourself.

- Do the distributor's facilities and/or literature give the impression of competence and order?

- Do prices seem reasonable and in line with what other companies charge?

- Are most items in stock, or does the distributor have to back order many of them; wasting your precious time?

- Does the distributor offer a broad line of products, or will you have to find other sources of supply for many of your needs?

- Does the distributor specialize in any particular kinds of products that you typically order?

- What kind of payment options does the distributor offer: Open order account, credit card, COD, check, etc.?

- How soon after receipt of an order does the distributor ship?

- Does the distributor add a shipping surcharge, or a handling charge?

- Does the company list a toll-free number to save you money on calls?

- Are such ordering options as fax, and telex available? Do they have a website where you can look up products and order what you need?

- What is the distributor's return policy as regards to returned items?

- Are all of the distributor's policies well documented, or do you have to guess at them? Or do they seem to differ depending on his whim?

- What kind of warranty, if any, does the distributor offer?

- Does the distributor publish a catalog? If so, is it clear and easy to understand?

- Is there a minimum order amount? If so, is it reasonable?

- What kind of shipping options are available? Do they offer options such as mail, UPS, Federal Express, etc.?

- What kind of special services, such as assembling cables, etc., do they offer?

- What research services does the distributor offer to help you to find the part you need?

Some important questions to ask

Some of these questions may not seem

important, but from what we have learned from some of our readers, they may be very important. For example, we learned from one of our readers that one mail order company that he dealt with made a regular practice of charging unnecessarily high shipping charges on the products he sells.

Another practice that some distributors indulge in is to hold shipment of products for some time after the purchaser's check has cleared. This gives the distributor a nice little interest-free loan between the time the check clears and the time he decides to ship the merchandise. This is not necessary. Some companies ship the product immediately after receiving an order from a service center.

One other thing to keep in mind is that some distributors charge a restocking fee even when they were responsible for shipping the incorrect product in the first place.

This showcase may help

The purpose of this distributors' showcase is to provide the distributors who advertise in it with additional space to give readers information about their companies. We hope you'll take this opportunity to learn a little more about these companies so that you'll have a better idea of their capabilities and practices.

Let the buyer beware

Most replacement parts distributors are hard-working, well-organized, ethical companies, who will make every effort to help you obtain the correct replacement for a faulty component. Some are less ethical in their practices. It's not always easy to locate the good ones and avoid the ones that will give you problems.

When you're considering ordering products from a new distributor, it might be wise to start out with a small order and see what kind of treatment you get. If the service is good, you might gradually increase the size of your order and gradually build up a close working relationship.

If the service you receive is not what you'd like, or not what you had expected, try someone else. It's your business that will suffer if you don't get what you order when you need it, or if you're hit with exorbitant freight charges that you have to pass along to your customer. ■

Sencore

3200 Sencore Drive
Sioux Falls, SD 57107
Phone: 1-800-736-2673
Website: www.sencore.com

As Sencore celebrates its 50th anniversary, we remain committed to one goal — making our customers more successful in a multiplicity of servicing challenges. Today, Sencore is a leading manufacturer of electronic test equipment because we listen to our customers needs and design instruments that help them achieve success. Sencore is committed to its customers success with an exclusive product line and the absolute best support in the industry. Our obligation and support are just beginning when a customer says "yes" to Sencore equipment.

Sencore was started in 1951, in downtown Chicago, Illinois, by R.H. ("Herb") Bowden. As the business grew, Sencore moved west to Sioux Falls, South Dakota, in 1971, attracted by the area's superb quality of life. The now second generation business remains in Sioux Falls where Sencore is proud to be actively involved in community events and charities. Sencore's second generation, represented by co-owners Al and brother Doug Bowden, is committed to adapting to the technical challenges necessary to take Sencore into the 21st century.

The future looks exciting at Sencore. As technology advances from the broadcast studio to your living room TV receiver, Sencore is preparing itself for new challenges and forming global alliances to stay on top of the industry. We're a forward looking engineering/manufacturing/marketing firm with an eye on the future.

With the ushering in of Digital Television, Sencore is proud of our

alliance with Adherent Technologies in servicing North America with MPEG, DTV, and other excellent digital products. These offerings are providing cutting edge answers for the broadcasting industry in this exciting technical revolution. On November 1, 1999, the top 10 television networks went digital with the use of Sencore technology! For the past five years, Sencore has been instrumental in educating and providing the right tools to the manufacturers and broadcasters responsible for compressing video signals. They rely on Sencore to be their "digital" resource for all the changes and regulations they need to meet. Sencore provides digital solutions that support: Studios, Networks, Local TV Stations, Cable Companies, Retailers, Consumers, and ultimately Servicers!

That's what Sencore has been up to. Now here are a few items that we think you should investigate as we move into the 21st century. ■

Service Facts & Tips

As we move toward the 21st century, the consumer electronics service industry continues to evolve. How you adapt to the changes will determine your success in the new millennium. I recently attended NPSC99 in Dallas, where I met many successful servicers and manufacturers. An overriding theme was service is alive and well and that manufacturers need their independent servicer networks to manage the escalating flow of new products to the market. I can away feeling that there are some vital moves servicers can make today to build their businesses:

Go To The Home To Service Products

Consumers are demanding and manufacturers are promising, fast service turnaround on their new, high-end products. In-home service is a real paradigm shift for many of you, but it's absolutely critical. This in-home service may not be what you think of as a "service call" (pulling covers, troubleshooting circuitry, etc.). New large screen direct view TVs, projections systems, and other home theater components require professional installation and adjustment, and usually require only a laptop, color meter, signal generator, and a RF level meter. This in-home service is very profitable and reworks are almost nonexistent — once you have the process down. This relates directly to the growth of CEDIA (Custom Electronic Design & Installation Association — once dealing primarily with audio systems, but now moving into the high end display market. Imaging Science Foundation (www.imagingscience.com), among other activities, provides training classes (always full) for home theater installers. Many of these attendees are nowhere near as technically capable as you are in servicing consumer electronics products. This is a growing market; these folks are making great profits, and many are home-based businesses. You owe it to yourself to investigate this opportunity, especially with opportunities like HDTV on the horizon (browse www.cema.com). I spoke to several

servicers who have very successfully made this transition, but it did take a shift in what they consider "service."

Exploit The Internet

Manufacturers are committed to improving their web sites to provide more information. This includes everything from service manuals, technical bulletins, symptom causes, quick fixes, and product training, to warranty claims information. I think the bottom line here is — don't wait, get Internet savvy now, your competitors already have. Here's a tip on the Internet; many city, state, and federal government agencies list on their web site what they need for services. In my web searches for opportunities for our primary business (selling service solutions), I always come across golden opportunities for servicers, like a state agency advertising to contract out the service of their computers and monitors. You have the right to bid on these contracts, which are usually quite lucrative. Check it out (a good starting point is www.cbd.com).

Practice Customer Relationship Management (CRM)

That's a mouthful, but it sounds like common sense — everybody takes good care of their customers. . .right? It's much easier to keep an existing customer than it is to find a new one (and less expensive). Also, a satisfied customer usually remains silent while a dissatisfied customer tell his friends. How do you use this to your advantage? Establish a customer referral program — existing customers get a price break if they refer a customer to you. Provide customers with the status of repairs (don't leave them hanging). Return equipment adjusted to manufacturers' specifications to provide top performance. Send out Christmas card to your customers. (You can even put a coupon inside.) I get cards from three businesses here in Sioux Falls, and I'm a repeat customer. A final point; how are you and your employees' soft skills with customers? "The cus-

tomers is always right" is a hard pill to swallow but it can go a long way in retaining customers. A \$25 front-end loss to satisfy a customer could, instead, be a \$500 back-end loss if a dissatisfied customer never comes back, and could be even more if he tells his friends. Customer expect to be treated politely, and want their equipment repaired in a timely and professional manner.

Become Informed On New Technologies

DTV, HDTV, Home Theater. Projection TVs, etc., and be prepared to share that information with your customer. This not only makes you a valuable resource to your customers, but also leads to repeat business and opportunities for in-home installations and setups.

Join A Service Organization

Local, state, national, and participate in discussions of issues that affect all servicers. NESDA is a great place to start; they have a great web site (www.nesda.com). I particularly enjoy NESDANet, which is a nationwide pulse of what your fellow servicers are running into.

I think Bob Mesa, owner of Electra-Sound, Inc., and moderator for the manufacturers' roundtable, stated it best when he said "We don't have years anymore, we are down to months to get ready." It's going to be tough for many of you, but we are here to help and provide solutions to make you more successful, now and in the future. As you read through the articles of "Service Facts & Tips" we" show you how to be more productive, use fewer parts, service products in the home, attract new customers, and explore new, very profitable business opportunities. We'll also tell you where to get training, and how to attract technicians to work in this expanding field. When you're done and would like more information on how to get started, give one of our trained consultants a call at 1-800-SENCORE (736-2673).

Good Servicing!
Jeff Murray

Andrews Electronics

25158 Avenue Stanford
Santa Clarita, CA 91355

Phone: 800-289-0300 Fax: 800-289-0301

Website: www.andrewselectronics.com



Stocking the Largest Inventory of O.E.M. Parts, Accessories, and Service Literature in the Country

**AIWA
HITACHI
OPTONICA
QUASAR
SHARP
RCA*
PROSCAN*
GE*
TOSHIBA
SONY
JVC
PANASONIC
TECHNICS
ZENITH**

*Premier

**OVER 1/4 MILLION DIFFERENT
PARTS IN STOCK.
SHIPPED THE SAME DAY!**

- ✓ Over a 90% Fill Rate
- ✓ FREE or Discounted Freight Program
- ✓ No Minimum Orders
- ✓ Backorder Reports with ETAs Mailed Biweekly
- ✓ No Handling Charges
- ✓ Fast, Efficient Research
- ✓ Factory Authorized

We routinely ship over 90% of all orders the same day.

Phone (800) 289-0300 • Fax (800) 289-0301
25158 Avenue Stanford • Santa Clarita, CA 91355
Inquiries (661) 257-7700 Fax (661) 295-5162
E-mail us at customerservice@andrewselectronics.com
Visit us at www.andrewselectronics.com

Andrews Electronics is housed in 50,000 square feet of warehousing and office space. Miles of shelving are arranged for immediate identification and easy accessibility for over 250,000 different parts that we carry.

Maintaining an inventory of this size has been the cornerstone of our success as the O.E.M. parts distribution industry leader. It provides us with an average first pass fill rate of above 90% and makes us the largest supplier in America for the manufacturers we represent. Our fill rate is calculated on not only everything that is ordered but also on every call or fax we receive for availability, even if it isn't ordered! Our dealer order desk has 32 available sales representatives to handle all of your ordering needs.

We've built our reputation on a very simple philosophy. . . service. Not very fancy, but very effective. Our constant growth attests to it. You see, all of our policies that have been developed over the years have been based on that one simple thought: "How may we better serve the industry?" How about:

- 14 major brands to save you time, frustration, and money with "one-stop shopping."
- Orders placed before 2:30 PST are routinely shipped the same day.
- A freight program that offers free and discounted shipping.
- No minimum orders or handling charges.
- Automatic backorder reports with ETA's mailed bi-weekly.
- A fast, highly-efficient research department, second to none.
- A program that converts make/model descriptions to part numbers instantly for the majority of research requests.
- 24-hour toll-free phone and fax order lines.
- Over 100 full-time employees waiting to serve your needs.

Our already outstanding freight program has been drastically improved! The minimum qualifying amount has been cut in half and the 2 day air discount has been almost doubled! With this type of shipping program, we're a lot closer than you might think.

In case you've heard this elsewhere before, now's the time to let us prove it to you. By investing a mere two minutes of your time, you can discover what thousands of others have: that there is a difference. When you place your next order with your local supplier, check the availability of all the items. Then call or fax Andrews and check out our stock levels. We believe you'll be pleasantly surprised! Wouldn't getting those extra units repaired a week or two sooner be good for your reputation? Sure it would! And we can help! After all is said and done, it is performance that counts. We know that your ability to perform your job depends on how well we perform ours. Our regular office hours are from 8:15 to 4:45 PST and we're closed for lunch between 12:00 and 12:30. When you think of electronic parts . . . think of Andrews. ■

Circle (60) on Reply Card

Thomson Consumer Electronics

Thomson Consumer Electronics believes that you should have a choice. We realize that you rely on our genuine replacement parts not only during the required warranty period, but also when you want the highest level of quality and performance available. We also realize that not every estimate you give can be converted to a repair using original parts. That's our difference. We give you a choice!

Original Parts

RCA and GE genuine replacement parts provide today's service professional with the reliability they need when completing in-warranty repairs. And they are delivered to you by parts distributors who provide an outstanding level of service. In fact, our most recent survey of the service industry continues to show that three out of four servicers believe that no other manufacturer provided a consistently better parts fulfillment system than the Thomson Consumer Electronics' parts distributors.

Thomson Premier Distributors can fill your warranty parts orders either off their shelves on all in-stock products, or by placing a Direct Drop Shipment (DDS) order via computer directly into the TCE national parts depot. Either way, you receive the part you need to complete the repair quickly and you get the highest possible fill rate for warranty parts to service RCA, GE, and ProScan products. This computer link also allows the Premier Distributor access to all the information needed to provide you with the high level of service you require in today's fast paced business.

SK Series Universal Parts

You know that lower estimates

equal more repairs and more business for you. To help you turn more of those COD estimates into repairs, Thomson continues to broaden its line of SK Series Universal Products. These quality parts let you reduce the repair estimate by lowering your replacement parts cost, and that's good news for you!

SK Series Universal Products cover a wide range of high wear, high usage parts. Whether you need video heads, flyback transformers, video replacement parts, belts, tires, pinch rollers, laser pickups, RF modulators, exact semiconductors, servicer aids, repair kits, capacitors, resistors and more, you can look to SK Series first.

TCE Literature

Thomson also provides a number of publications which makes finding the right part for the repair even easier. Our latest SK Series Product Guide (Catalog #301) is a quick reference tool to the SK Series Universal Product line. Photographs, text, and graphic illustrations all help guide you to the right stock number very quickly and easily.

In addition to TCE service data, the "Television Components Quick Reference Guide" contains key part numbers for recent RCA, GE, and ProScan chassis. It's ideal for the technician on the road. It folds to fit in your pocket. The Quick Reference Guide also contains a section dedicated to the EPROM's associated with chassis CTC 168 through CTC 187.

And there is of course, our well-known and widely accepted OEM Remote Control book. This book is

printed once a year and no one that repairs TCE products should be without one!

These publications are available from your Authorized Thomson Parts Distributor. For the SK Series Product Guide order publication 1J1226, for the Quick Reference Guide, order publication 1J9548 and for the Remote Control Book order 1F5790.

Accessories and Components Business

The Thomson Consumer Electronics, Accessories and Components Business provides service from a 358,000 square foot facility located in Deptford, New Jersey. All business functions — customer service, sales and marketing, quality assurance, product analysis, administrative departments and warehousing — operate under one roof. Some parts are stocked in satellite warehouse facilities in El Paso, TX and Indianapolis, IN.

A full line of RCA brand Consumer Electronics Accessories is marketed from this facility as well. The business is managed by Jack Nick, Vice President. Thomson Consumer Electronics corporate headquarters is in Indianapolis.

One Call Is All You Need To Make

Whether you need original RCA and GE parts or SK Series products, your Thomson distributor is your one stop source. A single call to a Thomson Distributor gives you the choice you deserve, making your business more profitable. To locate a nearby Thomson Authorized Distributor simply call (800) 338-1900 today.

Howard W. Sams

2647 Waterfront Parkway East Drive
Indianapolis, IN 46214-2041
Phone: 800-428-SAMS
Fax: 800-552-3910

Over 50 years ago, Howard W. Sams was the first company to recognize that the increasing popularity of home entertainment electronics meant a corresponding demand for reliable service documentation. This insight gave birth to the first PHOTOFACT® which presented concise technical information to help service technicians repair specific makes and models of radios. Televisions were soon added to the product line, followed by computer equipment and then VCRs.

Today, Howard W. Sams is the nation's largest provider of after-market service data for televisions and VCRs in the form of PHOTOFACT® and VCRfacts® through subscription services, distributors, and direct order. Some 95% of after-market repair companies use Howard W. Sams technical data.

The recent introduction of E:fact®, a downloadable version of Sams' PHOTOFACT®, will take Sams into the 21st Century. E:fact® is available for all PHOTOFACT® from 1992 through current sets. E:fact® is only available at www.hwsams.com and sells for \$10.95. E:fact® is delivered to the customer's e-mail box, generally within 24 hours of ordering. Additional details along with a free sample of E:fact® can be found at www.hwsams.com.

Prompt® Publications is fast becoming one of the top technical imprints in the nation. Prompt® Publications is focused on technical books designed for both the novice and the experienced technician. Each Prompt® Publications book provides a clear understanding of the principles involved in the installation, maintenance, and performance of the electronic

devices that have become such a large part of our daily lives.

At www.hwsams.com, guests are treated to complete titles summaries for Prompt® books as well as downloadable chapters of select books and an entirely searchable version of the Annual Index. On-line response forms are provided to request free copies of the Annual Index and Prompt® Publications Book Catalog.

PHOTOFACT® and Prompt® Publications strive to produce appropriate, timely, and well-written technical documentation and books in a manner that develops long-term, loyal customer relationships. To receive more information on any of Howard W. Sams products or services, please call 800-428-7267 or visit www.hwsams.com. ■

EXPAND YOUR KNOWLEDGE

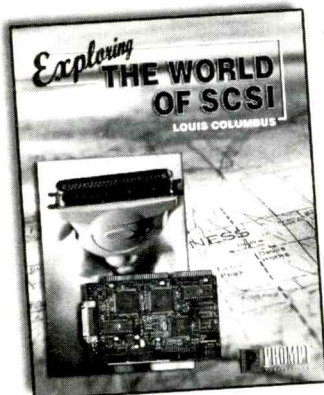

Exploring the World of SCSI by Louis Columbus

Focusing on the needs of the hobbyist, PC enthusiast, as well as system administrator, this is a comprehensive book for anyone

interested in learning the hands-on aspects of SCSI. This book offers the functionality that intermediate and advanced system users need for configuring SCSI on their systems.

Electronic Technology • 338 pgs. • 7-3/8" x 9-1/4"

ISBN 0-7906-1210-0 • Sams 61210

Price \$34.95

Howard W. Sams
1.800.428.SAMS

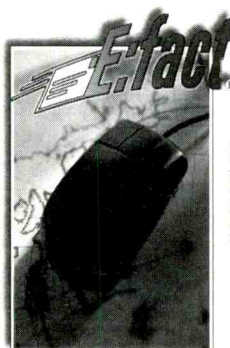

The wait is over!

Electronic Service Data from SAMS is here!

Log on to www.hwsams.com and order E:fact®! You'll have what you need in a day!*

*See Our Website For Important Restrictions and Requirement.

Each E:fact® Electronic Service Data includes the following features:

- SAMS Standard-notation schematics
- Source voltage locations
- Waveforms for important test point locations
- Detailed parts lists for major components
- Placement charts showing component location

All for only \$10.95

Available only at www.hwsams.com

Howard W. Sams
1.800.428.SAMS

Circle (7) on Reply Card

Electronic Design Specialists

4647 Appalachian Street
Boca Raton, FL 33438

Phone: 561-487-6103 • Website: www.eds-inc.com

Electronic Design Specialists makes test equipment designed to help servicing electronic technicians troubleshoot problems as quickly and accurately as possible. All test equipment is designed by David T. Miga, CET, who is both an electronic engineer and a certified electronic technician.

The EDS Corporation was started in 1986 when Dave designed a digital capacitor meter and a semiconductor analyzer to increase his own productivity as a contract technician. When other technicians saw what the EDS-52 capacitor meter and the EDS-59 semiconductor analyzer could do, Dave found himself being asked to build more of these prototypes for them. The production version of the semiconductor analyzer, the SemiAnalyzer 59C, was very successful and was sold from 1987 until 1997. Other unique test equipment followed, such as the Bus Line Tracer, the MicroAnalyzer, the LeakSeeker, and the very popular CapAnalyzer. Although designed for independent service technicians, regular users are the U.S. military, most of the Fortune 500 companies, NASA, the TV networks and cable companies, Panasonic, Pioneer and many trade schools and colleges.

Dave designs his test equipment with an entirely different perspective than most test equipment companies. All ideas start with interviewing thousands of independent service technicians for their opinion and special needs. This approach is different from conventional test equipment manufacturers, where equipment is designed by engineers that may have never picked up a soldering iron, who wouldn't be able to repair their own television, even with their own test instruments. Their idea for test equipment is to bombard the technician with numbers, to be expensive and to be difficult to use. This is overkill for a servicing technician; check out the "used test equipment" section in the classifieds of this magazine for these products.

For this reason, all EDS equipment is designed to give the technician the tools to tell whether a component is good, poor, or bad, in circuit, as accurately as possible. A technician doesn't need to know what a capacitor's dissipation factor or dielectric constant is; just is it bad, can I move on? EDS test equipment is designed by technicians for technicians, is guaranteed accurate for in-circuit tests, and is designed for easy use. Determining the quality of a component in question is done by the

test instrument, not the technician.

To design a test instrument to decide whether a component is good or bad, EDS analyzes actual defective components sent in by technicians. Calibrating the test equipment is done by comparing new, old but still working, and known defective components, then programming the test equipment to make the decision, with Dave's 30-year experience as helpful input. Every CapAnalyzer 88A is still tested with the same actual good, poor, and bad electrolytics and tantalums used to design the original prototype, before releasing it to the customer.

EDS was the first on the World Wide Web with animated demonstrations of test equipment products, and has one of the best technical assistance programs on the Internet. You can even download replacement owner's manuals and review tech tips, and get self-maintenance help for each product.

As the electronic service repair industry moves into the twenty-first century, more and more technicians will discover that to be productive, less time must be spent looking at schematics of increasingly complicated circuits. Simply checking components in the circuit with the problem, with the right test instruments, is how profitable repairs will be done by the surviving technicians of the next millennium.

EDS products are available from your distributor. For international sales contact EDS directly. Check out www.eds-inc.com for a current list of distributors. All products come with a 60-day satisfaction guarantee or money-back policy. ■

BOB SAVED THE WORLD TODAY...



Bob, Super-Tech extrodinaire, has a secret weapon.

This amazing device allowed him to locate and replace all 34 bad electrolytic capacitors in this TV in less than 30 minutes. So instead of throwing this TV into the local landfill and adding more pollution, Bob's secret weapon enabled him to give the World a brighter future. Impressed his manager and his customer too. Bob's secret weapon? The world's best in-circuit cap checker, the *CapAnalyzer 88A* by EDS.

Smart techs know that to be productive you need to find defective components quickly and accurately.

That's why General Motors, Matsushita Industrial, Sears Service, Pioneer Electronics, Panasonic Authorized Service, NASA/Kennedy Space Center, Time/Warner Communications, NBC TV and thousands more independent service technicians have chosen the *CapAnalyzer 88A* over all of the other capacitor checkers. Check www.eds-inc.com/88users.html for actual *CapAnalyzer* users' comments as they compare their *CapAnalyzer* to the "wizards" and "z-meters" they already own. They all prefer the *CapAnalyzer* because it checks electrolytic capacitors, *in-circuit*, with 100% accuracy. No unsoldering to check out-of-circuit, no mistaking a shorted or leaky cap as good, as other "ESR" meters do, no guessing about whether a value is good or bad. With our exclusive three-color comparison chart right on the front panel, auto-discharge, multi-beep alert, and one-handed tweezer test probe, even your pet monkey could find defective caps in that problem PWM power supply, TV, monitor or VCR in a few seconds.

...NOW IT'S YOUR TURN.

So get your own *CapAnalyzer 88A*. It's only \$179. With our exclusive 60-day satisfaction-or-money-back guarantee, you risk nothing. Prepare to be amazed: your only problem will be running out of work as you take care of all of those "dogs" that you've been sitting on. We're **Electronic Design Specialists**. We make test equipment designed to make you money.

Available at your distributor now, or call 561-487-6103.

Check out www.eds-inc.com for all of the details.

B&D Enterprises

P.O. Box 460
Main & Liberty St.
Russell, PA 16345
Phone: 800-458-6053
Fax: 814-757-5400
E-mail: sales@bdent.com
Website: www.bdent.com

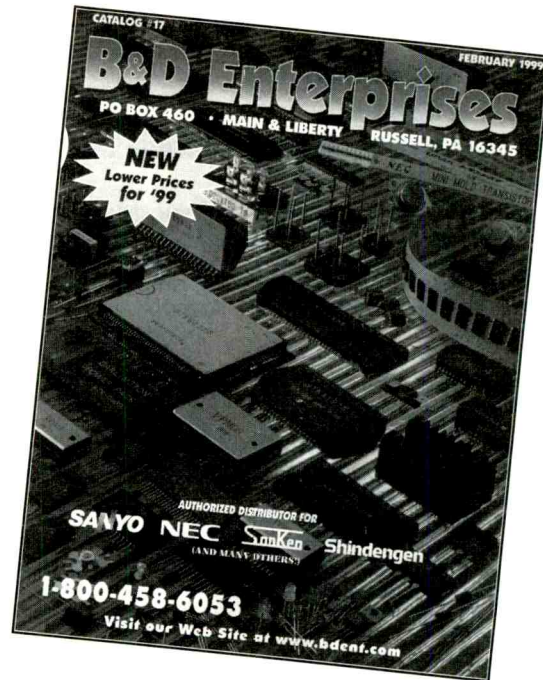

B&D Enterprises is your *Semiconductor* specialist. Filling your semiconductor requirement is our #1 priority. Our objective is to meet the consumer and industrial repair market's demand for a price competitive, well-stocked, highly knowledgeable, factory authorized distributor.

JAPANESE SEMICONDUCTORS

B&D Enterprises stocks more than 15,000 line items. Specializing in Japanese semiconductors, we can help you solve your component problems.

Since 1976, B&D Enterprises and their parent company have been entrusted by the manufacturers to be the authorized distributor in the United States. Companies such as Sanyo Semiconductor, Sanken Electric, Shindengen America, and NEC Electronics trust us to handle the ever-growing need for a dependable, customer service oriented stocking distributor. At B&D, you'll find 23+ years of accumulated product knowledge and factory direct supported sales.

We also carry an extensive inventory of hard-to-find and discontinued products, as well as many components made by non-Japanese manufacturers.

PRODUCT KNOWLEDGE

Our sales staff is technically trained. To service the OEM customers, we have to be. We have the largest library of semiconductor manuals in the market available to support our sales. Hundreds of part cross references are in our database. We back what we say. When we offer a cross, we know it's right and can send you the specifications to prove it. Feel free to talk to our Engineering/Technical Support office at 814-757-8300.

PRODUCT RELIABILITY

As a factory authorized distributor, we only sell original quality manufactured parts. NO "rebrands," NO "off-brand" imi-

tation manufactures, just original components. We feel that our customers deserve a part that works, not one that's close.

CONVENIENCE

To better serve our customers we offer them the WEBSITE — at www.bdent.com you will find our ENTIRE INVENTORY for you to view. 24 hrs a day, 7 days a week, you can check prices, request quotes, and place orders on a secure server. We update our site DAILY with new parts and prices.

Go factory direct with B&D and get the price you need with the factory authorized service you deserve!

Call today for our FREE 1999 CATALOG and see what a difference we can make! Selling a lot of things doesn't make us better, just diversified. At B&D, we do one thing, and we do it right! ■

B&K Precision

1031 Segovia Circle
 Placentia, CA 92870
 Phone: 714-237-9220
 Fax: 714-237-9214
 Website: www.bkprecision.com

For over 50 years, B&K Precision Corporation has developed a reputation for excellence in the design and manufacture of high-quality, reliable, and cost-effective test and measurement products. The company's products are used in a wide range of applications including engineering, research and development, production line testing, industrial maintenance and repair, electronic field service, and education.

B&K Precision is the only U.S. manufacturer with a complete selection of general instrumentation products from AC and DC power supplies to a quality line of hand-held and bench-top multimeters at the most competitive price points in the market. Other products include high performance spectrum analyzers, function and signal generators, oscilloscopes and EPROM programmers, probes and testers, multifunction counters, and a full line of accessories.

B&K Precision is committed to continuing the support of their core distribution business with excellent price/performance test equipment, but they are also actively developing new, more sophisticated products to meet the changing demands for test instrumentation. These new products will enable the company to offer a wider range of test products over a broader market segment than ever before. With the on-going expansion of the product line, the company is poised to be one of the leading suppliers of multimeters, function generators, oscilloscopes, power supplies, device programmers, counters, and test accessories in the world.

Recognized for their price-performance value, ease of use, measurement accuracy and application flexibility, B&K Precision Corporation products are available worldwide through a global network of authorized distributors.

For further information, contact B&K Precision Corporation, 1031 Segovia Circle, Placentia, CA 92870, (714) 237-9220, Fax: (714) 237-9214, Website: WWW.bkprecision.com

Universal Cable Tester

Test just about any cable or harness in fractions of a second.

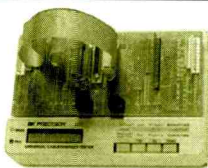

PC Cable Tester

Tests most PC data cables and network cables, such as printer, monitor, modem, mouse.

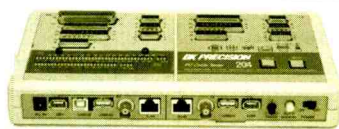

IC Tester

Tests hot chips like TTL, CMOS, & LSI



Universal Device Programmer

Programs EPROM chips for HDTB, CDMA or GSM.



Arb Generator

Creates waves point by point like nobody else.

So, notice anything different?



It's our **new look** for the millennium...
 But with the same **quality and reliability**
 you've trusted for the past **50 years**. We'll be
 celebrating our 50th birthday in 2000...so watch for
 many more new products in the coming months.

Ask for our new 2000 Product Catalog...
 It's hot off the presses and it's free.

BK PRECISION®

1031 Segovia Circle, Placentia, CA 92870
 (714) 237-9220 Fax: (714) 237-9214
bkprecision.com

Products

Contact cleaner/enhancer

R5 Power Booster from Caig Laboratories is an electrical contact cleaner/enhancer formulated to improve the flow of electricity on metal surfaces. The product contains active ingredi-

ents that dissolve contamination on the metal surfaces, fill in the minute gaps in the metal surfaces and provide long lasting protection from future contamination, according to the manufacturer. The chemical is offered in many convenient applicators: pump spray, aerosol spray, precision dispenser, and bulk containers. It is useful on switches, batteries, speaker terminals, outdoor lighting, car/trucks/boats, car stereos, musical instruments, model car/train tracks (communicators, brushes), connectors, plugs and sockets, edge connectors, terminal strips, interconnecting cables — anywhere metal conducts electricity.



Caig Laboratories, 12200 Thatcher Court, Poway, CA 92064,

Phone: 800-224-4123, Website: www.caig.com, E-mail: caig123@aol.com

Circle (100) on Reply Card

DVD test disc

Adjust your audio, video and computer equipment with the DVD test disc from Electronix. Use your DVD player along with this economical test disc to output video test patterns, including full/split color bars, grey staircase, various color rasters, and more. Full spectrum audio test tones accompany each pattern, including 20 to 20K sweeps, white noise, silence, and more. Patterns run continuously from the menu driven interface.

Electronix Corporation, 1 Herald Square, Fairborn, OH 45324-5155,

Phone: 937-878-1828, Fax: 937-878-1972, E-mail: sales@electronix.com,

Website: www.electronix.com

Circle (101) on Reply Card

Soldering device

PDR XYtronic's 710 SolderLight incorporates Infrared (IR) technology into a handheld soldering/desoldering tool for use on BGA's, QFP's, PLCC's, SOIC's, SMD's, SMT Sockets, and connectors. Double and single-sided PCB's can be soldered/desoldered. The IR method eliminates hot air/gas adjacent component movement and damage that can result from conventional contact rework methods. The Topheat IR power is 150W; backheater IR

power is 500W. The 710 SolderLight is the bridge between a hand soldering tool and high end SMT rework systems.

PDR XYtronic, 6320 Belleau Wood Lane, Suite 3, Sacramento, CA 95822,

Phone: 877-700-6085, Fax: 916-395-5596, E-mail: sales@pdrxy.com,

Website: www.smtrework.com

Circle (102) on Reply Card

Portable NTSC generator

BK Precision announces the new Model 1257 handheld NTSC generator. The lightweight, portable, battery-powered generator provides a convenient S-Video mini-DIN output port for connection to the latest large-screen TVs, as well as composite video and audio outputs. It's small size makes the model 1257 useful for the field or service bench.

The Model 1257's video pattern generator capabilities include: color bars; white, yellow, cyan, green, magenta, red, blue, and black; crosshatch; 15 vertical x 11 horizontal white lines on black raster; dot; 15 vertical x 11 horizontal white dots on black raster; staircase; linear staircase with 5 equal steps from black to white; circle; circle with 1 x 1 crosshatch; raster; white, red, green, blue, yellow, cyan, magenta, black; window: white window on black background; center cross; centering box on screen.

Powered by one 9V battery or common AC adapter (optional), the generator offers both interlaced and progressive scanning, composite video output of 1.2V pp into 75Ω and luminance plus sync output of 1V pp into 75Ω and audio sound of 1Khz audio tone.

BK Precision, 1031 Segovia Circle, Placentia, CA 92879-7137,

Phone: 714-237-9220, Fax: 714-237-9214, Website: www.bkprecision.com

Circle (103) on Reply Card

Lubricants and penetrants

LPS Laboratories offers lubricants and penetrants for all industrial applications.

The lubricants are specially formulated and tested to solve specific problems encountered by end users. The family of lubricants includes both wet and dry lubricants with advanced formulations and additives to tackle the most demanding require-



ments of industrial applications. Products offer special properties such as non-flammability or high temperature/pressure capabilities or special additives such as Teflon.

LPS Laboratories, Inc., P.O. Box 105052,

4647 High Howell Road, Tucker, GA 30085-5052,

Phone: 800-241-8334, Fax: 800-543-1563, Website: www.lpslabs.com

Circle (104) on Reply Card

Aqueous cleaning solution

JNJ Industries' new AquaSonic™ cleaners are non-toxic, non-hazardous, non-flammable, and non-corrosive. Unlike harsh, strong smelling, toxic solvents, these aqueous cleaners consist of three individually formulated water based concentrated cleaners, all water-soluble and water-rinsable, that have almost no odor at all.

The cleaners have been developed to remove a variety of soils including solder paste and flux, epoxy and adhesives, and for degreasing metal and plastic parts. Each chemistry has been formulated for a specific application, but their secret is that they utilize an "electro-chemistry" technology to clean by lowering the surface tension between the substrate and the contaminant.

JNJ Industries, Inc., 195 East Main Street, Suite 303, Milford, MA 01757, Phone: 800-554-9994, Fax: 508-478-5290, Website: www.jnj-industries.com

Circle (106) on Reply Card

Handheld oscilloscopes

Fluke Corporation announces the ScopeMeter 190 Series handheld, battery-powered oscilloscopes. The new series is designed to meet the needs of service professionals and electronic engineers involved in system integration of engineering, installation and second-line service, and who need high performance oscilloscopes that are easy to carry, have fast troubleshooting capabilities and allow for detailed analysis.

Specifications include up to 200 MHz bandwidth and a 2.5 GS/s real-time sampling using separate digitizers on both isolated inputs. In addition, the series has a memory of 27,500 points per input for long, high-resolution recording. This continuous roll mode store signals for up to 30 hours while still capturing past intermittents and glitches as fast as 50 nsec.



The products run four hours on a single battery load and without the need for forced draft cooling, it is possible to put it in a sealed, dust and drip proof case.

The unit features the Connect-and-View automatic triggering which provides a stable

and accurate display of virtually any signal whatever the signal complexity or dynamics, without the need for setting up the instrument. Besides advanced automatic triggering, the series offers various manual triggering modes such as edge, pulse width, video (line count and field select), delay, and external triggering. This gives the user the trigger power to capture virtually any signal.

The oscilloscope offers the ability to look at "missed" signals at the touch of the replay button. In normal mode, the instrument continuously memorizes the last 100 screens. At any moment, these 100 screens can be frozen and scrolled through picture by picture or replayed continuously as a "live" animation. With the advanced trigger capabilities, the same feature automatically captures up to 100 predefined intermittent glitches and signal anomalies in a sort of "baby-sit" mode.

Fluke Corporation, P.O. Box 9090, Everett, WA 98206, Phone: 888-492-7541, Fax: 425-356-5116, E-mail: fluke-info@tc.fluke.com, Website: http://www.fluke.com

Circle (107) on Reply Card

Multimeter

BK Precision announced the Model 2408 Mini-Pro® DMM. The lightweight, portable digital multimeter also features a non-contact voltage indicator, making it a "two-in-one" tool for use by field service technicians, and in educational, plant and maintenance applications.

The non-contact voltage indicator, which measures ac voltages from 70V to 480V @ 50-60 Hz, provides both an audible "buzz" and a flashing indicator light when placed in close proximity to an ac power source. Other features include measurement of Volts to 600V and current to 10A, resistance to 20MΩ, as well as diode test, continuity test, data hold and max hold, a 2000 count LCD, low battery indicator and auto zeroing.



B&K Precision Corporation, 1031 Segovia Circle, Placentia, CA 92870-7137, Phone: 714-237-9220, Fax: 714-237-9214, Website: www.bkprecision.com

Circle (105) on Reply Card

Zenith L-Line power supply

by Steven J. Babbert

A recent article outlined the operation of the TV power supply. The low-voltage, high-voltage, and secondary or scan-derived supplies were covered, as were start-up and shut-down systems. This follow-up will look at an actual power supply used in a Zenith Model S1907S (Figure 1).

In this circuit, the ac voltage supplied to the bridge rectifier passes through relay RY3400. This relay is controlled by driver transistor Q3401 via predriver Q6016. A high on the power control line causes the transistor to conduct, providing a current path to ground for the relay coil. The predriver is controlled by the syscon, which we will discuss shortly.

The LV (low-voltage) regulator in this chassis is IC3400, an STR30130 linear regulator. This five-terminal device requires just a few external components to function. The 158V raw dc from the bridge rectifier is applied to pin 3 via RX3430, a 5.6Ω, 5W resistor. The 130V regulated output is available at pin 4 where it is routed to the horizontal output transistor, Q3200, via the primary winding of the IHVT, TX3200. This voltage is also applied to horizontal driver Q3201 via the primary of T3201.

In this particular system, HOR V_{CC} for start-up is also derived from the LV regulator. The 130V B+ is passed through dropping resistor R3422 and then shunt regulated to 9V by Zener diode CR2296 (Figure 2). After filtering, it is applied to pin 26 of the main processor ICX1200. This is known as the trickle start system. If the LV output is up, the chassis should start as long as ICX1200 is generating drive pulses and the horizontal driver and output sections are okay.

Standby supply

The Achilles' heel of this start-up system is the standby supply (refer again to Figure 1). Pin 6 of line filter TX3400

feeds ac to the relay. It also feeds ac to standby rectifier CR3401. The half-wave output is dropped by 10W resistor R3402 and filtered by C3401 resulting in a dc voltage of about 13V. Commutating diode CR3404 passes current to the high side of the relay coil.

In addition to powering the relay coil at start-up, the standby supply is required to keep the syscon and remote sensor alive when the chassis is off. A connection to the 12V standby supply is made by R3404, which is a dropping resistor for shunt regulator CR3414. This 5.1V Zener diode maintains a stable 5V supply for the syscon, IC6000, at pin 42.

The 5V standby supply is also applied to the collector of the relay predriver transistor, Q6016 (Figure 3). This transistor is configured as an emitter follower (no phase inversion). When syscon power control pin 35 goes high, Q6016 conducts, causing the emitter voltage to go high owing to the drop across the emitter resistor. A high at the emitter of Q6016 turns on relay driver Q3401, discussed earlier.

The standby supply is only required to keep the relay energized long enough for the secondary supply to take over. It was designed to do nothing more. When the relay energizes, charge is drained from C3401 faster than it is being restored by R3402. If the secondary supply does not take over, the standby voltage will begin to drop.

As the standby voltage drops, so does supply voltage for the syscon and the syscon reset trigger, Q6020 (Figure 4). Once it drops to about 4V, the syscon will remove drive from the relay driver. When the relay drops out, the standby voltage will begin to rise and the syscon will energize the relay once again. The process will repeat resulting in a "tic-tic" noise that will continue until the set is switched off. Note: "tic-tic" noises aren't only caused by relays. IHVTs and switching transformers can emit a similar noise when startup problems exist in certain chassis.

Power from the secondary supply is applied to the high side of the relay coil via commutating diode CRX3425. This voltage is derived from the IHVT at pin 6. The commutating diodes prevent current from passing between the secondary and standby supplies. As long as the secondary supply rises before C3401 discharges, the chassis will continue to run after start-up. Secondary power from this source is also applied to pin 26 (HOR V_{CC}) of ICX1200 via commutating diode CR3413 and R3427. Zener diode CR2206 clamps the voltage to 9.1V (refer again to Figure 2).

Standby regulator

The standby supply is regulated by Q3400. Zener diode CR3403 and current limiting resistor R3403 are in series with emitter-base junction of the transistor. The combined voltage drops of the Zener and the e-b junction is about 12.6V. The drop across the resistor is very small and depends on the degree of regulation needed at any given time.

The resistor's value is selected so that as long as the collector voltage doesn't rise much above 12.6V, the Zener will not conduct appreciably and the transistor will be in cutoff. As the voltage rises above 12.6V, the Zener will breakover and begin to bias the transistor on. The transistor will then conduct, thereby presenting a low resistance path to ground and lowering the regulated voltage. In actual use, Q3400 will conduct just enough to keep the voltage in check.

Dc-to-dc converter

Certain models of the L-line series use a dc-to-dc converter, allowing operation from a 12V source. The S1907S does not include this module, but it will be covered since it is used in other models having the same main board. When it is used, it is connected by a five-line ribbon cable.

The dc-to-dc converter isn't much different than a conventional switching power supply. The main difference is

Babbert is an independent consumer electronics servicing technician.

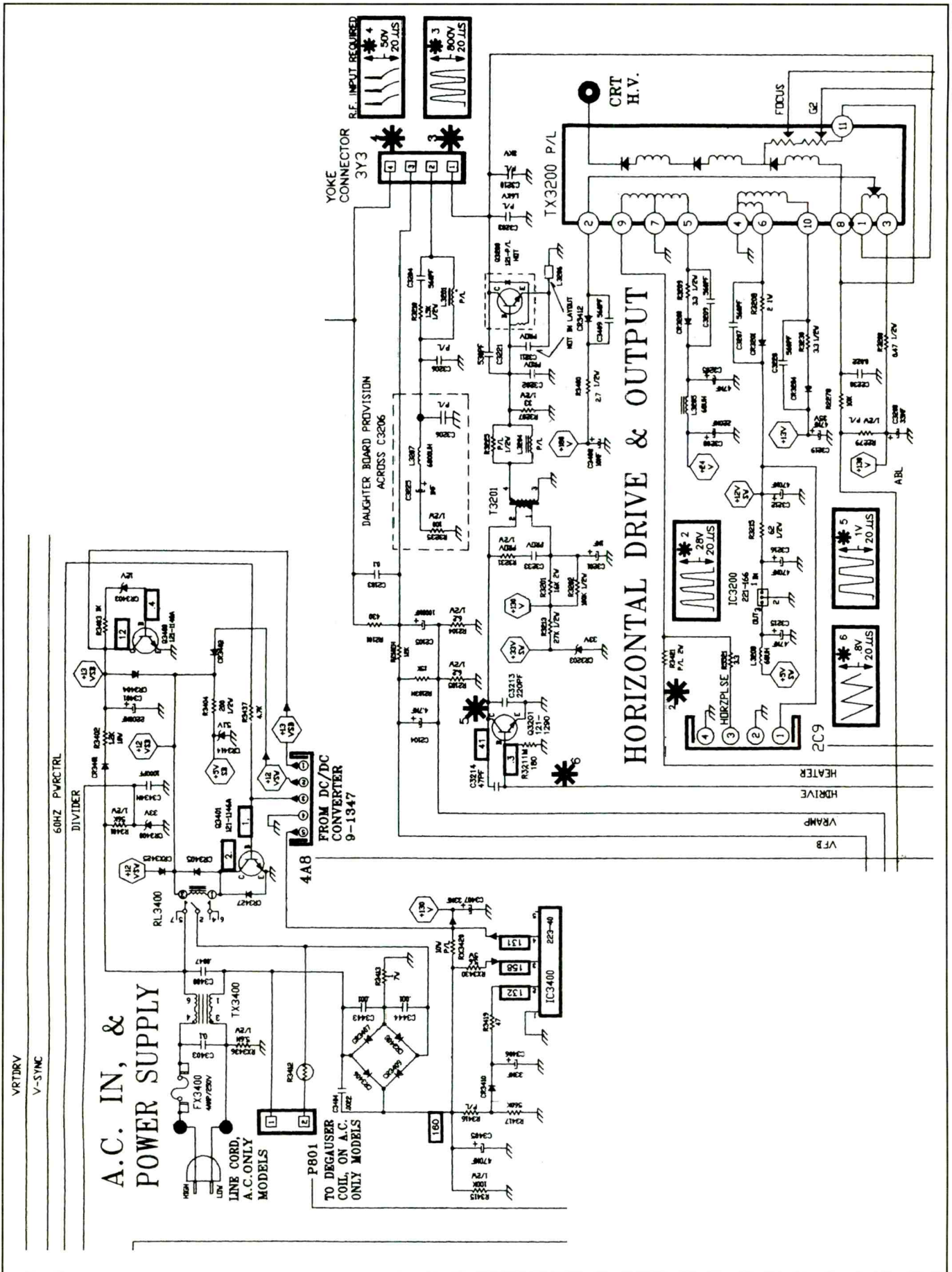

Figure 1. The main or "primary" power supply, as well as the horizontal output section and its associated scan-derived or "secondary" supply.

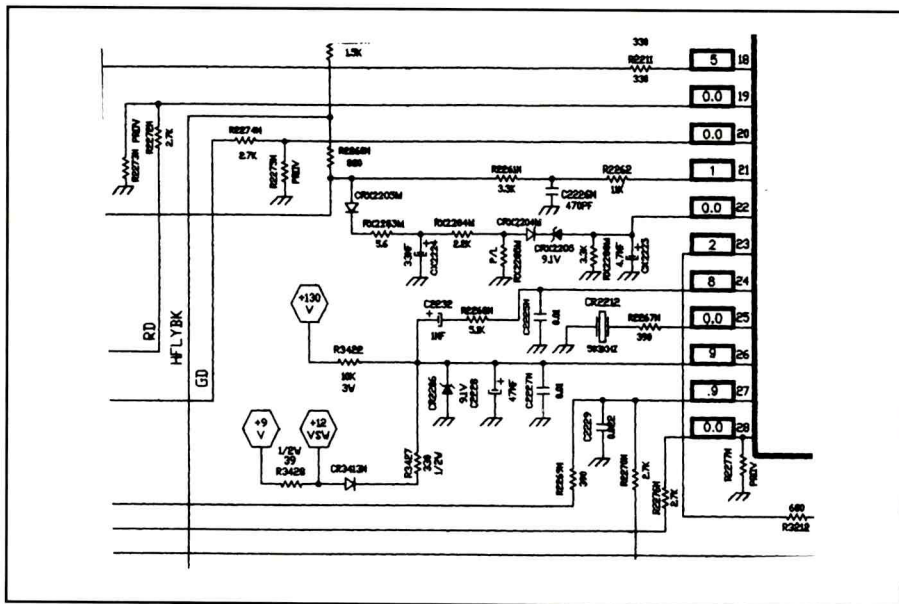

Figure 2. Various connections between the power supply and the HOR V_{cc} supply input of the main signal processor ICX1200.

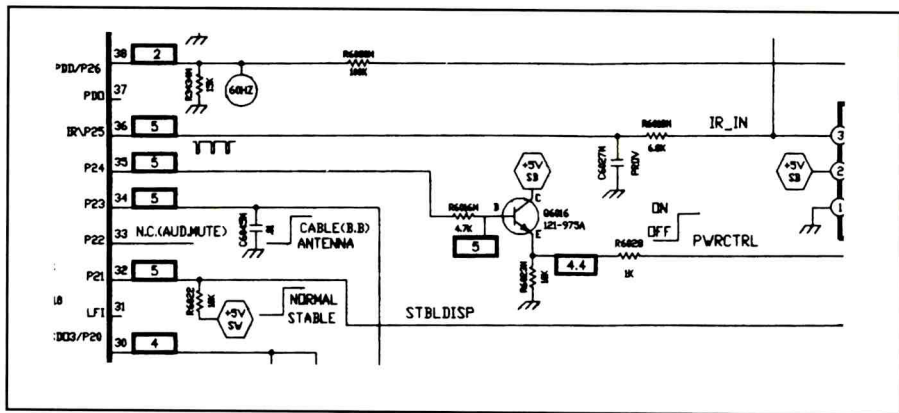

Figure 3. This is the relay predriver which is controlled by the SYSCON.

that it uses a lower input voltage and a higher current. The heart of this converter is IC3400, a switchmode PWM controller (Figure 5).

The PWM drive signal exiting pin 8 is routed to the base of switch driver QX3402. Its emitter is tied to the gate of MOSFET switch QX3406. The PNP transistor is turned off by a positive pulse on its base allowing the emitter to float high. The positive drive pulse from the IC also passes through CR3402 to the emitter of QX3402 and to the gate of the MOSFET. The positive pulse turns the MOSFET on. When the drive pulse goes low, the transistor conducts, grounding the MOSFET's gate. This ensures a hard turn-off and a high amplitude pulse in the primary of TX3401. The high side of the primary is held at 12V.

The frequency of the controller IC is set by the values of C3404 and R3404 at pins 5 and 6 respectively. V_{cc} is applied to pins 9 and 10. Feedback for monitoring the output voltage of the supply is applied to pin 1. Changes in the output voltage due to loading cause the PWM block to make corrective changes in the duty cycle of the output waveform.

The controller is turned on by QX3403, which gets its control signal from the power control line via connector pin 3. When this transistor is turned on, pin 4 of IC3400 is pulled low. This causes IC3400 to produce drive pulses.

Switch QX3404 is situated so that it can override the on/off power control line from the main board. If QX3404 is turned on, the base of QX3403 will be pulled low which will shutdown the

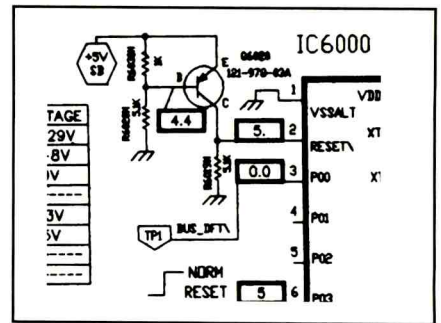

Figure 4. This is the transistor that helps to shape the reset pulse when the chassis is plugged in.

power supply. QX3404 is not being used in this chassis (its base is tied to ground via connector pin 4 so that it will not turn on.) In other chassis, pin 4 may be used as part of a fail-safe system.

When the dc-to-dc converter is being used, the 12V battery itself is being used for standby power and is fed to the main board through connector pin 1. The 130V regulated B+ is developed by the secondary winding of TX3402 and halfwave rectifier CR3401. It is applied to the main board through pin 5.

Since there is no 120Vac in the main power supply when the dc-to-dc converter is used, it is impossible to use a conventional degaussing circuit, which relies on an alternating magnetic field that gradually decays to zero. In this case, the degaussing coil is connected to the converter board via connector P801A. Pulsating dc from CR3403 is applied to the coil via C3410. The net effect is the same as that caused by ac.

SCR QX3407 is normally off. Its gate is controlled by transistor QX3406. This PNP transistor is normally off. The scan-derived 12V source is connected to its emitter. When the chassis is switched on, the degaussing coil receives a pulsating waveform. A voltage of 12V from the secondary supply enters the converter board at pin 2. As the 12V secondary supply begins to build, C3415 in the emitter circuit of QX3406 begins to charge, which gradually turns on QX3406. This in turn causes the gate of Q3407 to become more positive.

The SCR will be turned on by a positive pulse on its anode if the gate voltage is sufficiently positive. The exact point at which the SCR turns on during any pulse cycle is dependent on the gate

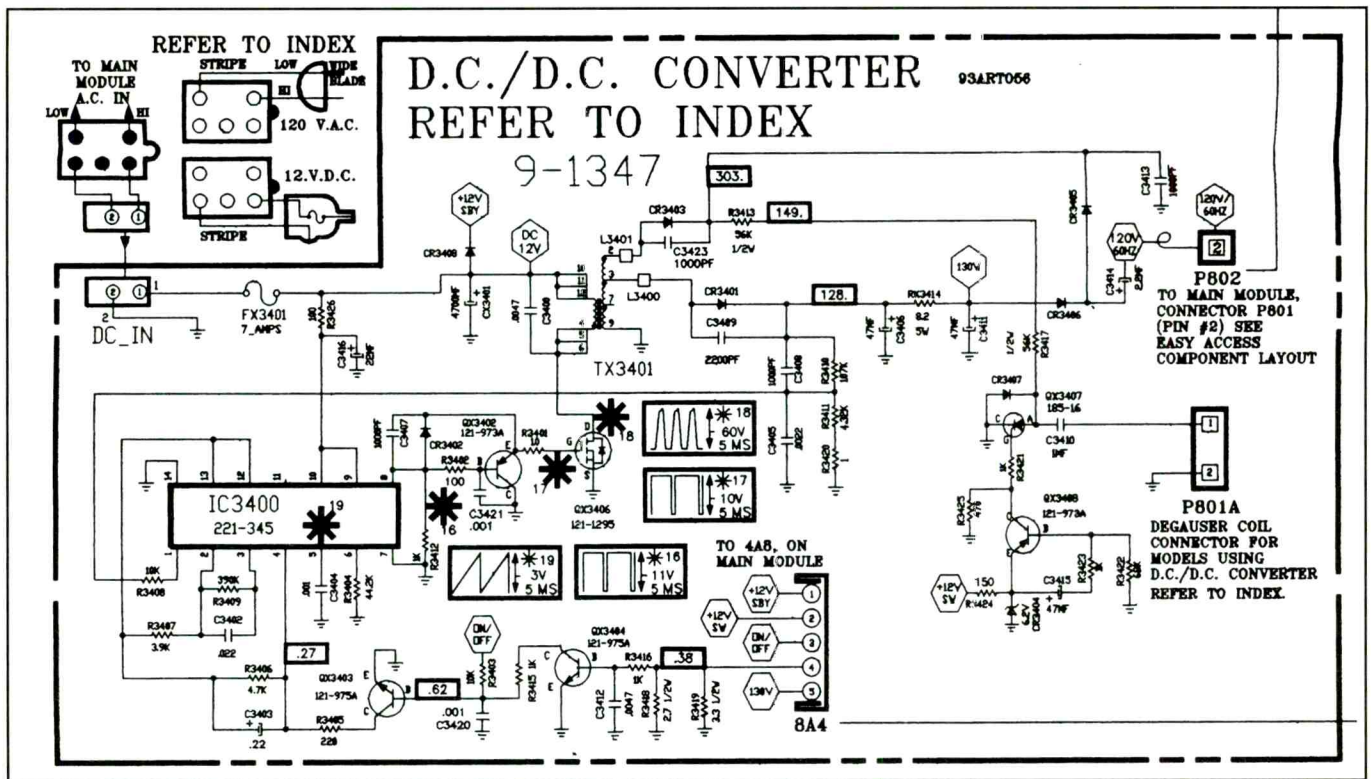

Figure 5. This dc-to-dc converter is used in some models. The unusual degaussing circuit generates a decaying ac waveform from a dc voltage.

voltage. The SCR will always turn off when the pulse drops to zero.

Since the gate voltage rises gradually after the set is switched on, the SCR will turn on a little sooner during each subsequent pulse until the point is reached where the SCR will turn on at the beginning of the pulse. When the SCR is on, the degaussing pulse is shunted to ground. The overall effect is that the pulses coupled to the degaussing coil will start out strong and gradually decay to zero, creating the decaying field required for demagnetization.

High-voltage shutdown

The high-voltage shutdown or x-ray protect circuit used in this chassis is a very simple design that is widely used by many manufacturers (refer again to figure 2). The heater voltage for the CRT comes from pin 9 of the IHVT, TX3200. A sample of this voltage is rectified by CRX2203M and filtered by CX2224. The resulting dc voltage is then applied to Zener diode CRX2205 via CRX2204M. If the heater voltage rises above normal due to an increase in high voltage, the Zener will conduct, raising the voltage at pin 22 of the main

signal processor and disabling the horizontal drive.

Troubleshooting

A tic-tic symptom in this chassis indicates that the 12V "run" supply is not taking over after the relay is energized by the standby supply. This means that the supply is either not coming up at all or possibly it is just not coming up enough. A good first step would be to determine which is the case.

Measuring the voltage at the anode of the commutating diode CR3425 may help you to isolate the problem. Since this diode will block current from the standby supply, any voltage that you measure will be from half-wave rectifier CR3201 in the scan-derived supply (TX3200 pin 6). Of course, this voltage will rise and fall as the relay cycles if there is any secondary voltage at all. A measurement of 0V indicates that the horizontal output section is not running at all, or possibly current limiting resistor R3208 at pin 6 of TX3200 is open. A measurement of insufficient voltage may indicate loading from another circuit powered by the 12V supply or loading of another scan derived supply.

Loading of any secondary supply will

affect all secondary supplies. If there is any doubt, scope pin 6 for the characteristic HOT pulse. The amplitude is much lower than that found directly at the collector of the HOT, so no special methods are required. If pulses appear each time the relay closes, then you have verified that the horizontal output section is basically operational.

If you suspect that loading is the problem, check for low resistance paths to ground at the outputs of each scan rectifier. Remember that secondary windings are often tied to ground on one side. Note that the 12V scan supply provides power for almost the entire signal processor section, which requires 9V. This voltage is developed across a 9V Zener diode (not shown). Any problems in this section can load the supply.

If you determine that the horizontal output section is not running at all, troubleshoot as you normally would. The circuit is conventional. Check for B+ at the HOT and driver transistor. Remember that the voltages will disappear each time the relay opens. If the voltages are missing everywhere (excluding standby), check the low voltage regulator and RX3430 which feeds raw dc from the bridge rectifier.

Don't overlook the possibility that the relay itself is failing to make a solid connection.

Taking measurements while the relay cycles on and off will help you to pinpoint the trouble, though it may also lead to frustration since the readings will be erratic. If this method becomes too troublesome, temporarily bypass the relay contacts with a jumper and use a Variac to run the chassis at a reduced voltage. Start at about 70Vac and work your way up while monitoring the voltage at the output of the bridge rectifier. Do not allow this voltage to rise above 130V.

If you suspect that the chassis is in shutdown due to excessive high voltage, disconnect one leg of the Zener diode in the x-ray protect circuit and follow the procedure outlined above with a Variac. If operation is restored, check for problems with the low-voltage regulator such as a shorted pass transistor. If the regulator is regulating properly, then the problem must be in the horizontal output section. Check the "holddown" capacitor, C3203, in the collector circuit of the HOT.

If you can get the set to run, then there is a good chance that there will be a noticeable symptom that will indicate the source of the problem. No vertical scan, for example, would probably indicate that the vertical output section is loading the supply. Running the set for very long under this condition may result in a blown fuse or fusible resistor. It is advisable to run the set for the shortest possible period while making any measurements if you suspect an overload exists. If the problem is not due to an overload, then nothing in the chassis will be stressed. Bypassing the relay contacts will make it simple to trace the B+.

In some later runs of this chassis, the value of R3402 has been changed from 1.2K to 680Ω. This "stiffens" the standby supply to the point that the relay will not drop out if the secondary supply fails to take over. You may replace R3402 with a 10W, 680Ω unit during troubleshooting to eliminate relay cycling; however, it is a good idea to restore the circuit to its original condition once you have repaired the chassis. The chassis uses about half the power in the standby mode with the 1.2K resistor. ■

Coming next month

The May issue will feature an article by John Ross on the subject of IEEE Standard 1394, also known as "firewire." If you haven't heard of this technology before, you will. It is a high-speed/high-volume digital/power bus that allows viewers/listeners to connect audio/video components in daisy-chain fashion and send an all digital signal from the receiver to the monitor/speakers. This new technology will require some adjustments in the thought process of technicians servicing these systems.

Also featured will be camcorder servicing. These compact devices are a challenge to service, but a familiarity with the vocabulary, and awareness of computer-based adjustments can help.

An article on service tips software will describe the wealth of service tips information available in the form of computer-based service tips software.

In addition, in next month's issue we will publish our annual Tools & Toolcases Showcase, a special advertising supplement that invites vendors of tools and toolcases to publish details on the products they offer, and the type and level of service their customers can expect from them.

Photofacts

GE	RCA	SCC-K96R-A	4280
CTC185AB	CTC187AJ	SCC-K97N-A	4280
CTC185AB2	E13201BKC04	SCC-N28C-A	4280
CTC185AB3	E13201BKF04	SCC-S25B-A	4277
25GT516TX1	F25675BCYX1	SCC-S25F-A	4277
25GT518TX1	F27676BCYX1	SCC-S27E-A	4284
27GT616TX1	F27678BCFE1	SCC-S27F-A	4284
27GT619SX1	F27678BCYX1		
27GT619TX1	TX825TB	TOSHIBA	
27GT624TX1		CE32T11	4279
	SANYO	CN27H95	4276
JVC	DS25530	CZ32V51	4279
AV-27015	25530-00	TAC9814	4276
AV-27020	25530-01	TAC9910	4279
	25530-02		
PANASONIC	SONY	ZENITH	
PV-4514	KV-13M52	B27A24Z	4274
PV-4562	KV-13M53	IQB27B42W	4282
PV-4564	KV-21ME42	IQB36B42W	4282
	KV-21ME42C	IQB36B86R	4282
PHILIPS MAGNAVOX	KV-27V22	LGB29A24ZM	4274
19PR19C122	KV-29V22T		
19PR19C125			

Service management software

by the ES&T Staff

If your company still doesn't have a computer to help in the day to day administrative activities of the service center, it should. If you're not using some kind of service center management computer software to help operate your business, you should be.

For starters, the economics of such a choice are obvious. For less than \$1,000 these days, a small business can purchase all the computing power it will ever need. For a few hundred to around a thousand more, depending on the sophistication of the package, a service center can purchase a powerful service management software package capable of handling and automating all of the business's transactions.

But there are other good reasons to have a computer, or several, for a small business. Some manufacturers these days have either ceased, or will cease, offering paper service literature, and will offer it on CD-ROM or on-line. Many manufacturers require that warranty claims be filed electronically. Moreover,

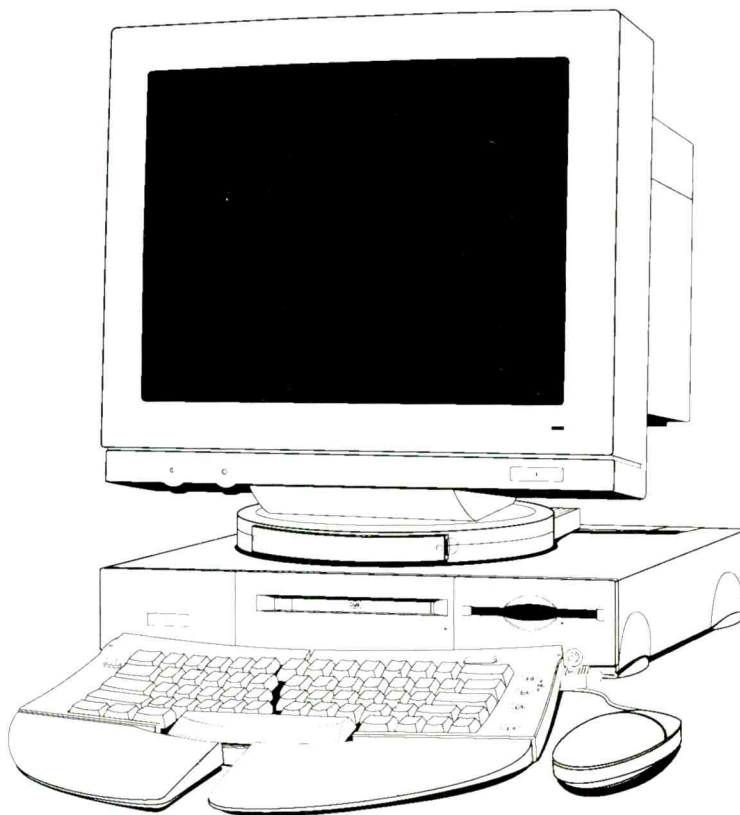

tons of useful information is available on the Internet day or night.

Benefits of using a computer in business

To state the obvious, there are few things that a service center can do with a computer that can't be done manually. You can make out customer claim checks, service orders, invoices, purchase orders, and all of the other paperwork associated with a service center manually. You can file all of those documents manually. You can call the manufacturer or distributor to find out price and availability of parts or other needed products for the service center.

Moreover, you can even do data analysis using paper records, some paper, a pencil, and maybe a calculator. For example, if you want to determine what portion of your total customer base is in a given area code so you can decide where

to concentrate your prospecting for new clients, you can search through those records, note the pertinent information, and calculate totals, percentages, etc.

When it comes time to send out invoices, letters of appreciation, and other paperwork, you can type them up on the old Smith-Corona.

But all of those activities take time. And if you find yourself in the situation that so many business people do today, of not having enough time to get things done no matter how many hours you devote to it, a personal computer can help immensely. And these days, with consumer electronics products becoming less expensive, and needing fewer repairs, service center managers need all the timesaving help they can get so they can devote more time to studying alternative business, prospecting for new business, creating new advertising and promotional brochures, and more.

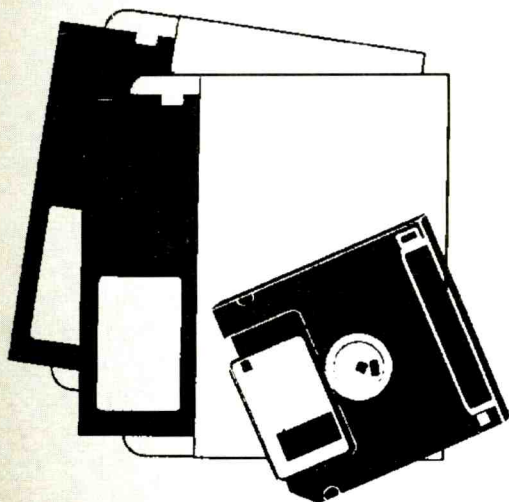

There used to be a downside to all this. When computers were new to business, there was a considerable learning curve to using just about any software. Today, graphic user interfaces and intuitive software have shortened the learning process to the point that it's almost as easy as plugging the computer in, turning it on, and getting started.

Service management software

So what is service management software all about? For those of you still without a computer in your business, and this is who this article is aimed at mostly, service management software is a computer program, or group of related programs, that allow you to handle all of the paperwork you now do, only to do it on the computer.

Let's take a look at a typical repair procedure, and the documentation that accompanies it:

- When the client brings in a TV, VCR, monitor, or personal computer, the front desk person enters the name, address, telephone number, and other data, including a description of the nature of the problem in the customer data form. It may be a multipart form. Various copies go various places, including one copy to the customer as a claim check.

- A job ticket is made out that will accompany the product through the service center.

- Once a diagnosis has been made, an order will be written for any parts, etc., that need to be replaced.

- On completion of the repair, an invoice will be prepared, or if the product is under warranty, the warranty claim form will be filled out and filed.

That's just a general idea of the paperwork process that follows a product through the repair process. Various service centers will use different procedures. Other efforts that will have to be expended in conjunction with this repair includes posting the payment to the financial books, annotating the records of the technician who performed the repair, and possibly other paperwork.

Automation saves time and effort

If the service center has a computer with a good service management software package installed, all of this effort

is streamlined. When the customer comes in, the front desk person asks for a phone number. If the customer is a repeat customer, when the phone number is entered, the name and address, and other pertinent information on that client comes up on the screen. The attendant asks if the client still lives at the current address, and if everything is current, creates a blank duplicate of the existing customer data form.

The attendant then enters the information about the product to be serviced, including manufacturer, model, type of product, and nature of problem. Then a claim check for the customer and a job sheet for the technician are printed out.

If the technicians in the service center are also provided with computers, then any activity they perform on the computer, such as preliminary evaluation, ordering of parts, or repair completion, can be entered into the system. Then any time the customer calls in for an update of the status of the repair, the desk person can simply key in the phone number, or other ID, and determine instantaneously what the status of the repair is.

Parts orders, warranty claim forms, and other such transactions can be set up automatically, using the data in the computer, and transmitted electronically. When it comes time to write up the invoice, the technician can choose from a number of pre-prepared repair descriptions and enter them automatically into the form without ever typing or printing a single character.

Software modules

Most complex software consists of a number of different segments called modules that are invoked by the individual using the program, depending on what needs to be done. Typically, when the program is started, there will be a main screen that offers the user a number of options, such as: service module, sales module, purchase order module, parts inventory module, accounting module, accounts receivable module, reports module, and service manual database.

The following is a description of the modules that may be found in a typical service management software program. Some manufacturers sell the entire package bound together. Others may allow you to buy some modules but not others, if you prefer. The actual capabilities of

any given software program, the appearance of any of the screens, and ease of use, will vary, depending on the particular manufacturer.

For someone considering purchase of a service management software package, it might be a good idea to request demonstration products from several suppliers and try them out to find out which one you prefer. Just as with cars, or toasters, or any other product, different people have different preferences.

Service module

This module includes all of the functions that bear directly on the service aspect of the business. It allows service center personnel to handle all of the activities that involve the service process. Here are some of the functions that you might see in this module:

- Customer data entry/database lookup
- Printing of service orders, claim checks, and inventories
- Part number and labor rate lookup
- Inventory
- Generation/lookup of estimates, warranty information, contract repairs
- Sequential claim numbering
- Automatic entry of descriptions of the most common repairs you encounter
- Information about the status of the repair process
- Technician performance records
- Additional fields that the service center manager can define

Sales module

For a service center that is also involved in selling consumer electronics products, this module enables the staff to record and keep track of sales information, including:

- Recording of over the counter sales
- Product inventory and customer database
- Sales posted to the accounts receivable module

Purchase order module

A typical service center purchases a lot of replacement components, supplies, tools, test equipment, and more in a year. That means a lot of purchase orders. Many service center management software packages feature a purchase order module that allows the individual who performs this function to

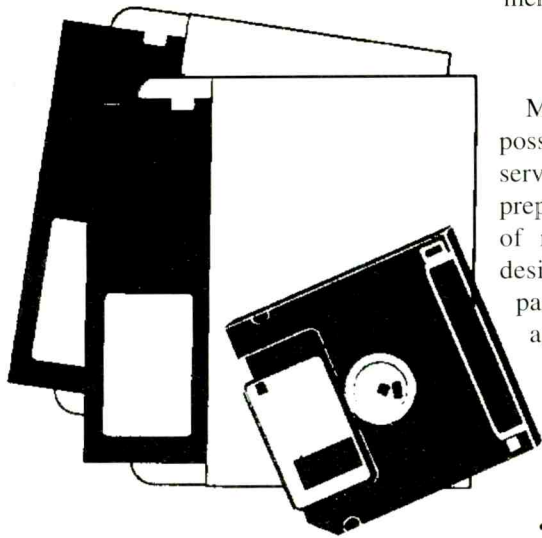

- Automatic inventory readjustment when items are consumed

Accounting module

Many service center managers possess finely honed skills in the service area, but are less well-prepared in the financial niceties of running a business. A well designed accounting module as part of the service center management software package can help keep the financial side of a service center healthy. Here are some of the functions you might find in an accounting module:

- Parts income
- Labor income
- Delivery, shipping, taxes
- Totals of both taxable and non-taxable items
- Reports of technician parts and labor
- Reports by any interval that suits the service center: day, week, month, year.

prepare and track purchase orders via the computer. Some of the functions you might find in a purchase order module are these:

- A database of vendors the service center buys from
- Purchase orders, from preparation, to pending, to completion
- Automatic tracking and control of inventory of products purchased

Parts inventory module

Some less well-managed service centers, and even some that are pretty well managed, have a problem keeping a tight rein on their parts inventories. Occasionally, a service center will order a part, or a module, only to find that they had one on hand. Or conversely, they may need a frequently used part that should be in inventory, and find that somehow that part is depleted, and has not been reordered. The parts inventory module of a service management software package can reduce the likelihood any of those types of problems occurring. Some of the functions of a parts inventory module include:

- A database of part numbers with that service center's cost/price, and location within the service center
- Quantity of each part on hand
- A prompt to reorder at the quantity level determined by the service center manager
- Most recent order database

Accounts receivable

If the service center isn't collecting amounts owed to it, cash flow can become a problem. A service center manager may be busy running the service side of the business and not pay enough attention to receivables. The accounts receivable module in a service center management software package can help a manager focus on this important aspect of the business. A typical accounts receivable module may include the following functions:

- Open receivables
- Customer account status
- Customer statements

Reports module

One of the amazing capabilities of a computer is that of organizing data in usable form, in just about any way the user wants to look at it. For example, if the service manager is running the business using paper, and wants to look at the status of repairs of all the products in the service center, he has to somehow collect the data, write it down, organize it, and perhaps enter the information on some kind of report sheet. Then he might study the information available, reflect on it, and decide that he needs to arrange it in

some other order to make it useful.

Given the power of the computer, the service manager can consider the data, arrange it any way he wants to, and draw conclusions about a number of the aspects of the service center. If each technician has a networked computer workstation at his position, and has been instructed as to what data to enter, that information will be immediately available to the service manager. So if he wants to know which product has been in the service center, and why, or needs a list of repairs that are awaiting parts, from which supplier, and for how long, he can examine that data. Now.

A reports module might include the following functions:

- Status of repairs
- Status of technicians
- Quantity and type of products serviced by month
- Cash receipt
- The capability to generate reports defined by the service manager

Still have reservations?

Some people still have reservations about using a computer in the business. They're afraid that they'll lose data or the computer system isn't compatible with their business. Those are, of course, valid concerns. But thousands of service centers, not to mention just about every store, medical office, and other business, have adopted computers and couldn't be happier that they did.

In the short run, a service center can maintain records both on paper, on some kind of magnetic media backup device, and in the computer, and still save time and effort. Everything that is in the computer can be printed out and filed just as it was before the computer was introduced into the business. In the long run, the service center can maintain backups of the computer database on an additional hard drive, zip disks, or whatever works for that company.

Power outages can be a problem, of course, but in most areas of the country they're rare. If this is a big concern, uninterruptible power supplies can be bought extremely reasonably.

Computers are here, they're inexpensive, they're increasingly powerful and reliable, and they can help a business immensely. What are you waiting for? ■

Video interfacing

by Jim Van Laarhoven

Ever since color television was developed in the early fifties, the electronics industry has faced the challenge of improving the picture quality. Black and white (luminance) and color frequencies (chrominance) are transmitted simultaneously, and that does present some unique problems. Even though this frequency combination that was developed during the fifties was quite a remarkable accomplishment, it was still a compromise. To this day, these two transmitted picture components continue to interfere with each other. It is interesting to realize that a standard high-quality black and white TV set has better picture resolution than a comparable composite color set. Since luminance is the only video frequency being accepted by the black and white set, it will not be subject to the problems of interference that a color set experiences.

Many systems have evolved over the years to improve picture quality. Until the concept of separating the two video signals came about, however, many of these improvements were really just more compromises. Currently, two different video information separators are being used to improve video quality. One is Component Video, which you will see more often in higher-priced TVs and DVD players. Another is S-Video, which is recognized and used more by the average consumer. This article will concentrate on these two, however it may be an advantage to go over some of the characteristics of the more traditional video inputs first.

RF video

RF video is a composite signal that is modulated into RF and then transmitted through a single cable. Composite video is similar to RF in that it carries the same signal and uses one cable, but it does not have to be modulated to radio frequency before it is transmitted. Both combine

Van Laarhoven is an independent technician and consultant for computer based lighting.

the luminance (Y) and the chrominance (C) into one composite signal.

Luminance (Y) is the unit of measurement for the lightness/brightness part of the signal (this can also be stated as the intensity or gray level) and is usually transmitted at full bandwidth. Studies show that the human eye is more sensitive to changes in luminance than it is to changes in Chrominance. The eye can distinguish luminance levels from 0.000003 cd/m² (beginning of visual perception) to 300,000.000 cd/m² (which is equal to the radiance of the sun). This wide range of perception is due to the fact that the sensitivity of the eye decreases as luminance increases.

Chrominance (C) is the two-color component of the video signal. It is usually transmitted at half the bandwidth. Chrominance has two characteristic features; coloration and saturation. Coloration is the light that is reflected by another surface. Saturation is the ratio of white that is contained in a color.

S-Video

S-Video (also known as Super Video or Y/C Video) is a high quality luminance and chrominance separation system. It differs greatly from RF and composite video because of this signal separation feature (note that pins 3 (Y), 4 (C) and their respective grounds of Figure 1, carry luminance and chrominance separately). Since these two signals are not combined as the signals are in RF or composite, the need for filtering is virtually eliminated. Filtering is one of the factors that can contribute to reduced video output quality.

S-Video cables are available in a broad range of prices. It really depends on whether you need to run the cable a long distance or not. If a short run (under 20 feet) is needed, you probably don't need to spend much. In this case, a standard 75Ω mini-coaxial cable will probably suffice. In case you need to run a distance of 50 feet or more (most manufacturers recommend runs to be less than

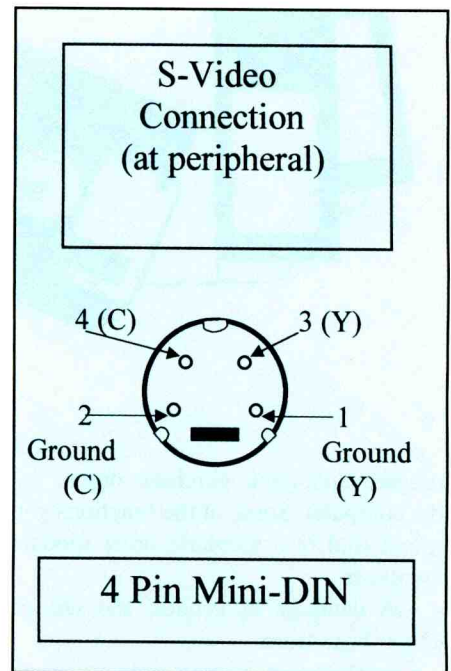

Figure 1. S-video differs greatly from RF and composite video because of its signal separation feature. Note that pins 3 (Y), 4 (C), and their respective grounds carry luminance and chrominance separately.

this), there is cabling available that uses superior materials to combat the effects of interference and impedance. One type offered has polymer-coated silver conductors with a copper-braided outer shield. This type of cabling is expensive, but it may be worth the cost when you are faced with the many problems that are incurred in long cable runs.

There have been some complaints that the S-Video connector (4 Pin Mini-DIN) is too fragile and has a higher failure rate than other video connectors of the past. This problem does not seem to be a widespread complaint, and when it has occurred may have been caused by installer error (jamming the connector in without regard to polarity).

Splitters for S-Video also are available in many different configurations and price ranges. A typical splitter will have one S-Video input and up to eight outputs. They generally operate on a

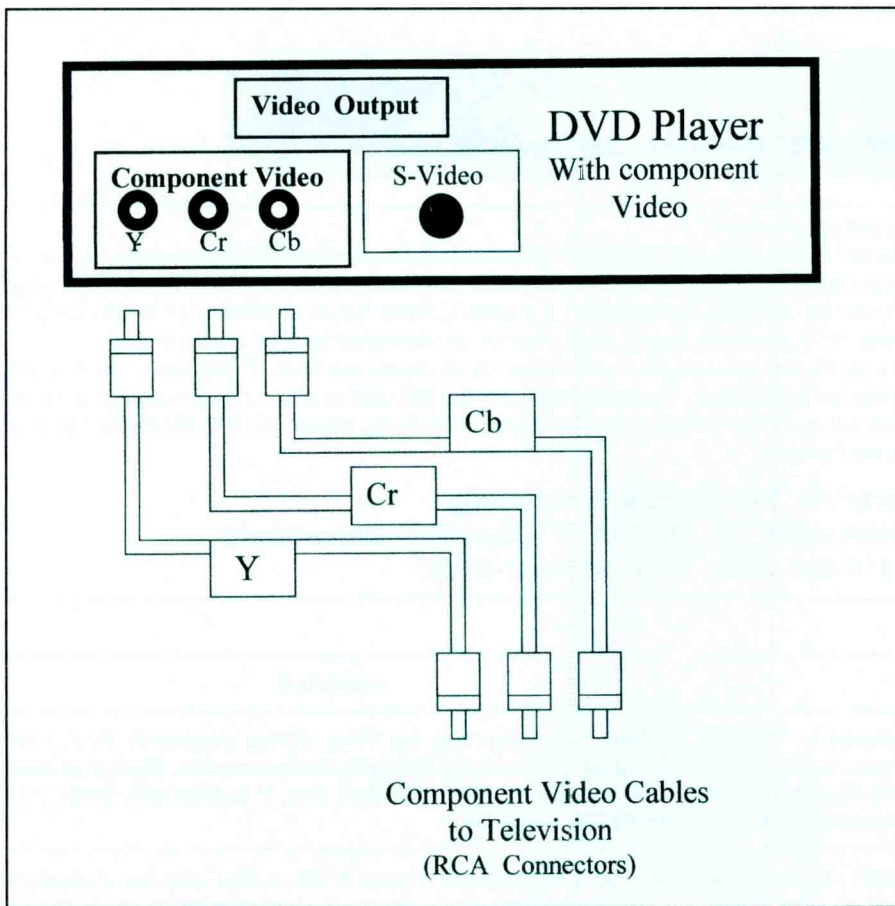

Figure 2. Component video separates the luminance and chrominance signals just as in S-Video but goes one step further and separates the two color signals contained in chrominance. Three cables are used in this video system. The connectors shown here are RCA-type and are usually color-coded for ease of installation. Connections on Component video equipment are normally labeled (Y) for luminance, (Cr) for one color component, and (Cb) for the other color component.

30-MHz bandwidth and are either self-powered or work with an 110Vac input. Some units are non-adjustable while others have switch-selected gain circuitry. System size (location and number of S-video components) will dictate what kind of splitter needs to be used.

A composite to S-Video adapter is another product that may improve video quality. When a customer wants improved picture quality and their equipment does not support S-Video, an adapter may be the solution you are looking for. These adapters are designed to accomplish the same luminance and chrominance separation that a built-in system offers. Usually, they are attached in-line between the video source and the video equipment.

Component video

Component video is of a higher quality than S-Video. It generally only

appears in equipment of a very high grade like that of high-priced DVDs and TVs. Component video separates the luminance and chrominance signals just as in S-Video. Component video goes one step further, however, and separates the two color signals contained in chrominance. Three cables are used in this video system. The connectors in Figure 2 are RCA-type and are usually color-coded for ease of installation. Connections on Component video equipment are normally labeled (Y) for luminance, (Cr) for one color component, and (Cb) for the other color component. Component video cables look like standard audio/video types, but the materials they are made of are quite different. One cable manufacturer uses gold plating on the RCA connector and also incorporates various high-grade conductors and insulations into the cabling. Additionally, the cabling is

impedance matched and double-shielded. All this attention to detail permits this type of cable to have ultra-low capacitance characteristics, which in turn, provides a superior signal transfer to the Component video equipment.

This article focused mainly on video interfacing that pertained to television and its peripherals, but there are many other video interfacing potentials. Computer cards that support the S-Video format are available that permit the user many input/output options. One such option is a computer monitor that outputs to a large-screen TV. Other options include digital camera and camcorder inputs to a computer. The list is much larger than this and it is still growing.

When a corporation or an individual creates a new video product that is both useful and interesting, word usually spreads fast. The technical world responds to the discovery and plans are set in motion to make it even better. Parallel discoveries are eventually made from the original discoveries and so it goes on. The ripple effect is an amazing thing to behold.

Do You Repair Electronics?

- Repair Databases for TV, VCR, Monitor, UL Audio, FCC, and more.
- Over 76,000 records
- Private user forums
- Live on-line chat rooms

RepairWorld.com

Electronics Corp. 1 Herald Sq. Fairborn, OH 45324 (937) 878-9878

Circle (58) on Reply Card

Use Your FREE **ELECTRONIC** **Reader Service Card For More Information On Companies Advertising In This Issue.**

FREE Reader Service Card
For Issues of April 2000. Valid after July 2000.

DATE LABEL OR FILL IN INFORMATION

1	2	3	4	5	6	7	8	9	10	11	12	13	14	15	16	17	18	19	20	21	22	23	24	25	26	27	28	29	30	31	32	33	34	35	36	37	38	39	40	41	42	43	44	45	46	47	48	49	50	51	52	53	54	55	56	57	58	59	60	61	62	63	64	65	66	67	68	69	70	71	72	73	74	75	76	77	78	79	80	81	82	83	84	85	86	87	88	89	90	91	92	93	94	95	96	97	98	99	00
---	---	---	---	---	---	---	---	---	----	----	----	----	----	----	----	----	----	----	----	----	----	----	----	----	----	----	----	----	----	----	----	----	----	----	----	----	----	----	----	----	----	----	----	----	----	----	----	----	----	----	----	----	----	----	----	----	----	----	----	----	----	----	----	----	----	----	----	----	----	----	----	----	----	----	----	----	----	----	----	----	----	----	----	----	----	----	----	----	----	----	----	----	----	----	----	----	----	----	----

Monitor Test Equipment

- Sweep rates to 64kHz
 - Gray Scale/Color Bars & More
 - "AutoScan" (auto rate switching)
 - Portable & Bench units
 - TV/Stereo/S-Video Products
- LOW COST**
- CMM 1-800-466-4411, 770-662-5633**
www.computermonitor.com
Visa-MC-AMX-Discover—On-line ordering

Circle (59) on Reply Card

Classified

Classified advertising is available by the word or per column inch.

By-the word. \$1.65 per word, per insertion, pre-paid Minimum charge is \$35 per insertion. Initials and abbreviations count as full words. Indicate free category heading (For Sale, Business Opportunities, Miscellaneous, Wanted). Blind ads (replies sent to ES&T for forwarding) are \$40 additional. No agency discounts are allowed for classified advertising by the word. Contact Alycia Nichol森 at 516-681-2922 to place your classified ad (by-the-word). Mastercard, VISA, American Express and Discover are accepted for FAX or mail orders.

Per column inch (classified Display): \$235 per column inch, per insertion, with frequency discounts available, 1" minimum, billed at 1/4" increments after that 10" maximum per ad. Blind ads are \$40 addition. Reader Service Number \$25 additional to cover processing and handling costs. (Free to 4-inch or larger ads.) For more information regarding classified display advertising, please call 630-584-5333. Optional color (determined by magazine) \$150 additional per insertion.

Electronic Servicing & Technology
25 Newbridge Rd, Hicksville, NY 11801 Attn: Classified Department
Ph: 516-681-2922 FAX: 516-681-2926

FOR SALE

TEST EQUIPMENT FOR SALE: REASONABLE PRICES SENCORE, TEKTRONIX, HP and MUCH MORE. View complete list at: <http://www.astglobal.com> or contact: **AST GLOBAL ELECTRONICS.** Voice: 888-216-7159; Fax 814-398-1176; e-mail: sales@astglobal.com

All VCR Drop In Power Supplies Rebuilt, \$29.95. Free Shipping. Liberty Electronics, 207 W. Clinton Avenue, Oaklyn, NJ 08107. 856-854-4443. E-mail jkliberty@aol.com

'nControl!® COST-EFFECTIVE SOFTWARE The most complete package tailored for service centers. Has features you won't see anywhere else! From \$49/mo. Download free trial <http://ServicerSolutions.com> (888) PBS-6288

WinSTIPS! — 141,000 Current tips from 500 shops! All brands. \$149.95. ServiceTalk E-mail repair group \$59.95. WinSERV Repair software \$299.95. <http://www.kdtviwe.com>. KDTV 514 3rd St., Aurora, IN 47001. **1-888-KD-STIPS.** All c/cards. FREE 30 day full trial.

TV Troubleshooting Made Easy! From Classifying Symptoms to Localizing problem stages, this sturdy, laminated 16 card deck will increase tech production with its clear, logical, and time-proven approach! Your techs will use it everyday! Only \$29.95. Make check or MO to E. Prince, 5611 Brices Lane, Virginia Beach, VA 23464 (757) 523-8946.

SENCORE, TEKTRONIX, HEWLETT PACKARD (all models). We **BUY, SELL, & TRADE.** Please call "**CHOICE ELECTRONICS**" for all of your test equipment needs. Complete financing options available. Call 1-800-609-0677, 605-361-6386 ask for Lance Tople.

TEST EQUIPMENT BOUGHT & SOLD: OSCILLOSCOPES, ETC. 925-706-0177. FAX: 925-706-0156. www.oscilloscopesetc.com

*******NAP Tuner 340309******* RCA Tuner TCHRIA or TCCRIA and more. Snowy picture? **Will rebuild for \$25.00, Free Shipping!!! Tip Top TV & VCR,** 18441 Sherman Way, Reseda, CA 91335, **818-345-1974.**

Retiring: Must sell Sencore, Leader, Hitachi test equipment, SAMS, etc. Please send SASE for listing. William B. Crowell, P.O. Box 757, Whiteville, NC 28472 or e-mail wbc@weblnk.net (910) 642-0393.

FOR SALE

****FREE** Service Tips for TV's, VCR's, Projection TV's, CAM-CORDER's. Must have IBM compatible computer. Send your Name and Address to: FREE SERVICE TIPS, P.O. BOX 464, WHEATLEY HEIGHTS, NY 11798.**

TV CASE HISTORIES: Volume 8 with 3,325+ histories. Satisfaction assured. Only \$59.75 (plus \$3.25 shipping). Over 9,800 books and supplements sold with only 1 returned for a refund! **Mike's Repair Service,** P.O. Box 217, Aberdeen Proving Ground, MD 21005. Same mailing address 36+ years. Send SASE for samples. 410-272-4984, 1-800-2-FIX-TVS 11a.m.-9 p.m. (<http://mikesrs.webjump.com>)

SC3100 waveform analyzer, \$2000.00. CR70 univ. CRT analyzer & restorer, \$500.00. CM2125 computer monitor analyzer, \$2000.00. TF46 Cricket, trans/fet, \$100.00. Powerite II, \$500.00. All equipment brand new, includes manuals and all accessories. Telephone 718-927-1937, E-mail brawell@aol.com

WANTED

WANTED:USED TEST EQUIPMENT. TURN IDLE OR EXCESS EQUIPMENT INTO CASH. AST GLOBAL ELECTRONICS. Voice: 888-216-7159; Fax 814-398-1176; e-mail: sales@astglobal.com.

BUSINESS OPPORTUNITIES

CENTRAL FLORIDA TV/ELECTRONICS Business/Building. Heart of the retirement area. 36 years (75K). Owner retiring. **941-385-0359.**

Electronic Service Shop for sale. Northern Colorado. 24 years in business. Price negotiable depending on terms of the sale. **970-203-0864.**

If you are a better an average technician and are not averaging at least 1K per week, maybe it's time for a change. Ownership is an option when I retire next year. Small busy shop in scenic arrear near mountains and beach. Lake Elsinore, CA. Harvey, **909-674-7333 or FAX 909-674-8885.**



ES&T Presents Computer Troubleshooting & Repair

Features information on repairing Macintosh computers, a CD-ROM primer, and a color monitor. Also included are hard drive repair tips and computer diagnostic software.
61087 • \$24.95

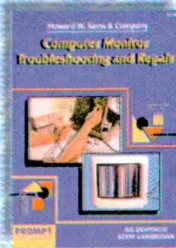

Computer Monitor Troubleshooting & Repair

Learn the basics of computer monitors with chapters on tools and test equipment, monitor types, special procedures, how to find a problem, and how to repair faults in the CRT.
61100 • \$34.95

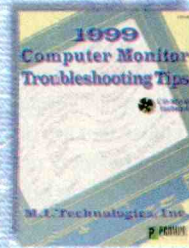

1999 Computer Monitor Troubleshooting Tips

Includes over 2,000 troubleshooting and repair tips listed by manufacturers name and model number featuring such major names as Apple, Gateway, Compaq, IBM, and Dell.
CD-ROM Included
61179 • \$49.95



ES&T Presents the Test Equipment Guide

Includes the latest information on how to choose the best equipment, how to build test equipment and accessories, how to set up the ideal service bench, and how to put together a practical tool kit.
61089 • \$24.95

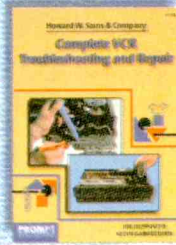

Complete VCR Troubleshooting & Repair

In addition to troubleshooting procedures, this book contains nine detailed VCR case studies, each focusing on a particular model of VCR with a very specific and common problem.
61102 • \$34.95

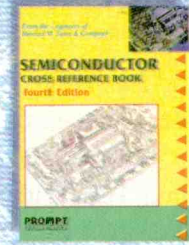

Semiconductor Cross Reference, 4th Edition

With more than 490,000 part numbers, type numbers, and other identifying numbers listed, technicians will have no problem locating the replacement or substitution information needed.
61080 • \$29.95
Also available on CD-ROM, 61140 • \$29.95



ES&T Presents TV Troubleshooting & Repair

Presents important and new information that will make it possible for technicians, students, and electronics hobbyists to service TVs faster, more efficiently, and more economically.
61086 • \$24.95

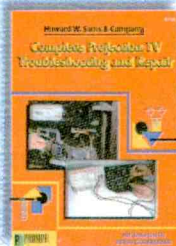

Complete Projection TV Troubleshooting & Repair

Covers everything from the basics of projection circuits, tools and test equipment, TV types, safety procedures and measurements, to the finely detailed repair techniques.
61134 • \$34.95



Troubleshooting & Repair Guide to TV, Second Edition

The most comprehensive, complete, and up-to-date television repair book available, with tips on how to troubleshoot the newest circuits in today's TVs.
61146 • \$34.95



ES&T Presents VCR Troubleshooting & Repair

This book provides in-depth and thorough information on a variety of VCR troubleshooting and repair areas.
61158 • \$24.95

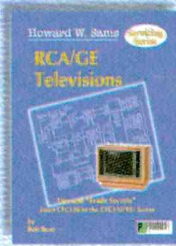

Howard W. Sams Servicing Series RCA/GE Televisions

From RCA component numbering systems to the infamous "tuner wrap" problem, this book gives you all you need to make more efficient repairs.
61171 • \$34.95

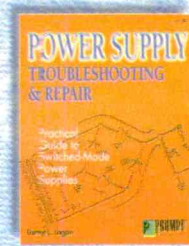

Power Supply Troubleshooting & Repair

Designed to provide technicians with a better understanding of how switched-mode power supplies operate. It also provides practical, useful procedures to follow when troubleshooting power supplies.
61138 • \$24.95

YES! I want to learn from the experts. Rush me my book(s) right away!

Please add \$4 shipping & handling. **FREE shipping & handling for orders \$50 and over.**

Please make your check or money order payable to: Electronic Servicing & Technology
U.S. and possessions - add \$4 shipping/handling. FREE S/H on orders \$50 and over. Foreign - shipping/handling charges are calculated by order weight & destination. A \$4 credit will be applied for Foreign orders over \$50.

**To Order Call
800-853-9797**

Qty	Order#	Description	Price	Total Price
Shipping/Handling				
New York Residents add applicable sales tax				
Total				

Name _____

Address _____

City _____ State _____ Zip _____

MC/VISA/AMEX/Discover # _____ Expires _____

Form of payment: MC VISA AMEX Discover Check Money Order

Please mail your orders to: Electronic Servicing & Technology, 25 Newbridge Rd., Hicksville, NY 11801-9962 FAX: 516-681-2926

Reader's Exchange

Readers' Exchange is a free service.

The following restrictions apply to Readers' Exchange:

- Only individual readers may use Readers' Exchange, and items must be restricted to those that are ordinarily associated with consumer electronics as a business or hobby. If you're in business to sell the item(s) you want to offer for sale, the appropriate place for your message is in a paid advertisement, not Readers' Exchange.
- Readers' Exchange items must be restricted to no more than three items each for wanted and for sale.
- All submissions must be typed or printed clearly!

Send your Readers' Exchange submissions to:
Readers' Exchange
Electronic Servicing & Technology
25 Newbridge Road, Hicksville, NY 11801
Phone: 516-681-2922 Fax 516-681-2926

FOR SALE

B&K 545 component analyzer can test most any component in-circuit with no power applied. \$1450.00. *Contact: Kim Gutzke, 612-869-4963.*

Mitsubishi, Matsushita, Toshiba, Sony, Pioneer and more schematics in good condition for VCR/camcorder/audio. *Contact: Ernest, 541-756-2264, E-mail ergoode@msn.com*

Sencore LC102 capacitor/inductor analyzer, mint condition, \$800.00. Sencore CR70 CRT tester/restorer, mint condition, \$500.00. Sencore PR57 powerite/variatic, excellent condition, \$225.00. Tentel VHS VCR gauges, full set with video training tape, all mint condition, \$400.00. Tenma bench-top NTSC pattern generator Model 72-4015, mint condition, \$175.00. *Contact: Randy, 8362 Sylvania Metamora Rd., Sylvania, OH 43560, phone 419-882-8961.*

WANTED

Phillips P3212 oscilloscope and a navy impedance bridge ZM 11/U. Working or not. *Contact: Sidney, 510-357-3788.*

Hi-Fi tube amps (Marantz, McIntosh, Scott, Fisher, etc.) Hickok tube tester, tubes, etc. *Contact: Kim Gutzke, 612-869-4963.*

Zenith HV module 9-815-04 or its Fly 95-4146-02 or similar part # for projection Model. Zenith ultrasonic remote controls that have keys 0-9, working or not. *Contact: Joel Koiviste, 11821 Co. Road 55, Naskauk, MN 55769, phone 218-885-2175.*

Teac/Pioneer LV5000DS/CLD900 laserdisc, MAG Technology model MX15HY monitor, JVC model HR-VP450U VCR. Need service manual/schematic for each one. Willing to copy and return. *Contact: Chris, 614-899-9049, e-mail tech113@juno.com.*

Aiwa DC stereo amplifier P22, model number SA-P22H schematic and parts list. *Contact: Salvage King, 2818 O'Donnell St., Baltimore, MD 21224, phone: 410-675-7525.*

Advertisers' Index

Company	Page Number	Reader Service Number	Advertiser Hotline
Andrews Electronics	42	60	800/289-0300
B & D Enterprises	3	6	888/815-0508
B & K Precision.....	49	61	714/237-9220
Computer & Monitor Main.....	61	59	800/466-4411
Electronic Design Specialist	45	64	561/487-6103
Electronic Servicing & Tech.....	63		800/853-9797
Electronics Technicians Assoc.	22	63	800/288-3824
Electronix Corporation	61	58	937/878-1828
Iscet.....	20	68	817/921-9101
Jesse Jones Industries	64		800/825-6690
Nexent Corporation	IBC	115	519/250-5151
Sams & Company, Howard.....	44	7	800/428-SAMS
Sencore	IFC	1	800/SENCORE
Thomson Consumer Elec.	BC	67	800/336-1900

We'd like to see your company listed here too. Call Jonathan Kummer at 516-681-2922 to work out an advertising program tailored to suit your needs.

ORGANIZE AND PROTECT YOUR COPIES OF

Electronic Servicing & Technology

Now there's an easy way to organize and keep copies of your favorite magazine readily available for future reference.

Designed exclusively for **Electronic Servicing & Technology** by Jesse Jones Industries, these custom-made titled cases and binders provide the luxury look that makes them attractive additions to your bookshelf, desk or any location in your home or office.

Each binder/case is covered durable leather-like material; title is hot stamped in gold.

Whether you choose cases or binders, you'll have a storage system that's durable and well organized to help protect your valuable copies from damage.

Quantity	Cases	Binders
One	\$ 8.95	\$11.25
Three	\$24.95	\$31.85
Six	\$45.95	\$60.75
Add \$1.50 per case/binder for postage and handling.		
Outside USA \$3.50 per case/binder. (U.S. funds only)		

Credit cards accepted: AMEX, Visa, MasterCard, Diners Club (Min. \$15) PA
 Residents add 7% sales tax Allow 4 to 6 weeks delivery

Electronic Servicing & Technology
Jesse Jones Industries, Dept. 95 EST
499 East Erie Avenue, Phil., PA 19134
Call TOLL FREE 7 days, 24 hours
1-800-825-6690

You wouldn't trust just anyone with your Service Management, would you?

Miracle Service Electronic and Appliance Edition is a state of the art software system designed to keep pace with industry change and growth by offering a wide variety of standard and optional features that ensure a customer satisfaction level that sets us apart from the competition. So when it comes to your service management operation, put your trust in Miracle Service Electronic and Appliance Edition.

- Suppliers, Makes and Manufacturers
- Scalable - Access or SQL Server
- Purchase Orders
- Claims Companies
- Inventory Control
- Electronic Warranty Claims
- Multiple Warehouse
- Dealers
- Reports
- Invoicing
- Customers
- Equipment
- Technicians
- Task Tickets
- Work Orders
- Sales Invoice
- Network Ready
- NESDA, NARDA, CEASA forms

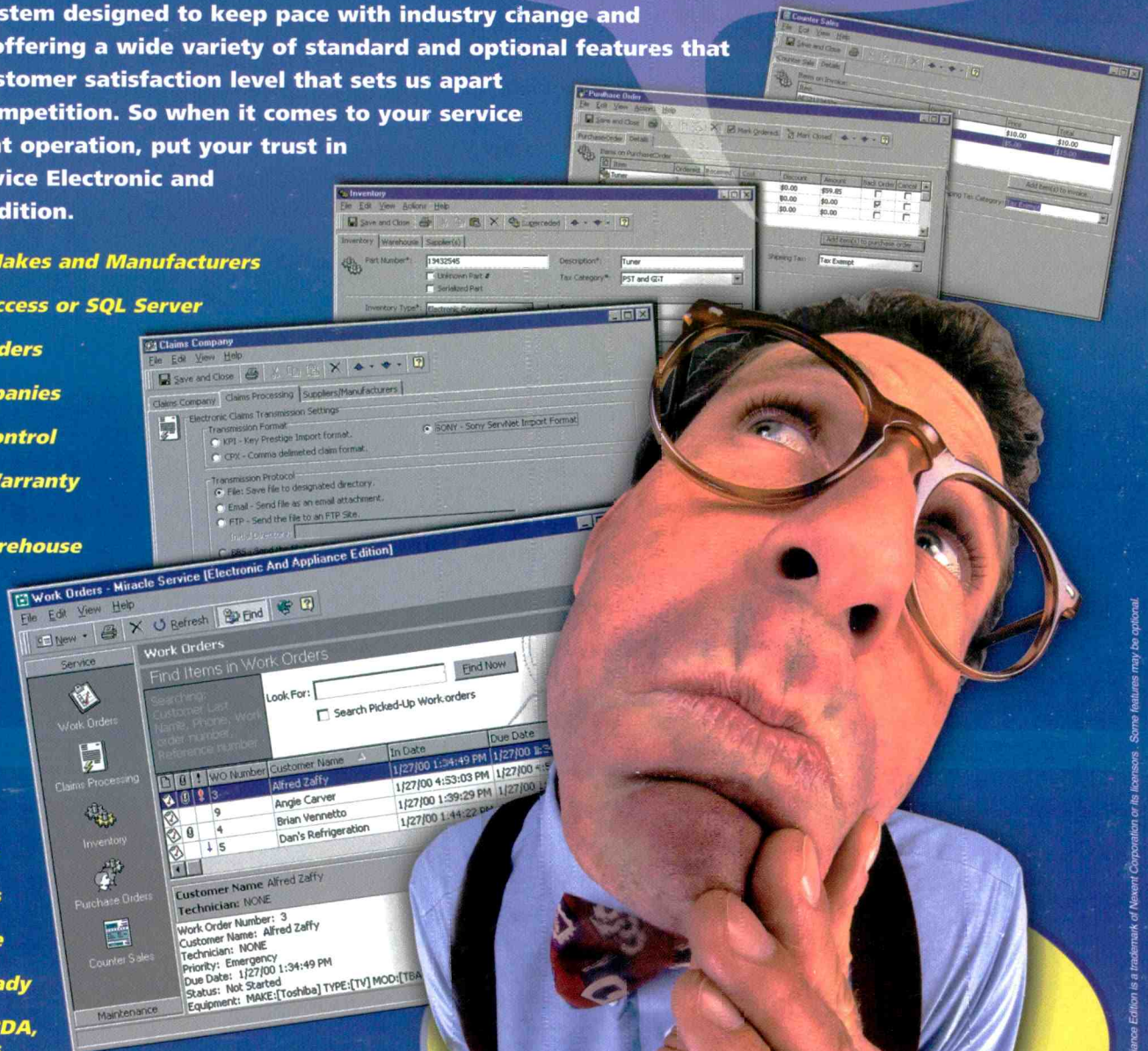

Phone: 519-250-5151
 Fax: 519-250-5252
 E-mail: sales-msea@nexent.com

Circle (115) on Reply Card
**Free Demos available
 at www.nexent.com**

nexent
 corporation

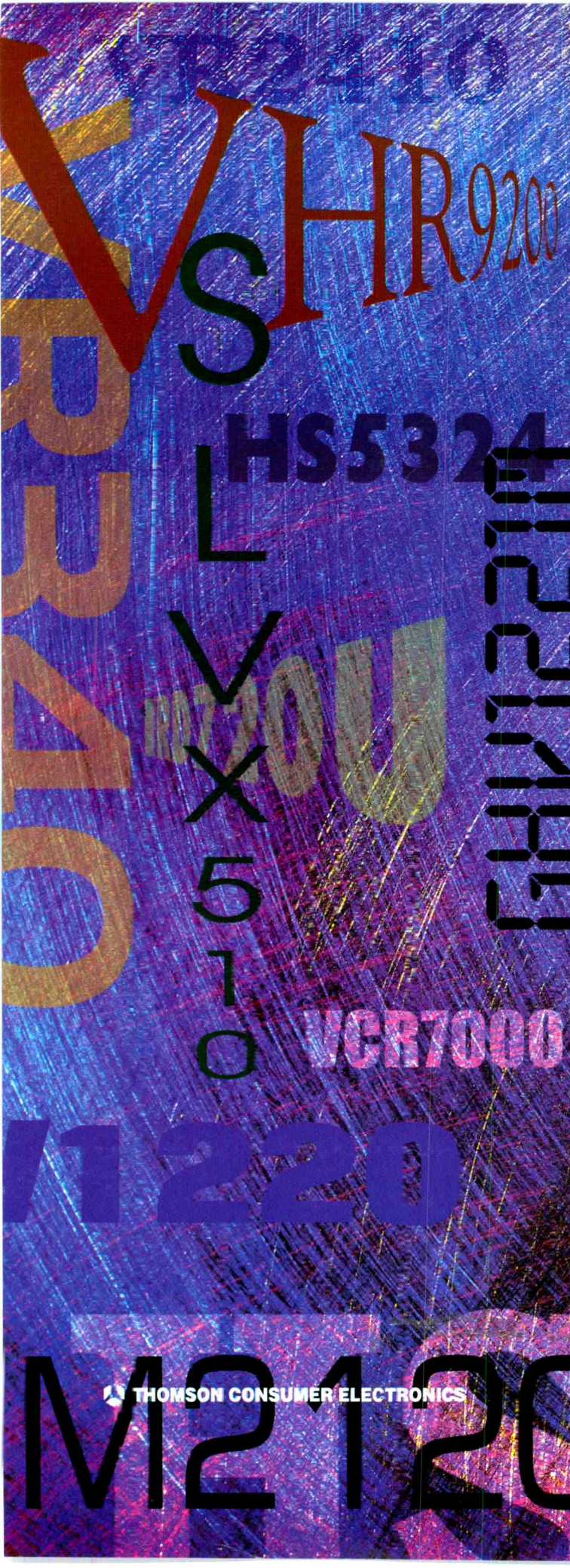

Video Heads

Pick A Number Any Number

When you're looking for a replacement head, SK Series is way *ahead* of the competition.

SK Series replacement video heads cross over to 4,500 different models and 68 different brands.

And when you're in need of any exact semiconductors, belts, tires, flyback transformers or video replacement parts, we have them too.

But we don't stop there.

Every SK Series product comes with the quality assurance and accuracy you expect from all Thomson products.

For more information on SK Series products, contact your nearest Thomson Distributor.

SK Series...The parts you need to do the job. "Trust me!"

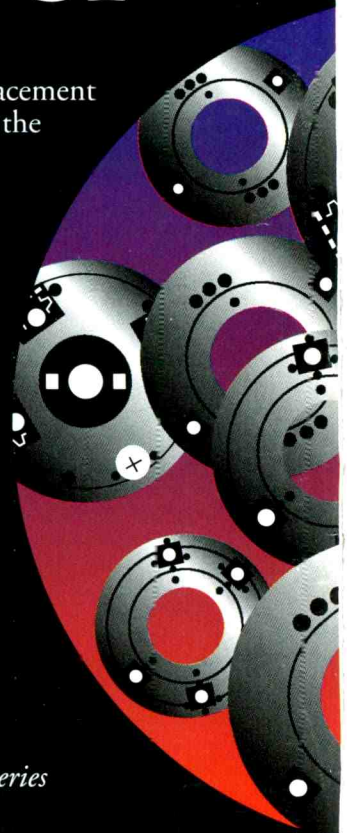

THOMSON CONSUMER ELECTRONICS



Circle (67) on Reply Card