

MLP

PANORAMA

TELEVISION
TODAY AND
TOMORROW

NOVEMBER 1980
\$2.00

The Sexual Revolution: Is TV Keeping Pace with Our Society?

**Why TV is
So Obsessed
with Nazis**
By William L. Shirer

**Special Shoppers'
Guide:
Rating the
Video Games**

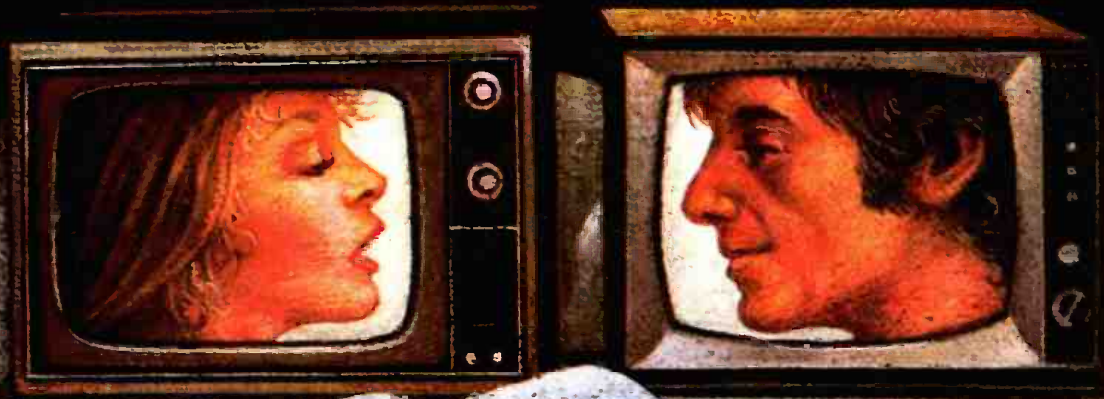

Inside Those Bloody Network Sports Wars

Antagonists Debate:

Was the FCC Right in Freeing Cable?



INTRODUCING THE NEW WORLD CAR



ENGINEERING TEAMS FROM AMERICA AND OVERSEAS JOIN FORCES TO CREATE A NEW CAR WITH BETTER IDEAS FROM AROUND THE WORLD

Top engineers drawn from the world-wide resources of Ford Motor Company teamed up to create Escort.

They pooled their expertise ... compared, tested, evaluated, experimented—to come up with better ideas. The result: a high-mileage car built in America to take on the world. Escort will be made in America for American drivers ... with other models built and sold overseas.

HIGH MILEAGE THROUGH ADVANCED TECHNOLOGY

Escort's fuel efficiency comes from highly efficient new power teams, the use of special weight-efficient steel, refined aerodynamics and other new and better ideas, not less car. In fact, Escort has the room of a Compact (based on EPA Volume Index).

ESCORT

30

EPA EST. MPG*

44

EST. HWY*

EVEN HIGHER GAS MILEAGE THAN
THESE LESS ROOMY SUBCOMPACTS.

VW RABBIT (GAS)	28	42
TOYOTA COROLLA H/B	28	39
HONDA ACCORD	27	36

*Applicable only to sedans without power steering or air conditioning. For comparison. Your mileage may differ depending on speed, distance, weather. Actual hwy mileage and Calif. ratings lower. Excludes diesels.

ONE OF THE MOST POWER-EFFICIENT ENGINES AVAILABLE IN AMERICA

Escort's advanced-design compound valve hemispherical head (CVH) engine focuses the incoming

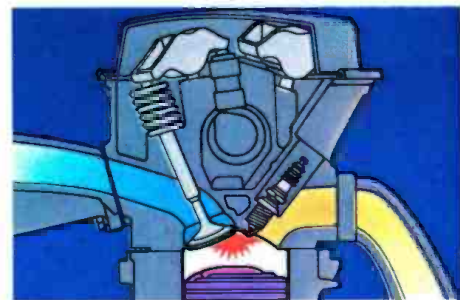

combustion charge for power efficiency. Result: high mileage plus power for freeway driving.

And Escort has a new manual transmission with fuel-efficient fourth gear overdrive standard.

FRONT-WHEEL DRIVE AND FOUR-WHEEL INDEPENDENT SUSPENSION

Escort has front-wheel drive ... four-wheel fully independent suspension ... rack-and-pinion steering ... stabilizer bar and new all-season steel-belted radials. And Escort makes use of a special steel—high-strength steel—along with other weight-efficient materials, for high mileage. Plus Escort offers a special all-new fast-cooling air-conditioning system.

FORD ESCORT



Escort Liftgate... 4 doors and wagon room when you need it.

DRIVE A WORLD CAR

Whether you buy or lease, see your Ford Dealer now to order your Escort... 3-door Hatchback, 4-door Liftgate—ten choices in all—even a Squire wagon option. And remember to ask about Ford's Extended Service Plan.

EVERY ESCORT HAS ALL THESE FEATURES STANDARD

- Front-wheel drive for traction.
- Fully independent four-wheel suspension for smooth road-holding.
- New-design compound valve hemispherical head (CVH) engine.
- Fully synchronized manual transmis-

- sion with fuel-efficient fourth gear overdrive (automatic available).
- Rack-and-pinion steering.
- Bucket seats... scientifically contoured for comfort.
- Front stabilizer bar.
- All-season steel-belted radials.
- Lifeguard Design Safety Features.
- AM radio. (May be deleted for credit.)
- Electro-drive cooling fan.
- Pin slider disc brakes.
- Self-adjusting clutch.
- Front-wheel bearings need no periodic adjustment.
- Hideaway luggage compartment.
- Fold-down rear seat for extra cargo.
- Rectangular Halogen headlights.
- Flash-to-pass headlight control.
- Handy European-style wiper-washer fingertip control lever. And more.

BUILT TO TAKE ON THE WORLD

FORD ESCORT

FORD DIVISION



PANORAMA

TELEVISION
TODAY AND
TOMORROW

CONTENTS

NOVEMBER 1980

VOLUME 1, NUMBER 10

ARTICLES

38 The Sexual Revolution: Is TV Keeping Pace with Our Society?

A writer has some surprising answers
By Marcia Seligson

42 Desegregating Central High: It Was TV's First Jab at the Nation's Conscience

How TV first became the accidental agent for the civil-rights movement
By Marshall Frady

44 Playing for Blood

An inside look at those nasty network sports wars
By Mark Ribowsky

48 One Picture Is Worth \$2000 a Second



Resourceful artists are bringing an exotic—and expensive—new look to TV graphics

52 They Surely Won't Throw This Newspaper on Your Doorstep

Electronic newspapers are here, with projected services that can change the way you live
By Ron Powers

58 The Nazis Are Coming! The Nazis Are Coming!

Why TV is so obsessed with that era now—and how it will affect viewers
By William L. Shirer

62 Antagonists Debate... Was the FCC Right in Turning Cable Loose?

Here are the pro and con on the agency's decision about importing syndicated programs
By Thomas Wheeler and David Gerber



Special Holiday Shopping Guide

64 Video Games—Telling the Good Ones from the Bad Ones



Join devotee Thomas (TheBlip) Corbett as he surveys the field and offers his ratings
By Len Albin

69 Surprise Your VCR with Thoughtful Extras

The latest video accessories range from image enhancers to commercial killers
By David Lachenbruch

72 Birth of a Salesman

Spooing a Government official—with a nod to "Being There"
By Douglas Bauer

75 Psst! Wanna Be a Star? Hire Mr. Mean!



How personal manager Jay Bernstein launches 'em and loses 'em in grand Hollywood style
By Anthony Cook

DEPARTMENTS

4 Letters

6 Perspective By Roger Simon

11 Impressions By Cyra McFadden

13 This Month

20 Cable and Pay-TV By Jeri Baker

22 Q&A: Hal Linden and Danny Arnold Interview by Dick Adler

30 Sports By John Schulian

32 Panoramic View

106 Videocassettes and Discs By David Lachenbruch

112 Rear View By Harry Stein

Cover: Painting by Richard Hess.
Other picture credits on page 110.

PANORAMA MAGAZINE (ISSN 0191-8591) IS PUBLISHED MONTHLY BY TRIANGLE COMMUNICATIONS INC. 850 THIRD AVENUE, NEW YORK, NEW YORK 10022. PLEASE ADDRESS ALL EDITORIAL MAIL TO PANORAMA MAGAZINE, P.O. BOX 950, WAYNE, PENNSYLVANIA 19087. ADDRESS ADVERTISING MAIL TO PANORAMA MAGAZINE, 850 THIRD AVENUE, NEW YORK, NEW YORK 10022. SUBSCRIPTIONS: UNITED STATES, ONE YEAR \$15.00. CANADA AND MEXICO, ONE YEAR U.S. \$21.00. ALL OTHER COUNTRIES, U.S. \$30.00. REMIT BY CHECK OR POSTAL MONEY ORDER. CURRENCY SENT AT SUBSCRIBER'S RISK. SEND NO STAMPS. SUBSCRIPTIONS WILL START WITHIN SIXTY DAYS AFTER RECEIPT OF ORDER. SEND SUBSCRIPTION CORRESPONDENCE TO PANORAMA, SUBSCRIPTION DEPARTMENT, RAD-

NOR, PENNSYLVANIA 19088. NOTIFY SUBSCRIPTION DEPARTMENT OF CHANGE OF ADDRESS AT LEAST SIX WEEKS IN ADVANCE. PLEASE INCLUDE NAME, NEW ADDRESS AND MAILING LABEL FROM MOST RECENT ISSUE. SINGLE COPY IN THE UNITED STATES AND CANADA \$2.00. VOLUME 1, NUMBER 10. ISSUED MONTHLY. SECOND CLASS PERMIT PENDING AT NEW YORK, NEW YORK AND AT ADDITIONAL MAILING OFFICES. COPYRIGHT © 1980 BY TRIANGLE COMMUNICATIONS INC. ALL RIGHTS RESERVED. NOTHING APPEARING IN PANORAMA MAY BE REPRINTED OR COPIED EITHER WHOLLY OR IN PART WITHOUT PERMISSION. PRINTED IN THE U.S.A. POSTMASTER SEND FORM 3597 TO PANORAMA MAGAZINE, RADNOR, PENNSYLVANIA 19088.

My new home, portable video recorder. Panasonic calls it Omnivision. I call it "Reggievision."

"This Panasonic portable Omnivision™ VHS™ video tape recorder is like an all-star team. The PV-3100 recorder with its optional programmable tuner/timer (PV-A35P) lets you record up to 6 hours of TV at home and 8 different shows over 14 days when you're making a road trip.

"When there's nothing good on TV, make your own shows—either indoors or outdoors—by adding a Panasonic PK-700 color-sound camera. And look at these major league features: A motorized 6-to-1 zoom lens, automatic exposure control, color balance and a telescoping condenser mike.

"The portable recorder comes complete with a Panaloid™ rechargeable battery so you can shoot for up to 1 hour. And for an extra hour of taping, there's an

optional battery pack. There's also an optional car-battery adapter. (The Panasonic portable video recorder has almost as many options as my contract.)

"And this Omnivision ought to win the MVP (Most Valuable Panasonic) award with its special features that let you freeze any frame. Or advance slowly frame by frame and see every detail of the action.

"With all this going for it, just one more touch would make it perfect—a name with a certain inimitable style and grace. Which is, of course, why I call it 'Reggievision'!"

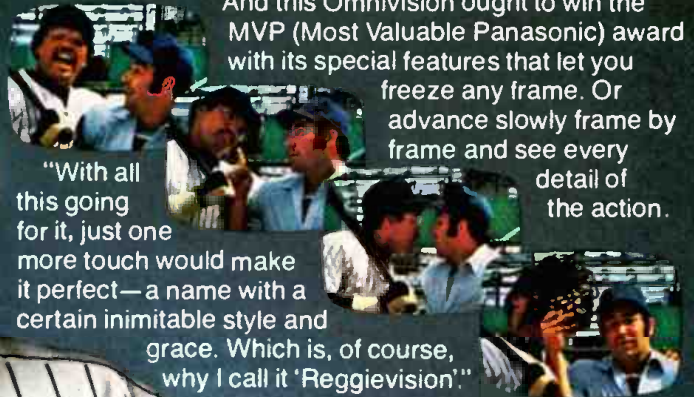

Panasonic.
just slightly ahead of our time.

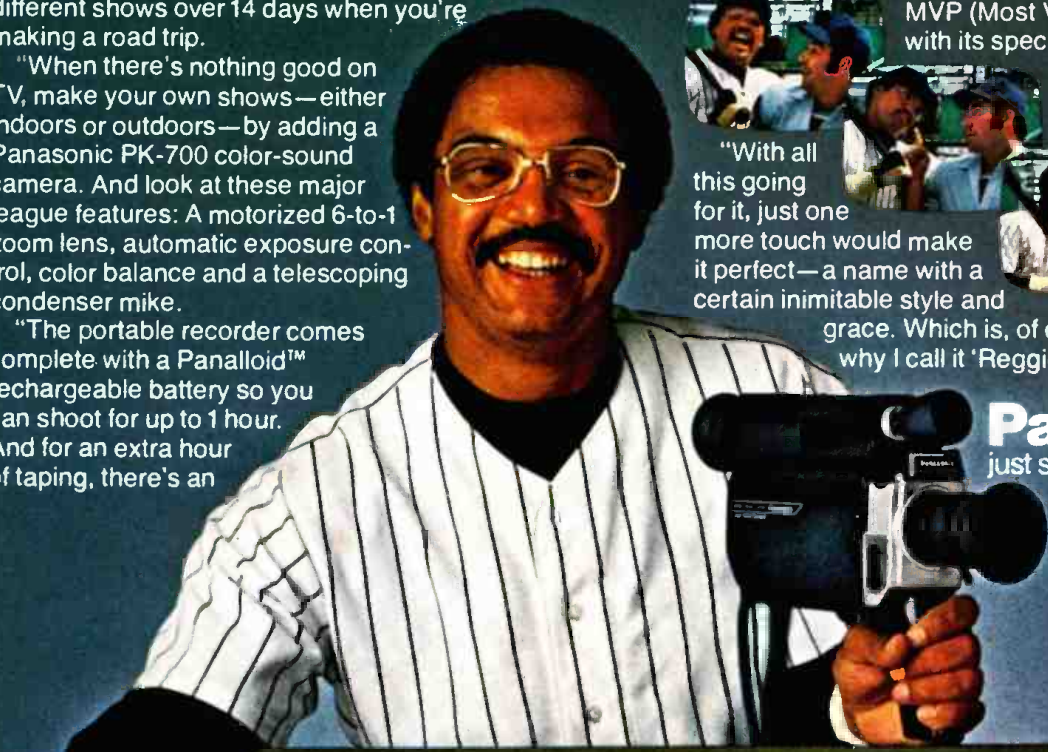

TV picture simulated.

LETTERS



Point-Counterpoint

Re: "Why You Can't Always Trust *60 Minutes* Reporting," September. Despite your reporter's contrary impression, neither I nor my colleagues on *60 Minutes* plead infallibility, nor do we believe we should be immune from public criticism. Nonetheless, I read with some bewilderment PANORAMA's September cover-story account of assorted *60 Minutes* misdeeds, inadequacies and oversights.

From your report, one had to come to the conclusion that our lies, dissembling and confusion put on the record before a jury in New York Supreme Court in Mineola, Long Island, had resulted in a devastating public scrutiny. So I am forced to ask, if such was the case, why did Dr. Joseph Greenberg abruptly discontinue his \$30 million lawsuit against us, an action he had pursued at extraordinary expense to him in time, effort and money over a period of almost four years?

Dr. Greenberg's case was heard by a jury for eight days, replete with details that your reporter reproduced in his piece. As CBS was about to begin its defense, our attorneys advised Dr. Greenberg's counsel that not only would we prove all that he had denied in court, but that CBS would also hold him accountable for all CBS's costs and expenses unless he would discontinue. Subsequent conversations between opposing attorneys resulted in the drafting of a statement in which Dr. Greenberg withdrew "all charges of negligence in the preparation and execution of the broadcast" . . . and CBS regretted "any embarrassment Dr. Greenberg feels he sustained as a result of the broadcast."

Did it not seem strange to your reporter that after all the *Sturm und Drang* Dr. Greenberg would suddenly call it quits and agree to pay all of his

own costs? Could it have been that Dr. Greenberg realized our hitherto confidential witnesses were in the courtroom waiting to testify? Could it have been that this diet doctor, whose annual gross income runs between \$650,000 and \$750,000, was not anxious for discussion of his working procedures, methods and prescriptions in open court? Or could it simply have been that he had to acknowledge that our piece had been accurate to begin with and that the jury was going to find in our favor?

Of course we've made mistakes in the past, but this wasn't one of them.

Mike Wallace
CBS News
New York City

When contacted, Dr. Greenberg's counsel, Jonathan Weinstein, felt that Mr. Wallace's belated protestations were contrary to the record and not worthy of further response.—Ed.

Paul Good's story was good, but a bit on the soft side. You can't trust *60 Minutes* because they have so flagrantly distorted the facts in numerous instances that you can't assume that they are reporting accurately in any given case.

Take the case of "Garn Baum vs. the Mormons," aired by *60 Minutes* on Dec. 9, 1979. *60 Minutes* made a big story of an obscure lawsuit in Utah. They tried to show that the Mormon Church has the entire legal profession in Utah, including the Federal judges, under its thumb. They gave the impression that Mr. Baum had experienced great difficulty finding an attorney in Utah with enough guts to sue the Mormon Church and that having failed to obtain justice in Utah he was having to take his case to a court in Colorado. Actually, Baum had hired five lawyers, the first of whom was one of the best antitrust lawyers in Utah. His last attorney, who was from Colorado, admitted in the Federal District Court that nothing in the extensive legal record of the case indicated any wrongdoing on the part of the Mormon Church.

All of this was known to *60 Minutes* and ignored. When CBS was pressed to tell the truth, they made a grudging on-the-air admission that Baum had employed several lawyers. They also admitted that Baum's taking the case

to Colorado was a routine appeal to the U.S. Circuit Court of Appeals. Those admissions struck at the heart of the *60 Minutes* story, but that was not explained to the viewers. The producer of this program is no longer employed by *60 Minutes* but CBS has never apologized for its smear of the Utah lawyers or the Mormon Church.

Reed J. Irvine
Chairman, Accuracy in Media, Inc.
Washington, D.C.

20/20 in Hindsight

Roone Arledge is right that he bears the responsibility for the debacle of the opening hour of *20/20*, as he so gallantly implies in David Frost's interview (September), although for reasons ludicrously at odds with those he suggests. Didn't see the show, he said, until he glanced at a cassette the next day. Should have been minding the store. Shucks.

The fact is, *20/20* was conceived, developed and staffed by Bob Shanks over a six-month period under the direct supervision of Arledge in his capacity as president of ABC News. The title of the show was cleared with Arledge, the opening music, the set, the format—indeed, even the selection of Robert Hughes and me as co-anchors.

The concept belonged wholly to Shanks, however, until the six weeks prior to airing, at which time Arledge became a factor of substance. Upon his request, every segment of the proposed hour was presented to him for his approval or rejection. Many of these segments were altered, truncated, or set aside in response to his reactions. Interstitial material to be spoken by Hughes and me was revised on command. For example, the "wisecracks" in the opening news summary, which now he finds so offensive, were revised many times over several days by the writer, Edward Tivnan, to meet his objections.

In bypassing his producer and assuming total authority of the enterprise, he took advantage of this authority to revise the best efforts of an imaginative producer and talented staff. Technically speaking, he is correct in saying he couldn't see a cassette of the show until the program was over since a complete tape was not ready by air time. He saw what a lot

of the critics saw, however, since he was right there in the control room telling the rest of us what to do. The captain at the bridge, shouting orders as we sank. And then he jumped ship.

His failure to assume editorial responsibility for a disaster he personally orchestrated is, to me, boggling. I have told him this in private; his insistence on revising the facts for purposes which one can only assume to be consistent with his new role as a responsible newsman obliges this correction to be made in public.

*Harold Hayes
New York City*

Mr. Hayes co-hosted the first telecast of 20/20.—Ed.

Shōgun, the Article

I was distressed to find that selective quotation gave a negative and hostile tone to my comments about the historical accuracy of James Clavell's "Shōgun" ("The Shōgun Blitz," August). When pressed to give examples of specific ways in which the world of "Shōgun" is at odds with historical reality, I did so. But I would certainly like the record to bear my overall opinion, that on the whole, Clavell has written a novel which is instructive about Japan and sympathetic to the beliefs and customs of the Japanese people. Clavell is a storyteller and not a historian. But he is also an idealist, and the liberties which he takes with Japanese history help him to say something about Japan as a mirror for America—and in the process to suggest a few lessons for professional historians.

*Henry D. Smith II
Associate Professor
University of California
Santa Barbara, Cal.*

Correspondence for this column should be addressed to: Letters Department, PANORAMA, P.O. Box 950, Wayne, Pa. 19087. No anonymous correspondence will be published. Letters may be abridged because of space limitations. We regret that it will not be possible for us to reply individually to letter writers.

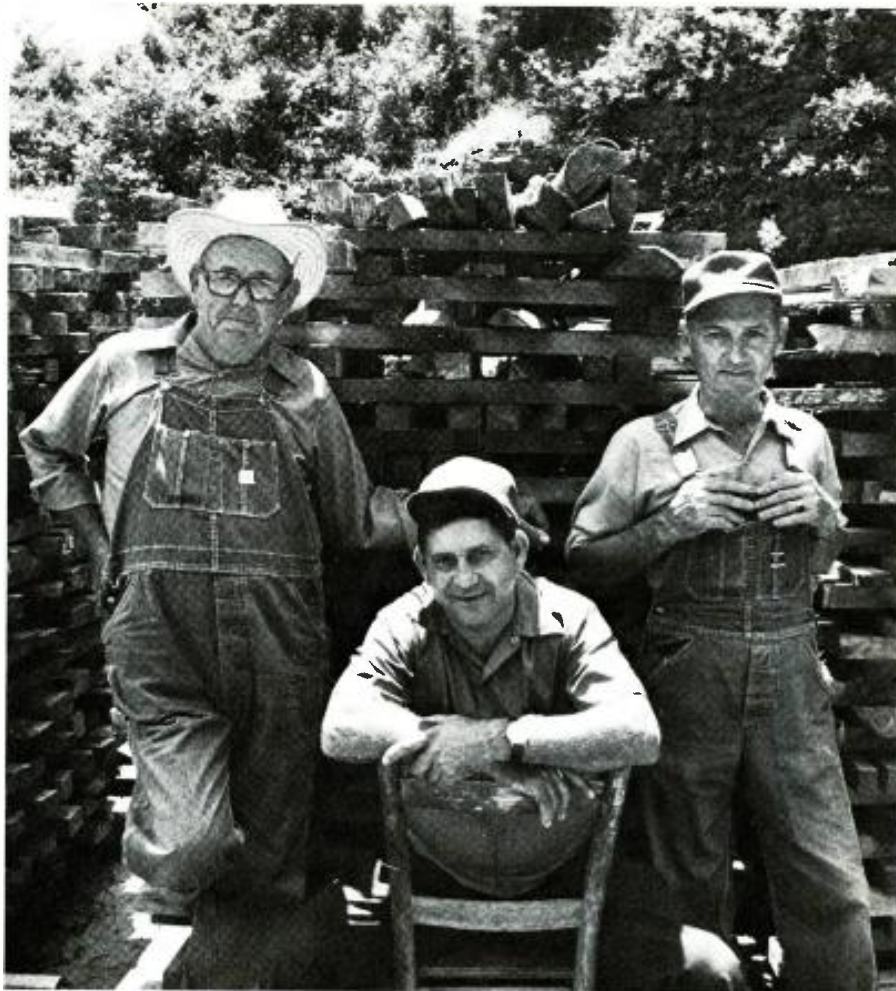

If you'd like to know *how* these boys can get charcoal by burning hard maple wood, drop us a line

BATEMAN, BURNS AND BRANCH sound like Philadelphia lawyers. Actually, they're rickers from Tennessee.

There aren't many men who can take a rick of hard maple wood and burn it into tiny pieces of charcoal. But these three gentlemen can. And, after the charcoal is packed into big vats, we gentle our whiskey down through it. If you're wondering what accounts for Jack Daniel's smoothness, give the credit to this charcoal. But don't overlook a trio of rickers—named Bateman, Burns and Branch.



CHARCOAL
MELLOWED



DROP



BY DROP

Tennessee Whiskey • 90 Proof • Distilled and Bottled by Jack Daniel Distillery,
Lem Motlow, Prop. Inc., Route 1, Lynchburg (Pop. 361), Tennessee 37352
Placed in the National Register of Historic Places by the United States Government.

some guys have to do radio.

"You think the day is over then? No. You often have to physically take care of the crew. Literally. Where do they sleep? Where do they eat?"

Sound like fun? Sound like somebody you would like your sister to marry? Or become?

Wonder now why the crews fly—with some exceptions—on the zoo plane? And, because they fly on the zoo plane, that makes the aisle seats of that plane the most dangerous seats in the air. The crews drag their equipment up and down the aisles with furious speed, bouncing it off whoever is sitting there.

I know one reporter who switched from one side of the aisle to the other during a campaign swing, just so the black-and-blue marks would even up.

The zoo plane often seems marked for particularly bad luck. In 1976, after the second Presidential debate in San Francisco, the Carter press bus ran into the parked zoo plane and knocked off the wing tip. It was repaired, but upon landing at its next stop in the Southwest, the zoo plane came down too hard and lost a landing strut. In Cleveland it simply stopped functioning and everybody had to be put on the A Plane, called Peanut One.

On takeoff, the captain of the plane made an announcement. It was raining very hard, he said, and the plane was very, very heavy. There were extremely high crosswinds whistling in from Lake Erie and there was a teeny problem with the port engine. "We would appreciate your cooperation," he said.

Jim King, Carter's travel coordinator, got on the loudspeaker. "I have a press advisory," he said. "Our Father, who art in heaven . . ."

One great tension lightener on the zoo plane is known as Beer Bomb. Legend has it that Beer Bomb was invented on Oct. 31, 1972. George McGovern was running for President, and on Halloween the press corps gave him a pumpkin as a gift. The story goes that he kept it on his lap until takeoff. Then he set it down in the aisle to fasten his seat belt. As the plane left the ground, the pumpkin sped backwards as if shot from a cannon. It exploded in the rear cabin of the plane,

and reporters were picking pumpkin seeds out of their hair from Portland to Poughkeepsie.

Since carrying pumpkins around was found to be inconvenient, Beer Bomb was the logical spinoff. On takeoff, a person in the front of the plane takes an unopened can of beer and rolls it down the aisle. The acceleration of takeoff combined with the tilt of the plane causes the can to travel with terrifying speed. The object of Beer Bomb is to have the can hurtle to the back of the plane, explode, and whirl around madly, spraying everyone.

Once during a game of Beer Bomb over Seattle, I watched an NBC cameraman throw his body on the beer can and yell "I'm old! Save yourselves. I'm old!"

He was given a standing ovation.

Actually, much of the buffoonery that takes place on the planes is to cover up the fact that some reporters are simply terrified of flying, especially since the candidates often insist on flying through any weather and in any type of plane.

One of the most famous planes of all was the plane Mo Udall used during the 1976 Wisconsin primary. I boarded it one day in Wisconsin and sat next to a very moody and very famous TV reporter who was chewing wads of Aspergum. I assumed his bad mood was because of his sore throat but later found out he was afraid of flying. A Udall aide tried to calm him down. The plane was the same one used by the New York Sets, the professional tennis team, the aide said.

Then why aren't they still using it? the reporter asked. "They lost an engine and they gave it up," the aide said.

The TV reporter turned pale.

"Don't worry, don't worry," the aide said, patting his arm. "We spent \$30,000 and got a new engine."

As the plane began to taxi, the reporter grabbed the armrests in a death grip. I could see his knuckles turn white. I tried to help. "Relax," I said, "it's going to be fine. They replaced the engine."

"Fool," he said through clenched teeth, as we rattled down the runway. "Where would Mo Udall get \$30,000?" ■

Editor:
David Sendler

Managing Editor:
Ellie Kossack

Associate Editors:
Dick Friedman,
Brandy Rommel, Jack Friedman,
Tim Whitaker

Art Director:
Norman S. Hotz

Picture Editor:
Laddie Marshack

Assistant Art Director:
Patricia Ryan

Production Manager:
Louis Terracciano

Editorial Coordinator:
Debra Sheer

Copy Editors:
Gail Harlow (*Chief*)
Nyoka Hawkins, Deborah Lyons,
Teresa Schwab, Karen Grigsby

Art Assistants:
Fran Strauss, Monica Garb

New York Bureau:
Doug Hill, Howard Polskin

Los Angeles Bureau:
Don Shirley

Correspondents:
Steve Weinberg (*Washington*)
Richard Gilbert (*London*)

Contributing Editors:
Douglas Bauer, Bill Davidson,
Edwin Diamond, Steve Gelman,
David Lachenbruch,
Lawrence Linderman,
Sam Merrill, Ted Nelson,
Richard Reeves, John Schulian,
Harry Stein

Advertising Director:
Robert G. Baumler

Eastern Advertising Manager:
Malcolm B. Niedner

Western Advertising Manager:
James L. Lee

New York Advertising Manager:
Michael L. Fulford

Advertising Production Manager:
Margaret E. Kilmartin

Advertising Representatives:
Atlanta:

Advertising Sales/South Inc.

Chicago:
Warden, Kelley, Allen and Opfer, Inc.

Los Angeles:
Lowell Fox & Associates

Circulation Director:
Hugh Crocker

Research Director:
Bruce Gershfield

Public Relations Manager:
Brian Levitt

Business Manager:
John T. Larkin

Publisher:
Frank G. Wolf

Editorial Director:
Merrill Panitt

Walter H. Annenberg: Founder

Tonight, turn on the coffee table.



Picture simulated.



When you switch it on, movies come out of your furniture, your favorite news reporters emerge from beneath the glasses and ash trays, and your living room turns into a theater.

It's just another little innovation from Sony: VideoScope™ television.

It consists of a television projection unit (in the coffee table) and a screen (completely separate), so you're free to arrange your furniture just about any way you choose.

You're also free to choose between an incredibly big screen (50" measured diagonally) and an even bigger screen (72" measured diagonally).

But what's most important about the picture isn't how *large*; it's how *good*.

This good: the absolutely beautiful and sharp and bright picture you'd expect from Sony.

After all, Sony did invent the Emmy Award-winning system that's the heart of every Trinitron® television. Now most of that same technology can be the heart of your coffee table.

And it's nice to know that when you turn it off, the room switches instantly back to normal.

So you gain a theater without losing a living room. **SONY**
THE ONE AND ONLY

© 1980 Sony Corporation of America. Sony, Trinitron, and VideoScope are trademarks of Sony Corporation. Model shown: KP-7220.



Marlboro

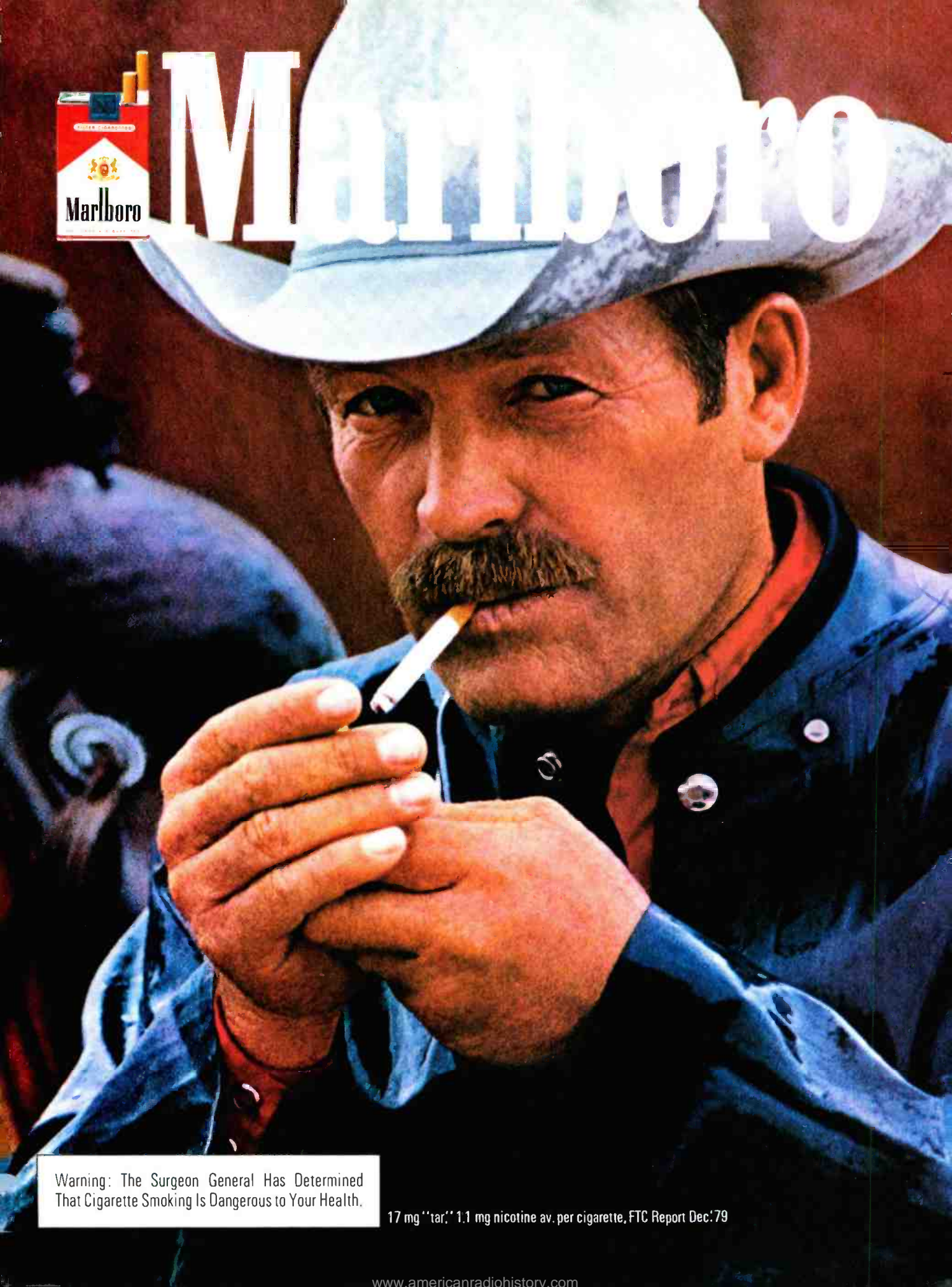

Warning: The Surgeon General Has Determined That Cigarette Smoking Is Dangerous to Your Health.

17 mg "tar," 1.1 mg nicotine av. per cigarette, FTC Report Dec. '79

Hope for TV's Black Series Is "Up and Coming"

By CYRA McFADDEN



The cast of PBS's new series *Up and Coming*: (from left) L. Wolfe Perry, Cindy Herron, Robert Doqui (seated), Yule Caise and Gamy L. Taylor.

To point out that situation comedy relies on stereotypes is to point out that the sun comes up in the mornings. As Walter Cronkite would put it, "That's the way it is."

Thus it isn't surprising that in this area of American life, at least, blacks have attained full equality: television sitcom generally caricatures them as shallowly as it does everybody else.

Given ethnic sensitivities and the genuinely liberal convictions of producers such as Bud Yorkin and Norman Lear (*Sanford and Son*, *The Jeffersons*, *Good Times*), black stock characters suffer not so much from racial stereotyping as from the stereotyping ubiquitous in sitcom. Black family life—like white family life, or Chicano family life, or family life on Mars—is shrill slapstick full of double takes and double-entendres. Fathers (such as George Jefferson) are clowns or louts or both. Mothers, black or white, are the stuff greeting-card verse is made of, without a selfish bone in their heads.

As for children, I give you one example, in the hope that you will take him—anywhere. Arnold of *Diff'rent Strokes* is the black version of sitcom's Everykid, relentlessly precocious, cute as a calendar kitten. Yes, he's mischievous, the little scamp, but like all those WASP children on half-a-dozen interchangeable sitcoms, Arnold is good. You're not going to catch him smoking dope or stealing hubcaps.

Some form of reverse discrimination, in fact, dictates that blacks on television do "gooder" than anybody except, perhaps, Mother Teresa. So one-dimensional characters prevail, salvaged only by broad comedy and the performances of some first-rate actors.

Now there are a few signs that TV

series are ready to treat their black characters in more depth. *The White Shadow* is one prime-time example: its black high-school basketball players are credible and complex human beings, rather than types.

Stereotyped as neither petty criminals nor plastic saints, the blacks on the show demonstrate the same spectrum of behavior blacks and whites demonstrate in the real world. In one episode, blacks manufactured and sold angel dust, blacks were among the victims and blacks turned the manufacturers in.

Another departure from the superficial sitcom version of black life is *Up and Coming*, a new series making its debut on PBS this fall. Produced by KQED in San Francisco, the show is intended primarily for teen-agers. Since it's lively, believable and thoroughly entertaining, it just might find an adult audience as well.

Like the Jeffersons, the Wilson family of *Up and Coming* is black, urban and middle-class. There, however, all resemblance ends. The mother isn't just another earth mama; rather she's an assistant loan officer at a bank. The father, played by veteran actor Robert Doqui, is a man instead of a loudmouth. And the kids, though they are all good-looking, have escaped the disease that strikes most TV children—without, unfortunately, killing them. None of the three Wilson children suffer from cuteness.

The series is unusual in other ways. Because it makes use of outside locations, *Up and Coming* looks authentic. Parents and kids go about their lives in a real city: not the San Francisco of the tourist brochures, but the city that its residents know, complete with fog, unscenic neigh-

borhoods and exhaust-belching buses. And unlike most TV characters, Frank Wilson has a believable working life. The owner of a small construction company, he works alongside his crew at building sites, pounding real nails into what are apparently real boards.

Up and Coming isn't sitcom but realistic drama, aimed at helping teenagers confront and solve problems in their own lives. Occasionally, it is overearnest. More often it's affecting and funny, and the comedy is that rare species called "character comedy"—humor that derives from fully developed characters leading fully developed lives. No by-the-numbers jokes, no pratfalls and no one-liners. You can laugh at it without wondering whether your brain cells have been affected by the thinning of the ozone layer.

In one episode, a black high-school basketball star, "Highrise," (played by an electrifying young actor named D'Alan Moss) is pursued by recruiters from small-time colleges. Slickly dressed smoothies in three-piece suits, the recruiters must walk the fine line between blandishment and bribery. One follows Highrise up the stairs and straight into a friend's living room. "I was just in the neighborhood," he explains.

Also novel is the casting of the series, a mix of professional actors and novices. One of the latter is former Stanford basketball star L. Wolfe Perry, who plays the Wilsons' 17-year-old son Kevin. Perry, who has a pleasantly natural quality in front of the camera, has already been signed as a regular on a CBS series. You guessed it: *The White Shadow*.

Let us hope the rest of the cast and, most of all, *Up and Coming's* writers somehow infiltrate *The Jeffersons* and *Diff'rent Strokes*. [■]

Our newest Video Director gives you 14 day programming, remote control with stop action and Speed Search* (fast forward and reverse with picture), 5 hour tape time, audio dubbing, electronic tuning, automatic indexing and superb picture quality.

The Video Director.



The 14 day Programmable Video Director.

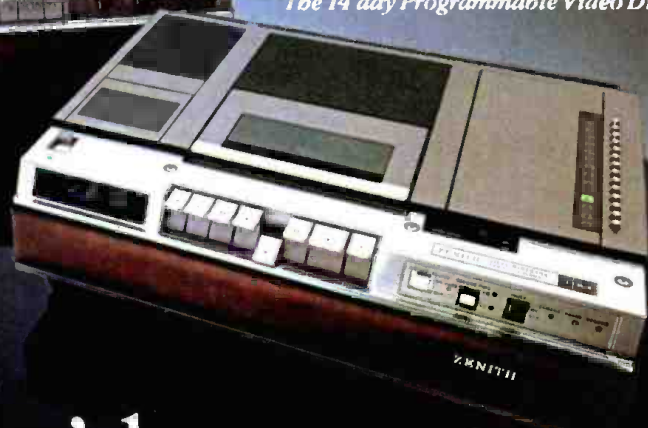

Just
what you'd expect
from Zenith.



ZENITH

*Beta III mode

The quality goes in before the name goes on.

THIS MONTH

NOVEMBER 1980

The Great TV Talent Hunt . . . The Muppets Big Score . . . Should Trials Be Televised? . . . "New" Shakespeare Play Unearthed

WHAT'S HAPPENING

HOLLYWOOD

Don Shirley reporting

Go east, young man. Where do television actors come from? Sometimes it seems as if they've all been spawned on either the beaches of Southern California or the streets of New York City. At least that's the complaint you often hear from actors who are plying their trade neither in California nor in New York.

Perhaps this is why ABC's L.A.-based casting department conducted a widely publicized four-city search for "new faces" of 1980, combing San Francisco, Chicago, Atlanta and (surprise) New York. Approximately 2900 actors were considered; of these, 90 were given screen tests and at least five were placed in series or pilots. This season you will likely see—as regulars—Ralph Maccio in *Eight Is Enough*, Ethan Phillips in *Benson* and Phoebe Cates in the possible midseason replacement *Mr. and Mrs. Dracula*.

Is the Los Angeles-New York actors' monopoly in danger? Hardly. It seems that all the young actors that ABC discovered—the ones that were placed in series—came from (you guessed it)—New York City. ABC might as well have confined its shopping trip to the Big Apple.

Los Angeles-based actors and casting directors are not amused. When an ABC executive mentioned his network's talent search at a seminar, which was heavily attended by Los Angeles actors, he was met with a chorus of hisses. Columbia Pictures Television casting chief Al Anorato then took the floor to lambaste the project: "I resent the fact that we pat ourselves on the back because we go to six cities to find 10 people who have 30 minutes of training. New talent is coming off the plane and the bus here every day; you don't have to go out there and look for it. You're not going to find it in Tuscaloosa." ABC executives reply that they examine Los Angeles actors constantly.

Currently, there are plans for at least one more talent search; this one will be aimed into the very heart of Texas. Perhaps ABC execs will run into some promising actors there . . . who hail from either New York or L.A.

A vote for Evita. Hopping on the proverbial bandwagon has always been a favorite programming strategy at the networks. So it hardly comes as a surprise that NBC—taking its cue from the success of the Broadway musical "Evita"—plans to broadcast its own dramatization of the life of Eva Peron. Tentatively titled "Evita Peron, First Lady" and produced by Marvin Chomsky ("Attica," *Holo-*

caust), the four-hour NBC film probably would not have been ordered had "Evita" not been a hit, acknowledges Irv Wilson, NBC's movies-for-TV boss. Before theatergoers took "Evita" to their hearts, NBC had already considered—and rejected—its current Eva Peron project. But when "Evita" struck gold, the idea was revived.

"Evita" co-producer David Land bears no grudge against NBC for jumping on his bandwagon—even though the TV-movie might cut into the audience for his feature-film version of the musical. Land predicts the small-screen version "will be good publicity for us." Besides, he adds, the story of Argentina's unofficial queen "is in the public domain. As long as they don't use our tunes, there's nothing we can do about it."

The title role in the NBC movie will be played by Faye Dunaway—Meryl Streep turned it down. Gary Coleman's company is co-producing the film, but there is no truth to the rumor that the precocious *Diff'rent Strokes* star will play the role of Juan Peron.

NEW YORK

Doug Hill reporting

Muppets and megabucks.

Q: What's green and amphibious and destined to make Jim Henson a richer



Faye Dunaway: *Evita*, si! Gary Coleman, no!



Kermit: Moves to a high-rent pond.

SPORTS

The Instant Replay Conspiracy

By JOHN SCHULIAN



ly. Which was not to say, the League added, that its camera angle was the right one.

The inescapable truth, you see, is that TV cameras are often no more reliable than officials' peepers. There are maybe two dozen angles from which to shoot a game, and since no network uses more than 11 cameras on any given regular-season game, the odds for total visual truth are still lousy. So, incidentally, are the chances of any network spending the extra millions it would take to fill all the empty camera angles; a defeat for electronics perhaps, but certainly a victory for perspective. "Cripes," says Beano Cook, the associate director of publicity and resident social critic at CBS Sports, "they only used two or three cameras when MacArthur returned to the Philippines."

From all indications, the high muck-a-mucks of the NFL don't think their battleground is any less important than that of World War II. But they have risen up against instant replay for officiating on the grounds that it takes the human element out of football.

It is a strange concern when you consider just how large a role technology already plays in the game. There are linemen who live on Dexedrine, quarterbacks who protect their battered bodies with the equivalent of bulletproof vests, and entire teams with computers advising them that blinking in unison is the key to victory. But if the League's pooh-bahs want to decry science this once, they have found an ally. For no matter what players have in them or on them, they are always going to be just as capable of God-awfulness as they are of greatness. Surely, then, they should be judged by creatures as fallible as they.

In a game built on emotion, it wouldn't seem right if the players, the home crowd and the sporting press didn't have bad calls to kvetch about. Besides, if the officials' eyesight is as bad as it frequently appears to be, they couldn't see the instant replay anyway. ■

It has always been hard to tell who appreciates instant replay more—the football fan who can't believe what he has just seen on TV, or the sportscaster with the easily tied tongue. In either case, there is something undeniably reassuring about knowing that you are going to see a solid-gold play two or three times, from two or three angles. No wonder some of us have more trouble recognizing our own children from behind than we do Terry Bradshaw's passing style.

More parental confusion, however, is nothing compared with the dastardly proposition currently polluting the National Football League. There are demands that instant replay be used as an aid in officiating games, and that can only mean we are but a down-and-out pattern away from putting robots in shoulder pads.

It is one thing to turn on the TV and let Walter Cronkite change the dinner hour and Johnny Carson rearrange our sex lives. But there is just too much of George Orwell's worst dreams in this instant-replay nonsense. Not only is the idea anti-human, but it would rob the public of its divine right to vilify the men in striped shirts. Surely the Kremlin is behind all of this and the CIA should be notified.

Alas, no fan worth his undershirt and beer can is going to campaign against this electronic intrusion, because his beloved NFL players are the ones lobbying the loudest for an official instant replay. And the most anguished howls come from the players who are the latest to get the shaft by a blown call.

Consider the case of Mike Renfro, a tough little mutt employed by the Houston Oilers as a wide receiver. One Sunday last January, Renfro ran into the deep right corner of the end zone in Pittsburgh, thinking of nothing but catching the touchdown pass

that would erase the Steelers' 17-10 lead. He leaped the way only an athlete in a play-off game can leap, and when he alighted the ball looked like it was clutched to his bosom and his feet looked like they were in bounds. All he needed was the seal of approval from a side judge named Donald Orr. Alas, Mr. Orr was too busy imitating a municipal statue to make a call.

Thus began a scenario that gave fanciers of conspiracy theories one more bone to chew on. One minute Orr and his six fellow officials were huddling in the end zone, a rare sight indeed. The next, they were signaling that Renfro's catch was no good, albeit without ever explaining just why. Later—after Pittsburgh had hung on to beat the stunned Oilers 27-13—Jim Tunney, the chief of the officiating crew, told disbelieving reporters that Renfro never had the ball firmly in his grasp, *ergo* no touchdown. And the unusual conference? "We wanted to double-check and be sure we agreed," Tunney sniffed.

No doubt the people who watched the play at home on NBC thought the officials should have simply marched over to the TV monitor 20 yards away from them. On its screen was an instant replay that made Renfro's catch look as good as gold. Historians claimed that the officials should have looked at the replay because they had done so eight years earlier to validate a controversial catch now known in Pittsburgh as Franco Harris's "Immaculate Reception." The justice-for-all folks argued that the replay should be used any time there is a play too tough for the human eye to follow.

That sounded fine until the NFL studied the game film—its own, not television's—and declared that Renfro had indeed juggled the ball fatal-

Look at television the way we do.

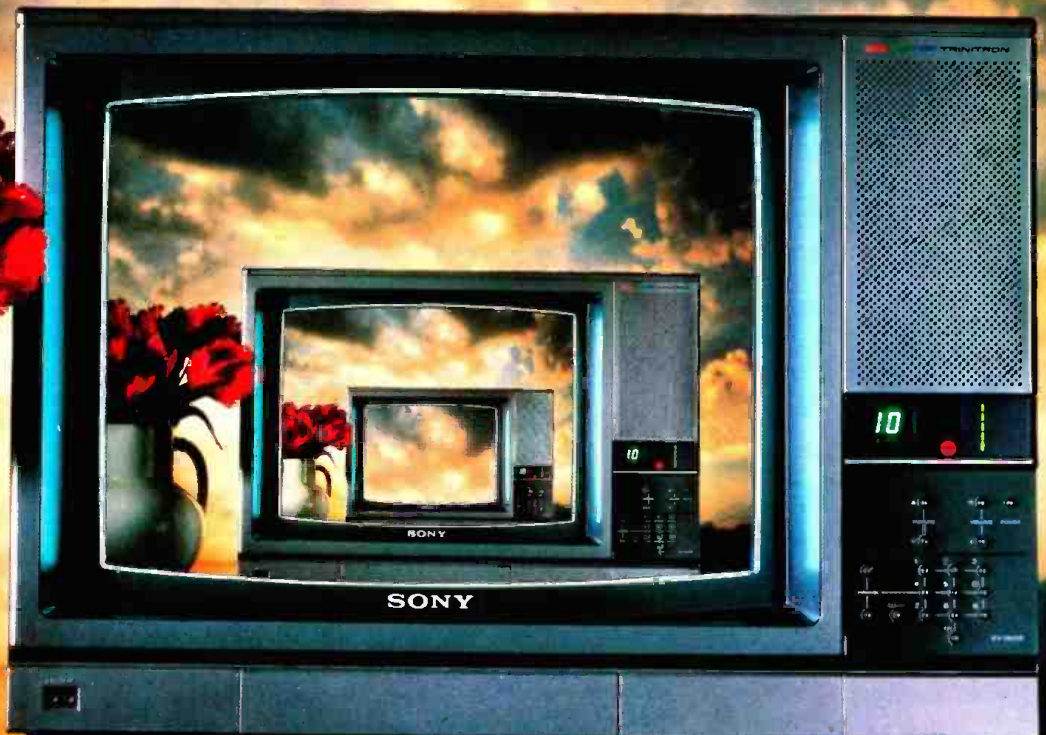

Television should be more than an electronic tranquilizer.

At its best it is art, and like any art form it should involve you, touch you, move you.

Experience the art of television at its best on the one television that is itself a work of art: the Emmy Award-winning Sony Trinitron.

From the world's smallest color screen to the largest available in the U.S., there are 23 different models, and every one is every inch a Trinitron.

Experience television at its finest.

Look at it our way.

SONY
THE ONE AND ONLY



Model shown: KV-1945R
© 1980 Sony Corporation of America.
Sony and Trinitron are trademarks of Sony Corporation.

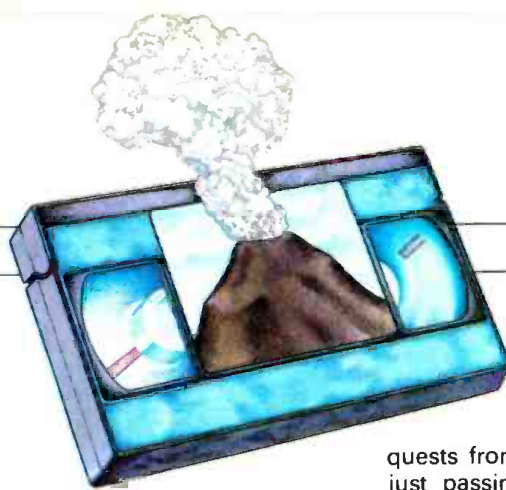

THAR'S GOLD IN THEM THAR VOLCANOS

“In 1984, we won't even need conventions. All we'll need is Howard Cosell, during the break on *Laverne & Shirley*, telling us whom we ought to elect.”

—George Bush, shortly after dropping out of the Presidential race, on the CBS News Sunday Morning program

It had to happen. Given the miles of news film and the spectacular visuals involved, two enterprising TV stations have put together “the best of” the Mount St. Helens eruption. Available in both Beta and VHS, this 26-minute cassette can be yours for a mere \$39.

The joint venture by KOMO-TV (Seattle) and KATU (Portland) grew out of the enormous local interest in the Mount St. Helens disaster (both stations are within 130 miles of the volcano). “People wanted to see more and more,” explains KATU’s Ken Strobeck. “I mean, it’s not every day a mountain blows up in your back yard. We did a couple of special programs on the air, which got good ratings. So . . .”

So, KOMO and KATU—both owned by Fisher Broad-

casting—ransacked their tape and film libraries for their most effective disaster footage. After adding narration, music, historical background and a bit of Indian lore regarding the mountain, the result, according to Strobeck, is “sort of like a video coffee-table book, a living souvenir. We’ve got film of Harry Truman [the octogenarian who refused to leave his Mount St. Helens lodge]. We’ve got before-and-after shots of all the devastation. There’s Spirit Lake—or what’s left of it. We’ve also got flooding and a house coming down a river and crashing into a bridge. It’s something you can watch and be knocked off your feet by.”

Who’s buying the cassette? “We’re getting a lot of re-

quests from people who are just passing through,” says Art Pattison of KOMO. “I guess that’s because local people have experienced it too directly. Still,” Pattison notes, “we’ve had some local folks who don’t even own a Beta or VHS system buy the tape. I suppose that when they get a machine, they’ll want to show this thing to their kids.”

Although Strobeck and Pattison both want the tape to do well, they seem to differ on the sort of cooperation they want from Mount St. Helens.

Says Pattison, “Strictly in terms of marketing, every time the mountain burps it stimulates interest in the tape.”

Says Strobeck: “I wish it were history. Frankly, we’re tired of dealing with it.”

BIG BIRD LAND

Bird-watchers, take note. Big Bird of PBS’s popular *Sesame Street* has a new roost. No, it’s not another TV show. It’s an amusement park called Sesame Place, and it’s located 18 miles north of center-city Philadelphia, in Langhorne, Pa.

In the mid-’70s, the Children’s Television Workshop, creator of *Sesame Street*, hatched the concept of an educational but lively play park for kids 3 to 13. This past summer, the \$9 million park finally opened after a few years of creative brainstorming by a 20-member development team anchored by creative heavyweights such as the Muppets’ Jim Henson and well-known designer Milton Glaser. The opening day ribbon-cutting ceremonies were

led by—who else?—Big Bird himself.

Unlike other amusement parks, Sesame Place has no mechanical rides like roller coasters or ferris wheels;



there are no sideshows or junk-food emporiums. Additionally, it’s relatively small (three acres) and costs only \$3.95 for admission. So what’s in it for the kids?

Plenty. Sesame Place has

more than 40 outdoor play elements that make half the park look like a vast outdoor gymnasium landscaped with cargo nets, wooden mazes, a small forest of huge punching

their coordination and motor skills in the process.

When children tire of the outdoor activities, they can exercise their brains by tackling about 70 specially created electronic games in what is said to be the country’s largest collection of educational computers. There’s also an exact replica of the *Sesame Street* set—complete with a live TV camera and monitor placed so kids can see themselves sitting on those famous front steps.

If Sesame Place draws crowds as successfully as its video cousin, there will probably be other similar parks constructed around the country in the next three years. Judging from the initial popularity of Sesame Place, it looks as though Big Bird’s new nest is another feather in CTW’s cap.

Enter a World of Pure Magic.



WALT DISNEY Home Video

Let yourself escape to a realm of imagination and enchantment that's as near as your television set. Now your whole family can enjoy Disney's happiest movies on home videocassettes.

Voyage aboard Captain Nemo's submarine, *20,000 Leagues Under the Sea*. Blaze a wilderness trail with *Davy Crockett, King of the Wild Frontier*. Experience the farthest reaches of space amid the awesome mystery of *The Black Hole*. And, for a special treat, be sure to catch Mickey Mouse, Donald Duck, and Goofy in their most memorable animated adventures.

You can rent or purchase Walt Disney Home Videocassettes from leading home video deal-

ers. Or, send in the coupon below to join the Walt Disney Home Video mailing list. You'll receive a free full-color catalog plus news of all upcoming releases.

Free Walt Disney Home Video Catalog

Please send me a free Walt Disney Home Video catalog and place my name on the Disney video mailing list.

Name _____

Address _____

City _____ State _____ Zip _____

Clip and mail to: WALT DISNEY HOME VIDEO
P.O. BOX 7089, BURBANK, CA 91510

VCBAG

**OF SNAKES,
REGGAE
AND BATTERED
WIVES**

You suspect it's not *The Tonight Show* when the host clumsily swings across the studio on a ragged rope, wearing a tatty batik shirt, baggy Bermuda shorts and a rumpled safari jacket. The stunt and the props are by way of introducing the next three guests—an African bush baby, a scaly python and a mild-mannered gent from the Boston Zoo who seems never to have been on TV before.

"Do [pythons] breathe through their skins or do they have little noses—and exactly how long are they?" asks host Matt Seigel, who seems never to have seen a snake. The handler slowly, wordlessly, unravels a crumpled cloth tape measure that could have come from your grandmother's sewing basket and measures the python, now slumped across Matt Seigel's torso, darting its tiny tongue for effect. Definitely not *The Tonight Show*.

What it is is *Five All Night Live All Night*—*FANLAN* to the cognoscenti—the only live, late-night TV talk show in

the country. The program first appeared March 5, 1980, on Boston's WCVB-TV (Channel 5) and has garnered voluminous local press and a surprising number of viewers, considering that it is broadcast immediately following the ABC late-night schedule, often as late as 2 A.M.

"*FANLAN* is not from production values," says a viewer, "but it's got spirit and warmth." The show comes across as a combination of ragged-but-sincere film-student movie, "Groove Tube"-type video improv, underground cabaret, off-Broadway experimental theater and radio talk show, this last reflecting its host's origins as an FM radio personality best known for his fine-tuned sense of the absurd.

For instance—Seigel modeled the zoo's "longest" resident during a recent show featuring rock musician Frank Zappa, who came complete

with excerpts from his film, "Baby Snakes." The vitriolic Mr. Zappa, unlike the python, did not arrive with a handler—and could have used one. In between the animal acts, continuous call-ins and local comedians alternate with features such as "Dr. Matt's Advice to the Lovelorn" and performances by rock, jazz, reggae and blues musicians.

Other guests have included Phil Donahue; Douglas Fraser, president of the UAW, who answered questions from viewers anxious about the future of their jobs and curious about what kind of car he drove; authors; critics; battered wives; politicians; representatives of consumer organizations and an array of local characters.

Inevitably, some of those local characters are car dealers. A 30-second spot on *FANLAN* costs a lowly \$50, and area manufacturers and retailers, radio stations and

home-grown musicians are lining up to buy time. It's probably not a bad buy—no ratings are done, but an average two-hour show (approximate budget: \$400, excluding guest and musician fees) draws more than 7000 calls, and broadcasters generally assume that each call represents some 200 viewers.

Former producer Danny Schechter, a devotee of "alternative journalism," attributes much of *FANLAN*'s "late-night feeling" to the emphasis on content, not form. "Slickness isn't an asset if the content of the show is 'Chinese-food television—eat it and 30 minutes later you're hungry,'" he says.

Producer Kevin Dawkins says the program seeks guests—and feature topics—that are different, interesting, or simply "a little weird."

Seigel sums up: "If you have a friend who always fools around, you don't bring your problems to him. But if the guy's always serious, you wouldn't ask him to a party. I try to switch around, so that people have fun with the show but can also tell me their problems."

P.S. He adds that having a python around his neck was less scary than being knocked to the ground by another recent *FANLAN* guest, wrestler Killer Kowalski.

—Lynda Morgenroth

SCENIC DRIVES

It lives at the golf course, eating quarters, catching errors and producing television shorts.

Just what the heck is it?

Instant Replay, a new coin-operated device that videotapes your golf swing and then plays it back so you can either marvel at your beautiful swing or figure out just what's causing that awful slice. The unit is about the size of a small washing machine

and sits on a three-foot-high frame with wheels.

Duffers plunk in their quarters (anywhere from one to eight, depending on what the golf-course operator thinks he can get away with), wait a few seconds until they hear a beep, and then swing for the fences. For anywhere from one-and-a-half to eight minutes the weatherproof unit, which houses a camera and VHS video recorder, tapes your swing. It automatically

rewinds and will play back in either slow-motion, stop-action, frame-by-frame or normal-speed modes.

The manufacturer of Instant Replay, Video Dynamics Inc. of Ogden, Utah, reports that so far only 20 units are being used around the coun-

try. Nineteen are at golf courses and the other one is in use on a tennis court. Golf courses can either buy the machine for \$6495 or lease it from Video Dynamics. For whatever reason, the unit is not sweeping the sports industry by storm. Perhaps golfers reject the idea of coming to play their game with a pocketful of change.

Or maybe they just resent having a TV screen putting in its two bits.

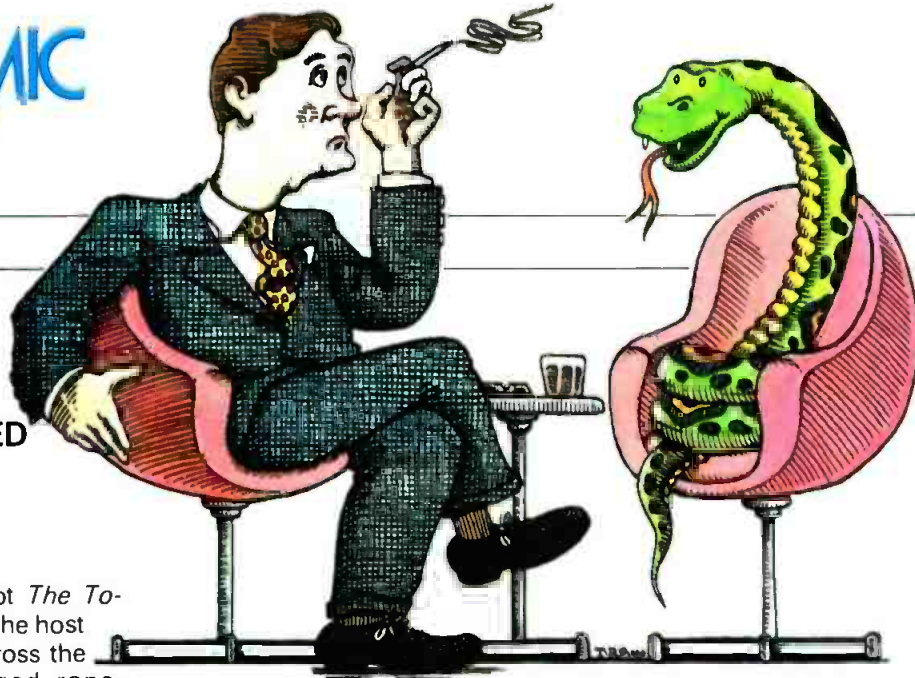

VIS...THE VIDEO LIBRARY ORGANIZER



PATENT PENDING ©COPYRIGHT 1979

INTRODUCING THE ONLY SYSTEM THAT TELLS YOU WHAT'S ON YOUR VIDEOCASSETTES, HOW TO FIND IT, AND HOW TO GET MORE RECORDING TIME OUT OF IT.

VIS... It stands for Video Information System. What it does is make what used to be a difficult job of organizing and cataloging your videocassettes a simple one.

With **VIS** you can create a complete comprehensive video library catalog of your VHS or BETA cassettes by program, title, artist as well as subject matter. And that makes life easy.

Each **VIS** system includes a VHS or BETA recording counter/time translation guide. With it, you can tell at a glance how much tape you've used and how much recording time remains. And that means you make the most of your videocassette investment. What it all adds up to is more recording time, and more entertainment for your money.

VIS I systems give you four one-write/snap-out forms per cassette for full cross referencing, of your programs. **VIS II** systems, which don't

include cross referencing, give you four title index cards per cassette. So you always know where everything is.

Still, there's even more to **VIS**. Like alpha numeric ID labels. Cassette inventory controls. Re-record inventory controls. As well as a future programming guide, complete easy to understand **VIS** instructions, and even a video recording guide full of valuable information no video enthusiast should be without. What's more, the entire **VIS** system is designed for any video format and comes in a fully self-contained attractively styled sturdy file box.

How do you make a difficult job simple? It's as easy as **VIS**.

Phone toll free 1-800-453-8777, N.Y. residents 212-541-7722 or mail the coupon with your check. Please allow 4-6 weeks for delivery.

Yes! I want "THE VIS SYSTEM."

Quan **VIS I SYSTEMS**

_____ Model 1000 (10 cassettes /40 programs) \$ 39.95 plus \$ 4.00*

_____ Model 2500 (25 cassettes/100 programs) \$ 69.95 plus \$ 7.50*

_____ Model 5000 (50 cassettes/200 programs) \$ 89.95 plus \$ 9.50*

_____ Model 7500 (75 cassettes/300 programs) \$109.95 plus \$14.50*

Quan **VIS II SYSTEMS**
(without subject and artist cross-referencing)

_____ Model 10 (10 cassettes /40 programs) \$19.95 plus \$ 4.00*

_____ Model 25 (25 cassettes/100 programs) \$29.95 plus \$ 7.50*

_____ Model 50 (50 cassettes/200 programs) \$39.95 plus \$ 9.50*

_____ Model 100 (100 cassettes/400 programs) \$59.95 plus \$14.50*

Connecticut residents add 6% sales tax.

*Postage and handling.

NAME _____ SIGNATURE _____

ADDRESS _____ PHONE NO. _____

VISA MASTER CHARGE DINERS CARTE BLANCHE AM. EXP.

CITY _____ STATE _____ ZIP _____

CREDIT CARD NO. _____ EXP. DATE _____



Please make check payable and mail to:
VIDEO INFORMATION SYSTEMS, INC.
P.O. Box 185/Dept. P-6, Deep River, Conn. 08417

Box design differs slightly between models. DEALER INQUIRIES WELCOME



In the '50s, the décolletage of *What's My Line?* panelist Fayé Emerson (inset) was daring. The novelty has worn off, but TV's breast fixation hasn't.

The Sexual Revolution: Is TV Keeping Pace with Our Society?

A writer has some surprising answers

By Marcia Seligson

In the early 1960s, Grant Tinker, now head of MTM Enterprises, was a programming vice president at NBC. A man not only of taste and discriminating intelligence, but of real social conviction, he became concerned with the plague of venereal disease among American teen-agers. He saw an opportunity for the network to do a bit of public service through its series *Mr. Novak*, in which James Franciscus played a high-minded high-school teacher. Acting on writer E. Jack Neuman's idea, Tinker proposed the creation of a two-part episode dealing with VD, and was immediately and adamantly shot down by the higher-ups. They would agree to a VD documentary in a 10-to-11-P.M. time slot, but definitely not in a family-oriented series, and not at 7:30 while children were at the set.

Incensed, Tinker boarded a plane to New York and confronted a major NBC executive. This was vitally important, he coaxed, it was good television, and he *wanted* kids to be watching it at 7:30—that was, in fact, the whole point. The major NBC executive responded with one of the classic lines of contemporary broadcasting. "Grant, please," he said. "Forget it. They're eating in Chicago."

Since then, times may have changed some—as evidenced by Tinker's *The White Shadow* doing an episode on VD

Marcia Seligson is the author of "Options: A Personal Expedition Through the Sexual Frontier," which will be made into a six-hour miniseries on ABC. She is currently writing a novel.

last season. But in addition to being a quotable and piquant little anecdote, this story neatly capsulizes the subject of Sex in Television, then and now. It speaks to the issues of what is considered fit and unfit for family viewing, to the variables of programming during different hours of the day, to the power struggles among corporate brothers, and to the supposition that a group of elite business honchos actually understand what 200 million people want to see on television. But the salient question remains: What is the networks' responsibility to present issues of sexuality in an adult and realistic manner?

It goes without saying that the sexual life of this country has roared through volcanic cataclysms since the television set invaded our homes some 30 years ago. Sexuality has emerged from the dark bedroom into the glaring light of freedom and merciless examination. Virginity after age 18 or so is obsolete, weird; extramarital relations, statistically, happen for nearly half of marrieds; *Masters and Johnson* are about as celebrated a team as *Mork and Mindy*; women finally have acknowledged that they are at least as sexual as men; nudity—male and female—dominates many popular magazines; Americans are obsessed with orgasm. Sex is everywhere, and most citizens live significantly different lives from those they did 20—or even five—years ago. And the popular arts, which usually reflect and sometimes predict the state of any society, are a barometer of the shifts.

Why is it, then, that television—the



GROTE © '80



Playing for Blood

A look inside those nasty network sports wars—where unsportsmanlike conduct is the name of the game

By MARK RIBOWSKY

The Plaza, the Pierre and a view of Central Park South can be seen from Barry Frank's Fifth Avenue office window. Although Frank himself sells schlock, it sure got him into a nice neighborhood. Now the corporate vice president of the International Management Group, Frank sold a whole lot of schlock as president of one of his company's subsidiaries, Trans World International, which is the television-rights seller for some three dozen sporting groups and sporting events. To be fair, some of these events are nonembarrassing—Wimbledon tennis, USAC auto racing, track meets. Most, however, aren't—roller disco, karate, women's body-building, *Superstars*, *Battle of the Network Stars*, *Celebrity Challenge of the Sexes*, *Games People Play*. Still, Frank is giddy enough to describe the latter four as "extremely creative programming"—and he can get away with it. Because regardless of how mindless the premise is, regardless of how many people hang by their teeth from rooftops and run dashes with refrigerators on their backs, someone will be standing there with a checkbook if the bizarre antics can possibly be classified as a sporting event.

The someones are mainly named CBS, NBC and ABC.

"The competition for events among the networks is fierce—a war, really," Frank says as he swivels around with gleeful abandon behind his big desk. "Sometimes it seems like they're trying to cram all the events they can into

their schedules, more and more in prime time." The abundance of teeth he bares tells you he's not a bit interested in helping negotiate peace.

Which is only natural, since Frank was a very prominent soldier in the escalation of the sports war. After six previous years at TWI, he left in 1976 to "fulfill my dream of running a network sports department," and became vice president of CBS Sports. But the dream soon crumbled when the voices on the other end of the phone came from the FCC—in the wake of CBS's four "winner-take-all" tennis matches that turned out to be winner-take-some. It turned out that the losing players were walking away with a lot more than a supply of used tennis balls. Although Frank was cleared of official dishonesty, the little deceptions and omissions involved in ballyhooing the matches as something they were not—which some contend led to Frank's and CBS Sports president Bob Wussler's resignations, although both deny that was the reason they left—loudly pointed up two very important industry trends: how crucial sports had become to the networks in the mid-'70s, and to what lengths network sports people will go for what seems a sellable product.

The volume of phone calls Frank had waiting for him when he returned to TWI two years after leaving it wasn't a bad indicator, either. "Believe me," he says, "after the politics, BS and pressures of the network, this is paradise. I feel loved, popular. I'd forgotten what

Mark Ribowsky is a free-lance New York journalist who specializes in sports stories.

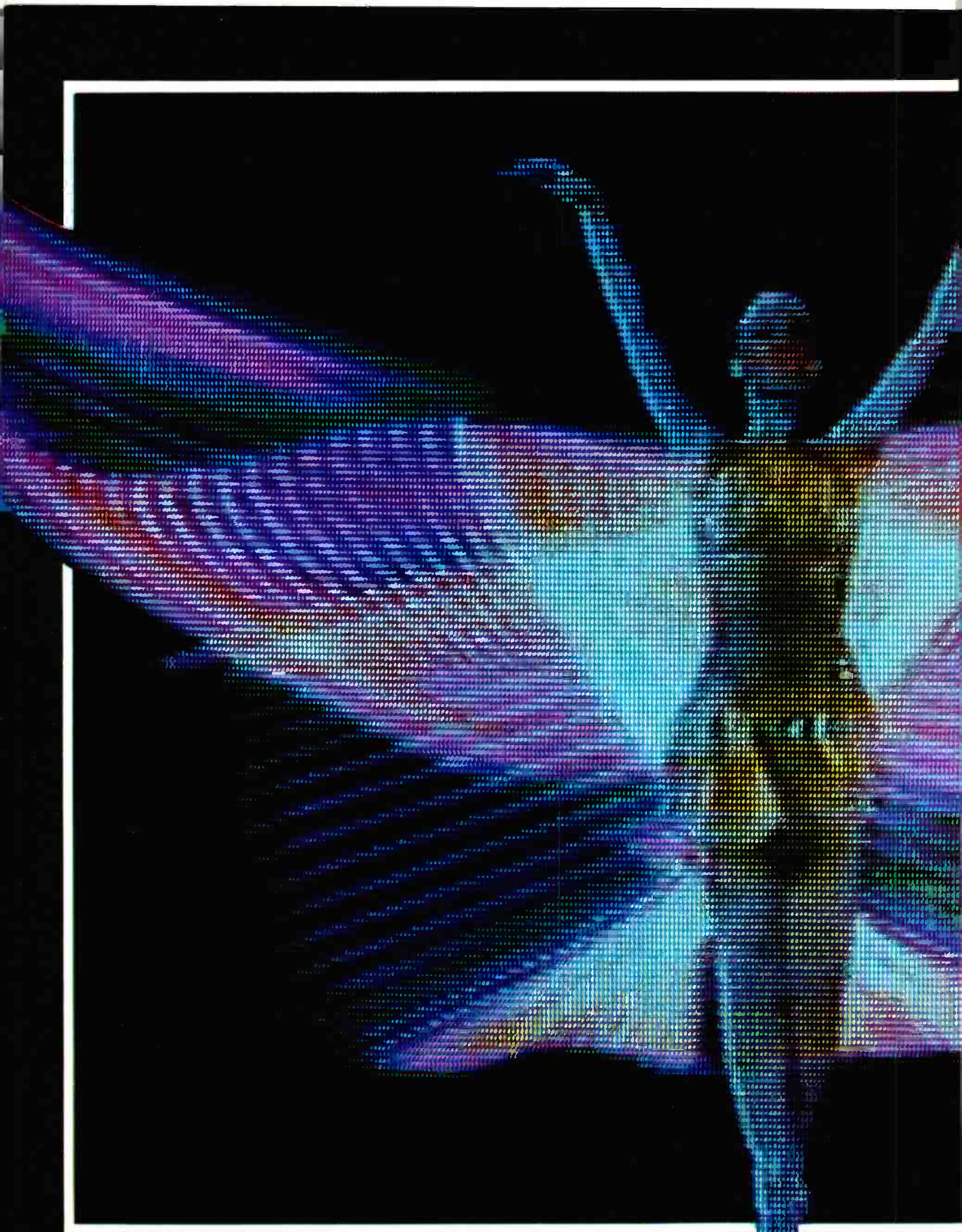

48 NOVEMBER 1980

One Picture Is Worth \$2000 a Second

Resourceful artists are bringing an exotic—and expensive—new look to TV graphics

Van Gogh died too early. Given an extra 80 years, he could have traded in his oil paints for a video synthesizer and turned his beloved cornfields into an intergalactic swirl of iridescent cornflakes. Or, if he couldn't raise \$10,000 to \$200,000 for a synthesizer, he might still have relished the opportunity of playing with the countless technological toys that today are changing the visual language of TV and film. The computer, the microchip and sophisticated photographic techniques have given us the art of the impossible—an art for which producers of movies, television programs and commercials are willing to pay up to \$2000 per *second*.

The radiant "butterfly" figure illustrated on these pages was created by Dolphin Productions, the company responsible for the opening effects seen on *CBS Evening News*, as well as for NBC's "7th Inning Stretch" logo (*next page*). The butterfly was one of a series of projected dream images used by the New York City Opera corps de ballet in a 1977 production of Stravinsky's "L'Histoire du Soldat." Dancer Mercedes Ellington was photographed on videotape and her image was fed into a synthesizer—an analog computer—which then furnished her with "wings."

How does a computer make wings? By manipulating the electronic signal that is continuously rushing from the top to the bottom of the cathode-ray tube. A video synthesizer can subject the signal to a host of pattern-generating functions—such as an undulating sine wave—that will make the image on the screen grow or shrink in size, pulsate, move at varying speeds, change color, alter direction and perform any number of curious acrobatic tricks. Says Bruce Davis of Dolphin: "We're using the machine like a big paintbrush."

But not all the phantasmagoria we see on our screens have their origins in a synthesizer. The elaborate effects in

the commercial for Energizer batteries, an Image Factory production (*top left*), were achieved by a variety of other means, including old-fashioned model-making; frame-by-frame photography; and, for the background, a technique called Slitscan, which enables a two-dimensional artist's drawing to be endowed with a false perspective.

The camera that photographed the Energizer battery as it swooped and dove was computer-controlled—a procedure used also for the *Sunday Big Movie* title and in the making of the ABC Winter Olympics logo (*center*), the work of the Diamond and Diaferia studio. Here, all the components of the logo were suspended on fine wire, and, as they moved toward convergence, they were photographed one frame at a time.

Diamond and Diaferia was also responsible for the figure of the football player at far right, which appears in the opening titles for *NCAA Football*. This image was produced by running a motion-picture film through an animation camera, which can enlarge each frame and project it onto a table, and then drawing the outline of the football player by hand from each still picture.

Fred Diamond, president of the studio, says: "We don't do effects just for the sake of effects. Maybe this is what separates our work from the studios that blast the screen with effects only because they bought the gadget that can do it."

One of the remarkable capacities of computer-graphics technology is the ability to represent an environment in depth using as input only two-dimensional data. Times Square, circa 1932 (*bottom left*), was re-created and explored in three dimensions on the basis of photographs and engineering drawings alone. In effect, the computer becomes a surrogate consciousness that can place itself at any point in the environment and look around just as a human observer or camera might do. Judson Rosebush, president of Digital Effects, the company that prepared this sequence for a movie studio, refers to this kind of electronic fabrication as a "synthetic reality." "We can take space apart, dissect it and put it together again in ways in which it is probably impossible for it to exist in actuality. I think that's the real power of the tool."

Vincent, thou shouldst be living at this hour!

—Peter Crown and Stanley Marcus



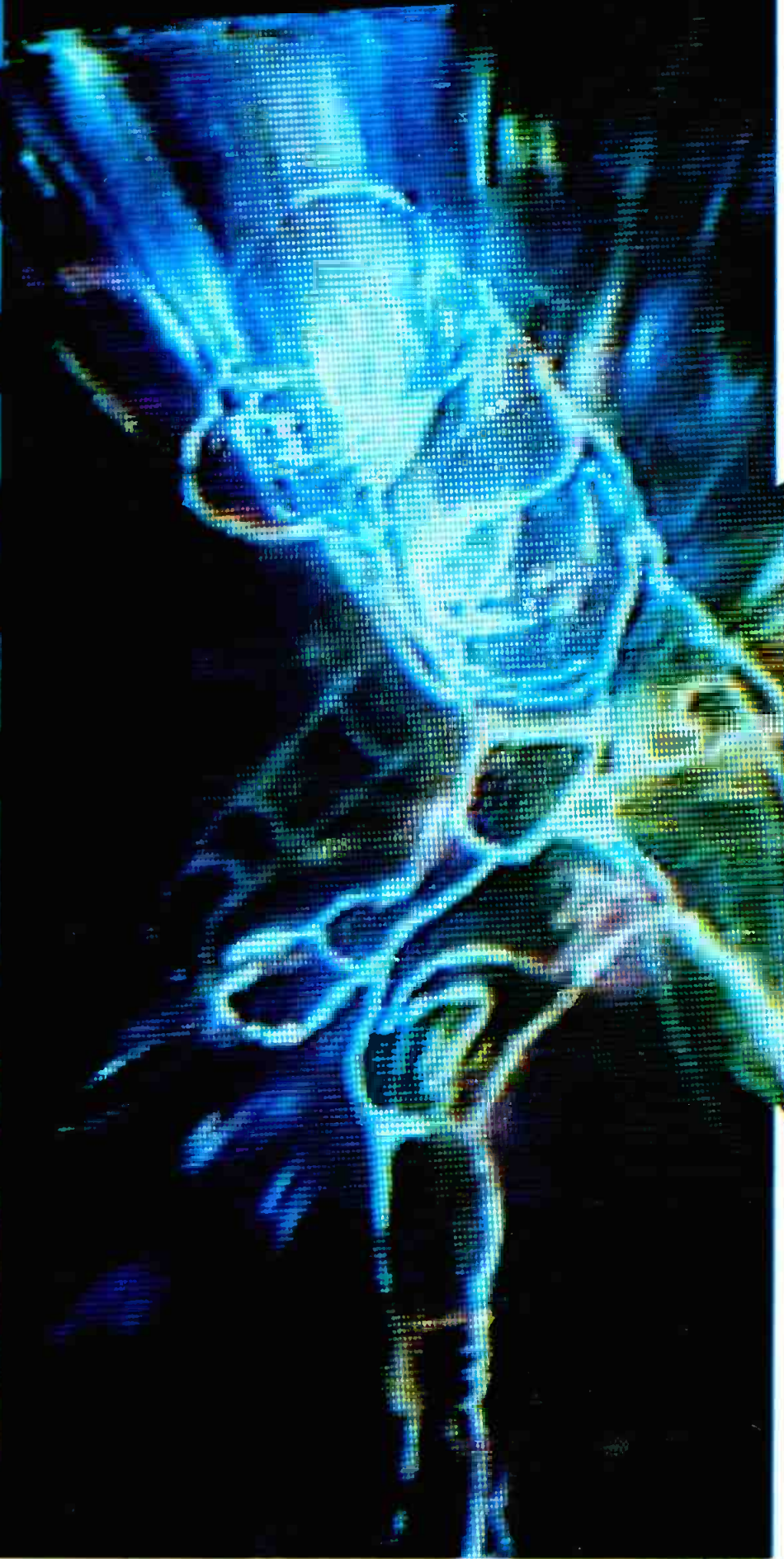
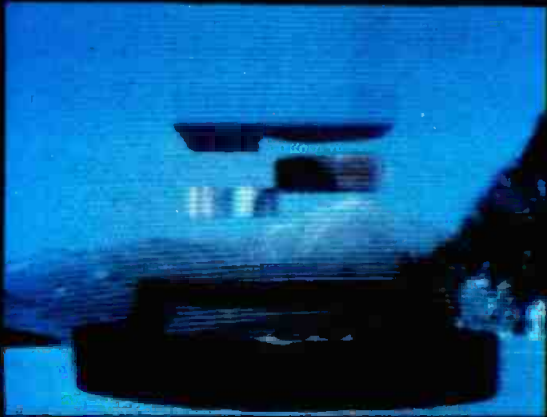

They Surely Won't Throw This Newspaper on Your Doorstep

Electronic newspapers are here, with projected services that can change the way you live

By RON POWERS

Judy Arkell is not doing the *Today* show and she knows it. There is no predawn limousine to transport her at six o'clock each morning to her TV "studio"—a closetlike room in the basement of The (Danbury, Conn.) News-Times. No hair stylist. Or make-up person. Just Judy, her dictionary, a plastic cup of coffee and rolls of news-wire copy. And, oh yes—a keyboard.

Judy's picture doesn't even appear on her own television show. Nor does anyone else's. Just words. *Printed* words. Short, two-page news items. The community calendar. School menus. Judy punches the words up on her keyboard—a Video Data Systems character generator—and out goes the news along leased Teleprompter cable lines. But is anybody, uh, *reading* Judy Arkell's show?

The News-Times has decided that's a good question. A year after its 24-hour-a-day TV service went on the air ("NewsCable" is what the newspaper calls it), management has finally completed its first poll of whether anyone is watching—and if they are, what they think. NewsCable is costing \$83,000 in capital expenses and another \$100,000 a year in operating costs, yet until late this summer its sponsors knew almost nothing about who was on the other end.

Not that The News-Times has ever kidded itself about instant stardust in its basement. Even before taking that first survey, Joe Richter, Judy's boss and Danbury's answer to Roone Arledge, had guessed that "no one watches NewsCable for more than 15 minutes at a stretch." The returned

questionnaires disclosed that 23 percent of the households able to receive NewsCable have tuned to it. About three quarters of those folks now tune in at least once a week, but even among those devotees the average viewing time is five minutes.

The (Danbury) News-Times is a part of the 20-newspaper Ottaway chain, which is a subsidiary of Dow Jones, the organization that compiles all those New York Stock Exchange averages—an outfit not known for leaping pell-mell into new business ventures. But despite the seriousness of the folks who are putting up the bucks for the project, the low-keyed folksiness at the Danbury outpost masks the gravity of the mission: being part of the advance guard of the coming video revolution. Similar experiments in other cities are approaching "on-line" status. Nearly every major communications group in the U.S.—TV as well as print—is conducting research into the form. At issue (among other things) are the viability of the American daily newspaper, the marketing habits of an entire society, the potential specter of a centralized, monopolistic news - and - advertising "authority"—and, ultimately, the very definition of "information" itself. The future of journalism may hang in the balance.

With its pool of 23,000 potential viewers (the number of people served by cable TV in the Danbury area), NewsCable is the first "electronic newspaper" actually to reach the TV screens of paying customers. But oth-

er communications groups are hurrying into the field. In Coral Gables, Fla., Knight-Ridder—the Nation's largest newspaper chain—has invested \$1.3 million in a test of two-way technology involving 160 volunteer families. Knight-Ridder expects to decide whether to pursue development of the system by early 1981. The Gannett chain, whose 80 dailies are already among the most computer-automated in America (and the most profitable, with annual sales of more than \$800 million) is quietly conducting research in several electronics areas, including video publishing, in Cocoa, Fla. The Columbus Dispatch is transmitting an "electronic newspaper" to home computer terminals, rather than to TV screens, in 3000 homes. And Bonneville International Corp., owner of station KSL-TV in Salt Lake City and other broadcast properties, has been tinkering for two years with a system that would blanket an area from Arizona to Montana and from Colorado to Nevada.

No two of these experiments are exactly alike. Some transmit by cable. Some use telephone wires. (Bonneville sends its practice signals over the airwaves.) What they have in common is a goal that seems, at first, to be a giant step backwards in video technology: the TV screen as a page. The medium as (literally) a message. From talking heads to nontalking non-heads.

But most newspaper publishers see beyond the drab surface of this new form. Those few who do not—in the

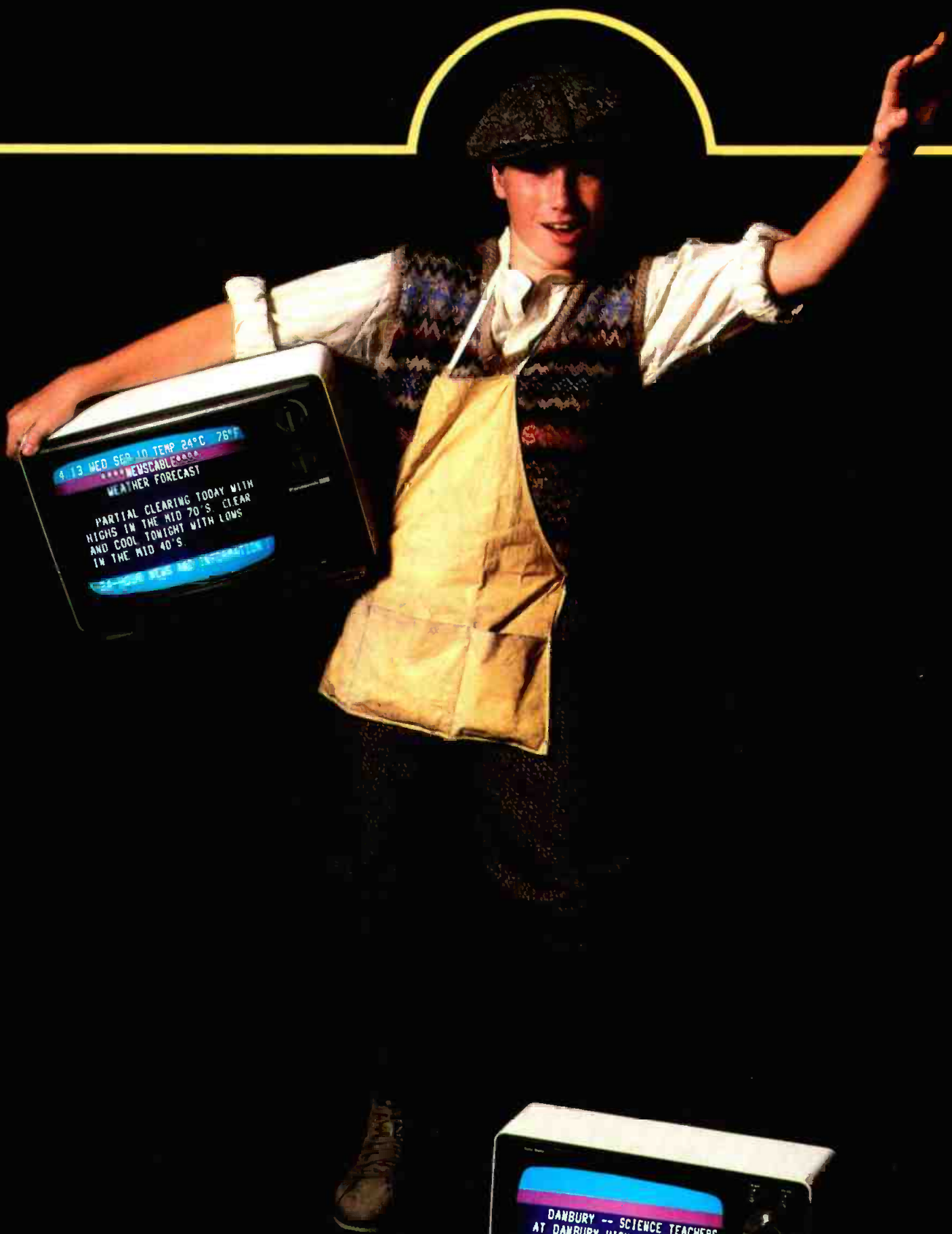

4.13 WED 5:00 PM TEMP 24°C 76°F
****NEWSABLE****
WEATHER FORECAST

PARTIAL CLEARING TODAY WITH
HIGHS IN THE MID 70'S. CLEAR
AND COOL TONIGHT WITH LOWS
IN THE MID 40'S.

DANBURY -- SCIENCE TEACHERS
AT DANBURY HIGH AND BROADVIEW
JR HIGH HAVE BEEN FORCED TO
ALTER SOME SCIENCE EXPERI-
MENTS AND POSTPONE OTHERS IN
THE FACE OF A CITY HEALTH
DEPT BAN ON 133 CHEMICALS

opinion of experts—risk being left hopelessly behind when the new technology takes off.

"The impact of this form is going to be substantial," predicts Edgar J. Gladstone, a director of Quantum Science Corporation, a multinational consulting firm. And when Gladstone talks, corporations listen—including a goodly share of the Fortune 500. Looking owlishly savvy behind spectacles and a jaunty gold beard, Gladstone flourishes on a very fast track: he dares to make definitive long-range analyses of emerging technology for the giants of Western-world commerce. AT&T, to drop just one giant's name.

"Our research," Gladstone says with an air of absolute conviction, "has led us to believe that the electronic newspaper's effects will start to reach critical mass by 1985. What the American viewer will have is an electronic publishing terminal that can be updated almost instantly. We don't believe that this will cause the traditional newspaper to become extinct, but newspapers will certainly be different. I think you can expect a number of foldings. And the survivors are going to look a lot more like Time and Newsweek than like the newspapers we know.

"As for the impact on advertising—it is going to be profound."

"Videotext" (sometimes spelled "videotex") is a term commonly used to cover the whole field of video publishing. The two major divisions within that field are called "teletext" and "viewdata." Teletext, first developed by the BBC, began making 800 pages (TV screenfuls) of data available over the air to subscribers in 1976. Viewdata, also British in origin, comes to home screens through telephone lines. It began to take form some six years ago as a solution to the problem of under-used phone service (fewer than three quarters of all British homes even *have* telephones). Someone in the recesses of the British Post Office, which regulates telephone service, came up with the inspiration of transmitting constantly updated classified information over phone wires to TV screens, thereby encouraging greater use of existing phones and more new installations.

In 1979 the Post Office launched the new service officially, to considerable interest both within and outside England. No wonder. Viewdata's potential data base is stunningly vast—up to the equivalent of a half-million pages of copy available to the viewer at any one time. The home viewer consults an on-

screen index to select the desired information, then summons it up by punching his keypad. Programming material might include news summaries, home-education courses, airlines' flight data, sports standings, weather bulletins, the recent voting records of elected officials and other kinds of tabular data. Not to mention display advertising and classified ads. In America, these will be the key to the coming revolution.

But not for a time. So far, though the two competing forms of videotext have both begun to take hold throughout much of western Europe as well as in Canada and Japan, none of these sophisticated services is available for full-scale domestic consumption. So far, that lonely keyboard in The News-Times' basement is all we've got. And compared to what is on the horizon, it is only a step or two out of the primal ooze.

In fact, kibitzing NewsCable over "input editor" Arkell's shoulder, a visitor could be excused for wondering what all the uproar is about. The NewsCable viewer has no power to select among offerings. What he gets is a straight cable transmission. Like a vegetable garden, the screen is divided into three horizontal sectors. The largest, occupying the middle two thirds of the screen, is a dark blue field. On it, little white words and paragraphs jump and crawl heavenward, like the opening legend of "Star Wars." This is the news section. Above it is a blue-green band that announces the time of day, the date and the weather. At the bottom of the screen, against another field of lighter blue, advertising and promotional copy files by. Even with the accompanying background of "easy-listening" music, NewsCable is not something you would want to cancel Saturday-night dinner plans for.

Joe Richter knows all this. Dark-haired and youthfully intense, Richter has been a newspaperman for 13 years, six of them in the Ottaway chain. Richter came to Danbury in 1978 to set up NewsCable after Ottaway targeted the city because of its favorable demographics and its high (60 percent) penetration by cable TV.

"This is an open-ended experiment with no break-even point," Richter says of NewsCable. "We are here to present an entirely new advertising medium. We have to change people's perceptions as to how to receive information—open people's minds as to what is coming."

Richter knows that public awareness

of something as exotic as NewsCable takes a long time to sink in. That is why he waited patiently for more than a year before conducting any kind of public-opinion sampling.

"If our survey shows that a large percentage of NewsCable viewers are also regular readers of The News-Times, we are accomplishing our goal," Richter says. "Dow Jones doesn't expect this system to be a medium that stands on its own. It is strictly supplementary to the newspaper."

One Danbury resident whose opinion Richter would be pleased to hear is Roger Connor. A 25-year-old policeman, Connor is a member of the broad-based, middle-class consumer group that probably will determine, in the long run, whether electronic newspapers succeed or fail—regardless of their appeal to communications visionaries.

Since discovering NewsCable several months ago, Connor routinely switches it on when he comes home from his beat, particularly when he is working the night shift. "I've gotten to the point where I watch it several times a week," says Connor. "I also read The News-Times pretty thoroughly, but I've found that the TV thing does a good job on local news, better than I'd expected. City budgets are a big thing in Danbury, and NewsCable has summarized the budget story pretty well, I think."

Connor, however, echoes Richter's declaration that NewsCable is a "supplement," rather than a replacement, for the newspaper. And in so doing, this new consumer of videotext touches on what might be seen as the electronic newspaper's defensive strategy.

"We see newspapers as changing," says Richter, echoing Gladstone. "The costs of printing a paper are more staggering every year. Newsprint is \$400 a ton—that's double from just a few years ago. And consider gasoline. We have 30 delivery trucks in Danbury that are still driving the same routes as they did in 1972 when gas was 40 cents a gallon.

"These patterns are the same all over the country. The result is, in the coming 10 years you are going to see a more selective system of newspaper circulation and a thinner news product. We see NewsCable as relieving The News-Times of some of the material that makes it thick: community items, tabular material such as sports standings, all types of statistics. The small, the simple, the immediately perceptible information. We don't believe



When Judy Arkell punches words on her keyboard, NewsCable goes out to Danbury, Conn., TV sets.

that the nature of print on a screen is conducive to long, complex stories, or to news opinion or analysis."

Thus, in the immediate sense, NewsCable (and its emerging counterparts) may be understood as an electronic, cost-cutting adjunct to the traditional daily newspaper. And this indeed might be the extent of its significance—were it not for the existence of a company known as American Telephone and Telegraph.

AT&T is a \$45-billion corporation that owns lines to 140 million U.S. telephones. Because of this near-monopoly (over 80 percent), the Government has historically forbidden AT&T to originate programming over those lines. Its programming prohibitions were most recently expressed in a 1956 Justice Department antitrust consent decree.

Last April, however, the Federal Communications Commission—in a move "to remove the barricades from the door to the communications age," in the words of its chairman—effectively circumvented that consent decree. It voted to allow AT&T entry into "enhanced services"—including data processing and information retrieval, activities that are the substance of videotext transmission. Although the corporation (along with General Telephone & Electronics Corp.) must conduct its activities through subsidiaries, it will be permitted to begin offering services by March 1982.

AT&T has announced that it has some doubts about being able to start offering those services so soon. And other interested parties are decidedly opposed to its being allowed to—at any time. Comments requesting reconsideration of the Commission's decision have been filed by 35 organizations. The Computer and Communications Industry Association has gone so far as to file a petition for review with the U.S. Court of Appeals, and more than 30 groups, including the American Newspaper Publishers Association, have petitioned to join in that suit. ANPA head Katharine Graham has characterized "the possibility of one giant corporation becoming the information supplier—an increasingly dominant information supplier—to four out of five American households ..." as "profoundly troubling."

If and when AT&T does begin offering those "enhanced services," one of the most significant—at least for present considerations—may well be a superclassified data base, an electronic version of the Yellow Pages. This is what Ed Gladstone means when he cites "an electronic publishing terminal that can be updated almost instantly." Imagine being able to dial into a sales channel that flashes a one-day-only special on steel-belted radial tires at Sears, or an hour-long reduction on LP albums at K Mart. Imagine being able to consummate a purchase on such a sale from your home by punching up a code on your handy computer.

This is the secret warhead of videotext, the "impact" on advertising that Gladstone predicted.

"Of course we see the specter of the phone company," Richter says candidly. "They will be the first big outside threat, in terms of revenue. It would not be unfair to say that we are trying to establish a hedge here—to get viewers accustomed to us before certain big competitors get rolling. I'd like to think that our primary goal is a positive one, however. We're trying to retool ourselves to meet the reading patterns of the next 25 years."

Positive goals aside, AT&T's potential presence is a wonderfully motivating force for the flurry of videotext experiments around the country. And with the pool of cable-equipped households expected to double in the coming decade—to at least 35 million—it is no surprise that many major publishing groups, in addition to the chains previously mentioned, are pouring capital into cable properties. Times Mirror Company of Los Angeles, with revenues of more than \$1.4 billion, has set up a cable subsidiary covering 130 communities in 13 states from New England to Southern California. Time Inc. owns the second-largest cable operation in the country, American Television & Communications Corp., with more than 100 systems. Capital Cities Communications, Inc., is entering the field. And Scripps-Howard. And many others.

What form will videotext take in this country? Both teletext and viewdata have their adherents, but even within those groups controversy exists. The Electronic Industries Association set up a subcommittee at the FCC's request to evaluate the British and French versions of teletext, hoping to recommend one system to become standard. Teletext systems, like Beta and VHS videocassette recorders, are incompatible with one another, and TV manufacturers would prefer to know exactly what kind of signal their sets should be receiving before they start up production lines. So far, though, the 23 TV broadcasters, manufacturers and engineering companies EIA has been polling have not come to any conclusive opinion on which system to adopt. CBS, the one commercial network actively involved in teletext, has attempted to force the issue by petitioning the FCC to adopt the French system. Until and unless there is an agreement, the costs of receiver equipment might keep most potential con-



Color TV Model #4236 sold separately.

Simulated TV reception.
Sears Portable BetaVision VCR
Model #5356 includes Recording Deck
with Rechargeable Battery, Tuner with
AC Adapter, Softshell Carrying Case, Cigarette Lighter
Adapter, 60/90 minute tape plus other accessories for in-home use.



Sears BetaVision VCR goes portable

Enjoy the latest features of in-home VCR. High-speed BetaScan. Freeze frame. Delayed recording. Plus the advantage of taping "live" events in or out of home.

Step out of the living room and take this Sears 2-speed BetaVision with you. This dual-unit VCR converts in moments to a Recording Deck complete with shoulder strap. Simply plug in a Sears Video Camera (available separately) and you're ready to capture the action at a ball

• **High Speed BetaScan.** Time to play the game back. BetaVision has recorded everything, including the halftime show you may prefer to skip. Just hit the BetaScan button and it zips you through a half hour of action, forward or reverse, in just about two minutes. That's aver-



Freeze any frame from coin toss to final whistle.



BetaScan Picture Search advances tape at high speed to the play you're interested in. Then hit the Pause Button, moving action step-by-step from the hand-off to the touchdown run.



game, a fishing trip or a family reunion.

Back in the living room just attach the Deck to the Tuner, sit back and enjoy your handiwork. But even without a camera, you can still plug into your TV set and get the sophisticated performance of a non-portable BetaVision.

• **Delayed Recording.** It's Monday night. Shall you watch ABC football or the movie on NBC? BetaVision will record one while you view the other. Away for the evening? Just set the 24-hour timer and the program will be taped from start to finish to play back at your leisure.

And don't worry about a game going into overtime. When programmed for long-playing speed, this BetaVision gives you up to five full hours of playing time on a Sears L-830 Beta cassette.

aging 15-times-normal speed. And the speeded-up picture is displayed while you scan.

• **Freeze Frame/Edit by Remote Control.** During playback, your plug-in remote control unit lets you "freeze frame" the action. While recording, you can stop the cassette to edit out unwanted material. Restart it, and recording resumes with no tell-tale "breaks" in the finished tape.

Other remarkable features include: audio dubbing, automatic speed selection, tracking control and memory switch. Request a free demonstration at your nearest Sears store.

BetaVision is designed to expand opportunities for your personal in-home TV viewing and not for any usage which might violate copyright laws.

Available in most larger Sears retail stores

Sears

© Sears, Roebuck and Co. 1980

Where America shops for Value

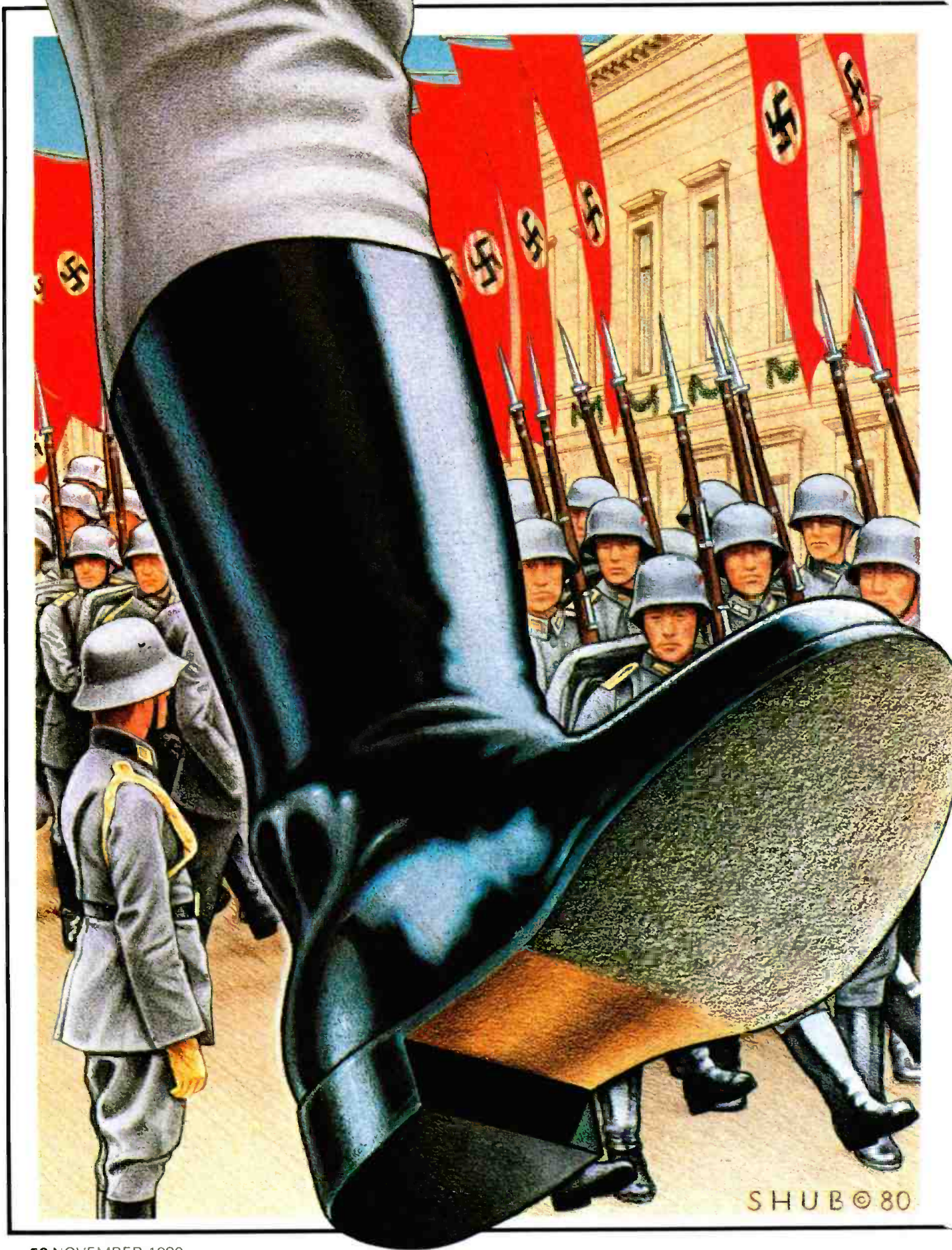

SHUB © 80

The Nazis Are Coming!

The Nazis Are Coming!

Of all the mysteries connected with the Hitler era, one of the most intriguing may be the intense, sustained interest of Americans in Nazi Germany. It defies rational explanation. Why do Americans want to live again through those beastly, brutal years—in books and especially in TV films? It was a horrible time actually to live through, as this writer knows from personal experience in Berlin. Yet American interest in it grows. Books on the subject continue to sell. The impact of NBC's *Holocaust* is still felt.

And, beginning this fall, the major television networks are scheduling a surprisingly large number of films relating in one way or the other to Hitler and Nazi Germany. The trend will continue into 1981—and 1982. Apparently, there is no end.

Let us see what's coming up on television screens.

This month there is a remake by NBC of "The Diary of Anne Frank." ABC is producing *Inside the Third Reich*, based on the book by Albert Speer, Hitler's chief architect, who is reported to be a consultant on the movie project.

CBS appears to be taking the biggest plunge in luring us back to the Nazi days, with no less than three new major films. One is "The Bunker," a three-hour account of the last days of Hitler in the bunker in Berlin, starring Anthony Hopkins and based on the book of the same title by James P. O'Donnell.

William L. Shirer is the author of seven non-fiction and three fiction books, the most recent of which is "Gandhi: A Memoir." He is currently at work on the second volume of his memoirs, "20th Century Journey."

Why TV is so obsessed with that era now—and how it will affect viewers

By WILLIAM L. SHIRER

The second is "The Wall," a three-hour film adaptation of the fine John Hersey novel about the Jewish uprising in the Warsaw ghetto and its murderous suppression by Nazi Gestapo troops. And, of course, there was the controversial "Playing for Time," which starred Vanessa Redgrave in a script written by Arthur Miller from the book of the same title by Fania Fenelon, who survived the horrors of the ghastly Auschwitz extermination camp by playing in an inmates' orchestra.

Another TV film, produced by the BBC, may incite even more controversy when it is shown in this country. This is "The Journal of Bridget Hitler," which purports to be the story, by a British woman who married Adolf Hitler's half-brother Alois—a wandering waiter and razor-blade salesman—of the future Nazi dictator's lengthy stay in England with them in his seedy days before the outbreak of the First World War. I am convinced that Adolf Hitler never visited England in his life and that the account is a fabrication. I am surprised that the staid BBC would

make a film based on so spurious a story.

So here we have six well-budgeted television projects (there is a seventh, about Treblinka, untitled as yet, being planned by ABC), all relating in one way or another to the calamitous Nazi years, all made especially for television and scheduled for prime time. Why? Why all these films on such a subject? And why now? Perhaps most important of all, what effect will these movies have on millions of American viewers (particularly in light of the impact of *Holocaust*, about which, as history, I had certain doubts)? In presenting these movies, is television really trying to respond conscientiously to our interest in history and to our hunger to know what really happened and why? Or is it merely trying to cash in on the commercial success of *Holocaust* and the strange American appetite for books and films about Hitler and his murderous regime?

Even one's answers raise further questions. For years I pondered the popularity of Nazi subjects—in the beginning because, though the phenomenon confounded me, I greatly benefited from it. My very first book, "Berlin Diary," published in June 1941, quickly became a best seller and sold, I believe, a million copies in hardcover, with comparable success in the Book-of-the-Month Club edition. But this was wartime, and though we were not yet in the war we soon would be, so there was naturally general concern with one of our great antagonists.

Interest in the Third Reich continued

for about 10 years after the end of the war. Ever since I had come home at the end of 1945, I had lectured extensively in colleges and universities about Hitler and Germany. The audiences were surprisingly large and attentive. But at the beginning of the 1950s I began to note a slackening of interest. Audiences would quickly exhaust their questions about Nazi Germany and turn their queries to the Soviet Union and the prospects of nuclear survival. I remember returning to New York from a long tour at the end of the lecture season in the spring of 1955 to find my lecture agent telling me frankly that he could no longer book me for talks on Hitler's Germany. No more interest in that subject, he said.

By that time I was more than halfway through a book I intended to call "The Rise and Fall of the Third Reich." I had been working on it full time, except for the lectures, for six years, drawing on not only the priceless secret German documents that had been captured, but also on my own experience as a foreign correspondent in Berlin. As I neared completion of the book in 1959, my savings were exhausted, I was greatly in debt, our family wondered where the next meal was coming from, and my dreams of recouping my sagging fortunes by having a best seller were dashed. My publisher, my editor, my literary agent, my friends agreed it was a good book, the first of its kind, but that it wouldn't sell.

They were wrong. At the end of the first day of publication in that fall of 1960, the first edition was exhausted. For weeks the presses could hardly keep up with the demand. "The Rise and Fall" climbed to the top of the best-seller list.

Why? Why the renewed interest in the rise and fall of the Third Reich? In Hitler? In his terrible deeds? The war he started? The coldblooded slaughter of six million Jews and another six million Slavs? The answers to those questions, I believe, might also satisfy the questions provoked by the showing of the Nazi-related movies on TV beginning this fall.

To begin with, there is the fascination with evil. It intrigues us. Adolf Hitler incarnates it. He was a genius, but an evil genius. In the purge of the S.A., the brown-shirted storm troopers, in June 1934, only a year and a half after he took office, Hitler ordered the murder of his only close friend, Ernst Roehm, chief of the S.A.; the massacre of hundreds of other brown-shirt leaders who had helped him gain power; the



Scenes from some of TV's new crop of Nazi dramas: Top, Vanessa Redgrave (fourth from left) as Fania Fenelon in "Playing for Time"; middle, right, Scott Jacoby and Melissa Gilbert in "The Diary of Anne Frank"; bottom, Maurice Roëves and Nina Zuckerman as Hitler and his niece in "The Journal of Bridget Hitler"; silhouette, Roëves, also from "Journal."

slaughter of his predecessor as chancellor, General Kurt von Schleicher, and his wife; and the coldblooded killing of scores of others against whom he held a grudge. This was the man who ordered the mass murder of millions of innocent Jews and Slavs during the war. It was he who commanded that the army officers who led the attempt on his life in 1944 be strung up on meat hooks and slowly strangled.

Human beings, apparently, are more interested in monsters than in saints.

I think they become absorbed, too, in how such a monster could gain absolute control of a great, civilized, Christian people and lead them uncomplaining down the path to barbarism. We know that it happened. I saw most of it unfold in all its horror. But we continue to ask—I keep asking myself—*how on earth could it happen?* And we are drawn to books and films that promise to tell us. The bizarre, the implausible, attract us.

I think this is especially true among those who are too young to have any memory at all of the Third Reich. They constitute today, I would judge, at least half of our TV-viewing population. They have no personal recollection of the crimes of Nazism. They approach these films and books with the curiosity of the innocent. A story, strange and shocking, unfolds. It grips them.

And aside from all the barbarism, the Nazi story is in itself fascinating to readers and viewers—the unbelievable rise of a coarse and uneducated Hitler from the gutter to the dictatorship of a great world power; from the flophouses of Vienna, where he spent much of his wasted youth, to the gilded chancellery in Berlin, from which Prince von Bismarck had once ruled the Reich. The ups and downs of this strange career, the incredible setbacks and triumphs, make for powerful drama. There is that touch of the Horatio Alger story, which has always fascinated Americans.

Hitler, as those of us who worked and lived under the Third Reich know, had tremendous charisma. It helped him maintain his uncanny hold on the German people long after the fortunes of war turned against them. Charisma adds to human drama; to watch it in action is an unforgettable experience.

Then there is the cast of characters around Hitler, the men who helped to run the country for him. Rather colorful they were, but thugs, knaves, cutthroats. Probably no other country in history has been run by such a band of ruffians. There was

Hermann Goering, the fat Luftwaffe chief and number two after Hitler, with his love of luxury, rich food, palaces and toy trains, and his streak of cruelty and his greed for power and money. There was the vituperative Goebbels, the clubfooted propaganda minister: a liar, a fanatic, a spellbinder, a womanizer. And Himmler, the murderous chief of the S.S. and Gestapo: a former chicken farmer who, with his pince-nez, looked like a mild schoolteacher and could dispatch millions to their deaths without a qualm. And so on. The Nazi rogues' gallery has become well known and has added color to the Nazi story we get in our books and films.

Also we must remember that we know more about Hitler and his gang and what they were up to than about any other leading figures of our time. This is because of the Allied capture of the secret documents of the Nazi German government, its ministries, its armed services, its secret police, its party. No other story of our time can be so thoroughly documented. This has helped to enrich and authenticate the accounts of what happened in Germany, and given writers and directors spectacular material.

Finally, I think, our fascination with Nazism comes about partly because of our absorbing interest in World War II. This deserves some comment in itself.

It was the last war we fought as a united people. We believed in the justice of our cause. We *had* to fight to keep an evil Hitler from conquering the world. We also had to fight to see that the Japanese, Hitler's allies, did not share that conquest. We were the "good guys," fighting the "bad guys." And we, the "good guys," won. The United States of America stood out not only as victor over the forces of evil, but as the hope of "the free world." Our prestige and our power—military and economic—were at their zenith. And we were proud of it.

It has seemed to many Americans, I think, that it was all downhill after that. The wars that followed divided our people rather than united them. We had doubts about our cause. And, for the first time in history, victory eluded us—in Korea, then in Vietnam.

No wonder, then, that most Americans look back to World War II with a touching nostalgia. Reading books on it, viewing films on it, we recall a glory about us and our Nation that has departed. Our pride in ourselves, in our country, is rekindled. Not just in those of us who fought in that last world war

or who lived through it, but in the half of our people who were too young to experience it. For them the Second World War is not only fascinating but inspiring. It creates for them a time, in contrast to the clouded, confused present, when the issues were simpler and more clear-cut, when we knew as a people what we were doing—and believed in it.

The Nazis and their crimes against humanity are a significant part of the story of the 1939–1945 war, which finally brought their downfall and freed the world at least of that terrible threat. Hence our fascination with the one and the other, interlocked as they are.

I must confess that some aspects of our fascination with the Third Reich, on which the producers of the upcoming TV films are counting for good ratings, elude me—or, if I understand them, depress me.

One is the attitude of some of our youth. For though it has not, as yet, been much exposed in the press, there is today a Hitler cult, a Nazi cult, among some of our young. I still get mail from American youngsters, usually after they've read my juvenile books on Hitler and the sinking of the Bismarck, avidly requesting more information about the Führer, the S.S., the S.A., the Nazi German Army, Navy and Air Force. "Gee, Hitler must have been a great guy," they write, and ask if I can send them some Nazi mementos—a genuine swastika flag, an S.S. standard and (God save the mark!), best of all, a lock of Hitler's hair.

Their fascination with Hitleriana seems unaffected by all I've written about the awful consequences of the Nazi regime. Their letters have left me puzzled and depressed. But perhaps they say something about us and add to our understanding of why the parents of these children, who help make up the massive audience for TV, have become so taken with books and films about the "master race."

All of these Nazi-related films scheduled by the networks are based on books, as are most of the previous movies about the Third Reich ("Hitler: The Last Ten Days," "Hitler—A Career," "The Rise and Fall of the Third Reich"). And this raises some questions. How reliable are the books? How trustworthy are the films made from them? Are they historically accurate? Do they respond honestly to our desire to know how it really was, how it possibly could have happened?

"The Wall," by John Hersey, is a finely researched novel that gives us a

Was the FCC Right in

Here are the pro and con on the agency's decision about importing syndicated programs

Last July, the Federal Communications Commission handed down a long-awaited and controversial decision repealing two major restrictions on cable television: the so-called distant-signal and syndicated-exclusivity rules. Thanks to the FCC's action, there will soon be no limit on the number of distant independent stations a cable system can bring to its subscribers (previously, in the top 50 markets, the limit was three); and cable systems now may show syndicated programming previously prohibited to them because broadcast stations in the same market areas owned the rights. (As compensation to the copyright owners, cable operators pay copyright fees—which amount to about one percent of their gross revenues—into an industry fund parceled out by the Copyright Royalty Tribunal, established by Congress in 1976.)

Said FCC chairman Charles Ferris of the decision: "We have thus expanded the choices consumers will have in the future." The cable industry agreed, but not everyone else did. Particularly aggrieved were over-the-air broadcasters and program suppliers, who felt that the two stricken rules had provided necessary and legitimate protection for their products. Already the FCC rulings face legal challenges.

Here, to discuss the FCC's decision and its consequences, PANORAMA presents the views of two men on opposite sides of the issue: Thomas Wheeler, president of the National Cable Television Association, the cable industry's chief Washington lobbying organization; and David Gerber, Hollywood-based executive producer of such shows as Beulah Land, Police Story and Eischied and a member of the Caucus for Writers, Producers and Directors. Their edited statements:



"A Monumental Victory for Consumers"

By THOMAS WHEELER

A terrible wrong perpetrated on the American television viewer has finally been righted.

For several years, the services that cable TV could offer consumers were limited in order to protect over-the-air broadcasters and program producers. For years, the whole concept of cable-television regulation was based on the impact that cable TV had on broadcasters and their profitability.

The American TV viewer wants program diversity.

Now, he'll get it. The FCC's decision is a monumental victory for consumers who desire additional choices in television viewing.

The FCC's recent decision will make first-class TV citizens out of the great mass of the population who do not live in the three largest cities. Before, not only were those viewers limited in the number of additional distant signals their cable system was allowed to bring in, but they were also restricted as to the programs they could see on that limited number of signals.

In Washington, where I live, a local broadcast station used to show *Star Trek* at 5 P.M. The cable system that imported a channel that carried *Star Trek* would have to black it out even though it was shown at 8 P.M. Now if I'm a *Star Trek* fan with a 9-to-5 job, I'm not going to be able to see it at all because I'm going to be at the office. I get no chance to see *Star Trek* because it might have been harmful to the local broadcaster to have that show imported at night on cable. That

argument just doesn't wash any more. In the Milwaukee suburb of Wauwatosa, 64 percent of the programs that were being imported had to be blacked

continued on page 110



Turning Cable Loose?



“There Is No Competitive Balance Left”

By DAVID GERBER

Such a decision would have been considered not too long ago as unthinkable. But the unthinkable is here.

When program suppliers take their shows into the syndication market-

place, local broadcasters buy on the assumption that they are purchasing the exclusive rights to those shows within their own markets. But cable systems, with their technical capability of bringing in distant stations, now can import the same shows from other markets—without ever participating in the marketplace. Without any regard for the contractual rights of producers, cable systems exploit their programs for profit.

There is no competitive balance left. Cable systems do contribute a token payment to the program suppliers and broadcasters through the Copyright Royalty Tribunal, but it is a mere pittance. This system defies all the basic tenets of supply and demand. The more successful series, which would sell for higher prices in a competitive market, must now go to cable TV for the same percentage of a pittance that shows of lesser demand get. And producers have absolutely no control over which cable-TV systems exhibit their programs. All the basic market rules and equities that apply throughout American industry are being trampled on by a bureaucratic commission with no understanding of the realities of the marketplace.

The FCC states that the elimination of the rules would not result in any substantial harm to producers or suppliers, that TV-station profits have continued to increase over the past several years despite the growth of cable. So with one fell swoop, the FCC has assumed that television suppliers would

not be hurt, and then it has the temerity to judge that the producer has enough of a profit situation. Similar actions once raised the hackles of Congress and were denounced as nationalization, socialism—all types of *tions* and *isms* seemingly detrimental to our American system. And yet, the FCC comes very close to these situations, cloaking itself in the proclamation that all of this is in the public interest.

What is in the public interest? Cable television is not noted for initiating any decisive programs to enhance or entertain the local communities. FCC chairman Ferris claims nonexclusivity will increase the consumer's options as to when and what to watch beyond local-station schedules. Evidently, from the FCC's viewpoint, the public interest means that cable now can have reruns of *Police Woman* or *Starsky & Hutch* or *I Love Lucy* or *All in the Family* and just lay back and not worry about original programming and putting more dollars into the enhancement of the community through television.

Ferris is playing Don Quixote. But even Don Quixote's old, battered spear could hurt. Through the mechanism of the Copyright Royalty Tribunal, one percent of cable's gross income is allocated to the program suppliers and broadcasters. This leaves cable with 99 percent. That virtually gives cable a license to steal.

Ironically, there is sympathy from the FCC for cable systems that are being hit with the theft of their signals by electronic pirates. But that situation is not any different from the cable system usurping syndicators' products without paying a legitimate market price. To paraphrase Gertrude Stein, "Piracy is piracy is piracy."

The program suppliers are being called "fat cats." "They make enough profit as it is," we hear; or, "Their kind of product deserves this treatment." What audacity! What arrogance! Since when has this country put a limit on what a person or company can legitimately earn?

Something else has escaped Ferris. Most shows are deficit-financed. The producers' only hope of recouping their loss and making a profit is in the

continued on page 110



Video Games—Telling the Good

Join devotee Thomas (The Blip) Corbett as he surveys the field and offers his ratings

By LEN ALBIN

In his short life, Thomas Corbett has already saved earth from alien invaders, kicked an 83-yard field goal, blown up 7854 aircraft carriers, drawn to an inside straight, and dodged dragons in quest of the Holy Grail. Thomas, at 19, is a chronic video-games addict, and his bloodshot eyes light up whenever one of the devices is mentioned. "I can't help it," he admits. "Even when I'm asleep, all I see are flashing white blips."

While his peers were struggling through high-school English, Thomas (alias The Blip) was mastering coin-operated video games, and he has recently stocked his room at home with *serious* hardware: consoles that hook up to his color TV, battery-operated "hand-held" units, and even several sophisticated home computers with typewriter-like keyboards. So when we began our 1980 shopping tour of home video games, we went straight to Thomas for help. "I'll be glad to come along," blurted The Blip when we found him at a Times Square games arcade. "I'm clean out of quarters."

Ten years ago America's youth were not distracted by visible blips and audible bleeps. Though the first home video-game patents were filed in 1968, the first hardware—Magnavox's Odyssey—didn't appear until late 1972, and even then it was a crude device. Designed for home-TV hookup, it featured a master control box and two hand controls but required the hanging of plastic Mylar overlays on the TV screen. After that, the industry picked up steam. By 1974 more than 20 firms were elbowing for space in the coin-operated video-game market—including Atari, which created Pong.

The next frontier was home video games. In late 1975, when General Instrument offered a \$6 microprocessor chip that could work six games, the electronic firms moved in like Space

Len Albin is a free-lance writer based in New York City.

Thomas Corbett's "Silicon Chip" Video-Game Rating System

CHIPS	EVALUATION	Rating	Description	
■	No fun.	■	All prices are approximate.	
■■	Not much fun.	■■■■		Lots of fun.
■■■	Good clean fun.	■■■■■		So much fun you won't eat.
		■■■■■■	Hyperfun.	

TV-HOOKUP MODELS



Coleco's Telstar Marksman (\$32). This no-frills model has four Pong-like games (Hockey, Tennis, Handball and Jai Alai), with two player controls built into the console. It also offers Skeet and Target games, complete with a

two-foot-long plastic rifle that seems to fire a beam at the screen and makes moving blips disappear. "Less is more," said The Blip, picking up the rifle. "Now, can we please switch to *Dallas*?" ■■■■

Mattel's Intellivision (\$300). This new TV-hookup unit supplies a "master component," two hand controls and the choice, ultimately, of 18 entertainment cartridges and two educational ones for kids—each priced at \$30. (Not all the entertainment cartridges were available at press time.) Intellivision's built-in 16-bit microprocessor makes it the genre's smartest unit, and its so-

phisticated hand control gives each player uncanny command over the game action. That control, which fits into your palm, consists of 12 pressure-sensitive keys (arrayed in calculator fashion), a 16-direction dial the size of a silver dollar and two "action" buttons on each side. Every cartridge comes with a pair of four-color plastic



Ones from the Bad Ones

Atari's Video Computer System (\$200). This model offers the most cartridges (42, selling from \$22 to \$38), and the graphics are better on some of these (Backgammon, Canyon Bomber and Breakout, the brick-chipping Pong variant) than in anything by Mattel—and they're more fun to play. "Mindless shoot-'em-up games are always better fun than realistic sports games designed for frustrated armchair athletes," quoth The Blip.

The VCS offers a version of Space Invaders, the classic game of international arcade fame, which can be played in 112 different modes, including one where the Invaders are invisible. The celebrated Pong appears in the Video Olympics cartridge, a 50-game program that includes 4-player Quadrapong and 2-player, 3-paddle Fozzpong. Combat, which comes free with the VCS unit, features a delightful jetfighter dogfight game where pilots can hide in clouds. But the best of the war games is Air-Sea Battle—a noisy, cluttered, 27-mode cartridge with subs, blimps, carriers, biplanes, copters, and even ducks to shoot at. Much more peaceful is the new Adventure, a search for an enchanted goblet through castles and moats. The player must evade three dragons (Yorkle, Grundle and Rhindle), which vary in

overlays for the keypads so you'll never forget, for example, how to throw the bomb.

The Major League Baseball cartridge shows off Intellivision's brainpower. Each fielder is manipulated by the player (*not* the computer), and each can chase hits, retrieve the ball and throw to any other fielder. The runners can take leads and steal bases, and the batter can "pull" the ball or hit to the opposite field. One glaring defect is the lack of fly balls (everything's a grounder in this 2-D league), but the crowd does cheer and each out is heralded with a guttural "Yer out!" from the umpire. The players, as you'd expect, are little blue and red "men" rather than formless blips.

In NFL Football, there are just five players on a team, and only one on each—the ball carrier on offense and the "monster back" on defense—can be directly controlled. "But that's good," The Blip observed. "Two players are all you watch on a televised



meanness and speed, but he gets to use "Good Magic" as a weapon. Basketball is a pleasant one-on-one with dribbling players, blocked shots and nets that swish after a hoop. The top program, though, might be Video Chess, which finished second in last summer's San Francisco computer chess tournament and is tough to beat in most of its playing strengths.

football game anyway." The real action, though, takes place before every down: the offense selects a running or (most often) a pass play, each player picks one of nine formations and the offense chooses first a receiver, then a specific pass pattern. After the catch, the receiver becomes player-controlled, replacing the quarterback, and the other blips respond automatically, with the defenders outrunning the ball-carrier in an open-field chase. A visible set of chains moves after each down.

NBA Basketball and NASL Soccer are inferior cartridges, in The Blip's view, because it's too hard to pass the ball accurately. But Poker and Blackjack got high marks for special effects—the sound of shuffling cards and the eyes of the cartoon-character dealer, which shift from side to side as he deals—and the bulk of the other game cartridges (NHL Hockey, Checkers, Backgammon, Roulette, Space Battle) offer beautiful color displays.

The only drawback to the VCS is having to change from one type of hand-held control to another, depending on which cartridge is in use. But each of the three types (joy stick, paddle, keyboard) has a nice "touch" that allows for more deft manipulation than the dial on Mattel Intellivision's omnibus control. The VCS also has a two-setting "difficulty" switch. ■■■■■

Armor Battle, a two-tank vs. two-tank war game, is an unqualified masterpiece. The tanks slog at a realistic turtle speed through a terrain of woods, rivers and abandoned farmhouses, recoil after shooting, and can also lay mines. Authentic sounds of tank engines and guns accompany the action, and after one tank team gets destroyed, the computer selects another of the hundreds of battlegrounds for the next round, so that each situation is new. "Just like real war, I think," remarked The Blip.

The coming wave of cartridges, all to be available by January, consists of PGA Golf, Auto Racing, Tennis, Skiing, Boxing, Sea Battle and Horse Racing. But the major innovation is Mattel's deal with General Instrument, a joint venture called PlayCable. By late 1981, Intellivision owners will be able to subscribe to 15 game cartridges a month for \$6 to \$10 through their local cable systems, rather than buying specific software. ■■■■■

Invaders, creating TV-hookup units like Magnavox's Odyssey 200 (\$79), which played three Pong-like games. Shortly thereafter, the first "hand-held" video games appeared: Mattel's Football and Auto Racing, both retailing for less than \$30. "You need good eyesight for hand-helds," The Blip conceded. "But you can't always drag a 21-inch television into the movies."

Since 1977, the technology in hand-helds hasn't progressed that much, but TV-hookup units have spawned interchangeable cartridges and have been refined with extra integrated-circuit chips. These added "guts" produce more colors, finer image resolution and better memory, which enables a player to manipulate more on-screen planes, tanks or gremlins. The technology is so advanced nowadays that Dr. Dave Chandler of Mattel Electronics, like other video-games engineers, automatically spews terms such as "chip set," "data stream" and "systems' architecture" when describing baseball, although the simple phrase "national pastime" worked fine for over a century. As a matter of fact, the man is delirious over the Baseball cartridge in Mattel's new Intellivision unit, which allows manipulation of all nine fielders on every play.

"Baseball, up to this point, was played by the computer," says Chandler, beaming. "But now *you're* actually playing the game!" It's not the same as *actually* playing the game, of course, but still very impressive for indoors.

At industry sales-leader Atari, whose Video Computer System (VCS) ignited a stagnant home video-game market in 1977, technology shares the limelight with the advanced-systems concept of "fun." At first, Atari adapted one after another of its own successful arcade games for the VCS; games that collected the greatest number of quarters were, logically, the most fun. But today, manager of games software Dennis Koble (whose background is in military radar-warning systems and biofeedback research) periodically rounds up VCS owners to test brand-new games. "Through the warranty cards, we find people who are heavy users," he says. "... That is, heavy *players*. And when they come in, they play a cartridge that's under development and they talk about it for an hour. It's all recorded, and they're viewed through one-way mirrors by people who developed the game."

This "focus group," as it's called,



Magnavox's Odyssey² (\$170). This hookup unit has 25 reasonably priced (\$20) cartridges (for a total of 38 games), but it's often hard to tell your spacecraft from an alien vessel, except for color. One cartridge, Invaders from Hyperspace, makes annoying screeching sounds. "And you can't even rotate

your starship 360 degrees!" The Blip complained. In Thunderball, the pinball cartridge, the ball got stuck in a "loop" and would *still* be bouncing between two bumpers if The Blip hadn't turned off the set. Though the Odyssey² controls aren't bad, we felt that its electronic sensor keyboard is a bit pretentious. ■■

NOT SHOWN:

Bally's Video Arcade (\$299). Sadly, the hardware suffers from controls so wildly inaccurate that the cowboys in its "gunfight" game can't shoot straight and, worse, often appear to have limp wrists. The image resolution is passable, and the cartridges cheap (\$25), but this unit will very soon go the way of Fairchild's once-popular Channel F: extinction. ■■

Fairchild's Channel F (about \$150 at close out). If you can find the hardware, now out of production, don't bother buying it. This game gets a

mention only because 1980 brings us four new cartridges: Checkers, Casino Royale, Galactic Space Wars and Pro Football. Its graphics are ugly and its controls contain the gadgets for maneuvering and shooting in the same knob, so it's difficult to fire without losing your position. ■

Coleco's Telstar Colortron (\$25). A two-player, four-game, three-skill-level model that uses no cartridges, Colortron has the same four Pong-like games as Coleco's Marksman (Hockey, Tennis, Handball and Jai Alai) but without Skeet or Target. ■■■■

HAND-HELD MODELS

Milton Bradley's Microvision (\$40). The first hand-held with interchangeable game cartridges (\$16 each), this unit has a miniature screen the size of a wallet ID photo and adjustable difficulty levels. It's sold with the Blockbuster game (a version of Breakout) and the best of the other eight cartridges is Connect Four, a baffling hybrid of Tic-Tac-Toe and the oriental game of Go. The new 1980 cartridges are Baseball and Sea Duel. The Blip, still trying to master the Mindbuster pattern game, was impressed, even though he felt Bowling was contrived and that Star Trek Phaser Strike was just a one-target, one-gun bore. ■■■■■





Bambino's Boxing (\$45). Playable by one or two video freaks, Boxing's distinctly humanoid fighters bob, weave and punch when you press the proper button, and each can be sent down for

a 4-count or knocked out. Since the boxers must lean into a punch to be creamed, the timing needed for KO blows is quite realistic: decisions settle four-round, full-route bouts. Note—this is an unwieldy table model unit. ■■■■



Tomy's Slimline Speedway (about \$45). Five auto-race games with some cute "putt-putt" sound effects are contained in this slim metal unit that can be slipped neatly into a shirt pocket. It's the right size for making your boss think you're diligently working a pocket calculator—if the air conditioner's on. ■■■■



Parker Brothers' Split Second (\$47). This gorgeous hand-held, a ringer for a red walkie-talkie, has a self-adjusting speed capability. Since quarters aren't required, this leads to *hundreds* of consecutive replays and eventually isolation from the outside world. The unit has three maze, three target and two chase games, but the best is Visible Mad Maze, where one completes a series of 10 different maze patterns one after another. If you're skillful, it should take just 25 seconds. ■■■■



Mego's Pulsonic II Electronic Baseball (\$34). This model is the best of the market glut of hand-held baseball games because of its classy design (a sculpted stadium surrounds the viewing field) and because, unlike the others, it's easier to score runs here than in Wrigley Field. Otherwise, it's the usual format: the microchip decides what happens after you press a button and thereby "swing" at the flashing red blip approaching from the pitcher's mound. ■■■■

usually just ends up confirming Koble's assessment of a game, because by this late state, everyone at Atari down to the mail-room clerks has tried the game and word gets around fast if it's "a turkey." If so, Koble and a team of engineers and designers check out of the plant and into a secluded place for one of their sporadic "game-storming" sessions, which may last up to three days. Only a handful of the 200-or-so game ideas generated ever make it to the drawing board, but Koble recalls that "some of the losers are just *far out*. Once we contemplated a DC-10 game. The idea was you were flying a DC-10 and pieces of it kept falling off. You had to land it before it cracked up."

The next generation of games, Mattel's Dr. Chandler speculates, is three years away and will provide better memory and higher resolution for today's prices. In 1983, he thinks, video games will be part of a "home-entertainment center" with its own color-TV monitor, or else be played on a legitimate home-computer system. It's a safe bet, because even today there are several home computers with game programs (or, as Texas Instruments puts it, "Entertainment Command Modules") to supplement their usual role as sophisticated tools for business planning or children's education. Texas Instruments' 99/4 home computer (\$995), for one, plays 11-man football in full color, complete with nuances such as fumbles, passes and the coin toss.

In Radio Shack's TRS-80 Level I 16 K microcomputer system (\$633), the unit's monochrome graphic display tends to minimize its game-playing role; still, fascinating game software is available, like Invasion Force (\$14.95), a complicated space battle in which the monitor fills with reams of instrument readings; or Eliza Artificial Intelligence (\$14.95), a software psychiatrist. "She will discuss your problems in two different levels of difficulty," The Blip noted. "And I should know."

The Blip fondly speculates that one day there will be a game cartridge version of CBS's *Dallas*. "My dream," he says, "is to nail J.R. with a surface-to-air missile." But, for now, his vision of the future of reasonably priced home video games is served by Atari's Star Raiders program (\$60), an amalgam of many of the space games secretly played on campus computers throughout America. It's a cartridge playable only on Atari's 400 Personal Computer System (\$630) or its 800 PCS



Mego's Time Out: Fireman Fireman (\$40). Imported from the Ninetendo company of Japan, this model measures 3¾" by 2½" by ¾", runs on two camera batteries and serves as a digital quartz watch when the "Time" button is pressed. "It's the first game featuring municipal employees and the religious concept of Heaven," noted The Blip. You control the position of a stretcher manned by two firemen

near a burning building, and the task is to catch people leaping out of windows and then carry them to a waiting ambulance. When the firemen miss, the jumper becomes an angel (with halo) and flies to the upper right of the screen. Three angels and the game ends. ■■■■■■

Mego's Time Out: The Exterminator (\$40). Another Ninetendo import, this game is the same size and contains the same timepiece as Fireman. Known as Vermin in Japan, it challenges you, the exterminator—with the aid of two big sledgehammers—to keep "moles" from creeping through holes in the floor. "Moles?" The Blip wondered. "They sure look like rats to me!" ■■■■■■



Tomy's Tomytronic Tennis (about \$40). A one- or two-player table model with a semi-3-D court display, this unit features humanoid tennis players who swing their rackets on command. Six buttons are provided to correspond spatially with six front-, mid- and back-court positions and there's no volley return without precise timing. The scoring is traditional game, set, match. ■■■■



Bambino's Football Classic (\$49). If you can stomach the hand-helds' *reductio ad blip* of the complicated sport of football, this is the only decent choice. It's tough to roll up big yardage, but the blips are humanoid, the two teams are of different colors and there are three formation controls (attack left, right or center). The problem with this, and other hand-held football games, is that you may see a 90-yard run but when the play resets, it turns out you've only moved 10. ■■■■



Entex's Space Invader (about \$35). There are no panic-inducing noises made by this miniature of the arcade classic—just weak chirps—but unlike the other hand-held Space Invader clones, here the gun turret is provided with shields and it moves sideways in a continuous line instead of jumping from spot to spot. And, of course, the invaders overrun you, inevitably, in the end. ■■■■

Entex's Raise the Devil (about \$35). A moving red dot "bounces" under a painted-on course of troughs and bumpers in this pinball game. The "ball" seems to move at the same speed as in real pinball, and it's knocked about by (what else?) flashing red video flippers. "Plenty of noise," The Blip said approvingly. "And no tilts!" ■■■■

NOT SHOWN:

Mattel's Computer Gin (\$60). This new unit displays your 10-card gin rummy hand and works like a genuine card game, except you use buttons to dis-

card and select. The object is to call gin before the computer does. You can't see its hand, but then, you can't see a human opponent's hand either—unless you cheat. ■■■■

(\$1080)—plus your TV. Though The Blip had carefully constructed a video-games rating system of one to six "silicon chips" for all the games in our survey, he quickly awarded Star Raiders an extraordinary six chips. "Excuse me," he said, setting up the game. "I'm going to be Han Solo for a while."

First, he consulted the on-screen Galactic Chart, looking for the quadrant the enemy was lurking in. Warp energy? Fine. Shields on? Check. Next, he

switched to the optical display—a universe full of stars surrounding his cross-hair missile sight at midscreen. Range finder? Looks good. Instrument readings, in futuristic typeface, were displayed in a thin strip at the bottom of the screen. Soon Thomas went into Hyperspace and the passing stars whipped by with increasing speed, accompanied by a sound like that of an SST taking off. In no time, he was nose-to-nose with an enemy warship and

sent a blue fireball hurtling at it. A direct hit . . . the sound of a massive explosion . . . another shot, another explosion. This time, The Blip was hit and his digital readouts were flashing on and off and visibly crackling! Damage to the engines! Then another shot, a red flash—and a curious ringing sound. Thomas hit a button and turned around. "This is the best part," he said. "I can put Armageddon on hold while I get this phone call from Mom." ■

Suprise Your VCR with Thoughtful Extras

The latest video accessories range from image enhancers to commercial killers

By DAVID LACHENBRUCH

One of the happy things about a videocassette recorder is that it's complete just as you buy it. Already equipped with all the necessary cables and adapters for recording programs off the air or playing prerecorded cassettes, it should chug along happily, asking only to be kept in tape, electricity and normal care.

But with VCR sales soaring and the home recorder population now pushing 1.5 million, it was inevitable that whole new industries should spring up to offer accessories of all kinds, running the gamut from useful through unnecessary to downright stupid, and including just about everything you can think of from cassette labels to sophisticated electronic image enhancers.

In reviewing some of the accessories you can buy to surprise your VCR for Christmas, I'll try to stick to those specifically designed for home use that cost less than the VCR itself. That excludes such professional products as \$6000 editing machines or color video cameras. Many of the products mentioned are available from video dealers, others by mail. Always try dealers first—you may get a better price, defective units are easier to return, and you'll get far quicker delivery. (And be sure to check with mail-order companies by mail or phone *before* sending in any money to get up-to-date price changes, tax and handling-charge information.)

Telecine Adapter. If you already have a video camera and you also have film movies or slides and a projector, this neat little extra may interest you. It is a tabletop box containing a mirror and ground-glass arrangement that lets you transfer your home movies or

slides onto cassettes. The way it works is simple: the slides are first projected onto the screen or prism and then photographed by a video camera for ultimate viewing on the VCR—the design of the prism prevents distortion of the image being photographed. Got that? It's available under the Quasar brand for about \$130 and will work with any make video camera or VCR. Of course, if you don't want to take the time to do it yourself, professional film-to-cassette transfer service is available from Fotomat stores and many video dealers.

Head Cleaners. Probably the most popular and widely advertised VCR accessory is the head cleaner. Video recorders generally have either two or four magnetic heads—mounted on a revolving drum—that lay down the magnetic track on the tape during recording and read the magnetic signals on the tape during playback.

Now, audio hobbyists who own sound recorders often are avid head-scrubbers; a clean head makes clearer recordings, and all *audio* tape-recorder manufacturers recommend frequent head-cleaning. But video-recorder heads are far more delicate than those in sound recorders, and VCR manufacturers are divided on the merits of home head-cleaning; some companies say the job should be done—*infrequently*—only by trained service technicians using special equipment.

The most common type of head cleaner is a specially treated tape packed in a standard cassette. These come under labels of major tape-makers, such as Fuji, Scotch and TDK. To clean the heads, you merely load the head-cleaning cassette into the record-

er as you would a tape and run it for a specified number of seconds. *Too long or frequent cleaning can damage the heads.* If you just have to have a head cleaner, here's a tip: don't buy it until you need it—the temptation to use it needlessly may otherwise be too strong. If your recorded picture becomes snowy (that is, considerably snowier than the original broadcast picture) it *may* mean your heads need cleaning. To paraphrase Barbara Fritchie: Clean if you must that dirty head, but why not play a tape instead?

Commercial Eliminators. Probably the fondest dream of most home video-tapers is to be able to record a program without the commercials. Well, there's good news and bad news. Automatic commercial eliminators are available—but not one of them works exactly as it should all of the time.

If you're an old-movie buff and like to record those black-and-white flicks that come on in the wee small hours, you're in business. Admittedly, this is a fairly specialized taste, but The Killer will cater to it. Plugged into the remote-pause socket of a VCR, The Killer automatically puts the recorder in the "pause" mode when a color signal is transmitted and restarts it when black-and-white broadcasting is resumed; it does this by sensing the presence or absence of a "color burst" in the incoming broadcast signal. Since virtually all commercials are in color—even those inserted in black-and-white movies—The Killer usually works fine for its relatively limited purpose. Of course, it won't eliminate any commercials that happen to be in black and white. And it *will* eliminate the program itself if the engineer at the broadcasting station

Legend: 1. Head cleaner 2. Channel converter 3. Cassette changer
4. and 5.: Switching systems—The Switcher and Distrivid
6. and 7.: Editing devices—The Editor and The Killer

neglects to kill the broadcast color pulse. The Killer costs \$99.50 from Video Services Inc., 80 Rock Ridge Rd., Fairfield, Conn. 06430, and from some video dealers.

The most widely advertised commercial eliminator is the Shelton Video Editor. This also attaches to the remote-pause socket of the VCR, as well as to the "audio out" and "video out" jacks, and detects the absence of picture and sound—as when the screen fades to black in preparation for a commercial. When the fade occurs, the Editor puts the recorder in the "pause" mode. Then it takes 30 seconds to search for another fade and either keeps the recorder in "pause" (if it finds a second fade) or releases the pause control (if it doesn't). Unfortunately, you usually miss the first 25 to 30 seconds after the show resumes, because there's a fade to black at the end of the commercials, too.

The basic Editor (there also are deluxe versions) is \$249.95 from Shelton Video Editors, Inc., P.O. Box 860, Vashon, Wash. 98070, or 7964C Winston St., Burnaby, B.C. V5A 2H5, Canada, and from video dealers. When ordering either The Killer or Editor, specify the make and model of your VCR.

Cable-TV Problem-Solvers. Market research shows cable-TV subscribers are more likely to buy home VCRs than are people who get all their TV off the air; yet cable often poses unforeseen problems when the VCR comes home. Although manufacturers advertise that you can record one channel on your VCR while watching another, this isn't always the case with cable TV. Here's why: the cable company supplies you with a converter box to bring in lettered channels (A, B, C, and so forth) in addition to the numbered channels 2 through 13—but the VCR can't receive the lettered channels with its own tuner. You must make a choice: (1) give up the ability to watch one channel while recording another, or (2) sacrifice the capability of recording the lettered channels. Fortunately, there are several ways out of this dilemma. One is to order a second converter from the cable system, so you have one box for your TV set and one for your VCR. The trouble with this solution is that you must rent the box from the cable company and pay for it every month. Another solution is to have a special switching system installed or buy one made for the purpose, such as The Switcher video-control panel offered by Fidelitone (3001 Malmo Rd., Arlington Heights, Ill.

60005) at \$79.95, or one of the more complex switchers, about which more later. The problem here is that throwing the switch (which electrically "moves" the converter from the TV to the VCR or vice versa) is one more thing you must remember to do.

The third answer is an ingenious new device that lets you get rid of the cable company's converter box (unless the company scrambles its signal) and in some cases pays for itself in reduced cable fees. And it's legal! Some of the latest 1981 TV sets permit direct tuning of special cable channels, thus eliminating the box, simply by converting the lettered channels to numbered channels in the UHF band.

Although the sound
recorded on home
VCRs isn't the greatest,
you'd be surprised
what a good amplifier
can do for it

The purpose of this is to make it possible for the first time to tune in the special cable channels by wireless remote control. No viewing options are lost, since cable systems don't use UHF channels (they do carry programs broadcast by UHF stations, but convert them instead to channels 2 through 13 or the lettered channels).

Well, now the same system that's used in these new sets is available as a relatively low-cost accessory to solve the cable TV-VCR dilemma once and for all. This is a small signal converter that can be attached out of sight in back of the VCR and connected directly to the incoming cable. To either record or view Cable Channel A, you tune to UHF Channel 49 on your VCR or TV set; for Channel B, you tune to Channel 50; for Channel C, to 51; and so forth.

The converter is available under at least two brand names, and more undoubtedly will be coming. The Vidcor 2000 (Vidcor, Inc., 200 Park Ave. South, Suite 1411, New York, N.Y. 10003) may be purchased through some video dealers at a suggested list price of \$89.95. However, you'd be smart to inquire first about the RCA Channel-Trak, which is identical to the Vidcor and sells for as little as \$59.95 (although it has no suggested list price).

Cassette Changers. If you own one of the original single-speed Sony Beta-max VCRs (model SL-7200 or LV-1901) or the two-speed SL-8200 or SL-8600, you can now triple its unattended recording or playing time with a Beta-stack changer. Using the longest-playing tape, you can now get close to four-and-a-half hours of recording on single-speed units and nine hours on two-speed ones by adding the AG-200 Betastack, which automatically removes one cassette and inserts a new one, whether you're present or not.

A different model Betastack (the AG-300) is designed for newer Sony and Zenith Beta VCRs—the ones that include the Bill speed—and accommodates four cassettes, bringing recording or playing time to as much as 20 hours. The AG-200 Betastack is \$125 from Sony dealers. The 20-hour version should be available by the time you read this, but it hadn't yet been priced at press time. When you inquire about either of these, be sure to have the model number of your VCR.

Sound Improvers. There are accessories that can make a substantial improvement in the sound of your video recordings, and, incidentally, of your TV set as well. These are simply external amplifier/speaker combinations, which process the sound just as any hi-fi system would. Although the sound recorded on home VCRs isn't the greatest, you'd be surprised what a good amplifier can do for it. Some of these amplifiers were really designed to be plugged into the audio output or earphone jack of a television set; unfortunately, most TV sets don't have those jacks. However, all VCRs do, so by adding an external audio amplifier/speaker system you can use your VCR to improve the sound of regular TV reception as well as the sound of your tapes.

If you have a stereo or hi-fi system in the same room as your TV set and VCR, you can improve the sound of both with a simple connector cable for a couple of dollars: hook the "audio out" jack of your VCR to one of the "aux in" or "tape in" jacks on your stereo receiver or amplifier, set the mode control on your stereo to "mono"—and the sound will come from both speakers. In order to channel the sound from a regular TV program to your hi-fi with such a setup, it is necessary to tune the TV set with the VCR's tuner, instead of its own. This means turning the VCR on with the selector switch set to the VCR position when you watch TV. Of course, if there is an audio or earphone

continued on page 90

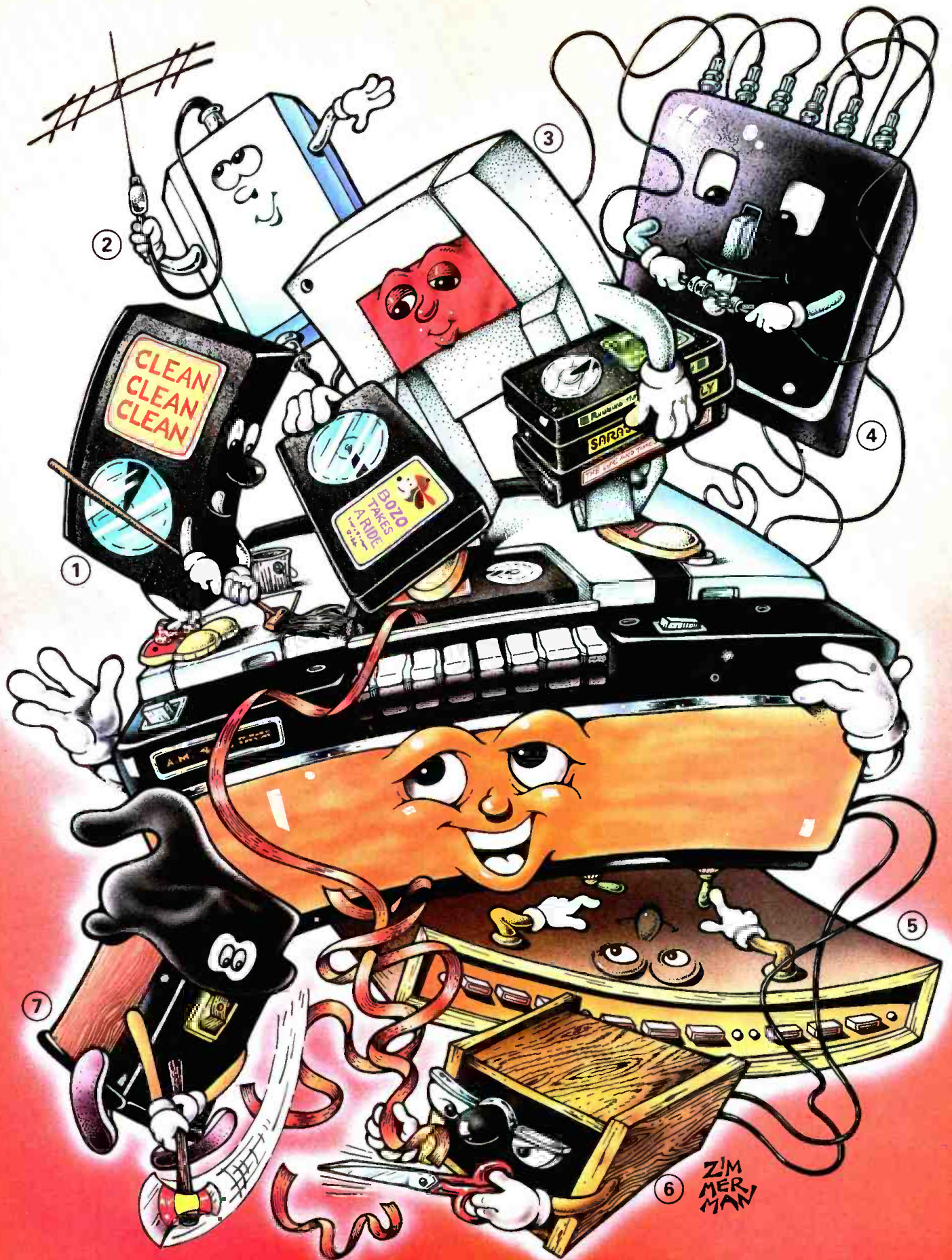

Birth of a Salesman

"When you build up a reputation such as I have over 37 years you get to where you can recognize a quality very early on. . . . A tremendous feeling of patriotism is now sweeping the country. I, myself, am so proud of being an American and when I go to bed at night it's very important to have the right person making a good presentation on the news so that I know where I stand. You feel the strength in Carter's delivery. . . . You can feel him stabilizing things on sensitive issues. . . . I am tremendously impressed and when I'm impressed I move."

—Norman Brokaw, a senior vice president of the William Morris agency, announcing that Hodding Carter had selected the Morris agency and Mr. Brokaw to represent him following his July resignation as assistant secretary of state for public affairs

Spoofig a Government official—

FADE IN:

Summer, 1980. Washington, D.C.

EXTERIOR. PENNSYLVANIA AVENUE—EARLY EVENING

FULL SHOT of HUDDLESTON CARVER, carrying briefcase and suitcase, walking slowly away from the White House, through gates. He turns and heads up avenue. CAMERA follows him. Walking tall and with great dignity through pedestrian traffic, he moves slowly, as if in a trance.

CUT TO:

INTERIOR. GROCERY STORE—NIGHT

Huddleston Carver, among food shoppers, pushing cart up and down aisles. Manner distracted, dislocated. He takes an eggplant from produce bin, inspects it as if he's looking for its starter button. Suddenly, a MAN lunges toward him, clutching microphone, smiling, displaying several octave-widths of huge teeth.

MAN WITH MICROPHONE (*tattletale lilt*)

We've been spying on you!

CARVER (*slow, flat, but somehow emotional voice*)

Certainly, it is my position that within the legitimate course of any operation, a degree of reconnaissance might be assumed. This does not mean, however, that the tacit code of international harmony need, or *should*, be violated.

MAN (*same gurgling voice*)

It took you 20 minutes to choose that eggplant! Are you always that choosy?

CARVER (*takes man's microphone*)

All options were thoroughly assessed and are continuously reviewed, and that's all I'm prepared to say about it at this time.

MAN (*shoves peanut-butter-laden cracker at Carver*)

Here! Taste this. We're on live TV right now and



with a nod to "Being There"

By DOUGLAS BAUER

I want you to tell me, is this peanut butter as good as the one you normally buy? Or, *is* it the one you normally buy? Or, is it as good as an eggplant? Or, would you ever consider spreading this peanut butter on the eggplant—sliced and fried—thereby using the eggplant as a multipurpose paraculinary device? And when you're finished I have a follow-up.

CARVER (*chewing peanut butter, appearing unruffled*)
I can say, in the absence of a full accounting of ingredients, that this does appear to be peanut butter. But that cannot be confirmed until a thorough review has been completed.

MAN (*pressing*)
When will that be? Would you say "months"? "Weeks"? "Days"?

Carver begins to back away from the man and, not watching where he's going, steps into the path of another shopping cart. It rams into Carver, pinning his leg between it and his own cart.

CARVER (*takes a long, careful look, remarkably unruffled, weighing all aspects of incident*)
YEEOOOWWWWWWWW!!!

WOMAN *pushing cart scrambles to help Carver.*

WOMAN (*quite ruffled*)
Oh, I'm terribly sorry. Are you hurt?

CARVER (*grasping shin*)
It would be premature to make a judgment until a lasting repose has set in along the length of the tibia. Let me just comment that, at present, a great deal of pain is under way.

WOMAN
Oh, dear. I am sorry. It shouldn't hurt too long.

CARVER (*firmly*)
It is my feeling that one second of pain is a second too many.

WOMAN (*whispering to herself*)
That's a "whiplash" rap if I've ever heard one. If he finds out who I'm married to, he'll sue Melvin for syndication rights to Leonard Nimoy.
(*to Carver*)

Here, please, you should rest that leg. Climb into my shopping cart and sit for a minute.

CUT TO:

INTERIOR. MELVIN KROKAW'S DEN—NIGHT

Luxurious wood-paneled room. Giant TV dominating. Set is on and shows live peanut-butter commercial featuring Huddleston Carver. KROKAW, eating dinner from TV tray, is sitting straight up, at attention, watching screen. Screen shows Carver sitting in Mrs. Krokaw's cart. Krokaw riveted by events on screen. So is an ASSISTANT, next to him.

KROKAW
My God, look! It's Betty! What luck!

ASSISTANT

I should say. This just ain't your day, Mr. K. First you can only get a half-million advance for Loni Anderson's love poems. Now your wife rams into a guy with her shopping cart during a peanut-butter commercial.

KROKAW

No, you idiot! Don't you see, this is great! I was watching that guy before when he was eating the peanut butter. The camera couldn't get enough of him. There's something about him, some quality that transmits honesty right through the screen. Look at him now, sitting in that shopping cart. Ridiculous, right? A fool. Yet, somehow he's pulling it off. The guy is sitting there, all beat up, and yet he's saying "dignity" to me.

ASSISTANT

 (*skeptically*)

But, look at him. The guy has no chin. The man is chinless.

KROKAW

I like that. It's fresh. It's new. It's saying "weakness." Dignity with weakness. No, weakness with dignity. That's better.

ASSISTANT

 (*warming to idea*)

Yeah, but kind of a firmness, too.

KROKAW

Exactly. Listen. Get down there before Betty leaves. Take my car. Take his name. Take a meeting. Here, take this tray.

ASSISTANT

 (*hurrying out with TV tray, mumbling*)

"Weakness with dignity." "Cowardice with resolve." "Fear with principles."

CUT TO:

INTERIOR. MELVIN KROKAW'S OFFICE—FOLLOWING AFTER-NOON

Krokaw behind his desk. Huddleston Carver in nearby chair. Mounted on Krokaw's walls, several famous clients' photographs.

KROKAW

You were brilliant on that peanut-butter thing last night, Huddleston. May I call you Huddleston? May I call you brilliant? What's so beautiful is that it was *live*. There aren't 10 guys in the business who can do stand-up live and pull it off. You did brilliant, spontaneous, natural, believable stand-up—live.

CARVER

 (*slightly embarrassed*)

While it would be an exaggeration to say that I'm entirely comfortable with such a format, clearly, for the period of time that I have made regular, intense, unrehearsed appearances on television, I have developed a certain calisthenic flexibility of thought.

KROKAW

Right. Right. But that's behind you. What now?

continued

What do you want to do next?

CARVER

Certainly, as I have told you, I stand ready to explore all feasible alternatives.

KROKAW

Beautiful, Hud. May I call you Hud? Now, climb into my head with me. First, you do some quiz-show guest shots, maybe working up to the lower left-hand corner box on *Hollywood Squares*. Then a couple of prime-time specials, maybe a special guest-star cameo on *CHiPs*. You'd be great playing off Erik Estrada. The two of you would be sim-pa-ti-co. Then commercials. You've got breakout potential on commercials. You've got calm, honest dignity oozing out of every pore. Maybe, in time, your own product. I could see you as the Shell Answer Man. I could see you *plainly* as the Shell Answer Man. Or bumping Robert Young from that Sanka gig. Robert Young says *old*. He says ulcers and low-sodium diets.

(pause)

Well, how does it sound so far?

CARVER

Not wishing to raise false hopes and expectations, I will acknowledge the real possibility of a positive reaction.

CUT TO:

INTERIOR. FILM STUDIO—DAY

Huddleston Carver taping a commercial under bright lights. Full replica of a news conference has been constructed. Carver behind podium; ACTORS playing newsmen and newswomen in folding chairs.

DIRECTOR

We're rolling now. Ready? Action.

CARVER

... And that's all I have on the situation at this time. I'll alert you as developments unfold. Thank you.

Actors rise and begin to shuffle out. Carver takes a few steps from podium, stops, looks into camera.

CARVER

You've never seen a celebrity talk about masculine protection on television before. Well, after some deliberation, an internal decision was reached that I should be the first, because, reasoning went, this is an area of extreme sensitivity that could greatly benefit from a public airing.

(holds up can)

After a long press conference, during which several insistent questioners have pressed me to reveal secrets of State, I can say to you with total candor that my body, that is to say that part of me situated underneath and in support of my shirt, suit, tie, et cetera, is unusually wet. That's when it's appropriate to reach for No Comment, the masculine-protection spray that reveals no

information about problem areas of masculine wetness. So, remember. No Comment. When you want your body to make no statement.

DIRECTOR

Cut! Print it. Beautiful! I believed it, Hud. I believed *you*. You spoke right through the product and on out to the audience. Breathtaking.

CARVER

That assessment is received with appreciation.

CUT TO:

MONTAGE OF HUDDLESTON CARVER RAPIDLY BUILDING HIS NEW CAREER:

INTERIOR. COMMERCIAL STUDIO—DAY

End of another commercial.

CARVER (holding toothpaste)

... Final Word. With fluoride and whiteners equally proportioned. Get Final Word, so you won't be caught with your mouth open.

CUT TO:

INTERIOR. TELEVISION STUDIO—DAY

Carver, REX REED, JAYE P. MORGAN seated as judges of The Gong Show. Carver appearing bemused, but remarkably unruffled.

CUT TO:

INTERIOR. MELVIN KROKAW'S OFFICE—DAY

Krokaw heartily shaking Carver's hand, giving him contracts to sign, handing him huge stack of money, then taking some bills off the top and stuffing them in his pocket.

CUT TO:

INTERIOR. TV STUDIO—NIGHT

CAMERA roams wildly enthusiastic audience at The Tonight Show. BAND playing. DOC SEVERINSEN hitting sonic screech on trumpet to end song. WILD AUDIENCE APPLAUSE. CAMERA shows CARSON, behind desk, with BERT CONVY, FERNANDO LAMAS, HELEN GURLEY BROWN on couch. Carson drumming desk with pencil.

CARSON (amidst end of applause)

Ah, that was great, Doctor. We have to do that more often. Really turn the band loose.

AUDIENCE

Yeah! Yeah!

CARSON (nodding)

OK. We'll be back in a moment after a word from Dog Yums, the meaty, 100-percent-nutritious dog food.

CUT TO:

INTERIOR. STUDIO—NIGHT

In another part of studio, Huddleston Carver shown bending down to pet a large BLOODHOUND, which is looking mournfully into empty dish.

continued on page 87

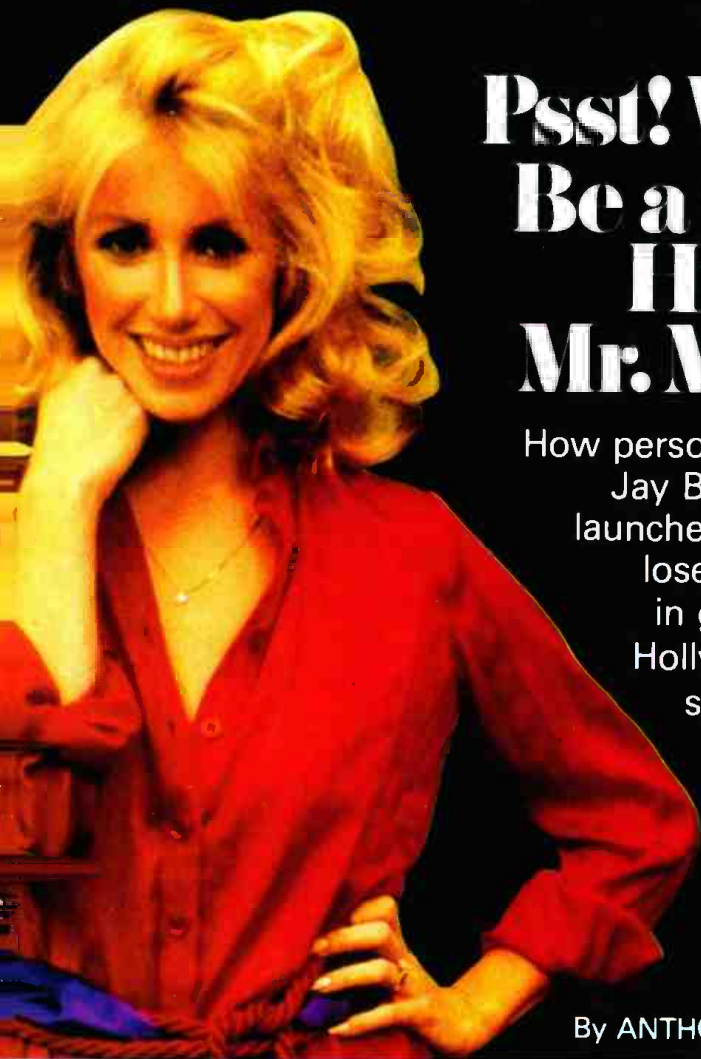

Psst! Wanna Be a Star? Hire Mr. Mean!

How personal manager Jay Bernstein launches 'em and loses 'em in grand Hollywood style

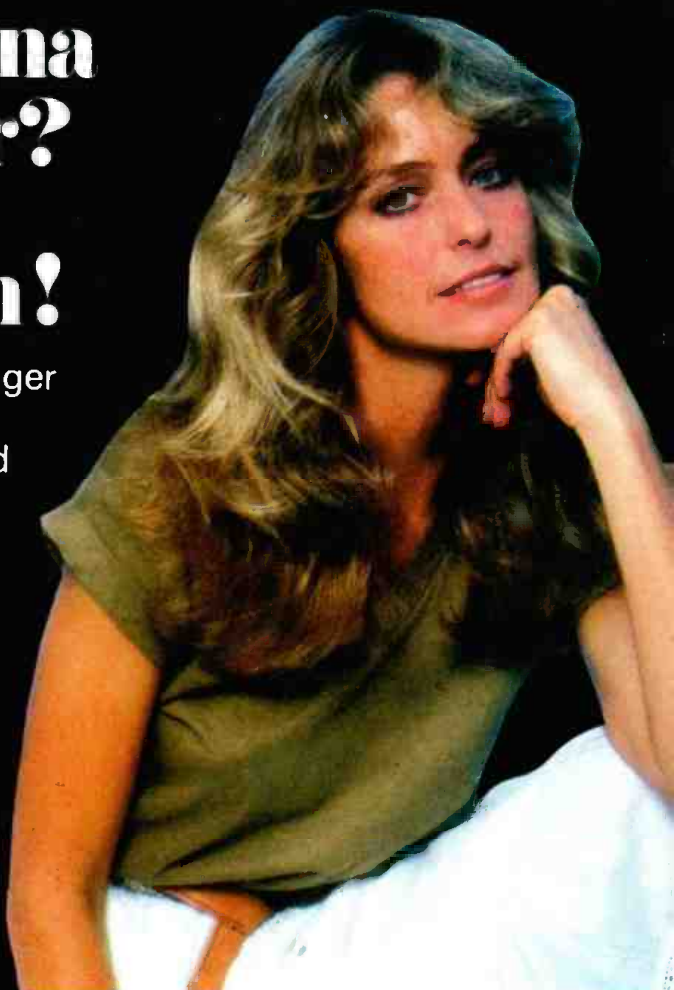

By ANTHONY COOK

First there was Farrah. Then there was Suzanne. Who will be Jay Bernstein's next star?

It is 10 A.M. Friday in Beverly Hills. A black Cadillac limousine (license plate 1 JB) pulls up to the curb at the Rodeo Drive entrance to Vidal Sassoon's. Out of the car steps a middle-aged man with a salt-and-pepper beard, wearing a diamond pinkie ring and a brown bracelet made from the vertebrae of an African python. In his right hand he is clutching a decorative cane. The man strides into the hair salon, up the stairs to the ladies' section, and sits down next to a striking blonde. Not just any blonde, but the star of Three's Company, Suzanne Somers.

The actress greets the man with the cane like an old friend. Then, while each of them is trimmed and manicured, the boulevardier and the starlet fall into a whispered exchange. Around them, like extras in an E.F. Hutton commercial, Sassoon regulars try to eavesdrop. They know, from observing this ritual week in and week out, that when Jay Bernstein talks, Suzanne Somers listens.

Anthony Cook is a free-lance writer based in Los Angeles.

Not every TV star has a Jay Bernstein. But Jay Bernstein manages several TV stars. He gives them advice—which jobs to take and which to turn down—and they give him 15 percent of their gross earnings; with a client like Somers, this can mean millions.

Bernstein is one of the more conspicuously successful operators among those in Hollywood who grease the wheels of the star-making machinery—the lawyers, the accountants, the publicists, the people who solicit work for actors, approve their contracts, manage their money and write their press releases. A personal manager like Bernstein stands at the apex of this pyramid of professionals. He keeps track of what the other hired hands are doing. He is the show-business equivalent of the paid political confidant—the man the public sees whispering directives in the candidate's ear—who, more than anyone else, is in a position to have the final word. In Hollywood, the final word is worth 15 percent.

Typically, each of the 250-odd per-

sonal managers in the country has only a few clients and trades on his undivided loyalty as a justification for such healthy fees. In turn, many of the stars grant them enormous influence over their careers. Among the most influential are Ron Samuels, who manages his wife, ex-Wonder Woman Lynda Carter, as well as ex-Bionic Woman Lindsay Wagner; and Jerry Levy, whose clients include Hal Linden of *Barney Miller*.

But the most powerful, the most colorful, the most outspoken and controversial manager of them all is Jay Bernstein, the man who presided over the spectacular rise and fall of Farrah Fawcett, who helped make names such as Kristy McNichol and Susan Saint James household words. The man who has milked the networks for millions of dollars and who, over 20 years, has made a fortune building legends and reading the fine print in their contracts. The man who turns unknowns into stars—and then loses them.

The 43-year-old former publicist now calls himself a "career strate-

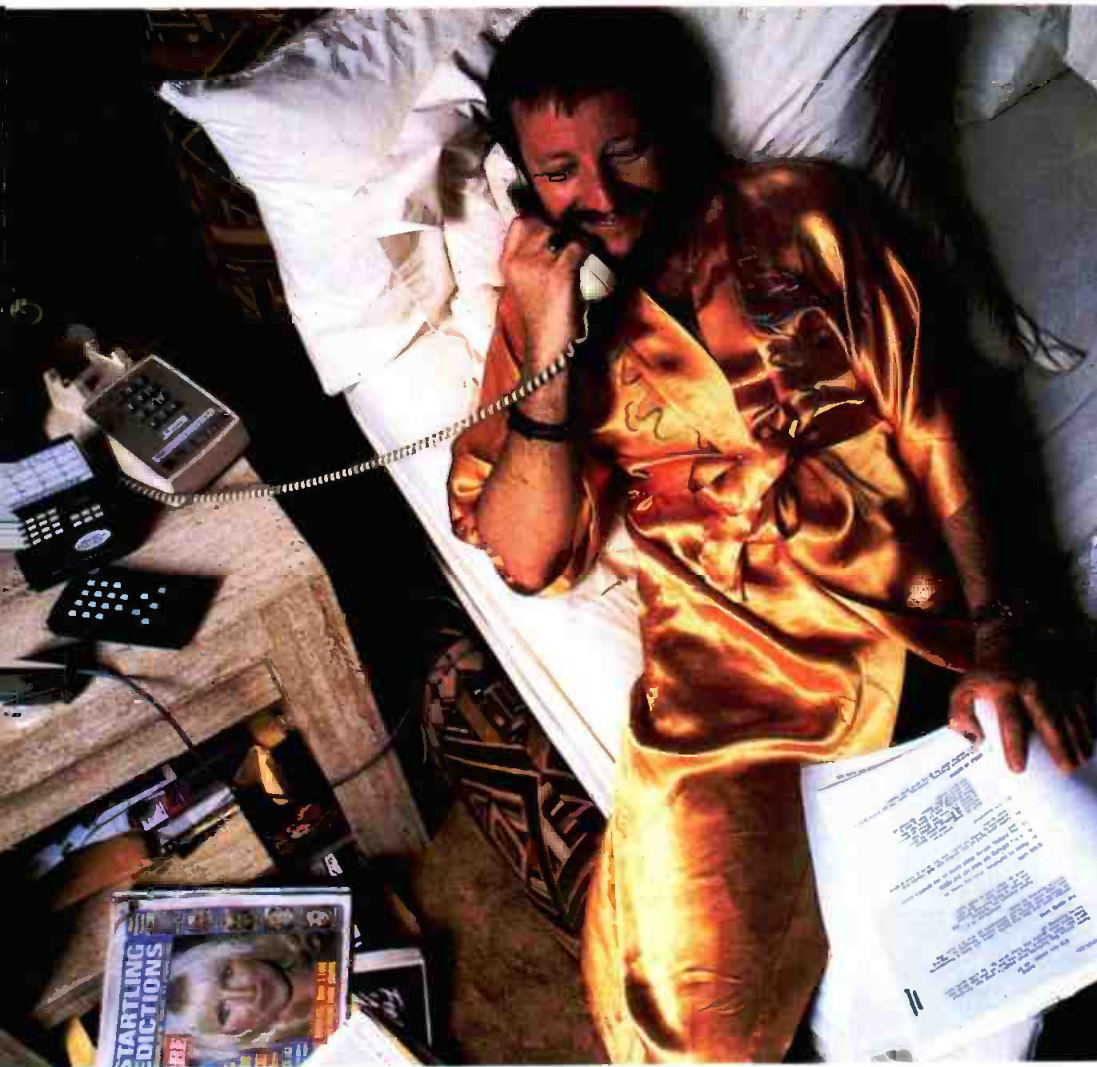

Even in bed, Bernstein can't cut the umbilical cord: he has six home phone lines.

gist"—a sort of Clausewitz of the Hollywood suites. In negotiations he acts as the point man. "I'm the guy," he says, "who absorbs the abuse." When Farrah suddenly abandoned *Charlie's Angels* to launch a movie career, it was Bernstein who hammered out a settlement with the show's producers, Aaron Spelling and Leonard Goldberg. When Suzanne Somers and Kristy McNichol signed with CBS while their series were running on rival ABC, it was Bernstein who ran interference for them. The stars love him. The networks hate him. He has been threatened, shot at, and called nasty names.

Bernstein's cheeky bravado makes it impossible for anyone to feel neutral about him. One day he'll be shaking hands with Lord Lew Grade over a movie deal made on an airplane, the next day he'll be listening to some producer shout that Bernstein's face should never darken his set again. His detractors call him an overreaching hype-artist who has made one fast buck too many. His admirers say he is a

shrewd veteran of the Hollywood wars with an uncanny knack for turning even bad news into favorable publicity.

Bernstein himself has cultivated a kind of Black Bart image, growing his beard to "look Machiavellian" and making sure, even in meetings, that he is carrying his cane. A personable man in private, he has deliberately fashioned what he thinks is a useful "don't mess with me" professional pose. Half in jest, Suzanne Somers nicknamed him "Mr. Mean."

Mr. Mean sits in his baronial bachelor pad, the one-time hideaway of Gable and Lombard, reflecting on the miracle that made it possible for a chubby, movie-obsessed, Jewish kid from Oklahoma City to wind up mingling with the people who once occupied his dreams. The house, with its indoor swimming pool, suede walls, elephant tusks, wall-sized TV and glass-enclosed cane collection, suggests the owner has had his fantasies fulfilled.

There is George, the butler, and, in

the daytime, Susie, the assistant, to attend to him, and scattered around the house are the instruments of his profession: telephones. Bernstein spends almost all his waking moments either on airplanes, in restaurants, or on the phone. He fields up to 75 calls a day just taking care of business. To make sure he doesn't miss anyone's call, he has six telephone lines at home.

The man with the phones began his climb in the manner of the legendary moguls—at the bottom rung of a talent agency. Having come West to Pomona College to be closer to the glamour of Hollywood, Bernstein was ready to make his move when he learned that an accident had befallen a messenger at William Morris; he applied for the opening and landed a job in the firm's mail room. He worked hard, offended the brass with his high jinks, and was fired. Next, he joined an old-line Hollywood public-relations firm, Rogers and Cowan, where he was assigned to the then-notorious Rat Pack: Frank Sinatra, Joey Bishop, Peter Lawford, Dean Martin and Sammy Davis Jr. Bernstein would breeze around town clad in dark, tight-fitting suits and white shirts, sporting star-sapphire cuff links. For this he was once referred to as the agency's "cuff-link cutie pie." Professionally he was known as "Frankie's Flack."

The main object of press agency in those days was to get ink for clients in the national newspapers. Bernstein was good at it. When Sammy Davis was cast as a prizefighter in a television movie Bernstein saw a way, without being obvious, to play on the fact that Davis was the first black man to land a leading role in such a drama. He knew that a simple press release to that effect would be ignored. So instead, he paid a stunt man on the set \$200 to punch Davis in his bad eye during a fight scene. Then he invited a press-photographer friend to visit the set. The stunt man did his job, Davis got bloodied, and Bernstein landed his story on the front pages. To this day, according to Bernstein, Davis doesn't realize he was set up for a sucker punch by his own publicist to generate headlines.

Even his employers considered Bernstein's methods controversial; he was always either in the doghouse or on a throne. But nobody could argue that he wasn't effective. In 1962 he founded his own firm, Jay Bernstein Public Relations, and by 1968 he had 90 clients. The list of names he handled

now reads like a Hollywood Who's Who: everyone from Edd "Kookie" Byrnes to William Holden to Zsa Zsa Gabor. In addition he did corporate P.R. for Fortune 500 companies like AT&T and General Motors. Ralston Purina even hired him to promote a new product for grooming horses.

As a boss, Bernstein apparently modeled himself after Gen. George Patton. He called his employees The Green Berets. On call day or night, they called themselves The Beeper Bunch. At times the general would revert to some of his old high jinks: Bernstein once packed his office with people off the street to impress some visiting corporate brass. But still, he expected everyone to be a workaholic like him. Stan Rosenfield, a former employee who now runs his own successful P.R. firm, jokes that his tenure with Bernstein was like ten years on the Rock. He says, "Jay is a charming, adorable, cunning czar."

Eventually, in the course of promoting his clients, Bernstein began performing more of the functions of a manager, arranging bookings and working out terms on various performance deals. Traditionally a personal manager was someone hired by musicians to work out the logistics of working on the road. But the mushrooming complexity of the business side of acting provided Bernstein with an opportunity. He figured he could make more money directing the careers of a few name performers than he could doing publicity for scores of them. He had confidence in his grasp of the do's and don'ts of attaining celebrity status, and in the use of Svengali-like charm—especially with actresses. He wanted to handle women, because, he said, "Women are used to depending on a man."

Persis Khambatta strides across the Astroturf at Ma Maison, the open-air watering hole for Hollywood's glitterati, and pulls up a chair next to her new manager, ordering a strawberry daiquiri. "Hello, Jay," she purrs in her faintly accented English. The actress, an expatriate from India who starred in the movie "Star Trek," has just flown in from New York where she is shooting a film with Sylvester Stallone. She explains that she had a choice of doing a Harper's Bazaar cover or winging to L.A. for 24 hours. "I wanted to see Jay," she says.

Up to this point Bernstein has been bantering with two producer friends over lunch, discussing a couple of upcoming projects for his clients: a new version of Mickey Spillane's Mike

Hammer and a proposed series about a gossip-laden Hollywood restaurant, modeled on the exquisitely trashy *Dallas*. But now he focuses on his newly acquired jewel, Persis, the actress he has signed to prove that a woman who is dark-skinned, sloe-eyed and exotic-looking can be a major star.

For several minutes they huddle to talk about business, including a Playboy magazine request to publish some paintings of the actress done by a friend. Bernstein says, "Tell 'em to call me." Then, getting up from lunch, they amble over to a small gift shop next door where Persis quietly admires an ostrich egg covered with decorative feathers from a guinea hen. Bernstein

lingers as the actress leaves the shop to get into her car, then he catches up and surprises her with a little gift—the feathered egg. From a distance, her giddy "Thank you" seems to echo something she said about Bernstein over her daiquiri: "As far as I'm concerned, he's a legend."

The legend, such as it is, first gathered momentum in 1976, the year Bernstein took on Farrah Fawcett as a client. Ironically, as he tells it, the partnership with his biggest name began by accident. Sonny Bono had retained Bernstein to pull him out of the professional doldrums after the performer had split up with Cher. Bern-

GET UP TO 30% MORE RECORDING TIME!



Are you wasting valuable video tape because you're not sure how much time is left on your cartridges? VIS Video DIAL-A-TIME shows you exactly how much time you've got—in 5 minute intervals. So you get more entertainment for your money!

Simply set your recorders' counter number on the VIS Video DIAL-A-TIME sturdy plastic disc. The amount of recording time used and remaining for all standard recording speeds POPS UP LIKE MAGIC in the disc's windows.

Two calculators in one . . . Each VIS Video DIAL-A-TIME disc contains two separate calculators (one on each side) for the popular cartridge sizes. Models are available for VHS and BETA I, II, III formats. So get more out of your video cartridge investment. Start saving money NOW!

Phone toll free 800-223-2100, N.Y. State residences 212-541-7722 or mail the coupon with your check. Please allow 4-6 wks. for delivery.



VIDEO INFORMATION SYSTEMS, INC.

Order today and receive FREE THE 24 page VIS System Instruction and Video Recording Guide Book. You'll find valuable tips and suggestions on programming techniques, library development and maintenance, multi-set hook-ups, cable connections, editing and much more! A \$4.95 value yours FREE.

Visa, Master Charge, Diners, Carte-Blanche and American Express honored by phone or mail.

Please send me the VIS Dial-A-Time Calculator and free Video Recording Guide Book.

Quan _____ VHS T-180/T-90 \$14.95 plus \$2.00* Quan _____ BETA L-250/L-500 \$14.95 plus \$2.00*
 _____ VHS T-120/T-80 \$14.95 plus \$2.00* _____ BETA L-750/L-830 \$14.95 plus \$2.00*

*Enclosed is my check for \$_____ including postage and handling
 Connecticut residents add 6% sales tax

NAME _____ SIGNATURE _____

ADDRESS _____ PHONE NO. _____

CITY _____ STATE _____ ZIP _____

CREDIT CARD NO. _____ EXP. DATE _____

VISA MASTER CHARGE DINERS CARTE BLANCHE AM. EXP.

Please make check payable and mail to:
 VIDEO INFORMATION SYSTEMS, INC., P.O. Box 185/Dept. M8 P6, Deep River, Conn. 06417
 DEALER INQUIRIES WELCOME.



Still-life with shades: Bernstein adds a realistic touch to his portrait.

stein told him, "Sonny, what you need is a new girlfriend who's better looking than the woman who dumped you." Sonny said, "You're right, Jay—go find one for me." Not long afterward, in Palm Springs, Bernstein looked across his hotel swimming pool and "discovered" a suitable candidate, Susie Coelho. He got on the phone to Sonny in L.A. and told him to charter a plane to the desert so he could meet this eligible lady. When Sonny arrived, Bernstein introduced him to his find and, before long, Bono and Coelho were inseparable.

On the strength of this, Bono appeared on the cover of *People* (with an assist from Bernstein). The publicity, in turn, garnered the actor a role in *The Six Million Dollar Man*, where he met actor Lee Majors. Bono introduced Majors to Bernstein at a Rams football game and the two of them hit it off. According to Bernstein, the actor said to him, "I don't know exactly what it is you do, but you can handle me if you want." Bernstein said "great" and signed Majors—along with his wife, Farrah Fawcett-Majors, who was added almost as an afterthought. Such is life in show biz: if it hadn't been for Susie Coelho, Farrah Fawcett might have been just another of Charlie's forgotten Angels.

When Bernstein took control of her

career, Farrah was the second lead on the jiggly ABC series, making \$5000 an episode. The hours were long, and Lee was pressuring her to come back to their tennis court; she announced she was going to quit. What happened next has become a well-publicized tale. Farrah became the biggest media phenomenon since the launching of *Pet Rocks*. Playing on the publicity he himself arranged, Bernstein helped get her a string of lucrative deals, including a reported \$3 million from Fabergé to put her face on Farrah shampoo. He lined up three movie roles for which she collected \$2.25 million. At the climax of his deal-making spree, he bludgeoned a Beverly Hills jeweler into paying her an outrageous sum to promote some gold charms shaped like miniature faucets. The faucet man paid Farrah \$1 million for three hours' work.

At the height of Farrah's popularity, Bernstein made another shrewd move. He hedged his bets on his star by signing another blonde—Suzanne Somers. Soon he was getting the same kind of results for her that he had for Farrah, bumping her TV salary from \$2250 to \$35,000 an episode and signing her for Las Vegas appearances and merchandising deals. He read the fine print in Somers' *Three's Company* contract and figured out a way to sell

her services for movies and television specials to a rival network, a move that promised the actress a huge sum of money and drove the ABC brass right up the wall. Somers' end run meant the network would have to lock up several of their series stars with expensive contracts to prevent any more Bernstein-inspired deals. Flushed with victory, Mr. Mean found his client in a CBS waiting room. "Congratulations," he told Somers. "You're a millionaire."

By this time, Bernstein was really riding high. He had two instant celebrities making worldwide waves. At his Sunset Boulevard office, one wall was plastered with pictures of Farrah, another with pictures of Suzanne. His years of experience in P.R. had made him a master at orchestrating publicity, at taking advantage of even the worst revelations about his clients. There were the disasters involving mug shots of Suzanne, taken when she was arrested years before for passing bad checks, and stories about shoplifting charges against Farrah in Los Angeles. Each time, Bernstein managed to leak effective counterstories to blunt the sharp-toothed press, using the same method he was to employ early this year when he forced *Playboy* to cough up \$10,000 and a diamond ring after the magazine published some cheesecake photos of Somers. The

continued on page 80

Use this TV to tune in on the world's most complete video cassette selection.

If it's on video cassette, it's on Video Artists' playlist.

You'll find all major film productions. Including the complete cassette libraries of 20th Century Fox, Warner Brothers, Universal, Paramount, Allied Artists, Columbia and Media.

In fact, you'll find ours is the most complete playlist in the industry. And getting longer all the time.

Everything on the Video Artists playlist is priced right, too. So when you do business with us, you know you're getting the very best values possible. (That includes the lowest prices anywhere on blank video cassettes.)

To get the Video Artists complete playlist, use the coupon in this ad. Or call the number below. (Most initial cassette orders can be filled in 2-4 weeks.)

Video Artists. No one offers more entertaining ways to turn your TV screen into a movie screen.



VIDEO ARTISTS

Call Toll-Free
1-800-328-8181

(In Minnesota, Call 1-612-933-8072.)

VIDEO ARTISTS 11336 K-Tel Drive, Minneapolis, MN 55343

- I would like to receive the Video Artists playlist(s) checked below (check one or both — enclose \$5, refundable with first purchase):
- Family Movie Master Playlist
 - Other Movie Master Playlist

NAME _____ AGE _____

SIGNATURE _____ DATE _____

ADDRESS _____

CITY _____ STATE _____ ZIP _____

HOME PHONE () _____ BUS. PHONE () _____

- I'm interested in purchasing one of the selections at right. Please have a Video Artists Manager of Motion Picture Distribution call me. Best time to call: _____

TDK Brand Tapes Available

PA-11

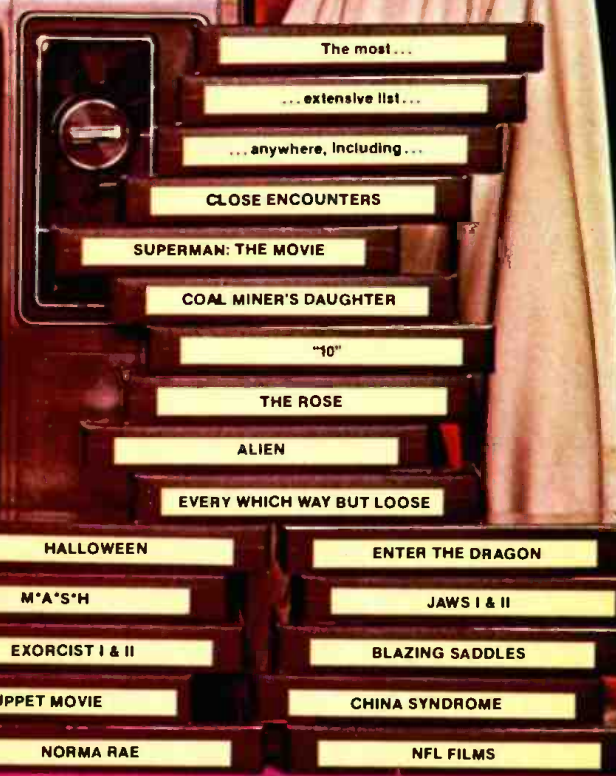

JAY BERNSTEIN

continued from page 78

public learned about the agreement when they read that the star had donated her booty to charity. According to one rival publicist, Bernstein's sleight of hand simply added another zero to whatever his clients were asking for their deals.

Ultimately, however, Bernstein's ploy of pyramiding his stars' press releases into bargaining chips caught up with Farrah. In quick succession her movies bombed, her shampoo fizzled and sales of her little gold faucets dried up. Stung by the reversals, she decided that her wheeler-dealer manager was more than partly to blame. In short order, she fired him, along with her lawyer, her agent, her P.R. man and even her husband, Lee Majors, who, during the same period, also dumped Bernstein as *his* manager. All of a sudden, people in Hollywood were saying that Bernstein's tactics had transformed him from a star-maker into a star-breaker.

The industry's pundits divided into two camps: those who thought Bernstein had exploited Farrah by hyping her into oblivion and those who thought he had done her a favor by achieving more with less than any manager around. The actress herself held him responsible for her rotten roles, suggesting he was too impatient, always focusing on the short-term gains. Bernstein counters by saying he couldn't pick and choose her properties because the studios—afraid of offending the networks and encouraging other stars to treat their contracts with equal disdain—had blackballed Farrah after her dispute with Spelling-Goldberg, and that in any event she has garnered more money and better billings than any of her fellow Angels. Besides, he says, the story isn't over yet, because Farrah landed a role opposite Burt Reynolds in a new picture, "Cannonball."

He thinks the parting of the ways with Farrah was predictable: "You build 'em up to where the air is rarified, they become deified, and you get nullified." He says he's the only guy in Hollywood who's made a career out of getting fired.

Bernstein's former P.R. client Dionne Warwick sits in an NBC dressing room, surrounded by agents, lawyers, and publicists, her 1000-watt smile distorted in pain. She is waiting to tape a Barry Manilow special sponsored by Bernstein's current client, Dr Pepper, but the muscle spasms in her back have made it difficult for her to stand up, much less sing. When her old



Tête-à-tête with new client Maren Jensen.

friend walks in, cane in hand, her face lights up. Sizing up the situation, Bernstein beats a path past the assembled retainers and begins schmoozing with the star while he rubs her shoulders. Everyone else in the room looks helpless or chagrined while Warwick and Bernstein trade stories, reminiscing about, among other things, the day he attended the birth of her first baby. Then, taking her by the hand, Bernstein escorts the ailing singer out to her limousine so she can keep an emergency appointment with a Burbank chiropractor. As she climbs gingerly into the black Cadillac, Bernstein kisses her lightly on the lips. "Thanks, Jay," she whispers. "Thanks for everything."

The brief encounter provides a glimpse of another side of Bernstein than the image of the coldly calculating, high-stakes poker player suggests: his easygoing rapport with the people who are the foundation of this business—the stars. The man has countless stories about his celebrity friends, including his former roommates Fabian, Nick Adams, Robert Culp and Sammy Davis. He tells anecdotes about going on safari with Lee Majors and William Holden, and fishing for marlin with Susan Hayward. He plays on the fact that it is his friends he is protecting when he represents his clients in negotiations. That's why, even while the people on the other side of the table think of Bernstein as Jesse James, he imagines himself as Sir Lancelot.

Still, there are plenty of people around who would like to knock him

off his high horse: the producers who complain that he uses the strength of his clients too crudely, the network executives who resent his end runs with Farrah and Suzanne, the agents he's harassed for jobs on behalf of his clients, not to mention people like the man with the golden faucets who wishes he'd never met Bernstein.

Even his clients get disenchanted with their protector. Some of them have concluded that he cultivates too much of his own publicity, creating confusion over who is the star—the actor or the manager. Partly because he was getting more attention than some of the people he handled, Bernstein recently lost Donald Sutherland and Susan Saint James.

But no sooner was he fired than he arranged to get hired by new clients, potential Farrahs like Catherine Hicks, who played Marilyn Monroe on ABC's movie biography, and Maren Jensen of *Battlestar Galactica*. Recently, to solidify his client base, he formed a partnership with lawyer Larry Thompson, and the two of them promptly signed William Shatner, Mike Douglas and Cicely Tyson. On the other hand, he is the first to acknowledge that nothing in his business is forever, that most actors don't make it to the big time and those who do don't last. His own chauffeur is Paul Petersen, former star of the old *Donna Reed Show*. Petersen's presence serves as a reminder to his boss that people who ride in the back seat of a limousine can wind up sitting in the front.

The phone rings in Bernstein's den. It is Alan Hamel, TV's Alpha Beta supermarket spokesman, with some bad news. He is quitting his Canadian talk show to manage his wife's career. Suzanne Somers won't be needing Bernstein any more.

Bernstein hangs up the phone and sits glumly on his sofa. He thinks about the five years of friendship, the \$11 million worth of deals, the fail-safe career. Not that he hadn't expected to be dumped—that's, after all, the predictable pattern—but he feels dejected just the same.

Impulsively, he reaches up and unhooks the gold chain with bold gold lettering from around his neck and puts it in his jewelry box. The chain is a token he received a year ago from Somers, and the letters spell out a message to her then-manager. The message reads, "I Love You, Mr. Mean." ■

6 REASONS WHY YOUR AUDIO & VIDEO TAPES ARE KEPT IN **SHAPE**®

4 VENTED FOR
CONDENSATION FREE
ENVIRONMENT

1 DISPENSES TAPE
AT A TOUCH OF THE FINGER

5 AUDIO CASSETTEBOX—
LOCKS TAPE HUBS AUTOMATICALLY,
PREVENTING TAPE JAM

2 LABELING
UP FRONT—
EASY TO
READ WHEN
STORED

3 INTERLOCKING SYSTEM—
BUILDS VERTICALLY OR
HORIZONTALLY

6 PROTECT YOUR TAPES—
MADE OF DURABLE
HIGH IMPACT PLASTIC

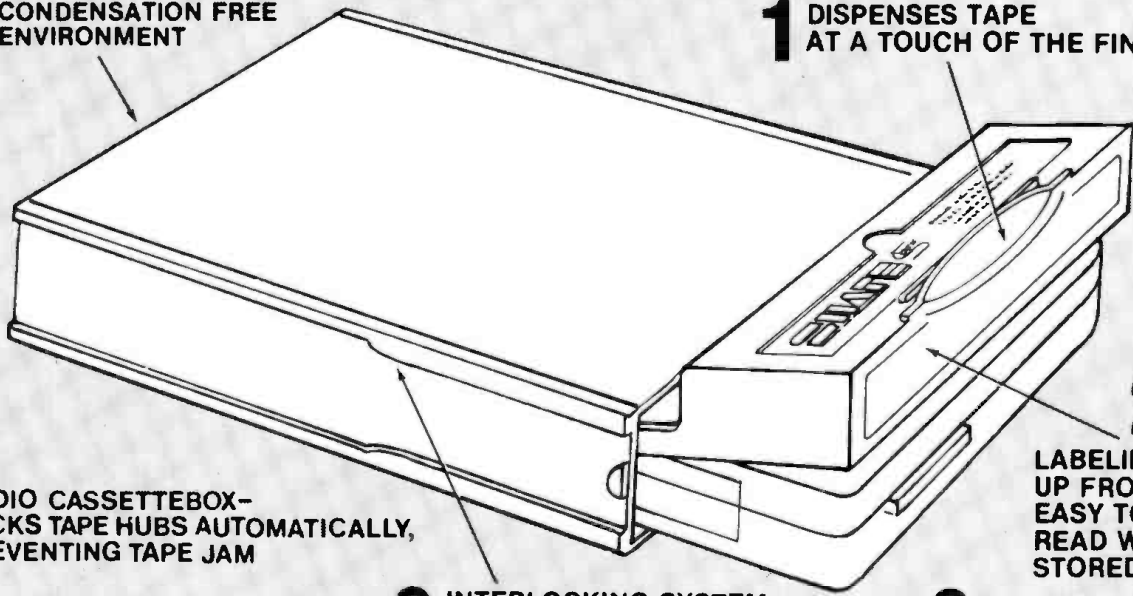

SHAPE® VIDEOBOX™

Shape Videobox is a compact expandable storage system. Each Videobox will interlock to make any system combination you desire...stack them vertically or horizontally.

Protect your valuable VHS or Beta tapes in the Videobox ventilated environment. Store and organize your library using patented, interlocking features. Complete with silver drawer labels, mounting pads, Beta insert.

SHAPE® CASSETTEBOX™

Shape Cassettebox protects your valuable tapes in a ventilated environment.

Each Cassettebox stores your tapes easily and with one hand operation dispenses at the touch of your finger. Organize all your tapes in a horizontal or vertical arrangement with a patented interlocking system...re-arrange anytime. Complete with silver drawer labels and mounting pads.

SHAPE®

SHAPE Consumer Products Div.
P.O. Box 366, Biddeford, Me. 04005

For additional information:
207-282-6155

Shape Videobox
 Shape Cassettebox

Name _____

Address _____

City _____ State _____ Zip _____

PAN 11/80

PLAYING FOR BLOOD

continued from page 47

million over four years, and NBC now would get the highly lucrative Series only every other year, and the play-offs and All-Star Game in the off year.

"A total shock to us," says NBC's Auerbach. "Baseball was very unfair to us. We thought we were entering into good-faith negotiations. But we were told, 'Here's what's left of the package; we've already made a deal with ABC.' We obviously expected better treatment—and some common courtesy—after all those years."

Outside NBC, however, it wasn't as shocking as it was revealing. "Sure, the baseball people weren't up front. But, hell, NBC was asleep at the switch," says O'Malley, confirming the general view among CBS and ABC people that NBC is the patsy in the sports war. O'Malley adds, "NBC thought that baseball was bluffing when they said they had other bidders. They're just not on the ball over there."

"You know what they say about nice guys," says that unidentified promoter's associate. "Auerbach's naive—they all are over there. They're in a different era. They're big on loyalty, think everyone should be as nice as the Rose Bowl and Orange Bowl people—whom NBC has a very warm, airtight relationship with. The problem is, there are very few of those relationships left—maybe only the Indianapolis 500 and ABC. We represent clients who want the best deal for their product. That's the battleground now."

NBC had to think it had gotten even with ABC by landing the Moscow Olympics—especially after starting with what was considered the slimmest chance to pull off that deal. All the networks, fed up with the Russians constantly altering the bidding procedure, had walked out of Moscow. Then, after some brief talk about pooling three-way coverage, CBS dropped out altogether. ABC—not, of course, taking NBC seriously—was genuinely convinced the door was wide open for them. They didn't know that CBS had quietly released Lothar Bock, the influential West German TV producer and agent with ties to Moscow, from his CBS commitment, and that NBC had hired him.

"We were not averse to seeing ABC get screwed," says a CBS source.

Giggles an NBC man, "When Boone [Arledge] heard the decision, he came in from Paris yelling and screaming about dirty pool. It was beautiful."

Then came Afghanistan, the Moscow boycott—and NBC bit the dust, losing huge amounts of projected ad revenue and promotional-slot spots for hyping its general programming (the \$87 million the Russians got for the rights was

almost fully covered by insurance). "There's a hidden power watching over us," says an ABC man, only a little in jest. "And a curse over NBC."

Even if ABC seems blessed, O'Malley calls the baseball deal only a mixed blessing for ABC. "At about \$92 million each for four years [the amount nearly doubled for each network with this year's renewal], NBC and ABC are losing money on it. That's the sacrifice you make for the Series. Nothing else draws. I heard that ABC's affiliates voted 155-2 against renew-

“Quite frankly, there’s a feeling around that CBS doesn’t really care that much about its sports.”

ing, but they can ignore the affiliates because of Boone. What he says goes." Auerbach's response is to ask why CBS was talking seriously with baseball commissioner Bowie Kuhn about a three-network package.

"Well," O'Malley says, "we would've gone with Saturday afternoons—but not prime time. ABC's philosophy is that they can frequently disrupt their entertainment schedule for sports. It's not ours."

"As usual, O'Malley's got it wrong," says Spence. "It'll be a cold day in hell when any network can ignore its affiliates. We may have had some flak—but only because we'd had overruns, past the 11 P.M. local-news slot. So we backed up to 8 P.M., and now 8:30, and so everybody's happy. Furthermore, I'm tired of this negative posturing about baseball. The last two weeks in June, we beat 45 programs with *ABC Baseball* during the rerun season. It's a very viable package."

"Listen," says the other ABC man, "CBS would've done it in prime time. But there was a real concern by the baseball people that they would treat it like they do the National Basketball Association—embarrassing it, putting play-off games on delayed tape, for example. Quite frankly, there's a feeling around that CBS doesn't really care that much about its sports."

Frank disagrees that his old network doesn't care—he only says that it's a bit

confused. *Sports Spectacular*—the weekly anthology that competes with ABC's *Wide World of Sports* and NBC's *SportsWorld* on weekends—he says, "has monumental problems." O'Malley, applying the old best-defense-is-a-good-offense technique, promises a "new push" for *Sports Spectacular* in January—but quickly veers off to talk about *SportsWorld*: "I don't think it's as much of a priority as before the Olympics—which is why NBC started the thing, to push the Olympics. They don't seem to be in the events chase now."

Auerbach is shocked by that. "Most objective industry people recognize the giant strides *SportsWorld* is making: our fresh, modern graphics and presentation—as opposed to the rather staid, unstable nature of *Sports Spectacular*. We're probably the most consistent, honest. For example, I don't care for the way *Wide World* breaks up events, teases viewers, makes you wait through events you don't want to see for one you do. Or sending a crew to a mountain after the event, just to tape lead-ins, to look up and say, 'Here comes so-and-so down the hill now'—as if they were there the whole time. It also irritates me how much they blow their own horn and plug network shows. We don't do any of that and I think it shows in the ratings. *Wide World* is not invincible."

ABC has heard that kind of talk before. That's why they smirk at it now. Says Spence: "We're the quality anthology show. We do the most important events and they're presented in the best manner—and recognized as such universally. As for blowing our horn, I think it's in [NBC sports announcer] Joe Garagiola's contract that he has to say how great the NBC camera work is during every baseball game—that's how it seems, anyway. And as for breaking up events, NBC does it just as much."

ABC also likes to imply that convincing the NFL to split its package and sell them *Monday Night Football* derived from the same brilliant legwork as the baseball coup. "I'm always amused by the notion that Boone Arledge 'invented' *Monday Night Football*," says O'Malley. "The harsh fact is, all three networks had turned down the show—with us, more than once. The only reason ABC took it was because the NFL was going to give it to the Hughes Sports Network and ABC found out it would lose 75 affiliates that night to Hughes. Our affiliates weren't nearly that crazy about it."

"Even now, it's not a great success—a 30 share is acceptable; they get a 33. CBS owns Monday night. They also

continued on page 84

Make prime time, YOUR time

THE VIDEO TAPE/DISC GUIDES Give you the whole world of pre-recorded video programming to choose from

- Find every program on video tape and disc you want to see – plus descriptions, where-to-buy/rent info, formats, casts, directors, producers, etc. Over 7,000 listings!
- Read the latest about home video systems – how you can set one up to give you and your family the most enjoyment every day of your lives!

Ask for

THE VIDEO TAPE/DISC GUIDE MOVIES & ENTERTAINMENT, 4,000 programs – all the great films, TV shows, concerts and other entertainment features... 256 pages. \$12.95

THE VIDEO TAPE/DISC GUIDE CHILDREN'S PROGRAMS, 2,000 programs for children of all ages. Includes cartoons, young-adult movies, educational and cultural features (hobbies, crafts, music, art, health and social studies)... 160 pages. \$9.95

Look for THE VIDEO TAPE/DISC GUIDES at your closest video retailer

Alaska: Alaska Video Systems, Fairbanks • Alaska Visual Entertainment, Anchorage • Kenri Communications, Homer • Shimek & Company, Anchorage • The Sound Shoppe, Homer • Video Concepts, Anchorage • Arizona: Video Cassettes Unlimited, Tucson • Arkansas: Video Cassette Store, Little Rock • California: Alco Paramount, San Jose • American Home Video, El Cajon • Certified Electronics, Los Angeles • Channel A, Canoga Park • Delta Video Center, Stockton • Discount Video Tapes, Burbank • EID's Television, Berkeley • Hollywood Video Cassettes, Hollywood • Home Video, Huntington Beach • The Larry Edmunds Bookshop, Hollywood • Middle Earth Video, Riverside • Nickelodeon, Los Angeles • Pasadena Video, Pasadena • Ron's TV, Tarzana • TVX Distributors, Hollywood • Video Cassette Rentals, San Diego • Video Cassettes Unlimited, Bakersfield, Santa Ana, Studio City • Video Cinema Center, San Rafael • Video Mart, San Bernardino • Video One, Santa Ana • Video Service Center, Sacramento • The Video Stallion, San Francisco • Video Tape Exchange, Los Angeles • Video Tape Mart, Sepulveda • Video 2000, San Diego • Video World, San Diego • Colorado: American Home Video, Englewood • Audio Video Systems, Aurora • King Bee, Denver • Smokestack Entertainment, Grand Junction • Valis Corp., Denver • Video Fair, Aurora • V & W Distributing Enterprises, Denver • Connecticut: Craig Greenwich Sales Corp., Greenwich • Video Shack, Hartford • Video Unlimited, Southington • D.C.: Video Place • Florida: Video Concepts, St. Petersburg • Super Size TV Systems, Orlando • TV Dimensions, Miami • The Video Den, Ft. Lauderdale • Video Center, Miami • Video Exchange, N. Miami Beach • Video Mart, Bradenton • Wildman Exports, Lauderhill • Wisconsin: Pompano • Georgia: Home Video Mart, Atlanta • Video Warehouse, Atlanta • Hawaii: EMC Corp., Honolulu • Idaho: Video Worlds, Boise • Illinois: Alice in Videoland, Chicago Heights • Columbia Video Systems, Highland Park • Joe's Electric TV & Appliance, Calumet City • Ken's Communication Company, Addison • Lens & Camera Company, Peoria • National Radio & TV, Chicago • Orland Home Video, Orland Park • Precision TV, Bellwood • Quality Books, Northbrook • Ship to Shore Stores, Chicago • Video Etc., Deerfield • Video Variety, Palos Hills • Indiana: Double Exposure, Munster • Fathers & Sons, Indianapolis • Marbaugh Engineering



or write to:

THE NATIONAL VIDEO CLEARINGHOUSE, INC.
100 Lafayette Drive, Syosset, New York 11791
(516) 364-3686

- Play great games: sports and movie trivia quizzes – kids' games to stretch their imaginations
- Improve your skills and learn new crafts with how-to tapes
- Enjoy pages and pages of exciting video stills – many in full-color – favorite movies, sports classics, kids' heroes
- Keep these handsome coffee-table books handy for endless browsing – for friends and family

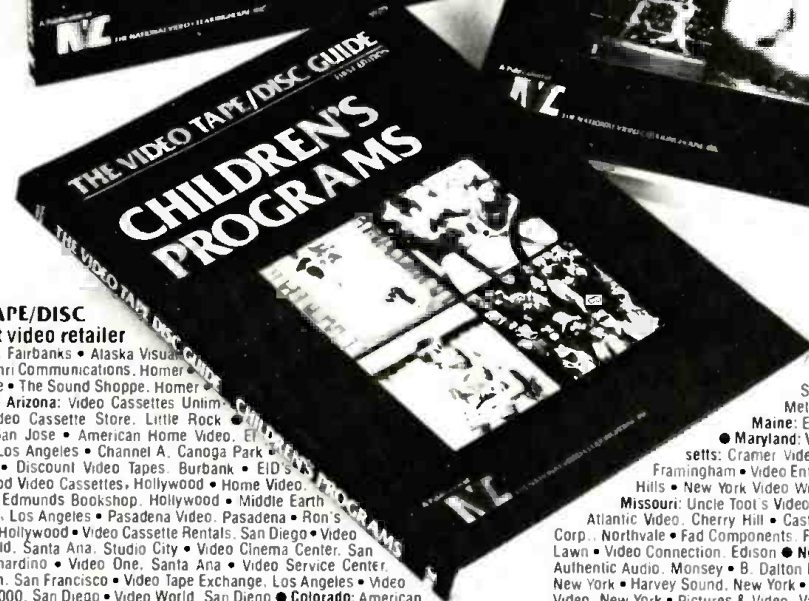
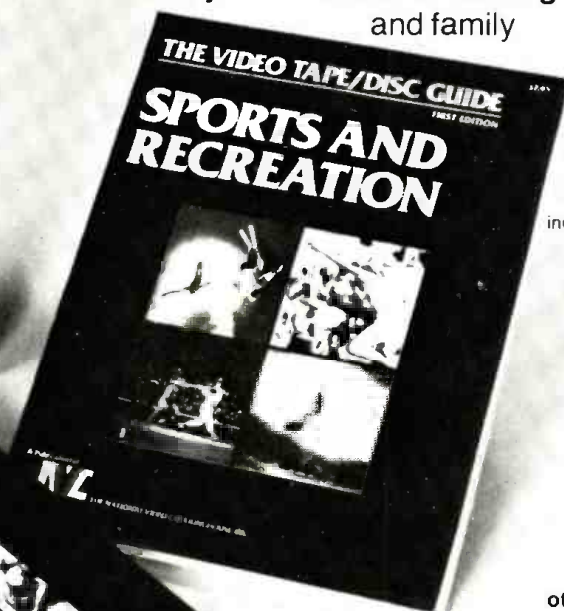
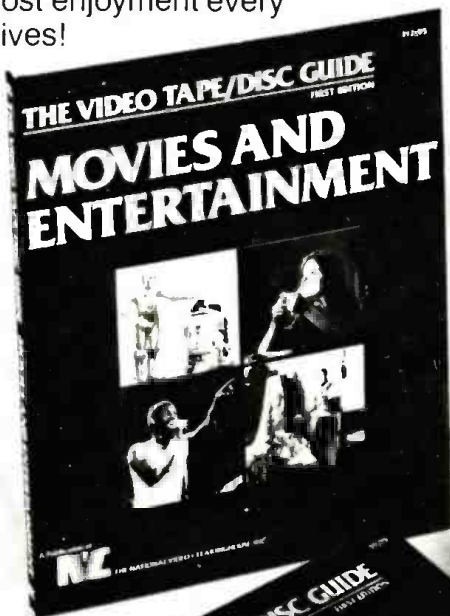

THE VIDEO TAPE/DISC GUIDE SPORTS & RECREATION, 1,000 programs on sports and outdoor activities – including great moments in sports, documentaries, instructional "how-to" programs and sports related movies... 128 pages. \$7.95

Look for THE VIDEO TAPE/DISC GUIDES at your closest Bookstore B. Dalton's, Waldenbooks and other fine bookstores

Supply, Indianapolis • Video Station, Indianapolis • The Video Studio, Muncie • Iowa: Davis Electronics, Waterloo • Kansas: Antin House of Video, Overland Park • Electronic Services Co., Dodge City • Louisiana: McCann Electronics, Metairie • Video Index, New Orleans • Video Spectrum, Metairie • Maine: Electronics Services, Gorham • Entertainment Horizons, Portland • Maryland: Video Equipment, Baltimore • Video Place, Bethesda • Massachusetts: Cramer Video, Needham • Movie Madness, Cambridge • The Movie Store, Framingham • Video Entertainment Center, Dedham • Michigan: Video Trend, Farmington Hills • New York Video World, Warren • Minnesota: Video Entertainment, Minneapolis • Missouri: Uncle Toot's Video Co., Manchester • New Jersey: American Sound, Toms River • Atlantic Video, Cherry Hill • Castle Video & Electronics, Newton • Comprehensive Video Supply Corp., Northvale • Fad Components, Fairfield • Monmouth Stereo, Shrewsbury • The Video Center, Fair Lawn • Video Connection, Edison • New York: Abraham & Straus, Brooklyn • Adwar Video, New York • Authentic Audio, Monsey • B. Dalton Bookseller, New York • Barnes & Noble, New York • Cinemabilia, New York • Harvey Sound, New York • J & R Music World, New York • JAR Video, Mamaroneck • MPSC Video, New York • Pictures & Video, Valley Stream • The Scribner Book Store, New York • Sixth Avenue Audio, New York • T.J. Marcucci & Associates, Schenectady • Video Environment, Latham • Video Shack, New York • Carle Place, Scarsdale • Willoughby's, New York • Ohio: Akron Video Center, Akron • Back Row Book Shop, Fairborn • Columbus Video Center, Whitehall • Dodd's Camera, Cleveland • Heights Video Center, Cleveland Heights • Kline TV Sales, Cincinnati • Technimedia Systems, Cleveland Heights • The Video Store, Cincinnati • Video World, Cincinnati • Oklahoma: Audio Visual Entertainment, Tulsa • Kaleidoscope Video Shop, Oklahoma City • Oregon: Electronic Supermarket, Beaverton • Janzen Beach, Max. Portland • Video Plus, Eugene • Pennsylvania: Ace Electronics, Erie • The Media Center, Shadyside • Ralph's TV Appliance, Media • Video Audio, Williamsport • Viking Cameras & Audio, Philadelphia • Puerto Rico: Televideo, Hato Rey • Rhode Island: Jabbar Electronics City, Pawtucket • South Carolina: The Company Store, Gaffney • Radio Shack, Hilton Head Island • The Video Exchange, Florence • York Dollar Store, York • Tennessee: Bondurant Brothers Co., Knoxville • Mr. Video, Memphis • Tennessee Audio, Tullahoma • The Video Station, Nashville • Video To Go, Memphis • Texas: Associated Video, Houston • Audio Visual Services, Houston • El Centro Sound Center, Pharr • Sight & Sound, Dallas • Video Cassettes Etc., Lubbock • Video Center, San Antonio • Video Concepts, Houston • Video Specialties Co., Houston • The Video Station, Dallas • Videoland, Dallas • Utah: Marketex International, Drém • Videoland, Provo • Virginia: The Video Station, McLean • Washington: A & B TV, Yakama • Cinema Books, Seattle • Video One, Bellevue • The Video Store, Bellevue • Video World, Bellevue • West Virginia: Video Center, Charleston • Wisconsin: Beautiful Day Records, Racine • State Wide Electronics Distributors, Oregon • Video Images, West Ellis • The Video Station, Milwaukee • Canada: Astron VCR Canada, Ottawa, Ont. • Collingwood Sales, Smithers, BC • TV Tape Resources, Vancouver, BC • Videoland, Downsview, Ont. • Videotron, Dorval, Que.

PLAYING FOR BLOOD

continued from page 82

have an option to do six extra games—Sunday and Thursday nights. They only do four. The ratings are that bad.”

Replies Spence: “We have a provision in the contract to do a certain number of extra games, predetermined by us and the NFL. This time it was four.” As for the show’s ratings, Spence says, “You’ve got to look at *Monday Night Football* over the long haul of the ’70s—an average [share] of slightly more than 34 for 10 years, and against some very formidable entertainment opposition,” says Spence. “It’s been the only successful prime-time sports program in history, and we simply had the foresight to take it while all the others passed—and, I daresay, O’Malley is full of crap if he says he wouldn’t want it now. Hell, both CBS and NBC want it every time the damn contract runs out.”

Like *Monday Night Football*, ABC would like people to think *Superstars* was yet another stroke of genius. It’s even got a nickname: “Roone’s Revenge”—revenge on CBS for taking the NBA. But O’Malley is just as ready to play kill-joy. “*Superstars* is another show we turned down—we thought it at cross-purposes with sports: an edited, contrived-for-TV event. But ABC had no alternative after losing the NBA. They reluctantly put it on—and its success was a shock even to them.”

Spence will agree on the last point, but when O’Malley goes on to say, “However, that success is leveling off now, and advertisers aren’t as anxious to buy into it any more—preferring to be identified with legitimate competition,” Spence bitterly disagrees. And he laughs in derision at Auerbach’s comment that “there’s a place for the lighter side of sports—but only *occasionally*.”

“*Superstars*,” Spence says, “has had a slight dip in ratings—but it’s still a pretty damn solid entity, the fifth-highest-rated sports show last season, a consistent advertising winner—and it’ll be more so now because we’ll be doing the finals live. Obviously, we have nothing to apologize about for *Superstars*—and just ask O’Malley if he’d like to have it. At least we’ve never stooped to guys carrying iceboxes on their backs—such as in CBS’s *World’s Strongest Men*—or half-naked broads lying on rocks. NBC had that one, a swimsuit contest that was clearly sexual titillation and nothing else. Our level of quality would prohibit that. We do wholesome family entertainment.”

The other ABC man gets even meaner: “What the hell does Auerbach think *Games People Play* is? *Masterpiece Theatre*? Hell, that’s a trash-

sport series—in prime time. *We’d never do that.*”

All three networks have had their versions of the “Battle of the Network T’s and A’s,” but O’Malley, Auerbach and Spence all claim that their networks’ entertainment divisions should take the “credit,” even though the sports divisions are involved with the productions. And, intriguingly, all blame Fred Silverman—during each of his stops as network president—for not only hatching the idea, but getting sports departments into it. Chet Simmons, the former president of NBC Sports who left last year to head ESPN, the cable-TV sports network, says of *Games People Play*: “Fred had only a vague idea of what it should be—and still he plunged right into it. And it shows.”

“I don’t think sending a guy through a wall of fire is good business anyway. I’m just waiting for the day someone gets killed on one of these [trash-sport] things.”

Simmons goes on, “But I don’t think sending a guy through a wall of fire is good business anyway. I’m just waiting for the day someone gets killed on one of these things. Are ratings worth that?” A sigh. “But contrived sports sells. And despite what they say, CBS and NBC would leap at the chance to get *Superstars*.”

But if trash sports are an excess of the war, they’re only an esthetic excess, like Howard Cosell. Other excesses are far more visceral—and it is no coincidence that the most tawdry are associated with boxing, such as first-refusal rights with fighters Sugar Ray Leonard (ABC) and Howard Davis (CBS), the aborted Don King heavyweight tournament (ABC) and fights broadcast from South Africa (CBS and NBC).

“Greed, that’s all it is,” says a network insider. “You just hope that by dealing with boxing promoters like King and Bob Arum, nothing horrendous will crop up. Like the kickbacks fighters had to pay King to get in his tournament. ABC knew what was happening. Hell, their people were talking about it before the fight—but you ra-

tionalize: ‘Well, that’s King’s business, not ours. We don’t police the NFL, either.’ Boxing is the filthiest part of network sports. But there’s money in it.”

Says Simmons, “It always concerned me [when he was at NBC]—and we expressed our opinion by being the least involved in the glamour fights. I mean, I deal with Arum now on a minor fight show every week and, on a business level, he delivers—always has. But, underneath, you know he and King are using boxing, using the boxing organizations [King, the World Boxing Council; Arum, the World Boxing Association] to get at each other, and the networks are, in turn, not only giving those organizations the power and credibility they don’t deserve, but encouraging shared titles—keeping great fighters from meeting each other.

“But who else can you deal with? *Someone* has to promote fights.”

The question of whether CBS and ABC were acting as fight promoters—which is illegal—in signing Leonard and Davis so irked the FCC that both networks dealt off their first-refusal rights. And NBC and CBS now claim to have established tough safeguard methods against seaminess and mismatches: NBC with Ferdie Pacheco, the ring doctor, as its boxing czar; CBS with Morton Sharnik, a former boxing writer. (Sniffs O’Malley: “What does Ferdie know? He’s just a doctor.”)

Still, the overriding morality may be summed up by Auerbach when asked about presenting fights from South Africa: “We can’t change apartheid so why not buy fights there? We will, however, give both sides of the story during the broadcast.” CBS, apparently, is less committed to giving both sides. Last year when CBS broadcast a fight from Bophuthatswana (an impoverished black section of South Africa that the South African government declared an independent state—a guilt-saving ploy that not-one nation in the world fell for), the network announcers grandly proclaimed: “From the black independent state of Bophuthatswana . . .”

But as tainted as the boxing battles have become, ABC can stay clean when purchasing delayed tapes of glamour fights that first appeared on theater TV—such as the Roberto Duran vs. Sugar Ray Leonard bout—because the other networks have left the field of combat. “They’re the only ones willing to pay \$4 million [the Ali-Holmes price tag] to show a delayed tape that may be a month old,” says O’Malley, “because they’re the only ones who, again, can ignore their affiliates. That’s

continued on page 87



SUPER AVILYN:

It's always the same new picture.

Most videotape looks great at first. But secretly, it's fighting for its life. Under a perfectly civilized exterior, your videodeck is giving it a beating. Videoheads move against tape at an unrelenting 1800 rpm. At that speed many videotapes suffer from oxide shedding. After a dozen hours, colors begin to bleed. Images get shaky. Pictures lose their punch. What's worse, loose oxide particles gum up the works. And that can ruin your deck. Not a very pretty picture.

Super Avilyn is made to take the punishment and look good as new. TDK developed this unique tape

formulation with super-fine oxide particles. A strong binder rivets them onto the tape surface. Which virtually wipes out oxide shedding. Pictures stay brilliant, crisp, unshakable. Colors don't bleed, even at the grueling .43 inches per second of six-hour play. While other videotapes can get worn down before their time, Super Avilyn shows you the same new picture after hundreds of hours, with barely a difference. And that's a big difference.

 **TDK**
The Vision of the Future

THE ULTIMATE IN VIDEO CASSETTE RECORDING

The Editor ELIMINATE COMMERCIALS

Now, you can relax and enjoy your video-taped programs virtually commercial free thanks to the invention of "The Editor". "The Editor" will remove up to 95% of all commercials color and/or black and white. "The Editor" is compatible with all major brands of VCR's and once installed, no

adjustments are necessary. Comes with a full, one year limited warranty. Order "The Editor" today — Call "Mr. Shelton" Person to Person, Collect 206-463-3778 P.O. Box 860 — Vashon, Wa. 98070 Or See Your Favorite VCR Dealer

Series 100

Series 100 W



Manufactured in Canada by:



7964C Winston St., Burnaby, B.C. Canada V5A 2H5
Phone: 604-420-6630 Telex: 04-356609
Canada, U.S.A. & Foreign Patents Pending

Series 200

PLAYING FOR BLOOD

continued from page 84

why they keep blocks of prime-time hours open for preemption. I don't know if that's wise or not, but it does make it tough to compete with them on some things." ("That's absurd," says Spence. "It's not our policy to keep blocks of prime time open.")

"It's not the affiliates—it's *judgment*," the other ABC man says. "CBS, for example, overbid the Cotton Bowl badly the last time that contract came up for renewal—\$3.2 million for a Bowl totally lacking in identification and excitement. They overplayed their hand, and it elevated the price of all Bowl games. That was dumb judgment."

Auerbach makes the same point about CBS's handling of the Cotton Bowl—and O'Malley himself says that was a mistake, but goes on to say, "Forgive me for not taking NBC's innocence on the Cotton Bowl seriously. First of all, we didn't even attend the Bowl meetings. NBC sent *four* people—whose bid, I might add, was extremely close to ours—one of whom sat in the lounge after the decision was made, screaming at the Cotton Bowl people about a lack of good-faith bargaining. Frankly, they didn't give a very positive impression of that network's operations."

Sometimes the FCC doesn't have "a very positive impression" of the sports war, and the network sports people live in constant fear that the Commission will step in and look at some of their affairs closely. When the agency did investigate the "winner-take-all" tennis scam, insiders say, jobs fell like dead flies. "Keep the FCC mollified, that's our watchword," says a network man. But even when there are human sacrifices, the underlying philosophy of the competition remains: get away with what you can.

Even today O'Malley talks about no wrongdoing, says the FCC didn't censure the network—and "*only*" came down on it for "misleading advertising." And Frank will go to his grave pointing out he was at CBS only for the fourth match in the series, and was only "peripherally involved."

The FCC report rang with words that could be the very chapter and verse in the television sports war: "It was a hard-nosed attempt to get an audience [using] deliberate misrepresentation."

"You know what the problem was?" asks a network man. "They got *caught*. It's not doing something through deceit—that's expected when you get this job. It's making it *work* for you. If you don't, they're gonna move you out and get people who *can*."

That's show biz. ■

BIRTH OF A SALESMAN

continued from page 74

CARVER (to camera)

You know, Faulkner here is 15 years old.

(pets bloodhound)

Given the accepted method for determining the human equivalent, a formula that is internationally recognized and practiced in all areas of canine habitation regardless of particular ideology, that makes him roughly 105.

(reaches for bag of Dog Yums)

And part of Faulkner's secret for long life—that bemusing stretch of hope and fury running with a profound and galloping determination toward a vast, sudden, blazing eternity—is Dog Yums. For it is commonly accepted among members of the dog-food community that Dog Yums is one-hundred-percent nutritious.

(pours Dog Yums into dish. Dog rises from stupor, sniffs, eats)

I can say that with no equivocation.

(dog eating ferociously, moving dish around on floor in his zeal. Carver pours more Dog Yums. Dog laps it down in one huge gulp)

It has come to our attention that some rumors persist to the effect that a meaty dog food is not healthy for dogs. These rumors have gained wide circulation, claiming that such a diet is too rich for a dog.

(pours more Dog Yums. Dog leaps into Dog Yums sack and begins to eat contents)

Well, I think it can be said that Faulkner dramatically disputes any vestige of credibility that rumor may have. So, remember, the next time you hear some ill-intentioned speculation that Dog Yums is harmful for your dog—

(dog climbs out of empty sack, licks mouth, suddenly straightens stiff as a rod, grasps his heart with his front paws, has small seizure, spins and falls dead)

—Uh, that, uh . . .

(Carver stares at dog)

. . . that, you, uh . . .

(Staring at dog, but remarkably unruffled)

. . . that you keep in mind the example of Faulkner, who lived 105 happy years on Dog Yums.

(Carver reaches down, takes dog's mouth and stretches it into smile)

Dog Yums. The dog food your dog will love to death!

HUGE APPLAUSE AND LAUGHTER FROM AUDIENCE

CUT TO:

INTERIOR. TV STUDIO

Carson, behind desk, laughing and applauding, too. He stands, motions for Carver to come over to him.

CUT TO:

INTERIOR. MELVIN KROKAW'S DEN—NIGHT

Krokaw also on his feet, watching Carver on his TV.

KROKAW (to himself)

Brilliant! The man is a living genius! It was down the toilet and he saved it. Oh, my God—

(pointing to TV screen)

Carson's calling him over to the couch! This is history being made!

continued

BIRTH OF A SALESMAN

continued from page 87

CUT TO:

EXTREME CLOSE-UP OF KROKAW'S TV SCREEN

Carson, wiping tears of laughter from his eyes, shaking Carver's hand and offering him chair next to desk. ED McMAHON pounds Carver's back in a show of professional esteem.

KROKAW VOICE-OVER

Nobody's ever been called over to sit and talk with Johnny after his first *Tonight Show* commercial!

KROKAW'S PHONE RINGS

Krokaw, eyes on screen, distractedly moves to answer phone.

KROKAW

Hello.

(pause)

Who? Calling here? Of course I'll take it.

(pause)

Yes. Good evening, Mr. President. This is a surprise and an honor. I'm fine, thank you.

(pause)

Yes, yes, that's right, I *do* represent Huddleston Carver.

(pause)

Yes, of course, sir, I have been watching him, too.

(pause)

Well, I'm sure Mr. Carver will be thrilled to know you feel that way, sir.

(pause)

Tomorrow morning? Of course, Mr. President. Not at all. Thank you very much. Good night, sir, and I'll see you in the morning.

Krokaw hangs up phone. A slow smile spreads across his face.

CUT TO:

INTERIOR. THE PRESIDENT'S OFFICE—FOLLOWING MORNING

PRESIDENT seated at his desk. Krokaw being ushered in by PRESIDENTIAL ASSISTANT. President rises, offers Krokaw a chair.

PRESIDENT

Melvin, I apologize for asking you to come and see me on such short notice, but I was very eager to speak with you.

KROKAW

I was delighted to come, sir. Any way I can help. You know that.

PRESIDENT

Melvin, let me get straight to the point. I was most impressed with your friend Carver last night. Watching him rescue that commercial was an extraordinary thing. There's something very special in the presence he communicates. Something new. I can't quite put my finger on it. It's almost a vulnerability—

KROKAW

Yes.

PRESIDENT

—and yet a quality of reassurance, too. A

reassuring vulnerability, I believe, is what I feel from him.

KROKAW

Yes, yes, Mr. President. One might even go so far as to say that he projects a certain weakness, but a dignified weakness. Don't you think?

PRESIDENT

Yes, I do! It's most reassuring, though. Calming. Just the image the country seems to be needing right now.

(shifts to suddenly serious tone)

Melvin. I don't need to tell you that I'm very concerned about the mood out there.

(hand sweeps to his window)

It's as if the American people believe no one is really on top of things, really in there every day making sure it all works. I'm sure you've sensed it.

KROKAW (hesitantly)

I must admit, sir, that I have.

PRESIDENT

That's why I was so taken with your man Carver last night. He conveys that trust that's been missing. He seems to say, "I may not be great, but I'll always be here when you need me." And people will just get into the habit of being there to support him in return. That sense of partnership that's been missing. I'm sure you know what I'm leading up to, Melvin.

(Krokaw's eyes widening)

Yes, I believe Huddleston Carver could be of great help to me. Do you think he'd be interested?

KROKAW

Interested! Mr. President, I think he'd be overwhelmed. And I must say that I think he'd be perfect, sir.

PRESIDENT

Good. Then you'll help me persuade him that he has to do it, that he's sorely needed.

KROKAW

I'll do whatever I can, Mr. President.

Both men stand, shake hands heartily.

PRESIDENT

Let me show you out.

(at door)

And, Melvin. Believe me, I appreciate your show of deference. But I'm quite aware that you're a very important man in this town, yourself. So, what do you say? Let's drop the "Mr. President, sir" stuff. Please. Just call me Freddie.

CUT TO:

INTERIOR. TV STUDIO—NIGHT

MUSIC heard. Familiar theme. AUDIENCE maniacally applauding. Pause in energy as ANNOUNCER takes microphone.

ANNOUNCER

And now, ladies and gentlemen. Heeeeeerrrrree's Huddleston!

THE END

Telesound^{T.M.} TV Sound Breakthrough!

with TeleStereo



Don't let poor television sound keep you from full enjoyment of your video equipment.

With TeleSound, any TV, videotape recorder or videodisc player can sound as good as an expensive stereo system.

TeleSound is a totally self-contained stereo amplifier and speaker system. It plugs right into the audio output jack of your videotape recorder or videodisc player, the earphone jack of your television set or connects directly to the audio output terminals of your television set.

It does not require any other sound equipment or cables of any kind.

TeleSound amplifies and separates normal monaural TV or videotape recorder signals and dynamically projects them through a pair of matched, hi-fidelity speakers. Stereo signals from a videodisc result in true stereo.

Your living room takes on the rich, full, resonant sound of a movie theatre.

All-Encompassing TeleStereo™

Television manufacturers have long ignored TV sound. Good quality picture is what they sell. But when you hook up TeleSound to your TV or videotape recorder, you'll be amazed at what you've been missing.

All of a sudden, watching TV becomes an all-encompassing, even sensual experience. TeleSound adds depth and presence to TV sound.

Movies come alive. You'll find yourself turning to follow voices. When you watch a football game, you'll feel the stadium thundering all around you. Music and dance delight your ears, as well as your eyes.

If you've ever watched a program simulcast

over a quality stereo system, you know the thrill of watching TV with TeleSound. But you can enjoy TeleSound any time, anywhere.

TeleSound is compact and contemporarily designed. It measures 18" wide by 6" high and 5" deep. It will fit comfortably on top of any TV, VTR or book shelf. And it's light enough so that you'll feel free to move it from room to room.

TeleSound, with TeleStereo, was invented by an engineer who was fed up with the poor

for two weeks *at no risk.*

Compare TeleSound with the sound you hear on your TV or from your VTR. Then compare it with your stereo system. If you don't agree that TeleSound represents a major breakthrough in video enjoyment, simply return it for a prompt and courteous refund, including your postage and handling fee.

And every TeleSound unit we ship is protected by an unprecedented lifetime warranty on parts and workmanship. You can't lose.

TeleSound transforms TV, videotape or videodisc audio signals into a deeply enriched simulated-stereo sound. Full controls allow you to bring TV sound to the level of hi-fidelity recording.



sound quality of even his most expensive home video equipment. He was almost immediately overwhelmed by requests from family, friends and "friends of friends" for TeleSound units of their own. Today, TeleSound Inc. is the largest producer of self-contained video sound enhancers in the world.

No-Risk Trial offer.

TeleSound must truly be experienced to be believed. We invite you to listen to TeleSound

Nowhere Else Available.

To order TeleSound, simply send your check or money order for \$129.95, plus \$4.50 postage and handling to TeleSound Inc. at the address below. Or call toll-free and charge your order to your Master Charge or Visa Card.

We'll send your complete TeleSound unit, ready to hook-up instantly to either your TV or videotape recorder. Nothing else is needed.

CALL TOLL FREE 800-228-2606
In Nebraska Call 800-642-8777

TelesoundTM
 1243 U.S. Highway 22
 Mountainside, N.J. 07092

™ TeleSound and TeleStereo are trademarks of TeleSound Inc.

Telesound Inc.
 1243 U.S. Highway 22
 Mountainside, N.J. 07092

Please send me _____ TeleSound unit(s) at \$129.95, plus \$4.50 postage and handling for each unit ordered. New Jersey residents add 5% sales tax.

Check or money order enclosed for \$ _____
 Bill my Master Charge Visa

Card No. _____ Expires _____ PAN II

Master Charge Interbank No. _____
 Signature _____
 Name _____
 Address _____
 City _____ State _____ Zip _____

In a hurry? Call our toll-free number anytime, day or night.

Choose 1 free...

- The Omen CL-1079
 Silver Streak CL-1080
 Norma Rae CL-1082
 M*A*S*H CL-1038
 Breaking Away CL-1081
 The French Connection CL-1009
 The African Queen CL-2025
 Butch Cassidy and the Sundance Kid CL-1061
 Carnal Knowledge CL-4003
 Von Ryan's Express CL-1003
 Julia CL-1091
 Poseidon Adventure CL-1058
 The Turning Point CL-1089
 An Unmarried Woman CL-1088
 Alien CL-1090

when you join The Video Club of America.



Choose from over 300 of the most-wanted videocassette movies and programs on the market today when you join THE VIDEO CLUB OF AMERICA. The quality is tops; and you can purchase a full-length feature film for as little as \$44.95. It costs only \$20 to join the Club for a lifetime, AND YOU ARE NEVER OBLIGATED TO BUY. You'll receive only those items you specifically order.

Send your membership fee today and choose one of the movies shown in this ad—FREE. As a member you'll receive our full-color 1980 Program Catalog listing over 300 titles (Beta II or VHS formats available). You'll also be eligible to phone in for weekly Video Club "Unadvertised Specials" like 2 videocassette movies for \$50, or a free blank videocassette for each movie you buy. In addition, you'll receive our quarterly newsletter about Club discounts, a glossary of video terms and an equipment display sheet to help you shop for a VCR if you don't already own one.

Because Video Club is a dealer for films by major Hollywood studios including 20th Century-Fox, Columbia Pictures and Disney Productions, as well as Nostalgia Merchant, our selection is unbeatable. So join the Club today. Send the coupon at the right or call TOLL-FREE: 1-800-521-0230 (in Michigan, Hawaii or Alaska, phone 1-313-476-8460) between 8 A.M. and 8 P.M., EST, Monday to Friday.

THE VIDEO CLUB OF AMERICA
Dept. PA 11, Box D, Madison Heights, Michigan 48071

PLEASE ENROLL ME IN THE VIDEO CLUB OF AMERICA. I understand that this is a no-obligation membership. I will only receive those videocassettes I specifically order. By joining now, I will receive one FREE movie, selected from those listed above.

Please enroll me as a member and send the movie I have indicated at the right. Catalog Number _____ Format Beta II VHS
 CL- _____

Enclosed is my check or money order for \$20. Please charge my \$20 membership to my credit card.
 Master Card Master Charge Visa American Express Diners Club Carte Blanche
 Account # _____ Exp. date _____

Signature _____

Name _____

Address _____

City _____ State _____ Zip _____

As a member, I'd like to receive a copy of your Equipment Display Sheet.

I do not wish to enroll in the Club now, but I enclose \$1 for your full-color 1980 Program Catalog.

Only one membership per family household. The Video Club of America reserves the right to reject any application.

OFFER GOOD THROUGH DECEMBER 31 1980. ONLY



A Twentieth Century Fox Company

SEXUAL REVOLUTION

continued from page 41

it, but no more authentic. Sex herein is a commodity only, like money and power; adultery is still subtly punished (rarely on television has adultery been portrayed as a solution to a problem, only as an evil for which the perpetrators ultimately suffer). From Lorimar, *Dallas's* producer, this season come two of the new evening soaps: *Secrets of Midland Heights* (*Dallas* for the "American Graffiti" crowd), in which the American viewer will discover that all his teen-agers are really doing with their days is panting; and *Flamingo Road* (*Dallas* on both sides of the tracks). Common threads, according to executive producer Mike Flerman: "No social issues, just the same deadly sins. Rich, pretty people who dress well and have big, big troubles."

Why can *Dallas* get away with what other shows can't? Its late hour helps. "Children watching" is the key network guideline early in the evening, although everybody sees the foolishness in the assumption that kids toddle off to bed at 9, and nobody seems to care about their watching the spicy daytime soaps during vacation. (Indeed, this summer's ratings on *General Hospital*—while schoolchildren were home—were the highest in history.) The other reason is that sitcom characters tend to become family and the people on *Dallas* et al. are to be gaped at from afar, their actions not offending to the viewer. *Rhoda's* audience would not tolerate her divorce—the ratings plummeted—but J.R.'s followers will grin and bear anything.

It is in miniseries and movies made for TV that we see the most groundbreaking presentations of permissiveness, serious sexual themes and candid language. In part, more freedom is allowed because the audience doesn't have to live with these characters week after week, and warnings of "adult material" can be tacked onto promos. Moreover, the networks can feel proud in handling thorny issues, creating a thimbleful of controversy while acquiring hot ratings and trying not to upset anybody. So CBS does a movie—last season's "Flesh and Blood"—with an incest implication while the network party line foolishly denies that you would recognize the incest if you hadn't read the book. (Well, but how about the scene where Mom slithers into the bedroom with Sonny waiting frozen at the door, and her cooing: "It's all right . . . Everything is all right?") And ABC plans a provocative miniseries called *Through the Looking*

Glass, in which we'll see six hours of a group marriage in Kansas City.

Now and then there have been some well-handled breakthroughs, in series and TV-movies, such as *Mary Hartman, Mary Hartman*, in which CBS invested \$100,000 and then became too frightened to air; "That Certain Summer," a TV-film about homosexuality, in which the people were nice, middle-class citizens, not from the underbelly of a weird subculture; and "A Question of Love," in which a lesbian relationship and its effect on a family were maturely presented. These examples and others have opened doors for more frankness, more social realism, but they are exceedingly rare instances, so unusual as to be instantly memorable and probably overblown.

Good literature has always wanted to plumb the depths of sexuality; TV has wanted to leer. In 1971, television producer Gerald Isenberg was in charge of *Movie of the Week* at ABC, and he was in constant tussles with the Standards and Practices editor, Dorothy Brown, about what sexual frontiers he could break through. One night, at home watching a movie that had first been released theatrically, called "The Naked Prey," starring Cornel Wilde, Isenberg was astonished to see—right on the tube, and on his very own network—frontal nudity, one of the inflexible taboos. At 9 A.M. sharp the next morning he phoned Brown from his office. "Dorothy," he said excitedly. "I saw it. Last night. Breasts on TV." "You're crazy," said she.

"Wrong," said Isenberg. "Breasts on television. And on this network!"

She was firmly disbelieving until he explained where he had seen it, whereupon she exhaled a relieved sigh. "That's different," she said. "They were African women. Natives in a native setting. In that situation it's permitted."

"Tell that to a black man!" Isenberg shrieked.

As long as it's not real folks, nothing that Aunt Martha can call her own, nothing that makes Uncle Harry a little—well, you know—a little funny.

Why is network television so maniacally chicken? Why, on 1978's "National Love, Sex and Marriage Test" (viewers actually took a written quiz about their relationships) did NBC fight to take "sex" out of the title? (They finally compromised by leaving the word in the title but changing it to "sexuality" throughout the entire two-hour show.) The logical place for an-

swers resides in the Standards and Practices division of any network, the people finally in control of what goes on the air. They are the most feared, loathed and mocked figures in the industry; their task is unenviable and almost impossible. They consider themselves the watchdogs of the airwaves.

Tom Kersey is a conservative-looking man, solemn, with an overly wrinkled brow and a nervous demeanor suggesting the specter of bogymen lurking on the other side of his office wall. His title: Vice President, Broadcast Standards and Practices, West Coast, for ABC. Through Kersey, I come to understand the dilemma better. He says: "We will not purposely go out and offend a significant segment of our viewership. TV goes into your home like an invited guest, into the privacy of the family unit. You wouldn't want a guest in your home who said and did vulgar things."

In his view the two most sensitive subjects right now are incest and masturbation, and he would not permit them on his network. "Maybe someday we can do them, at some time in the schedule, but not now." How will he know, I ask, when America is ready to deal with incest over its beer and pretzels? How can this man, in the rarified air of Century City, judge if masturbation will be tolerated on TV in Dubuque? His answer is canned and doesn't satisfy. "Reporting procedures from the stations' management, mail and phone calls, research, talks at seminars and universities." The truth, which he finally acknowledges later in our interview, is that the networks—or anybody else, for that matter—know as much about what will offend as they do about what will be a smash hit. That is, nothing. *All in the Family* was a shocker in its success; so were *Mary Hartman, Soap*, and even *Dallas*. It's all guesswork, and in the networks' case the guess generally veers towards the safe, the tried and true, the riskless.

"Our purpose," says Kersey, "is, above all, to entertain and satisfy the viewer according to his intellectual needs and his own values. We definitely fulfill that function. In addition, our goal is not to offend." So it is Kersey and his brethren at the other networks who determine whether a "goddamn" will pass in a given script, or whether the country will accept a woman on *Soap* talking about orgasm. There are no set rules, however; any insider will tell you that flexibility is granted when the show's a hit, when a lot of money is

invested, and when the producer is a Lee Rich of Lorimar or a Norman Lear.

Kersey admits that television has not kept up with the changes in the culture. Whereas the original TV guidelines were modeled on the Hollywood movie codes, films today are galaxies beyond television in terms of sexual realism. How to explain? Well, the numbers vary considerably, a big film reaching perhaps 10 million people, a big TV show seen by anywhere from 30 to 50 million. (Kersey likes to tell you that the number of people throughout history who have ever seen a film or live production of "Hamlet" does not equal the viewing audience of one segment of *Happy Days*.) Thus, television has to be responsible to appeal to everyone, the great common denominator, and to offend no one. "We respond to what we think is the general public attitude," is the byword. The airwaves are considered to be owned by the public and mandated by their mass desires. And, unlike films, the networks are watched over by the FCC, which dispenses and revokes licenses, judging whether a station is fulfilling its community responsibility.

It would be unlikely—probably unconstitutional—for the FCC to dictate programming, but it appears that they don't need to. The pressure is always on from the National Association of Broadcasters, the affiliates (some stations wouldn't carry CBS's innocuous TV-movie, "Portrait of a Rebel: Margaret Sanger," starring *One Day at a Time*'s Bonnie Franklin, because they said it advocated birth control) and from the gamut of special-interest groups who often coerce advertisers to abandon a show. Active pressure from religious groups, spearheaded by the United States Catholic Conference—before even seeing *Soap*—resulted in difficulty finding and keeping sponsors for the show's entire first season, even though the ratings were impressive. ABC took a very strong stand against the danger of pre-censorship and was willing to support the show, although the network often had to find new sponsors each week, selling the time at fire-sale rates.

More pervasive, I believe, than the networks' fear of literal pressure is the insidious terror of offending the audience. One disgruntled TV writer says: "I've been told a hundred times not to write anything that will depress or disturb people. Network executives have actually said to me, 'Oh God, no, you can't do that; that's much too real.'

They are sure that if any truth were told about marriage, for example, marriages would break up and they'd be held responsible."

Network television people, it appears, are so scared of their power to affect audiences that they'd rather not affect them at all. Taking the path of least objection—with an occasional soupçon of controversy thrown in for self-congratulation ("You see, we did a lesbian movie three seasons ago")—they hope to God they can balance their needs to make money, to entertain and not to offend. And, thus, television is what it is.

TV is the most global communications medium in the history of the planet. Where is the mandate to educate, enlighten, inspire or transform? Somewhere else, perhaps, but not on the networks. "They are responsible for getting an audience," says Paul Klein. "That's all. If you can do something that uplifts, that will be OK and you'll do it. But if it loses money or gets too much flak, the network's in trouble, and you'll lose your job."

And the future? There has been some speculation that network programming is bound to change drasti-

cally very soon; that with the proliferating competition of cable systems and videocassettes, in which the liberty for candor is virtually unrestricted, the networks will be forced to leap into R-rated, provocative, risqué material for their own survival. And yet, even with this clear-cut challenge, I could not find a TV pro who could foresee the scenario moving along those lines. Grant Tinker, for instance, says: "Cable is still a private matter, not a public airway. It's like going out to a film rather than having the guest in your home. I'm sure the networks will go on doing what we've always done, clumping along behind reality. And occasionally there will be a breakthrough that will either set a slightly new tone, or just be one exception to the same old rules."

So this season you'll see the familiar faces and stories of previous years, a trunkful of new, easily forgettable and fast-disappearing shows, a rare flicker of brilliance and perhaps a flurry of controversy. What you will *not* be privileged to see this season is much of anything that resembles the complex, multidimensional, richly textured sexual life of the American viewer. []

Browse through 34 pages of high technology name-brand products.



34 color pages

Now available! The 1981 Inovision High Technology Catalogue.

Brought to you by Inovision, a subsidiary of the multi-national Electronic Data Systems—one of the world's largest computer service organizations.

Send for your 1981 Inovision High Technology Catalogue filled with hundreds of the newest and most innovative videocassette recorders, portable video recorders and cameras, large-screen projection TV's, home computers, calculators, energy-savers, video and home computer furniture, blank videocassette tapes, video games, and more!

You'll find the best by Sony, JVC, RCA, Atari, Casio, Canon, Texas Instruments, and other top manufacturers. And some items are so new they're not available at retail stores.

When you order from us, you get extra-special Inovision service.

Inovision sends you a card notifying you that we have received your order.

When we ship your order, we send you another notice telling you when you can expect the shipment.

And everything you buy from Inovision is guaranteed to please—or you get your money back!

INOVISION™

AN EDS CORPORATION
Inovision, Dept. P11, P.O. Box 402425,
1250 American Parkway, Dallas, TX 75240

Yes, send me a 1981 Inovision High Technology Catalogue for \$2. I have enclosed my payment. (Make check or money order payable to Inovision.)

Name _____
(please print)

Address _____

City _____

State _____ Zip _____

Mail to: Inovision, Dept. P11, P.O. Box
402425, 1250 American Parkway,
Dallas, TX 75240

WHEELER: CONSUMER VICTORY

continued from page 62

out because the local broadcasters were demanding similar protection—for shows like *I Love Lucy*, *I Dream of Jeannie*. Some of these programs weren't even being shown in the market by local broadcasters. They had purchased the rights to the programs but were "warehousing" them and not making them available to the public. They were not being aired by the local broadcasters, and the cable operator, because of the old FCC rule, couldn't put the programs on, either. Who lost? The consumer.

Now the Hollywood producer will argue that his rights are being exploited. But the fact is that deregulation of cable TV won't significantly affect his profits or his incentive to produce. Program production has never been more profitable. Program producers are selling their products to the superstations for increasingly higher prices. Ted Turner's superstation WTBS is routinely paying 100 to 500 percent more for programming because of its expanded carriage by cable systems. It's an Atlanta station paying Chicago rates because of its new audience. That's good. That's the way the marketplace should function.

What the producers are really saying is "We want more." It's what the whole Angelgate mess uncovered with its allegations of artful accounting designed to enrich producers at the expense of others. The TV producers don't want to share any money or power with others, whether they be part-owners or cable operators.

Of course, TV producers will complain about the percent of revenues cable TV pays in copyright fees. Broadcasters pay about 25 percent of gross income but a cable-TV operator pays only about one percent. The TV producers moan that they're being exploited.

But there are crucial differences between a broadcast operation and a cable operation. A broadcast operation delivers eyeballs to advertisers. When a cable operator imports, say, a

Star Trek or *Odd Couple* from another city, he's required to carry the advertising as well. Although advertisers pay millions of dollars to buy TV time on syndicated programs, cable-TV operators do not share in a penny of that. The broadcasters sell time to advertisers. We sell complete channels—including commercials—to viewers. A broadcaster uses the public's airwaves to reach viewers. That's a free ride to the consumer's doorstep. In the cable business, it can cost as much as a hundred million dollars to wire a major market. We have to build a path to the consumer's doorway. We don't get that free ride like the broadcasters.

A journalist recently asked me if I thought cable operators would use the FCC's decision to attract more subscribers. I told him they will if they are smart businessmen. The whole reason the rules were there in the first place was to deny the cable operator something to sell to the consumer. Before the decision, a cable operator would send his salesman banging on the door of a potential subscriber. "Good afternoon, sir," he'd say. "I'd like to sell you some cable-TV service for the average price of \$9 a month. We'll give you probably two more signals on which I can show you half the programs." And the potential subscriber would say, "Get out of here, kid."

Now that the rules are lifted it will not only allow a cable operator to import more than one superstation; it will create more cable-TV regionalism. For instance, a cable operator in Fort Wayne will be able to bring in a signal from Indianapolis. It will be the cable operator's decision if he thinks that's what his subscribers want. Of course, he'll have to pay for the transportation of that signal and also for the rights to the programming through the formula specified in the copyright law.

The FCC, after years of protecting broadcasters and the Hollywood interests by restricting consumer choice, has finally decided the cable-TV issue—in favor of the viewer. ■

GERBER: NO COMPETITIVE BALANCE

continued from page 63

syndication market. A series generally must be telecast on a network four to five years to become a hit. Series that last two years—or less—frequently do not get sold into syndication. It is not easy to get into that market and make up your show's deficits. Suppliers must also pay heavy residuals to actors, writers, directors and others who have a vested interest in getting fair value for their time and talent.

The FCC is arbitrarily dictating to these people what they should receive on their risk capital or for the use of their talent. Something is wrong when a regulatory agency can dictate regulations that affect the market prices. Such actions in the past usually have been in the hands of the President or Congress, who utilize such powers during national emergencies.

If the FCC's rule stands, we must face the reality that programs the cable operators will be televising will be of lesser quality and cannot in any way serve the public interest. If the prices for their programs are restricted and diminished, producers will become more cost-conscious and eliminate or diminish deficit-financing as risk capital toward future profits. The quality of the product cannot help but suffer. Some wonderful products that could be in the public interest will be abandoned. Free television will decline.

We have always acknowledged that one who creates with his time, talent and money deserves to receive the best price in a free and open market. That is a principle by which this country has prospered and grown. Are we threatening to change this principle? If so, then it's just a beginning—a dangerous trickle—because, if this oppressive decision of the FCC is allowed to stand, such sentiments could find their way into other segments of American industry. This country, then, will be forever changed, and I'm not sure that we will find a more productive system than the one we have enjoyed until recent years of corrosive bureaucracy. ■

CREDITS

Cover: Painting by Richard Hess. 4: Illustration by Roy McKie. 6: Illustration by Jeff Leedy. 11: Photo courtesy of KQED, San Francisco. 20: Illustration by Peter Lippman. 22-28: Photos by Gene Trindl. 30: Illustration by Bruce Dundore. 32: Illustration by Wallop; photo by Phil Swetz. 33: Illustration

by Andy Lackow. 34: Illustration by Deborah Bazzel; photo courtesy of CTW. 36: Illustration by Tim Raglin; photo—Focus on Sports. 38-39: Photo by Al Francekevich; inset photo courtesy of United Press International. 43: Illustration by Gary Van Der Steur. 44-45: Illustration by Rick Grote. 48-51: Photos by Peter Crown. 53: Photo by Ron Schwerin. 54-55: Photos by Barry

Tenin. 58: Illustration by Steve Shub. 62-63: Illustration by Deborah Bazzel. 64-68: Photographs by Irene Stern. 71: Illustration by Jerry Zimmerman. 72: Illustration by Richard Oden. 75: Photos by Gamma-Liaison—Elyse Lewin and Herb Ritts. 76-77: Photo by Gene Trindl. 78: Photo by J. Silverman. 106: Illustration by Arnie Levin. 112: Illustration by Ed Koren.

Panasonic

SONY

MAGNAVOX

Quasar

one good reason to buy from us.*

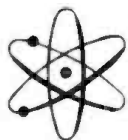

ELECTRONIC DISTRIBUTORS, INC.

WE BEAT ALL PRICES AND ALL ORDERS ARE SHIPPED WITHIN 24 HOURS. CALL TOLL FREE NOW FOR THE LOWEST PRICES!!!

1-800-327-3376

(in Florida 305/885-7098)

We are one of the nation's largest consumer electronics outlets... specializing in video. We have been selling to our competition for years and we now offer you a chance to buy at wholesale prices. Our huge warehouse and volume discounts let us pass all of our savings on to you. We carry just about every major video brand in our 25,000 square foot warehouse. Just pick up the phone and call us toll free! A video expert will take your order; answer all of your questions; and be sure your order is shipped factory-new within 24 hours. Usually sooner.

We also stock a full line of video software. Pre-recorded and blank tape, game cartridges and more! No order is too small or too large. Call us first! Call us last! Find out why **Electronic Distributors** is Number 1!

DEALER INQUIRIES WELCOME



CALL FOR FREE PRICE QUOTE & INFORMATION!



OUR 25,000 SQ. FT. MIAMI FACILITY

* THE COMPETITION DOES!!!

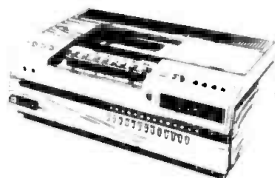

VIDEO RECORDERS

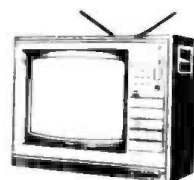

TELEVISIONS



BIG SCREEN TELEVISIONS

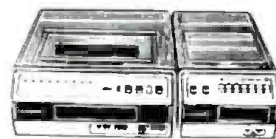

PORTABLE VCR's



VIDEO CAMERAS

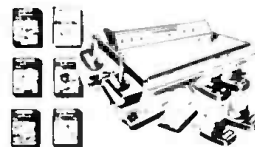

TV GAMES

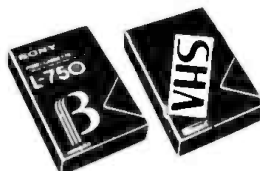

BLANK TAPE



MOVIES!



ELECTRONIC DISTRIBUTORS, INC.

3550 N.W. 77th Court,
Miami, FL 33122

1-800-327-3376

Name _____

Address _____

City _____

State _____ Zip _____

VISA/Mastercharge No _____

Exp Date _____

CALL OR WRITE FOR LOWEST PRICE!

- Enclosed is \$1 for your latest catalog.
- I am a dealer. Please send dealer information.
- Please put me on your mailing list.

SHARP

TDK

JVC

WCI HOME VIDEO

Performance TELEVISION

SONY

Panasonic

SANYO

ZENITH

AKAI

BASF

SYLVANIA

MAGNAVOX

RCA

ATARI

REAR VIEW

By HARRY STEIN

Less Is Enough

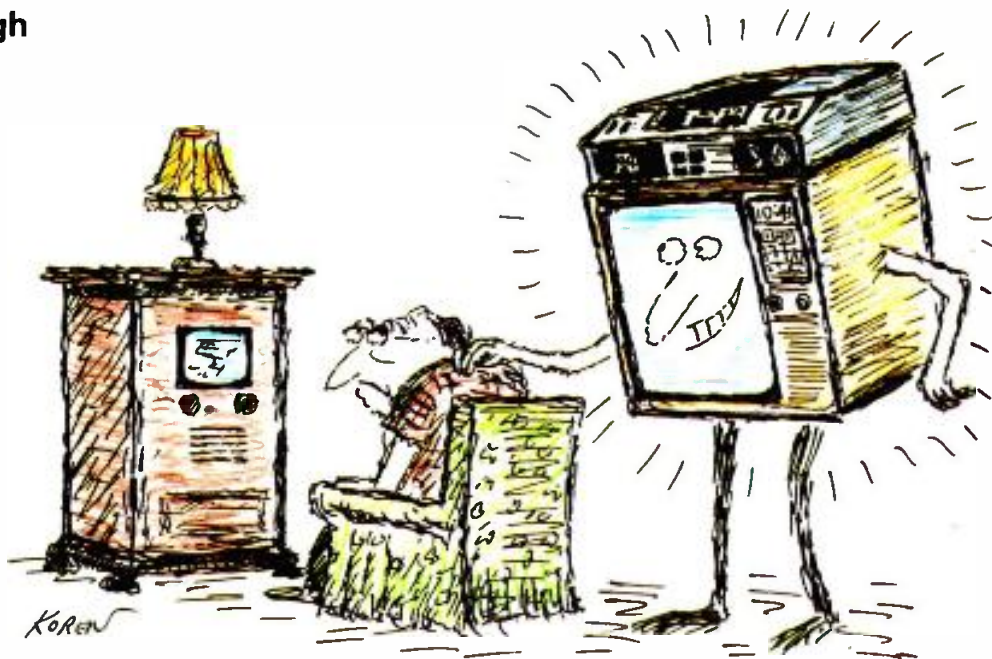

We are, as everyone knows, in the midst of a video revolution. New gadgets have come at us over the past several years at an utterly dizzying rate: huge screens, Beta systems, VHS systems, discs, new-age video games and on and on.

Most people are, of course, absolutely delighted by all of this. But there are some of us who—how can I put it?—are *intimidated* by the whole business. I mean, just last week a guy came up to me at a party and asked me what generation my Betamax was.

"Sony," I replied uneasily.

"What generation?"

"Oh. I'd say it's about three years old. This generation."

He rolled his eyes. "What I want to find out is whether it's compatible with my girlfriend's unit."

I studied his girlfriend, standing across the room. She was wearing a frumpy dress and a glazed expression and she seemed to be drooling in the potato salad. "I don't think it would get along with her unit."

"What's wrong with you, anyway?" he demanded. "Don't you follow the video revolution?"

The honest answer to that is that I'd like to but I can't quite manage it. For starters, the terminology baffles me: I have no idea what software is. To me, hardware will always be hacksaws and

hammers and light bulbs and all the other boring stuff Mr. Glickman used to sell in his store. Then, too, it takes so much time. "I've got other revolutions to follow," I said defensively. "I follow the Iranian Revolution. Before that I followed the Greek Revolution. Maybe I'll get to the video revolution next year." I paused. "Unless I decide to bone up on the French Revolution."

But in not following the video revolution I am a piker. I at least know there *is* a video revolution and even buy much of the new gear. Consider, for a moment, the case of my great-uncle Abe. The attitude toward video of Abe, who is 91 and once resided in Warsaw, has always been simple: "TVs, as concerned, they all good." (This is also, by the way, Abe's attitude toward automobiles, dishwashers and gum-ball machines. Any machine that more or less does its job is OK by him.) Sitting in the corner of Abe's living room in Brooklyn is the same 6-inch black-and-white console he bought in 1952 to watch wrestling. The last development in the video revolution that Abe noticed was the introduction of portables.

"Abe," I said to him one afternoon, "don't you think you should consider getting a new TV?"

"What for?"

"Wouldn't you like to watch in color? Wouldn't you like to have a larger

screen?"

He shrugged.

So I packed Abe off to my house to show him what he was missing. "OK," I said, sitting him down before my 26-inch Sony, "watch *this*." I flicked on the set and all the Trinitron colors of the rainbow danced before our eyes. A grocer squeezed the Charmin.

"Look at that idiot," exclaimed Abe. "Same idiot I got, only not so big! Who needs the idiot so big?"

"Big?" I said, grabbing his arm and leading him to another room, "Why, he's not big enough!"

I pushed him into an easy chair and turned on my Advent, with the 7-foot-diagonal screen. A small boy smirkingly accused a small girl of being a gold-digger.

Uncle Abe covered his eyes. "I got, I got. Littler, but I got."

"OK, Abe," I said, whirling the dial, "I know you don't have cable."

He let out a sudden cackle and tapped a finger against the side of his head. "Confusion, confusion. Tele-*phones* cable is for."

But there before him on the huge screen, in grainy black-and-white, on Channel X, was a gentleman doing unmentionable things to a dog.

Uncle Abe turned and stared at me dolefully. "Revolutions, as concerned, I prefer the Russian." ■

Elegant furniture.

Giant TV, too.



Doors closed, it's beautiful furniture that takes little more floor space than a console TV.

Doors open, it's a bright, giant screen 45" diagonal color TV that fills the room with action and excitement.

All-new, this Quasar[®] TV includes major advances in electronic technology. 105 channels, 23 ready for cable TV.



Compact, computerized remote control tuning.

And stereo capability with 4 speakers and 2 separate audio amplifiers, for use with existing stereo audio equipment. Manufacturers' suggested retail price under four thousand dollars.

That's fantastic! That's Quasar!

Quasar

ONE GREAT IDEA AFTER ANOTHER...

AFTER ANOTHER...AFTER ANOTHER...AFTER ANOTHER...AFTER ANOTHER...AFTER ANOTHER...



Component style, component features, integrated into one high-performance stereo system.

TV Pictures Simulated.

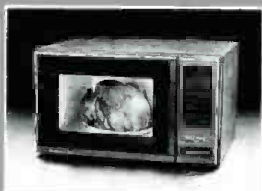

Microwave/Convection Combination Oven that bakes and browns. With 3 separate functions, it's like 3 ovens in one.



Programmable Video Cassette Recorder tapes 6 hours of your favorite TV shows while you're gone for a week.

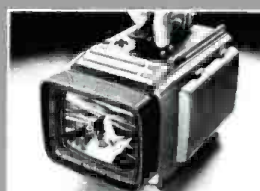

Your own personal, take-it-anywhere 5-inch diagonal TV with AM/FM radio. Runs on AC, DC or ordinary D-cell batteries.



Information Processor with memory capsules that translates words and phrases, gives instant facts on many subjects.

Quasar Company, Franklin Park, Illinois 60131.
Division of Matsushita Electric Corporation of America

GET TRUE COLORS, SHARP PICTURES AND \$4.00 BACK.

Get it all with Scotch® Videocassettes. Now you can get a whopping \$4.00 cash rebate when you buy our special Scotch Videocassette twin pack (either Beta or VHS)*. Just mail in the rebate coupon. We'll send you the \$4.00.

When you buy Scotch, you buy the same brand all three networks use. And the networks are pretty picky about their video tape. They demand a sharp, bright



picture with brilliant, true color. That's why they all use Scotch.

Those are good reasons for you to use Scotch in your home recorder. Scotch Videocassettes are specially formulated and engineered to give you all the



performance your VTR can deliver.

So when you record at home, use the brand the networks use—Scotch. You'll get a sharp picture, true color and—best of all—\$4.00 back.

*Offer limited to cassettes purchased for home use only. Limit three rebates per household. Quantity subject to availability.

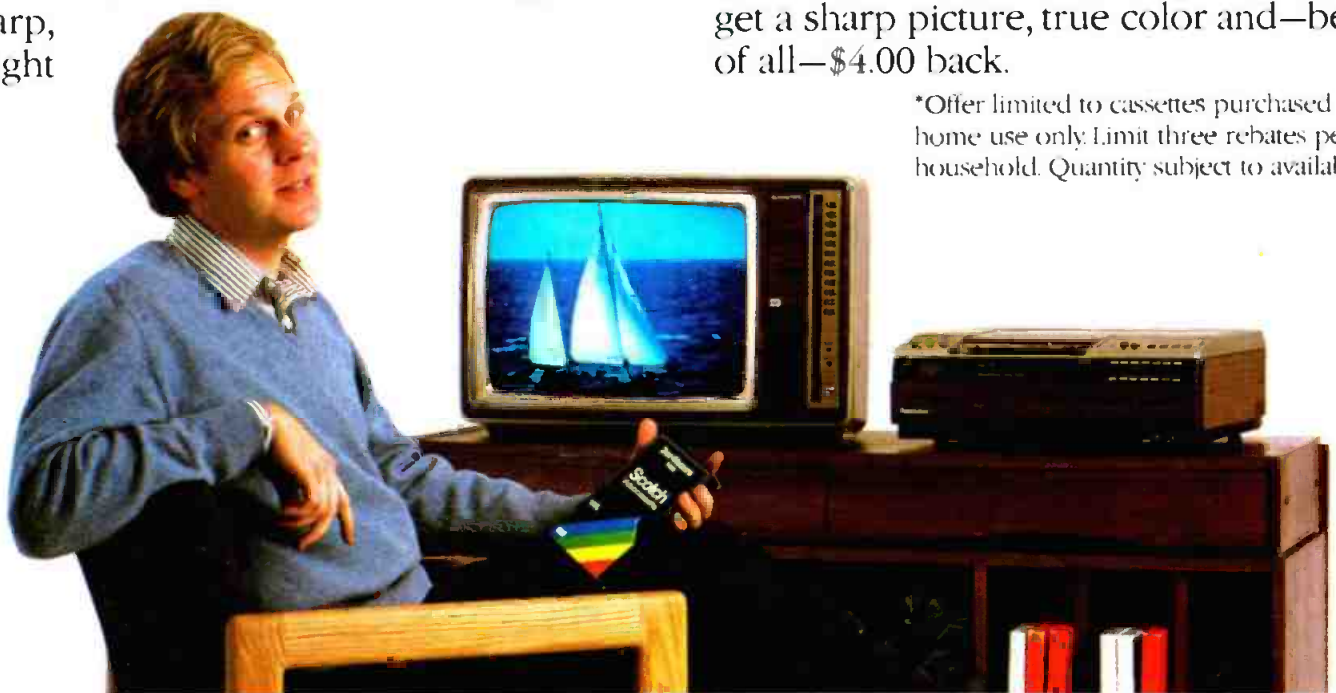

SCOTCH® VIDEOCASSETTES. THE TRUTH COMES OUT.

3M