

*E. L. Marnon*

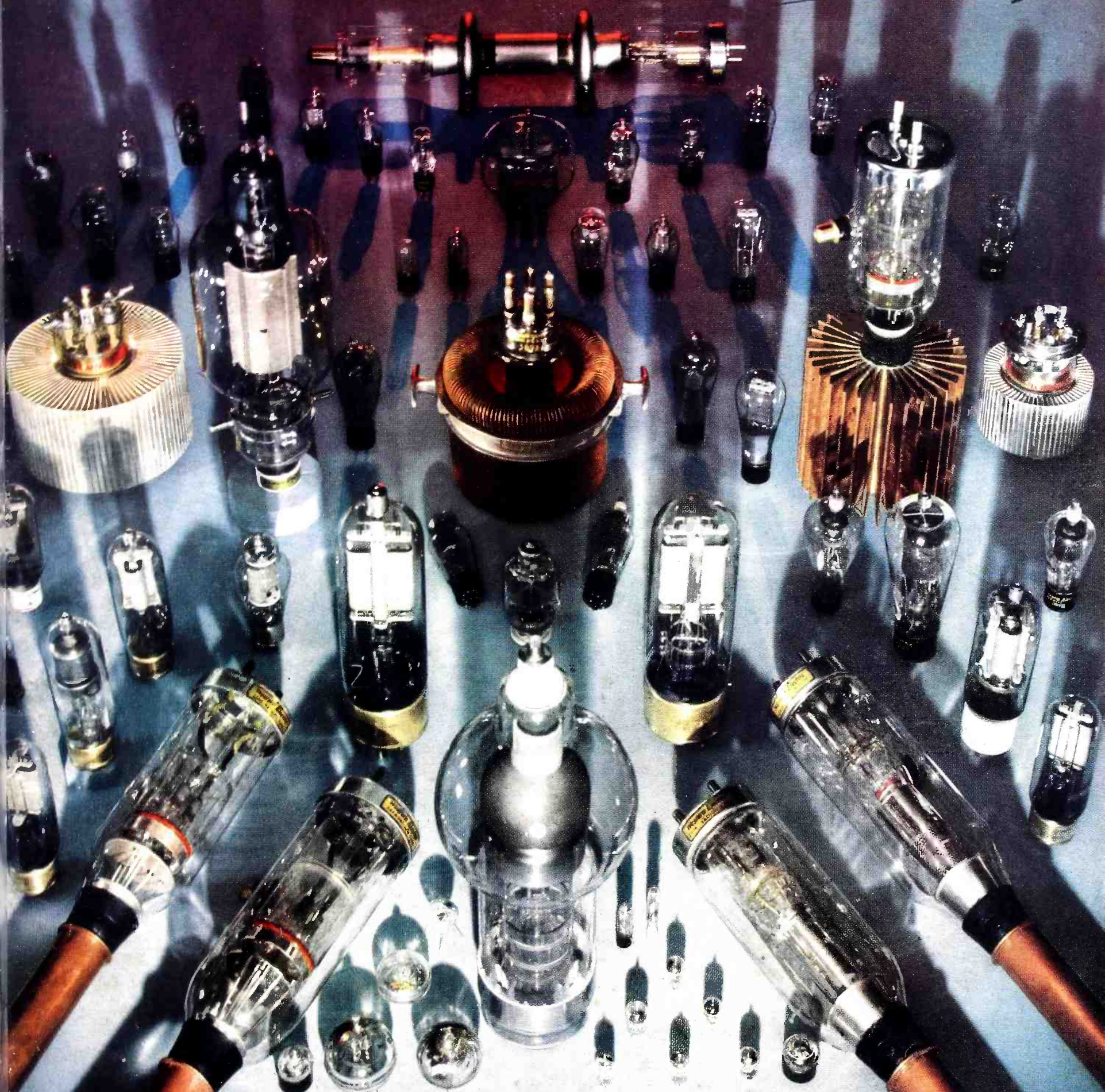

# *Western Electric* **OSCILLATOR**

NUMBER 7

MARCH 1947

FM on the Campus at U.S.C. • Miniature Tubes • "Mobile Operator, Please"

# Western Electric OSCILLATOR

MARCH

1947

DEVOTED TO DEVELOPMENTS IN COMMUNICATIONS AND ELECTRONICS

Published periodically from November, 1935 to May, 1942 under the name *Pick-Ups* by the

**Western Electric Company**

195 Broadway New York, N. Y.

C. G. STOLL . . . . . President  
N. R. FRAME . . . . . Secretary  
H. H. REDDALL . . . . . Treasurer  
F. R. LACK . V. Pres. and Mgr., Radio Div.

WILL WHITMORE, Editor

VANCE HILLIARD, Assistant Editor

The *Oscillator* does not accept responsibility for quoted statements appearing in the magazine. Such statements reflect only the opinions of the person quoted.

Copyright, 1947

by Western Electric Company, Incorporated  
Printed in U.S.A.

## THE COVER

Sixty-six different electron tubes — or little more than one-third of Western Electric's commercial line — are shown in this color photograph made by N. Lazarnick. The unusual effect was obtained by directing a red-filtered spotlight on the background, a blue spot on the foreground, and using a low angle for the general illumination. • Two of the newest tubes to be added to the line are the transmitting triodes for FM, seen in the upper left and right edges of the picture and distinguished by their silver plated cooling fins. These are the 10 kilowatt 5541 on the left edge and the 3 kilowatt 5530 on the right. • In the foreground directly above the word "Electric" are some of the new Western Electric miniatures. A word-and-picture story of the manufacture of these miniature tubes at the Western Electric Electronics Shop begins on page 17.

## THIS ISSUE

	Page
IRE — 1947 National Convention . . . . .	3
"Mobile Service Operator, Please!" . . . . .	4
Directional Patterns with 54A Array . . . . .	7
FM Goes to College at U.S.C. . . . .	8
New Arc-Back Indicator . . . . .	12
Alexander Graham Bell — 1847-1947 . . . . .	14
The 757A Loudspeaker . . . . .	16
Miniature Electron Tubes . . . . .	17
Clover-Leaf in the Clouds . . . . .	20
Music While You Ride . . . . .	22
"How We Put Radios Hilversum and Luxembourg on the Air" . . . . .	24
WHDH Modernizes for Service . . . . .	26
Announcing New Reproducer Sets . . . . .	30
Contributors to This Issue . . . . .	34

## True Values

Take another look at the cover of this magazine. In the color photograph is a large variety of electron tubes. Each of those tubes is a masterpiece of modern manufacture. The arts of the glass blower, the metal artisan, the chemist, the engineer and scores of other workers are represented in each of those tubes. Yet who would say that the value of the tube is expressed in the fine workmanship displayed? The fact that parts are made and assembled to tolerances of thousandths or millionths of an inch is incidental.

The substance, the value, the significance of those tubes cannot be assayed by their appearance. It is the unseen, the intangible, that makes the tubes valuable. When they become animated by the flow of electrons — and only then — are they of value or significance.

Now turn to page 14. There is the picture of a man. The face is that of a stalwart man. He was a man of strong muscle, a man of great stature, but it was not because of the muscle and stature of the man — the part of him one could see — that makes us carry his picture and cherish his memory today, 100 years after his birth.

No, it is the intangible something, the unseen, that lay behind his eyes that gave greatness to his life. The mind of Alexander Graham Bell was the something that produced the telephone, and who can weigh or measure or analyze the mind of a man!

Last summer we stood on the bridge of a ship and gazed at a point eleven miles away. Suddenly the greatest spectacle ever witnessed by man rose up out of the placid waters of a Pacific lagoon. Ten millions of tons of water rose to a height of a mile. It was propelled by the unseen force that comes into play upon the interaction of plutonium and uranium. But there is little significance in either of the elements by themselves. It is only when they interact and the unseen forces are unleashed that they take on significance.

One is tempted to say that it is only the unseen, the intangible that has force, solidity, value, significance. The ton of coal is just a ton of coal lying in a yard. Yet when it is turned into heat, it produces light; it warms our houses, it animates a city.

Today we have a thousand or more radio stations in this country. By the end of the year there will be 700 or more FM stations alone, we are told. Their erection represents the expenditure of millions of dollars and millions of man-hours of work. Yet those stations in themselves are of absolutely no significance. It is only when those stations come to life that they have significance. When they radiate the culture, the thoughts and aspirations, the dreams and

desires, the heritage of man expressed in music and literature — then and only then, do they begin to take on value and substance and solidity.

The engineer and the scientist and the manufacturer and the radio entrepreneur have and are providing the means for supplying something of great value and substance to this country and to the world. The total value, the total significance remains yet to be unlocked and realized. There is little room for exultation in the fact that more and better stations go on the air. The time for exultation will come when we learn to *use* these stations, deriving from them the solidity that is not expressed in signal strength, coverage and audio frequency range.

W. W.

## Bell and the IRE

It is particularly fitting that the Institute of Radio Engineers' 1947 National Convention should open on March 3 — the day that marks the centennial of the birth of Alexander Graham Bell, father of electrical voice communications. For both the man and the organization have contributed greatly to radio communications and radio broadcasting. This year's *IRE* convention has for its theme "Electronics at Peace" and as its goal the application of Electronics for the betterment of Man. It might be said in the same way that the theme of Bell's lifelong work was "The Telephone for Peace" and his goal the use of his invention for the betterment of Man. For while others considered the telephone a toy, or at best, a minor convenience, he envisioned it as an instrument for binding the peoples of the world together and promoting good will and understanding. Any scientist and any organization with these goals deserve the tributes of mankind.

## For the Technically Minded

Of particular interest to technical people are three articles in this issue of the *Oscillator*. The first, on page 7, reports experiments with 54A Antenna models in a directional array. The antenna array gains and two typical patterns are discussed. Beginning on page 12 is a technical description of a new circuit for the unerring location of faulty mercury vapor rectifier tubes, under the title "New Arc-Back Indicator." The heart of this valuable device is a small saturated-core toroidal transformer. The third article of interest to engineers is the story of the problems encountered in putting the European radio stations at Hilversum and Luxembourg on the air during the war. This story begins on page 24.

ELECTRICAL RECORDING AND REPRODUCTION • POWER AND MANUFACTURING APPLICATIONS OF RADIO-AND-ELECTRONIC

R-F MEASUREMENTS • ENGINEERING EDUCATION • ELECTRON OPTICS • SOUND AND PICTURE

TECHNIQUE • INDUSTRIAL ELECTRONICS • MEDICAL ELECTRICAL RESEARCH AND APPLICATIONS

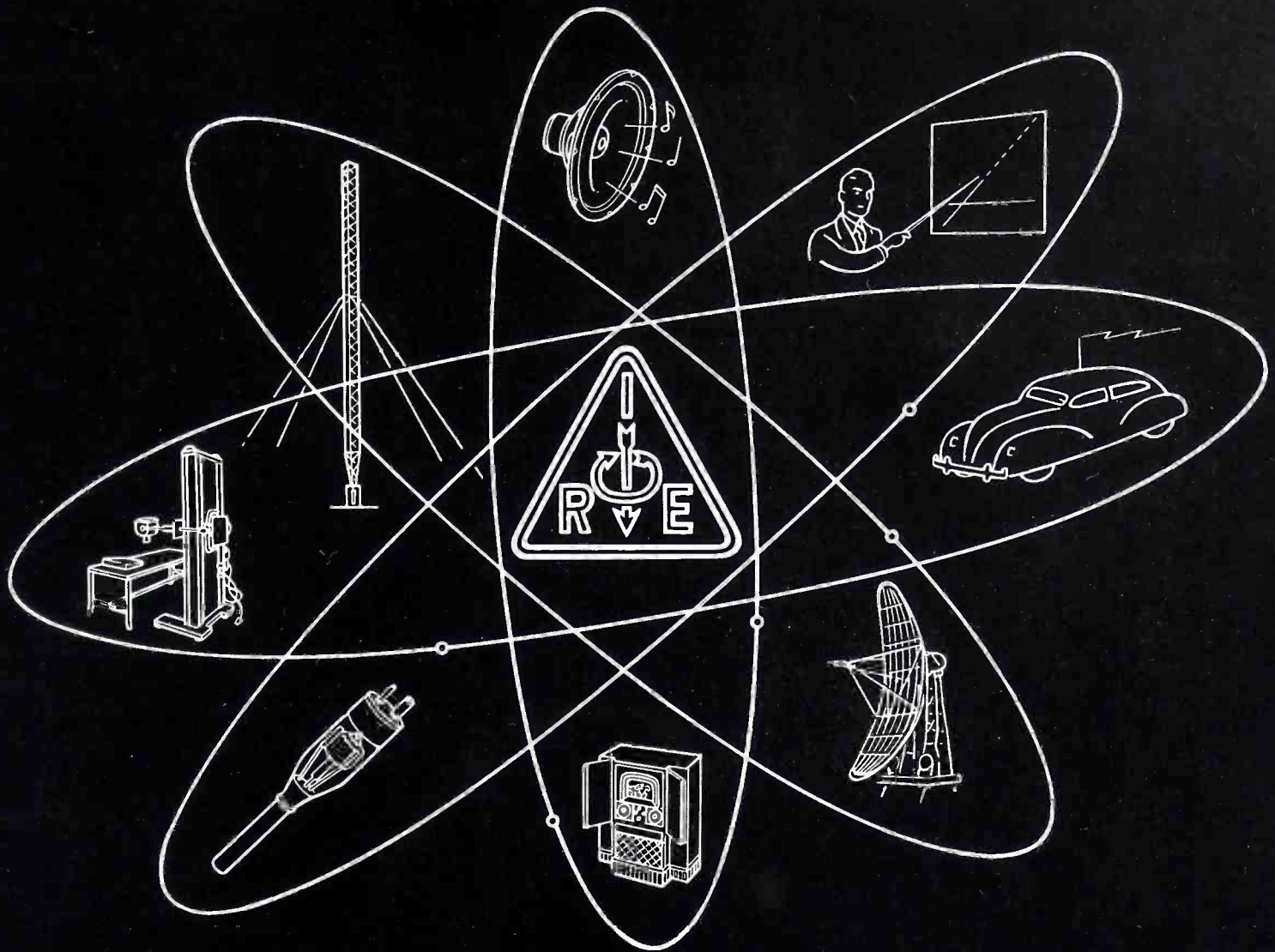

RADIO COMMUNICATION • SOUND BROADCASTING • TELEVISION • MARINE AND AERIAL GUIDANCE • TUBES

# I·R·E

*1947 National Convention • New York • March 3-6*

**T**HE Institute of Radio Engineers has been for 35 years a prime force in the development of Radio and its allied sciences. Its meetings have always been a focal point for the interchange of valuable and vital information which has benefited not only members of the radio industry but also the general public, both directly and indirectly.

Many scientific achievements, many new developments and important advances in Electronics were first announced to the world at *IRE* meetings, and this year's National Convention, like the others, is thus a major scientific event. Its activities are sure to have

a far-reaching effect — through its services to Electronics — on the life of the average man.

Founded May 13, 1912, the Institute flourished from the beginning — paralleling the amazing growth of all the sciences and particularly those of Communications and Electronics. The charter membership numbered 43. By January 1913, the membership had increased to exactly 100.

Today, there are nearly 19,000 members, 21 technical committees publishing brochures on standards, 38 sections and 4 subsections of the *IRE* throughout the United States, Canada and Argentina.

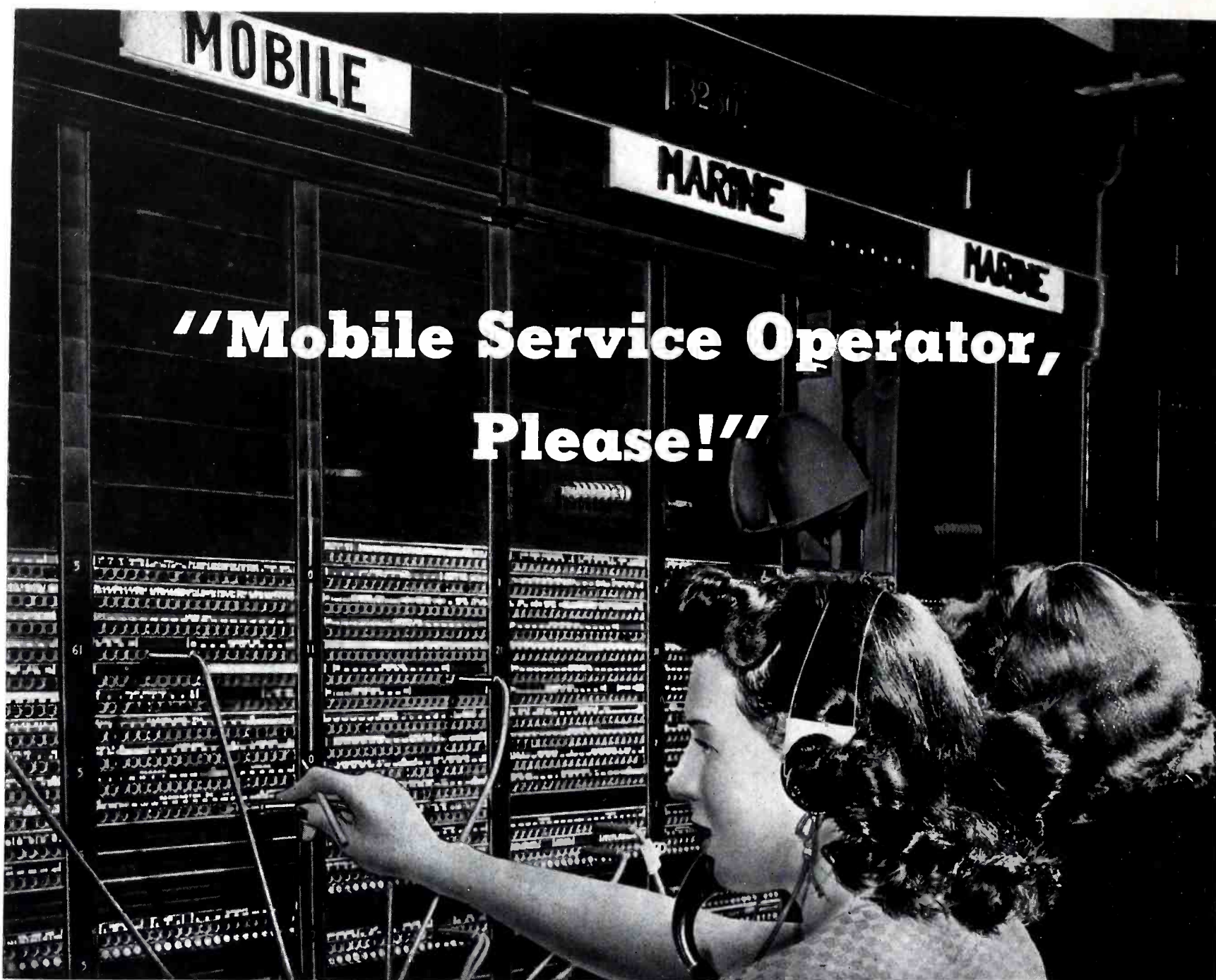

## "Mobile Service Operator, Please!"

### **A report on the spectacular acceptance of the Bell System's mobile telephone service and its rapid expansion throughout the Nation**

**I**N more than 30 cities in nearly every section of the country, the Bell System's Mobile Radiotelephone service is now a going concern. While the service has its first anniversary still ahead of it, the public acceptance of this new facility has been spectacular, and a telephone subscriber originating a call to his home or office from a mobile unit or vice versa—whether it be on land or at sea—promises shortly to become a commonplace. As more and more cities and highways receive mobile service, the phrase "Mobile Service Operator, Please!" is rapidly being absorbed into the daily language.

Due to the interest and service demands, many of the cities in which the service is being offered have filed applications for

*By H. N. Willets*

Manager, Radio Telephone Sales,  
Western Electric Radio Division

more channels. Twenty additional cities have also filed applications and received construction permits from the F.C.C., which allow the installation of the necessary equipment prior to offering commercial service. It is anticipated that by the end of 1947, most cities of more than 100,000 population will have had applications filed for this service!

Since June 1946, when urban service opened in St. Louis, mobile telephony has become available in Cincinnati, Detroit, Philadelphia, Newark, Chicago, Washing-

ton, D. C., Cleveland, San Francisco, Boston, Houston, Pittsburgh, Atlanta, Baltimore, Milwaukee, Columbus, New Orleans, New York, Denver, Kansas City, Oklahoma City, Fort Worth, Memphis, Dayton, Salt Lake City, Birmingham, Los Angeles, Indianapolis, Miami, Minneapolis, Springfield, Mass. and Portland, Ore.

Cities for which construction permits have been filed and granted are—Seattle, Toledo, Montreal, Toronto, Louisville, Richmond, Akron, Worcester, Norfolk, Des Moines, Providence, Omaha, Nashville, Knoxville, Chattanooga, Jacksonville, San Diego and Dallas.

In addition to these locations, in which service is now available or for which construction permits have been granted, ap-



"Truck 116 okay now . . . just a clogged fuel line . . . what's my next move?" This terse report via Bell System radiotelephone from maintenance truck of Consumers Company in Chicago demonstrates time-saving feature of new service.



"We'll be at Citizen's Bank in five minutes . . . have everything ready for the pick-up" might be what this messenger is saying from inside an armored car of Brinks, Inc., as it speeds to a bank to receive shipment of money and bonds.



"We're pushing four barges . . . arriving at locks about 3:45," says helmsman of the "Chicago Bridge," en route from Chicago to St. Louis, as he talks to lock-master of the Federal Govt. locks along the Chicago Sanitary District Canal.



"What's the address?" asks repair car driver as he records a call for assistance from a Chicago Motor Club member, received over his mobile telephone. Anywhere in the Chicago area, he gets the call and is on his way in minutes.



"Just about finished here . . . any more calls?" While the mechanic works to get the stalled car started, his driver — shown in photo right, above — calls the office. Auto repair car can go on to another job without returning to garage.



"Need six more loads of sand . . . fast!" For routine messages and in emergencies this Broadview, Ill., paving contractor finds the mobile telephone service provided by the Illinois Bell Telephone Company indispensable in his work.

proximately 27 other cities are being considered for this service during 1947. The foregoing concerns only urban service operating in a specific area employing the frequencies in the 152-162 mc band.

Another mobile radiotelephone system of equal importance to moving vehicles is known as Mobile Radio Highway Service. This is a service comprising receivers and transmitters established along the major travel arteries of this country to afford communication facilities from wire line subscribers to vehicles moving along these arteries. This service would naturally apply to contiguous waterways, such as river systems and coastal areas, as well as the highways for wheeled vehicles. In operation as of February 1947 was the system between Chicago and St. Louis and sections of systems at Cincinnati and Green Bay, Wis. Construction permits have been granted for such systems between Boston, New York and Washington; New York through Albany to Buffalo; Cleveland to Cincinnati; Davenport to Omaha; a network in Texas radiating from Dallas south through Galveston and San Antonio to the Southern border and west as far as Odessa, Texas; also, between Los Angeles and San Diego. Plans under consideration for 1947 as shown in the map below include the connection of

many of the trunk lines together, such as, Los Angeles north through San Francisco and Sacramento to Oregon; Chicago through Davenport to Fargo, North Dakota and Chicago east through Detroit, Grand Rapids, Saginaw, etc.

As a matter of interest, in St. Louis there are over 70 subscribers on the Urban Mobile Radio channel which include services to such vehicles as ambulances, automobile repair trucks, burglar and fire alarm service, electric utility trucks, fuel distributor cars, general contractor vehicles, newspaper cars, and others. In other cities, service is provided to armored car operators, boat operators, food distributors, pick-up and delivery trucks, radio broadcasters, taxicabs, trolley and bus transportation companies, railroads, physicians and such. Here, obviously, is a tool which our economy can readily employ.

### Three Classes of Service

Mobile radio is offered in three service classes: (1) a two-way telephone service between a mobile unit and any wire telephone station; (2) a two-way dispatching service between a customer's office and his own mobile units only, and (3) a one-way signalling service to mobile units, which notifies the driver that he should comply with prearranged instructions.

The service which has received so much comment in press and cartoon is, of course, the general two-way service which connects the mobile radiotelephone subscriber into the Bell System so that he may be connected with almost any other telephone subscriber anywhere in the country or, for that matter, anywhere in the world, since the Bell System connects with 95 per cent of the world's telephones.

The technical aspects of the equipment and the methods of transmission have already been described\*. The only limitation to the number of mobile units which can be served seems to be the availability of radio frequencies for this service. One instance may be cited. Assuming a demand for 12,000 mobile units in some urban area, based on present experience, several hundred frequencies would be required to provide adequate facilities for the mobile service subscribers.

Ease of installation is another factor which must not be disregarded. These and other problems associated with this new service have only whetted the desire and inspired the imagination of engineers and manufacturers, and from all indications it looks as though mobile radiotelephony, like radio broadcasting, is here to stay!

\* "Telephone on Wheels" by Robert Bright, Jr., and Stanton Vanderbilt, *Western Electric Oscillator*, p. 3, July 1946.

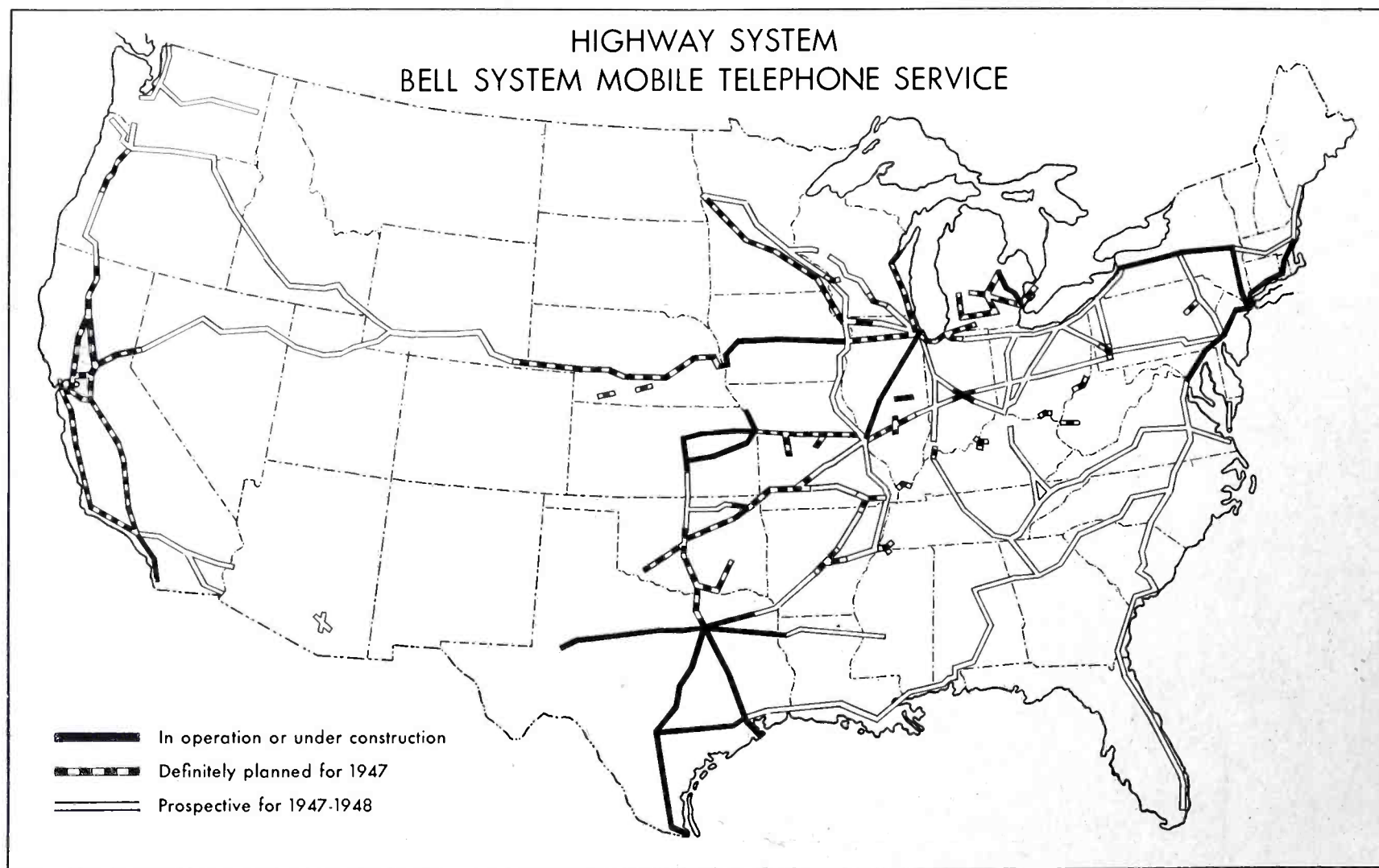

Map indicates remarkable growth of Mobile Radio Highway Service on the 30-44 mc band, with the new construction planned to extend service across the country.

# Directional Patterns with 54A Array

By H. R. Whaley

Western Electric  
Broadcast Field Engineering Force

USUALLY a requirement for FM antennas is that they radiate energy uniformly in all horizontal directions. A circular radiation pattern in the horizontal plane was, therefore, one of the design objectives in the development of the Western Electric 54A Clover-Leaf Antenna. Its uniform horizontal plane radiation characteristic is highly desirable when the antenna is to be located at or near the center of the proposed service area.

Should an occasion arise, however, in which horizontal directivity is desirable, the light, rugged and inexpensive 54A can be used advantageously. Sea coast cities or those in hilly or mountainous areas, for example, might provide a strong incentive to locate the FM transmitter near one side of the desired area of service to listeners.

While the problem of designing antennas to fulfill specific requirements in directivity is not new, it is complicated at best. Usually the most successful designs will be found to be the most simple. In addition to its desirable mechanical characteristics, its circular horizontal radiation pattern makes the 54A Antenna particularly useful as a directive array element.

Suitable control of space relationship between two radiators, and of the phase relationship between the currents in them, gives the array designer a considerable variety of radiation patterns. Two useful patterns are shown here as illustrations. The data from which the curves were plotted

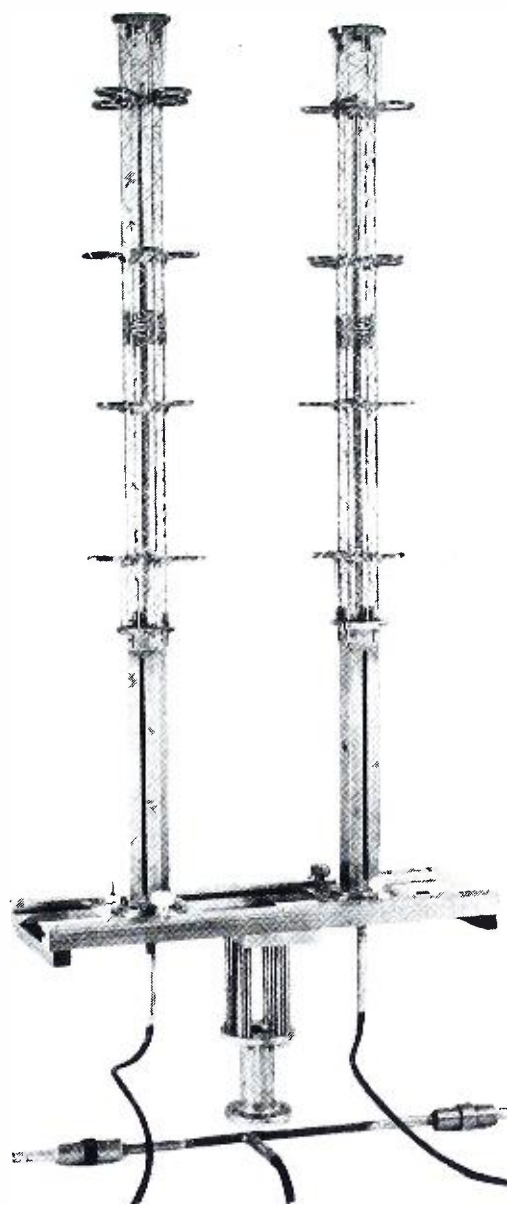

Test fixture composed of accurate 1/10 scale models used for directional array experiments with 54As.

were taken from accurate 1/10-scale models.

In order to secure any one of the many possible patterns, it is necessary, in general, to adjust both the spacing between antennas and the relative phase of the currents flowing in them. The test fixture illustrated at left was so constructed that each of the 1/10 scale models could be rotated about its own axis. (As was to be expected from the circular pattern of a single 54A Antenna, this rotation of one of the antennas about its own axis produced no measurable effect.) The spacing between antennas was made adjustable from a minimum of about .325 wavelength to a maximum of 1.4 wavelength, the spacings being measured between the axes of the two antennas.

No provision was made for adjusting the ratio of current magnitudes. Relative phase of the antenna currents was controlled by means of a variable tap in the feed line bridge. This tap may be seen at the left just in front of the base of the test fixture. By sliding the tap to the left the current in the left antenna was made to lead that in the right antenna and vice versa. The maximum phase difference obtainable by means of the tap shown was about 270 degrees. In practice, phase differences in excess of 180 degrees would not be required.

The assembly at the left was mounted on a pedestal four feet high (not shown),  
(Continued on page 32)

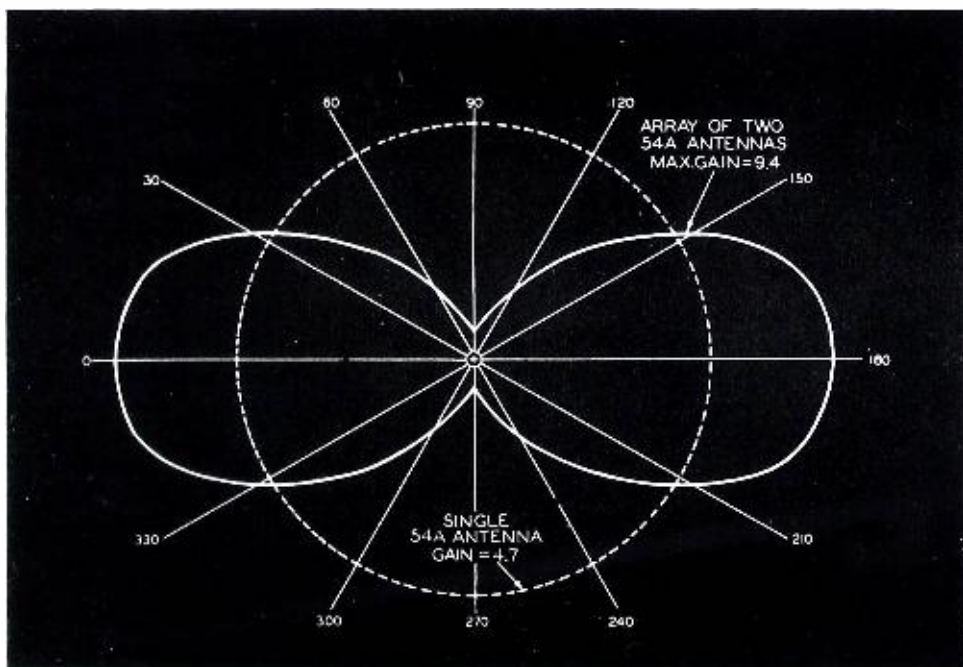

Typical patterns that may easily be achieved with an array of two 54A Antennas. Figure 1 (left) shows pattern when area to be served is long and narrow.

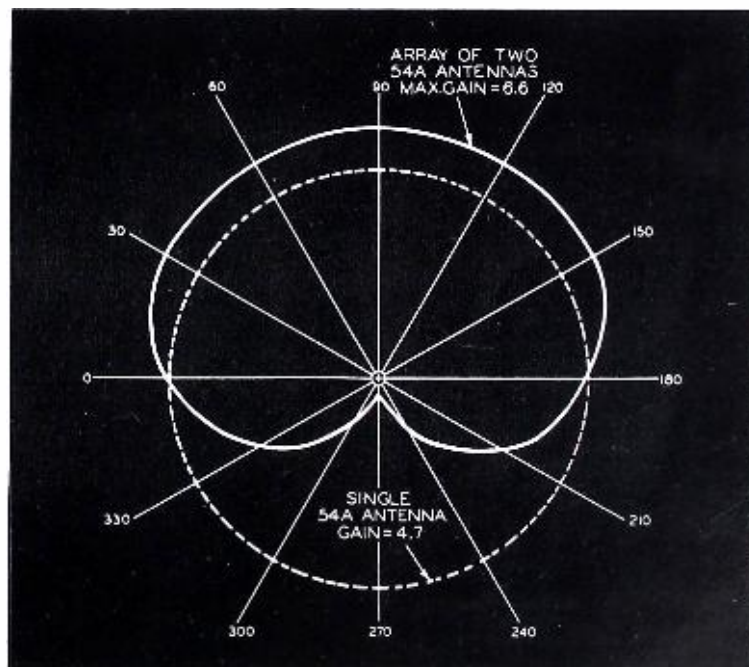

Maximum array gain is 9.4. Figure 2 (right) is a useful pattern where transmitter site lies near one side of area to be served. Maximum array gain here is 6.6.

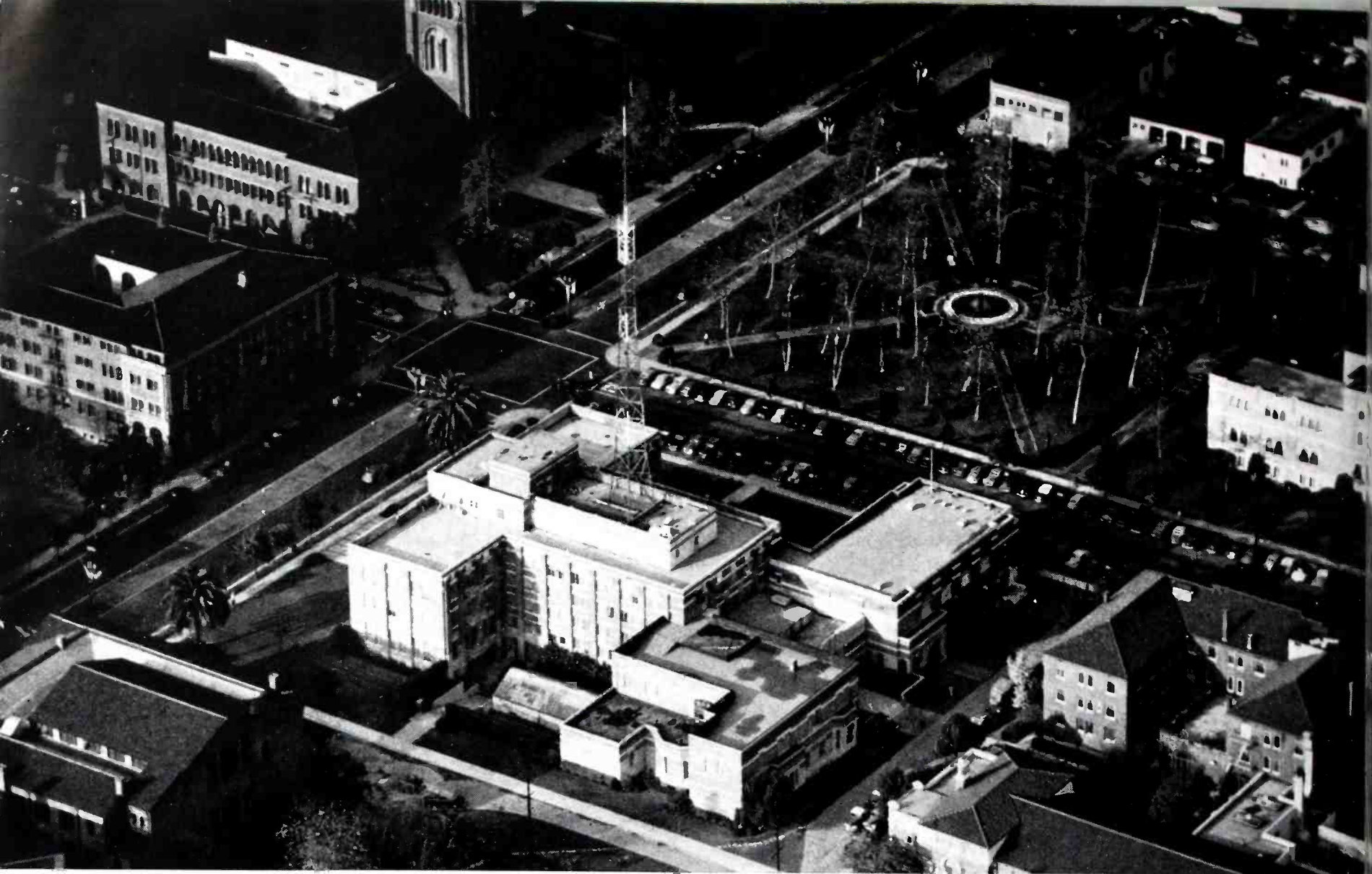

Radio activities on the campus at University of Southern California, Los Angeles, center in the Allan Hancock Foundation Building, home of FM station KUSC.

# FM Goes to College at U. S. C.

## University of Southern California Operates a 1 KW FM Station, KUSC, and a Radio Department that Is an Innovation in Education

"THIS is the Southern California Network" is now the cue for station identification of two stations, KUSC, a 1 kw FM with a licensed effective radiated power of 2.9 kw, and KTRO, a carrier current junior partner—both owned by the University of Southern California Hancock Foundation.

The story of these two stations exemplifies the vision of Captain Allan Hancock, oilman, scientist, musician, aviator, explorer and philanthropist, who established the Hancock Foundation at the University of Southern California in 1939 and is its present director. The foundation built its own building on the campus in 1940, and the Hancock Ensemble, founded some years before as a musical organization, moved to the campus to become a part of the musical life of the University. Perhaps a broadcast station was visualized when the Hancock building was erected on the University campus, for the administrative wing proved unusually suitable for the modern

*By William H. Sener*

Director, Radio Department,  
University of Southern California

*and Carson Donaldson*

Chief Engineer, KUSC,  
University of Southern California

broadcast and recording studio which was later established. The walls were "hinged" and sound-proofed and telephone lines were installed from the University exchange for the reception and feeding of

---

• • This article indicates something of the vital role played by Radio in Education. It shows how a radio station on the campus not only serves the university's radio department but also functions as a workshop for students of all other departments, especially engineering, music, literature and drama. • •

---

programs on the campus and to the local broadcasting stations. From the very beginning of this enterprise, the guiding hand and enthusiasm of Captain Hancock have been the motivating factor in the development of what is now an outstanding university radio organization.

The story of the evolution of this station and the way it serves a modern educational institution may be of interest to broadcasting people. Radio on the University of Southern California's campus goes back to 1940, several years before it had its own transmitting equipment. In that year, the first studio—now known as Studio A—was built in the Hancock building and used as a broadcasting studio for the Hancock Ensemble, which at that time was doing a regular Don Lee Network program. Facilities included provision for mixing programs, continuous disc recording, 16mm sound film recording, playback and recording monitoring, and cue and program monitoring. The in-



terior of the studio, in addition to the normal acoustic treatment, was arranged to make "live end—dead end" effects possible. This was achieved by placing a heavy monks cloth draw-string curtain over the live, or hard wall of the studio at the end opposite the control room.

Based on the functions desired, a Western Electric 23C Console was selected as the best standard unit to build around, and in 1941 the studio was put into operation.

The auditorium of the Hancock Building (now studio B of KUSC), seats 450 people and was originally designed as an intimate recital hall. It was only a short time after construction that this hall was discovered to be ideal for broadcast purposes and many Ensemble broadcasts have originated from the stage.

### Planning Their Own Station

In the early days of the war and before the actual entry of this country, the problem of program schedules and broadcast stations was a difficult one. The difficulties of release of the Ensemble programs and of many other series planned by the University raised the question of construction of a radio station. When it was learned that a 1000-watt FM transmitter might be purchased from the Western Electric Company, Captain Hancock and Dr. Rufus B. von KleinSmid, Chancellor of the University, decided to build what was later to be named KUSC.

Carson Donaldson, co-author of this article and chief engineer of KUSC, was from the inception of the idea the engineering adviser. Mr. Donaldson has been associated with Captain Hancock's interests since 1937.

"Tonight in Los Angeles", presented each weekday over KUSC, features Lee Charles, Valerie Webster.



March 1947



Captain Allan Hancock is founder and director of the Hancock Foundation for Scientific Research.

The FCC assigned KUSC the frequency of 41.9 megacycles and 1000 watts output power, allowing the usual six months' construction period. (However, it was to take several years to complete construction and get the station "on the air.") The decision to locate the transmitter and antenna on the campus was based on several factors: (a) Adequate coverage of all of the Los Angeles area could be achieved from this point. (b) Costs could be reduced by using the Hancock Building as a base for the tower. (c) Operation would be much less difficult from the campus area.

Now came the many problems of wartime shortages, such as lack of steel for a tower and conscription by the armed forces of all radio transmitters under construction. Thus progress toward completion of KUSC was held up until the war's end. In the interim, the Frequency Modulation

band was changed, and KUSC received its present allocation at 91.7 megacycles and a licensed effective radiated power of 2.9 kilowatts.

In March 1946, notice was received that the first transmitter converted to the new FM frequency by Western Electric would be displayed in Columbus, Ohio, at the Sixth Annual Broadcast Engineering Conference and that the same transmitter would then be recreated and shipped to the University of Southern California. The transmitter was received, and work begun on a new tower. Before the tower was finished, however, the initial test broadcasts were made on a simple ground plane antenna fastened to the transmission line and extending about 15 feet above the roof of the Foundation building.

Reception of the early tests was spotty. Strong reports were received from San Diego, over 100 miles away, and no reception reported in Glendale, only 15 miles away. Construction proceeded rapidly on the tower and with the arrival of two of the planned four radiating bays, a strong signal was created for the Los Angeles area. As this article goes to press, the large tower using the two bays, and 451 feet above sea level, is in operation, and preliminary field strength measurements underway indicate excellent coverage of the tremendous population concentrated in and around Los Angeles. Also, the new Western Electric 25B Console is now in use in the auditorium studio. The station operates from three studios: the original Hancock studio, the 450-seat auditorium, and a simple announcer's booth (for talks and transcriptions) equipped with two transcription players, necessary microphones and amplifiers.

Headline musical offering of KUSC is the Allan Hancock Ensemble, shown here in broadcast position on the stage of Studio B. Three Western Electric Cardioid microphones are employed to pick up this program.





**Above:** Carson Donaldson, chief engineer, stands beside KUSC's Western Electric FM transmitter, operating on a frequency of 91.7 mc. Transmitter power is 1 kw, licensed effective radiated power is 2.9 kw.

**Below:** Rex Morrow, assistant chief engineer, seated at the 40A Console section of the Western Electric 25B Speech Input Equipment. Studio B, which seats 450 people, can be seen through control room window.



Early plans had included the use of a  $\frac{7}{8}$ -inch coaxial transmission line and two circular radiating antennas constructed for the 40 to 50 megacycle FM band, but with the change of frequency allocation and anticipation of possible higher power requirements,  $1\frac{5}{8}$ -inch flanged type concentric line was secured from Graybar Electric Company, and an order placed for an array of four bays. The 250-foot transmission line from the transmitter to the base of the tower is installed completely within the air-conditioned foundation building, eliminating the necessity for expansion considerations.

#### First Scheduled Broadcast

While the engineering development went forward under Carson Donaldson, the production department grew rapidly, and the first program scheduled was planned with Captain Hancock; Chairman of the Board of Trustees of the University, Chancellor von KleinSmid; Dr. A. S. Raubenheimer, Educational vice president, and Dr. Max T. Krone, Dean of the Institute of the Arts under which the radio department operates, acting as an informal committee to discuss the program suggestions. The original schedule was developed in September 1946, and called for three hours of broadcasting, six days a week. The first scheduled broadcast was made on October 24, 1946.

A typical program of the Station is set forth below:

#### PROGRAM SCHEDULE

- 6:00-6:15 p.m.—Musical Miniatures, recorded serious music.
- 6:15-6:30 p.m.—Check the Scoreboard, late sports news.
- 6:30-6:45 p.m.—Footlight Review, recorded show tunes.
- 6:45-7:00 p.m.—Tonight in Los Angeles, discussion of outstanding cultural events appearing tonight in Los Angeles.
- 7:00-8:00 p.m.—Hancock Concert Hour, features the Hancock Ensemble and artists from the Foundation as well as the College of Music.
- 8:00-8:15 p.m.—Night Extra, late news.
- 8:15-9:00 p.m.—Trojan Lyceum, campus events, and recorded symphonic music.

Major program in the original schedule is the Hancock Concert Hour heard from 7:00 to 8:00 o'clock each evening and presented through the cooperation of the Hancock Foundation and the University of Southern California College of Music. Each Thursday evening this hour features the Hancock Ensemble. Music numbers are selected by Captain Hancock and Mr. William Strobridge who is conductor and arranger for the Ensemble. Special members of the Ensemble also appear as solo-

ists. Other evenings on the Concert Hour are presented by noted artists—all of whom are teaching members of the University of Southern California College of Music. Direction of the Concert Hour is by Professor Ingolf Dahl, who conducts the U. S. C. orchestra and teaches the classes, "Music in Radio," and "Composition for Radio." (Mr. Dahl this fall has been the maestro on the Victor Borge—Benny Goodman NBC show originating in Hollywood.)

"Night Extra" regularly heard from 8:00 to 8:15 p.m. is developed from news from the United Press and the University of Southern California *Daily Trojan*. Each program includes from three and one-half to four minutes of news commentary on the significant news of the day which is prepared and presented by Don Prismon, a graduate student in the school of International Relations. "Night Extra" is written by Ray Lieberman, who is a student in Radio.

"Tonight in Los Angeles" is based on the theme, "where will we go tonight" and features Mr. and Mrs. Leo Malamuth under the names Lee Charles and Valerie Webster. Copy is prepared by Mort Diener, Marilyn M. Miller, and Boyd Upchurch.

Thus far, one change has been made in the original programming. It was found that the "Trojan Lyceum" scheduled for 45 minutes and designed to broadcast outstanding campus events could be reduced to 30 minutes, and the time from 8:15 to 8:30 p.m. is now allotted to "Songs for Tonight" which is prepared and brought to the air by special students in the College of Music. Tuesday and Friday evenings feature William Chapman, baritone, who created the series, and Monday evenings have as performing soloist Margaret Christman, soprano.

#### Future Schedule — 12 Hours a Day

Future programming will encompass a schedule of a minimum of 12 hours of broadcasting daily and will be planned to include every department of the University and special school programs with the cooperation of the Los Angeles City and County Schools. The station is building a highly specialized record library of serious music, and in programming, KUSC already has become a personification of the slogan "FM means fine music."

The radio department of the University is an innovation in education. While most universities have maintained radio as a part of another department, Southern California has established a separate unit for this field. The Institute of the Arts, of which Dr. Max T. Krone is dean, is made up of the departments of radio, speech,

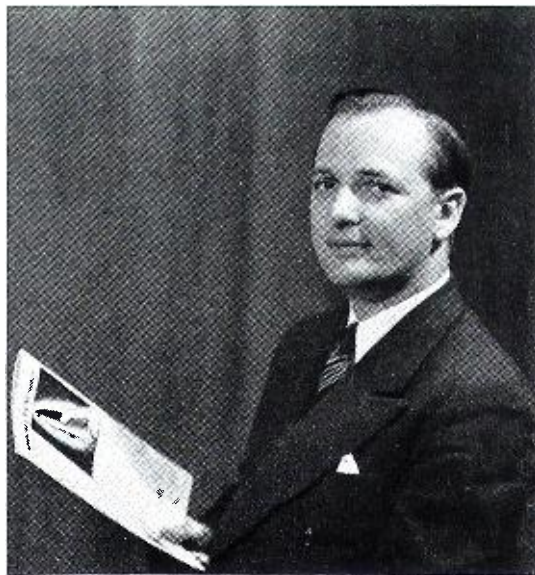

Co-author, William H. Sener — head of Radio Department and Manager of KUSC — reads in a recent "Oscillator" a description of the new 640AA Microphone which will soon be in use at his station.

music, drama, cinema and fine arts. As a department, radio has a four-year major with special emphasis in any of four fields: (1) acting or announcing; (2) writing; (3) production; (4) business management and personnel. Those who select the major fields are required to take additional courses in related departments such as psychology, education, cinema, speech, drama, sociology, languages, merchandising, advertising, science and literature. The department recently released a statement about its aims which said: "The student completing the course will have two things: (1) a thorough fundamental Liberal Arts educational background and (2) an appreciation and comprehension of radio technique and radio's responsibility to its audience and society."

Members of the technical staff stand in front of the transmitter truck and portable studio mobile units at KUSC, Los Angeles. Left to right, they are: Wayne Johnson, Richard Rowe, Rex Morrow, James Wolf, Keith Reed and Carson Donaldson, chief engineer. Technicians not present when the picture was taken are Lyle Farrell, the transmitter engineer and Marshall Brown, Ivan Goodner and John Moseley, assistants.

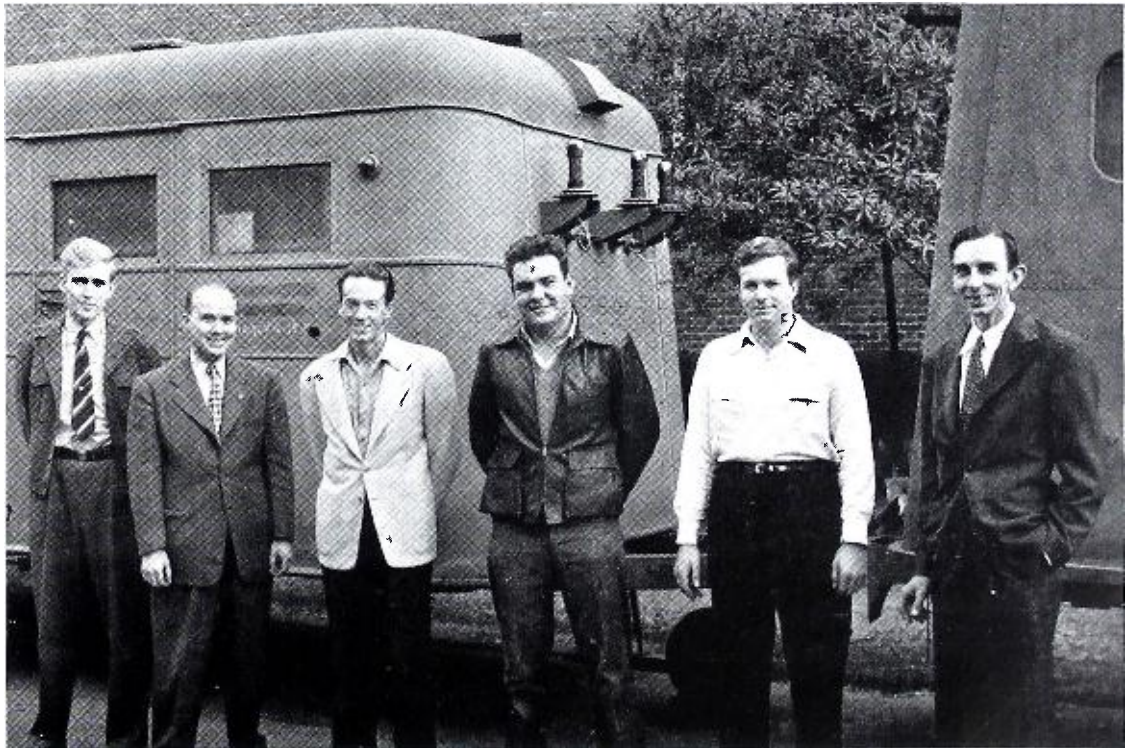

The staff teaching radio courses includes Dr. Grace Ingledue, formerly of WFIN, Finlay, Ohio; Ingolf Dahl, associate professor in the College of Music; Harriet Louise Touton, who won her spurs in radio as director of the Beverly Hills, California, High School Workshop; Dr. Martin H. Neumeyer of the Sociology department who teaches "Radio as a Social Institution;" and Mr. Art Gilmore, announcer on the "Dr. Christian," "Red Ryder," "Guild Wine," and "Meet Me at Parky's" network programs. Among planned courses is one in "Control Room Techniques" to be taught by Carson Donaldson, staff member of the Hancock Foundation. Others include "Program Planning," "Audience Measurement" and "Radio Advertising."

#### Student Staff Members

Special students have been designated as student staff members in the various departments of KUSC. These departments include production, script and continuity, chief announcer, news, music and sports.

From a large number of engineering students, all of whom possess commercial radio licenses, a few were chosen as transmitter operators and control room technicians. The group includes: Marshall Brown, Ivan Goodner, John Moseley, and Richard Rowe. Of particular interest and making possible a "commercial" quality of performance is the fact that all the above-mentioned students have had considerable radio training and experience, either commercially or in the armed forces.

To provide a laboratory for testing pro-  
(Continued on page 33)

# NEW ARC-BACK INDICATOR

## Western Electric's 10 KW FM Transmitter Features Novel Circuit for Unerring Location of Faulty Tube

**H**OT cathode mercury vapor rectifiers for high voltage plate supply in broadcast stations afford high efficiency, excellent regulation, simple installation, and require little maintenance. The phenomenon known as "arc-back" occurring in such rectifiers, though rare under normal conditions, is occasionally annoying because of the uncertainty as to which tube is at fault. With a new circuit just introduced by Western Electric for positive identification of a faulty tube, this uncertainty has been removed and another forward step made in minimizing time off the air.

In an arc-back the tube stops behaving as a rectifier and conducts current in the reverse direction. The trouble may be brought on by improper tube temperature, power line surges, heating from overloads, or old age. An arc-back acts as a short circuit on the a-c supply and will seldom clear until power is shut off from the rectifier. If the tube is faulty the arc-back may recur when power is reapplied. Each arc-back means a program interruption for the station. If the arc-backs persist, it may be necessary to shut down and to locate and replace the bad tube. With a spare tube available in the warm-up position, positive indication as to which tube is at fault permits quick restoration of power.

### Requirements for Indicator

Considerations of transformer cost, peak inverse voltage and ripple output have led to the general use of full wave bridge-type rectifier circuits for high voltage supplies in radio broadcasting. In such circuits if one tube arcs back, the reverse current is carried in the forward direction by some other tube in the circuit. The two tubes in series act as a short circuit on the a-c supply. The short circuit current is a very heavy overload on the good tube which is conducting in the normal direction and will overheat its anode. A fraction of a second later the phase of the a-c power reverses, and inverse voltage is applied to the overheated tube which may then arc back also. A third tube then carries the short circuit current and may be sufficiently overheated (in its normal direction) to arc back in turn, so that in the few milliseconds, representing one cycle of the power supply, several tubes in the rectifier may arc back.

To be effective, then, an arc-back indicator circuit must meet several requirements: (1) As the arc-back current in one

*By N. C. Olmstead*

Bell Telephone Laboratories

tube always appears as a forward current in another tube, the indicator circuit cannot operate simply on the magnitude of the tube currents but must sense the direction of the current in the tube. (2) Half the tubes in a bridge-type rectifier have both the cathode and anode at high voltage to ground so that any indicator must be oper-

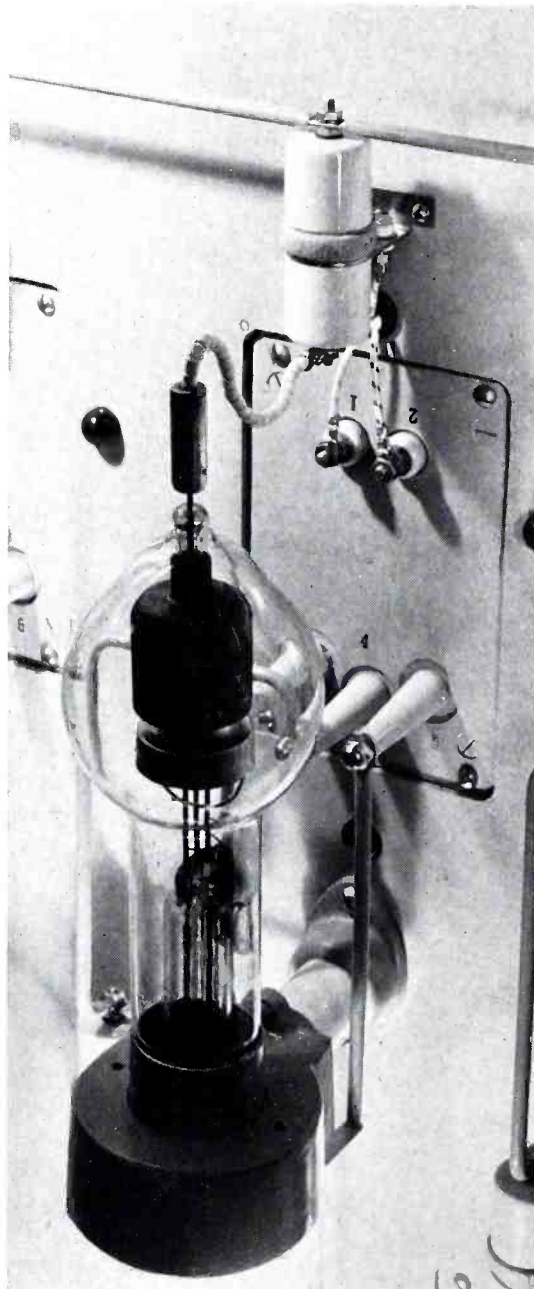

Saturated toroidal transformer — heart of arc-back indicator circuit — shown above mercury vapor tube.

ated at high voltage or provide insulation between the rectifier tube and the indicator circuit. (3) An arc-back may be followed by a string of "sympathetic" arc-backs in any or all of the other tubes, hence, the first tube to arc back must be indicated to the exclusion of the others.

The heart of the arc-back indicator circuit provided in the new Western Electric 10 kw FM transmitter is a small toroidal-wound transformer, shown in the photograph on this page, which provides in a simple manner the necessary insulation between the high voltage tube circuit and the low voltage indicating circuit, and which responds only to reverse current in the rectifier tube—thus meeting requirements (1) and (2) above. This transformer has a single-turn primary consisting of the anode lead of the rectifier tube carried through the center of the toroid in a ceramic bushing.

The secondary consists of a multi-turn toroidal winding on a permalloy tape core, at essentially ground potential, as shown in Figure 1. The core is operated in a saturated condition by passing a biasing current of a few milliamperes d-c through the multi-turn secondary. This bias current is so poled that the normal primary current pulses (the forward current through the rectifier tube) are in a direction to add to the magnetizing force of the bias current. As the bias current saturates the core, the addition of the primary pulses will have relatively little effect on the core flux and will therefore induce little voltage in the secondary winding. However, if the current in the primary is reversed (such as would be caused by an arc-back in the rectifier tube) its effect bucks the magnetization of the bias current and the resulting large flux change will induce a substantial voltage in the secondary winding.

### Use of Permalloy Tape

By using permalloy tape for the core of the transformer a magnetization curve is obtained which is very steep for low magnetizing forces and has a very sharp knee, as illustrated in the graph in Figure 2. The steeper the curve up to the knee and the sharper the knee, the greater will be the ratio of output voltages for the same values of reverse and forward current. In the commercial design of this transformer this ratio is between 20 and 30. This difference in output voltage may be used to control a vacuum tube which is biased to be inoperative on the small output voltage from the forward current pulses but is operated by the much higher voltages produced by the reverse current.

For the actual indication, a cold cathode three-element gas-filled tube is used. When sufficient voltage is applied to the control

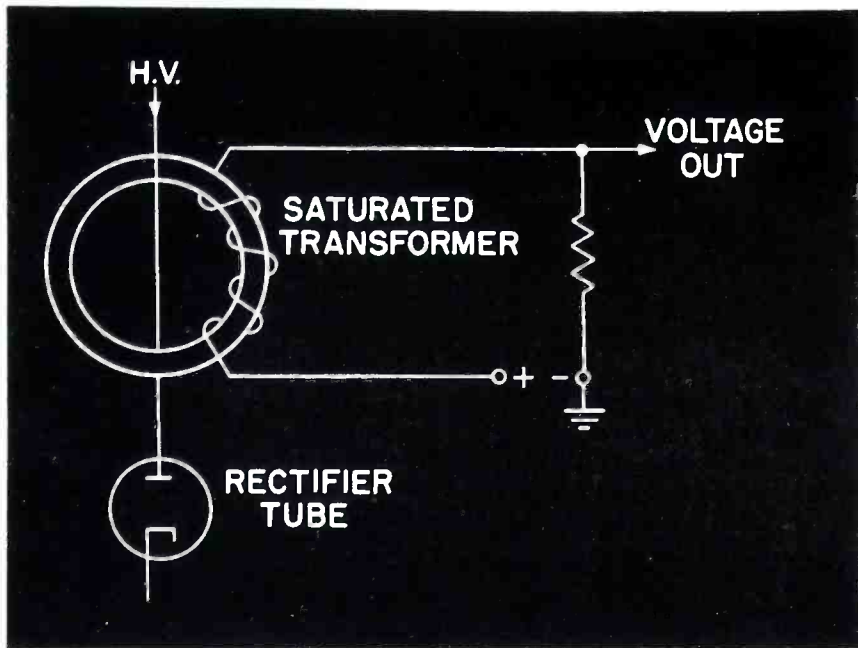

Figure 1 — Toroidal core — saturated by running small d-c through multi-turn secondary at ground potential — is responsive only to reverse currents in tube.

electrode of this tube, the resulting ionization permits the gap between the main anode and the cathode to break down. The discharge in the main gap is readily visible and serves as indication that the tube has been fired. If several of these tubes are operated with a common cathode resistor and one tube is fired, the current in the main gap flowing through this common resistor raises the cathodes of all the tubes to a high positive potential. The circuit is so designed that the same amplitude of voltage pulse from any rectifier tube which may arc-back subsequently will not be sufficiently more positive than the cathodes to fire any other indicator tube, hence Requirement (3) — identification of the faulty tube to the exclusion of the others — is fulfilled.

As used in the new Western Electric 10 kw FM transmitter, the circuit has been carried a step further. The voltage from the saturated transformer does not operate

directly on the indicator tube but is used to trigger a small thyatron tube. The firing of this thyatron in turn fires the indicator tube. The common resistor in the cathode circuit of the indicator tubes blocks all the indicator tubes except the first one to fire. A sensitive relay in the common plate supply of the thyatrons acts to open the a-c power to the rectifier whenever one of the thyatrons is fired. As this sensitive fast-operating relay is the only mechanical link between the saturated transformer and the tripping circuit for the power supply, the time required to remove power in case of an arc-back is greatly reduced as compared with that required when depending on primary overload relays. Power is then reapplied automatically and immediately, as the fast-tripping action has minimized the damage to the good tubes, and the chances of carrying on without further interruption are substantially improved.

By using separate sets of gas tubes in

this way for the tripping and indicating functions, the indication is maintained until the operator restores the circuit by manually operating a push button, while the tripping tubes are reset automatically as soon as power is removed and are therefore ready to function again as soon as power is reapplied. Should a second arc-back occur at once, the operator can immediately replace the tube known to be faulty with the heated spare and go back on the air.

The Western Electric 321A Rectifier Tube used in this transmitter, like the well known 315A of the same rating, is noted for long life, and arc-backs are unknown to many of its users. The circuit described here, however, by removing any possible error as to the tube at fault, permits using the tube well beyond the normal time for removal without fear of losing program time, and, in addition, provides faster protection than has ever been possible in rectifiers of this type.

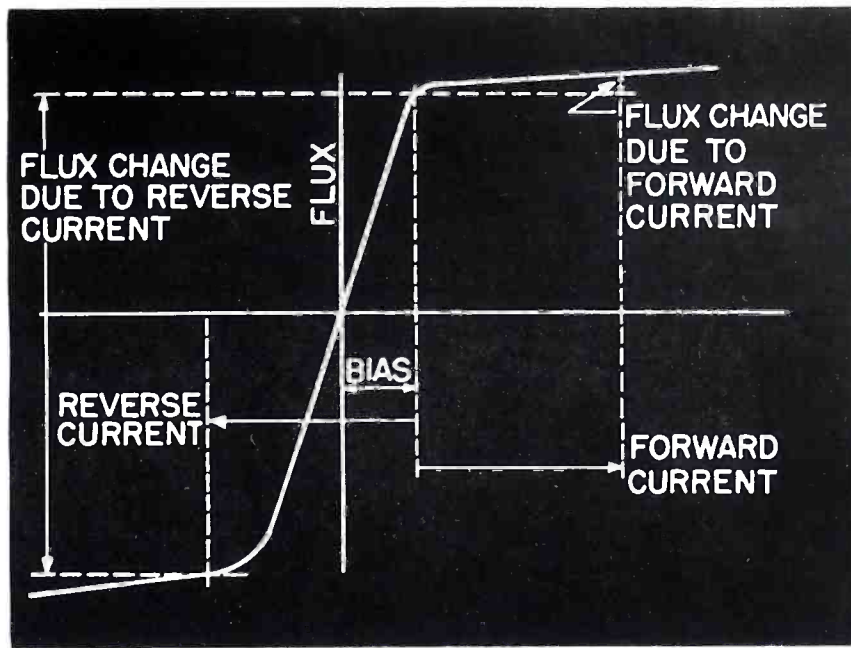

Figure 2 — Graph showing high ratio of sensitivity to reverse as compared to forward currents, achieved by use of saturated permalloy tape for the core.

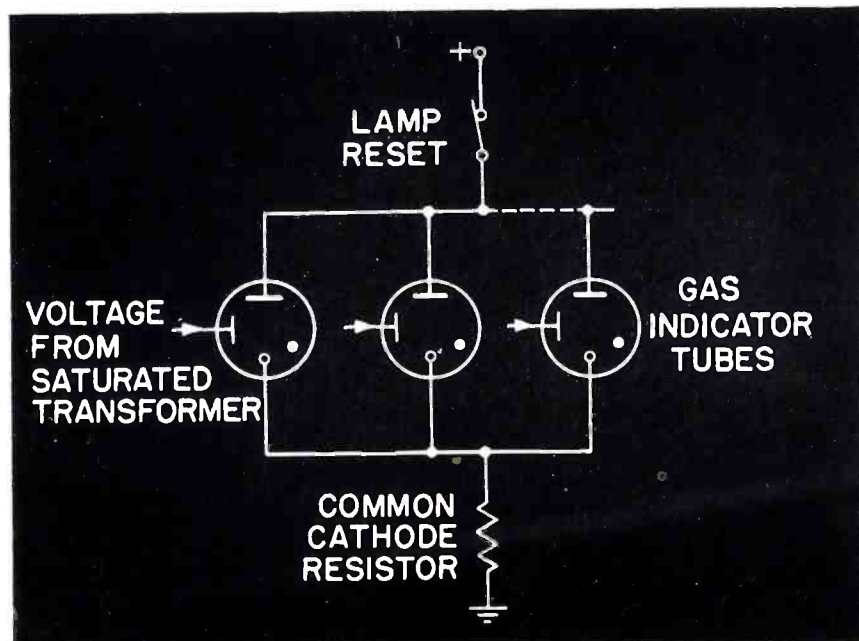

Figure 3 — Schematic showing a common cathode resistor in the indicator tubes which insures that only indicator tube receiving first impulse will be fired.

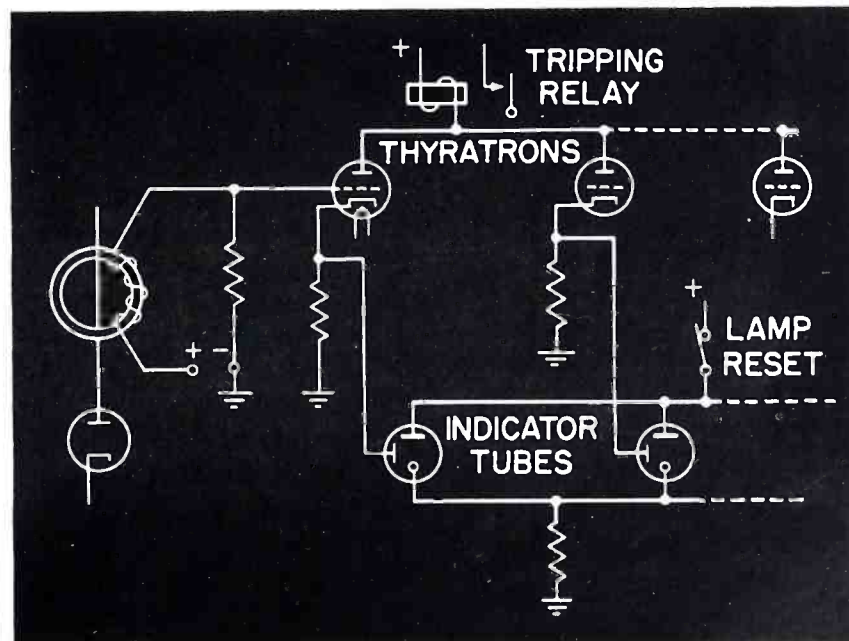
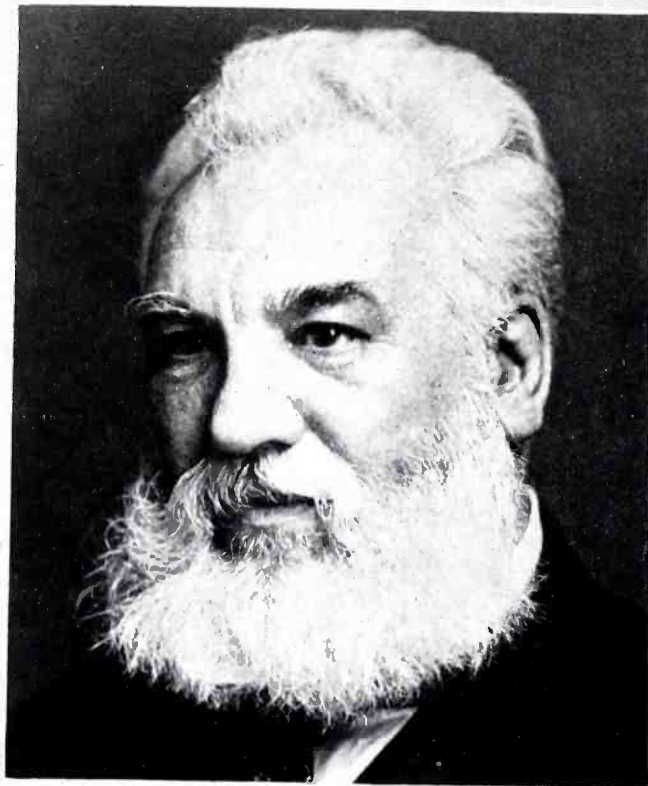

Figure 4 — Schematic shows small thyatrons and tripping relay between saturated transformers and indicator tubes, giving fast protection against arc-backs.

# ALEXANDER GRAHAM BELL

## Centennial



1847

1947

## His Inventions Were of Basic Importance to Radio

ONE hundred years ago—on March 3, 1847—a man was born destined by his genius to give wings to the human voice. The fruit of his mind knit the world closer together, transcended boundaries, built vast industries. His name was Alexander Graham Bell. In 1876, at the age of 29, he invented the telephone and set forth two basic principles upon which electrical voice communication is founded.

The first principle illustrated by his invention was the discovery that to transmit sound electrically, it was necessary to have a current that could be "shaped" by sound. Secondly, he conceived the idea of the transmitter—as a single membrane or diaphragm which, through its vibration, would bring about corresponding variations in the current flowing on the wire. These two principles underlie all voice communication from telephony to radio broadcasting and every field that uses a microphone—public address, music distribution, acoustic aids—derives from that early Bell transmitter. Guglielmo Marconi is quoted as saying: "... the message received at St. John's (that is, the first transatlantic radiotelegraph signals) was received through a telephone receiver, and in connection with

radio the name of Bell is inseparable."

The man who gave this priceless invention to the world and whose centennial is now being celebrated was born at Edinburgh, Scotland, son of Alexander Melville Bell, who won a world-wide reputation as a teacher of correct speech, lecturer on elocution and inventor of Visible Speech, a code of symbols that indicated the position and action of the throat, tongue and lips in pronouncing syllables and uttering various sounds.

### Harmonic Telegraph Experiments

In 1870, the Bell family moved to Canada and settled at Tutelo Heights in Ontario. In 1871, Alexander Bell, then 24 years old, went to Boston for an engagement to teach Visible Speech to the deaf and demonstrate his methods for teachers of the deaf. In 1873, while professor of Vocal Physiology at Boston University, he began electrical experiments trying to devise a harmonic telegraph, an instrument that would send more than one tone over a wire by intermittent pulses of electric current. He tried employing, at first, electrically driven tuning forks and later steel reeds, and it was these efforts that launched him

on the most significant work of his career.

In that year, Thomas Sanders, a Boston leather merchant whose son Bell took as a special pupil, and Gardiner Greene Hubbard, a champion of teaching the deaf to speak rather than use sign language, agreed to finance Bell's experiments. In 1874, Bell met Thomas A. Watson when he took parts of his apparatus to the Charles C. Williams, Jr. model shop to be rebuilt, and Watson later became his assistant. Meanwhile, Bell experimented with the "phonograph" and the "manometric capsule," devices which made wave line pictures of sound waves. Later, at the suggestion of a surgeon, he experimented with the drum and bones of a human ear, mounted to make similar wave line patterns, and this work with the eardrum gave him the idea for his telephone transmitter.

From this time on, the germ of the telephone took root in him. During the summer of 1874, he told his father of a theoretical apparatus for transmitting speech. In February of 1875, he described a theory of a mechanism that "will make a current of electricity vary in intensity as the air varies in density when sound waves are

*(Continued on page 32)*

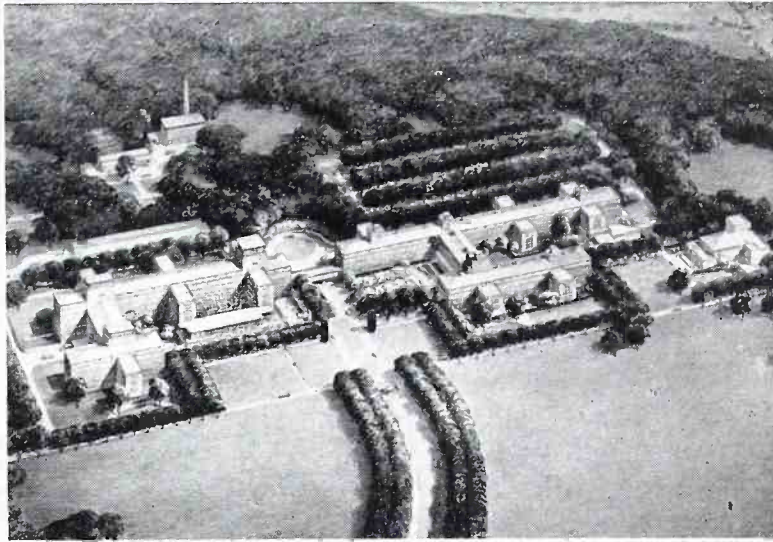
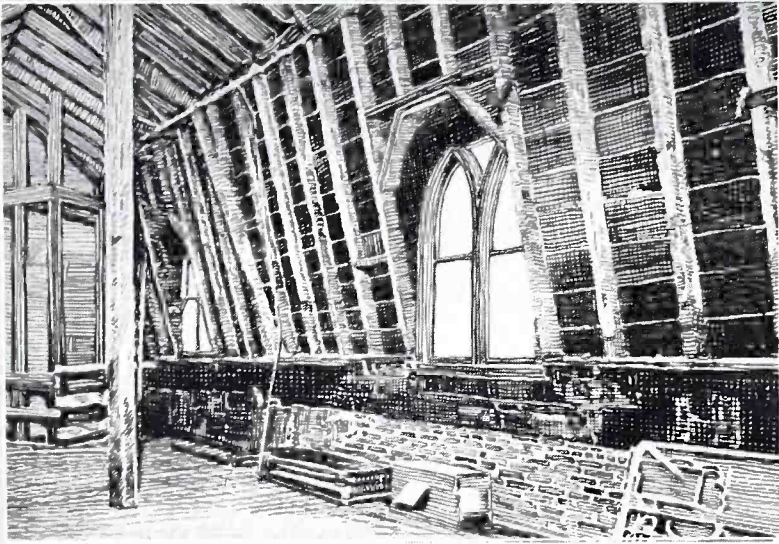

From Bell's attic at 109 Court Street, Boston, left above, where he made his early telephone experiments, has grown the world's largest research center

devoted to electrical communications — Bell Telephone Laboratories. In drawing, above right, is Laboratories unit at Murray Hill, N. J., showing new wing at left.

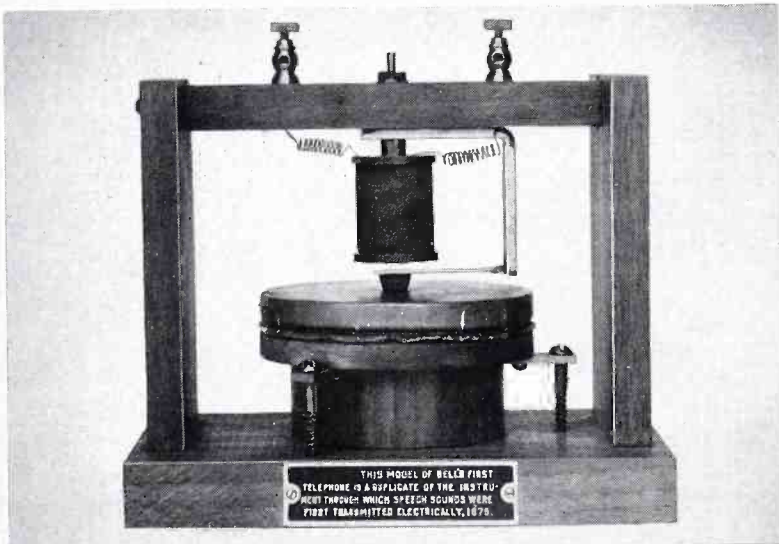

From Bell's original "gallows frame" telephone, through which speech sounds were first transmitted in 1875, evolved the Nation's and the world's vast telephone sys-

tems, symbolized by modern handset at right. Each of the Bell System's 26,000,000 telephones can be connected with any one of 95 per cent of world's telephones.

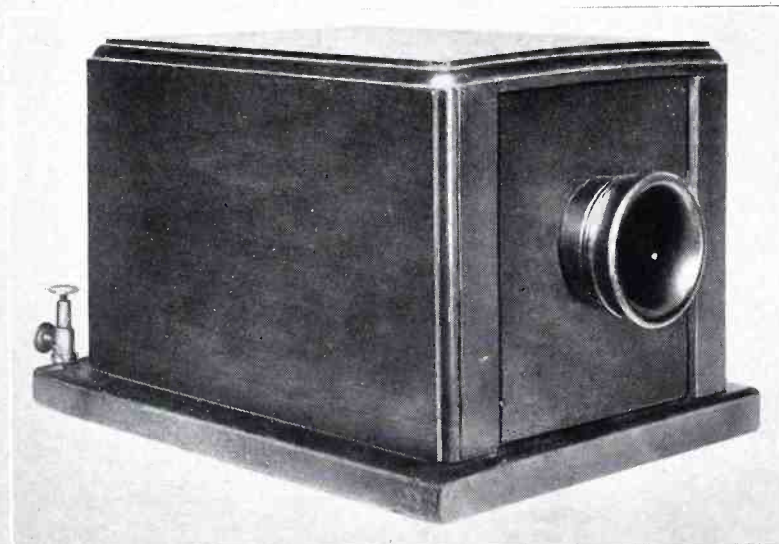

The first "microphone", shown left, was Alexander Graham Bell's 1877 box telephone into which Thomas Watson shouted and sang in first intercity demonstra-

tions of infant art of telephony. The box telephone is thus the grand-daddy of all modern microphones, represented by the Western Electric Cardioid, right.

# THE 757A LOUDSPEAKER

## A New Two-Unit System for Highest Quality Sound Reproduction

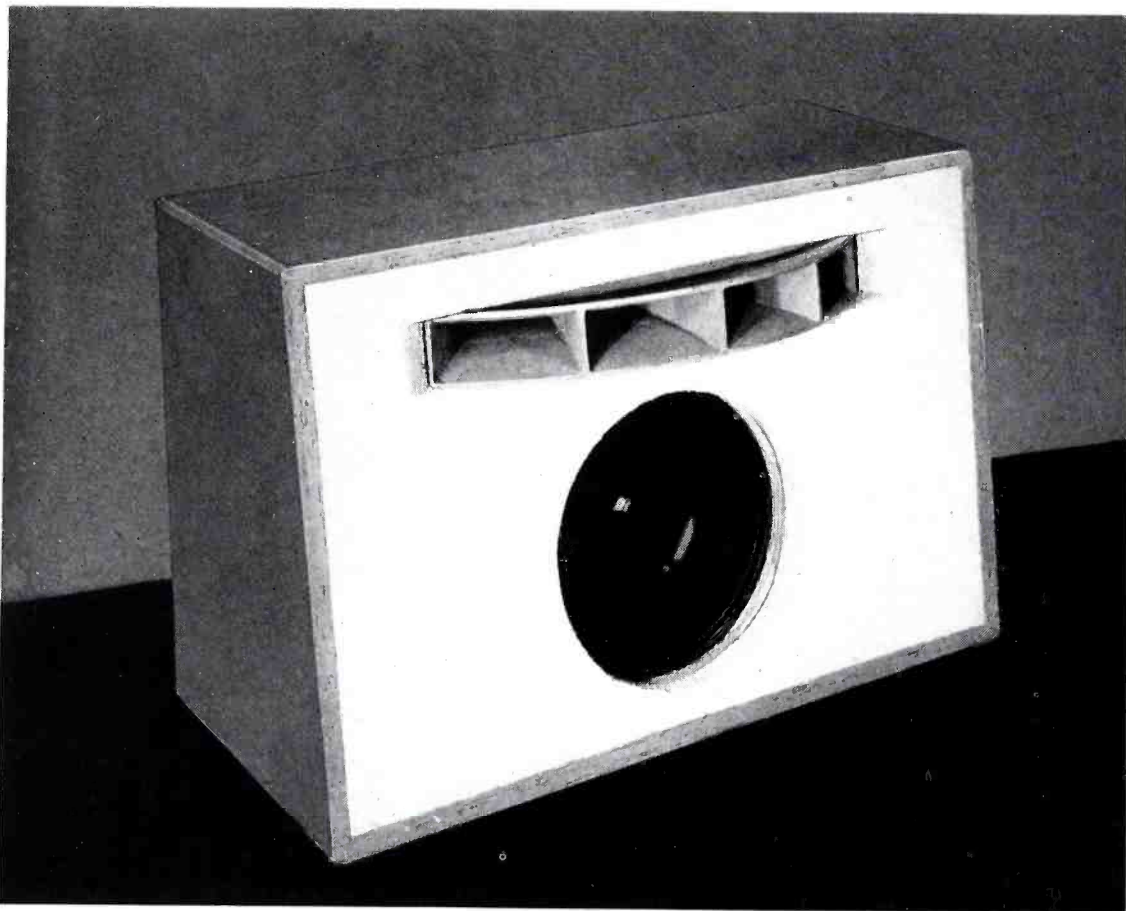

Dual-unit 757A Loudspeaker, showing the high frequency horn, above, and the 728B in sloping front cabinet.

By combining its new 728B loudspeaker with a new high-frequency unit, the 713C, in a "woofer-and-tweeter" system of advanced design, Western Electric has produced a loudspeaker for the very highest quality sound reproduction in FM and AM broadcast monitoring, recording studios, wired music and public address applications. The new speaker is coded the "757A" and is a complete system with a utility cabinet, dividing network, and special sectoral horn for high-frequency distribution. It provides unusual qualities of clarity and "presence," covering the whole frequency range of 60 to 15,000 cycles per second. It is capable of handling an input power level of 25 watts continuously.

### Description of Components

The units included in the 757A loudspeaker are the 728B as the low-frequency speaker; the 713C as the high-frequency speaker; the KS-12027 sectoral horn for projection of the highs; the 702A dividing network for separation of high- and low-frequency energy; the 700A attenuator for adjustment of the frequency balance, and a utility cabinet to house all of the units and provide proper acoustic "backing" for the speakers.

The dividing network is so designed

that the 728B covers the range from 60 to 1,000 cycles, with the cabinet providing proper baffling and acoustic characteristics for smooth response through the bass range. The 713C speaker covers the range from 1,000 to 15,000 cycles. Distribution of the high frequency energy over an angle of 90 degrees in the horizontal plane is achieved with the KS-12027 horn, which is coupled to the 713C high frequency speaker. This horn is of cast aluminum, sectoral in form, and is partitioned to avoid reflections in the horn column. It is used to match the mechanical impedance of the speaker to the air and to distribute the high frequency sound over the 90 degree angle. With this wide-angle distribution, the frequency balance is maintained throughout the service area of the speaker.

The dividing network has an electrical input impedance of 4 ohms, and is designed with ample power capacity for the 25-watt rated input of the system. The cross-over point of 1,000 cycles provides optimum performance of the system as a whole, with the characteristic of each speaker properly adjusted to the other elements of the system.

The 700A attenuator is inserted between the 713C and the dividing network, and makes possible the adjustment of the bal-

ance between highs and lows to match the characteristics of the space in which the loudspeaker is used.

### Sound-Treated Cabinet Front

The utility cabinet, as indicated above, is designed as an integral and important part of the whole system, and not only mounts all of the components but also provides the necessary acoustic conditions, both in front of and in back of the speakers, for proper operation. As can be seen in the accompanying illustration, the high frequency horn is mounted to project through the upper part of the cabinet front, directly over the 728B. The sloping front of the cabinet is covered on the outside with a sound-absorbing material which aids in the maintenance of the smooth response of the system. The cabinet is finished in gray which will match the majority of architectural schemes without difficulty, or, if desired, it can be readily refinished to suit any particular requirements.

The cabinet is 20 inches high, 30 inches wide, and 14 inches deep, and thus takes up only a little more than four cubic feet of space over-all. The convenience arising from the small space requirements of this new high-quality loudspeaker system, as compared with earlier two-unit systems for handling such a wide frequency range at high power levels, is one of its important advantages, and makes installation easy and economical.

### Specifications

The specifications of the 757A loudspeaker system are tabulated below for ready reference:

Low frequency speaker:

Western Electric 728B

High frequency unit:

Western Electric 713C

Power input capacity:

25 watts continuous

Frequency response:

60 to 15,000 cycles

Impedance:

4 ohms

High frequency horn:

Western Electric KS-12027,  
sectoral aluminum

Cabinet:

20 inches high, 30 inches wide, 14 inches deep, finished in gray enamel, front treated with sound absorbing material.



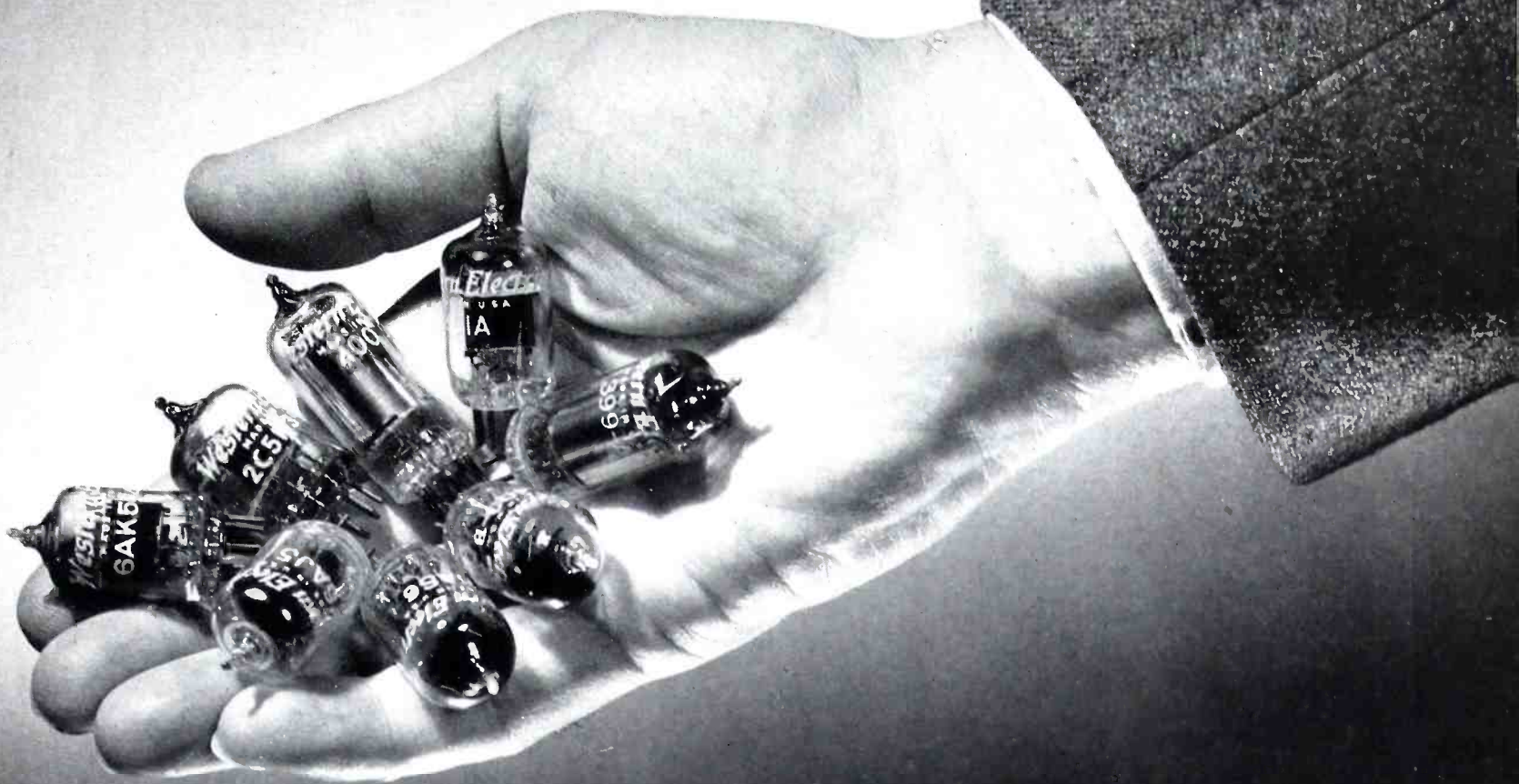

# MINIATURE ELECTRON TUBES

**M**INIATURES—relative newcomers to the tube field—are playing a vital role in making Bell System equipment lighter, more compact and still more efficient. To meet the rapidly increasing demands, Western Electric's assembly lines are turning them out by the thousands—a new generation of specialists for a great variety of important electronic circuits!

The production of these extremely small tubes to the tolerances required for their high performance and long life demands an unusual degree of skill. Precision is evident in every step of the processes at the

---

•• They're small, efficient, versatile . . . combine minimum space requirements, high frequency performance, low signal-to-noise ratio and low interelectrode capacitance. ••

---

Western Electric Electronics Shop where nimble-fingered girls—some working with microscopes—fabricate the parts, assemble them, inspect the work at each stage, evac-

uate and seal off the assembled tubes, and finally age and test the finished products.

Before assembly, the tiny cathodes, with integral welding tabs, are given a coating under carefully controlled conditions which are an important factor in the stability and long life of these miniature tubes. During this spray treatment, the cathode elements are set up in a rack on a conveyor which carries them slowly before a pair of automatic spray guns. These coat the cathode uniformly with a triple carbonate mixture composed of barium, strontium

*(Continued on page 31)*

Twenty-five separate parts go into the assembly of a typical miniature. The components of the stem are grouped around the finished stem at the lower left.

In the center are the grids and other parts which are assembled and welded to the stem to form the finished mount structure shown at tip of the tweezers.



# The Making of a Miniature

Fabricating the tiny parts, assembling the mounts, sealing, evacuating, aging and testing are a study in precision at Western Electric's Electronics Shop

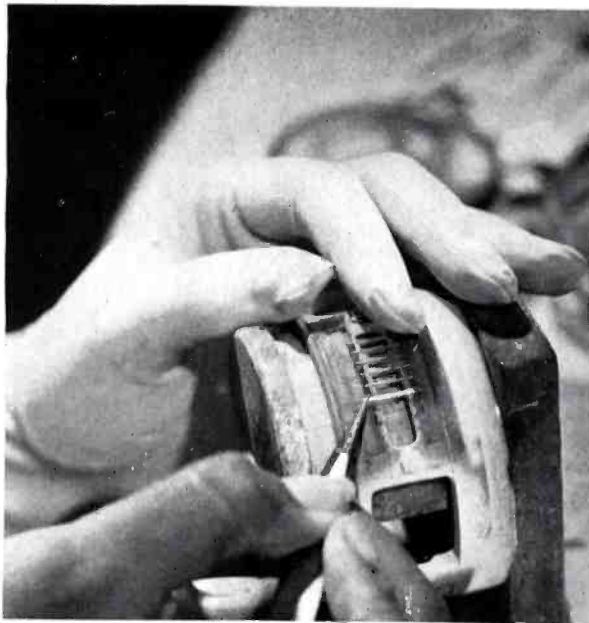

**1** Preparation of components is the first step. Here cathode elements, with welding tabs attached, are assembled in a jig prior to spraying.



**2** Here the cathode elements, mounted in the circular jig, pass before spray guns which coat them uniformly with a triple carbonate mixture.



**6** Next come the grids. Here the first is put in position. Care must be taken not to damage the extra fine wire, which may be only .001 inch in diameter.

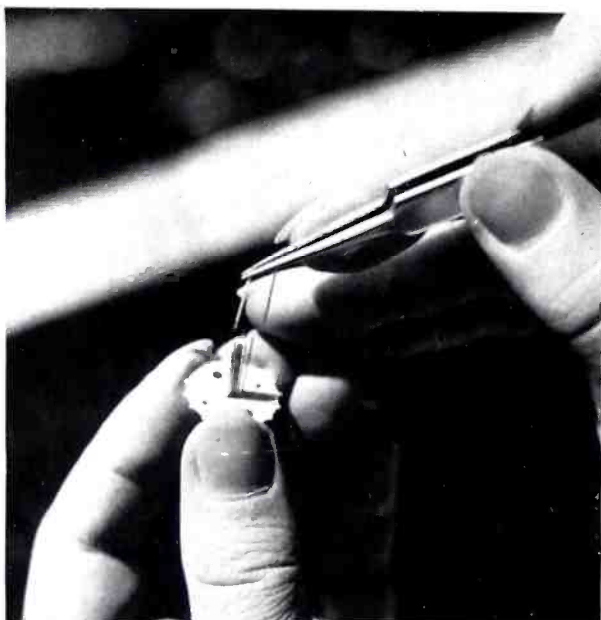

**7** Precision is the watchword! Here last grid is assembled. Spacing between the grids and from grid to cathode must be extremely accurate.

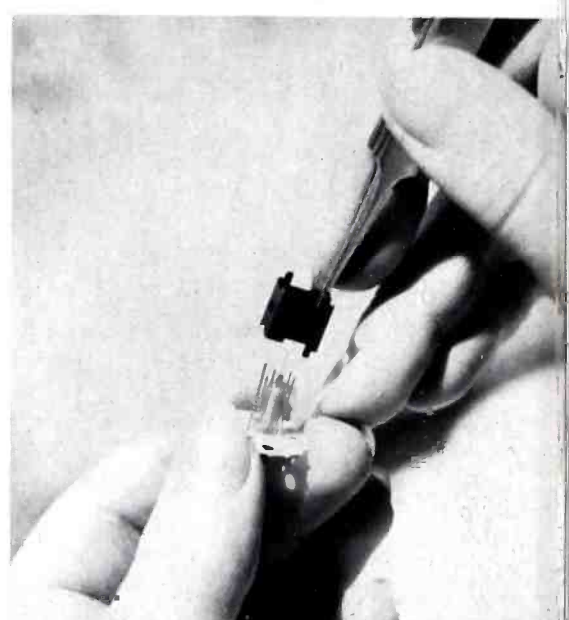

**8** In another delicate operation, rectangular metal anode is lowered into its position on the mica base around the assembled cathode and grids.

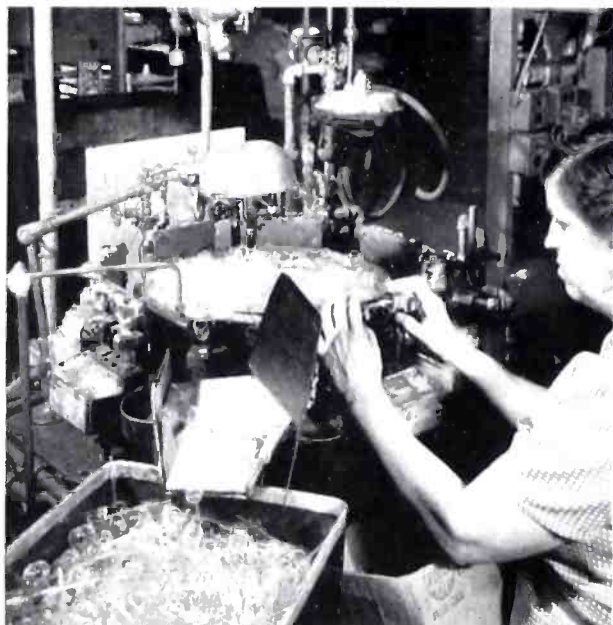

**12** The glass envelopes are prepared by joining envelope sections to the tubulations on this machine. One round trip fuses the glass parts together firmly.

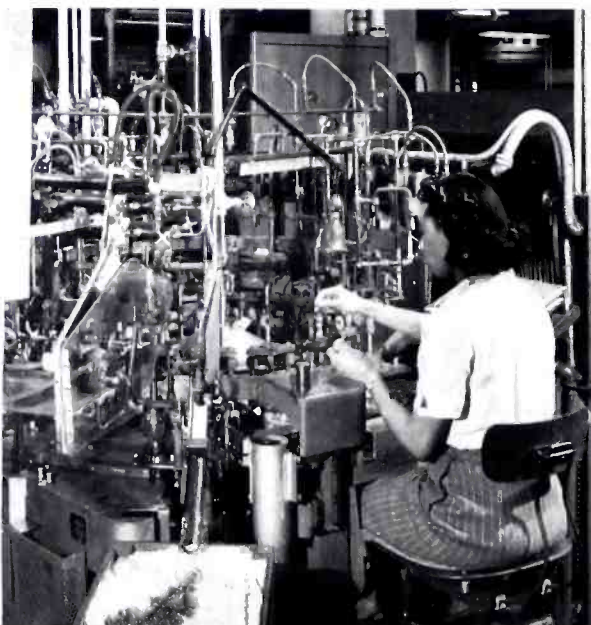

**13** In final manufacturing step, mount structures join glass envelopes for evacuation and seal-off. Finished products are delivered at lower left.

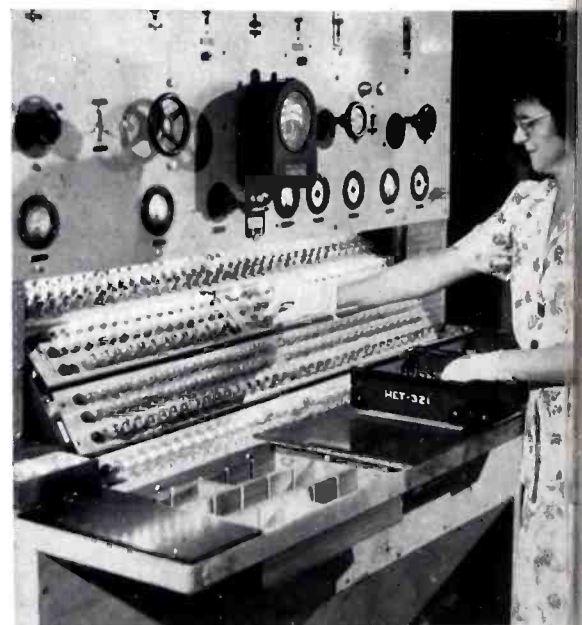

**14** Aging miniature tubes on this unique revolving drum insures uniformity and stability in operation. Here, panel is being filled with tubes.

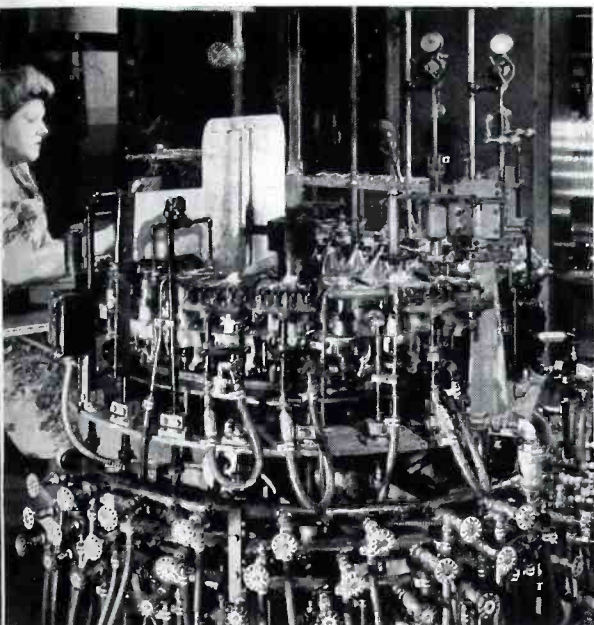

**3** In this intricate stem-forming machine, leads are automatically fed into jigs. The operator adds rings of glass and the machine does the rest.



**4** Rows of girls assemble the components. Teams of six operators and an inspector carry the assembly through to the finished mount structure.

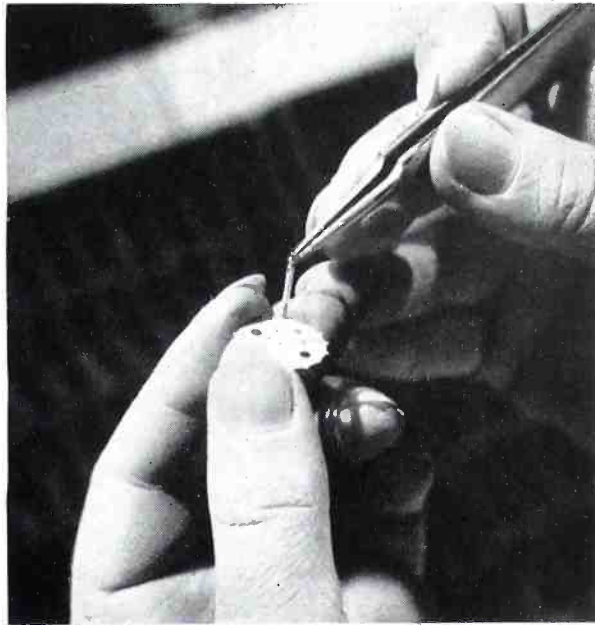

**5** Assembling coated cathode on a mica base is the first operation. Deft fingers and a steady hand are required for this and the succeeding operations.



**9** Next, the top mica and getter are placed in position. Although the individual parts are fragile, finished structure is extremely rugged.



**10** Spotwelding fastens structure together securely and joins it to leads in glass stem. This close mounting is important at higher frequencies.



**11** Finished mount structures receive a critical inspection under a microscope, then are tested for "shorts" and "opens" before proceeding to next step.

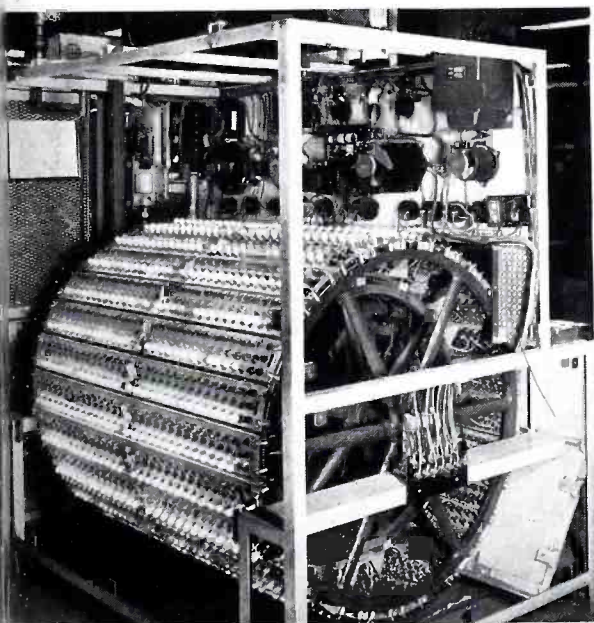

**15** Rear view of aging machine shown in photo at left, with safety panels removed. Drum moves intermittently, one revolution completes process.



**16** Each tube receives a thorough electrical test. Console-type test equipment is shown in foreground; rack-mounted type is shown in upper left.

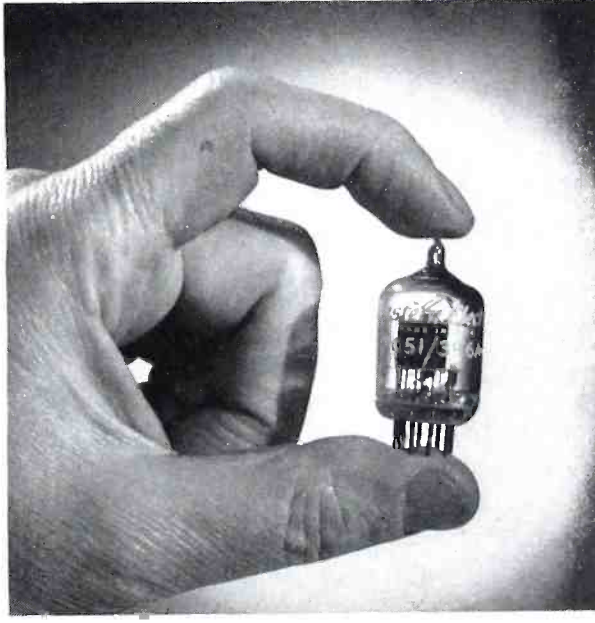

**17** A finished miniature tube—manufactured carefully, tested thoroughly and aged properly—ready to go to work in a countless variety of electronic circuits.

# CLOVER-LEAF IN THE CLOUDS

**WKY's New Antenna Tower Structure—the Nation's Tallest—Looks Down on the Oklahoma Countryside**

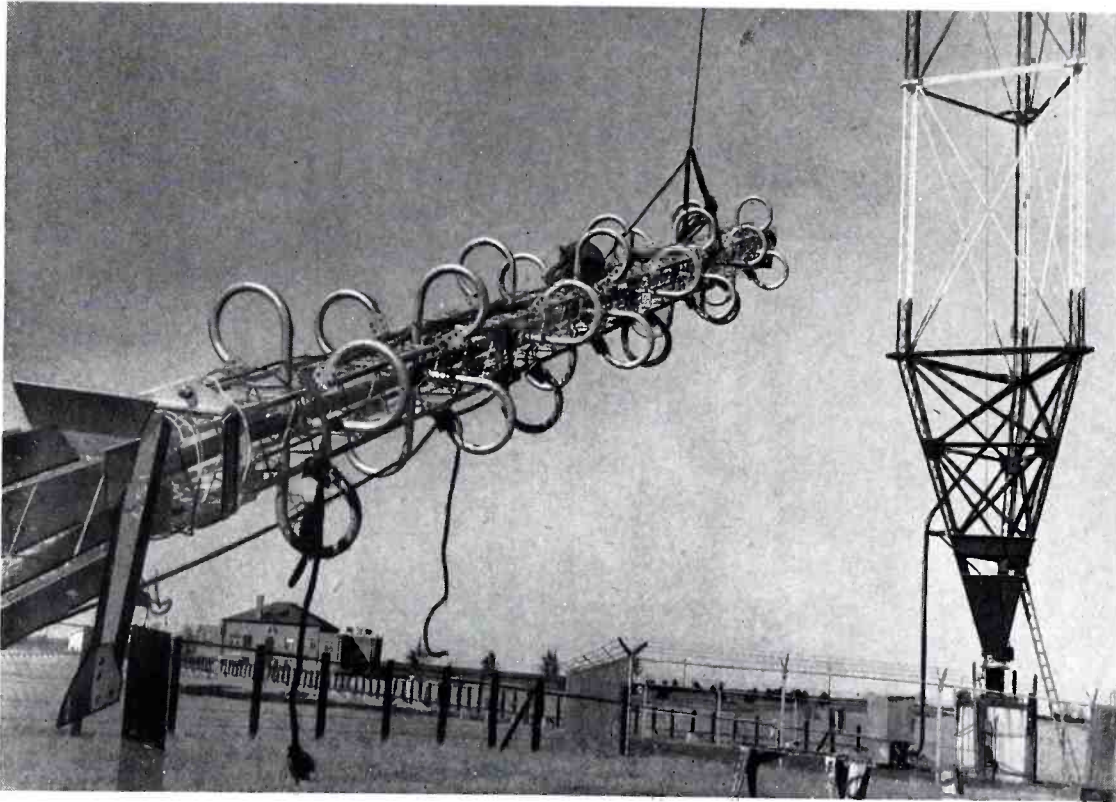

A Western Electric Clover-Leaf begins its long skyward journey to the top of WKY's 915-foot supporting tower. Riggers assembled the 54A on the ground, complete with airplane beacon, in slightly over 10 hours.

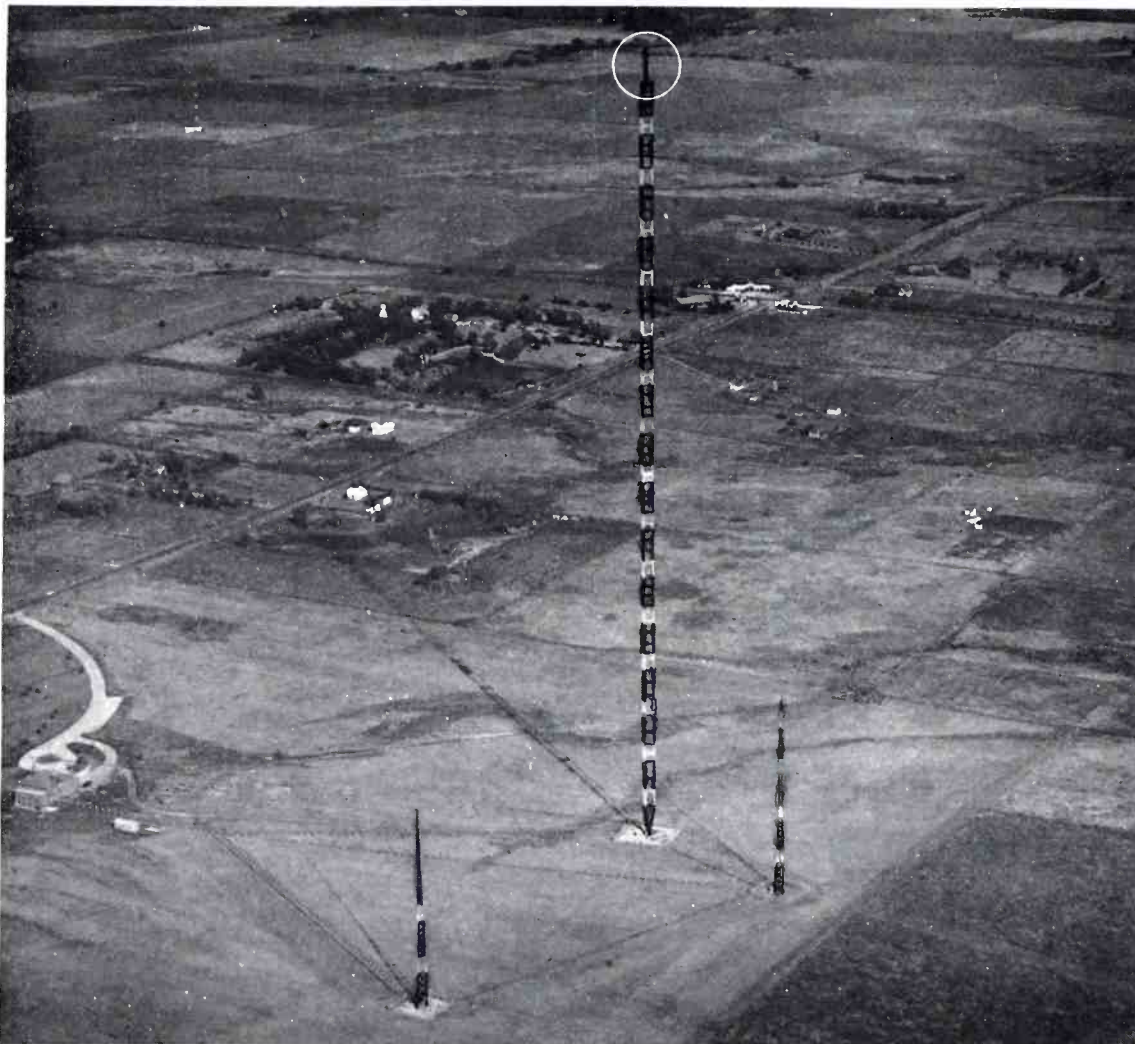

Dwarfing the two 250-foot antennas nearby, WKY's giant 959-foot antenna tower structure — tallest in the land — stands with its Clover-Leaf and airplane beacon aloft. Raising of Clover-Leaf took only one day.

RIDING high atop WKY's 915-foot AM tower at Oklahoma City is a new Western Electric 54A FM Antenna, the highest above ground of any Clover-Leaf yet installed. This installation was made in a surprisingly short time—one day for assembling the antenna on the ground and one day for hoisting it to the top of the tower and bolting it down. Mechanical simplicity and ruggedness, ease with which it can be assembled and erected, and the low wind-loading factor were advantages of the 54A of particular importance in this instance.

Personnel at WKY, including P. A. Sugg, Station Manager and H. J. (Jack) Lovell, Chief Engineer, were eager to take advantage of the radiating advantages of having an FM antenna atop their extremely tall AM mast. Working with Dixie McKey, of the radio engineering consulting firm of Dixie B. McKey and Associates, Washington, D. C., they carefully planned the details of the installation. McKey and Lovell had made the original "proof of performance" tests on WKY's three-element directional array and were familiar with all of its characteristics. Anticipating the advance of FM, WKY had made provision in the design of their AM tower for an additional bending moment of 31,000 ft.-lbs. It is interesting to note that the bending moment of the eight-unit 54A Antenna which is 25,646 ft.-lbs. came well within the limits of the provision.

## 1750-Foot Transmission Line

Another consideration was the problem of feeding the FM antenna at this height. To solve this, the Graybar Electric Company supplied WKY with 1750 feet of  $6\frac{1}{8}$  inch coaxial transmission line. "I am quite sure that this is the largest transmission line order for a single FM antenna ever placed," said William A. Arthur, manager of Graybar's Oklahoma City office.

The next important step in the erection was that of assembly and mounting. The 915-foot tower posed quite a problem here. Obviously, it would be quite a difficult task to assemble an antenna at this height. Too, the antenna adjustments must be stable and its mechanical strength sufficient that maintenance and readjustments after installation could be held to an absolute minimum. The 54A antenna design, which does not require ceramic insulators or multiple transmission lines, answered these problems with its inherent stability and

ease of installation.

How well it provided the solution is described by Mr. Sugg, who writes, "We successfully installed the Clover-Leaf atop our main transmitter tower Sunday without mishap. The riggers arrived Thursday and assembled the tower on the ground in slightly over ten hours—four men working. . . ."

"You will be interested to know that Western Electric now has an FM antenna reposing at the highest altitude from a supporting structure. We currently have a tower totaling 959 feet in height, and if you do not think your heart stops when men are working at that altitude. . . ."

#### Field Intensity Measurements

McKey and Lovell made the field intensity measurements necessary to determine that the installation would not cause distortion of the directional pattern of the AM array. Before the installation of the Clover-Leaf, they made horizontal field intensity measurements in the directions of WTAD, Quincy, Ill.; WJAX, Jacksonville, Fla.; KHJ, Los Angeles, Calif.; and KSEY, Pocatello, Idaho. A series of measurements in the vertical plane were made from an airplane in the direction of WTAD. These measurements checked the results of previous tests. The Clover-Leaf was then installed at the top of Tower No. 0 of the three-tower array. This tower is insulated and loaded 145 degrees or 427 feet above the base to simulate two towers, one above the other, the lower 145 degrees and the upper 176 degrees. A slight adjustment was found necessary in the loading coil for this tower. McKey and Lovell made further field intensity measurements to check the effects of the additional height on the directional pattern, and found that it was necessary to readjust the divider network for the other towers. Final measurements were made to establish the field patterns, and at the conclusion of these tests, McKey reported:

"A study of the results of the tests after the installation of the high frequency antenna indicates that the increase in height of Tower No. 0 has not materially affected the directional operation of the system. The only readjustments necessary were the loading coil of Tower No. 0 and the dividing network for the other towers. . . ."

The Western Electric 54A Antenna mounted on top of the AM tower is an eight-unit Clover-Leaf. Each radiating unit is composed of a cluster of four curved elements. In plan view, these clusters form a symmetrical shape similar to that of a four-leaf clover, hence the name "Clover-Leaf". The antenna is designed to radiate horizontally polarized radio waves and to

*(Continued on page 31)*

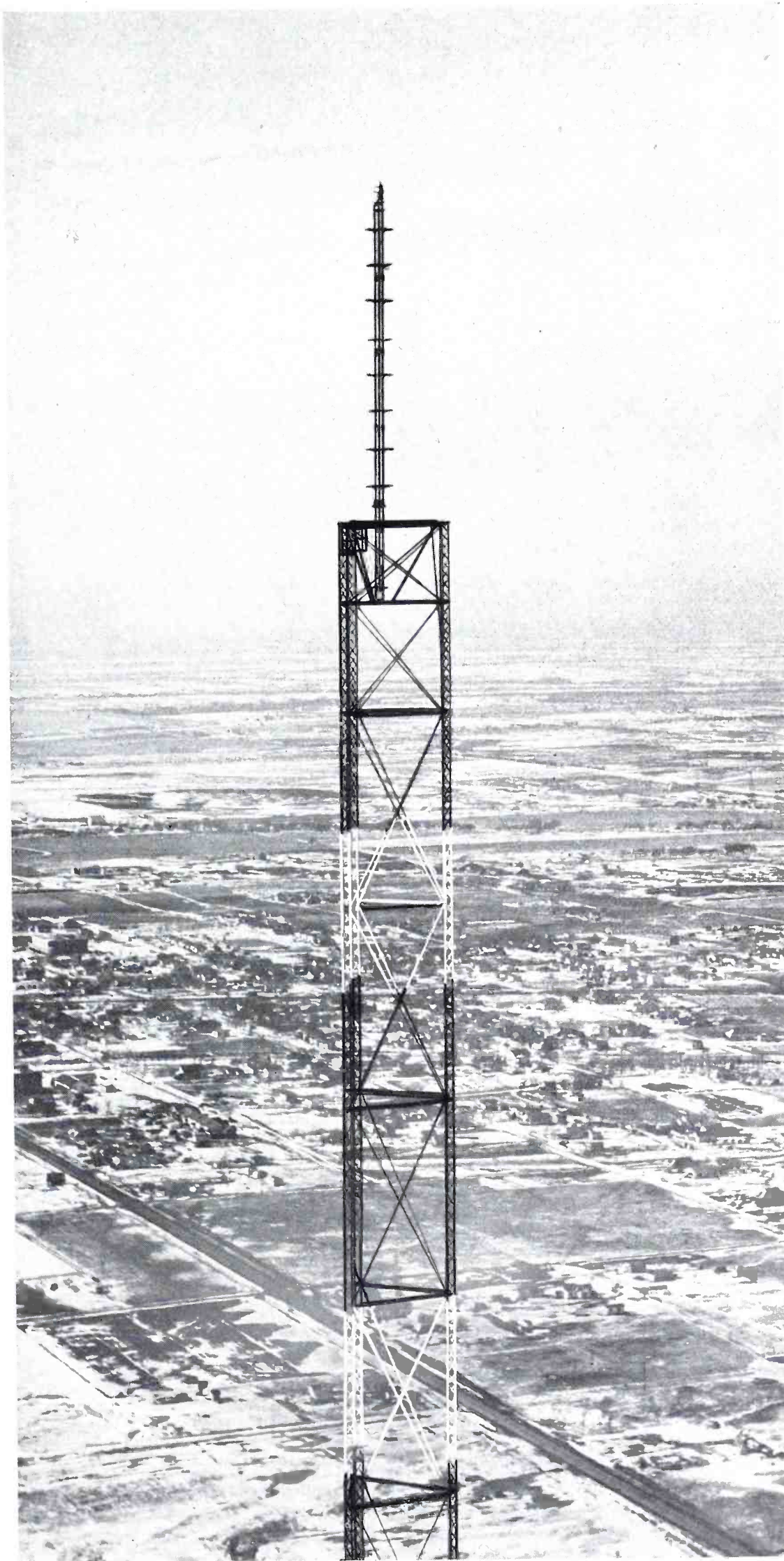

Air view of the 54A Clover-Leaf installed at the top of WKY's cloud-piercing radio tower, overlooking the flat Oklahoma countryside. This Clover-Leaf is fed by 1,750 feet of 6 $\frac{1}{8}$  inch coaxial transmission line.



New "Twin Cities Zephyrs," now under construction, are shown in this artist's drawing against a background of the scenic route between Minneapolis-St. Paul and Chicago. These and six "California Zephyrs" will all have Program Distribution Systems furnished by Western Electric. Note the modern Vista-dome cars.

## Music While You Ride

**A new Program Distribution System offers train travelers in lounges, private rooms and coaches a choice of several recorded or radio programs**

*By Frank Nickel*

Western Electric Radio Division

**M**AKE the trip interesting—make the traveler comfortable—make the American public travel-conscious! These are the slogans of the railroads of the United States as new, deluxe, streamlined passenger cars roll off the assembly lines and swing into place behind the huge, new, high-speed locomotives which can take you to your destination faster, smoother and more enjoyably than ever before.

In the design of these new trains the problem of passenger entertainment was considered. "What can we do," asked the railroads, "to increase the enjoyment of long trips and keep passengers interested for many hours at a stretch?"

As soon as the war ended Western Electric went to work on the problem—with the idea of distributing high quality recorded and radio programs throughout the train for the entertainment of rail travelers.

The Chicago, Burlington and Quincy Railroad, "The Way of the Zephyrs", was one of the first to recognize the advantages

of such an entertainment service, and agreed to cooperate in tests to determine what equipment was necessary, the type of programs required to relieve fatigue, and the electrical and mechanical requirements needed to keep such equipment operating dependably and economically under the conditions of vibration and stress experienced in today's high-speed passenger trains.

### A Test Run

In February 1946, Western Electric and Bell Telephone Laboratories undertook extensive road tests to find the answers to these questions. In a car furnished by the Burlington, an installation was made, consisting of two types of radio receivers, a magnetic wire reproducer, turntable, and the necessary loudspeakers and power conversion equipment. In a test run from Chicago to San Francisco and return, the performance of the various types of equipment was closely watched by representa-

tives of Western Electric, Bell Telephone Laboratories, Graybar Electric, the Burlington Lines, the Denver & Rio Grande Western and the Western Pacific Railroads.

The data obtained on this test run resulted in the development of the Railroad Program Distribution System pictured on the opposite page. This engineering model contains the necessary equipment for a distribution system which affords passengers a choice of two recorded programs and one radio program, or one recorded program and two radio programs, depending upon which of the channels is in stand-by position.

The sound system equipment panel illustrated contains four magnetic wire reproducers, two radio receivers, three power amplifiers and monitor speaker, as well as the necessary switching and control equipment. This panel is installed in the diner, observation or other similar type of car which is always included in the train make-up, permitting continuity of service irre-

spective of the arrangement of the cars.

Both recorded and radio programs, as well as microphone announcements, are distributed through a train-line cable to every public space and private room or compartment. A single loudspeaker is provided in each private space with facilities for program selection and control of volume, and several speakers are provided in each public space with a common selector switch, and are operated at low volume to produce pleasing and uniform sound distribution.

In addition to allowing passengers a choice of three programs, the steward or conductor may break in at any time for station announcements or comments concerning points of interest in the country through which the train is passing.

The number of recorded or radio channels may, of course, be varied to suit the requirements of each individual railroad, although it is probable that in most cases the system will be essentially as described.

Attempts have been made in the past to utilize conventional turntable and pick-up equipment, but this has been found to be virtually impossible on a moving train, as the jolting and vibration to which the pick-up is subjected prevents the stylus from properly tracking in the groove. Furthermore, cars on a high speed train "roll"

considerably, particularly on curves so that the turntable does not remain in a level position. Even turntables mounted in gimbals are unsatisfactory as the velocity and magnitude of the "roll" is constantly changing, and in most cases the compensating action of the gimbals is either too fast or too slow to maintain the turntable in a level position. The magnetic wire reproducer which will operate in any position and which is not affected by deviation from its original position is therefore the answer to this problem.

#### Four Hours of Continuous Music

Each of the wire reproducers shown in the illustration has a playing time of two hours. However, by an ingenious automatic switching device, each pair is coupled together so that when the first unit reaches the end of its program, the second one starts, affording a total of four hours continuous playing time. Simultaneously, the other pair of reproducers is providing a different four hour program. This is deemed sufficient for the average trip, say from New York to Chicago, and on longer trips additional magazines may be carried. It is even possible, if the railroad desires, to decouple the units and operate them independently, resulting in four separate two-hour programs.

The radio receiver is a special unit designed specifically for this type of service. Experience in the use of conventional types of radio equipment on trains in the past as well as on the Chicago-San Francisco test run, indicated the need for a receiver with a higher degree of noise suppression and freedom from fading than can be obtained in ordinary types. This was particularly emphasized by the fact that on the Burlington test run, a communications receiver, considered to be the best commercially available, was definitely outperformed in every respect by the special receiver now adopted as standard for the Western Electric Railroad Program Distribution System.

This receiver provides a number of crystal-controlled frequency channels which are tuned to the carriers of pre-selected stations along the route. As the train passes out of the range of a station, the receiver is shifted to the next station within range. The high degree of sensitivity and wide range of automatic volume control afforded in this system go far to eliminate the fading and noisy radio reception experienced on trains in the past.

Several radical innovations in receiver design practice will be noted in this new receiver.

The i-f is approximately 2 megacycles, resulting in the crystal oscillator covering a frequency range of approximately 2540 kc

to 3600 kc, a considerably reduced frequency ratio over that which would be obtained should a conventional 455 kc system be employed. This, in turn, provides better oscillator adjustment and a range of crystal frequencies allowing the use of better, and, incidentally, less expensive crystals.

The 2 megacycle i-f affords extremely high image rejection ratios, and the i-f rejection ratio, which might be an adverse factor, is taken care of by a fixed i-f rejection trap circuit in the r-f portion of the receiver. Furthermore, with the i-f at two megacycles, all i-f and oscillator harmonics are well outside and above the r-f tuning range so that spurious responses from this source are eliminated.

The second detector circuit is of the infinite impedance type, which has better demodulation capabilities than the diode type detector and does not present any loading on the last i-f transformer. The detector output, which is adjusted to be normally in the neighborhood of ten volts, is passed through a volume control, which, by a screwdriver adjustment, is used as a level-setting device.

The antenna circuit is individually and automatically adjusted for each frequency  
(Continued on page 32)

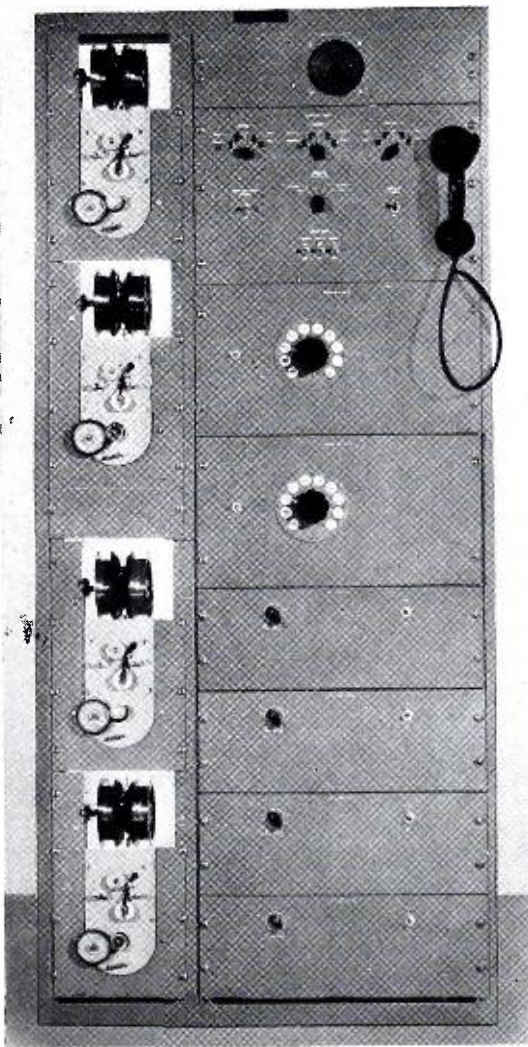

Control panel of Railroad Program Distribution System, showing one type of arrangement having four magnetic wire reproducers and two radio receivers.



High quality loudspeakers which project entertainment programs in the new railroad sound system. Above, eight-inch 755A; below, twelve-inch 728B.

# "How We Put Radios Hilversum and Luxembourg on the Air"

## Some Technical Notes on the Operation of Two European Radio Stations during the War

THIS is the story of two foreign transmitters during wartime, of their equipment and technical performance.

It was in March 1945 that I was assigned to the SHAEF Mission to the Netherlands as Chief Technical Officer. The radio division of this mission was primarily concerned with rehabilitating Dutch broadcasting after the Germans had been driven out. A small section of the country was free, and a 10 kw transmitter was in operation, by the Philips people,\* from their factory in Eindhoven. A sudden push by the Canadian army opened additional territory, and I went forward to inspect the Kootwijk transmitter site.

The towers and buildings were in ruins. The 400 kw longwave transmitter was gutted, and the 200 kw rig a mass of melted copper and ceramics. The Germans had used incendiary bombs, set under the cubicles!

An 'armed truce' to permit the passage of food into the still-occupied portions of

\*N. V. Philips' Gloeilampenfabrieken.

*By Don V. R. Drenner*

KGGF, Coffeyville, Kansas

---

• • The former Chief Technical Officer of the SHAEF Mission to the Netherlands and Chief Engineer of Radio Luxembourg describes some of the technical features of the Hilversum Radio at Ijselstein in the Netherlands which uses the Doherty High Efficiency Circuit and of Radio Luxembourg, one of Europe's most powerful stations. • •

---

Holland found us near Apeldoorn, attempting to get to Lopik where the medium wave transmitters of Radio Hilversum were supposed to be. It was several weeks later that I finally managed to get through to the studios at Hilversum, and the transmitters, which proved to be nowhere near Lopik, but at Ijselstein.

Both transmitters, on 995 and 722 kc,

were intact—the most beautiful transmitters in all of Europe, I think. These were built by Philips, and were Doherty-system linear amplifier transmitters. All stages, except the finals—which were triodes—used pentodes and tetrodes. The photograph shows more adequately than words the physical beauty of these two identical installations. The regrettable thing was that having acquired these high-powered and beautifully-clean transmitters, we were unable to run them. The total power required from the high-lines was in the order of 1000 kw, and there just wasn't enough coal in the whole of Holland to generate that much power at that time. What stocks were left had been carefully allocated for a small ration of lights and emergency power to hospitals, etc.

The operation of these transmitters was identical with that of the high-power Doherty as installed at many 50 kw stations in America. There were, however, several novel features. From the oscillators the entire transmitter chain, up to the final



The original staff of Radio Luxembourg, famous high-powered station carrying the Allied message during the European campaign: l. to r. — J. J. H. Peyser, pro-

gram director; Don V. R. Drenner, chief engineer; William Harlan Hale, chief of station; Irving Berenson, administration officer; Ed Codell, program assistant.



linear amplifiers, was in push-pull. The two transmitters were arranged in a large hall, facing each other. Built in three decks, the power supplies and generators were in the basement, and the main amplifiers on the ground floor. The exciter stages were arranged on the third floor, or deck, accessible by a chromium-plated winding ladder at each end of the main deck. The driver stages of each transmitter were situated in the center, and the subsequent stages radiated in opposite directions to the ends of the deck, thence down to the lower deck where the final amplifiers were located. The grid and plate circuits of the Doherty Linear Amplifiers were arranged behind the final tube cubicles, with complete accessibility for tuning purposes through side doors. A massive console for each transmitter was arranged in front of each, on the main deck, and all metered circuits were duplicated, and a large oscilloscope installed for checking. Built-in 'scopes were in each successive compartment of the lower-power stages. The final amplifiers used water-cooled triodes, mounted on small dollies for quick replacement, and a spare was in place in a separate compartment with switches to the main tank circuit. Radiated power for each transmitter was 125 kw with separate vertical antennae.

The main power supplies were mercury-tank rectifiers—an almost universal type power source in Europe and England—with a single spare high-vacuum power supply, which could be switched to either transmitter in case of failure of the tank system.

Because of the lack of power, only the lower-powered stages were tuned initially, but in conversations with the Dutch engineers I was told that tuning the grid and plate networks of the finals was just as simple and easy as I had experienced with Western Electric Doherty transmitters in the States.

### Radio Luxembourg

The second transmitter of technical interest, it seems to me, is the famous Radio Luxembourg, one of Europe's most powerful stations.

I arrived at the newly captured long wave transmitter of Radio Luxembourg in September of 1944, carrying a raft of studio gear and K rations. This transmitter—a 147 kw job, on 232 kc—had suffered only minor damage: the studios, however, were thoroughly dynamited, illustrative of the Germans' technique. The Luxembourg engineers salvaged four Bell (Belgium) amplifiers, and created a control console from bits of debris. Using two Western Electric 630 and two Western Electric 633 Microphones and a ST&C relic which Metty

*(Continued on page 33)*

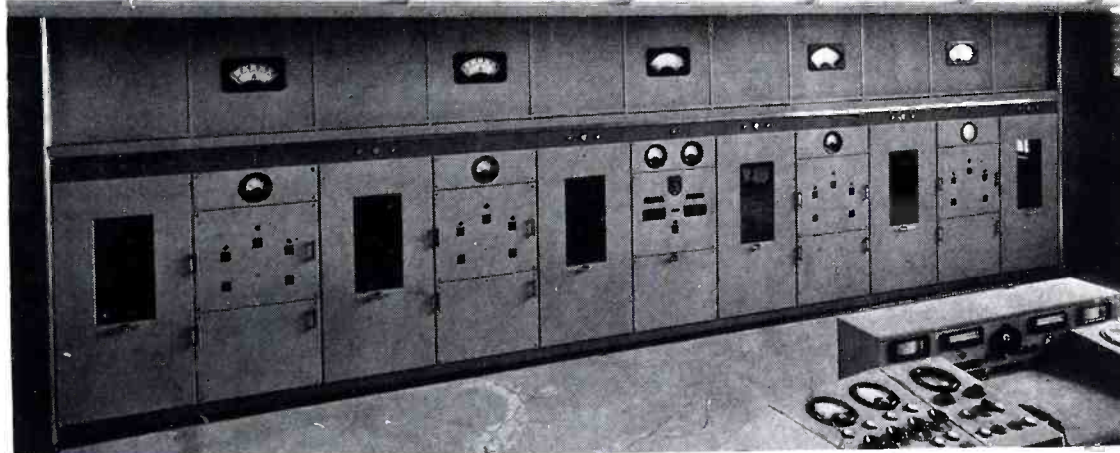
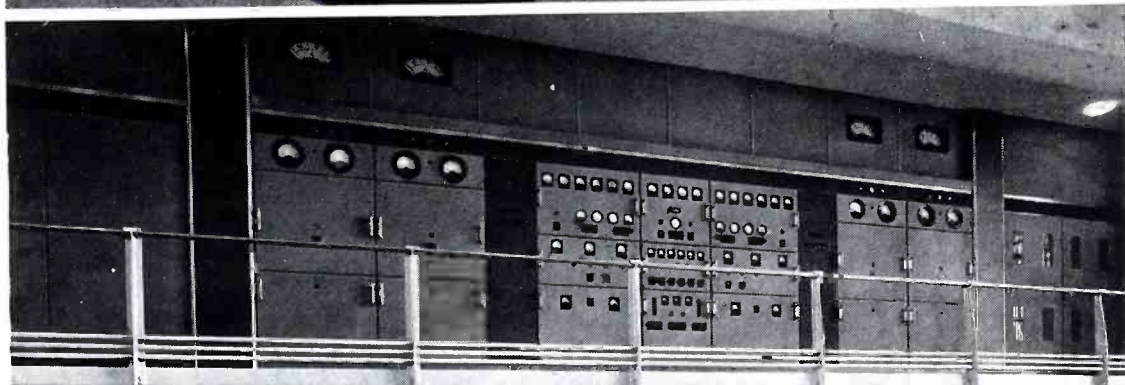
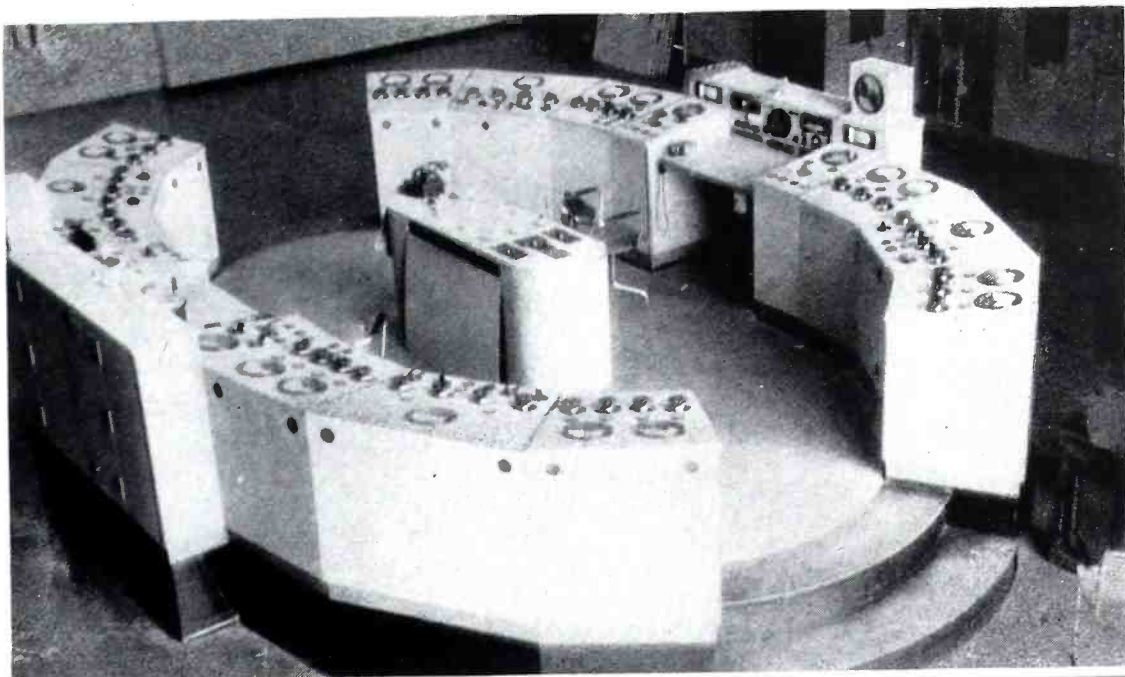

The "most beautiful transmitter in Europe", the double 125 kw station at Hilversum. Top: the two semi-circular control consoles. Above: the driver stages and final amplifiers, with console in lower right corner.



Tuning transmitter at Radio Luxembourg for "Operation Annie", the OSS propaganda program to the Germans. Left, Don V. R. Drenner, chief engineer, and right, Lt. E. A. Rotterman, technical representative.

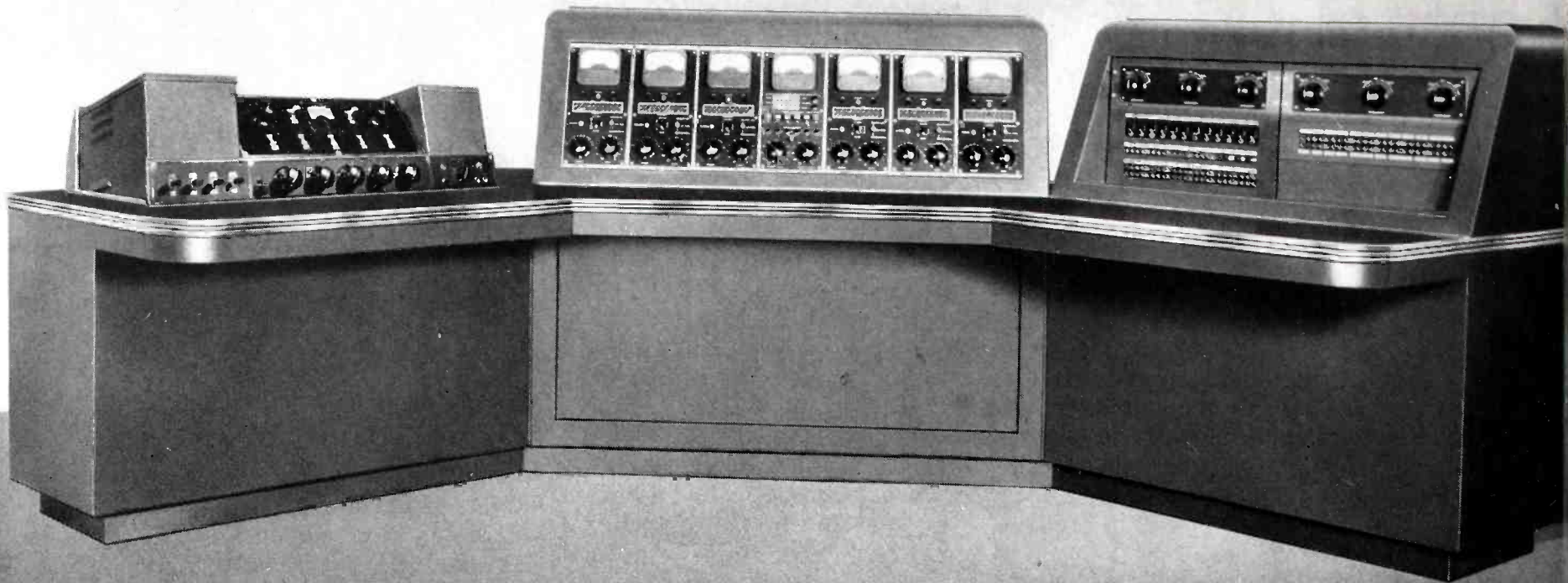

Console for new Master Program Dispatching System at WHDH. In center section is the Relay Type Program Dispatching equipment, composed of a Group Release Unit and six line units. Section at right is an Auxiliary Panel. Left is a Western Electric 23C Speech Input Console, used for the control of Studio 1.

# WHDH Modernizes for Service

## New Relay Type Program Dispatching System Solves Line Switching Problems for Boston Station

*By Harry L. Parker*

INSTALLATION of the Western Electric Relay Type Program Dispatching System at Boston's WHDH emphasizes a significant trend in modern studio arrangement. Six studios, each with its own separate control booth, make possible complete functional coordination between the sales, program, and production departments, without conflicts with the operating schedules. Philip K. Baldwin, WHDH's chief engineer, describes his engineering department as "a service department to a service industry" and explains that the basic objective of all his planning is to provide the other departments of Boston's aggressive independent station with the necessary service and facilities.

Every detail of the new studios, every piece of equipment, and every operating procedure have been planned with this objective in mind and have been justified economically by their value to the successful operation and prestige of the station. The Western Electric Relay Type Program Dispatching System is the focal point of these new facilities and was chosen because it solves the line switching program dispatching problems and makes possible simple, flexible, yet positive operating procedures.

In February 1946, Phil Baldwin joined the staff of WHDH, acquired only a short

time before by Boston's Herald-Traveler Corporation, and was given the job of building and equipping new studios. With plans already underway for an increase in AM power to 50 kw, for FM, and for regional network operation, it was evident that studio facilities should include provisions for quite a bit of expansion within the next few years.

Ably assisted by Hollis Gray, Control and Field Supervisor, Baldwin established studio specifications and procedures to accommodate the proposed operations. With over 20 years' experience in broadcasting, Baldwin was fully aware of the need for more than minimum requirements in order to provide for station expansion. His experience had indicated that when ample facilities are available, they can always be utilized economically.

### A Control Booth for Each Studio

It was first decided that there should be a minimum of four studios, *each with a separate control booth*. With this arrangement, each studio and its associated control booth could function as a separate unit complete in itself. There are enough such separate operating units so that the sales department can let a time buyer audition a show or listen to a recorded program, the production department can schedule

rehearsals, the program department can audition new talent—all without running into schedule "bottlenecks" or interfering with the operating program.

The management of WHDH has the firm belief that these separate studio and control booth facilities help sell time and enable the operating department to cooperate more fully with the other departments. They feel that if local business supports sufficient local program production to require simultaneous use of more than one studio for the functions outlined above, a station should have these separate facilities, and that their value then more than justifies any extra expense incurred in equipping them, especially if the local market is competitive.

A minimum of five outgoing lines was required for normal operations; two to feed the AM transmitter (one spare), one for the FM transmitter, one to feed a toll line for network originations, and one to an outside recording location. In addition to these requirements, plans are underway for cooperative pickups between Boston's several broadcast stations. In this case extra outgoing lines would be needed to feed the stations being serviced.

Now back to the studio arrangement and design for a moment. Approximately 10,000 square feet of open floor space,

with posts every twenty feet, was available for laying out the studios and offices. By ingenious methods, the architects and engineers were able to lay out a suite that met the management's electrical, acoustic, and operational requirements and which is a credit to any broadcast station. In the final plans, provisions were made for six studios, each with a separate control booth. This floor plan showing the offices arranged around the outside window areas and the six studios grouped in the center or "dark" area is shown in Figure 3.

To provide the most flexible and simple operating procedures possible, every detail of the facilities was worked out with care by Chief Engineer Baldwin, Jack Lynch, Graybar's Broadcast Equipment Manager in Boston and H. F. Scarr, Audio Facilities Sales Engineer of the Western Electric Radio Division. It was decided that one of the larger control booths should be equipped to function both as a Master Control and as a control booth for its associated studio.

#### Flexible and Simple in Operation

With the arrangement of six separate control rooms and a minimum of five outgoing lines, the need of a Master Program Dispatching System was evident. However, the usual key or switch type systems did not fit in with WHDH's operating procedures and plans. It was desirable to have a system in which the actual switching operation could be controlled either from the Master Panel or from any selected control booth. It was also necessary to have a system that would indicate positively the sequence of operation of the program following, the point of origin, and the point of control responsibility. The system had to be

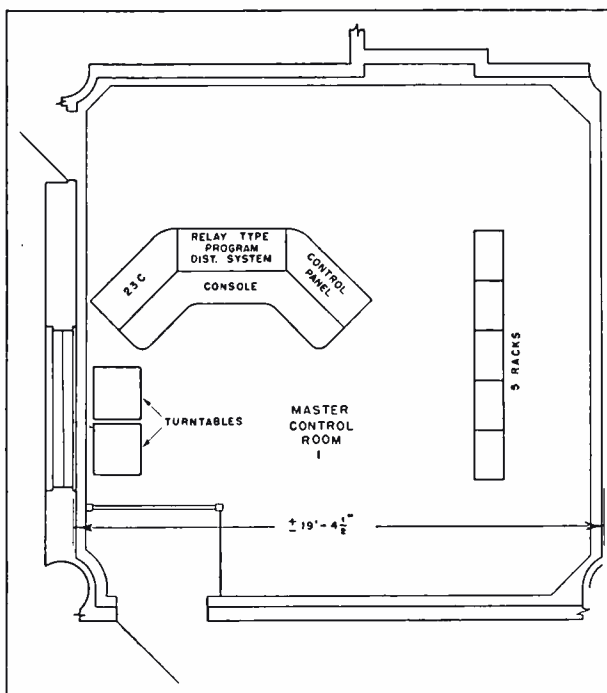

Figure 1 — Plan of Master Control Booth, with the Program Dispatching System in center of console.

flexible, simple in operation and yet eliminate all guesswork.

The new Western Electric Relay Type Program Dispatching System with its many unique features was the answer to WHDH's Master Control Switching problem. This equipment is a new type relay switching system consisting of a Master Control Panel and several Control Signal Indicator Panels, one in each studio control booth. The Master Control Panel includes six line units, one for each of the six outgoing lines, and a Group Release Panel for controlling several lines simultaneously when desired. At all times the Master Control Operator has positive supervision over all operations. However he may preset the system for the next program condition and transfer the actual re-

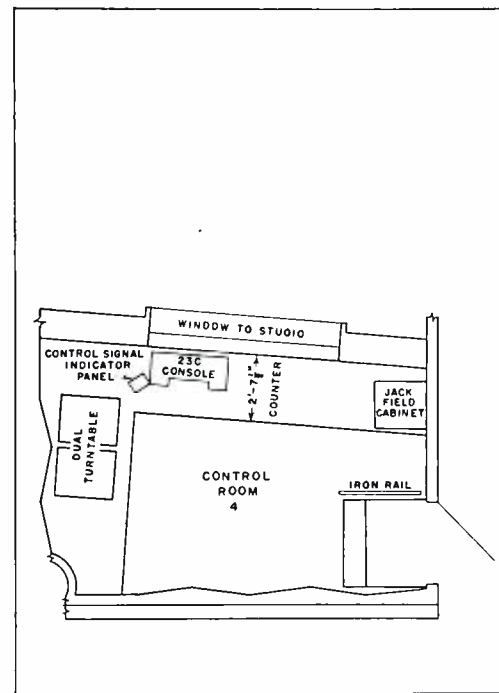

Figure 2 — Control room for Studio 4 is typical, with Control Signal Indicator Panel at console.

lease operation to the control booth on the air at the time. Positive lamp indications on the Master Control Panel and the Control Signal Indicator Panels in the control booths show the exact circuit condition, the preset condition, and the point of release responsibility.

An outstanding feature of this system is that the next operating circuit condition can be set up at any time while a program is on the air. Then at the instant when the program must be switched to the new condition, the actual release or switch is made by the movement of a single key. In addition, this release can be made either by the Master Control Operator or by the operator in the control booth of the studio that has just finished its program, depending on the point of release responsibility design-



Hollis Gray, WHDH Control and Field Supervisor, left, and Philip K. Baldwin, Chief Engineer, study blueprint of their modern and flexible studio layout.

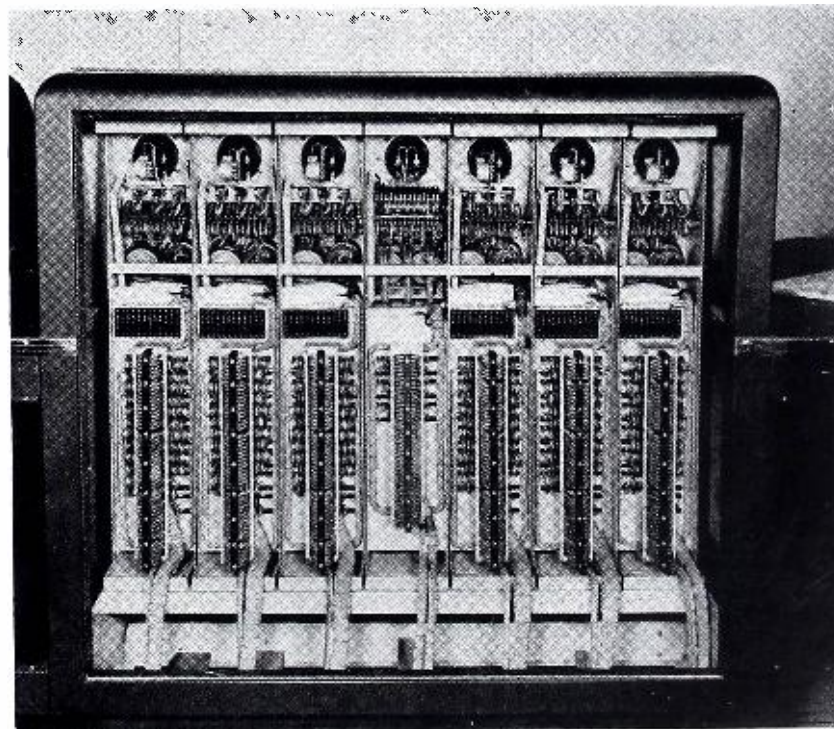

Rear view of the Relay Type Program Dispatching System in the Master Control Booth, with the Group Release Unit in center and six line units at the sides.

nated by the Master Control Operator. Details of the release procedure are given in an article *Program Dispatching Made Easy* in the January 1947 issue of the *OSCILLATOR*.

In the opinion of WHDH, no station other than a network originating center can fully utilize and justify a separate Master Control Booth. Therefore, one of the larger studio control booths has been equipped to function both as Master Con-

trol and as the control booth for its associated studio. While a program is on the air, the operator at the Master Control Panel will preset the next program condition and will transfer the release control to the control booth of the studio then on the air. When the program is over, the Control Booth Operator will release the line to the next program. This arrangement enables the operating work load to be distributed among several technicians, allows

the operator in the Master Control Booth to be free to perform other duties, and makes possible more flexible operations and accurate logging.

Each control booth is equipped with a Western Electric 23C Control Console. This provides complete facilities for the control of program production and monitoring for studio and transcribed programs, as well as for programs originating on incoming lines. Each control booth has a

Figure 3 — Complete floor plan for the new studios at WHDH. Unmarked areas at left and bottom are offices, which are outside rooms with natural lighting. Studios with their control rooms, and service areas are grouped in the center in this efficient and flexible plan. Shaded areas — Master Control Room and Con-

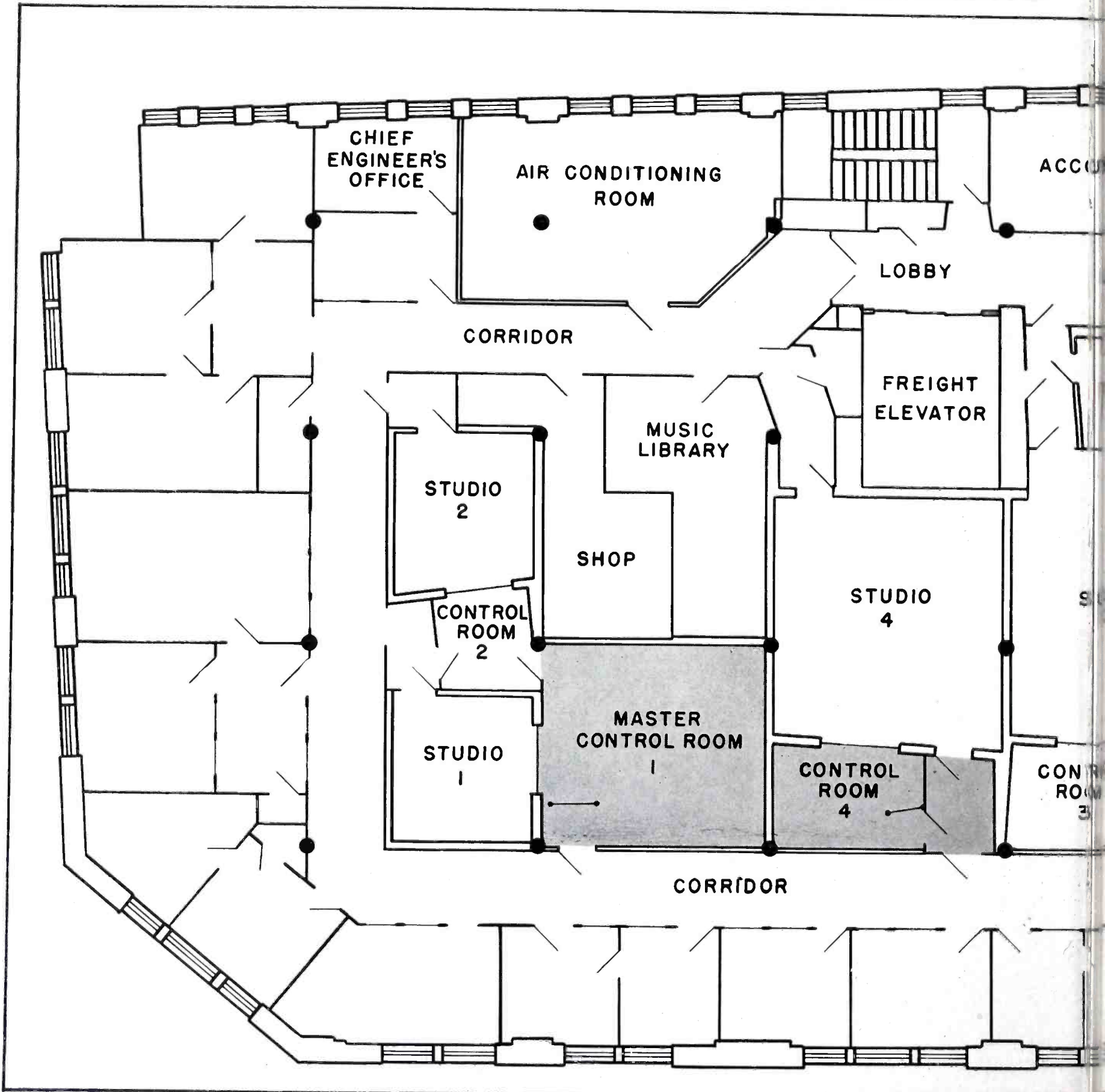

pair of turntables equipped with the Western Electric 109AA Reproducing Groups.

The control booth for Studio 4 is typical. The floor plan (Fig. 2) shows the arrangement of the equipment. This and the other control rooms are roomy and attractive in appearance. In Control Room 4, the turntables are at the control operator's left and are raised approximately three inches to place the record just below

the operator's eye level. This item is an indication of the thoroughness with which all details were designed and planned. The 23C is located directly in front of the studio viewing window, giving the operator complete view of the operating controls and indicators, and the studio action at all times. The studio unit of the Relay Type Program Dispatching System is located in the corner of the desk between the turntables and the console. The jack panel at

the right provides facilities for any emergency condition and is mounted in a cabinet rack built into the wall. Access to this rack for servicing is through the rear door which opens up in the sound lock area.

Each control booth is connected to the Master Control Booth by adequate wiring—including a 26 pair cable. The arrangement of equipment in the Master Control Booth, shown in Figure 1, is different from  
(Continued on page 31)

Control Room 4 — are shown in detail in Figures 1 and 2 on page 27. The Master Control Room serves double duty as the control room for Studio 1, while each of

the other five studios has its individual control room. New Program Dispatching System ties these control rooms with Master Control for switching purposes.

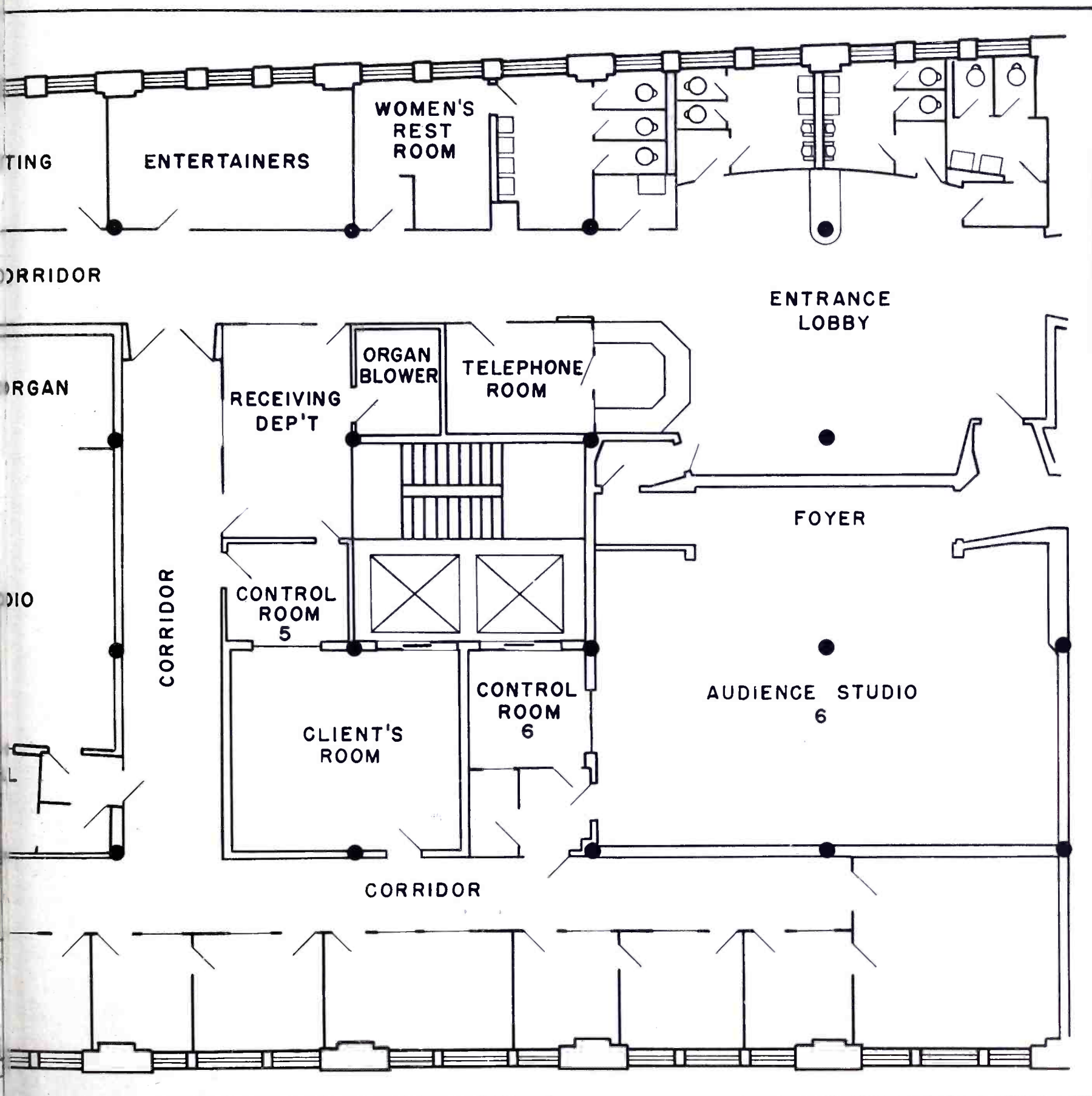

# Announcing New Reproducer Sets

**Electrical speed change and mechanical isolation of turntable are features of 1304A and 1304B Reproducer Sets**

A NEW series of disc reproducing units has been engineered by the Bell Telephone Laboratories to bring the transcription-playing function in broadcast stations, recording studios and wired music installations to the highest level of quality and precision. The two-speed drive mechanism in the new units is a new design from the ground up, perfected to give trouble-free rotation and to bring out the full quality of the finest transcriptions produced. Large bearing surfaces, properly distributed loads, and a carefully designed lubrication system—in accordance with the best power transmission practices—assure long life, a minimum of wear, and the maintenance of excellent operating characteristics over long periods of time under the severe conditions of professional use. Among its advantages are a unique electrical method of changing speed and complete isolation of the turntable from the motor and cabinet.

The 1304A and 1304B Reproducer Sets are complete table-height units of integral design incorporating all of the equipment needed for feeding amplifier systems in the reproduction of transcriptions or disc recordings, at either  $33\frac{1}{3}$  or 78 rpm, and either vertically or laterally cut. They include the new 22A floor cabinet, the new 6A turntable, and a Western Electric Reproducer Group—either the 109AA or the 109B, depending on whether the 9A or 9B Reproducer is desired.

## Advanced Drive Mechanism

The drive mechanism used in the new Reproducer Sets was designed to eliminate "wows" and rumble as an operating problem at either  $33\frac{1}{3}$  or 78 rpm. The turntable is isolated from both the cabinet and the driving mechanism by mechanical filters so that vibrational energy reaching the disc from the motor, from its associated driving mechanism, or from building vibration, is negligible. At either speed the motor is coupled to the turntable with a belt and a one-step helical-gear reduction. This eliminates rubber-tired or rim-drive wheels and the consequent possibility of "flats" or wear in such drives.

Speed change from  $33\frac{1}{3}$  to 78 rpm and vice versa is accomplished without clash gears or planetary ball devices by a new system based on reversing the direction of rotation of the motor. This reversal and the resulting change of speed are accom-



Western Electric's new Reproducer Sets are mounted in the efficient adjustable height cabinet shown above.

plished with an electrical switch, which can be located at any convenient position. The change can safely be made while the turntable is in motion.

Rapid acceleration to stable operating speed is one of the most valuable features of the new drive mechanism, the turntable going from standstill to a constant  $33\frac{1}{3}$  rpm operating speed in *approximately one-half revolution*.

The 22A cabinet has been styled by Henry Dreyfuss, noted industrial designer. This new design is attractive, efficient from the operating point of view and will harmonize with modern studio decoration. The cabinet is adjustable for a turntable height between 29 and 32 inches above the floor—an important advantage which permits its use with various types of control desks.

If a separate floor-standing cabinet is not required, the operating elements are assembled as the 304A and 304B Reproducer Panels which include the turntable platter, motor, drive mechanism, speed-

change and on-off switches, and Reproducer Group with either the 9A or 9B Reproducer. This panel assembly can be installed in any suitable cabinet or shelf.

The principal specifications of the new drive mechanism are as follows:

Record Platter: Standard 16-inch, felt surfaced.

Speed:  $33\frac{1}{3}$  or 78 rpm with electrical switch control.

Average Flutter (Including "wow"); Less than  $\pm 0.1$  per cent at either  $33\frac{1}{3}$  or 78 rpm.

Total playing time variation over 15 minute program at either speed:  $\pm 4.5$  seconds (Speed constant to  $\pm 0.5$  per cent).

Starting acceleration: To full speed in approx.  $\frac{1}{2}$  revolution at  $33\frac{1}{3}$  rpm and  $1\frac{1}{2}$  revolutions at 78 rpm.

Power: 115V ( $\pm 5\%$ ), 60-cycle a-c.

Approx. over-all dimensions: Height—adjustable 29" to 32"; Width— $23\frac{1}{2}$ "; Depth—at top,  $29\frac{3}{4}$ "; at base,  $25\frac{3}{4}$ ".

## **Book Reviews**

**QUARTZ CRYSTALS FOR ELECTRICAL CIRCUITS.** By Raymond A. Heising. 563 pp. New York: D. Van Nostrand Co. \$7.00.

This comprehensive text on the theory, design and manufacture of quartz crystals for use in electrical circuits has been edited by Raymond A. Heising, Radio Research Engineer of Bell Telephone Laboratories. The seventeen chapters were written by engineers of Bell Telephone Laboratories and Western Electric Company who participated in the extensive program of crystal design, development and manufacture completed by these two organizations during the war.

Mr. Heising has contributed an historical introduction of great interest, which describes the discovery of the piezo-electric effect by the Brothers Curie in 1880, and the subsequent development of knowledge about this invaluable property of certain crystals. The part played at the end of World War I by A. M. Nicholson of Bell Laboratories and others in the development of the first crystal oscillators is described.

Of particular interest is the description of the methods used to design the famous FT 241 wire mounted crystal for the Armed Forces.

**FUNDAMENTALS OF INDUSTRIAL ELECTRONIC CIRCUITS.** By Walter Richter. 569 pp. New York: McGraw-Hill Book Company. \$4.50.

The author has produced a book which will be of the greatest value to persons who must design, maintain, or make use of industrial electronic equipment, but who do not possess the complete training of the electronics engineer. The fundamentals of d-c and a-c electric theory are given at the beginning, in a treatment which does not require advanced mathematics, but lays a thorough groundwork for the discussions of electron tube applications which follow. Electron tubes in their various fundamental roles of detectors, amplifiers, oscillators, etc., are fully described including a complete discussion of gaseous tubes, photoelectric tubes, cathode ray tubes, and the auxiliary equipment that operates with them.

The author has the power of clear exposition, and his book is unusual in the extent to which thoroughness and comprehensiveness have been combined with readability. The material has been restricted to general applications, eliminating specific application data and allowing space for the remarkably thorough exposition of the *principles* involved.

## **Miniature Electron Tubes**

(Continued from page 17)

and calcium carbonates. While still on the conveyor, the cathodes are allowed to air dry.

The care with which these cathodes are coated is indicated by the weight test made regularly to be certain that only the correct amount of coating is applied. By weighing the cathodes on a very sensitive scale before and after coating, it is possible to determine whether the rigid requirements are being met. The gain in weight after spraying must be no less than .0010 and no more than .0012 grams—which means that the tolerance for coating weight must be kept within .0002 grams or *seven millionths of an ounce*.

In the spray process, it is necessary to use cylinders of a specially pure dry nitrogen to operate the spray guns, in order to avoid any possibility of injecting moisture and impurities into the spraying mixture.

In assembly operations, the girls are divided into teams, each team consisting of six operators and one inspector. These teams combine the mica insulators, heaters, cathodes, grids, anodes and stems into finished mount structures. The assemblies are then given a visual inspection with the aid of binocular microscopes and are tested electrically for shorts or opens. The mounts then go to a machine which seals them into their glass envelopes and evacuates them. The glass envelopes have previously been imprinted with code numbers and other information by a silk screen process which fuses the letters permanently into the glass.

In every step, precision is the watchword. An example of the extreme accuracy which must be maintained is found in the dimensions controlling element spacing. One of these in particular—the space between the control grid and cathode—must have a nominal measurement of only .0035 inch, about the diameter of one of the hairs from your head!

In producing these tubes in quantity, unusual machines have had to be developed to do complex jobs. Such a machine is one of the special aging racks. Aging amounts essentially to putting each tube through its paces under various carefully controlled conditions designed to give the required stability and uniformity of its electrical characteristics. A typical aging rack consists of a large rotary drum of 37 panels, with 36 sockets for miniature tubes in each panel. Associated with each tube socket are small lamps which act as the load during the aging process. As each of the panels is filled with tubes, the drum slowly revolves and when it has made one complete revolution, the aging process is complete.

Although the individual parts of a min-

ature tube are in themselves small and fragile, the completed tubes are extremely rugged. The short supporting wires between the elements and the stem and the support provided by the top insulator, which is close fitting within the bulb, result in the whole structure being a relatively rigid unit. The small parts making up the structure are very light in weight and therefore exert small forces on their supporting members under conditions of mechanical shock.

## **WKY—Oklahoma City**

(Continued from page 21)

concentrate this radiated energy into the service area. The radiating units are stacked vertically on the tower supplied with the antenna. This tower is only one foot square, and it is composed of an assembly of standardized structural steel welded sections. No tuning of the radiating elements or antenna array is required. The elements are clamped to the tower at half-wavelength intervals at the time of installation. The power gain of the antenna depends upon the number of radiating units.

The eight-unit Clover-leaf with its power gain of 4.7, its true circular azimuth pattern, and its wide vertical beam width, will play an important part in WKY's rapid progress toward providing excellent FM facilities to further its broadcasting services to the large Oklahoma City area.

## **WHDH—Boston**

(Continued from page 29)

that of the other Control Booths. Since this combination control booth and Master is used mainly for recorded programs, turntables are located directly in front of the studio window with the 23C Console at the right. This arrangement makes for additional smoothness of operation for the recorded shows. The Relay Type Program Dispatching Master Control Panel is conveniently located at the operator's right. All line terminations are made in the five racks located at the rear of this Master Control Booth.

Adequate provision is made for accurate timing and positive communication facilities between control booths. A complete system of interphones with selective ringing and selective talking interconnects all control booths. A Western Union Clock in the Master Control Booth provides the standard time reference. Then an Edwards Program Clock System with dual motors provides synchronized time for all clocks located in all studios and control booths.

A recent afternoon's schedule will serve to illustrate a typical operating condition

and will emphasize the need of an adequate master switching system. Two remote football games were being picked up. One game was being fed to the AM transmitter while the other was being routed to a network. At the same time, one of the programs was being fed to the recording facilities at the transmitter. In this case four outgoing lines were being used.

The thorough planning of every detail indicates that the keynote of WHDH is its very forward thinking. However, there are no frills nor is it over-engineered. Every item is justified on a functional and economic basis. The fact that it is top quality and is modern and attractive is a tribute to the thorough job of planning and engineering.

## Alexander Graham Bell

*(Continued from page 14)*

passing through it" to Joseph Henry, Secretary of the Smithsonian Institution in Washington, and Henry encouraged him to work it out further before letting it become public. That year, he was granted a patent on his Harmonic Telegraph.

On June 2, 1875, during the course of his experiments on the harmonic telegraph, the reed on one of the telegraph transmitters stopped vibrating because the contact point had been screwed too tightly against it. Watson began to adjust the screw, while plucking the reed to free it, and at the receiver end Bell heard the sound of the reed's vibrations—"sound-shaped" electric current—and suddenly realized his theory of transmitting speech was practicable. After an hour or so of plucking the reed and listening to the transmitted sound, he gave Watson instructions to make the first "telephone" for transmitting voice sounds. That summer he began writing the specifications for a telephone patent. On February 14, 1876, the application for Bell's first telephone patent was filed. On March 7, the patent was issued, and on March 10, the telephone carried its famous first sentence, "Mr. Watson, come here, I want you!"

These well-known facts of Bell's life do not fully indicate the breadth and scope of his interests or how basic were his contributions to Radiotelephony. The mere enumeration of his experiments and preoccupations throughout his long life will give some indication of the scope of his interests.

In 1881, Bell began work with Sumner Tainter and Chichester A. Bell, a cousin, on wax phonograph recording inventions. These were ultimately successful in improving the reproduction of sound as compared with the metal foil recordings made with Edison's phonograph, invented in

1877. These basic patents for phonograph recording on wax cylinders and discs were sold to an operating company which launched the recording industry as it is known today. He established in 1882 the publication "Science" which later became the official organ of the American Association for the Advancement of Science. He financed the flight experiments of S. P. Langley in 1891. He financed the establishment of the astrophysical observatory of the Smithsonian Institution in that year. He invented an electric probe for which he received an honorary Doctor of Medicine degree from the University of Heidelberg. He even undertook sheep breeding experiments which introduced a more profitable breed of sheep. He worked on experiments on transmitting sound by radiant energy.

Today, Bell Telephone Laboratories, the Nation's largest research center devoted to electrical communications, is the descendant of the small attic on 109 Court Street, Boston, where Bell invented the telephone, and from Bell Laboratories have come many advances vital to Radio, including basic developments in transmitters, vacuum tubes, amplifiers, antennas and speech input equipment.

Alexander Graham Bell may thus be honored not only as the father of the world's vast, present-day telephone system but also as a man whose contributions were of basic importance to the Radio art.

## 54A Directional Array

*(Continued from page 7)*

and secured by its mounting flange to a support plate which could be rotated through 360 degrees in the horizontal plane. This plate, in turn, was mounted on a horizontal axis which provided free movement in a vertical plane. By combining these two movements properly, it was possible to achieve any combination of tilt and horizontal orientation.

In the measurement of field intensities, the flexibility of orientation of the array proved to be a great convenience. Instead of moving the receiving antenna about the array in order to observe the radiation pattern produced, it was convenient to determine the distribution of field intensity in all directions above the earth plane by use of fixed locations for both the array being tested and the receiving antenna. Change of array orientation produced the effect of moving the receiving antenna about the array.

### Typical Patterns

It is not the purpose of this article to predict just what particular field distributions will prove to be most desirable in the future. The two patterns shown here, which are easily obtainable with an array

of two 54A Antennas, are examples of the variety of field distributions which may be secured.

In the event that the transmitter site is chosen near one side of the area to be served, the field distribution of Figure 2 should prove of real benefit in the solution of the problem of adequate service for the desired area and minimum loss of signal strength into areas in which there may be no listeners. The array power gain is 1.4. This array power gain is to be multiplied by the gain of a single element of the array, that is, a single 54A Antenna, in order to determine the gain in the direction for which gain is a maximum. As indicated on Figure 2, the maximum gain is 6.6. It will be noted that the field intensity is considerably greater than that due to a single 54A Antenna over one half-plane adjacent to the antenna site, while considerably reduced in the other half-plane.

Spacing of .325 wavelength between the two antennas in the array and a relative current phasing of 117 degrees are required to produce field distribution shown in Figure 2. The maximum intensity lies along the projection of the axis of the array, and the minimum is in the opposite direction.

In the event that the area to be served is long and narrow, a pattern similar to Figure 1 may be of advantage. The field intensity distribution illustrated in this figure is secured by spacing the antennas .5 wavelength and exciting them in phase. Under these conditions the array power gain in the maximum directions is 2, so that an array comprising two eight-element Clover-Leaf antennas would give a maximum power gain of 9.4.

Deep nulls or minima such as those in Fig. 1 will probably not be required in FM practice since it is not anticipated that protection against interference will be needed. An adjustment could have been made readily to make these minima less pronounced, with only a small reduction in signal intensity in the maximum direction.

## Music While You Ride

*(Continued from page 23)*

merely by turning the single control knob to the next desired station.

To provide smooth, even distribution of high quality sound, the new Western Electric 728B will be used in the coaches and all public spaces on the trains. The 755A (an 8-inch version of the 728B) will be used in private rooms and compartments, thus assuring faithful reproduction of radio, recorded programs and announcements.

While thus far, we have described only the equipment to be used to reproduce the



program, the program itself has by no means been forgotten. Arrangements have been made to enable the railroads to take advantage of the programming and recording services offered by such organizations as the Muzak Corp., World Broadcasting and others, so that no programming or maintenance of a recording staff or equipment will be required by the railroads.

### Relieves Fatigue

As a result of years of research and study on the part of these recording companies, definite conclusions have been reached as to the effect on the listener of various types of music under varying conditions. Consequently, it is possible to select a musical program consisting of compositions which will not only relieve fatigue, but will provide an entertaining background which promotes enjoyment throughout the trip.

The recording companies will dub high quality vertical cut transcriptions onto the wire, so that the finest quality reproduction is realized. By proper placement of speakers operating at low level at numerous locations in public spaces, a sound distribution pattern is effected that is most pleasing to the ear. In private rooms, of course, the passengers may adjust the volume or select programs at will. A pre-established maximum volume setting assures that passengers in adjoining rooms will not be disturbed.

The Budd Company, of Philadelphia, has recently placed an order for eight Western Electric Railroad Program Distribution Systems which are to be installed in eight new streamlined "Zephyrs" now under construction. Six of the trains will be "California Zephyrs" which will operate between Chicago and San Francisco over the tracks of the Burlington, Denver & Rio Grande Western and Western Pacific Railroads. The other two will be "Twin Cities Zephyrs", deluxe streamliners which will be placed on the Burlington run between Chicago and Minneapolis.

"All Aboard!" will signal for tomorrow's travelers, the new, modern way to get from here to there—beautiful, luxurious trains equipped with all that science can muster to make their trip a memorable experience.

## FM Goes to College

(Continued from page 11)

grams and training competent personnel, KTRO, a carrier-current station broadcasting at 660 kilocycles, was established. It operates from the building used and equipped for radio classrooms and has two studios with a central control. Programs

and performance are under the direction of a Student Program Board.

KTRO has a very limited range due to signal depreciation on the power lines but is designed for campus listening only. Programs include a good portion of "swing music," campus activities, and, of course, simultaneous broadcasting of a number of KUSC presentations. This enables the students, many of whom do not have FM receiving sets, to hear some of the fine programs.

A typical KTRO morning schedule includes: "Tommy Trojan's Morning Club," (a wake-up program) "Auntie Bellum Melodies" (popular tunes before 1911), and "Start With a Song."

In addition to its use as a campus station, KTRO also operates as a laboratory for all radio classes. Students in radio writing are assured productions of anything worthwhile created for the class, and if the student has had sufficient training or experience in production, he (or she) may produce his or her own show. The basic radio production class provides producers for this station and the announcing class nominates announcers. Any student in the University may present a program idea to the program board or apply for an audition for KTRO. Outstanding students are invited, on the basis of their performance, to appear on KUSC.

## Hilversum & Luxembourg

(Continued from page 25)

Felten, the Luxembourg Studio Chief, had brought from his home, we had the studios in operating condition in three days.

Nicolas Schmidt, Senior Transmitter Engineer, had been instrumental in convincing the Reichspost supervisory personnel (non-technical) that the proper way to keep the Americans from using the transmitter was to damage the contactor circuits, and destroy the big tubes in the final. Consequently, when Morrie (R. Morris) Pierce went out to give a hand while I worked on the studios, this relatively minor damage was nearly repaired. A set of tubes had been located in a barn near Diekirch, and we were almost ready to go.

The Radio Luxembourg transmitter is based on a system developed by H. Chireix<sup>1</sup> called Outphasing Modulation. This system results in high efficiency with low-power modulators because the entire chain of amplifiers is operated Class C. The transmitter is divided into two parallel chains fed by a balanced modulator, so that the sideband frequencies are shifted 90 degrees and inserted in equal amounts but in opposite phase in the two parallel amplifier systems. The outputs of the two amplifiers

are then combined in the load impedance so that the net input to the load is the vector difference of the outputs of the two amplifiers<sup>2</sup>. A 'scope is essential in tuning this large and complex transmitter.

The angle difference between the two final amplifiers is important, if linearity is to be had, and we evolved a quick method of measuring this angle (135 degrees) by using some a-c theory. After detuning the plate circuits, the current readings of each branch were noted, and the current into the third leg feeding the load taken. By division this gave a figure which was twice the cosine of one-half the angle. The whole thing took a couple of minutes, compared to half an hour's tuning and retuning with a 'scope.

### "Operation Annie"

This transmitter was operated at 90 kw, to conserve the tubes, but later went to the full power. We were concerned with some nice technical legerdemain for an operation by OSS when, after our regular hours as "Radio Luxembourg," we changed frequency from the normal channel of 232 kc to 247 kc and reduced power to 30 kw for "Operation Annie," known to the Germans as "Radio 1212" since the wavelength of the new operation was 1212 meters. This job took place in *half an hour*, no mean accomplishment of frequency changing. One of the OSS sergeant technicians had to run a quarter of a mile out to the antenna tuning house, eluding the transmission line supports and stray trigger-happy American sentries, while various long-range guns, airplanes, and an occasional bomb carried on their part of the war around him! After four hours of this operation, the transmitter was placed back on its original frequency, and we all collapsed for half an hour until the regular day's schedule began.

Although I spent considerable time at the Luxembourg transmitter, and on high-power transmitters in Germany, I would have traded them all for the Doherty's at Ijsselstein. My biggest regret is that because of the shortage of power I wasn't able to fire up those 125 kw finals there!

1. H. Chireix, High Power Outphasing Modulation, *Proc. I.R.E.*, Vol. 23, p. 1370, Nov. 1935.

2. Terman, *Engineers' Handbook*, p. 546.

## Correction in Article Liveness in Broadcasting

In the article, "Liveness in Broadcasting" Figure 4, page 7 of the January 1947 issue of the *Oscillator*, Reverberation Time in Seconds on the graph should read: .4, .6, .8, 1.0, 2.0 and 3.0.

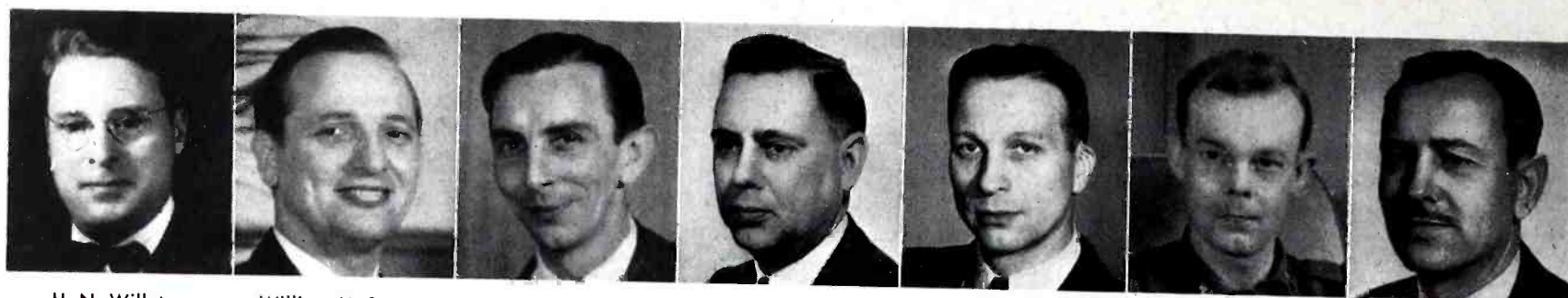

H. N. Willets

William H. Sener

Carson Donaldson

N. C. Olmstead

Frank Nickel

Don V. R. Drenner

H. R. Whaley

## Contributors to This Issue

**H. N. WILLETS**, author of *"Mobile Service Operator, Please!"* (page 4), joined the Company in 1917 in what was then the Western Electric laboratories on West Street. After serving with the Army Air Corps in World War I, he was appointed as the engineering representative at the newly organized Philadelphia Instrument Shop. The first Western Electric broadcast equipments were made in this shop. In 1924, he came to New York to take charge of sales of high voltage power line equipment and public address systems for the Western Electric Supply Department. In 1928, his position was head of the Radio Broadcast Sales Group with the General Commercial Engineering Department, and shortly thereafter, head of the Aviation Sales Engineering Department. He went to Kearny in 1939 as Assistant Sales Manager of the Specialty Products Group, and was appointed Manager of Commercial Sales when the Radio Sales Division was formed in 1941. The organization of the Radio Division in 1942 brought Mr. Willets back to New York as Manager, Commercial Radio Contract Service. In 1945 he was appointed Manager of Radio Telephone Sales of the Radio Division, in charge of Bell System requirements in the new fields of Highway, Urban, Microwave, Power-Line Carrier and Rural Radio, as well as the Trans-Oceanic single sideband and point-to-point systems.

**WILLIAM H. SENER**, co-author of *FM Goes to College at U.S.C.* (page 8), has a long background of experience in radio and education. He has been Production Director of the Chicago Radio Council; Program Director at the University of Minnesota broadcast station WLB (now KUOM); and Program Director at WSUI, University of Iowa. During the war he served in the Army Air Forces. He went to the University of Southern California in July 1946 to establish and direct the newly organized Radio Department.

**CARSON DONALDSON**, co-author of *FM Goes to College at U.S.C.*, has been

associated with Captain Allan Hancock, in various engineering capacities with the Hancock Foundation, for twelve years. He traveled with Captain Hancock on his 1939 Pacific Expedition, and during the war was an electronics instructor in U. S. Army schools. He has been the recording and sound engineer for the Hancock Ensemble, and has been Chief Engineer for Station KUSC since its inception.

**N. C. OLMSTEAD**, author of *New Arc-Back Indicator* (page 12), received a B.S. in Electrical Engineering at M.I.T. in 1928 and M.S. in 1929. He worked as a research assistant on radio transmission problems at the M.I.T. Round Hill Laboratory, and in 1930 joined the A.T.&T. Department of Development and Research, to work on radio transmission and frequency allocation for radio telephone circuits. In 1934 he transferred to the Commercial Products Department of Bell Labs to work on Western Electric broadcast transmitter development. During the war his assignment was radar bombing computers. At the end of the war he returned to broadcast development work, with responsibility for power equipment and control circuits in all Western Electric broadcast transmitters. He is the author of an article for *Pick-Ups* on the control circuits in Western Electric 50-kw transmitters and was co-author with A. A. Skene of a paper in the *Proceedings of the I.R.E.* describing the grounded plate amplifier in the pre-war 10-kw FM transmitter.

**FRANK NICKEL**, author of *Music While You Ride* (page 22), was issued one of the first amateur licenses after the first World War, with the call 3GF. He was a wireless operator in the Merchant Marine, and then, from 1922 to 1929, shared in many of the broadcasting firsts at station WIP in Philadelphia, starting as engineer and rising to chief engineer of this pioneer station. From 1929 to 1936 he was in theatre engineering with ERPI, becoming interested in program distribution while with that organization. He became chief

engineer of the Muzak Corporation when that firm took over the ERP accounts in the wired music field. In 1942 he returned to Western Electric. He is now Program Distribution Sales Engineer of the Radio Division.

**DON V. R. DRENNER**, author of *"We Put Radios Hilversum and Luxembourg on the Air"* (page 24), entered radio via the "ham" route in 1928. In 1941 he left a transmitter engineer job at KGGF, Coffeyville, Kansas, to enlist in the RAF, and served in England first as radar engineer for the RAF and later as engineer with BBC. In March 1943 he was made Chief Engineer of the American Forces Network. Thereafter, he was Chief Engineer for "ABSIE" for construction; Chief Engineer, Radio Luxembourg; erected 2 kw mobile at Cherbourg; erected 2 kw mobile for Dutch at Meppel, Holland; took over Radio Hilversum; worked on 200 kw station at Cologne; erected 20 kw mobile at Frankfurt. He returned to the United States in October 1945, and resumed his job as transmitter engineer at KGGF, which he characterizes as "fine station, small town—suits me fine."

**H. R. WHALEY**, author of *Directional Patterns with 54A Array* (page 7), is a broadcast engineer in Western Electric's Radio Division. After three years in Physics at U. C. L. A. and a year in Electrical Engineering at U. of C., he served as Aircraft Radio Engineer for Pan American Airway's Treasure Island Base. He entered broadcasting as transmitter engineer for Associated Broadcasters, Inc., San Francisco. Later he was an engineer in the Hollywood laboratory of the Don Lee Broadcasting System. He joined Western Electric as a Field Engineer on Navy fire-control radar. At war's end he transferred to the Broadcast Engineering Department. During the past year he has worked with Bell Laboratories engineers on FM antenna and transmission line problems. He wrote *New High Frequency Bridge* for the October, 1946 *Oscillator*.

**New FM BROADCAST TRANSMITTERS**

by **Western Electric**

**PHASE MONITOR**  
2A  
Facilitates the adjustment of directional antenna arrays

Western Electric EQUIPPED FOR BETTER BROADCASTING

**25B SPEECH INPUT EQUIPMENT**

**Western Electric**

**443A-1 TRANSMITTER**  
DEPENDABILITY  
RELIABILITY

**Western Electric**  
BROADCASTING EQUIPMENT  
1000 WATTS AM  
— QUALITY COUNTS —

**Western Electric**  
**ELECTRON TUBES**

DESIGNED BY BELL TELEPHONE LABORATORIES

**Designed for FM!**

INTRODUCING

**Western Electric FM Transmitting Triodes**  
TYPE 5530 3 KW    TYPE 5541 10 KW

Designed by BELL TELEPHONE LABORATORIES

**238 TYPE MOBILE RADIO TELEPHONE**  
FOR URBAN USE

FROM LAND STATION TO AIR FROM SHIP  
INTERCONNECTION WITH TELEPHONE SYSTEM  
FROM FIXED STATION TO MOVING CAR

**Western Electric**

**Western Electric Presents**

**A NEW IDEA IN MARINE RADIOTELEPHONE EQUIPMENT**

**Western Electric Presents RAILROAD RADIO TELEPHONE COMMUNICATIONS**

**Time is Money! RAILROAD RADIO SAVES TIME**

**Music WHILE YOU RIDE...**  
with the **Western Electric PROGRAM DISTRIBUTION EQUIPMENT**

**Western Electric NOISE ANALYZERS**

for Noise Measurements and Analysis in  
FACTORIES • AIRCRAFT TRAINS •  
Acoustic testing and inspection of products for quality control

**Western Electric FASTAX**  
HIGH SPEED MOTION PICTURE CAMERA

**NEW BOOKLETS** . . . issued recently by Western Electric describing broadcasting equipment, electron tubes, mobile radiotelephones, program distribution systems for railroads, acoustic instruments and other products . . . include the following:

- |                                     |   |  |
|-------------------------------------|---|--|
| T2266—New FM Broadcast Transmitters | T2287—FM Transmitting Triodes                       | T2306—Railroad Radiotelephone Communications |
| T2257—2A Phase Monitor              | T2315—238 Type Mobile Radiotelephone for Urban Use  | T2321—Railroad Program Distribution          |
| T2265—25B Speech Input Equipment    | T2311—A New Idea in Marine Radiotelephone Equipment | T2260—Noise Analyzers                        |
| T2272—1 KW 443A-1 Transmitter       |   | T2314—Fastax High Speed Camera               |
| T2258—Electron Tube Data Booklet    |   |  |

Copies of these and other Western Electric booklets may be obtained from your local Graybar Representative or by writing to Graybar Electric Co., 420 Lexington Ave., New York 17, N. Y.

# Blueprint for highest quality FM Broadcasting



Pick up your live programs and start them on their way with highest quality. Choose Western Electric's 639 type Cardioid Microphone—adjustable to meet your every program requirement.



Get the most out of all types of transcriptions and records. Use Western's 109 Type Reproducer Group available with 9A Reproducer having diamond stylus tip, or 9B Reproducer with sapphire tip.

Monitor and audition your programs with the new 728B speaker—a faithful, high quality, single direct radiator. For the widest frequency range, you'll want Western Electric's new two-unit loudspeaker system.

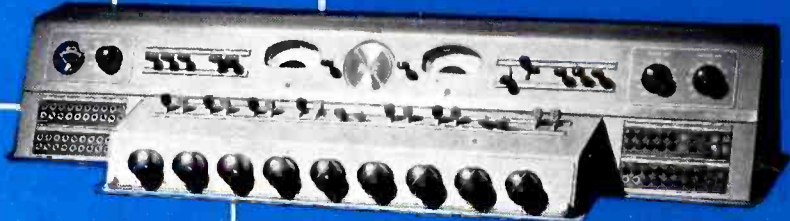

For simultaneous control of two programs, the attractive, high quality Western Electric 25B Console provides two main channels at moderate cost. For economical single channel studio control, use the 23C Audio equipment. Special Custom Built Control Consoles and Dispatching Systems are also available to meet "individualized" production and programming requirements.

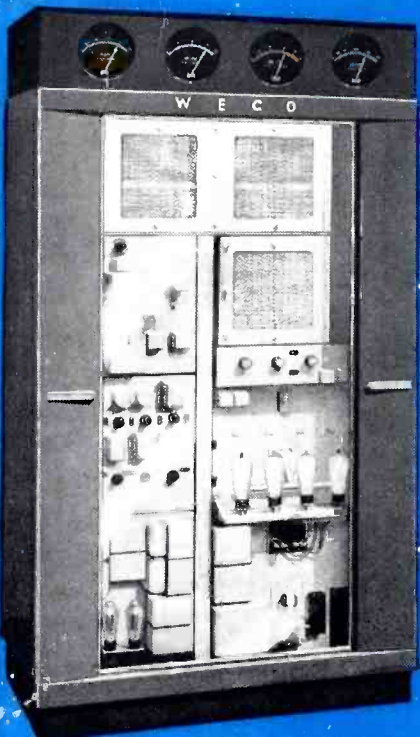

Operate at maximum level, yet preclude the possibility of program distortion in your listeners' receivers by automatically eliminating transmitter over-swing with the 1126C Program Operated Level Governing Amplifier.



For the "heart" of your station, get outstanding performance with one of Western's beautifully designed "Transview". Synchronized FM Transmitters. In addition to the 1 kw shown, the line includes 250 watt, 3 kw, 10 kw, 25 kw and 50 kw powers.



Put your program "on the air" with the easily erected high gain 54A Clover-Leaf Antenna. This highly efficient broad band antenna provides full 50 kw capacity.

Give your listeners the quality they expect from FM—choose Western Electric equipment from microphone to antenna. Every item has been designed by Bell Telephone Laboratories to meet fully FM's rigid requirements and to give the broadcaster more than his money's worth in performance, dependability and low cost of operation.

For particulars, see your nearest Graybar Broadcast Representative, or write to Graybar Electric Co., 420 Lexington Ave., New York 17, N. Y.



# Western Electric

— QUALITY COUNTS —