

# NRI

June/July 1962

# news

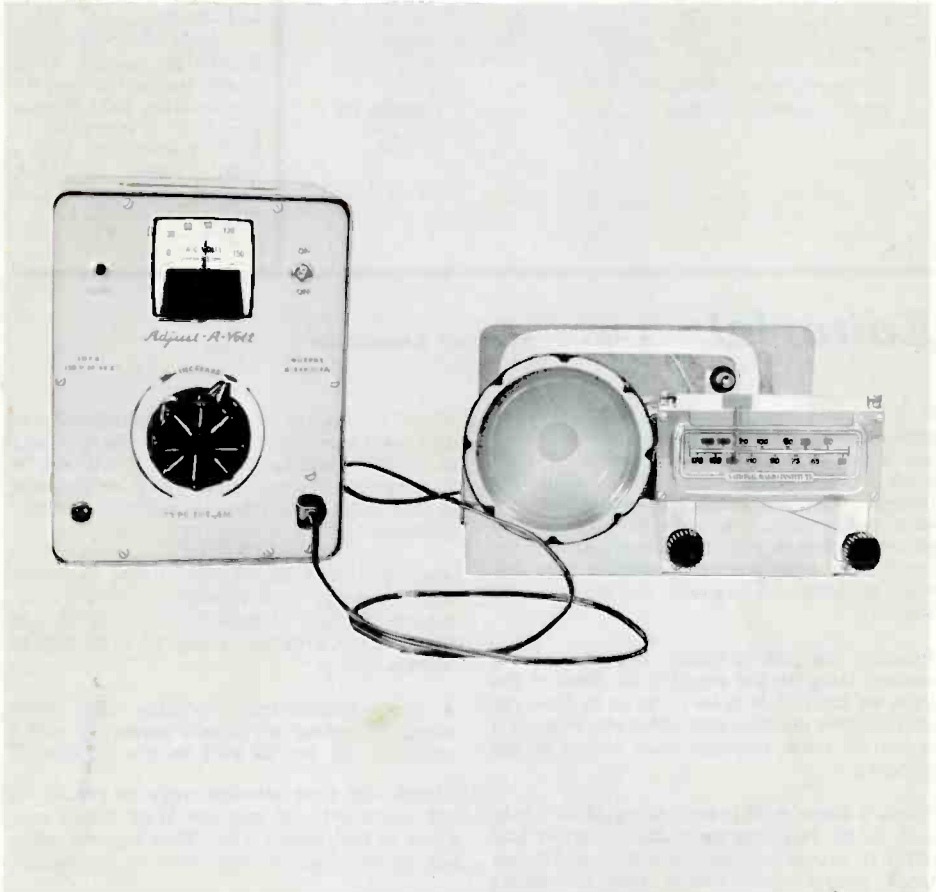

**USING AN ADJUST-A-VOLT TO CHECK INTERMITTENT OPERATION  
AT LOW LINE VOLTAGE**

---

**ALSO IN THIS ISSUE**

**BASIC ELECTRICAL MEASUREMENTS**

**KIRCHHOFF'S LAWS AND BASIC APPLICATIONS**

## Contents

SERVICING WITH THE ADJUST-A-VOLT  
ISOLATED VARIABLE TRANSFORMER ..... PAGE 1

BASIC ELECTRICAL MEASUREMENTS ..... PAGE 6

KIRCHHOFF'S LAWS AND  
BASIC APPLICATIONS ..... PAGE 20

T. E. Rose  
*Editor*  
J. B. Straughn  
*Technical Editor*  
T. A. Ferraro  
J. A. Jordan  
*Publication Editors*  
L. L. Menne  
*Editor Emeritus*

Published every other month by the National Radio Institute, 3939 Wisconsin Ave., Washington 16, D. C. Subscription \$1.00 a year. Printed in U.S.A. Second class postage paid at Washington, D. C.

## Editorial: A PRAISEWORTHY AMBITION

If you can't say something good about a person, keep silent. Even when a person asks you outright to criticize, be careful. People often fish for compliments and praise in this indirect way, and criticism is definitely not what they want. It's your job then to find something which you can honestly praise. Be frank only when you're absolutely sure that your technical or personal opinion is really wanted.

Pointing out the mistakes of others is the easiest thing in the world to do. Most of the time we don't do it to be mean or to show the other fellow up. Speaking of the other fellow's faults is more common than telling of his virtues.

There's some good in everything, if we'll only look for it. Praising the good, no matter how little it be, will make you a thousand times more popular with people than criticizing even the most serious and glaring faults of others.

All of us have a perfectly normal tendency to look out for Number One. We like others, to be sure, but we like ourselves better. We wish other people lots of luck, but we ourselves would like to be well up in line when that luck is being passed out.

All of us neglect wonderful opportunities to do a good turn for Number Two. We tend only to do that good turn at times it will not be inconvenient to us. This isn't selfishness necessarily. More often it is simply thoughtlessness.

When you have the chance, listen to others with sympathy - not boredom. Discover convenient excuses to praise people. Be nice to somebody you haven't bothered to be nice to before.

A multi-millionaire executive used these words to praise a Pullman porter, "I wish I could do my job as well as you do yours!"

There are even sincere ways to praise an old radio set: "It was one of the finest sets made in that period," or "That highboy cabinet is certainly a fine piece of furniture."

You'll get quite a kick out of such adventure. And in handing out praise you will find that you have accomplished something rather extraordinary for yourself.

J. M. Smith  
President

# Servicing With The Adjust-A-Volt Isolated Variable Transformer

By

Art Widmann

**Technical Editor**

The use of a variable supply voltage has long been recognized as a valuable service aid. Likewise an isolated transformer placed between the supply line and any ac-dc equipment under test is a good safety precaution. These two desirable features are combined in a single unit called the ADJUST-A-VOLT isolated variable transformer.

As shown in Fig. 1 the unit is housed in a rugged metal case. The 0-150 volt ac meter on the front panel indicates the output voltage selected by rotating the control knob. The output voltage is taken from a convenience outlet located in the lower right-hand corner. The on-off switch controls the line voltage input to the instrument. A red indicator lights when the switch is on. The RESET button in the upper left-hand corner resets the thermal overload device. This overload will trip and de-energize the instrument if excess current is drawn from the unit. The unit is rated at 4 amps continuous duty but it will withstand large overloads for short periods of time.

For maximum personal safety, the line cord terminates in a standard three-prong grounding plug. The ground prong connects to the case of the unit preventing any possibility of getting a shock from the case. Also, the generous use of high-grade insulating material makes it very unlikely that a short would ever occur between the case and the internal circuit. Another reason that the case is grounded is to provide maximum shielding between the transformer of the unit and any nearby sensitive equipment that might be affected by a magnetic field.

Fig. 2 shows a schematic of the ADJUST-A-VOLT isolated variable transformer. The transformer has two insulated windings on a toroidal core of laminated silicon steel. The schematic diagram shows that the secondary output winding is completely isolated from the primary. The output winding has a bared plated commutator track that exposes each

turn of the coil. A carbon brush rides in contact with the commutator track. Thus, as the brush is rotated, it picks off the available voltage from any selected turn of the secondary winding. Since the secondary winding has more turns than the primary, the upper turns on the secondary provide a step-up turns ratio. In this way the output voltage can be varied from 0 to 140 volts.

## OVERVOLTING AND UNDERVOLTING

One of the most reliable methods of quickly determining if a repaired piece of equipment will hold up in use is to operate it with a supply voltage in excess of the normal voltage. This procedure, often called "overvolting" puts a strain on the parts within the circuit. Any part that is weak or ready to break down will fail during overvolting. For example, if you apply 130 volts instead of 115 volts to a repaired TV set, all the voltages in the set will increase proportionately. The sweeps will overdrive both vertically



FIG. 1. The Adjust-A-Volt isolated variable transformer.

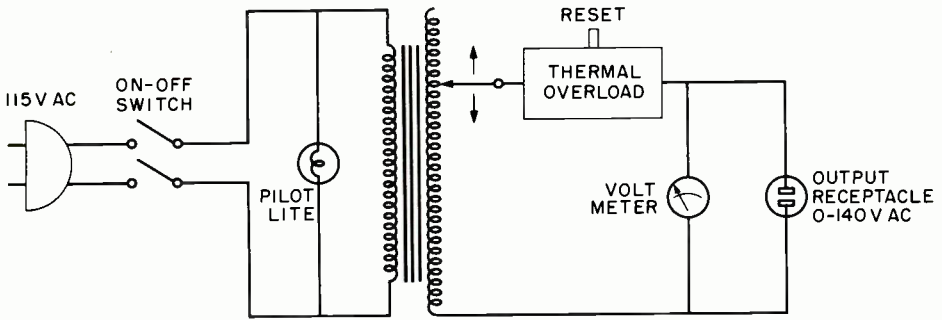

FIG. 2. Schematic diagram of the Adjust-A-Volt isolated variable transformer.

and horizontally and the set will produce excess B+ and high voltage. This means that every component in the circuit is operating at a voltage in excess of its normal voltage. Since all components are conservatively rated, a good component will not be damaged by this excess voltage. However, any component with a marginal defect will probably break down quickly under the excess voltage. Any component that does break down during overvolting would not last very long in normal service. Overvolting is particularly effective in showing up weak capacitors and components with faulty insulation. If a set operates for half an hour or so at 130 volts, it's a pretty good bet that it will give good service for a long time when operated on the normal supply voltage. Overvolting a repaired TV set is good insurance against costly callbacks.

One of the most useful features of a variable supply voltage is for determining the permissible variation in line voltage over which a piece of equipment will work. In many areas the line voltage will vary an appreciable amount at different times of the day or evening. It's disappointing and costly to deliver a TV set that is working perfectly in the afternoon only to have the picture shrink and show black on the edges that evening. How is the technician to know that at this customer's house the line voltage drops each evening? And, if he knows it is going to drop, what can he do about it? You will soon learn to know what line voltage fluctuation to expect in your service area. By using a variable supply you can quickly check the set operation at the low voltage value before it leaves the shop.

Intermittent defects in a piece of electronic equipment can often be located by overvolting the circuit. The excess voltage may break down the defective part completely or cause the defect to occur at more frequent intervals. In either case it will enable you to locate the defect quicker than waiting for the intermit-

tent to recur.

The use of a lower-than-normal supply voltage is a standard check of the local oscillator in a radio receiver. If the efficiency of the local oscillator circuit is below normal, a low supply voltage will cause it to stop oscillating. The low efficiency may be due to a weak tube or to losses in the circuit. For example, an oscillator coil with a low Q will cause energy losses in the circuit. These losses cause the oscillator signal amplitude to decrease or the oscillator may quit. After an oscillator circuit has been repaired, a good final check is to see if it will continue to oscillate with a lowered supply voltage. If it does, you can be pretty sure that the circuit is in good shape.

#### TV ALIGNMENT AID

The radiated signals from the horizontal and vertical sweep circuits in a TV receiver often interfere with the scope presentation of a TV alignment curve. You can disable the sweep circuits and eliminate the interference by removing the horizontal and vertical output tubes. However, when you disable the sweep circuits, you will usually discover that the B+ voltage has increased considerably because of the reduced load on the power supply. This change in B+ voltage will cause a large change in the response of the i-f amplifier. You can get the correct B+ voltage by using the ADJUST-A-VOLT variable transformer to supply the ac voltage to the TV low voltage power supply. Fig. 3 shows the necessary circuit connections to a typical TV power supply circuit.

To make the circuit setup shown in Fig. 3, first disconnect one lead of the high voltage winding of the power transformer. This lead is easily located because it usually connects to the fusible surge resistor in the power supply. Either tape the end of the disconnected transformer lead or position it where it cannot touch anything because it will have volt-

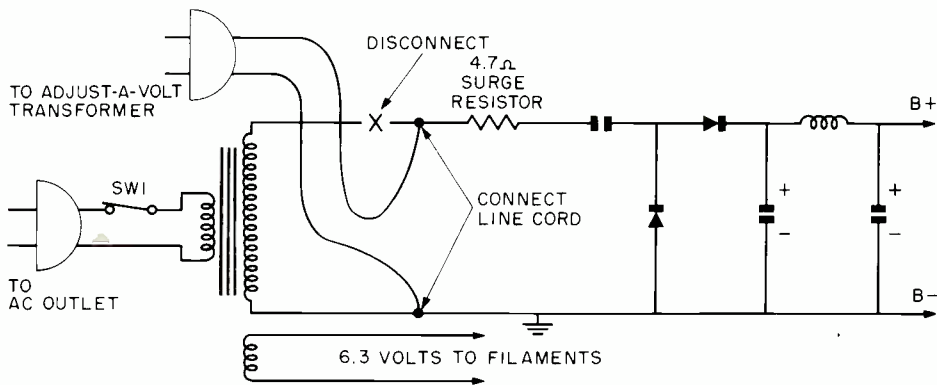

FIG. 3. Partial schematic of a typical TV low voltage power supply showing connections for varying the B+ supply voltage.

age on it when the set is energized.

Now connect one wire of a line cord to B- and the other wire of the line cord to the free end of the surge resistor. Plug this line cord into the outlet on the ADJUST-A-VOLT transformer. Next, plug the TV set into a 115 volt bench outlet and turn on the TV on-off switch. This energizes the filaments with the correct voltage through the 6.3 volt winding of the power transformer. Connect a dc voltmeter between B+ and B- on the TV set and turn on the ADJUST-A-VOLT transformer. Rotate the control on the ADJUST-A-VOLT transformer while observing the dc meter that you connected to the power supply. Bring the B+ voltage up to its normal value or use the value listed in the alignment instructions for the set that you are aligning. Better results will be obtained by using the B+ values given in the alignment instructions because that voltage was used when they obtained the curve shown in the alignment instructions. The scope's presentation will now be free from sweep interference and you can proceed with the alignment.

#### VARIABLE DC POWER SUPPLY

A source of variable dc power is a convenient aid in servicing. Low voltage units with a maximum voltage of about 20 volts are available at a reasonable cost for servicing transistor radios and supplying bias voltages. However, as these units go up in voltage and current ratings, the price becomes appreciable. You will find numerous instruction articles in electronics magazines for building dc power supplies. These supplies usually call for a voltage divider network with voltage taps and/or switching arrangements that provide several convenient values of dc voltage. The voltage divider network must

use high wattage resistors if the unit supplies appreciable current. If the unit provides an adjustable dc supply, it usually uses a relatively expensive, high-wattage, wire-wound potentiometer. All of these disadvantages can be overcome by constructing a simple rectifier and powering it from the ADJUST-A-VOLT variable transformer.

Fig. 4 shows a sample arrangement that will produce a variable dc supply from 0 to 175 volts dc. The variable ac output from the ADJUST-A-VOLT transformer is rectified by the selenium rectifier producing a pulsating dc voltage. The pulsating dc is filtered by the capacitor input filter producing a smooth dc output. The dc output voltage is adjusted to any desired value from 0 to 175 volts by simply rotating the control on the ADJUST-A-VOLT transformer. The amount of dc current that you can draw from this supply is limited by the current rating of the selenium rectifier. If you use seleniums rated for very high current, the maximum dc current will be limited by the current rating of the choke or when you draw 4 amps ac from the ADJUST-A-VOLT transformer.

With small additions to the circuit in Fig. 4, you can construct a dc power supply that will

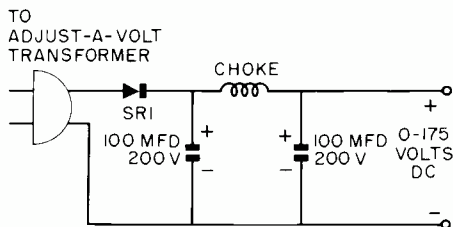

FIG. 4. Half-wave rectifier for producing variable dc supply voltage.

produce variable dc from 0 to over 350 volts dc. Fig. 5 shows the voltage doubler circuit that is used to get a higher output voltage. Silicon diodes may be used instead of the selenium rectifiers indicated for SR1 and SR2. The silicon units have a very low forward resistance and are physically small for their current rating.

You will notice that no surge resistor is shown in the ac supply for either the half-wave rectifier circuit or the voltage doubler circuit. The surge resistor is not necessary if you always start the variable supply voltage at zero and bring it up to the operating voltage. You will probably have occasion to switch the supply off and on without changing the ADJUST-A-VOLT setting. Therefore, it is best to include a 4 to 8-ohm surge resistor like the one used in the power supply of a TV circuit.

The power supply circuits, shown in Figs. 4 and 5, are completely isolated from the ac line because of the isolation in the ADJUST-A-VOLT transformer. Therefore, you can use the dc output voltage for either a negative or a positive supply. That is, you can connect either the positive or the negative terminal of the dc supply to the chassis of the equipment you are working on.

Either the half-wave rectifier or the voltage doubler circuit can be easily mounted on a 4" x 5" metal chassis. When permanently wired in this manner, the circuit makes a fine addition to your test equipment.

The two photos in Fig. 6 show the top and bottom views of a power supply constructed by the author. I built this unit at home from on-hand parts so some of the parts are non-standard. For example, I insulated the filter can with plastic tape instead of procuring a cardboard-covered can. The chassis is a hammer-and-hand job using .05" aluminum. No part of the electrical circuit connects to the chassis -- the chassis serves simply to hold the insulated parts in place. The negative and positive output terminals are insulated pin jacks although banana jacks or

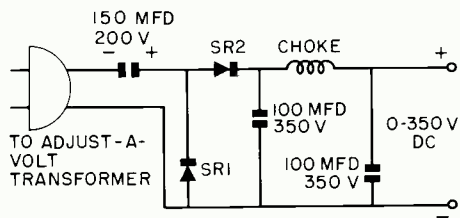

FIG. 5. Voltage doubler circuit used to produce a large variable dc supply voltage.

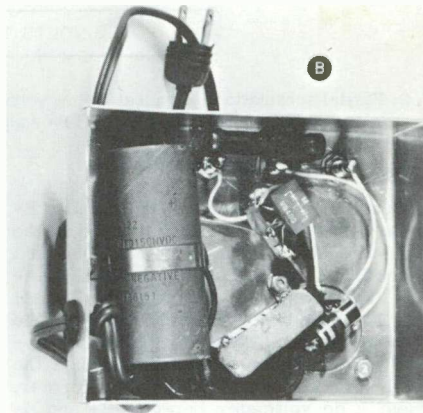
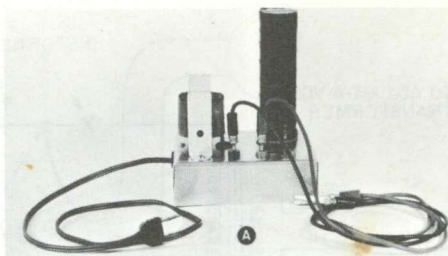

FIG. 6. The variable dc supply constructed by the author for use with the Adjust-A-Volt transformer. Top view (A) and bottom view (B).

screw-type terminals would serve just as well. The output leads are terminated in alligator clips for easy connection to the circuit being supplied. Nothing is critical in the parts layout.

Fig. 7 shows the schematic for the unit pictured in Fig. 6. Several components have been added to the basic circuit. Capacitor C2 is a .01-mfd, 500-volt disc capacitor. It is used to suppress high frequency transients that sometimes develop at the silicon rectifier. Resistor R2 is a bleeder resistor that puts a constant minimum drain on the power supply. This improves the power supply regulation and prevents the filter capacitors from holding a charge after the supply is turned off. Resistor R3 and capacitor C3C were added to provide an output with an additional filtering. The ripple voltage at terminal 1, under load, measured less than 5%. At terminal 2, the ripple was estimated at less than 1%. I operated a 9-volt transistor radio from terminal 1 and the ripple was not perceptible in the receiver output. Here's a list of the parts:

R1 4.7-ohm fusible resistor

FIG. 7. Schematic diagram of the dc supply shown in Fig. 6.

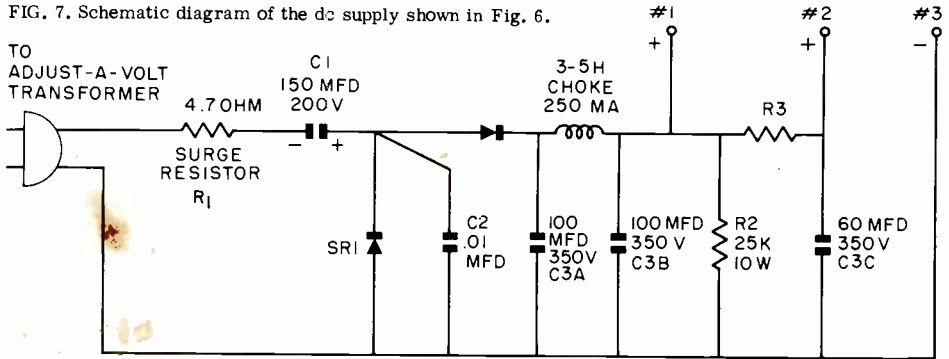

- R2 25K-ohm, 10-watt resistor
- R3 330-ohm, 2-watt resistor
- C1 150 mfd at 200 volts electrolytic capacitor
- C2 .01-mfd, 500-volt disc capacitor
- C3 three-section electrolytic capacitor.  
(A) 100 mfd; (B) 100 mfd; (C) 60 mfd  
-- all at 350 volts
- SRI dual silicon diode
- Choke 3-5 henrys, 250 ma
- Terminals 1 and 2, insulated pin jacks, red.
- Terminal 3, insulated pin jack, black
- Line cord
- Insulated capacitor mounting wafer
- Two 3/8" rubber grommets
- Assorted nuts and screws

The parts used in the construction of this power supply are NOT available from NRI. They are all standard components that can be obtained at your local parts dealer.

#### CONCLUSION

A variable ac supply source such as provided by the ADJUST-A-VOLT transformer adds a new dimension to servicing. After you have used it for a while, you will wonder how you ever got along without one. The longer you have one, the more uses you will find for it.

The purchase price of an ADJUST-A-VOLT transformer is considerable and it is only (continued on page twelve)

## Adjust-A-Volt Isolated Variable Transformer



Conar price **\$79.50**

A quality variable transformer for the laboratory or service shop. Fully adjustable AC voltage from 0 to 140 volts at 4 amps rated output. Eliminates the danger of shock by safely isolating AC-DC receivers and other equipment from the power line.

Shows up intermittent radio and TV operation quickly as you increase or decrease AC voltage. Makes it possible to duplicate home or on-the-job power line conditions in your shop. Use it as vernier output adjustment for shop power supply or as B+ voltage supply in TV alignment.

Equipped with easy-to-read AC meter, pilot light, on-off switch, plug receptacle and voltage control on front panel. Disappearing carrying handle on top of cabinet. Built-in circuit breaker eliminates blown fuses.

#### SPECIFICATIONS

Input Voltage: 120V. Output Voltage: 0-140, 50-60 cycles.  
Rated Amps: 4. KVA Max.: .56. Width 7-1/2". Height 9-1/2".  
Actual Weight: 17 lbs. Shipping Weight: 20 lbs. Shipped Express Collect only. Stock No. 1V14MWT.

**USE ORDER BLANK ON PAGE 17**



Dale Stafford

# Basic Electrical Measurements

By  
Dale Stafford

***NRI Consultant***

How's your test prod technique? Do you handle them like a surgeon handles a scalpel? Or do you display about as much confidence as a first-time father handling his infant son?

Making measurements for the first time in an actual radio receiver is, normally, a "big moment" for the student of electronics. To him, it is about as important as the first "solo" is to the student flyer.

Most students are eager to get started with this part of their training but some few have a rough time getting started right. Some are over-cautious; they are not sure what they should do or how to go about it. The thought that a mistake might damage the set or their tester also makes them uneasy. As a result, they check and recheck until, by the time the test prods touch, they have forgotten what they expected to measure.

Another student may go to the opposite extreme. He grabs the test prods and starts touching them to every terminal in sight with no idea as to what results to expect.

The attitude of most students, fortunately, lies somewhere in between these two extremes. Most of them try to learn just what they should do. Then they try to do this as exactly as possible - checking their work carefully without wasting all their time making the same checks over and over again.

Indecision and uncertainty can waste a lot of time. Aimless prodding around can waste even more. Before picking up the test prods, one should know just what he intends to measure and have a definite reason for making the

measurement. He should know how to go about it, about what results to expect and what a reading, or lack of one, will indicate. Until then, the prods are better left lying quietly on the workbench. They won't get him in trouble there - the way they might if he absent-mindedly started tapping terminals with his test instrument set to the wrong function or range.

Even the simplest radio receiver seems like a pretty complicated piece of gear to a student who is just learning troubleshooting. Gradually, though, the mystery begins to disappear as he learns just what measurements he needs to concern himself with. The more familiar he becomes with troubleshooting, the more he learns that it is just the application of things he has already learned.

Let's go back for the moment to the simple series circuit shown in Fig. 1A. What information are we likely to want about this circuit, how would we get this, and what test instruments would we use?

There should be a continuous circuit from one battery terminal to the other. None of the coils should be open or shorted. None of the resistors should be open or have changed in value. The battery should not be weak. The circuit current should be neither excessive nor too small - and it won't be if the other conditions are fulfilled. If there are any variations from these conditions, we want to know about them.

Now that we see what information we need, how do we go about getting it? As you see, we are concerned with voltage, current, and resistance. We are also interested in con-



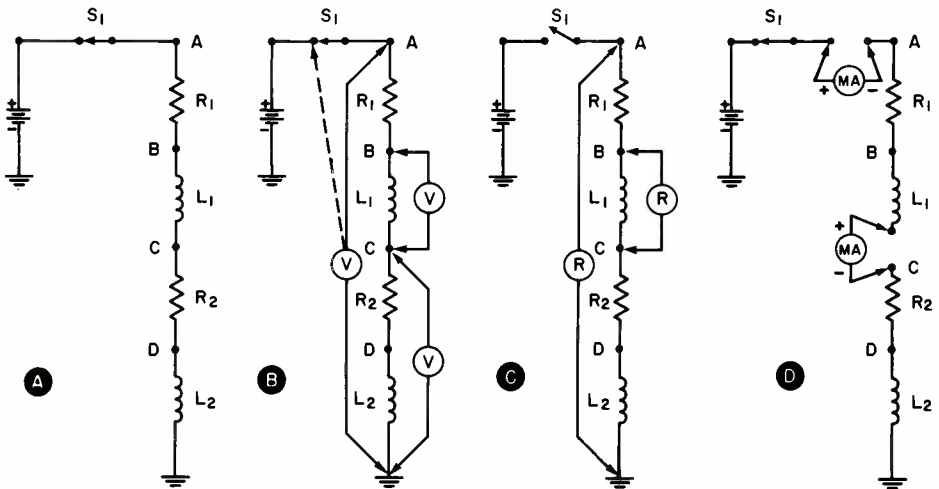

FIG. 1. Basic electrical measurements of the circuit shown in (A), using a voltmeter at (B), an ohmmeter at (C), and a milliammeter at (D).

tinuity - in other words, whether or not there is a continuous circuit from one point to another.

A voltmeter connected from terminal A to ground, as in Fig. 1B, shows us the voltage across the entire load made up of the two coils and two resistors. Since terminal A is connected to the positive battery terminal and the negative battery terminal is grounded, this connection also measures the battery voltage under load when switch S1 is closed. If we move the test prod from terminal A to the left hand switch terminal, as shown by the dotted line in Fig. 1B, and open the switch, we measure the battery voltage with no load.

Connecting the voltmeter leads to terminals B and C shows us the voltage across L1. If we connect the voltmeter from terminal C to ground, we read the sum of the voltage drops across L2 and R2.

For all these measurements, the meter must be connected with the proper polarity. In other words, the positive test lead goes to the terminal nearest the positive battery terminal. The negative test lead goes to the terminal nearest the negative terminal of the battery.

An ohmmeter can be used to measure the resistance of the circuit or its individual parts or to check for an open circuit. First, however, the switch must be opened to remove the power from the circuit. Otherwise the ohmmeter may be damaged. Even if it is not, the readings will be meaningless. An ohmmeter furnishes its own current and any other current flowing in the circuit makes the readings inaccurate.

Connected from A to ground, as in Fig. 1C, the meter measures the resistance of all the parts between these points and checks the continuity of the circuit from A to ground. Connected from B to C, the meter shows the resistance of L1 and so checks for an open or badly shorted coil. A few shorted turns, however, wouldn't show up. An ohmmeter isn't accurate enough for this and, if it were, we couldn't be sure that a small variation from the expected reading was not due to the normal manufacturing tolerance of the coil. Meter polarity is unimportant here as the ohmmeter furnishes the only current flowing in the circuit.

If the circuit is broken at any point between the two battery terminals, a current meter may be connected in series with the circuit as shown in Fig. 1D to measure the circuit current. The meter may be an ammeter, milliammeter, or microammeter, depending on the circuit current. Again, it is necessary to observe meter polarity - the positive meter terminal goes to that side of the circuit connected to the positive terminal of the battery. The negative meter terminal goes to that side of the circuit leading to the negative battery terminal. If we reversed the polarity of the battery, connecting the positive terminal to ground, we would also have to reverse the meter. Make sure you don't connect the meter between the two battery terminals as this will burn it out.

Consider, for a moment, what we have just discussed. Once we decided what we needed to know about the circuit, a few simple tests gave us all the information we needed. We can do pretty much the same thing with a radio

receiver. We have more parts to check, more voltage and resistance values to measure, and more circuits to check for continuity. However, the tests are no more difficult than those just described. We'll look at a radio in a moment, but first let's take a brief look at the test instruments used.

Rather than use separate meters for the various measurements, the technician ordinarily uses a Volt-Ohm-Milliammeter (VOM) or a vacuum-tube voltmeter (VTVM). The VOM and the type of VTVM used in radio servicing perform essentially the same functions except that the VTVM does not measure current. This is because there is no direct connection to the meter from the circuit under test. Instead, the voltage to be measured is applied to the grid circuit of a tube.

Both measure positive and negative dc voltages and resistance over several ranges. Both normally contain rectifiers so ac voltages can be measured. To measure negative dc voltages with a VOM, it is necessary to reverse the test leads, while the VTVM has a switch to reverse the polarity of the meter.

A detailed discussion of these instruments would take more space than can be devoted to it here. However, we will point out the differences in their use a little later.

Right now, let's suppose that we are working on the receiver shown in Fig. 2. Remember that our tester is not going to point out any defective parts or do our thinking for us. It just makes it possible for us to get certain information. We can then use this to determine if everything is normal.

Our readings won't mean much to us, though, unless we have a pretty good idea of what normal conditions are.

With the receiver operating as it should, current flows in the filament circuit to heat the tubes. The ac is rectified by the 35W4, shown near the lower left corner of the diagram, and the rectified dc voltage is applied to the plates and screen grids of the other tubes. The correct negative bias is being developed and applied between the grid and cathode of each tube. The oscillator is operating and developing a negative voltage at the oscillator grid. Current flows from one side of the power line through the B- circuit, the cathode circuit of each tube, the tubes, the plate and screen grid circuits, the filter choke and rectifier back to the other side of the power line. With the rectifier cut off, the path is the same except that it leads only from the lower plates of the filter capacitors around to the upper plates - the output filter capacitor is now the voltage source.

If a signal is being picked up, the AVC circuit is operating and developing an AVC voltage.

This gives a pretty good idea of what we should find. We'll mention the main points briefly. With the filaments connected in series and connected across the ac line as they are here, we would expect to find continuity from one line cord wire through the filament string to the other wire. We would also expect to measure an ac voltage across the filament of each tube.

The control grids should be negative with respect to the cathodes and the plates and screen grids should be rather highly positive with respect to the cathodes.

There should be a complete path from the cathode of the rectifier to the plates and screen grids of each tube. There should also be a complete path from the cathodes of tubes V1 through V4 to B-. So that signal voltages can be applied between the control grid and the cathode, the grid circuits are returned to the cathode or B-. Thus, we would expect to find continuity from each control grid to B-.

Few of these paths are direct connections, of course - we have to check the diagram to find the resistance in each path.

The cathode is the reference point for the voltages at the other tube elements in a vacuum tube stage. However, it is quicker and handier to measure all voltages to one common reference point. For this we use B- in a set like this and the chassis in a receiver having a power transformer. In a similar manner, resistance readings are taken by measuring the resistance from each tube socket lug to B- or to the rectifier cathode, depending on the circuit under test. On most schematic diagrams of commercial receivers, you will find the value of these readings, either from the diagram or from tables on an attached sheet.

Let's see how we would take our readings. We'll use the NRI Model W as most students are familiar with this VTVM. The Model W uses two attached test leads for all measurements in a radio receiver. The common or ground lead has a clip at the end; we'll call this the "ground clip" lead. The other lead is fitted with a probe. A Function Switch sets the VTVM to +DC, -DC, AC or OHMS. A Range Switch selects various voltage ranges with the VTVM set to one of the voltage functions and resistance ranges with the Function Switch set to OHMS.

We'll take the ac readings first so we set the Function Switch to AC. Set the Range Switch

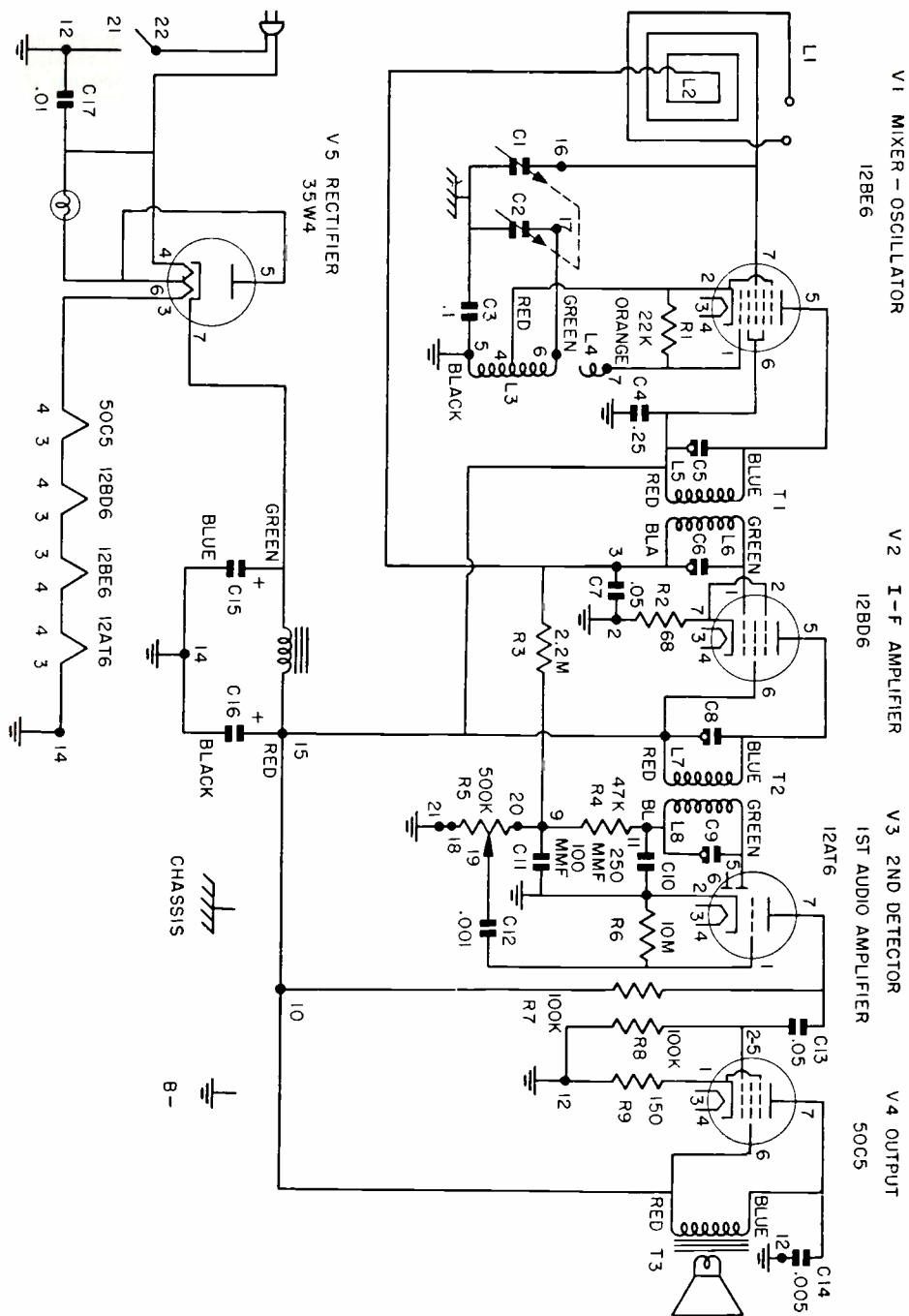

FIG. 2. Schematic diagram of AC-DC receiver.

high enough for the voltage to be measured. If you're not sure what to expect, use a high range and switch to a lower one if necessary.

With the Model W VTVM, there is little chance that the instrument will be seriously damaged if you do accidentally use too low a range. The meter pointer may kick off scale, but it isn't likely to be bent nor will the meter burn out.

You are unlikely to burn out the voltage divider in the voltmeter section. In the ohmmeter section, you may burn out one of the resistors if a measurement is attempted without first removing the power from the circuit.

Connect the ground clip lead to B- at terminal 21, the set side of the On-Off switch. Should this be hard to get to, use the terminal to which the negative lead of a filter capacitor is connected. Turn on the set and measure the rectifier ac plate voltage by touching the probe to pin 5 of the 35W4. The reading should be less than the line voltage by the value of the voltage drop across that part of the filament between pins 4 and 6. Since the pilot lamp is in parallel with this section, the voltage drop is a little over 4 volts.

Measure the voltages in the series filament circuit by touching the probe to the filament pins on the tube sockets. The voltage drop across the tube filaments should be about 35 volts for the 35W4, 50 volts for the 50C5, and 12.6 volts for each of the others. Thus, at pin 4 of the 35W4, you should read the line voltage; at pin 3 of this tube or pin 4 of the 50C5, the reading should drop about 35 volts. At pin 4 of the 12BD6 or pin 3 of the 50C5, the reading should drop 50 volts more. It should drop about 12.6 volts as you move the probe past each of the other tubes.

If you like, you can disconnect the ground clip from B- and check the filament voltages directly between the filament pins on each tube socket.

With the Function Switch set to +DC, measure B+ voltages by touching the probe to the rectifier cathode, the positive lead of the output filter capacitor, and the plates and screen grid pins on the tube sockets. At pin 7 of the 35W4, the dc voltage should be higher than the plate.

Theoretically, it should approach the peak value of the ac at the plate. However, there is a voltage drop across the rectifier and some leakage in the input filter capacitor so the voltage will be somewhat less than the peak value.

At terminal 15, the reading is about 25 volts less due to the voltage drop across the 350-400 ohm filter choke. All the other readings except two are the same as at terminal 15. The reading at the plate of the 50C5 is down about 10 volts due to the voltage drop across the primary winding of the output transformer. The 100K-ohm resistor drops the voltage at pin 7 of the 12AT6 to about 55 or 60 volts. The readings may all vary 10-25% depending on the condition of the rectifier and filter capacitors, the tubes, the resistor tolerances, and the line voltage.

In the stages using cathode resistors, you will normally measure a small positive dc voltage at the cathode.

The dc voltage at the control grids should be zero or slightly negative so we set the Function Switch to -DC to measure these. At pin 2 or 5 of the 50C5, the reading is zero. The bias is developed across R9 which makes the cathode positive with respect to B-. No dc current flows in R8 so the grid has the same potential as B-. If we want to measure the bias voltage, we measure the +dc voltage across R9.

Bias for the 12AT6 is developed by electrons on their way from the cathode to the plate accidentally striking the grid and flowing back to the cathode through R6. These are few so the voltage is small (about -1 volt).

The dc voltages at the control grids of the i-f amplifier and converter depend on how much AVC voltage is developed by the set. With no signal tuned in, this is due to rectification of stray noise voltages and will be very small. It increases considerably, however, when a strong station is tuned in. Convenient places to measure the AVC voltage are from B- to either lead of the AVC filter resistor, the 2.2 meg resistor, R3 in Fig. 2. You can connect your VTVM in this manner to use it as an output meter during receiver alignment, making all adjustments for maximum AVC voltage.

Finally, we touch the probe to the oscillator grid, pin 1 of the 12BE6, to measure the negative bias voltage developed by the oscillator. We should read from -5 to -15 volts at pin 1.

Next, we will make our resistance readings in this receiver. First, however, we must unplug the set from the wall receptacle and discharge the filter capacitors by temporarily shorting point 15 to B-. Then we connect the ground clip to B-, set the Function Switch to OHMS, and touch the probe to the lugs on each tube socket.

If we have a table that gives the correct

readings, all we need do is compare our readings with those in the table. If we have no table, we need to trace the dc path from each pin to B- to see what parts are included in the path. Then we add up the resistance values of the parts to see if our readings are correct.

For example, the path from the control grid of the 12BE6 goes through the loop, through the 2.2 meg resistor, R3, and through the 500K volume control, R5, to B-. Thus the reading at this pin is the sum of the two resistances or about 2.6 megs. In the path from the cathode of the output tube, however, there is only a single resistor so the reading is about 150 ohms. The path from the cathode of the 12BE6 to B- goes through that part of the oscillator coil between terminals 4 and 5.

As you saw, the readings from the cathodes and grids to B- checked the continuity of the grid and cathode circuits. They also checked each circuit to insure that none of the parts were shorted out or changed in value.

There is no obvious dc path from the plates and screen grids to B- so it might seem that we should get no reading at these pins. There is a path, nevertheless. All electrolytic capacitors have some leakage so the path goes through the filter capacitors. The readings at the plates and screen grids will vary with the condition of these capacitors.

To check the continuity of the plate and screen grid circuits we need to move the ground clip from B- to the cathode of the rectifier. Now we touch the probe to the plate and screen grid pins to make sure we have a complete path from each one to the rectifier cathode.

Now, let's look at the filament circuit. You can see this in the lower left corner in Fig. 2. As you can see, a connection to any of the filament pins measures the resistance of the filaments connected between that particular pin and B-. Thus, the reading will vary, depending on where one connects the probe. The continuity of the entire filament circuit can be checked simply by closing the switch and touching the ground clip to one of the prongs on the line cord plug and the probe to the other prong.

If you get no reading, connect the ground clip to one of the prongs on the line cord plug and touch the probe to pin 4 of the rectifier. If you still get no reading, you may have the clip on the wrong prong - try the other one. If you get a reading now, go right on around the filament circuit. Touch the probe to the tube pins in the order they are listed from left to right on the diagram. At the end of the filament string, pin 3 of the 12AT6, move the probe back to the terminals of the On-Off

switch. Somewhere along the line you should find the break in the circuit. As you touch one terminal, you get a reading - when you move the probe to the next point, you get none. The break must be between these two points.

When you are using the ohmmeter, there are some things which might cause you to think there is a defect in the circuit or the test instrument when actually nothing is wrong.

In checking continuity, you may notice a tendency for the pointer to swing all the way over instead of indicating the correct reading. This is due to the presence of charged electrolytic capacitors in the circuit and may be corrected by discharging the capacitor. You'll notice a tendency for the pointer to back off scale if you try to measure the resistance of an electrolytic capacitor without discharging it first. The remedy, of course, is to discharge the capacitor.

Other odd symptoms are due to the fact that a hot cathode in a vacuum tube will continue to emit electrons for a short time after the power is turned off. Thus, if an ohmmeter is immediately connected between the cathode and B-, the pointer may kick off scale for a few seconds before swinging over to the correct reading.

Connected between the grid and cathode with the probe to the grid, the ohmmeter may show a low reading and make one think the tube is shorted. The reading will increase to the proper value, however, as the cathode cools. However, you can simply reverse the test leads or pull the tube to correct the condition.

The fact that the VTVM does not measure current will not be much of an inconvenience to the technician. He will seldom have any occasion to measure current in a radio receiver. If this should be necessary, he will almost always be able to do so by measuring the voltage drop across a resistor and calculating the current.

For example, if he wanted to know how much current the output tube is drawing, he would first check the value of the 150-ohm cathode resistor with his ohmmeter. He then turns the set on and measures the voltage drop across the resistor. He can now use Ohm's law to find the current, dividing the cathode voltage by the value of the resistor.

Readings in transformer-operated sets are much the same as in the set we have discussed. There are a few differences you should keep in mind. The chassis, rather than an isolated B- circuit is used as the common reference point for the readings. The output of the power supplies normally

run considerably higher - plate voltages of 250 volts or more are common, with screen grid, cathode and bias voltages proportionately higher. The filaments are usually connected in parallel across the filament winding of the transformer. Usually one lead of this winding is grounded and so is one filament pin on each tube socket. Thus, one measures the filament voltage on a tube by connecting the ground clip to the chassis and touching the probe to the ungrounded filament pin.

Some changes in the methods described will be necessary if we use some other test instrument rather than the Model W VTVM. For example, some instruments have an extra switch on the probe that is thrown to one position for dc and to the other for ac and

(continued from page five)

#### **SERVICING WITH THE ADJUST-A-VOLT**

justified as a long-term service investment. The unit weighs seventeen pounds and every pound is made up of high quality material necessary to produce a rugged instrument. Don't confuse the ADJUST-A-VOLT isolated transformer with lighter units that are simply auto-transformers. The auto-transformer type does not provide electrical isolation from the line.

I took a very careful look at the ADJUST-A-VOLT transformer before I would recommend it as a good investment for the service technician. I disassembled the instrument to see the internal construction. I was impressed with the careful attention to detail and the rugged construction throughout. About the only thing I found to criticize in the whole instrument was the upper-limit stop on the control. Repeated slamming into the upper stop could damage the carbon brush or cause it to override the stop. In normal use, you would tend to approach the upper stop slowly. When used in this way, the stop is very adequate. However, it is not like the lower stop which you can slam as hard as you like and still not put any strain on the brush.

Minor details that make an instrument a pleasure to work with and live with have been carefully taken care of. For example, strain relief has been provided for the line cord so it is impossible to pull it out of the instrument. You can pick up the instrument by just the line cord, shake it and the line cord won't even budge from its anchor in the case! The handle is cleverly designed. When not in use, the handle lies flush with the top of the instrument providing a flat surface where you can set other equipment. There isn't even a recess by the handle to collect dirt. Pressing on either end of the handle causes the other end to lift up enough so you can easily get your hand under the handle. When the

ohms. Other instruments may require the use of a third test lead.

The VOM needs no power to operate so does not need to be plugged into the ac line. However, it is necessary to reverse the test leads to reverse the meter polarity. It may also be necessary to move the positive lead to different jacks for some measurements.

One should study the operating manual furnished with his test instrument very carefully before attempting to use it. Once he is sure he understands the instructions, he should use the instrument at every opportunity. If he really tries to get as much practice as he can, he should soon find himself using his test instrument like a technician should.

handle is released, it drops back into the case.

The instrument should give ten or fifteen years service in normal use. With lots of use, you may have to replace such items as the switch or socket. However, this would not be difficult nor expensive.

#### **PROTECT YOUR TEXTBOOKS**

*with the NRI DELUXE BINDER*

Have you ever asked yourself "How can I keep my NRI textbooks from being soiled, torn or lost?"

Here's the answer: the new, improved NRI DeLuxe Binder. Made especially for your NRI textbooks. A handsome, easy-to-use binder of generous capacity.

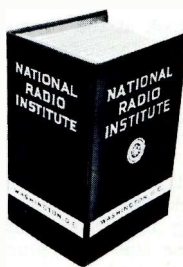

**A PRACTICAL BINDER**

It has a simple secure binding device. Easy and quick to operate. Insert or remove any book instantly, without interfering with any other book. No stitching. No typing or lacing. No punching holes in your books.

You may order one or more binders, as you wish. Use the order blank on page seventeen. Send check or money order with your order (the low price won't permit charge or C.O.D. shipments).

## NEW

# Cathode Conductance Tube Tester Kit

- Tests old and new tube types including Nuvistors, Compactrons, 10-pin Min.
- Easy to build and easy to operate
- Triple window, hi-speed geared roll chart lists over 1000 tube types
- High-quality, American-made components throughout

Assembled Stock No. 220WT  
\$57.00 (student price)

Every Radio-TV technician needs this tube tester in his business. It's your constant companion in the customer's home or your shop. Easily pays for itself in extra profits and helps make better estimates on repair jobs.

You'll be impressed by the smooth action, quality and streamlined proportions of this important instrument. The Conar Model 220 is recognized immediately as a professional tube tester!

The Model 220 was designed primarily for (1) completeness of test; (2) ease of operation; (3) long life; (4) appearance and (5) low cost. Highly flexible test circuit makes use of four-position, lever-type element switches to provide individual control of each tube element under test. There are *eighteen* filament voltages to cover testing requirements of all popular receiving tubes. Performance and value in one package!

Uses approved and recommended Electronics Industries Association emission test circuit. Years of experience have convinced us this type circuit is best suited for rapid service work at lowest possible cost.

To keep your tester up-to-date with new tube types as they are introduced, revised roll charts are made available periodically. Model 220 owners are notified automatically whenever a new chart is prepared.

## FEATURES:

**ACCOMMODATE ALL SERIES STRING AND OTHER UP-TO-DATE TUBE TYPES:** 18 individual filament voltages from .75 to 110 volts. Tests all standard base types: octal, locial, 7, 9 and 10 pin miniatures, nuvistors, 12 pin Compactrons, etc.

**OPEN ELEMENT TESTS:** This special test facility supplements the primary Emission Test.

**LEVER ELEMENT SELECTOR-DISTRIBUTING SYSTEM:** This important CONAR feature provides complete flexibility and anti-obsolescence due to changing and new tube basing terminations.

**TRIPLE WINDOW, HIGH SPEED, GEAR-OPERATED ROLL CHART**

**INDEPENDENT FILAMENT TERMINAL SELECTION:** Locates terminals of all filaments regardless of pin positions.

**VISIBLE FILAMENT CONTINUITY TESTS:** Quickly shows up open filaments (single, double, center-tapped) regardless of rotating pin positions.



Kit Stock #220UK  
(12 lbs. parcel post)

**\$46.25**  
(student price)

**TESTS SPECIAL TUBES:** Tests special purpose tubes and gas rectifiers as 0Y4, 0Z3, 0Z4, etc.

**TESTS MULTI-SECTION TUBES:** Individual test for each section of multi-section tubes. Has visible "eye" test for cathode ray indicator tubes.

**HOT CATHODE LEAKAGE TESTS:** Reliable, sensitive neon method quickly shows up poor cathodes in accordance with leakage specifications of tube manufacturer.

**INTER-ELEMENT SHORT TESTS:** Made simple through use of CONAR'S master-lever distribution system.

**PILOT LIGHT TESTS:** All miniature screw-base and bayonet type lamps.

**METER:** Large, easy-to-read with clear plastic case. Accurately balanced and factory calibrated to within 2% accuracy. Double-jeweled D'Arsonval type.

**MICRO-LINE ADJUSTMENT:** Continuously variable, heavy-duty line voltage control.

**TEST CIRCUITS TRANSFORMER - ISOLATED FROM POWER LINE:** Assures utmost safety to operator and instrument.

## SPECIFICATIONS:

**All Top Quality, American Made Parts. Actual Weight:** 10 lbs. **Shipping Weight:** 12 lbs. **Size:** 10½" x 15¼" x 4". Satin-finish aluminum panel with black lettering—won't rub off. Durable black leather-fabric case. **Power Requirements:** 50-60 cycle, 110-120 volts AC only. Removable hinged lid with safety catch. Standard EIA warranty on all parts. Shipped parcel post, insured.



**OPTIONAL ACCESSORIES** 70°-90° Picture Tube Adapter and Companion 110° Adapter available. Enables you to test picture tube in receiver or in carton. Includes cathode emission check and test for shorts between elements.

70°-90° Adapter—Stock #3AD..... **\$4.98**  
110° Adapter—Stock #5AD..... **\$4.77**

(Note: You must have 70°-90° Adapter in order to use 110° Adapter.)

**USE ORDER BLANK ON PAGE 17**

**NRI designed . . .**

# CONAR instruments

**Quality**—only the best American made components—built to last!

**Performance**—exclusive features not found elsewhere at the same price.

**Low Cost**—your choice of easy to build kits or factory assembled units.

**Guarantee**—your money back at once if not completely satisfied—enthusied—convinced  
you can't buy better equipment for the money!

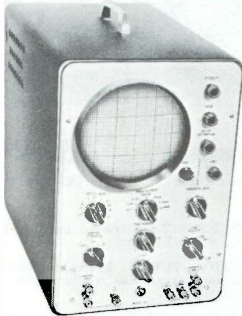

## **5" Lab-Type Oscilloscope**

**\$89.50**

**Model 250** Superb value in a general-purpose scope. Ideally suited for servicing black-white or color TV, AM-FM radios, transistor sets, hi-fi equipment and industrial electronic equipment. Has wide-band response; reads peak-to-peak voltages directly. Syncs and locks easily - with positive action. Features built-in flyback transformer tester; measures ripple output of any power supply; checks auto radio vibrators dynamically. Black wrinkle finish cabinet; satin finish panel. Size: 9-3/8" x 13-3/4" x 15-1/4" Weight: 25 lbs. Shipped Express only to insure safe handling. Kit Price - \$89.50. Assembled Price - \$139.50. Optional set of 4 probes - \$16.95

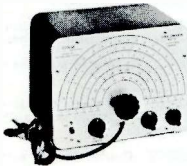

## **Signal Generator**

**\$21.50**

**Model 280** A tuned-type Signal Generator for AM-FM-TV alignment and trouble shooting. Fundamental Frequency Coverage 170 kc to 60 mc. Harmonic Frequency Coverage over 120 mc. Average accuracy better than 1%. Steel cabinet with satin finish aluminum panel. Shipping Weight: 8 lbs. Kit Price - \$21.50. Fully assembled for just \$29.50.

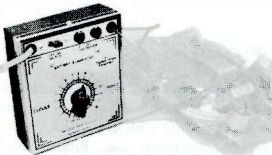

## **Battery Eliminator**

**\$13.67**

**Model 2** Does away with batteries used to operate transistor radios and other transistorized equipment. No need to run down expensive batteries trouble-shooting equipment. Max. Output: 100 ma., 0-15 volts (not for auto radios). Weight: 2 lbs. Sold as assembled unit only. Price with test leads - \$13.67.



## **Appliance Tester**

**\$20.00**

**Model 18** Designed specifically for servicing all types of electrical appliances. Measures volts, ohms, amps and wattage. Built for years of trouble-free service. A specially designed instrument for shop and home owners. Can be used for appliance repairs, house wiring, automotive work, Radio-TV servicing -- for 101 different jobs! AC Volts Ranges: 0-150, 0-300, Ohms Ranges: 0-1000 ohms, 0-10,000 ohms. Ammeter Range: 0-20 amps. Direct Line plug in panel for testing line voltage and amps. 1.5 Volt "D" battery cell for ohms circuit. 1% precision resistors. Gray aluminum panel with white lettering. Plastic-fabric covered cabinet with carrying handle and removable top. 40" red and black test leads -- alligator clips on end. Fused for protection. All American Made Parts. Assembly-operating instructions. Kit Price - \$20.00. Assembled Price - \$25.00.

**USE ORDER BLANK ON PAGE 17**



### **6-Transistor Portable**

**\$25.50**

Model 291 A favorite with NRI men everywhere! Features tone, sensitivity, styling not generally found in portables costing much more. Uses four ordinary penlight batteries for hours of pleasant listening. 4" speaker with 1-1/2 oz. magnet. Civil Defense stations marked on dial. Easy to build and listen to! Size: 5-1/4" x 8-1/4" x 2-1/4". 3 lbs. Kit - \$25.50. Assembled - \$34.50.



### **Signal Tracer**

**\$39.95**

Model 230 A tuned Signal Tracer featuring exclusive cathode-follower probe for tube or transistor sets. Has tuning "eye" indicator and built-in speaker (use it as a radio if you wish). Quickly localizes sources of hum, noise and distortion -- trace signal from antenna to speaker -- pinpoint trouble in minutes. Steel cabinet with satin finish aluminum panel. Weight: 11 lbs. Kit price - \$39.95. Assembled - \$57.50.



### **Pocket Volt-Ohmmeter**

**\$17.95**

Model 240 Compact, battery operated, accurate tester for "on the spot" tests. Has 20,000 ohms per volt sensitivity. Measures AC-DC volts and ohms; jeweled d'Arsonval meter. Size: 3-3/4" x 6" x 2"; black bakelite case; aluminum panel. Weight with test leads and batteries - 3 lbs. Kit - \$17.95. Fully assembled - \$19.95.

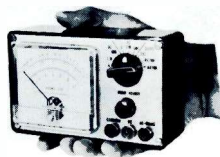

### **Compactron Adapter**

**\$11.50**

Model 6AD Instantly modernizes any tube tester for checking the new 10-pin miniature tubes, Compactrons, Nuvistors and Novar types. Detailed operating instructions included. Shipped fully assembled, ready to use. 2 lbs. Price - \$11.50.



### **Resistor-Capacitor Tester**

**\$21.95**

Model 311 Accurately test resistors and capacitors quickly - without guesswork. Measures resistance, capacity, leakage, power factor, opens, shorts and electrolytics. "Floating chassis" design eliminates shock hazard. Can be used for many in-circuit tests; a matching instrument for Model 230 and Model 280. Weight: 1 lb. Kit price \$21.95. Assembled - \$29.95.

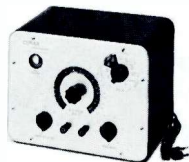

### **VTVM with 6" Meter**

**\$31.95**

Model 211 The VTVM you'd want at any price! Years ahead, styling, quality and accuracy at a low price. Full 6" meter with flat arc scale for readings at a glance. Twenty-four separate ranges. Measures AC, DC, ohms, RMS and peak-to-peak scale. Steel cabinet with black wrinkle finish, satin finish aluminum panel. Shipping Weight: 6 lbs. Kit - \$31.95. Assembled - \$44.95.

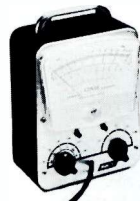

### **TV Probe**

**\$5.50**

Model 13PB For use with NRI Model W VTVM or Conar Model 211. Extends DC to 30,000 volts. Weight: 1 lb. \$5.50.



**USE ORDER BLANK ON PAGE 17**

# New Products Available from Conar

FOR THE OUTDOOR MAN

## POCKET STOVE KIT

Most compact outdoor stove available today—easily fits in coat pocket! Will actually boil six quarts of water in six minutes. Burns any type gasoline, kerosene or lighter fluid. Five oz. filling will last 1½ hours. No pumping, no priming, no moving parts. Stove regulates itself after lighting and creates its own pressure.

Sides of case make raised platform for cooking—sturdy enough to stand on! Burner unit can be safely held in hand for use as blow torch, paint burner or thawing frozen pipes and locks.

Size in case is 5" x 4½" x 1⅞". Burner made of SOLID BRASS with stainless steel case for years of dependable service. Use it for picnics, hunting, fishing, power shortages. Approval of this stove has been issued by the Office of Civil Defense.

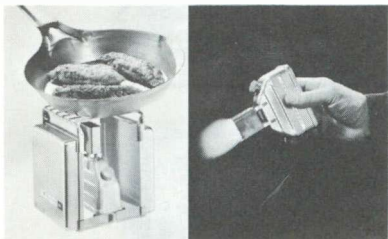

Stock # 101TO (2 lbs. parcel post)

**\$12.95**

## Liquid Lifter PUMP KIT

Pumping was never like this! Here's one of the most useful new products we've seen—makes pumping liquids quick and easy. Can be used to drain oil from cars, lawnmowers and marine engines, to pump soapy water out of jammed washers, to clean aquariums, drain wading pools, drain window wells—transfer *practically any liquid* from one place to another.

Use with any electric drill—¼" or larger. Will pump 20 quarts of water per minute—needs no priming! Pumps oil, water, fuels, numerous chemicals and acids without harm. Housing made of Dupont Zytel resists heat and corrosion. Needs no lubrication (in 2,000 hour test, pump showed no appreciable wear.)

Kit includes pump, three suction lines—½", ¼" and ⅜" diameters—two discharge lines—½" and ⅜"—and discharge line wire hanger.

Stock # 17TO (3 lbs. parcel post) only..... **\$13.45**

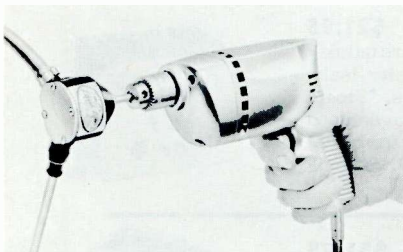

USE ORDER BLANK ON PAGE 17

**HOW TO ESTIMATE PARCEL POST CHARGES**

WEIGHT 1 Lb. and Not Exceeding	Local	1st-2nd Zone, up to 150 mi.	3rd Zone 150 to 300 mi.	4th Zone 300 to 600 mi.	5th Zone 600 to 1000 mi.	6th Zone 1000 to 1400 mi.	7th Zone 1400 to 1800 mi.	8th Zone Over 1800 mi.
2	\$0.24	\$0.33	\$0.35	\$0.39	\$0.45	\$0.51	\$0.58	\$0.64
3	.26	.38	.41	.47	.55	.64	.74	.83
4	.28	.43	.47	.55	.65	.77	.90	1.02
5	.30	.48	.53	.63	.75	.90	1.06	1.21
6	.32	.53	.59	.70	.85	1.03	1.22	1.40
7	.34	.58	.65	.77	.95	1.16	1.38	1.59
8	.36	.63	.71	.84	1.05	1.29	1.54	1.78
9	.38	.68	.77	.91	1.15	1.42	1.70	1.97
10	.40	.73	.83	.98	1.25	1.55	1.86	2.16
11	.42	.77	.89	1.05	1.35	1.67	2.02	2.34
12	.44	.81	.95	1.12	1.45	1.79	2.18	2.52
13	.46	.85	1.01	1.19	1.55	1.91	2.34	2.70
14	.48	.89	1.07	1.26	1.65	2.03	2.50	2.88
15	.50	.93	1.13	1.33	1.75	2.15	2.66	3.06
16	.52	.97	1.18	1.40	1.85	2.27	2.81	3.24

**ORDER BLANK**

CONAR Instruments, 3939 Wisconsin Ave., Washington 16, D. C.

I enclose \$\_\_\_\_\_ plus \$\_\_\_\_\_ for postage. Please ship at once the equipment I have indicated below. See chart for correct Postal charges.

- Adjust-A-Volt Isolated Variable Transformer. . . . . \$ 79.50
- 5" Lab-Type Oscilloscope, Model 250 (Kit). . . . . 89.50
  - (Assembled). . . . . 139.50
- Optional Set of 4 Probes. . . . . 16.95
- Signal Generator, Model 280 (Kit). . . . . 21.50
  - (Assembled). . . . . 29.50
- Battery Eliminator, Model 2. . . . . 13.67
- Appliance Tester Kit, Model 18 (Kit). . . . . 20.00
  - (Assembled). . . . . 25.00
- Cathode Conductance Tube Tester Kit, Model 220. . . . . 46.25
  - (Assembled - Student Price). . . . . 57.00
- 70° - 90° Adapter, Model 3AD. . . . . 4.98
- Both 70° - 90° and 110° Adapters, Models 3AD and 5AD. . . . . 9.75
- 6-Transistor Portable Receiver, Model 291 (Kit). . . . . 25.50
  - (Assembled). . . . . 34.50
- Signal Tracer, Model 230 (Kit). . . . . 39.95
  - (Assembled). . . . . 57.50
- Pocket Volt-Ohmmeter, Model 240 (Kit). . . . . 17.95
  - (Assembled). . . . . 19.95
- Compactron Adapter, Model 6AD. . . . . 11.50
- Resistor - Capacitor Tester, Model 311 (Kit). . . . . 21.95
  - (Assembled). . . . . 29.95
- VTVM with 6" Meter, Model 211 (Kit). . . . . 31.95
  - (Assembled). . . . . 44.95
- TV Probe, Model 13PB. . . . . 5.50
- DeLux Binders (Postpaid) each. . . . . 3.00
- Pocket Stove Kit. . . . . 12.95
- Liquid Lifter Pump Kit. . . . . 13.45

If you live in Washington, D.C., add 3% Sales Tax \_\_\_\_\_

TOTAL ENCLOSED \_\_\_\_\_

Name ..... Stn. No .....

Address .....

City ..... Zone ..... State .....

Express Office .....

Tell me how I can buy this equipment on terms.

REPRINTED FROM

# Electronics World

APRIL 1962 / VOL. 67 NO. 4

## Product Test Report

### Conar Model 211 Vacuum-Tube Voltmeter

ONE of the most useful pieces of test equipment on the service bench is the v.t.v.m. This is the instrument that the technician usually turns on in the morning and keeps on throughout the day so that he can take d.c. and a.c. readings on circuits with minimum loading. Advantages of the Conar Model 211 v.t.v.m. kit, which we have just assembled and tested, are its utter simplicity, lack of frills, and ease of construction. These characteristics not only make the meter easy to build (it took us only 6 hours), but, once completed, there is little to go wrong.

Unlike most v.t.v.m.'s, which use either three test leads or a switchable probe, this meter uses only two test leads for all measurements. There is no 1-megohm isolating resistor in the test prod; instead, a special low-C coax cable is used that makes this resistor unnecessary. We measured the capacitance of this lead and found that it was only 42  $\mu\text{m.f.}$  When we later tried using the meter for direct r.f. measurements, we found that its low loading permitted it to be used well up into the r.f. range.

The large 6-inch meter with its simple, uncluttered dial makes it easy to take accurate readings with a minimum of eye-strain. The meter has a 1-ma. movement rather than the usual 200- $\mu\text{a.}$  value, so that it should be rugged and hard to damage. A look of the photo above shows that there are no knobs on the knurled, plastic shafts on the pots used for zero set and ohms adjustment. Once these controls were set, we found the long-time stability as well as the range-to-range stability so good that it was not necessary to touch these at all.

The meter has six d.c. and a.c. ranges (from 3 to 1200 v.) and six resistance ranges (from 10 ohms to 10 megohms, mid-scale). The polarity of the instrument can be reversed if required. A special peak-to-peak scale is also included. The circuit itself is simple and conventional. A 12BH7 twin-triode is employed in the usual

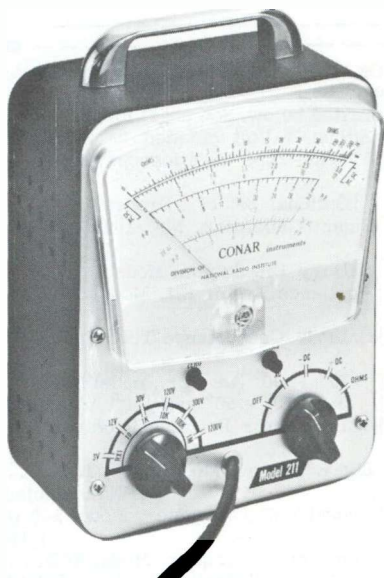

balanced bridge arrangement with the 0-1 ma. meter connected between the two cathodes. One diode section of a 6X4 is used as a simple peak rectifier for a.c. signals. Resistance is measured by use of a 1½-volt flashlight battery, a voltage divider, and the voltmeter circuitry. One per-cent resistors are used in the d.c. and a.c. dividers, while 5% resistors are used for ohms measurements. A half-wave selenium rectifier supplies a measured 80 volts to the twin-triode. Built-in calibration pots are provided for d.c. (using the 1½-volt flashlight cell) and for a.c. zero adjust. We were a little surprised that there was no calibration pot for setting up the a.c. ranges for some known voltage. Most v.t.v.m.'s use the line voltage for this

purpose. In this case, such an adjustment was found to be completely unnecessary and a.c. readings were quite accurate without it.

The first test we made was of the d.c. accuracy of the instrument. We took several voltage readings (using a variable power supply) on each range and compared our readings with those obtained on a lab-type v.o.m. All readings fell between -1% and +2% of full scale. The same procedure was followed in checking a.c. accuracy. We found all readings to be between -1/2% and +3%. The accuracy was thus seen to be well within the limits needed for service work. What is more, there was excellent agreement of readings of the same voltage taken on several scales. Input impedance of the meter is 12.2 megohms on d.c. and close to 1.5 megohms on a.c. We measured this latter value at 1000 cps on the three lower ranges.

Next, we measured the a.c. frequency response of the meter to see how good a job it could do in audio work. At the low end of the audio spectrum, response was found to be down only 1/2 db at 50 cps and 1 db at 20 cps. At the high end, response was perfectly flat out well beyond the top limit of the audio range. As a matter of fact, the meter was still absolutely flat out to 6 mc. before it started to show a rise in reading. We hit a peak of 6 db at 9 mc. before the reading started to roll off. This rising response in the r.f. range is typical of

many v.t.v.m.'s we have checked; it is probably due to the shunt capacitance across the multiplier resistors, forming a high-frequency peaking network that boosts response at higher frequencies. Just out of curiosity we continued still higher in frequency. We found another peak at about 18 mc., then a gradual roll-off, but we were still reading r.f. directly on the meter up to about 30 mc. We would have liked to see a db scale on the instrument since it is so well suited for audio measurements, except for low-level values.

Finally, the resistance ranges were checked by measuring a number of known 1% and 5% resistors. All measurements were very close except for those on the lowest resistance range. We wondered why a meter that was so accurate on all its other functions should read low on the lowest resistance range. We checked the 1 1/2-volt battery while switched to the lowest resistance range and we found that it read only 0.4 volt with the test prods shorted for a while. Substitution of a fresh flashlight cell brought all readings up to their proper values. The cell, by the way, is soldered to its leads; it would have been a little more convenient to have a battery holder with built-in leads.

In summary, the Model 211 is a simple, but accurate and highly useful piece of test equipment that will give plenty of satisfactory use on the service bench. It is available for \$31.95 in kit form. . . . . E. W.

---

### OPPORTUNITY FOR SERVICE IN THE PEACE CORPS

NRI Graduates and Advanced Students who will complete their courses in the next few months may qualify as Peace Corps Volunteers for service in countries in Asia, Africa, and Latin America.

Opportunities are open to volunteers who have skills in a number of vocational fields. Of particular interest to NRI men is the need for Radio-Television servicemen.

In this connection, the Peace Corps Director of Recruitment, Mr. Richard A. Graham, wrote Dr. David A. Lockmiller, Executive Director of the National Home Study Council, as follows:

"I encourage your schools' students to complete their courses. Students who complete home study courses demonstrate a desire to develop new skills and to assume greater responsibility. Completion of home study courses could

qualify many of your schools' students for additional training which would be provided by the Peace Corps at leading universities in the United States and for final training in host countries.

"Peace Corps Volunteers receive a living allowance which covers food, clothing, housing, and medical care. In addition, they accumulate a termination allowance of \$75 for each month of satisfactory service which amounts to a lump sum payment of \$1800 upon completion of a two year tour of duty."

NRI men interested in the possibility of serving in the Peace Corps should fill out a Peace Corps questionnaire available at Post Offices or from the Peace Corps in Washington. For any additional information write to Mr. Richard A. Graham, Director of Recruitment, Peace Corps, Washington 25, D. C.

# Kirchhoff's Laws And Basic Applications

By  
**T. A. Ferraro**  
PUBLICATIONS EDITOR

Almost everyone has heard of Ohm's law. Many nontechnical men are acquainted with  $E = IR$  and the radio man is thoroughly familiar with this basic law. However, Kirchhoff's laws are another matter. Most nontechnical persons never heard of them. Even some men working in electronics or communications are not completely familiar with these laws. This is unfortunate. Kirchhoff's laws are an extension of Ohm's law. These laws make it easier to analyze complicated circuits like the bridges, filters, and impedance-matching networks. So the technician who can apply Kirchhoff's laws has an advantage over the one whose knowledge stops with Ohm's law.

Gustav Kirchhoff was a German scientist who formulated the laws to be discussed in this article. He discovered these laws way back in 1847. Does this surprise you?

Kirchhoff stated two laws. One is a current law and the other a voltage law. They are:

1. The sum of the currents flowing into a junction is equal to the sum of the currents flowing out of it.
2. In any closed circuit, the sum of the voltage drops is equal to the applied voltage.

Let's discuss these laws in detail so you will completely understand Kirchhoff's theories. Then, complicated networks will look simple. You will receive much satisfaction from being able to solve your problems quickly and accurately.

## KIRCHHOFF'S CURRENT LAW

Kirchhoff said that the sum of the currents flowing into a junction is equal to the sum of the currents flowing out of it. This is reasonable. If 6 amperes enter a junction, 6 amperes should flow out of that junction.

In Fig. 1 we have isolated part of a circuit so we can examine Kirchhoff's current law. This diagram consists of three circuit elements with a common terminal connection at point P. This point P is called a junction point. A junction point is where three or more circuit elements are connected together.

we see the current  $I_A$  is flowing into the junction point P. Kirchhoff said that since point P is quite small, it is not capable of storing charge. So the amount of current that enters point P must also be the amount that leaves point P. Hence, Kirchhoff's current law was formed.

By analyzing Fig. 1 more closely, we see that when  $I_A$  flows out of point P, it separates into currents  $I_B$  and  $I_C$ .

In Fig. 2A we have 6 amperes entering point P, so 6 amperes must leave point P. Since  $R_B$  and  $R_C$  have equal resistance, the 6 amperes will divide equally. Therefore, 3 amperes will flow through  $R_B$  and 3 amperes will flow through  $R_C$ .

In Fig. 2B,  $R_B$  and  $R_C$  do not have equal resistance, so they will not draw equal currents. Since  $R_C$  offers less resistance to the flow of current, more current will flow through  $R_C$  than through  $R_B$ . As a matter of fact, twice as much current will flow through  $R_C$ .

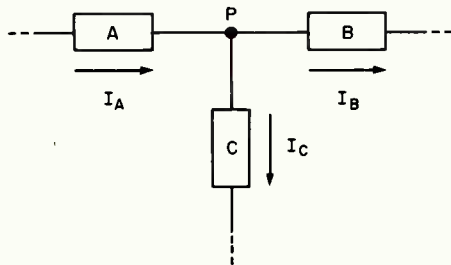

FIG. 1. Three circuit elements with a common junction point.

because it offers half the resistance  $R_B$  offers. Therefore, the 6 amperes entering point P will divide, with 2 amperes flowing through  $R_B$  and 4 amperes flowing through  $R_C$ .

Now you can appreciate the importance of Kirchhoff's current law. We can find the currents flowing through any circuit element by simply applying his current law.

Later on in this article you will see how to use this current law to solve difficult networks. Just keep in mind that the sum of the currents flowing into a junction is equal to the sum of the currents flowing out of it. It's as simple as that. Now we will take a look at Kirchhoff's voltage law.

## KIRCHHOFF'S VOLTAGE LAW

Kirchhoff stated that in a closed circuit, the sum of the voltage drops is equal to the applied voltage. Let's examine this voltage law by using a simple circuit.

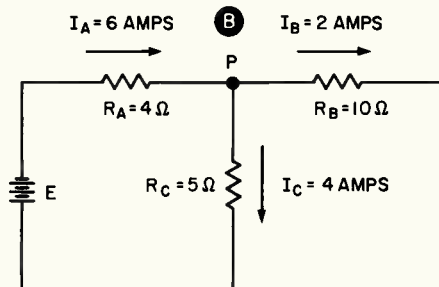
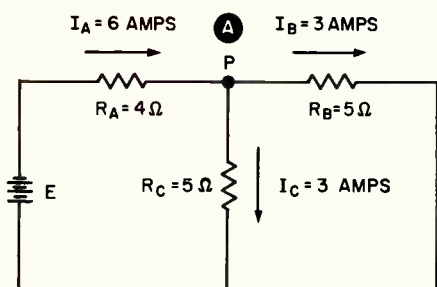

FIG. 2. Voltage source and three resistors of known value with a common junction point.

In Fig. 3 we have shown a closed path with a voltage source and three resistive elements. Across each resistor a voltage will be dropped. Kirchhoff said that these voltage drops, when added together, will equal the voltage applied to the circuit.

In mathematical form we would have

$$E = IR_A + IR_B + IR_C$$

If 20 volts were applied to the circuit, the total voltage drop of the three resistors would be 20 volts.

The circuits that you have seen so far have been simple ones. With a working knowledge of Ohm's law, you could solve them quickly. But take a look at Fig. 4. It would be very difficult to solve this circuit by using Ohm's law. However, by using Kirchhoff's laws you can solve it with little difficulty. This is why we stated previously that the technician who can apply Kirchhoff's laws has an advantage over the one whose knowledge stops with Ohm's law. Let's see how you can solve complicated circuits with the use of Kirchhoff's laws.

#### APPLICATION OF KIRCHHOFF'S LAWS

In solving a circuit by using Kirchhoff's laws, there are a few rules you must follow.

Rule 1. Use a different current for each closed circuit or loop.

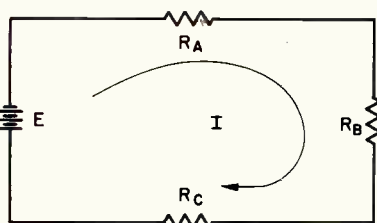

FIG. 3. Closed path with a voltage source and three resistors.

Rule 2. In any loop, the IR drops caused by loop currents are always positive.

Rule 3. In any loop, the IR drops caused by the current from an adjacent loop may be positive or negative. If the adjacent loop current flows in the same direction as our loop current, the IR drop is positive. If it flows in the opposite direction, it is negative.

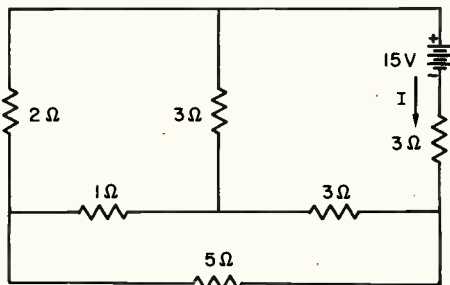

FIG. 4. Network circuit.

Rule 4. A voltage source is given a positive sign in the equation if its polarity is such that it aids the loop current - that is, if the loop current flows from negative to positive in the external circuit. A voltage source is given a negative sign in the equation, if it opposes the loop current.

An understanding of the above rules is all that is needed to solve seemingly difficult network problems. We will now apply them to the network shown in Fig. 4 which has been redrawn in Fig. 5 to show the various closed circuits or loops.

Since we have three loops in Fig. 5, we begin by assuming three currents,  $I_A$  flowing through loop A,  $I_B$  flowing through loop B, and  $I_C$  flowing through loop C (Rule 1). There is nothing in the rules about the direction of the assumed currents. In Fig. 5 we have shown the three currents flowing in a clockwise direction simply as a matter of choice.

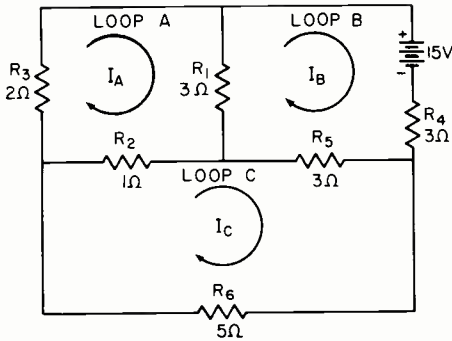

FIG. 5. Network circuit with direction of loop currents.

Loop A is redrawn in detail in Fig. 6A, so we can concentrate on the factors in that loop without being distracted by the rest of the circuit.

$I_A$  flows through  $R_1$ ,  $R_2$ , and  $R_3$ , producing IR drops (which means the drop is equal to the current in amperes multiplied by the resistance in ohms) of  $3I_A$ ,  $1I_A$ , and  $2I_A$ . Since  $I_A$  is the loop current, all three of these IR drops are positive (Rule 2). However,  $I_B$  and  $I_C$  from adjacent loops flow through  $R_1$  and  $R_2$  respectively. Since their direction is opposite to  $I_A$ , they cause negative voltage drops,  $-3I_B$  and  $-1I_C$  (Rule 3). Since there is no battery or generator in the circuit, the IR drops are equal to zero. Gathering all these facts, we can now write the equation describing loop A:

$$3I_A + 1I_A + 2I_A - 3I_B - 1I_C = 0$$

Combining the terms involving loop A, our equation becomes:

$$6I_A - 3I_B - 1I_C = 0 \quad \text{Equation (A)}$$

We next examine loop B, as redrawn in Fig. 6B. The loop current  $I_B$  flows through  $R_4$ ,  $R_5$ , and  $R_1$ , producing three positive IR drops of  $3I_B$  each (Rule 2).  $I_A$  and  $I_C$  from adjacent loops flow through  $R_1$  and  $R_5$ , respectively. Since their direction is opposite to  $I_B$ , they cause negative voltage drops,  $-3I_A$  and  $-3I_C$  (Rule 3). The polarity of the battery is such as to aid  $I_B$  and hence, (by Rule 4), the 15 volts is given a positive sign in the equation. Gathering the facts concerning loop B gives:

$$-3I_A + 3I_B + 3I_B + 3I_B - 3I_C = 15$$

Combining the  $I_B$  terms gives:

$$-3I_A + 9I_B - 3I_C = 15 \quad \text{Equation (B)}$$

Following the same procedure with loop C,

Fig. 6C, as we did for loops A and B, will give:

$$-1I_A - 3I_B + 9I_C = 0 \quad \text{Equation (C)}$$

Let's group our loop equations:

$$6I_A - 3I_B - 1I_C = 0 \quad \text{Equation (A)}$$

$$-3I_A + 9I_B - 3I_C = 15 \quad \text{Equation (B)}$$

$$-1I_A - 3I_B + 9I_C = 0 \quad \text{Equation (C)}$$

We now have three equations with three unknowns,  $I_A$ ,  $I_B$ , and  $I_C$ . We must find values for these currents that will satisfy all three equations. It would take many hours of work if we try to find the correct currents by a trial and error method.

Any number of values can be found for  $I_A$ ,  $I_B$  and  $I_C$  that will satisfy any one equation taken by itself. However, only one set of values will satisfy all three equations. To find this single solution, all three equations must be considered at the same time or simultaneously, and therefore, they are called simultaneous equations.

Simultaneous equations are solved by adding or subtracting them in such a way as to obtain one equation with one unknown. The first step is to change the equations by multiplying or dividing them so that a term in one becomes identical with a term in the other. As long as each of its terms on both sides of the = sign is multiplied or divided by the same number, the equality of the equation is not changed.

We can choose to eliminate either  $I_A$ ,  $I_B$  or  $I_C$ . Let's eliminate  $I_B$ . In examining equations (A) and (B) we see the terms  $-3I_B$  and  $+9I_B$ . Since we want to eliminate  $I_B$  from equations (A) and (B), we must make these two terms numerically equal, but opposite in sign. If

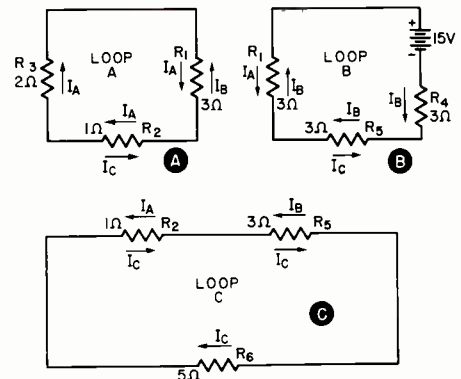

FIG. 6. Network circuit of Fig. 5 divided into three loops. The loop current that flows through each resistor is shown.



we multiply equation (A) by 3, we would have a  $-9I_B$  term. When we add equations (A) and (B), the  $-9I_B$  term will cancel the  $+9I_B$  term. Hence, we have eliminated  $I_B$  from equations (A) and (B). Let's see how this is done.

We begin by multiplying equation (A) by 3 and then adding (A) and (B) to eliminate  $I_B$ .

$$\begin{array}{rcl} 18I_A - 9I_B - 3I_C = 0 & (A) \times 3 \\ -3I_A + 9I_B - 3I_C = 15 & (B) \\ \hline 15I_A & - 6I_C = 15 & (A + B) \end{array}$$

We must also eliminate the  $I_B$  term from equation (C). If we multiply equation (C) by 3, we would have a  $-9I_B$  term. This would cancel the  $+9I_B$  term in equation (B).

Multiplying (C) by 3 and then adding (C) and (B) to eliminate  $I_B$ ,

$$\begin{array}{rcl} -3I_A - 9I_B + 27I_C = 0 & (C) \times 3 \\ -3I_A + 9I_B - 3I_C = 15 & (B) \\ \hline -6I_A & + 24I_C = 15 & (C + B) \end{array}$$

We now have two equations with the unknowns,  $I_A$  and  $I_C$ .

$$\begin{array}{rcl} 15I_A - 6I_C = 15 & (A + B) \\ -6I_A + 24I_C = 15 & (C + B) \end{array}$$

We must eliminate one equation and one unknown. We can do this if we multiply (A + B) by 4 and then add (A + B) + (C + B) to eliminate  $I_C$ . We multiply equation (A + B) by 4 because we want the  $-6I_C$  term in this equation to become  $-24I_C$ . Then the  $-24I_C$  term will cancel the  $+24I_C$  term of equation (C + B) and we will have eliminated the  $I_C$  term from both equations.

$$\begin{array}{rcl} 60I_A - 24I_C = 60 & (A + B) \times 4 \\ -6I_A + 24I_C = 15 & (C + B) \\ \hline 54I_A & = 75 & (A + B) + (C + B) \end{array}$$

$$I_A = \frac{75}{54} = 1.388 = 1.39 \text{ amps}$$

substituting  $I_A = 1.39$  amps in (A + B) gives

$$\begin{array}{rcl} 15(1.39) - 6I_C = 15 \\ 20.85 - 6I_C = 15 \end{array}$$

transposing

$$\begin{array}{rcl} 20.85 - 15 = 6I_C \\ 5.85 = 6I_C \end{array}$$

$$I_C = \frac{5.85}{6} = 0.975 = 0.98 \text{ amps}$$

We can now substitute the values of  $I_A$  and  $I_C$  in any of the original equations to find  $I_B$ . Using equation (A) we have:

$$\begin{array}{rcl} 6I_A - 3I_B - 1I_C = 0 \\ 6(1.39) - 3I_B - 1(0.98) = 0 \\ 8.34 - 3I_B - 0.98 = 0 \end{array}$$

transposing

$$\begin{array}{rcl} 8.34 - 0.98 = 3I_B \\ 7.36 = 3I_B \end{array}$$

$$I_B = \frac{7.36}{3} = 2.453 = 2.45 \text{ amps}$$

We get the final solution by going back to the circuit diagram and filling in the values for the currents, adding or subtracting them as necessary. The result is shown in Fig. 7.

Back in the section on Kirchhoff's current law we stated that the sum of the currents flowing into a junction is equal to the sum of the currents flowing out of it. Notice in Fig. 7, we have four junction points,  $P_1$ ,  $P_2$ ,  $P_3$ , and  $P_4$ . For your easy inspection, we have divided Fig. 7 into four parts. The four junction points and the currents associated with them are shown in Fig. 8. You can see, in each case, the sum of the currents flowing into the junction is equal to the sum of the currents flowing out of that junction. This proves that our math is correct.

In Fig. 7 the voltage drop across  $R_6$  should equal the sum of the voltage drops across  $R_2$  and  $R_5$  because these two resistors are connected in parallel with  $R_6$ . The voltage drop across parallel paths should be equal. Let's see if these two parallel paths produce the same voltage drop.

The voltage drop across  $R_6$  is

$$0.98 \times 5 = 4.9 \text{ volts}$$

The voltage drop across  $R_2$  and  $R_5$  combined is

$$\begin{array}{rcl} (0.41 \times 1) + (1.47 \times 3) = \\ .41 + 4.41 = 4.82 \text{ volts} \end{array}$$

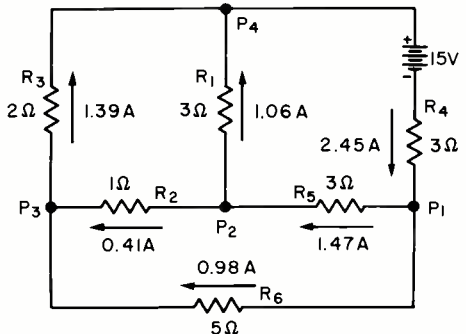

FIG. 7. Network current values and direction.

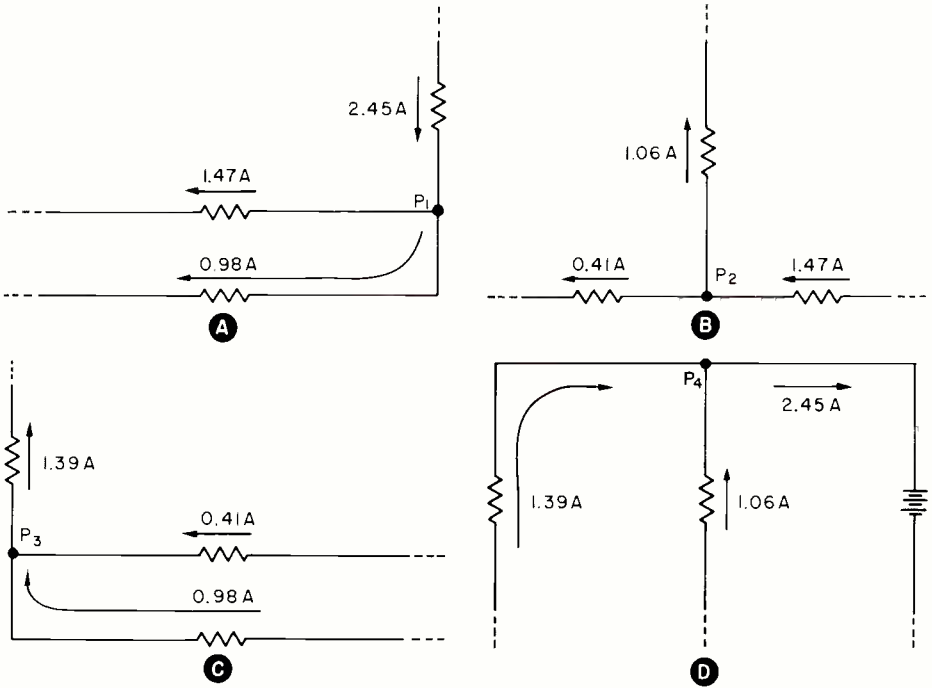

FIG. 8. Four junction points and the currents associated with them.

We see that our voltage drops do not agree. However, we can easily account for this difference. When we calculated  $I_A$ ,  $I_B$  and  $I_C$ , we rounded them off to two decimal places. We changed

$$\begin{aligned} I_A &= 1.388 = 1.39 \text{ amps} \\ I_B &= 2.453 = 2.45 \text{ amps} \\ I_C &= 0.975 = 0.98 \text{ amps} \end{aligned}$$

This accounts for our slight difference in voltage drops. For all practical purposes our calculations are correct.

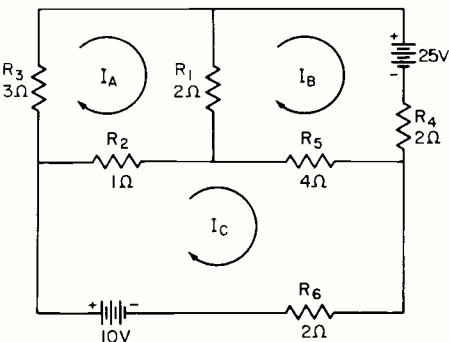

FIG. 9. Practice network problem.

Would you like to tackle a network problem on your own? Then how about the one shown in Fig. 9? We gave you a good start by drawing the loop currents and also drawing Fig. 10. Work this problem the same way we worked the one in this article. HINT: be careful when you write equation (C); the voltage source is not aiding loop current. I'll give you the answers on page 28. Remember, to succeed, just follow the four rules of the game.

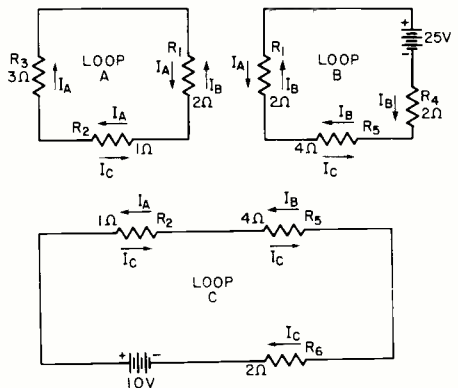

FIG. 10. Network circuit of Fig. 9 divided into three loops.

# NRI ALUMNI NEWS



Frank Skolnik ..... President  
Walter Berbee ..... Vice President  
James Kelley ..... Vice President  
J. Arthur Ragsdale ..... Vice President  
David Spitzer ..... Vice President  
Theodore E. Rose ..... Executive Sect.

## Chapter Chatter

### *HOWARD SMITH AND LYMAN BROWN OF SPRINGFIELD, MASS., AND ART RAGSDALE OF SAN FRANCISCO VISIT NRI*

Howard Smith, chief organizer of the Springfield, Mass., Chapter and a past Vice President and President of the NRI Alumni Association, together with Lyman Brown, former Technical Advisor to the Springfield Chapter, paid a visit to the National Radio Institute immediately following Washington's Cherry Blossom Festival.

It was only one of several visits that they have made to NRI. This time they renewed acquaintances with the Institute staff and personnel, and repeated their customary practice of photographing everything in sight. They were then guests of NRIAA Executive Secretary Ted Rose at luncheon.

Just two weeks later the Institute was pleased to welcome Art Ragsdale, chief organizer, first Chairman, and currently Secretary of the San Francisco Chapter, also a National Vice President of the NRI Alumni Association for 1961 and 1962. He and Mrs. Ragsdale vacationed in Miami in early spring. On their return trip they came by way of Washington so Art could drop in at the Institute. It was his first visit. Ted Rose acted as host, introduced him to the staff, and took him on a grand tour of the Institute to show him how the wheels go round.

All three of you gentlemen, come back again real soon!

DETROIT CHAPTER made a tour of Radio Station WLDM-FM. The group included the wives of four of the members. The tour was conducted by Mr. Dick Bernard, Engineer. He was very courteous and generous with his information and explanations of such things as the Conelrad System, Wave Guides, background music for hotels and restaurants, station programming, and of course the stereo equipment and its use.

Interest and enthusiasm were quite high at

another meeting due to two projects which had been scheduled for the evening. Secretary George Povlich was scheduled to give a talk and demonstration on TV sync systems using the NRI TV Kit that came with his course. The other project was an auto radio brought in by Charles Cope and it stirred up quite a discussion about the best way to service an auto radio. Secretary Povlich had his way and some of the other members had theirs. It ended by John Nagy and one group taking the radio to one end of the hall and Secretary Povlich and his group going to other end. Eventually everyone was happy with the results.

Radio and TV demonstrations are still being conducted at each meeting. The members feel that these demonstrations are valuable and important in improving their practical knowledge of Radio-TV servicing.

While on vacation in California, John Nagy visited the Los Angeles Chapter. He enjoyed his visit and brought back a taped message from the members, which the Detroit Chapter members were pleased to hear.

FLINT (SAGINAW VALLEY) CHAPTER members enjoyed a social evening to which they brought their wives or sweethearts (except the Chairman who brought his mother-in-law, his wife being ill in the hospital). The occasion was a visit to WNEM-TV Studios. The program put on by the station for the group lasted two and one-half hours. The members and their wives and sweethearts thoroughly enjoyed the evening.

At the preceding meeting, the B and K Manufacturing Company staged a program for the Chapter which was very well attended indeed.

The members were saddened by the passing of Treasurer Edward Miller. James Windom was elected to assume his duties as Treasurer.

In the list given in the April-May issue of the officers elected to serve the Chapter for 1962, it was indicated that Henry Hubbard

was a member of the Executive Committee. This was an error. Actually, he is Secretary of the Chapter. Our apologies, Henry.

LOS ANGELES CHAPTER was very pleased to welcome John Nagy, Past Chairman of the Detroit Chapter, who while visiting friends in California also dropped in at a meeting of the Chapter for a visit. He addressed the members on the projects under way in the Detroit Chapter, also on transistor power supplies and portable tape recorders. The members considered this visit quite a treat.

The Chapter has made arrangements with the telephone company for the loan of their films to be shown at meetings. At one meeting three such films were shown. At another one the members particularly enjoyed a film entitled "Aleutian Sky Watch: A Continuation of the Radar Dew Line at the Arctic Circle."

Plans to purchase a TV Kit from NRI and assemble it as a project at meetings has been under consideration.

The latest member to join the Chapter is William G. Panakls. Pleased to number you among the membership, Bill!

SOUTHEASTERN MASSACHUSETTS CHAPTER spent an entire evening on a subject that is becoming more and more important, color TV. Manuel Sousa headed up this program. Use of Ernest Grimes' slide projector and slides that he made from an RCA color set schematic made this program much more interesting and informative than it otherwise would have been. The Chapter plans to devote more time in the future to color TV.

As we go to press a social evening was planned to be held late in May in New Bedford. These socials are always well attended.

The Chapter reports three new members: Manuel Figueiredo, New Bedford; Raymond Valcourt, Swansea; and Joseph Valcourt, Tiverton. Our congratulations to these new members!

MINNEAPOLIS-ST. PAUL (TWIN CITY) CHAPTER was plagued with the effects of a severe winter in Minnesota. Frequent and heavy snowstorms handicapped some of the members in getting to the meetings, particularly those who live considerable distances from St. Paul where the meetings are held. But now that this is all behind us the Chapter has once again returned to normal.

NEW YORK CITY CHAPTER is humming along with its usual activity, due to the excellent programming job done by the Executive Committee in scheduling lectures and

demonstrations by its members.

Executive Chairman Tom Hull spends a great deal of his time giving informative and educational lectures. Recently he has concentrated on jogging the members' memories with a series on basic fundamentals, something the members all feel they need now and then.

Frequently a member will keep the others entertained at a meeting with tales of his experiences in television or radio servicing. And the members always enjoy and are enlightened by Vice Chairman Jim Eaddy's many fine lectures on and demonstrations of transistor servicing.

Chairman Dave Spitzer and Tom Hull are pooling their talents in a series of lectures and scope instructions on signal tracing in television receivers.

PHILADELPHIA-CAMDEN CHAPTER members were again guests of the General Electric Company in Philadelphia for another of the spectacular programs GE puts on for the Chapter. Without doubt GE has a high regard for the Philadelphia-Camden Chapter, since this is the third such program the company has staged for the Chapter. This one was called the "General Electric Color Television Seminar; Exclusively for Members of the National Radio Institute Alumni Association."

Mr. George Walker, General Manager, Special Products Division, did his usual fine job of conducting the program. He not only gave the members a first-hand knowledge of color but also some valuable pointers on troubleshooting and how to set picture tubes up without the use of too many instruments. He also went into detail about the instruments and how to get the most out of them. The members felt that this was a very profitable meeting and that with the knowledge and information they obtained, they will be able to service color sets a lot easier.

Representatives of the Philco Corporation were scheduled to deliver a talk and demonstration on the new Philco portables but plans for this fell through. Harvey Morris took over for the evening and gave a talk on tracking down short circuits. Harvey did as excellent a job with this as with all his other talks and demonstrations.

It seems that hardly a month goes by that new members are not admitted to the Chapter. Those joining in the past few months were John Sgrignuoli, Zygmunt Zogiel, Thomas Raab, David Maher, all of Philadelphia, and Louis Polito, of Camden. Welcome to the Chapter, gentlemen!

## **PITTSBURGH CHAPTER HOPES TO RIVAL PHILADELPHIA-CAMDEN CHAPTER**

The Pittsburgh Chapter has shown a remarkable new spirit in the past year and a half. It is all due to the dynamic leadership of Howard Tate, now serving his second term as Chairman, and to those members who are aiding him in his efforts to build a bigger and better Chapter.

Tate has been using many ideas like those in the Alumni Association bulletin "Suggestions To Local Chapters Concerning Programs, Getting New Members and Maintaining Attendance." This bulletin was distributed in quantity to all the Chapters last March. Tate points out that the effectiveness of the suggestions is proved by the growth in membership, improvement in programs and increase in attendance of the Pittsburgh Chapter. He says "I still have that hazy idea of making the Pittsburgh Chapter on a par with the Philadelphia-Camden Chapter." Tate has taken on a formidable opponent. The Philadelphia-Camden Chapter has long been the largest and strongest of all the local Chapters, mostly as the result of go-getter Jules Cohen's drive, enthusiasm and hard work. But go ahead and try, Howard. Not only is competition healthy but your Chapter is bound to benefit.

PITTSBURGH CHAPTER held an "Open House" which the members had long looked forward to with a great deal of anticipation. There were sixty men present, of which fifty-six were NRI or NRIAA connected, two from B and K Manufacturing Company and the other two from the sponsor, the Radio Parts Company.

The program included a wonderful service clinic on TV receivers and transistors, as B and K demonstrated their 1076 Analyst and their 960 Transistor Analyst. This was a thorough and complete demonstration. It did carry the program well into the night but the guest speaker, Mr. J. W. Kuntz, and his superior were so pleased with the turnout of NRI men that they would have accommodated the meeting with almost anything that was asked of them.

For door prizes, the Radio Parts Company supplied a condenser checker, a big RCA Wall Clock and a large Burnzomatic Torch outfit. All the members present were well pleased with this program.

At another meeting, Mr. Wade H. Gaylor, Service Engineer for Motorola, was a guest speaker. He also spoke on transistors and the members thoroughly enjoyed his talk.

SAN FRANCISCO CHAPTER Program Chair-Andy Royal gave a lecture on TV high voltage circuits. This well-delivered lecture was met with warm enthusiasm by the members present. Practical application of this information in troubleshooting a defective high voltage set in the Chapter's shop was definitely effective and fruitful.

At another meeting Andy Royal undertook a discussion program devoted to transistor theory and servicing, also TV servicing.

Chairman Ed Persau has initiated an intensified campaign to bring in new members by urging each member of the Chapter to submit suggestions and proposals in support of this campaign.

The Chapter recently admitted W. Hillman to membership. Congratulations, Mr. Hillman!

SPRINGFIELD (MASS.) CHAPTER'S shop meetings are one of the most important and valuable of its various activities. The following is an account of a typical shop meeting.

It was proposed, and the suggestion was adopted, that members bringing sets to be repaired in the shop should go to work on them immediately. Then, during the regular meeting, a discussion would be held as to what was wrong with the set, the part or parts which caused it and the procedure used to repair it.

This gives all the members present an opportunity to learn from actual practice; seeing the problem and how it is solved is worth more than reading for hours. It also gives skill in interpreting schematics. Some members travel as much as a hundred miles to attend these shop meetings and it is felt that adoption of the proposal enables them to get much more out of these shop meetings.

Ray Sauers finally completed his portable FM transistorized set and it works fine. Mr. Richardson brought in a hi-fi and explained to Mr. Dorman what was wrong with it and how he fixed it. Joe Gaze is still babying his "dog" in the corner but we believe that his troubles will soon be over. Hugo Walpurgis, Frank Piantek, Steve Chomyn and Stanley Szpakowski had fun repairing a TV set which had poor high frequency response; the problem was solved by adjusting the ringing coil in the set. Gus Lorenzatti, Joe Gaze and Secretary John Park were still working on a set when Chairman Norman Charest said it was getting close to 11 o'clock and he had to go to work. A half hour later he was still saying the same thing. That's when the members decided to call it a night and go home.

## CHAIRMAN OF LOS ANGELES CHAPTER OF NRIAA TRIPLES HIS RADIO-TV SERVICE BUSINESS

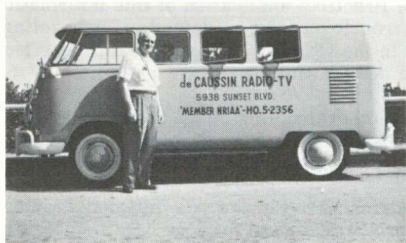

The accompanying photo shows Graduate Eugene deCaussin and his new service wagon. Mr. deCaussin, who is Chairman of the Los Angeles Chapter of the NRI Alumni Association, operates a full-time Radio-TV service shop in Hollywood. According to reports reaching NRI, Mr. deCaussin's business has tripled in the last year and he owes his success to honest prices and fair dealing with his customers.

### Directory of Local Chapters

*Local chapters of the NRI Alumni Association cordially welcome visits from all NRI students and graduates as guests or prospective members. For more information contact the Chairman of the chapter you would like to visit or consider joining.*

CHICAGO CHAPTER meets 8:00 P. M., 2nd and 4th Wednesday of each month, 666 Lake Shore Dr., West Entrance, 33rd Floor, Chicago. Chairman: Edwin Wick, 4928 W. Drummond Pl., Chicago, Ill.

DETROIT CHAPTER meets 8:00 P. M., 2nd and 4th Friday of each month, St. Andrews Hall, 431 E. Congress St., Detroit. Chairman: James Kelley, 1140 Livernois, Detroit, Mich., VI-1-4972.

FLINT (SAGINAW VALLEY) CHAPTER meets 8:00 P. M., 2nd Wednesday of each month at Chairman Andrew Jobbagy's Shop, G-5507 S. Saginaw Rd., Flint Mich., OW 46773.

HAGERSTOWN (CUMBERLAND VALLEY) CHAPTER meets 7:30 P. M., 2nd Thursday of each month, at homes or shops of its members. Chairman: George Fulks, Boonsboro, Md., GE2-8349.

LOS ANGELES CHAPTER meets 8:00 P. M., 2nd and last Saturday of each month, 5938 Sunset Blvd., L. A. Chairman: Eugene DeCaussin, 5870 Franklin Ave., Apt. 203, Hollywood, Calif., HO 5-2356.

MILWAUKEE CHAPTER meets 8:00 P. M., 3rd Tuesday of each month, at home of

Treasurer Louis Sponer, 617 N. 60th St., Wauwatosa, telephone SP4-3289. Chairman: Philip Rinke, RFD 3, Box 356, Pewaukee, Wis.

MINNEAPOLIS-ST. PAUL (TWIN CITIES) CHAPTER meets 8:00 P. M., 2nd Thursday of each month, Walt Berbee's Radio-TV Shop, 915 St. Clair St., St. Paul. Chairman: Paul Donatell, 1645 Sherwood Ave., St. Paul, Minn., PR 4-6495.

NEW ORLEANS CHAPTER meets 8:00 P. M., 2nd Tuesday of each month, home of Louis Grossman, 2229 Napoleon Ave., New Orleans. Chairman: Herman Blackford, 5301 Tchoupitoulas St., New Orleans, La.

NEW YORK CITY CHAPTER meets 8:30 P. M., 1st and 3rd Thursday of each month, St. Marks Community Center, 12 St. Marks Pl., New York City. Chairman: David Spitzer, 2052 81st St., Brooklyn, N. Y., CL 6-6564.

PHILADELPHIA-CAMDEN CHAPTER meets 8:00 P. M., 2nd and 4th Monday of each month, K of C Hall, Tulip and Tyson Sts., Philadelphia. Chairman: John Pirrung, 2923 Longshore Ave., Philadelphia, Pa.

PITTSBURGH CHAPTER meets 8:00 P. M., 1st Thursday of each month, 436 Forbes Ave., Pittsburgh. Chairman: Howard Tate, 615 Caryl Dr., Pittsburgh, Pa., PE-1-8327.

SAN ANTONIO ALAMO CHAPTER meets 7:30 P. M., 2nd Thursday of each month, National Cash Register Co., 436 S. Main Ave., San Antonio. Chairman: Thomas DuBose, 127 Harcourt, San Antonio.

SAN FRANCISCO CHAPTER meets 8:00 P. M., 1st Wednesday of each month, 147 Albion St., San Francisco. Chairman: E. J. Persau, 1224 Wayland St., San Francisco, Calif., JU 4-6861.

SOUTHEASTERN MASSACHUSETTS CHAPTER meets 8:00 P. M., last Wednesday of each month, home of John Alves, 57 Allen Blvd., Swansea, Mass. Chairman: James Donnelly, 30 Lyon St., Fall River, Mass. OS 2-5371.

SPRINGFIELD (MASS.) CHAPTER meets 7:00 P. M., 1st Friday of each month, U. S. Army Hdqts. Building, 50 East St., Springfield, and on Saturday following 3rd Friday of each month at a member's shop. Chairman: Norman Charest, 43 Granville St., Springfield, Mass.

#### ANSWER TO PROBLEM

$$I_a = 1.54 \text{ amps}$$

$$I_b = 4.06 \text{ amps}$$

$$I_c = 1.12 \text{ amps}$$

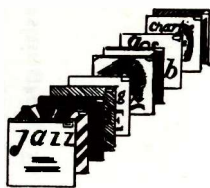

FREE - 10

# STEREO LP RECORDS

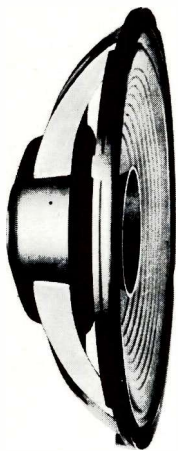

Buy this top quality, extended range, American made 15" speaker and get 10 stereo records FREE! Of course, to make up for all the records we expect to give away, we'll have to charge a little more for the speaker -- say \$64.50.

**HOWEVER . . .**

If you just want a smooth, crisp, 15" speaker (35-13,000 cps response) that handles 20 watts easily (40 watts peak) -- at a rock bottom price -- then forget all about the free records and this exceptional Conar buy is yours for

only **\$20.75**  
(student and graduate price)

**ADDITIONAL SPECIFICATIONS:**

Free cone resonance 50 cps. Mechanical crossover 4500 cps. 10,500 gauss flux density. Diameter: 15-1/8". Depth: 6-11/32". Baffle opening: 13-7/8". Heavy duty die-cast frame. Net weight: 9 lbs. Shipping weight: 10 lbs.

# CONAR *instruments* - Division of NRI

----- **ORDER BLANK** -----

CONAR Instruments, 3939 Wisconsin Ave., Washington 16, D. C.

I enclose \$\_\_\_ plus \$\_\_\_ for postage and insurance. Please ship at once Conar 15" Extended Range Speaker (s). See page 17 for postage rates.

Name ..... Stu. No .....

Address .....

City ..... Zone ..... State .....

**NRI NEWS**  
3939 Wisconsin Ave.  
Washington, D. C.

Mr Ed H Engel  
906 Taylor  
Crystal City Mo

H19-C239

FCC

Second-class  
postage paid  
at Washington, D. C.

STEREO EP  
PRICE - 10