

Scanning - Shortwave - Ham Radio - Equipment
Internet Streaming - Computers - Antique Radio

Monitoring Times[®]

A Publication of Grove Enterprises

Volume 30, No. 11
November 2011
U.S. \$6.95
Can. \$6.95
Printed in the
United States



2012 Annual

Radio Buyer's Guide

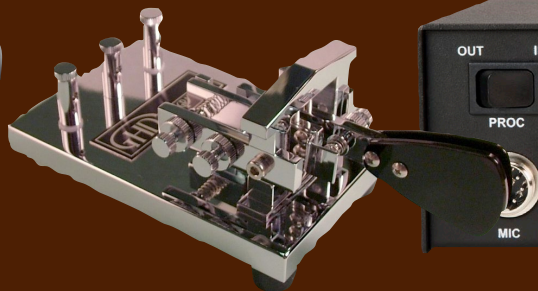

In this issue:

- Linears, Keys and Other Necessities
- Guide to Buying a New Scanner
- Next Level Shortwave Listening

GROVE

**Your Source for Radio Scanners,
Receivers, Accessories,
and Publications**

**Grove means service. You won't find
better customer service anywhere. BUY TODAY!**

Established in 1979 by well-known communications expert Bob Grove, Grove Enterprises has become a world leader in radio monitoring equipment, accessories, and publications.

If you decide you don't like a product, Grove Enterprises doesn't penalize you for it. There is NO restocking fee so long as you call our toll free number for a return authorization within fifteen days of shipment and the item is returned in new condition. Once the item is received we will give you credit toward another item or issue a full refund (less shipping charges). Software cannot be returned if opened.

That's it! No hassle! No negotiations! Just call 1-800-438-8155 and our friendly staff will assist you with a return authorization number.



Shipping/ Handling Charges

Total Order	Shipping Charges
\$1-\$19.99	\$3.00
\$20-\$49.99	\$6.95
\$50-\$99.99	\$9.95
\$100-\$399.99	\$13.95
\$400-\$899.99	\$17.95
\$900-\$1499.99	\$20.95
\$1500-\$1999.99	\$24.95
\$2000-\$2499.99	\$28.95
\$2500+	\$32.95

GROVE
(800) 438-8155
www.grove-ent.com

**CALL
TODAY!**

Grove Enterprises, Inc. - www.grove-ent.com
(800) 438-8155; (828) 837-9200; fax: (828) 837-2216
7540 Hwy 64 W; Brasstown, NC 28902 - email: order@grove-ent.com

ALINCO

DJ-X7T	SCN 3	\$179.95
DJ-X11T	SCN24	\$329.95

GRE

PSR-100	SCN16	\$89.95
PSR-200U	SCN17	\$89.95
PSR-310	SCN22	\$179.95
PSR-410	SCN23	\$179.95
PSR-500	SCN18	\$399.95
PSR-600	SCN19	\$399.95
PSR-700	SCN56	\$189.95
PSR-800	SCN57	\$449.95

UNIDEN

BCT15X	SCN31	\$219.95
BCD996XT	SCN21	\$469.95
BCD396XT	SCN53	\$469.95
BCD346XT	SCN45	\$214.95
BCT8	SCN08	\$162.95
HomePatrol-1	SCN55	\$499.95
BC355C	DS-BC355	\$99.95
BC95XLT	DS-BC95XLT	\$109.95

ICOM

R6	SCN54	\$199.95
R20	SCN 20	\$539.95

AOR

AR8200IIIB	SCN51	\$669.95
------------	-------	----------

RAMSEY

ABM1 Air Band Monitor	SCN05	\$149.95
-----------------------	-------	----------

ANTENNAS & CABLES

Grove Hidden Flex-tenna	ANT49	\$19.95
Austin Condor	ANT 14	\$34.95
Grove Scanner Beam III	ANT 03	\$69.95
Procomm CD144M/BN mag mount antenna	ANT50	\$19.95
OMNI II Scanner	ANT 5	\$29.95
WiNRADiO AX-71C Disccone	ANT01	\$89.95
WiNRADiO AX-37A Wide-band Log Periodic	ANT28	\$389.95
WiNRADiO AX-37AM Wide-band Log Periodic	ANT29	\$499.95
WiNRADiO AX-07B flexible VHF/UHF	ANT47	\$27.95
WiNRADiO AX-91M magnetic antenna base	ANT48	\$27.95
Icom AH-8000 Wide-coverage Disccone	ANT54	\$269.95
Grove Flex-tenna HVU	ANT45	\$14.95
Grove Flex-tenna VU	ANT46	\$9.95
Professional Wideband Disccone	ANT 9	\$99.95
Scantenna + 50' coax	ANT 7	\$49.95
Super-M Ultra Base Station	ANT61MBS	\$189.95
Super-M Ultra Mobile antenna w/NMO mount	ANT61NMO	\$109.95
Super-M Ultra Mobile mag mount	ANT61	\$124.95
Super-M Multiband base antenna	ANT10MBS	\$99.95
Super-M Mobile antenna w/ NMO mount	ANT10NMO	\$79.95
AOR DA3200 ultra wideband disccone antenna	ANT 62	\$199.95
AOR MA500 Wide Range	ANT 12	\$109.95
AOR SA7000 super-wide receiving	ANT 39	\$249.95
WiNRADiO WR-AX-31C Log-Periodic Antenna	ANT 58	\$139.95
WiNRADiO AX-24B disccone antenna	ANT 63	\$349.95
Grove Universal Telescoping Whip	ANT 6	\$14.95
Diamond HT/Receiving & Scanner antenna	ANT 64	\$21.95
Super-M Superior Mobile Antenna	ANT 10	\$94.95
Create CLP51301N Log-Periodic Antenna	ANT 16	\$439.95
Create CLP51302N Log-Periodic Antenna	ANT 17	\$319.95
Diamond SRH77CA HT/Receiving & Scanner Ant	ANT67	\$21.95
25' of RG-6U cable	CBL25	\$14.95
50' of RG-6U cable	CBL 50	\$19.95
100' of RG-6U cable	CBL 100	\$24.95

MISCELLANEOUS ACCESSORIES

UNIDEN UA-72 DC CORD	DCC 19	\$19.95
Universal Cigarette Adaptor	DCC 3	\$12.95
Ramsey Broadband Preamp	PRE 2	\$59.95
Scancat Gold for Windows	SFT 2W	\$79.95
Scancat Gold for Windows SE Upgrade	SFT 2SE	\$49.95
Scancat-Lite Plus	SFT 19	\$29.95
PAR VHF Intermod Filter 152MHz	FTR 152DS	\$69.95
PAR VHF Intermod Filter 158MHz	FTR 158DS	\$69.95
PAR VHF Intermod Filter 462MHz	FTR 462DS	\$69.95
FM Trap Filter 88-108MHz	FTR-FMDS	\$69.95
PAR NOAA Weather Filter 162 MHz	FTR 162DS	\$69.95
GRE Superamplifier	PRE 1	\$53.95
Noise Cancelling Mobile Speaker	SPK 7	\$8.95

The WINRADIO *EXCALIBUR Pro*TM receiver has a *Pause* button to pause the audio while you are away. Neat?



WINRADIO[®] ... the future of radio.TM Online Shop Site Index

Home | Products | Dealers | Developers | Downloads | Registration | About us | Careers | Contacts

WR-G33DDC 'EXCALIBUR Pro'

Overview

The WINRADIO WR-G33DDC 'EXCALIBUR Pro' is a high-performance, low-cost, direct-sampling, software-defined, shortwave receiver with a frequency range from 9 kHz to 49.995 MHz. It includes a *real-time* 50 MHz-wide spectrum analyzer and 4 MHz-wide instantaneous bandwidth available for recording, demodulation and further digital processing.

This product is an advanced version of the award-winning **WR-G31DDC** receiver, offering many additional features and improvements, such as for example:

- 4 MHz instantaneous processing bandwidth
- Low-noise preamplifier
- Configurable preselection filters
- Filter bandwidth adjustable down to 1 Hz
- 0.5 ppm frequency stability
- Test and measurement functions
- Pause function



The receiver's superior performance results from its innovative, direct-sampling, digital down-conversion architecture along with the use of lead-free components and design concepts.

Features

- 9 kHz to 49.995 MHz continuous frequency range
- Direct sampling
- Digital down-conversion
- 16-bit 100 MSPS A/D converter
- 50 MHz-wide, real-time spectrum analyzer
- 4 MHz recording and processing bandwidth
- Continuously adjustable filter bandwidth down to 1 Hz
- Three parallel demodulator channels
- Pause function
- Waterfall display functions
- Audio spectrum analyzer
- Audio and IF recording and playback
- Recording with pre-buffering
- EIBI, HFCC and user frequency databases support
- Very high IP3 (+31 dBm)
- Excellent sensitivity (0.20 μ V SSB, 0.10 μ V CW)
- Excellent dynamic range (107 dB)
- Excellent frequency stability (0.5 ppm)
- Selectable medium wave filter
- User-configurable preselector
- Selectable low-noise preamplifier
- Test and measurement functions
- USB 2.0 interface

The receiver's robust front-end is equipped with an ultra-linearity amplifier which results in exceptional strong-signal performance. This already robust front-end is further enhanced with a user-selectable preselector that can operate either automatic or user-configurable mode. As many as 119 different filter combinations can be constructed by the user (91 band 14 low-pass and 14 high-pass). The front-end employs 3-subminiature electromechanical relays (rather than often distortion-prone semiconductor switches) to ensure high range.

Internet | Protected Mode: Off 100%

Shouldn't you pause and have another look?
www.winradio.com/epro

Monitoring Times

Vol. 30 No. 11 November 2011



Cover Story 8 2012 Annual Radio Buyer's Guide

This month *MT*'s third annual *Radio Buyer's Guide* looks at some of the things that make our shacks click: scanners, accessories, antennas and a new crop of shortwave radios.

In addition, some of our regular columnists have chipped in and examined other products of interest to readers. For example, Kirk Kleinschmidt NTOZ looks at the subject of amateur radio antenna rotators, what works, what doesn't; Dan Farber ACOLW reviews the stealthy Chameleon VI 80-10 meter vertical antenna that proves to be inexpensive and effective; Bob Grove W8JHD looks at the Sangean ATS-909X shortwave portable as well as the Jetstream power supply, and Ken Reitz KS4ZR looks at two inexpensive, amplified TV antennas that actually work.

And, as usual, there's plenty more to pique the interest of every radio enthusiast from radio restorations to plumbing the depths of longwave; chasing new HF digital signals to working the oldest AMSAT still circling the globe.

On Our Cover

This month *MT* looks at radio accessories for your shack. Tokyo Hy-Power solid state linear amp (Courtesy: Tokyo Hy-Power); Heil Pro Set Plus (Courtesy: Heil Sound); Ten-Tec 715 speech processor (Courtesy: Ten-Tec); ALS-600 linear amp (Courtesy: Ameritron); GHD single-lever paddle key (Courtesy: Tohiko Ujiie JA7JHD); Alinco DX-R8T (Courtesy: Alinco); AOR 2300 screen (Courtesy: AOR); AOR loop antenna (Courtesy: AOL); ATS-909X (Courtesy: Sangean)

MT's Guide to Buying a new Scanner 6

By Larry Van Horn N5FPW

Product models for scanner enthusiasts in the market for a new scanner have never been better. The latest crop of scanners can put you in the middle of the action with little or no effort. But, such convenience comes with a price. And, while this new generation of public service band radios is more capable than ever, there are tradeoffs to consider. It all comes down to frequencies and what's happening where you live. Larry looks at conventional analog, trunk-tracking, APCO25, civilian and military capable receivers, and guides you toward a decision that will be useful now and in the future.

Taking Shortwave Listening to another Level 10

By Ken Reitz KS4ZR

Rising sunspots lift all SWLers' spirits, but to really enjoy HF to its fullest you may need to take your listening to another level. Ken looks at three recently introduced radios spanning the price point range. Sangean's new ATS-909X proves to be a capable and portable shortwave, AM and FM receiver; Alinco's DX-R8T delivers a solid table-top performance with pluses that include DRM reception at a reasonable price; and, for the SWL who needs an all-in-one HF to UHF top shelf performer, AOR's AR2300 is just a credit card swipe away.

The Quest for Power, the "Keys" to Success, and the Accessories of Life 12

By Kirk Kleinschmidt NTOZ

There's nothing like being able to put a little steam into a frequency when band conditions get rough, that's the attraction of linear amplifiers. While Kirk is an old school QRP man, he understands your quest for more power and brings his veteran operator insights to the question of which amp is right for you. Here he examines the pros and cons of low-end to high-end linear amplifiers.

Kirk also examines other accessories that have long attracted hams, including outboard speech processors, after-market microphones, antenna rotators, and special CW keys. There are dozens of brands of each product on the market vying for your hard earned dollar and Kirk makes it a little easier to find just the right product to help you decide.

Finding the Perfect Antenna (it's not that easy!) 16

By Bob Grove W8JHD

Without an antenna your radio is just a curiosity on a shelf. *MT* publisher and antenna guru Bob Grove W8JHD looks at some of the most important aspects of radio antennas: size, frequency, design and feed. In this in-depth analysis, Bob examines vertical and horizontal antennas, mono-elements and beams, ground-planes and log periodic dipole arrays with examples and prices for some of the best available. If you're a ham, scanner enthusiast or shortwave listener, Bob will help you find the perfect antenna for your radio shack.

R E V I E W S

Sangean ATS-909X Portable SW and Two Jetstream Power Supplies 70

By Bob Grove W8JHD

Sangean has a new portable shortwave radio and *MT* founder Bob Grove W8JHD puts it to work in his listening post. Find out why Bob calls it "a good example of superior performance from a modern compact portable at a lower cost." Bob also looks at two versatile power supplies from Jetstream.





MONITORING TIMES
(ISSN: 0889-5341;
Publishers Mail Agree-
ment #1253492) is
published monthly by
Grove Enterprises, Inc.,
Brasstown, North Caro-
lina, USA.

Copyright © 2011 Grove Enterprises, Inc. Periodicals postage paid at Brasstown, NC, and additional mailing offices. Short excerpts may be reprinted with appropriate credit. Complete articles may not be reproduced without permission.

Address: 7540 Highway 64 West,
Brasstown, NC 28902-0098
Telephone: (828) 837-9200
Fax: (828) 837-2216 (24 hours)
Internet Address: www.grove-ent.com or
www.monitoringtimes.com
Editorial e-mail: editor@monitoringtimes.com
Subscriptions: order@grove-ent.com

Subscription Rates: \$32.95 in US; \$42.95 Canada; and \$58.95 foreign elsewhere, US funds. Label indicates number of issues left. Renewal notice is cover sheet 3 months before expiration. See page 76 for subscription information.

WRITE FOR MONITORING TIMES:
Learn how at
www.monitoringtimes.com/html/write_for_mt.html or
write to editor@monitoringtimes.com

Postmaster:
Send address changes to *Monitoring Times*,
7540 Highway 64 West, Brasstown, NC
28902-0098.

Disclaimer:
While *Monitoring Times* makes an effort to ensure the information it publishes is accurate, it cannot be held liable for the contents. The reader assumes any risk for performing modification or construction projects published in *Monitoring Times*. Opinion or conclusions expressed are not necessarily the view of *Monitoring Times* or Grove Enterprises. Unsolicited manuscripts are accepted. SASE if material is to be returned.

Subscription Questions?
belinda@grove-ent.com

Owners
Bob and Judy Grove
judy@grove-ent.com

Publisher
Bob Grove, W8JHD
bobgrove@monitoringtimes.com

Managing Editor
Rachel Baughn, KE4OPD
editor@monitoringtimes.com

Assistant and Reviews Editor
Larry Van Horn, N5FPW
larryvanhorn@monitoringtimes.com

Features Editor
Ken Reitz
kenreitz@monitoringtimes.com

Art Director
Bill Grove

Advertising Services
Judy Grove
(828) 837-9200
judy@grove-ent.com

TABLE OF CONTENTS

Departments:

Communications	6
Letters	74
Stock Exchange.....	76
Advertisers Index.....	76

First Departments

Getting Started	
Scanning Report	20
<i>By Dan Veeneman</i>	
<i>The Truth about Encryption</i>	

Ask Bob	23
<i>By Bob Grove W8JHD</i>	
<i>Linear amp bypass; NOAA frequencies; Inboard vs outboard DSP; Ham and public service HT combos; Nulling FM signals; Solar cycle maximum flop; Defining RDS, SDR and DSP, and a shortwave interference puzzle.</i>	

Utility World	24
<i>By Hugh Stegman NV6H</i>	
<i>WLO Begins Public RTTY Broadcasting</i>	

Digital Digest.....	27
<i>By Mike Chace</i>	
<i>New Digital Signals</i>	

On the Ham Bands	28
<i>By Kirk Kleinschmidt NT0Z</i>	
<i>The Right Rotator for the Job</i>	

Beginner's Corner	30
<i>By Ken Reitz KS4ZR</i>	
<i>Low Profile TV Antennas and PC to TV</i>	

Programming Spotlight.....	32
<i>By Fred Waterer</i>	
<i>New Programs and News Programs</i>	

Second Departments

QSL Report	34
<i>By Gayle Van Horn W4GVH</i>	
<i>New Stations, New Website, New QSLs</i>	

English Language SW Guide	35
--	-----------

MTXtra Shortwave Broadcast Guide..	47
<i>Portuguese/French</i>	

Milcom	52
<i>By Larry Van Horn N5FPW</i>	
<i>Profile of Edwards AFB</i>	

Fed Files	54
<i>By Chris Parris</i>	
<i>2011 Fed Files Wrap-up</i>	

Boats, PLANES, Trains.....	56
<i>By Iden Rogers</i>	
<i>Aeronautical Frequencies Part 2</i>	

Globalnet	58
<i>By Loyd Van Horn W4LVH</i>	
<i>Clearing Out the GN Mailbag</i>	

Below 500 kHz	60
<i>By Kevin Carey WB2QMY</i>	
<i>Tackling an RDF</i>	

Technical Departments	
Radio Restorations.....	62
<i>By Marc Ellis N9EWJ</i>	
<i>Addressing the Meissner Mystery</i>	

Antenna Topics	64
<i>By Dan Farber AC0LW</i>	
<i>Stealthy Little Vertical: The Chameleon VI</i>	

SkySurfing	66
<i>By Keith Baker KB1SF/VA3KSF</i>	
<i>Spotlight on AMSAT OSCAR-7</i>	

On the Bench.....	68
<i>Handy Video Tuning Tool: Your Wireless Camera; VHF Audio/Video Transmitter</i>	

First Look	70
<i>By Bob Grove W8JHD</i>	
<i>Sangean ATS-909X Multiband Portable Radio; Jetstream JTPS31MB Power Supply</i>	

What's New	72
<i>By Larry Van Horn N5FPW</i>	
<i>New Dictionary for Hams; NRC AM Radio Log, and ARRL's Small Antennas for Small Spaces</i>	

You may contact any MT staff writer by email by combining their **first and last name @ monitoringtimes.com**. By postal mail, you may write them in care of MT Headquarters in Brasstown. Please enclose a self-addressed, stamped envelope if you wish the columnist to reply.



COMMUNICATIONS

by Ken Reitz



AMATEUR/SHORTWAVE

Hams React to Irene

The American Radio Relay League (ARRL) reported on the activities of amateur radio operators who swung into action from Puerto Rico to Maine the week hurricane Irene wreaked havoc from the Caribbean to Canada in late August. Among the major on-air HF operations were W1AW (ARRL HQ station in Newington, Connecticut), WX4NHC (National Hurricane Center HQ station in Miami, Florida), the Hurricane Watch Net, the Salvation Army Team Emergency Radio Network (SATERN) as well as the Voice over Internet Protocol Weather Net (VOIPWX).

In addition, dozens of local ARES VHF and HF nets were also active reporting on flood conditions, handling emergency traffic and working with affected local police and fire services as needed throughout the East Coast.

Scientists "Hear" Sunspots

Stanford University researchers have developed a method of using acoustic waves to "catch sunspots in the early stage of development and giving as much as two days' warning," before such waves materialize as spots on the Sun's surface, according to an article in *Stanford Report* from August 19.

With help from data collected by NASA's Solar and Heliospheric Observatory (SOHO) satellite and its successor the Solar Dynamics Observatory (SDO), a Stanford graduate student discovered that "in the near-surface region, small-scale convection cells – about the size of California – generate sound waves that travel to the interior of the sun and are reflected back to the surface." The sunspot precursors are as deep as 65,000 kilometers inside the sun when "heard" by SDO, and they emerge on the surface one or two days later as sunspots.

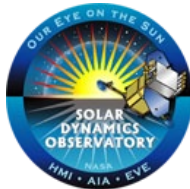

AM/FM/TV BROADCASTING

FCC Lops Off Channel 51

As part of its relentless drive to force Over-the-Air (OTA) television stations off precious UHF spectrum so that vast new fortunes can be made in mobile wireless broadband cable-TV fare, the FCC has lopped off another channel. Reporting on the action by the FCC to freeze TV and Low Power TV (LPTV) applications for channel 51 at the end of August, the *Broadcast Law Blog* noted, "it certainly looks like the FCC is predisposed to adopting the proposal of the

wireless users to clear this channel."

Channel 51 was the top-end channel for broadcast television, and proponents of wireless broadband, now occupying the spectrum that formerly had been channels 52-69, complain that those stations still on channel 51 cause interference to their wireless transmissions.

There is little wonder that wireless broadband advocates have such a strong influence on the FCC since two of the current four Commissioners came directly from the wireless broadband industry to the Commission. The fifth FCC Commissioner's chair is currently vacant, following the resignation of Meredith Attwell-Baker, who left this past June to join cable giant Comcast. Atwell-Baker had also come to the FCC from the wireless industry.

Broadcast industry watchers will have to wait to see who President Obama will nominate to fill that chair.

CCTV Goes 24/7 in D.C.

MHz Networks, which broadcasts international programming from a wide variety of sources including NHK, Al Jazeera English, and France 24 in Washington, D.C., has added two channels from China Central TV (CCTV) to both their OTA and cable broadcasts. According to a press release from the station, CCTV News will air on channel 30.3 and CCTV Documentary will air on channel 30.6.



MHz Networks CEO Fredrick Thomas is quoted as saying, "The addition of CCTV programming in D.C. opens a full-time window into China for all the residents of the region through free over-the-air and cable TV distribution." It also joins local D.C. AM giant WCRW, whose programming is a 24/7 relay of China Radio International.

Are You Ready for a New TV Standard?

Cynics among us are suspicious of change, especially if it appears to serve no real purpose. The switch from analog to Digital TV (DTV) in 2009 struck some as much ado about nothing, particularly since many rural viewers lost many long time favorite TV channels in the aftermath. But, the new 16:9 aspect ratio screens are better suited to the display of HD movies, so most consumers applauded the change.

Then, just a year later, came a wave of PR office generated hype about 3D TV. Wait a minute; weren't we just forced to buy a new DTV set? Now, we're told we have to buy a 3D TV? You may or may not be thrilled to know that the folks who brought us both (the Consumer Electronics Association) are now asking engineers to come

up with new standards for what are being called next-gen TV sets.

The new feature? 21:9 aspect ratio screens. According to a report on *TVTechnology.com*, Euro-TV manufacturer Philips began the move to 21:9 last year when it introduced its Cinema 21:9 Platinum set (about \$6,500) which is used for CinemaScope 3D HDTV using active shutter glasses. Oh, the 3D glasses are extra.

PUBLIC SERVICE RADIO

Oakland Police Radio Problems

A column in the San Francisco *Chronicle* from late August notes the problems that the nearby city of Oakland has been experiencing with its brand-new \$10 million, 2,000 radio system. While the system's technical director called it "a very solid system," the column reports that police on the beat tell another version. One officer was quoted as saying, "Sometimes it sounds like everyone is underwater." The tech director acknowledged the problem, saying that was the price of switching to a digital system.

Piggy-backing on Motorola System

An article in the Hinds County (Mississippi) *Clarion-Ledger* reported the settlement of a lawsuit brought against Motorola by the county which had paid the company for an 800 MHz radio system. The county later found out that a "number of entities" outside Hinds County were somehow given the county's confidential ID, which allowed them "to operate their own radio communications networks using Motorola brand radios" on the Hinds County system.

The article notes that Motorola paid \$1.4 million to settle the suit on the very day the case was set to be tried. The problem is that terms of the settlement were to remain confidential. The fact that some details were made public has in turn produced additional litigation to find out how details of the settlement were leaked. Several local media companies joined in a request to make the details public, noting that the county is a public government entity.

TECHNOLOGY

Infrastructure vs. Irene

The fury of Hurricane Irene in late August that left millions without power for days also took its toll on the East Coast's communications infrastructure as detailed in an article in *Computer World*. According to the article 6,500 cell phone towers and sites were damaged or disrupted. That number included 44% of all such sites in Vermont, 36% in Connecticut, 31% in Rhode Island, 25% in Virginia and 14% in North Carolina.

In addition, 210,000 wired customers and 1 million cable-TV customers were also said to be without service. The good news is that the FCC reported that no 911 call centers were out of commission as a result of the emergency.

SATELLITE

DISH, DirecTV Lay Their Bets

In an article from August 29, the *Wall Street Journal* examined the two decidedly different directions DISH Network and DirecTV are taking towards their futures. DISH is in the midst of a spending spree that included purchasing the ailing video store chain Blockbuster (\$320 million) and bankrupt TerreStar (\$1.375 billion), a wireless broadband hopeful that had planned a big nationwide smartphone business. These purchases would somehow combine with DISH's plans for a U.S.-wide wireless broadband network that would position the company for a brave new dish-less world.

Already suffering significant subscriber defections, the article notes that CEO Charlie Ergen could always sell out to a phone company eager for the spectrum that comes with the TerreStar purchase or even merge with rival DirecTV.

For its part, DirecTV, with its satellite rights lock on NFL football, seems confident to continue business as it's always been. In fact, according to the article, DirecTV is going into debt to buy back its own shares.

But, things aren't as they've always been. As noted in the *Hollywood Reporter*, both satellite services saw their first ever quarterly loss of subscribers since their launch in the mid-1990s. The article quoted one industry analyst as describing pay TV subscriber growth as "a zero sum game."

Space Debris = "Collision Cascade"

A report by the National Research Council, commissioned by NASA, warns that the worlds' various Low Earth Orbit satellite systems are at risk because of the amount of space debris in orbit along with those systems, according to an article in the *Washington Post*. The report warns that such debris could trigger a "chain reaction known as a 'collision cascade.'"

The report also noted that the U.S. Strategic Command, which tracks orbital debris, says there are some 22,000 bits of space junk 10 cm or larger and there could be hundreds of thousands, if not millions, of smaller pieces that it doesn't track, but that could still cause a serious collision with a working satellite.

Among the solutions the report recommends: Increased staffing (not an easy thing to do under present austerity budgets) and working with the State Department on the international front to urge cooperation among space debris generating nations (also not an easy task, given that China created thousands of bits of debris when it famously destroyed one of its own defunct satellites in a demented demonstration of its satellite killing technology).



FCC ENFORCEMENT

\$25,000 for Interference on Police Frequency

A Las Vegas, New Mexico man has been fined \$25,000 by the FCC for operating on 159.150 MHz, the primary dispatch frequency for that city's police department. According to FCC documents, field agents were called in to investigate on-air interference from an unknown party using the city's police frequency to broadcast obscenities and threats to officers and their families. The on-air antics forced the department to use a backup frequency for their communications. The agents were advised that the individual had made over 400 such transmissions in the three days prior to their arrival.

Using direction finding equipment the agents determined that the subject was in fact mobile, but were able to track his position until he stopped at a duplex apartment. The transmissions continued, which allowed the agents to determine exactly where he was in the apartment. Local police officers observed the subject inside the duplex holding a handheld radio. The subject was apprehended along with the HT he had used in the alleged crime.

In assessing the fine the FCC noted that the base fine for unauthorized transmission is \$10,000 and the base fine for interference is \$7,000. The fine was increased another \$8,000 because of the threats against the individual officers and their families and because the city was forced to use a backup frequency to continue normal dispatch operations.

QRO FM, Two AM Pirates Tagged

FCC field agents would have had no trouble locating any of the following FM operators in this month's FM Pirate Busts thanks to their huge signals. The FCC issued Notices of Unlicensed Operation (NOUO) to the operator of a pirate FM station in Aurora, Colorado for operating on 94.1 MHz at more than 69,000 microvolts/meter at 3 meters and to an FM pirate operating out of Barberton, Ohio on 94.5 MHz at 188,464 microvolts/meter at 83 meters. Another FM pirate out of Enterprise, Oregon was found operating more than 96,000 microvolts/meter at 600 meters. Maximum allowed under Part 15 rules is 250 microvolts/meter at 3 meters.

There were two AM pirates bagged by FCC field agents in the 30 day reporting period since the last issue of *Communications* went to press. A man from Santa Clarita, California was issued an NOUO for operating on 1610 kHz with an output of 2,730 microvolts/meter at 145 meters. A man from South Richmond Hill, New York was caught on 1620 kHz at 900 microvolts/meter at 1132 meters (maximum allowed for AM Part 15 operations at 1610 kHz is 14.9 microvolts/meter at 30 meters).

Communications is compiled by Ken Reitz KS4ZR (kenreitz@monitoringtimes.com) from clippings and links supplied by our readers. Many thanks for this month's fine reporters: Anonymous, Rachel Baughn, Bob Grove, Larry Van Horn

NEW 5th Edition!

THE WORLDWIDE LISTENING GUIDE

by John Figliozzi

This new 5th Edition of John Figliozzi's *Worldwide Listening Guide* includes completely updated listings of popular radio programs that can be heard using traditional shortwave receivers, as well as today's newer listening technologies. Program listings are classified by genre and tell you the time of day and day of the week they are on-the-air, and how to find them on your shortwave receiver, WiFi radio, computer, and other listening devices.

This new edition updates and reviews all of the ways programs can be heard — "live," on-demand, WiFi, podcast, satellite, internet, digital and, of course, analog AM, FM and SW.

Spiral-bound to open in a flat, easy-to-use format. This all-new edition will be available about December 1, 2011 — a perfect holiday gift!

112 pages — \$24.95 + shipping

We're accepting pre-orders, so order your copy today from:

The W5YI Group
1-800-669-9594
www.w5yi.org

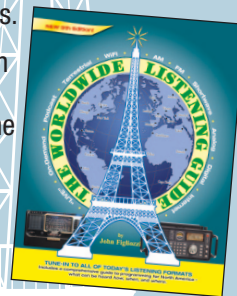

SCANNERS

MT's Guide to Buying a new Scanner

By Larry Van Horn, N5FPW
MT Assistant/Technical Editor

It is a question as old as the scanner hobby itself and it is one of the most often asked questions we receive on our technical support lines at Grove Enterprises – “What scanner do you recommend I buy?” My usual reply is that this is a very difficult question to answer straight up without some additional information from the potential buyer.

So, in this portion of our 2011 *MT Buyers Guide*, I will address some of the common questions that need to be answered by you as a potential buyer before you make your purchase of a VHF/UHF receiver/scanner. This will help you make a decision on what scanner is right for you. Because of page restraints, this article will be restricted in its scope and nature. I won't deal with additional scanner accessories such as outside or mobile antennas, external speakers, or computer programming of the specific scanners.

Before I jump into specific details, let me get one bit of important business out of the way: the difference between a scanner and a wide-band communications receiver (HF/VHF/UHF). Although they are often lumped in with scanners, a communications receiver with wide frequency coverage, from manufacturers such as Yaesu, Alinco, AOR, Icom and WinRadio, are actually quite a bit different from a scanner.

Yes, they have a wide, continuous frequency coverage, which is a plus, but most of these receivers do not offer some of the specific “Police/Public service” monitoring features that are important to a monitor, such as TrunkTracking technology, dynamic memory systems/bank grouping, fire page tone-out, close call/stalker capability or digital P25 APCO reception found on many Uniden or GRE models. It should also be noted that WinRadio has limited analog-only trunk tracking capability with an add-on software package and AOR has an add-on unit that can decode conventional P25 communications only, no trunk systems. These wide band receivers also scan quite a bit slower than Uniden/GRE scanners.

That leaves the VHF/UHF scanner. A scanner is a frequency agile radio that will allow you to program various radio frequencies and then scan those frequencies looking for activity, stopping to allow you to listen when it finds activity.

The traditional scanners from Uniden/GRE are optimized for scanning frequencies between 25 and 1300 MHz – basically the Police, Air (civilian/military), Fire, EMS, Marine and federal government/military “Action Bands.” This

optimization includes presets (modes, steps and functions) that are automatically set based on the frequency range being monitored.

If you want the extended frequency coverage (shortwave and AM/LW coverage below 25 MHz) and UHF to microwave frequencies above 1300 MHz, the wide-band receiver should be considered in your buying equation, but you will have to deal with a more limited set of some scanning functions that I mentioned previously.

Understanding Specifications

The importance of the specifications indicating a scanner's performances largely depends on where you live. If you live in a large urban area, you will need a high degree of selectivity (the ability to reject interfering signals) because of the large number of radio signals found in urban areas. If you live in a rural area with few stations, then greater sensitivity (the ability to detect weak radio signals) will be more important.

Sensitivity is measured in microvolts, abbreviated mV. The lower the number of microvolts, the weaker the signal that the scanner can detect from which to produce intelligible audio.

Selectivity is measured in kHz for a certain level of interference rejection. This rejection is measured in decibels (dB), usually at 50 dB. A “50 dB” rejection means an interfering signal is reduced to a level 100,000 times weaker than its actual strength. If a scanner has a selectivity specification of “30 kHz at 50 dB,” this means signals 30 kHz or more away from the signal you want to hear are reduced in strength 100,000 times.

Signals can also “mix” in a scanner's internal circuits, producing false signals known as images. Images are an unavoidable by-product of a scanner's circuitry, but the better scanners with triple conversion circuitry can reject most of these phantom signals and reduce their strength. Image rejection is how this is measured, and a good scanner should have image rejection of 50 dB or greater.

While there are some exceptions, as a general rule you do get what you pay for in scanner performance. More expensive models will have better sensitivity, selectivity, and image rejection than less expensive units.

What Frequencies Do You Want to Monitor?

An important consideration to make when purchasing any radio is what frequency ranges you're interested in monitoring. The “Action Bands” listed below offer some general ranges in the VHF/UHF spectrum where the bulk of voice traffic occurs that most radio hobbyists are interested in monitoring.

25-50 MHz:

This is known as the “VHF low” band. Stations that can be heard in this range include businesses, federal, state, and local governments, law enforcement agencies, military communications and various commercial/industrial radio services.

50-54 MHz:

This is the six-meter ham radio band. 50-51 MHz is mainly used for USB, AM, CW, FSK and other digital modes. The remainder of the band is used for narrow band FM, both simplex and through repeaters.

72-76 MHz:

This range is used for remote control signals for model airplanes and garage door



GRE PSR-800
photo by Judy Grove

openers, wireless microphones (including those used by law enforcement agencies), and two-way communications inside factories, warehouses, and other industrial facilities. Most channels are spaced at 20 kHz intervals.

108-137 MHz:

This range is used for civilian aeronautical communications (all transmissions are in AM). Aeronautical navigation beacons use 108-118 MHz. The rest of the band is used for air traffic control, ACARS digital traffic and FBO/Airline Company traffic. Channels here are spaced at 25 kHz intervals but there is a slow move to 8.33 kHz spacing.

138-144 MHz:

This is a Department of Defense LMR/Aero band. Most transmissions are narrowband FM and AM and spaced 12.5 kHz.

144-148 MHz:

This is the two-meter ham radio band. This is the most heavily used ham radio band in the United States. USB and various digital modes are found in the first 500 kHz and the rest of the band uses narrowband FM. Most of this voice activity is through repeaters.

148-150.8 MHz:

See the 138-144 MHz range.

150.8-174 MHz:

This is known as the "VHF high" band, and it is used by the same users listed in the 30-50 MHz band. Spacing from 150.8-162 MHz is 7.5 kHz and 12.5 kHz is used up to 174 MHz.

222-225 MHz:

This is the 1.25-meter ham radio band. It is mainly used for FM communication through repeaters, although it is much less used than the two-meter band.

225-400 MHz:

This very wide band is used for military aviation communications in AM. Channels are spaced 25 kHz apart up to 380 MHz. 380-400 MHz is a mix of aero/land mobile communications (AM/FM) and spaced 12.5 kHz between frequencies.

406-420 MHz:

Used exclusively by the federal government and military. All transmissions are narrowband FM, with 12.5 kHz frequency spacing.

420-450 MHz:

This is the 70-centimeter ham radio band. It is second in popularity to the two-meter band on VHF/UHF. The 420-444 MHz range is used for USB, digital modes, ham television, and ham communications satellites. The 444 to 450 MHz range is used for FM, mainly in conjunction with repeaters.

450-470 MHz:

This is known as the "UHF" band on most scanners and it is used by the same users

listed in the 30-50 and 150.8-162 MHz bands. Spacing is 6.25 and 12.5 kHz spacing.

470-512 MHz:

This is known as the "UHF-T" band, and covers the same frequency range as television channels 14 to 20. This band is used for many of the same purposes as the "UHF" band above in selected areas of the country without UHF TV stations on those channels.

698-806 MHz:

A new public safety band is being carved out from portions of this radio spectrum by the FCC. Communications in this new PS band will be totally digital when fully implemented.

851 to 866 MHz:

This is used by many of the same users as the other public safety bands, with channels spaced at 12.5 kHz intervals.

866-869 MHz:

This allocation is used by public safety and law enforcement agencies and is being rebanded to the 851-866 MHz ranges.

Not all scanners cover the same frequencies. Most scanners currently on the market cover most of the public safety and business bands I mentioned previously in our "action band" list. It is important to determine what bands or range of frequencies interests you to get the scanner you need to hear the frequencies that interest you.

So the first task that you should perform is to determine what frequencies are active in your area that you are interested in monitoring. A good source of information available online is the [RadioReference.com](http://www.radioreference.com) website database at www.radioreference.com/. This database will go a long way toward aiding you in making your decision of what scanner you need to buy.

When you are researching your area, remember to see if your scanner needs to have trunking support and/or digital capability. If a trunking system is used in your area and you want to monitor it, be sure to note the system type and system voice lines, found on the page that has the data on your system. This will provide the critical information you need to buy the right trunking scanner. A common mistake by new scanner purchasers who have an interest in, for example, military air communications, is to discover after purchasing that their scanner does not cover that band.

Ask More Questions: Get More Answers

The basic question of which radio to buy has two corollaries: "*What is the best scanner for where I live?*" and "*What is the cheapest analog or digital scanner out of that list?*"

VHF/UHF radios/scanners are different from many other consumer-level radios or even a shortwave radio. If we are looking at a consumer radio or shortwave we are primarily concerned

about features and performance. If you're looking to buy your first scanner radio, you probably feel a bit confused and overwhelmed by the features and specifications of the models you're considering!

Should you buy new or used? A good analog-only trunk tracking scanner can be had for less than \$200; however, if you need to be able to monitor an APCO P25 digital system, the price jumps to around \$500. The used market provides an attractive alternative for the new hobbyist. The caution here is to ensure that the product you are buying will meet your scanning needs and, of course, don't forget the watchword whenever dealing in used products – "buyer beware."

As with most consumer items, there is no one "best" scanner radio for everyone. For example, if you want to simply listen to your local police and fire departments, a basic, low cost scanner will do fine as long as they aren't trunked or using digital modes. Finally, budget is usually a decision of how much you want to commit to this hobby and how much your better half is willing to let you commit.

Scanner Purchase Considerations

• *Scanners come in two basic configurations – Handheld and Mobile/Base Radios.*

Handhelds are portable scanners designed to be carried around by hand, clipped to your belt, or in some cases slipped into your pocket. Portable scanners have become very popular and let you follow the action onsite at sporting events, airshows, public exhibitions, etc. These units are battery powered and are therefore limited in the amount of time they may be used before the battery power is diminished.

Several handheld scanners do use rechargeable batteries and usually include a recharging circuit in the radio to recharge the batteries. The smart radio hobbyists carry extra batteries with them and also do not recharge the batteries in the radio, but use an external battery charger.

Mobile/Base scanners are designed to operate from vehicle power (usually a nominal 12 volts DC), or in the case of base-only scanners from home/office power mains. Most of these base/mobile class of scanners are really mobile scanners that use a 120/12 volt "wall wart" to supply the needed power. In most cases, there is usually a handheld model that is the sister to the mobile/base model; typically in this case the radios are exactly the same with the only difference being the case and the size of the speaker inside the radio. Many avid scanner fans have both a home scanner and a portable unit.

• *Scanners are roughly divided into two types – Conventional and Trunk Tracking.*

A conventional scanner is designed to follow a series of discrete frequencies programmed into the scanner, each one carrying separate types of conversations. Conventional scanners cannot properly follow conversations on a trunked radio system. If you want to monitor a trunk radio system, you need a trunk tracking scanner.

A trunk-tracking scanner is designed to allow the user to program a set of trunk system

frequencies that are used among several channels or agencies on a shared basis. A trunk tracking scanner can also perform the same scanning functions as a conventional scanner.

We have covered trunk basics here in the pages of *MT* in our *Scanning Report* written by Dan Veeneman. You can review many of Dan's *MT* columns on his website at www.signalharbor.com/.

The most common trunking system types that can be monitored on trunk tracking scanners in today's marketplace include: Motorola, EDACS, LTR, and Project 25. Scanners are available to work with all of these types of systems, but not all scanners currently being sold can receive all these types.

• All scanners can decode the common modulation types used in public safety or aircraft monitoring (such as FM and AM), but there are newer modes, and not all scanners can receive them.

The analog mode is the most common type of transmission method currently in use by land mobile services; however, it is giving way to digital modulation modes. All scanners are capable of monitoring analog transmissions. In regards to public safety monitoring, this typically means narrowband FM transmissions. Some scanners and many receivers can also receive the wideband FM signals used by FM broadcast stations.

When digital modes are introduced into the scanning equation, this is where things become a little more involved. Over the years various methods of digitally encoding voice have been developed. Public safety agencies today use two main ones that you will need to be concerned with – P25 CAI and ProVoice.

The important thing to remember is that there are “no” scanners capable of decoding ProVoice or any of its variants. There are other digital modes that you may run across, including Motorola VSELP and OpenSky, neither of which cannot be monitored.

In today's marketplace the only digital mode used that can be monitored by scanners are the APCO-25 (P25 CAI) digital transmissions. Do not confuse the P25 Common Air Interface, which is just the audio encoding method, with a Project 25 system which is the entire trunking system that uses a 9600-bps control channel. The important thing to remember is that the ability to decode P25 digital modulation comes with a premium price.

• New scanners have two basic memory management schemes – Banks/Lists and Dynamic Memory.

The banks and lists scanners are the most common type of scanner in the marketplace. It consists of a fixed number of banks with a fixed number of slots in each bank in which frequencies may be programmed.

The dynamic memory style scanners were first introduced in scanners made by Uniden in 2004. GRE has a related system that is referred to as ‘Object Oriented’ programming. Dynamic memory style scanners have quickly become the prime method of managing memory/frequencies in newer scanners manufactured today. In a dynamic memory system, the number of slots for frequencies and trunking talkgroups is flexible.

Scanners by the Numbers

To better understand what scanners are available relative to cost, I have prepared the following guide. The higher the level, the higher the cost.

Level 1: Crystal-Controlled Scanners

Avoid these scanners for anything other than antique-radio collections.

Level 2: Budget Scanners

Scanners in this category receive the major “action bands” mentioned previously. They have a limited number of memory channels, may not have a search mode for finding new stations, and usually do not receive any aircraft communications. These scanners are adequate for people in rural areas interested in listening to only one or two public safety agencies, such as their local police or fire department.



Uniden
BC-95xlt

Level 3: Conventional Scanners without 800 MHz

These radios have more features than the level 2 budget scanners. They receive all major “action bands” except 800 MHz. Some even include the civilian aircraft band. They typically have more memory channels so you can listen to more agencies, and they usually do have a search mode. These scanners are recommended for users who do not need 800 MHz coverage or trunking, such as users in a rural area or those only interested in hearing VHF equipped aircraft.



GRE PSR-100

Level 4: Conventional Scanners with 800 MHz

These scanners can hear all major “action bands” plus civilian aircraft (some also have military aero frequencies). Frequency coverage includes: 30-54, 108-174, 406-512, and 806-956 MHz. They do not have a trunk-tracking capability. They can monitor 800 MHz conventional radio systems and can monitor audio on analog

trunked systems, but cannot follow the conversations as they hop across frequencies.



GRE PSR-410

Level 5: Analog Trunk Tracker Scanners

These radios can follow conversations on analog (non-digital) trunked radio systems and conventional radio frequencies. These scanners contain all major “action bands,” both civilian/military aero bands, and they can trunk track Motorola Type I, II, and I/II hybrid systems. Most can also track G.E. / Ericsson EDACS trunking systems, while some models can follow conversations on E.F. Johnson LTR trunking systems.



GRE
PSR-500

Level 6: Digital Trunking Scanners

These scanners can follow analog/digital trunked and conventional radio frequencies. All radios at this level have a built-in or add-on device for decoding the Motorola APCO-25 digital protocol. Due to their high price, they are recommended only if the agencies you would like to monitor are APCO-25 digital. Such scanners will not decode encrypted voice or voice transmitted in other, incompatible digital formats.

Level 7: Memory Card Scanners

There are only two scanners in this category – the Uniden HomePatrol-1 and the GRE-800. These two scanners are considered the best of the best in today's marketplace. They are easy to use, easy to program, can be used as a handheld or a mobile/base, and they have the highest price tag. They both use memory cards and are updated via computer, so a PC is a must.

Now it is Decision Time

Now it is time to apply the information gathered above to your individual needs. Obviously each person reading this article will have different needs, wants, and budget. You can get additional help and particulars on available scanners on the Grove Enterprises website/online catalog www.grove-ent.com/. Bottom line? Only you can provide the answer as to what the “best scanner” is for you.



GRE PSR-600



Uniden Home Patrol

SCANNER MASTER



SCANNERS
COMMUNICATIONS RECEIVERS
ACCESSORIES & ANTENNAS
SOFTWARE

REMOTE MONITORING
PROGRAMMING
CONSULTING
SYSTEM DESIGN & INSTALLATION

www.SCANNERMASTER.com
1-800-SCANNER

THE NATION'S LEADING SCANNER DEALER - NOW IN OUR 33RD YEAR

Visit Our Boston Area Scanner Museum & Store: 260 Hopping Brook Road, Holliston, MA 01746

SHOR T W A V E

Taking Shortwave Listening to another Level

By Ken Reitz KS4ZR

We've wallowed along at the bottom of what appears to have been the most dismal of solar cycles in anyone's memory. In addition, we've witnessed the disappearance of many old stalwart shortwave broadcasters and the drastic reduction in budgets and broadcast hours of many others. Add the fact that some traditional shortwave radio manufacturers seem to have forgotten the source of many millions of dollars of their profits, and you could get the impression that shortwave was on the way out. But, it's just not so.

In fact, China's entry into shortwave radio production has brought a whole new group of labels and models to the market, picking up the slack where others such as Sony, once the dominant player in the portable shortwave radio field, have left off. With these Chinese models have come innovations in size and capability at competitive prices.

And, in the developing world, notably Africa and South Asia which are flush with cash from new-found oil revenues or burgeoning manufacturing industries, new shortwave transmitters are being installed. This past July, for example, Nigeria's Minister of Information, speaking at the commissioning of a new shortwave station for the Voice of Nigeria (VON), noted, "Every nation is trying to reach out to the world and VON is needed to manage Nigeria's image abroad."

These countries are acutely aware of the power and reach of shortwave broadcasting and as old shortwave icons recede, they are more than eager to be the target of an audience still relying on shortwave for news and entertainment.

So, if you're new to the shortwave spectrum or an old hand who's dissatisfied with what you're hearing, don't blame propagation or budget cuts. Instead, consider taking your shortwave listening to another level.

Sangean's New ATS909X Portable

After years of coasting along on older designs, last year Sangean finally released a new portable all-band shortwave receiver capable of tuning from 153 to 29,999 kHz. The new case is slightly smaller and lighter than its ATS909 predecessor but it offers considerably more: More memory presets, more power options that include selectable battery recharging and more tuning options, while retaining some of the features of the previous model such as record-



Sangean ATS909X (MSRP \$450) portable shortwave radio. (Courtesy: Sangean)

ing timers and alpha-numeric memory channel naming.

Over a several week testing period, from the end of August to mid-September (not exactly prime DX season), I found this portable an excellent AM performer. Reception, using the built-in whip was typical for a portable, but when used with a Radio Shack AM loop antenna (there's an AM antenna jack on the side of the receiver) it became quite an AM DX machine. One August night, from my East Coast location and between the bursts of countless lightning storms, I logged a half-dozen Cuban and a dozen Canadian stations, at least six Major League Baseball games, and stations as far west as St. Louis.

FM performance on the ATS909X is typical for a portable radio using the built-in whip antenna. Reception of local and distant stations to 30 or 40 miles was possible but greatly improved with the addition of an external antenna, not an easy task since there's no provision for an external FM antenna. The Radio Data System (RDS) display is a plus for IDing FM stations. Pressing the SSB button in FM brings up the three data lines: Station Call Sign, Program Type and Radio Text (usually the song title).

Longwave performance on this radio at this time of year was not expected to be great, so I was not disappointed with the minimal results. It would be interesting to see what reception is like at the peak of the longwave season.

But, shortwave performance was another matter altogether. With the generous and sturdy 47 inch telescoping whip antenna, nighttime tuning on the 49 and 31 meter bands netted solid signals on many international broadcasters. WWV came in nicely on 5,000, 10,000 and 15,000 kHz. In the morning Australia, Korea and Vatican Radio came in nicely on the whip.

This radio comes with a 24 foot long reel-type antenna and an adapter to clip it to the whip

which improved the signals nicely. I found that attaching my 480 foot horizontal loop antenna, which is 30 feet high, did not overload the radio's front end and greatly increased signal strength while allowing weaker stations to be easily heard. This made reception on the ham bands particularly nice.

A front-mounted tuning wheel with the option of 1 to 100 kHz fast or slow tuning as well as up/down tuning buttons, auto-scanning, direct frequency entry and over 400 memory presets, makes this radio a snap in getting around the bands. The large, easy-on-the-eyes LCD display gives you all the information you need at a glance. The three inch speaker is very easy to listen to even when tuning narrowband ham radio transmissions. The sound on FM is crisp and balanced while shortwave broadcasters come through with excellent clarity. Additional side-mounted audio adjustments can be made, but don't seem to have much effect.

Don't let the MSRP of \$450 scare you away from the Sangean ATS909X; it's widely and deeply discounted to nearly half that price at many *MT* advertisers, so shop around. At the prices offered, this portable is a serious shortwave receiver, an excellent AM DX receiver and a sensitive FM radio. With dozens of convenient features and balanced audio, this versatile portable should give you daily entertainment for many years to come.

Alinco's SWL Answer

After years of developing a solid reputation in the amateur radio community for making capable and less expensive HF and VHF/UHF transceivers, Alinco entered the shortwave listening world with the DX-R8T communications receiver. The result is an outstanding, all-band, 150 to 29,999 kHz receiver costing hundreds less than some competitors.

The 9.45 x 3.7 x 10 inch case is packed with over eight pounds of sensitive electronics in a traditional communications receiver design. The DX-R8T offers a well laid out front panel that features a large LCD display, no fewer than 23 buttons, a hefty, fast-spinning tuning knob as well as phone and speaker outputs. With AM, LSB, USB, CW and FM modes and room for 600 channel memory settings, the sensitive double super-heterodyne tuner lets you listen to all modes including Digital Radio Mondiale (DRM), which is done by utilizing a special rear-mounted IQ port running free DRM DREAM software on your computer.



Alinco DX-R8T/E (MSRP \$550) desk-top shortwave receiver. (Courtesy: Alinco)

If you take longwave through HF listening seriously, if you'd finally like to catch the action Hugh Stegman writes about each month in his *Utility World* column or Larry Van Horn writes in his *Milcom* column, or you want to catch the rare DX, clandestine, pirate or low-powered shortwave broadcasters, you're not going to be able to do it on anybody's portable radio. It's time to step up in class and, pound for pound, feature for feature, the Alinco DX-R8T is the most cost effective way to do that.

Just be aware that, when you graduate to this model, you're going to have to buy an outboard power supply and consider putting up a new all-band HF antenna. A three or four amp 13.2 or 13.8 volt D.C. power supply will be an additional \$25, unless you already have one so rated. Next, you'll need an antenna. The DX-R8T is a throwback to the days when table-top shortwave receivers had SO-239 fittings for PL-259 plugs attached to a coax feedline. Comb the back issues of *MT* for advice on upgrading your antenna, because the performance of any top-grade receiver is dependent on having the best possible antenna plugged into the antenna jack.

While the Alinco DX-R8T lists for \$550, it's discounted at Universal-Radio to \$500 and could be the best stand-alone, all-band, all-mode communications receiver available at that price. During the few weeks I had this unit in my listening post for evaluation, spotty propagation and solar-cycle doldrums were simply ignored as I punched in the frequencies from the *MT Shortwave Guide*. The incredible sensitivity and bandwidth of the tuner lets you pick out the signals in between the signals, and when combined with IF shift and narrow filtering, you can really dig out the weak ones.

The DX-R8T is a full-value receiver with

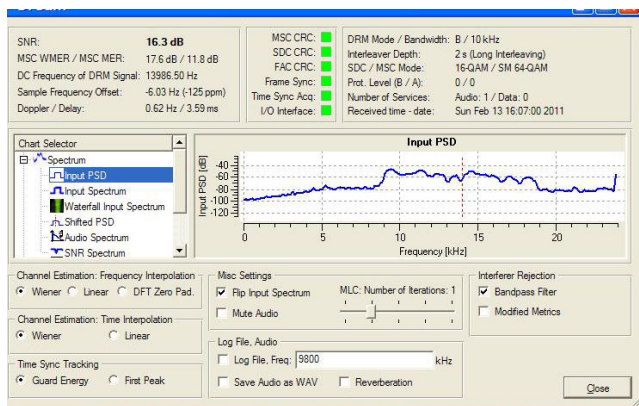

DRM reception of Radio Canada International on the Alinco DX-R8T is possible with a good antenna, computer and free Digital Radio Mondiale software. (Courtesy: Universal Radio)



AOR's AR2300 is a wideband, "black box" receiver that does it all from 40 kHz to 3.150 GHz (less the cellular frequencies) and has a price tag to match: MSRP \$3,999. (Courtesy: AOR)

a real future. While DRM reception is possible, it's difficult, mainly because there are so few such transmissions aimed at North America. Tuning is also tricky and, as with all digital reception, requires more signal to decode than analog transmissions. As DRM transmissions are more widely utilized and the DRM consortium finally comes up with software compatible with everyone's computer and sound card, the future for DX-R8T owners is very bright.

The Amazing AOR AR2300

If there were such a thing as a professional radio listener, the AOR AR2300 would be that person's radio. This radio goes beyond the concept of the radio listening hobby and would be right at home in any embassy, information ministry or even CIA HQ at Langley, Virginia.

But, before you embark on your new career in the Foreign Service, there are some important considerations. The learning curve on this radio is exceedingly steep. Between me and my wife, who is the residential computer guru at our house, it took more than an hour to load and start operating the software for this Software Defined Radio (SDR). Once we got past that hurdle, it operated flawlessly.

In addition to a fairly robust computer, you'll also need to reboot your brain. Operating this SDR bears little resemblance to operating a traditional stand-alone HF receiver. For starters, all the action is done with the mouse, fully utilizing left and right clicking as well as the scroll wheel. Get used to it, and once you do, you'll be amazed at how easily a person adapts to this method of tuning. It's just a little weird at first.

The actual radio circuitry is in a mostly non-descript "black box" (hence the reference to black-box radios) which itself weighs over seven pounds and has only an on/off switch on the front panel. Every single thing associated with tuning the radio is done on your computer. It was truly amazing to simply scroll in a frequency between 40 kHz and 3.15 GHz (yes, GHz) and listen. Every conceivable mode from CW to Stereo FM and DRM to P25 (with optional board and software – and another hour with the installation process)



Portable shortwave listening then and now: Uniden 2510 vs. Sangean ATS909X. (Courtesy: Author)

is possible on this direct conversion, double and triple super-heterodyne receiver. The AR2300 has 2,000 memory channels, a scanning speed of 100 channels per second and offers insane bandwidth out to six digits.

Want more? With the optional I/Q board and software, the AR2300 offers inboard recording of great swaths of frequencies for later evaluation, allowing single frequencies to be explored and looped to discern even the weakest audio or digital data. Well, it's excessive, but for the MSRP of \$4,000 you wouldn't expect any less. A more thorough review of the AR2300 by Bob Grove W8JHD is found in the resources chart.

The Radio for your Future

The next few years will prove to be promising ones for shortwave listeners as we move up the solar cycle into better HF propagation. But, making your next radio purchase in today's economy requires some serious thought. If you're new to shortwave listening and want an all-purpose, inexpensive introduction to the hobby, the ATS-909X is a good choice.

In 1982 I bought its equivalent, the Uniden 2510, for \$190. According to the Bureau of Labor Statistics inflation calculator, that was like spending \$444 in today's money. For that I got an all-band, all mode 150-30,000 kHz receiver with 6 (!) memory presets, that was about twice the size and weight of the ATS-909X, without the timers, rechargeable batteries, tuning options or bandwidth. I was lucky it had direct-entry tuning! Times have changed and (in the case of portable shortwave radios) definitely for the better.

Diving into the deep end of the hobby takes even more thought. But, the Alinco DX-R8T simplifies the thought process. The satisfaction of being able to tune the whole HF spectrum with a state-of-the-art radio that includes the possibility of DRM reception for \$500, when compared to subscribing to Sirius/XM radio, for instance, is hard to beat. If you buy into satellite radio, at the end of three years you'll have spent that same amount of money and there won't be anything to show for it. The Alinco DX-R8T provides a much better entertainment value.

RESOURCES

A review of the AOR AR2300 by *MT* publisher, Bob Grove, may be found here: www.monitoringtimes.com/1210first.pdf
The AR2300, Alinco DX-R8T3 and Sangean ATS909X are available at deeply discounted prices from several *MT* advertisers. Dream DRM software may be found here: <http://sourceforge.net/projects/drm/files/>

ACCESSORIES

The Quest for Power “Keys” to Success and the Accessories of Life

By Kirk A. Kleinschmidt, NTOZ

The ultimate insider’s tip about buying the right RF power amplifier is that you probably don’t need one until you’ve maximized the performance of your station’s antennas and feed lines! Then, as detailed in “How Green is Your Radio Hobby?” in the April 2011 *MT*, an amplifier’s 6-12 dB transmit-only signal boost can help you achieve the results you’re looking for: solid QSOs and more of them.

BASE STATION AMPS

Amplifying a typical 100-W transceiver to 500, 1000 or 1500 W produces only a 7, 10 or 12 dB power gain, respectively (remember: TX only, no boost on RX), which translates into 1.1, 1.66 and 2 S-units of improved signal strength – not a lot. Improving your antennas and feed lines can boost your signal, transmit and receive, by 3-20 dB at a fraction of the cost.

Still, there are several things to consider when making your purchasing decision.

Amplifiers are often bulky, heavy and require 240-V ac service, which can add additional expense. Some lower-power amps can run okay on 120 V, but potential problems abound. Any amp that puts out more than about 600 W really wants 240-V service.

Inexpensive amps tend to have minimal features and often lack desirables such as current in-rush protection, automatic tuning and band-switching, high-SWR protection (operator error), quiet cooling fans, full-break-in CW, etc. These amps may also use multiple, inexpensive tubes or transistors instead of one (or two) higher-power, better-performing devices, which can degrade their RF and audio (IMD) performance.

Tube amps tend to be bulkier, noisier and require high-voltage dc power supplies, but they often produce cleaner (lower distortion) signals than their more compact solid-state cousins (especially solid-state amps that run on 12 V dc). Almost every tube amp is manually tuned, while solid-state amps are all no-tune (although some inexpensive models lack automatic band-switching). There are pros and cons for each type, so do your research before buying.

More than a dozen HF amplifiers have been dissected in detail in *QST Product Reviews* since 2001. Members can access these reviews at www.arrl.org. Although more anecdotal in nature, the user-written product reviews at www.eham.net can be very enlightening (especially in identifying manufacturers that exhibit qual-

ity control issues). “High quality” amps tend to be expensive, while “high value” amps can be found in most price categories.

There has been a shift toward solid-state amps over the past decade. Tube amps are still available – and sometimes desirable – but some RF power tubes are becoming hard to find. This especially affects older models that may no longer be in production (but may still be good values). Many transceivers now cover 6 meters, which has prompted manufacturers to build more HF+6 amplifiers. Prices for ham amplifiers have increased sharply over the past five years (several hundred dollars for most models).

Mobile Amps

Required to operate from 12 V dc in less-than-ideal environments, mobile HF amps can draw as much as 100 A from a vehicle’s electrical system! Indoors, these compact amps can be convenient, but 12-V designs aren’t usually as “clean” RF-wise as desktop units. With SGC’s SG-500 (500-W, \$1500) mobile amp listed as “unavailable” at press time, Ameritron’s venerable ALS-500M and Tokyo-Hy Power’s HL-450B compete for market share. (Considering the costs and limitations of mobile amps, Kenwood’s 200-W TS-480HX HF+6 meter mobile transceiver, priced at \$1149, may be a better solution than any mobile amp.)

✓ MT Picks

Ameritron ALS-500M: \$750, options extra. 160-10 (with 12/10 kit). 500 W PEP/400 W CW output with 100 W or less in. Requires 14 V dc at 80 A.

Plus: Compact and lightweight (7 lbs). Thermal and load-fault protection. Least-expensive 500-W amplifier.

Minus: Optional remote control desirable for most mobile installs. Some users report low power output and quality-control issues.

Tokyo Hy-Power HL-450B: \$1140, options extra. 80-10. 350-400 W output on all modes with 50 W in. Requires 13.6 V at 60 A.

Plus: Easy to use. Automatic band selection. Excellent build quality. Mobile or base. Thermal and load-fault protection.

Minus: Expensive. Relatively low power output (although a nice match for 40-W transceivers common in Japan).



Inexpensive HF Amps

Much like “affordable family sedans” that now cost \$25,000, inexpensive HF amps are mostly a thing of the past. Although priced less, the few models in this category must compete with amps that are much more expensive, which isn’t easy. Certain used amps in good condition may be better values.

✓ MT Picks

Ameritron ALS-600: \$1279 with analog PS, options extra. 160-10 (with 10-meter kit). 600 W PEP/500 W CW output with 90 W in.

Plus: Compact and lightweight. Thermal and load-fault protection. Least-expensive desktop amplifier. Simple operation. Only 4 dB down from legal limit.

Minus: No QSK without modification. Manual band-switching. Some users report quality-control issues and difficulty in adjusting ALC.

Ameritron AL-80B: \$1330, options extra. 160-15 (licensed users can modify for 10 meters). 1000 W PEP/800 W CW output with 90 W in.

Plus: Low-cost desktop kW amp with single-tube design. Only 2 dB down from legal limit. Compact, classic design uses a single, rugged 3-500Z tube. Two-year warranty.

Minus: QSK via expensive add-on. Some users report issues with WARC-band operation, input SWR, and ALC adjustments.

Mainstream HF Amps

These mid-priced “bread and butter” amps put out 750 to 1500 W and have features and “design margins” above and beyond entry level units.

✓ MT Picks

Ameritron AL-82: \$2330, options extra. 160-15 (licensed users can mod for 10 meters). 1500 W PEP and CW output with 75 W in.

Plus: Affordable legal-limit amp uses a pair of rugged, inexpensive 3-500Z tubes (running well below their maximums) in time-tested design. More tolerant of “operator error” and much cheaper to re-tube than



more expensive single-tube models.

Minus: Some users report fan noise and build-quality issues. Grid-protection circuit is optional and not built-in. QSK via expensive add-on.

Tokyo Hy-Power HL-1.2Kfx: \$2500, options extra. 160-10. 750 W PEP/600 W CW output with 80 W in.

Plus: Solid-state. No-tune. Compact. Lightweight. Excellent build quality. Comprehensive fault-protection. Built-in QSK. 100-240 V operation from built-in PS.

Minus: Manual band-switching. Some users report excessive fan noise.

HF + 6 Amps

These easy to use, versatile amps don't leave 6 meters out in the cold!



Elecraft KPA500: \$2400 assembled/\$2000 for "no solder" kit, options extra. 160-6. 500 W PEP with 40 W in.

Plus: Solid-state. No tune. Auto band-switching with RF-sensing input and PTT connection (simplest interfacing with any radio). Tiny. Excellent build quality. Comprehensive fault-protection. Built-in QSK. 100-240 V operation from built-in PS.

Minus: Only puts out 500 W!

Tokyo Hy-Power HL-1.5Kfx: \$3500, options extra. 160-6. 1000 W PEP/900 W CW/650 W 50-MHz output with 80 W in.

Plus: Solid-state. No-tune. Auto band-switching with most modern rigs (specific cable required). Excellent build quality. Comprehensive fault-protection. Built-in QSK. 100-240 V operation from built-in PS.

Minus: Expensive. Some users report SWR sensitivity. Amp must be turned on to use connected antennas "barefoot."

KEYS AND PADDLES

Morse code proficiency hasn't been a licensing requirement for years, yet Morse code is as popular as it ever was, perhaps even more so! And, keyboards and computers aside, the keys we use to send code are mostly unchanged since the early days of radio.

A straight key, the most primitive keying method, is an all or nothing proposition – on or off. The operator adjusts for dits, dahs and spaces. Despite their simplicity, many ops find them fatiguing or even painful to use at higher speeds or for long periods.

Some nostalgia-minded ops use semi-automatic mechanical keys called "bugs," or Vibroplex keys, named after the company that made them popular back in the day. Pressing the paddle to the left allows the user to manually make dahs just like a straight key. Pressing the paddle to the right starts a pendulum in motion that automatically makes dits (at one speed only).

Some extra-complex models use pendulums to make dits and dahs (again, at one set

speed only). Bugs aren't recommended for beginners, and Old-Timers already have their favorites, most of which are no longer produced!

Most of us use single- or dual-lever paddles with an electronic keyer (external or built into our rigs). There are many variations in how keyers process single and dual paddle inputs, but in this limited guide we focus only on the paddles themselves.

Much like the age-old rivalry between a Chevy Man and a Ford Man, the "best" keyer settings and paddle types are hotly debated. The bottom line is, the perfect key for you depends on your ability, the way you learned the code (and on what hardware), the anatomy of your hand and arm, the conditions in which the key will be used, etc. It's a deeply subjective, personal experience that doesn't allow a particular paddle to be proclaimed "best" for everybody. You just have to try them for yourself!

Keys and paddles range from crude to elegant, and costs vary from "a case of beer" to the price of a new transceiver. Some paddles are factory-made, while others are hand-crafted by master artisans. Despite persistent dogma and nostalgia, some mass-produced paddles are awesome, and some hand-made "works of art" aren't.

Because paddle quality and feel are so subjective, the models recommended here are low- to mid-priced models that have been well-reviewed by other hams and are readily available in the US. If your taste and budget allow, you can certainly spend two to ten times as much in pursuit of your ultimate key!



Straight Keys

Wm. M. Nye Speed-X: \$60. Classic oval-base design has been produced for decades. Good then, good now!



Ameco AM-K4: \$25. In continuous production since the 1950s, the K4 isn't the least-expensive key available, but it's arguably the least-expensive key you'd enjoy using on the air every day.

Single-Lever Paddles

GHD GH-GN407A: \$229. This single-lever paddle made by Toshihiko Ujiie, JA7GHD, features exceptional mechanical and finish quality for its price class (as do all GHD keys).

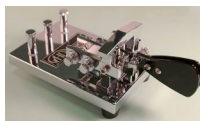

K8RA P6: \$170. The P6 weighs 4 lbs and is made of solid brass with silver contacts and precision bearings. Even heavy-handed ops won't push this key around!

Dual-Lever Paddles

Begali Simplex Basic: \$171, options extra. The Simplex Basic, made by famed Italian key craftsman Piero Begali, I2RTF, the company's least-expensive paddle (among



many), still features gold-plated components and precision adjusters.

K8RA P1: \$95, options extra. Featuring silver contacts and smooth, adjustable bearings, the paddle's oak base saves you money and hides a 2-lb lead slug for stability.

Touch Paddles

CW Touch Keyer P1W: \$90. Sumner Eagerman's P1W is an electronic keyer that features a set of non-moving, gold-plated touch paddles that require no adjustment and only the slightest touch to actuate. Although touch paddles aren't for everyone, many ops report increased comfort and operating speed.

Portable/Mini Paddles

Paddlette PK-1 and PK-2: \$65 each, options extra. Designed for field/mobile use, the tiny PK-1 (dual-lever) and PK-2 (single-lever) paddles can be used at a picnic table or attached to your thigh with an optional leg mount! Be sure to let the sheriff know before you stride into the saloon!

Palm Radio Mini Paddles: \$105, options extra. These German-made, retractable mini paddles (1 x 1 x 3 inches) are housed inside a protective enclosure (that looks like a mini toaster!) and feature gold-plated contacts. In keeping with the German design mythos, there's a lot of elegant engineering under the paddle's tiny hood.

Kit Paddles

American Morse Dirt-Cheap Paddle Kit: \$41. These fully-adjustable, easy to assemble, mini paddles may be "dirt cheap," but they're not cheaply made. With a pending patent and a lifetime warranty, the rugged little paddles have no delicate parts are drilled and tapped for base, leg or desk mounting.

W5JH Black Widow Paddle Kit: \$67. This full-size, dual-lever paddle is made from CNC-milled brass for fit and accuracy. The paddle has spring and magnetic return forces, silver-plated contacts, precision bearings and is easy to assemble. You can "super polish" the brass parts for a "museum grade" finish if that's your thing (or just throw it on the air as a daily driver!)

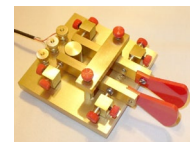

ROTATORS

If you're thinking about putting up a directional antenna, unless you're content to mount it in a fixed direction, you'll need some kind of a rotator to aim it to and fro. Choosing can be very difficult. A rig, for example, can easily be exchanged, but needlessly swapping out a tower-mounted rotator can be challenging, expensive and even dangerous!

In simple terms, rotators are rated by the wind load (square feet in the US) they can safely handle. Ideally, you'd buy a correctly-sized unit and happily use it for the next 20 years. Actually, there are many additional confounding factors, including "brand loyalty" and "brand mythology."

Unlike PCs and ham transceivers, which cost much less than they used to in inflation-adjusted dollars, rotators, towers and antennas haven't followed suit. They're expensive, but price alone doesn't guarantee suitability.

Many veteran ops also feel that "they don't make 'em like they used to," which is sometimes true, especially for low-end models. Modern cheapie rotators are almost universally reviled, while some bargain-basement models from the 60s, 70s and 80s were reportedly much sturdier. And, everyone's heard at least one fantastic story about a particular ham who used a certain rotator in a hostile environment, turning an oversize array flawlessly for 23 years... Even if the story's true you probably won't be so lucky!

Basic setups use desk-mounted control boxes (analog or digital, plain or fancy) to control the rotator. More complex systems add delayed braking, computer control or adjustable elevation (for satellite or moonbounce). Some units require only a few control wires, while others require many. Depending on your wants, needs and budget, choosing the best unit can be challenging.

For the best results be sure to keep your antennas comfortably within the rotator's wind-load ratings. Experts suggest a 15-20 % safety margin, so if your unit is rated for 10 square feet, limit your antennas to 8 or 8.5 square feet. Any rotator, regardless of price or quality, will fail if loaded beyond its capacity.

Pay attention to installation issues, too. A unit that's rated for 10 square feet when tower mounted may be rated for only 5 square feet when mast mounted. And no, you can't install an extra-long mast on top of the rotator to "add another 10 feet to your tower." Sooner or later, extra-long masts will fail, taking your rotator with them.

If you live in the Frozen North, don't touch the rotator controls if your antennas are covered with ice! The extra weight and wind load can easily shred your rotator, so let the sun do its thing before re-aiming your antennas.

The rotators and accessories in this necessarily limited guide have been generally well-reviewed by users and were selected for overall value, price and availability in the US. Be sure to carefully research your specific needs before purchasing.

Light-Duty Rotators

Designed to handle TV and VHF/UHF ham antennas with wind loads of up to 3 square feet, light-duty rotators are frequently used and abused by budget-conscious hams! Amazon.com, eBay and neighborhood farm supply stores are flooded with inexpensive HDTV-oriented rotators that have plastic gears, poor quality control and questionable parentage. Avoid them. You won't save money in the long (or short) run. If possible, buy a beefier rotator.



Hy-Gain AR-40: \$320, options extra. Square-foot rating: 3 (tower)/1.5 (mast-mount).

Plus: Dual 12-ball bearing races. Automatic position sensor. Solid-state controller. Quiet operation.

Minus: Very expensive. Some beefier models have three times the capacity and cost less.

Alliance U110: \$199/\$149. Square foot rating: 5 (tower)/3 (mast-mount).

Plus: Available only from Norm's Rotor Service, new or remanufactured (note prices), the U110 is arguably the best "inexpensive" rotator available. It's been out of production for years (NRS acquired all Alliance inventory and parts), but its gear train is all metal, American-made, with no plastic in sight! Priced right and "built like they used to make 'em."

Minus: Control box can be noisy, looks dated and won't win any beauty contests.



Medium-Duty Rotators

Designed to handle antennas with wind loads of 5-10 square feet, medium-duty rotators are at the crossroads of price and performance.



Yaesu G-450A: \$290, options extra. Square foot rating: 10 (tower)/5 (mast-mount).

Plus: Inexpensive for its class. Control box is easy to use, attractive and informative. A good step up from most light-duty units.

Minus: Some users complain about finicky control box cable connectors and calibration difficulties.



Heavy-Duty Rotators

Designed to handle beefier arrays with wind loads of 11-20 square feet, heavy-duty rotators must withstand tremendous physical and environmental forces, day in and day out.



Yaesu G-800SA: \$390, options extra. Square foot rating: 20 (tower)/10 (mast-mount).

Plus: Inexpensive for its class. Modern, up-to-date control box. 450 degrees of rotation. Smooth, quiet operation.

Minus: The "SA" model lacks directional presets. Some users complain about finicky control box cable connectors and calibration difficulties.



MICROPHONES

For many hams, the microphone that the manufacturer packaged with a particular radio is the only microphone that will ever be used with that radio. Most OEM mics work okay, but what if you want a better microphone, a better sounding signal, or a mic for a special purpose such as contesting, DXing, or bicycle mobile?

Maybe you have a desk mic right now, but want a boom mic with a foot switch. Maybe you'd like to replace your handheld mic with a headset for convenience and better environmental noise performance. The options are just about endless. So how do you choose?

At a minimum, any microphone must at least match the input impedance of our radio's speech amplifier, and the connector must match that of our radio (or be adaptable). Most modern radios are designed for low- to medium-impedance dynamic or condenser microphones, and some can even handle the higher-impedance (crystal) mics favored by some older tube-type transceivers. The mic connectors on most modern radios also provide the low DC voltage required by electret condenser mics.

Whether headset, desk or hand-held, how a microphone – and ultimately your transmitted signal – "sounds" depends on many factors. These include variations in the human voice (male or female, young or old, etc), the physical and electronic characteristics of the microphone, the audio response of the transmitter circuitry, and any equalization or audio processing present in the signal path.

Each of these factors can be critically important. If, for example, you connect a high-fidelity, broadcast quality microphone to a transmitter with a sharply limited audio response, no amount of processing and equalization will provide the sound you're looking for. The opposite is also true. If you connect a microphone optimized for contesting and DXing to a high-fidelity transmitter, the sound (transmitted signal) will not be high fidelity.

Although many modern transceivers feature capable DSP-based transmit equalization and audio/RF processing, there are still many variables involved in finding the right microphone and EQ settings for your voice and your intended on-air usage. Ultimately, plenty of tweaking and experimentation may be required!

The mics and accessories in this limited guide have been well-reviewed by users and were selected for overall value, price and availability in the US. Be sure to carefully research your specific needs before purchasing.

Desk/Boom Mics

Designed for shack or studio use, these versatile mics can be hand-held or fixed to desktop or boom mounts. The audio response of the various models may be designed for hi-fi, general-purpose or contesting/DXing, and some can switch between one or more mic elements. Many models do not have ham-style PTT switches, so this function will have to be provided by the user, if needed.



Audio-Technica ATR20/ATR30/ATR50: \$39. Unidirectional dynamic vocal/instrument microphone.

Plus: Very inexpensive. Universally well-reviewed. Comparable to mics that cost much more. Bal-



anced XLR and single-ended connectors. Good “noisy environment” performance. One of the highest-quality, low-cost mics on the market.

Minus: No ham-style PTT. These mics are listed as being “out of production” but are still widely available in retail channels.

Heil GM Elite: \$160, options extra. Unidirectional dynamic communications mic with dual elements.



Plus: Dual mic elements optimized for ragchewing and general on-air chatting (wide) and DXing/contesting (narrow). Versatile. Built-in soft-touch PTT. Balanced XLR and single-ended connectors. Excellent build quality.

Minus: Expensive.

HEADSETS

Whether you’re on the go, in a noisy environment, need to reclaim precious desk space or want the convenience of hands-free communication, headset mics do it all!

MT Picks

W2ENY Boom Mic Headset: \$37. Lightweight noise-canceling headset with full-range audio.

Plus: Inexpensive. Good noise perfor-

mance. Well-reviewed. Built-in RFI protection. Includes adapters for most modern radios. Stereo.

Minus: No ham-style PTT. Not designed for harsh environments.

Heil Proset Plus: \$199, options extra. Rugged headset with dual mic elements.

Plus: Dual mic elements optimized for ragchewing and general on-air chatting (wide) and DXing/contesting (narrow). Removable, oversize earmuffs for comfort and noisy environments. Stereo. Headphone audio response curve reduces hiss. Switchable “spatializer” can improve received signal intelligibility and reduce operator fatigue. Excellent build quality.

Minus: Expensive. No ham-style PTT (w/o accessory). Some users complain about lack of comfort.

AUDIO/RF PROCESSORS

Modern transceivers offer greater control of transmitted signals than ever before, but a good external audio or RF processor can still make a great signal even better.



MT Picks

W2IHY 8-Band Audio Equalizer and Noise Gate: \$269, options extra. Sophisticated, versatile audio communications equalizer in a single package.



Plus: Eight-band EQ. Separate input and output amps with adjustable levels. Multiple high- and low-Z inputs and outputs (use any mic with any radio). PTT. Headphone monitor. Well-reviewed. The “gold standard” of external communications EQs. Three-year warranty. Expert support and usage instruction.

Minus: Expensive. Does not provide audio compression.

Ten-Tec 715 RF Speech Processor: \$250, options extra. A high-performance, “true RF-type” speech processor designed to operate with most modern transceivers.



Plus: The 715’s RF processing can increase average SSB power output by up to 6 dB. Less distortion and better performance than conventional AF and RF compressors (built-in or external). Enhances readability. Simple operation.

Minus: Works best for DXing and contesting (not hi-fi ragchewing). Doesn’t work well with some mics and mic connectors. Initial adjustments can be tricky.

MT

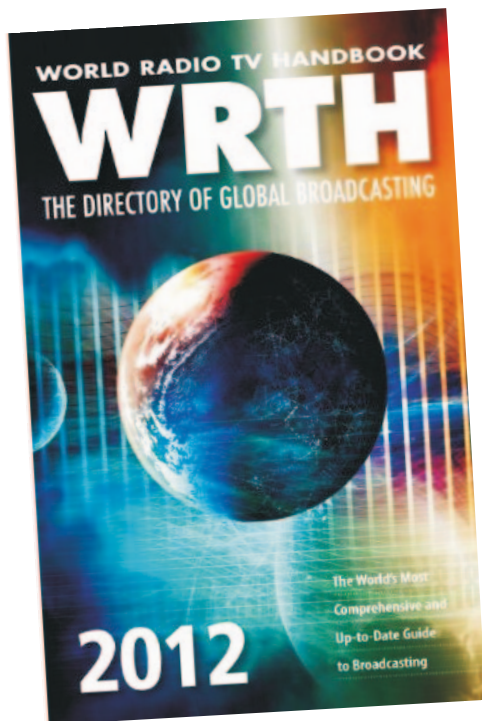

2012 EDITION WORLD RADIO TV HANDBOOK

The World Radio TV Handbook continues as the leading annual reference for shortwave broadcasting stations. Not only does it include comprehensive frequency and schedule listings, but it provides in-depth profiles of the stations and staffs along with contact information.

And as if this in-depth shortwave information isn't enough, additional listings include medium wave AM, and non-U.S. TV and FM broadcasting details as well!

Order BOK03-12

\$29⁹⁵

**plus \$6.95 USPS
First Class Mail**

Shipping to Canada, \$10/book by Intl First Class Mail.
All other countries, \$20/book by Intl First Class Mail.

www.grove-ent.com

GROVE

800-438-8155

828-837-9200; FAX 828-837-2216 7540 Highway 64 West, Brasstown, NC 28902 email: order@grove-ent.com

ANTENNAS

Finding the Perfect Antenna (It's not that easy!)

By Bob Grove W8JHD

When choosing an antenna, there are myriad considerations for the best selection. Among these are: frequency range, feed-point impedance, size, weight, radiation/reception pattern (directivity), polarization, gain, durability, weather tolerance (moisture, corrosion, wind loading, ice bearing), mounting requirements, and cost.

Even a simple mobile whip faces these criteria. If it's placed in the center of the roof, it has an ideal circular "donut" pattern, but if mounted on a fender cowl, the pattern is skewed in the direction of the most metal.

Is a good transmitting antenna always a good receiving antenna? Yes, if its aperture is large enough to capture enough signal to overcome receiver noise. The law of reciprocity states that if an antenna system efficiently radiates a signal into space, it will just as efficiently deliver an intercepted signal to a receiver.

Is a good receiving antenna a good transmitting antenna? Not necessarily. If randomly erected, it may be susceptible to power loss due to impedance mismatch. Its pattern will be unpredictable and reactance may shut down a transmitter with built-in protection against mismatches.

Size does Matter

The energy-intercepting area of an antenna is called its aperture (another similarity to light as in the aperture of a camera lens) or capture area; the larger its aperture, the more signal it captures.

Curiously, a large antenna is not necessarily better at transmitting (or receiving) than a smaller antenna. If a small element can be designed to be just as efficient as a large antenna, and radiates the same pattern, there is no benefit in using a larger antenna unless it can be configured to offer gain, which comes from shaping the directionality of the antenna.

Similarly, all antennas of the same size (wire dipoles, folded dipoles, fans, trap antennas, or cages) radiate the same amount of power. Their relative advantages come from pattern directivity.

The purpose of a receiving antenna is to detect enough signal to overcome the receiver's own internally-generated noise; once that is accomplished, more signal only means more atmospheric noise with its attendant interference from strong-signal overload.

Below approximately 50 MHz, atmospheric noise (static) becomes increasingly worse the lower we tune. This background hiss is a composite of thousands of lightning strikes occurring simultaneously around the world. Once we detect enough signal to overcome the receiver's own self-generated circuit noise, a larger aperture will only increase the atmospheric noise right along with the signal.

If the noise is locally generated (power lines or an electrically-noisy neighbor, for example) a beam or loop antenna can be rotated away from the source of the noise to null the interference, hopefully toward the direction of the signal as well.

As we tune upwards from 50 MHz, atmospheric noise diminishes; therefore, larger and better-matched antenna systems do improve reception because they help overcome receiver noise, which can be higher than atmospheric noise at VHF and UHF frequencies. Ultimately, once the aperture is great enough to overcome receiver noise at these higher frequencies, larger aperture will only pick up more noise (just as at the lower frequencies) so directivity should be the goal for better reception.

Low or High Frequencies?

Radio waves have a tendency to propagate differently for different frequency ranges. At very high and ultra high frequencies (VHF and UHF), they behave more like light, travelling in a straight line. At the lowest frequencies, they tend to follow the curve of the earth, through it as well as over it.

For listening to very low frequencies (VLF) below the AM broadcast band, a simple vertical antenna may be ground mounted for reception of beacons. In fact, a long, random wire can be simply draped over the ground, or even buried an inch or two under the soil for satisfactory monitoring.

If directivity is required, an open-wire loop or a ferrite rod antenna may be used. Such antennas are effective up through the AM broadcast band and even into the first few megahertz of shortwave. One example of a wide-frequency-coverage loop with amplification and band switching from 150 kHz-500 MHz is the AOR LA-390 (\$389.95):



Most shortwave listeners choose horizontal wire antennas. They are the least expensive, they require simple suspension systems and they can be oriented to favor specific directions. But they do require a fair amount of yard space and can be conspicuous in restrictive residential neighborhoods.

Vertical antennas on these bands are omnidirectional, thus receiving signals equally from all compass points. This is a good thing when sheer signal abundance is the object, but can also compound co-channel interference among users of the spectrum who happen to be transmitting on the same frequency.

At shortwave (more correctly, high frequency or HF), distant (DX) signal patterns have been altered substantially by the time they arrive, and vertical or horizontal antennas are chosen more on a basis of convenience. Each has its retinue of loyalists who claim that one is better than the other.

Active or Passive?

With one singular exception, all antennas are passive; that is, they have no amplifying electronic circuitry. They simply reflect, refract, radiate or conduct the electromagnetic energy which reaches them.

The exception is the active (voltage probe or E-field) antenna which consists of a short (a few inches to a few feet) receiving element coupled to a wideband, small-signal amplifier. It is not used for transmitting.

Among the most popular is the LF Engineering H-800 (\$149):



A ruggedized, compact active antenna is the WiNRADiO AX-17C (\$199.95):



Tunable frequency preselection also included in MFJ's 1020C (\$89.95):



For a harsh maritime environment, try WiNRADiO's AX-81S (\$189.95):



While active antennas may have small size and wide bandwidth, and can deliver large signals to the receiver, they have their disadvantages. They are expensive, they require power, they may burn out or degrade in performance from nearby lightning or strong signals, they generate noise and intermodulation interference ("intermod"), and they are usually placed close to interference-generating electronic appliances. Don't use an active antenna if an adequate passive antenna is available.

Scanner Antennas

Signals at the VHF/UHF wavelengths don't curve around the earth, so for distant reception, antenna height is a dominant consideration. As a rule of thumb, a scanner antenna mounted high enough to see over nearby obstructions is likely to hear base stations and repeaters 50-75 miles away.

Radio waves, like light waves, follow the line of sight. Because of the curvature of the Earth, higher antennas "see" a farther horizon. Assuming a flat, unobstructed terrain, the visual horizon is about 8 miles for a 30-foot-elevated antenna, increasing to only 16 miles at 120 feet!

The "square law" is in effect here. It requires roughly four times the height to get twice the distance. From a practical standpoint, once an antenna is high enough to "see" past nearby obstructions, it takes at least double that height to notice any improvement.

The lower the frequency, the more radio waves are capable of following the curvature of the earth beyond the visual horizon. Typical base-to-mobile communications ranges are about 50 miles in the 30-50 MHz band, 30 miles at 150-174 MHz, 25 miles at 450-512 MHz, and 20 miles at 806-960 MHz. These distances will vary considerably depending upon radiated power, receiver sensitivity, antenna gain, elevation and location.

50 or 75 ohm Coax?

The standard 50 and 75 ohm cable impedances were selected decades ago for two considerations. For transmitters, the best power-handling capability is at 77 ohms, while the best voltage tolerance occurs below 30 ohms. 50 ohms is a good compromise and matches several standard antenna designs.

For receiving purposes, 75 ohms is optimum for low coax losses, so it was adopted by the cable TV industry. Conveniently, it also matches several, common, folded-dipole antenna designs.

Low-loss cable increases in importance the higher the frequency and the longer the length. It makes little difference whether you use 50 or 75 ohm cable for transmitting or receiving. Good cables included RG-8/X, RG-8/U, Belden

9913, 1/2" foam, Heliac, RG-59/U, RG-6/U, and RG-11/U. For VHF/UHF, especially at long lengths, avoid RG-58/U and RG-174/U.

Mysteries of Gain Explained

The concept of gain may seem rather elusive, especially when you read the claims of manufacturers. The unit is the decibel (dB), and in plain language, the improvement in signal as compared to a standard antenna.

That standard may be one of two: an imaginary, ball-shaped (isotropic) antenna (which doesn't exist in the real world), or a half-wave dipole, often emulated by a quarter-wave antenna mounted on a quarter-wave counterpoise like a ground plane of radial elements.

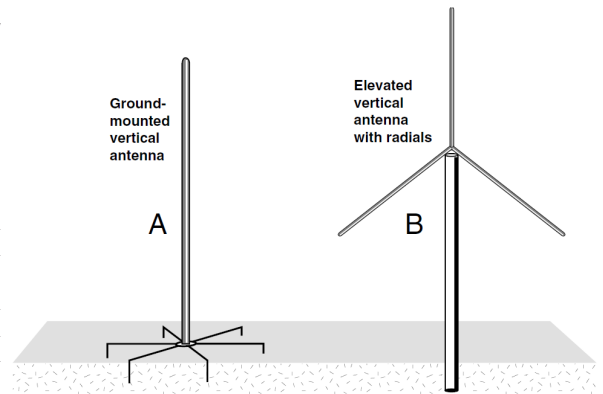

the pattern in one direction means reducing it in another. Such pattern re-direction often refers to front-to-back ratio and side-lobe rejection. The pattern can be shaped by adding parasitic elements, which are unconnected but secured to the boom, called reflectors and directors. This is the structure for a beam antenna, more correctly called a Yagi.

Because this can get cumbersome at low frequencies with their longer wavelengths, beams are generally reserved for the VHF/UHF frequencies and the high end of the shortwave spectrum, typically above 14 MHz. Adding a second identical antenna separated by 1/2 wavelength and connected in phase, known as stacking, will increase transmitted and received signal strengths by 3 dB, regardless of the original gain. Thus, two 1-dB-gain antennas will provide 4 dB total gain (a 3 dB increase), and two 20-dB-gain interconnected antennas will provide 23 dB total gain (still a 3 dB increase).

In a mobile whip, this can be done by co-phasing an upper and lower element on a continuous whip. This is known as a col-linear (two elements in line) antenna. The sections are isolated from one another by a coil. Such antennas can deliver roughly two decibels of gain, barely noticeable except on extreme fringe.

One Size doesn't Fit All

It would seem that one could construct a single antenna to cover all frequency ranges. One can't. A given geometry for an antenna will behave differently at different frequencies. Its pattern, its gain, and its feed-point impedance will vary dramatically.

But there are ways to widen the optimum frequency performance of an antenna. At VHF and UHF frequencies, the discone is a popular choice. Originally, the discone was named for its construction: an upper, metal, horizontal disc, and a lower, metal, conical skirt. The sheet metal construction has now been replaced by an array of straight metal rods for less weight and better wind load resistance.

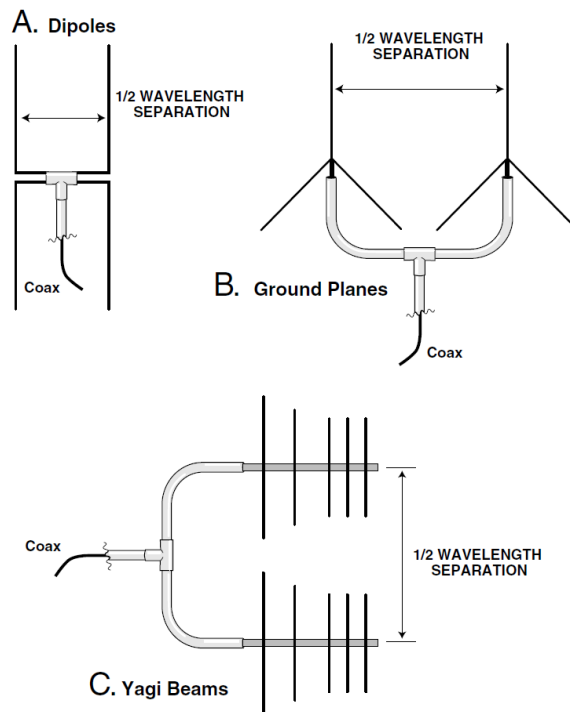

To let the reader know which of these the product is being referenced to, the gain must be stated in the appropriate unit, dBi (isotropic) or dBd (dipole). Since the imaginary antenna radiates equally in all directions, it is the 0 dB starting point.

Since a dipole radiates from its sides, but not its ends, it has 2.1 decibels of gain (2.1 dBi) over the isotropic model. Manufacturers prefer to specify their antenna gains in dBi since it will be a higher number, even though it's a fictitious reference. Beware of products that give only the number and not the unit.

Increase in gain comes from shaping the radiation/reception pattern, but adding to

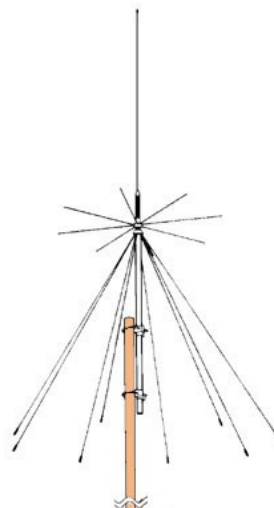

Discons can be designed to cover at least an 8:1 transmit frequency range by maintaining a steady feed-point impedance. This means that multiband transmitting from, say, 120-960 MHz is achievable, and even wider reception frequency range which isn't quite so impedance-matching critical.

A good example is the widely-sold Diamond D130J (\$99.95). It adds (as many competitors now do) a top-mounted, base-loaded vertical whip to add 50-54 MHz transmit/receive coverage.

There are two downsides to such an antenna. First, they have no gain, and second, their takeoff angle (radiation/reception pattern) rises on the higher frequencies rather than favoring the horizon. This raised pattern may favor aircraft and satellite reception on the UHF ranges. In spite of these minor drawbacks, discons have assumed a rightful place as one of the most popular, wide-frequency-coverage scanner antennas.

Another trick, especially for receiving, is to simply couple two or more dissimilar antennas, each for its own successive frequency range, as is done with the 30 kHz-2 GHz coverage AOR SA7000 (\$249.95)

Log periodic dipole arrays are beam antennas with a series of gradually shortening, interconnected elements. Their active bandwidth is even wider than that of the discone. Probably the most popular LPDA on the market is the Create 5130-1N (\$439.95) with a manufacturer's claim of continuous 50-1300 MHz frequency coverage with an average gain of 11-13 dBi (roughly 8-10 dBd). A smaller, 105-1300 MHz version, the 5130-2N (\$319.95), is available as well:

Ground Planes

The ground plane antenna may be thought of as a vertical dipole in which the bottom element is replaced by an array of horizontal or drooping elements, or even a sheet of metal, simulating a perfectly conductive earth. Like the dipole, a ground plane designed for a specific frequency will experience an increase in feed-point impedance and radiation angle toward its ends (in this case upward and downward) as the applied frequency increases. This reduces its effectiveness for harmonic operation unless you are planning to work overhead aircraft and orbiting satellites!

Mobile Antennas

In an automotive environment, the vehicle body is the ground plane; its contours and antenna placement influence the radiation (and reception) pattern of the signal. Directivity generally favors the mass of metal—a roof-mounted whip has a basically omnidirectional pattern, while a rear-bumper mount favors the forward direction of the vehicle.

At frequencies above 10 MHz or so, the surface area of the vehicle and the length requirements for a vertical antenna are practical for efficient operation. A quarter-wave whip exhibits

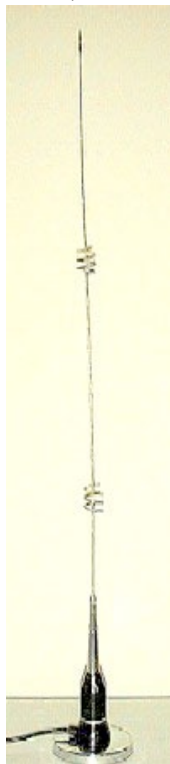

a feed-point impedance of about 36 ohms, a good match for conventional 50-ohm cable.

But as frequencies lower, the electrically-short antenna possesses less and less radiation resistance (less than one ohm at 2 MHz) and more and more capacitive reactance which must be cancelled by a series inductance (loading coil).

Base-loading the whip requires less inductance than center- or top-loading because the upper whip section's capacitance with the car body reduces its own capacitive reactance; but the radiation resistance remains low (in some cases a few ohms), so that coil and transmission line resistances contribute a proportionately-higher loss.

Raising the position of the loading coil changes the current distribution along the antenna, increasing the radiation resistance, but the longer loading coil requirement introduces more resistive loss. A position approximately 2/3 the way up the whip may be an optimum compromise.

For mobile scanning, the magnetic-base AOR MA500 offers collinear phasing and decoupling of resonant sections to increase its frequency range (\$109.95).

Scanner Whip Antennas

Hand-held scanners are extremely sensitive, their specifications closely matching those of their base/mobile counterparts. So why is it that some scanners seem much more sensitive than others to weak signal response? It's probably the factory-supplied antenna.

In order to validate the claim that some aftermarket antennas will provide better performance than the original whips accompanying the scanners, we decided to put some of these antennas to the test.

Specifically, we decided to try the Diamond RH77CA and the Austin Condor, arguably the two most popular replacement antennas on the market with legions of scanner fans lauding these two models. For comparison, we included a conventional rubber ducky sent with the high-end GRE EZ-Scan as the original equipment component. Since the least expensive antenna is a straight piece of wire, the common 18" whip was used as the baseline of comparison.

Early experiments performed at Grove Enterprises show that a 48" whip also does a good job, especially if 30-50 MHz low band is important.

A second test to corroborate these findings was then performed with the antennas successively tested on top of a vehicle. This was also more reliable since it's a real-life application. The second test, measured on a Meili AT5011 spectrum analyzer, yielded the results in the table shown. All whips were individually mounted on a Hewlett Packard M1405A ground-plane base.

Readings shown below are in decibels (dB) above or below the base-

line levels set by the 18" whip. The ---- symbol means the signal was too low to be accurately measured.

FMHz	18" WHIP	RH77CA	GRE	CONDOR	48" WHIP
50.1	(Baseline)	-6	----	-1	+11
102.7	(Baseline)	0	-20	-3	+6
109.8	(Baseline)	-2	----	-20	2
151.4	(Baseline)	0	-21	-1	5
162.5	(Baseline)	-1	-10	0	1
460.2	(Baseline)	+10	+2	+7	
860.4	(Baseline)	-10	-13	+1	-5

What the Test Shows

Using a simple, inexpensive 18" whip antenna as the baseline reference (0), we are looking for antennas that are at least equal (0) or better (+) in performance in frequency ranges of greatest interest to a scanner listener. Significantly lousy performance (-) is shown as well.

From a practical standpoint, there should be at least 2-3 dB difference on the most marginal signals before you can hear an audible difference. Keep in mind that these are all relative, not absolute readings, and nearby metallic objects can reflect signals, and belt-worn radios suffer from body absorption, causing considerable variations in readings at different frequencies.

Two of the frequencies under measurement, 102.7 MHz and 109.8 MHz, show FM broadcast band and lower aircraft band respectively. If these aren't of interest, their performance should be ignored.

For typical scanner listening, then, the five remaining test frequencies are critical. Here is what we learned. The 48" telescoping whip is hot at the lower frequencies when fully extended, but drops 5 dB at the 800 MHz range. Of course one supreme advantage of a telescoping whip is that it can be adjusted to the appropriate length for any frequency in its range.

Grove ANT06 telescoping whip (\$14.95):



Diamond SRH77CA scanner antenna (\$21.95):

The Condor lives up to its reputation for hot performance in a 12" antenna. It performs slightly better than its longer RH77CA competitor on low band and even better on the 860 MHz band, but the RH77CA is slightly better in the 460 MHz range.

The GRE stubby rubber ducky was the worst performer in the group, probably accounting for the fact that GRE offers several optional replacement antennas on their website.

And finally, the 18" whip. It's outperformed only on the 460 MHz range by the RH77CA and Condor, and low band by the 48" whip.

The Bottom Line

For the average scanner user, virtually any of these antennas is going to bring in signals. In fringe-reception areas will you notice a difference in weak signal response, most obvious when replacing the GRE antenna.

Antenna Switches

It is often desirable to select among two or more antennas for optimum reception or transmission. For receiving purposes, or even for low power (a few watts) transmitting, most TV coax antenna switches work admirably from DC through 1000 MHz. CB-type antenna switches work fine up to about 30MHz, for both receiving and transmitting. For higher power, especially at higher frequencies, select a commercial coax switch rated for the frequency range and power required.

Splitters and Combiners

A splitter is essentially a broadband RF transformer which allows one signal source to be equally divided into two or more paths. This allows two or more receivers to operate from one antenna. Since a two-way splitter is a power divider, each output will be reduced by 3 dB, half the original power level. There will also be some minor additional loss from the resistance in the windings.

Connected in reverse, a splitter becomes a combiner, allowing two signal sources to add commonly. This allows, for example, two separate-frequency antennas to be used simultaneously with one wide-spectrum receiver. But there is a caveat for doing this. If the two antennas have a similar frequency response, they can produce destructive interference (signal canceling) from signals arriving out of phase from certain directions.

This same anomaly can be an advantage as well – it provides 3 dB overall gain in other directions! Basically, the system comprises a directional array – a “beam” antenna. TV splitters marked “V/U” or “VHF/UHF” or “54-890 MHz” actually work reasonably well from the low HF range (typically around 3 MHz) up through 1 GHz. They typically sell in the \$4-\$5 range:

For transmitting, TV splitters will also allow low power – a few watts – to pass without much problem, but higher power levels will heat the fine winding and saturate the small ferrite core, wasting power and even destroying the device. Transmitter splitters and combiners are also available, but due to their rugged requirements, they are substantially more expensive.

Preamplifiers

A preamplifier (“pre-amp” or “signal booster”) is simply a small-signal amplifier placed between the antenna and receiver. When integrated with a small receiving antenna, the combination is called an active antenna (previously discussed). Preamps connected to poorly-located antennas will not perform as well as well-placed, larger “passive” (unamplified) antennas, but they may be the only alternative

when better antennas are not practical. Keep in mind, however, that these preamps cannot withstand a transmitter’s power. They must be bypassed or disconnected from the antenna line during transmission.



The WiNRADiO LNA-3500 preamp (\$199.95) and the AOR LN4000 preamp (\$189.95) can be mounted right at the outdoor antenna for best performance:

If a shortwave receiving antenna is at least 20 feet long and in the clear, a preamplifier is probably unnecessary.

A preamp must have a lower noise figure (self-generated “hiss”) than the receiver, or the only thing it accomplishes is increasing both signal and noise, just as if you had merely turned up the receiver’s volume control.

It must have wide dynamic range – the ability to amplify weak and strong signals equally without becoming overloaded and thus generating spurious signal products, known as intermodulation (intermod), which interferes with normal reception.

The Ramsey wideband preamp is a popular favorite (\$59.95):



Suffering from strong-signal overload? Try a PAR filter (\$69.95):



At VHF and especially UHF frequencies and above, where transmission line losses may become significant, a preamplifier mounted at the antenna will boost signals above the loss

characteristic of the line. Still, the preamp is vulnerable to all the problems described above. Use it as a last resort.

Disguising the Obvious

Not every spouse and neighbor is delighted to see antennas and feed lines obscuring their view. Hams, SWLs, and scanner listeners have come up with many clever ways to disguise their hobbies. One claims to have worked the world on ten meters using an inconspicuous grocery cart on his lawn. Another put up a flagpole – actually a whip antenna. Yet another found that the mast for a birdhouse worked well to camouflage the vertical antenna.

A wire antenna can be disguised quite well if the insulated covering is blue or grey. And coax works just as well buried as draped across the property to a window. If you have to have an indoor antenna, try several test locations. Usually, an attic crawl space, as high as possible, is the least interference prone.

The bottom Line

In general terms, there are almost no conditions for which some sort of antenna can’t suffice. Height above ground, freedom from obstructions, and absence of electrical interference are probably the most important considerations. Then make your selection based upon frequency, direction, and range requirements.

M_T

CCRadio2



Designed for Even Better Long Range AM & Now Emergencies

- AM, FM, 2-Meter Ham, Weather Band and NOAA Weather Alert
- 2-Meter Scans Five Memories for Active Frequencies, Squelch
- Built-in Twin Coil Ferrite® AM Antenna for Max. Reception
- Signal & Battery Strength Meters

\$159⁹⁵

C. CRANE

Free Catalog

800-522-8863 • ccrane.com



SCANNING REPORT

THE WORLD ABOVE 30MHZ

Dan Veeneman

danveeneman@monitoringtimes.com

www.signalharbor.com

The Truth about Encryption

November is the traditional month when we give thanks for what we have. Overall, listeners have had a pretty good year, with advanced, easy-to-use scanners coming on the market and radio-related information easy to find.

However, November also heralds the coming winter. Some listeners can see the equivalent of dark clouds on the horizon as they worry about how long public safety radio transmissions will be available to the public. In contrast to so many politicians proclaiming their desire for "transparency" in government operations, we find many police departments choosing to encrypt their radio systems.

Washington, D.C.

On September 15, 2011, Washington D.C.'s Metropolitan Police Department (MPD) switched over to full-time encryption on nearly all of their radio channels. The MPD Chief made the claim that "The technology being used by our criminals is really hampering the way we do our job," and referred to smartphone-based scanner applications that allow a user to monitor police transmissions.

Curiously, the MPD has so far been unable to document a specific instance where such "hampering" affected the outcome of a case. "It's not something we're doing to keep the press out, it's something that we're doing to keep our community and our police officers safe," the Chief said.

The decision to encrypt has negative consequences for mutual aid from surrounding jurisdictions, especially in the National Capitol Region where multiple, overlapping law enforcement agencies are common. In most areas of the country, police officers are able to monitor and participate in conversations with nearby agencies and departments. This basic level of interoperability allows police to keep track of events in their area and give them the needed awareness to make a difference in preventing crime and apprehending criminals. If they are unable to communicate with MPD, such inter-agency cooperation will become much more difficult and much less likely to occur.

MPD indicated they would share their encryption keys with area jurisdictions, as if that cures the problem. It requires each of these jurisdictions to pay a significant amount of money to their respective equipment vendor to install compatible encryption software into every one of their radios. This is a windfall for the vendor, certainly, but another expenditure that must ultimately be borne by taxpayers.

Jacksonville, Florida

Jacksonville is the largest city in Florida, located in the northeast corner of the state with more than 800,000 residents and covering nearly 900,000 square miles of land and water. This area of Florida is sometimes jokingly referred to as "South Georgia," being located less than 30 miles from its northern neighbor. The city government is consolidated with the government of Duval County, despite four smaller towns existing within the county.

Jacksonville operates a Motorola Type II SmartZone system that carries both analog and APCO Project 25 digital voice traffic, operating from half a dozen repeater sites located around the county. The city is licensed to use a number of frequencies in the 800 MHz band, including: 854.9625, 855.2125, 855.4875, 855.9625, 855.9875, 856.2125, 856.2625, 856.4625, 856.7125, 856.7375, 856.9375, 856.9625, 856.9875, 857.2125, 857.2375, 857.2625, 857.4625, 857.4875, 857.7125, 857.9375, 857.9625, 858.2125, 858.2375, 858.2625, 858.4625, 858.4875, 858.7375, 858.9375, 858.9625, 858.7125, 859.2125, 859.2625, 859.4625, 859.4875, 859.7125, 859.9375, 859.9625, 859.9875, 860.2125, 860.2625, 860.4625, 860.4875, 860.7125 and 860.9375 MHz

Fortunately for listeners, most digital-capable scanners have a control-channel-only feature that allows you to program just the control channel frequencies, which have been identified on the Jacksonville trunked system as 856.9625, 860.4625, 860.7125 and 860.9375 MHz.

Of course, if you have a Uniden HomePatrol-1, Radio Shack PRO-18 or GRE PSR-800, you can easily scan the system without programming anything, since these scanners come pre-programmed with the proper frequencies.

As you might expect, the Jacksonville trunked radio system carries many talkgroups representing a variety of city and county operations. These are both analog and digital, with nearly all of the law enforcement talkgroups hidden by encryption. Some of the talkgroups you can hear are listed below.

Dec Hex Description

16	001	Jacksonville Public Works
48	003	Jacksonville Public Works
80	005	Jacksonville Public Works
112	007	Jacksonville Solid Waste
176	00B	Jacksonville Signal Bureau
304	013	Jacksonville Mosquito Control
336	015	Parking Enforcement
368	017	Jacksonville Fleet Maintenance
400	019	Jacksonville Adult Services
432	01B	Parks Department (Maintenance)
464	01D	Parks Department (Hanna Park)

560	023	Jacksonville Public Works
592	025	Jacksonville Solid Waste
624	027	Jacksonville Solid Waste
656	029	Jacksonville Solid Waste
688	02B	Jacksonville Streets Department
816	033	Jacksonville Solid Waste
848	035	Jacksonville Parking Lots
880	037	Jacksonville Fleet Maintenance
944	03B	Parks Department (Landscaping)
976	03D	Parks Department (Huguenot Park)
1072	043	Citywide 1
1104	045	Citywide 2
1136	047	Citywide 3
1168	049	Citywide 4
1200	04B	Citywide 5
1232	04D	Citywide 6
1264	04F	Fleetwide
1296	051	Emergency Operations Center 1
1328	053	Emergency Operations Center 2
1360	055	Mayor Command Network
1616	065	Jacksonville Aquatics (Lifeguards)
1648	067	Jacksonville Transportation Authority (Bus Dispatch)
1680	069	Jacksonville Transportation Authority (Bus Operations)
1712	06B	Jacksonville Transportation Authority (Bus Operations)
1744	06D	Jacksonville Transportation Authority (Bus-to-Bus)
1776	06F	Jacksonville Transportation Authority (Connexion)
1808	071	Jacksonville Transportation Authority (Bus Operations)
1872	075	Jacksonville Transportation Authority (Bus Operations)
2384	095	Jacksonville Fire Rescue (Patch)
2416	097	Jacksonville Medical 6
2448	099	Jacksonville Medical 8
2480	09B	Emergency Operations Center link to Emergency Alert System
17360	43D	Jacksonville Fire Rescue (Main)
17392	43F	Jacksonville Fire Rescue (Dispatch)
17584	44B	Jacksonville Fire Rescue (Support)
17616	44D	Jacksonville Fire Rescue (Training)
17648	44F	Jacksonville Fire Rescue (Prevention)
19632	4CB	Animal Control (Dispatch)
19696	4CF	Special Events Announcements
19760	43D	Parks Department (Special Projects)
19792	4D5	Commercial Building Inspectors
19824	4D7	Parking Meter Maintenance
21360	537	Duval County Health Department
21392	539	Duval County Health Department
21424	53B	Duval County Health Department
21456	53D	Duval County Health Department
21488	53F	Duval County Health Department
21584	545	Jacksonville Transportation Authority (Bus Dispatch)
21616	547	Jacksonville Transportation Authority (Bus)
21648	549	Jacksonville Transportation Authority (Bus)
21680	54B	Jacksonville Transportation Authority (Bus Supervisors)
21712	54D	Jacksonville Transportation Authority (Bus Supervisors)
21904	559	Jacksonville Transportation Authority (Bus Operations)

21936	55B	Jacksonville Transportation Authority (Skyway)
21968	55D	Jacksonville Transportation Authority (Skyway)
22000	55F	Jacksonville Transportation Authority (Skyway)
22032	561	Jacksonville Transportation Authority (Skyway)
22064	563	Jacksonville Transportation Authority (Skyway)
22096	565	Jacksonville Transportation Authority (Skyway)
22128	567	Jacksonville Transportation Authority (Skyway Announcements)
22480	57D	Animal Control (Pound Operations)
22512	57F	Animal Control
22544	581	Animal Control
22576	583	Animal Control
22608	585	Animal Control
22640	587	Animal Control
22672	589	Special Events 1
22704	58B	Special Events 2
22736	58D	Special Events 3
22768	58F	Special Events 4
22800	591	Special Events 5
22832	593	Special Events 6
22864	595	Special Events 7
22896	597	Special Events 8
22928	599	Special Events 9
22960	59B	Special Events 10
22992	59D	Special Events 11
23024	59F	Special Events 12
23056	5A1	Special Events 13
23088	5A3	Special Events 14
25616	641	Parking Enforcement
25648	643	Jacksonville Parking Lots
25680	645	Parking Meter Maintenance

❖ Media Relations

Law enforcement talkgroups on the Jacksonville system have been encrypted for some time. Under an early agreement with the local news outlets, the Sheriff's Office programmed several radios with the proper encryption keys and rented them to local news organizations. This arrangement allowed the media to monitor the otherwise hidden police activity as it happened, giving them the ability to report live, inform the public in a timely manner and ask detailed questions based on information they overheard.

In July 2011, the Jacksonville Sheriff's Office demanded the return of radios rented to local news agencies but were unclear exactly why they wanted them back. They first mentioned the issue of cost, but when the media offered to purchase the radios outright, the Sheriff's Office made the same claim as Washington, D.C. – namely, that is was really about officer safety.

The urge to encrypt seems to be a virus spreading in Florida. The state's Highway Patrol has been encrypted for several years, and recently the Jacksonville Fire and Rescue Department (JFRD) announced they would also encrypt their transmissions, making it nearly impossible for media and other community organizations to stay informed on local activity.

JFRD defends their decision by explaining that personal information like addresses and health conditions that might be sent over the radio are subject to legal privacy limitations, including federal Health Insurance Portability and Accountability Act (HIPAA) laws. A department spokesman made the claim that encryption is part of a Department of Homeland Security (DHS) upgrade that has been in the works since HIPAA passed in 1996, despite the fact that DHS was created in 2002.

In addition to the analog and unencrypted digital talkgroups on the city system, there are a number of analog conventional frequencies worth checking.

Frequency	Description
154.950	Sheriff's Net (Inter-agency)
155.340	Hospital Emergency Administrative Radio (HEAR)
155.370	Police (Inter-agency)
155.850	Emergency Alert Radio System (EARS) (media alerts)
453.075	Trauma One Helicopter Dispatch (Shands Jacksonville)
460.575	Jacksonville Fire Rescue (Dispatch)
462.950	Lifeflight Helicopter Dispatch (Baptist Medical Center)
462.975	Trauma One Helicopter (Lake City)
463.125	Jacksonville Fire Rescue (Medical 6)
463.175	Jacksonville Fire Rescue (Medical 8)

❖ Impacts to the Community

Encryption has traditionally been used only for sensitive police operations, such as SWAT, narcotics, and undercover work that would be put at significant risk if revealed. However, in areas where encryption is used for all transmissions, whether sensitive or routine, mutual aid from nearby agencies becomes difficult. Public safety personnel, unless their department provides enough radios, will not be able to use a scanner to keep track of events while off duty. Motorists will be less informed about hazardous areas and emergency scenes to avoid. Good Samaritans will no longer be able to act as extra eyes and ears of the police, phoning in relevant tips to help curtail crimes in progress and apprehend fleeing suspects. Neighborhood Watch organizations and community activists will no longer be able to stay abreast of late-breaking events that directly affect them.

More significantly for a free society, when the media and the public are kept in the dark about government activity, it fosters an atmosphere of distrust between civil servants and the people they claim to serve. When government agencies have the sole ability to decide what information to release and in what form, it becomes all too common for the community to receive a sanitized version of events that fails to fully inform the public in a timely manner. The vital civic element of an informed citizenry is significantly weakened.

❖ Related Constitutional Issues

In August of 2011, the United States Court of Appeals for the First Circuit ruled, in part, that there is a First Amendment right to videotape police officers in a public space. The case arose after a Massachusetts resident was arrested as he used his cellular telephone to record the actions of three Boston police officers. He was charged with three offenses, including violation of the state wiretap law. All of the charges were eventually dropped, but after the Boston Police Department ignored his subsequent complaint, the resident filed a civil rights violation lawsuit against the arresting officers and the City of Boston, claiming violation of his First and Fourth Amendments rights.

The Massachusetts District Court ruled

WWW.SCANCAT.COM

TOLL FREE 888-722-6228

ScanCat-Lite-PLUS

Reg. \$39.95 - Limited Time Special \$29.95

Now It's Easier Than Ever To Use Your ScanCat Software.

FREE walk-you-through set up video. NEW! Home Patrol Video Tutorials!

www.scancat.com Click on "Learn as you view." **You Tube**

NOW AVAILABLE \$CALL HOKA Code 3-32

NOW! Open Up Uniden HomePatrol's True Potential

Program ANY Frequency Into The HomePatrol Without Limitations (CB-Ham-Marine-GMRS-FRS)

COMBO ALL-IN-ONE CD

ScanCat-Lite-Plus.....\$29.95
Mr. Scanner FCC Public Safety\$29.95
Nat-Com's FCC Scancat Files\$9.95
Bonus Disk Of Frequencies.....\$15.00
If Purchased Separately \$84.85

NOW \$49.95

PLUS FREE Scanning Magazine(s)
(With Any Order Over \$40.00)



COMPUTER AIDED TECHNOLOGIES

ORDERS: (318) 687-4444 FAX: (318) 686-0449
Info/Tech Support: (318) 687-2555
(9 a.m. - 3 p.m. Central M-F)

WWW.SCANCAT.COM

GRE PSR-800



Finally, a wide-frequency-coverage, hand-held scanner with just about every feature you'll need! Easy programming from its own USA/Canada database; automatic loading and tracking of all major trunking systems; P-25 digital voice decoding; database and CPU firmware updating from the Internet; computer control or stand-alone operation; spectrum sweeper to instantly receive and display nearby unprogrammed signal frequencies; S.A.M.E. weather alert; built-in recording of received frequencies; informative multi-line LCD display; standard BNC connector for external antennas; and much, much more!

Order SCN57

\$449^{95*}

* plus \$17.95 UPS Ground shipping in the U.S.

GROVE

800-438-8155
828-837-9200 fax: 828-837-2216

order@grove-ent.com
7540 Highway 64 West
Brasstown, NC 28902

www.grove-ent.com

against the officers and included a statement of constitutionality, specifically that “in the First Circuit...this First Amendment right publicly to record the activities of police officers on public business is established.” The officers appealed and a unanimous Appeals Court sided with the resident.

While on its face the ruling does not address scanning, it does spell out a line of reasoning that directly addresses the rights of citizens to monitor and disseminate the activities of government agencies and individuals. Here are some excerpts from the ruling:

As the Supreme Court has observed, “the First Amendment goes beyond protection of the press and the self-expression of individuals to prohibit government from limiting the stock of information from which the public may draw.”

Gathering information about government officials in a form that can readily be disseminated to others serves a cardinal First Amendment interest in protecting and promoting “the free discussion of governmental affairs.”

Ensuring the public’s right to gather information about their officials not only aids in the uncovering of abuses, [...] but also may have a salutary effect on the functioning of government more generally [...] “many governmental processes operate best under public scrutiny.”

“The First Amendment protects the right to gather information about what public officials do on public property, and specifically, a right to record matters of public interest.”

The ruling also addresses the artificial distinction made between professional journalists and the general public, negating the claim that traditional media organizations somehow have more of a right to information than an ordinary citizen.

The First Amendment right to gather news is, as the Court has often noted, not one that inures solely to the benefit of the news media; rather, the public’s right of access to information is coextensive with that of the press.

Moreover, changes in technology and society have made the lines between private citizen and journalist exceedingly difficult to draw. The proliferation of electronic devices with video-recording capability means that many of our images of current events come from bystanders with a ready cell phone or digital camera rather than a traditional film crew, and news stories are now just as likely to be broken by a blogger at her computer as a reporter at a major newspaper. Such developments make clear why the news-gathering protections of the First Amendment cannot turn on professional credentials or status.

❖ Practical Issues

Just because a system is encrypted does not mean it is secure. Radio messages sent by the German and Japanese armed forces in World War II were encrypted using hardware and methods that were quite advanced for the time. However, those encryption schemes were rendered ineffective by Allied codebreakers,

who were able to find and exploit weaknesses that revealed the underlying messages.

In modern times, the first widespread encryption standard for wireless Internet access, called Wired Equivalent Privacy (WEP), used a weak algorithm and made mistakes in the way data was processed. The result was insecure wireless connectivity and an opportunity for people with the appropriate software to make use of “protected” wireless resources.

As we discussed in last month’s column, APCO Project 25 (P25) is one of the most popular radio standards used by public safety agencies. P25 specifies encryption mechanisms and equipment vendors sell hardware and software that embodies those mechanisms. However, just because encryption is in use does not mean the system is secure.

Generally speaking, encryption requires two things: a specific and well-defined *algorithm* that spells out the steps required to encrypt and decrypt information, and a secret value known as a *key*. In P25 systems, the same algorithm and the same key must be programmed into all of the radios in order for encryption to take place. If a radio does not have the correct algorithm or the correct key, it cannot participate in an encrypted conversation.

The choice of which algorithm to use is limited by the manufacturer of the radio. The P25 standard only requires that all vendors must implement one algorithm, known as DES-OFB (Data Encryption Standard, Output Feedback). P25 supports other algorithms, including 3DES (Triple Data Encryption Standard) and AES (Advanced Encryption Standard); however, the use of these alternatives is not required nor are they widespread.

So, if the Washington, D.C. Police Department uses DES in their radios but neighboring Prince George’s County, Maryland uses AES, they will not be able to communicate even if they do share keys, since the algorithms are incompatible.

❖ Cracking Keys

The Data Encryption Standard (DES) was designed in the 1970s and was replaced long ago by stronger algorithms that do a better job at protecting information. The strength of a particular algorithm can be measured in a very rough way by the number of bits in the key, since the most straightforward way an attacker who doesn’t know the right key might try to decrypt a message is through a process called *exhaustive key search*, where every possible key is tried. This “brute force” method is similar to opening the three-digit locks on an unfamiliar briefcase – simply try every combination from 000 to 999 until you run across the one that allows you to open it.

DES uses a key that is 56 bits long. Although this means there are about 70 quadrillion (7×10^{16}) possible keys, a very large number that has sixteen zeros in it, high speed computing devices exist that can check all of those possible DES keys in less than nine days. Although this may seem like a long time, once the key is found it can be used to decrypt all the traffic that used that key, past or future.

By way of comparison, 3DES can have an

effective key length as high as 168 bits, while AES can support key lengths of 128, 192 and 256 bits.

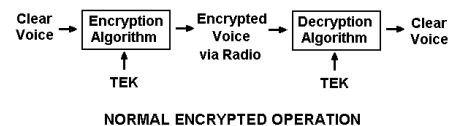

❖ Key Management

A large public safety agency will have several thousand radios. Each of these radios will be programmed with the algorithm that the agency selected and purchased from their vendor. The radio will also be loaded with two kinds of keys, called Traffic Encryption Keys (TEKs) and Key Encryption Keys (KEKs).

TEKs are used to protect normal transmissions to and from the radio, encrypting and decrypting the voice and data traffic carried in talkgroups. A radio may have several active TEKs loaded in memory, allowing it to operate in multiple talkgroups. TEKs may be used hundreds of times each day and remain in use and unchanged until they are replaced. If an attacker were able to determine one of these TEKs, he or she would be able to monitor the activity on the talkgroup protected by the TEK as if it were not encrypted at all.

Because TEKs are shared by many radios and can remain in use for a long period of time, an attacker with the proper skills will have ample opportunity to work out their exact values. Because of this key exposure problem, it is a common security practice to replace old TEKs with new ones.

Rather than having to physically return each radio to the station to get new keys, TEKs in a P25 system may be changed by using a process called over-the-air rekeying (OTAR). During the OTAR process the radio exchanges commands and data with a centralized key management mechanism within the P25 system, resulting in new keys being loaded into the radio. The transmissions during this process are encrypted with KEKs, which is the only time they are used.

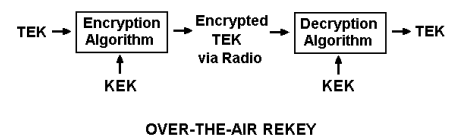

The biggest problem with OTAR is ensuring that all radios are updated. A system cannot switch from an old key to a new key until all of the participating radios have the new key. This is a difficult logistical problem within a large agency, but becomes far more problematic if a new key must be distributed to nearby agencies who provide mutual aid. The net effect is that TEKs remain in use far longer than they should and that an attacker who discovers a TEK by whatever means may have a long time to make use of it.

That’s all the room I have for this month. Enjoy the holiday season and keep sending in those questions, comments and frequency reports to danveeneman@monitoringtimes.com. My web site at www.signalharbor.com contains more radio-related material. Until next month, Happy Thanksgiving!



Not Quite Right

In my September column, I made the statement that when an external linear power amplifier on an HF transceiver is turned off, the antenna is disconnected from the rig. This is not true in most cases.

Larry Wheeler, W9QR, reminded me that most modern linear amplifiers have a relay that bypasses the amplifier. When the amp isn't operating, the antenna is connected directly to the transceiver, making it vulnerable to high-level received signals.

So what is the likelihood of damage to the receiver's RF input stage? Years ago, when low-voltage, low-current transistors first replaced more resilient vacuum tubes, burnout of the RF transistor was common. Nowadays, extensive use of diode protection in the receivers' front ends makes such burnout far less common.

Additional protection against high-level RF or even nearby lightning strikes is achieved by simply grounding the unused antenna with a switch.

Ten NOAA Frequencies?!

Years ago (1980s) I bought a Radio Shack TRC-483 40-channel 2-way CB. It has a NOAA capability. The issue is that there are not seven, but ten frequencies:

- 161.650 MHz
- 161.775 MHz
- 162.400 MHz (US) and Canada
- 162.425 MHz (US), and Canada
- 162.450 MHz (US), and Canada
- 162.475 MHz (US), and Canada
- 162.500 MHz (US), and Canada
- 162.525 MHz (US), and Canada
- 162.550 MHz (US) and Canada
- 163.275 MHz

The three unmarked I heard were international weather frequencies – in use in Canada and Mexico. Can you confirm/deny any of this?

The next question is – which is which? Which one or two are used in our neighbors' radios?

Morgan Little

Interesting question, Morgan. I found this from the National Weather Service on the Marine Forecasts page:

"Many NOAA Weather Radio receivers are also programmed for three additional frequencies; 161.650 MHz (marine VHF Ch 21B), 161.775 MHz (marine VHF Ch 83B) and 163.275 MHz. The first two frequencies are used by Canada for marine weather broadcasts. 163.275 MHz was used by the National Weather Service for internal coordination in the event of a power outage but is no longer in active use."

Q. My Icom R-75 receiver has the DSP unit installed. Would an additional outboard DSP unit help

further, or would it be redundant, like wearing suspenders and a belt? (Jim Rubin, KC2LMH, Forest Hills, NY)

A. More like wearing two belts! The built-in unit does well for most general-purpose listening. You would probably benefit more by just adding a larger external speaker, but not by much, just better bass.

Perhaps if you monitor a wide variety of digital modes, a more complex audio processor would help in some cases. But maybe it would be more like adding a button when you already have a belt!

Q. My desirable FM radio stations are getting blasted by locals here in Breinigsville, PA. What can I use for a directional indoor antenna?

A. A set of TV rabbit ears set to about 48" tip to tip should do the trick. If your FM receiver has a pair of screws for twin lead, you're all set; if it has a coax connector, you'll need a standard TV balun transformer to match the balanced 300 ohm antenna to 50 or 75 ohm coax.

Q. What is the difference among radio terms like RDS, SDR, and DSP?

A. The Radio Data System (RDS or, in the USA, Radio Broadcast Data System – RBDS) is a means of digitally embedding text in an FM radio station's signal, such as call letters and format, which can be shown on the receiver's LCD display.

Software Defined Radio (SDR) is a classification or design indicating that formerly-analog RF stages like mixers, IFs, and detectors, have been replaced by digital circuitry which can be addressed and manipulated by software commands.

Digital Signal Processing (DSP) is a means of digitally controlling single-signal clarification circuitry like final IF, detector, audio, and noise interference to optimize a signal.

Q. According to SETI (Search for Extra Terrestrial Intelligence), we have been sending signals out to the surrounding universe for some 70 years. Wouldn't this just be white noise to an alien? (Mark Burns, Terre Haute, IN)

A. The signals vary in content, some with video and audio, others as photos, text strings, or even mathematical or geometric progression. It is assumed (hoped) that if heard by ears or seen by eyes not familiar with our languages or music, the mathematical repetition, progressions, and other unnatural relationships should indicate their artificial origin to a distant listener, and encourage decoding or demodulation.

Q. I have a Grundig Satellit 800, a Drake SW8, and Icom R75 short-wave radio. When I listen to 80 and 40 meter amateur bands at night with the same outdoor antenna alternatively switched to each radio, I hear electrical interference periodically for a minute or so on the Drake and Grundig, but none on the Icom when tuning the same frequencies. All three radios work fine on all modes and on other frequencies without the interference. (Jimmy J. Fulford, Jacksonville, FL)

A. I am puzzled that the R75 hears no noise when connected to the same antenna at the same time that the other two would hear the noise. I can think of two reasons for this.

If the other two radios are using switching-type power supplies, these are notorious for generating radio frequency interference (RFI). It's possible, of course, that another common noise-generating circuit might be found in the two radios, such as the frequency display circuitry.

Do you still hear the noise, even if reduced, with the antenna disconnected? That would be indicative of an internal circuit source of the interference.

A second possibility is that you have Icom's DSP or noise blanker switched on. Be sure that these noise-reduction features are switched off when you are listening for the noise.

If you have a portable transistor radio with a whip, place it close to the radios' display and try tuning in the noise on the AM band to see if it coincides with the reception of the same interference by the shortwave receivers.

If you can hear it even when the portable is some distance from the receivers, walk around the house to see where it's loudest in order to isolate the source.

Questions or tips sent to Ask Bob, c/o MT are printed in this column as space permits. Mail your questions along with a self-addressed stamped envelope in care of MT, or e-mail to bobgrove@monitoringtimes.com. (Please include your name and address.)



WLO Begins Public RTTY Broadcasting

On August 17, 2011, the always interesting WLO (ShipCom) station in Mobile, AL began an ambitious new project called WLOWNEWS. This is a continuous broadcast of real news stories, using the narrow-band teleprinting modes radioteletype (RTTY) and Simplex Telex Over Radio mode B (Sitor-B), alternating on 8473.0 kilohertz (kHz).

WLO is not the first to attempt a fully public RTTY broadcast, as opposed to the point-to-point links and government news feeds that ruled the bands at one time. An amateur experimental station tried this for a couple of years once, before disappearing.

Today, we have KSM, a fully licensed commercial station operated on Saturdays using the awesome resources of the Maritime Radio Historical Society (MRHS) at the old KPH "power house" in California. Current KSM frequencies have been 8433 and 12631 kHz for some years now. 6328 is also licensed but not yet in service, according to the MRHS web site.

Now, add WLOWNEWS. It appears to be the brainchild of Rene Steigler, K4EDX, WLO's owner and all around radio good guy. It began in cooperation with a number of amateur RTTY enthusiasts, including Stephen, W0TTY, and George, W7TTY.

The transmitter is modest, with 1000 watts into an unknown antenna type from WLO's Alabama site. KPH/KSM it is not. Reception is something of a challenge. Here, it is printable most evenings, but regular fades create huge holes in the copy and many lines of something more resembling encrypted Klingon. Attempts at clearer reception on GlobalTuner remotes have given mixed results.

RTTY signal parameters are a speed of 45.45 baud with a shift of 170 Hertz. It uses the standard 5-bit International Telegraph Alphabet #2 (ITA2) character set, also known as "Baudot." The signal polarity seems to have changed at least once, and at press time it's "Reverse" for upper sideband (USB) and "Normal" for lower sideband (LSB). Sitor-B is the usual system, also known as "FEC" mode for "Forward Error Correction."

It's interesting to note that Sitor-B is still required in some situations under the maritime Global Distress and Safety System. Mariners now have another way to test their decoding equipment.

Currently, every news story is broadcast in RTTY, followed by an announcement that the broadcast will switch to Sitor-B. It does just that, followed by a station and ShipCom identifier, then the announcement to go back to RTTY.

Things are still very much in flux with this new service. Some or all of these details could have

changed by the time this column is published.

All the best to WLOWNEWS, and may the revival of full-time RTTY news be underway!

❖ Itty Bits?

At one point, there was evidence that WLOWNEWS was being fed over the Internet by an interesting streaming audio service called ITTY (Internet Teletype). ITTY is a genuine, frequency-shift-keyed RTTY signal that is fed over the net from W7TTY in Sequim, WA.

Listeners can use any program with capability to open a Web address and play .pls (playlist) files. Quicktime works just fine here. Send the Internet audio to any standard decoder program, and watch hours of copy come out. It, too, is 45 baud and 170 shift.

The precise relationship between ITTY and WLOWNEWS is unknown at press time, and seems to be somewhat in flux. At present, it does not appear to be feeding WLO directly. The continuous service has severely tested the limitations of Internet streaming on Windows computers. One thing for sure is that WLOWNEWS is still evolving.

❖ Internet Resources

Questions and reception reports go to WLOWNEWS@olypen.com. The station will verify by e-mail. There is also a web site, still embryonic, with only a stub page at press time. It is at www.wlownews.com.

ITTY is explained fully at www.rtty.com/itty/index.htm. I should add to this that Winamp, Quicktime and RealPlayer are not the only choices for the .pls file streaming, though the Windows Media player requires add-on codecs and some file association tweaking to handle them.

The ITTY signal is available by going to the "play URL" menu item on your player, and dropping in this link: <http://65.243.191.51:8000/listen.pls>



YOU ARE COPYING ITTY NEWS
- SEQUIM, WASHINGTON, USA

❖ Vietnamese Mystery Deepens

One sentence that comes up an awful lot in this column is, "Just when it can't get any stranger, it does just that." Well, it's happened again.

This time, it's the Vietnamese numbers station, which is always good for a nice mystery. ENIGMA 2000, the European Numbers Information Gathering and Monitoring Association, finally assigned this one the designator of V30, effective July first.

But something else happened on July first. The station went off the air. Nothing has been heard since on its frequency of 10255 kHz USB. Many people, including me, have listened daily, both at home and on remote receivers in the region. "Token" has monitored this frequency 24/7, and with his equipment it would have turned up, even in summer conditions. Neither have any other frequencies been found.

Another HF disappearance? Not exactly. Also on July first, another broadcast in Vietnamese with a very similar format began, this time in continuous-wave (CW) Morse code.

Some of the Vietnamese words used in the voice transmissions appear here as well. They are actually spelled out in International Morse, without all the accented Roman letters usually used for phonetic Vietnamese. These include "So dien" (code key), and "so nhom" (group count).

The procedural signal "TK" also appears. This is possibly an abbreviation for "message," but this is not confirmed. This is followed by the usual message in 5-figure groups. However, the message is framed with strings of the Morse "A" at the beginning and "K" at the end.

The first schedule to be discovered was and still is daily on 10375 kHz CW, at 1500 coordinated universal time (UTC). As with the older V30, the entire day's broadcast is sent twice.

Ary Boender, who puts out the very comprehensive "Numbers and Oddities Newsletter," has an excellent log on his web site. He says that the daily schedule is confirmed by Token, who has put a watch on the slot.

It gets better: For various technical reasons, this broadcast is very likely the same station that has been heard by Eddy Waters in Australia. He has heard some extremely strange CW transmissions in Morse code which seem to contain only phonetic versions of e-mail spam in Vietnamese. Of the two sent to Google Translate by Ary, one hawked some type of dietary supplement while another one promised to add "smilies" (happy faces, etc.) to your e-mail.

It is likely that these are some kind of test. Presumably, e-mail spam is as good a text source as anything else. There's certainly enough of it around.

One weird inconsistency in the logs is the frequent appearance of the exclamation mark (!) in the e-mail spam messages. There is no such

character in the International Morse Code. Perhaps they are using one of several nonstandard codes that have been suggested for this character.

These transmissions have used many different times and frequencies. It is not known if slots are ever reused. Ary's log contains five intercepts, between 9 and 20 MHz. The document is available at www.numbersoddities.nl/V30-profile.pdf

❖ Hurricane Frequency List?

This year, hurricane Irene has raised questions on whether there should be a list of "hurricane frequencies" any more. The list on this column's web site began in the very dark ages, when utility fans were still exchanging small text files over dialup services, or mailing out print newsletters. In the ensuing decades, it has gone viral on the Internet, and now it turns up in some very strange places.

While the list is still kept as current as anything like this can be, Hurricane Irene did not produce the usual increased activity on the listed frequencies. Irene was an unusually broad storm, with emergency conditions and catastrophic flooding all the way up the US East Coast and into Canada. Internet sites like Twitter went crazy, but HF voice and digital remained eerily quiet.

In fact, this column got negative feedback on the list. An experienced listener downloaded it, but heard only hours of silence. Some of this was

bad luck, but most of it really was due to an unexpectedly low level of activity. Band conditions, for once, were excellent, so that wasn't the problem.

There are a number of possible reasons for this. Just about everyone in affected areas had cell phones, text messaging, and even hand-held Internet terminals. These, for the most part, weathered the storm unusually



well. Also, Irene's path hugged the coast, requiring way less long-distance HF communication. Finally, skip zones probably caused issues in the Mid-Atlantic and Northeast.

But HF utility radio really has changed. Years have gone by since anyone could just flip a switch and hear continuous HF voice traffic. There's a lot more hunting, technical geeking, and detective work involved now. This makes it much more engrossing for many people, but it's not for everybody.

The question remains: has the Hurricane Frequency List seen better days, and should it be discontinued? Fortunately, any decision is premature until more major storms have occurred. Let's see how this situation develops, and see you next month.



ABBREVIATIONS USED IN THIS COLUMN

AFB.....Air Force Base	Meteo.....Meteorological (weather office).
AFRTS.....US Armed Forces Radio/TV Service	MFA.....Ministry of Foreign Affairs
ALE.....Automatic Link Establishment	MX.....Generic for Russian single-letter markers/ beacons
AM.....Amplitude Modulation	NATO.....North Atlantic Treaty Organization
ARQ.....Automatic Repeat reQuest	PACTOR.....Packet Teleprinting Over Radio, modes I-IV
CAMSLANT.....USCG Communications Area Master Station, Atlantic	PSK.....Phase-Shift Keying
COTHEN.....US Customs Over-The-Horizon Enforcement Network	RTTY.....Radio Teletype
CW.....On-off keyed "Continuous Wave" Morse telegraphy	S06.....Numbers in Russian, male computer voice
DHFCS.....UK Defence High-Frequency Communications Service	S28.....Russian Buzzer/ UVB76, buzzes and voice messages
DSC.....Digital Selective Calling	Selcal.....Selective Calling
EAM.....Emergency Action Message	SITOR.....Simplex Telex Over Radio, modes A & B
FAX.....Radiofacsimile	Stanag 4285.....NATO "Standardization Agreement;" 8PSK teleprinting
G11....."Stritch" (/) family German version, unknown origin	UK.....United Kingdom
HFDL.....High-Frequency Data Link	Unid.....Unidentified
HF-GCS.....High Frequency Global Communications System	US.....United States
LDOC.....Long-Distance Operational Control	USAF.....US Air Force
LSB.....Lower Sideband	USCG.....US Coast Guard
M12.....Russian Intelligence CW, format is like voice stations	VC01.....Chinese voice chip robotic numbers, lasts for hours
MFA.....Ministry of Foreign Affairs	V13.....Taiwan "New Star," music and live female voice
MARS.....US Military Auxiliary Radio System	Volmet.....Formatted aviation weather broadcasts

All transmissions are USB (upper sideband) unless otherwise indicated. All frequencies are in kHz (kilohertz) and all times are UTC (Coordinated Universal Time). "Numbers" stations have their ENIGMA (European Numbers Information Gathering and Monitoring Association) designators in ().

2142.5	ZLST-German Customs Control Post, Cuxhaven, working ZBOR, Customs Cruiser Borkum (DBHD), also on 3831, ALE at 2247 (MPJ-UK).	6483.0	9MR-Malaysian Navy, Johore Bahru, RTTY marker at 1807 (PPA-Netherlands).
2673.0	ZLST, working ZPRI, Customs Boat Priwall (DLVI) ALE and data, at 2142 (MPJ-UK).	6535.0	Dakar-African air route control, Senegal, selcal JS-CP and position from Europa 041, Air Europa A332 reg EC-JPF, at 0411 (PPA-Netherlands).
3241.0	XSS-UK DHFCS control, Forest Moor, ALE sounding; also on 3226, 4329.5, 7535, 12230, and 16948.5; at 2231 (MPJ-UK).	6577.0	New York-Caribbean air route control, position from Teal 75, a USAF Reserve "Hurricane Hunter" WC-130J on a mission to hurricane Irene, at 0250 (Allan Stern-FL).
3246.5	Unid-Russian Air Defense, formatted CW tracking strings with (?) for missing items, also on 6421.5 and 9222, at 2049 (MPJ-UK).	6631.5	DTN-Algerian government, calling INGUEZ and TINZA, PACTOR-I at 0001 (ALF-Germany).
4075.0	Unid-Chinese Robot (VC01), rapid-fire voice-chip "female," in progress at 2025 (Ary Boender-Hong Kong remote).	6776.5	AFC2MC-USAF MARS, PACTOR-I net with various stations, at 2027 (Terry Netzley-OH).
4380.0	Unid-Male voice with high-speed Russian numbers, at 0650, 0726, 1155, and 1220 (Michel Lacroix-France).	6861.5	Unid-Bechar Provincial Net, Algeria, calling ELWATA, BELBALA, KERZAZ, and KHODEIR; PACTOR-I at 2303 (ALF-Germany).
4625.0	The Buzzer-Russian military channel marker and command broadcasts (S28), ten voice messages in five hours from MDZhB and IA6N, starting at 0900 (Boender-Netherlands). [Time coincided with fall of Tripoli, Libya.-Hugh]	6884.0	Unid-Probable NATO psychological operations, with messages in Arabic and English aimed at Libyan troops, at 1237 (Lacroix-France).
5097.0	CFH-Canadian Forces, Halifax, NS, Stanag 4285 channel availability marker "NAWS DE CFH ZKR F1 2822 3394 6242 8324 12371 16552 AR," parallel on 10945 and 15920, at 0247 (Hugh Stegman-CA).	6895.0	5JL1-Venezuelan Navy Frigate Mariscal Sucre (F-21), calling T5L1 (Puerto Cabello) with LSB ALE text message and voice, at 0335 (ALF-Germany).
5210.0	RCV-Russian Navy, Sevastopol, Ukraine, male with Russian voice traffic, at 2108 (Lacroix-France).	6963.0	3KF4-Venezuelan Navy, LSB ALE link check with 3WP1, at 2323 (ALF-Germany).
5258.0	BPLEZS-German Federal Police, Cuxhaven, working BP26, Police Boat Eschwege (DBGZ), ALE and data at 2148 (MPJ-UK).	6986.0	Unid-"Stritch" family German version (G11), callup V75/00, ended "Ende," at 0941 (ALF-Germany).
5368.0	MOBILE28-Lybian Great Man-Made River Authority, calling MOBILE27, ALE at 2054 (PPA-Netherlands).	7562.0	LD3-Angolan Ministry of Information, Luanda, ALE sounding at 0300 (ALF-Germany).
5446.5	Unid-US Navy rebroadcast of AFRTS Interruptible Voice Channel, sports program at 0503 (PPA-Netherlands).	7637.0	0322WACAP-US Civil Air Patrol, WA, ALE sounding at 1247 (PPA-USA remote).
5652.0	"04"-HFDL ground station, Riverhead, NY, uplink to CS-TFW, Arik Air/HiFly A340, at 0449 (PPA-Netherlands).	7833.0	2WKT-Polish Forces, traffic in Polish with 2ZAZ, at 0558 (PPA-Netherlands).
5779.6	FAV22-French Morse code training, CW drill messages at 1921 (MPJ-UK).	7868.0	401-Turkish Civil Defense, calling 2016; also on 7870, 8092, and 10160; ALE at 1926 (MPJ-UK).
6450.0	PWZ33-Brazil Navy, Rio de Janeiro, PACTOR-I marker and warnings in English, at 0230 (ALF-Germany).	7931.0	Unid-Russian intelligence (M12) CW callup "257 257 257 2," and into message in 5-figure groups, at 1928 (PPA-Netherlands).
		7995.0	WHV382-SailMail, WA, PACTOR-III message to KTUK, Pearce Point Harbor, at 1256 (PPA-USA remote).

- 8045.0 RAP-Saudi Arabian aero net, calling JAP, ALE at 2029 (PPA-Netherlands).
8056.5 143001-Turkish Emergency Net, calling 106001, also on 12209, ALE at 2000 (PPA-Netherlands).
8058.5 KWA37-US Department of State, ALE and voice with KWT93, Europe, at 0730 (PPA-Netherlands).
8062.0 68-Singapore Navy vessel Formidable, calling CN6, ALE at 2004 (PPA-Netherlands).
8096.0 APM-Chilean Navy, working DBM, ALE at 0245 (ALF-Germany).
8281.2 Unid-South American net, possible regional vessel calling channel, many stations in Spanish, one calling Santa Rosa 13, at 0250 (ALF-Germany).
8294.0 Unid-Coastal station with navigation warnings in Vietnamese, at 1242 (PPA-USA remote).
8310.0 GWPWZ33-Brazil Navy, ALE link check with GWPWBL, Training Ship Brasil, (PWBL), at 0058 (ALF-Germany).
8320.0 Unid-Unknown weather FAX, no background map [Supplied by receiving station? -Hugh] at 0221 (ALF-Germany).
8353.0 AA5-Possible Venezuelan Navy, LSB ALE link checks with CC7 and YN4, at 0300 (ALF-Germany).
8473.0 WLO-ShipCom, Mobile, AL, RTTY news broadcast at 0235 (ALF-Germany).
8658.0 Unknown-Probably JFX, Kagoshima Prefectural Fishery Radio, Japan, very weak FAX chart at 1804 (PPA-Netherlands).
8812.0 TAH-Istanbul Radio, Turkey, weather in Turkish at 1800 (PPA-Netherlands).
8825.0 New York-North Atlantic air route control, selcal check AF-ER with KLM 753, an MD-11 reg PH-KCA, at 0251 (PPA-Netherlands).
8829.0 Unid-Turkish Airlines company LDOC, Ankara, selcal AB-CR and voice in Turkish with TC-JKN, a B737, at 2026 (PPA-Netherlands).
8879.0 Mumbai-Indian Ocean air route control, selcal JM-LQ to Air Arabia flight ABY0402, an A320 reg A6-ABA, at 1735 (PPA-Netherlands).
8891.0 Iceland-Iceland Aeradio, North Atlantic air route control, selcal FM-GL for Canforce 2285, a Canadian Forces C-130 #130339, at 1832 (PPA-Netherlands).
8894.0 "11"-HF DL ground station, Panama, uplink to N647AV, an Avianca A319, at 0405 (PPA-Netherlands).
8912.0 D49-US Customs and Border Protection, a P-3 reg N149CS, COTHEN ALE sounding at 0347. ROS-USCG Cutter Spencer (WMEC 905/NROS), ALE sounding at 0412 (PPA-Netherlands).
8930.0 CS-TKI-White Airways A310, getting weather from Stockholm LDOC, at 0409 (ALF-Germany).
8942.0 Singapore-Southeast Asia air route control, working Jetstar 72, an A321 reg VH-VWU, at 1838 (PPA-Netherlands).
8945.0 Sondrestrom-Greenland ground station, working Skier 23, at 1936 (PPA-Netherlands).
8951.0 Tashkent-Tashkent Aeradio, Uzbekistan, calling Ashkhabad (Turkmenistan), at 0104 (ALF-Germany).
8957.0 "13"-HF DL ground station, Santa Cruz, Bolivia, uplink to 4M4521, a LAN Dominicana flight, at 0256 (PPA-Netherlands).
9017.0 JSRD-Venezuelan Navy, ALE link check with T5L1 (Puerto Cabello); also calling on 8340, 8298, 8273, 8150; finally raised T5L1 on 6895 LSB ALE and voice; at 0159 (ALF-Germany).
9025.0 210187-USAF C-17A #01-0187, calling ADW (Andrews AFB, MD), AED (Elmendorf AFB, AK), CRO (Croughton, UK), and finally raising ICZ (Sigonella, Italy) for an autopatch; at 2045 (ALF-Germany).
9221.0 A6V-Tracking net control in international Panamax 2011 exercise off Pacific coast of Panama, passing various "Puma" messages in Spanish to X5L, M4T, and V2U, at 2330 (ALF-Germany).
9264.0 Unid-Russian intelligence (M12), coded CW message in 5-figure groups, ended "TTT TTT" (cut zeroes), at 1720 (PPA-Netherlands).
9725.0 New Star Radio Station-Taiwan intelligence (V13), flute music and coded messages, at 0500 (Boender-Hong Kong).
10000.0 Unid-Unknown station sending brief encrypted messages in Stanag 4285, strong at 1140 (Waters-Australia). [Frequency is supposed to be allocated only to time stations. -Hugh] PPE-Brazilian standard time signal, Rio De Janeiro, with an "Observatorio Nacional" voice identifier, at 2141 (Lacroix-France).
10087.0 B-6323-Sichuan Airlines flight 3U8668, an A320 over China, HF DL position for Krasnoyarsk, at 1702 (PPA-Netherlands).
10090.0 Tashkent Volmet, Uzbekistan, aviation weather at 1641 (PPA-Netherlands).
10125.0 Unid-Probable NATO psychological operations, messages to Libyan troops in Arabic and English, at 1233 (Boender-Netherlands). [Frequency is likely Libyan military, grandfathered into the ham band. -Hugh]
10207.0 LO3-Possible Dutch military, calling A96, ALE at 1042 (Waters-Australia).
10404.0 Unid-Probable NATO psychological operations, in Arabic and English to Libyan troops, at 1144 and 1212 (Lacroix-France). MOBILE29-Possible Libyan military on Great Man-Made River Authority net, calling MOBILE3, ALE at 1946 (PPA-Netherlands).
10455.5 VIE-Globe Wireless, Darwin, Australia, digital header identifier in Globe idler [Sounds like PACTOR-I to the ear -Hugh], at 1801 (PPA-Netherlands).
10476.2 VZX-SailMail Australia, Firefly, New South Wales, PACTOR-I idler at 0837 (Waters-Australia). PH7352-Dutch sailing vessel Sogno D Oro, PACTOR-III e-mail traffic for VZX, at 1748 (PPA-Australia remote).
10555.0 VMW-Wiluna Meteo, Australia, FAX wind chart at 1813 (PPA-Netherlands).
10943.2 CFH-Canadian Forces, Halifax, NS, Stanag 4285 channel availability markers at 1142 (Waters-Australia).
11000.0 RIW-Russian Navy headquarters, Moscow, CW message to RGR70 in 5-figure groups, at 0926 (PPA-Netherlands).
11090.0 KVM70-Honolulu Meteo, HI, FAX wind/wave chart at 0748 (PPA-Netherlands).
11168.6 KWS94-US Department of State, Europe, ALE and voice with KWX57, Europe, at 0742 (PPA-Netherlands).
11494.0 TSC-COTHEN Technical Service Center, FL, ALE link with 712 (USCG HC-130H #1712), then voice patch from "Sacramento" regarding code keys, at 2303 (Stegman-CA).
12133.5 Unid-US Navy, Saddlebunch Key, FL, AFRTS rebroadcast at 0653 (PPA-Netherlands).
12135.0 RWH3-Russian point-to-point, working RVQ4 in RTTY, then encrypted data, at 0434 (PPA-Netherlands).
12140.0 STAT22-Tunisian Ministry of Information, raised STAT152, then traffic in CW and PACTOR-II, at 1249 (PPA-Netherlands).
12172.0 VHK-Australia Control, Lyndoch, passing aviation weather to an unknown station, at 0558 (PPA-Netherlands).
12184.0 RQF-Russian point-to-point, working RDI in RTTY, then encrypted data, at 0420 (PPA-Netherlands).
12205.5 Unid-North Korean MFA, ARQ at 0640 (PPA-Netherlands).
12222.0 LNT-USCG CAMSLANT Chesapeake, VA, calling J08 on COTHEN, ALE at 1928 (PPA-Netherlands).
12464.0 RJP98-Russian navy vessel, working, unknown station in CW, at 1356 (PPA-Netherlands).
12599.5 UAT-Moscow Radio, CW identifier in SITOR-A marker, at 1154 (Lacroix-France).
12702.0 CKN-Canadian Forces, Vancouver, BC, Stanag 4285 channel availability marker "NAWS DE CKN ZKR F1 2740 4167 6236 8303 12371 16567 22203 26630 AR," very loud at 0009 (Stegman-CA).
12783.5 9MR-Malaysian Navy, RTTY test loop at 1816 (PPA-Netherlands).
13267.0 Kirensk Volmet, female Russian voice with aviation weather at 1133 (PPA-Netherlands).
13270.0 "06"-HF DL ground station, Hat Yai, Thailand, uplink to PK-GMG, Garuda Indonesia flight 899, a B737, at 1722 (PPA-Netherlands).
13312.0 "02"-HF DL ground station, Molokai, HI, uplink to 7T-VJZ, Air Algerie flight 3061, an A330, at 0808. Molokai, uplink to B-6756, China Eastern Airlines 2841, an A320, at 1123 (PPA-Netherlands).
13321.0 D-ALCG-Lufthansa Cargo 8385, an MD-11, HF DL position for Johannesburg, then getting weather from ground station "08," at 1705 (PPA-Netherlands).
13327.0 Iberia Madrid-Iberia Airlines company LDOC, selcal check GQ-DJ with Iberia 6651, an A346 reg EC-LEV, at 1033 (PPA-Netherlands).
13342.0 SDJ-Stockholm LDOC, selcal check AJ-EH with TAAG Angola Airlines B770 reg D2-TED, at 1051 (PPA-Netherlands).
13371.5 Unid-North Korean MFA, Pyongyang, encrypted text in ARQ, at 0847 (Waters-Australia).
13927.0 Dawg 40-GA Air National Guard C-130H, patch to a commercial number via USAF MARS AFA5RS (IN), then AFA9AY (CA), at 2057 (Stern-FL).
14384.0 IC9X-Russian military, CW message in 5-figure groups for unknown station, at 0854 (PPA-Netherlands).
14438.5 Unid-Austrian military, encrypted data through a 39 tone modem, at 0934 (PPA-Netherlands).
14463.0 CM4-Algerian 4th regional military command, calling DJT, Djanet, and ILZ, Illizi, at 0856 (PPA-Netherlands).
14582.0 LNT-CAMSLANT, VA, working unknown USCG HC-130 on COTHEN, ALE at 1302 (MPJ-UK).
14640.0 Unid-Egyptian MFA, Cairo, encrypted messages in 16-tone Codan [Continuous PSK teleprinting mode - Hugh], at 0715 (Waters-Australia).
14641.7 Unid-Egyptian MFA, Cairo, Arabic text in SITOR-A, then switched to Codan-16, at 0712 (Waters-Australia).
14780.0 FUJ-French Forces, Noumea, New Caledonia, calling OMFUX, St. Denis-Reunion, ALE at 0615 (Waters-Australia).
15016.0 McClellan-USAF HF-GCS, CA, EAM with header V3GDJ6, at 1732 (PPA-Netherlands).
15091.0 PLASPR-USAF Secure Internet Protocol Routed Network (SIPRNET) gateway, Lajes, Azores, working CROSPR, Croughton, UK, at 1550 (MPJ-UK).
16213.3 "CHF"-Unknown Philippines vessel, PACTOR-II message regarding hydraulic oil to unknown station in Tagalog, at 0914 (Waters-Australia).
16307.2 RFPFTA-French Air Force, N'Djamena, Chad, ARQ idler at 0748 (Waters-Australia).
16327.0 The Russian Man-Russian intelligence (S06), ending a numbers broadcast in Russian, at 0843 (Waters-Australia).
16545.0 Unid-Unknown Philippine seaman, duplex traffic in Tagalog, at 1907 (PPA-Netherlands).
16912.0 VCS-Globe Wireless digital idler, Halifax, NS, at 0055 (Netzley-OH).
16926.0 HEC-Globe Wireless digital idler, Bern, Switzerland, at 0100 (Netzley-OH).
16963.3 FUF-French Navy Fort de France, Martinique, test loop in Stanag 4285, at 0103 (Netzley-OH).
17155.4 8PO-Globe Wireless digital idler, Bridgetown, Barbados, at 0120 (Netzley-OH).
17189.0 KFS-Globe Wireless digital idler, Palo Alto, CA at 0125 (Netzley-OH).
17405.0 Khabarovsk-Russian SITOR-B weather, at 0730 (Waters-Australia).
17435.0 2011-Moroccan Civil Defense, calling 2414, ALE at 1757 (PPA-Netherlands).
18321.7 Unid-Egyptian MFA, Cairo, Arabic text in SITOR-A, at 0903 (Waters-Australia).
20047.7 "D"-Russian cluster beacon (MX), Sevastopol, Ukraine, CW at 0737 (Boender-Netherlands).
20400.0 193-Unknown, calling 191, ALE at 0631 (Waters-Australia).



New Digital Signals

This month we take a look at a new HF modem making its first appearance on the HF bands, the Finnish diplomatic service's return to HF after a long absence, and an update on the Sudanese diplomatic network.

❖ New 4 Tone Modem

One morning a standout signal in the 22 MHz maritime band caught my attention. It was far, far stronger than anything on the air at the time. The modem is centered at +1500 Hz above the carrier (USB) point and has four tones of 166.6bd QPSK that are separated by 250 Hz. Here are the spectra of the signal in traffic mode and in standby:

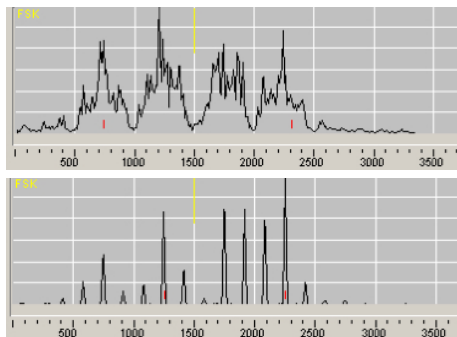

So far, the only two channels carrying this new signal are 22819 and 17040 kHz USB or 22820.5 and 17041.5 kHz center of data, although there have been reports of a 13 MHz channel. Signals to the Northeastern seaboard certainly suggested a close-in European location. A friendly listener's direction-finding fix puts the modem in Southern France, so the organization behind the new signal could be the French Navy.

❖ Finnish Diplo Service Returns to HF

Back in the late nineties, the Ministry of Foreign Affairs (MFA) Helsinki was a regular, if infrequent [don't know how you can be regular and infrequent] user of the HF bands. At the time, their modem of choice was a Nokia-made messaging terminal, the M85200 M/90, which ran at speeds of approximately 150, 301 and 602bd all with 800Hz tone shift. I remember the 300bd mode in particular, which sounded much like a standard amateur packet radio modem.

During a late August evening I happened to be trawling around the upper reaches of 14 MHz and happened upon a new pair of ALE calls

on 14710 kHz USB, where "HK11" and "RIA" were busy exchanging LQAs (Link Quality Assessments) every 15 minutes or so. After a while, modem traffic followed in the form of the 22 tone version of the SkyOFDM modem, not something I've heard often despite the mode being in existence for a few years now.

SkyOFDM is a proprietary data mode developed by the same company that sold the now discontinued SkySweeper data decoder (see the May 2009 issue of *MT*). In the 22 tone version, the signal starts with a 7 tone start sequence of about half a second. Traffic is sent using 22 tones separated by 86Hz each QPSK modulated at 64bd. The bottom channel sits at around 600Hz above the carrier point and the total bandwidth is around 2 kHz, which means that the signal easily fits in a standard voice channel bandwidth of 3000Hz.

In one of those strange coincidences, an hour or later, I was checking 17400-17500 kHz, a favorite hangout for utility stations, sandwiched between the end of the 17 MHz maritime band and the 17 MHz broadcast allocation. Much to my surprise, after tuning down past Tokyo fax on 17430 kHz, I bumped into... Guess who? "HK11" and "RIA" again. Now the hunt was on!

Armed with two frequencies of a network, one can use this information to help find other channels. Regular readers of this column will remember that most ALE networks are based on a pool of channels, usually 1 per MHz, in order to provide a good selection of frequencies based on the time of day, location of stations and the prevailing propagation conditions. Stations will usually step up or down the channels running link checks between stations or simply sounding.

If you are lucky enough to have two VFOs or two quickly selectable memories on your radio, simply monitor both channels and see whether the upper or lower is used first. Now you know the scan direction. The timing between the two channels being used will probably help you figure out how long you'll have to look for the next channel up or down after you've heard one of the known channels being used.

In my case, there were about 20 seconds between the LQAs on each channel, so, guessing that there would be an 18 MHz frequency, I waited for 17418 kHz to activate and then spun the dial rapidly across 18 MHz. Bingo! After a couple of tries, I found 18586 kHz, and few minutes later, I had 20186 kHz.

Looking at the Finnish Diplomatic Service profile at Utility Monitoring Central (see Resources) shows that the 17 MHz channel corresponds to an old Nokia frequency. Judging by

the list of known past channels, 13400 to 13500 kHz is likely to contain another channel.

So "HK11" is likely to be the MFA in Helsinki, but what about "RIA"? The best fit is probably their Embassy in Riyadh.

❖ Sudanese Diplomatic Update

No sooner had I finished the July column featuring the Sudanese network, than I noticed the Sudanese using a different set of PACTOR callsigns and a different encryption scheme on one of their channels. In this case, I was monitoring their long-established slot of 21000 kHz USB or 21002.1 kHz center of data. Sharp-eyed readers will of course recognize that this is inside the protected 15m amateur band and is therefore an intruder. This has brought the stations plenty of attention over the years and it has been examined in many direction-finding fixes by European telecommunications agencies attempting to pinpoint the source.

While monitoring 21000 USB in the mornings recently, there has been regular traffic between "8888" (presumed to be the MFA in Khartoum) and "0000" which is probably the Embassy in Sanaa, Yemen. The stations can be heard chatting away before and after modem transfers. In case you happen to come across it elsewhere, here is the new encryption scheme in use:

```
called station: 0000
+stno+
+ftype+
.bag
+size+
1358
++++++
R# # PXIP(H.4V;FU,$X_+(B-?I5&HEE4U2ESW_<#)
E4HU6:9IQ)V8#K..?*(JMN9'FUI<|[rest of
message body]
A ^ 4A8?=MS+F6']$>=KH4IL1\)%FS2QW,#
>C#4::NWXA ?.J;+9;&
```

That's all for this month, so have fun listening to HF's digital signals and please keep your letters and emails with your ideas and suggestions coming.

RESOURCES

- Nokia Modem Audio Clip
signals.taunus.de/WAV/FNL-BURST.HTML
- SkyOFDM Modem Audio Clip
signals.taunus.de/WAV/22x_48Bd.WAV
- UMC's Finnish Diplo Profile
chace-ortiz.org/umc/mfatext/Finland.txt



The Right Rotator for the Job

A friend of mine recently became a ham, and even before he had acquired his first transceiver he had installed a 50-foot tower next to his garage. You've got to admire that kind of spirit! The first antenna supported by the new tower was one end of an HF horizontal loop (a wire antenna) which, while quite useful, left the very tippy-top of the tower looking rather sparse and lonely.

If only to rectify that situation, my friend hatched a plan to install several VHF/UHF directional antennas, which need to be aimed. That plan, of course, led to several discussions about rotators: how they work, which ones are the best, how they're installed, how much they cost, and where they should be purchased – all rather large topics in and of themselves!

My friend got into ham radio through TV DXing, and his only prior experience with antenna rotators was using a bunch of junky old TV rotators, some of which were pushing 40 and had been sitting around unused for 20 of those years. My personal experience was pretty much the same. I'd used a couple of inexpensive TV rotators over the years, but until I moved to Connecticut in the late 1980s, I hadn't seen a "real" rotator up close and personal.

As a teenage ham I mounted a 1970s-vintage Channel Master rotator on top of my own "hand me down" TV tower to aim a pair of two-element "bamboo beams" I'd put together from salvaged parts. The old rotator worked for

a while, but for reasons unknown, it soon locked up and never worked again. I doubt I exceeded its rated capacity, but its history was unknown to me, so it may have been near death when the previous owner gave it to me. Sometimes you do get what you pay for!

A lot of hams have similar experiences with rotators. Most beginning hams haven't owned an amateur grade rotator. They've more than likely used TV rotators – if they've used rotators at all – which are suitable only for the smallest amateur radio antennas or arrays and are subject to premature and unfortunate failure, even if they're not abused!

Unlike amateur radio transceivers, which cost a lot less now than they used to in inflation-adjusted dollars, rotators are comparably more expensive than ever before. That means you really need to do your homework before sinking your hard-earned dollars into a rotator for your shiny new directional antenna.

Mixing and matching rotators is much more difficult than swapping transceivers or some other accessory in your shack. Switching radios is easy, but removing the rotator from the top of your tower or antenna mast, rigging the new rotator and reinstalling it is much more difficult – and can even be dangerous! If you live in the frozen North, switching rotators is all but impossible for several months of each year. And even if you live in a sunny climate, swapping tower-mounted rotators isn't a casual task that anyone would likely look forward to.

Much like automobiles, cameras, and just about any other consumer electronics devices, many Old-Timers feel that modern rotators just aren't built to the same standards that they were in the good old days. And like everything else, depending on the specific make and model, there is undoubtedly some truth to that sentiment. But even if some models aren't built as solid as they once were, learning about how they work, how they're rated and how to correctly and safely install them will help you choose the best rotator for your needs and your budget. (Well, the budget part may be wishful thinking!)

We've all heard stories about some ham who used a cheapie rotator to turn an oversized stack of antennas, through summer's blazing fury and winter's freezing chill, for 26 years without so much as greasing

the bearings. As we look at how rotators work and how to use them in this month's column, let me suggest without reservation: Should you decide to duplicate that feat, you won't be as lucky.

The folklore surrounding antenna rotators is a big part of the problem. There isn't a lot of beginner appropriate material in the amateur radio literature concerning the ins and outs of antenna rotators. There are a few product reviews, and small articles or technical correspondence that describe various modifications to rotator control boxes, position indicators or braking mechanisms, but precious little practical advice. And without this nuts and bolts information, new hams are left to learn from folklore, myths and legends (like the one in the previous paragraph).

I will do my best to cover some of the missing introductory material in this month's column. I'm not an authority on antenna rotators, but in doing the research for my part of *MT's 2012 Buyer's Guide*, I talked to several experts who gave me some good advice, which I'm going to pass on to you.

❖ The Basics

At the simplest level, a rotator is a motorized gearbox, reasonably weather sealed, mounted on top of your tower or antenna mast to aim your antenna in the desired direction. Although some are squarish and boxy, many ham radio rotators have a distinctive "bell housing" shape that makes them look like miniature vehicle transmissions!

Inside the housing is an ac or dc motor that turns a gearbox or gear mechanism (planetary or worm), a brake to hold the rotator in a fixed position when it's not supposed to rotate, and a position feedback sensor that lets a shack-mounted control box accurately display the direction the antenna is pointed. The control box is also used to control the position of the rotator mechanism, thereby aiming the antenna.

A multi-strand control cable usually runs between the shack-mounted control box and the tower-mounted rotator. Some rotators require only a few wires, while some require a whole bunch. Generally speaking, the wires related to position sensing can be smaller than those carrying power to the drive motor.

Although somewhat similar, there are enough variations in drive motors, gear mechanisms and position sensors to make things interesting (or confusing). Many of the specific mechanisms vary with the rotator's design ca-



Expertly installed at W7MRE (The American Museum of Radio and Electricity in Bellingham, WA), this Yaesu G800-SA rotator (a best buy in this year's MT Buyer's Guide), rated for a beefy 17 square feet of wind load) loafs along while aiming the club station's Traffie Technology Hex-Beam antenna, which has a wind-load rating of less than 5 square feet. Note the rotator shelf (see text). (Photo by, and courtesy of, Phil Terzian, AE6K.)

capacity. Much like comparing the parts of an economy car to those of a bulldozer, the gearbox and braking mechanisms required to rotate a large antenna and hold it in place in a 50-MPH breeze are different from the parts required to handle a small 2-meter beam on a sunny day.

❖ Installation Types

Typical rotators can be mounted in one of several ways. The most robust involve mounting the rotator on (in) the tower, usually at the top, but occasionally at the bottom. Most antenna towers have a “rotator shelf” near the top to support the rotator. Depending upon the make and model of your tower, the holes drilled in the rotator shelf may or may not match the bolt pattern of your rotator. If the holes don’t match, you’ll have to purchase or fabricate a suitable shelf or adapter. Be sure to figure this out before installation day (I’m speaking from experience here)!

If mounting your rotator at the top of your tower isn’t your cup of tea, some towers and installations can accommodate rotators mounted at ground level. You’ll have to install a mast inside the tower (all the way from the bottom, through the length of the tower and out the top) to make this work, but servicing, adjusting, and accessing the rotator will be a piece of cake (installing the giant multi-section mast likely won’t).

Whether your rotator is mounted to the top or bottom shelf, the use of a thrust bearing at the very top of the tower is an ideal way to extend the service life of your rotator and keep it from self-destructing during “extreme events.” The idea is to mount the rotator in the center of the tower while extending the rotating mast vertically through the thrust bearing. When used in this way, the bearing isolates the rotator from “side to side” and “up and down” forces. Remember, the rotator’s main job is to steer the antenna left and right and absorb any rotational forces (torque) that are present. If the rotator doesn’t have to accommodate other forces, it will function at its rated capacity, work better, and last longer.

Not every installation is tower-based, however, so most rotators can be mast mounted (sometimes requiring a model-specific adapter). In this configuration the bottom of the rotator is mounted to a fixed support mast, while a rotating mast (with attached antennas) is mounted to the top part of the rotator.

With no thrust bearing and no rotator shelf to safely transmit mechanical forces to the tower, all of those forces must be handled by the rotator itself, and the effective capacity of the rotator is *greatly reduced* (usually by 50%). That means an antenna rotator rated for 10 square feet of antenna load while tower mounted, can safely handle only five square feet when mast mounted. Understanding this is *critically important!* Not understanding it, according to the experts, contributes to most rotator failures.

❖ Performance Specifications

Rotators are sized by a variety of performance specifications, the most common being wind load, typically measured in square feet

(in the US). At the most basic level, if a rotator is designed to handle a maximum wind load of, say, 10 square feet, that means it can handle an antenna (or antennas) with the total (or combined) wind load of 10 square feet *while properly tower mounted with a mast of a reasonable length in reasonable weather conditions.*

Did you catch that last part? It’s *very important.* A rotator with a wind load specification of 10 square feet isn’t an absolute value, and it doesn’t give the user a license to do crazy things, all the while keeping the antennas to 10 square feet or less. Most rotators with capacities beyond a few square feet will also list their braking or torque specifications, which indicate the point at which the rotator can no longer hold an antenna in a fixed position.

So, even if your antenna’s wind load meets that particular specification, if it has an extra-long boom, for example, the extra torque transmitted to the rotator may cause it to fail prematurely (or instantaneously in the next stiff breeze). The same goes for the antenna mast, especially if there’s no thrust bearing in the system. If you install a 12-foot mast atop a rotator designed to handle a 6-foot mast, the additional leverage applied to the rotator will likely cause it to fail prematurely. The extra long mast may also cause your tower to fail as well, so don’t think you’ll just be sacrificing your rotator!

If this isn’t immediately apparent, think back to your middle school physics class. When using a lever and a fulcrum to raise a heavy object, a longer lever provides *much more* mechanical advantage to the lifting process, as does the use of long-boom antennas and extra-long masts.

Rotators come in a variety of capacities, from about 3 square feet for cheapie models designed to aim small TV antennas, to monster-size units that might as well be built from tractor parts. Mid-sized units are rated for 5 to 15 square feet, and the big twistlers handle larger arrays from 20 to 50 square feet. Prices start high and get higher, so be sure to do your homework before buying. This year’s *MT Buyer’s Guide* is a good place to start.

❖ Control Boxes and Accessories

The basic function of a rotator’s control box is to sit in your shack and display the direction in which the antenna is pointed and provide control knobs or buttons that allow you to point the antenna in the desired direction. Most rotators come with a basic control box. It may not win any beauty contests, but usually gets the job done. Some manufacturers offer deluxe control boxes, as do some third parties. The features they offer might be desirable, but they come at quite a price.



If you just don’t like the looks of your present rotator control box, or you’d like to add about a hundred new features, Green Heron Engineering’s RT-21 Controller with USB is what every OEM controller wants to be when it grows up! It can add computer control and super accuracy (among many other amazing things) to just about any rotator ever made. The only downside is the \$500+ price tag! See it in action at www.greenheronengineering.com.

Basic control boxes typically don’t incorporate digital interfaces, so if you want your logging or rig-control software to steer your antenna, you’ll have to upgrade the control box or purchase a digital interface. Some companies also offer kits or upgrade boards that add delayed braking capabilities or swap LEDs for persnickety incandescent indicator lamps.

❖ Rotator Secrets

Unless you’re spinning a very small VHF/UHF antenna, don’t buy a cheapie TV rotator unless it’s mounted in the attic or some other easily accessible location. Instead, buy an entry-level ham-grade unit. It will cost a bit more, but it will last much longer and it will actually work! Murphy’s Law clearly states that your cheapie TV rotator will fail on top of your tower in the dead of winter. You have been warned!

Don’t rotate your antenna if it’s loaded with ice. The extra weight and wind load may shred your rotator.

Be sure to use control wires of the specified size or your rotator’s motor may not work, may work slowly, or may fail prematurely.

Don’t overload your rotator! Experts recommend loading your rotator to 85% of maximum capacity to build in a reasonable safety margin. So, if your rotator’s rated for 10 square feet, limit your antennas to 8.5 square feet to ensure a long and healthy service life.

When it’s time to buy, try to purchase your rotator from a vendor that will actually test it prior to shipping. And when you receive it, thoroughly test it before installing it.

Follow all applicable safety rules when installing a rotator on your tower or mast. The life you save could be your own!

For help in choosing the right rotator, check out the product reviews in the ham magazines and at www.eham.net, and the information in this year’s *MT Buyer’s Guide*.

Finding the right rotator for your particular application can indeed be a challenge, but armed with the right knowledge you can be assured that it will likely be trouble-free for years to come.



Low Profile TV Antennas and PC to TV

The cord-cutting phenomenon – consumers cutting their cable or satellite-TV subscriptions in favor of watching TV off-air and/or on-line – is gaining momentum across the U.S. An entire generation of Americans has grown up not realizing that their local TV stations are available for free off-air, so there's this nationwide epiphany among the young who are discovering this "new" way of watching TV. The result is that many hundreds of thousands have either cancelled their cable or satellite-TV subscriptions or drastically cut back. Of course, the continually lagging economy is responsible for some cord-cutting, but the polls show that those doing most of the cord-cutting are not unemployed.

The first obstacle cord-cutters encounter is just how to get a viewable TV signal from their condo, apartment complex, suburban or rural home. The advent of digital TV (DTV) made it much harder to pull in reliable TV signals and former cable-TV viewers were without a clue. Some found success with old-fashioned rabbit ears or new-fangled, plastic dish-like set-top antennas. Most do a dismal job. There are a lot of cheap and worthless TV antennas out there. But, this is the 21st century; aren't there some truly new designs for a really effective TV antenna without having to put up a monstrosity on the roof? There are!

❖ **Amplified Indoor Antennas that Work**

Since I live out in the country some 20-30 miles from most major network TV stations, I'm used to struggling with the idea of reliable off-air TV viewing. My solution has always been to put up the biggest, mast-mounted, pre-amplified, rotatable TV antenna as high as I could. The costs have mounted over the years but I've been happy with the results. But, most people aren't going to scramble around on their roofs holding cumbersome antennas. So, what are the alternatives?

In the antenna business, whether it's amateur radio or TV reception, money talks. It's a universal equation: the better the antenna the higher the price. Now, you'll hear stories about people who find old-style TV rabbit ears in a junk shop for 75 cents that will pull in everything in a 40 mile radius. Maybe so, but that won't be your experience, so forget about the bargain bin and the under \$10 or \$20 antenna solutions. I've tried them and they don't work out in the country.

❖ **Philips SDV2940 Amplified TV Antenna**

Recently I was attracted to a product I found in the local Walmart, the Philips SDV2940. It's a compact, mast-mountable UHF-TV antenna that boasts a built-in 18dB amplifier. At nearly \$40 it's out of the cheap category and, though I was skeptical, it looked like it might actually work. What I was looking for was something I didn't have to install outdoors or even in the attic. I wanted solid reception from inside the house and I knew I was asking a lot, especially this far away from most TV stations.

The unit itself was well designed and well made. Though the coax from the antenna to the power injector/splitter was very poor quality, you could easily and fairly cheaply replace that with heavier RG/6 coax – not that it might make that much difference.

The results were mixed. I found the Philips antenna surprisingly effective and quite directional. Simply mounted on top of a shelf in the study it picked up a total of 11 channels: 3 local CBS (45 miles away), 3 local NBC (20 miles away), 2 local ABC, and 3 local Fox channels (all 45-50 miles away). The main network channels and their subchannels included local radar/weather channels, CW network, Antenna TV Network, MHz Networks (showing various international news channels and foreign movies) and THIS, a movie channel showing older movies. If I turned the antenna just so, I could get PBS but lost the others. It was a close thing, but I wanted more.



Philips HDTV amplified antenna (\$40) works surprisingly well. It's cheap and available locally. (Courtesy: Philips)

❖ **Winegard SquareShooter SS2000**

My next solution was the Winegard SquareShooter SS2000. In this column, back in June 2008, I mentioned this antenna as part of an article about off-air DTV options one year before the big DTV switch, but I didn't get a chance to review it.

I bought the SS2000 at www.SolidSignal.com, an online outlet for all things antennas, for \$74. Shipping brought the total to just under \$90.

I also found this antenna at Sears, so if there's a Sears near you, try there first. You'll also find this antenna at considerably higher prices at various other online retailers, including Winegard Direct where they'll ship it to you for \$146.

The SS2000 will detect VHF channels 7-13, and, if you're close enough to the station, it will probably receive those channels, but it's optimized for UHF frequencies. The SS2000 measures 16 x 16 x 4 inches, utilizes an outdoor 12dB amplifier, comes with a metal wall/balcony/roof mount, six feet of RG/6 coax and a plug-in power injector.

The SS2000 is quite directional, with an average front-to-back of 13 dB. It's also excellent at handling multi-path distortion, a common problem in urban and hilly areas where a station's signal arrives at the antenna from different directions (having been bounced off large buildings or nearby mountains). In the old analog days, multi-path would show up on the screen as "ghost" images of the same picture. In DTV the receiver is confused by the timing of the different data streams and gives up, displaying nothing or only occasionally showing an image.

Installation of the SS2000 couldn't be easier. Unless you plan to mount the antenna outdoors, there's nothing to put together. The complete antenna is contained in an unobtrusive gray-colored plastic box that even the Home Owners Association police won't be able to object to. The antenna comes with a short piece of RG/6 coax with F-fittings on each end, a signal splitter and power injector. You'll have to come up with the RG/6 cable for the run from wherever you plan to mount the antenna to your TV set.

Results with the SS2000 were considerably better than with the Philips. With the antenna simply shelved flat atop the bookshelf in the study, it received 16 channels: the same 11 received on



Winegard's SquareShooter SS2000 (\$80) amplified UHF-TV antenna works amazingly well. It's not cheap, but it's made in the U.S.A. (Courtesy: Winegard)

the Philips plus the elusive 3 PBS channels from 45 miles away, as well as one CBS and one Fox lower-powered channel from 20 miles away that the Philips missed. With the SS2000 only the lowest-powered independents and one VHF channel 12 station from 50 miles were not received that I can receive on my big outdoor mast-mounted, rotated and amplified antenna. That's quite an accomplishment.

When this antenna first came out it won an award for innovation at the Consumer Electronics Show. For ease of installation, cost and effectiveness, I highly recommend the SS2000. And, here's a real surprise: it's made in the U.S.A.

❖ NetGear's PC to TV Solution

The next step in cord-cutting for many will be displaying online content not on your little 18-inch computer screen but on your 48-inch HDTV screen. NetGear, a company that specializes in whole-house routers, is making available a wireless device that, through the use of one of your computer's USB ports, will send whatever you have from the Web to whichever HDTV set you decide to hook the wireless receiver to. The product, PTVU1000, had just been announced as I'm writing this, and is one of several options now for consumers to watch Internet content directly on a TV set. At press time the company did not have a retail price for this unit. Similar products sell for \$50-100.



NetGear PTVU-1000 diagram shows how it will send the output from your computer to any HDTV set wirelessly. (Courtesy: NetGear)

Until recently, networks (both off-air and cable) were happy to let consumers download episodes from their favorite TV shows. The rise of popular gaming consoles that allow streaming content as well as stand-alone boxes, such as Roku and Sony's Blu-Ray DVD players, have brought millions to online program streaming. New TV sets now feature WiFi connectability and set makers have reached agreements with Internet programming providers such as Hulu or Netflix to allow direct streaming of online content through these TV sets. All you need is a whole-house router and a "high-speed" Internet connection. For more details on the definition of high-speed and high-definition see last month's *Beginner's Corner*.

But, there's a problem. So many consumers have joined the online viewing throngs that cable and satellite TV providers are now nervous. What if everyone just decides to watch network shows off-air and stream their favorite programs

online? Well, hundreds of thousands have done so this year alone. So, the networks and cable programmers stepped in and set up restrictions for viewing such content. Some require proof that you already pay for cable or satellite TV service before being allowed to view their online content. Hulu and Netflix recently raised their monthly fees (following closely the cable and satellite-TV business plan) and others are following suit. Is this the end of "free" Internet streaming? No – but with binoculars you can see it from here.

❖ The Limits of "Unlimited"

Before everyone started streaming video content on line, many services – from Internet Service Providers (ISPs) to Netflix – touted what they called "Unlimited" streaming. And, while those terms still appear in promotional material, the truth is vastly different. Many news sources have noted this year that much of the Internet traffic each evening is composed of Netflix customers streaming movies. Not missing an opportunity to cash in, the company raised its monthly fee for its "unlimited" service, and quickly paid the price themselves when an estimated 1 million customers cut the Netflix cord.

But ISPs, realizing that most of their bandwidth was being eaten up by Netflix customers, started imposing limits even to customers that had previously been offered "unlimited" online streaming. The wireless broadband service I use for Internet streaming has imposed a 15 GB limit on long-time customers and a 10 GB limit on new customers subscribing to the "unlimited" wireless broadband plan. Oh, it's still unlimited, they won't cut off your service; you'll just have to pay an extra \$10 per GB over your limit. So, the limit imposed by the ISP naturally limits the amount of online streaming that can be done via Netflix's unlimited plan.

I found this out when I received an email from my ISP alerting me to the fact that I had used 80% of the month's total allowed on the "unlimited" plan. But, many customers don't have such obliging ISPs. One friend found out only after the bill arrived, with \$80 in overage for the month. Most online services such as Hulu and Netflix offer only 720p resolution, but even at that rate a customer's monthly allowance is eaten up quickly when watching hour and a half long movies.

Limits are being imposed that will soon make it financially impractical to stream movies online. You might as well sign up for cable-TV where the average cable bill is now \$70 per month. Perhaps that will keep the numbers down. Still, I was reminded of a feature article that appeared in the January 2010 issue of *MT* written by Frank McCoy, a broadcast engineer, titled, "The Problem Isn't Demand, It's Bandwidth." In the article he brings up the subject of bandwidth usage and the necessity for limits. It's worth checking out.

One good thing is that audio streaming takes very little bandwidth. You could pretty much stream audio 24/7 and not eat up your monthly "unlimited" plan. Still, the view in the binoculars shows that images are moving faster toward us than we realize and it's not hard to imagine a time when we'll be asked to pay for the content we enjoy the most. Why should we imagine that it will always be free?



- ✓ Sale price
- ✓ Free Go Bag
- ✓ Free UPS shipping
- ✓ Free Race Scanning book

This is our **best deal** ever on a portable wideband receiver! The stylish Icom IC-RX7-05 receiver tunes from 150 kHz to 1300 MHz (less cellular and gaps), has 1650 memories, CTCSS/DTSC, backlit LCD, RF gain, attenuator and keypad. With Li-Ion battery, BC-149A charger and belt clip. List \$364.00 Regular price \$299.95 **SALE \$199.95**

universal radio inc.
 6830 Americana Pkwy.
 Reynoldsburg, OH 43068
 ♦ Orders: 800 431-3939
 ♦ Info: 614 866-4267
www.universal-radio.com

MT X PRESS

The Real Deal

The best tool for today's internet-savvy radio listener is our bargain-priced pdf version of *Monitoring Times*. Saving \$13 off the cost of the print magazine, you receive:

- Prompt delivery,
- Clickable internet and email links,
- Full color photos, and
- The ability to print out as much of the magazine as you want.

It's the real deal at a steal at only \$19.95. Call 1-800-438-8155, go to our website, or e-mail order@grove-ent.com to start your MT Express subscription today!

MT X PRESS

www.grove-ent.com



PROGRAMMING SPOTLIGHT

WHAT'S ON WHEN AND WHERE?

Fred Waterer

fredwaterer@monitoringtimes.com

www.doghousecharlie.com/radio

New Programs and News Programs

A new program has been added to the always evolving **Voice of Russia** program schedule. Airing Wednesdays at 0730 and Tuesdays at 1330, it carries the improbable name **London Calling**. The program “offers an inside view at the growing ties between Russia and the UK in terms of business, culture and lifestyle, interviewing Russian artists, businessmen and intellectuals who move between the two countries.”

The program talks about Brits doing business with Russia, visits some swanky neighborhoods in London where Russian oligarchs like to buy houses, and looks at how Russian immigrants have fared in the UK.

The time makes hearing it on shortwave in North America problematic, but one can always listen online at english.ruvr.ru/radio_broadcast/52446268/

❖ New Flags Flying

Radio New Zealand International (RNZI) has launched a new online feature called **New Flags Flying**.

This online service features archival audio and transcripts of 17 former Pacific leaders as they reminisce about the various independence movements in the Pacific.

“From 1960 onwards, first in Polynesia, then in Melanesia and Micronesia, colonies became nations and millions of ‘subjects’ became citizens. The interviews on the website provide a unique record of Pacific history and reflect the views and memories of the most influential decision makers of their time.

“The project is the work of veteran New Zealand broadcaster/writer Ian Johnstone and former New Zealand diplomat Michael Powles and has support from Radio New Zealand and UNESCO’s Office for the Pacific States in Samoa.”

You can access this programming by going to www.rnzi.com/newflagsflying/ This is a neat little feature and an education in Pacific history, politics and culture. It is well worth checking out!

❖ Old Time Radio Shows

My Facebook friend **Mark Panopoulos** picks out the Old Time Radio Shows heard on **CHML 900** in Hamilton, Ontario. Judging from some posts on a page he has set up, the programs are heard quite widely, especially in the US North-East. With sunset coming earlier now, it’s a good time of year to tune in these gems. Unless there is a Toronto Maple Leafs game, try



CHML between 10pm and 2am to hear these gems from yesteryear. Some weekly themes include: **Mondays – Lux Radio Theatre** and **Amos and Andy**; **Tuesdays – Detective and Adventure** programs; **Wednesdays – Westerns**; **Thursdays – Fibber Mcgee** and **The Great Gildersleeve**; **Fridays – Adventure and Intrigue**; **Saturdays – Jack Benny, Orson Welles** and **Suspense**. (**CHML** website)

Often you can see which programs are coming up by going to the **CHML** website at www.900chml.com/station/oldradioshows.aspx, where you can also connect to Mark via Facebook and Twitter for updates on the program.

❖ More Unusual Programming

Last time we shone the *Programming Spotlight* on some unusual programs. For many years in my ODXA column, I used to include a feature called Languages of Shortwave. Many unique, interesting, and obscure languages were, and are, heard on the shortwave bands. One of these is Latin. It’s not like there are many native speakers of this language any more. In fact there are none that I am aware of. Yet Latin is still used in religious and scientific circles.

WWCR airs the **Traditional Latin Catholic Mass** at 1600 UTC on 15825 kHz. It’s not often that one hears the Latin language on radio, though for a time, one could hear a brief weekly newscast in Latin via **Radio Finland**, before that station left shortwave.

This program started out on one station in New Rochelle, NY in 1970. Over the next 20 years, the program spread to other radio stations covering much of the United States. In the 1990s, “when the number of registered short-wave receivers rose worldwide to 950 Million, the **CTM** has redirected its radio Mass apostolate by broadcasting every Sunday from one of the world’s most powerful short-wave stations, **WWCR-Nashville**, Tennessee, reaching enthusiastically responding Catholics in some 125 countries” (emphasis theirs). (950 million “registered” shortwave receivers...uh oh, as far



as I know mine is unregistered).

According to the program website, this program moves to 1700 UTC in the fall winter season, which may necessitate a change of frequency. You can visit them online at www.latinmass-ctm.org/

A word of warning: when you go to the website there is audio of some women singing that is a bit startling if one isn’t expecting it. This use of automatic audio is one of my pet peeves!

❖ News as it Happens, Sort of...

World changing events happen frequently in far flung parts of the planet. Wars, natural disasters, political crises and the like, often fly under the radar in this part of the world. Sometimes they just don’t get the coverage that they deserve, or that we want to hear from domestic media.

International broadcasting via shortwave and the internet fills a niche when these things happen. Radio stations around the world often provide key details that are under-reported half a world away. They also provide the background to stories that sometimes seem incomplete.

Some stations, notably the **BBC**, **Radio Australia** and others, provide live, up-to-date newscasts, and many, wide ranging current affairs programs covering a broad spectrum of topics from politics to business to world events. Many of these twenty-four hour broadcasters will cover major breaking stories for hours or even days.

Other radio stations with smaller budgets do a good job with limited resources. While their news and current affairs programming may often be pre-recorded and sometimes not as up-to-date as one would like, they still manage to give the listener a different perspective on events in their parts of the world, and in general.

News in Europe

Anything happening in Europe will be widely covered by many radio stations. The **BBC** is obviously the go-to station for breaking news anywhere in the world. The **World Service** and **BBC Radio 4** are jam-packed with news and current affairs programming and will sometimes suspend normal programming for major events such as elections in the UK, the deaths of important persons (Princess Diana)



and dramatic events (9/11). Even with budget cuts eating into their infrastructure, the BBC is still the place to start for breaking news events. Some programs include:

NewsHour: updated daily at 1405 and 2105 UTC, **NewsHour** provides "interviews, news and analysis of the day's global events." It is the Cadillac of international news broadcasting. If it's happening in the world **BBC NewsHour** is probably covering it. In early September a typical broadcast looked at America's remembrance ceremonies for 9/11, the latest news from Libya that Gaddafi's son had just fled to Niger, and the rescue by UK police of slaves being kept against their wills in a "gypsy encampment." Listen to or download the latest edition at:  www.bbc.co.uk/programmes/p002vsnk

The World Today: This program airs at 0305, 0405, 0505, 0605, 0705 and 0805 daily. It presents live news and current affairs, business and sport news from around the world. Listen to the latest program or subscribe to a podcast at  www.bbc.co.uk/programmes/p002vsn9

World Update: Every morning from Monday to Friday, **World Update** brings you a "comprehensive briefing on the stories that are making the news." The program is presented by **Dan Damon** and makes use of the extensive network of **BBC** correspondents around the world with particular emphasis on business and technology stories. The program is heard on "over 200 FM stations in the US" and other parts of the world and can be heard online at  www.bbc.co.uk/programmes/p007dhp8 New programs are available at 1005 UTC daily, and like other programs can be downloaded as a podcast.

From Our Own Correspondent: This is one of the longest running **BBC** news programs and, as the name suggests, consists of reports from the **BBC's** worldwide network of correspondents, who cover the news with more depth than a 5 or 10 minute newscast could. New editions, generally hosted by **Alan Johnston** go out at 0850 UTC, repeated at 1150, 1650, 1950 and 0450 UTC. Reporters in such diverse places as Syria, Libya, Ireland and Zimbabwe bring context to the latest news. It is a fascinating program. Listen to the latest editions at  www.bbc.co.uk/programmes/p002vsn9

Deutsche Welle is home to **Newslink**, one of the best non-BBC news programs from Europe. The program is updated daily and covers European and world events in a fast-paced 30-minute program featuring lots of correspondent reports. Recent editions focused on Israeli-Turkish tensions, Syrian political unrest, and in-depth coverage of financial news, as befits the largest economy in Europe. Politics is also a focus, from the efforts of Chancellor Merkel to navigate the European monetary crisis to the extracurricular activities of the Italian Prime Minister, Berlusconi.

Newslink also presents interesting features, such as a report just before the 10-year anniversary of 9/11 on the Landstuhl Medical Centre, a hospital in Germany where many of the wounded in Iraq and Afghanistan go for treatment and recuperation. While Landstuhl is often mentioned in this context, one rarely hears details about the hospital itself. 99.5% survival rate!  www.dw-world.de/dw/0,,3083,00.html?id=3083

Newslink Plus is a 60-minute version of the program, which one can listen to online or download as a podcast  www.dw-world.de/dw/0,,8511,00.html?id=8511

Very few international broadcasters provide live newscasts any more. Nevertheless, stations like **Radio Prague**, **Polish Radio External Service** and **Radio Bulgaria**, among others, provide a unique viewpoint on world events. Get the latest news from Prague at  www.radio.cz/en; **Polish Radio External Service** can be heard at  www.thenews.pl/ or on shortwave at 1200 UTC on 11675 and 11980 kHz. **Radio Bulgaria** news can

be heard online at  <http://bnr.bg/sites/en/Pages/default.aspx> or at 0200 UTC on 9700 and 11700 kHz.

Asia and Africa

English language broadcasts from the Middle East and Africa are limited. **Israel Radio** used to have a fairly authoritative newscast (one memorable evening during the 1990 Gulf War, the newscast was interrupted by an air raid... the newsreader calmly moved to a more secure studio and resumed where he left off) and **Radio Cairo** has always been iffy more for technical reasons. **Radio France Internationale**, **BBC Netherlands**, **Voice of America** and the **BBC** have a history of being authoritative news voices to and from Africa.

Swinging over to Asia, **Radio Australia** is probably the pre-eminent voice in the Pacific region with a wealth of news and current affairs programming. They even have a nifty news website, which seems to be in the development stages at www.radioaustralianews.net.au/topstories.htm Here you can connect to streaming audio, or peruse news stories from Australia and the Pacific Region.

Radio Australia programs include hourly newscasts and current affairs programs such as **Asia Pacific**, **Correspondent's Report** and **The World Today**. **Asia Pacific**, hosted by **Sen Lam**, as the name suggests, focuses on Asia-Pacific news and events. The program is produced by **Radio Australia**. When you visit the website  www.radioaustralia.net.au/asiapac/, you can subscribe to a podcast, listen to the latest program, contact the program and access the program's Twitter feed. **Asia Pacific** is a good example of a program making use of all the current methods of staying in contact with you, the listener.

Correspondents Report, like **From Our Own Correspondent** at the **BBC**, consists of reports from around the world by the **ABC's** team of reporters. Hosted by **Elizabeth Jackson**, the program can be heard at the website  www.abc.net.au/correspondents/ where there is also an archive of past shows.

The World Today, hosted by **Eleanor Hall**, tends to cover a lot of Australian issues as well as world events. Grab the podcast at  www.abc.net.au/worldtoday/rss/twtrss.xml or visit the program website at www.abc.net.au/worldtoday/ Like many **RA** programs it originates with the **ABC**.

Before leaving Australia, we should mention another advantage of these fancy computin' machines. Domestic networks are also available worldwide thanks to the internet. Like an **ABC** version of **NPR** or **CBC Radio One**, Australia has **Newsradio**. A domestic news network across Australia, **Newsradio** provides 24 hour coverage of events at home and abroad. You can find **Newsradio** at www.abc.net.au/newsradio/

Getting back to Asia, **The Beijing Hour**, mentioned a number of times over the past months in this column, is an interesting take on world news. The program is a very "western" sounding program. A chance listen might cause those tuning in to think they had found **VOA** or **BBC** if **Susan Orman** is hosting. The presenter, during a recent listen in September, spoke American-accented English and could easily have hosted a program at **CNN**. The only hint that the program is from abroad would be the occasional reports by Chinese-accented reporters.



The program is aired twice a day, at 08 and 20 hours (Beijing time)...check out 0000 UTC broadcasts of **CRI**, 6020 and 9570 kHz. The international news reporting is interesting, giving a Chinese take on events. Lots of local Chinese news as well. Like many broadcasters, **CRI** seems to be encouraging listeners to access their programming via the internet. You can check out the **Beijing Hour** online, along with many other features and many archived editions at <http://english.cri.cn/cribb/programs/hour.htm>

Closer to Home

CBC Radio One and all other **CBC** networks are available online, too. Check out such programs as **The Current** with **Anna Maria Tremonti**, promising a "fresh take on the issues." It can be heard at 8:30 am ET, or whichever time zone or stream you may be accessing.

Other weekday news programs include **The World at Six**, the main half hour supertime newscast, and **As It Happens**, the long-running **CBC** program which turns the call-in program on its head. Instead of people calling in, hosts **Carol Off** and **Jeff Douglas** call out to news makers and common folks with an interesting story. The program was credited with bringing world attention to the Rwandan genocide in 1994, thanks to a number of phone conversations between then host **Michael Enright** and Canadian General Romeo Dallaire, in charge of the UN Peacekeepers in that country. **As it Happens** follows the **World at Six**. **Jeff Douglas** may be familiar to some, due to a rather viral advertising campaign in which he played "Joe Canadian" www.youtube.com/watch?v=BRI-A3vakVg

These are just a few of the many sources of breaking news available to the listener through international broadcasting. Let us know if you have another favorite that has been left out.

Tune in next month for a festive edition of *Programming Spotlight!*

NASB
National Association of
Shortwave Broadcasters

Representing the privately-owned
shortwave stations in the USA

- Find links to all of our members at www.shortwave.org
- Take the **NASB Shortwave Listener Survey** and get a free subscription to the **NASB Newsletter**.
www.surveymonkey.com/s/6L RVL J7
- Listen to "The Voice of the NASB" on **HCJB's DX Party Line** on **WRMI's 9955 kHz**. Visit www.wrmi.net for schedule
- **NASB** is a member of the **HFCC (High Frequency Coordination Conference)** and the **DRM (Digital Radio Mondiale) Consortium**

THE QSL REPORT

VERIFICATIONS RECEIVED BY OUR READERS

Gayle Van Horn, W4GVH

gaylevanhorn@monitoringtimes.com

http://mt-shortwave.blogspot.com

Twitter @QSLRptMT



New Stations, New Website, New QSLs

Radio enthusiasts can add a new country to their log book with the inauguration of the foreign service of Radio Afghanistan. Based in Kabul, programming is currently being heard on 6100 kHz in English 1530-1600 and Urdu from 1600-1630 UTC. Future plans include Arabic, Russian, French and German services. Programming is targeted to listening audiences in Asia, Africa and Europe. Postal address: P.O. Box 544, Central Post Office, Kabul, Afghanistan or street address: Street 13, Lane 2, Wazir Akbar Khan, District 10, Kabul, Afghanistan. Website: <http://rta.org/af/> Email: rta_afg@yahoo.com You Tube audio link <http://youtu.be/CacuILcC-Mwo>

Another station has been added to Peru's growing list of shortwave stations. Radio JPJ, named after its director Jesús Párraga, is being heard on 3360 kHz. At press time, a current schedule has not been released, but listeners are hearing JPJ from 0820-1015 UTC. Postal address: Manzana D, Lote 9, Asoc. Vivienda

Monte Los Olivos, Distrito de San Martín de Porres, Provincia y Departamento de Lima, Perú.

Streaming audio www.radiojpp.com/ Shortwave Central blog audio post: <http://mt-shortwave.blogspot.com/2011/09/blog-logs.html>

DXers have observed Papua New Guinea's Radio New Ireland active again on 3905 kHz, following a silent period since December 2010. Programming is in a mix English and Tok Pisin, heard from 1055-1345 UTC. If country-counting, this one counts as New Ireland. Send your correspondence with return mint postage to: P.O. Box 477, Kavieng, Papua New Guinea.

Radio Taiwan International launched a new English website on its recent 83rd anniversary. RTI Chairman Chang Jung-kung noted, "the new English website is a bridge that connects RTI and the Republic of China to the rest of the world." Check out the website at: <http://english.rti.org.tw/> The RTI English broadcast schedule is included in MT's *Shortwave Guide*.

In November, as part of its 15th Anniversary card series, Radio Free Asia will be offering a

card featuring a quote from Burmese political leader, Aung San Suu Kyi. To learn more about the anniversary, go to: www.rfa15.org. Reception reports may be submitted at www.techweb.rfa.org: (follow the *QSL Reports* link). or to qsl@rfa.org. Postal address: Reception Reports, Radio Free Asia, 2025 M. Street NW, Suite 300, Washington, DC 20036 USA. Complete RFA broadcast schedules are included in *MTXpress* monthly editions.

Radio Gloria International is set to make a November broadcast on the 27th. Programming is scheduled via Wertachtal, Germany at 0900-1000 and 1300-1400 UTC. Send details to radiogloria@aol.com.

With thoughts of Thanksgiving upon us, pirate fans are wondering if US pirate station, Turkey Breast Radio plans to revive their Thanksgiving broadcast this year. Last year's premier broadcast put in an amazingly solid signal on 6925 USB. How about a shout out to *Monitoring Times*?... But please, no *Gobble Gobble* song!

AMATEUR RADIO

Canada-VY2TT, 20 meters USB. Full data photo QSL card. Received in three months via ARRL bureau (Larry Van Horn, NC).

Norway-A9VDA, 17 meters USB. Full data color photo card. Received in two years and three months via ARRL bureau (Van Horn, NC).

Zambia-9J2KK, 20 meters JT6FA. Full data photo QSL card. Received in 15 days for \$2.00US and SASE. QSL address: QSL Manager JK1NSR, Tsuyoshi Kojima, 4-3-17, Mizukino, Moriya City, Ibaraki-Pref, Japan (Van Horn).



9J2KK

Republic of Zambia

CQ Zone: 36
ITU Zone: 53



MEDIUM WAVE

CKOC, 1150 kHz AM. *Oldies 1150*. Full data QSL Certificate signed by Mark, Engineer, plus frig magnet. Received in 27 days for an AM report and SASE. Station address: 883 Upper Wentworth Street, Suite 401, Hamilton, ON, Canada L9A 4Y6 (Frank Halaburak, Montreal, QC Canada). Streaming audio www.oldies1150.com/

WENJ 1450 kHz AM *ESPN South Jersey*. E-QSL from Kristen Lucca, Promotions Coordinator. Received in 51 days for report to kristen.lucca@mrgnj.com after five follow ups including two via postal mail and four emails. Postal address: WENJ 1450-AM, 950 Tilton Road, Suite 200, Northfield,

NJ 08225 USA (Mauricio Molano, Spain/playdx).

Streaming audio www.1450espn.com

WFAN 660 kHz AM. *Sport Radio 66*. E-QSL from Eric Spitz, Program Director. Received in 13 minutes after follow-up email to espitz@wfan.com Postal address: WFAN Radio 345 Hudson Street, New York, NY 10014 USA (Molano). Streaming audio www.newyork.cbslocal.com

WFEA, 1370 kHz AM. *Unforgettable Hits*. No data verification letter signed by Peter J. Stohrer, Director of Engineering, plus station info sheet. Received in 13 days for an AM report, SAE and \$1.00US. Station address: 500 Commercial Street, Manchester, NH 03101 USA (Halaburak). Streaming audio www.wfea1370.com/

PALAU

T8WH/World Harvest Radio, 9930 kHz. Full data 25th Anniversary card, unsigned. Received in 30 days after a follow up report. QSL address: WHRI, P.O. Box 12, South Bend, IN 46624 USA (J.D. Stevens, Hampton Cove, AL). Streaming audio www.whr.org

TAIWAN

Radio Taiwan International, 9680/15320 kHz. Two full data photo QSL cards, unsigned, plus souvenir postcards, sticker and bookmark. Received in 45 days for an English report posted online at Reception Report link <http://english.rti.org.tw/receptionreport.aspx> Postal address: 55 Pei'an Road, Taipei 10462, Taiwan (Tom Banks, Dallas, TX). On-demand and streaming audio <http://english.rti.org.tw/>

UTILITY

French Guyana-Cayenne Aero 8855 kHz. Full data prepared QSL card signed and stamped as verified. Received in 23 days for a utility report. QSL address: Centre de Controle de la Navigation Aérienne, Aerodrome de Cayenne-Rochambeau, F-97351 Matouri, France (Patrick Robic, Austria/UDXF).

Germany-DDH47, 147.3 kHz/ DDK2 4583 kHz. Deutscher Wetterdienst Pinneberg verified with two full data cards signed by Hans Herbert Gribl. Received in nine days for a utility report. QSL address: Haidkamp 100, 25421 Pinneberg, Germany (Robic).

United Kingdom-GFF Kinloss Rescue 5680 kHz. Verification letter and full data QSL card signed by J. Wright, Communications & IT Manager. Received in 11 days for a utility report. QSL address: Aeronautical Rescue Coordination Centre, Royal Air Force, Kinloss, Forres, Morayshire IV36 3UH United Kingdom (Robic).

USA

Radio Free Afghanistan, 19010 kHz via Kuwait. Full data RFE/RL card, unsigned. Received 56 days for an English report of Dari service and return mint postage. QSL address: 1201 Connecticut Avenue NW, Washington, DC 20036 USA (Sam Wright, Biloxi, MS). Station is the Afghan branch of Radio Free Europe/Radio Liberty (RFE/RL) broadcast services in conjunction with Voice of America. On-demand/streaming audio www.azadiradio.org





HOW TO USE THE SHORTWAVE GUIDE

0000-0100 twhfa USA, Voice of America 5995am 6130ca 7405am 9455af
 ① ② ⑤ ③ ④ ⑥ ⑦

CONVERT YOUR TIME TO UTC

Broadcast time on ① and time off ② are expressed in Coordinated Universal Time (UTC) – the time at the 0 meridian near Greenwich, England. To translate your local time into UTC, first convert your local time to 24-hour format, then add (during Standard Time) 5, 6, 7 or 8 hours for Eastern, Central, Mountain or Pacific Times, respectively. Eastern, Central, and Pacific Times are already converted to UTC for you at the top of each hour.

Note that all dates, as well as times, are in UTC; for example, a show which might air at 0030 UTC Sunday will be heard on Saturday evening in America (in other words, 7:30 pm Eastern, 6:30 pm Central, etc.).

FIND THE STATION YOU WANT TO HEAR

Look at the page which corresponds to the time you will be listening. English broadcasts are listed by UTC time on ①, then alphabetically by country ③, followed by the station name ④. (If the station name is the same as the country, we don't repeat it, e.g., "Vanuatu, Radio" [Vanuatu].)

If a broadcast is not daily, the days of broadcast ⑤ will appear in the column following the time of broadcast, using the following codes:

Codes	
s/Sun	Sunday
m/Mon	Monday
t	Tuesday
w	Wednesday
h	Thursday
f	Friday
a/Sat	Saturday
occ:	occasional
DRM:	Digital Radio Mondiale
irreg	Irregular broadcasts
vl	Various languages
USB:	Upper Sideband

CHOOSE PROMISING FREQUENCIES

Choose the most promising frequencies for the time, location and conditions.

The frequencies ⑥ follow to the right of the station listing; all frequencies are listed in kilohertz (kHz). Not all listed stations will be heard from your location and virtually none of them will be heard all the time on all frequencies.

Shortwave broadcast stations change some of their frequencies at least twice a year, in April and October, to adapt to seasonal conditions. But they

can also change in response to short-term conditions, interference, equipment problems, etc. Our frequency manager coordinates published station schedules with confirmations and reports from her monitoring team and MT readers to make the Shortwave Guide up-to-date as of one week before print deadline.

To help you find the most promising signal for your location, immediately following each frequency we've included information on the target area ⑦ of the broadcast. Signals beamed toward your area will generally be easier to hear than those beamed elsewhere, even though the latter will often still be audible.

Target Areas

af: Africa
 al: alternate frequency (occasional use only)
 am: The Americas
 as: Asia
 ca: Central America
 do: domestic broadcast
 eu: Europe
 me: Middle East
 na: North America
 pa: Pacific
 sa: South America
 va: various

Mode used by all stations in this guide is AM unless otherwise indicated.

MT MONITORING TEAM

Gayle Van Horn
 Frequency Manager
 gaylevanhorn@monitoringtimes.com

Larry Van Horn, MT Asst. Editor
 larryvanhorn@monitoringtimes.com

Additional Contributors to This Month's Shortwave Guide:

Thank You to ...

BCL News, Cumbre DX; Hard-Core DX; DSWCI/DX Window; DBS 2011; DX Mix News WWDXC/Top News.

Alokesh Gupta, India; Babcock; Evelyn Marcy, FL/WYFR; Ivo Ivanov, Bulgaria; Rachel Baughn/MT; Sean Gilbert, UK/WRTH; Wolfgang Büeschel, Germany.

SHORTWAVE BROADCAST BANDS

kHz	Meters
2300-2495	120 meters (Note 1)
3200-3400	90 meters (Note 1)
3900-3950	75 meters (Regional band, used for broadcasting in Asia only)
3950-4000	75 meters (Regional band, used for broadcasting in Asia and Europe)
4750-4995	60 meters (Note 1)
5005-5060	60 meters (Note 1)
5730-5900	49 meter NIB (Note 2)
5900-5950	49 meter WARC-92 band (Note 3)
5950-6200	49 meters
6200-6295	49 meter NIB (Note 2)
6890-6990	41 meter NIB (Note 2)
7100-7300	41 meters (Regional band, not allocated for broadcasting in the western hemisphere) (Note 4)
7300-7350	41 meter WARC-92 band (Note 3)
7350-7600	41 meter NIB (Note 2)
9250-9400	31 meter NIB (Note 2)
9400-9500	31 meter WARC-92 band (Note 3)
9500-9900	31 meters
11500-11600	25 meter NIB (Note 2)
11600-11650	25 meter WARC-92 band (Note 3)
11650-12050	25 meters
12050-12100	25 meter WARC-92 band (Note 3)
12100-12600	25 meter NIB (Note 2)
13570-13600	22 meter WARC-92 band (Note 3)
13600-13800	22 meters
13800-13870	22 meter WARC-92 band (Note 3)
15030-15100	19 meter NIB (Note 2)
15100-15600	19 meters
15600-15800	19 meter WARC-92 band (Note 3)
17480-17550	17 meter WARC-92 band (Note 3)
17550-17900	17 meters
18900-19020	15 meter WARC-92 band (Note 3)
21450-21850	13 meters
25670-26100	11 meters

Notes

- Note 1 Tropical bands, 120/90/60 meters are for broadcast use only in designated tropical areas of the world.
- Note 2 Broadcasters can use this frequency range on a (NIB) non-interference basis only.
- Note 3 WARC-92 bands are allocated officially for use by HF broadcasting stations in 2007 WRC-03 update. After March 29, 2009, the spectrum from 7100-7200 kHz will no longer be available for broadcast purposes and will be turned over to amateur radio operations worldwide

"MISSING" LANGUAGES?

A **FREE** download to MTXpress subscribers, the online MTXtra Shortwave Guide is 115+ pages of combined language schedules, sorted by time. Print subscribers: add the MTXtra SW Guide to your subscription for only \$11.95. Call **1-800-438-8155** or visit **www.monitoringtimes.com** to learn how.

0000 UTC - 7PM EST / 6PM CST / 4PM PST

0000 0030	Egypt, Radio Cairo	6270na	
0000 0030	USA, BBG/Voice of America	7555as	
0000 0045	India, All India Radio/External Svc	6055as	
	7305as	11645as	13605as
0000 0057	Romania, Radio Romania International	9580na	7385na
0000 0058	Germany, Deutsche Welle	9885as	13780as
0000 0100	Anguilla, University Network	6090na	
0000 0100	Australia, ABC NT Alice Springs		4835do
0000 0100	Australia, ABC NT Katherine	5025do	
0000 0100	Australia, ABC NT Tennant Creek		4910do
0000 0100	Australia, Radio Australia	9660pa	12080pa
	13690pa	15240pa	17715pa
			17795pa
0000 0100	Bahrain, Radio Bahrain	6010me	
0000 0100	Canada, CFRX Toronto ON	6070na	
0000 0100	Canada, CFVP Calgary AB	6030na	
0000 0100	Canada, CKZN St Johns NF	6160na	
0000 0100	Canada, CKZU Vancouver BC	6160na	
0000 0100	Canada, Radio Canada International		11700as
0000 0100	China, China Radio International		6020eu
	6075as	6180as	7350eu
	9570na	11790as	11885as
			15125as
0000 0100	Malaysia, RTM Kajang/Traxx FM		7295do
0000 0100	Micronesia, The Cross Radio/Pohnpei		4755 as
0000 0100	New Zealand, Radio NZ International		15720pa
0000 0100	New Zealand, Radio NZ International		17675pa
0000 0100	Palau, T8WH/ WHRI		15700as
0000 0100	Russia, Voice of Russia		9665va
0000 0100	Russia, Voice of Russia		9800va
0000 0100	Spain, Radio Exterior de Espana		6055na
0000 0100	Thailand, Radio Thailand World Svc		15275na
0000 0100	UK, BBC World Service		5970as
	9410as	9740as	12095as
			15335as
			15755as
			17685as
0000 0100	USA, American Forces Network/AFRTS		4319usb
	5446usb	5765usb	7812usb
	12759usb	13362usb	12133usb
0000 0100	USA, EWTN/WEWN Irondale, AL		11520af
0000 0100	USA, FBN/WTJC Newport NC		9370na
0000 0100	USA, WBCQ Monticello ME		5110usb
			9330usb
0000 0100	USA, WHRI Cypress Creek SC		5920na
	7315na	9860na	
0000 0100	USA, WINB Red Lion PA		9265ca
0000 0100	USA, WRMI Miami FL		9955ca
0000 0100	USA, WTWW Lebanon TN		5755va
0000 0100	USA, WWCN Nashville TN		3215eu
	5935af	7465eu	4840na
0000 0100	USA, WWRB Manchester TN		2390na
	3215na	5050na	3185na
0000 0100	USA, WYFR/Family Radio Worldwide		5930ca
	7360sa	7520sa	15440ca
0000 0100	Zambia, CVC Radio Christian Voice		4965af
0030 0045	Albania, Radio Tirana		9860na
0030 0100	Australia, Radio Australia		15415as
0030 0100	Canada, Bible Voice Broadcasting		7405as
0030 0100	Serbia, International Radio Serbia		9685na
0030 0100	Thailand, Radio Thailand World Svc		15275na
0030 0100	USA, BBG/Voice of America/Special English		
	7430va	9715va	9780va
			11725va
			12005va
			15205va
			15290va
			17820va
			9955ca
0030 0100	USA, WRMI/Radio Slovakia Intl		
0035 0045	India, All India Radio/Aizawl		5050do
0035 0045	India, All India Radio/Chennai		4920do
0035 0045	India, All India Radio/Guwahati		4940do
0035 0045	India, All India Radio/Hyderabad		4800do
0035 0045	India, All India Radio/Imphal		4775do
0035 0045	India, All India Radio/Port Blair		4760do
0035 0045	India, All India Radio/Shillong		4970do
0035 0045	India, All India Radio/Shimla		4965do
0035 0045	India, All India Radio/Thiruvananthapuram		5010do

0100 UTC - 8PM EST / 7PM CST / 5PM PST

0100 0130	Vietnam, Voice of Vietnam/Overseas Svc	6175na	
0100 0157	North Korea, Voice of Korea	7220as	9345as
	9730as	11735ca	15180sa
0100 0200	Anguilla, University Network	6090na	
0100 0200	Australia, ABC NT Alice Springs		4835do
0100 0200	Australia, ABC NT Katherine	5025do	
0100 0200	Australia, ABC NT Tennant Creek		4910do

0100 0200	Australia, Radio Australia	9660pa	12080pa
	13690pa	15240pa	15415as
	17750as	17795pa	17715pa
0100 0200	Bahrain, Radio Bahrain	6010me	
0100 0200	Canada, CFRX Toronto ON	6070na	
0100 0200	Canada, CFVP Calgary AB	6030na	
0100 0200	Canada, CKZN St Johns NF	6160na	
0100 0200	Canada, CKZU Vancouver BC	6160na	
0100 0200	China, China Radio International		6020eu
	6175eu	6180as	9410eu
	9535as	9570na	9580na
	9790na	11870as	15215as
			15785as
0100 0200	Cuba, Radio Havana Cuba	6000na	6050na
0100 0200	Malaysia, RTM Kajang/Traxx FM		7295do
0100 0200	Micronesia, The Cross Radio/Pohnpei		4755 as
0100 0200	Mongolia, Mongolian Radio 2/Ulaanbaatar		7260do
0100 0200	New Zealand, Radio NZ International		15720pa
0100 0200	New Zealand, Radio NZ International		17675pa
0100 0200	Palau, T8WH/ WHRI		15700as
0100 0200	Russia, Voice of Russia		9665va
0100 0200	Russia, Voice of Russia		9800va
0100 0200	Taiwan, Radio Taiwan International		11875as
0100 0200	UK, BBC World Service		7395as
	9740as	11750as	11955as
			12095as
			15310as
			15335as
			15360as
			17685as
0100 0200	USA, American Forces Network/AFRTS		4319usb
	5446usb	5765usb	7812usb
	12759usb	13362usb	12133usb
0100 0200	USA, BBG/Voice of America		7430va
	11705va		9780va
0100 0200	USA, EWTN/WEWN Irondale, AL		11520af
0100 0200	USA, FBN/WTJC Newport NC		9370na
0100 0200	USA, KJES Vado NM		7555na
0100 0200	USA, WBCQ Monticello ME		5110usb
			9330usb
0100 0200	USA, WHRI Cypress Creek SC		9840na
	9860na		
0100 0200	USA, WHRI Cypress Creek SC		5920na
0100 0200	USA, WHRI Cypress Creek SC		7315na
0100 0200	USA, WINB Red Lion PA		9265ca
0100 0200	USA, WRMI Miami FL		9955ca
0100 0200	USA, WTWW Lebanon TN		5755va
0100 0200	USA, WWRB Manchester TN		2390na
			5050na
0100 0200	USA, WYFR/Family Radio Worldwide		15440ca
0100 0200	Zambia, CVC Radio Christian Voice		4965af
0120 0200	Sri Lanka, SLBC	6005as	9770as
0130 0200	USA, BBG/Voice of America/Special English		4319usb
	7465va	9820va	
0145 0200	Albania, Radio Tirana		7425na

0200 UTC - 9PM EST / 8PM CST / 6PM PST

0200 0215	Croatia, Croatian Radio	3985eu	7375am
0200 0230	Thailand, Radio Thailand World Svc		15275na
0200 0230	USA, KJES Vado NM		7555na
0200 0230	USA, WINB Red Lion PA		9265ca
0200 0245	USA, WYFR/Family Radio Worldwide		5985ca
0200 0257	North Korea, Voice of Korea	13650as	15100as
0200 0300	Anguilla, University Network	6090na	
0200 0300	Argentina, RAE	11710am	
0200 0300	Australia, ABC NT Alice Springs		4835do
0200 0300	Australia, ABC NT Katherine	5025do	
0200 0300	Australia, ABC NT Tennant Creek		4910do
0200 0300	Australia, Radio Australia	9660pa	12080pa
	13690pa	15240as	15415as
			15515pa
			17750as
			21725pa
0200 0300	Bahrain, Radio Bahrain	6010me	
0200 0300	Bulgaria, Radio Bulgaria	9700na	11700na
0200 0300	Canada, CFRX Toronto ON	6070na	
0200 0300	Canada, CFVP Calgary AB	6030na	
0200 0300	Canada, CKZN St Johns NF	6160na	
0200 0300	Canada, CKZU Vancouver BC	6160na	
0200 0300	China, China Radio International		11770as
	13640as		
0200 0300	Cuba, Radio Havana Cuba	6000na	6050na
0200 0300	Egypt, Radio Cairo		9315na
0200 0300	Indonesia, Voice of Indonesia	9526va	
0200 0300	Malaysia, RTM Kajang/Traxx FM		7295do
0200 0300	Micronesia, The Cross Radio/Pohnpei		4755 as
0200 0300	New Zealand, Radio NZ International		15720pa
0200 0300	New Zealand, Radio NZ International		17675pa
0200 0300	Palau, T8WH/ WHRI		17800as
0200 0300	Philippines, PBS/ Radyo Pilipinas		11880me
	15285me	17700me	

0200	0300	Russia, Voice of Russia	9665sa	15425na
0200	0300	South Korea, KBS World Radio		9580sa
0200	0300	Sri Lanka, SLBC	6005as	9770as
0200	0300	Taiwan, Radio Taiwan International		5950na
		9680ca		
0200	0300	UK, BBC World Service	6005af	6195as
		12095as	15310as	17790as
0200	0300	USA, American Forces Network/AFRTS		4319usb
		5446usb	5765usb	7812usb
		12759usb	13362usb	
0200	0300	USA, EWTN/WEWN Irondale, AL		11520af
0200	0300	USA, FBN/WTJC Newport NC 9370na		
0200	0300	USA, WBCQ Monticello ME	5110usb	7415usb
		9330usb		
0200	0300	USA, WHRI Cypress Creek SC		5920na
		9840na	9860na	
0200	0300	USA, WRMI Miami FL		9955ca
0200	0300	USA, WRNO New Orleans LA	7505am	
0200	0300	USA, WTWW Lebanon TN	5755va	12100va
0200	0300	USA, WWCN Nashville TN	3215eu	4840na
		5890af	5935af	
0200	0300	USA, WWRB Manchester TN	2390va	3185na
		5050na		
0200	0300	USA, WYFR/Family Radio Worldwide		9385ca
0200	0300	Zambia, CVC Radio Christian Voice		4965af
0215	0300	Nepal, Radio Nepal	5005as	
0230	0300	Albania, Radio Tirana	7425na	
0230	0300	Myanmar, Myanma Radio/National Svc		5915do
		5920al		
0230	0300	Vietnam, Voice of Vietnam/Overseas Svc		6175na
0245	0300	Australia, HCJB Global Australia		15400as
0245	0300	India, All India Radio/Bhopal	7430do	
0245	0300	India, All India Radio/Delhi	4860do	6030do
		7235do	11830do	15135do
0245	0300	India, All India Radio/Gorakhpur		3945do
		6030do	7235do	11830do
0245	0300	India, All India Radio/Guwahati		4940do
0245	0300	India, All India Radio/Hyderabad		7420do
0245	0300	India, All India Radio/Imphal	7335do	
0245	0300	India, All India Radio/Itanagar		4990do
0245	0300	India, All India Radio/Jaipur	4910do	
0245	0300	India, All India Radio/Kolkata	7210do	
0245	0300	India, All India Radio/Kurseong		4895do
0245	0300	India, All India Radio/Lucknow		4880do
0245	0300	India, All India Radio/Radio Kashmir		4760do
0245	0300	India, All India Radio/Shillong	4970do	
0245	0300	India, All India Radio/Shimla	6020do	
0245	0300	India, All India Radio/Thiruvananthapuram		7290do
0245	0300	Zambia, ZNBC/Radio Two	6165do	
0250	0300	Vatican City State, Vatican Radio		6040am
		7305am	9610am	
0255	0300	Swaziland, TWR Africa	3200af	

0300	0400	Canada, CKZN St Johns NF	6160na	
0300	0400	Canada, CKZU Vancouver BC	6160na	
0300	0400	China, China Radio International		9690am
		9790na	11770as	13750as
		15120as	15785as	15110as
0300	0400	Cuba, Radio Havana Cuba	6000na	6050na
0300	0400	Germany, Deutsche Welle	15595as	
0300	0400	Malaysia, RTM Kajang/Traxx FM		7295do
0300	0400	Micronesia, The Cross Radio/Pohnpei		4755 as
0300	0400	New Zealand, Radio NZ International		15720pa
0300	0400	New Zealand, Radio NZ International		17675pa
0300	0400	Oman, Radio Sultanate of Oman		15355af
0300	0400	Palau, T8WH/ WHRI		17800as
0300	0400	Russia, Voice of Russia	9665sa	15425na
		15585as		
0300	0400	South Africa, Channel Africa	3345af	
0300	0400	Sri Lanka, SLBC	6005as	9770as
0300	0400	Taiwan, Radio Taiwan International		5950na
		15320as		
0300	0400	UK, BBC World Service	3255af	5875af
		6005af	6145af	6190af
		6145af	6190af	6195af
		7255eu	9410af	9750af
		12095as	15310as	15365as
		15365as		17790as
0300	0400	USA, American Forces Network/AFRTS		4319usb
		5446usb	5765usb	7812usb
		12759usb	13362usb	
0300	0400	USA, BBG/Voice of America/African Svc		4930af
		6080af	9885af	15580af
0300	0400	USA, EWTN/WEWN Irondale, AL		11520af
0300	0400	USA, FBN/WTJC Newport NC 9370na		
0300	0400	USA, WBCQ Monticello ME	7415usb	9330usb
0300	0400	USA, WHRI Cypress Creek SC		5920na
		7385na	9840na	
0300	0400	USA, WRMI Miami FL		9955ca
0300	0400	USA, WTWW Lebanon TN	5755va	12100va
0300	0400	USA, WWCN Nashville TN	3215eu	4840na
		5890af	5935af	
0300	0400	USA, WWRB Manchester TN	2390na	3185na
		5050na		
0300	0400	USA, WYFR/Family Radio Worldwide		11740ca
0300	0400	Zambia, CVC Radio Christian Voice		4965af
0300	0400	Zambia, ZNBC/Radio Two	6165do	
0315	0400	Australia, Radio Australia	15240pa	
0330	0400	Albania, Radio Tirana	7425na	
0330	0400	Iran, IRIB/ VOIRI	9605na	11920na
0330	0400	Vietnam, Voice of Vietnam/Overseas Svc		6175na
0335	0345	India, All India Radio/Aizawl	5050do	
0335	0345	India, All India Radio/Delhi	7235do	11830do
		15135do		
0335	0345	India, All India Radio/Kolkata	7210do	

0400 UTC - 11PM EST / 10PM CST / 8PM PST

0300 UTC - 10PM EST / 9PM CST / 7PM PST

0300	0315	India, All India Radio/Imphal	7335do	
0300	0315	India, All India Radio/Itanagar		4990do
0300	0315	India, All India Radio/Shillong	4970do	
0300	0325	Swaziland, TWR Africa	3200af	
0300	0327	Iran, IRIB/ VOIRI	11920na	
0300	0330	Egypt, Radio Cairo	9315na	
0300	0330	Myanmar, Myanma Radio/National Svc		9731do
0300	0330	Philippines, PBS/ Radyo Pilipinas		11880me
		15285me	17700me	
0300	0330	Vatican City State, Vatican Radio		7305af
		7360af	9660af	
0300	0355	South Africa, Channel Africa	5980af	
0300	0355	Turkey, Voice of Turkey	6165as	9515va
0300	0357	North Korea, Voice of Korea	7220as	9345as
		9730as		
0300	0357	Romania, Radio Romania International		7335na
		9645na	11895as	15340as
0300	0358	Germany, Deutsche Welle	12005as	
0300	0400	Anguilla, University Network	6090na	
0300	0400	Australia, ABC NT Alice Springs		4835do
0300	0400	Australia, ABC NT Katherine	5025do	
0300	0400	Australia, ABC NT Tennant Creek		4910do
0300	0400	Australia, Radio Australia	9660pa	12080pa
		13690pa	15240as	15415as
		15415as	15515pa	15515pa
		17750as	21725pa	
0300	0400	Bahrain, Radio Bahrain	6010me	
0300	0400	Canada, CBC Northern Quebec Svc		9625na
0300	0400	Canada, CFRX Toronto ON	6070na	
0300	0400	Canada, CFVP Calgary AB	6030na	

0400	0427	Iran, IRIB/ VOIRI	9605na	11920na
0400	0430	USA, BBG/Voice of America/African Svc		4930af
		4960af	6080af	9855af
		15580af		11670af
0400	0457	Germany, Deutsche Welle	7240af	
0400	0458	New Zealand, Radio NZ International		15720pa
0400	0458	New Zealand, Radio NZ International		17675pa
0400	0459	Germany, Deutsche Welle	13840af	
0400	0500	Anguilla, University Network	6090na	
0400	0500	Australia, ABC NT Alice Springs		4835do
0400	0500	Australia, ABC NT Katherine	5025do	
0400	0500	Australia, ABC NT Tennant Creek		4910do
0400	0500	Australia, Radio Australia	9660pa	12080pa
		13690pa	15240as	15515pa
		15515pa		17750pa
		21725pa		
0400	0500	Bahrain, Radio Bahrain	6010me	
0400	0500	Canada, CBC Northern Quebec Svc		9625na
0400	0500	Canada, CFRX Toronto ON	6070na	
0400	0500	Canada, CKZN St Johns NF	6160na	
0400	0500	Canada, CKZU Vancouver BC	6160na	
0400	0500	China, China Radio International		6020na
		6080na	13750as	15120as
		15120as	15785as	
		17730va	17855va	
0400	0500	France, Radio France Internationale		9805af
		11995af		
0400	0500	Germany, Deutsche Welle	6180af	
0400	0500	Malaysia, RTM Kajang/Traxx FM		7295do
0400	0500	Micronesia, The Cross Radio/Pohnpei		4755 as
0400	0500	Palau, T8WH/ WHRI		17800as
0400	0500	Russia, Voice of Russia	13775na	15585as
0400	0500	South Africa, Channel Africa	3345af	
0400	0500	Sri Lanka, SLBC	6005as	9770as

0400	0500		UK, BBC World Service	3255af	5875eu
			6005af	6190af	7255af
			11945af	12035af	12095as
			15310as	15365as	17790as
0400	0500	DRM	UK, BBC World Service	3955eu	
0400	0500		USA, American Forces Network/AFRTS		4319usb
			5446usb	5765usb	7812usb
			12759usb	13362usb	12133usb
0400	0500		USA, EWNT/WEWN Irondale, AL		11520af
0400	0500		USA, FBN/WTJC Newport NC9370na		
0400	0500		USA, WHRI Cypress Creek SC		5920na
			7385na	9825na	
0400	0500		USA, WRMI Miami FL	9955ca	
0400	0500		USA, WTWW Lebanon TN	5755va	12100va
0400	0500		USA, WWCR Nashville TN	3215eu	4840na
			5890af	5935af	
0400	0500		USA, WWRB Manchester TN	3185na	
0400	0500		Zambia, CVC Radio Christian Voice		4965af
0400	0500		Zambia, ZNBC/Radio Two	6165do	
0430	0500	mtwhf	Swaziland, TWR Africa	3200af	4775af
0430	0500		USA, BBG/Voice of America/African Svc		4930af
			4960af	6080af	11670af
					15580af
0435	0445		India, All India Radio/Delhi		4860do
0455	0500		Nigeria, Voice of Nigeria	15120af	
0459	0500		New Zealand, Radio NZ International		11725pa
0459	0500	DRM	New Zealand, Radio NZ International		11675pa

0500 UTC - 12AM EST / 11PM CST / 9PM PST

0500	0507	twhf	Canada, CBC Northern Quebec Svc	9625na	
0500	0530		Germany, Deutsche Welle	7430af	9480af
			11875af		
0500	0530		Japan, Radio Japan NHK World		5975va
			6110na	11970va	
0500	0530		UK, BBC World Service	5975eu	
0500	0530		Vatican City State, Vatican Radio	5965va	
			7250eu	9660af	11625af
0500	0557		China, China Radio International		6020na
			6190na	11710af	11895as
			15465as	17505va	17540as
			17855va		17730va
0500	0600		Anguilla, University Network	6090na	
0500	0600		Australia, ABC NT Alice Springs		4835do
0500	0600		Australia, ABC NT Katherine	5025do	
0500	0600		Australia, ABC NT Tennant Creek		4910do
0500	0600		Australia, Radio Australia	9660pa	12080pa
			13630pa	13690pa	15160pa
			17750as		15240pa
0500	0600		Bahrain, Radio Bahrain	6010me	
0500	0600		Bhutan, Bhutan Broadcasting Svc		6035do
0500	0600		Canada, CFRX Toronto ON	6070na	
0500	0600		Canada, CKZN St Johns NF	6160na	
0500	0600		Canada, CKZU Vancouver BC6160na		
0500	0600		Cuba, Radio Havana Cuba	6000na	6010na
			6050na	6060na	6150sa
0500	0600	mtwhf	Equatorial Guinea, Radio Africa 2		15190af
0500	0600	Sat/Sun	Equatorial Guinea, Radio East Africa		15190af
0500	0600	mtwhf	France, Radio France Internationale		11995af
			13680af		
0500	0600		Malaysia, RTM Kajang/Traxx FM		7295do
0500	0600		Micronesia, The Cross Radio/Pohnpei		4755 as
0500	0600		New Zealand, Radio NZ International		11725pa
0500	0600	DRM	New Zealand, Radio NZ International		11675pa
0500	0600		Nigeria, Voice of Nigeria	15120af	
0500	0600		Palau, T8WH/ WHRI	17800as	
0500	0600		Russia, Voice of Russia	13775na	
0500	0600	mtwhf	South Africa, Channel Africa	7230af	
0500	0600	mtwhf	Swaziland, TWR Africa	3200af	4775af
0500	0600		Swaziland, TWR Africa	9500af	
0500	0600	Sat/Sun	Swaziland, TWR Africa	4775af	
0500	0600		Taiwan, Radio Taiwan International		6875na
0500	0600		UK, BBC World Service	3255af	6005eu
			6190af	7255af	9410af
			12095af	15310as	15365as
			17640as	17790as	15420af
0500	0600	DRM	UK, BBC World Service	3955eu	
0500	0600		USA, American Forces Network/AFRTS		4319usb
			5446usb	5765usb	7812usb
			12759usb	13362usb	12133usb
0500	0600		USA, BBG/Voice of America/African Svc		4930af
			6080af	11670af	155870af
0500	0600		USA, EWNT/WEWN Irondale, AL		11520af
0500	0600		USA, FBN/WTJC Newport NC9370na		
0500	0600		USA, WHRI Cypress Creek SC		7385va
			9825va	11565va	
0500	0600		USA, WRMI Miami FL	9955ca	

0500	0600		USA, WTWW Lebanon TN	5755va	12100va
0500	0600		USA, WWCR Nashville TN	3215eu	4840na
			5890af	5935af	
0500	0600		USA, WWRB Manchester TN	3185na	
0500	0600		Zambia, CVC Radio Christian Voice		4965af
0500	0600		Zambia, ZNBC/Radio Two	6165do	
0515	0530	Sat	Greece, Voice of Greece	11645eu	
0530	0550	Sun	Greece, Voice of Greece	11645eu	
0530	0557	DRM	Romania, Radio Romania International		7305eu
0530	0557		Romania, Radio Romania International		9655eu
			17760eu	21500eu	
0530	0600	Sat/Sun	Clandestine, Sudan Radio Service/SRS		13720af
0530	0600		Thailand, Radio Thailand World Svc		17655va

0600 UTC - 1AM EST / 12AM CST / 10PM PST

0600	0615	Sat/Sun	South Africa, TWR Africa	11640af	
0600	0630		Germany, Deutsche Welle	9545af	15275af
0600	0645	smtwhf	South Africa, TWR Africa	11640af	
0600	0655	mtwhf	South Africa, Channel Africa	15255af	
0600	0657		China, China Radio International		11710af
			11870me	11895as	13660as
			15350as	15465as	17505va
			17710as		15140me
0600	0658		New Zealand, Radio NZ International		11725pa
0600	0658	DRM	New Zealand, Radio NZ International		11675pa
0600	0700		Anguilla, University Network	6090na	
0600	0700		Australia, ABC NT Alice Springs		4835do
0600	0700		Australia, ABC NT Katherine	5025do	
0600	0700		Australia, ABC NT Tennant Creek		4910do
0600	0700		Australia, Radio Australia	9660pa	12080pa
			13630pa	13690pa	15160pa
			15415as	17750as	15240pa
0600	0700		Bahrain, Radio Bahrain	6010me	
0600	0700		Canada, CFRX Toronto ON	6070na	
0600	0700		Canada, CFVP Calgary AB	6030na	
0600	0700		Canada, CKZN St Johns NF	6160na	
0600	0700		Canada, CKZU Vancouver BC6160na		
0600	0700		Cuba, Radio Havana Cuba	6000na	6010na
			6050na	6060na	6150sa
0600	0700	mtwhf	Equatorial Guinea, Radio Africa 2		15190af
0600	0700	Sat/Sun	Equatorial Guinea, Radio East Africa		15190af
0600	0700	mtwhf	France, Radio France Internationale		11615va
			15160af	17800af	
0600	0700		Malaysia, RTM Kajang/Traxx FM		7295do
0600	0700		Malaysia, RTM/Voice of Malaysia		6175as
			9750as	15295as	
0600	0700		Micronesia, The Cross Radio/Pohnpei		4755 as
0600	0700		Nigeria, Voice of Nigeria	15120af	
0600	0700		Palau, T8WH/ WHRI	17800as	
0600	0700		Papua New Guinea, Radio Fly	5960do	
0600	0700		Russia, Voice of Russia	15405pa	
0600	0700	mtwhf	South Africa, Channel Africa	7230af	
0600	0700		South Africa, CVC 1 Africa Radio		13590af
0600	0700		Swaziland, TWR Africa	9500af	
0600	0700		UK, BBC World Service	6005af	6190af
			7365af	9410af	9860af
			12095as	15310as	15420af
			17790as		17640af
0600	0700	DRM	UK, BBC World Service	5875eu	7430eu
0600	0700		USA, American Forces Network/AFRTS		4319usb
			5446usb	5765usb	7812usb
			12759usb	13362usb	12133usb
0600	0700		USA, BBG/Voice of America/African Svc		6080af
			11670af	15580af	
0600	0700		USA, EWNT/WEWN Irondale, AL		11520af
0600	0700		USA, FBN/WTJC Newport NC9370na		
0600	0700		USA, WHRI Cypress Creek SC		7385va
			9825va	11565va	
0600	0700		USA, WRMI Miami FL	9955ca	
0600	0700		USA, WTWW Lebanon TN	5755va	12100va
0600	0700		USA, WWCR Nashville TN	3215eu	4840na
			5890af	5935af	
0600	0700		USA, WWRB Manchester TN	3185na	
0600	0700		USA, WYFR/Family Radio Worldwide		9680na
0600	0700		Zambia, CVC Radio Christian Voice		13590af
0600	0700		Zambia, ZNBC/Radio Two	6165do	
0602	0700		Swaziland, TWR Africa	6120af	
0630	0645		India, All India Radio/Guwahati		7280do
0630	0645		India, All India Radio/Hyderabad		7420do
0630	0645		India, All India Radio/Kurseong		7230do
0630	0645		India, All India Radio/Mumbai		7240do
0630	0645		India, All India Radio/Thiruvananthapuram		7290do
0630	0700		Bulgaria, Radio Bulgaria	9600na	11600na
0630	0700		Vatican City State, Vatican Radio		11625af
			13765af	15570af	

0645	0700	Sun	Germany, TWR Europe	6105eu	
0645	0700	Sun	Monaco, TWR Europe	9800eu	
0659	0700		New Zealand, Radio NZ International		6170pa
0659	0700	DRM	New Zealand, Radio NZ International		7440pa

0700 UTC - 2AM EST / 1AM CST / 11PM PST

0700	0730	Sun	Canada, Bible Voice Broadcasting	5945eu	
0700	0745	Sat	Canada, Bible Voice Broadcasting	5945eu	
0700	0745		USA, WYFR/Family Radio Worldwide	7570eu	
0700	0750	mtwhf	Germany, TWR Europe	6105eu	
0700	0750	smtwhf	Monaco, TWR Europe	9800eu	
0700	0758		New Zealand, Radio NZ International		6170pa
0700	0758	DRM	New Zealand, Radio NZ International		7440pa
0700	0800		Anguilla, University Network	6090na	
0700	0800		Australia, ABC NT Alice Springs	4835do	
0700	0800		Australia, ABC NT Katherine	5025do	
0700	0800		Australia, ABC NT Tennant Creek	4910do	
0700	0800		Australia, Radio Australia	9475as	9660pa
			9710pa	11945as	12080pa
			15160pa		13630pa
0700	0800		Bahrain, Radio Bahrain	6010me	
0700	0800	m/DRM	Belgium, TDP Radio	6015eu	
0700	0800		Canada, CFRX Toronto ON	6070na	
0700	0800		Canada, CFPV Calgary AB	6030na	
0700	0800		Canada, CKZN St Johns NF	6160na	
0700	0800		Canada, CKZU Vancouver BC	6160na	
0700	0800		China, China Radio International	11895as	
			13660as	15125va	13710eu
			15465as	17490eu	17540as
0700	0800	mtwhf	Equatorial Guinea, Radio Africa 2	15190af	
0700	0800	Sat/Sun	Equatorial Guinea, Radio East Africa	15190af	
0700	0800	mtwhf	France, Radio France Internationale	15615af	
			17605af		
0700	0800		Malaysia, RTM Kajang/Traxx FM	7295do	
0700	0800		Malaysia, RTM/Voice of Malaysia	6175as	
			9750as	15295as	
0700	0800		Micronesia, The Cross Radio/Pohnpei	4755 as	
0700	0800		Palau, T8WH/ WHRI	17800as	
0700	0800		Papua New Guinea, Radio Fly	5960do	
0700	0800		Russia, Voice of Russia	15405pa	
0700	0800	mtwhf	South Africa, Channel Africa	7230af	
0700	0800		South Africa, CVC 1 Africa Radio	13590af	
0700	0800		Swaziland, TWR Africa	6120af	9500af
0700	0800		UK, BBC World Service	6190af	11760me
			11765af	11830af	12095af
			15400af	15575as	17640af
			17830af		17790as
0700	0800	DRM	UK, BBC World Service	5875eu	11925eu
0700	0800		USA, American Forces Network/AFRTS	4319usb	
			5446usb	5765usb	7812usb
			12759usb	13362usb	
0700	0800		USA, EWTN/WEWN Irondale, AL	11520af	
0700	0800		USA, FBN/WTJC Newport NC	9370na	
0700	0800		USA, WHRI Cypress Creek SC	7385va	
			9825va	11565va	
0700	0800		USA, WRMI Miami FL	9955ca	
0700	0800		USA, WTWW Lebanon TN	5755va	12100va
0700	0800		USA, WWCR Nashville TN	3215eu	4840na
			5890af	5935af	
0700	0800		USA, WWRB Manchester TN	3185na	
0700	0800		USA, WYFR/Family Radio Worldwide	5950ca	
0700	0800		Zambia, CVC Radio Christian Voice	13590af	
0700	0800		Zambia, ZNBC/Radio Two	6165do	
0715	0750	Sun	Germany, TWR Europe	6105eu	
0715	0750	Sat	Monaco, TWR Europe	9800eu	
0730	0745		India, All India Radio/Aizawl	5050do	
0730	0745		India, All India Radio/Delhi	6190do	11710do
			15185do	15260do	
0730	0745		India, All India Radio/Guwahati	7280do	
0730	0745		India, All India Radio/Imphal	7335do	
0730	0745		India, All India Radio/Jaipur	7325do	
0730	0745		India, All India Radio/Kolkata	7210do	
0730	0745		India, All India Radio/Kurseong	7230do	
0730	0745		India, All India Radio/Shimla	6020do	
0730	0800		Australia, HCJB Global Australia	11750pa	
0730	0800		India, All India Radio/Chennai	4920do	
0745	0800		Saudi Arabia, BSKSA/External Svc	17785af	
0759	0800		New Zealand, Radio NZ International	6170pa	
0759	0800	DRM	New Zealand, Radio NZ International	7440pa	

0800 UTC - 3AM EST / 2AM CST / 12AM PST

0800	0830		Australia, ABC NT Alice Springs	4835do	
0800	0830		Australia, ABC NT Katherine	5025do	
0800	0830		Australia, ABC NT Tennant Creek	4910do	

0800	0830		Australia, HCJB Global Australia	11750pa	
0800	0845		USA, WYFR/Family Radio Worldwide	5950ca	
0800	0900		Anguilla, University Network	6090na	
0800	0900		Australia, Radio Australia	5995pa	9475as
			9590pa	9710pa	9580pa
			12080pa	13630pa	
0800	0900		Bahrain, Radio Bahrain	6010me	
0800	0900	t/DRM	Belgium, TDP Radio	6015eu	
0800	0900		Bhutan, Bhutan Broadcasting Svc	6035do	
0800	0900		Canada, CFRX Toronto ON	6070na	
0800	0900		Canada, CFPV Calgary AB	6030na	
0800	0900		Canada, CKZN St Johns NF	6160na	
0800	0900		Canada, CKZU Vancouver BC	6160na	
0800	0900		China, China Radio International	11620as	
			11895as	13710eu	15350as
			15625va	17490eu	17540as
0800	0900	mtwhf	Equatorial Guinea, Radio Africa 2	15190af	
0800	0900	Sat/Sun	Equatorial Guinea, Radio East Africa	15190af	
0800	0900	3rd Sat	Italy, IRRS-Shortwave/Radio City	9510eu	
0800	0900	1st Sat	Italy, IRRS-Shortwave/Radio Joystick	9510va	
0800	0900		Malaysia, RTM Kajang/Traxx FM	7295do	
0800	0900		Malaysia, RTM/Voice of Malaysia	6175as	
			9750as	15295as	
0800	0900		Micronesia, The Cross Radio/Pohnpei	4755 as	
0800	0900		New Zealand, Radio NZ International	6170pa	
0800	0900	DRM	New Zealand, Radio NZ International	7440pa	
0800	0900		Palau, T8WH/ WHRI	17800as	
0800	0900		Papua New Guinea, Radio Fly	5960do	
0800	0900		Russia, Voice of Russia	15405pa	
0800	0900		Saudi Arabia, BSKSA/External Svc	17785af	
0800	0900	mtwhf	South Africa, Channel Africa	9625af	
0800	0900		South Africa, CVC 1 Africa Radio	13590af	
0800	0900	Sun	South Africa, SA Radio League	7205af	
			17570af		
0800	0900		South Korea, KBS World Radio	9570as	
0800	0900		UK, BBC World Service	6190af	11760me
			12095af	15310as	15400af
			17640af	17790as	17830af
0800	0900		USA, American Forces Network/AFRTS	4319usb	
			5446usb	5765usb	7812usb
			12759usb	13362usb	
0800	0900		USA, EWTN/WEWN Irondale, AL	11520af	
0800	0900		USA, FBN/WTJC Newport NC	9370na	
0800	0900		USA, WHRI Cypress Creek SC	7385va	
			11565va		
0800	0900		USA, WRMI Miami FL	9955ca	
0800	0900		USA, WTWW Lebanon TN	5755va	12100va
0800	0900		USA, WWCR Nashville TN	3215eu	4840na
			5890af	5935af	
0800	0900		USA, WWRB Manchester TN	3185na	
0800	0900		Zambia, CVC Radio Christian Voice	13590af	
0815	0900		Zambia, ZNBC/Radio Two	6165do	
0820	0900	mtwhfa	Nepal, Radio Nepal	5005as	
0820	0900		Guam, TWR Asia/KTWR	15170as	
0830	0845		India, All India Radio/Aizawl	5050do	
0830	0845		India, All India Radio/Chennai	4920do	
0830	0845		India, All India Radio/Delhi	6190do	11710do
			15185do	15260do	
0830	0845		India, All India Radio/Hyderabad	7420do	
0830	0845		India, All India Radio/Imphal	7335do	
0830	0845		India, All India Radio/Itanagar	4990do	
0830	0845		India, All India Radio/Kolkata	7210do	
0830	0845		India, All India Radio/Shillong	7315do	
0830	0845		India, All India Radio/Thiruvananthapuram	7290do	
0830	0900		Australia, ABC NT Alice Springs	2310do	
0830	0900		Australia, ABC NT Katherine	2485do	
0830	0900		Australia, ABC NT Tennant Creek	2325do	
0830	0900		Guam, TWR Asia/KTWR	11840as	

0900 UTC - 4AM EST / 3AM CST / 1AM PST

0900	0910		Guam, TWR Asia/KTWR	11840as	
0900	0930	Sat/Sun/DRM	Bulgaria, BNR Horizont/Home Svc 1	11900eu	
0900	0959		Germany, Deutsche Welle	15640as	
0900	1000		Anguilla, University Network	6090na	
0900	1000		Australia, ABC NT Alice Springs	2310do	
0900	1000		Australia, ABC NT Katherine	2485do	
0900	1000		Australia, ABC NT Tennant Creek	2325do	
0900	1000		Australia, Radio Australia	9475as	9580pa
			9590pa	11945as	
0900	1000		Bahrain, Radio Bahrain	6010me	
0900	1000	w/DRM	Belgium, TDP Radio	6015eu	
0900	1000		Canada, CFRX Toronto ON	6070na	

0900	1000	Canada, CFVP Calgary AB	6030na	
0900	1000	Canada, CKZN St Johns NF	6160na	
0900	1000	Canada, CKZU Vancouver BC6160na		
0900	1000	China, China Radio International	11620as	
		13790pa	15210as	15270eu
		17490eu	17570eu	17750as
0900	1000	Germany, Deutsche Welle	17820as	
0900	1000	Germany, XVRB Radio	6045va	
0900	1000	Greece, Voice of Greece	9420va	15630va
0900	1000	Malaysia, RTM Kajang/Traxx FM		7295do
0900	1000	Malaysia, RTM/Voice of Malaysia		6175as
		9750as	15295as	
0900	1000	Micronesia, The Cross Radio/Pohnpei		4755 as
0900	1000	DRM New Zealand, Radio NZ International		7440pa
0900	1000	New Zealand, Radio NZ International		6170pa
0900	1000	Nigeria, Voice of Nigeria		9690af
0900	1000	Papua New Guinea, Radio Fly		5960do
0900	1000	Russia, Voice of Russia		15170as
0900	1000	South Africa, Channel Africa		9625af
0900	1000	South Africa, CVC 1 Africa Radio		13590af
0900	1000	UK, BBC World Service		6190af
		9740as	11760me	12095af
		15400af	15575as	17640af
		17790as	17830af	21470af
0900	1000	USA, American Forces Network/AFRTS		4319usb
		5446usb	5765usb	7812usb
		12759usb	13362usb	
		USA, EWTN/WEWN Irondale, AL		11520af
		USA, FBN/WTJC Newport NC9370na		
		USA, WHRI Cypress Creek SC		7385va
		9825va	11565va	
		USA, WRMI Miami FL		9955ca
		USA, WTWW Lebanon TN		5755va
		USA, WWCR Nashville TN		4840na
		5935af	7520eu	5890af
0900	1000	USA, WWRB Manchester TN		3185na
0900	1000	USA, WYFR/Family Radio Worldwide		9465as
		9755ca		
0900	1000	Zambia, CVC Radio Christian Voice		13590af
0900	1000	Zambia, ZNBC/Radio Two		6165do
0930	1000	Sun Italy, IRRS-Shortwave		9510va
0930	1000	Sun Italy, IRRS-Shortwave/Euro Gospel Radio		9510eu
0959	1000	Netherlands, R Netherlands Worldwide		12065as
		15110as		

1000 UTC - 5AM EST / 4AM CST / 2AM PST

1000	1030	Japan, Radio Japan NHK World		9605as
		9625pa	9840pa	
1000	1030	Vietnam, Voice of Vietnam/Overseas Svc		9840as
		12020as		
1000	1057	Netherlands, R Netherlands Worldwide		12065as
		15110as		
1000	1057	North Korea, Voice of Korea		11710ca
		13650as	15180sa	11735as
1000	1058	DRM New Zealand, Radio NZ International		7440pa
1000	1058	New Zealand, Radio NZ International		6170pa
1000	1100	Anguilla, University Network		11775na
1000	1100	Australia, ABC NT Alice Springs		2310do
1000	1100	Australia, ABC NT Katherine		2485do
1000	1100	Australia, ABC NT Tennant Creek		2325do
1000	1100	Australia, Radio Australia		9475as
		9590pa	11945as	9580pa
1000	1100	Bahrain, Radio Bahrain		6010me
1000	1100	h/DRM Belgium, TDP Radio		6015eu
1000	1100	Canada, CFRX Toronto ON		6070na
1000	1100	Canada, CFVP Calgary AB		6030na
1000	1100	Canada, CKZN St Johns NF		6160na
1000	1100	Canada, CKZU Vancouver BC6160na		
1000	1100	China, China Radio International		6040na
		11610as	11635as	13590as
		13790na	15190as	15210as
		17490as		15350as
1000	1100	India, All India Radio/External Svc		7270as
		13695pa	15260as	15410as
		17800as	17895pa	17510pa
1000	1100	Indonesia, Voice of Indonesia		9526va
1000	1100	Sun Italy, IRRS-Shortwave		9510va
1000	1100	Sun Italy, IRRS-Shortwave/Euro Gospel Radio		9510eu
1000	1100	Malaysia, RTM Kajang/Traxx FM		7295do
1000	1100	Micronesia, The Cross Radio/Pohnpei		4755as
1000	1100	Nigeria, Voice of Nigeria		9690af
1000	1100	Russia, Voice of Russia		15170as
1000	1100	Saudi Arabia, BSKSA/External Svc		15250af
1000	1100	mtwhf South Africa, Channel Africa		9625af

1000	1100	South Africa, CVC 1 Africa Radio		13590af
1000	1100	UK, BBC World Service		6190af
		9740as	11760me	12095af
		15400af	15575as	17640af
		17790as	21470af	21660as
1000	1100	Sat/Sun UK, BBC World Service		17830af
1000	1100	USA, American Forces Network/AFRTS		4319usb
		5446usb	5765usb	7812usb
		12759usb	13362usb	
1000	1100	USA, EWTN/WEWN Irondale, AL		9390as
1000	1100	USA, FBN/WTJC Newport NC9370na		
1000	1100	USA, KNLS Anchor Point AK		11870as
1000	1100	USA, WHRI Cypress Creek SC		7385va
		11565va		
1000	1100	USA, WRMI Miami FL		9955ca
1000	1100	USA, WTWW Lebanon TN		5755va
1000	1100	USA, WWCR Nashville TN		4840na
		5935af	7520eu	5890af
1000	1100	USA, WWRB Manchester TN		3185na
1000	1100	USA, WYFR/Family Radio Worldwide		9465na
1000	1100	Zambia, CVC Radio Christian Voice		13590af
1000	1100	Zambia, ZNBC/Radio Two		6165do
1030	1100	Iran, IRIB/ VOIRI		17710as
1030	1100	Mongolia, Voice of Mongolia		12085as
1059	1100	New Zealand, Radio NZ International		9655pa
1059	1100	DRM New Zealand, Radio NZ International		7440pa

1100 UTC - 6AM EST / 5AM CST / 3AM PST

1100	1105	Pakistan, PBC/Radio Pakistan		15725eu
1100	1120	f/DRM Japan, Radio Japan NHK World		9760eu
1100	1127	Iran, IRIB/ VOIRI		17710as
		21630as		
1100	1130	Sat/DRM South Korea, KBS World Radio		9760eu
1100	1130	fa UK, BBC World Service		9760eu
1100	1130	Vietnam, Voice of Vietnam/Overseas Svc		7285as
1100	1145	USA, WYFR/Family Radio Worldwide		9755ca
1100	1157	Romania, Radio Romania International		15210eu
		15430eu	17510af	17670af
1100	1158	DRM New Zealand, Radio NZ International		7440pa
1100	1200	Anguilla, University Network		11775na
1100	1200	Australia, ABC NT Alice Springs		2310do
1100	1200	Australia, ABC NT Katherine		2485do
1100	1200	Australia, ABC NT Tennant Creek		2325do
1100	1200	Australia, Radio Australia		5995pa
		9475as	9560pa	9580pa
		11945as	12080pa	
1100	1200	Bahrain, Radio Bahrain		6010me
1100	1200	f/DRM Belgium, TDP Radio		6015eu
1100	1200	Sat/Sun Canada, CBC Northern Quebec Svc		9625na
1100	1200	Canada, CFRX Toronto ON		6070na
1100	1200	Canada, CFVP Calgary AB		6030na
1100	1200	Canada, CKZN St Johns NF		6160na
1100	1200	Canada, CKZU Vancouver BC6160na		
1100	1200	China, China Radio International		5955as
		6040as	11650as	11660as
		11795as	13590as	13645as
		13720as	17490eu	13650eu
1100	1200	Sun Italy, IRRS-Shortwave		9510va
1100	1200	Sun Italy, IRRS-Shortwave/Euro Gospel Radio		9510eu
1100	1200	Malaysia, RTM Kajang/Traxx FM		7295do
1100	1200	New Zealand, Radio NZ International		9655pa
1100	1200	Nigeria, Voice of Nigeria		9690af
1100	1200	Russia, Voice of Russia		12065as
1100	1200	Saudi Arabia, BSKSA/External Svc		15250af
1100	1200	mtwhf South Africa, Channel Africa		9625af
1100	1200	South Africa, CVC 1 Africa Radio		13590af
1100	1200	Taiwan, Radio Taiwan International		7445as
		11715as		
1100	1200	UK, BBC World Service		6140as
		9740as	11760me	12095af
		15310as	15400af	15575as
		17760as	17790as	17830af
1100	1200	USA, American Forces Network/AFRTS		4319usb
		5446usb	5765usb	7812usb
		12759usb	13362usb	
1100	1200	USA, EWTN/WEWN Irondale, AL		9390as
1100	1200	USA, FBN/WTJC Newport NC9370na		
1100	1200	USA, WHRI Cypress Creek SC		7385va
		9410va	11565va	
1100	1200	USA, WRMI Miami FL		9955ca
1100	1200	USA, WWCR Nashville TN		4840na
		5935af	15825eu	5890af
1100	1200	USA, WWRB Manchester TN		3185na
1100	1200	USA, WYFR/Family Radio Worldwide		5950na
		15560sa		

1100	1200	Zambia, CVC Radio Christian Voice	13590af
1100	1200	Zambia, ZNBC/Radio Two	6165do
1130	1140 f	Vatican City State, Vatican Radio	15595as
		17765as	
1130	1200	Vietnam, Voice of Vietnam/Overseas Svc	9840as
		12020as	
1135	1145	India, All India Radio/Aizawl	5050do
1135	1145	India, All India Radio/Delhi	9595do
		15185do	11710do
1135	1145	India, All India Radio/Shillong	4970do

1200 UTC - 7AM EST / 6AM CST / 4AM PST

1200	1215	Vatican City State, Vatican Radio	13730am
1200	1230	Germany, AWR Europe	17535as
1200	1230	Saudi Arabia, BSKSA/External Svc	15250af
1200	1245	USA, WYFR/Family Radio Worldwide	5950na
1200	1258	New Zealand, Radio NZ International	9655pa
1200	1259	Poland, Polskie Radio Warsaw	11675eu
		11980eu	
1200	1300	Anguilla, University Network	11775na
1200	1300	Australia, ABC NT Alice Springs	2310do
1200	1300	Australia, ABC NT Katherine	2485do
1200	1300	Australia, ABC NT Tennant Creek	2325do
1200	1300	Australia, Radio Australia	5995pa
		9475as	6020pa
		9560pa	9590pa
		11945as	
1200	1300	Bahrain, Radio Bahrain	6010me
1200	1300	Belgium, TDP Radio	6015eu
1200	1300	Canada, CBC Northern Quebec Svc	9625na
1200	1300	Canada, CFRX Toronto ON	6070na
1200	1300	Canada, CFVP Calgary AB	6030na
1200	1300	Canada, CKZN St Johns NF	6160na
1200	1300	Canada, CKZU Vancouver BC	6160na
1200	1300	China, China Radio International	5955as
		9460as	9600as
		9645as	9730as
		9760pa	11650as
		11660as	11690va
		11760pa	11980as
		13645as	13650as
		13790eu	17490eu
1200	1300	Ethiopia, Radio Ethiopia/National Program	5990do
		7110do	9705do
1200	1300	Japan, Radio Japan NHK World	6120na
		9695as	
1200	1300	Malaysia, RTM Kajang/Traxx FM	7295do
1200	1300	Nigeria, Voice of Nigeria	9690af
1200	1300	Russia, Voice of Russia	9445as
1200	1300	Russia, Voice of Russia	11500as
1200	1300	South Africa, CVC 1 Africa Radio	13590af
1200	1300	South Korea, KBS World Radio	9650na
1200	1300	UK, BBC World Service	5875as
		6190af	6195as
		6195as	9740as
		11750as	11750as
		11760me	12095af
		15310as	15575as
		17640af	17790af
		17830af	21470af
1200	1300	USA, American Forces Network/AFRTS	4319usb
		5446usb	5765usb
		7812usb	12133usb
		12759usb	13362usb
1200	1300	USA, BBG/Voice of America	7575va
		9510va	
		12075va	12150va
1200	1300	USA, EWTN/WEWN Irondale, AL	13580va
1200	1300	USA, FBN/WTJC Newport NC	9370na
1200	1300	USA, KNLS Anchor Point AK	11870as
1200	1300	USA, WHRI Cypress Creek SC	7385va
		9410va	11565va
1200	1300	USA, WRMI Miami FL	9955ca
1200	1300	USA, WWCR Nashville TN	7490af
		9980af	
		13845eu	15825eu
1200	1300	USA, WWRB Manchester TN	3185va
1200	1300	USA, WYFR/Family Radio Worldwide	15560as
		17520as	17880as
1200	1300	Zambia, CVC Radio Christian Voice	13590af
1200	1300	Zambia, ZNBC/Radio Two	6165do
1215	1300	Egypt, Radio Cairo	17870as
1230	1245	India, All India Radio/Aizawl	5050do
1230	1245	India, All India Radio/Chennai	4920do
1230	1245	India, All India Radio/Delhi	4860do
1230	1245	India, All India Radio/Hyderabad	4800do
1230	1245	India, All India Radio/Jeyapore	5040do
1230	1245	India, All India Radio/Kurseong	4895do
1230	1245	India, All India Radio/Port Blair	4760do
1230	1245	India, All India Radio/Radio Kashmir	4950do
1230	1245	India, All India Radio/Shillong	4970do
1230	1245	India, All India Radio/Thiruvananthapuram	5010do
1230	1300	Australia, HCJB Global Australia	15400as
1230	1300	Thailand, Radio Thailand World Svc	9890va
1230	1300	Turkey, Voice of Turkey	15450va

1230	1300	Vietnam, Voice of Vietnam/Overseas Svc	9840as
		12020as	
1259	1300	New Zealand, Radio NZ International	6170pa

1300 UTC - 8AM EST / 7AM CST / 5AM PST

1300	1325	Turkey, Voice of Turkey	15450va
1300	1330	Egypt, Radio Cairo	17870as
1300	1330	Japan, Radio Japan NHK World	15735as
		15660al	
1300	1357	North Korea, Voice of Korea	9335na
		13760eu	15245eu
1300	1400	Anguilla, University Network	11775na
1300	1400	Australia, ABC NT Alice Springs	2310do
1300	1400	Australia, ABC NT Katherine	2485do
1300	1400	Australia, Radio Australia	5995pa
		9560pa	9580pa
		9590pa	9590pa
1300	1400	Bahrain, Radio Bahrain	6010me
1300	1400	Belgium, TDP Radio	6015na
1300	1400	Canada, CBC Northern Quebec Svc	9625na
1300	1400	Canada, CFRX Toronto ON	6070na
1300	1400	Canada, CFVP Calgary AB	6030na
1300	1400	Canada, CKZN St Johns NF	6160na
1300	1400	Canada, CKZU Vancouver BC	6160na
1300	1400	China, China Radio International	5995as
		9570na	9650na
		9730as	9760pa
		9765va	9870as
		11660as	11660as
		11980as	13610eu
		13755as	13760eu
		13790eu	15260na
1300	1400	Greece, Voice of Greece	15630va
1300	1400	Greece, Voice of Greece	9420va
1300	1400	Indonesia, Voice of Indonesia	9526as
1300	1400	Italy, IRRS-Shortwave	15610va
1300	1400	Italy, IRRS-Shortwave/Overcomer Ministries	7290va
1300	1400	Malaysia, RTM Kajang/Traxx FM	7295do
1300	1400	New Zealand, Radio NZ International	6170pa
1300	1400	Nigeria, Voice of Nigeria	9690af
1300	1400	Russia, Voice of Russia	12065as
1300	1400	South Africa, CVC 1 Africa Radio	13590af
1300	1400	South Korea, KBS World Radio	9570as
1300	1400	Tajikistan, Voice of Tajik	7245va
1300	1400	UK, BBC World Service	5875as
		6190af	6190af
		6195as	9740as
		11760me	12095af
		15310as	15420af
		15575as	17790as
		17830af	21470af
1300	1400	USA, American Forces Network/AFRTS	4319usb
		5446usb	5765usb
		7812usb	12133usb
		12759usb	13362usb
1300	1400	USA, BBG/Voice of America	7575va
		9510va	
		12150va	
1300	1400	USA, EWTN/WEWN Irondale, AL	13580va
1300	1400	USA, FBN/WTJC Newport NC	9370na
1300	1400	USA, KJES Vado NM	7555na
1300	1400	USA, WBCQ Monticello ME	9330usb
1300	1400	USA, WHRI Cypress Creek SC	7385va
		11565va	
1300	1400	USA, WHRI Cypress Creek SC	9840af
1300	1400	USA, WRMI Miami FL	9955ca
1300	1400	USA, WWCR Nashville TN	7490af
		9980af	
		13845eu	15825eu
1300	1400	USA, WWRB Manchester TN	9385na
1300	1400	USA, WYFR/Family Radio Worldwide	11560as
		12160ca	
1300	1400	Zambia, CVC Radio Christian Voice	13590af
1300	1400	Zambia, ZNBC/Radio Two	6165do
1330	1345	India, All India Radio/Delhi	6085do
1330	1400 w	Guam, AWR/KSDA	11880as
1330	1400	India, All India Radio/External Svc	9690as
		11620as	13710as
1330	1400	Vietnam, Voice of Vietnam/Overseas Svc	9840as
		12020as	
1345	1400	Canada, Bible Voice Broadcasting	17945as
1359	1400	Netherlands, R Netherlands Worldwide	11835as

1400 UTC - 9AM EST / 8AM CST / 6AM PST

1400	1415	Germany, Pan American Broadcasting	15205as
1400	1430	Japan, Radio Japan NHK World	11705as
		15735as	21560va
		15660al	
1400	1430	Thailand, Radio Thailand World Svc	9575va
1400	1430	UK, FEBA Radio	12025as
1400	1457	Netherlands, R Netherlands Worldwide	9800as
		11835as	

1400	1500		Anguilla, University Network	11775na	
1400	1500		Australia, ABC NT Alice Springs	2310do	
1400	1500		Australia, ABC NT Katherine	2485do	
1400	1500		Australia, ABC NT Tennant Creek	2325do	
1400	1500		Australia, Radio Australia	5995pa	6080as
			7240pa	9590pa	11660as
1400	1500		Bahrain, Radio Bahrain	6010me	
1400	1500	DRM	Belgium, TDP Radio/Disco Palace	6015eu	
1400	1500	Sat	Canada, Bible Voice Broadcasting	17945as	
1400	1500	Sat/Sun	Canada, CBC Northern Quebec Svc	9625na	
1400	1500		Canada, CFRX Toronto ON	6070na	
1400	1500		Canada, CFVP Calgary AB	6030na	
1400	1500		Canada, CKZN St Johns NF	6160na	
1400	1500		Canada, CKZU Vancouver BC	6160na	
1400	1500		China, China Radio International	5955as	
			9765va	9870as	11665me
			13710eu	13760eu	11740na
			17630af	13790eu	
1400	1500	Sat/Sun	Equatorial Guinea, Radio East Africa/Malabo		
			15190af		
1400	1500		India, All India Radio/External Svc	9690as	
			11620as	13710as	
1400	1500		Libya, LJB Voice of Africa	17725af	
1400	1500		Malaysia, RTM Kajang/Traxx FM	7295do	
1400	1500		New Zealand, Radio NZ International	6170pa	
1400	1500		Nigeria, Voice of Nigeria	9690af	
1400	1500		Oman, Radio Sultanate of Oman	15140va	
1400	1500	DRM	Russia, Voice of Russia	9750eu	
1400	1500		Russia, Voice of Russia	4975va	11500as
1400	1500		South Africa, CVC 1 Africa Radio	13590af	
1400	1500		UK, BBC World Service	5845as	5875as
			6190af	6195as	7435af
			12095as	13820as	15310as
			17830af	21470af	17640af
1400	1500		USA, American Forces Network/AFRTS	4319usb	
			5446usb	5765usb	7812usb
			12759usb	13362usb	12133usb
1400	1500	mtwhf	USA, BBG/Voice of America	9405va	
1400	1500		USA, BBG/Voice of America/African Svc	4930af	
			6080af	12080af	15580af
					17545af
1400	1500		USA, EWTN/WEWN Irondale, AL	15610va	
1400	1500		USA, FBN/WTJC Newport NC	9370na	
1400	1500		USA, Overcomer Ministries	9655eu	13810va
1400	1500		USA, WBCQ Monticello ME	9330usb	
1400	1500		USA, WHRI Cypress Creek SC	9840va	7385va
1400	1500	Sat/Sun	USA, WHRI Cypress Creek SC	9840af	
			17510af		
1400	1500		USA, WJHR International Milton FL	15550na	
1400	1500		USA, WRMI Miami FL	9955ca	
1400	1500		USA, WWCR Nashville TN	7490af	9980af
			13845eu	15825eu	
1400	1500		USA, WWRB Manchester TN	9385na	
1400	1500		USA, WYFR/Family Radio Worldwide	9615as	
			11560as		
1400	1500		Zambia, CVC Radio Christian Voice	13590af	
1400	1500		Zambia, ZNBC/Radio Two	6165do	
1405	1435	Sat/Sun	Canada, Bible Voice Broadcasting	9345as	
1415	1430		Germany, Pan American Broadcasting	15205as	
1415	1500	Sun	Canada, Bible Voice Broadcasting	17945af	
1415	1500		Nepal, Radio Nepal	5005as	
1420	1440		India, All India Radio/Itanagar	4990do	
1430	1445	Sun	Germany, Pan American Broadcasting	15205as	
1430	1445		India, All India Radio/Aizawl	5050do	
1430	1445		India, All India Radio/Delhi	6085do	9575do
			9835do		
1430	1445		India, All India Radio/Jeyapore	5040do	
1430	1445		India, All India Radio/Mumbai	4840do	
1430	1500	mtwhfa	Albania, Radio Tirana	13625na	
1430	1500		China, CNR-11/Xi'an	4905do	4920do
			6010do	6130do	
1430	1500		Guam, AWR/KSDA	9560as	
1430	1500	Sat	India, All India Radio/Gangtok	4835do	
1430	1500		UK, BBC World Service	17870af	
1445	1500	smtwhf	Australia, HCJB Global Australia	15340as	
1450	1500		India, All India Radio/Itanagar	4990do	
1450	1500		India, All India Radio/Kurseong	4895do	

1500 UTC - 10AM EST / 9AM CST / 7AM PST

1500	1515	Sun	Canada, Bible Voice Broadcasting	12035as	
1500	1525	ff	Guam, TWR Asia/KTWR	12140as	
1500	1530	Sun	Canada, Bible Voice Broadcasting	17945as	
1500	1530		Clandestine, Sudan Radio Service/SRS	17745af	
1500	1530		Guam, AWR/KSDA	11720as	

1500	1530		India, All India Radio/Jeyapore	5040do	
1500	1530		Vietnam, Voice of Vietnam/Overseas Svc	7285as	
			9840as	12020as	
1500	1535	mwhfa	Guam, TWR Asia/KTWR	12140as	
1500	1550		New Zealand, Radio NZ International	6170pa	
1500	1557		North Korea, Voice of Korea	9335na	11710na
			13760eu	15245eu	
1500	1558		Libya, LJB Voice of Africa	17725af	
1500	1600		Anguilla, University Network	11775na	
1500	1600		Australia, ABC NT Alice Springs	2310do	
1500	1600		Australia, ABC NT Katherine	2485do	
1500	1600		Australia, Radio Australia	5995pa	6080as
			7240pa	9475as	9590pa
					11660as
1500	1600		Bahrain, Radio Bahrain	6010me	
1500	1600		Bhutan, Bhutan Broadcasting Svc	6035do	
1500	1600	Sat/Sun	Canada, CBC Northern Quebec Svc	9625na	
1500	1600		Canada, CFRX Toronto ON	6070na	
1500	1600		Canada, CFVP Calgary AB	6030na	
1500	1600		Canada, CKZN St Johns NF	6160na	
1500	1600		Canada, CKZU Vancouver BC	6160na	
1500	1600		Canada, Radio Canada International	11675as	
			15125as		
1500	1600		China, China Radio International	5955as	
			6095me	7325as	7395as
			9765va	9800as	9870as
			13640eu	13730na	13760eu
					17630af
1500	1600	Sat/Sun	Equatorial Guinea, Radio East Africa/Malabo		
			15190af		
1500	1600		Malaysia, RTM Kajang/Traxx FM	7295do	
1500	1600		Nigeria, Voice of Nigeria	15120af	
1500	1600		Russia, Voice of Russia	4975va	9660as
			11985va	12040eu	
1500	1600	mtwhf	South Africa, Channell Africa	9625af	
1500	1600		South Africa, CVC 1 Africa Radio	13590af	
1500	1600		Uganda, Dunamis Shortwave	4750af	
1500	1600		UK, BBC World Service	5875as	6190af
			6195as	7435af	9540as
			12095as	13820as	15310as
			15420af	17640af	17830af
			21470af		17870af
1500	1600	DRM	UK, BBC World Service	15640as	
1500	1600		USA, American Forces Network/AFRTS	4319usb	
			5446usb	5765usb	7812usb
			12759usb	13362usb	12133usb
1500	1600		USA, BBG/Voice of America	12080af	13570va
			15530va		
1500	1600	Sat/Sun	USA, BBG/Voice of America	9405va	
1500	1600		USA, BBG/Voice of America/African Svc	4930af	
			6080af	12080af	15580af
1500	1600		USA, BBG/Voice of America/Special English		
			6140af	7465va	9485va
					9760va
1500	1600		USA, EWTN/WEWN Irondale, AL	15610va	
1500	1600		USA, FBN/WTJC Newport NC	9370na	
1500	1600		USA, KNLS Anchor Point AK	9920as	
1500	1600		USA, Overcomer Ministries	9655eu	13810va
			17485af		
1500	1600		USA, WBCQ Monticello ME	9330usb	
1500	1600		USA, WHRI Cypress Creek SC	9840af	7385af
1500	1600	Sat/Sun	USA, WHRI Cypress Creek SC	9840af	
1500	1600	Sat	USA, WHRI Cypress Creek SC	17510af	
1500	1600	Sun	USA, WHRI Cypress Creek SC	15195va	
1500	1600		USA, WJHR International Milton FL	15550na	
1500	1600		USA, WRMI Miami FL	9955na	
1500	1600		USA, WWCR Nashville TN	9980af	12160af
			13845eu	15825eu	
1500	1600		USA, WWRB Manchester TN	9385na	
1500	1600		USA, WYFR/Family Radio Worldwide	11605as	
			17580af		
1500	1600		Zambia, CVC Radio Christian Voice	13590af	
1500	1600		Zambia, ZNBC/Radio Two	6165do	
1515	1530		Australia, HCJB Global Australia	15340as	
1515	1545	Sat	Canada, Bible Voice Broadcasting	13670as	
1525	1555	Sat/Sun	Swaziland, TWR Africa	4760af	
1530	1540	Sat	Vatican City State, Vatican Radio	11850as	
			13765as	15235as	
1530	1545		India, All India Radio/Aizawl	5050do	
1530	1545		India, All India Radio/Bengaluru	9425do	
1530	1545		India, All India Radio/Bhopal	4810do	
1530	1545		India, All India Radio/Chennai	4920do	
1530	1545		India, All India Radio/Delhi	5015do	
1530	1545		India, All India Radio/External Svc	9910as	
1530	1545		India, All India Radio/Guwahati	4940do	
1530	1545		India, All India Radio/Hyderabad	4800do	
1530	1545		India, All India Radio/Itanagar	4990do	
1530	1545		India, All India Radio/Jaipur	4910do	

1530	1545	India, All India Radio/Kolkata	4820do	
1530	1545	India, All India Radio/Kurseong	4895do	
1530	1545	India, All India Radio/Lucknow	4880do	
1530	1545	India, All India Radio/Panaji, Goa	9820do	
1530	1545	India, All India Radio/Port Blair	4760do	
1530	1545	India, All India Radio/Radio Kashmir	4950do	
1530	1545	India, All India Radio/Shillong	4970do	
1530	1545	India, All India Radio/Shimla	4965do	
1530	1545	India, All India Radio/Thiruvananthapuram	5010do	
1530	1600	Afghanistan, Radio Afghanistan	6102as	
1530	1600	Belgium, TDP Radio/Disco Palace	15775as	
1530	1600	Canada, Bible Voice Broadcasting	13590me	
1530	1600	Canada, Bible Voice Broadcasting	13670as	
1530	1600	Germany, AWR Europe	15255as	
1530	1600	Iran, IRIB/ VOIRI	9600as 11945as	
1530	1600	Mongolia, Voice of Mongolia	12015as	
1530	1600	Myanmar, Myanma Radio/National Svc	5985do	
1530	1600	UK, BBC World Service	5845as	
1545	1600	Canada, Bible Voice Broadcasting	13590me	
1551	1600	New Zealand, Radio NZ International	7440pa	
1551	1600	New Zealand, Radio NZ International	6170pa	

1600 UTC - 11AM EST / 10AM CST / 8AM PST

1600	1605	Sun	Croatia, Croatian Radio	6165eu	
1600	1615	tf	Canada, Bible Voice Broadcasting	13590me	
1600	1615	mtwhfa	Croatia, Croatian Radio	6165eu	
1600	1627		Iran, IRIB/ VOIRI	9600as 11945as	
1600	1630		Afghanistan, Radio Afghanistan	6102as	
1600	1630		Australia, Radio Australia	9965pa	
1600	1630	DRM	Belgium, TDP Radio/Disco Palace	15775as	
1600	1630		Guam, AWR/KSDA	11805as 12035as	
1600	1630		Myanmar, Myanma Radio/National Svc	5985do	
1600	1630		Vietnam, Voice of Vietnam/Overseas Svc	7220me 7280eu 9550me 9730eu	
1600	1645	h	Canada, Bible Voice Broadcasting	13590me	
1600	1645		USA, WYFR/Family Radio Worldwide	11865na	
1600	1657		Germany, Deutsche Welle	6170as	
1600	1657		North Korea, Voice of Korea	9990va 11545va	
1600	1659		Germany, Deutsche Welle	15410as	
1600	1700		Anguilla, University Network	11775na	
1600	1700		Australia, ABC NT Alice Springs	2310do	
1600	1700		Australia, ABC NT Katherine	2485do	
1600	1700		Australia, Radio Australia	5995pa 6080as 7240pa 9475as 9710pa 11660as	
1600	1700		Bahrain, Radio Bahrain	6010me	
1600	1700		Bhutan, Bhutan Broadcasting Svc	6035do	
1600	1700	Sat/Sun	Canada, Bible Voice Broadcasting	13590me	
1600	1700	Sat	Canada, CBC Northern Quebec Svc	9625na	
1600	1700		Canada, CFRX Toronto ON	6070na	
1600	1700		Canada, CFVP Calgary AB	6030na	
1600	1700		Canada, CKZN St Johns NF	6160na	
1600	1700		Canada, CKZU Vancouver BC	6160na	
1600	1700		China, China Radio International	6060as 7420af 7235as 9570af 11900af 11940eu 11965eu 13760eu	
1600	1700		Egypt, Radio Cairo	15345af	
1600	1700	Sat/Sun	Equatorial Guinea, Radio East Africa/Malabo	15190af	
1600	1700		Ethiopia, Radio Ethiopia	7235va 9560va	
1600	1700		Malaysia, RTM Kajang/Traxx FM	7295do	
1600	1700	DRM	New Zealand, Radio NZ International	6170pa	
1600	1700		New Zealand, Radio NZ International	7440pa	
1600	1700		Russia, Voice of Russia	4975va 11985va 12040eu	
1600	1700		South Africa, CVC 1 Africa Radio	13590af	
1600	1700		South Korea, KBS World Radio	9515eu 9640as	
1600	1700		Taiwan, Radio Taiwan International	9435as 15485as	
1600	1700		Uganda, Dunamis Shortwave	4750af	
1600	1700		UK, BBC World Service	3255af 5845as 5975as 6190af 9495as 12095as 13820as 15400af 15420af 17640af 17795af 17830af 21470af	
1600	1700		USA, American Forces Network/AFRTS	4319usb 5446usb 5765usb 7812usb 12133usb 12759usb 13362usb	
1600	1700		USA, BBG/Voice of America/African Svc	4930af 6080af 15580af	
1600	1700	mtwhf	USA, BBG/Voice of America/Special English	11890va 12080va 13750va	
1600	1700	Sat/Sun	USA, BBG/Voice of America/Special English	11890va 13570va	

1600	1700		USA, EWTN/WEWN Irondale, AL	15610va	
1600	1700		USA, FBN/WTJC Newport NC	9370na	
1600	1700		USA, WBCQ Monticello ME	9330usb	
1600	1700		USA, WHRI Cypress Creek SC	7385af 9840af 17520af	
1600	1700		USA, WJHR International Milton FL	15550na	
1600	1700		USA, WRMI Miami FL	9955na	
1600	1700		USA, WWCR Nashville TN	9980af 12160af 13845eu 15825eu	
1600	1700		USA, WWRB Manchester TN	9385na	
1600	1700		USA, WYFR/Family Radio Worldwide	11850as 17545af 21525af	
1600	1700		Zambia, CVC Radio Christian Voice	13590af	
1600	1700		Zambia, ZNBC/Radio Two	6165do	
1630	1700		Guam, AWR/KSDA	11740as	
1630	1700		Palau, T8WH/ WHRI	9930as	
1630	1700	m	South Africa, SA Radio League	3230af	
1630	1700		Turkey, Voice of Turkey	15520as	
1630	1700	mtwhf	USA, BBG/Voice of America	13830af	
1630	1700	mtwhf	USA, BBG/Voice of America/Sudan in Focus	9675af 12015af 13830af	

1700 UTC - 12PM EST / 11AM CST / 9AM PST

1700	1720	t	Canada, Bible Voice Broadcasting	13590me	
1700	1725		Turkey, Voice of Turkey	15520as	
1700	1729	DRM	Romania, Radio Romania International	7350eu	
1700	1730	m	South Africa, SA Radio League	3230af	
1700	1730		Vietnam, Voice of Vietnam/Overseas Svc	9625eu	
1700	1755	mtwhf	South Africa, Channel Africa	9675af	
1700	1757	DRM	Romania, Radio Romania International	9535eu	
1700	1757		Romania, Radio Romania International	11735eu	
1700	1759	DRM	Poland, Polskie Radio Warsaw	7265eu	
1700	1759		Poland, Polskie Radio Warsaw	9770eu	
1700	1800		Anguilla, University Network	11775na	
1700	1800		Australia, ABC NT Alice Springs	2310do	
1700	1800		Australia, ABC NT Katherine	2485do	
1700	1800		Australia, Radio Australia	5995pa 6080as 9475as 9580pa 9710pa 11880pa	
1700	1800		Bahrain, Radio Bahrain	6010me	
1700	1800	Sat/Sun	Canada, Bible Voice Broadcasting	11960me	
1700	1800	Sat	Canada, CBC Northern Quebec Svc	9625na	
1700	1800		Canada, CFRX Toronto ON	6070na	
1700	1800		Canada, CFVP Calgary AB	6030na	
1700	1800		Canada, CKZN St Johns NF	6160na	
1700	1800		Canada, CKZU Vancouver BC	6160na	
1700	1800		China, China Radio International	6090as 6140as 6145eu 6165me 7235as 7265as 7410as 7420as 11900af 13760af	
1700	1800		Egypt, Radio Cairo	15345af	
1700	1800	Sat/Sun	Equatorial Guinea, Radio Africa	7190af	
1700	1800		Malaysia, RTM Kajang/Traxx FM	7295do	
1700	1800		New Zealand, Radio NZ International	7440pa	
1700	1800	DRM	New Zealand, Radio NZ International	6170pa	
1700	1800		Palau, T8WH/ WHRI	9930as	
1700	1800		Russia, Voice of Russia	4975as 11985af 12040eu	
1700	1800		South Africa, CVC 1 Africa Radio	4965af 13590af	
1700	1800		Swaziland, TWR Africa	3200af	
1700	1800	Sat	Swaziland, TWR Africa	3200af	
1700	1800		Taiwan, Radio Taiwan International	15690af	
1700	1800		UK, BBC World Service	3255af 5845as 5975as 6190af 7405af 7565as 9410af 9495as 12095af 15400af 17795af 17830af	
1700	1800		USA, American Forces Network/AFRTS	4319usb 5446usb 5765usb 7812usb 12133usb 12759usb 13362usb	
1700	1800		USA, BBG/Voice of America/African Svc	6080af 12015af 15580af 17895af	
1700	1800		USA, EWTN/WEWN Irondale, AL	15610va	
1700	1800		USA, FBN/WTJC Newport NC	9370na	
1700	1800		USA, WBCQ Monticello ME	9330usb	
1700	1800		USA, WHRI Cypress Creek SC	7385af 9840af 17520af	
1700	1800		USA, WJHR International Milton FL	15550na	
1700	1800		USA, WRMI Miami FL	9955ca	
1700	1800		USA, WWCR Nashville TN	9980af 12160af 13845eu 15825eu	
1700	1800		USA, WWRB Manchester TN	9385na	
1700	1800		USA, WYFR/Family Radio Worldwide	7395af	
1700	1800		Zambia, CVC Radio Christian Voice	4965af 13590af	

1700 1800	Zambia, ZNBC/Radio Two	6165do	
1720 1740 Sat/Sun	USA, BBG/Voice of America/Studio 7	4930af	
	7210af	12130af	
1720 2740 fas	USA, BBG/Voice of America	7210af	
1730 1745	India, All India Radio/Bhopal	4810do	
1730 1745	India, All India Radio/Delhi	5015do	7370do
	9575do	9835do	
1730 1745	India, All India Radio/Guwahati		4940do
1730 1745	India, All India Radio/Hyderabad		4800do
1730 1745	India, All India Radio/Jaipur		4910do
1730 1745	India, All India Radio/Kolkata		4820do
1730 1745	India, All India Radio/Kurseong		4895do
1730 1745	India, All India Radio/Lucknow		4880do
1730 1745	India, All India Radio/Radio Kashmir		4950do
1730 1745	India, All India Radio/Shimla		4965do
1730 1745	India, All India Radio/Thiruvananthapuram		5010do
1730 1800	Bulgaria, Radio Bulgaria	5900eu	7400eu
1730 1800 DRM	Bulgaria, Radio Bulgaria	9700eu	
1730 1800 mtwhf	Clandestine, Sudan Radio Service/SRS	9590af	
1730 1800 Sun	Italy, IRRS-Shortwave/Overcomer Ministries		7290va
1730 1800 mtwhf	Moldova, Radio PMR/Prednistrovina		9665eu
1730 1800 mtwhf	USA, BBG/Voice of America		7210af
1730 1800 mtwhf	USA, BBG/Voice of America/Studio 7		4930af
	7210af	12130af	
1730 1800	Vatican City State, Vatican Radio		11625af
	13765af	15570af	
1740 1745	India, All India Radio/Chennai		4920do
1745 1800 DRM	India, All India Radio/External Svc		9950eu
	11580af		
1745 1800	India, All India Radio/External Svc		7400af
	7410af	7550eu	9415af
	11670eu	11935af	9445af
1759 1800	Netherlands, R Netherlands Worldwide		6020af
	15495af		

1800 UTC - 1PM EST / 12PM CST / 10AM PST

1800 1815 Sun	Canada, Bible Voice Broadcasting		13590me
1800 1815 Sat	Canada, Bible Voice Broadcasting		11855as
1800 1820 f	USA, BBG/Voice of America		7210af
1800 1830	South Africa, AWR Africa		3215af
1800 1830 w	South Africa, AWR Africa		9755af
1800 1830 mtwhf	USA, BBG/Voice of America/African Svc		6080af
	9850af	12015af	15580af
1800 1830 Sat/Sun	USA, BBG/Voice of America/African Svc		4930af
	6080af	9850af	12015af
			15580af
1800 1835	New Zealand, Radio NZ International		7440pa
1800 1835 DRM	New Zealand, Radio NZ International		6170pa
1800 1845 Sun	Canada, Bible Voice Broadcasting		9430me
1800 1857	Netherlands, R Netherlands Worldwide		6020af
	15495af		
1800 1857	North Korea, Voice of Korea		13760eu
1800 1900	Anguilla, University Network		11775na
1800 1900 mtwhf	Argentina, RAE		15345eu
1800 1900	Australia, ABC NT Alice Springs		2310do
1800 1900	Australia, ABC NT Katherine		2485do
1800 1900	Australia, Radio Australia		6080pa
	9475as	9580pa	9710pa
			11880pa
1800 1900	Bahrain, Radio Bahrain		6010me
1800 1900 Sat	Canada, Bible Voice Broadcasting		9430me
1800 1900 Sun	Canada, Bible Voice Broadcasting		6030eu
1800 1900	Canada, CFRX Toronto ON		6070na
1800 1900	Canada, CFPV Calgary AB		6030na
1800 1900	Canada, CKZN St Johns NF		6160na
1800 1900	Canada, CKZU Vancouver BC		6160na
1800 1900	Canada, Radio Canada International		9530af
	11765af	17810af	
1800 1900	China, China Radio International		6175eu
	9600eu	13760eu	
1800 1900 Sat/Sun	Equatorial Guinea, Radio Africa		7190af
1800 1900 DRM	India, All India Radio/External Svc		9950eu
	11580af		
1800 1900	India, All India Radio/External Svc		7400af
	7410af	7550eu	9415af
	11670eu	11935af	9445af
1800 1900	Italy, IRRS-Shortwave/Overcomer Ministries		7290va
1800 1900	Kuwait, Radio Kuwait		15540eu
1800 1900	Malaysia, RTM Kajang/Traxx FM		7295do
1800 1900	Nigeria, Voice of Nigeria		15120af
1800 1900	Palau, T8WH/ WHRI		9930as
1800 1900	Russia, Voice of Russia		4975me

1800 1900	South Africa, CVC 1 Africa Radio		4965af
	13590af		
1800 1900	South Korea, KBS World Radio		7275eu
1800 1900	Swaziland, TWR Africa		9500af
1800 1900	Taiwan, Radio Taiwan International		6155eu
1800 1900	UK, BBC World Service		3255af
	11765va	11810af	12095af
			15400af
1800 1900	USA, American Forces Network/AFRTS		4319usb
	5446usb	5765usb	7812usb
			12133usb
			12759usb
			13362usb
1800 1900	USA, EWTN/WEWN Irondale, AL		15610va
1800 1900	USA, FBN/WTJC Newport NC		9370na
1800 1900	USA, KJES Vado NM		15385na
1800 1900	USA, WBCQ Monticello ME		9330usb
1800 1900	USA, WHRI Cypress Creek SC		7385af
	9840af	17520af	
1800 1900	USA, WJHR International Milton FL		15550na
1800 1900	USA, WRMI Miami FL		9955ca
1800 1900	USA, WWCR Nashville TN		9980af
	13845eu	15825eu	
1800 1900	USA, WWRB Manchester TN		9385na
1800 1900	USA, WYFR/Family Radio Worldwide		5905af
	7395af	9770af	9925af
			13750af
1800 1900	Zambia, CVC Radio Christian Voice		4965af
	13590af		
1800 1900	Zambia, ZNBC/Radio Two		6165do
1805 1810 Sat	Croatia, Croatian Radio		6165eu
1805 1815 mtwhf	Croatia, Croatian Radio		6165eu
1810 1820 f	USA, BBG/Voice of America/Studio 7		4930af
	7210af	12130af	
1815 1845 Sat	Canada, Bible Voice Broadcasting		6030eu
1815 1900	USA, WINB Red Lion PA		13570ca
1830 1845	India, All India Radio/Delhi		5015do
1830 1900	South Africa, AWR Africa		9610af
1830 1900	Turkey, Voice of Turkey		9785eu
1830 1900	UK, BBC World Service		9850as
	5905af	5950as	5950as
			5975as
			6190af
1830 1900	UK, BBC World Service		9410af
1830 1900 mtwhf	USA, BBG/Voice of America		7210af
1830 1900	USA, BBG/Voice of America/African Svc		4930af
	6080af	9850af	12015af
			15580af
1830 1900 mtwhf	USA, BBG/Voice of America/Studio 7		7210af
	12130af		
1836 1850	New Zealand, Radio NZ International		9615pa
1836 1850 DRM	New Zealand, Radio NZ International		9890pa
1845 1900 mtwhfa	Albania, Radio Tirana		7520na
1851 1900	New Zealand, Radio NZ International		9615pa
1851 1900 DRM	New Zealand, Radio NZ International		15720pa
1859 1900	Netherlands, R Netherlands Worldwide		7425af
	11610af		

1900 UTC - 2PM EST / 1PM CST / 11AM PST

1900 1925	Turkey, Voice of Turkey		9785eu
1900 1930	Germany, Deutsche Welle		6150af
	11795af	17610af	9735af
1900 1930	USA, BBG/Voice of America/African Svc		4930af
	4940af	6080af	9850af
			15580af
			17895af
1900 1930	Vietnam, Voice of Vietnam/Overseas Svc		7280eu
	9730eu		
1900 1945 DRM	India, All India Radio/External Svc		9950eu
	11580af		
1900 1945	India, All India Radio/External Svc		7400af
	7410af	7550eu	9415af
	11670eu	11935af	9445af
1900 1950	New Zealand, Radio NZ International		9615pa
1900 1957	Netherlands, R Netherlands Worldwide		7425af
	11615af	15195af	
1900 1957	North Korea, Voice of Korea		7210af
	11535va	11910af	9975va
1900 2000	Anguilla, University Network		11775na
1900 2000	Australia, ABC NT Alice Springs		2310do
1900 2000	Australia, ABC NT Katherine		2485do
1900 2000	Australia, Radio Australia		6080pa
	9500as	9580pa	9710pa
			11880pa
1900 2000	Bahrain, Radio Bahrain		6010me
1900 2000	Canada, CFRX Toronto ON		6070na
1900 2000	Canada, CFPV Calgary AB		6030na
1900 2000	Canada, CKZN St Johns NF		6160na
1900 2000	Canada, CKZU Vancouver BC		6160na
1900 2000	China, China Radio International		7295va
	9435af	9440af	
1900 2000	Cuba, Radio Havana Cuba		11760sa

1900 2000		Egypt, Radio Cairo	11510af	
1900 2000	Sat/Sun	Equatorial Guinea, Radio Africa	7190af	
1900 2000		Indonesia, Voice of Indonesia	9526eu	
1900 2000		Italy, IRRS-Shortwave/Overcomer Ministries	7290va	
1900 2000		Kuwait, Radio Kuwait	15540eu	
1900 2000		Malaysia, RTM Kajang/Traxx FM	7295do	
1900 2000		Micronesia, The Cross Radio/Pohnpei	4755as	
1900 2000	DRM	New Zealand, Radio NZ International	15720pa	
1900 2000		Palau, T8WH/ WHRI	9930as	
1900 2000		Russia, Voice of Russia	12040va	
1900 2000		South Africa, CVC 1 Africa Radio	4965af	
1900 2000	mtwhf	Spain, Radio Exterior de Espana	9665eu	
1900 2000		Swaziland, TWR Africa	3200af	
1900 2000	Sat	Swaziland, TWR Africa	3200af	
1900 2000		Thailand, Radio Thailand World Svc	7205eu	
1900 2000		UK, BBC World Service	3255af 5875as	
1900 2000			5950as 6005af 6190af 9410af	
1900 2000			11810af 12095af 15400af	
1900 2000		USA, American Forces Network/AFRTS	4319usb	
1900 2000			5446usb 5765usb 7812usb 12133usb	
1900 2000			12759usb 13362usb	
1900 2000		USA, BBG/Voice of America/Special English		
1900 2000			7485va 9630va	
1900 2000		USA, EWTN/WEWN Irondale, AL	15610va	
1900 2000		USA, FBN/WTJC Newport NC9370na		
1900 2000		USA, WBCQ Monticello ME	7415usb 9330usb	
1900 2000			15420usb	
1900 2000		USA, WHRI Cypress Creek SC	7385af	
1900 2000			9840af 17520na	
1900 2000		USA, WINB Red Lion PA	13570ca	
1900 2000		USA, WJHR International Milton FL	15550na	
1900 2000		USA, WRMI Miami FL	9955ca	
1900 2000		USA, WWCR Nashville TN	9980af 12160af	
1900 2000			13845eu 15825eu	
1900 2000		USA, WWRB Manchester TN	9385na	
1900 2000		USA, WYFR/Family Radio Worldwide	3230af	
1900 2000			6020af 7270af 7395af 9610af	
1900 2000			9775af 18980eu	
1900 2000		Zambia, CVC Radio Christian Voice	4965af	
1900 2000			13590af	
1900 2000		Zambia, ZNBC/Radio Two	6165do	
1905 2020	Sat	Mali, ORTM/Radio Mali	9635do	
1930 2000	Sat/Sun	Germany, Pan American Broadcasting	9515af	
1930 2000		Iran, IRIB/ VOIRI	5940eu 6205eu 9780eu	
1930 2000			9800af	
1930 2000	mtwhf	Moldova, Radio PMR/Prednistrovica	9665eu	
1930 2000		South Africa, RTE Radio Worldwide	5840af	
1930 2000		USA, BBG/Voice of America/African Svc	4930af	
1930 2000			4940af 6080af 15580af	
1945 2000	DRM	Vatican City State, Vatican Radio	9800am	
1950 2000		Vatican City State, Vatican Radio	4005va	
1950 2000			5885va 7250va 9645va	
1951 2000		New Zealand, Radio NZ International	11725pa	

2000 UTC - 3PM EST / 2PM CST / 12PM PST

2000 2015	Sat	Germany, Pan American Broadcasting	9515af	
2000 2027		Iran, IRIB/ VOIRI	5940eu 6205eu 9780eu	
2000 2030	mtwhfa	Albania, Radio Tirana	7465eu 13735na	
2000 2030		Egypt, Radio Cairo	11510af	
2000 2030		South Africa, RTE Radio Worldwide	5840af	
2000 2030	Sat	Swaziland, TWR Africa	3200af	
2000 2030		USA, BBG/Voice of America/African Svc	4930af	
2000 2030			4940af 6080af 15580af	
2000 2030		Vatican City State, Vatican Radio	7365af	
2000 2030			9755af 11625af	
2000 2050		New Zealand, Radio NZ International	11725pa	
2000 2050	DRM	New Zealand, Radio NZ International	15720pa	
2000 2057		Germany, Deutsche Welle	6150af 11865af	
2000 2057		Netherlands, R Netherlands Worldwide	7425af	
2000 2057			11615af	
2000 2059		Germany, Deutsche Welle	11795af	
2000 2059		USA, WINB Red Lion PA	13570ca	
2000 2100		Anguilla, University Network	11775na	
2000 2100		Australia, ABC NT Alice Springs	2310do	
2000 2100		Australia, ABC NT Katherine	2485do	
2000 2100		Australia, ABC NT Tennant Creek	2325do	
2000 2100		Australia, Radio Australia	6080pa 7240pa	
2000 2100			9500as 11650pa 11660pa 11880pa	
2000 2100		Bahrain, Radio Bahrain	6010me	

2000 2100		Belarus, Radio Station Belarus	7255eu 7360eu	
2000 2100			7390eu	
2000 2100	DRM	Belgium, TDP Radio/Disco Palace	17755am	
2000 2100		Canada, CFRX Toronto ON	6070na	
2000 2100		Canada, CFVP Calgary AB	6030na	
2000 2100		Canada, CKZN St Johns NF	6160na	
2000 2100		Canada, CKZU Vancouver BC	6160na	
2000 2100		Canada, Radio Canada International	15235af	
2000 2100			15330af 17735af	
2000 2100		China, China Radio International	5960eu	
2000 2100			5985af 7285eu 7415eu 9440af	
2000 2100	Sat/Sun	Equatorial Guinea, Radio Africa	7190af	
2000 2100		Kuwait, Radio Kuwait	15540eu	
2000 2100		Malaysia, RTM Kajang/Traxx FM	7295do	
2000 2100		Micronesia, The Cross Radio/Pohnpei	4755as	
2000 2100		Palau, T8WH/ WHRI	9930as	
2000 2100		Russia, Voice of Russia	12040va	
2000 2100		South Africa, CVC 1 Africa Radio	4965af	
2000 2100			9505af	
2000 2100		UK, BBC World Service	3255af 6005af	
2000 2100			6190af 9410af 11810af 12095af	
2000 2100			13710af	
2000 2100		USA, American Forces Network/AFRTS	4319usb	
2000 2100			5446usb 5765usb 7812usb 12133usb	
2000 2100			12759usb 13362usb	
2000 2100	mtwhf	USA, BBG/Voice of America	5930va 9480va	
2000 2100		USA, EWTN/WEWN Irondale, AL	15610af	
2000 2100		USA, FBN/WTJC Newport NC9370na		
2000 2100		USA, WBCQ Monticello ME	7415usb 9330usb	
2000 2100			15420usb	
2000 2100		USA, WHRI Cypress Creek SC	7385na	
2000 2100			15665na	
2000 2100		USA, WJHR International Milton FL	15550na	
2000 2100		USA, WRMI Miami FL	9955ca	
2000 2100		USA, WWCR Nashville TN	9980af 12160af	
2000 2100			13845eu 15825eu	
2000 2100		USA, WWRB Manchester TN	9385na	
2000 2100		USA, WYFR/Family Radio Worldwide	12060af	
2000 2100			15195af 17725ca	
2000 2100		Zambia, CVC Radio Christian Voice	4965af	
2000 2100			9505af	
2000 2100		Zambia, ZNBC/Radio Two	6165do	
2030 2045		Thailand, Radio Thailand World Svc	9680eu	
2030 2057	DRM	Romania, Radio Romania International	9765eu	
2030 2057		Romania, Radio Romania International	11880na	
2030 2100			11940na 13800na	
2030 2100		Turkey, Voice of Turkey	7205va	
2030 2100		USA, BBG/Voice of America	7555as	
2030 2100		USA, BBG/Voice of America/African Svc	4930af	
2030 2100			6080af 15580af	
2030 2100	Sat/Sun	USA, BBG/Voice of America/African Svc	4930af	
2030 2100			4940af 6080af 15580af	
2030 2100		Vietnam, Voice of Vietnam/Overseas Svc	7220me	
2030 2100			7280eu 9550me 9730eu	
2045 2100		India, All India Radio/External Svc	7550eu	
2045 2100			9445eu 9910pa 11620pa 11670eu	
2045 2100			11715pa	
2045 2100	DRM	India, All India Radio/External Svc	9950eu	
2051 2100	DRM	New Zealand, Radio NZ International	11675pa	
2051 2100		New Zealand, Radio NZ International	11725pa	

2100 UTC - 4PM EST / 3PM CST / 1PM PST

2100 2125		Turkey, Voice of Turkey	7205va	
2100 2130		Australia, ABC NT Alice Springs	2310do	
2100 2130		Australia, ABC NT Katherine	2485do	
2100 2130		Australia, ABC NT Tennant Creek	2325do	
2100 2130		Austria, AWR Europe	11955af	
2100 2130	Sat	Canada, CBC Northern Quebec Svc	9625na	
2100 2130		South Korea, KBS World Radio	3955eu	
2100 2150	DRM	New Zealand, Radio NZ International	11675pa	
2100 2150		New Zealand, Radio NZ International	11725pa	
2100 2157		Germany, Deutsche Welle	9735af	
2100 2157		North Korea, Voice of Korea	13760eu	
2100 2200		Angola, Angolan National Radio	7217af	
2100 2200		Anguilla, University Network	11775na	
2100 2200		Australia, Radio Australia	9500as 9660pa	
2100 2200			11660pa 11650pa 11695as 13630pa	
2100 2200			15515pa	
2100 2200		Bahrain, Radio Bahrain	6010me	
2100 2200		Belarus, Radio Station Belarus	7255eu 7360eu	
2100 2200			7390eu	
2100 2200	DRM	Belgium, TDP Radio	17555eu	
2100 2200		Bulgaria, Radio Bulgaria	5900eu 7400eu	

2100	2200		Canada, CFRX Toronto ON	6070na
2100	2200		Canada, CFVP Calgary AB	6030na
2100	2200		Canada, CKZN St Johns NF	6160na
2100	2200		Canada, CKZU Vancouver BC	6160na
2100	2200		China, China Radio International	5960eu
			7205af 7285eu 7325af	7415eu
			9500eu	
2100	2200	Sat/Sun	Equatorial Guinea, Radio Africa	7190af
2100	2200		Germany, Deutsche Welle	11865af
			15640af	
2100	2200		India, All India Radio/External Svc	7550eu
			9445eu 9910pa 11620pa	11715pa
2100	2200	DRM	India, All India Radio/External Svc	9950eu
2100	2200		Malaysia, RTM Kajang/Traxx FM	7295do
2100	2200		Micronesia, The Cross Radio/Pohnpei	4755 as
2100	2200		Palau, T8WH/ WHRI	9930as
2100	2200		South Africa, CVC 1 Africa Radio	4965af
			9505af	
2100	2200	Sat/Sun	Spain, Radio Exterior de Espana	9650eu
2100	2200		Syria, Radio Damascus	9330va
2100	2200		UK, BBC World Service	3255af
			5875as 5905as 6005af	6190af
			6195as 9410af 9915af	12095af
2100	2200		USA, American Forces Network/AFRTS	4319usb
			5446usb 5765usb 7812usb	12133usb
			12759usb 13362usb	
2100	2200		USA, BBG/Voice of America	7555as
2100	2200		USA, BBG/Voice of America/African Svc	6080af
			15580af	
2100	2200		USA, EWTN/WEWN Irondale, AL	15610af
2100	2200		USA, FBN/WTJC Newport NC	9370na
2100	2200		USA, WBCQ Monticello ME	7415usb
2100	2200		USA, WHRI Cypress Creek SC	7385na
			13660na	
2100	2200		USA, WINB Red Lion PA	9265ca
2100	2200		USA, WJHR International Milton FL	15550na
2100	2200		USA, WRMI Miami FL	9955ca
2100	2200		USA, WWCN Nashville TN	7465eu
			9980af 15825na	9350af
2100	2200		USA, WWRB Manchester TN	3215na
2100	2200		USA, WYFR/Family Radio Worldwide	7425af
			12060af	
2100	2200		Zambia, CVC Radio Christian Voice	4965af
			9505af	
2100	2200		Zambia, ZNBC/Radio Two	6165do
2115	2200		Egypt, Radio Cairo	6270eu
2130	2200		Australia, ABC NT Alice Springs	4835do
2130	2200		Australia, ABC NT Katherine	5025do
2130	2200	mtwhfa	Canada, CBC Northern Quebec Svc	9625na
2130	2200	smtwh	Moldova, Radio PMR/Prednistrovia	9665eu
2151	2200	DRM	New Zealand, Radio NZ International	17675pa
2151	2200		New Zealand, Radio NZ International	15720pa

2200 UTC - 5PM EST / 4PM CST / 2PM PST

2200	2205		Zambia, ZNBC/Radio Two	6165do
2200	2230		India, All India Radio/External Svc	7550eu
			9445eu 9445eu 9910pa	11620pa
			11670eu 11715pa	
2200	2230	DRM	India, All India Radio/External Svc	9950eu
2200	2230	smtwh	USA, BBG/Voice of America	5895va
			7575va 11955va	7480va
2200	2245		Egypt, Radio Cairo	6270eu
2200	2255		Turkey, Voice of Turkey	9830va
2200	2257		Romania, Radio Romania International	5960eu
			7435eu 9790eu 11940eu	
2200	2300		Anguilla, University Network	6090na
2200	2300		Australia, ABC NT Alice Springs	4835do
2200	2300		Australia, ABC NT Katherine	5025do
2200	2300		Australia, Radio Australia	9660pa
			13630pa 15230pa 15515pa	15560pa
2200	2300		Bahrain, Radio Bahrain	6010me
2200	2300	smtwhf	Canada, CBC Northern Quebec Svc	9625na
2200	2300		Canada, CFRX Toronto ON	6070na
2200	2300		Canada, CFVP Calgary AB	6030na
2200	2300		Canada, CKZN St Johns NF	6160na
2200	2300		Canada, CKZU Vancouver BC	6160na
2200	2300		China, China Radio International	9590as
2200	2300	Sat/Sun	Equatorial Guinea, Radio Africa	7190af
2200	2300		Malaysia, RTM Kajang/Traxx FM	7295do
2200	2300		Micronesia, The Cross Radio/Pohnpei	4755 as
2200	2300	DRM	New Zealand, Radio NZ International	17675pa
2200	2300		New Zealand, Radio NZ International	15720pa
2200	2300		Palau, T8WH/ WHRI	9930as
2200	2300		Russia, Voice of Russia	9800va

2200	2300		UK, BBC World Service	3915as
			5905as 5935af 6195as	5875as
			9580as 9915af	7490as
2200	2300		USA, American Forces Network/AFRTS	4319usb
			5446usb 5765usb 7812usb	12133usb
			12759usb 13362usb	
2200	2300		USA, BBG/Voice of America	7555as
2200	2300		USA, EWTN/WEWN Irondale, AL	15610me
2200	2300		USA, FBN/WTJC Newport NC	9370na
2200	2300		USA, WBCQ Monticello ME	7415usb
2200	2300		USA, WHRI Cypress Creek SC	9850na
			9860na 13620na	
2200	2300		USA, WINB Red Lion PA	9265ca
2200	2300		USA, WRMI Miami FL	9955ca
2200	2300		USA, WWCN Nashville TN	7465eu
			9980af 15825na	9350af
2200	2300		USA, WWRB Manchester TN	3215na
2200	2300		USA, WYFR/Family Radio Worldwide	15255sa
			15440ca	
2200	2300		Zambia, CVC Radio Christian Voice	4965af
2215	2230		Croatia, Croatian Radio	3985eu
				7375ca
2230	2300		China, Xizang PBS/Lhasa	4905do
2230	2300		South Africa, AWR Africa	15320as
2230	2300		USA, BBG/Voice of America/Special English	
			7460af 9570va 11840va	15340va
2245	2300		India, All India Radio/External Svc	6055as
			7305as 11645as 13605as	

2300 UTC - 6PM EST / 5PM CST / 3PM PST

2300	0000		Anguilla, University Network	6090na
2300	0000		Australia, ABC NT Alice Springs	4835do
2300	0000		Australia, ABC NT Katherine	5025do
2300	0000		Australia, Radio Australia	9660pa
			13690pa 15230pa	15415pa
2300	0000		Bahrain, Radio Bahrain	6010me
2300	0000		Bulgaria, Radio Bulgaria	9700na
2300	0000	smtwhf	Canada, CBC Northern Quebec Svc	9625na
2300	0000		Canada, CFRX Toronto ON	6070na
2300	0000		Canada, CFVP Calgary AB	6030na
2300	0000		Canada, CKZN St Johns NF	6160na
2300	0000		Canada, CKZU Vancouver BC	6160na
2300	0000		China, China Radio International	5915as
			5990ca 6145na 7350eu	7410as
			9610as 11690as	11790as
2300	0000		Cuba, Radio Havana Cuba	5040ca
2300	0000		Egypt, Radio Cairo	6270na
2300	0000		India, All India Radio/External Svc	6055as
			7305as 11645as 13605as	
2300	0000		Malaysia, RTM Kajang/Traxx FM	7295do
2300	0000		Micronesia, The Cross Radio/Pohnpei	4755 as
2300	0000		New Zealand, Radio NZ International	15720pa
2300	0000	DRM	New Zealand, Radio NZ International	17675pa
2300	0000		Palau, T8WH/ WHRI	9930as
2300	0000		Russia, Voice of Russia	9665va
2300	0000		UK, BBC World Service	5935af
			9580as 9740as 9890as	7490as
			12010as	11850as
2300	0000		USA, American Forces Network/AFRTS	4319usb
			5446usb 5765usb 7812usb	12133usb
			12759usb 13362usb	
2300	0000		USA, BBG/Voice of America	5895va
			7555va 7575va 11955va	5915va
2300	0000		USA, BBG/Voice of America/Special English	
			7460af 9570va 11840va	15340va
2300	0000		USA, EWTN/WEWN Irondale, AL	15610me
2300	0000		USA, FBN/WTJC Newport NC	9370na
2300	0000		USA, WBCQ Monticello ME	7415usb
2300	0000	mtwhfa	USA, WHRI Cypress Creek SC	9850na
2300	0000	Sun	USA, WHRI Cypress Creek SC	7315na
			17820va	
2300	0000		USA, WINB Red Lion PA	9265ca
2300	0000		USA, WRMI Miami FL	9955ca
2300	0000		USA, WTWW Lebanon TN	5755va
2300	0000		USA, WWCN Nashville TN	7465eu
			9980af 13845na	9350af
2300	0000		USA, WWRB Manchester TN	3215na
2300	0000		USA, WYFR/Family Radio Worldwide	11580sa
			15440ca	
2300	0000		Zambia, CVC Radio Christian Voice	4965af
2300	2330	DRM	Vatican City State, Vatican Radio	9755am
2330	0000		Australia, Radio Australia	17750as
2330	0000		Vietnam, Voice of Vietnam/Overseas Svc	9840as
			12020as	
2330	2345		India, All India Radio/Aligarh	9470do



MTXTRA

Shortwave Broadcast Guide

PORTUGUESE / FRENCH / ARABIC

The following language schedule is extracted from our new *MTXtra Shortwave Broadcast Guide* pdf which is a free download to all *MTXpress* subscribers. This new online *Shortwave Broadcast Guide* has more than 9,100 station entries that include all languages being broadcasts via shortwave radio worldwide, sorted by time and updated monthly.

2300 UTC - 7PM EDT / 6PM CDT / 4PM PDT

2300 0000	Brazil, Educadora/Braganca	4825do	
2300 0000	Brazil, Radio 9 de Julho	9820do	
2300 0000	Brazil, Radio A Nossa Voz	4974do	
2300 0000	Brazil, Radio Alvorada/Parintins	4965do	6135do
2300 0000	Brazil, Radio Aparecida	5035do	6135do
	9630do	11855do	
2300 0000	Brazil, Radio Brasil 5000	4785do	
2300 0000	Brazil, Radio Congonhas	4775do	
2300 0000	Brazil, Radio Cultura do Para	5045do	
2300 0000	Brazil, Radio Cultura Ondas Tropicais	4845do	
2300 0000	Brazil, Radio Cultura/Araquara	3365do	
2300 0000	Brazil, Radio Cultura/Sao Paulo	6170do	
	9615do		
2300 0000	Brazil, Radio Daqui	4915do	
2300 0000	Brazil, Radio Difusora Acerana	4885do	
2300 0000	Brazil, Radio Difusora Caceres	5055do	
2300 0000	Brazil, Radio Difusora de Macapa	4915do	
2300 0000	Brazil, Radio Difusora do Amazonas	4805do	
2300 0000	Brazil, Radio Difusora Roraima	4875do	
2300 0000	Brazil, Radio Difusora/Londrina	4815do	
2300 0000	Brazil, Radio Educadora 6 de Agosto	3355do	
2300 0000	Brazil, Radio Educadora/Limeira	2380do	
2300 0000	Brazil, Radio Gaucha/Porto Alegre	6020do	
2300 0000	Brazil, Radio Gaucha/Rio de Janeiro	11915do	
2300 0000	Brazil, Radio Gazeta	9684do	15325do
2300 0000	Brazil, Radio Gazeta Universitaria	5955do	
2300 0000	Brazil, Radio Globo	11805do	
2300 0000	Brazil, Radio Guaiba	6000do	11784do
2300 0000	Brazil, Radio Guarujá Paulista	5045do	
2300 0000	Brazil, Radio Imaculada Conceicao	4754do	
2300 0000	Brazil, Radio Inconfidencia	6010do	15190do
2300 0000	Brazil, Radio Itatiaia	5970do	
2300 0000	Brazil, Radio Jornal A Critica	5055do	
2300 0000	Brazil, Radio Maria	4885do	
2300 0000	Brazil, Radio Missoes da Amazonia	4865do	
2300 0000	Brazil, Radio Mundial	3325do	
2300 0000	Brazil, Radio Municipal	3375do	
2300 0000	Brazil, Radio Nacional da Amazonia	6180do	
	11780do		
2300 0000	Brazil, Radio Novas de Paz	6080do	9515do
2300 0000	Brazil, Radio Novo Tempo	4895do	
2300 0000	Brazil, Radio Record	6150do	9505do
2300 0000	Brazil, Radio Rural4765do		
2300 0000	Brazil, Radio Transmundial	9530do	
2300 0000	Brazil, Radio Verdes Florestas	4865do	
2300 0000	Brazil, Radio Voz Misionaria/Camboriu	9665do	
2300 0000	Brazil, Radio Voz Misionaria/Florianopolis	11749do	
2300 0000	Brazil, Super Radio Deus e Amour/Sao Paulo	6120do	9585do
2300 0000 fas	Canada, Radio Canada International	13760sa	
2300 0000	China, China Radio International	9560sa	
	13650sa		
2300 0000 mtwhfa	Portugal, RDP Internacional	9715na	
2300 0000	Russia, Voice of Russia	9430sa	11605sa
2300 0000	USA, WYFR/Family Radio Worldwide	7360sa	7520sa
	15190sa		
2300 2330	Egypt, Radio Cairo	9290sa	
2300 2359	Brazil, Radio Alvorada/Londrina	4865do	
2300 2359	Brazil, Radio Bandeirantes	6090do	9645do
	11925do		
2300 2359	Brazil, Radio Boa Vontade	6160do	9550do
	11895do		
2300 2359	Brazil, Radio Brasil Central	4985do	11815do
2300 2359	Brazil, Radio Cancao Nova	4825do	6105do
	9675do		
2300 2359	Brazil, Radio Capixaba	4935do	
2300 2359	Brazil, Radio Clube do Para	4885do	
2330 0000	Cuba, Radio Havana Cuba	15370sa	

MT FRENCH SHORTWAVE BROADCAST GUIDE

0000 UTC - 7PM EST / 6PM CST / 4PM PST

0000 0100 DRM	France, Radio France Internationale	3965eu	
0000 0100	USA, WYFR/Family Radio Worldwide	15255sa	
0030 0100	Cuba, Radio Havana Cuba	5040ca	

0100 UTC - 8PM EST / 7PM CST / 5PM PST

0100 0157	North Korea, Voice of Korea	13650as	15100as
0100 0157	Romania, Radio Romania International	9570na	7385na
0100 0200	Bulgaria, Radio Bulgaria	9700na	11700na
0100 0200 DRM	France, Radio France Internationale	3965eu	

0200 UTC - 9PM EST / 8PM CST / 6PM PST

0200 0300 DRM	France, Radio France Internationale	3965eu	
0230 0250	Vatican City State, Vatican Radio	7360af	
0230 0300	Vatican City State, Vatican Radio	7305am	9610am

0300 UTC - 10PM EST / 9PM CST / 7PM PST

0300 0315 mtwhf	Australia, Radio Australia	15240pa	
0300 0315 Sat/Sun	Australia, Radio Australia	12080pa	
0300 0357	North Korea, Voice of Korea	15180sa	13760ca
0300 0400 twhfa	Argentina, RAE	11710am	
0300 0400 DRM	France, Radio France Internationale	3965eu	

0400 UTC - 11PM EST / 10PM CST / 8PM PST

0400 0500 DRM	France, Radio France Internationale	3965eu	
0400 0500	France, Radio France Internationale	7215af	
	11700af	13630af	13695af
0400 0500	South Africa, Hirondele Foundation	11690af	
0430 0450	Vatican City State, Vatican Radio	9660af	
	11625af		
0430 0500	Austria, AWR Europe	6155af	
0430 0500	UK, BBC World Service	6035af	7365af
	15490af		
0430 0500	Vatican City State, Vatican Radio	5965va	7250va

0500 UTC - 12AM EST / 11PM CST / 9PM PST

0500 0527 DRM	Romania, Radio Romania International	11810eu	
0500 0527	Romania, Radio Romania International	15340eu	17770eu
0500 0600 DRM	France, Radio France Internationale	3965eu	
0500 0600	France, Radio France Internationale	11700af	13695af
		15300af	11605af
0500 0600	Gabon, Africa No. 1	9580af	
0500 0600	USA, WYFR/Family Radio Worldwide	11580eu	11530af
0530 0545 Sun	Greece, Voice of Greece	11645eu	
0530 0600	Japan, Radio Japan NHK World	13840af	11730af
0530 0600 mtwhf	USA, BBG/Voice of America	9880af	13710af
		4960af	6095af

0600 UTC - 1AM EST / 12AM CST / 10PM PST

0600 0630	Bulgaria, Radio Bulgaria	9600eu	11600eu
0600 0630	UK, BBC World Service	6105af	7305af
	11865af 15430af		
0600 0630 mtwhf	USA, BBG/Voice of America	4960af	6095af
	9880af 13710af		
0600 0630	Vatican City State, Vatican Radio		11625af
	13765af 15570af		
0600 0700	China, China Radio International		17865eu
0600 0700 DRM	France, Radio France Internationale		3965eu
0600 0700	France, Radio France Internationale		11605af
	11700af 13695af	15300af	17850af
0600 0700	Gabon, Africa No. 1		9580af
0600 0700	USA, WYFR/Family Radio Worldwide		9355eu
	9385af		
0630 0700	Iran, IRIB/ VOIRI	15430eu	17700eu

0700 UTC - 2AM EST / 1AM CST / 11PM PST

0700 0727	Iran, IRIB/ VOIRI	15430eu	17700eu
0700 0730	UK, BBC World Service	11800af	15490af
0700 0800	China, China Radio International		17865eu
0700 0800 DRM	France, Radio France Internationale		3965eu
0700 0800	France, Radio France Internationale		11700af
	13695af 15170af	15300af	17850af
	21580af		
0700 0800	Gabon, Africa No. 1		9580af
0700 0800	Nigeria, Voice of Nigeria		15120eu

0800 UTC - 3AM EST / 2AM CST / 12AM PST

0800 0845	USA, WYFR/Family Radio Worldwide		11530af
0800 0900 DRM	France, Radio France Internationale		3965eu
0800 0900	France, Radio France Internationale		13695af
	15300af 17620af	17850af	21580af
0800 0900	Gabon, Africa No. 1		9580af
0800 0900	Saudi Arabia, BSKSA/External Svc		17785af

0900 UTC - 4AM EST / 3AM CST / 1AM PST

0900 0955	Saudi Arabia, BSKSA/External Svc		17785af
0900 1000 DRM	France, Radio France Internationale		3965eu
0900 1000	France, Radio France Internationale		13695af
	15300af 17620af	17850af	
0900 1000	Gabon, Africa No. 1		9580af

1000 UTC - 5AM EST / 4AM CST / 2AM PST

1000 1057	Romania, Radio Romania International		11830eu
	15240va 15380af	17785af	
1000 1100 DRM	France, Radio France Internationale		3965eu
1000 1100	France, Radio France Internationale		15300af
	17620af		
1000 1100	Gabon, Africa No. 1		9580af
1000 1100	USA, WYFR/Family Radio Worldwide		9625sa
	11970sa		
1030 1100	India, All India Radio/Gangtok		4835do

1100 UTC - 6AM EST / 5AM CST / 3AM PST

1100 1110 mtwhf	Vatican City State, Vatican Radio		5965va
1100 1130 Sat	USA, BBG/Voice of America	11925af	13770af
	15715af 17630af		
1100 1157	North Korea, Voice of Korea	11710ca	11735as
	13650as 15180sa		
1100 1200 DRM	France, Radio France Internationale		3965eu
1100 1200	France, Radio France Internationale		15300af
	17620af		
1100 1200	Gabon, Africa No. 1		9580af

1200 UTC - 7AM EST / 6AM CST / 4AM PST

1200 1230	UK, BBC World Service	17525af	17585af
	21630af		
1200 1230	Vietnam, Voice of Vietnam/Overseas Svc		7285as
1200 1257	Germany, Deutsche Welle		11795af
1200 1300	China, China Radio International		15205eu
1200 1300 DRM	France, Radio France Internationale		3965eu

1200 1300	France, Radio France Internationale		15300af
	17620af 17660af	21580af	
1200 1300	Gabon, Africa No. 1		9580af
1200 1300	Germany, Deutsche Welle		13730af
	15410af 17820af	21780af	15275af
1200 1300	USA, WYFR/Family Radio Worldwide		13695na
1230 1300	Japan, Radio Japan NHK World		17690af

1300 UTC - 8AM EST / 7AM CST / 5AM PST

1300 1330	France, Radio France Internationale		17850af
	17875af 21580af		
1300 1400	China, China Radio International		13710eu
	15205eu		
1300 1400 DRM	France, Radio France Internationale		3965eu
1300 1400	France, Radio France Internationale		15300af
	17620af 17875af		
1300 1400	Gabon, Africa No. 1		9580af
1300 1400	USA, WYFR/Family Radio Worldwide		11970sa

1400 UTC - 9AM EST / 8AM CST / 6AM PST

1400 1457	North Korea, Voice of Korea	9335na	11710na
	13760eu 15245eu		
1400 1500	China, China Radio International		11920af
	13670af		
1400 1500 DRM	France, Radio France Internationale		3965eu
1400 1500	France, Radio France Internationale		15300af
	17620af 17875af		
1400 1500	Gabon, Africa No. 1		9580af
1400 1500	Saudi Arabia, BSKSA/External Svc		17660af
1440 1500 Sat	Swaziland, TWR Africa		9635af

1500 UTC - 10AM EST / 9AM CST / 7AM PST

1500 1525 Sat	Swaziland, TWR Africa		9635af
1500 1600	China, China Radio International		11920af
	13670af		
1500 1600 DRM	France, Radio France Internationale		3965eu
1500 1600	France, Radio France Internationale		15300af
	17620af 17845af		
1500 1600	Gabon, Africa No. 1		9580af
1500 1600	Saudi Arabia, BSKSA/External Svc		17660af

1600 UTC - 11AM EST / 10AM CST / 8AM PST

1600 1630	Vatican City State, Vatican Radio		4005va
	5885va 7250va	15595va	
1600 1645	USA, WYFR/Family Radio Worldwide		11910na
1600 1655 mtwhf	South Africa, Channel Africa		15235af
1600 1657	North Korea, Voice of Korea	9335na	11710na
	13760eu 15245eu		
1600 1657	Romania, Radio Romania International		9680af
	11950eu		
1600 1658	Libya, LJBC Voice of Africa		17725af
1600 1700	China, China Radio International		11690eu
1600 1700 DRM	France, Radio France Internationale		3965eu
1600 1700	France, Radio France Internationale		15300af
	17850af 17875af		
1600 1700	Gabon, Africa No. 1		9580af
1600 1700	Russia, Voice of Russia	9900af	11635af
	12050va 15465va		
1600 1700 DRM	Russia, Voice of Russia		9880eu
1630 1700	Vietnam, Voice of Vietnam/Overseas Svc		7220as
	9550me		

1700 UTC - 12PM EST / 11AM CST / 9AM PST

1700 1715	Vatican City State, Vatican Radio		13765af
	15570af		
1700 1730	Bulgaria, Radio Bulgaria		5900eu
1700 1730 DRM	Bulgaria, Radio Bulgaria		9700eu
1700 1745	USA, WYFR/Family Radio Worldwide		17885af
1700 1755	Saudi Arabia, BSKSA/External Svc		17660af
1700 1757	Germany, Deutsche Welle	17610af	17840af
	21780af		
1700 1758	Libya, LJBC Voice of Africa		17725af
1700 1759	Germany, Deutsche Welle		9735af
1700 1800	China, China Radio International		11690eu
1700 1800	Ethiopia, Radio Ethiopia		7235va
1700 1800 DRM	France, Radio France Internationale		3965eu

1700	1800	DRM/mtwhf	France, Radio France Internationale	17875af	
1700	1800		France, Radio France Internationale	15300af	
			17850af	17875af	21690af
1700	1800		Gabon, Africa No. 1	9580af	
1700	1800		Germany, Deutsche Welle	15620af	
1700	1800		Russia, Voice of Russia	11635eu	15465va
1700	1800		USA, WYFR/Family Radio Worldwide	6100af	
1730	1800	mtwhfa	Albania, Radio Tirana	7465eu	

1800 UTC - 1PM EST / 12PM CST / 10AM PST

1800	1830	mtwhf	Moldova, Radio PMR/Prednistrovia	9665eu		
1800	1830		UK, BBC World Service	6095af	11755af	
			15105af	15180af	17885af	
1800	1857		North Korea, Voice of Korea	7210af	9975va	
			11535va	11910af		
1800	1900		China, China Radio International	5970eu		
			6055af	9480eu	11695af	
1800	1900		France, Radio France Internationale	11705af		
			15300af	17875af	21690af	
1800	1900	DRM	France, Radio France Internationale	3965eu		
1800	1900	DRM/mtwhf	France, Radio France Internationale	17875af		
1800	1900		Gabon, Africa No. 1	9580af		
1800	1900		Russia, Voice of Russia	9870eu	9900af	
			11635af	12050va	15465va	
1800	1900	DRM	Russia, Voice of Russia	9880eu		
1800	1900	mtwhf	Spain, Radio Exterior de Espana	9665eu		
1800	1900		USA, WYFR/Family Radio Worldwide	18930eu		
			21525af			
1830	1845		UK, FEBA Radio	15250af		
1830	1900		China, China Radio International	7350af		
			9645af			
1830	1900		Iran, IRIB/ VOIRI	5940eu	9860af	11865af
			13600af			
1830	1900		USA, BBG/Voice of America	9815af	17530af	
1830	1900		USA, WYFR/Family Radio Worldwide	17585af		
1830	1900		Vietnam, Voice of Vietnam/Overseas Svc	7280eu	9625eu	9730eu

1900 UTC - 2PM EST / 1PM CST / 11AM PST

1900	1927		Iran, IRIB/ VOIRI	5940eu	9860af	11865af
			13600af			
1900	1930		USA, WYFR/Family Radio Worldwide	17585af		
1900	1945		USA, WYFR/Family Radio Worldwide	17555eu		
1900	2000		Canada, Radio Canada International	11765af		
			13730af	15320af	17735af	
1900	2000		China, China Radio International	5970eu		
			6055af	9480af	11695af	
1900	2000		France, Radio France Internationale	9790af		
			11705af	15300af	17875af	21690af
1900	2000	DRM	France, Radio France Internationale	3965eu		
1900	2000	DRM/mtwhf	France, Radio France Internationale	17875af		
1900	2000		Gabon, Africa No. 1	9580af		
1900	2000		Russia, Voice of Russia	9900eu	11635af	
			12050af	15465va		
1900	2000	DRM	Russia, Voice of Russia	9880eu		
1900	2000		South Korea, KBS World Radio	6145eu		
1900	2000	Sat	Spain, Radio Exterior de Espana	9570af		
1900	2000	Sun	Spain, Radio Exterior de Espana	12015me		
1900	2000		Syria, Radio Damascus	9330va	12085va	
1900	2000		Taiwan, Radio Taiwan International	3985eu		
			15690af			
1900	2000		USA, BBG/Voice of America	9815af	17530af	
1900	2000		USA, WYFR/Family Radio Worldwide	11840af		
			21525af			
1901	1930	mtwhfa	Albania, Radio Tirana	7465eu		
1930	1940		Vatican City State, Vatican Radio	4005va		
			5885va	7250va	9645va	
1930	1945	Sat	Canada, Bible Voice Broadcasting	9510af		
1930	2000		Austria, AWR Europe	15220af		
1930	2000		Cuba, Radio Havana Cuba	11770eu		
1930	2000	f	Germany, Radio Santec	9900va	12030va	
			12050va	13850va	15465va	
1930	2000	f/DRM	Germany, Radio Santec	9880eu		
1930	2000		Turkey, Voice of Turkey	9535eu	9635eu	
1930	2000		Vietnam, Voice of Vietnam/Overseas Svc	7280eu	9730eu	
1935	1950		Swaziland, TWR Africa	9525af		
1940	2000	Sat/Sun	Belarus, Radio Station Belarus	7255eu	7360eu	
			7390eu			
1945	2000		India, All India Radio/External Svc	7410af		
			9620af	13640af		
1950	2000	Sat	Swaziland, TWR Africa	9525af		

2000 UTC - 3PM EST / 2PM CST / 12PM PST

2000	2020	Sat	Swaziland, TWR Africa	9525af	
2000	2025		Turkey, Voice of Turkey	9535eu	9635eu
2000	2027	DRM	Romania, Radio Romania International	9655eu	
2000	2027		Romania, Radio Romania International	11970eu	
2000	2030		China, China Radio International	7350af	
			9645af		
2000	2030		Cuba, Radio Havana Cuba	11760am	
2000	2030		Germany, AWR Europe	9830af	
2000	2030		Germany, AWR Europe	9765af	
2000	2030		India, All India Radio/External Svc	7410af	
			9620af	13640af	
2000	2030	mtwhf	Moldova, Radio PMR/Prednistrovia	9665eu	
2000	2030		USA, BBG/Voice of America	6170af	9815af
			12080af	15730af	17530af
2000	2057		North Korea, Voice of Korea	13760eu	15245eu
2000	2100		Angola, Angolan National Radio	7217af	
2000	2100	mtwhf	Argentina, RAE	15345eu	
2000	2100		Bulgaria, Radio Bulgaria	5900eu	7400eu
2000	2100		Egypt, Radio Cairo	6270eu	
2000	2100		France, Radio France Internationale	7205af	
			9790af	17875af	21690af
2000	2100	DRM/mtwhf	France, Radio France Internationale	17875af	
2000	2100		Gabon, Africa No. 1	9580af	
2000	2100		Indonesia, Voice of Indonesia	9526va	
2000	2100		Nigeria, Voice of Nigeria	7255eu	
2000	2100		Russia, Voice of Russia	11635af	12030eu
2000	2100	DRM	Russia, Voice of Russia	9880eu	
2000	2100		South Korea, KBS World Radio	5950va	
2000	2100	mtwhf	Spain, Radio Exterior de Espana	9690me	
			11610af		
2000	2100		USA, WYFR/Family Radio Worldwide	9390eu	
			9595af		
2030	2040		Vatican City State, Vatican Radio	7365af	
			9775af	11625af	
2030	2100		Austria, AWR Europe	11955af	
2030	2100		China, China Radio International	7320eu	
			9430eu	11660eu	
2030	2100		Egypt, Radio Cairo	9280af	
2030	2100		Serbia, International Radio Serbia	6100eu	
2030	2100	Sat/Sun	USA, BBG/Voice of America	9885af	12080af
			15185af	15730af	

2100 UTC - 4PM EST / 3PM CST / 1PM PST

2100	2115		Egypt, Radio Cairo	6270eu	
2100	2130		China, China Radio International	7320eu	
			9430eu	11660eu	
2100	2130	mtwhf	USA, BBG/Voice of America	9815af	9885af
			12035af	12080af	
2100	2130		Vietnam, Voice of Vietnam/Overseas Svc	7220me	
			7280eu	9550me	9730eu
2100	2200		Canada, Radio Canada International	9525af	
			15235af	15330af	17735af
2100	2200		China, China Radio International	9430eu	
			11660eu		
2100	2200		Egypt, Radio Cairo	9280af	
2100	2200		France, Radio France Internationale	7205af	
			21690af		
2100	2200		Gabon, Africa No. 1	9580af	
2100	2200		USA, WYFR/Family Radio Worldwide	9715af	
			17725sa		

2200 UTC - 5PM EST / 4PM CST / 2PM PST

2200	2230		China, China Radio International	9430eu	
			11660eu		
2200	2230		Egypt, Radio Cairo	9280af	
2200	2230	smtwh	Moldova, Radio PMR/Prednistrovia	9665eu	
2200	2245		USA, WYFR/Family Radio Worldwide	15600eu	
2200	2300	DRM	France, Radio France Internationale	3965eu	
2200	2300		Gabon, Africa No. 1	9580af	

2300 UTC - 6PM EST / 5PM CST / 3PM PST

2300	0000		Spain, Radio Exterior de Espana	6055eu	
			6155eu		
2300	0000		USA, WYFR/Family Radio Worldwide	6985na	
2300	2330		Canada, Radio Canada International	9525as	

MT ARABIC SHORTWAVE BROADCAST GUIDE

0000 UTC - 7PM EST / 6PM CST / 4PM PST

0000	0010	Tunisia, RTV/Radio Tunisia	7345af	
0000	0030	Egypt, Radio Cairo/ Voice of the Arabs	11540af	
0000	0045	Egypt, Radio Cairo	9250sa	9990sa
0000	0100	Bahrain, Radio Bahrain	9745me	
0000	0100	Egypt, Radio Cairo/General Svc		9305na
0000	0100	Iran, IRIB/ VOIRI 9420as		
0030	0100	Egypt, Radio Cairo	6270na	

0100 UTC - 8PM EST / 7PM CST / 5PM PST

0100	0200	Bahrain, Radio Bahrain	9745me	
0100	0200	Egypt, Radio Cairo	6270na	
0100	0200	Egypt, Radio Cairo/General Svc		9305na
0100	0200	Iran, IRIB/ VOIRI 9420as		

0200 UTC - 9PM EST / 8PM CST / 6PM PST

0200	0227	Iran, IRIB/ VOIRI 9420as		
0200	0300	Bahrain, Radio Bahrain	9745me	
0200	0300	Canada, Radio Canada International		5950me
0200	0300	Egypt, Radio Cairo	6270na	
0200	0300	Egypt, Radio Cairo/General Svc		9305na
0200	0300	Kuwait, Radio Kuwait/General Svc		5960me
0200	0300	Oman, Radio Sultanate of Oman		15355af
0200	0300	Sudan, Sudan Radio	7200do	
0230	0300	Iran, IRIB/ VOIRI 9420as	11660eu	11760eu

0300 UTC - 10PM EST / 9PM CST / 7PM PST

0300	0330	Canada, Bible Voice Broadcasting		7310me
0300	0330	Clandestine, Radio Dardasha 7		7310va
0300	0330	USA, BBG/Afia Darfur Radio	5945af	7330af
		9815af		
0300	0330	USA, BBG/VOA/Hello Darfur	5945af	7330af
		9815af		
0300	0400	Bahrain, Radio Bahrain	9745me	
0300	0400	Canada, Radio Canada International		7230me
0300	0400	Egypt, Radio Cairo	6270na	
0300	0400	Egypt, Radio Cairo/General Svc		9305na
0300	0400	Iran, IRIB/ VOIRI 9420as	11660eu	11760eu
0300	0400	Kuwait, Radio Kuwait/General Svc		5960me
0300	0400	Saudi Arabia, BSKSA/General Program	29580va	
0300	0400	Saudi Arabia, BSKSA/Qur'an Program	9715va	
		15170as	17895as	
0300	0400	Sudan, Sudan Radio	7200do	
0300	0400	Tunisia, RTV/Radio Tunisia	9725va	12005va
0300	0400	UK, BBC World Service	5790me	6040me
		9440me	9915me	11820me
0300	0400	Yemen, Rep of Yemen Radio	9780me	
0330	0400	Iran, IRIB/ VOIRI 9610as	11875as	
0330	0400	Iran, VO Islamic Palestinian Revol		9610me
		11875me		

0400 UTC - 11PM EST / 10PM CST / 8PM PST

0400	0427	Iran, IRIB/ VOIRI 9610as	11875as	
0400	0427	Iran, VO Islamic Palestinian Revol		7295me
		9610me		
0400	0430	Egypt, Radio Cairo	6270na	
0400	0430	Vatican City State, Vatican Radio		9645me
		11715me		
0400	0458	Algeria, Radio Algerienne	7295af	
0400	0500	Bahrain, Radio Bahrain	9745me	
0400	0500	Clandestine, Sudan Radio Service/SRS		13720af
0400	0500	Egypt, Radio Cairo/General Svc		9305na
0400	0500	Germany, AWR Europe	12050va	
0400	0500	Jordan, Radio Jordan	11960eu	
0400	0500	Kuwait, Radio Kuwait/General Svc		5960me
0400	0500	Oman, Radio Sultanate of Oman		17590af
0400	0500	Saudi Arabia, BSKSA/General Program	29580va	
0400	0500	Saudi Arabia, BSKSA/Qur'an Program	9715va	
		15170as	17895as	
0400	0500	Sudan, Sudan Radio	7200do	
0400	0500	Tunisia, RTV/Radio Tunisia	7275eu	9725va
		12005va		
0400	0500	UK, BBC World Service	5790af	7325af
		7375me	9915af	11740me
		13660me		11820me

0400	0500	Yemen, Rep of Yemen Radio	9780me	
0430	0500	Canada, Bible Voice Broadcasting		9735me
0430	0500	Clandestine, Radio Dabanga	13620af	15550af

0500 UTC - 12AM EST / 11PM CST / 9PM PST

0500	0515	f	Canada, Bible Voice Broadcasting		9735me
0500	0527		Iran, IRIB/ VOIRI 9420as	11660eu	11760eu
0500	0530	Sun	Canada, Bible Voice Broadcasting		11810af
0500	0530		Clandestine, Radio Dardasha 7		11810af
0500	0530	Sat/Sun	Clandestine, Sudan Radio Service/SRS		13720af
0500	0555		Saudi Arabia, BSKSA/General Program	29580va	
0500	0555		Saudi Arabia, BSKSA/Qur'an Program	9715va	
			15170as	17895as	
0500	0558		Algeria, Radio Algerienne	9535af	9535af
0500	0600		Bahrain, Radio Bahrain	9745me	
0500	0600		China, China Radio International		9515af
			9590me	11775af	
0500	0600		Clandestine, Radio Dabanga	13730af	
0500	0600		Egypt, Radio Cairo/General Svc		9305na
0500	0600		Germany, AWR Europe	12050af	
0500	0600		Jordan, Radio Jordan	11960eu	
0500	0600		Kuwait, Radio Kuwait/General Svc		5960me
0500	0600		Kuwait, Radio Kuwait/Holy Qu'ran		15515as
0500	0600		Oman, Radio Sultanate of Oman		17590af
0500	0600		Sudan, Sudan Radio	7200do	
0500	0600		Tunisia, RTV/Radio Tunisia	7275eu	9725va
			12005va		
0500	0600		UK, BBC World Service	7375me	9915af
			11680af	11820me	13660me
13660me					15790me
0500	0600		USA, WYFR/Family Radio Worldwide		9355eu
			9385eu		
0500	0600		Yemen, Rep of Yemen Radio	6135me	9780me
0530	0600		Clandestine, Radio Dabanga	13620af	
0530	0600		Iran, IRIB/ VOIRI 13790as	13800as	15150as

0600 UTC - 1AM EST / 12AM CST / 10PM PST

0600	0610		Tunisia, RTV/Radio Tunisia	9725va	12005va
0600	0630		Japan, Radio Japan NHK World		11975me
0600	0630		Tunisia, RTV/Radio Tunisia	7275eu	
0600	0658		Algeria, Radio Algerienne	11985af	
0600	0700		Bahrain, Radio Bahrain	9745me	
0600	0700		China, China Radio International		9515af
			9590me	11775af	
0600	0700		Clandestine, Radio Nacional De La R.A.S.D.		6297af
0600	0700		Egypt, Radio Cairo/General Svc		9305na
0600	0700		Iran, IRIB/ VOIRI 13790as	13800as	15150as
0600	0700		Kuwait, Radio Kuwait/General Svc		5960me
0600	0700		Kuwait, Radio Kuwait/Holy Qu'ran		15515as
0600	0700		Saudi Arabia, BSKSA/General Program	117730af	
			17740af		
0600	0700		Saudi Arabia, BSKSA/General Program	211855va	
0600	0700		Saudi Arabia, BSKSA/Qur'an Program	9715va	
			15380va	17895as	
0600	0700		Sudan, Sudan Radio	7200do	
0600	0700		UK, BBC World Service	7375me	11680af
			11820va	13660va	15790me
0600	0700		Yemen, Rep of Yemen Radio	6135me	
0630	0657		Romania, Radio Romania International		11730af
			11790af	15180af	15400af
0645	0700	mtwhf	Vatican City State, Vatican Radio		5965eu
			7250eu	9645me	11740va
					15595va

0700 UTC - 2AM EST / 1AM CST / 11PM PST

0700	0755		Saudi Arabia, BSKSA/Qur'an Program		9715va
			15380va	17895as	
0700	0800		Bahrain, Radio Bahrain	9745me	
0700	0800		Clandestine, Radio Nacional De La R.A.S.D.		6297af
0700	0800		Egypt, Radio Cairo/General Svc		17510af
0700	0800		Iran, IRIB/ VOIRI 13790as	13800as	15150as
0700	0800		Kuwait, Radio Kuwait/General Svc		5960me
0700	0800		Kuwait, Radio Kuwait/Holy Qu'ran		15515as
0700	0800		Saudi Arabia, BSKSA/General Program	117730af	
			17740af		
0700	0800		Saudi Arabia, BSKSA/General Program	211855va	
0700	0800		Sudan, Sudan Radio	7200do	
0700	0800		Tunisia, RTV/Radio Tunisia	7335af	
0700	0800		UK, BBC World Service	13660af	15180af

0700 0800 USA, WYFR/Family Radio Worldwide 11530af
 0700 0800 Yemen, Rep of Yemen Radio 6135me

0800 0855 Saudi Arabia, BSKSA/Qur'an Program 9715va
 15380va
 0800 0900 Bahrain, Radio Bahrain 9745me
 0800 0900 Egypt, Radio Cairo/General Svc 17510af
 0800 0900 Kuwait, Radio Kuwait/General Svc 5960me
 0800 0900 Kuwait, Radio Kuwait/Holy Qu'ran 15515as
 0800 0900 Saudi Arabia, BSKSA/General Program 211855va
 0800 0900 Sudan, Sudan Radio 7200do
 0800 0900 USA, BBG/VOA/Radio Sawa 15780af 17880af
 0800 0900 Yemen, Rep of Yemen Radio 6135me
 0830 0900 Iran, IRIB/ VOIRI 13740as 13790as 13800as
 15150as

0800 UTC - 3AM EST / 2AM CST / 12AM PST

0800 0815 w Italy, IRRS-Shortwave 11910va
 0800 0827 Iran, IRIB/ VOIRI 13790as 13800as 15150as
 0800 0830 Tunisia, RTV/Radio Tunisia 7335af
 0800 0830 UK, FEBA Radio 15280me
 0800 0855 Saudi Arabia, BSKSA/General Program 117730af
 17740af

MT SHORTWAVE STATION RESOURCE GUIDE

Afghanistan, Radio Afghanistan www.rta.org.af
 Albania, Radio Tirana <http://rtsh.sil.at/>
 Angola, Angolan National Radio www.rna.ao/
 Argentina, RAE www.radionacional.gov.ar
 Australia, ABC NT Alice Springs www.abc.net.au/radio/
 Australia, ABC NT Katherine www.abc.net.au/radio/
 Australia, ABC NT Tennant Creek www.abc.net.au/radio/
 Australia, HCJB Global Australia www.hcjb.org/
 Australia, Radio Australia www.abc.net.au/ra/
 Austria, AWR Europe www.awr2.org/
 Bahrain, Radio Bahrain www.radiobahrain.fm/
 Belarus, Radio Station Belarus www.radiobelarus.tvr.by/eng/
 Belgium, TDP Radio www.airtime.be/schedule.html
 Belgium, TDP Radio/Disco Palace www.airtime.be/schedule.html
 Bhutan, Bhutan Broadcasting Svc www.bbs.com.bt
 Bulgaria, Radio Bulgaria www.bnr.bg/
 Canada, Bible Voice Broadcasting www.biblevoice.org/
 Canada, CBC Northern Quebec Svc www.cbc.ca/north/
 Canada, CFRX Toronto ON www.cfrb.com
 Canada, CFPV Calgary AB www.classiccountriam1060.com
 Canada, CKZN St Johns NF www.cbc.ca/listen/index.html
 Canada, CKZU Vancouver BC www.cbc.ca/bc
 Canada, Radio Canada International www.rcinet.ca/
 China, China Radio International www.cri.cn/
 Clandestine, Sudan Radio Service/SRS www.sudanradio.org
 Cuba, Radio Havana Cuba www.radiohc.cu/
 Egypt, Radio Cairo www.ertu.org
 Equatorial Guinea, Radio Africa www.radiopanam.com/
 Equatorial Guinea, Radio Africa 2 www.radiopanam.com/
 Equatorial Guinea, Radio East Africa www.radiopanam.com/
 Equatorial Guinea, Radio East Africa/Malabo www.radiopanam.com/
 Ethiopia, Radio Ethiopia www.ertagov.com
 Ethiopia, Radio Ethiopia/National Program www.ertagov.com
 France, Radio France Internationale <http://rfienglish.com>
 Germany, AWR Europe www.awr2.org/
 Germany, Deutsche Welle www.dw-world.de/
 Germany, Pan American Broadcasting www.radiopanam.com/
 Germany, TWR Europe www.twr.org
 Greece, Voice of Greece www.voiceofgreece.gr/
 Guam, AWR/KSDA www.awr2.org/
 Guam, TWR Asia/KTWR <http://nea.ktwr.net/>
 India, All India Radio/Aizawl www.allindiaradio.org/
 India, All India Radio/Bengaluru www.allindiaradio.org/
 India, All India Radio/Bhopal www.allindiaradio.org/
 India, All India Radio/Chennai www.allindiaradio.org/
 India, All India Radio/Delhi www.allindiaradio.org/
 India, All India Radio/External Svc www.allindiaradio.org/
 India, All India Radio/Gangtok www.allindiaradio.org/
 India, All India Radio/Gorakhpur www.allindiaradio.org/
 India, All India Radio/Guwahati www.allindiaradio.org/
 India, All India Radio/Hyderabad www.allindiaradio.org/
 India, All India Radio/Imphal www.allindiaradio.org/
 India, All India Radio/Hanagar www.allindiaradio.org/
 India, All India Radio/Jaipur www.allindiaradio.org/
 India, All India Radio/Jeyapore www.allindiaradio.org/
 India, All India Radio/Kolkata www.allindiaradio.org/
 India, All India Radio/Kurseong www.allindiaradio.org/
 India, All India Radio/Lucknow www.allindiaradio.org/
 India, All India Radio/Mumbai www.allindiaradio.org/
 India, All India Radio/Panaji, Goa www.allindiaradio.org/
 India, All India Radio/Port Blair www.allindiaradio.org/
 India, All India Radio/Radio Kashmir www.allindiaradio.org/
 India, All India Radio/Shillong www.allindiaradio.org/
 India, All India Radio/Shimla www.allindiaradio.org/
 India, All India Radio/Thiruvananthapuram www.allindiaradio.org/
 Indonesia, Voice of Indonesia www.voi.co.id
 Iran, IRIB/ VOIRI www.irib.ir/English/

Italy, IRRS-Shortwave www.nexus.org
 Italy, IRRS-Shortwave/Euro Gospel Radio www.nexus.org
 Italy, IRRS-Shortwave/Overcomer Ministries www.nexus.org
 Italy, IRRS-Shortwave/Radio City www.nexus.org
 Italy, IRRS-Shortwave/Radio Joystick www.nexus.org
 Japan, Radio Japan NHK World www.nhk.or.jp/english/
 Kuwait, Radio Kuwait www.media.gov.kw/
 Malaysia, RTM Kajang/Traxx FM www.traxxfm.net/index.php
 Malaysia, RTM/Voice of Malaysia www.rtm.gov.my
 Mali, ORTM/Radio Mali www.ortm.ml
 Micronesia, The Cross Radio/Pohnpei www.pmapacific.org/
 Monaco, TWR Europe www.twr.org/
 Nepal, Radio Nepal www.radionepal.org/
 Netherlands, R Netherlands Worldwide www.radionetherlands.nl/
 New Zealand, Radio NZ International www.rnzi.com
 Nigeria, Voice of Nigeria www.voiceofnigeria.org
 Oman, Radio Sultanate of Oman www.oman-tv.gov.om
 Pakistan, PBC/Radio Pakistan www.radio.gov.pk
 Palau, T8WH/ WHRI www.whr.org/
 Philippines, PBS/ Radyo Pilipinas www.pbs.gov.ph/
 Poland, Polskie Radio Warsaw www.polskieradio.pl
 Romania, Radio Romania International www.rri.ro/
 Russia, Voice of Russia <http://english.ruvr.ru/>
 Saudi Arabia, BSKSA/External Svc www.saudiradio.net/
 Serbia, International Radio Serbia www.glassrbije.org/
 South Africa, AWR Africa www.awr2.org/
 South Africa, Channel Africa www.channelafrica.org
 South Africa, CVC 1 Africa Radio www.1africa.tv
 South Africa, RTE Radio Worldwide www.rte.ie/radio1/
 South Africa, SA Radio League www.sarl.org.za
 South Africa, TWR Africa www.twrafrica.org/
 South Korea, KBS World Radio www.worldkbs.co.kr
 Spain, Radio Exterior de Espana www.ree.rne.es/
 Sri Lanka, SLBC www.slbc.lk
 Swaziland, TWR Africa www.twrafrica.org
 Syria, Radio Damascus www.rtv.gov.sy/
 Taiwan, Radio Taiwan International <http://english.rti.org.tw/>
 Thailand, Radio Thailand World Svc www.hsk9.org/
 Turkey, Voice of Turkey www.trt-world.com
 Uganda, Dunamis Shortwave www.biblevoice.org/stations/east-africa
 UK, BBC World Service www.bbc.co.uk/worldservice/
 UK, FEBA Radio www.febaradio.net
 USA, American Forces Network/AFRTS <http://myafn.dodmedia.osd.mil/>
 USA, BBG/Voice of America www.voanews.com/
 USA, BBG/Voice of America/African Svc www.voanews.com/
 USA, BBG/Voice of America/Special English www.voanews.com/
 USA, BBG/Voice of America/Studio 7 www.voanews.com/
 USA, BBG/Voice of America/Sudan in Focus www.voanews.com/
 USA, EWTN/WEWN Irondale, AL www.ewtn.com/
 USA, FBN/WTJC Newport NC www.fbnradio.com/
 USA, KNLS Anchor Point AK www.knls.org/
 USA, Overcomer Ministries www.overcomerministry.org/
 USA, WBCQ Monticello ME www.wbcq.com/
 USA, WHRI Cypress Creek SC www.whr.org/
 USA, WINB Red Lion PA www.winb.com
 USA, WRMI Miami FL www.wrmi.net/
 USA, WRMI/Radio Slovakia Intl www.wrmi.net/
 USA, WRNO New Orleans LA www.wrnoradio.com
 USA, WTTW Lebanon TN www.wttw.us/
 USA, WWCN Nashville TN www.wwcn.com
 USA, WWRB Manchester TN www.wwrb.org/
 USA, WYFR/Family Radio Worldwide www.familyradio.com/
 Vatican City State, Vatican Radio www.vaticanradio.org/
 Vietnam, Voice of Vietnam/Overseas Svc www.vov.org.vn
 Zambia, CVC Radio Christian Voice www.voiceafrica.net
 Zambia, ZNBC/Radio Two www.znbc.co.zm



A Profile of Edwards AFB Aircraft from Concept to Combat

There is one base in the U.S. unlike any other within the Department of Defense. Almost every United States military aircraft since the 1950s has been at least partially tested here, and it has been the site of many aviation breakthroughs. From the development of the country's first jet aircraft to the Air Force's newest fighter, the F-35, the test forces at this base have played a role in the development of virtually every aircraft to enter the Air Force inventory since World War II.

The base is Edwards AFB located in southern California.

The Air Force Flight Test Center at Edwards Air Force Base is the Air Force Materiel Command center for conducting and supporting research, development, test and evaluation of aerospace systems. It operates the U.S. Air Force Test Pilot School and is home to NASA's Dryden Research Center and considerable test activity conducted by America's commercial aerospace industry.

The two major organizations supported by the center are the 412th Test Wing and the 95th Air Base Wing, with more than 10,000 service members and government employees.

The 412th Test Wing manages the center's flight operations programs and functions. In doing so, it manages all engineering support for manned and unmanned aerospace vehicle test programs. With many different types of planes operated by the 412th aircrews, the Edwards flight line takes on an almost expeditious aerospace force look. The aircraft flown here include the B-1B, B-2, B-52, C-12, C-17, C-130, NKC-135, KC-135, CV-22, F-16, F-22, F-35, F-117, T-38 and T-39. Additionally, the Global Hawk and Predator unmanned aerial vehicles and L-23 glider are tested at Edwards.

The Airborne Laser 747 test platform is currently undergoing development and modifications for testing here. The 412th Test Wing also programs, develops, operates and maintains engineering technical services and facilities which conduct and support testing, as well as operating and managing logistic support.

The test wing's support-side counterpart, the 95th Air Base Wing, led by the installation commander, runs Edwards like a small town, delivering a quality of life that makes the base a great place to live and work. The air base wing maintains the security, roads, buildings, transportation and community support services that make the flight test mission possible. It provides the housing, child-care, recreational activities and medical care that affect every person on base.

Base Facilities

Edwards AFB Main Base includes the Dryden Flight Research Center at its north end and is directly connected to the South Base. The Main Base airfield has a control tower, a TRACON (callsign Joshua), and a Radar Control Facility (callsign Sport). Its ICAO airport code is KEDW (IATA: EDW). As a military airbase, civilian access via an aircraft is severely restricted but not impossible given prior coordination and good reason to land there.

There are three lighted, paved runways:

- 04R/22L is 15,024 x 300 feet, and an extra 9,588 feet of lake bed runway is available at its northerly end. It is equipped with arresting systems approximately 1,500 feet from each end.
- 04L/22R is 12,000 x 200 feet and was constructed to temporarily replace 04R/22L while it was being renovated in 2008.
- 06/24 is 8,000 x 50 feet (this runway is technically part of the South Base) and an extra 10,158 x 210 feet of lake bed runway is available at its easterly end.

There are 13 other official runways on the Rogers lake bed:

- 17/35 is a 39,907 x 900 foot primary runway. It is actually marked as three adjacent 300 foot-wide runways (left, center and right). Imagery from the 1990s shows an additional 7,500 feet extending to the north from 17L/35R, including a visual cue and centerline markings that extend about 15,000 feet down the currently declared portion of the runway.
- 05L/23R is a 22,175 x 300 foot runway.
- 05R/23L is a 14,999 x 300 foot runway and is immediately adjacent to 05L/23R at the 23L eastern end.
- 06/24 is a 7,050 x 300 foot runway. This is not to be confused with the South Base 06/24 paved runway (which also extends onto the lake bed), or the north base 06/24 paved runway.
- 07/25 is a 23,100 x 300 foot runway.
- 09/27 is a 9,991 x 300 foot runway.
- 12/30 is a 9,235 x 600 foot runway. It is actually marked as two adjacent 300 foot-wide runways (left and right). Runway 30 rolls out onto the compass rose, so its corresponding, unmarked, runway 12 is never used.
- 15/33 is a 29,487 x 300 foot runway.
- 18/36 is a 23,086 x 900 foot runway. It is actually marked as three adjacent 300 foot-wide runways (left, center and right).

The Rosamond lake bed has two runways painted on it - 02/20 and 11/29 are both four miles long.

The Main Base is the home of the Benefield Anechoic Facility (BAF), an electromagnetic and radio frequency testing building. Main Base also houses the Air Force Flight Test Center Museum, which has over 15 aircraft on display.

Contained inside Edwards Air Force Base is NASA's Dryden Flight Research Center (DFRC), where modern aircraft research is still active (e.g. the Boeing X-45). The DFRC is home to many of the world's most advanced aircraft. Notable recent research projects include the Controlled Impact Demonstration and the Linear Aerospike SR-71 Experiment.

During the Space Shuttle program, DFRC was also the home of the Shuttle Carrier Aircraft (SCA), a modified Boeing 747 that was designed to carry the Space Shuttle back to Kennedy Space Center when the Orbiter landed at Edwards.

The Air Force Research Laboratory (AFRL), Propulsion Directorate, maintains a rocket engine test facility on and around Leuhman Ridge, just east of Rogers Dry Lake. This facility traces its roots to early Army Air Corps activities.

North Base is located at the north-west corner of Rogers Lake and is the site of the Air Force's most secret test programs at Edwards. The site has one 6,000 x 150 foot paved runway, 06/24, and is accessed from the lake bed or via a single controlled road.

Communications

Frequencies/Systems

Several years ago, I wrote the first major base frequency profile ever published for this base in one of our Grove Military/Government frequency guides. If you looked at that old profile you would see a plethora of land mobile frequencies for various agencies and users on the base. Dozens of repeater/simplex frequencies were used in the 30-50, 138-150.8 and 162-174 MHz frequency ranges.

Since that profile was published, the era of trunked radio systems has arrived and as you will see in our new frequency profile below, Edwards no longer has a LMR presence in the 162-174 MHz range and has mostly aeronautical frequencies (AM mode) in the 138-150.8 MHz frequency range. The base trunking system has really changed the landscape of the land mobile radio systems on this base since its introduction several years ago.

Well, that does it for this month. Until next time, 73 and good hunting.

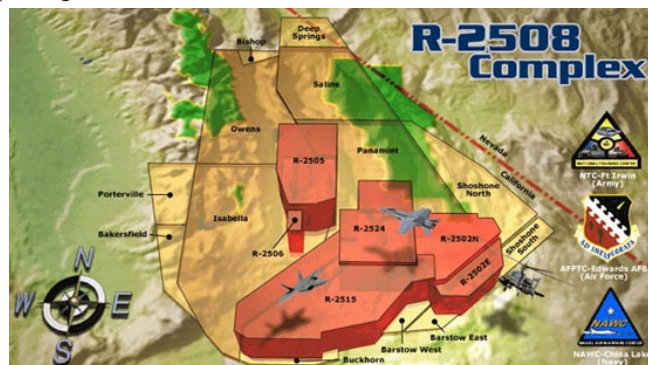

Edwards Air Force Base Frequency Profile

Compiled by Larry Van Horn N5FPW

HF FREQUENCIES

NASA Emergency Net – DFRC (KHA-910) – Various modes: 3395.0 4603.0 6982.5 14455.0 kHz
 SHARES – NASA DFRC (KHA-910) – USB: 5211.0 10493.0 kHz
 USAF Nationwide Domestic Support Operations and Contingency Net (USB): 3338.0 3355.0 4988.0 6915.0 8104.0 9983.0 13436.0 14772.0 kHz
 USAF Range Operations/Flight Test (ALE-EDW): 3376.1 4455.1 4835.1 5735.1 6770.1 7330.1 kHz

AERONAUTICAL FREQUENCIES

Note: Frequencies in MHz and mode is AM unless otherwise indicated.

FAA Approach/Departure Control "Joshua"
 Isabella MOA/ATCAA 133.650/348.700 (U/V Preset 6)
 Owens MOA/ATCAA 126.550/322.300 (U/V Preset 7)
 Palmdale-High 124.550/363.000 (ex-290.300) (U/V Preset 13)
 Paramint MOA/ATCAA 120.250/291.600 (U/V Preset 9)
 Saline MOA/ATCAA 123.950/256.800 (U/V Preset 8)
 Other Listed Freqs 269.200 319.000 347.100 348.700 (ex-335.600)
 USAF Radar Control Facility "Sport"
 R-2515 App/Dep Control 132.750/343.700 (ex-272.000 MHz) (U/V Preset 5)
 Low Level Approach 315.900 (UHF Preset 11)
 NASA DFRC Flight Test Support 121.950 135.825 237.000 373.550
 NASA DFRC R&D Missions 122.850 123.225 123.375
 NASA Operations 373.150 (ex-371.100)
 NASA Research Aircraft Mission 371.100 382.600 395.100
 USA WSMR Range Operations 142.925
 USAF 412TW Command Post 304.000 (UHF Preset 2) "Conform"
 USAF 412TW/410FLTS Operations 228.950 322.700 "Dagger Ops"

Note: The 410FLTS performed testing on the B-1 Lancer and F-117 Nighthawk aircraft from 1980-2008 and was deactivated with the retirement of the F-117 from the Air Force inventory.

USA 412TW/411FLTS Operations 230.275 230.775 324.650 325.900 375.400 "Raptor Ops"
 USA 412TW/411FLTS F-22 Air Operations 141.925 229.950 237.625 237.725 251.350 255.725
 USAF 412TW/412 OG Det 2/ER-2 Operations 328.025 "Xray Ops"
 USAF 412TW/416FLTS Operations 139.900 264.600 311.200 349.600 "Zoom Ops"
 USAF 412TW/417FLTS YAL-1A Laser Aircraft Flight Test Support 149.175
 USAF 412TW/418FLTS Operations 123.150 251.250 257.075 267.800 361.400 379.700 "Tiger Ops"
 USAF 412TW/419FLTS Operations 136.425 266.300 276.650 279.900 287.200 324.700 "Torch Ops"
 USAF 412TW/445FLTS Operations 300.800 351.400 "Eagle Ops"
 USAF 412TW/452FLTS Operations 136.225 314.200 349.300 "Global Ops"
 USAF Aerial Refueling Missions 234.825 252.175 (may no longer be active) 354.400 (UHF Preset 10) (Grizzly/Torch refueling mission) 375.025
 USAF Air/Air Training 141.400 143.250
 USAF Air Operations 139.000 139.825 141.625 141.725 141.825
 USAF AFFTC Mission 286.400 (UHF Preset 15)
 USAF ATIS 116.400/269.900 (U/V Preset 1)
 USAF Command Post (unknown unit) 378.100 398.100
 USAF Drop Zone Training 342.525 Edwards Farm Drop Zone
 USAF Flight Test Support VHF Air 123.125 123.175 123.200 123.225 123.250 123.275 123.325 123.350 123.375 123.400 123.425 123.450 123.475 123.525 123.550
 USAF Flight Test Support VHF Hi 139.1125 141.950 142.1125 142.9625 143.100 143.150 148.5625 148.900 149.800
 USAF Flight Test Support VHF UHF 225.025 225.275 225.375 225.500 225.650 225.700 225.725 225.850 226.100 226.350 226.700 226.800 227.400 227.425 227.800 228.000 228.300 228.350 228.375 229.500 229.625 231.400 233.525 233.600 233.650 233.950 234.800 249.425 249.500 249.525 249.575 274.150 274.200 274.700 275.200 275.900 276.600 276.675 278.700 282.675 283.700 283.725 284.100 286.250 286.800 292.300 294.975 295.000 296.800 296.900 297.825 298.300 298.675 300.350 300.675 301.000 301.500 301.700 310.000 311.200 311.400 313.900 314.400 318.050 321.125 322.700 325.100 335.450 338.700 339.225 340.000 340.900 341.750 342.075 342.175 358.400 359.200 363.425
 USAF Flight Test Support R-2508 237.000 269.800
 USAF Ground Control 121.800/225.400 (ex-390.100) (U/V Preset 3)
 USAF Have Quick 225.150 235.050 239.950 252.925 262.450 267.850 271.950 279.750 284.150 289.050 293.550 298.650 303.275 308.750 314.450
 134.050
 USAF Isabella MOA/SUA Advisories 257.700 354.000 391.900
 USAF Local Control 148.075
 USAF Miscellaneous Net 238.825 348.400 372.200
 USAF Pilot-to-Dispatcher (PTD) 342.400
 USAF Pilot-to-Metro (PTM) 140.800 141.850
 USAF Range Control 319.000 322.500 347.100 349.600 351.400 359.200 "Sport"
 USAF Radar Control Facility 237.000 268.100 "Sport"
 USAF Radar Control Facility R-2508 142.025 142.750 265.500
 USAF Range Operations 141.5125
 USAF Range Safety 140.8625 141.275 150.1375 150.3875 231.125 232.275 232.875 257.250
 USAF R&D Support 308.700 (UHF Preset 20)
 USAF Supervisor of Flight (SOF)/Tech Assist 286.800 (ex-297.400) (UHF Preset 17) 375.025 (ex-262.500) (UHF Preset 18)
 USAF Test Pilots School Mission 149.150 304.000 "Cobra Ops"
 USAF Test Pilots School Operations 120.700/318.100 (U/V Preset 4)
 USAF Tower (Primary) 353.600 (UHF Preset 19)
 USAF Tower (Secondary) 138.4375 138.550 138.625 138.950 139.225 139.525 140.200 140.500
 USAF Training Air/Ground 141.1625 141.925 142.250 142.600 142.700 148.675 149.000 149.1125 293.350
 USMC HMH-764 Air/Air 32.450 34.550 291.200 326.600 363.450

Edwards AF Auxiliary North Base (K9L2)

USAF Tower 318.100 353.600

Los Angeles ARTCC ZLA (Palmdale RCAG)

Low Altitude 125.275/351.675 132.500/284.700

NAS China Lake (KNID)

USN Tower 120.150/340.200 (U/V Preset 12)

Palmdale (KPMD)

FAA Approach Control 124.550/363.000
 FAA ASOS 118.275
 FAA Ground Control 121.900
 FAA Tower 123.700/317.600 (U/V Preset 14)
 NG General Atomics Aero Systems (WCXLR) 123.225 123.325 123.475 123.550
 NG Lockheed Martin Euro Radio Test (WD2XFOW) 123.1583 123.3333
 USAF Aircraft Maintenance 138.4875/140.8375
 USAF Command Net 140.650 Simplex
 USAF Fire Alarm Systems 141.3625
 USAF Fire Net Primary 140.050/140.8875 and 149.2875 Simplex
 USAF Flight Test 361.400
 USAF Maintenance Ramp/Tower Control 138.650 Simplex
 USAF Security Force 140.075/143.025 and 140.775 142.075 Simplex

AREA CALL SIGNS

Ground Based Callsigns

AFFTC Operations Center/ROC CONFORM
 AFFTC Command Net PONDEROSA
 SPORT Radar Control Facility R-2515 SPORT

Airborne Call Signs

AFFTC Command EDDIE
 USAF Test Pilot School COBRA – Normal Operations
 AMMO – Student Crew Solo (No IP on Board)
 DRAG – Low L/D (Lifting Body Approaches)
 410 Flight Test Squadron (F-117) DAGGER
 411 Flight Test Squadron (F-22) RAPTOR/RAGE/VAPOR
 412 OG TOPS/370 FLTS (C-12, C-135, KC-10, T-3, T-38, T-39, F-15, F-16) GHOST
 412 Flight Test Squadron (Speckled Trout) TROUT
 416 Flight Test Squadron (F-16, F-15, T-38) ZOOM/EAGLE/RICK
 418 Flight Test Squadron (C-17, C-130, C-135 (Test), CV-22, C-5) ARRIS/OSPREY
 419 Flight Test Squadron (B-1, B-2, B-52) TORCH
 452 Flight Test Squadron (GH UAV, ABL) HAWK/HITEST
 Det 2, 412 OG XRAY
 AFTI AFTI
 NASA NASA

Call Sign Notes: Use numerical suffix assigned by the applicable organization. Formation flights may use the lead aircraft call sign or use the call sign of the individual aircraft. All foreign national aircraft commanders flying in the R-2508 Complex will use a "90-series" call sign (e.g. Cobra 95). For units that use tail numbers as call signs, add the number nine (9) to the beginning of the numerical portion of the call sign. Foreign national pilots or other crew members that are flying with a US pilot-on-board need not use the 90-series call sign.

CONVENTIONAL LAND MOBILE RADIO (LMR) FREQUENCIES

Note: Mode is narrowband FM unless otherwise indicated

NASA DFRC Admin Net 407.0375/415.0375
 NASA DFRC Admin Net 414.1375
 NASA DFRC Medical Safety Net 406.4375/415.4375
 NASA DFRC Miscellaneous Net 408.0875 411.5875 414.2875 417.0875
 NASA DFRC Security Net 406.2375/415.2375
 USAF Digital Paging System 413.1375 (Giant Talk) 413.500
 USAF Miscellaneous Net 413.225 413.250 413.275 413.325 413.375
 USAF Range Operations 49.650 49.850
 USAF Unknown Net 150.350

LMR TRUNK RADIO SYSTEM

System Type: Project 25 Phase I (FDMA) System ID: C007
 System Voice: APCO-25 Common Air Interface Exclusive
 Base: 406.1625 MHz Spacing: 12.5 kHz Offset: 380
 Main Site 406.7625/415.7625 407.3625/416.3625 407.4750/416.4750 407.6375/416.6375
 407.9625/416.9625 408.1625/417.1625 409.0250/418.0250 409.1625/418.1625
 409.4250/418.4250 409.5625/418.5625 409.6375/418.6375
 406.1625/415.1625 406.3500/415.3500 407.2500/416.2500 407.2750/416.2750
 Leuhman Ridge Site 407.5625/416.5625
 Palmdale 408.3625/417.3625 408.5625/417.5625 408.9625/417.9625
 Palmdale Plant 42 407.4250/416.4250 409.9750/418.9750 410.5625/419.5625
 Philips Lab Site 407.1625/416.1625 407.7625/416.7625 409.3625/418.3625
 Red Hill Site 406.3625/415.3625 406.9625/415.9625 407.9500/416.9500 410.7625/419.7625
 410.9000/419.9000
 Shadow Mountain Site 406.1125/415.1125 407.8875/416.8875 409.1250/418.1250 409.6875/418.6875
 409.8875/418.8875
 Unknowns 409.5500/418.5500 409.7000/418.7000
 Note: There are no known plans for a 380-400 MHz trunk system at this base as of presstime.



2011 Fed Files Wrap Up

It's hard to believe that 2011 is almost over. As usual at the end of the year, I have a number of *Fed Files* items that have not made it into the column yet, so let me see how many we can squeeze into November's pages.

❖ P25 Security Called into Question

A couple of interesting research papers recently surfaced on the Internet and caused some uproar in the radio communications industry, law enforcement and the hobbyist radio community.

In early August, researchers at the University of Pennsylvania released a paper entitled "*Why (Special Agent) Johnny (Still) Can't Encrypt.*" The report takes a look at the security of APCO P-25 digital radio communications systems and why the security of such systems should be a cause of some concern to law enforcement users. While the paper is somewhat technical in nature, it is a fascinating read for anyone interested in federal radio communications. You can download the research material at these links. (See also the October and November Scanning Report columns in MT for more discussion and explanation - ed.)

www.crypto.com/papers/p25sec.pdf

www.crypto.com/p25/

Unfortunately, the conclusions of the report were misinterpreted by editors across the Internet and stories about this paper seemed to indicate (in the headlines at least) that encrypted P-25 had been "hacked," as in broken to allow un-authorized users to monitor encrypted communications. Indeed many posters on radio hobby Internet forums took the erroneous headlines and ran with all sorts of uninformed commentary. These headlines were incorrect.

The basic summary of the research is that APCO P-25 digital radios are subject to both operator errors and design deficiencies that make the use of encryption sometimes difficult

for end users, thus allowing clear voice traffic to be broadcast. The authors stated that they monitored and cataloged P-25 transmissions on federal law enforcement radio channels over a period of time and found that quite a bit of sensitive information could be acquired from simply catching accidental clear radio traffic.

In addition to the problems with encryption, the research authors claimed that P-25 radio systems can be "attacked" in ways similar to attacks on computer networks. They showed that transmitting false data packets, similar to those used by the legitimate radios, could jam some P-25 radios and prevent them from properly transmitting their voice traffic.

A few weeks after this first report made its way around the Internet, another report surfaced from Australia that proclaimed researchers there had cracked the encryption scheme used by some P-25 radio systems. The paper, titled "*Insecurity in Public-Safety Communications: APCO Project 25,*" can be viewed here:

www.nicta.com.au/pub?doc=5076

Again, as in the case of the previous research, the headlines and postings about this paper seemed to be somewhat removed from the truth. In this case, the researchers revealed that some of the encryption methods available for use in APCO P-25 digital radios suffer from weak encryption keys that might be able to be discovered in a "brute force" attack on the encryption keys. Again, some of the Internet forums postings were misleading, as they proclaimed that P-25 voice encryption had been hacked.

In reality, there is no such thing as "P-25 encryption." The APCO P-25 standard allows system designers to choose from any number of encryption schemes, including Digital Encryption Standard (DES), Advanced Encryption Standard (AES) and Motorola's Advanced Digital Privacy (ADP), among many. Each of these encryption protocols have their own strengths and weaknesses and are not really dependent on the APCO 25 standard for their security.

This Australian research paper dealt with the *theoretical* breaking of DES and ADP encryption, since they are among the weakest of the available commercial encryption schemes for P-25 radio systems. The theoretical discovery of the ADP or DES encryption keys has been a well-known weakness of these cryptographic systems even before their use on P-25 radios.

Will all this attention to the shortcomings of APCO P-25 and digital encryption result in any changes? Only time will tell, but one of the recommendations of the researchers is already being implemented. More and more federal

agencies are mandating the elimination of the "secure" switch on the radio and requiring that digital channels be programmed with the encryption enabled full time so that radio users have no ability to turn encryption off. This should help to eliminate the accidental clear voice traffic that we have long sought out on federal channels.

As for unintentional, clear voice communications, scanner listeners have known this fact for many years now, ever since encrypted communications first started being heard on federal channels, even prior to P-25 digital. Indeed, that might even be considered the reason why this column exists.

As for me, I consider myself a frequency collector: I collect frequencies, channel plans, and so forth like others collect coins or stamps. While I do enjoy actually hearing what is going on over these radio channels, the fact that most federal government channels are encrypted and conversations cannot be monitored does not dissuade me from seeking out these frequencies.

❖ Presidential Travels

Early in August 2011, the White House announced a Presidential "Bus Tour" of the upper Midwest US. Much speculation went on about how this was going to be carried out and what kind of "bus" the President might be using and if this tour might make for some interesting monitoring. News reports then surfaced that the Secret Service had purchased two specially equipped buses for use by President Obama on these tours and for future bus campaign trips by the President and candidates running for the office.

During the actual tour, most of the communications came from the local and state authorities providing traffic and perimeter protection. Experienced monitors know that the Secret Service and White House Communications Agency communications are much more limited than in years past. Most routine communications are now carried out on cell phones or secure texts. But there will always be some radio traffic at any POTUS travels, and this was no exception:

164.4000, N001 - USSS PAPA
165.3750, N001 - USSS CHARLIE
166.5125, N001 - WHCA ALPHA
167.0125, N001 - USSS PPD (Presidential Protection Detail)

In addition to these known Secret Service and WHCA channels, a new frequency appeared to be in use. **169.7000 MHz, N653** was heard during the bus tour and at some of the stops.





Activity heard was definitely related to the tour and the events at the various stops. The frequency is a nationwide Department of the Interior allocation, but has some possible history of FBI use as well. The P-25 NAC of N653 has been associated with federal interoperability channels in other situations, so this one remains an unknown frequency to keep an ear on.

After the bus tour I also received some similar frequency information about a Presidential visit to the Detroit area on Labor Day:

167.0375, N001 - USSS PPD
 166.5125, N001 - WHCA ALPHA
 165.3750, N001 - USSS CHARLIE
 164.8875, N001 - USSS OSCAR

As with the bus tour, a new frequency was reported active by my Detroit source. **170.4750 MHz, NAC001** was heard active during the POTUS visit to the area, but I never received any confirmation as to what was heard and whether it was encrypted or not. The P-25 NAC appears right for the Secret Service, but also could be used by many other agencies. Again, keep this frequency in the list of unknowns to look for to see if it shows up at other times and places!

For a more complete listing of confirmed Secret Service and WHCA frequencies, check the *Fed Files Blog* page that gets updated as new information comes in:
<http://mt-fedfiles.blogspot.com/2008/02/secret-service-frequency-list.html>



❖ Federal IWN Expansion Continues

In the September *Fed Files* column, I noted the recent addition of the Washington DC area portion of the Justice Department's Integrated Wireless Network, or IWN. The original deployment area of the IWN was the state of Washington.

Since the initial 15 sites along Interstate 5, it's now grown to over 60 sites covering most of the states of Oregon and Washington, as well as the newest sites in and around the National Capitol Region (NCR).

The original design of the IWN only appeared to cover the major cities in the area and corridors along major Interstate highways. Over the last four years, many new IWN trunked sites have begun to appear across Oregon and Washington, providing coverage for much more rural areas.

There are now agreements in place to allow the Washington State Patrol (WSP) to start utilizing the IWN radio network for their own public safety communications. The WSP has identified a need for better communications in

some areas of Washington State and IWN management offered the use of their radio network. You can read more about this cooperative project at this link:

http://isb.wa.gov/lessonslearned/integrated_wireless_netproj_wsp.pdf

While this may seem to be an unusual move (having a local police agency utilize a highly secured federal communications network), there are already similar users on the IWN. The local police departments of Blain, Lynden and Sumas, Washington are already utilizing the IWN for daily police communications. This was done primarily to enhance the ability of these police agencies located on the US/Canada border to easily communicate with DHS Border Patrol agents, who are also using the IWN for communications.

Exactly how and where the Washington State Patrol will begin to use the IWN trunked system remains to be seen. But one has to wonder if this might be a way for the federal government to help offset the ever increasing costs of the IWN by selling space on the system to non-federal users.

❖ Montana BLM and BIA Frequencies

Recently I came across some frequencies for two agencies of the Department of the Interior, namely the Bureau of Land Management and the Bureau of Indian Affairs. These were contained in an MOU or Memorandum Of Understanding between various agencies in the Lake County and Missoula County areas in the state of Montana. These were designated as frequencies that can be used in a cooperative fire protection association.

Oftentimes an MOU will exist between certain federal agencies and local, county or state public safety organizations that allow some cooperative use of radio frequencies. More often than not, these are used for fire fighting in or near federally managed lands. These used to be fairly easy to find by searching on the Internet, but over the last few years, many agencies consider these For Official Use Only (FOUO), and either keep them off the web, or redact the frequency data. But keep looking: you never know what you are going to find!

BUREAU OF INDIAN AFFAIRS, FLATHEAD AGENCY Confederated Salish & Kootenai Tribes of the Flathead Nation

	Repeater OUT	Repeater IN	Tone
BASSOO REPEATER	166.9250	166.3250	110.9 pl
PISTOL REPEATER	166.9250	166.3250	127.3 pl
OLIVE REPEATER	166.9250	166.3250	114.8 pl

BUREAU OF LAND MANAGEMENT, MISSOULA FIELD OFFICE			
	Repeater OUT	Repeater IN	Tone
MOUNT SENTINEL	169.6750	169.6750	123.0 pl
ELEVATION REPEATER	162.1625	169.6750	110.9 pl
RAM REPEATER	162.1625	169.6750	167.9 pl
BELMONT REPEATER	162.1625	169.6750	131.8 pl

US FOREST SERVICE, LOLO NATIONAL FOREST			
	Repeater OUT	Repeater IN	Tone
LOLO EAST DIRECT	164.7000	164.7000	123.0 pl
LOLO AIR TO GROUND	164.8250	164.8250	CSQ
LOLO TAC 2	170.5500	170.5500	CSQ
LOLO TAC 3	172.3500	172.3500	CSQ
MINERAL PEAK REPEATER	164.7000	164.1000	146.2 pl
WHITE MOUNTAIN REPEATER	164.7000	164.1000	136.5 pl

❖ North Central CO USFS Radio Systems

And now our final installment for 2011 of monthly radio information for some US Forests and other federally managed lands across the country. This time we head over to northern Colorado and "ARP".

The Arapaho and Roosevelt National Forests and Pawnee National Grassland are located in north central Colorado.

These three federally managed areas comprise over 1.5 million acres of forests and grasslands and the combined areas are denoted as **ARP (Arapaho, Roosevelt, Pawnee)** by the US Forest Service. The headquarters of ARP is in Fort Collins, with district offices in Boulder, Fort Collins, Idaho Springs, Granby and Greeley.

Here are some of the radio channels that are in use in the Arapaho, Roosevelt and Pawnee areas:

	Repeater OUT	Repeater IN	Tone
ARAPAHO DIRECT	169.8750	169.8750	CSQ
SQUAW REPEATER	169.8750	170.4750	110.9 pl
MINES PEAK REPEATER	169.8750	170.4750	123.0 pl
COTTONWOOD REPEATER	169.8750	170.4750	131.8 pl
BLUE RIDGE REPEATER	169.8750	170.4750	136.5 pl
ARAPAHO WORK	164.1000	164.1000	CSQ
ROOSEVELT DIRECT	169.1750	169.1750	CSQ
GUNBARREL REPEATER	169.1750	169.9750	103.5 pl
DEADMAN REPEATER	169.1750	169.9750	110.9 pl
BUCKHORN REPEATER	169.1750	169.9750	123.0 pl
TWIN SISTERS REPEATER	169.1750	169.9750	131.8 pl
THORODIN REPEATER	169.1750	169.9750	136.5 pl
PAWNEE REPEATER	169.1750	169.9750	167.9 pl
PORTABLE REPEATER	169.1750	169.9750	151.4 pl
ROOSEVELT WORK	166.5625	166.5625	CSQ
AIR-TO-GROUND ZONE PRI	166.8500	166.8500	CSQ
AIR-TO-GROUND	172.3250	172.3250	CSQ
AIR-TO-GROUND BACKUP	166.9125	166.9125	CSQ
AIR TO GROUND SECONDARY	171.5250	171.5250	CSQ
WIDE AREA MOBILIZATION	163.7125	163.7125	CSQ
INTERAGENCY FIRE	168.6750	168.6750	156.7 pl
COMMON USE	168.6125	168.6125	179.9 pl

In addition to the ARP channels, they have access to frequencies for other nearby forests and national parks, including Rocky Mountain National Park, for fire incidents. Here are some channels for RMNP:

	Repeater OUT	Repeater IN	Tone
RMNP EAST DIRECT	166.3500	166.3500	CSQ
TWIN SISTERS REPEATER	166.3500	166.9500	100.0 pl
TUNDRA REPEATER	166.3500	166.9500	123.0 pl
RMNP EAST WORK	164.4750	164.4750	110.9 pl
RMNP TACTICAL EAST	164.4250	164.4250	110.9 pl
RMNP WEST DIRECT	166.3000	166.9000	CSQ
RED MOUNTAIN REPEATER	166.3000	166.9000	136.5 pl
SHADOW MTN REPEATER	166.3000	166.9000	103.5 pl
RMNP WEST WORK	171.3625	171.3625	CSQ

As always, if you have any corrections or additions to these lists, please pass them along to me at *Monitoring Times*. That's all for this month and this year. Have a very Happy Holiday Season. I will be back with more from the *Fed Files* in January!



Aeronautical Frequencies – Part 2

This column picks up from the *Monitoring Times* August 2011 issue, where we covered the basics of Clearance Delivery, Ground Control, Tower, Automatic Traffic Information Service (ATIS), Automated Surface Observing System (ASOS), Automated Weather Observing System (AWOS), Terminal Radar Approach Control (TRACON), Air Route Traffic Control Center (ARTCC), and UNICOM frequencies, plus info on the *Airport/Facility Directory (A/FD)*.

This time, we will look at “company frequencies”/VHF Aeronautical Operational Control (AOC), Fixed Base Operators (FBOs), Domestic VHF Networks, 121.5 MHz, Flight Service Stations (FSS), 121.95 - 123.6 MHz, and Airport/Airline FM Frequencies. Fasten your seatbelts!

❖ VHF Company Frequencies

These frequencies are used by Airlines, Air Cargo Carriers, Corporate Jets (BizJets), Charter Flights, Air Taxis, and others on the VHF Aeronautical Operational Control (AOC) / “Company Frequencies” to communicate with their respective company offices. They occur in the 128.825-132.0 and 136.5-136.975 MHz ranges. Company frequencies are managed by Aviation Spectrum Resources, Inc. (ASRI).

There is no easy look-up to find a list of users for each commercial airport. Each listener must create his own list by listening and by sharing info on various forums with other listeners. In order to hear the ground side, there must be one or more commercial airports within your listening radius. With a roof-mounted antenna, like a scanner discone, you may hear aircraft out to 75 miles or more if in line-of-sight (no obstructions between the aircraft and your antenna).

You will find that this is a different type of listening from Air Traffic Control (ATC) and it poses an interesting challenge. The goal is to tie a named air carrier at a given commercial airport to a specific company frequency. Some airlines will have the same company frequency at more than one airport, but there are no guarantees.

To complement the brief company frequency topic presented here, please refer to the more detailed *Monitoring Times* August 2008 *Planes* column entitled *Airline Company Frequencies*. If you don’t have that issue at hand, see if there is a back issue option that works for you at www.grove-ent.com/MT.html.

❖ FBOs

Fixed Base Operators (FBOs) are businesses at airports that provide services for pilots/companies and their aircraft when they have no facilities of their own at a given airport. Capabilities and services offered can vary from FBO to FBO. They offer some combination of things like fuel and fueling, maintenance, parts and accessories, hanger space, etc. They typically have a pilot/crew lounge, waiting areas, aero charts and manuals, and other things for sale. They have information about and can make arrangements for rental cars, shuttle service, overnight accommodations, charter flights, sightseeing, plane rentals, and more – depending. Radio exchanges can relate to the above subjects.

At towered airports, some FBOs use 122.95 UNICOM and others use frequencies in the “company” frequency range. To see if an airport near you has an FBO and a frequency, go to www.airnav.com/airports/, select an airport, and then scroll to near the bottom under “FBO, Fuel Providers, and Aircraft Ground Support.” You will see the names of any businesses and whatever frequency each may use. A frequency will usually be noted in this fashion – “ASRI 130.075”

❖ Domestic VHF Networks

The ARINC Domestic VHF Voice Networks also carry similar traffic. In ARINC’s words: “ARINC’s Air/Ground Domestic Voice Service is the aeronautical industry’s air/ground voice communications link for aeronautical operational control (AOC) messages.” Go to www.google.com and enter “ARINC-1 VHF Radio Networks” (with the quotes). It will be at or near the top of the search result list.

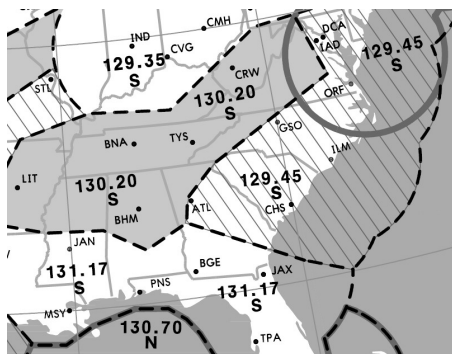

This is a portion of the ARINC-1_VHF Domestic Network map. “S” under a frequency means it is controlled by facilities in San Francisco. “N” means New York. Courtesy: Jeppesen

The site will provide a nice PDF map of the U.S. showing the frequencies. Enter the frequency or frequencies for your listening radius into your scan sequence. You should hear talk from time to time.

❖ AOC Message Content

The above-mentioned frequencies belonging to “company,” FBO, 122.95, and the ARINC VHF network can produce rather routine traffic like flight arrival times, needed supplies, maintenance issues, requests regarding specific passenger needs, etc. What you hear on these frequencies can often be tied to what you hear on ATC frequencies for the same planes, which can help to identify them.

Messages can include aircraft and medical emergencies which may necessitate phone patches to support personnel on the ground. This can be quite interesting, but remember that phone patch, personal information, and security type message content is sometimes sensitive. When in doubt, do not post it or do not include any personally identifying detail to Internet discussion forums.

❖ 121.5 MHz

The VHF emergency frequency is 121.5 MHz (243.0 for military). It is also known as “Guard” and International Air Distress (IAD). Put it in your aircraft scan sequence. It may not talk often, but when it does it can be interesting, as the frequency is used when a pilot is having a serious in-flight problem. The frequency is monitored by many Air Traffic Control Facilities and by many airlines in flight.

- There are other uses for 121.5 MHz:
- One is when an aircraft does not respond on its controller-assigned frequency. A TRACON (Terminal Radar Approach Control) or ARTCC (Air Route Traffic Control Center) controller may call the aircraft on the Guard channel. If contact is made, the pilot will be asked to change to a specified ATC frequency.
 - When a transoceanic aircraft does not respond on its assigned HF frequency, it is not uncommon for the ARINC operator to contact another aircraft that is likely to be within VHF range of the anticipated position of the non-responding aircraft. He will ask the assisting pilot to call the non-responding aircraft on Guard, since VHF does not go far beyond the coastline. If contact is made, the assisting pilot will give the specified HF frequency or relay the status of the non-responding aircraft back to the controller.
 - When an unauthorized aircraft is about to enter or has entered a restricted airspace, warnings of military interception to civil aircraft will be given on 121.5 MHz. From the FAA *Aeronauti-*

cal Information Manual: "All aircraft operating in the U.S. national airspace, if capable, will maintain a listening watch on VHF guard 121.5 or UHF 243.0. It is incumbent on all aviators to know and understand their responsibilities if intercepted. Additionally, if the U.S. military intercepts an aircraft and flares are dispensed in the area of that aircraft, aviators will pay strict attention, contact air traffic control immediately on the local frequency or on VHF guard 121.5 or UHF 243.0 and follow the intercept's visual ICAO signals. Be advised that noncompliance may result in the use of force."

- Emergency Locator Transmitters (ELTs) are required for most General Aviation (private) aircraft. When an ELT experiences an impact, such as when a plane crashes, it automatically begins to transmit a signal by battery power to assist others in finding the downed aircraft. The frequency for civil aircraft has been 121.5 for a long time. These analog devices simply send out a homing signal. Newer ones are on 406 MHz and digitally transmit owner and aircraft data and some include flight data and GPS location information. However, many older ones are still in use. Commercial airline pilots who monitor 121.5 will report such reception, along with their own position and altitude to ATC when they hear them. Hobbyists can hear this on their scanners if it happens within listening range.

❖ Flight Service Stations

A Flight Service Station (FSS) as described in the FAA *Aeronautical Information Manual* is: "An air traffic facility which provides pilot briefings, flight plan processing, en route radio communications, search and rescue services, and assistance to lost aircraft and aircraft in emergency situations. FSSs also relay ATC clearances, process Notices to Airmen, broadcast aviation weather and aeronautical information, and notify Customs and Border Protection of transborder flights. In addition, at selected locations, FSSs provide En Route Flight Advisory Service (Flight Watch) and Airport Advisory Service (AAS)."

FSS frequencies are not as active as ATC frequencies and may be found in the rear section of the *Airport/Facility Directory (A/FD)* volumes as described in the August 2011 *Monitoring Times* issue. Their frequencies may also be found on aero charts.

For on-line aero charts, go here www.airnav.com/airports/ and pick an airport, scroll down, and click on the Sectional Chart on the right. Zoom in as needed. Click on the chart and drag as needed. You will see info boxes on the charts similar to the graphics in this column.

❖ 121.95 - 123.6 MHz

You may find some interesting *uses* and *users* in the 121.95 - 123.6 MHz range. It com-

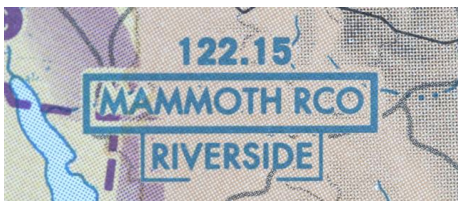

122.15 is the frequency for both the aircraft and the ground side. "MAMMOTH RCO" is the name of the Remote Communications Outlet. "RIVERSIDE" is the particular FSS facility.

prises 66 frequency allocations for non-ATC functions. It includes most of the FSS frequencies. Here are some of the things you may run into not otherwise mentioned above: News helicopters, law enforcement, search & rescue, air-to-air, flight test, gliders, aviation support, pilot training, aircraft with parachute jumpers, fire fighting aircraft, and medical transport flights. For searching this range in busy metro areas, you may wish to divide up this frequency range into narrower searches.

❖ Airport FM Frequencies

Many airports are busy places with all kinds of things going on. The various activities are often assisted by the use of two-way FM radios.

The extent and the names of the various functions vary from airline to airline and from airport to airport. Here are some examples (not drawn from any one single airport): Customer Service, Baggage Handling, Cargo Handling, Ticketing, Gate & Ramp Agents, Individual Airline Operations (Ops), Mechanics, Ground Crews, Fueling, Cabin Service, Tow Maintenance, Ground Transportation, Facilities Maintenance, Parking Lot Control, Concessions, Airport Authority, Rescue/EMT, and more.

The FM frequencies used at airports may be found in many different bands, not necessarily those dedicated for airport use. There is an exception. The primary use for the frequencies in the 460.650 - 460.89375 / 465.650 - 465.89375 bands is for "the servicing and supplying of aircraft" and designated as "Airport Terminal Use Frequencies."

Unlike most AM aero frequencies, these airline and airport frequencies are a little harder to come by. Try poking around at www.radioreference.com and use the search box at the top right. Here are some examples:

- "US Airways (McCarran International Airport)" shows a 900 MHz trunked system www.radioreference.com/apps/db/?sid=3454.
- "John Wayne-Orange County Airport (SNA)" shows mostly 460 MHz and a list of "Airline Dispatch" (company) frequencies www.radioreference.com/apps/db/?aid=4749.
- "Dallas/Fort Worth International Airport (DFW)" nice company freq list and more 460 MHz www.radioreference.com/apps/db/?aid=6855.
- "Metropolitan Washington Airports Authority" shows an 860 MHz trunked system <http://www.radioreference.com/apps/db/?sid=229>.
- "Los Angeles International (LAX)" www.radioreference.com/apps/db/?aid=5824 has lots of most everything listed.

Among the FM frequencies used at airports, some are simplex, some are repeated, and some are trunked. On the average, they are low power,

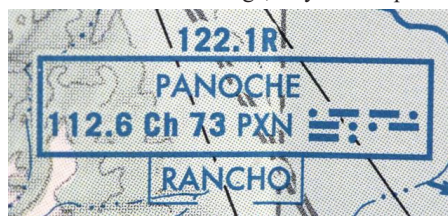

122.1R is the frequency on which the FSS listens and the VOR frequency of 112.6 is the frequency on which FSS talks to the aircraft. "PANOCHE" is the VOR station name. "RANCHO" is the FSS facility name.

so closer-in monitoring may be required.

In addition to Airport Security/Police, large airports can also have a presence from among: Transportation Security Administration (TSA), U.S. Customs and Border Protection (CBP), Immigration and Customs Enforcement (ICE), Drug Enforcement Administration (DEA), and the Federal Bureau of Investigation (FBI).

❖ Changing Technology

With the move to narrow banding to squeeze more FM frequency allocations into given frequency ranges, you may encounter Narrow FM (NFM) and "in-between" channels on some of these airline/airport frequencies. If your scanner is older, NFM reception will be at a lower volume level, the new/added channels will not program exactly, and there is the possibility of adjacent channel interference. When NFM, trunking, and P25 start leaving you out of the loop, it may be time to start saving or shopping for a new scanner.

❖ Yahoo Group

If your interests include discussing airline company communications, Airline Operations and FBO's, the VHF Networks and FM Airline Frequencies, Airline Hubs and Routings, Airport Diagrams and Gate Maps, and more. Take a look at <http://groups.yahoo.com/group/ScanAirlineOps> - See you next time!

**EARN YOUR
HAM RADIO LICENSE
THE QUICK AND EASY WAY!
NO MORSE CODE REQUIRED!!**

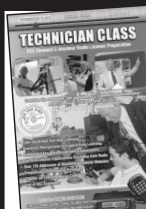

Start earning your Technician ham license today! Get on the air and enjoy the fun hobby of amateur radio. Learn from the best - Gordon West, WB6NOA. Study book includes all possible test Q&A, and more.

GWMT \$20.95+\$6 S&H

Study at your PC using W5YI interactive practice exam software with book. **NCS \$29.95+\$6 S&H**

**ENJOY WORLDWIDE
LISTENING FUN!**



Figliozi's new *Worldwide Listening Guide* explains radio listening in all of today's formats—"live," on-demand, WiFi, podcast, terrestrial, satellite, internet, digital and, of course, AM, FM and SW. Includes a comprehensive program guide to what can be heard how, when and where. Spiral bound to open in a flat, easy-to-use format.

WWLG \$24.95+\$6 S&H

THE W5YI GROUP
POB 565101 - Dallas, TX 75356
Order today on-line or by phone:
www.w5yi.org • 800-669-9594
Mention this ad to receive a free gift with your order!



Clearing out the GN Mailbag

I have always encouraged my readers (you) to send in questions or comments for inclusion in the *GlobalNet* mailbag. Whenever I get a chance, depending on space, I try to include your emails here in my column.

This month, not only did we have several submissions to the mailbag, but I had the space to include several of them in the column. So, let's see what our readers have on their minds as we dig some e-mails out and answer your questions. I want to thank each of these readers for submitting their questions for this month's column. Remember, you can always submit your questions or comments to loyd@globalnetmt.com or loydvanhorn@monitoringtimes.com.

❖ Aero Listening

Hi Loyd - I subscribe to Monitoring Times. Your page will be the first that I go for, then the 'What's New' page. I travel every year to the Caribbean from Canada for the winter. Have since got interested in airlines and their magazines. Have portable scanners that I take with me. Now for years have heard the VHF/UHF transmissions. Can you direct me to Web sites where one can receive HF frequencies or receivers on the market you can buy? Much obliged for some tips. Monitoring Times is great reading, keep up the good work to all the folks. Best regards; Neville L. Seaton

Neville – Probably the best one-stop place on the Web to find HF Aviation transmissions is LiveATC (find a link in the GlobalNet links below). Here you can find streams for transmissions for Atlantic, Pacific, African and Caribbean regions. Streams can be tuned in using Winamp, iTunes, Windows Media Player, RealPlayer, or by Java or Flash plug-ins for in-browser listening.

There are no dedicated streaming receivers for LiveATC streams (although, that wouldn't be a bad idea), but there is a LiveATC.net app for smartphone users. If you have a smartphone, you can download the app and listen to the same HF

streams you can access from the Web site. Check your smartphone app store for more information. Hope this helps answer your question!

❖ Apps for Computer?

Loyd - This question may be of interest for the GlobalNet column. How do I run mobile device apps on my Windows XP home desk computer? I have tried it but get some kind of error message about HTML5. There are so many interesting apps out there for sale. It would be nice to run some of them on my desk computer. Thank you. William Tobin, Albuquerque NM

William – There are emulators you can download which will allow you to run some mobile device apps on your computer (usually those that are Java-based). From a streaming standpoint, right now you cannot run an emulator to operate any apps that require Internet access (as in those that stream Internet radio, etc.). However, I don't think you will be happy with the results in any case.

While I understand that you might have interest in running these smartphone apps on your computer, there is no easy or really effective way to do this. There are no options currently available to allow you to operate your apps in the way you are accustomed to on your devices. First, most require a touch-screen interface. The multi-touch mouse and trackpad for Macs gets you close to this, but again, it isn't the same as what you would experience on your smartphone device.

If you are looking for a larger screen interface for your apps, the best bet is to look at one of the tablets that are now on the market. There are a number of new tablets available that range in price enough that they should be able to fit most budgets. There are devices for both Android and iOS operating systems. There are other operating systems available, but these might be limited in the number of apps that are available for them.

I, too, have thought that it might be useful for certain apps to be accessible on your computer.

For a streaming app, for instance, it might be helpful to have access to all of your streams from one location, rather than having to bookmark a bunch of Web sites or even specific streams.

❖ ooTunes

Hi - I read your article in the latest issue of Monitoring Times about Internet radio and was wondering what you thought of the app ooTunes. I like TuneIn Radio and am interested in finding stations from other countries, especially ones that are or were on shortwave. Also maybe a way to get these stations/shows recorded for later playback where I don't have access to WiFi. Thanks, Mike Garcia

Mike – ooTunes was one of the first streaming apps I downloaded for my iPhone, because I had already used it on the BlackBerry platform. It is definitely a good app for streaming radio use, but for what you are trying to do, I think TuneIn is closer to what you are looking for.

The main difference between using ooTunes versus TuneIn is that while both record streaming content, ooTunes starts recording once you start playing the stream. Personally, I prefer the TuneIn interface that allows me to decide when I am going to record streaming content. With this method, even if you decide you want to go back and record something you already heard, you can move the slider back to the point where you want to begin recording and hit the 'record' button. This way, you don't miss anything, but you also aren't using up your device's storage space on recordings you aren't interested in.

Another feature I like with TuneIn is that I already use TuneIn's Web site to listen to streams, so I have favorite stations set up that I can access easily on the app or the Web site.

Both apps use the TuneIn database of stations, which means you can find stations by searching by location to find those stations in other countries as you mentioned. There is a wealth of stations available through either app.

My suggestion is to read the reviews and features of both and decide which one meets your needs the best.

❖ Ear on Florida Weather

Loyd - While reading some of my back issues of MT, I came across your article on tracking the tropics. I use Weather Underground which is good but I was just recently introduced to myfloridahurricane.info, which is great, since I live in Delray Beach Florida. This site

ATC Facility	ATC Radio Frequencies
HF (Shortwave) Oceanic ATC Feeds HF Atlantic Oceanic (NAT-A) Amherst, New Hampshire, United States Feed Status: UP Click on your favorite media player to listen: Or simply listen in your browser: LISTEN (in browser, requires Flash) LISTEN (in browser, requires Java) LISTEN (Standalone Java player) Listeners: 2 out of 2512 total	NAT-A: 3.016 NAT-A: 5.598 NAT-A: 13.306 HF Oceanic Frequencies NAT Westbound Tracks NAT Eastbound Tracks Receiver location: Amherst, NH Antennas: DX Engineering DXE-ARAV2-1P (Active Vertical Receive Antenna) Note: Receiver switches frequency every 60 minutes to follow radio propagation

has – and I am not kidding – 50 weather maps to check out as you scroll down the page. I am using a WINRADIO for the fax maps and my 1980 Drake R7 receiver driving a Universal V1 M-8000 decoder into a Hitachi CRT monitor. Am using an ICOM IC-75 Rcvr., BC-996XT for the trunked Palm Beach County Fire Rescue traffic, and an ICOM IC-R7100. My antenna is a 4-story rain drain pipe that branches out to an inverted L zip-wired with an alligator clip to the drain pipe strap and terminated to a banana plug into the SO 239 plug on my MFJ-1610 antenna tuner. 73s, Jeff Michaelson, Delray Beach, Florida

Jeff – Thanks for the heads up on the Web site. I have since taken a look at it, and I must say, there is a lot of information here that is helpful for anyone looking to track hurricanes as was discussed in my recent column (July 2011 MT).

While, from a streaming standpoint, there aren't any resources here on listening to hurricane coverage, knowing where activity is going to happen is crucial in planning your listening strategy and knowing where to focus your streaming listening. That is why Web sites like this one are a crucial tool to any listening enthusiast. Thanks, Jeff, for your contribution. By the way, that is a nice sounding setup!

Thanks again to each of our readers that submitted their questions this month. It is always nice to be able to interact directly with the people that read the column!

❖ News Flash concerning Flash

All of the iOS users that have lamented for several years now that the iOS version of Safari did not support Flash videos, fear not. There is an answer coming soon!

Adobe's Flash Media Server 4.5, while not an actual support by the iOS version of Safari itself, is going to be a work-around for iOS users to at least be able to access Flash video content on their devices.

The way it works is that the Flash Media Server will detect what type of device is attempting to access Flash content, and then deliver it in a format that the device will support.

For those using an iOS device, this is a perfect answer. You will have the ability to access Flash videos without the device's resources being drained of processing power and battery life that other Flash-supported devices typically encounter.

This doesn't fix the Apple/Flash dispute that has been raging for several years, and in fact, this may even add an extra wrinkle to it. Also, Flash-enabled advertisements and Web sites constructed in Flash format will not be supported (yet). But for those wanting to access Flash videos on their devices, it's at least a start.

❖ New AirPlay Devices Hit the Market

While they were among the first developers to add AirPlay functionality to their A/V receivers, Pioneer has now added AirPlay to some of their tabletop devices as well. Pioneer's



MusicTap systems (\$399 for the Pioneer-branded system, \$479 for the Elite-branded system) began shipping last month.

The devices will allow iOS users not only to stream audio content from their iOS devices using the AirPlay functionality, but they can also use their iOS device as a remote control for the system. The MusicTap system uses a WiFi network to stream audio from an iTunes library, an AirPlay-enabled app, or music stored on the iOS device through the MusicTap system.

It's a bit pricey, but for those looking to simply have the ability to use AirPlay to stream their favorite audio apps and files through an audio system, this might be an option to consider. For those who scoff at the price tag, fear not: developers are continuing to add AirPlay functionality to their devices, so hopefully, a more consumer-friendly device will be on the market soon.

One such option is the iHome iW1 system. At a retail of \$299, it is a little more affordable, and is a little more portable than the MusicTap systems. The iW1 utilizes a rechargeable battery and premium speakers to bring AirPlay functionality where you want it.

It will be interesting to see if AirPlay becomes a more standard feature as more developers add it to their devices. With the sheer number of iPhone, iPod and iPad devices in the hands of consumers, this should be an increasingly popular and desired feature for consumers.

That will do it for this month. Next month is going to be the final issue of 2011. It hardly seems possible we have already gone through another year. In the early part of 2012, I will be celebrating 3-1/2 years of writing this column: another milestone that doesn't seem possible!

Until next month, 73s!

GLOBALNET LINKS

LiveATC HF Streams - www.liveatc.net/feedindex.php?type=hf
 My Florida Hurricane Info - <http://myfloridahurricane.info/>
 Flash work-around comes to iOS devices - www.digitaltrends.com/mobile/adobe-flash-is-coming-to-apple-ios-devices/
 Pioneer to add AirPlay functions to tabletop devices - www.twice.com/article/473373-Pioneer_Adds_AirPlay_To_Tabletop_Music_Systems.php
 Pioneer's Music Tap System - www.digitaltrends.com/home-theater/pioneer-music-tap-speaker-systems-support-apple-airplay/
 iHome iW1 - www.ihomeaudio.com/iW1BC/

GRACE Wi-Fi

Play Internet radio, music services, iTunes and windows media player in any room of your house

Order DS-IR2500
\$129^{95*}



The new Grace Wi-Fi Stereo Micro System (GDI-IRMS300) is perfect for your apartment, den or office. Listen to and create Pandora stations, NPR, Rhapsody, your local and international AM, FM and HD radio stations, iheartradio and even Sirius XM Internet radio without a satellite dish. Direct from your broadband DSL or cable internet connection. No computer needed.

Order DS-IRMS300
\$199^{95*}



* plus \$13.95 UPS
 Ground or Priority
 Mail shipping

GROVE

800-438-8155
 828-837-9200
 fax: 828-837-2216

order@grove-ent.com
 7540 Highway 64 West
 Brasstown, NC 28902

www.grove-ent.com

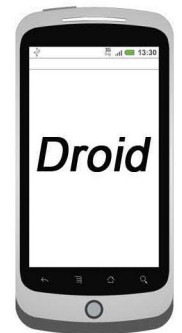

App Blanks

Get the Book that will help you
 create and design your apps



Visit this site today:
www.appblanks.com



BELOW 500 kHz

DXING THE BASEMENT BAND

Kevin Carey, WB2QMY
kevincarey@monitoringtimes.com

Tackling an RDF

From time to time a hobbyist may need to take stock of what projects are on hand, the status of those projects, and the probability of bringing them to successful conclusion. In my own case, I have a number of radio projects awaiting my attention, and the time has come to decide whether or not to make repairs, move them on to “new homes,” or discard them altogether. Of what use is it to collect more project sets when you’re running out of room for the ones you already have? It’s time to downsize and simplify.

To improve things, I have created a list of likely candidates for repair. I plan to tackle them one at a time in an attempt to get my backlog under control. I will cover some of these projects in *MT*. This will allow me to make forward progress while doing something I enjoy (writing). Perhaps it will also inspire others facing similar tasks and stimulate further discussion in the column – always a good thing. Two-way contact is welcome and encouraged here!

❖ Project No. 1 – an RDF

First on the list is an *Aqua-Guide* Radio Direction Finder (model RDF 304) shown in Figure 1. According to the rear panel label, the set was made by Columbian Hydrosonics Corp. of Freeport, NY. This Long Island firm was a subsidiary of the Columbian Bronze Corporation, maker of high end marine propellers. According to a source attributed to *Newsday.com*, Columbian Bronze was founded in 1901 and made the propeller for *Nautilus*, the world’s first nuclear-powered submarine. They are said to have closed their doors in 1988. I’d appreciate any other information on this firm, especially the division that made this radio.

I don’t recall just where I found this set, but most likely it was at one of the many hamfests we have here in Western NY, quite possibly at the big one: Rochester. The price was probably less than \$40, which I consider to be reasonable for these older RDFs, provided they are complete. I have not yet powered it up, so I don’t know what, if any work it will require. Most likely it will need something. This article will cover the steps I go through to evaluate it and make any necessary repairs.

Some Background

About 10 years ago RDFs began showing



Figure 1. The *Columbian Aqua-Guide* is a solid state radio direction finder covering longwave, AM broadcast, and MF marine bands. I’m starting it up for the first time in this column. (Photo by Kevin Carey)

up at swap meets as GPS began to take its position in recreational boating. Longwave marine beacons had been phased out well before that, so boaters still using RDFs had to rely on longwave aero beacons or AM broadcast stations to get their bearings. Eventually, most users just retired their old RDF sets, and they continue to show up at hamfests today for reasonable prices.

RDFs can make excellent receivers for beacon chasers because they are generally quite sensitive, selective, and have highly directional antennas built right in. We’ve discussed RDFs before, and I encourage anyone wanting to know more about them to visit the excellent website at www.angelfire.com/space/proto57/rdf.html. (The link opens two advertising windows on top of the desired site, so just close these and you’ll be ready to go.)

I spoke with the creator of the RDF website to see if any documentation might be available for the RDF 304. Apparently, it is a rather scarce unit, as nothing more than a magazine advertisement from the early-1960s could be found. I’ve run requests for a manual or schematic here and in other publications, but to no avail. As a result, I will have to “go it alone,”

without even a wiring diagram for the set. Obviously, this is not the ideal way to go, but I am out of other options at this point! In truth, I have little to lose by tackling the challenge with some common sense and my experience with similar sets. The radio really doesn’t owe me anything.

First Checks

My first check is to see if the radio plays. To do this, I need to figure out how to power it. A label on the rear panel indicates that it runs on nine “D” cell 1.5 volt flashlight batteries. It shows no provision for external power, so there must be a battery holder inside. Upon removal of the rear panel I found it attached to the backside as shown in Figure 2.

Luckily, the battery tray shows no signs of corrosion. This is a real risk on such a set, due to simple battery cell leakage and because the radio was probably used in a marine environment. The previous owner apparently had the foresight to remove the batteries when taking the radio out of service, preventing one source of possible corrosion.



Figure 2. *RDF 304* with rear panel removed. “D” cell battery tray is shown in foreground, facing down on the bench. Luckily, it shows no signs of corrosion. (Photo by Kevin Carey)

Powering it Up

Not wishing to go out and buy nine “D” cells just to do a simple test on the radio, I did some math and determined that the set was intended to run on a nominal 13.5 Vdc (1.5 volts x 9 cells in series = 13.5 Vdc). Instead of batteries, I will connect my 12.8 Vdc benchtop

power supply to the radio, with the positive lead attached to the white wire on the battery tray, and the negative to the black wire.

Turning the set's power to ON, I am almost immediately greeted by background noise from the speaker.

Tuning around the longwave band has revealed a few beacons, and I can hear plentiful stations on the AM broadcast band, too, but the audio from the set is very distorted. It sounds severely compressed. The signal strength meter and all other functions seemed to be working fine. Distorted audio then, appears to be the major problem with this set, and will be the focus of our repair efforts.

Could it be a faulty speaker? An alignment issue? Bad audio coupling capacitor(s)? These are some of the things we will check into, so please come back next month for another installment of this adventure. Now, let's share some other news of longwave interest...

❖ Two Standout Websites

Here are brief descriptions of two websites I highly recommend for longwave enthusiasts. Be sure to check them out!

The **WebSDR Receiver** located in Delft, Netherlands, is operated by Wouter Weggelaar, PA3WEG, and can be accessed at <http://websdr.pa3weg.nl/>. This site allows multiple users to tune a VLF receiver in real time. All you need to do is go to the site, click the band you want to hear (VLF or 500 kHz) and turn your speakers up! I have used this site to listen to the historic transmissions of SAQ on 17.2 kHz, as well as other VLF signals.

The **NDBRNA Database** website at www.classaxe.com/dx/ndb/rna/index.php is nothing short of amazing. Site creator Martin Francis of Ontario, Canada has done an excellent job collecting and presenting beacon loggings from all across North America.

Want to see if a particular beacon near you has been heard from afar? No problem, it will tell you who has heard it, when, and where they are located. Are you chasing a challenging DX target and want to know what else is on or near the frequency? Again, no problem – all of this data is shown. You can search for an unidentified beacon you have heard, and even add your own loggings to the list to help others.

❖ Mailbag

An abbreviated form of our Mailbag feature is presented this month because we have many contributions (some that I've held onto for quite a while) and limited space in the column.

Kriss Larson, KR6ISS (CA), heard "datalink" transmissions between 130-150 kHz during a recent trip to Ireland. He was informed that they are signals from a vehicle tracking system used mostly by armored car companies to know exactly where their trucks are at all times. The low frequency transmitters put out a signal that is picked up by the trucks where a position is calculated, and then a UHF transmitter on the truck sends the position to a local receiving antenna which relays it to the headquarters. Why GPS wouldn't do the same thing equally well is unknown, except it may deal better with signal blockage problems, especially in congested areas, he says.

NEED Mystery: *MT's* own **Ken Reitz, KS4ZR**, checked in with a question about an unknown signal heard at 505 kHz. He was tuning a new Alinco DX-R8T/E receiver when he copied NEED at this frequency. He couldn't find any information about it other than the fact that it has been monitored for years. He wonders what the story is on this signal.

NEED has been a stubborn mystery. The only thing I've gathered from monitoring the online chatter about this station is that it is likely a military installation located somewhere on the East Coast. Adding to the mystery is that it only operates sporadically, perhaps in support of military training flights.

The oddity of a 4-letter ID has also been discussed, and there is a possibility this is a miskeying issue. The latest information learned via the NDBRNA site (mentioned earlier), is that this could be a portable military NDB under test at Fort Rucker, AL. Directional bearings from other readers are welcome, so that we can put an end to this mystery.

John Wheaton, KI4VXU (TN), wrote with a report that PBC/365

in Mt. Pleasant, TN has gone silent after miskeying as "PBK" for nearly a year. He also reports that LYQ/529 in Morrison, TN is silent for the 2nd time in the last year. He's listening with a Ten-Tec RX-350 which is not guaranteed to work below 100 kHz, but he finds that his does just fine when used with a LF Engineering Co. preamp.

Finally, John wonders if LF and VLF signals originating on Earth can be heard in outer space? I don't know the answer to this, but I do know that whistlers and tweeks are propagated in the waveguide "duct" formed between our atmosphere and Earth, so my feeling is that they would not be propagated very well outside of the atmosphere. On the other hand, some extremely low frequencies are used to communicate through the barrier of water (for submarine communication), so I hesitate to say for sure how well these signals would travel beyond the limits of Earth. How about it readers? Anyone have additional information that would answer John's question?

Bruce Egloff, SWL WDX2TAU (NY), wrote with a report from his far Western NY location. He has logged over 170 beacons since beginning his quest in 2009. YQ in Churchill, MB was one of his first loggings. More recently he has heard RB in Resolute Bay, NU on 410 kHz, which also ranks as his most distant catch so far. His farthest catch to the south was CBC in the Cayman Islands.

Ralph Craig, AJ8R (OH), is a retired FAA Supervisory Electronic Technician who is very familiar with LF beacons. He has written articles featured in *MT* and other publications. He notes that LUK/335 (Cincinnati, OH) mentioned in an earlier issue, used the middle tower of an old four course A/N radio range when he was still with the FAA. The towers are now gone and the site is home to a recreational park.

The current LUK is located in a nearby RCAG (Remote Center Air/Ground) facility. Ralph has visited the site, and reports that the antenna is only about 10 feet tall with a small capacity hat. The transmitter itself is mounted in a small box attached to the mast, he reports.

That's it for this month. Have a great Thanksgiving. □

NOW AVAILABLE

Radio hobbyists interested in receiving and identifying radio stations in the HF/VHF/UHF radio spectrums now have a new whopping 1414 page CD-ROM publication to aid them.



International Callsign Handbook is a concise world directory of various types of radio station identifications covering the military, government, maritime, aeronautical, and fixed radio stations on CD-ROM. Thousands of callsigns and other types of identifiers have been collected from our own personal log book, official sources and dedicated hobbyists who contributed their material.

World QSL Book - Radio hobbyists interested in receiving verifications from radio station now have a new CD-ROM publication to aid them in the art of QSLing. This 528-page eBook covers every aspect of collecting QSL cards and other acknowledgments from stations heard in the HF spectrum.

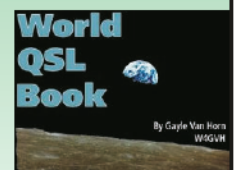

"I'm impressed. This is a comprehensive collection of worldwide radio identifiers likely (and even some less likely) to be heard on the air. Over the years the Van Horns have earned the well-deserved respect of the monitoring community. Accurately assembling a collection like this is a mammoth undertaking. Congratulations on a job well done."
Bob Grove - December 2008 *What's New Column, Monitoring Times magazine*

Both books may be ordered directly from Teak Publishing via email at teakpub@brmemc.net or via our two main dealers, Grove Enterprises, www.grove-ent.com, and Universal Radio, www.universal-radio.com.

TEAK Publishing
PO Box 297
Brasstown, NC 28902
teakpub@brmemc.net

From Teak Publishing either book is \$19.95 plus \$3.00 (US) and \$5.00 (Int'l) first class mail. Paypal, Cash, Check or Money Order accepted. NC residents add state sales tax.
Dealer inquiries/orders welcomed.



RADIO RESTORATIONS

BRINGING OLD RADIOS BACK TO LIFE

Marc Ellis, N9EWJ

marcellis@monitoringtimes.com

Addressing the Meissner Mystery

❖ From the Readers

I'm pleased to be still receiving reader feedback on our BC-1206-C aircraft receiver project.

Michael Allen, W6EAV, (Fort Benton, MT) may be inspired to fire up a 1205-A he acquired many years ago and had done nothing with. His set was made by Detrola and has octal tubes rather than the Loktals in my radio. He suggested that the troublesome buzz saw noise I was experiencing might have been due to the fact that I had kept the original bypass capacitors – which he felt might well be leaky. This opinion was echoed by Anthony Jacobs (Youngstown, OH), who suggested specific capacitors that might cause buzz saw type regeneration if leaky or shorted.

Regular readers may recall that I had decided not to replace the bypasses – an unusual decision for me – because the radio had obviously been stored in environmentally decent conditions, the capacitors were 250-volt units, and there was no voltage greater than 32 in the radio. In a later article, I reported hearing the same buzz-saw noise in another LF set (a BC-344) – which would seem to prove that the noise was coming from outside the BC-1206-C. I'll try listening again come winter, when the QRM situation should be much improved.

Michael also called attention to an unusual circuit trick employed in the 1206. The negative voltage developed at the grid resistor of the local oscillator (R11 on the schematic shown in the September column) is used to bias the audio output stage. He suggests that "...if you only have 28 volts to work with you don't want to waste any volts on a cathode bias resistor." Michael surmises that this trick might well have been used on the old 32-volt farm sets that ran on wind-powered lighting plants.

I also heard from Iden Rogers, K6JHQ, who is an editor in MT's "Boats, Trains and Planes" column. He tells me that he has enjoyed the BC-

1206 coverage. He had purchased a 1206 about 1958 and was amazed by the low plate voltage. The 1206 might have been his introduction to NDB (non-directional beacon) DX-ing, which he still does in the winter months. However, he didn't take that set with him when he moved in 1998, a decision he regrets.

❖ The Meissner Puzzle

Our current project is a Meissner 7-Tube "Utility" Broadcast Receiver, also known as the Broadcast "7" (all quotes are Meissner's). When I first acquired this set, I tried to identify it by checking my copies of the Meissner "How to Build" manual. As mentioned last time, these Meissner publications contain technical and assembly information – including schematic and pictorial diagrams – on every Meissner kit available at time of printing.

I first assumed that what I had was the two-band "7-tube Broadcast and Shortwave Receiver." This was a logical assumption because the receiver's slide-rule dial had a 6-18 MHz scale in addition to the broadcast band. However, the pictorial for that set showed four controls on the receiver's front apron (Sensitivity, Volume, Tone/on-off, and Bandswitch) in addition to the tuning control. But the control configuration on my set matched that in the pictorial for the "Utility" Broadcast Receiver. That diagram showed only two controls (Volume and Tone/on-off) in addition to the tuning control.

As mentioned in the previous column, I was beginning to think that the original kit builder had accidentally received the wrong dial scale and never bothered to have the factory make good on it. That wouldn't be typical behavior for the average electronics hobbyist – including myself – but it was all I could come up with at the time.

Even if that was true, however, it wouldn't explain another anomaly that I noticed when comparing the component layout diagrams with the actual layout of

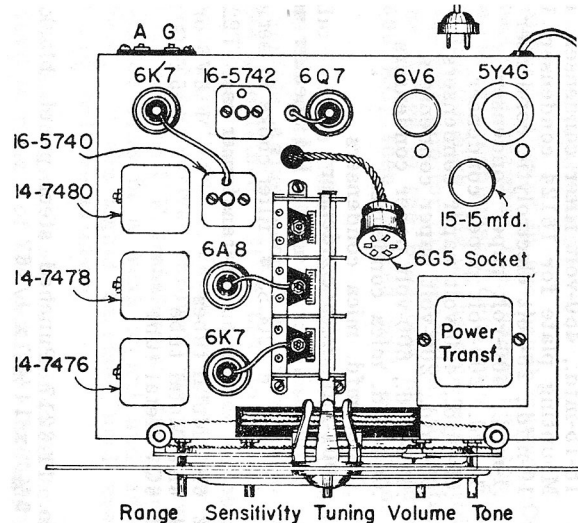

Fig. 2. Chassis Layout of the Broadcast and Shortwave Receiver

my set. The diagram for the "Utility" Broadcast set (Figure 1), which does not match my layout, shows the antenna, r.f., and oscillator coils, in round cans, mounted alongside the three-gang tuning condenser. The r.f. tube, oscillator tube and first i.f. transformer are mounted beside the coil cans along the edge of the chassis.

On the diagram for the "Broadcast and Shortwave receiver" (Figure 2), the positions of the coils and other components are reversed. The tubes and i.f. transformer are mounted alongside the tuning condenser, while the three coil cans (which are square rather than round) are mounted along the edge of the chassis. This *does* match the actual layout of my receiver, even including the shape of the cans.

Now I was really scratching my head. Why would my set share the dial and coil arrangement of the broadcast/shortwave radio yet lack a bandswitch or any other sign that it could receive on shortwave? I could see why such hybrid construction was possible because – judging from the pictorial diagrams – the same chassis base was used for both models. For example, the hole pattern that accepted the bandswitch on the broadcast/shortwave model is shown, unused, on the broadcast only model.

Now wondering if my radio might be more closely related to an earlier or later variation, I began to look on line for other editions of the "How to Build" books. In my library I have a Lindsay Publications reprint of the 1943 edition and an original copy of the 1949 edition. My online search turned up a free copy of a 1953

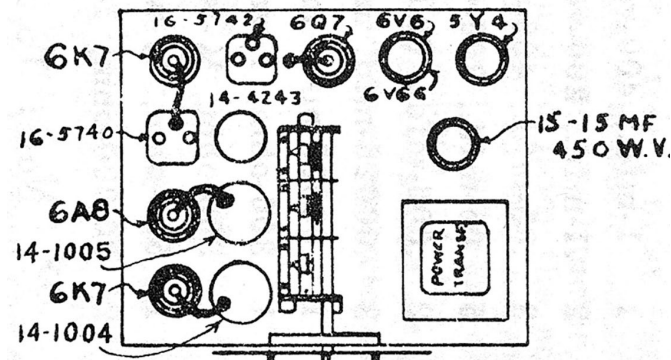

Fig. 1. Chassis Layout of the Meissner "Utility" Broadcast Radio.

MEISSNER ADJUSTABLE UNIVERSAL COILS

Adjustable inductance. Hi-Q. iron-core coils. Replace defective broadcast coils in practically any receiver. High gain. Inductance easily adjusted with screwdriver. Oscillator coils for IF's between 175 and 520 kc. Shielded and unshielded oscillator coils listed below are two-winding type. With complete instructions. Black crackle finish shield, 1 3/4" square x 2 1/2". Shpg. wt., 5 oz.



SHIELDED TYPE

60-140. Antenna (14-7413)	} EACH
60-141. RF Coil (14-7558)	
60-142. Oscillator (14-7560)	1.99

UNSHIELDED TYPE

60-135. Antenna (14-1026)	} EACH
60-136. RF Coil (14-1027)	
60-137. Oscillator (14-1028)	1.24

Fig. 3. The part numbers (in parenthesis) on the shielded adjustable broadcast coils displayed in the 1951 Allied Radio catalogue matched those on the coils in our receiver.

printing at www.junkbox.com/electronics/Meissner_manual_1953.pdf. You might like to download it. Be warned that it has 163 pages and will take a little time. The "Utility" Broadcast set is identical as described in all three editions.

❖ Going Inside

I had learned just about everything possible from the documentation and without removing the chassis from the cabinet. It was time to go inside. Opening up a vintage receiver for the first time can be an adventure. Sometimes it is like opening Pandora's Box as one discovers crude repairs or modifications, evidence of short circuits or burning, missing key components or the installation of what another writer has described as "rogue" parts. Sometimes one might find evidence of an intelligent repair done by a long-ago technician and it is possible to infer what the original problem was, tease out his solution, and return the radio to its original configuration if necessary.

However, what I did find on studying the chassis was a deepening mystery, though it looked untouched, unmodified and clean. My first clue for solving the mystery was that this was no kit-built item. The geometric routing of leads, extensive cabling and perfection of the solder joints all suggested factory production. And yet, as far as I've been able to determine, the Meissner equipment was rarely, if ever, sold factory built.

I next turned my attention to the antenna, oscillator and r.f. coils – which had square cans like those in the broadcast/shortwave set. But were these broadcast/shortwave coils? One hint lay in the fact that each had an adjustment screw accessible through a hole in the top of the can. Normally single-band coils would not be adjustable; all necessary adjustment would be done via trimmers located on the tuning capacitor.

However, there is another type of broadcast-band-only

Meissner coil with a screwdriver adjustment. I came across mention of it in a "How to Build" book. It is the "Meissner Adjustable Universal Coil." Intended for replacement purposes, the adjustment is there to tweak the inductance of the coil to match whatever the inductance of the original coil might have been, thus insuring accurate tracking across the band.

I was able to read the numbers on two of the three coils in my set and, checking them against a 1951 Allied catalogue (Figure 3), I was able to verify that these are "Meissner Adjustable Universal" units. One might not be surprised to find *one* of these coils installed in a radio as a replacement for a defective unit – though not in a factory wired set such as this. At the factory, a fixed coil of the correct inductance would be easily available out of stock. In any case, *three* replacement coils would be unheard of.

So, I think what we're looking at here is a factory test unit or prototype. This is believable when you realize that I had purchased the set at a radio meet in a town not too far from the Mount Carmel, Illinois location where Meissner had (and has) its headquarters. In a test unit such as this might be, a broadcast/short wave dial scale might be perfectly acceptable if a single band scale didn't happen to be immediately available.

What were they testing for or prototyping? Perhaps something to do with the design of the r.f. sections of the radio, where it would be helpful for them to manipulate the coil inductances. Or perhaps, as might have been the case with the dial scale, the adjustable coils were used because they were handy. The testing may have been for something else entirely. That the coils had been installed in the broadcast/short wave set configuration meant only that their physical profile matched that of the coils for the two-band set and therefore used the same mounting holes.

❖ Checking the Circuitry

To see, once and for all, if this radio is, in fact, basically a "utility" broadcast set, I made good use of the very clearly drawn pictorial diagram of the set in the "How to Build" book. A bit at a time, I went over the entire underside of the chassis, comparing it with the diagram. I found that virtually every component under the chassis matched, in position and value, the corresponding component in the set. Other than a penlight cell that had been wired in place of the original Mallory bias cell in the first audio circuit, the only exceptions were in the power supply circuitry.

My eye had been drawn, almost immediately, to a couple of power resistors associated with the multi-section electrolytic filter capacitor. These large, obvious, units did not appear on any of the schematic or pictorial diagrams for the radio, so I began a detailed examination of the power supply circuitry.

The first thing I noticed was that the d.c. output of the 5Y4 rectifier tube was not taken

from one of the filament connections, as is usual and as was specified on the schematic. It was taken instead from a center tap on the transformer's 5-volt filament winding. I'm not sure if I remember ever having run into a center-tapped rectifier filament winding before.

The other anomaly in the power supply circuitry was that, instead of the dual 15 uF filter capacitor specified on the schematic, a triple 50 uF unit had been installed. I believe that 50 uF filter capacitors were not in wide use at the time I assume this set was put together. The extra capacitor, along with the two 125-ohm power resistors connected in series, was wired to form an extra section of power supply filtering.

Both this extra filtering and the use of a center-tapped rectifier filament winding suggest an attempt to improve hum control – which may have been one of the things that this radio had been put together to test.

❖ For Next Time

All of the paper capacitors will be replaced. That's something I would normally do anyway for a set of this vintage, but it's particularly important because this radio is loaded with the infamously unreliable Sprague "Black Beauties." I do believe I'm going to try to keep and "re-form" the triple-50 electrolytic.

I'll find a new replacement battery for the Mallory bias cell, possibly another penlight cell. All tubes will be checked. One resistor looks as if it has been overheated, so I'll check its value and replace if necessary. The dial cord, though intact, is slipping and needs attention.

This set requires an external dynamic speaker with a field resistance of 1500-2000 ohms. I do have a spare dynamic that might work. If a dynamic speaker is not available, Meissner suggests using a PM speaker with a filter choke/power resistor combination substituting for the dynamic speaker's field coil. If I get close enough, next time, to testing the radio, I'll have to deal with this speaker issue first. See you then!

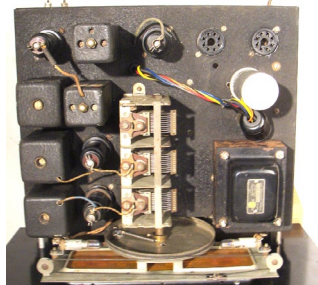

Fig. 4. Our chassis matches the layout of the Meissner broadcast and shortwave Receiver (Fig. 2) rather than that of the broadcast only set (Fig. 1), but it is definitely the broadcast model (see text).

Join the AWA

ANTIQUÉ WIRELESS ASSOCIATION

THE ORIGINAL AND LARGEST HISTORICAL RADIO-COLLECTOR GROUP

- Publishes *AWA Journal* with:
 - Battery and AC receiver restoration
 - Vacuum-tube history and collecting
 - Old-time amateur-radio contests
 - Communications receivers
 - Free want-sell-swap ads
 - Early television
 - Horn loudspeakers
 - Reviews of current books
 - Keys and land-line telegraphy
 - News of U.S. and foreign clubs
 - Information on public radio museums
- Maintains unique radio-TV museum.
- Produces the annual Rochester meet.
- Co-sponsors local meets.
- Publishes the annual *AWA Review*.

Membership is only \$25 per year U.S.A. (\$30 per year elsewhere). Write to:

AWA Membership Director
PO Box 421, Bloomfield, NY 14469-0421

www.antiquewireless.org



Stealthy Little Vertical: *The Chameleon V1*

Welcome back, friends. Since this is our magazine's annual Buyer's Guide issue, I thought I'd provide a little "buyer guidance" by purchasing, installing, testing, and reviewing a neat little entry in the stealth vertical category – the Chameleon V1 multi-band vertical.

I considered several different multi-band verticals to try out here at the station, but the V1 took the prize, because it is a true stealth antenna. At only eight and a half feet, it's about as concealable as a vertical gets, and its dull black finish makes it even harder to spot outdoors.

The concept here is pretty simple: the V1 obviously started life as a mobile antenna design. Many operators have discovered that using a mobile antenna at the home QTH is an excellent and potentially effective way to get on HF stealthily, and it can simplify portable operation, too.

Chameleon does bill the V1 as being for "Base/Portable/Mobile Use" but ups the ante over other mobile antennas by providing a counterpoise kit for base/portable operation, and a 9:1 unun (UNbalanced to UNbalanced transformer) for HF operation. According to the literature, it can be used to operate every HF band (80, 60, 40, 30, 20, 17, 15, 12, and 10 meters) as well as (with the unun removed) 6, 2, 1.25, and .70 meters. This is quite a lot to claim for a vertical antenna only eight and a half feet long with no external loading coils. Never fear, however: your trusty antenna columnist proceeded to run the V1 through the testing mill.

❖ **Setting Up**

I have the good fortune to live in the Greater Kansas City area, home to the nationally-known Associated Radio. After perusing the V1 on Associated's website as well as Chameleon's, a quick phone call to Associated confirmed they had the V1 in stock. I made the short drive there, bought the V1 for \$249, and had it home in about 45 minutes. The first photo shows everything you get: two-piece antenna element, counterpoise kit, 9:1 unun, two snap-on ferrite "beads," mounting bracket, and a 2" C clamp. I also bought a 50' roll of RG-8/U coax with PL-259 connectors attached.

I considered several ways of installing the antenna including roof mounting and back-steps-railing-mounting, but decided on an impromptu "fence mounting," simply fastening the mounting bracket to a large pair of Vise-Grips clipped on one of the metal posts of my back dooryard fence. This, I felt, would give a more realistic appraisal of how portable operation might evolve, and also would let us see how well the antenna works close



The Chameleon V1 comes with everything you see here! Radio and tuner not included. (Photo by author)

to the ground. The top of this little metal fence is only three feet high. Also, it got the antenna far enough away from the house to give it a chance at being in the clear. You can see from the pictures, though, that trees are quite prevalent around my back yard.

It took only a couple of minutes to unroll the 25' counterpoise wires, stretch them out and hook them to the tent stakes provided. Ring tongue connectors at each end of the wires make bolting them to the mounting bracket and hooking them on the tent stakes a snap, and the reels stay on the wires so you can wrap them back up quickly.

Thread the unun onto the bracket, thread the two antenna sections together and onto the bracket, snap the two ferrite "beads" onto the coax and thread it onto the unun, and route the coax into the house and to the rig. Seriously, I easily completed the entire setup in 15 minutes. Now it was time to do some on-air testing.

❖ **Putting it to the Test**

I divided the testing effort into two parts. In Phase One, I would tune up on unused spots in the CW and 'phone segments of each HF band (except 60 and 30 meters, which lack a CW and a 'phone segment respectively) and see what sort of SWR I obtained. First with the tuner on BYPASS, to test the manufacturer's claims, and then with the TUNED function to see if any high SWRs could be minimized at the tuner end.

I must admit I was skeptical. Chameleon's website shows their SWR figures for a "typical" setup, and 80 meters showed a figure of over 6, which, with coax feed, might as well be infinity. (Recall that high SWRs don't matter much with ladder line, since it is essentially lossless at HF, but that coaxial cable becomes *very* lossy above 2 or 3 SWR.)

On the remaining bands, they pretty much had results of 2 and under, sometimes near a perfect 1. Surely a very short vertical with no matching network of any kind, except its own internal construction and the 9:1 unun at its feedpoint, could not show a low SWR across the entire HF spectrum.

Well, yes and no. On 80 I got a reading around 10, but was able to get down near 1.5 with the tuner. On 60 and 40, I got readings of 2 and 3, but could still get down near 1.2 with the tuner. On 30, 20, 17, 15, 12, and 10 I got a range of figures between 1.9 and 1.15, which easily tuned to a perfect 1 in all cases. Amazing! Of course, the tuner doesn't resolve the mismatch at the antenna, only at the radio...

Now it was time to make some QSOs – Phase Two. I am almost exclusively a CW operator, so I focused on those segments. I started testing at 2p.m. local, so I reasoned that I would leave 40, 60 and 80 for the coming of darkness, and try 30 through 10 while it was still broad daylight. This was Labor Day weekend, and a combination of contests and chancy band conditions made for some tricky test conditions, but all in all I was pleasantly surprised.

On ten meters I found almost no activity. There was a station in Chile, CA3KHZ, at about 449, calling CQ repeatedly at 28.015, but he could not seem to hear my replies. I gave up on ten and moved to twelve, and got my first pleasant surprise. Many of you probably know Eduardo, CO8LY, in Cuba. There he sat all alone on an empty wide-open band calling CQ. With the tuner bypassed, I answered him – and he came right back to me! I wish I knew how well he'd heard me, but he gave me the same 599 he seems to always give everyone who works him, as though ham radio was one never-ending contest on every band. Nevertheless, here was the first definite sign that the V1 was indeed getting out. Thanking Eduardo, I moved on to fifteen.



The V1 mounted on my back dooryard fence. Note the numerous trees in the background. (Photo by author)

The results on fifteen really made me start to think that the folks at Chameleon have something here. The untuned SWR was about 1.9, so I used the tuner to get to 1 to 1. On the big island of Hawaii, Dennis, AH6V, was calling CQ, and he was nice and loud at 569. Crossing my fingers, I answered his call. He came right back to me, and told me "ur also 569 OM." All right! Then he swung the beam more directly at me – and we had a super link at 589 both ways!

Seventeen and twenty were both a mess – lots of QRN, heavy fading. I went back to these two bands a few times before making QSOs. On seventeen I worked Tom, KJ7CY, in Oregon, on the 'phone segment. We averaged 46 to 47 both ways.

On twenty with the tuner bypassed I managed to reach Joel, AD6KH, in California. He was 569 and I was only 539 – but he was running 700 watts to a 4 element beam, and I was at 100 watts to this tiny vertical, so there's easily 2 or 3 S units difference right there. His Big Gun station only getting a strength report of "6" shows you how ugly twenty was that day.

On thirty I reached Bill, W9VP, in Indiana. He was 589, and he gave me a 599. "Ur ant wrks fb om," Bill told me.

While I waited for dark to try the lower bands, I idly tuned across six meters. To my surprise there was some activity – an opening on six in September is rather rare. I ran outside and took the unun out of the circuit, then back downstairs to check SWR – about 1.1 on bypass. Dennis, K2SX, was working quite a pileup from South Carolina. I got through the pile after about



A close-up of the mounting, showing the counterpoise wires, the unun, and the clip-on ferrite beads. (Photo by author)

twenty minutes, and we were both 59 in great band conditions. Sweet!

When it got dark, with the unun back in circuit, I tried forty. SWR was 2, so I used the tuner to get to 1. After much hunting and calling, I finally reached Ed, WA4ZXH, in Kentucky. The QSO was 569 both ways, although there was a lot of noise and fading. On sixty I got a 1 with the tuner but could not raise anyone on a noisy, deserted band. On eighty SWR was very high, but the tuner got me to a 1. I stepped into the Tennessee QSO Party, amid a hailstorm of QRN, to work K4RO in Cheatham county, 466

miles from my house. "599" both ways, but that's what we *always* say in a contest...

I spun the dial and mode to SW broadcast bands, and A/Bed between the V1 and my big dipole to check the V1's performance. Often there was no difference; and when the dipole was louder, the V1 was less noisy.

❖ Conclusions

The V1 is certainly no world beater on any of the lower frequencies. On fifteen and six I saw amazing results. In the middle, on thirty, twenty and seventeen, I felt the antenna was adequate, but iffy conditions made it hard to be objective. In other words, about what you might expect for a physically very short antenna.

The fact that one doesn't have to mess with any external loading coils is definitely a plus, as is the extreme speed and ease with which the antenna can be set up and taken back down. As an SWL antenna, it is very effective, especially near 6 MHz, where one might be skeptical of a very short antenna's performance.

At only \$249, it is certainly competitively priced, and its small size and quick assembly/disassembly make it very attractive for the stealth and the portable operators. You can check it out, find a dealer, or order (online only) at <http://chameleonantenna.com>, and you can also find it in Associated's online catalog at <http://associatedradio.com> (or call 1-800-497-1457 or visit their store in Overland Park, Kansas).

That's it for 2011 from your trusty HF antenna columnist. Have a great holiday season, and I hope to see all of you again in January. Happy operating!

JETSTREAM POWER SUPPLIES!

Jetstream JTPS31MB

- Variable 4-16VDC
- 30 Amp Surge
- 25 Amp Continuous
- Light Weight, only 3 lbs!
- High current jacks on the back
- Switchable volt/current meter
- Over voltage protection
- Over current protection
- Compact, only 5" x 2.375" x 6.125"
- Switchable AC input voltage, 110 or 220 Vac



**DS-JTPS31MB
Only \$89.95***

* plus \$9.95 UPS
Ground shipping

Jetstream JTPS28

- 13.8 VDC
- 28 Amp Surge
- 25 Amp Continuous
- Light Weight, only 4 lbs!
- Compact, only 7" x 2.25" x 8"
- Five way binding post for high current radios
- Quick connectors for low current accessories
- Over voltage protection
- Over current protection
- Quiet internal cooling fan with "fan on" LED
- Switchable AC input voltage, 110 or 220 Vac
- AC line fuse (5 amps)



**DS-JTPS28
Only \$84.95***

**ORDER
NOW!**

GROVE

800-438-8155
828-837-9200 fax: 828-837-2216
WWW.GROVE-ENT.COM

order@grove-ent.com
7540 Highway 64 West
Brasstown, NC 28902



Spotlight on AMSAT-OSCAR 7

In previous columns, I've discussed how those interested in receiving and (if properly licensed) actually working through our growing fleet of Amateur Radio satellites could do so with just modest radio equipment. In this edition, I'll turn the spotlight on one of our oldest satellites...one that's been in orbit (and at least semi-operational) for going on 30 years now!

❖ Beginnings

AMSAT-OSCAR 7 (AO-7) was launched November 15, 1974 by a Delta 2310 launcher from Vandenberg Air Force Base near Lompoc, California as a secondary payload along with ITOS-G (NOAA 4) and the Spanish INTASAT satellite. AO-7 was the second satellite in AMSAT's so-called "Phase II" satellite series (Phase II-B). That is, unlike their relatively short lifetime predecessor satellites that only carried beacon transmitters, AMSAT's Phase II satellites carried amateur radio RF transponders aboard.

When it was launched into a relatively circular, 1444 by 1459 km, 101.7 degree inclination orbit, the octahedrally shaped (360 mm high and 424 mm in diameter) satellite weighed in at about 65 pounds. The antenna array consisted of a circularly polarized, canted turnstile VHF/UHF antenna system along with an HF dipole.

Similar to its immediate predecessor (AMSAT-OSCAR 6), AO-7 was built by a multinational (German, Canadian, United States, and Australian) team of radio amateurs under the direction of AMSAT-North America. It carried both a *non-inverting* Mode A (Mode V/A) and an *inverting* Mode B (U/V) linear transponder. Telemetry beacons on 10 and 2 Meters as well as on 70 cm rounded out the satellite's RF suite. Unfortunately, AO-7's 2304.1 MHz experimental beacon was never activated due to international



AMSAT's satellites are often built in the basements and garages of its experimenters. Here Dick Daniels, W4PUG, solders components into one of AO-7's electronic modules. (Courtesy: AMSAT)

frequency allocation issues.

Four antennas mounted at 90-degree intervals on the base and two experimental repeater systems provided store-and-forward capability for Morse and Teletype messages as it orbited around the world. The Mode-B transponder was designed and built by Professor Dr. Karl Meinzer, DJ4ZC and Werner Haas, DJ5KQ (SK). The Mode B transponder was the first such transponder using Dr. Meinzer's "HELAPS" (High Efficient Linear Amplification by Parametric Synthesis) techniques...a technology that was painstakingly developed by Dr. Meinzer as part of his Ph.D. dissertation. HELAPS was very effectively used on a number of AMSAT's subsequent satellites.

The two transponders were operated alternately by means of a timer arrangement, but transponder selection and output power control could also be accomplished by ground command. Each of the transponders included a keyed telemetry beacon at the upper edge of the downlink passband to provide housekeeping data as well as a reference marker to assist amateurs in setting their uplink power level. The cross-band design of the two transponders was one of the first such arrangements that permitted amateurs to monitor their own downlink signals so as to help them compensate for changing path loss, transponder loading and Doppler shift.

❖ The Lost is Found

AO-7 was operational for nearly 7 years until a supposed battery failure caused it to cease operation in mid 1981.

Then, on June 21, 2002, Pat Gowen, G3IOR, stumbled onto something he noted as "remarkable" when hunting for what he called "interlopers" on our 2 Meter amateur satellite band. During his search, he came across a beacon sending slow, 8-10 wpm Morse code on 145.973 MHz that was also slowly drifting downward to 145.970 MHz before fading out completely. The beacon sounded VERY familiar to him, but, clearly, it was coming from none of the (then) current satellite fleet. And because of the Doppler shift, the signals were obviously coming from a satellite. But which one?

The beacon peaked at S9 and at times it took on a rough quality, wobbling in frequency, then coming back strong and quite stable again. To his surprise, Pat later learned that the satellite he had been listening to was none other than our old AO-7 that had somehow come back to life!

Jan King, W3GEY, the AO-7's original Project Manager later noted that the satellite had



AO-7's final assembly "Clean Room" consisted of stud lumber and plastic sheeting installed in the basement of Dick Daniel's (W4PUJ) home in suburban Washington, DC. Despite such sparse assembly arrangements, AMSAT has never had a satellite rejected by a launch agency because of contamination. (Courtesy: AMSAT)

a very good set of solar panels and the first Battery Charge Regulator (BCR) AMSAT ever flew. It was also the first spacecraft AMSAT ever built that was capable of actually overcharging the battery. As expected, when the battery failed, one or more of the individual battery cells eventually failed "short."

However, what AO-7's experimenters *hadn't* counted on was what would happen if any one of the failed cells lost its "short" and the battery circuit became "open." Then, the entire power bus would become "unclamped" from ground and the all spacecraft loads (including the transponders) could then draw power from the highly efficient solar arrays. At that point, AO-7 might have enough solar power to become a "daytime only" satellite.

Indeed, this is *precisely* what has since happened and what has miraculously caused AO-7 to come back to life after so many years of being dormant. The only downside to this now "daytime only" satellite is that, every time sunlight hits the spacecraft and it powers up after exiting an eclipse, AO-7 comes up randomly in either Mode V/A (the old Mode A) or Mode U/V (the old Mode B).

AO-7 FREQUENCY AND MODE DATA:

MODE	UPLINK (MHz)	DOWNLINK (MHz)	BEACONS (MHz)
V/A (Mode A)	145.850 - 145.950	29.400 - 29.500	29.502
U/V (Mode B)	432.125 - 432.175	145.975 - 145.925	145.975
			435.100

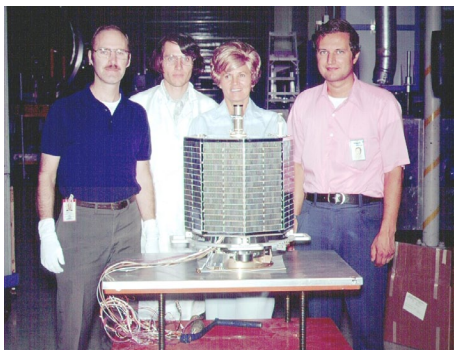

Members of the AO-7 project team pose with the fruits of their labor. From left are Dick Daniels, W4PUJ; Jan King, W3GEY; “hired hand” Marie Marr and AMSAT Founding President Perry Klein, W3PK. (Courtesy: AMSAT)

❖ Current Status

Subsequent analysis has revealed that, even after almost 30 years in orbit (and with the notable exception of the now “open” battery) AO-7 remains in surprisingly good shape. The solar arrays, the BCR, the Instrumentation Switching Regulator, along with the Mode B and Mode A transponders appear to all be working beautifully.

What’s more, the Morse code telemetry encoder and voltage reference circuitry and other onboard electronics are all still providing useful data to AO-7’s ground handlers. And what a testament AO-7 has since become for a satellite that was built (quite literally) by a group of “amateurs” in their basements and garages and launched into Earth orbit almost 30 years ago!

❖ When and Where to Listen

Since it sprang back to life, AO-7 has once again become one of AMSAT’s most popular linear (analog) satellites. Indeed, when AO-7 is in full sunlight, it provides surprisingly strong (albeit somewhat “chirpy”) downlink signals... even using modest satellite antenna arrays.

However, it takes a bit of patience to determine which mode the satellite is in when it first pops over the horizon. I do this by first setting my *downlink* frequency in the middle of either passband (at, say 29.450 MHz or 145.950 MHz) and then sending a few widely-spaced CW “dits” on the uplink while tuning the frequency of my uplink signal around. Once I hear my own “dits” coming back to me on the downlink, I immediately know which mode the satellite is in, and I then start looking for a contact.

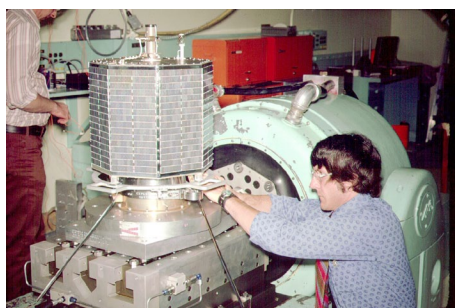

Jan King, W3GEY, prepares the AO-7 satellite for vibration testing. (Courtesy: AMSAT)

❖ Operating Tips

Because of its relatively high power (2-8 watt) downlink transmitters, you should be able to hear very weak signals from AO-7 without needing a lot of uplink power. Remember, this satellite was *never* intended to be an FM bird! Indeed, I’ve successfully worked through AO-7 with 5 watts or less to my eggbeaters. You may need to increase power if the satellite is at a distance, but be sure to reduce power as the satellite approaches.

Unfortunately, AO-7’s mode B uplink is also in the middle of the informal, 70cm, so-called “weak signal” terrestrial band that was established *after* AO-7 first went silent. Excessive uplink power may interfere with other services in that band, and may be considered by some to be a spurious, out of band emission.

Also, if you hear your downlink signal start to rapidly change frequency (indicated by a “warbling” sound) this means you are putting too much power into the bird. Reduce power and the situation should correct itself.

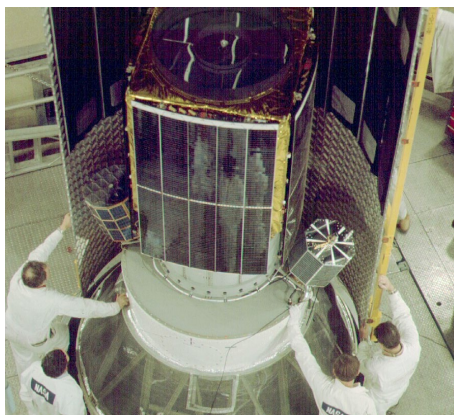

AO-7 is shown here mated to the upper stage of its Delta rocket. AO-7 is shown at the bottom right, next to the much larger main payload. (Courtesy: AMSAT)

What’s more, as the strongest signals are in the middle of the passband, you will therefore need less power to hear your downlink there. Remember, too, that, voice signals strain the power system on AO-7 the least. So, if you are using CW, please be extra vigilant about the amount of uplink power you are using. Hopefully, with reasonable care from all of us, AO-7 has many years of “semi-operational” life still left in it.

❖ ARISSAT-1 Update

In my February, 2011 *SkySurfing* column in *Monitoring Times*, I gave you a detailed rundown on a new Amateur Radio satellite that might (hopefully) be in orbit by the time that column went to press. After a series of delays (none of which were attributable to AMSAT) I’m happy to report that on August 4, 2011, ARISSAT-1 was at last successfully deployed from the International Space Station (ISS) and, at press time (early September), was *still* up and running.

After an approximately 3 hour delay due to the surprise discovery that the UHF receiving antenna on the bottom of the spacecraft appeared to be missing, Russian Cosmonauts Sergei Volokov and Alexander Samokutyaev successfully

released the satellite into its own orbit from the ISS near the end of their nearly 7-hour space walk. AMSAT’s experimenters later determined that a portion of the quarter-wave UHF whip uplink antenna on the bottom of the spacecraft had apparently been broken off somewhere in transit. However, despite this potentially debilitating setback, after consulting with AMSAT’s experimenters, ground controllers made the decision to deploy the satellite “as is.”

Since that time, strong FM downlink signals have been heard from the satellite. At press time, ARISSAT-1 was orbiting about 30 minutes *ahead* of the ISS in the same orbital path and its 22 greeting messages in 15 different languages were cycling on and off as expected on the FM downlink at 145.950 MHz. What’s more, despite its now shortened UHF uplink antenna, many amateurs so equipped were still making strong contacts with other amateurs through ARISSAT-1’s analog Mode U/V (Mode B) transponder. Indeed, I’ve heard my own downlink signals though the transponder on numerous occasions using just my eggbeater satellite antennas and about 10 watts of uplink power.

Needless to say, ARISSAT-1’s builders were ecstatic about how well the satellite was performing in orbit. The only concerns were that the spacecraft was running a bit warmer than expected (about 40 degrees Centigrade) and its Russian Silver-Zinc spacesuit battery was failing somewhat faster than originally thought... a situation which has caused the satellite to reset its onboard computer (sometimes once or twice) during each orbit. This, in turn, meant that a lot of the data from the satellite’s onboard atmospheric experiment could not be reliably processed and then sent down to ground controllers.

On the other hand, ARISSAT-1’s Software Defined Radio (SDR) transponder, its SSTV downlinks and its BPSK 1000 experiment were all working perfectly, along with the satellite’s onboard power management and other systems. What’s more, reception reports from school children and others around the world were pouring in to ARISSAT’s project managers, indicating that the satellite had become a real hit with the younger set.

All in all, the ARISSAT-1 project was shaping up to be another great success story for Amateur Radio, AMSAT and the Amateur Radio on the International Space Station effort. Unfortunately, however, by the time you read this, there’s a good chance that ARISSAT-1 will have either gone silent or it will have already de-orbited.

However, firm plans are now in the works for at least one follow-on mission using one or more of the remaining three ARISSAT space frames now in various stages of construction. Stay tuned to the AMSAT Web site (www.amsat.org) along with the ARISSAT Web Site (www.arissat1.org) for further updates on ARISSAT-1 and follow-on missions.

❖ Wrap up

That’s all for this time. In future columns, I’ll once again focus on another series of Amateur Radio satellites now in orbit and I’ll bring you up to date on other happenings in this fascinating aspect of our radio hobby. See you then.

Handy Video Tuning Tool: Your Wireless Camera

By Mario Filippi, N2HUN

Earlier this year, while attending the Trenton Computer and Ham Fest in Trenton, New Jersey, I purchased a 2.4 GHz wireless security camera system for \$59.00 from a vendor, figuring it had many uses other than its intended purpose. These are also available at even cheaper prices on the Internet from a number of vendors such as Amazon.com. They run as cheap as \$26.00 if you shop around.

Here is what the unit looks like boxed up:



The wireless cam system consists of a small, adjustable-lens camera/transmitter, two power supplies, audio/visual (A/V) cable, battery cable (for the camera), two wall wart power supplies (for camera and receiver), 2.4 GHz receiver, manual, and mounting screws. Below is what you get:



Here is a close-up of the mini-cam/transmitter. It can be powered either by a 9VDC battery or the wall wart. The camera lens is threaded so you can adjust it for close-up use (up to an inch focus) or for landscape/distance use. As per the manufacturer it can transmit up to 330 feet line of sight. I've used it at distances of up to 80 feet with no problem and transmission is in color. Audio is excellent, too.

Interestingly, the manual makes no mention of the camera's outboard four-position dipswitch which allows four different transmitting frequen-

cies, thereby allowing expansion of up to four different cameras.

The receiver is powered off the wall wart, but I have found it'll chug along using a 9 VDC battery. A/V connectors can be attached to a computer or mini/full-size televisions. There is a tune knob next to the rubber-duddy antenna which you have to fiddle with a bit to get it tuned just right.



Now here's the reason for this epistle: Satellite dishes sometimes go out of whack due to a number of reasons, such as ground heaves due to frost, loosened bolts, warped hardware, dish shift due to high winds, etc. Renegade horizon-to-horizon motors can decide to shift due to wear, age, sudden unexplained internal circuit inaccuracies, or even software bugs from set-top-boxes (STBs). There is an array of influences on an FTA (free-to-air) system that will result in a frustrated viewer looking at an unexplained, blank, TV screen.

A wireless mini-cam system can aid in the troubleshooting process when these events occur. I have used this system to set up and troubleshoot my Ku-band FTA systems, and it has saved me loads of time. It's like having a second pair of eyes and hands. Many trips back and forth into the house or up and down the ladder are a thing of the past. No more shanghaiing the unwilling wife for help, no more aches and pains from climbing a ladder while saddled down with heavy tools, satellite meters, cables, etc.

When problems occur or when setting up a system for the first time, I attach the wireless camera (using pipe cleaners) to the mounting tube of the horizon-to-horizon motor and aim it at the degree scale on the motor housing, as shown in the next photo.

Next, hook up the wall wart power source or a 9 VDC battery to the camera. I use a portable power pack. To the right, my 39.4 inch motorized



dish used for birds from 61 West to 125 West.

Now, back to the shack to see if the camera is positioned right. With experience you can get it aimed correctly with one or two tries. Now back into the house!

On the next page is my FTA receiving epicenter. On the Sony flat screen TV is the marker card for satellite AMC 1 transponder 21 at 103 West. To the bottom left is a small Accurian LCD TV attached to the mini-cam receiver that's aimed at the degree scale on the horizon-to-horizon motor. At the right is the mini-cam receiver.





You can see that AMC 1 at 103 West corresponds to a 30 degree position on my horizon-to-horizon motor using the Universal Satellite Automatic Location System (USALS). This is handy to know in case the system ever shifts a degree or two; all I need to do is adjust it a bit using DiSeQC (Digital Satellite Equipment Control), or if I have the energy, do a complete readjustment of the dish and motor.

Here is a close-up of the Accurian screen



with the cam aimed at the horizon-to-horizon motor scale. The metal pointer is clearly visible at approximately 30 degrees.

Using the mini-cam can also give insight into how the horizon-to-horizon motor moves, such as:

1. When doing a "step" move. Some motors behave erratically using step move while others move a fraction of a degree. Normally it's a shot in the dark, but with this camera attached you'll know exactly how far to move and in what direction.
2. Horizon-to-horizon motor degree positions for each satellite you want to receive. E.g. 61 West corresponds to 15 on the horizon-to-horizon scale. If for some reason 61 West is being received with poor quality or no signal at all, you can attach the camera and recheck.
3. Quirky motors. I have had motors that according to the STB are moving when in reality they are not, indicating possible need to do a reset. Again, the camera, with its audio and video signal will positively confirm what is really happening.

These ideas are just the tip of the iceberg as to the mini-cam system's capabilities for an electronics tinkerer. I have even used the system in the "reverse" mode when aiming OTA (over the air) antennas on the roof – I just point the mini-cam at the TV screen back in the house, then climb up the roof with the mini-cam receiver and a portable TV, and adjust the antenna until the indoor TV gets optimal signal. ❖

VHF AUDIO/VIDEO TRANSMITTER

By Raj.K.Gorkhali, Hetauda, Nepal

The circuit presented here is a simple audio/video transmitter with a range of three to five meters (9-16 feet). The audio/visual (A/V) signal source for the circuit may be a VCR, a satellite receiver or a video game, etc.

The circuit uses inexpensive components which are easily available in the market. A block diagram showing the principle of its operation and complete circuit diagram is shown in the figure. A mixer, which also operates as an oscillator on the VHF channel 5 TV frequency, is amplitude modulated by the video signal and mixed with the frequency modulated audio signal.

The resulting modulated signal, which is radiated through the antenna, contains video carrier frequency of 180.75 MHz.

The circuit consists of transistor T1 with its resonant tuned tank circuit formed by inductor L1 and trimmer capacitor VC1, oscillating on the channel 5 frequency. Transistor T2, with its tuned circuit

formed using Solenoid Inter-Force (SIF) coil and inbuilt capacitor, forms a 5.5 MHz oscillator. The audio signal applied at the input to T2 results in frequency modulation of the 5.5 MHz oscillator signal.

The output of the 5.5 MHz FM stage is coupled to the mixer stage through capacitor C8 while the video signal is coupled to the emitter of T1 via capacitor C4 and variable resistor VR1. Finally, the AM video and FM audio carrier frequencies corresponding to TV channel 5 are transmitted via the antenna.

Inductor L1 can be wound on a 3-mm (.11 inch) core using 24-gauge enameled wire by just giving four turns. Calibration/adjustment of the circuit is also not very difficult. After providing 12 VDC power supply to the circuit and tuning your TV set for channel 5 reception, tune trimmer VC1 until you see plain raster on your TV screen. Tuning the 5.5 MHz oscillator to the exact frequency can be done using either a frequency counter or a properly calibrated radio receiver on SW1. Adjust the core of the SIF coil for the best results. ❖

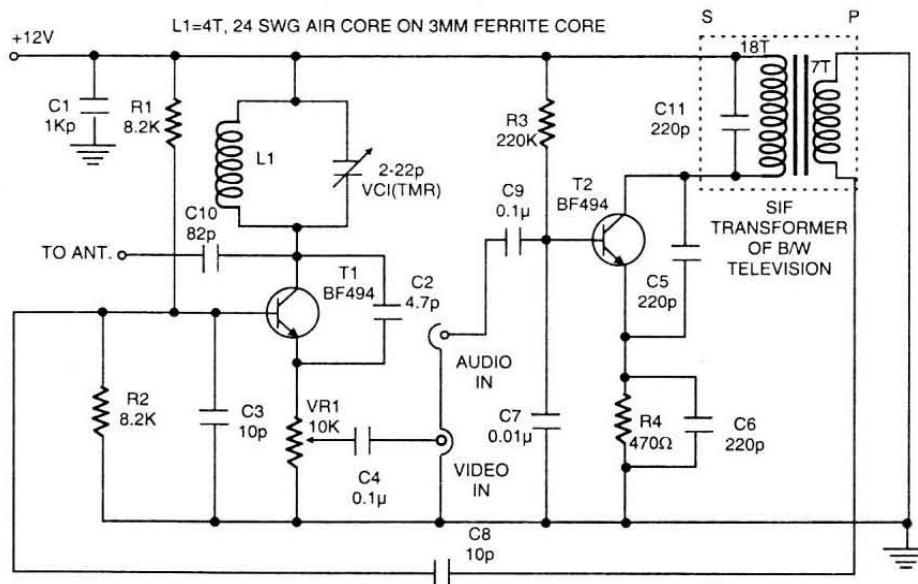

Kaito

YOUR LEADING SOURCE FOR SOLAR AND DYNAMO POWERED RADIOS!

Visit us at www.kaitousa.com to view our wide range of innovative products. Dealer inquiries welcome: (866) 524-8676, info@kaitousa.com.

Sangean ATS-909X Multiband Portable Radio

Three reviews by Bob Grove, W8JHD

The notion of worldwide shortwave reception on a portable radio has titillated listeners for decades. The early offerings pale in comparison to modern solid-state technology with direct frequency entry, digital signal processing, and other advances that trickle down from more sophisticated products.

Many long-time SWLs will recall the hoopla surrounding the Barlow-Wadley XCR-30 when it was released in 1977. Developed and manufactured in Zambia, this was the first portable sporting direct frequency readout and exalted carrier selectable sideband (ECSS). Its cost was a mere \$269.

But even with this innovative design, it suffered from severe front-end overload, and no attenuator switch was provided to alleviate this condition. It was also faulted for poor medium-wave sensitivity.

An excellent collection of reviews and critiques of this old classic may be found at www.barlowwadley.it/literature.htm.

The Sangean ATS-909X

A good example of superior performance from a modern compact portable at lower cost is available in the recently-released ATS-909X from Sangean Corporation.

Measuring 7-3/4 inches wide x 5-1/4 inches high x 1-1/2 inches deep and weighing in at 28 ounces, its three inch speaker is rated at three watts and puts out clean sound from the radio's one watt of audio. A rear-panel tilt bracket supports the radio at a more convenient desktop or tabletop viewing angle.

A side slide switch serves as a tone control, contouring the audio for best reception of talk and news programming or music. Audio jacks are also provided for recording are auxiliary input, line out, and standby switching (see details below).

Internal power is provided by four AA cells (alkaline or rechargeable, not included). A nine-volt, 700 mA, AC adapter/charger comes with the radio, as does a pair of ear buds for FM stereo listening. Also in the pack is a protective, vinyl soft case.

Frequency coverage and modes are 87.5-108 MHz FM and 153-29999 kHz AM/USB/LSB in four bands.

A wide/narrow switch allows a choice of selectivity on the medium wave and shortwave AM bands. In the SSB mode, narrow is automatically selected. The same switch doubles as a stereo/mono selector in the FM mode. In the stereo mode, left and right channels are separated for monitoring through stereo earplugs (provided).

Once made, preferred settings can be locked



The compact ATS-909X shown next to a pen for size comparison (No, the pen isn't included!)

to avoid accidental change or tampering by a press of the lock key.

The large backlit LCD display is easy to read and includes information on more than two dozen selections including frequency, tuning speed, signal strength, squelch, band, mode, memory page, button/memory lock, battery condition, and time.

The display may be activated manually in battery mode, but stays on when using the included AC adapter.

Antennas

The subject of antennas always comes up when dealing with radio equipment, whether transmitting or receiving. In the case of the 909X, it has two integrated antennas – a telescoping whip for FM and shortwave, and an internal ferrite bar for long wave and medium wave reception.

The 46-inch telescoping whip can be extended even further for shortwave reception by connecting the included 24-foot reel-up antenna accessory. It can be plugged into the radio's external antenna jack, attached directly to the whip with its snap-on adaptor.

Tuning

Frequency entry can be direct via the numeric keypad, selected during automatic scanning, manually tuned by up/down step keys, or rotary tuned in the traditional fashion.



Lots of audio interconnect possibilities, an external AM antenna jack, and an RF gain control.

Fast or fine tuning is accomplished by selecting 100 or 50 kHz in the FM mode, 9/10 kHz or 1 kHz on AM long wave, 10 or 1 kHz on AM medium wave, 5 kHz or 1 kHz on AM shortwave, and 1 kHz or 40 kHz on single sideband (USB/LSB).

Toggleing between fast and slow tuning speeds is quickly enabled by a pushbutton in the center of the tuning dial.

Digital Signal Processing

Digital signal processing (DSP) has become a trigger phrase in modern receiving equipment. It is an incisive means of removing unwanted interference while passing desired signal contents.

There has been considerable debate on chat rooms about whether or not the ATS-909X has DSP. The latest answer, direct from Sangean engineers, is that it has DSP for both FM and AM receiving modes (including shortwave), but not for SSB.

Memory

The ability to store lists of discrete frequencies for fast selection is endemic among shortwave radios. The ATS-909X can store up to 406 station frequencies which are assigned to nine-frequency pages ("banks" on scanners).

Selections include 351 memory frequencies for shortwave, 27 for FM, 18 for medium wave, and nine for long wave.

If you pay special attention to one particular frequency, you can recall it at any time instantly by simply pressing the priority key.

RF Gain Control

One of the most common shortcomings of inexpensive portable radios is their vulnerability to front-end overload. This can be compounded by the use of an external antenna.

Excessively strong signals produce a variety of degrading symptoms like reduced sensitivity and phantom signals on multiple frequencies. By purposely reducing the signal levels as they enter the radio, these artifacts can be moderated or even eliminated. Certainly, shortening the whip is one answer for FM and shortwave, but on long and shortwave, there is no way to adjust the internal ferrite antenna.

Sangean handles this by including a thumb-wheel potentiometer which has a continuous range of gain control. For most environments, you will keep the gain at maximum, but in those cases where a nearby, excessively-strong broadcaster is causing problems, it's a handy gadget. But keep in mind, all signals are reduced, including desirable weak ones.



The LCD window, shown here only partially filled, is a busy place, and it's backlit.

World Time with Alarm

Once you enter your own time zone into the 909X, it automatically reports the correct time for 42 cities around the globe. When seasonal time changes (daylight savings time), a key press automatically advances the time one hour.

Three timer circuits are individually selectable for time and frequency to be activated for that wake up call. A snooze feature is activated by pressing any key during the alarm sound to deactivate the alarm for five minutes.

Additionally, the radio can be set to auto-

matically shut off in any ten-minute increments between 10 and 90 minutes.

Squelch

Scanner listeners know how irritating it is to have to listen to the noisy hiss on a vacant channel as you await activity. This is the reason for a squelch feature. The 909X also has an adjustable squelch to remove the irritating background noise as you search for active stations.

Audio In/Out

A standard 3.5 mm jack is provided, allowing the user to feed an iPod, MP3, or CD player into the radio to benefit from the 909X's audio.

In addition, two additional jacks, line out and standby out, can be used to feed an optional recorder like Sangean's DAR-101.

Radio Data System

Newer automobile radios often have the Radio Data System (RDS) feature which alphanumerically displays name and/or call sign of the FM station, the format (news, classical, etc.), and any texted news items. The 909X has an RDS display for that information.

The Bottom Line

As I sit here typing this review, I'm listening to Rossini's *Overture to the Barber of Seville* as broadcast from a 100-mile distant FM station. On most other portables, reception would be a bit "iffy," but on my 909X using only its whip, it's full quieting with brilliant sound coming from the internal speaker.

While the radio was sensitive on FM and AM broadcast reception, it did lack sensitivity on shortwave. I confirmed that with a second radio for comparison. This is probably why Sangean includes the reel antenna for better signal capture.

I did find that one section of the telescopic whip was resistant when trying to compress it. This was likely one of those occasional anomalies that wouldn't be found on all radios. A polite wipe of WD40 silicone lubricant helped.

The recently-released Sangean ATS-909X has a lot going for it at its competitive pricing point, but don't expect it to compare with a more expensive desktop.

The Sangean ATS-909X is available from Grove Enterprises for \$259.95, and is also available from other *MT* advertisers.

Jetstream JTPS31MB Power Supply

There is no question that the traditional linear power supply with the husky transformer is inherently quieter than the newer switching type supplies. Place a portable radio next to a switching supply and you're likely to hear quite an audio assault.

The very fact that the high efficiency (75% in the case of the JF-PS31MB) of a switching supply is accompanied by the generation of enormous numbers of harmonics from its square-wave switching of the internal voltage regulator guarantees wideband noise.

But that doesn't mean that this electrical noise is necessarily going to radiate enough to compromise reception on a sensitive receiver connected to an outdoor antenna. Such noisy circuitry, when properly designed, can confine most of its harmonics inside the box.

Switching-mode power supplies typically switch at between 50 kHz and 1 MHz, thus generating hash at the lower frequencies, and these harmonics diminish the higher you tune.

I recently replaced my heavyweight 20 amp linear supply with a smaller, lighter, cheaper, Jetstream switch-

ing supply and noticed only a slight presence of occasional weak switching harmonics on the low-frequency range of my HF ham transceiver. Of course I was using an external antenna. An antenna close to the power supply will guarantee the reception of radio frequency interference (RFI)!

The Specs

Considering the power it produces (up to 500 watts), the little Jetstream leaves a small footprint (5 inches wide x 2-1/2 inches high x 6 inches deep plus knob extensions), and weighs slightly more than two pounds. Voltage is variable from 4-16 VDC, and the adjustment knob has a convenient detent at 13.8 VDC to emulate automotive voltage.

Power is delivered from a black and red pair of rear-panel binding posts. An internal, rear-slotted fan is automatically activated under heavy current drain (up to 32 amps) to prevent overheating. The speed of the fan is regulated by the amount of heat being generated.

A rear-panel slide switch selects operating voltage between 100-120 VAC and 220-240 VAC at 50-60 Hz. A removable line cord is included.



Jetstream JTPS28 13.8 VDC PS

Designed for operating mobile equipment from AC, Jetstream's new 13.8 VDC power supply is handy and affordable. Like the JTPS31MB, the circuitry is of the switching type of lightweight, compact affordability. And as with the previously-described model, you don't want to get an antenna close to the unit if you want to avoid switching harmonics.

With that caveat, we found this model quieter than the variable-voltage model in terms of RFI.

The JTPS28 is not voltage adjustable, but it is voltage regulated for stability throughout its current range, and that's up to 28 amps surge, 25 amps continuous duty. The circuitry is overload-protected.

Voltage is available from three places, a rear panel pair of binding posts for up to seven amps, a front panel pair of binding posts for up to 28 amps, and a front panel cigarette lighter jack for up to seven amps.

The JTPS28 is also equipped to operated from 120/240 VAC lines at the flip of a switch. An internal fan is automatically activated under high-heat stress, indicated by a front panel LED. As with the previously-described model, the speed of the fan varies with the heat being produced.

The power supply weighs in at three pounds and measures 7 inches wide x 2-1/4 inches high x 8 inches deep. A removable line cord is included.



The Bottom Line on the Jetstreams

I found both power supplies to be well constructed and properly specified. With the RFI aspects of all switching power supplies understood, I would recommend these two units from a price/performance perspective.

The Jetstream JTPS31MB sells for \$84.95 and the JTPS28 for \$89.95 each. Both are available from Grove Enterprises.

What's NEW

Tell them you saw it in Monitoring Times

Larry Van Horn, New Products Editor

New Dictionary for Hams

The ARRL's new publication *Hamspeak: A Dictionary for Radio Amateurs* is a collection of terms and acronyms commonly used in the ham radio community. As seen in *QST* magazine, it was created to make articles easier for newcomers to understand.

Whether you're new to the hobby or you just want to brush up on your ham radio jargon, *Hamspeak* is a complete guide to the unique language of amateur radio. Inside you'll find many of the definitions include images, references to other material and more.

This soft-covered 64-page book has over 1,300 entries. This ARRL publication (ISBN: 978-0-87259-842-3) sells for \$17.95 plus shipping.

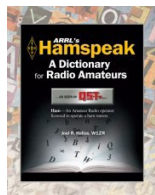

NRC AM Radio Log

As this issue hits the newsstand, we are experiencing the beginning of the fall/winter AM broadcast band DX season. That band is one of my favorite places in the radio spectrum to DX. This time of year also means that one of my favorite annual radio publications is again available for purchase –

The NRC AM Radio Log.

Formerly known as the *National Radio Club Domestic Log*, the first edition of this annual favorite was published by mimeograph and the stencils were hand-typed in Boston by the legendary AM radio hobbyist John Callarman. Since that first edition (which I still have, by the way), the *Log* has gone from its early crude roots to today's sleek professional publication produced by Wayne and Joan Heinlen.



The 2011-2012, 32nd annual edition of the National Radio Club's *AM Radio Log* contains 278 8-1/2 x 11-inch, 3-hole punched, loose leaf pages that you can put it neatly into a 1-inch binder.

AM band radio stations from the United States and Canada are listed by frequency, including the expanded (X-band) from 1610-1700 kHz. Each station listing consists of its operating frequency, callsign, location (city and state of license), time zone, antenna and transmission power, mailing address and daytime telephone number, hours of operation, broadcast format/networks, and much more.

There are also cross reference listings by city and by callsign, as well as a list of stations conducting AM stereo operations.

New to this year's log is a comprehensive list of FM translators that are now simulcasting

with AM broadcasters. Other recent additions to the log are listings of regional groups of stations in the groups section, and a cross reference of those stations licensed to use IBOC (In Band On Channel) digital audio.

There are nearly 11,000 updates to this edition since the 31st edition was released in the fall of 2010.

The *NRC AM Radio Log* is available from several radio dealers as well as directly from the club website at www.nrcdxas.org/. This publication lists in the US for \$25.95 (non-NRC members) and \$19.95 (for members): in Canada, \$26 members/\$29 non-members (a price increase). New York residents will have to add sales tax.

For those ordering from the NRC website, orders are shipped postpaid Media Rate or add \$3.50 for priority shipping to US and Canada. Overseas orders, please consult the website. You can also get additional information or send orders via mail to: National Radio Club Publications, P.O. Box 473251, Aurora, CO 80047-3251.

The *AM Radio Log* is the most accurate source on AM radio stations in the United States and Canada. If you tune the AM broadcast band, you need the *AM Radio Log*. Quite frankly, no self respecting AM DXer or listener should be without this superb publication on his/her radio room bookshelf.

ARRL's Small Antennas for Small Spaces

By Steve Ford, WB8IMY

Amateur radio operators love antennas – the bigger the better – but if you don't have acres of property to erect the antenna of your dreams, does it mean you're effectively off the air? Not at all! With the right antenna design you could be on the air right now.

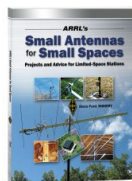

ARRL's *Small Antennas for Small Spaces* is a valuable resource for amateurs who live in apartments, condominiums, or houses on small lots. Filled with practical advice, this book guides you to finding the right antenna design to fit whatever space you have available. In *Small Antennas for Small Spaces* you'll find ideas and projects that will get you on the air regardless of where you live.

Some of the subjects tackled in this new ARRL book include:

- Tips to Get You Started the Right Way – Optimizing your limited-space station is about more than just building an antenna. Learn important tips about feed lines, SWR, RF amplifiers, operating modes and RF safety.
- Indoor Antennas You Can Install this Weekend – Design ideas and projects for VHF and HF antennas you can use inside your home.
- Outdoor HF Antennas for Any Property – Dipoles, inverted Ls, end-fed wires, loops, verticals and temporary antennas.

- Outdoor Antennas for VHF and Beyond – Compact omnidirectional and directional antennas you can install anywhere.
- Creative Solutions – A collection of limited-space antenna ideas from well-known amateurs, including the innovative Folded Skeleton Sleeve 40 and 20 Meter Dipole Antenna by QST Technical Editor Joel Hallas, W1ZR.

This 128 page book (ISBN: 978-0-87259-839-3) sells for \$25.95 plus shipping and is available from several *MT* advertisers or direct from the ARRL.

You can order any of the ARRL books mentioned in this column via snail mail to ARRL, 225 Main Street, Newington, CT 06111-1494, via their 800 order line: 1-800-594-0200, or through their website at www.arrl.org.

Tower Site Calendar 2012 Celebrates 90 Years of Radio

North American broadcasting became a booming industry in 1922, 90 years ago, when more than 500 stations signed on around the country. This year's *Tower Site Calendar* marks that anniversary by honoring some of the stations that trace their heritage back to 1922.

The 12-month wall calendar, which features a monthly photo of a well-known broadcast transmitter site, is photographed and written by Scott Fybush, the creator of *Tower Site of the Week* and *NorthEast Radio Watch*, both available at www.fybush.com.

The full-color 12-month calendar has become an annual tradition for many radio engineers, as well as for those who like looking at the towers and landscapes. They have also made a popular holiday gift.

This year marks only the second time in the calendar's 11-year history that Fybush has featured a European tower. September showcases Ireland's original high-power broadcast transmitter site in Athlone, made immortal in a Van Morrison song.

In addition to tower photos, the calendar's monthly pages include significant dates in radio and television history, as well as civil and religious holidays.

The 2012 calendars cost \$18 each (\$19.44 including sales tax for New York State residents) and can be purchased by check (payable to "Scott Fybush") or money order to 92 Bonnie Brae Avenue, Rochester NY 14618. Orders can also be placed with major credit cards at www.fybush.com.

Books and equipment for announcement or review should be sent to What's New, c/o Monitoring Times, 7540 Highway 64 West, Brassstown, NC 28902. Press releases may be faxed to 828-837-2216 or emailed to Larry Van Horn, larryvanhorn@monitoring-times.com.

When ordering or inquiring about the products mentioned in this column, be sure to tell them that you saw it in the pages of *Monitoring Times* magazine.

Uniden HomePatrol-1 Digital Radio Scanner

Simple Programming - Simply enter your zip code or city, and HomePatrol-1 selects the channels in use in your area.

TrunkTracker IV (Motorola APCO 25 Digital, Motorola, EDACS, LTR) - Lets you monitor all of the major types of communications systems used by public safety, local government, amateur radio operators, and more.

S.A.M.E. Emergency/Weather Alert - Allows you to specify the area that you need to hear any alerts that may be Weather, Civil, Biological, Nuclear, or National in nature.

Covers US and Canada - The built-in database includes all known channels in use in the United States and Canada. (Some services not available in all areas.)

Quick Record and Playback - Lets you record sessions for later playback or archiving.

Instant Replay - Lets you replay the most recent reception with a single tap.

3.5" Daylight Viewable Display

Free Radio System Updates - Radio System database is updated weekly.

No Subscription Needed.

Touchscreen Operation - Makes it easy to control what you are hearing.

HomePatrol Sentinel PC Software Included - Lets you update the HomePatrol-1's database, update firmware, and more easily manage favorites lists and other settings in your HomePatrol-1.

HomePatrol-1 lets you quickly hear the communications systems used by Public Safety, Aircraft, Military, Weather Spotters and more. Simply enter your US Zip code or Canadian Postal Code and HomePatrol-1 does the rest. Whether it is across town or across the street, HomePatrol-1 keeps you informed.



For credit card orders call
1-800-USA-SCAN

email: cei@usascan.com
www.usascan.com

PO Box 1045, Ann Arbor, MI 48106-1045 USA
For information call 734-996-8888 or FAX 734-663-8888





Aircraft Receiver Project

MT writer Kevin Carey joins the folks who enjoyed Marc Ellis's now-completed series on the BC-1206 LF/MF Receiver:

This is an intriguing little set that until recently was seen with some regularity at ham-fests. I believe there were other manufacturers of similar-looking sets, as well. I always wondered just how they were used aboard aircraft, and now you have answered that mystery for me. Also nice to see a mention of the WASPs – an unsung group of heroes (heroines?) if there ever was one.

I once acquired a BC-1206 at a flea market, and just as you were stumped in high school about how to power it, I could think of no good way to come up with 24 volts. So, in true experimenter style (aided by youthful exuberance), I decided to simply connect it to a 12-volt car battery. There was silence for quite a while, but then it slowly came to life with a pretty decent audio level, and several signals heard in the headphones! I was astounded that it was actually working on 12 volts. I had little fear of damaging the set, because I was applying a lower voltage than what was called for.

I remember that the selectivity of the '1206 was very broad (perhaps intentionally), but I was impressed with how well it performed overall. I know that you will achieve much better results with an outdoor antenna. Think about what happens when you drive under a bridge with an AM radio... Now consider that you are using an even lower frequency, and a subterranean antenna. I'd be amazed if you could hear anything more than a few miles away with such a setup. It may work well on shortwave, but LF is a different animal!

Kevin Carey, Bloomfield, NY

Kudos to *MT*

I saw Bob at the MFJ booth at Dayton and told him I was really enjoying *MT* more these days because it's more ham oriented. Bob said that a huge percentage of subs were hams and the August issue shows there is a lot there for ham ops like me.

The August issue just arrived and while I have not read a lot of it, I have skimmed through it and can't wait to read the many, many articles that are of interest! And not just the straight ham articles either. There are a huge number of articles of interest to a very active ham op.

Keep up the good job!
Jim Stafford, W4QO

Bob, can't recall when I started my *MT* sub but it has been years. I have been a member of The Radio Club of America (RCA) since about 1983/4. It has become mostly a social organization with many members being recruited from non-technical organizations such as APCO!

Was quite surprised and happy to see the article about the failure of Project 25 by Kirk Kleinschmidt and share his frustration. Recall Kirk from his ARRL days. I am equally frustrated with them. Have been a member since 1946/7 and watched them become a publishing house.

Keep up the great work down there and will keep reading!

Hank Schultz W13U exW2WIK (1947)

Even More on Disc Antennas

Last month's letter referencing Kent Britain's wideband antenna designs in the June *Antenna Topics* column was just the tip of the iceberg. Following are three additional emails with Kent's responses given in bold type.

Kent; I enjoyed your article, and I love useful projects. My question is this: is there any function involving the far side of the circular disc, away from the coax connection? Otherwise I could cut the circle in half, saving size and materials. I have a small sheet of copper from which I could make one 16" disc. Think it will work?

Jim Reid

It will affect the lowest frequency the antenna works on. So instead of a 150-3000 MHz, you end up with something like a 250-3000 MHz antenna. The big one in the article was Pizza Pans from a dollar store. I also did one using sort of football shaped elements. Similar results of the circles, but the circles are easiest.

Kent WA5VJB

Concerning your pie plate antennas, mount them on PVC pipe and paint them with clear lacquer. Also did you experiment with the mesh splatter covers for pans? I have an NRD 545 DSP and an antenna farm, so I like to play antenna. Also have astronomy and sat tracking programs. Think I'll go and pick up a few pans and collect electrons.....

Michael Carroll

Kent, your June 2011 *Monitoring Times* antenna article referring to Super Wide Band Antennas and their construction was very interesting and informative. Especially enlightening are the measurement data of actual antennas which is often not included or is brief if at all in many publications.

Hi Dennis, I have the test equipment and the antenna range, so you will be seeing more data instead of opinion on how well the antennas work.

The design you have presented does seem to offer another opportunity if nothing else for a wide band receiving/transmitting antenna of which I have planned to build using commonly available wire mesh material which I use often. It is made of dipped and plated wire mesh of approximately 1/2 inch segments, that sells locally for around \$3 dollars for a 24-inch X 5 foot section. Since this antenna would seldom be used beyond 1 GHz, I am proposing using the full 24-inch diameter width for both antenna elements to further optimize performance somewhat lower than 130 MHz noted using the 16-inch disks. And it is certainly less costly than PCB material.

When you get near 1 GHz, the mesh will not work as two slot antennas. I'm pretty sure the mesh will have an upper frequency limit.

One question is the polarization acceptance of this design and any directional preferences that it may have. I assume the majority of its fields are in the vertical plane if so mounted, but never having used an antenna with such LD ratio before, I am curious of its horizontal plane response, if significant, when vertically mounted. In using so called 'fat elements' before, they seem to be somewhat more tolerant than thin designs.

Having used the so-called 'Bow Tie' method of element construction in the past for broad banding a prototype VHF-only TV antenna in conjunction with a massive screen reflector behind it to minimize an adjacent hill reflection, your configuration may have been better suited for that purpose. Since the higher VHF channels are 3/4 wavelength of the TV low band, I ended up using a 'V' configuration of the antenna for additional forward gain and seemed to improve the hill reflection also.

On VHF and UHF the pattern is pretty much what you would see from any other Ground Plane Vertical, or vertically mounted dipole. When you get above 1 GHz, the two slots start to become a pair of exponential slot antennas. Ever see a ridged horn? Sort of a ridged horn without the horn. Now much of the RF energy is into beams coming out the plane of the disks.

You mentioned in your Antenna Measuring Notes, Log Periodics, "All my current LP designs terminate the back of the booms; it just cleans up so many problems." However, in looking at several of the ones pictorially given on your website, those do not appear to



be terminated as best I can determine from the pictures of them. Possibly 'terminated LP's' is an option or of another design or usage?

Most ham and hobby LP's are two open booms at the back. Many commercial and military LP's extend the booms then connect them together in an inductor or a phase delay line. All my LP's have a loop in the PCB that shorts the booms to each other. So a DC short, but with a phase delay. Much flatter SWR response.

The reason I ask that question, my adventures so far in LP design have not included a termination at the back end of the boom/drivers. As it stands now, it is an antenna for use from the VHF air band through 1 GHz, but is used as an 'aluminum mass effect' with modest results admittedly at lower VHF frequencies. I would assume that would be a detriment to that kind of use if terminated properly?

Originally I used a modified design similar to some VHF TV antennas that were of a series of progressively shorter lower channel elements bent toward the front of the antenna and made use of 3/4 wavelength resonance to improve and narrow performance at the higher VHF band that were monitored including the 2 meter band. These of course were fed alternating the phase connections at each element as required of LP design configuration.

Ah, the classic "Herringbone" LP design that works on its odd harmonics.

I have been a non professional builder and user of several antennas for many years as a ham. I guess you could say that during the 54 years that I have been a ham, I have tried and built so many for ham use or just experimenting, that I have tried about all of them!

Thank you for your great article and your straightforward application ideas! Any comments or suggestions you may have are appreciated.

73 - Denny - K0LGI

Always good to hear from readers. I've had plans for some time to come up with a 145/440 MHz for hams, or 150/460 MHz for scanning, herring bone LP antenna. Easy to design, but a @#@#! to construct in a way that the readers can easily duplicate.

73 Kent WA5VJB

Soldering to Aluminum?

Dear KS4ZR,

In reference to the loop you described [June *Beginner's Corner* (Loop Your Way to HF DX Success)], how do you solder to aluminum? I have thought about using split bolts if I go that route. Copper is not a problem to solder for me as long as I clean and flux the project.

I would not be opposed in putting a loop up 20-foot as one can get high angle radiation that way for North American stations if so desired on the lower bands. I think a loop is

more desirable than a tower in my book.

Ronald D. Erickson, K0IC

Hi Ronald -

A great question! I forgot to mention in the text that I attached the two ends of the loop to the wire pigtailed from the Unadilla W2AU 4:1 balun (\$29 from Universal Radio) that connects the coax to the wire loop with normal house wiring nuts.



A loop doesn't have all the advantages of a tower and beam antenna, but the price is right and the all-band performance has it all over a 3 element tribander.

73, Ken Reitz KS4ZR

Digital TV DXing

By way of introduction, I'm an *MT* subscriber and an enthusiast of Ham, VHF/UHF scanning, FTA satellite reception, Shortwave, and TV DXing. Currently I use a bowtie-cage antenna mounted on the chimney for OTA reception.

When analog TV was in vogue, DXing was fun, especially during the spring and summer. But I figured all was lost with the roll out of Digital TV, and luckily, my assumption proved to be incorrect, because TV DXing is certainly still viable with this new mode of transmission.

I have attached a recent photo of Channel 16, WBOC, from Salisbury, MD, which I received the other day around 6:30am. Distance from my QTH is about 140 miles as the crow flies. Reception of WBOC lasted about 15 minutes with excellent audio and video. Most times TV DX rolls in during the morning rush hour at this location.

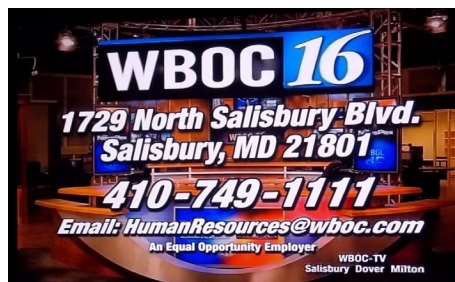

My antenna is mounted about 22 feet off the ground with no rotor, and oriented Northwest. I purchased it from Solid Signals.com, then added a Radio Shack preamplifier. With this setup I receive about 55-60 digital channels from the NYC and Philadelphia area.

Every morning around 6:30 I'll do a scan, using the TV set's Autoscanner feature to see if anything (i.e. DX) interesting is coming in.

Well that's it for now. I thoroughly enjoy each and every *MT* magazine that appears in my mailbox. The breadth of subjects covered in the communications field is phenomenal, something of interest to everyone.

Mario Filippi N2HUN

Apocalypse Now??

Roy Berger, an occasional feature writer and contributor to *Monitoring Times*, has recently published a book with the intriguing title, *2012: Rabbits and the Happy Apocalypse on Shortwave Radio*. I was honored to receive the first ebook from Amazon in the Kindle format.

Roy commented in the *Cornwall Free News*: "There have been many apocalyptic and post-apocalyptic books ... I wanted to write something that wasn't dismal and horror based. No crazed violence or porn. It's hard to top *Mad Max*, *THX-1138* or *On The Beach*. Those are tall shoulders. I wondered what a pleasant end of the world story would be like? Could it be tastefully Canadian, could it be a whopper of a story? This book took about four years to write. *I think watching geese in the park helped*. Last Man Standing discovers radio, dogs, travel then nature vs humanity."

Not that the end of the world is exactly pleasant subject matter... But Roy's Canadian hero, Stanley, does face up to his last-man-on-earth status in typically stoic fashion, doing what must be done without a lot of drama – and copious amounts of alcohol. It seems like I waited a long time for the shortwave connection to appear (it probably seemed a long time to Stanley, too). Radio buffs will appreciate Berger's understanding of what technologies will be useful or useless in a post-apocalyptic world.

Far-fetched as the scenario might seem to be (and Berger makes a good case that's it's not), it's impossible to read the story without wondering how we would handle surviving alone for years? And how might individuals do things differently once they started living together again?

In these days of fear-mongering and dire predictions of the future, Roy Berger has mocked up the worst scenario any of us would ever want to face. In doing so, he makes a number of discoveries about life, ingenuity, technology (old and new), nature, and the human spirit. I wonder if four years ago, Roy could have imagined the state the world would be in, now that 2012 is almost here?

2012 Rabbits and the Happy Apocalypse on Shortwave Radio is available in an electronic edition for \$2.99, text to speech enabled, from www.Amazon.com in Canada, United Kingdom, Germany. Released in the USA. E-book ISSN: 978-09877363-0-7 Paper 978-0-9877363-1-4

Rachel Baughn, *MT* Managing Editor

This column is open to your considered comments. Opinions expressed here are not necessarily those of Monitoring Times. Your letters may be edited or shortened for clarity and length. Please mail to Letters to the Editor, 7540 Hwy 64 West, Brasstown, NC 28902 or email editor@monitoringtimes.com
Happy monitoring!
Rachel Baughn, Editor

INDEX OF ADVERTISERS

Amsat.....	76
Antique Wireless.....	63
AOR.....	CVR4
AppBlanks.....	59
Kevin Carey (Longwave).....	76
C Crane.....	19
CIDX.....	76
Communications Electronics.....	73
Computer Aided Technology.....	21
Grove.....	CVR2, 15, 21, 59, 65
Kaito.....	69
MT Express.....	31, CVR3
NASB.....	33
Roswell Astronomy.....	76
Scanner Master.....	9
Stealth Amateur Radio.....	76
TEAK Publishing.....	61
Universal Radio.....	31, 76
WiNRADiO.....	1
W5YI.....	5, 55

Reach new customers with your advertising message in *Monitoring Times*! Contact Judy Grove at 1-800-438-8155 or email judy@grove-ent.com

Columnist Blogs and Web Sites

These blogs and web pages were created by some of our columnists to better serve their readers. While we highly recommend these resources, they are not official instruments of *Monitoring Times*.

AMERICAN BANDSCAN
<http://americanbandscan.blogspot.com/> - by Doug Smith

ANTENNA TOPICS
www.wa5vjb.com - by Kent Britain

BELOW 500KHZ
<http://below500khz.blogspot.com/> - by Kevin Carey

FED FILES
<http://mt-fedfiles.blogspot.com/> - by Chris Parris

LARRY'S MONITORING POST
<http://monitor-post.blogspot.com/> - by Larry Van Horn

MILCOM
<http://mt-milcom.blogspot.com/> - by Larry Van Horn

SCANNING REPORT
<http://www.signalharbor.com/> - by Dan Veeneman

SHORTWAVE
<http://mt-shortwave.blogspot.com/> - by Gayle Van Horn

UTILITY WORLD
<http://mt-utility.blogspot.com/> - by Hugh Stegman
www.ominous-valve.com/uteworld.html

Stock Exchange

For information on Stock Exchange or commercial advertising, contact Judy Grove at 1-800-438-8155 or judy@grove-ent.com

Line Ads \$1 per word

*Just downloaded the August issue, saved it in iBooks, and have read about half. Looks *great* on the iPad. This is definitely the way to go....*

- Scott D.

Subscribe to *MT* for as little as \$17.95 (U.S. Second Class Mail)

7540 Hwy. 64 W.; Brasstown, NC 28902
1-800-438-8155 US and Can.; 828-837-9200; Fax 828-837-2216
e-mail order@grove-ent.com

	6 months	One Year	Two Years	Three Years
Electronic Subscription	<input type="checkbox"/> \$17.95	<input type="checkbox"/> \$19.95	<input type="checkbox"/> \$38.90	<input type="checkbox"/> \$57.85
US Second Class Mail	<input type="checkbox"/> \$32.95	<input type="checkbox"/> \$32.95	<input type="checkbox"/> \$59.95	<input type="checkbox"/> \$89.95
US 1st Class Mail	<input type="checkbox"/> \$32.95	<input type="checkbox"/> \$59.95	<input type="checkbox"/> \$119.00	<input type="checkbox"/> \$179.95
Canada Surface*	<input type="checkbox"/> \$22.95*	<input type="checkbox"/> \$42.95*	<input type="checkbox"/> \$79.95*	<input type="checkbox"/> \$119.95*
Canada Air*	<input type="checkbox"/> \$35.95*	<input type="checkbox"/> \$69.95*	<input type="checkbox"/> \$125.95*	<input type="checkbox"/> \$189.95*
Foreign International*	<input type="checkbox"/> \$30.95*	<input type="checkbox"/> \$58.95*	<input type="checkbox"/> \$119.95*	<input type="checkbox"/> \$179.95*
Foreign Air*	<input type="checkbox"/> \$62.95*	<input type="checkbox"/> \$119.95*	<input type="checkbox"/> \$229.95*	<input type="checkbox"/> \$349.95*

If you order *MT* Print Edition AND *MTXpress* Electronic together, *MTXpress* is only \$11 per year!

* All payments must be in US funds drawn on a US bank.

MasterCard, Visa, Discover Cards and Paypal accepted!



www.SecondHandRadio.com **FREE** classified advertising with photos for used radios & electronics.

Check schedules, log stations, manage QSLs with Reception Log – Advanced Edition: www.dxtreme.com

STEALTH Amateur Radio

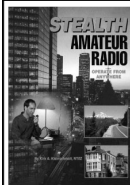

Complete Guide

- Apartments
- Condos
- CC&R Neighborhoods
- Operate from...

ANYWHERE!

stealthamateur.com

We're Going Back To Space!



AMSAT®
Join Us!

www.amsat.org
(888) FB AMSAT

Discover Longwave!

BeaconFinder II Directory

- 100's of beacons
- 75+ pages, 3-hole punched
- Covers 0-530 kHz spectrum
- \$13.95 postpaid

Sounds of Longwave

- Hear Natural Radio, Milcom, WWVB, beacons, Euro-BC, Lowfers, more!
- \$13.95 postpaid (specify CD or cassette)

Kevin Carey
Box 56, W. Bloomfield, NY 14585



ROSWELL ASTRONOMY CLUB
ROSWELL, NEW MEXICO

Meets 2nd Thursdays
Roswell Adult Center,
Live! Radio Meteor Listening
www.roswellastronomyclub.com

Join the Club!

Open to hobbyists worldwide, the **CANADIAN INTERNATIONAL DX CLUB** is Canada's national, general coverage radio club serving members since 1962.

For a free sample of our monthly electronic newsletter, **Messenger**, please e-mail CIDX at:

cidxclub@yahoo.com
Web: www.cidx.ca

HUGE 100 PAGE CATALOG

- Shortwave & Ham Gear
- Scanners & RTTY/FAX
- Antennas & Accessories
- Radio Books & CDs.

Send \$1 to 

Universal Radio
6830 Americana Pkwy.
Reynoldsburg, OH 43068
Tel. 800 431-3939
www.universal-radio.com

MTX PRESS

**SPECIAL
OFFER
BELOW!**

Going **Green** has never been more exciting!

Before the rising prices of gasoline, and before going “green” became a sales pitch, Monitoring Times created MT Express. The full version of the magazine you’ve come to depend on, in full electronic form. Now going into our 11th year of digital perfection, MT Express is better than ever. You get more with our digital magazine than you could ever have with print. The entire magazine is full color. All of the web links are clickable, so if you see a link to a website that you want to visit, just click on it! Want to email an author? Just click on their email address at the top of their column, and MT Express opens your email program, drops in their address, and is ready for your input! All of this, and it’s even CHEAPER than the regular print version! Plus, you’ll get it faster than you would your print copy, no matter where you are in the world. Now is the time to make the switch to digital. Sure, it’s saving a tree and saving some gas, but it’s also getting you what you need, when you want it. Make the switch today.

For a mere \$19.95 U.S., **MT EXPRESS** gives you *Monitoring Times* magazine

- in PDF format viewable with free software, delivered by FTP
- viewable in **brilliant color** (the *whole* magazine, not just what you see in the print version) on your computer screen
- easily navigated by clicking on the Table of Contents
- printable using your own computer printer
- searchable to find every mention of a topic or station schedule
- compatible with software to convert text to audio for sight impaired listeners

Now with
MTXTRA

Not only do you now have the complete Monitoring Times magazine, in full color, but for no extra cost, we are now adding MTXTRA, which will have a worldwide broadcast guide with ALL offered languages, not just English! So no matter where you are in the world, Monitoring Times has something just for you!

To find out if this new subscription is the delivery solution for you, you may download a sample issue for free! Just go to <http://www.grove-ent.com> to find out how.

If you order NOW, you will get 14 ISSUES for the price of 12! That’s right, for only \$19.95 you’ll get an EXTRA 2 MONTHS AND MTXTRA! Just mention code MTNOV11 when you place your order! And, if you order MT Print AND MTXpress together, MTXpress is only \$11 per year!

GROVE

800-438-8155
828-837-9200 fax: 828-837-2216

WWW.GROVE-ENT.COM



AR5001D Wide Coverage Professional Grade Communications Receiver

The Legend Lives On!



The AR5001D delivers amazing performance in terms of accuracy, sensitivity and speed.

Available in both professional and consumer versions, the AR5001D features wide frequency coverage from 40 KHz to 3.15 GHz*, with no interruptions.

Developed to meet the monitoring needs of security professionals and government agencies, the AR5001D can be controlled through a PC running Windows XP or higher. Up to three channels can be monitored simultaneously. Fast Fourier Transform algorithms provide a very fast and high level of signal processing, allowing the receiver to scan through large frequency segments quickly and accurately. AR5001D standard features include storage of up to 2000 frequencies, 45 MHz IF digital signal processing, direct digital sampling, a high performance analog RF front-end, a DDS local oscillator and advanced signal detection capabilities which can detect hidden transmitters. With its popular analog signal meter and large easy-to-read digital spectrum display, the AR5001D is destined to become the choice of federal, state and local law enforcement agencies, the military, emergency managers, diplomatic service, news-gathering operations, and home monitoring enthusiasts.

Discover the next generation in AOR's legendary line of professional grade desktop communications receivers.

- Multimode receives AM, wide and narrow FM, upper and lower sideband and CW
- Up to 2000 alphanumeric memories (50 channels X 40 banks) can be stored
- Analog S-meter
- Fast Fourier Transform algorithms
- Operated by a Windows XP or higher computer through a USB interface using a provided software package that controls all of the receiver's functions
- An SD memory card port can be used to store recorded audio
- Analog composite video output connector
- CTCSS and DCS squelch operation
- Two selectable Type N antenna input ports
- Adjustable analog 45 MHz IF output with 15 MHz bandwidth
- Triple-conversion receiver exhibits excellent sensitivity
- Powered by 12 volts DC (AC Adapter included), it can be operated as a base or mobile unit
- Professional (government) version is equipped with a standard voice-inversion monitoring feature

Add to the capabilities of the AR5001D with options:

- Optional APCO-25 decoder
- Optional LAN interface unit enables control via the internet
- Optional I/Q output port allows capture of up to 1 MHz onto a computer hard drive or external storage device
- Optional AR-I/Q Windows software facilitates the easy storage and playback of transmissions captured within the selected spectrum in conventional modes, or, signals can be subjected to further analysis
- Optional GPS board can be used for an accurate time base and for time stamping digital I/Q data



® The Serious Choice in Advanced Technology Receivers

AOR U.S.A., Inc.
20655 S. Western Ave., Suite 112
Torrance, CA 90501, USA
Tel: 310-787-8615 Fax: 310-787-8619
info@aorusa.com • www.aorusa.com

*Cellular blocked for US consumer version. Unblocked version available to qualified purchasers with documentation. Specifications subject to change without notice or obligation