

Scanning - Shortwave - Ham Radio  
Equipment - Computers - Antique Radio



# Monitoring Times

A Publication of Grove Enterprises

Volume 26, No. 3  
March 2007

U.S. \$5.95  
Can. \$8.95  
Printed in the  
United States

**Up, up and Away!**  
**Monitoring  
The Air Show  
Experience !**



### ***In this issue:***

- MT's Annual Air Show Guide
- Andrews Air Show: Best of the Best
- CW Test Goes Gently Away
- More Low-End Portables

# AR-ALPHA

## Communications Receiver

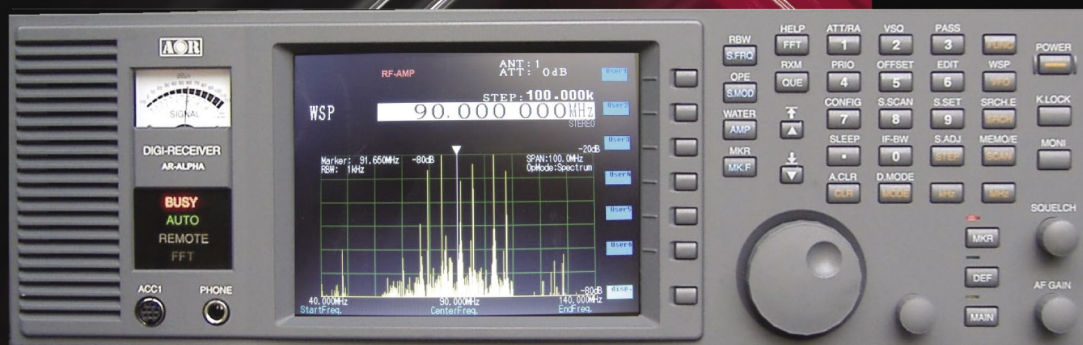

- Multi-mode unit capable of receiving AM (synchronous), ISB, RZ-SSB, USB, LSB, CW, WFM including FM stereo, NFM, APCO-25 digital, and TV in both NTSC and PAL formats
- 6-inch TFT color panel can display received video signals or depict spectrum activity over a wide choice of bandwidths including a "waterfall" function to show signal activity over a specified time period

## Welcome to the Future!

**AOR proudly introduces the AR-ALPHA, the first in a new class of professional monitoring receivers! Designed to cover 10KHz to 3.3GHz, with no interruptions,\* this receiver features a 6-inch color TFT display, five VFOs, 2000 alphanumeric memories that can be computer programmed as 40 banks of 50 channels, 40 search banks, a "select memory" bank of 100 frequencies, and a user designated priority channel. It includes APCO-25 digital and a DVR with six channels that can record up to a total of 52 minutes audio. Monitoring professionals will appreciate the world class engineering and attention to detail that makes the AR-ALPHA such an amazing instrument.**

- Composite video output on the rear panel of the unit
- Selectable IF bandwidths: 200 Hz, 500 Hz, 1 KHz, 3 KHz, 6 KHz, 15 KHz, 30 KHz, 100 KHz, 200 KHz and 300 KHz along with the ability to shift the IF.
- CTCSS and DCS selectable squelch functions
- DTMF tone decode
- Built-in voice-inversion descrambling
- CW pitch control, AGC, AFC
- Auto-notch feature
- User selectable spectrum display function from 250 KHz through 10 MHz in 1 KHz increments. Above 10 MHz bandwidth, it can display 20 MHz, 50 MHz, 100 MHz or 1 GHz, but above 20 MHz bandwidth, no audio will be available
- Resolution bandwidth is also user-selectable in increments of 1 KHz, 4 KHz, 32 KHz, 64 KHz, and 128 KHz.
- Fast Fourier Transform (FFT)
- Rear panel connections include 12 VDC power, RS-232C, USB 2.0, I/Q output with 1 MHz bandwidth, two antenna ports (one SO-239 and one Type N) and up to four antennas may be selected through the receiver's controls with the optional AS5000 antenna relay selector.
- Use desktop or with 19" rack mount

**The AR-ALPHA redefines excellence in professional monitoring receivers. No wonder so many monitoring professionals including government, newsrooms, laboratories, military users and more, rely on AOR.**



**AOR U.S.A., Inc.**  
20655 S. Western Ave., Suite 112, Torrance, CA 90501, USA  
Tel: 310-787-8615 Fax: 310-787-8619  
info@aorusa.com • www.aorusa.com

*Specifications subject to change without notice or obligation.  
\*Documentation required for qualified purchasers in the USA.*

# A marine receiver like no other.

**At WiNRADiO, the innovation never stops.** The new WR-G33EM model represents yet another breakthrough: the world's first PC-based marine receiver.

- Frequency range 9kHz to 30MHz
- AM, LSB, USB, DSB, CW conventional modes
- DSC, HF Fax, NAVTEX, TELEX marine modes
- Very high sensitivity
- Excellent dynamic range
- Real-time spectrum analyzer
- Spot-on tuning in 1Hz steps
- Continuously variable bandwidth 1Hz - 15kHz
- Automatic scheduling, recording and playback
- GPS option

The WR-G33EM receiver easily outperforms a conventional receiver, thanks to advanced signal processing techniques making it possible to implement sharper selectivity filters with more accurate demodulators and decoders.



*The USB-interfaced WR-G33EM receiver*

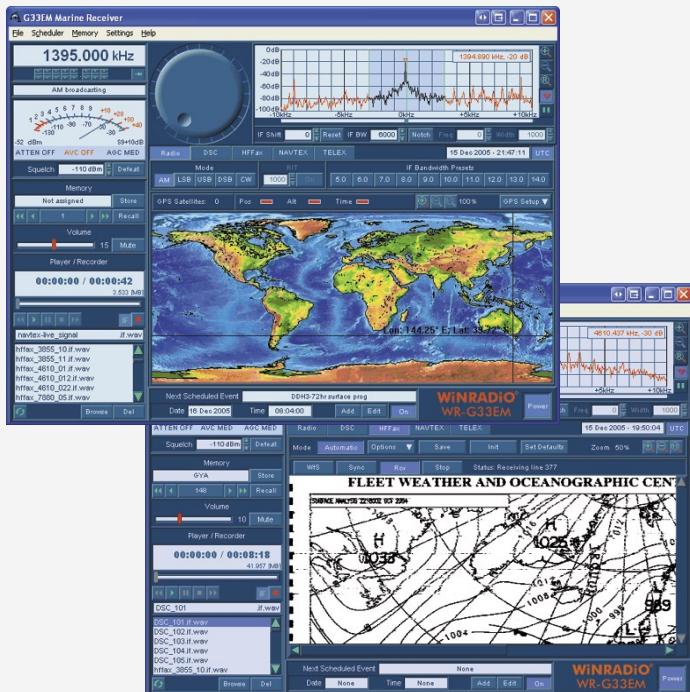

*A laptop controlling a WR-G33EM Marine Receiver*

The WR-G33EM receiver offers far more features and facilities than a typical conventional receiver. For example, the real-time spectrum analyzer with continuously variable bandwidth, graphical notch filter and IF recording are just some of the many features which were previously unavailable on a conventional marine radio, in particular at such an affordable price level.

All decoding functions are seamlessly integrated with the receiver: Switching from classical AM or SSB modulations to receiving DSC, HF Fax, NAVTEX or TELEX messages is just one mouse click away.

## **NEW! AX-81S Active HF Antenna**



Our latest, compact active HF antenna, ruggedized to suit harsh outdoor environments, and particularly suitable for marine environments. While it has been designed primarily as a marine antenna, it can be useful anywhere where good HF performance and reliability are required, and where space is at premium. It is especially

suitable for the WinRadio G33EM marine receivers and G303/G313 range of HF receivers.

The AX-81S antenna is stereo only, and covers the frequency range of 2 to 30 MHz, or 300 kHz to 50 MHz with somewhat reduced (but still excellent) performance. Designed for rapid installation, it is an excellent addition to your monitoring system.

[www.winradio.com](http://www.winradio.com)

*...the future of radio.™*



## Cover Story

### Monitoring the Air Show Experience

By Larry Van Horn

For the eighth year in a row, Monitoring Times brings you its popular air-show package. Starting on page 7, we profile the major demonstration teams and the frequencies on which they are most likely to be found. Also included are parachute teams, civilian flight demonstration teams, and even some foreign military flight teams that have been reported to us.

For the right equipment to bring and air show schedules for 2007, turn to the Milcom column on page 52.

**On Our Cover:** The F-22 Raptor performs seemingly impossible maneuvers at the Andrews AFB Joint Services Air Show. Photo by Kevin Burke.

## C O N T E N T S

### Andrews Air Show..... 11

By Kevin Burke

"Best of the best" is photographer Kevin Burke's assessment of the air show at Andrews Air Force Base. He's not alone in this opinion: First-timer B.A. Topolski and experienced monitor Daniel Myers (22 years in attendance) both agree the Andrews show is unique and boasts a variety that can't be matched. The three of them combine their experiences and tips on how to prepare, what to bring, and what frequencies to plug into your scanners. (Yes, that's plural!)

### 193rd Special Operations Wing..... 14

By Chris Paris

In a sense, "The Quiet Professionals" are not so quiet: Their mission is to be ready to broadcast critical information by any means necessary to a targeted population. "Have media, will travel," could be their motto. In recent years, the 193rd has been the most deployed unit in the Air National Guard.

### Winter SWL Festival..... 16

By Harold Cones

"It all started innocently enough," begins one founder of this unique gathering of shortwave listeners... (Not that we're sure we believe him...) One thing is for sure: The Winter SWL Festival – "Winterfest" for short – is a heck of a lot of fun, it's educational, and it's even inspirational to scanner and shortwave listeners who find little understanding for their radio hobby elsewhere. This month marks Winterfest's 20th annual gathering.

### Confessions of a Radioist..... 18

By Clem Small

Outside of resident staff, Clem Small has the greatest longevity of any other writer in Monitoring Times – nearly 23 years! Clem shares how he got started in radio and where it has taken him throughout his interesting life.

## Reviews

Low-end portables are on the menu again this month: In First Look we compare last month's winning Kaito KA1102 with a new competitor, the Sangean ATS-550P (see page 70). We also review the dynamo and solar-powered, multi-banded Kaito KA0009. This radio not only covers AM, FM, SW, weather, aircraft band, and VHF-TV, but it can

serve as a flashlight as well. Check it out on page 68.

John Catalano is playing spook this month – "vacuuming" up 190 kHz of spectrum for later listening and analysis. It's all made possible by SpectraVue's new version 2.20 software, used along with the RF Space SDR-14 receiver (page 72).



**MONITORING TIMES**  
 (ISSN: 0889-5341;  
 Publishers Mail Agree-  
 ment #1253492) is  
 published monthly  
 by Grove Enterprises,  
 Inc., Brasstown, North  
 Carolina, USA.

Copyright © 2007 Grove Enterprises, Inc.  
 Periodicals postage paid at Brasstown,  
 NC, and additional mailing offices. Short  
 excerpts may be reprinted with appropri-  
 ate credit. Complete articles may not be  
 reproduced without permission.

Address: 7540 Highway 64 West,  
 Brasstown, NC 28902-0098  
 Telephone: (828) 837-9200  
 Fax: (828) 837-2216 (24 hours)  
 Internet Address: [www.grove-ent.com](http://www.grove-ent.com) or  
[www.monitoringtimes.com](http://www.monitoringtimes.com)  
 Editorial e-mail: [editor@monitoringtimes.com](mailto:editor@monitoringtimes.com)  
 Subscriptions: [order@grove-ent.com](mailto:order@grove-ent.com)

Subscription Rates: \$28.95 in US; \$39.50  
 Canada; and \$58.50 foreign elsewhere,  
 US funds. Label indicates number of is-  
 sues left. Renewal notice is cover sheet 3  
 months before expiration. **See page 76**  
**for subscription information.**

Postmaster:  
 Send address changes to *Monitoring Times*,  
 7540 Highway 64 West, Brasstown, NC  
 28902-0098.

**Disclaimer:**  
 While *Monitoring Times* makes an effort  
 to ensure the information it publishes is  
 accurate, it cannot be held liable for the  
 contents. The reader assumes any risk for  
 performing modification or construction  
 projects published in *Monitoring Times*.  
 Opinion or conclusions expressed are  
 not necessarily the view of *Monitoring*  
*Times* or Grove Enterprises. Unsolicited  
 manuscripts are accepted. SASE if material  
 is to be returned.

**Owners**

Bob and Judy Grove  
[judy@grove-ent.com](mailto:judy@grove-ent.com)

**Publisher**

Bob Grove, W8JHD  
[bobgrove@monitoringtimes.com](mailto:bobgrove@monitoringtimes.com)

**Managing Editor**

Rachel Baughn, KE4OPD  
[editor@monitoringtimes.com](mailto:editor@monitoringtimes.com)

**Assistant Editor**

Larry Van Horn, N5FPW

**Art Director**

Bill Grove

**Advertising Svcs.**

Beth Leinbach  
 (828) 389-4007  
[bethleinbach@monitoringtimes.com](mailto:bethleinbach@monitoringtimes.com)

**TABLE OF CONTENTS**

**Departments:**

Letters ..... 4  
 Communications ..... 6  
 Stock Exchange ..... 76  
 Advertisers Index ..... 76

**First Departments**

**Getting Started**  
 Beginners Corner ..... 20  
*Exercise with Your Radio Hobby*  
 Ask Bob ..... 22  
 The MT Help Desk ..... 23

Scanning Report ..... 24  
*Choosing a Scanner*  
 Utility World ..... 28  
*ShipCom Frequencies*  
 Digital Digest ..... 31  
*Mexican Gulf and Brazilian Oil*

Global Forum ..... 32  
*Weeks of DST Confusion*  
 Broadcast Logs ..... 35  
 Programming Spotlight ..... 36  
*Unforgettable Radio*  
 The QSL Report ..... 38  
*Radio Prague Lookout Tower QSLs*

English Language SW Guide ..... 39

**Second Departments**

Milcom ..... 52  
*Air Show Schedules and Equipment*  
 The Fed Files ..... 54  
*The IRS - Where are They Now?*  
 Boats, Planes, TRAINS ..... 56  
*Hi-Rails, Track Permits, & Terminology*  
 Below 500 kHz ..... 58  
*New England Beacons*  
 Outer Limits ..... 59  
*Focus on Cupido Radio*  
 On the Ham Bands ..... 60  
*CW Testing Goes Gently Away*

**Technical Departments**

Antenna Topics ..... 62  
*Abbreviated Antenna Directory*  
 Radio Restorations ..... 64  
*T-O Recapped and Re-Rectified*  
 On the Bench ..... 66  
*Operational Amplifiers*  
 MT Review ..... 68  
*Kaito KA009 Emergency Radio*  
 First Look ..... 70  
*Kaito KA1102 vs Sangean ATS-505P*  
 Computers & Radio ..... 72  
*SDR-14's Real Time Spectrum Recording*  
 What's New ..... 74

**EDITORIAL STAFF** Email [firstlast@monitoringtimes.com](mailto:firstlast@monitoringtimes.com)

TJ "Skip" Arey.....	On the Ham Bands	Clem Small .....	Antenna Topics
Rachel Baughn .....	Communications	Doug Smith.....	American Bandscan
.....	Letters to the Editor	Hugh Stegman .....	Utility World
.....	What's New?	Ernest Robl.....	Trains
Kevin Carey .....	Below 500 kHz	Gayle Van Horn .....	Frequency Manager
John Catalano .....	Computers & Radio	.....	Broadcast Logs
Mike Chace.....	Digital Digest	.....	QSL Corner
Jim Clarke .....	First Look	Larry Van Horn.....	Milcom
Marc Ellis .....	Radio Restorations	.....	First Look
Bob Grove .....	Ask Bob	.....	MT Help Desk
Glenn Hauser .....	Global Forum	Dan Veeneman .....	Scanning Report
Chris Parris .....	Fed Files	Ron Walsh.....	Boats
Ken Reitz.....	Beginners Corner	Fred Waterer.....	Programming
Lee Reynolds .....	First Look	.....	Spotlight
Iden Rogers.....	Planes	George Zeller.....	Outer Limits

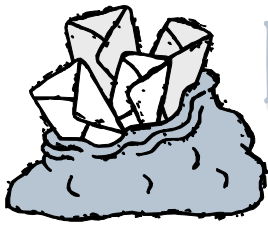

# LETTERS TO THE EDITOR

## And the Winners Are ...

We've enjoyed the influx of contest entries and the congratulations that accompanied them. Thanks to all who entered our 25th Anniversary Drawing, which ended January 15. After allowing a few days for late arrivals, we mixed them up and drew the winning entries.

Winner of the Kinetic Avionics SBS-1, donated by ENI Communications (70 Brookside Road, Randolph, New Jersey 07869; 866-500-SBS1; [www.kineticavionics.us](http://www.kineticavionics.us)) is long-time *MT* reader Greg Gilbert of Atlanta, Georgia. Congratulations, Greg, for winning your own virtual radar as reviewed in our air show issue one year ago this month. You'll be the envy of all, especially in the aviation-rich environment of Atlanta!

Second-place winner is Darrell Anderson of Renton, Washington, who won the compilation CD, including all issues of *Monitoring Times* from 1999 through 2005!

So, what was the headline on Volume 1 Issue 1 of *Monitoring Times*? "Space Shuttle Communications Monitoring" – a topic *MT* has continued to update through the years. Drawn from the pot of those with the correct answer was Donald Clift of Olympia, WA, who wins a life-time subscription to *MT*.

Diligent sleuths could have found the answer on *MT*'s web site, but we were amazed how many of you still had the original issue on a shelf, or in a box, or in the attic. Greg Diltz was curious to know "how many 'charter' subscribers are still on the roster?" Well, I can at least say that out of 28 entries with the right answer, 12 of you said you were subscribers from day 1!

Donald Clift said in his entry, "What a 25 year run it has been, from shuttle communication, razor blade receivers, Havana Moon, and the end of the world scenario. A whirlwind tour through the ever-changing and ever-interesting radio monitoring scene in three different formats ... May we see 25 more years."

Well, Donald, since you won the lifetime subscription, I hope we'll have 25 more years, too! Thanks for those kind words; I couldn't have summed it up better myself.

– And to Jim Ward, who wondered about finding two different issues dated May 1986 as he pawed through his back issues – I remember that one! I was the art director back in those days when everything was hand-pasted and major elements were used over and over. The new dates just never got pasted onto the header; "CSE: Canada's Ear on the World" should have been dated June 1986.

## The Shortwave Debate Continues

"Much has been written recently about the demise of shortwave radio and with major international broadcasters moving to satellite or internet, it certainly appears that shortwave's days are numbered. But, let's think about this for

a minute. Being an avid DXer since my childhood in the 1970s, I remember too well waiting with great anticipation for some far flung signal only to have the BBC, VOA or numerous other big international broadcasters sign on and crush any hope of hearing my weak little station.

"So now with the changes that are happening it could very well be a 'Golden Age' again for DXers! Also, the cold war now being pretty much a thing of the past, we no longer have the radio war that plagued the bands at one time. You know, the hours of communist block propaganda that was beamed towards us on many different frequencies shouting the wonders of the worker's paradise.

"Many of my DX targets are in the third world, where access to computers or satellite is years away, so with any luck many of these stations will continue to use the medium to reach domestic audiences. Of course, there will hopefully always be amateur radio operators to give a listen. Pirates are another source of listening. What about establishing a 'Pirate Band'? At first this may sound a little crazy, but if it were regulated by the FCC and stations had certain operating times and dates that they could broadcast legally, then it could stir more interest in the field."

– Larry Beth, Bryant, AR

"I have been an avid shortwave listener (SWL) for the past 13 years and at time did a bit of DXing as well. Unfortunately, like many of the international broadcasters, I have reached the time to turn off my shortwave radio. The news continues to be how different stations are finding a way or need to continually close down or eliminate shortwave from its broadcast media. The latest is Radio Canada International. The response from all of them is 'you can get our programs from the internet.' Well, I live in the technology rich US and where I live I only can get a dial-up. This makes live web streaming or down loading quite a chore. Besides, as a SWL, I don't want to be locked down to my computer.

"Additionally, with the larger shortwave broadcasters leaving the air, there is not much left on shortwave worth listening to (WBCQ the only slight exception). The rest seem to be hard to catch or just plan boring or preachy. Of course you can still get all the propaganda you want. I was being entertained by shows from the BBC, Deutsche Welle, Radio Canada, even Voice of Russia. Now the only clear catches in the US are China Radio International, Radio Havana Cuba, and Radio Taipei International. No thanks. Good-bye shortwave; guess I'll just have to turn on the TV."

– Bret Pollack, Marriottsville, MD, Subscriber to *Monitoring Times* and Member of NASWA

"Bret – I have had the feeling many times, but once in your blood, you keep returning to the dials. You could, as many of us have, start hunting

medium wave stations, especially trans-Atlantic stations. I have put a real punch in my listening by DXpeditioning and have become addicted to 12 volt DXing (will be submitting an article soon with techniques and experiences). You might try picking a geographic area and see how many stations you can hear (say, PNG regionals) – I have found that with 240 countries verified, I need a challenge to stay interested.

"Or, a break may do the trick (but not a long break). Try setting up in a new location and stringing new antennas. A healthy dose of the Winterfest will also help. Keep me updated on how it turns out (there might be a good musing for *The Journal* in here somewhere).

– Harold Cones, Editor-in-chief and member of the Executive Board, North American Shortwave Association (NASWA)

## Programming Spotlight

"Good column! (Dec 2006) Living in NE Pennsylvania, I listen to both CHWO and CHML at night.

"I belong to the 'Dietrich Theater Radio Players,' a group sponsored by the Dietrich Theater in Tunkhannock, PA. We have been performing old radio plays for the past few years in the spring and around Christmas. Two years ago, we performed 'A Christmas Carol.' I am the sound effects person and sound engineer for the group.

"There's nothing like a radio play for letting the imagination create the scene."

– Bob Kulow WA2UEH

"Just a little correction in your article on 'The Christmas Carol' on radio. It was Lionel Barrymore, not John, who played Scrooge."

– Darrel Anderson, Renton, WA

## Belated Photos

Speaking of gadgets, last month we printed a letter from Judy May W1ORO mentioning building electric motors from scrap parts. After the issue went to press, I discovered she had sent

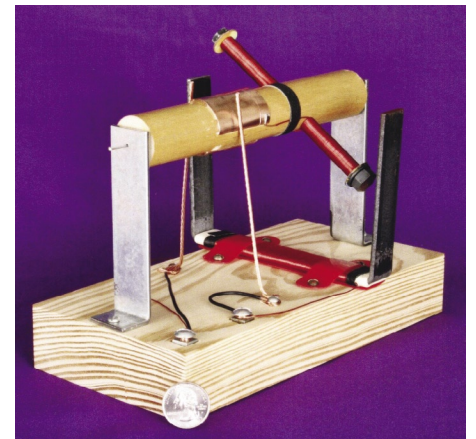

continued on page 53

# Universal Radio — Quality equipment since 1942.

## ICOM R75



Universal Radio is pleased to continue to offer the **ICOM R75** receiver. With full coverage from 30 kHz to 60 MHz; all longwave, medium wave and shortwave frequencies are supported plus extended coverage to include the 6 meter amateur band. Some innovative features of the R75 include: **Synchronous AM Detection**, FM Mode Detection (but not the FM broadcast band), Twin Passband Tuning, Two Level Preamp, 99 Alphanumeric Memories, four Scan Modes, Noise Blanker, Selectable AGC (FAST/SLOW/OFF), Clock-Timer, Squelch, Attenuator and backlit LCD display. Tuning may be selected at 1 Hz or 10 Hz steps plus there is a 1 MHz quick tuning step plus tuning Lock. The front-firing speaker provides solid, clear audio. The back panel has a Record Output jack and Tape Recorder Activation jack. The supplied 2.1 kHz SSB filter is suitable for utility, amateur, or broadcast SSB. However, two optional CW/SSB filter positions are available (one per I.F.). The formerly optional **UT-106 DSP board** is now included and factory installed! A great value. Order #0175—**Call for price.**

## ICOM PCR1500 R1500



The **ICOM PCR1500** wideband computer receiver connects externally to your PC via a USB cable. This provides compatibility with many computer models, even laptops. Incredible coverage is yours with reception from 10 kHz to 3300 MHz (less cellular gaps). Modes of reception include AM, FM-Wide, FM-Narrow, SSB and CW. (CW and SSB up to 1300 MHz only). The PCR1500 comes with an AC adapter, whip antenna, USB cable and Windows™ CD. #1501 **\$499.95**

The **ICOM R1500** is similar to the above, but also includes a controller head for additional operation independent of a PC. #1500 **\$599.95**

## ICOM PCR2500 R2500



The **ICOM PCR2500** wideband computer receiver uses a similar form-factor to the PCR1500, but has several enhancements, including two powerful features: **dual watch** (the radio can receive two signals simultaneously) and **diversity reception** (two antennas can be connected at the same time and employed to provide stable reception). The optional UT-118 Digital Unit provides D-STAR® digital voice reception and the optional UT-121 supports APCO25 digital voice decoding. The R2500 is shown above. #2501 **\$729.95**

The **ICOM R2500** is similar to the PCR2500, but includes a controller head for additional operation independent of a PC. #2500 **\$899.95**

**FREE**

**ICOM UT-121 APCO 25 Board included!**

A \$248.00 value included **FREE** with your R2500 or PCR2500 purchase valid to March 31, 2007.

## R9500

This device has not been approved by the Federal Communications Commission. This device may not be sold or leased, or be offered for sale or lease, until approval of the F.C.C. has been obtained.



The **ICOM R9500** clearly raises the bar for professional receivers. Covering 5 kHz to 3335 MHz, this instrument represents the state-of-the-art in receiver technology! Visit the Universal website for complete details.



The **R3** tunes 500 kHz to 2450 MHz (less cellular) in AM, FM-W, FM-N and TV via a 2 inch **TFT color TV screen**. You can receive regular TV [NTSC], and you may be able to see certain video feeds and ham radio Fast Scan TV. A second mono LCD display that can be used to conserve battery life. You get: 450 alpha memories, 4-step attenuator, bandscope, video and audio outputs and auto power-off. Comes with Li-Ion battery, charger, belt clip and BNC antenna. **Call**



The **ICOM R20** covers an incredible 150 kHz to 3304.999 MHz (less cellular) with 1250 alphanumeric memories, bandscope and SSB/CW. It has: two VFOs, dual watch, voice scan control, NB, large two line LCD and CTCSS/DTCS/DTMF. A built-in **IC audio recorder** can record 1, 2 or 4 hours of reception! This radio comes with charger, Li-ion battery, belt clip and wrist strap. **Call**

More info on website. **Call**

More info on website. **Call**

## R5



The **R5** covers 150 kHz to 1309.995 MHz (less cellular gaps) in: AM, FM Narrow and FM wide. 1200 memories store: frequency, mode, step size, duplex direction and offset, CTCSS tone, tone squelch and skip settings. Other features include: attenuator, LCD lamp, AM ferrite bar antenna, auto power off, CTCSS decode, weather function and battery save. A great value at under \$200.00. **Call, or visit website for price.**

**www.universal-radio.com**

◆ Visit our website or request our free 112 page catalog for other exciting ICOM products.

universal  
radio inc.

Universal Radio, Inc.  
6830 Americana Pkwy.  
Reynoldsburg, Ohio  
43068-4113 U.S.A.

☎ 800 431-3939 Orders & Prices  
☎ 614 866-4267 Information  
☎ 614 866-2339 FAX Line  
✉ dx@universal-radio.com



Universal Radio is also pleased to carry the complete ICOM amateur radio equipment line. The **IC-7800** shown.

- Visa
- MasterCard
- Discover
- JCB
- Prices and specs. are subject to change.
- Special offers are subject to change.
- Returns subject to a 15% restocking fee.
- Prices shown are after mfg. coupons.



# COMMUNICATIONS

"Communications" is compiled by Rachel Baughn KE4OPD (editor@monitoringtimes.com) from news stories submitted by our readers. Thanks to this month's fine reporters: Anonymous, Michael Dell, Robert Fraser, Bob Grove, Alokesh Gupta, Norman Hill, hl4@att.net, Jerry None, Ian Poole, Doug Robertson, Brian Rogers, Henry T, Larry Van Horn, Ed Yeary

## NEWS NOTES

### FCC and FAA Tower Rulings

After years of inaction, the Federal Communications Commission may finally be poised to do something about the untold millions of migratory birds which die in the U.S. after colliding with radio, TV and assorted communications towers. The comment period on a November proposed rulemaking has now been extended to mid-April, with reply comments due in May. For the first time, studies are also beginning to offer encouraging statistics as to what kind of tower lighting may cause the least damage: blinking lights versus steadily burning, white versus red, guyed towers or monopoles, etc.

In September 2006, the Federal Aviation Administration posted a Notice of Proposed Rulemaking to require broadcasters to notify it of construction or modification of towers before being approved by the FCC. The move has the communications industry in an uproar, as it would cause delays and added expense not only to broadcasters, but other types of FCC-authorized service, such as cellular, PCS, WiFi and WiMax systems.

The regulatory agency says it is requesting the changes to get a better handle on electromagnetic interference. But the rulemaking request raises the issue of spectrum management and exactly who has regulatory control over it. Broadcast spectrum is considered the domain of the FCC. Critics also point out that most of the information sought by the FAA already appears in the FCC database, and both agencies meet several times a month as members of the Interdepartment Radio Advisory Committee (IRAC).

### The Times They are a'Changing

In late December, HCJB World Radio, the world's first missionary broadcasting ministry, changed its name to "HCJB Global." The ministry also named its media ministries "HCJB Global Voice" and its healthcare ministries "HCJB Global Hands."

The ministry retained the call letters of its first radio station – HCJB – to honor its first radio station, established 75 years ago in Quito, Ecuador.

HCJB World Radio Engineering Center in Elkhart, Ind., has become the HCJB Global Technology Center, providing consulting, service and engineering assistance wherever technological solutions are needed to advance the gospel.

### Free Ham Radio Podclass

John Martin and Mike Dell are producing a new podcast that will teach listeners everything they need to know to get their Technician Class Amateur (Ham) Radio license – for free.

The Ham Radio Podclass podcast can be found at [www.hamradioclass.org](http://www.hamradioclass.org). To subscribe (for free) using iTunes or another podcast catching program, subscribe to <http://feeds.feedburner.com/hamradio>. But you don't need an iPod or MP3 player: You can listen right on your computer using most any audio player. Podcasting automatically transfers the digital media files to the user's computer for later use.

John Martin, KF8KK, has worked as a broadcast engineer for most of his career. Mike Dell, N7LMJ, is currently working in graphic arts for a printer / publisher. Both men are active in ARES/RACES and are ARRL accredited volunteer examiners.

## ON THE MT HOME FRONT

### Rare Antique Radios Auctioned

Dr. Harold Cones and Professor John Bryant (authors of December's cover story on the first use of shortwave radio in the Arctic and of *The Zenith Trans-Oceanic: Royalty of Radios* book) did some gratis consulting work for Zenith in Chicago as it was closing down.

Soon after they returned to their homes, each received a box from Zenith containing an UNOPENED, factory boxed, Zenith R7000-2 which had been discovered in the warehouse. The R7000-2 was the last and best Trans-Oceanic ever made and is one of the rarest. The R7000-2 was called "a masterpiece of innovative technology" in 1981 and is most likely the finest portable radio of the pre-digital era.

Cones and Bryant decided to archive the two T-Os – unopened – until such time as they needed additional funds to support their research. A decade later, as they begin work on the long-awaited 2nd Edition of the book, that time finally arrived and the two radios were auctioned on Ebay.

The auction closed Jan 22 with a top bid of \$1,426. The top two winners each received one of the unopened, boxed, R7000-2s; a copy of the original letter of transmittal from Zenith to the authors, dated Nov. 21, 1997; Certificate of Authenticity, signed by both

authors; a copy of *The Zenith Trans-Oceanic – Royalty of Radios*, autographed by both authors.

### What's the Frequency, Kenneth?

In 1986, newscaster Dan Rather reported being knocked down and kicked by someone asking, "Kenneth, what is the frequency?" Bob Grove recently came across "the rest of the story" in an AP story from 1997, and he thought some of our readers may have wondered about the outcome of the incident as he did.

The CBS anchorman said his assailant was William Tager, who went to prison for killing an NBC stagehand outside the *Today* show in 1994. Tager was convinced the media had him under surveillance and were beaming hostile messages to him, and he demanded that Rather tell him the frequency being used, according to a forensic psychiatrist who examined Tager after the NBC shooting.

### MT blog hits the big-time

Congratulations to Larry Van Horn in his moment of fame: Larry's January 19th blog reported on an *Aviation Week and Space Technology* story about a Chinese missile launch which successfully destroyed a low earth orbiting satellite. His blog was picked up by several newscrawlers which resulted in as many as 400 hits in one day. Check out <http://mt-milcom.blogspot.com> to see what he's up to now!

### Electronic Tutorials

The website Radio-Electronics.Com ([www.radio-electronics.com](http://www.radio-electronics.com)), edited by Ian Poole (author of this month's *On the Bench* column on operational amplifiers), provides free radio and electronics related information, tutorials, and articles, and has just surpassed 400 pages of tutorial content. The site, which is aimed at electronics engineers and students, strives to provide concise, useful overviews and tutorials in an easy to read form.



### It's Not Too Late

Make your plans now to attend the Winter SWL 20th Anniversary Festival in Kulpville, PA, March 8-10. Check out [www.swlfest.com](http://www.swlfest.com) for details or write SWL Winterfest, P.O. Box 4153, Clifton Park, NY 12065 for a registration form.





# Monitoring the Air Show Experience

## The Annual MT Air Show Guide

By Larry Van Horn, MT Assistant Editor, N5FPW



Photo courtesy USAF Thunderbirds

**A**ir Show! Nothing stirs up the aircraft enthusiast's juices more than those two magical words. And every year, from March through November, thousands travel all around the country each weekend to watch the action, as military and civilian aero teams put their aircraft through the paces to entertain and perform.

While there is nothing quite as thrilling as going out to one of these public air shows and watching the military or civilian demonstration teams strut their stuff in front of thousands of aircraft fanatics, you can add to the visual experience by monitoring the performing teams' radio communications. With a radio scanner in hand, you will experience a whole new perspective of the show that few attendees will realize or enjoy.

Since the new 2007 air show season starts in the second week of March, we proudly present our eighth annual *Milcom Air Show Guide*. In this feature we will give you the frequencies to monitor, and on page 52 you'll find the recommended list of air show radio equipment and schedules for the major military flight demonstration teams for the coming season.

### Where do you hear the action?

From time to time, frequencies for air show teams do change. Back in 2004, the Blue Angel team made some major changes after our annual guide was in the hands of *MT* readers. But when our annual list didn't have the new frequencies, seasoned veterans knew the right bands to target to look for the new frequencies being used.

So, what bands do veteran radio monitors search for new frequencies? You should concentrate on the bands listed below to locate air

show activity in your area (all frequencies in this article are in MHz).

- 118.0-137.0 25 kHz search steps (AM mode) Note: We have reports of a lot of new air show activity in the new portion of the civilian aero band – 136-137 MHz. Be sure to check out this frequency range out for civilian and military demo aircraft communications
- 122.7-123.575 25 kHz search steps (AM)
- 138.0-144.0 12.5 kHz search steps (AM/Narrowband FM)
- 148.0-150.8 12.5 kHz search steps (AM/NBFM)
- 225.0-390.0 25 kHz search steps (AM)
- 390.0-400.0 12.5 kHz search steps (AM/NBFM)
- 406.1-420.0 12.5 kHz search steps (NBFM)

### U.S. Navy Blue Angels

The U.S. Navy (USN)/Marine Corps (USMC) military team is represented on the air show circuit by the Blue Angels flying their F/A-18 Hornet aircraft.

A Blue Angels flight demonstration exhibits the skills possessed by all naval aviators. It includes the graceful aerobatic maneuvers of the four-plane Diamond Formation, in concert with the fast-paced, high-performance maneuvers of its two Solo Pilots. At the close of every show, the team illustrates the pinnacle of precision flying, performing maneuvers locked as a unit in the renowned, six-jet Delta Formation.

The team is stationed at Forrest Sherman Field, Naval Air Station Pensacola, Florida, during the show season. However, the squadron spends January through March training pilots and new team members at Naval Air Facility El Centro, California.

The Blue Angels are scheduled to fly 66 air shows at 35 air show sites in the United States during the 2007 season, as the team celebrates 20 years of flying the F/A-18 Hornet. Last season, more than 15 million spectators watched the Blue Angels perform. Since its inception in 1946, the Blue Angels have performed for more than 427 million fans.

The other major piece of hardware in the squadron is their C-130 Hercules transport aircraft, affectionately known as "Fat Albert." It is the only Marine Corps aircraft permanently assigned to support a Navy squadron and is flown by an all-Marine Corps crew of three pilots and five enlisted personnel. "Fat Albert" flies more than 140,000 miles during the course of a show season.

After coping with all the frequency changes noted during the 2004 season, the 2006 season was relatively stable. The primary AM mode UHF frequencies monitored during last season include:

Frequency	Usage
237.800	Solos <Channel 8>
255.200	Circle and arrivals discrete <Channel 17>
275.350	Diamond <Channel 9>
284.250	Show Box/Delta <Channel 16>
289.800	Aerial Refueling
302.100	Fat Albert <Secondary>
305.500	Fat Albert Primary <Channel 10>
346.500	Ground start/rollout/maintenance <Channel 18>

There were some other UHF frequencies that were not widely reported last season. These included – 251.600 302.150 307.700 (AM).

During the 2005 show season, the Blues started using a new ground cart for show communications. Two new narrowband FM splinter frequencies/designators were found in use

- 139.8125 <Alpha/Channel 3> and 142.6125 <Bravo/Channel 3A>. Last year another possible new narrowband FM frequency was reported - 141.5625 <Charlie> MHz.

We believe that the older widely reported 162-174 MHz Blue Angel FM LMR frequencies are apparently no longer used. But for the time being I have not deleted them from this list, as I did receive reports last year from some west coast monitors claiming that some of them were still being used.

I encourage those of you with Signal Stalker and Close Call capability to watch the LMR spectrum from 138-144 MHz closely for new additional 12.5-kHz splinter frequencies being used by the team's ground crews.

Other frequencies commonly reported for the team include:

**Cross Country Air-Air**

138.250 143.600 237.800 238.150  
275.350 284.250 (AM)

**Maintenance/Ground communications [Old communications comcart/ground frequencies]**

142.000 143.600 163.000 164.900  
165.225 167.500 167.800 168.900  
169.400 170.900 (NBFM)

**Tower-Comm Cart (May no longer be used)**

173.825 (NBFM)

**Tower Observer**

143.000 (AM)

Other UHF frequencies that have been reported in past years, but not reported last season include:

236.450 249.625 254.500 256.250  
262.850 263.350 264.350 264.550  
265.000 273.300 286.000 299.650  
381.000 (AM)

You can learn more about the Blue Angels flight demonstration team on their internet website at [www.blueangels.navy.mil/index.htm](http://www.blueangels.navy.mil/index.htm)

**U.S. Air Force Thunderbirds**

The premier U.S. Air Force (USAF) flight demonstration team is known as the Thunderbirds. This team uses six F-16C Fighting Falcon aircraft, performing formation flying and solo routines. The four-aircraft diamond formation demonstrates the training and precision of Air Force pilots, while the solos highlight the maximum capabilities of the F-16. The pilots perform approximately 30 maneuvers in a demonstration. The entire show, including ground and air, runs about an hour and 15 minutes.

The frequency list below has been in use by the team over the last eight air show seasons. It should be noted that at some performances the 143.850 and 235.250 MHz roles are reversed from what is published below.

Frequency	Usage
139.800	Possible New VHF (AM)
140.400	Support "T-Bird Ops"/Cross country air-to-air (AM)
141.850	Pre-take/Four ship/Diamond formation linked to PA system/Cross country air-to-air (AM) <Channel 2>
142.575	Program audio/Air-Ground communications (NBFM)
143.850	Diamond formation/Cross country air-to-air (AM) <Channel 1> Re-transmission to public through the

235.025	team PA system.
235.200	Unknown usage [Tentative]
235.250	Thunderbird Control/ComCart (AM)
322.950	Pre-Engine Start and Solo aircraft on/off show center/ linked to PA system (AM) <Uniform 1>
	Engine Starts/Solo aircraft (5-6) Air-Air (AM) <Uniform 2>

**Maintenance/Ground teams (NBFM/P25 digital)**

142.175	Analog
143.900	Analog
216.7275	Announcer PA Feed
216.9775	Team Airshow frequency feeds
413.000	Digital
413.025	Analog/digital <Channel 1>
413.100	Analog/digital) <Channel 2>
413.250	Analog
413.275	Analog
413.350	Digital
413.375	Digital
901.500	Comm Cart Headset
905.350	Comm Cart Headset

You can learn more about the T-Birds on their website at [www.thunderbirds.acc.af.mil/](http://www.thunderbirds.acc.af.mil/)

**Other DoD Military Flight Demo Teams**

In addition to the two units mentioned above, the Navy and the Air Force also have other flight demonstration units. Other branches of the Department of Defense (DoD) and David Shultz air shows (one of the premier air show companies) use a wide variety of VHF and UHF frequencies during air shows. Some of the frequencies recently reported for these organizations are listed below. (AM mode is used for all the frequencies listed below unless otherwise indicated.)

David Shultz airshows (civilian)	118.700 135.650 238.150 350.300
Heritage Flight	118.500 122.475 123.150 127.150 136.575 136.675 238.150 376.025 384.550
US Air Force A-10 Thunderbolt demonstration teams	122.475 123.150 123.475 136.575 138.050 138.100 138.200 138.250 138.300 138.475 138.500 139.900 139.625 139.725 139.800 139.975 140.400 141.675 142.200 225.500 236.850 269.900 283.700 305.400 327.700 341.500 343.000 343.000 384.550
US Air Force B-1B Bomber Flyover	238.150
US Air Force B-2 Bomber Flyovers (509BW)	290.225 335.550 370.900 388.850
US Air Force B-52 Bomber Flyovers	376.025
US Air Force F-15 Eagle East demonstration team (Replaced by the USAF F-22 Demo Team)	123.150 376.025 384.550
US Air Force F-15 Eagle West demonstration team	123.150 376.025 384.550
US Air Force F-16 Fighting Falcon demonstration teams	136.575 136.675 365.700 376.025 283.700 384.550
US Air Force F-22 Raptor East demonstration team	238.900 290.225 292.700 387.200



"Fat Albert" courtesy USN Blue Angels

US Air Force AETC T-6 Texan East Coast Team	118.900 122.925 123.150 123.400 127.150 138.400 226.100 283.700 295.000 Note: Ground support team reportedly uses FRS radios. It has been reported that last season was the last year for this team due to fiscal issues.
US Air Force Combat search and rescue (SAR) demonstrations	127.150 138.100 139.700 225.450 236.000 242.000 251.900 252.800 259.000 278.800 280.500 282.800 287.500 381.000 384.550
US Coast Guard aircraft/SAR demonstrations	122.900 (SAR) 157.050 (Drug Interdiction demo - NBFM) 157.075 (Command Post -NBFM) 237.900 282.800 326.150 345.000 379.050
US Coast Guard HITRON interdiction demo	157.050 (NBFM)
US Navy F/A-18 Demo Team	376.025
US Navy LCAC comms	40.400 (NBFM)
US Navy Light Amphibious Vehicle comms	30.000 (NBFM)
US Navy S-3 Viking aircraft demonstrations	263.400 325.400 325.800
US Navy SAR demonstrations	242.500 282.000 283.100

**DoD Military Parachute Demonstration Teams**

The premier DoD military parachute team on the air show circuit is the U.S. Army Golden Knights based out of Fort Bragg, North Carolina. The team aircraft used during air shows is either the C-31A Friendship or UV-18A Twin Otter.

Look for their communications on the often reported frequencies of 122.775, 123.400, 123.475, and 123.500 MHz. You should also keep the following plugged into your scanner for possible GK team activity - 32.300, 32.400, 122.575, 124.875, 126.200, 238.000, 284.900 and 367.700 MHz. And (in an exclusive tip to MT readers), you should also watch for a possible new VHF frequency of 142.800 MHz for Golden Knight radio activity in the near future. You can learn more about the Golden Knights on their official website at [www.usarec.army.mil/hq/goldenknights/Webpage2005\\_content.html](http://www.usarec.army.mil/hq/goldenknights/Webpage2005_content.html)

The US Army actually has more parachute teams than just the Golden Knights. The U.S. Army Special Operations Command parachute team is known as the Black Daggers (see MT *Milcom* May 2004). Several frequencies have been uncovered for them during the last three seasons and these include - 123.450 136.000 136.500 138.650 237.300 238.150 MHz. The team has a very nice website located at <http://news.soc.mil/blackdaggers/blackdaggers.htm>

Another Army parachute outfit is the Silver Wings. This is the Fort Benning, Georgia, Command Exhibition Parachute Team. They have been monitored on 34.650 and 44.900 MHz. Both these frequencies were common landing zone frequencies in the area they were performing in. So, in case you aren't hearing them at a performance you attend, I suggest a rigorous search of the VHF-low band frequencies be initiated if neither of the two frequencies above is heard.

In addition to the VHF low band frequencies I have mentioned above, ground and safety personnel associated with this team have been heard using 467.6125 MHz (FRS channel 10/GMRS) for communications. There was also one report that the team was using an Intra Squad radio frequency of 397.500 MHz. See our comments below about programming ISR, GMRS and FRS channels for air show monitoring. The Silver Wings team website is located at <https://www.infantry.army.mil/silverwings/>

The U.S. Army has several more teams, but we do not have frequency information for them. We would appreciate communication reports on the following U.S. Army teams if you catch them performing this air show season.

- All American Free Fall Team (82<sup>nd</sup> Airborne)  
Fort Bragg, North Carolina
- Green Beret Parachute Team Fort Bragg, North Carolina
- Screaming Eagles (101<sup>st</sup> Airborne Division)  
Fort Campbell, Kentucky
- Black Knights US Military Academy, West Point, New York

The U.S. Special Operations Command has a team based out of MacDill AFB in Florida. They have been heard on the following frequencies: 122.450, 123.450 and (no, this is not a misprint) 151.625 MHz, a nationwide business itinerant frequency.

And last, but not least, the colorful U.S. Navy Seal Parachute Team, known as the Leap Frogs, are frequent visitors around the country at various sporting events and air shows. This team has been regularly reported on 270.000 (AM) and 407.500 MHz (NBFM 131.8-Hz PL tone) nationwide over the last several years.

### GMRS Frequencies

During the 2001 and 2002 seasons I received several reports that the Golden Knights were using GMRS (General Mobile Radio Service) frequencies 462.625, 467.5625, and 467.6125 MHz. In addition to hearing air show demo crews, monitors have found vendors and other military ground units using GMRS frequencies. You should make these frequencies part of your scanner load-out prior to the air show.

A	B	C
462.550	467.550	462.5625
462.575	467.575	462.5875
462.600	467.600	462.6125
462.625	467.625	462.6375
462.650	467.650	462.6625
462.675	467.675	462.6875*
462.700	467.700	462.7125
462.725	467.725	

\*(462.675/467.675 National Emergency Frequency pair)



Photo courtesy USA Silver Wings

### Legend:

- A. Base station, Mobile relay, Fixed station, or Mobile station
- B. Mobile station, Control station, Fixed station operating in Duplex mode.
- C. Interstitial frequencies, base and portable simplex

397.4750	Channel 6
397.5500	Channel 7
397.9500	Channel 8
398.0500	Channel 9
399.4250	Channel 10
399.4750	Channel 11
399.7250	Channel 12
399.9250	Channel 13
399.9750	Channel 14

### Family Radio Service/Intra-Squad Radio Frequencies

We have also received several reports of the ground pyrotechnics personnel from the Tora Tora Tora and Warbirds flight demonstration team using FRS (Family Radio Service) radios for communications during shows. You will also find military monitoring enthusiasts attending an air show using FRS radios to coordinate meeting fellow monitors. Load up FRS frequencies below (NBFM mode) in your scanner or carry a FRS radio to the show, and you might make a new *Milcom* monitoring friend or two.

462.5625	Channel 1
462.5875	Channel 2
462.6125	Channel 3
462.6375	Channel 4
462.6625	Channel 5
462.6875	Channel 6
462.7125	Channel 7
467.5625	Channel 8
467.5875	Channel 9
467.6125	Channel 10
467.6375	Channel 11
467.6625	Channel 12
467.6875	Channel 13
467.7125	Channel 14

The government version of the Family Radio Service is known as the Inter-Squad Radio or ISR. As noted above, I have seen several reports over the last few years that these radios might be in use at air shows by military units, including the Civil Air Patrol (CAP), see below. It might be a good idea to program these frequencies in your scanner as part of your air show load out.

396.8750	Channel 1
397.1250	Channel 2
397.1750	Channel 3
397.3750	Channel 4
397.4250	Channel 5

### U.S. Civil Air Patrol Frequencies

Finally, you should program U.S. Air Force Civil Air Patrol frequencies in your scanner as well. We have received field reports of CAP frequencies (repeater and simplex) being used as ground support at several air shows.

The CAP is in the process of transiting to narrowband allocations/equipment during 2007 at a cost of \$23 million plus to the taxpayers. We have included both the old assignments as well as the new assignments that we found in the public domain.

Frequencies (variety of modes) until October 1, 2007			
143.750	143.900	148.125	148.1375
148.150	148.5375	148.975	149.5375
MHz			
Frequencies (variety of modes) starting in April 2006 and will be the norm after October 1, 2007			
138.0125	140.6375	142.2250	143.7250
143.9000	148.1750	148.7750	150.1625
150.5625	150.6375	MHz.	

### Civilian/Foreign Air/Parachute Demonstration Teams

The Canadian Forces Snowbird aircraft demonstration team (431 Air Demonstration Squadron) is another regular on the U.S./Canada air show circuit. The following frequencies have been recently reported for this popular aerial team: 123.325 227.600 242.600 243.400 245.500 245.750 246.500 272.100 (Primary) 284.900 299.500 333.300 340.100 MHz.

A new Snowbird VHF frequency has now been noted in use during the last two seasons



Photo courtesy USAF Thunderbirds

– 116.000 MHz (AM), 243.400 and 272.100 are the only two UHF frequencies reported in 2005-6.

At most air shows the military flight demonstration units aren't the only performers. Civilian organizations, companies, and individuals sponsor a wide variety of aerobatics teams and parachutists to thrill the crowd. A wide variety of frequencies are used by these teams in the civilian aviation band. If you load your scanner with the following frequencies, you shouldn't miss out on communications used by the civilian acts.

122.725	122.750	122.775	122.825
122.850	122.875	122.925	122.950
122.975	123.025	123.050	123.075
123.150	123.175	123.300	123.325
123.350	123.400	123.425	123.450
123.475	123.500	129.650	129.925
136.575	136.975		

Some specific frequencies reported to us for other foreign military and US civilian flight demonstration teams are included in the list that follows:

**Civilian Flight Demonstration Teams**

Aeroshell Aerobatics Team 123.150  
 Air Force Reserve Biplane (Ed Hammil) 123.150  
 All American Firebirds Flight Demonstration Team 122.775  
 Bud Light Air Force (ex- Coors Microjet) 122.925 123.350 123.475  
 Civilian Air Show Discrete Common 123.150  
 CJ-6/YAK-52 Flight Formation Team 122.775  
 Flight for Diabetes (Michael Hunter) 123.425  
 Firecat (Rich Perkins) 123.500  
 Flying Colors Hang Glider Aerobatic (Dan Buchanan) 123.300 132.950  
 French Connection Air Show 122.925 122.975 129.975  
 Geiko Extra 300 – Tim Webber 123.150  
 Ian Groom's FedEx Red Bull Aerobatic Team 122.725 122.775 122.825 122.925 123.150 123.350  
 Iron Eagles Aerobatic Team 122.925  
 Jim LeRoy Bulldog Team 123.150  
 John Klaff 123.475  
 L39 Patriots 127.300  
 Lima Lima Flight Team 123.150 123.175 123.425

Manfred Radius Glider Aerobatics Team 123.150  
 North American Jet Air Show Team 122.775 122.925 129.650 129.925  
 Northern Lights Aerobatic Team 123.325 136.975  
 Oreck Vacuum Cleaners Aerobatic Demo (Frank Ryder) 122.825 123.425 123.450  
 Otto the Helicopter 123.150 123.300  
 Patty Wagstaff Air Shows Inc 122.750 123.475  
 Pitts Special U.S. Air Force Reserve 123.150  
 Rayban Gold Aerobatics Team 122.925  
 Red Baron Stearman Squadron 122.725 122.775 123.150  
 Red Eagles Flight Demo Team 123.150 123.425 123.475  
 Sean Tucker Power Aerobatics 122.875 122.950 123.150 123.450 123.475  
 SIAI Marchetti SF260 Debbie Gary 123.150  
 Showcopters 123.150 134.700  
 Sky Soldiers Demonstration Team (Army Aviation Foundation) 123.025 242.400  
 Skytypers Team 122.750 122.775 123.450  
 Swift Magic Aerobatic Team 122.775 122.925  
 Team Red 123.350  
 Tora Tora Tora Warbirds Team (Commemorative Air Force) 122.850 122.875 123.150 123.450 469.500 469.550

**Foreign Military Flight Demonstration Teams**

Asas de Portugal, Esquadra 103 (Wings of Portugal 103 Squadron) Flight Team 262.150  
 Blue Eagles Royal Army Air Corps Flight Team (UK) 136.975  
 Blue Tango Helicopters 123.600  
 Brazilian Air Force Team (Brazil) 130.550 130.650 132.250  
 British Army Red Devils Parachute Team (UK) 462.625  
 Canadian Forces Skyhawks Parachute Jump Team (Canada) 123.000 294.700  
 Falcons Royal Air Force Parachute Jump Team (UK) 255.100 465.100  
 Frecce Tricolori Military Flight Team (Italy) 123.475 (Ground Secondary) 140.600 (Ground Primary) 362.625 (Primary) 263.250 (Secondary)

Grasshopper Helicopter Team (Netherlands) 281.100  
 Halcones Military Flight Team (Chile) 136.175  
 La Patrouille Adecce Air Force Flight Team (France) 121.850 123.600 138.450 141.825 143.100 143.850 242.650  
 La Patrulla Aguila Military Flight Team (Spain) 130.500 252.500  
 Le Royal Jordanian Teams (Jordan) 123.500  
 Les Breiling (Switzerland) 127.350  
 Les Iskry (Poland) 123.600  
 Marche Verte [Green March] (Morocco) 135.000 135.925 (Ground) 135.500 (Air-to-Air)  
 Military Stars Flight Team (Turkey) 264.400 279.600  
 Patrouille Suisse Military Flight Team (Switzerland) 288.850  
 Red Arrows Royal Air Force Flight Team (UK) 242.200 242.050 243.450 253.450

**In Closing**

It is always difficult to predict what a new season will bring, so I strongly encourage readers to watch my *MT Milcom Blogspot* (<http://mt-milcom.blogspot.com/>) and the *Monitoring Times* home page for any late breaking news and frequency information during the 2007 air show season.

If you attend an air show in 2007 and you find this list useful, please pass along any frequencies that you monitor, whether it is on this list or not. This will greatly aid in the production of next year's listing. You can reach me via e-mail at [larryvanhorn@monitoringtimes.com](mailto:larryvanhorn@monitoringtimes.com) or via our snail mail address: *MT Milcom*, 7540 Highway 64 West, Brasstown, NC 28902.

Finally, I would like to extend a sincere thanks to a record 101 contributors who took the time last year to share their post-show reports with us. I want to especially thank several overseas reporters who added new material to our foreign teams section. I deeply appreciate the time and effort each of you took to let us know what you have heard at many of the air shows in 2006.

Now, break out those scanners, plug in those frequencies, and get ready for the ride of a lifetime – a front row seat at the *air show!*



# ANDREWS AIR SHOW

## BEST OF THE BEST

### THE PHOTOGRAPHER

**Kevin Burke**  
photoz01@netzero.com

Andrews Air Force Base has been a favorite annual air show destination ever since I made my first drive down there from Massachusetts about five years ago. In 2006, I recruited two friends to share driving duties, lodging and expenses. But first I had to convince them it was worth the drive. Hopefully, the reasons I gave them will also sell you on this show and you will be convinced to make the trip to Andrews AFB, a few miles southeast of Washington D.C. in Prince George's County, Maryland.

First of all, an Andrews air show is a Joint Services Open House, so all branches of the military will be there to show you what they have. There are usually at least two large hangers full of informative displays of all things military, as well as static (parked) aircraft that you won't see at your average air show. I've seen a B-2, a U-2, a B-52 and the V-22 Osprey in past years, for example. 2006 had an F-22 and a mock-up of the F-35 Joint Strike Fighter on display.

Each year I have seen a mass jump of hundreds of paratroopers jumping out of a flight of three transport planes.

The major jet team is an obvious attraction. In 2007 it will be the USAF Thunderbirds. Last year it was the US Navy Blue Angels and the Canadian Forces Snowbirds. There is also a good chance of seeing Air Force One at Andrews.

In 2006 a bonus for me was the USAF Heritage Flight, which was actually two bonuses. The Heritage Flight (shown to the right) included an F-4 Phantom as well as the new F-22 Raptor. These two aircraft flew in formation with a P-51 and an F-15.

After the formation flying we were treated to several passes by each aircraft, but the F-22 was absolutely amazing! After its first pass, I looked away to observe the crowd to see if anyone else was as pumped as I was to see this plane, and a friend said to me with a look of disbelief, "...um... he already turned around and is inbound again!"

At show center he pulled the nose up and started to climb, but as I looked through the camera's viewfinder, after a little climb the plane wasn't getting smaller nor was it moving away from me. I knew something just wasn't right, but was afraid to remove the camera from my eye, fearing I would miss a shot. He *hovered* that jet at

a near vertical angle unlike anything I have ever seen! It totally explained the callsign he gave himself when saying good-bye to the Air Boss: "HOVER, as in like a helicopter, HOVER."

Since that show, I have been informed that you need to keep your eyes open and also watch behind the crowd *before* you expect a fly-by of an F-22. When attending another great show (Atlantic City in August) I witnessed this "warm-up" that goes on behind the crowd. Other moves you might expect to see that plane perform are to descend as if it were riding an elevator, and to nose up and do a brake stand—a whole lot better than "Maverick" did in the movie *Top Gun*.

Since 9/11, Andrews has made adjustments to their show planning like every other military installation. Instead of allowing thousands of vehicles onto the base, civilians park at Fed Ex Field a few miles away or at the Branch Avenue Metro station which is very close to the base (at which they can also arrive via the transit system, of course). At each location people are screened and then boarded onto buses and brought onto the base.

This system works very well with many buses running all day long. It does get tough at the end of the show, though. One year I had to break out of line for the shade of a nearby hangar, so plan for a bit of a wait if you need to hurry off base with everyone else.

Andrews AFB is definitely a must-see show. For me, it ranks in the top three with NAS Oceana (Virginia Beach, Virginia), and the up-and-coming, better-every-year Atlantic City, New Jersey, show.

### THE EXPERT

**Daniel O. Myers (KB3IBQ)**

It has been a long cold winter and seems like an eternity since our last air show. But, the warm sun of spring has finally arrived and it's time for a new air show season. Since 1984, our season has always kicked off with Armed Forces Weekend Joint Services Open House and Air Show at Andrews AFB in Camp Springs, MD, just outside Washington, DC.

I have been to many good air shows over the past twenty plus years, but Andrews has always remained unique. Perhaps my interest and excitement was first piqued by what I had heard and read about the air show in aircraft magazines. My first show and the twenty-one that followed lived up to all of those expectations.

What makes this show so unique? Let's first start with the units based there, most notably the 89<sup>th</sup> Airlift Wing, which among other responsibilities, is in charge of Presidential, Vice-Presidential, and VIP transport. Besides the large red and white checkered water tower



that greets you as you enter the main gate, the largest most notable structure on base has to be the large hangar housing the Presidential aircraft. The high security fence, motion detectors, security cameras (and who knows what else) leave no doubt in mind about the seriousness of this place. At countless air shows, Air Force One and its accompanying counterpart 747 (VC-25) have taken off or landed before, during, or after an air show. At what other air show can you see a line of HMX-1 helicopters, including Marine One, carrying the President and then have Air Force One taxi by and take off? Pretty exciting!

Other flying units based at Andrews are the 1<sup>st</sup> Helicopter Squadron (UH-1), 459<sup>th</sup> ARW (KC-135), 89<sup>th</sup> AW SAM (Special Air Mission C-20, C-21, C-32, C-37 and C-40) and the DC ANG 113<sup>th</sup> FW (F-16). Each year all of these aircraft are open and on display for public viewing.

This brings us to the next thing that makes Andrews so unique; the static display aircraft. While I'm not really big into photography myself, each year I do look forward to the large variety of unique aircraft on display. Like a kid at Christmas, my friends and I can't wait to see what each new year brings to the ramp. Each year is different and always distinct from what you will see at any other air show. The ramp display for 2006 was probably the best they had in ten years. Most notable was the Lockheed exhibit featuring the F-22 Raptor, the F-117 Nighthawk, and a very realistic looking mock-up of the new F-35 Joint Strike Fighter.

Andrews also opens three hangers for expositions of military, government, civic, and commercial; equipment, systems and personnel. Since this is a Joint Services Open House, the military presentations are represented from all four branches of the military as well as the Coast Guard. The volume of these displays is unmatched by any other air show I have attended. One could easily spend an entire day in the hangers alone. There is something of interest



for everyone from the sophisticated military enthusiast to small children.

The air show is always on Armed Forces Weekend in May: Friday through Sunday. Friday is set aside for Special Needs Children, VIPs, Handicapped, Media and Veterans. We have always been fortunate to gain access to the Friday show. For the Friday show only, the DC ANG F-16s fly as well as staging a parade by the Military District of Washington Old Guard, followed by speeches by distinguished visitors, usually including the Secretary of Defense. If you are able to attend the show, I would highly recommend doing so. I am sure it will live up to your expectations, just as it always has mine.

**Andrews Air Show 2006 Frequencies**

ATC / PUBLISHED	
349.000/118.400	Tower
275.800/121.800	Ground
335.500	Approach
270.275	Approach

**TACTICAL**

125.350	Show Control
379.200	Show Control
127.550	???
49.15	Apache Demo (RAVEN) a/a
122.825	Air Show Discrete
123.425	Lima Lima team a/a
123.475	Golden Knights a/a
136.675	F-16 VIPER a/a
139.900	F-16 DCANG (WILD) ops
143.600	F-16 DCANG (WILD) a/a
251.200	C-130 drop a/a (GRIFFIN)
283.700	T-6 Texan II Demo
363.300	AV-8 Harrier demo a/g
376.025	F-15E EAGLE demo a/g
384.550	F-16 VIPER Demo

**Andrews AFB 2005 Frequencies**

125.350	Show control
379.200	Show control
<b>PUBLISHED</b>	
275.800/121.800	Ground
119.700	Potomac Approach
269.500	Departure
270.275	Approach
294.500	Departure
306.300	Approach and Departure
335.500	ADW Arrival
348.725	Departure
285.475	
347.400	
354.800	

378.100	SAM CP 89 <sup>th</sup> AW
141.550	SAM CP 89 <sup>th</sup> AW
141.700	MUSSEL OPS 1 <sup>st</sup> Helicopter Squadron
292.200	MUSSEL OPS 1 <sup>st</sup> Helicopter Squadron

**DISCRETES**

122.775	Skytypers
122.825	Jet truck w/ Heritage Flight
136.725	AF w/ SAM 28000
376.025	F-15 Demo
234.650	C-130 a/a
264.100	S-3 Demo
283.700	T-6 Texan II East Coast Demo Team discrete
376.025	E. Coast F15 demo & Heritage Flight
384.550	F-15 DEMO
136.575	F-16 DEMO
136.575	Heritage Flight F-16/F-15/F-86

**THE FIRST-TIMER**

**B.A. Topolski**

I've attended many air shows since my novice days back in the '80s, but Andrews has established the reputation of being one of the "really good ones." So, when Kevin Burke called and asked if I wanted to make the trip, I jumped at the chance! This was going to be my first visit



to Andrews AFB.

Strategically located in Prince Georges County, just a few miles outside of Washington D.C., I knew it was going to be a hotbed of radio activity. I was not disappointed.

Now it was time for a plan. I like to think of radio waves as part of our invisible world, which we bring to life by being tuned in to the right place at the right time. Programming for this event turned into a time-consuming project. There is also no chance to test anything until you actually arrive. This is trial by fire.

In preparation, I turned to Grove's *Military Frequency Directory*. This proved to be an excellent source as it has a wealth of what I find to be very accurate information. Andrews AFB utilizes two types of radio systems: The first is a Motorola Type II Smartnet analog trunked system. It is a 400 MHz system and during the time I was able to monitor, I heard no digital usage. All the key players were here: Base Security, Fire/Rescue, Emergency Medical Services, and Public Affairs.

The second radio system is a Project 25 Standard. I did not monitor any activity on this system.

My portable set-up included two Uniden BC-250's with digital cards, two Radio Shack Pro-97's, and a Uniden BC-246. I used one of the BC-250's for state related systems and the other for local public safety, including Andrew's trunking systems. The Pro-97's are set up for VHF/UHF military ARTCC, ATC, USCG, air refueling and assorted squadron tactical air/air. The BC-246 is dedicated to Andrew's 400 MHz trunked system. Each unit is programmed with various search parameters and all radios except for the BC-246 have the featured jet teams.

Transporting five radios along with headphones and a digital camera turned out to be quite a handful, so I purchased a small, easily carried, rolling suitcase. Not only does this protect the electronics from the elements, but the wheels allow for good mobility. Also included in this ensemble were sunblock, sunglasses, portable chair, cap with visor, bottled water, spare batteries, pen/notebook, and a jacket/rain poncho.

Prior to entering the airshow, everyone funnels through security checkpoints where we undergo a thorough inspection of all carry-on items. This is for our own safety. The key word here is patience. Keeping everything neat and organized is essential. It not only lessens the process time, but also makes security personnel's job easier and less anxious.

Once inside, we were treated to an airshow that we still find hard to match. The non-stop flying action, along with the interesting, historic and often unusual static exhibits kept us entertained for the entire day.

I can't say enough in praise of the Andrews AFB personnel. Everyone we met showed both friendly and professional conduct. They are happy to speak with you and answer any questions they can. Interacting with this caliber of organization certainly helped to make our visit a memorable one. After all, Andrews AFB is the home of Air Force One.

Go ahead ... make the trip! You won't be disappointed.



## “Scanner Dan”

My usual complement of scanners for monitoring an air show are three base scanners attached to amplified speakers along with several handhelds used for searching. Some (maybe most) consider this to be a bit extreme, and I often get asked, “Why so many scanners?”

Well, it's simple: I don't want to miss any of the action. If someone keys a radio that is related to the air show, I want to hear it! It's the challenge of not missing a thing that drives my interest in the hobby. All of my radio gear is housed and brought into an air show onboard a large wagon with inflated tires.

I always have the scanners set up like this: one base radio monitors published (tower, ground control, etc...) and control (air boss) frequencies. The second base scanner monitors the tactical and discrete frequencies (air/air, jump LZ, etc.). The third scanner is used for the land mobiles.

As stated above, the hand-held scanners are for searching out the unknowns (non-published/discretes). I usually have three or four of those searching the UHF band (225.00 to 400.00), one for VHF mil (138.00 to 144.00 and 148.00 to 150.80). I use an amateur HT loaded with VHF discretes, and a PRO-92 with the search banks “bundled” covering low band military frequencies (30.00 to 50.00).

When the Thunderbirds are flying, I have one scanner set to their VHF discrete, the second set to their UHF and the third monitors their ground/maintenance. The Blue Angels are a little different. The Blues use three discrete frequencies for their show. I have one radio scanning the solos and show center; the second radio is scanning the diamond and show center, and the third monitors their representative in the tower and their maintenance channel.

While my set-up seems a bit out of the ordinary and sometimes draws attention from those passing by (and sometimes from security), it's worth the extra effort of dragging all this gear around. The genesis for having amplified speakers is not only for my own enjoyment (I find wearing a headset all day rather uncomfortable), but so that others can listen in as well. The radios usually draw a crowd, and at most air shows by the end of the day several folks have come up and thanked me for letting them listen. Many others have told me how much they enjoyed listening and how it really enhanced their air show experience. But, the most tangible outcome from my monitoring experience is the friends I have met over the years. We are all drawn to the hobby, keep in touch, and see each other at various air shows throughout the year.

Prior to 9/11, getting the radio wagon into an air show was never too much of a problem. But like a lot of things, 9/11 has changed operations at some military bases, Andrews being the most

obvious. Unless you have a DoD vehicle pass, you can no longer drive on base, but rather have to be bussed in. The wagon is impractical in that situation, which has led to the invention of “The Monitoring Chair.”

I took a canvas folding chair with cup holders and attached my three radios to it. I use small Shack Radio amplifiers attached to Shack Radio speakers to drive the radios. (Battery powered computer speakers work, too.) While it's not my system of choice, it works well enough. The nice part about the chair is, it can all be conveniently collapsed and stored inside the carrying bag.

- Daniel Myers



# 193<sup>rd</sup> SOW

## “The Quiet Professionals”

By Chris Parris

**T**ry to imagine that you wake up one day to find your country in turmoil. Perhaps there is a major natural disaster or maybe military units are moving all around your town, the power is out and you have no idea what is happening or what you should do. But, you are able to turn on your battery powered portable radio, only to find that your local broadcast stations are not on the air. Tuning around the dial, you find a strong signal broadcasting an unfamiliar voice urging you to remain calm and instructing you on what to expect next. Most likely that voice would be coming from a flying radio station courtesy of the United States Air Force.

“Electrons Not Bullets” is the motto of the 193<sup>rd</sup> Special Operations Wing of the Pennsylvania Air National Guard based in Harrisburg, Pennsylvania, which fly the EC-130J “Commando Solo” aircraft. These six highly modified planes fly military missions armed not with weapons, but broadcast transmitters and information. The missions they conduct are informational or civil affairs broadcasts and psychological operations, also known as PSYOPS. They provide an information outlet to people in an area that may be under military action or perhaps under the ravages of a natural disaster.

In July 2006 one of the 193<sup>rd</sup> EC-130J aircraft was on display at the Wings Over Pittsburgh air show at the Pittsburgh International Airport. The crew members on scene were very helpful and informative about their mission and provided a complete tour of the Commando Solo aircraft. It’s interesting that this aircraft and its capabilities are now on public display, when only a few years ago the existence and purpose of this aircraft were kept secret from the public.

The EC-130J is a complete broadcasting station with wings. It is a specially modified C-130 transport aircraft loaded with transmitting and receiving equipment, external transmitting antennas and support equipment that allows the crew to broadcast their message. It can transmit programming on any medium wave, short wave, FM broadcast, VHF or UHF TV channel available. And the television transmissions can be in any current analog television format, so that viewers in other countries can receive the signals.

### The Mission

The need for an aerial transmitting facility has been shown on many occasions. In 1983 during Operation Urgent Fury (the US invasion of Grenada), EC-130 aircraft, then known as Volant Solo, used their flying broadcasts to keep the citizens of Grenada informed about the military action. In 1989, the Volant Solo EC-130 aircraft were used to broadcast to the citizens of Panama during Operation Just Cause and the mission to end the regime of Manuel Noriega.

In 1990, the 193<sup>rd</sup> SOW was transferred to the newly formed Air Force Special Operations Command and the aircraft were designated Commando Solo. 1991 saw the wing serving operations in Turkey and Saudi Arabia during Desert Shield and Desert Storm. One of their duties was broadcasting the “Voice of the Gulf” programs intended to convince Iraqi soldiers to surrender. During Operation Uphold Democracy in 1994, the Commando Solo aircraft broadcast messages to the people of Haiti.

### Broadcasting Content

What types of programs are transmitted from these flying broadcast stations? The US Army’s 4th Psychological Operations Group at Fort Bragg develops program material for each mission. Here is an example of part of the “Voice of the Gulf” transmission into the Kuwait theater of operations, helping to prepare the battlefield psychologically by offering the Iraqi soldiers food, bedding and medical care if they surrendered and reminding them of the consequences if they did not. The text of one broadcast on 11 February 1991 went

something like this:

“Your only safety is across the Saudi Arabian border. That is where the bombing and the starvation stop. The Joint Forces offer you asylum. They offer you a warm bed, medical attention, and three filling meals a day. Embrace your Arab brothers and share in their peace.”

The program material that the Commando Solo aircraft broadcasts is played on board the aircraft from various media, including CD, cassette, VHS or U-Matic videocassette. The aircraft also has the ability to downlink voice from a military satellite channel for real time, live broadcasting, if the situation requires it. There are unconfirmed stories that in the early hours of Operation Enduring Freedom, during the 2002 invasion of Iraq, President Bush made a live broadcast through a Commando Solo aircraft to the Iraqi people.

Some critics might say that the 193<sup>rd</sup> SOF is doing nothing more than broadcasting propaganda. Propaganda is putting out false and misleading information often unsourced or credited to false sources. The goal of the 193<sup>rd</sup> broadcasts is to present factual information often unavailable in closed societies, allowing people listening to the transmissions to draw their own conclusions

### Delivery Techniques

The inside of the Commando Solo aircraft is loaded with electronic gear and the associated antenna plumbing that goes with transmitting high-powered RF. The medium wave, short wave, and TV transmitters on the aircraft







are the same models that you would find in your local AM, FM, or television broadcasting station. All of the antennas needed for broadcasting are located in pods on the outer surfaces of the aircraft. The aircraft carries a retractable long-wire antenna for MW and SW transmissions, but mission rules state that the long-wire antenna can only be deployed while flying over water. If there are problems retracting the antenna they can cut off the trailing wire and let it fall to the surface.

Along with the numerous transmitters, the aircraft crew also has quite a few receivers at their disposal. Equipment racks loaded with spectrum analyzers are at the ready to scan the frequency bands. The crew must locate unused TV channels or radio frequencies for their airborne broadcasts, as well as monitoring their own broadcasts for quality control. Besides transmitting, it's important for the crew to monitor the airwaves for signs of enemy broadcasts and for signs of jamming.

One of the risks for the flight crews on the EC-130J is that they have little or no defensive capabilities. The aircraft does carry chaff and

flare dispensers as well as infrared jamming gear for some self-defense, but the aircraft is not armed in any way. They depend on fighter aircraft for defensive protection, or the crew simply tries to avoid detection by enemy aircraft. In many cases they simply orbit the aircraft outside the danger areas that may be under enemy control.

Another risk the crew faces is exhaustion. While on the tour of the aircraft we noted several rather large insulated containers for coffee. One of the flight crew remarked that their missions can extend to quite a long time in the air – sometimes over 10 hours on station – and keeping alert can be a challenge. The aircraft also carries a galley for on-board meal storage and preparation.

## Tuning In

So, how can you hear the Commando Solo aircraft?

Hopefully you will never be in a situation where you would need to hear a broadcast from one of the 193<sup>rd</sup> aircraft, but if you moni-

tor the military and civilian aircraft bands, you should be able to catch one. The 193<sup>rd</sup> EC-130J Commando Solo aircraft use the squadron call sign of BATON with a two-digit number (such as BATON 50) to identify the aircraft on mission. Many military monitors in the northeast US have logged BATON aircraft flying in and out of Harrisburg International Airport (KMDT). The Air National Guard Operations frequency there is listed as 395.1 MHz.

As far as hearing a broadcast transmission from a BATON aircraft, you will have to search out the broadcast bands for signs of a PSYOPS transmission from an area where they are most likely to be operating. Listeners in Europe have caught MW transmissions that probably emanated from the Commando Solos. Some South Florida listeners have heard Radio Marti signals aimed at Cuba on 530 kHz that some presumed were coming from an EC-130J Commando Solo aircraft. Several BATON call signs were heard over military UHF air traffic control frequencies in the area prior to the broadcasts.

## Future Plans

What does the future hold for the 193<sup>rd</sup> SOW and the Commando Solo? An Air Force analysis recommended the Boeing 767-200 eventually replace the Commando Solo. The 767 aircraft is 60 percent longer and has more than twice the range of the EC-130. But for the time being, the EC-130J is the workhorse of the “most deployed unit in the Air National Guard,” the 193<sup>rd</sup> Special Operations Wing.

All photos courtesy of the US Air Force web site, [www.af.mil](http://www.af.mil)

---

### EC-130J Commando Solo -

#### General Characteristics

---

**Primary Function:** Psychological and information operations

**Builder:** Lockheed Aircraft Co.

**Power Plant:** AE2100D3 six-blade turboprops

**Thrust:** 6,000 shaft horsepower each engine

**Length:** 97.75 feet (29.7 meters)

**Height:** 38.8 feet (11.8 meters)

**Wingspan:** 132.6 feet (40.3 meters)

**Cruise speed:** 335 mph

**Ceiling:** 28,000 feet (8,534 meters)

**Maximum Takeoff Weight:** 155,000 pounds (69,750 kilograms)

**Range:** 2,300 nautical miles without refueling

**Crew:** pilot, copilot, flight systems officer, mission systems officer; loadmaster, five electronic communications systems operators

**Date Deployed:** 1986

**Unit Flyaway Cost:** approximately \$90 million

**Inventory:** Active force, 0; Reserve, 0; ANG, 6



# Winter SWL Festival For 20 years now...

By Harold Cones  
Photos by Harry Baughn

It all started innocently enough. Bob Brown, Kris Field and Harold Cones were waiting to enter a room at the Toronto ANARC (Association of North American Radio Clubs) Convention. By the time the room opened, a plan had been hatched to have a radio get together in the Philadelphia area the next February (1988). Booked at the Fiesta Motor Inn (now the site of a Best Buy) in Willow Grove, PA, we waited to see if anyone would attend. By the end of the day Friday, 40 hearty souls had assembled had called out for pizza for dinner.

An antenna was erected on the roof of the Fiesta Motor Inn (and tar footprints tracked across the lobby carpet) and all was in place for a radio event. As we ate pizza and watched television, a news flash told of a shooting at the Fiesta Motor Inn. We opened the door and looked out to see police all around the restaurant area of the Fiesta, which was right next to our now famous

Pink and Purple Pancho Villa Party Room, which was full of trash cans to catch leaks in the roof (by the way, Fest programs are still printed on pink and purple paper).

Undaunted, and stepping around the yellow tape in the restaurant the next morning, attendees were treated to a series of informative panel discussions all day Saturday, followed by a “banquet” of roast beef sandwiches. Even though it was only the first year, prizes for the prize draw had been donated by Bob Grove (Grove Enterprises) and Fred Osterman (Universal Radio) (who still donate prizes, now 20 years later) and Electronic Equipment Bank (now defunct).

A midnight event was the first-ever ride



*A rapt crowd listens to AWR's SW historian Adrian Peterson.*

of Pancho Villa, as “The Voice of Pancho Villa” (who still rides). We left on Sunday vowing to “do it again.”

## An Annual Family Reunion

And do it again we did. Nineteen more times (counting this year). And at a real motel (The Inn at Towamencin). With no shootings.

Each year the Fest features shortwave, medium wave, scanner, antique and every other conceivable form of radio. The material is broken into hour-long forums. A lunch is included in the registration price and a “beef or chicken?” banquet. There have been a number of after dinner remarks makers, including Ian McFarland, Franz Vassen, and many other radio personalities. After 13 years, the “Gang of Three” (Bob, Kris and Harold) turned the fest over to “Mr. and Mrs. Hospitality,” Rich Cuff and John Figliozzi. It is now operated as a NASWA (North American Shortwave Association) event, but nothing has changed; the Fest is a unique event that draws several hundred “faithful” each year to beautiful downtown Kulpsville.

Something very unique about the Fest is the laid back attitude. Unlike the old ANARC Conventions, famous radio personalities who attend are not advertised and are not considered a “draw,” but rather just other attendees. The surroundings are



*Those who survived the first Winterfest in the Pancho Villa Party Room! (Harold Cones 2nd row far right)*

comfortable, the people are comfortable and the feeling is more of a family reunion than a festival. As with any long running event, there are traditions: the Scanner Scum, Father John's blessings from Enid, Oklahoma, Gerry Kurtcher's formal poetry reading, the whacked out MC, the silent auction, the prize give away (which nowadays includes top class receivers), the Hospitality Suite, The Voice of Pancho Villa, pirates, and many others. New attendees are made welcome and quickly become one of the mob.

From its very humble beginnings, the Fest has become an event to be reckoned with. Through it all, it has remained, as was stated starting with the second Fest, an event where you can relax and



The grand prize is truly worth bidding for!



A whole table full of MT writers!!

“just talk radio.”

This year marks the 20th Anniversary of that first Fest in the pink and purple Pancho Villa Room at the beautiful and historic Fiesta Motor Inn in Willow Grove, PA. To mark the milestone, the Fest has been extended a day, with forums on Thursday, Friday and Saturday. A number of special events are planned to complement the usual dose of radio, fellowship and hospitality suite. The registration form, hotel and transportation instructions, and the forum schedule can be found at the Fest website, [www.swlfest.com](http://www.swlfest.com). (Those without internet access may request a form from: SWL Winterfest, PO Box 4153, Clifton Park, NY 12065) Hotel reservations must be made directly with the hotel (Best Western 215-368-3800) More information on the hotel and transportation are on the Fest website.

Listening is only half the fun...  
**POPULAR COMMUNICATIONS** is the other half.

If you enjoy radio communications in all its variety, you'll love *Popular Communications*

Since 1982 *Pop Comm* has delivered thousands of pages of great reading for both the radio enthusiast and the professional communicator.

Name your favorite interest... *Popular Communications* is there for you. Whether you're into Short-wave Listening, Scanner Monitoring, searching out Pirate Radio broadcasters, CB Radio, Satellite Broadcasting, ACARS, or Ham Radio; you name it, we cover it, every month.

*Popular Communications*  
 Subscribe today and save up to 58% off the newsstand price. Save even more with two or three year subs!

**YES! Enter my Subscription to Popular Communications today!**

	USA	Canada/Mexico	Foreign Air Post
1 Year	<input type="checkbox"/> 28.95	<input type="checkbox"/> 38.95	<input type="checkbox"/> 48.95
2 Years	<input type="checkbox"/> 51.95	<input type="checkbox"/> 71.95	<input type="checkbox"/> 91.95
3 Years	<input type="checkbox"/> 74.95	<input type="checkbox"/> 104.95	<input type="checkbox"/> 134.95

Allow 6 to 8 weeks for delivery

**FOR FASTER SERVICE FAX 1-516-681-2926** MT 01

**Popular Communications** 25 Newbridge Road, Hicksville, NY 11801 Telephone (516) 681-2922

# Confessions of a Radioist

By Clem Small KR6A

*We've heard from owner and publisher Bob Grove who created MT in 1982. Then we interviewed Assistant Editor Larry Van Horn, who first started writing for MT in 1983. The writer next in longevity is Clem Small, who became a regular columnist in 1984, though he had written some historical articles for MT prior to that. Clem's start in radio is beginning to sound like a familiar story ...*

**E**ver since I was old enough to wonder about what made things tick, I've been interested in radio technology. When I was a little kid I was fascinated by radio and wondered just how it could work. Later, when I got old enough to grab things and tear them apart with a screwdriver and pliers, I did what lots of us old-timers did: I got old, discarded radios and electrical gadgets that nobody wanted and took them apart. Then, with the parts so obtained, I made crystal sets, regenerative receivers, phono oscillators, and other electronic projects.

In junior high school I discovered Morgan's books on radio for boys in our school library. I read them and all the other radio books I could find. I remember finding an old automobile spark coil. Examining it, I realized that it had probably hundreds of feet of fine wire on its secondary winding. Excitedly, I thought it would make an excellent aerial and might bring in stations from as far away as China on my crystal sets! Hooking it to the antenna connection, it of course yielded no signal at all. It was just a small coil lying there by my crystal set. That's where I learned that a wire antenna works best if it is strung out high and long, not in a tiny coil lying beside the crystal set.

## Listening and Learning

Later, a neighbor who had been a radio man in the navy in WW2 gave me an old copy of the *ARRL Handbook* and took me to a radio supply house (Burstine-Applebee in K. C. Mo.). There you could buy surplus parts and even complete surplus military transmitters and receivers for very little money. That was an eye-opener for me: I had access to the parts I needed to make what I wanted – when I could save enough money to buy them!

I started making simple receivers from the *ARRL Handbook*. When I first tuned in Australia, I ran and got my father, and had him listen to the headphones on my home-made regenerative receiver. I proudly mentioned that Australia was on the other side of the world, as far away as a signal could come from! That was even more of a thrill than getting a spacecraft signal from Mars would be for me today, if I had the equipment to do that.

At one point I made a one-tube regenerative receiver, which gave great results with only a simple whip antenna. I built it in a large cigar box, and it would work even as I walked around with it and its short antenna. What a thrill! Sure beat my crystal sets for performance.

I even remember the number of the tube it used: It was a 1G6GT-G which operated with 1.5 volts on its filament. I think I used 45 volts on the plate. Those batteries took up much of the space in that cigar box – a far cry from the small 9-volt batteries so commonly used in radios today. The tube had two triodes in one envelope, and so provided detection, regeneration, and audio amplification in one tube. I was extremely pleased and excited with the success of that receiver. But I wanted a ham rig so badly that I started building a tube-type, ham transmitter with parts I had scrounged, and kept it, in its partially completed state, under my bed. At night I sometimes dreamed I had it finished and on the air, and that I also had other equipment that I wanted up and running.

I never did finish that transmitter – never got the rest of the parts at that time. On the other hand, at the same time I was able to receive all the HF ham bands with the various regenerative receivers I had made. I used a set of plug-in coils to change bands. I also listened to shortwave stations with old, castoff AM BC-SW receivers that I scrounged from here and there. Lots of broadcast receivers built in those days had good shortwave coverage. Tuning in those signals coming from far-away places with strange-sounding names was quite a thrill.

Later, I was able to complete a simple ham transmitter, but I still didn't have a ham license, so I didn't get it on the air. However, I did get "on the air" with a spark-gap transmitter I'd made. I never put it on an antenna, but it still buzzed in loud and clear on my folk's radio! They soon put a stop to that!

I also made a phono-oscillator. Phono-oscillators were one-tube, extremely-low power transmitters used to play phonograph records wirelessly on the AM broadcast band. That transmitter was so popular with my friends that I finally sold it to a group of them. I think they wanted to use it to play disk jockey and radio announcer.

## On the Air at Last

Going to the army was a big boost to my radio involvement. There I learned the Morse code and became an army radio operator. I attended the base radio operator's school in Anchorage, Alaska, and I got my code speed



*A picture of me and my grandson, Paul, at my ham station a few years back. No, he's not a licensed ham (yet).*

up to the novice level – so I got that license (WL7BDP). Then, when I was up to 12 wpm I got the general-class license (KL7BDP). Before I finished the school I copied the code at 18 words per minute.

Discharged and back home in Missouri, I became W0ZTY. Then, when I moved to California I became W6LZX. There I got the extra-class license, and was given my present call: KR6A.

After getting my ham ticket I built quite a number of ham transmitters and receivers. Mostly I built them from scrounged parts, but I also built a Heathkit AT-1. I believe that was the first model of a ham transmitter kit that Heath sold. I home-brewed a plate modulator and antenna tuner for it, and even worked a little DX with its low, almost QRP power level. Its final RF amplifier was a 6L6: a tube mainly used for audio amplification in radio receivers and audio amps.

I remember trying different antennas to see how they performed. One was a vertical cage antenna. It was a lot of work to build, and I was quite disappointed with it, as it didn't outperform my other simple antennas. At that point in my hamming I didn't realize that the cage's virtue was in its increased bandwidth as compared to a simple wire vertical antenna.

My interests have also led me to earn the FCC marine radio operators second-class license, the FCC radiotelephone first-class license (now re-issued as an industry certification by ISCET), the FCC general radio operator's license, a Civil Air Patrol radio

operator's license, the U. S. Infantry MOS number (1740 as I recall) for radio operator, and certification from the ISCET in industrial electronics, radio communications, and antenna technology. I also took a "minor" (technically a collateral-field) in electrical engineering in college.

### A Life in Radio

Although over the years I have worked mainly in areas other than radio and electronics, I have been a radio-TV service man, AM-broadcast station operating engineer, electronic technician, taught electronics, and worked as a technical writer in the electronics industry. I have written free-lance for various ham and electronic magazines, and I have been the antenna editor for *Monitoring Times* since November 1984 – nearly 23 years! I was also antenna editor for *US Scanning News* before it ceased publication. My *Antenna Handbook* is in its second edition.

In November 2007, I will be 75 years old. I'm really going to celebrate that birthday – I'll be a full three-quarters of a century old! And for most of those years I have been tinkering with radio in one way or another. I still enjoy making and repairing radio and electronic gear, learning more about radio and electronics, and occasionally getting on the air. Of all the operating modes I enjoy CW the most, using a keyer usually, but sometimes a bug for the nostalgia of it, and talking to old codgers like myself. Since 9/11 and Katrina, I am developing an emergency-response kit

for ham-radio communications.

So, for all the pleasure I have had from radio over the years, I offer a big thanks to Faraday, Maxwell, Hertz, Marconi, and all radio pioneers whose work has led to the development of today's fascinating technology of radio communications. That technology has brought me, and countless others, a very enjoyable hobby, as well as unbelievable advancement in our ability to communicate with one another. I believe that communication is a very powerful tool for world peace: it's difficult to want to bomb someone with whom you've just had a friendly conversation.

Peace, DX, and 73  
Clem KR6A



**Best Scanner Antenna**  
Best obstruction-penetrating in user surveys and testimonials.  
**NILJON ANTENNAS**  
Grove Enterprises 800-438-8155  
[www.grove-ent.com](http://www.grove-ent.com)  
Universal Radio 800-431-3939  
[www.universal-radio.com](http://www.universal-radio.com)

## Did your Antenna System Survive the Harsh Weather?

Performance and Price...these are the industry leaders!

Grove Enterprises offers these three exclusive products with decades of proven excellence:



**Grove Omni II**  
Looking for an economical solution for metropolitan monitoring? Look no further: The OMNI II is a low-profile (68"), single-element, 25-1300 MHz receiving antenna with astounding performance for city-wide coverage. Includes balun transformer (with F connector), offset pipe, mounting hardware and full instructions.

**Order ANT05**  
**Only \$29<sup>95</sup>**  
plus \$3 UPS Ground shipping



**Scantenna**  
Unsurpassed by any competitive, omnidirectional scanner antenna, the OMNI II provides continuous frequency coverage from 25-1300 MHz an ideal companion for modern scanning receivers. It comes with matching balun transformer, 50 feet of low-loss coaxial cable (with BNC adaptor) and mounting hardware.

**Order ANT07**  
**Only \$49<sup>95</sup>**  
plus \$6.95 UPS Ground shipping

**Grove Scanner Beam II**  
With continuous reception from 25-1300 MHz, the Scanner Beam is ideal for directional targeting (100-900 MHz) of specific locations. Gains are 4-6 dBd from 100-200 MHz, 6-8 dBd from 400-500 MHz and 10-12 dBd 800-900 MHz.



Hams can use the Scanner Beam for transmitting up to 25 watts on the amateur 50, 144, 223 and 430 MHz bands as well, with an SWR under 3:1. Balun transformer (with F connector), offset pipe and mounting hardware included.

**Order ANT18**  
**Only \$64<sup>95</sup>**  
plus \$8.95 UPS Ground shipping

**Accessories:**  
50' RG-6U    CBL50    \$19.95  
100' RG-6U    CBL100    \$24.95  
plus \$3 shipping each

**GROVE**  
WWW.GROVE-ENT.COM

800-438-8155  
828-837-9200  
fax: 828-837-2216  
7540 Highway 64 West  
Brasstown, NC 28902

## Exercise Your Way to Better Health with Your Radio Hobby

**A**s this month's column is written, the bells of the New Year are still ringing in my head along with the admonition from every quarter to do better in the coming year. Now, "doing better" almost always includes having a better diet and getting more exercise – twins to what the medical establishment assures us will lead to a long and healthy life.

### ☒ Biking for Hams and SWLers

The problem is that exercise, unlike the radio hobby, is a bore. But, what if you could combine your radio hobby with exercise? Would that take the sting out of the chore? Believe me when I tell you that I've tried many exercise regimens with the radio hobby and about the only one that really works is bicycling. The great thing about bicycling is that it can be a lot of fun (at least as fun as any exercise is likely to ever be). And, I've found that with the radio, the workout is over before you really know it.

I first wrote about bicycle radio in the pages of *MT* eleven years ago in a feature called "Road Trip for Your Radio" (Mar.

1996), and again in a feature called "Dave Boyd, N3ICN, Bicyclenomad" (May, 2004). A number of new developments make this subject worth revisiting.

The most obvious change from 11 years ago is the fact that almost everyone is now packing a cell phone. There's no longer a need to be able to hit a repeater in order to summon help when you're out on the road. Another big change is in the technology of electronics. The recent introduction of tiny MP3 players makes it possible to dispense with all bulky receivers and antennas and, with an iPod strapped to your arm and an earbud in your ear, you can listen to whatever you like! You could download Glen Hauser's *World of Radio*, the latest BBC World Service news, or go to any podcast site and listen as you pedal. You can even mount an XM or Sirius satellite radio set on your bike!

New double and triple band hand-held transceivers make your bike mobile installation even more versatile. Better batteries and lower power consuming rigs make it easier to mount equipment and dramatically reduce weight (a huge concern to serious bicyclists).

### ☒ Getting Started in Radio Bicycle Mobile

There are important considerations to be made when setting your bike up for a radio. If you're just listening to your MP3 player or AM/FM radio, all you'll need is an earbud for listening. You have to use an earbud because, regardless of speed, the noise from the wind makes it impossible to hear the speaker. I use a set of "disposable" earbuds handed to me on a recent plane flight. I simply cut off one of the earbuds, put the plug into the headset jack on the HT and found the audio on my HT quite nice. You'll have to figure out how long an earbud cord you'll need to allow full movement and not get tangled up in the gear levers or pedals.

If you're going to use a 2 meter HT without an external antenna (quite possible if just biking in town), you can use a radio vest or a small backpack where the antenna is behind you. Using an earbud to listen and a boom mic with a push-to-talk (PTT) switch mounted on the handle bars, you'll be able to keep both hands on the grips and work the repeater. To hold the rig in place, I use a thick piece of Styrofoam lashed to the handle bars with bungee cords. It protects the HT, is easily taken off, and allows operation of the radio with minimal mounting hassles.

There will be more than enough power in your HT to reach your local repeater for the duration of a typical one hour ride, but if you're riding in the hinterlands you'll need a lot more power and a more elaborate antenna. I've often used a mobile 2 meter rig with a motorcycle battery for power supply and a 5/8 wave vertical dipole mounted on a home-brew structure attached to various tapped holes on the bike frame. The antenna mount is universal, which allows me to exchange antennas for different bands. The mobile rig gives me substantially more power output, and the bigger antenna gives me a better signal – an important factor given the hilly terrain where I bike. The antenna is actually several feet away on the mount structure.

Last summer, using the universal mount, I tried using a 10 meter mobile rig and a 10 meter vertical on the bike. Unfortunately, 10 meters was so poor that I made only one contact, a ham in Canada, before switching back to 2 meters. It's more fun to actually chat than to call CQ on a dead band for the

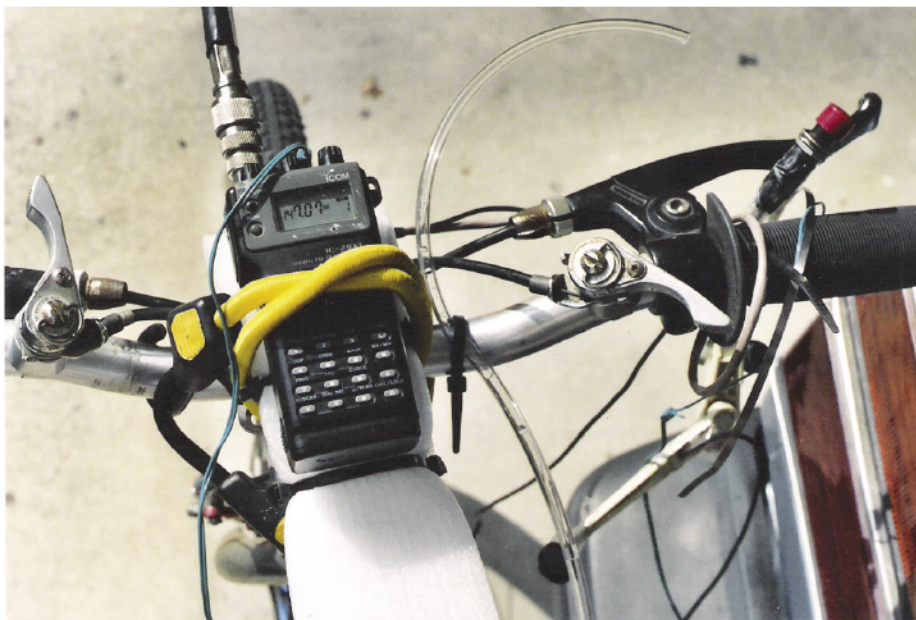

Going 2 meters mobile. Here an HT is lashed to the handlebars with bungee cords. A PTT switch is on the right which controls a home-brew boom mic. Note the drinking tube next to the HT. (Courtesy: Author)



*Close-up of antenna support with 2 meter 5/8 wave antenna. To get the full 5 watts output for the 1 hour daily trip I power the HT from a small trailer light battery I found at an auto supply store for under \$10. It's visible in the background under the seat. (Courtesy: Author)*

duration of the ride!

You can use any radio with this set-up. A shortwave portable and an earbud is all you'd need to enjoy some SWLing on the ride. An HT with scanning capability and NOAA WX frequencies programmed in will give you lots of enjoyable monitoring. An iPod or similar MP3 player with your favorite podcasts will also give you something interesting to listen to for as long as you like.

### ☒ Legal Affairs in Biking

I've been passed by many a sheriff's car and state police throughout the years and get no more than a friendly wave. That's because I'm always wearing a helmet, have a review mirror, rear and front reflectors, and generally follow the bicycling "rules-of-the-road" required by my state. These laws vary from state to state and you'll want to know all about them before you hit the road. While bicycles are not considered motor vehicles, there are definite laws regarding bicycle operation and bike riders. You can get all the info you need at the web site of your state's Department of Motor Vehicles.

Pay attention to helmet laws, earphone regulations, scanner radio operation, and road rules such as which side of the road you may or may not ride on. It also helps to know what rights you may have as a bicyclist when confronting bad dogs (or their owners!). Can you carry pepper spray, cudgels, raw meat?

### ☒ Join the Club

You don't have to be a member of your local 2 meter repeater club if you're an active (daily) rider. But, if you find yourself using many of the features of the repeater (automatic time and signal report, phone patch, etc.) you should consider joining. If the repeater is that useful to you and you use it every day, you should contribute to its upkeep.

I've found that locals are always willing to chat with me when I'm on the road and will often forgive a "scratchy" signal into the repeater once they realize the operating conditions. Often they're curious and want to know all about the set-up and will go out of their way to help if I have a break down

or need any other type of assistance. Even on a seemingly unused repeater, you'll find you can coax some repeater regulars to respond when they hear your call sign with the "bicycle mobile" suffix.

There are several local and regionally active bicycle mobile ham clubs and one national club called Bicycle Mobile Hams of America (BMHA). You can find out all about them at [www.lafetra.com/bmha](http://www.lafetra.com/bmha). You don't have to be a ham to be a member. The best thing about this club is that you can get all the information you need on technical questions regarding rigs, antennas, mics, power supplies and general bicycling information such as tires, seats, panniers, etc. Among the members of BMHA just about everything has been tried by someone at some time.

Once you get your bike and radio up and operating, you may find that you'd like a real change of scenery. There are many nationally advertised bicycling events which let you ride with dozens and even hundreds of other riders. Few will be hams, so organizers may waive your entry fees if you can help "police" the group or work with a "sag wagon." Of course, you'll have to be in pretty good shape to help. Many of these rides require 50 or 100 mile distances to be ridden each day. You may want to work up to it. There are links to these other clubs and organizations relating to bicycle mobile at the BHMA web page.

### ☒ Riding 'n' Radio

Now that spring is around the corner, the good riding weather is just starting for most of us. Depending on where you live you can ride most of the year. Hearty bikers ride year 'round. When it rains, snows, or gets too cold, you can mount your bike on a "trainer" which is simply a device which holds the back wheel up off the ground while you continue to pump the pedals. Once you put riding into your daily schedule it's easy to keep it up.

Let me know about your own radio and riding experiences and I'll pass them on to the rest of us beginners. Good luck, good DX and good health!



*Berger Bottle in bottle holder. To make your own: Drill a hole in the plastic bottle cap big enough to insert clear tubing to the bottom of the bottle. Drill a small breather hole next to the tube hole to equalize air pressure inside the bottle. The drinking end of the tube is secured to the handlebars with a tie-wrap. I used a Fiji water bottle because it fit nicely into the water cage and already had water in it when I bought it! (Courtesy: Author)*

**DIGITAL ACCURACY  
FOR VINTAGE RECEIVERS**

**DD-103 Universal Digital Dial  
Pre-programmed for many vintage  
receivers. Easy installation on most  
receivers by connecting to the  
oscillator section if the tuning gang.**

**\$125.00 Plus \$10.00 Shipping**

**ELECTRONIC SPECIALTY PRODUCTS  
3054 MOORE DR., OVIEDO, FL 32765  
407-366-4859 • [espelectronics.com](http://espelectronics.com)**

**Q.** *I measured the AC current on all three wires coming into my home; there were 12.5 amps on one "hot" wire, 9.1 amps on another, and 3.4 amps on the neutral. If the current had measured the same on both hot leads, would there have been any current in the neutral?*

**A.** The power transformer feeding your home carries 240 volts and a center tap (neutral) which divides the distribution into two 120 volt "hot" lines and a common neutral. The full 240 volts (the full transformer winding) go directly to large utilities like your range, hot water heater and home heating system. The two 120 volt lines (one from each end of the transformer winding plus the common center tap neutral) feed smaller utilities like lighting, fans and your wall outlets.

The amps you are reading are a composite of the two 120 volt and one 240 volt lines. Depending upon how much current is being used by each line, they will differ, but one of the two hot lines will always be higher because of the variability in power distribution throughout your home.

The only way the neutral would not be carrying current is if there is no 120 volt consumption, thus eliminating the need for the neutral wire. Theoretically, then, a 240 volt heater which doesn't require a neutral return could be in use.

**Q.** *I'm new to scanning; what are trunking and P-25 and how do I know if I need their capability in my area? (Greg Schedcik)*

**A.** If you're in a small town with few communications, you probably don't need them. If you're in a major city, or planning to listen to a nearby major city, you probably do.

Trunking is simply a pool of several frequencies, most often in the 800 MHz range, which are shared by several agencies. For example, if you had one frequency for police, another for sheriff, another for the road department, another for ambulance and so on, it's likely that only one or two of those frequencies would be in virtually constant use while the others are rarely heard. This is a waste of spectrum, and may even cause delays in reply during emergencies.

In trunking, all of the agencies share the same pool of frequencies; each time one of them presses the mike button, one of the presently-unused frequencies is automatically selected. That's trunking.

If you have a conventional (non-trunking) scanner, as it scans through that pool of trunked frequencies during a busy period, you would hear one agency, then another, then another without the continuity of just the back and forth of a single

agency. With trunking capability, the scanner is able to follow whichever agency you choose as it switches frequencies, allowing you to monitor that series of unbroken transmissions.

There are three dominant trunking manufacturers: Motorola (the most common—Types I, II), Johnson (LTR) and GE Ericsson M/ACOM (EDACS, SCAT). You need to ask a local scanner user, a local law enforcement dispatcher or officer, or a scanner dealer like Radio Shack about the system used in your area.

APCO P-25 (an abbreviation for the Association of Police Communications Officers Project 25) is a digital communications technique. Since its primary mode is not scrambled for security, it is lawful for you to monitor. With a conventional, non-P-25 scanner, all you would hear would be noise, no voice. P-25 is offered by several manufacturers, and has been federally recommended as the official digital mode for inter-agency communications.

**Q.** *What is the technical name for a pushbutton that can be pressed and stay closed until pressed again? Who sells one about 1" in diameter and can be flush mounted to table surface? I need it to activate the auxiliary jack on a tape recorder. (Brian Limbach, Pittsburgh, PA)*

**A.** Such a pushbutton is commonly called "push/push" or "push on/push off"; electrically, it is a toggling pushbutton. Such specialized switches are usually found only in large quantities for the electronics manufacturing industry. After you try Radio Shack, electrical contracting suppliers and automotive shops, you may wish to try the Internet. One company with a good reputation – and has a similar switch – is American Science and Surplus at: [www.sciplus.com/category.cfm?subject=on=14&category=141](http://www.sciplus.com/category.cfm?subject=on=14&category=141). Another favorite is All Electronics: [www.allelectronics.com](http://www.allelectronics.com).

You may also wish to consider a more readily available rocker switch or even a bat-handled toggle switch. In any case, you will probably need to mount it in a plate which, in turn, will have to be framed in a box for mounting on the table.

**Q.** *The dB gain for the Super Select-A-Tenna (ANT40) is "up to 40 dB," and for the Select-A-Tenna Medium Loop Antenna Booster (ANT21) "up to 30 dB." What is the gain of the original Select-A-Tenna – the one without the 3.5 mm jack? (Jim Thornton)*

**A.** Since the original Select-A-Tenna is a passive device with no reference (like dBi or dBd), and is not directly coupled to the radio, it has no gain figures. It must be compared to the loop antenna in the radio near which the Select-A-Tenna is being placed, and those loops are not standard enough to provide a reference point.

The variables include size of the radio's internal loop, separation between the two loops, and angle of the Select-A-Tenna next to the radio. As a relative guess, I'd say that the passive original provides some 20 dB signal improvement over the loop in the radio, and the amplified units add their stated gains to that.

**Q.** *When I feed signals from my outdoor antenna through a TV splitter into my two PRO-2052 scanners, I get interference between the two scanners which causes one scanner to stop scanning while I'm listening to a signal on the other. Will a Stridsberg passive splitter solve the problem? (Brad Metzger, email)*

**A.** Scanner lockup has been a problem since the invention of the scanner. It is caused by the oscillator circuit of one being heard as a signal by the other. This can be caused by:

- (1) the oscillator radiation penetrating the scanner case and into the other (more likely in plastic-encased scanners, and worse when positioned close together);
- (2) oscillator signal radiation from one antenna to the other (especially with the plug-in whips, and worse when positioned close together);
- (3) having the squelch setting too tight (close to the tripping point), over-sensitizing the scanners' signal sensitivity to each another's radiation;
- (4) and, in your case, inadequate splitter isolation in the common antenna line.

TV-style splitters generally work well for combining two scanners into one antenna, but they aren't as good as a well-engineered splitter like the Stridsberg. But before you invest in that, try these two tricks:

- (1) When the scanners hang up, simply transfer one of the frequencies into the other scanner (you can move another, non-lockup, frequency back again if you need the memory space).
- (2) When the scanners hang up, try entering one scanner frequency 5 kHz lower, and the other scanner frequency 5 kHz higher. This will give you a 10 kHz frequency separation which is less likely to lock up the scanners.

Questions or tips sent to Ask Bob, c/o MT are printed in this column as space permits. Mail your questions along with a self-addressed stamped envelope in care of MT, or e-mail to [bobgrove@monitoringtimes.com](mailto:bobgrove@monitoringtimes.com). (Please include your name and address.)



**Q.** Regarding the U.S. Government INTEROP frequencies you have written about, I am confused on the paired frequencies, e.g. LE 1 is 167.0875/162.0875. Which frequency do I program into my scanner (i.e. repeater out)? 167.0875 (LE A) is simplex. Arthur-Bryan E. Phelps via email.

**A.** My normal reporting mode and standard convention among most radio hobbyists is that the first frequency is the repeater output and the second frequency is the repeater input. LE A that you referred to is a simplex frequency used as a talk around frequency on the repeater output.

**Q.** Do you know of a company that makes a blocking filter for 152 and/or 158 MHz with BNC connector? Trying to eliminate those annoying pagers. Dan in Pennsylvania.

**A.** Grove carries the PAR 152/158/462 MHz scanner intermod filters that are very effective in blocking paging signals in and around these frequencies. They have BNC connectors and can be adapted for "F" and "SMA" connections. These filters sell for \$69.95 plus shipping. You can get more information at [www.grove-ent.com/filters.html](http://www.grove-ent.com/filters.html).

**Q.** I have an Icom R-75 I purchased from Grove some time ago. I would like to listen to the COTHEN radio system and the US Coast Guard. They use an ALE burst followed by voice then the system goes directly to scan again. I am trying to find a software to decode the ALE, connect to my Icom receiver and control it via the computer. Do you know of any software that will decode the ALE and control the receiver? Also what antenna does Grove sell for utility, COTHEN, and USCG (4-12 meg) reception? Calvin Springs, Myrtle Beach, South Carolina.

**A.** The best software available has been developed by Charles Brain, G4GUO, in the UK. It is called PC-ALE and the best part, it is free. You can learn more about it and download the decoding and receiver control program at [www.chbrain.dircon.co.uk/pcale.html](http://www.chbrain.dircon.co.uk/pcale.html). As for a good HF antenna, I prefer wire antennas and recommend either the Grove Skywire Dipole (Grove ANT02 at \$29.95) or the PAR High Performance Shortwave Antenna (Grove ANT08 at \$59.95). Both are excellent performers for utility style communications.

**Q.** I was told that you are the APCO guru. I am trying to monitor a fire system that uses an EF Johnson Multinet APCO 16 trunk system and I was told that there is no way to track talk groups. Is there a way? Mike Straff via email.

**A.** You can certainly monitor any of the digital audio present on the trunk system frequencies if you are using one of the newer digital capable scanners in our marketplace. But there is no scanner that can trunk track an EF Johnson Multinet trunk system, so you will not be able to display what talk groups you are monitoring.

**Q.** I am hearing several HF radio nets using many one and two letter callsigns, i.e. India Whiskey, Uniform, etc. What am I hearing? What other frequencies do they use? Anonymous via email.

**A.** In the particular instance you referred to in your original email, you were probably monitoring the *USS Eisenhower* (CVN-69) CSG (Carrier Strike Group) Composite Warfare Commander (CWC) net. These nets can be recognized by the use of the two letter identifier used by the net control. First letter can be any letter in the alphabet (ex: AF/AW, IF/IW, HF/HW, etc), but all CWCs in a particular battle group will use the same first letter. First letter often matches the first letter in the name carrier assigned (Ex: *USS Enterprise* has used E, the *Ike* uses I, and the *USS Harry S Truman* has used H, etc.). If multiple battle groups are in a theater, each group will use a different first letter.

There are quite a few CWC-type nets, but most of them are monitored on military UHF frequencies and are normally out of range for

scanner enthusiasts on shore. These are line of sight and the carrier is usually quite a distance off shore during their normal operations.

Quite a few of the transmissions you hear on HF are from one of these Composite Warfare Commander nets – specifically, the Force Track Coordinator (Link-11/Link-16) nets. They use a second letter of "F" or the generic identifier "FT." Another major player on HF is the Air Defense Commanders net like you monitored, which can be recognized by the second letter of "W."

Some of these Navy HF nets use tri-graph identifiers (H6F, B2W, etc). Most of these have not been positively IDed as to mission, but some appear to be associated with various FACSFAC operations. With the advent of the bulk of the Navy comms taking place on milsat these days, these CWC nets are about the only game left on HF to monitor US Navy communications.

As far as freqs for the Navy CWC nets, they use just about any ute freq range except for frequencies in the aero routed subbands. Here is a list from my database of some I have logged. This is by no means a complete list.

2069.0	2230.0	2250.5	2252.0	2334.5
2354.6	2370.0	2518.0	2656.0	2772.0
2844.0	3047.0	3048.5	3050.0	3100.5
3101.0	3125.0	3128.0	3130.0	3151.0
3166.0	3167.0	3167.4	3176.0	3265.0
3307.0	3349.0	3371.0	4039.0	4068.0
4101.0	4102.4	4145.0	4150.5	4153.0
4154.5	4156.0	4164.0	4372.0	(FACS-FAC Vacapes)
4382.0	4394.4	4395.0	4414.0	4417.0
4430.4	4432.0	4433.0	4433.5	4434.5
4513.0	4524.0	4528.0	4562.0	4620.0
4623.5	4645.0	4712.0	4720.0	4721.0
4732.0	4878.5	4939.0	4973.5	5228.6
5333.0	5335.0	5338.6	5399.6	5404.0
5411.0	5425.0	5437.0	5699.0	5708.0
5714.0	5725.5	5729.0	5840.0	5868.5
5908.0	6224.0	6235.0	6242.0	6249.5
6439.4	6554.3	6689.4	6690.0	6723.0
6724.0	6735.0	6748.0	6750.0	6786.6
6835.0	6953.0	6967.0	7653.0	7783.0
7893.5	7945.0	7988.6	7993.5	8149.0
8195.0	8246.0	8252.0	8667.0	8668.5
8776.0	8996.4	9008.0	9023.0	9213.6
9215.0	9257.0	9257.6	9283.5	9285.0
9323.0	10233.6	10376.5	10570.0	10608.0
10618.5	10848.6	10923.5	11053.5	11114.5
11123.6	11139.0	11191.0	11206.4	11220.0
11266.4	11476.0	11498.0	13893.6	14360.0
14364.0	20854.0	23200.0	23271.0	

Frequencies above 10 MHz are much rarer, due to the propagation needs of the ships in the Carrier Strike Group. Since they are normally within 100-300 miles of each other, they have no need for the longer distances associated with frequencies above 10 MHz. They need close-in comms which translates into lower frequencies; thus the reason you see more freqs below 10 MHz in the list above.

## Choosing a Scanner

**P**robably the most common question asked by readers is “What’s the best scanner to get?” As we’ve discussed in this column many times, the answer is always “It depends.” Many factors should be examined before purchasing a specific model, as we see below.

Dear Dan,

I am new to scanners but am thinking of buying one in the near future. I read your review on how “trunking” works. I have a better idea (after reading your review) on what trunking is. Now I have to decide on the best scanner to buy. I found many at Radio Shack. I don’t have a lot of money but want a good one. The model: PRO-2096, as described below, is way out of my price range but will consider if this is the best around. I want to monitor the local and state police, fire and citizen’s band radios (as well as GMRS radios). I live in Griffin, Georgia. Will this radio do all that (out of the box) without having to buy anything extra? Below are some of the features described by Radio Shack about the Pro-2096:

Digital Trunking Mobile/Base Scanner PRO-2096 (Catalog# 20-496)

\* Follows both digital & analog systems (including 9600bps Control Channel and C-Qpsk Modulation (whatever all this means)

\* Covers Frequencies:

25-50 MHz (VHF-LO)

50-54 MHz 6 Meter Ham

108-136.9875 MHz Aircraft

137-174, 216.0025-225 MHz

406-512 MHz, 806-960 MHz (excluding Cellular Bands)

1240-1300 MHz

Anyway, there are more things listed about this scanner. I have only touched on what I thought might be helpful to you in helping me decide if this is the best scanner for me. In the picture, it shows a small (telescopic) antenna coming out of the back. So how does the antenna work (which I assume you must have to pick up signals), on a car dash board if I use it in my car? I have some other questions as well, such as, how far are incoming signals picked-up by this model, as well as cheaper models?

Anything you can tell me about scanners (especially this one) will greatly be appreciated.

Alex in Georgia

Alex asks a number of great questions

about the PRO-2096 scanner, a relatively new base/mobile unit manufactured by GRE and sold through Radio Shack.

One of the most important factors to consider is – what do you want to listen to? Alex specifies state and local public safety agencies, as well as personal two-way communication like citizen’s band (CB) radio and General Mobile Radio Service (GMRS). Other popular choices include railroads, military and civilian aircraft, and amateur radio activity.

### CB Radio

Citizen’s Band radio, for those of you who missed the boom years of the 1970s, is a personal two-way radio service operating on 40 channels between 26.405 MHz and 27.405 MHz. This frequency band is sometimes referred to as “11 meters,” since the wavelength of signals at 27 MHz are about 11 Meters – 36 feet – long. Some real old-timers may remember back to 1958, when the FCC took the band from Amateur Radio operators and reassigned it for Citizen’s Band service.

The following is a list of CB channels and associated frequencies. Because of various historical issues, frequencies are not always in a sensible ascending order.

Channel	Frequency (MHz)
01	26.965
02	26.975
03	26.985
04	27.005
05	27.015
06	27.025
07	27.035
08	27.055
09	27.065
10	27.075
11	27.085
12	27.105
13	27.115
14	27.125
15	27.135
16	27.155
17	27.165
18	27.175
19	27.185
20	27.205
21	27.215
22	27.225
23	27.255
24	27.235
25	27.245
26	27.265
27	27.275
28	27.285
29	27.295
30	27.305
31	27.315
32	27.325
33	27.335
34	27.345
35	27.355
36	27.365
37	27.375
38	27.385
39	27.395
40	27.405

Although some have called CB a “vast wasteland,” listening to channel 9 (usually an emergency calling channel) and channel 19 (commonly used by truck drivers) may occasionally provide interesting listening. However, you may find the need to “lock out” the CB frequencies when listening to other services.

If you really want to monitor CB activity, it may be better to buy a used CB radio and

operate it separately from the scanner. There is likely to be a lot of noise and nonsense on the CB channels, and I would hazard to guess that you would soon tire of listening to it. Used CB equipment can often be found very inexpensively at secondhand shops or from classified advertisements in the local paper.

### FRS and GMRS

Newer personal two-way services have largely supplanted CB for short-range use, including Family Radio Service (FRS) and General Mobile Radio Service (GMRS). FRS radios always operate in *simplex* mode – the same frequency is used for both transmitting and receiving. Some of the GMRS channels can operate in *duplex* mode – one frequency is used for transmitting and another frequency is used for receiving. In order to hear both sides of a duplex conversation, you would have to program both frequencies into your scanner.

The following is a table of FRS and GMRS frequencies:

Ch	Freq	FRS	GMRS	Comments
1	462.5625	FRS	GMRS	Simplex Only
2	462.5875	FRS	GMRS	Simplex Only
3	462.6125	FRS	GMRS	Simplex Only
4	462.6375	FRS	GMRS	Simplex Only
5	462.6625	FRS	GMRS	Simplex Only
6	462.6875	FRS	GMRS	Simplex Only
7	462.7125	FRS	GMRS	Simplex Only
8	467.5625	FRS		Simplex Only
9	467.5875	FRS		Simplex Only
10	467.6125	FRS		Simplex Only
11	467.6375	FRS		Simplex Only
12	467.6625	FRS		Simplex Only
13	467.6875	FRS		Simplex Only
14	467.7125	FRS		Simplex Only
15	462.5500		GMRS	Duplex frequency is 467.5500
16	462.5750		GMRS	Duplex frequency is 467.5750
17	462.6000		GMRS	Duplex frequency is 467.6000
18	462.6250		GMRS	Duplex frequency is 467.6250
19	462.6500		GMRS	Duplex frequency is 467.6500
20	462.6750		GMRS	Duplex frequency is 467.6750
21	462.7000		GMRS	Duplex frequency is 467.7000
22	462.7250		GMRS	Duplex frequency is 467.7250

### Griffin, Georgia

Griffin, Georgia, is located about 40 miles south of Atlanta, in Spalding County, Georgia. Griffin is currently home to about 25,000 residents and is famous in certain



circles as the birthplace of Doc Holliday, one of the gunfighters at the OK Corral.

If you take an interest in military aircraft scanning ("MilAir"), Griffin is also less than thirty miles from Peachtree City, home of The Great Georgia Airshow, scheduled this year for the weekend of October 13 and 14.

City radio operations take place in the 150 MHz band. Transmissions from fixed locations will be easier to monitor, since the antennas are higher in the air and transmit with higher power.



Frequency	Description
154.3100	Griffin Fire (Dispatch)
155.3400	Griffin Emergency Medical Service
155.3550	Griffin EMS (Dispatch)
155.3700	Griffin Police (Statewide Intersystem)
155.7300	Griffin Police (Dispatch)
158.7600	Griffin Government

If you are close enough, you may be able to hear transmissions from mobile units on the following frequencies:

Frequency	Description
153.8000	Griffin Government
153.8900	Griffin Fire
156.0300	Griffin Police

Spalding County also operates in the 150 MHz band on the following frequencies:

Frequency	Description
154.2800	Fire Mutual Aid (Statewide)
154.3850	County Fire
154.6500	County Sheriff
155.3250	County EMS

Transmissions on all of the frequencies we've listed so far are *analog*, so nearly any scanner manufactured in the last twenty years will be able to monitor the city and county activity without any difficulty. If you're on a limited budget and new to scanning, finding a used scanner at a garage sale or thrift store might be a great way to get started. Be sure that it is at least "programmable" from a built-in keypad, since really old scanners used plug-in crystals and are not flexible enough for our purposes. For instance, I recently purchased a PRO-2002 for \$5 from a local Goodwill store. It has fifty memory channels, programmed from a keypad on the front of the unit. Although it is now more than ten years old, it would be fully capable of scanning all of the frequencies listed above (except for the Citizen's Band channels), as well as aircraft and weather stations.

However, time and technology march on. Like many scanner listeners, you may eventually find that some of the interesting activity in your area moves from simple analog transmissions to much more complicated digital trunked signals. If you find that to be the case, you will need a newer, more capable scanner.

### Digital Scanners

Over the next few years, state agencies in

Georgia will be moving to digital radios. The Georgia Technology Authority (GTA) adopted statewide standards in January 2004, making the use of APCO Project 25 mandatory for state agencies but optional for local governments. The eventual goal is for Georgia law enforcement personnel and first responders to be able to communicate directly with each other without needing a dispatcher.

Project 25 (P25) is a set of technical standards originating from the Association of Public Safety Communication Officials (APCO), describing in exacting detail how radios should communicate in a P25 network. Many states and municipalities, as well as agencies of the Federal government, have moved to P25 and more are scheduled to do so.

In order to monitor P25 networks, you will need a P25-capable scanner. These are sometimes referred to as "digital-capable" scanners, since P25 transmissions are digital rather than analog in nature. Both Uniden and Radio Shack sell such scanners.

To add to the confusion, there are also different types of P25 systems. Some are "pure" P25, meaning that both the voice traffic and the control traffic follow P25 standards. These "pure" systems require the newest digital scanners, which include the PRO-2096.

There are also "mixed" P25 systems, where the voice traffic follows the P25 standard while the control traffic follows an older protocol originally developed by Motorola. This older protocol delivers control traffic at a particular rate – 3600 baud – while the P25 standard for control traffic sends at 9600 baud. All digital-capable scanners are able to track these mixed systems.

The C-QPSK refers to the technical details of exactly how the radio transmits the signal. The original P25 systems used a modulation scheme referred to as C4FM, which the early digital scanners could handle. A few P25 systems built recently use C-QPSK instead of C4FM, which created problems for these early scanners. The newest digital scanners are able to handle both C4FM and C-QPSK signals.

### Trunking

Whether analog or digital, radio networks may operate either as *trunked* or as *conventional*. There are several common types of trunking technology, including a couple of Motorola variations, a type called EDACS (Enhanced Digital Access Communications System) from M/A-Com, and one called LTR (Logic Trunked Radio).

In Griffin, Caterpillar operates an LTR network for their power system products production plant. Five frequencies are assigned to the 300,000 square foot facility, used to coordinate manufacturing operations. The five frequencies are 462.1375, 462.4500, 463.5125, 463.8625 and 464.7125 MHz.

Here's where you need to check the fine print – although the PRO-2096 is a relatively new scanner, it does not support Logic Trunked Radio. So, it would probably not be the optimal scanner to use if you lived close to the Caterpillar plant.

For more specific details on the PRO-2096, including impressions on performance and

## INFORMATION & ORDERING WWW.SCANCAT.COM

INTERNET DOWNLOADS AVAILABLE  
**ORDER TOLL FREE**  
**888-722-6228**

**NEW!** All-In-One COMBO CD

Reg.  
ScanCat-Lite-Plus.....\$29.95  
Mr. Scanner FCC Public Safety .....29.95  
Nat-Com's FCC Scancat Files .....9.95  
Bonus List Of Frequencies.....15.00  
\$84.85

**SPECIAL \$49.95**

## SCANCAT®

Since 1989, The Recognized  
Leader in Computer Control

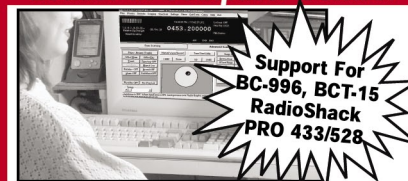

**Once you use SCANCAT with YOUR radio, you'll NEVER use your radio again WITHOUT SCANCAT!**

### ScanCat-Lite-PLUS

Limited Time \$29.95 Intro Special

Program Your Scanner

As Easy As 1-2-3-CLICK!

SC-Lite Supports PRO-83, PRO-95, PRO-96, BC246 & over 15 more Trunking Scanners

### ScanCat-Gold for Windows

Version 8.50 \$99.95

Supports all radios in ONE program - share files with all radios.

Two Scanning modules:

A Simple Basic Module - for beginners  
**Plus**—An Advanced Scanning System for the "experts".

### Scancat-Gold for Windows-SE -

\$159.95

All the features of our "Standard Scancat" plus additional functions.

- Long term logging of frequencies to hard drive.
- Record Audio to hard drive using sound card.
- Improved spectrum analysis with several great graphical analysis screens.

### Skysweep Decoder Software



Advanced Digital Signal Processing Software For HF/VHF Applications

All you need is any Windows® soundcard demo on our website

Order On Line \$99.95

## COMPUTER AIDED TECHNOLOGIES

P.O. Box 18285 Shreveport, LA 71138

ORDERS: (318) 687-4444 FAX: (318) 686-0449

Info/Tech Support: (318) 687-2555

(9 a.m. - 3 p.m. Central M-F)

INTERNET DOWNLOADS AVAILABLE  
**INFORMATION & ORDERING**  
**WWW.SCANCAT.COM**

ability to receive signals, see Larry Van Horn's review in the June 2005 issue of *Monitoring Times*. (Also posted on line at the [www.monitoringtimes.com](http://www.monitoringtimes.com) website.)

## ☒ Suburban Chicago Fire Mutual Aid

*Hello,  
I am trying to locate Fire Mutual Aid. It was on a frequency of 461.225 MHz back in the 1980s. I am not sure if it was from the town of Des Plaines or Naperville, but I was listening to it on my scanner. I hope you can help me out. I live in Chicago on the south side of Midway airport.*

*Paul in Chicago*

First, a little bit of geography for those not familiar with Chicagoland. Des Plaines is a city of about 60,000 people just outside Chicago in Cook County, Illinois. It is probably most familiar as the home of the first Ray Kroc McDonalds restaurant, a replica of which now stands downtown on Lee Street.

Naperville is about 25 miles southwest of Des Plaines, located along Interstate 88 in DuPage and Will Counties. It is home to about 130,000 residents, making it the fourth largest city in Illinois.

Midway Airport is ten miles southwest of downtown Chicago, about 25 miles south of Des Plaines, and about 25 miles east of Naperville. So, none of these locations are exactly adjacent to each other, and all are in heavily populated areas thick with radio services of all types.

## MABAS

Illinois has a mature and well-established mutual aid organization called MABAS (Mutual Aid Box Alarm System), first established in the early 1970s and currently comprising more than 800 fire departments from southern Wisconsin throughout Illinois down to St. Louis, Missouri. MABAS has focused on simple, inexpensive procedures and solutions to interoperability challenges when two or more departments need to work together. Besides procedures and call-out plans, MABAS has been instrumental in setting aside certain frequencies in Illinois for specific purposes.

Since the 1960s, the VHF frequency 154.2650 MHz has been reserved for mutual aid between fire departments. This frequency is known as NIFERN (Northern Illinois Fire Emergency Radio Network) and can be found on most fire radios in the Chicagoland area. MABAS also established a common fireground frequency of 155.8300 MHz to be used for local, tactical communication while on-scene. Additional fireground frequencies were established later, and eventually each was assigned a color as follows:

Fireground "Color"	Frequency	Description
Red	153.8300	Primary fireground
White	154.2800	Secondary fireground

Blue	154.2950
Gold	153.8375
Black	154.2725
Gray	154.2875

In a similar manner, police agencies in Illinois can use the Illinois State Police Emergency Radio Network (ISPERN) to communicate with each other. ISPERN is active on 155.4750 MHz. This frequency is used for police pursuits, interagency coordination, and certain other high-priority traffic.

The Illinois Department of Health established the Medical Emergency Radio Control for Illinois (MERC I), mandating that all ambulances and hospitals be capable of using specific VHF frequencies to communicate urgent health-related information. About 2,000 emergency medical service personnel in the state use the MERC I system.

Frequency	Comments
155.1600	East
155.2200	Dispatch
155.2800	Inter-Hospital
155.3400	South
155.4000	Northeast

Communication between different types of departments is also important, so another frequency was set aside as the Illinois Radio Emergency Assistance Channel (IREACH), to be used for interagency communications. IREACH can be heard on 155.055 MHz.

Mutual Aid for fire services in suburban Chicago is handled by a number of dispatch centers. Due to space limitations we'll cover just the areas mentioned in Paul's letter.

## Des Plaines, Illinois

Both fire and police services for Des Plaines and nearby Park Ridge are dispatched by the North Suburban Emergency Dispatch Center, headquartered in Des Plaines. Three frequencies are worth following here:

Frequency	Description
154.3400	Des Plaines and Park Ridge Fire Dispatch (MABAS Division 3)
155.7450	Des Plaines Police Dispatch
470.4875	Park Ridge Police Dispatch

## Naperville, Illinois

The City of Naperville operates a Motorola Type II analog trunked radio system on the following frequencies: 866.2375, 866.6250, 867.0375, 867.2000, 867.5750, 867.8250, 868.1500 and 868.6500 MHz.

The following talkgroups are in use on the system:

Decimal	Hex	Description
80	005	Police (Dispatch)
112	007	Police (Channel 2)
144	009	Police Records Inquiry
176	00B	Detectives
208	00D	Police Administrative
240	00F	Police (Special)
272	011	Police (Special)
304	013	Neighborhood Watch
336	015	Patch to ISPERN (155.4750 MHz)

1680	069	Fire Dispatch
1712	06B	Fireground
1744	06D	Fire Administration
1776	06F	Patch to MERC I (155.3400 MHz)
3280	0CD	Electric Service
3312	0CF	Roads
3344	0D1	Water Department
3376	0D3	Emergency Services
3408	0D5	Emergency Services
3568	0DF	Patch to NIFERN (154.2650 MHz)
3632	0E3	Fire Training
3664	0E5	Patch to Fireground (153.8300 MHz)

## DuPage County

DuPage Public Safety Communications ("Du-Comm") provides dispatch services for 12 police departments and 15 fire agencies and is the largest centralized 911 PSAP (Public Safety Answering Point) in Illinois, serving more than 700,000 county residents.

The county has half a dozen fire departments, including Elmhurst, Glen Ellyn, Hanover Park, Lombard, Villa Park and Wheaton. There are also larger, generally more rural fire protection districts (FPD) in the county, including Bartlett/Countryside, Carol Stream, Glenside, Lisle/Woodridge, Oakbrook Terrace, Warrenville, West Chicago, Winfield and York Center.

Fire activity can be heard on four main frequencies, as follows:

Frequency	Departments and Districts
151.3850	Lisle-Woodridge, Warrenville
154.1750	Addison, Bloomingdale, Carol Stream, Glen Dale, Glen Ellyn, Glenside, Lombard, West Chicago, Winfield, Wheaton
154.3100	Bartlett, Bloomingdale, Darien/Woodridge, Glen Dale, Hanover Park, Itasca, Oak Brook, Roselle, Wheaton
154.4150	Elmhurst, Lombard, Oakbrook Terrace, Villa Park, York Center

Du-Comm also rebroadcasts ISPERN traffic on a UHF frequency of 470.3625 MHz, which may be easier to receive than the lower VHF frequency. They also rebroadcast VHF IFERN traffic on 470.3625 MHz.

DuComm also uses county-wide frequencies that are common to all police and fire departments in the area, including 471.0125 and 476.4125 MHz.

That's all for this month. More information is available on my website, including APCO Project 25 information and detailed scanner comparisons. Please send your questions, comments and frequency lists to me at [danveeneman@monitoringtimes.com](mailto:danveeneman@monitoringtimes.com). Until next time, happy scanning!



# Big Savings on Radio Scanners

## Uniden® SCANNERS



### Bearcat® 796DGV Trunk Tracker IV with free scanner headset

Manufacturers suggested list price \$799.95  
**CEI Special Price \$519.95**

1,000 Channels • 10 banks • CTCSS/DCS • S Meter  
**Size: 6 15/16" Wide x 6 9/16" Deep x 2 3/8" High**

**Frequency Coverage:** 25,000-512,000 MHz., 806,000-956,000 MHz. (excluding the cellular & UHF TV band), 1,240,000-1,300,000 MHz.

When you buy your Bearcat 796DGV TrunkTracker package deal from Communications Electronics, you get more. The GV means "Great Value." With your BC796DGV scanner purchase, you also get a **free deluxe scanner headphone** designed for home or race track use. Headset features independent volume controls and 3.5 mm gold right angle plug. The 1,000 channel Bearcat 796DGV is packed with features to track Motorola Type I/II/III Hybrid, EDACS, LTR Analog Trunk Systems and Motorola APCO 25 Phase I digital scanner including 9,600 Baud C4FM and CQPSK. Also features control channel only mode to allow you to automatically trunk many systems by simply programming the control channel, S.A.M.E. weather alert, full-frequency display and backlit controls, built-in CTCSS/DCS to assign analog and digital subaudible tone codes to a specific frequency in memory, PC Control and programming with RS232C 9 pin port (cable not supplied), Beep Alert, Record function, VFO control, menu-driven design, total channel control and much more. Our CEI package deal includes telescopic antenna, AC adapter, cigarette lighter cord, DC cord, mobile mounting bracket with screws, owner's manual, trunking frequency guide and one-year limited Uniden factory warranty. For maximum scanning enjoyment, order magnetic mount antenna part number ANTMMBNC for \$29.95. For complete details, download the owners manual from the [www.usascan.com](http://www.usascan.com) web site. For fastest delivery, order on-line at [www.usascan.com](http://www.usascan.com).

### Bearcat® BCT8 Trunk Tracker III

Manufacturer suggested list price \$299.95  
**CEI Special Price \$169.95**

250 Channels • 5 banks • PC Programmable  
**Size: 7.06" Wide x 6.10" Deep x 2.44" High**

**Frequency Coverage:** 25,000-54,000 MHz., 108,000-174,000 MHz., 400,000-512,000 MHz., 806,000-823,987.5 MHz., 849,012.5-868,995.0 MHz., 894,012.5-956,000 MHz.

The Bearcat BCT8 scanner, licensed by NASCAR, is a superb preprogrammed 800 MHz trunked highway patrol system scanner. Featuring TrunkTracker III, PC Programming, 250 Channels with unique BearTracker warning system to alert you to activity on highway patrol link frequencies. Preprogrammed service searches makes finding interesting active frequencies even easier and include preprogrammed police, fire and emergency medical, news agency, weather, CB band, air band, railroad, marine band and department of transportation service searches. The BCT8 also has preprogrammed highway patrol alert frequencies by state to help you quickly find frequencies likely to be active when you are driving. The BCT8 includes AC adapter, DC power cable, cigarette lighter adapter plug, telescopic antenna, window mount antenna, owner's manual, one year limited Uniden warranty, frequency guide and free mobile mounting bracket. For maximum scanning enjoyment, also order the following optional accessories: External speaker ESP20 with mounting bracket & 10 feet of cable with plug attached \$19.95. Magnetic Mount mobile antenna ANTMMBNC for \$29.95.



### Bearcat® BCD396T Trunk Tracker IV

Suggested list price \$799.95/CEI price \$519.95

APCO 25 9,600 baud compact digital ready handheld TrunkTracker IV scanner featuring Fire Tone Out Paging, Close Call and Dynamically Allocated Channel Memory (up to 6,000 channels), SAME Weather Alert, CTCSS/DCS, Alpha Tagging. **Size: 2.40" Wide x 1.22" Deep x 5.35" High**

#### Frequency Coverage:

25,000-512,000 MHz., 764,000-775,987.5 MHz., 794,000-823,987.5 MHz., 849,012.5-868,976.5 MHz., 894,012.5-956,000 MHz., 1,240,000 MHz.-1,300,000 MHz.

The handheld BCD396T scanner was designed for National Security/Emergency Preparedness (NS/EP) and homeland security use with new features such as **Fire Tone Out Decoder**. This feature lets you set the BCD396T to alert if your selected two-tone sequential paging tones are received. Ideal for on-call firefighters, emergency response staff and for activating individual scanners used for incident management and population attack warning. **Close Call Radio Frequency Capture** - Bearcat exclusive technology locks onto nearby radio transmissions, even if you haven't programmed anything into your scanner. Useful for intelligence agencies for use at events where you don't have advance notice or knowledge of the radio communications systems and assets you need to intercept. The BCD396T scanner is designed to track Motorola Type I, Type II, Hybrid, SMARTNET, PRIVACY PLUS, LTR and EDACS® analog trunking systems on any band. Now, follow UHF High Band, UHF 800/900 MHz trunked public safety and public service systems just as if conventional two-way communications were used. **Dynamically Allocated Channel Memory** - The BCD396T scanner's memory is organized so that it more closely matches how radio systems actually work. Organize channels any way you want, using Uniden's exclusive dynamic memory management system. 3,000 channels are typical but **over 6,000 channels are possible** depending on the scanner features used. You can also easily determine how much memory you have used and how much memory you have left. **Preprogrammed Systems** - The BCD396T is preprogrammed with over 400 channels covering police, fire and ambulance operations in the 25 most populated counties in the United States, plus the most popular digital systems. **3 AA NiMH or Alkaline battery operation and Charger** - 3 AA battery operation - The BCD396T includes 3 premium 2,300 mAh Nickel Metal Hydride AA batteries to give you the most economical power option available. You may also operate the BCD396D using 3 AA alkaline batteries. **Unique Data Skip** - Allows your scanner to skip unwanted data transmissions and reduces unwanted birdies. **Memory Backup** - If the battery completely discharges or if power is disconnected, the frequencies programmed in the BCD396T scanner are retained in memory. **Manual Channel Access** - Go directly to any channel. **LCD Back Light** - A blue LCD light remains on when the back light key is pressed. **Autolight** - Automatically turns the blue LCD backlight on when your scanner stops on a transmission. **Battery Save** - In manual mode, the BCD396T automatically reduces its power requirements to extend the battery's charge. **Attenuator** - Reduces the signal strength to help prevent signal overload. The BCD396T also works as a conventional scanner to continuously monitor many radio conversations even though the message is switching frequencies. The BCD396T comes with AC adapter, 3 AA nickel metal hydride batteries, belt clip, flexible rubber antenna, wrist strap, SMA/BNC adapter, RS232C cable, Trunk Tracker frequency guide, owner's manual and one year limited Uniden warranty. Not compatible with AGEIS, ASTRO or ESAS systems. Order on-line at [www.usascan.com](http://www.usascan.com) or call 1-800-USA-SCAN.



### Bearcat® BC246T Trunk Tracker III

Suggested list price \$399.95/CEI price \$214.95

Compact professional handheld TrunkTracker III scanner featuring Close Call and Dynamically Allocated Channel Memory (up to 2,500 channels), SAME Weather Alert, CTCSS/DCS, Alpha Tagging. **Size: 2.72" Wide x 1.26" Deep x 4.6" High**

#### Frequency Coverage:

25,000-54,000 MHz., 108,000-174,000 MHz., 216,000-224,980 MHz., 400,000-512,000 MHz., 806,000-823,987.5 MHz., 849,012.5-868,987.5 MHz., 894,012.5-956,000 MHz., 1,240,000 MHz.-1,300,000 MHz.

The handheld BC246T TrunkTracker scanner has so many features, we recommend you visit our web site at [www.usascan.com](http://www.usascan.com) and download the free owner's manual. Popular features include **Close Call Radio Frequency Capture** - Bearcat exclusive technology locks onto nearby radio transmissions, even if you haven't programmed anything into your scanner. **Dynamically Allocated Channel Memory** - Organize channels any way you want, using Uniden's exclusive dynamic memory management system. 1,600 channels are typical but **over 2,500 channels are possible** depending on the scanner features used. You can also easily determine how much memory is used. **Preprogrammed Service Search (10)** - Makes it easy to find interesting frequencies used by public safety, news media TV broadcast audio, Amateur (ham) radio, CB radio, Family Radio Service, special low power, railroad, aircraft, marine, racing and weather frequencies. **Quick Keys** - allow you to select systems and groups by pressing a single key. **Text Tagging** - Name each system, group, channel, talk group



ID, custom search range, and S.A.M.E. group using 16 characters per name. **Memory Backup** - When power is lost or disconnected, your BC246T retains the frequencies that were programmed in memory. **Unique Data Skip** - Allows the BC246T to skip over unwanted data transmissions and birdies. **Attenuator** - You can set the BC246T attenuator to reduce the input strength of strong signals by about 18 dB. **Duplicate Frequency Alert** - Alerts you if you try to enter a duplicate name or frequency already stored in the scanner. **22 Bands** - with aircraft and 800 MHz. The BC246T comes with AC adapter, 2 AA 1,800 mAh nickel metal hydride batteries, belt clip, flexible rubber antenna, wrist strap, RS232C cable, Trunk Tracker frequency guide, owner's manual and one year limited Uniden warranty. For more fun, order our optional deluxe racing headset part #HF24RS for \$29.95. Order now at [www.usascan.com](http://www.usascan.com) or call 1-800-USA-SCAN.

## Buy with Confidence

### Order on-line and get big savings

For over 36 years, millions of communications specialists and enthusiasts worldwide have trusted Communications Electronics for their mission critical communications needs. It's easy to order. For fastest delivery, order on-line at [www.usascan.com](http://www.usascan.com). Mail orders to: Communications Electronics Inc., P.O. Box 1045, Ann Arbor, Michigan 48106 USA. Price includes \$30.00 UPS Ground shipping/handling/insurance per scanner to a street address in the continental USA excluding Alaska. Add \$20.00 shipping for all accessories. For shipments to Canada, Puerto Rico, Hawaii, Alaska, Guam, P.O. Box, APO/FPO, USPS Priority Mail or UPS 2 business day delivery, add \$30.00. Michigan residents add sales tax. No COD's. For Bearcat scanners your satisfaction is guaranteed or return item in unused condition in original packaging within 61 days for refund, less shipping charges. 10% surcharge for net 10 billing to qualified accounts. All sales are subject to availability, acceptance and verification. Prices, terms and specifications are subject to change without notice. We welcome your Discover, Visa, American Express, MasterCard, IMPAC or Eurocard. Order toll free, call 1-800-USA-SCAN or 1-734-996-8888 if outside Canada or the USA. FAX anytime, dial 1-734-663-8888. Dealer and international inquiries invited. Order your radio scanners from Communications Electronics today.

For credit card orders call  
**1-800-USA-SCAN**

e-mail: [cei@usascan.com](mailto:cei@usascan.com)

[www.usascan.com](http://www.usascan.com)

PO Box 1045, Ann Arbor, Michigan 48106-1045 USA  
 For information call 734-996-8888 or FAX 734-663-8888

**COMMUNICATIONS ELECTRONICS INC.**  
 Emergency Operations Center

## More Radio Products

Save even more on radio scanners when purchased directly from CEI. Price includes delivery in the continental USA excluding Alaska.

Bearcat 8987 500 channel TrunkTracker III base/mobile.....	\$209.95
Bearcat 796DGV 1,000 channel TrunkTracker III base/mobile.....	\$519.95
Bearcat BCD396T APCO 25 Digital scanner with Fire Tone Out.....	\$519.95
Bearcat 246T up to 2,500 ch. TrunkTracker III handheld scanner.....	\$214.95
Bearcat Sportcat 230 alpha display handheld sports scanner.....	\$184.95
Bearcat 278CLT 100 channel AM/FM/SAME WX alert scanner.....	\$129.95
Bearcat 248CLT 50 channel base AM/FM/weather alert scanner.....	\$104.95
Bearcat 92XLT 200 channel handheld scanner.....	\$109.95
Bearcat 72XLT 100 channel handheld scanner.....	\$99.95
Bearcat BR330T up to 2,500 ch. TrunkTracker III with Tone out \$274.95	
Bearcat BCT8 250 channel information mobile scanner.....	\$169.95
Bearcat 350C 50 channel desktop/mobile scanner.....	\$104.95
AOR AR16BQ Wide Band scanner with quick charger.....	\$199.95
AOR AR3000AB Wide Band base/mobile receiver.....	\$1,079.95
AOR AR5000A+3B Wide Band 10 KHz to 3 GHz receiver.....	\$2,599.95
AOR AR8200 Mark III Wide Band handheld scanner.....	\$594.95
AOR AR8600 Mark III Wide Band receiver.....	\$899.95
AOR AR-ONE Government/Export sales only 10 KHz-3 GHz.....	\$4,489.95
Scancat Gold For Windows Software.....	\$99.95
Scancat Gold For Windows Surveillance Edition.....	\$159.95

Visit [WWW.USASCAN.COM](http://WWW.USASCAN.COM) • 1-800-USA-SCAN

## ShipCom Frequencies

**S**hipCom, LLC, a Limited Liability Corporation, is the last United States full-service provider of HF (high-frequency) voice, data, and e-mail services to ships at sea. It owns and operates several stations. Let's look at these:

### WLO

This historic flame-thrower blisters the Gulf, Caribbean, and North Atlantic from its powerful transmitters at well-equipped sites southwest of Mobile, Alabama. It should be audible most of the day, over one frequency or another, on much of this planet's surface.



WLO offers a full range of commercial maritime traffic services. These include upper sideband (USB) voice, narrowband direct printing (NBDP) in Simplex Telex Over Radio (SITOR), and electronic mail in SITOR or Packet Teleprinting Over Radio (PACTOR). There's also remote entry to terrestrial and satellite networks for a number of services such as text facsimile (FAX), ordering flowers, and even whatever's left of the old Telex system. One can even make an old-fashioned "ship to shore" phone patch.

WLO's international Maritime Mobile Service Identity (MMSI) is 003660003. This is used by the newer Global Maritime Distress and Safety System (GMDSS) for automated calling. Finally, WLO supports the Very High Frequency (VHF) calling and distress channel 16 (156.800 megahertz), along with a few other voice channels.

One interesting service for utility listeners is the top-of-hour weather, given with the traffic list on selected frequencies by a "female" computer voice. It's good for hurricane season, as is WLO's famous "interoperability" capability, which can help get disparate radio users all talking to one another. This saved lives after Katrina, when WLO supported many emergency operations despite heavy damage to its facilities. It's too bad all our well-heeled Federal agencies can't seem to match the expertise of one commercial shore station in Alabama.

Like all US coast stations, WLO/ShipCom accepts AMVERS (position information for the Automated Mutual Assistance Vessel Rescue System) and OBS (formatted weather observations) for free. WLO encourages this by allowing subsequent free access to news headlines and weather forecasts.

This traffic is in SITOR mode A, the distinctive chirp-chirp-chirp sound. While "S" is for "Simplex," maritime teleprinting is duplex. The listener can develop an ear for the shorter receive-acknowledgment chirp, thus knowing when to

switch frequency to try to hear the vessel.

WLO is licensed on all relevant frequencies and modes, but the ones you'll actually hear are listed in the accompanying table.

### KLB

KLB, MMSI 003660061, is located near Silvan, Washington, in Snohomish County north of Seattle. It was added to expand ShipCom's reliable voice coverage into the Gulf of Alaska and Northeast Pacific. It transmits in upper sideband (USB) on International Telecommunications Union (ITU) channels 417 (4405 kHz shore/4413 kHz ship), 805 (8731/8207), 1209 (13101/12254) and 1624 (17311/16429).

KLB has its own top-of-hour weather and traffic lists on all four frequencies. Otherwise, there's just not a lot of voice on terrestrial maritime short wave radio any more. KLB, along with WLO, is usually also heard on traditional wireless telegraphy frequencies in the annual "Night of Nights" Morse code operations.

### KNN

KNN, MMSI 003660123, became something of a puzzle to your editor, when its licensed power was listed as 10 kilowatts in the FCC database. Something this strong ought to blow the top off my receiver, but I'd never even heard KNN. Neither had I seen any appropriately large antennas in the congested Marina area.

A quick e-mail exchange with Rene Stiegler, president of ShipCom, provided the answer:

"...the station only runs about 1kW. The antennas are vertical. It is a small facility restricted by the available space. It is active 24/7. We use it when propagation is such that we are having difficulty hearing a vessel from our two main stations..."

"It is used for radio-telephone only at this time. The active channels are ITU Channel 416, 814, 1203, 1616, and 2213." [4402/4110, 8758/8234, 13083/12236, 17287/16405, and 22732/22036, all upper sideband (USB). -Hugh]

We thank Rene for this useful information.

### WCL

The ShipCom web site mentions a small voice remote station right in Mobile, AL. Its call sign is WCL, with a MMSI of 003660122. It's apparently heard even less than KNN. It shows in a British Admiralty record with USB voice on ITU channels 403 (4363/4071), 802 (8722/8198), 1206 (13092/12245), 1601 (16360/17242), and 2243 (22822/22126).

Interestingly, running the coordinates shown

in the FCC records through Google Earth takes you directly to a residential street in Mobile, with no visible antennas. Either it's even smaller than KNN, or it's somewhere else in that city.

### EKA???

Even less is known about EKA, Yerevan Radio, in Armenia. It's been mentioned frequently in the hobby press as some kind of ShipCom affiliate. Unfortunately, hard listening data is nearly impossible to come by. Reported frequencies are 12604.5/12502 and 16818.5/16695.5 kHz SITOR or PACTOR, and USB on ITU channel 1206 (13092/12245).

Indeed, you can take a great deal of your time and find a rather dismal web site, in Russian, for an "EKA Maritime Radio." There are references to a company named "Karradio," not to be confused with the Russian Karaoke radio with the same name. In among the pretty pictures of cruise ships, computers, and radio consoles is a list of services that, when translated, does greatly match one on the ShipCom site.

Have fun with this stuff, and see you next month.

### WLO PRIMARY FREQUENCIES

USB Voice Channel #	Shore kHz	Ship kHz
405 *	4369.0	4077.0
414	4396.0	4104.0
607	6519.0	6218.0
824 *	8788.0	8264.0
830 *	8806.0	8282.0
1212 *	13110.0	12263.0
1226	13152.0	12305.0
1607	17260.0	16378.0
1641 *	17362.0	16480.0
1807	19773.0	18798.0
2237 *	22804.0	22108.0
2503	26151.0	25076.0

\* = Weather

### SITOR-A Teleprinting

(Selcal: 1090 / XVSV)

Channel #	Shore kHz	Ship kHz
406	4213.0	4175.0
606	6317.0	6265.5
806	8419.0	8379.0
810	8421.0	8381.0
815	8423.5	8383.5
1205	12581.5	12479.0
1211	12584.5	12482.0
1605	16809.0	16685.5
1810	19685.5	18875.0
2215	22383.5	22291.5
2510	26105.5	25177.5

### PACTOR or SITOR E-Mail

(Simplex - PACTOR Call WLO-1)

6416.0	8473.0	12886.5
13051.5	16997.5	22688.0

### ABBREVIATIONS USED IN THIS COLUMN

AFB.....	Air Force Base
ALE.....	Automatic Link Establishment
AM.....	Amplitude Modulation
ARQ.....	Automatic Repeat Request
AWACS.....	Airborne Warning and Control System
CAMSLANT.....	Communication Area Master Station, Atlantic
CAMSPAC.....	Communication Area Master Station, Pacific
COTHEN.....	Customs Over-The-Horizon Enforcement Network
CW.....	On-off keyed "Continuous Wave" Morse telegraphy
DEA.....	US Drug Enforcement Administration
DGPS.....	Differential Global Positioning System
E3.....	UK M16, Cyprus, poacher song and female voice
E7.....	Russian KGB/GRU/FSB etc., English version
E25.....	Any of 4 "numbers" voices, often Arabic music first
EAM.....	Emergency Action Message
FAX.....	Radiofacsimile
FEC.....	Forward Error Correction
FEMA.....	US Federal Emergency Management Agency
G6.....	Russian KGB/GRU/FSB etc., German version
HFDL.....	High-Frequency Data Link
HF-GCS.....	High-Frequency Global Communication System
LDOC.....	Long-Distance Operational Control
M8a.....	Cuban 3-msg CW/MCW, ANDUWRIGMT = 1-0
MARS.....	Military Affiliate Radio System
Meteo.....	Meteorological
MCW.....	Modulated CW or AM tone Morse telegraphy
MFSK.....	Multiple-Frequency-Shift Keying
MSK.....	Minimum-Shift Keying
NASA.....	US National Aeronautics and Space Administration
NDB.....	Non-Directional Beacon
NORAD.....	North American Aerospace Defense Command
RSA.....	Republic of South Africa
RTTY.....	Radio Teletype
Selcal.....	Selective Calling
SHARES.....	Shared Resources (US Government)
SITOR-A.....	Simplex Telex Over Radio, ARQ mode
SITOR-B.....	Simplex Telex Over Radio, FEC mode
STS.....	Space Transportation System (Space Shuttle)
Unid.....	Unidentified
US.....	United States
USCG.....	United States Coast Guard
UK.....	United Kingdom
V2a.....	"Atencion" Spanish numbers, 3-msg format

All transmissions are USB (upper sideband) unless otherwise indicated. All frequencies are in kHz (kilohertz) and all times are UTC (Coordinated Universal Time). "Numbers" stations have their ENIGMA (European Numbers Information Gathering and Monitoring Association) designators in ().

275.0	"BA"-MCW identifier of NDB, Banak, Norway, at 2046. (Ary Boender-Netherlands)	2749.0	VAR3-Canadian Coast Guard, advisories in English and French, at 0200 (Cyclops-TX)
284.5	"DY"-NDB, Düsseldorf, Germany, MCW at 2120. (Boender-Netherlands)	3016.0	Reach 171-US Air Force Air Mobility Command, answered selcal DQ-CE from Shanwick on the North Atlantic air control net, at 0749. (Patrice Privat-France)
294.0	"138"-DGPS Klamath Falls, OR, MSK at 0324. (Hugh Stegman-CA)	3167.0	"L-7-F"-US Navy, link coordination with "S-5-G" and "L-9-E," at 0022. (Mark Cleary-SC)
319.0	"VAR"-NDB, Stavanger, Norway, MCW at 2042. (Boender-Netherlands)	3341.0	FR4-FEMA, ALE sound at 0208. (Tom Severt-KS)
348.0	"LG"-NDB, Liege, Belgium, MCW at 0709. (Boender-Netherlands)	3349.0	AFA4VC-US Air Force MARS, working AAR8RE in ALE, at 2148. (Severt-KS)
365.0	"LI"-NDB, Köln, Germany, MCW at 2031. (Boender-Netherlands)	3845.0	The German Lady (G6), callup 308 965/124, in German, at 2000. (Mike L-West Sussex, UK)
368.5	"ELU"-NDB, Luxemburg, MCW at 2027. (Boender-Netherlands)	4017.0	Unid-2 unknown male sailors, one with a UK accent, at 0712. (Severt-KS)
372.0	"ODR"-NDB, Oddery, Denmark, MCW at 2025. (Boender-Netherlands)	4079.6	"TMP 52"-Unknown pirate hobby beacon, Southwestern US, broadcasting the outside Fahrenheit temperature every 15 seconds, at 0132. (Stegman-CA)
383.0	"SHD"-NDB, Scotstownhead, UK, MCW at 0651. (Boender-Netherlands)	4125.0	CAMSLANT-USCG, Norfolk, VA, working disabled butane tanker Maersk Scotland, at 0619. (Cleary-SC) M/V Maersk Scotland, advising CAMSLANT she was under tow to VA, two days later at 1557. (Allan Stern-FL)
406.5	"BOT"-NDB, Bottrop, Germany, MCW at 0710. (Boender-Netherlands)	4149.0	WPE-Crowley Marine Services, FL, working tugboats at 0602. (Stegman-CA)
417.0	"LI"-NDB, Düsseldorf, Germany, MCW at 0656. (Boender-Netherlands)	4316.0	NMN-USCG CAMSLANT, VA, weather at 0421. (Severt-KS)
426.0	"GBG"-NDB, Gleichenberg, Austria, MCW at 1734. (Boender-Netherlands)	4317.9	NMG-New Orleans Radio, LA, FAX weather chart at 0124. (Severt-KS)
		4604.0	Red Fox 98-US Civil Air Patrol, IL, working Columbus 45, Indiana Air National Guard, at 2300. (Chris Corley-GA)
		4724.0	Chivalry-US military, with a 28-character EAM, simulcast on 8992, 11175, and 15016, all strong, at 2033. (Jeff Haverlah-TX)
		4792.0	The English Man (E7), callup 887-1 793/18, AM at 2140. (Mike L-West Sussex)
		5036.0	INAS30P-Sonatrach Petroleum, In Amenas, Algeria, ALE sound at 1852. (Privat-France)
		5190.0	The German Lady (G6), callup 308 965/124 in German, at 1900. (Mike L-West Sussex)
		5379.0	TYVM1-Spanish Guardia Civil, Murcia, calling TZSG1 in ALE, at 0801. (Privat-France)
		5410.0	UN22-Algerian Ministry of Information, calling HA20 in ALE, at 0053. (Privat-France)
		5616.0	New Zealand 2-Air New Zealand Boeing 777-219, registration ZK-OKG, answering selcal FS-BR on the North Atlantic net, at 0920. (Privat-France)
		5680.0	Kinloss-UK Coast Guard Kinloss Rescue, Scotland, working helicopter Rescue 131 over distressed vessel M/V Ocean Seeker, at 0850. (Privat-France)
		5708.0	538025-US Air Force tanker, calling CRO, Croughton, ALE at 2051. (Privat-France) Chariot 01-Possible US Air Force E-3 AWACS, patch to Tinker AFB Meteo, OK, at 2257. (Cleary-SC)
		5711.0	KNY70-US National Communications System, VA, ALE sound at 2216. (Privat-France)
		5717.0	Coast Guard 232-Canadian Coast Guard, rescue exercise with Halifax Military, NS, at 2359. (Corley-GA)
		5732.0	WGY9034-FEMA, patch via Service Center (US Customs, COTHEN net) to South Carolina Emergency Operations Center, at 1418. (Cleary-SC)
		5807.0	JOS-Nigerian National Petroleum Corporation, Jos Distribution Depot, ALE sound at 2206. (Privat-France)
		5896.0	The English Man (E7), callup 887-1 793/18, AM with only a lower sideband, at 2120. (Mike L-West Sussex)
		5930.0	Cuban "Cut Number" Morse (M8a), CW 5-letter groups at 0718. (Severt-KS)
		6305.0	GS1-Georgian Border Guard, calling MB1 in ALE, at 1728. (Privat-France)
		6410.0	ZSJ-South African Navy, Silvermine, 32-tone MFSK traffic at 0910. (Bob Hall-RSA)
		6500.0	13061-Moroccan Civil Protection, ALE sound at 0205. (Privat-France)
		6501.0	NOJ-USCG, Kodiak, AK, Pacific weather but not the "Perfect Paul" voice, at 0220 (Cyclops-TX)
		6765.0	Unknown station in a SHARES exercise, gave frequency 6696.0

- for routine traffic, also using 4517, at 2217. (Corley-GA)
- 6768.0 Cuban Spanish AM "numbers" (V2a), 5-number groups at 0402. (Sevart-KS)
- 6786.0 Cuban "Cut Number" Morse (M8a), CW at 0623. (Sevart-KS)
- 6855.0 Cuban Spanish AM "numbers" (V2a), parallel 7975, 5-figure groups in progress at 1614. V2a, callup 14933 40813 08003, at 2100. V2a, callup 76451 59091 01871, at 2101. V2a in progress at 2102. (Cam Castillo-Panama) V2a, still competing with WYFR broadcast, at 2117. (Sevart-KS)
- 6892.0 The English Man (E7), callup 887-1 793/18, AM at 2100. (Mike L-West Sussex)
- 6932.0 Cuban "Cut Number" Morse (M8a), CW at 2133. (Sevart-KS)
- 6998.0 HWK7-Italian pirate CW station, long political broadcast in Italian at 1346. (Privat-France) [*Perennial shortwave weirdo, erroneously using what he thinks is a bootleg Vatican callsign. -Hugh*]
- 7554.0 Cuban "Cut Number" Morse (M8a), parallel on 8009, CW at 2034. (Sevart-KS)
- 7759.0 SULEJA-Nigerian National Petroleum Corporation, Suleja Distribution Station, ALE sound at 1930. KANO-NNPC Kano Pumping Station, ALE sound, also on 8086, at 2345. (Privat-France)
- 7887.0 Cuban Spanish AM "numbers" (V2a), callup 51933 13123 36243, at 2001. V2a, callup 76451 59091 0187, also at 2001. V2a, callup 76452 59092 01872, next day at 2001. V2a, callup 14933 40813 08003, at 2002. (Castillo-Panama) V2a, interrupted by warble tone on same transmitter, at 2010. (Cyclops-TX) V2a, in progress at 2033. (Sevart-KS)
- 7975.0 Cuban Spanish AM "numbers" (V2a), callup 46592 17282 52642, at 1601. (Castillo-Panama) V2a, callup 65413 07053 66243, also at 1601. (Sevart-KS) V2a, in progress at 1630. (Cyclops-TX)
- 8010.0 Cuban Spanish AM "numbers" (V2a), callup 82922 56662 97132, at 1700. (Sevart-KS) V2a, began at 1659 with Radio Havana, switched to numbers at 1705. V2a, callup 24833 68343 84233, at 1702. (Castillo-Panama)
- 8035.0 360-Probable Georgian Border Guard, working 376 in ALE, at 0429. (Privat-France)
- 8096.0 Cuban "Cut Number" Morse (M8a), MCW callup 53841 48811 91051 and 5-letter groups, at 1800. M8a, MCW callup 53842 48812 91052, next day at 1801. M8a, MCW callup 23212 4552 33632, at 1802. M8a, MCW callup 23213 45753 33633, next day at 1802. M8a, MCW callup 23212 4552 33632, at 1901. (Castillo-Panama)
- 8097.0 Cuban Spanish AM "numbers" (V2a), in progress at 0720. M8a, MCW callup 68862 61392 03372, at 1800. (Sevart-KS) M8a, 5-letter CW groups at 1800. (Cyclops - TX)
- 8463.0 CKN-Canadian Forces, Esquimalt, BC, RTTY Notice to Allied War Ships loop, at 1530. (Sevart-KS)
- 8502.0 NMN-USCG, VA, live female voice with weather, at 1721. (Sevart-KS)
- 8503.9 NMG-USCG, New Orleans, LA, FAX satellite image at 2009. (Sevart-KS)
- 8665.0 Unknown, possibly XSG, Shanghai Radio, China, long message in hand sent CW, at 0740. (Stegman-CA)
- 8682.0 NMC-USCG, CA, FAX chart at 1540. (Sevart-KS)
- 8764.0 NMO-USCG, HI, Pacific high seas forecast, parallel 13089, at 0020. NMC-USCG CAMSPAC, CA, Pacific forecast, also parallel 13089, at 2255 (Cyclops-TX)
- 8788.0 WLO, Mobile Radio, AL, voice-synthesized weather, parallel 8806, at 2016. (Sevart-KS)
- 8806.0 WLO-Shipcom, Mobile, AL, weather and traffic list at 2100 (Cyclops-TX)
- 8912.0 Coast Guard 1720-USCG HC-130, setting radio guard with CAMSLANT on COTHEN net, at 2009. (Cleary-SC)
- 8971.0 Goldenhawk-US Navy Tactical Support Center, ME, giving Wafer 22 3253 and 7710 kHz for Coast Guard 1711, at 1637. (Cleary-SC)
- 8983.0 CAMSLANT-USCG, VA, discussing medical evacuation from vessel *Carolyn Chouest* with Coast Guard 2120, at 1856. (Cleary-SC) CAMSLANT, working Coast Guard 2105, at 2141. (Sevart-KS) Stingray 13-Probable USCG on a drug mission, working CAMSLANT at 2202. (Stern-FL)
- 8992.0 Andrews-US Air Force HF-GCS control station, MD, with a 163-character EAM at 1724. (Sevart-KS)
- 9007.0 Canforce 2604-Canadian Forces, getting weather from Trenton Military, at 2119. (Cleary-SC)
- 9025.0 Sentry 08-US Air Force E-3 AWACS, patch via Andrews HF-GCS, MD, to Raymond 24 (Tinker AFB, OK), at 1857. (Cleary-SC)
- 9168.0 Unid-Unknown station simulcasting FAX from NMG, New Orleans, compressed circuit interrupted by data bursts, at 2024. (Sevart-KS) [*Oops? -Hugh*]
- 9450.0 Unknown agency "numbers" (E25), callup "780" repeated 22 times, then 10 4-figure groups, AM at 1244. (Mike L-West Sussex)
- 10242.0 PNR400-DEA Panther 400, Bahamas, ALE sound at 0750. (Privat-France) Coast Guard 1711-USCG HC-130, patch via COTHEN Service Center regarding data comms, at 1700. (Cleary-SC)
- 10275.0 RNOUSLR1-Sonatrach Petroleum, Rhoude Nouss, Algeria, ALE sound at 1921. (Privat-France)
- 10493.0 Back Stretch-Possible US military Nightwatch player, working Lions Den at 1804. (Cleary-SC)
- 10780.0 KRFB-NASA Booster Recovery Vessel *Freedom Star*, working BRV *Liberty Star* and Cape Radio, went to 7765 and then 7833 kHz for STS-116 mission, at 1731. (Stern-FL)
- 10993.6 Sector Key West-USCG, calling Shark 57 (USCG Cutter *Sawfish*), at 1722. (Cleary-SC)
- 11153.5 Offutt-US Air Force, Offutt AFB, NE, working Jail Door, probable US military Nightwatch net, at 2134. (Cleary-SC)
- 11175.0 Reach 3995-US Air Force transport, patch via Andrews to Shocker Control, McConnell AFB, KS, at 1555. (Corley-GA) "8-S-B"-Unknown submarine reporting torpedo tube malfunction in patch via Andrews HF-GCS, at 1438. Snoop 48-US Air Force RC-135 recon aircraft, patch via Andrews HF-GCS to Raymond 21 (Offutt AFB, NE), at 1556. (Cleary-SC) Reach 456-US Air Force C-17A, patch via Andrews HF-GCS for Dover AFB weather, at 1800. (Stern-FL)
- 11232.0 Chalice Foxtrot-US Air Force, patch via Trenton to Huntress, NORAD Eastern US Sector, at 1800. Goliath Charlie-US Air Force, patch via Trenton to Huntress, also at 1800. (Corley-GA) Chalice Golf-US Air Force E-3 AWACS, patch via Trenton to Deer Hunter (NORAD Western US), at 2013. (Cleary-SC)
- 11421.5 FJY5-French defense telecom, Crozet Island, ARQ idler at 0922. (Hall-RSA)
- 11494.0 Juliet 14-USCG MH-60J helicopter, setting COTHEN guard with CAMSLANT for training, at 1725. (Cleary-SC)
- 12579.0 NRV-USCG, Guam, SITOR-A iceberg alerts at 0924. (Hall-RSA)
- 13089.0 NMO-USCG, HI, Pacific forecast, parallel 8764, at 0015. NMN-USCG CAMSLANT, VA, Atlantic forecast at 2130 (Cyclops-TX)
- 13257.0 Sentry 61-US Air Force E-3 AWACS, patch via Trenton Military to Raymond 24 (Tinker AFB), at 1851. (Cleary-SC)
- 13339.0 "Mexico"-Aeromexico Dispatch, company LDOC traffic in Spanish with aircraft 184Mexico, 198Mexico, others, at 2320. (Mark Morgan-OH)
- 13510.0 CFH-Canadian Forces, Halifax, NS, RTTY weather text at 1753. (Sevart-KS)
- 13927.1 AFA2XD-US Air Force MARS, Satellite Beach, FL, patching Dark 31, a B-1B, to Dyess AFB, TX, at 1515. Sentry 07-US Air Force AWACS, MARS patch to Dixie Control, AL, regarding tanker refueling at 1623. (Stern-FL)
- 14487.0 The Lincolnshire Poacher (E3), music and callup 66758, at 1300 (Cyclops-TX)
- 15043.0 Sentry 61-US Air Force AWACS, patch via Offutt to Raymond 24, Tinker AFB, at 1931. (Cleary-SC)
- 15016.0 Fast Ball-US military, with a 28-character EAM, simulcast on 4724, 8992, and 11175, all strong, at 0130. (Haverlah-TX)
- 15682.0 The Lincolnshire Poacher (E3), music and callup 30555, at 1400 (Cyclops-TX)
- 16806.5 NMC-USCG CAMSPAC, CA, SITOR-B maritime information at 1733. (Sevart-KS)
- 16886.2 TAH-Istanbul Radio, Turkey, SITOR-A marker at 0930. (Hall-RSA)
- 17224.0 Unid-British military, Cyprus, MFSK at 0927. (Hall-RSA)
- 17314.0 NMC-USCG, CA, high seas forecast, parallel 8764 and 13089, at 1640 and 2230 (Cyclops-TX)
- 17314.0 NMN-USCG, VA, live female voice (not "Perfect Paul") reading weather (cold) at 1720 (Cyclops-TX)
- 28016.5 "AA"-CW fish net buoy, at 1808. (Castillo-Panama)
- 28151.3 "AA"-CW fish net buoy, at 1825. (Castillo-Panama)
- 28171.0 "AA"-CW fish net buoy, at 1835. (Castillo-Panama)
- 28181.5 "H"-CW fish net buoy, at 1700. (Castillo-Panama)



## Mexican Gulf and Brazilian Oil Activity

This month we take a look at a channel that appears to carry traffic from various oil operations off the Mexican and Brazilian coasts. The story is not complete on these networks, but hopefully you'll be spurred on to take a listen yourself and see what else you can discover.

### ☒ Nigerian Oil Update

But first, here's a quick update on last month's report on the Nigerian oil network. Proving how many ALE-listening monitors are on the case of these new networks, no sooner had we written last month's column than reports started appearing on the UDXF mailing list (see Resources). Other channels reporting NNPC activity are 5807 and 6500 kHz USB, making for a total of 6 channels so far and doubtless there are more to find. What remains interesting is the very close spacing of the channels, especially since the same stations seem to appear on all of them.

### ☒ STANAG 4529 On-air

Also news arrived of a station running STANAG 4529 – another high-speed modem standard, but one that is much more of a rarity than 4285 which we've featured in this column many times before. '4529 offers the same kinds of robust capabilities, but with a little less speed as compared to 4285, since it is designed to fit into a smaller channel of 1240 Hz bandwidth. You can hear an audio clip at Leif Dehio's website (see Resources).

In fact, in the eight years or so that we've had the capability to decode this mode, we had yet to hear it on-air. However, in early December a station appeared on 6953 kHz using 300bd with long interleaving and transmitting 15 or 20 minute-long messages with KG84 encryption.

The station appears to have left the air in late December. Interestingly, a French Forces station transmitting 184.6bd/400Hz shift ARQ-E has reappeared on 6955 kHz after a break. I've yet to hear the 4529 station active with the ARQ-E present, which raises the possibility that the KG84 was of French origin.

### ☒ PETROBRAS and PEMEX Oil Operations

There is little SITOR-A activity these days. The maritime sections of the radio dial were once filled with the distinctive chirp-chirp

ARQ of that mode, so my attention was caught by one such station on 4177 kHz back in late November.

The station was always weak, coming out of the noise around dusk and disappearing some time in the early morning hours EST. Messages were hard to piece together with the many errors, but they contained some intriguing formatting. There was also mixed operator chatter, some in Spanish and some in Portuguese, indicating the presence of perhaps two networks. As is often the case, the only solution to piecing the puzzle together is leaving the radio and decoder on frequency for days on end and catching as much traffic as possible.

As we've covered on many occasions in this column, selcals are vitally important for identifying networks, and there were a few being used regularly: VYXS and SSAA appearing the most consistently. Looking these up using the [kloth.net](http://kloth.net) maritime selcal translator (see Resources) confirmed a Brazilian coast station and a Mexican vessel.

For days, unremittingly poor conditions made any further identification impossible, until this message appeared, from the PEMEX ship *Neuvo Pemex IV* (callsign XCPW), confirming the existence of PEMEX, the Mexican oil company on frequency (the ~ characters are decoding errors):

de : b.t. nuevo pemex iv xcpw  
fecha : qe dic. wp06 at 2130 lt.  
asunto : petromar

para : veracruz, ver.  
pajaritos, ver.  
salina cruz, oax.  
~ guaymas, son.  
mader~~ ~amps~  
lazarro cardenas

~130101 c. 2130 lt. salinacruz / lazaro cardenas, cargados:

pemex magna 101,820.43 bls. nat.  
q00,733.51 bls. w0 gc.  
11,867.37 t.m.

pemex diesel 102,137.33 bls. nat.  
101,348.34 bls. w0 ~.  
geneu~mi~ t.m.

pemex premium 93,880.17 bls. nat.  
ownoeom08~bls. wp gc.  
qpntormri t.m.

ex~existencias de salida diesel 201 tons. ifo  
872 tons. lubr

34,165 lts. apot ~~~9 tons. ~adest 25 tons.  
calados 36'09/  
3~~~8, eta diciembre 15/1000 tl

cap. ~lt~m hector m. parra cosain.  
capitan del buque  
nnnnn

Well, at least that explained the Spanish operator chatter on the frequency. So, what of the Portuguese and its oddly formatted messages? For example:

sbm4am110530  
sbm4nv011410  
sbm4am110730  
p-43om081095  
sbm4nv011410  
sbm4am112480  
peregrino  
p-50nv011435  
p-50am111610  
p-50om021620  
sbm4am112400  
seabulk ipanema

Some web searches revealed that Seabulk Ipanema is an oil supply vessel working the Brazilian oilfields and that Peregrino is the name of a heavy oilfield about 85km south of Rio de Janeiro in the so-called Campos basin (see below)

Checking the website of PETROBRAS, the Brazilian oil organization (see Resources), finally explained the majority of these formatted messages. Each line appears to contain production figures from the platforms throughout the various oilfields. In the example above, P-50 and P-43 are two massive floating platforms in the Campos basin, where Peregrino is also located.

There is more work to be done. For example, it is quite possible that this is a supply operation working for both the Mexican and Brazilian companies. But where is the fun, unless you tune in and find out for yourself?!

Until next time, 73, and enjoy the digital DX.

### RESOURCES

UDXF Listeners - [groups.yahoo.com/group/udxf/](http://groups.yahoo.com/group/udxf/)  
STANAG4529 Clip - [www.signals.taunus.de/FFT/STANAG4529.HTML](http://www.signals.taunus.de/FFT/STANAG4529.HTML)  
Selcal Translator - [www.kloth.net/cgi-bin/selcall.pl](http://www.kloth.net/cgi-bin/selcall.pl)  
PETROBRAS - [www2.petrobras.com.br/Petrobras/Ingles](http://www2.petrobras.com.br/Petrobras/Ingles)

## Weeks of DST Confusion

Remember that SW schedules from the USA and Canada will be making one-UT-hour-earlier shifts March 11 with the new early start of Daylight Saving Time, while the rest of the world does not begin DST and the A-07 season until March 25. This could result in new frequency collisions.

## Latin America SW Radio Lists

Giampiero Bernardini, Italy, tells us: I made a Latin America SW frequency list, compiled starting from April 06, for me and my friends' personal use. Dario Monferini, *PlayDX*, helped me to update it. I got the idea from the original Mark Mohrmann site, [www.sover.net/~hackmohr/sw.htm](http://www.sover.net/~hackmohr/sw.htm) so far not completely updated. My list is just a simple compilation, it's a beta list, too. I hope Mohrmann will re-start again his great job! You can see my list on this blog: <http://lasw.blogspot.com>

## 2006 Clandestine Activity Survey by Mathias Kropf, via BC-DX

During 2006 the activity of political clandestine stations on SW increased by 5.4% to 1260 WBHs (Weekly Broadcasting Hours) according to the latest *Clandestine Activity Survey*, compiled annually since 1986.

Activity to the Asian continent has increased by 3% to 870 WBHs and to the African continent by the same percentage to 197 WBHs. On the American continent the increase was 19% now to 193 WBHs.

The three most active target areas worldwide are now China with 200 WBHs (+122 when compared with the previous year), Afghanistan with 196 WBHs (+6) and Cuba with 193 WBHs (+31). Activity to Iraq, which had been the most active target area each year since 1994, has dropped considerably.

The number of different target areas active worldwide has decreased by one to 24. While Syria and Pakistan are considered to be no longer active, Libya has been listed for the first time since 1990.

**AFGHANISTAN** 9345 USB, R. Sohl (Peace R), Bagram Air Base, fine signal at 1319 (Thomas Lindenthal, Germany, DSWCI DX Window) Any signal from this, we can only dream about over here. Or is this where the long-awaited new 100 kW transmitter supplied by India will first appear? (gh) R. Solh / R. Peace? At 1550 a station on 6700 with programs that sound exactly the same as earlier heard on 9345 from R. Solh. New frequency, additional or evening/night channel? (Jari Savolainen, Finland, *World of Radio*)

**ANDAMAN & NICOBAR ISLANDS** AIR Port Blair on 4764 at 0100, drifting downwards by 0117 to 4763, nominal 4760 (T. R. Rajeeesh, Kerala, HCDX) Also around 1500 on 4761.2 drifting slowly upwards (Jari Savolainen, Finland, *ibid.*) Helping to differentiate from the other AIR in Leh on 4760 (gh)

**BAHRAIN** R. Bahrain, 6010.1 in English with pop music, IDs, in the clear between 1900 and 1930 when Iran starts, reactivation? (Jari Savolainen, Finland, *DX Listening Digest*) Very good after China closes at 1900 (Maurits Van Driessche, Belgium, *ibid.*) Quite regular here starting with news headlines at 1900 (Mike Barraclough, England, *World DX Club Contact*)

**BELARUS** R. Belarus on new schedule including English 2100-2300, best on 7420 (Christer Brunström, Sweden, *World of Radio*) An hour later than before, but with DST probably will be one hour earlier (gh) Also on 7360, 7390 (DX Mix News, Bulgaria)

**BOLIVIA** Henrik Klemetz listened to my recording of 4695.1 and heard "Radio San Miguel, la voz del vicariato apostólico de Pando" (Björn Fransson, Sweden, DXLD) Tentatively this heard on 4694.54, at 1030-1040 (Chuck Bolland, FL, *ibid.*) E-mail at [radiosanmiguel\\_riberalta@yahoo.es](mailto:radiosanmiguel_riberalta@yahoo.es) or [radiosanmiguel\\_riberalta@hotmail.com](mailto:radiosanmiguel_riberalta@hotmail.com) (Alfredo Cañote, Perú, *ibid.*)

R. Logos, Santa Cruz, at 2250-2305 on 4865 with religious program in English until 2300, then Spanish; ID mentions only 6165. Probably changed to the inactive frequency of its sister station R. Centenario (Samuel Cássio Martins, Brasil, DXLD) Chuck Bolland, FL, was unable to detect it before 1100 on 6165. Could also be the unID heard by Carlos Gonçalves, Portugal, around the same hour in Low German, for Mennonites in Bolivia? (gh)

Parliament has approved transfer of land in Cobija to the Field Workers Union of Pando, upon which a SW station will function (ABI news agency via José Bueno, Spain, DXLD)

**BRAZIL** R. Globo, Rio, 11805 has distorted modulation at 1825 and puts out an even more distorted strong spur on 11995, covering 11975 to 12000 (Huelbe Garcia, Brasil, *radioescutas*) Also heard here until 1900 on 11990 (Giuseppe Cysneiros, *ibid.*)

**CONGO DR** 5066.38 at 0420, La Voix du Peuple, Bunia, Afro songs, talk in vernacular, ID in French at 0429, fair (Giampiero Bernardini, Italy, DXLD) 5066.38, R. Télé Candip - La Voix du Peuple, 1553-1620\*, orchestral music, very poor with CWQRM (Anker Petersen, Denmark, DSWCI DX Window) Reactivated after some months (gh)

**CUBA** Although R. Tapachula, Mexico, is listed on 6120, it is not (yet?) active. If you hear Spanish around 0358-0458\* it's R. Rebelde, // 5025 (Ron Howard, CA,

DXLD) Rebelde also heard on new 17555, under WYFR at 1700-1900 // 15570 and 11655, the latter under R. Nederland (Bernie O'Shea, Ont., *World of Radio*) At same time also on new 15370; Cuba has plenty of spare transmitters during the RHC break 15-20 (gh)

On occasions, RHC's 6060 transmitter stays on past 0700\* with the CMBF R. Musical Nacional network program *Teatro de la Ópera*, which starts at 0630; we were enjoying some great old recordings of Giuseppe di Stefano, such as *Celeste Aida* until cut off rudely at 0720. You never know when they will pull the plug (gh)

[non] After a few weeks on 9725, R. Marti shifted to 9825 in the 0000-0300 period. Heavy jamming accompanied 9825, but some remained on 9725 bothering Gene Scott via Costa Rica. It was not clear whether RM had permanently moved following a Cahuita complaint, or it was another floating frequency tactic to dilute jamming (gh)

**CYPRUS, TURKISH NORTHERN** 6150, Radio Bayrak International, heard from 0515 to 0545 in English; QRM from Austria after 0530, so helped to tune down to 6149 (Herbert Meixner, Austria, A-DX via BCDX) I was rather skeptical, but Bayrak International is alive and kicking and its programs are quite enjoyable, nostalgic soul and pop, IDs only mentioning FM, news headlines. Heard after 0500 on 6150.04 with QRM from Gene Scott, Costa Rica, slightly lower. But still tuned to lower side to avoid Austria splatter from 6155. Later heard Bayrak starting at 0300 (Andy Lavendel, Italy, *World of Radio*) CR blocks here; wait for that to be missing (gh)

**CZECH REPUBLIC** [non] Our contract with R. Prague has been extended indefinitely, so daily relays continue: Spanish 0530 and 1030 on 9955; English 1000 on 9955, 1500 to NAm 7385 (Jeff White, WRMI, DXLD) English programs run one day late now, such as *Insight Central Europe* on Sundays, *Mailbox* on Mondays. Times may shift March 11. Prague relays via Sackville expired Dec. 31. Eight QSL cards for 2007 are on the theme of Czech observation towers, mostly stone (gh)

**DOMINICAN REPUBLIC** From mid-December, 5009.8v was active, heard from around 1100 as late as 1210, at first unID (Alex Vranes, Jr., WV, DXLD) 5009.78, Radio Cristal canned ID in Spanish and English at 1129 (Chuck Bolland, FL, *ibid.*) Also R. Cristal, on same at 2235-2350+ with IDs at 2239 & 2305 (Brian Alexander, PA, *ibid.*) But then mostly heard with R. Pueblo IDs, the 15-10 AM station being relayed, such as 2151-2218 (Rafael Rodríguez R., Colombia, *playdx yg*)

**EGYPT** Arabic and English on 4680 at 0200-0330 is R. Cairo // 7270 (Rumen Pankov, Bulgaria, BC-DX) Also heard at 0215 with English news; it's 11950 minus 7270 = 4680 (Anker Petersen, Denmark, *@tividade DX*) Both for NAm, 11950 being in Arabic (gh)

**ETHIOPIA** [non] New target program appeared on TDP website [www.airtime.be/schedule.html](http://www.airtime.be/schedule.html) - Andenet Ledemocracy, 1700-1800, 7280 Tue/Thu/Sun, Amharic, [www.andenetledemocracy.org](http://www.andenetledemocracy.org) (Bernd Trutenau, Lithuania, DXLD)

**FINLAND** Various historical articles about YLE Radio Finland can be found at [www.ulkomaanmedia.net](http://www.ulkomaanmedia.net) maintained by Mr Juhani Niinisto, the longtime head of international radio at YLE. Not a YLE site and thus no YLE material or soundclips are used. The name in Finnish "ulkomaanmedia" means "media for

All times UTC; All frequencies kHz; \* before hr = sign on, \* after hr = sign off; // = parallel programming; + = continuing but not monitored; 2 x freq = 2nd harmonic; B-06=winter season; [non] = Broadcast to or for the listed country, but not necessarily originating there; u.o.s. = unless otherwise stated

(consumers) abroad" (Niinisto, DXLD) As planned, YLE stopped all SW broadcasting after Dec 31 (gh)

**GABON** The big buzz on Africa Numéro Un 9580 and harmonic 19160, and RTVG 4777, ceased as of Dec 22. Not only the buzz disappeared, also RTG on 4777 at 1600-1700 missing since the beginning of this year. I've the impression that Moyabi has only two fully working transmitters at the moment (Thorsten Hallmann, Germany, www.africalist.de.ms DXLD) Afropop music distraction on 17660v would go off at 1531, and then ANU would come up on 17630. For a couple weeks the harmonic was not heard at all, but then returned January 10 with clear audio heard as late as 2221, and around 1500 both 17630 and 17660v would be heard at the same time, so more transmitters in use (gh) see also LIBYA [non]

**GERMANY** [and non] From Jan 1, DW is no longer broadcast from Wertachtal, but the site remains on the air with other stations; two 100 kW transmitters from Jülich have been moved to Wertachtal for relays of Polish Radio. T-Systems continues transmitting various services via Jülich, expected to go dark sometime this year; selling it to CVC only saves it from complete demolition. It is simply impossible to run two big shortwave stations with altogether 28 transmitters without a general customer, by just selling airtime here and there. So Jülich has to go, thanks to DW's move to VTC (Kai Ludwig, Germany, DXLD)

From Jan. 1, Britain's VT Communications broadcasts Deutsche Welle, the first example of a state broadcaster outsourcing its output to a foreign contractor. VTC will initially broadcast 90 hours of programs in 14 languages to more than 100 countries in Europe, Asia, Africa and South America. That could increase to 150 hours from May 2007 when another contract with TSI ends (Guardian, via Mike Terry, DXLD) The latter refers to the Nauen site in Germany, originally contracted through 2016, but maybe expiring instead ten years after 1997 (Kai Ludwig, Germany, DXLD)

Since DW no longer broadcasts to North America on analog SW even in German, there is no need any more for technical monitors. Therefore, I have to inform you that my file of US-monitors will be closed as of January 1, 2007. Thus, I now have to thank you very, very much for sending in your reports regularly for over 20 years (Silke Broeker, DW monitoring director, to David Cole, OK, DXLD)

**GREECE** Since mid-December, VOG has a new music program presented in perfect English, UT Mondays at 0011 on 7475 (John Babbis, MD, DXLD) Same as on Sundays during the 1100 UT hour on 9420, 17525, Greek *In Style*, different female announcers from week to week. After a holiday break, the English hour from R. Filia resumed at 0700 on 15630 (Mike Barraclough, UK, *ibid.*) M-F only? 15630 is too high, skips over us, as does 17525 during what is now called *Saturday Hellenic Corner* at 1404-1500, also on 9420 (Wolfgang Büschel, Germany, *ibid.*)

**GUATEMALA** R. Coatán, 4780, remained audible past 1436 January 2, long after sunrise, sermon in Spanish; must have considerable power (gh, OK)

**HUNGARY** R. Budapest, English at 0200-0230 moved from 6110, colliding with Italy, to 5980, which mixes with Morocco. On UT Monday once (?) a month, such as Jan. 1, *And the Gatepost* still includes a DX program, but unfortunately the schedules given were months out of date, with summer timings, and other mistakes, worse than useless (gh) They even announced wrong time (local?) for their own broadcast (John Norfolk, DXLD)

**ICELAND** RUV, which was supposed to cease SW at yearend, still heard Jan 1 at 1215-1300 on 13865 (Friedrich Buettner, Germany, DSWCI DX Window) Also heard here, but not at 1755 on 12115 (Erik Koie, Denmark, DXLD) And heard from 1405 on 13864.98 (Mauno Ritola, Finland, *ibid.*) SW relays of newscasts to Eu and NAm were to continue until the inauguration of RUV's satellite service during the spring (Bernd Trutenau, Lithuania, *ibid.*)

**INDIA** AIR Guwahati, normally on 4940, heard on occasions on 4900 instead, such as 0005-0015+ but later the same date 1705-1715+ back on 4940 again (Mike Barraclough, UK, DXLD) May be due to careless operation of keypad entries. Mishandling of transmitters by technicians are normal incidents here! Not even checking with the digital receivers supplied to them (T. Ramachandran Rajeesh, Kerala, India, DSWCI DX Window) AIR Guwahati seems to be moving from 4940 to 4900 from day to day without rhyme or reason! Best on 4900 from 1148 as late as 1251, while on 4940 there is Chinese QRM after 1200. 4900 had very nice traditional Indian music (Alex Vranes, Jr., WV, *World of Radio*) Or 4900 could be a deliberate test (Rajeesh, dx india)

AIR Bhopal welcomes reception reports for 4810 as well as back reports for former frequency 3315, and replies with full data verie letter. Send to Mr. Sudhir Sodhia, Station Engineer, All India Radio Bhopal, Shamala Hills, Bhopal-462002, Madhya Pradesh, INDIA. E-mail to bhopal@air.org.in attn station Engineer. Fax +91 755 2661019. No return postage is required (T. R. Rajeesh, Kerala, dx india) Further, all verified reports are forwarded to Spectrum management division at New Delhi for an excellent AIR QSL Card (Rajeesh, HCDX)

**INDONESIA** Kang Guru Radio English program on 9680, RRI Jakarta, Wed and Sun 1000-1025, has been funded by AusAID through Dec 2007. Amount of co-channel from WYFR varies (Ron Howard, CA, DXLD)

RRI Nabire, 6125.29, was well heard in the 1230-1400\* period in late December but missing in early January (Steve Lare, MI, and Alex Vranes, WV, DXLD) Schedule of RRI-Nabire is confused with instability. I could receive 6125.3 and 7290 at the same time at 0800 Jan. 1, 6125.3 with local program and 7290 relaying Pro-tiga of Jakarta. On following days, 6125.3 which used to open around 0815, went off around 0800, while

7290 was heard from before 0700 past 1500 // 11860 (S. Hasegawa, NDXC, *World of Radio*)

**IRAN** [non] When 6225, R. International, and 6245, R. Zamaneh, are on air at the same time, 1730-1830, there always are strong mixing products on 6205 and 6265 (Jari Savolainen, Finland, DXLD) Both via Mykolaiv, Ukraine (Wolfgang Büschel, *ibid.*) 6225 sign-on varies from 1728 to 1733 (Anker Petersen, Denmark, DSWCI DX Window) Another spur from these heard on 6261 (Björn Fransson, Sweden, *ibid.*)

Radio Democracy Shorayee in Persian via TDP moved Dec. 28 from 7435 to 7470 at 1700-1800 Tue/Thu/Fri/Sun, to avoid WYFR relay in Russian (DX Mix News, Bulgaria)

**ISRAEL** After using 6280 for 2.5 months, Israel Radio should go back March 1 to 9345 for English at 0430 // 7545 17600; and 2000 // 7545 and 15640 (gh)

Radio Galei Zahal now broadcasts on two frequencies simultaneously, 6973 \ 15785 observed different dates at 1200-1430, 0600-1100, 1500-1800 and 0600-1400 (Rumen Pankov, Bulgaria, BC-DX)

**ITALY** Rai continued on SW into January of 2007 at least (gh)

**LATVIA** *Latvia Today* in English, announced as a weekly program produced by Radio SWH, heard on Sunday at 1300-1400 on 9290, mixture of music and features, also Saturdays 0800-0900. Website with some English pages www.radioswh.lv/swh/page.php?id=131 (Mike Barraclough, UK, DXLD) Sounded like an official foreign-language service as they had interviews with the Latvian President and minister of Culture (that) a private station would surely not get (Axel Röse, Germany, BDXC-UK Communication) Why not? Seems Pres has a show on their main FM station (gh)

**LIBYA** [non] Sawt al-Amal can be heard via www.libya-nclco.org/ (José Miguel Romero, Spain, DXLD) = National Conference of the Libyan Opposition; 5622G Ox Rd, PMB 26, Fairfax Station, VA 22039, USA (gh) E-mail announced is info@libyradio.net which has been the address for Advanced TV & Satellite Ltd., a company involved in Al Amal broadcasts (Jari Savolainen, Finland, DXLD)

A report in French dated 13 June 2006 from Gabonews says that Gabon and Libya had signed an agreement for Libya to help "rehabilitate" the equipment, including SW transmitters of Africa No. Un (via Bernd Trutenau, DXLD) This may cast some light on the appearance of the "Afropop" station vs Sawt Al-Amal (Trutenau) Aid with an ulterior motive, to help jam the Libyan clandestine in the 17.6-17.7 MHz area (gh)

I was already wondering what will happen with the plant when NHK transmissions are gone, even expecting a possible shut-down of the site since RFI already left it, while for ANO, shortwave doesn't appear to be a high priority. I wouldn't be surprised if it was TDF who tipped the Libyans on the Moyabi plant ("we know something you could use, too"). (Kai Ludwig, Germany, DXLD)

**MEXICO** UNID on 6045 at 0849-0905, continuous EZL orchestral, piano, flute music; might be R. Universidad de San Luis Potosí with an extended schedule? (Jim Ronda, OK, NASWA *Flashsheet*) I monitored this several nights from 0600 mixing with Korea via Canada, and clear from 0630 until Chile opens 6050 at 0659; played exactly same guitar music at same time on different nights. Frequency wobbles slightly, just as XEXQ has done in the past. Occasional Spanish announcements but hard to catch a clear ID. Apparently testing much extended schedule; also barely audible as late as 1530 (gh)

XEYU, R. Universidad Nacional, tested 9599.4 a few more days before Xmas, then gone again until mid-Jan, when also heard at 0630 with classical music. XEPPM, 6185, R. Educación made another surprise appearance in the daytime Jan 15 around 1530 with arts discussion (gh, OK) See also CUBA

**MONGOLIA** Unfortunately, VOM's English broadcast on 12015 at 1500 is blocked not only by Pyongyang but now WYFR relayed via UAE (gh) Now Voice of Mongolia has thrown in the towel: Densmaa Zorigt, Mail Editor, informs me: "Starting from January 1, 2007, we'll cut 12015 because it couldn't reach our listeners. We are trying to transmit program on the Internet in the first half of 2007."

This means the 1500-1530 and 2000-2030 transmissions have been discontinued, whereas 1000-1030 English on 12085 remains unchanged. It's a pity she didn't ask for assistance from experienced DXers in the choice of usable frequencies (Ullmar Qvick, Sweden, *World of Radio*) Surely a clear frequency could be found for these broadcasts. The DX community would be glad to help (gh)

Yes, still heard in English at 1000 on 12085, G to VG signal here in Uruguay (Moisés Knochen, DXLD) Weak but audible here in the summer (Eduardo Esteban Peñailillo Barra, Chile, *ibid.*)

**NETHERLANDS** Radio Netherlands Worldwide English Service will be rolling out new programs in 2007. Some existing programs have come to the end of their run, or will soon. In our Web feature *A Fond Farewell*, marking 10 years and over 600 editions of *A Good Life*, the English Department explains what's being planned, and why. www.radionetherlands.nl/radio-programmes/agoodlife/agl070104

Network Europe joins RNW's English language schedules every Friday, replacing *A Good Life*; a fresh perspective on events and life in Europe. On Sunday, *Dutch Extra* is replaced by our new listener contact program *Echoes*; and featuring every week, *A Critical Eye* - commentary from Perro de Jong (*Media Network* newsletter) We can already hear *Network Europe* on several other stations, so we have a net loss of programming choices. With ten stations involved, each only has to produce three minutes a week on average (gh)

**NICARAGUA** On 2139.9 kHz, 2 x 1070 harmonic, R. Chontaleña at

1155-1200, lively Latin American music, 1157 Clear ID, ad, more music, moderate signal, SINPO 34333. My first log of Nicaragua since 2002 (Jim Evans, TN, NASWA Flashsheet) Not listed in WRTM but a Google search finds references to a Radio Chontaleña, in Chontales on the AM band, but no frequency mentioned (gh)

**PERU** On 6536.3, R. La Voz del Rondero, Huancabamba, at 0154-0210, Huaynos, ID, "la radio grande en el norte del Perú" (Rafael Rodríguez R., Colombia, playdx yg) New name, ex-R. Huancabamba (gh) Also heard on 6535.97, 0145-0203\* Peruvian folk music, many mentions of Huancabamba, 0203 ID and off. Fair but some occasional ute QRM (Brian Alexander, PA, DXLD)

**POLAND** [and non] During the *Multimedia Show* of January 2, the presenter Slawek announced that R. Polonia is to be known as of January 1st as The External Service of Polish Radio, following the decision by the Polish Radio Company Board. This is a return to the old name of the station and it is unclear whether this change is permanent or a step towards a different name, Radio Warsaw being implied. The reasons behind such a change in name were not given (Jonathan Murphy, Ireland, World DX Club Contact via Mike Barraclough) The name Radio Polonia had already been used in the era until 1989 (Kai Ludwig, DXLD)

The name change from "Radio Polonia" to "External Service of Polish Radio" was made in order to avoid the misunderstanding that the transmissions for abroad are conducted by a separate station (something which DXers often misunderstand). They are, however, like home service programs, produced by the national public broadcaster Polskie Radio (= "Polish Radio"). (Bernd Trutenau, Lithuania, *ibid.*) This was also discussed on the *In Touch* program: "Polonia" refers to the diaspora, but the station is not just for them, but in several languages, hence the change. There is also a TV Polonia which is only in Polish (via Erik Koie, DXLD)

Certainly a move in the right direction, contrary to a number of other SW services which manage to survive, for a while anyway, like Finland's, only by catering to their diaspora. But P.R.E.S. is just too cumbersome. Why not go for a name totally new: Voice of Poland International? (gh)

On certain days when Indonesia is weak or missing from 9525, PRES in English via Wertachtal, Germany [q.v.] audible between 1300 and 1400 (Ron Howard, CA, DXLD)

**RUSSIA** Voice of Russia unveiled its new official site: www.ruvr.ru It is unclear what the abbreviation RUVR stands for. The old site www.vor.ru is still operational. However, it is safe to assume that the old address will eventually disappear, due to its unpleasant sound to a Russian ear. In most Slavic languages, the word "vor" means "thief" (Sergei Sosiedkin, IL, DXLD) Ha! Nice logo, whatever it means (gh)

**SLOVAKIA** It was uncertain whether R. Slovakia International would continue on SW into 2007, but it did, including English at 0100-0130 on 7230, 9440 as monitored by John Figliozzi, Roberto Scaglione,, Raúl Saavedra, José Miguel Romero, Kraig Krist for DXLD (gh)

**SOMALIA** [non] 7175, V. of the Somali People, via Asmara, Eritrea, 1730-1800\*, on a Sat; this followed V. of the Broad Masses of Eritrea, at 1645-1730 with no transmitter break (Anker Petersen, Denmark, DSWCI DX Window)

**SUDAN** In mid-February 2007 a new religious station will be installed in Ezo, southern Sudan, 250 Watts. Frequency is 6.00 MHz so possibly means 6000 kHz. No further details available (Jari Savolainen, Finland, DXLD)

[non] Ran across Sudan Radio Service on 9660, two Wednesdays in a row in English until 1500. SRS' own website www.sudanradio.org had not been updated since A-06, but this is in HFCC B-06 as 1400-1500, Moldova at 175 degrees with 300 kW to zone 48, which is actually only the eastern half of Sudan. Last month we had 9565 in use Wednesdays only at 1400-1500, so 9660 is a change from that (gh)

**TURKEY** One of the 250 kW units at Çakirlar is in faulty shape, and should be on corrective maintenance totally soon. 15350 with distorted spurious splatter spectrum on 15313 to 15377 channels. At 1410 another day, buzz from this at 15293-15328 and 15383-15397 (Wolfgang Büschel, Germany, BC-DX)

**TURKMENISTAN** Asqabat with English news at 1500-1507 on 5015 and 1630-1637 (new time) on 4930 (Rumen Pankov, Bulgaria, BC-DX)

[non] From Jan 1 a new signal on 7425 from 1800 to 1957, mentions Turkmenistan (José Miguel Romero, Spain, *World of Radio*) It's the RFE/RL Turkmen service, probably via Kuwait, extended beyond previous 1800\* on other frequencies, though not shown on their schedule. Already had programming to 2000 via satellite; Turkmen language website was removed "for strategic reasons" but streaming still available (gh) Stream matches what I hear on 7425 (Romero, DXLD)

**UGANDA** A new religious station "Dunamis Shortwave" was to start broadcasting 1 Jan 2007 on 4750. Located near Kampala, and using a 1 kW Crown transmitter with wire NVIS antenna, initially 15-17 English, 17-19 Luganda, Swahili, expanding later to 9 hours a day. It seems they forgot the Sudanese station on 4750 (Jari Savolainen, Finland, DXLD) Bible Voice website talks about these plans; Dunamis means dynamite in Greek. Already had FM station, and as implied by the Crown and NVIS setup, HCJB assisted. Still no reports of it by mid-Jan (gh)

**U K** BBCWS had reduced its Spanish broadcasts on SW to only one hour on two frequencies at 0300, but in mid-December unexpectedly added a

2.5 hour morning broadcast with little publicity, probably for the benefit of Cubans. José Bueno, Spain, found a webpage about it, with confusing frequency info. Following some changes, it appeared to be: via Guiana French, 10-11 9790, 11-1230 13760; via WHRI, 10-11 5835; via Greenville, 10-1230 6140 (gh)

**USA** On November 14, in a move indicative of President Bush's intention to continue to surround himself with political cronies with questionable ethics records, Kenneth Tomlinson was re-nominated by the president as chairman of the Broadcasting Board of Governors (Bill Berkowitz, *Dissident Voice* via kimandrewelliott.com) Tomlinson has asked Pres. Bush not to put his name in nomination for another term. He plans to remain in office until his successor is confirmed. In a letter to Bush dated January 9, Tomlinson said he is proud of his record of service and "appreciated deeply your repeatedly submitting my name to the Senate Foreign Relations Committee for reconfirmation to this position. However, I have concluded that it would be far more constructive to write a book about my experiences rather than to seek to continue government service." (BBG Press Release) His pending nomination was already stalled in the Senate and was unlikely to fare any better now that Democrats control the chamber (AP via Mike Cooper)

VOA is on one USA transmitter at 21-22 for the Music Mix shows, putting an excellent signal into CNAM though 15580 is aimed eastward from Greenville (gh) Mon *American Gold*; Tue *Roots & Branches* (eclectic); Wed *Classic Rock*; Thu *Top 20 Countdown*; Fri & Sat *Hip Hop Connexion*; Sun *Fusion* (world music) (via Rich Cuff, *swprograms*)

**WORLD OF RADIO** on WRMI: Sat 1330 7385, 2230 9955, Sun 0900 9955. WRMI dropped WRN relays in January, and added many more DX and feature program repeats between 13 and 16 M-F on 7385, including:

**WORLD OF RADIO**, Thu 1430, Mon 1330; *Mundo Radial*, Wed 1300; *Wavescan*, Mon 1300, Fri 1530. *DX Partyline & Aventura Diexista*, Mon 1400, Tue 1330, Wed 1530, Thu 1300, Fri 1430; *Viva Miami*, Mon 1430, Tue 1300, Wed 1400, Thu 1530, Fri 1400; *La Rosa de Tokio*, Tue 1400; *Monitor DX*, Wed 1315, Fri 1330; *Global Crisis Watch*, Fri 1300. However these filler-times are subject to immediate sale without notice. And times should shift one UT hour earlier for DST with its earlier start March 11, but by then there may be further jumbling (gh)

**WORLD OF RADIO** on WWCRC 12160 moved from Sat 1700 to 1730. DST changes early as of March 11 should make WOR appear: Fri 2030 on 15825; Sat 1630 on 12160; Sun 0230 on 5070, 0630 on 3215. On WBCQ: Wed 2200 on 7415, 2300 on 18910-CLSB, Mon 0300 on 9330-CLSB, 0415 on 7415 (gh)

KAIJ's new website: www.kaij.us Not too much there, but there is a live streaming link, pix of transmitter, antenna, and mentions some staff members we recognize as formerly with WWCRC (gh)

**VENEZUELA** A note on the Radio Nacional de Venezuela website says land has been acquired for the construction of a new SW broadcast center to guarantee the transmission of the Bolivarian message to the entire American continent (via Horacio Nigro, Uruguay, *condig* list) Already doing so via Cuban transmitters

UnID on 5125 at 0012 in Spanish with techno music (Rudolf Grimm, Brasil, *World of Radio*) Distorted blob centered around roughly 5118.6, at 1027-1037 with talks and ads, mentions of "bolivariana" and "Amazonas," so might be the R. Amazonas, Venezuela. Later at 2335 UT centered around 5127, even more distorted (Alex Vranes, WV, DXLD) R. Amazonas heard at 2054 on 5125, far off its nominal 4940 (José Elias Díaz Gómez, Venezuela, *ibid.*) Also 5125v at 0317, poor and distorted (Wade Smith, NB, *ibid.*)

From Dec 22 at 0500, YVTO time signals heard again on 5000, and spur on 5100 (José Elias Díaz Gómez, Venezuela, DXLD) Also at 0615 on 5100, 5000 and matching spur 4900 (Alex Vranes, WV, *ibid.*) As late as 0835 on 5000 and 5100 (Manuel Méndez, Spain, *ibid.*) 4900, weak at 1000-1130+ (Chuck Bolland, FL, *ibid.*) All three heard almost every night around 0235 (Vranes, WV, *ibid.*)

**WESTERN SAHARA** [non] Radio Nacional de la República Árabe Saharaui Democrática, after it moved to 6215, kept on moving, to 6208, then when Iran appeared on 6205, shifted to 6210; then back up to previous 7460, which was convenient for the Spanish hour at 23 since WWCRC was taking a break from 7465; but from early January it went to 6458 and stuck there for at least a fortnight despite almost constant utility interference (numerous reports summarized by gh)

**ZANZIBAR** Voice of Tanzania. Exceptionally good signal on 11735 after 1700 and continues with increasing strength to sign off with national anthem at 2100. News in English (usually heavily accented) at 1800, for 10 minutes, from Spice FM. The last hour usually has lots of local music, at times coming in like a local station (Bernie O'Shea, Ont, DXLD)

**ZIMBABWE** [non] R. Voice of the People, 11695 via Madagascar, \*1700-1753\*, sign-on with multi-lingual IDs, programming in English and vernacular. Many IDs with mentions of frequency, address and e-mail address. Brief breaks of local music. 1749 closing multi-lingual IDs, followed by local music. Fair strength but English difficult to understand due to accents (Brian Alexander, PA, DXLD)

*Until the Next, Best of DX and 73 de Glenn!*

# BROADCAST LOGS

NOTEWORTHY LOGS FROM OUR READERS

Gayle Van Horn, W4GVH

gaylevanhorn@monitoringtimes.com

http://mt-shortwave.blogspot.com

## 0003 UTC on 4750

BANGLADESH: Bangla Betar. Vernacular into Koran recitations. Announcements to possible anthem. Asian music with SINPO 24332. (Arnaldo Slaen, Buenos Aires, Argentina)

## 0020 UTC on 3310

BOLIVIA: Radio Mosoj Chaski. Quechua text by female announcer for SINPO 24432. Bolivians monitored: **Radio Virgen de Remedios** 4545.28, 2320+; **Radio Yura** (Aymara service) 4716.71, 2325+. **Radio Mallku** 4796.4, 2329+; **Radio San Jose** 5580.28, 2345-2349. (Slaen, ARG)

## 0021 UTC on 5060

CHINA: Xinjiang PBS, Urumqui. Vernacular text by announcer, SINPO 24332. (Slaen, ARG) **China Radio Int'l** 7130, 0133 *Cultural Regions in China*. (Stewart MacKenzie, WDX6AA, Huntington Beach, CA) **CRI** 6125, 2115. (Harold Frodge, Midland, MI)

## 0113 UTC on 5915

ZAMBIA: Radio Zambia/ZBC Radio One. DJ's regional programming of African hi-life music and multiple IDs as "Radio Zambia - Radio One." Fair signal quality during phone number quote for listeners call-in. (Ron Howard, Monterey, CA)

## 0125 UTC on 15325

JAPAN: Radio Japan/NHK. Pop music vocals to male/female duo and Japanese comments at 0134. Station ID to *Pop Joins the World* music program // 17845, 17810, 17825, 17560; 17685 at 0139 with interviews; 17810 at 0002. (MacKenzie, CA)

## 0438 UTC on 6000

CUBA: Radio Havana. Discussion on Cuba's bid to host the Olympics, followed by an impassioned discussion of keeping baseball as an Olympic sport. Good signal. 9660, 2329 (Joe Wood, Greenback, TN) **Radio Nacional Venezuela via Cuba** 11705 Spanish at 1248. (Bob Fraser, Belfast, ME)

## 0440 UTC on 7350

VATICAN CITY STATE: Voice of Russia relay. Male solo opera aria followed by choir music program. (MacKenzie, CA) 9645, 0734-0747 Item on Rwandan criminals and talk on relations between Belarus and Russia. (Wood, TN)

## 0618 UTC on 6185

MEXICO: Radio Educacion. Nicely done music program of big band Bossa Nova tunes and announcer's Spanish segments. Audible on recheck 0748-0804. (Wood, TN)

## 0736 UTC on 9525

ASCENSION ISLANDS: Star Radio, Liberia. Listener's phone greetings in English and local languages on *Star Contact* program, followed by phone number and "Star Radio Liberia" identification. (Kraig Krist, Manassas, VA)

## 0934 UTC on 5960

RUSSIA: Radio Tikhoy Okean (Radio Station Pacific Ocean). Radio Rossi program relay with Russian folk songs to ID "Radio Rossi" at 1000.\* // 7330 poor signal. (Howard, CA) 0940 ID "Radiostancia Tikhoy Okean"; audible 0335-0340 with ID and pop music. (Slaen, ARG) **Voice of Russia** 12030, 0405 // 9840. (MacKenzie, CA)

## 1300 UTC on 9525

GERMANY: Polish Radio via Wertachtal. Station ID to news headlines and features. (Krist, VA) 13820, 1203-1215 Russian news bulletin // 15520. (Slaen, ARG)

## 1300 UTC on 15105

ROMANIA: Radio Romania Int'l. SIO 353 to 1342 until BBC sign-on dominated frequency. // 17745 SIO 353 "This is Radio Romania International" into *Radio Newsreel* and *A Challenge for the Future*. Additional features, *City of Culture 2007* and *Practical Guide, Over Coffee with Artists* and *Listener's Letterbox* to 1355\*. (Krist, VA)

## 1317 UTC on 6125.29

INDONESIA: RRI-Nabire. Indonesian. Tuned in at close of Jakarta news relay at 1317, followed by two music tunes. Drum interval signal at 1329, presentation of lokal berita (local news) to three minute version of *Love Ambon* and voice-over announcement at 1400. Service close down at 1402 observed with S-9 + 10 dB peak. Audible two days later 1344-1354\*; **RRI-Manado** 3215.09, 1318-1355\* (John Wilkins, Wheat Ridge, CO)

## 1400 UTC on 15140

OMAN: Radio Sultanate of Oman. Ten-minute newscast with focus on Middle East, followed by 50 minutes of western style pop music program. Arabic programming at 1500. (Fraser, ME) Subsequent logging 1500 on 15140; 1800-1825 on 15355. (Duane Hadley, Bristol, TN)

## 1447 UTC on 7165.12

ETHIOPIA: Radio Ethiopia. Non-stop regional music to 1459, brief announcement and musical bridge. Arabic text presumably Clandestine-**Voice of Democratic Alliance**- amid fading signal // 9560.07 which was fair. (Wilkins, CO) 7110, 1942-2000\* // 9704 poor. (Scott Barbour, Dxpediton, NH)

## 1500 UTC on 9570

PHILIPPINES: Radio Blagovest via Palauig. Radio Veritas Asia ID at 1458 to invitation to "stay tuned for Russian broadcast." Bells signal at 1500 to "Blagovest" ID and Russian religious programming. Transmission break 1507-1515 and return with good signal. (Wilkins, CO) **VOA** Philippine relay via Tinang 7120 at 2235. (Hadley, TN) 15290, 2340 with news of protest on global economy to *VOA News* and *My Old Kentucky Home* music tune // 15150. (MacKenzie, CA)

## 1855 UTC on 12095

SOUTH AFRICA: BBC WS relay. Interview segment on the Book-stop program to 1859 closedown noted without identification or sign-off. (MacKenzie, CA)

## 1910 UTC on 15120

NIGERIA: Voice of Nigeria via Ikorodu. News and political program. Station ID at 1915 amid good signal though fading. Observed most afternoons at this time with good signal. (Jim Evans, Germantown, TN)

## 1940 UTC on 7345

CZECH REP: Radio Prague. Fair signal for report on cancer. News on *Mozart Music Festival* in Prague 5930 // 7345 at 2345. (Fraser, ME) 5930, \*0656-0702 interval signal to French ID, website address and pop music program. (Wood, TN)

## 2119 UTC on 9515

BRAZIL: Novas de Paz. Portuguese. Talking about palabras followed by pop music tune and station identification with freq quote. SINPO 13432. Brazilian's audible: **CBN Arhangueira** 11830, 2048 with ad on "telecom superotechnology, Laboratorio-Floranapolis" Station ID "Archangueira...kilohertz, ondas tropica." ID repeat, SINPO 25333; **Cancao Nova** 9675, 2050; **Radio Bandeirantes** 11925, 2057. (Zacharias Liangas, Thessaloniki, Greece) **Radio Nossa Voz** 4975, 2355-0005 (Slaen, ARG) **Radio Nacional da Amazonia** 11780, 2057-2106+. (Frodge, MI) **Radio Capixaba** 4935, 2314+ (Slaen, ARG) **Radio Clube do Para** 4885, 0531-0552. **Radio Brazil Central** 4985, 0618-0631. (Wood, TN)

## 2236 UTC on 3396

ZIMBABWE: Radio Zimbabwe. Vernacular service with music variety of Afro pops, rap and reggae to presumed brief commercial or promo. Tentative mention of Zimbabwe at 2300 to brief comment into hi-life music. Poor signal at tune-in with strong buzz interference. Steadily improving to SIO 322+, best to monitor in LSB. Nothing detectable in 3306 or 6612 kHz. (Frodge, MI/MARE Tip Sheet) Tentative 3396, 0243-0401 including African drums, frequencies quote, high-life music and choral anthem at 0354. Several mentions of Zimbabwe, but no positive ID. (Howard, CA)

## 2350 UTC on 11970

CANADA: China Radio Int'l relay. Segment on buying shoes in China, followed by announcer's comments from radio listeners. (MacKenzie, CA)

Thanks to our contributors – Have you sent in YOUR logs?  
Send to Gayle Van Horn, c/o Monitoring Times  
English broadcast unless otherwise noted.

## Unforgettable Radio

**A**lmost 30 years ago, I discovered a tiny little pizzeria. To this day, I can still see and almost taste the best food this correspondent has ever enjoyed. Pizza to die for. Meatball subs with a special sauce that had just a bit of a kick to it. And of course, I remember the hours spent with friends and many good times consuming that food.

Twenty-five years ago this little slice of heaven (pun intended) disappeared, as suddenly as it opened. I tried to find out where they went, but I never did learn what became of the company.

Radio programs are like that. Some day you discover one that provides you with so much enjoyment that you just have to listen. And you end up spending hours with these people, who may never know you, but nonetheless become good friends. Sometimes these friends disappear and very occasionally they reappear. But they are not forgotten.

This month I'd like to talk about a few of these friends and some new ones I've met along the way. I'd also like to take this opportunity to invite you to share your thoughts regarding what one can hear, via radio, via internet, via satellite or whatever platform you choose to use.

Back in the early eighties, the one show ... a program block really ... that I enjoyed the most of any I have heard in almost 30 years, was *Radio Earth*.

Heard via WRNO, it had such a great variety of programming and hosts. Hosted by Jeff White (currently of WRMI fame), it introduced me to a number of broadcasters that have given me so many hours of entertainment, that I consider them "old friends."

I've always enjoyed Jeff White's style of presentation. He clearly loves the shortwave medium, and has presented so many interesting features. Then there was the delightful Rudy Espinal. And a youngish Kim Elliott was involved with a program within the block, called *Shortwave Pandemonium*. I wonder what ever happened to Kim? (Okay, we all know ... but just in case you don't, check out: [www.kimandrewelliott.com/](http://www.kimandrewelliott.com/))

These folks made shortwave not only fun, but entertaining and memorable even 25 years later.

### Memorable Presenters

The key to a great program is often the presenter.

Looking back, I have been privileged to hear people like Joe Adamov of Radio Moscow/Voice of Russia. For years, Joe was an apologist



Joe Adamov (photo by Harry Baughn)



for the Soviet Union, but you could say he later apologized for that. Joe was such a friendly, gregarious chap. That was part of his charm. Like a fondly remembered uncle, many times you rolled your eyes at his corny jokes, but now that he's gone, wouldn't it be fun to hear just a few more?

And then my thoughts turn to another grand gentleman of shortwave broadcasting – Tom Meijer, longtime host of Radio Netherlands "Happy Station" program. Tom's show was a great way to wind up the weekend. Nice music, friendly conversation and a program that really connected you to the station. The show has been off the air for years, yet a group of fans still get together on the Happy Station Yahoo Group to exchange memories of Tom, Rosemary, "Birthday Bad-Luckers," and all aspects of this remarkable show. <http://groups.yahoo.com/group/thehappystation/>

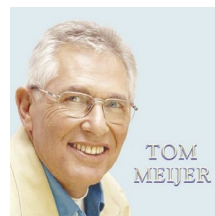

TOM MEIJER

Now *there* was a show that connected to its listeners, like few others. And seemingly still is

connecting people together, in a small way, all these many years later.

### Today's Classics

Now, let's fast forward to the 21<sup>st</sup> Century ... the era of the information highway. There are still very many shows and personalities to get jazzed about. Too often in the hobby, we see the glass half empty. Yes, shortwave stations are leaving us with appalling regularity, and sadly, with them go many hours of programming and the familiar voices that go with them.

But there are still many great programs to hear, not to mention newer platforms to deliver them. Here are a few I like.

### Channel Africa – "The Voice of the African Renaissance"

*Africa Rise and Shine* is a fast paced, informative program about African affairs. A typical edition might discuss rebel soldiers in Uganda, South African participation in peace keeping missions and the upcoming soccer World Cup in Johannesburg in 2010. The program is available via shortwave (although like many radio station websites, the policy seems to be "if we tell you when you can hear it, we'd have to kill you").

In Eastern North America, try late night Channel Africa transmissions. It can also be heard via the World Radio Network on demand, and via the Canadian Broadcasting Corporation's overnight Radio One schedule at 3.05 am local time. [www.cbc.ca/overnight](http://www.cbc.ca/overnight)

### Cool – Deutsche Welle

"With 30 jam-packed minutes of fun, info and what's hot in the music scene, *COOL* brings you the latest in youth culture from Germany and across Europe. How do young people feel in Berlin, Barcelona or Helsinki? What's so special about roof jumping, body art or poetry slams? Or how about hooking up with the latest music trends? *COOL* is broadcast every Thursday, Friday and Saturday or you can listen to it on the Internet.

"In case you thought youth shows were mindless monotony, think again! *COOL* pushes back the envelope on hot issues around the world. How are young people coping with HIV/AIDS? Should drugs be legalized? What's it like to study in the middle of a war zone? How are young activists trying to save the planet?

"...Plus you can win T-shirts, CDs and other great prizes in the *COOL QUIZ*. Just tune in to half an hour of mind stimulation, fun, info and music." (Deutsche Welle website)

I find the presenters of this program to be

both personable and professional. Youth oriented programs can be condescending at times...I don't find that attitude at all with this program. And as someone who is not terribly youthful any more, I still feel comfortable listening.

*Cool* can be heard on shortwave in some Thursday transmissions beamed to West Africa and on demand at the DW website.

### On Screen – BBC World Service

Wednesdays 09:30

"A lively look at what's new and interesting in film and television around the world, with reports and reviews, interviews with stars and film and TV-makers, and comment from viewers."

Nicola Christie is the host. While I have a passing interest in film, I find she does some great interviews that bring film and the film-making process to life to the casual viewer.

The show can be heard on World Service and on demand at the BBC WS website.

### New Friends via the Internet

Finally, three "friends" I would currently highly recommend via the internet.

Mark LaMarr of the BBC is perhaps one of the most entertaining music presenters on the BBC. He hosts a number of shows on BBC Radio 2, on such diverse topics as fifties rockabilly on *Shake Rattle and Roll*, obscure and alternative tunes on his *Alternative Sixties* show, and the world of Reggae and Ska on his *Reggae* show. I don't even really care for Reggae, but will listen to a show hosted by Mark any time. He has a high energy presentation style and a keen sense of humor from his days as a stand-up comic. More details about his shows at: [www.bbc.co.uk/radio2/shows/lamarr/](http://www.bbc.co.uk/radio2/shows/lamarr/)



Michael Godin hosts *Treasure Island Oldies*, a weekly netcast on Sunday nights, 0200-0600 UTC. The show has been on shortwave in the past. Michael started in radio in Montreal. While working at his high school radio station in Montreal, the teenaged "Mike Godin" managed to phone through to John Lennon's suite during the famous "Bed-In for Peace" and Lennon graciously gave him a few minutes of his time. Later, he had a second career in the music industry with A & M Records. There he signed a young Vancouver singer, Bryan Adams. *Treasure Island Oldies* is dedicated to digging up the lost treasures of the 50s, 60s and 70s...often some of the more obscure tunes, as well as forgotten favorites. You can listen to Michael's program online at [www.treasureislandoldies.com](http://www.treasureislandoldies.com)

Finally, may I recommend David Marsden and the Marsbar Theater, heard from 0000-0500 UTC Thursday and Friday nights via 94.9 The Rock ([www.therock.fm/](http://www.therock.fm/))

David Marsden has had a remarkable career in radio, and is a member of the broadcast wing of the Rock and Roll Hall of Fame. As Dave Mickie, he was known as a fast talking DJ, the most controversial thing on Toronto radio. He later morphed into David Marsden and has been influential in giving alternative music acts

and new music their first airplay.

Sometimes, David's music is not necessarily my cup of tea, but what these three men bring to the table is both an encyclopedic knowledge of the music they play and a highly entertaining presentation style.

### ☒ The Golden Age Comes Alive

The golden age of radio was a topic which popped up briefly in this column a few months back. Since that column was written, CHWO AM 740 has joined the growing number of stations carrying the old time radio shows like *The Lone Ranger*, *Burns and Allan* and many more. Currently they are on two nights a week Monday and Tuesday from 11-12pm Eastern. [www.am740.ca](http://www.am740.ca)

During the first episode on AM 740, I put the radio on for my ailing mother. She's a bit hard of hearing now, but I got the volume set high and she thoroughly enjoyed these old gems. This led to a chat about her listening habits back in the 1930s.

She and her mother would listen to a drama, apparently quite scary (sadly, she couldn't remember the name). The reason they listened together (according to my mother) was that they were too frightened to listen to it alone. One day, they were listening to this program. Unbeknownst to them, my uncle, then himself a teenager, snuck downstairs, and at a particularly appropriate point in the drama let out a blood curdling scream. Needless to say, my mother and grandmother had to be scraped off the ceiling. For my mother this was her "Marco's Pizza."

I also received this interesting email from Cincinnati:

"Your article on old radio programs was passed along to me by Mike Farrar at our station, WMKV in Cincinnati, Ohio. We've been carrying classic radio programs here since July of this year after they had a successful run on another public radio station in the area and were basically dropped when the station was sold. You can check out our broadcast schedule and listen at [wmkvfm.org](http://wmkvfm.org). Our streaming is in the process of getting an upgrade, so we've had a few glitches here and there, but we have thousands of listeners every month from around the world who comment on our music (big bands/standards/jazz) and nostalgia (classic radio comedies and dramas/many of Cincinnati's long-time broadcast legends such as Stan Matlock, Don Herman, Bob Trumpy, Annie Wagner, and more). It's a true treasure trove for those seeking nostalgia, but the really wonderful byproduct is that we're hearing regularly from folks from their teens into their thirties who are listening, especially for the classic radio shows! Families are really gathering around the radio again evenings for *Mystery Playhouse*, and kids are hearing these stories for the very first time!

"WMKV has an agreement with a marvelous organization in the Cincinnati area by the name of Media Heritage, a non-profit organization which is dedicated to preserving historic broadcasts and preserving memories through interviews and archiving old radio and televi-

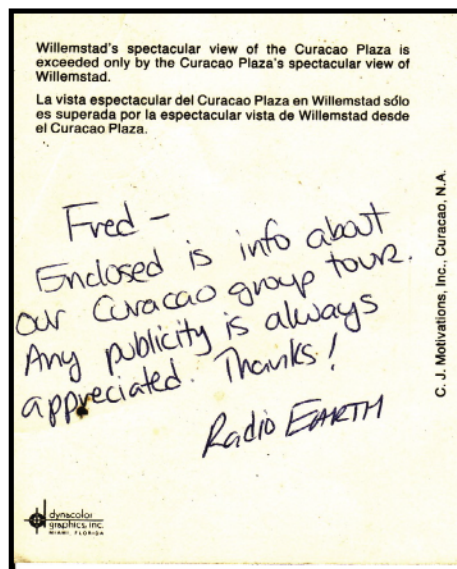

sion programs. In fairness and in full disclosure, I've served as a board member for them in the past, so I'm rather biased, but Mike Martini and Mark Magistrelli have been the real stalwarts in helping to preserve much of broadcast history through the organization. They have the complete Fred Ziv library and they produce a number of shows for us including *Theater of the Mind* which we run at 11am each weekday, *Hollywood Radio Theater* which runs at noon weekdays, and *Mystery Playhouse* weeknights at 7pm. On Saturday night, they bring us *The Big Broadcast* from 7-11pm with four hours of classic radio comedies, dramas, and variety shows. We're proud to be one of the last bastions of this programming, and I know Media Heritage is trying to get other stations interested in the Golden Age of Radio.

"From WMKV's perspective, this is a wonderful addition to our programming. If you have any questions on our programming, please contact me. We hope many folks can reach us via the internet at [wmkvfm.org](http://wmkvfm.org).

"Thanks for writing about something that has been too fast fading from the radio landscape, but is so valuable to many, many listeners, both old and young!"

George Zahn, Station Director  
WMKV-FM/LifeSphere

There is nothing like *Theater of the Mind*... where the story unfolds within the confines of your own imagination. Done well, it is riveting stuff.

Finally, a small correction: Lionel Barrymore played Scrooge on radio, not John, as I inadvertently said in December.

### Daniel Sampson's PRIME TIME SHORTWAVE

<http://www.primetimeshortwave.com>

Your guide for up-to-date English shortwave schedules sorted by time, country and frequency plus a DX media program guide and newsletter

# THE QSL REPORT

VERIFICATIONS RECEIVED BY OUR READERS

Gayle Van Horn, W4GVH

gaylevanhorn@monitoringtimes.com

## Radio Prague releases Lookout Towers QSL



Each year Radio Prague releases a new series of QSL cards, and the 2007 series has collectors raving about the colorful variety. *Lookout Towers in the Czech Republic* features eight famous towers including: Decinsky Sneznik; Krasny Dvur u Podboran; Minaret in Lednice; Petrin Observation Tower; Praded; Haj u Ase; Klet and Blanik located in central Bohemia.

For a closer look at the 2007 series, refer to the Radio Prague

homepage at [www.radio.cz/en](http://www.radio.cz/en) at the QSL Cards 2007 photo link. To begin your collection, send a reception report to: [english@radio.cz](mailto:english@radio.cz) or to: Radio Prague, 12099 Prague, Czech Republic.

For a complete listing of English service frequencies, please consult the *Shortwave Guide* beginning at 0127 UTC.

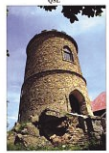

### AMATEUR RADIO

Italy, IQ3X/IV3SKKB, 15 & 20 meters SSB. IU2X, 15 meters SSB. Full data color cards. Received in 65 days via ARRL bureau. (Van Horn, NC)

W4NF Hatteras Island, NC (NA-067) 20 meters SSB. Full data card. Received in 20 days for an SASE to: John F.O. Mara, W4NF, 6913 Trumpeter Swan Lane, Manassas, VA 20112 (Van Horn, NC)

### CANADA

Radio Prague via Sackville, 5990 kHz. Full data 70<sup>th</sup> Anniversary card, plus packet of station goodies. Received in 28 days. Station address: Radio Prague, 12099 Prague, Czech Republic. (Edward Kusalik, Alberta, Canada)

### CLANDESTINE

Radio Voice of the People via Talata, Madagascar, 11695 kHz. No data email reply via Davidson Mudzingwa-VOP Producer. Received in eight hours for report to: [voxpopzim@yahoo.co.uk](mailto:voxpopzim@yahoo.co.uk) Email reply received via John Masuku-Executive Director in Zimbabwe, for an email report to: [voxpop@ecoweb.co.zw](mailto:voxpop@ecoweb.co.zw) No data, but included my report along with interesting information about the station. Postal address: P.O. Box 5750, Hurare, Zimbabwe. (Wendel Craighead, Prairie Village, KS)

### DJIBOUTI

Radiodiffusion-Television de Djibouti, 4780 kHz. Full data paper folder, including radio and television schedules, plus building and tower photo. Verification received one year to the day after my report, but had already received a QSL five months after the first report. Station address: Radiodiffusion-Television de Djibouti, Boite Postal 97, Djibouti, Djibouti. (Craighead, KS)

### KUWAIT

Voice of America/IBB 11730. Full data form verification letter with IBB-Kuwait Transmitting Station letterhead, signed by George O. Miller. Received in 40 days for an English report. Station address: c/o American Embassy-Bayan, P.O. Box 77, Safat, 13001 Kuwait. (Kusalik, CAN)

### MEDIUM WAVE

Australia, 4KZ 531 kHz AM. Friendly note and QSL card signed by Al Kirton-Gen. Manager, plus packet of station souvenirs. Received in 21 days for an AM report. Sta-

tion address: Coastal Broadcasting Pty. Ltd., P.O. Box 19, Innisfail, QLD 4860 Australia. Trying for this station 27 years, this makes Queensland # 64. (Patrick Martin, Oceanside, OR) *Congrats, Pat!*

### JAPAN

JOKB Okayama 1386 kHz AM. Full data verification letter signed by Akira Yamane. Received for an English AM report. Station address: NHK Okayama Station, 15-1 ekimotomachi, Okayama-City 700-8621 Japan. (Craig Edwards, Nhulunbuy (Gove) NT Australia)

JOYF Mito 1197 kHz AM. Full data QSL card and letter signed by Fujio Ozawa. Received for an English AM report. Station address: IBS Ibaraki Hoso 2084-2 Senbatyou, Mitoshi, Ibarakiken 310-8505 Japan. (Edwards, AUS)

KERR 750 kHz AM (*Kerr Country*). Color glossy QSL card signed by Les Rayburn, NRC/IRCA Broadcast Test Coordinator. Received in 30 days for a CD report. QSL address: Les Rayburn N1LF, High Noon Film, 100 Centerview Drive, Suite 111, Birmingham, AL 35216 (or) [Les@highnoonfilm.com](mailto:Les@highnoonfilm.com) (Martin, OR)

WVAL 800 kHz AM. Friendly full data verification letter signed by Carla Jurgens-Traffic, plus bumper sticker, coverage maps and assortment of station goodies. Received in 101 days for an AM report and one US dollar. Station address: Tri County Broadcasting Inc., 1010 2<sup>nd</sup> Street-North, Sauk Rapids, MN 56379. (Patrick Griffith, Westminster, CO)

South Korea 1566 HLAZ Cheju Island. Full data color postcard QSL of HLAZ transmitter site, signed by Karen Chase-English Secretary. Received in 18 days for a CD report. Station address: FEBC, MPO Box 88, Seoul 121-707, Republic of Korea. (Martin, OR)

South Korea 1188 HLKX. Incheon. Full data color postcard QSL of HLKX transmitter site, signed by Karen Chase-English Secretary. Signer mentioned they rarely receive reports via USA. Neither QSLs are new series, but wanted two new ones to add to collection. Station address: (see HLAZ) (Martin, OR)

### RUSSIA

Radiostantsiya Tikhyy Okean (Radio Station Pacific Ocean) 7330 kHz. Full data

verification. Received for an email report to: [ptr@ptr-vlad.ru](mailto:ptr@ptr-vlad.ru). Station address: Radiostantsiya Tikhyy Okean, GTRK-Vladivostok, ul. Uborevicha 20-A, 690950 Vladivostok, Primorskiy Krai, Russia. English or Russian correspondence accepted. Web: [www.ptr-vlru/tv&radio](http://www.ptr-vlru/tv&radio) (Ron Howard, Monterey, CA)

### ST. HELENA

Radio St. Helena, 11092.5 kHz. Full data DSWCI 50<sup>th</sup> Anniversary card, signed by Anker Petersen. Received in 52 days for an English report for reception of *Radio St. Helena Day 2006*, with one IRC and one U.S. dollar. QSL address: Danish SW Club International, Atten: RSH Reports, Tavleager 31, DK-2670 Greve, Denmark. (Joe Wood, Greenback, TN) QSLs via DSWCI and *Radio St. Helena direct* are likely to increase. GVH

### TIBET

Xizang People's Broadcasting Station via Lhasa, 5240 kHz. Full data card with illegible signature. Handwritten on envelope with reference to Holy Tibet. Received in 113 days for an English report and no return postage. Station address: 180 Beijing Zhonglu, Lhasa, Xizang 850000, People's Republic of China. (Dan Srebnick, Aberdeen, NJ)

### TRAVELERS INFORMATION STATION

Fort Lewis - 1500 kHz AM. Friendly letter signed by Robert D. Ball-Chief DPTMS Operations. Received in 11 days for an English report. Station address: I Corp and Fort Lewis, Attention: IMNW-LEW-PL-OO (MS16), Fort Lewis, WA 98433-9500. (Martin, OR)

### UTILITY

Maritime Coastal Station, CWA Cerrito Radio, 12,750 kHz (CW). Full data letter signed by Ing. José Luis Rodriguez. Received in 73 days for an English report and mint postage stamps (returned). Station address: Cerrito Radio/CWA ANTEL, Servicio Fibra y Radio, Vilardebo 1500, Piso 1, Montevideo, Uruguay. (Jim Pogue, Memphis, TN)

U.S. Naval Submarine Base, Groton, CT, NBL 7371.5 kHz LSB. Full data Armed Forces Day Communications Test QSL card. Received in seven months following an email follow-up. QSL address: NAVMARCORMARS Radio Station, P.O. Box 161, U.S. Naval Submarine Base, Groton, CT 06349-5161 USA. (Pogue, TN)





## HOW TO USE THE SHORTWAVE GUIDE



0000-0100 twhfa USA, Voice of America 5995am 6130ca 7405am 9455af  
 ① ② ⑤ ③ ④ ⑥ ⑦

### Convert your time to UTC.

Broadcast time on ① and time off ② are expressed in Coordinated Universal Time (UTC) – the time at the 0 meridian near Greenwich, England. To translate your local time into UTC, first convert your local time to 24-hour format, then add (during Standard Time) 5, 6, 7 or 8 hours for Eastern, Central, Mountain or Pacific Times, respectively. Eastern, Central, and Pacific Times are already converted to UTC for you at the top of each hour.

Note that all dates, as well as times, are in UTC; for example, a show which might air at 0030 UTC Sunday will be heard on Saturday evening in America (in other words, 7:30 pm Eastern, 6:30 pm Central, etc.).

### Find the station you want to hear.

Look at the page which corresponds to the time you will be listening. On the top half of the page English broadcasts are listed by UTC time on ①, then alphabetically by country ③, followed by the station name ④. (If the station name is the same as the country, we don't repeat it, e.g., "Vanuatu, Radio" [Vanuatu].)

If a broadcast is not daily, the days of broadcast ⑤ will appear in the column following the time of broadcast, using the following codes:

Day Codes	
s/S	Sunday
m/M	Monday
t/T	Tuesday
w/W	Wednesday
h/H	Thursday
f/F	Friday
a/A	Saturday
D	Daily
mon/MON	monthly
occ:	occasional
DRM:	Digital Radio Mondiale

In the same column ⑤, irregular broadcasts are indicated "tent" and programming which includes languages besides English are coded "vl" (various languages).

### Choose the most promising frequencies for the time, location and conditions.

The frequencies ⑥ follow to the right of the station listing; all frequencies are listed in kilohertz (kHz). Not all listed stations will be heard from your location and virtually none of them will be heard all the time on all frequencies.

Shortwave broadcast stations change some of their frequencies at least twice a year, in April and October, to adapt to seasonal conditions.

But they can also change in response to short-term conditions, interference, equipment problems, etc. Our frequency manager coordinates published station schedules with confirmations and reports from her monitoring team and MT readers to make the Shortwave Guide up-to-date as of one week before print deadline.

To help you find the most promising signal for your location, immediately following each frequency we've included information on the target area ⑦ of the broadcast. Signals beamed toward your area will generally be easier to hear than those beamed elsewhere, even though the latter will often still be audible.

#### Target Areas

- af: Africa
- al: alternate frequency (occasional use only)
- am: The Americas
- as: Asia
- ca: Central America
- do: domestic broadcast
- eu: Europe
- irr: irregular (Costa Rica RFP)
- me: Middle East
- na: North America
- oc: Oceania
- pa: Pacific
- sa: South America
- va: various

### Shortwave Broadcast Bands

kHz	Meters
2300-2495	120 meters (Note 1)
3200-3400	90 meters (Note 1)
3900-3950	75 meters (Regional band, used for broadcasting in Asia only)
3950-4000	75 meters (Regional band, used for broadcasting in Asia and Europe)
4750-4995	60 meters (Note 1)
5005-5060	60 meters (Note 1)
5730-5900	49 meter NIB (Note 2)
5900-5950	49 meter WARC-92 band (Note 3)
5950-6200	49 meters
6200-6295	49 meter NIB (Note 2)
6890-6990	41 meter NIB (Note 2)
7100-7300	41 meters (Regional band, not allocated for broadcasting in the western hemisphere) (Note 4)
7300-7350	41 meter WARC-92 band (Note 3)
7350-7600	41 meter NIB (Note 2)
9250-9400	31 meter NIB (Note 2)
9400-9500	31 meter WARC-92 band (Note 3)
9500-9900	31 meters
11500-11600	25 meter NIB (Note 2)
11600-11650	25 meter WARC-92 band (Note 3)
11650-12050	25 meters
12050-12100	25 meter WARC-92 band (Note 3)
12100-12600	25 meter NIB (Note 2)
13570-13600	22 meter WARC-92 band (Note 3)
13600-13800	22 meters
13800-13870	22 meter WARC-92 band (Note 3)
15030-15100	19 meter NIB (Note 2)
15100-15600	19 meters
15600-15800	19 meter WARC-92 band (Note 3)
17480-17550	17 meter WARC-92 band (Note 3)
17550-17900	17 meters
18900-19020	15 meter WARC-92 band (Note 3)
21450-21850	13 meters
25670-26100	11 meters

#### Notes

- Note 1 Tropical bands, 120/90/60 meters are for broadcast use only in designated tropical areas of the world.
- Note 2 Broadcasters can use this frequency range on a (NIB) non-interference basis only.
- Note 3 WARC-92 bands are allocated officially for use by HF broadcasting stations in 2007. They are only authorized on a non-interference basis until that date.
- Note 4 WRC-03 update. After March 29, 2009, the spectrum from 7100-7200 kHz will no longer be available for broadcast purposes and will be turned over to amateur radio operations worldwide

### MT MONITORING TEAM

**Gayle Van Horn**  
 Frequency Manager

[gaylevanhorn@monitoringtimes.com](mailto:gaylevanhorn@monitoringtimes.com)

**Daniel Sampson**  
 danielsampson@monitoringtimes.com

**Larry Van Horn, MT Asst. Editor**  
[larryvanhorn@monitoringtimes.com](mailto:larryvanhorn@monitoringtimes.com)

## Thank You ...

### Additional Contributors to This Month's Shortwave Guide:

Rich D'Angelo/*NASWA Flash Sheet*; Alokesh Gupta, New Delhi, India; Anker Petersen/*DX Window*; Ivo Ivanov; Alan Roe, UK; Adrian Sainsbury/R.NZ Intl; Harold Sellers/*ODXA/DX Ontario*; George Sherman, MN; Wolfgang Bueschel, Germany; Andreas Volk, Germany; *BCL News*; *Cumbre DX*; *DX Mix News*; *Bulgaria*; *Hard Core DX*; *NASWA Journal*; WWDXC-Top News.

**GLENN HAUSER'S  
 WORLD OF RADIO**  
<http://www.worldofradio.com>

For the latest DX and programming news, amateur nets, DX program schedules, audio archives and much more!

**0000 UTC - 7PM EST / 6PM CST / 4PM PST**

0000	0015	Japan, Radio Japan/NHK World	13650as	
		17810as		
0000	0030	Australia, Radio 9660as 12080as 13670as		
		15240pa 17715as 17750va 17775va		
		17795va		
0000	0030	Burma, Dem Voice of Burma	5955eu	
0000	0030	Egypt, Radio Cairo	11950na	
0000	0030	Thailand, Radio 9680af		
0000	0030	UK, BBC World Service	3915as 11945as	
		17615as		
0000	0030	USA, Voice of America	7405as	
0000	0045	India, All India Radio	9705as 9950as	
		11620as 11645as 13605as		
0000	0057	Canada, Radio Canada Intl	9880as	
0000	0057	Netherlands, Radio	6165na	
0000	0059	Spain, Radio Exterior Espana	6055am	
0000	0100	Anguilla, University Network	6090am	
0000	0100	Australia, ABC NT Alice Springs	2310do	
		4835do		
0000	0100	Australia, ABC NT Katherine	5025do	
0000	0100	Australia, ABC NT Tennant Creek	4910do	
0000	0100	Bulgaria, Radio 7400na	9700na	
0000	0100	Canada, CFRX Toronto ON	6070na	
0000	0100	Canada, CFVP Calgary AB	6030na	
0000	0100	Canada, CKZN St John's NF	6160na	
0000	0100	Canada, CKZU Vancouver BC	6160na	
0000	0100	China, China Radio Intl	6020na 6075as	
		7130as 7180as 9425na	6075as 9570as	
		11650as 11885as		
0000	0100	Costa Rica, University Network	5030va 6150va	
		7375va 9725va		
0000	0100	Germany, Deutsche Welle	7265as 15320as	
0000	0100	Guyana, Voice of 3291do		
0000	0100	Japan, Radio Japan/NHK World	6145na	
0000	0100	Malaysia, RTM/Trax FM	7295as	
0000	0100	Namibia, Namibian BC Corp	3270do 3290do	
		6060do 6175do		
0000	0100	New Zealand, Radio NZ Intl	15720pa	
0000	0100	New Zealand, Radio NZ Intl	17675pa	
0000	0100	Papua New Guinea, Wantok R. Light	7120va	
0000	0100	Singapore, MediaCorp Radio	6150do	
0000	0100	UK, BBC World Service	5970as 6195as	
		9605as 9740as 11955as	15285as	
		15360as		
0000	0100	UK, BBC World Service	6010na	
0000	0100	UK, Bible Voice	5945me	
0000	0100	USA, American Forces Radio	4319usb 5446usb	
		5765usb 6350usb 7811usb	10320usb	
		12133usb 13362usb		
0000	0100	USA, KAIJ Dallas TX	5755na	
0000	0100	USA, KTBN Salt Lake City UT	7505na 15590na	
0000	0100	USA, WBCQ Kennebunk ME	5110na 7415na	
		9330na		
0000	0100	USA, WBOH Newport NC	5920am	
0000	0100	USA, WEWN Birmingham AL	5810va	
0000	0100	USA, WHRA Greenbush ME	5850na	
0000	0100	USA, WHRI Cypress Creek SC	7315am 7490am	
0000	0100	USA, WINB Red Lion PA	9265am	
0000	0100	USA, WRMI Miami FL	7385na	
0000	0100	USA, WRMI Miami FL	9955am	
0000	0100	USA, WTJC Newport NC	9370na	
0000	0100	USA, WWCR Nashville TN	3215na 5070na	
		7465na 13845na		
0000	0100	USA, WWRB Manchester TN	3185na 5050na	
		6890na		
0000	0100	USA, WWRB Manchester TN	5745ca	
0000	0100	USA, WYFR/Family R Okeechobee FL	6065na	
		9505na 9715na 11720am		
0000	0100	Zambia, Christian Voice	4965af	
0005	0030	Austria, Radio Austria Intl	7325na	
0005	0100	Canada, Radio Canada Intl	9755am	
0013	0028	Austria, Radio Austria Intl	7325na	
0030	0045	Germany, Pan American BC	6165as	
0030	0100	Australia, Radio 9660as 12080as 13670as		
		15240pa 15415as 17715as 17750va		
		17795va		
0030	0100	Greece, Voice of 7475eu	9420eu 12105af	
0030	0100	Greece, Voice of 12105af		
0030	0100	Lithuania, Radio Vilnius	9875na	
0030	0100	Thailand, Radio 5890na		
0030	0100	UK, Bible Voice 5955as		
0030	0100	USA, Voice of America	7120va 9620va	
		11695va 11725va 11805va	12005va	
		15185va 15205va		
0033	0100	Austria, Radio Austria Intl	7325na	
0043	0058	Austria, Radio Austria Intl	7325na	
0055	0100	Italy, RAI Intl	11800na	

**0100 UTC - 8PM EST / 7PM CST / 5PM PST**

0100	0105	Canada, Radio Canada Intl	9755am	
0100	0115	Italy, RAI Intl	11800na	

0100	0127	Czech Rep, Radio Prague	6200na 7345na	
0100	0128	Vietnam, Voice of 6175na		
0100	0130	Germany, Universal Life	7260as	
0100	0130	Greece, Voice of 7475eu	9420eu 12105af	
0100	0130	Slovakia, Radio Slovakia Int	7230na 9440sa	
0100	0130	UK, BBC World Service	7230na 9440sa	
0100	0156	Romania, Radio Romania Intl	6150na 9515na	
0100	0157	Canada, Radio Canada Intl	5840as 5970as	
0100	0157	Netherlands, Radio	6165na	
0100	0158	Hungary, Radio Budapest	5980na	
0100	0200	Anguilla, University Network	6090am	
0100	0200	Australia, ABC NT Katherine	5025do	
0100	0200	Australia, ABC NT Tennant Creek	4910do	
0100	0200	Australia, Radio 9660as 12080as 13670as		
		15240pa 15415as 15515as 17715as		
		17750va 17795va 21745va		
0100	0200	Canada, CFRX Toronto ON	6070na	
0100	0200	Canada, CFVP Calgary AB	6030na	
0100	0200	Canada, CKZN St John's NF	6160na	
0100	0200	Canada, CKZU Vancouver BC	6160na	
0100	0200	China, China Radio Intl	6005na 6020na	
		6075as 6080na 7130eu	7180as 7180as	
		9570na 9580na 11650as	11885as	
0100	0200	Costa Rica, University Network	5030va 6150va	
		7375va 9725va		
0100	0200	Cuba, Radio Havana	6000na 6180na	
0100	0200	Guyana, Voice of 3291do		
0100	0200	Indonesia, Voice of 15150al	9525as 11785pa	
0100	0200	Japan, Radio Japan/NHK World	6030va 17685pa	
		11860as 11935sa 15325as	15325as 17685pa	
		17810as 17825ca 17845as		
0100	0200	Malaysia, RTM/Trax FM	7295as	
0100	0200	Namibia, Namibian BC Corp	3270do 3290do	
		6060do 6175do		
0100	0200	New Zealand, Radio NZ Intl	15720pa	
0100	0200	New Zealand, Radio NZ Intl	17675pa	
0100	0200	North Korea, Voice of Korea	7140as 9345as	
		9730am 11735am	13760am 15180am	
0100	0200	Papua New Guinea, Wantok R. Light	7120va	
0100	0200	Singapore, MediaCorp Radio	6150do	
0100	0200	Sri Lanka, SLBC 6005as	9770as 15745as	
0100	0200	Taiwan, Radio Taiwan Intl	11875na 15465na	
0100	0200	UK, BBC World Service	7320as 9605as	
		11955as 15285as	15310as 15360as	
0100	0200	UK, Bible Voice	5945me	
0100	0200	Ukraine, Radio Ukraine Intl	5820na	
0100	0200	USA, American Forces Radio	4319usb 5446usb	
		5765usb 6350usb 7811usb	10320usb	
		12133usb 13362usb		
0100	0200	USA, KAIJ Dallas TX	5755na	
0100	0200	USA, KTBN Salt Lake City UT	7505na 15590na	
0100	0200	USA, KWHR Naalehu HI	17655as	
0100	0200	USA, Voice of America	11705va 12005va	
0100	0200	USA, WBCQ Kennebunk ME	5110na 7415na	
		9330na		
0100	0200	USA, WBOH Newport NC	5920am	
0100	0200	USA, WEWN Birmingham AL	5810va	
0100	0200	USA, WHRA Greenbush ME	5850na	
0100	0200	USA, WHRI Cypress Creek SC	5835am 7490am	
0100	0200	USA, WHRI Cypress Creek SC	7315am	
0100	0200	USA, WINB Red Lion PA	9265am	
0100	0200	USA, WRMI Miami FL	7385na	
0100	0200	USA, WRMI Miami FL	9955am	
0100	0200	USA, WTJC Newport NC	9370na	
0100	0200	USA, WWCR Nashville TN	3215na 5070na	
		5935na 7465na		
0100	0200	USA, WWRB Manchester TN	3185na 5050na	
		6890na		
0100	0200	USA, WWRB Manchester TN	5745ca	
0100	0200	USA, WYFR/Family R Okeechobee FL	6065na	
		9505na 9715na 11720am		
0100	0200	mtwhfa	USA, WWRB Manchester TN	5745ca
0100	0200	USA, WYFR/Family R Okeechobee FL	6065na	
		9505na 15195as		
0100	0200	Uzbekistan, CVC International	7355as	
0100	0200	Zambia, Christian Voice	4965af	
0105	0159	Sun/Mon	Canada, Radio Canada Intl	9755am
0115	0130	twhf	Seychelles, FEBA	5885as
0130	0200	Iran, Voice of the Islamic Rep	6120na 7160na	
0130	0200	Lithuania, Radio Vilnius	7325na	
0130	0200	Sweden, Radio	11550va	
0130	0200	USA, Voice of America	5960va	
0130	0200	USA, Voice of America	7405va	
0140	0200	twhfa	Vatican City, Vatican Radio	5915va 7335va

**0200 UTC - 9PM EST / 8PM CST / 6PM PST**

0200	0205	Sun/Mon	Canada, Radio Canada Intl	9755am
0200	0227	Czech Rep, Radio Prague	6200na 7345na	
0200	0227	Iran, Voice of the Islamic Rep	6120na 7160na	
0200	0228	Hungary, Radio Budapest	5980na	
0200	0300	Anguilla, University Network	6090am	
0200	0300	twhfa	Argentina, RAE	11710am
0200	0300	Australia, ABC NT Alice Springs	2310do	

4835do			
0200	0300	Australia, ABC NT Katherine	5025do
0200	0300	Australia, ABC NT Tennant Creek	4910do
0200	0300	Australia, Radio 9660as	12080as 13670as
		15240pa	15415as 15515as 17750va
21725va			
0200	0300	Canada, CFRX Toronto ON	6070na
0200	0300	Canada, CFVP Calgary AB	6030na
0200	0300	Canada, CKZN St John's NF	6160na
0200	0300	Canada, CKZU Vancouver BC	6160na
0200	0300	China, China Radio Intl	11770as 13640as
0200	0300	Costa Rica, University Network	5030va 6150va
		7375va	9725va
0200	0300	Cuba, Radio Havana	6000na 6180na
0200	0300	Egypt, Radio Cairo	7270na
0200	0300	Guyana, Voice of	3291do
0200	0300	Malaysia, RTM/Trax FM	7295as
0200	0300	Namibia, Namibian BC Corp	3270do 3290do
		6060do	6175do
0200	0300	New Zealand, Radio NZ Intl	15720pa
0200	0300	DRM New Zealand, Radio NZ Intl	17675pa
0200	0300	North Korea, Voice of Korea	13650as 15100as
0200	0300	vi Papua New Guinea, Wantok R. Light	7120va
0200	0300	Philippines, Radio Pilipinas	11885va 15270va
		17665va	
0200	0300	Russia, Voice of	6230na 7250na 13665na
		15425na	
0200	0300	Singapore, MediaCorp Radio	6150do
0200	0300	South Korea, KBS World Radio	9560na
		15575na	
0200	0300	Sri Lanka, SLBC	6005as 9770as 15745as
0200	0300	UK, BBC World Service	6035af 6195as 15285as
		7320as	11955as
		15310as	15360as 17760as
0200	0300	USA, American Forces Radio	4319usb 5446usb
		5765usb	6350usb 7811usb 10320usb
		12133usb	13362usb
0200	0300	USA, KAIJ Dallas TX	5755na
0200	0300	USA, KJES Vado NM	7555na
0200	0300	USA, KTBN Salt Lake City UT	7505na
0200	0300	USA, KWHR Naalehu HI	17655as
0200	0300	USA, WBCQ Kennebunk ME	5110na 7415na
		9330na	
0200	0300	USA, WBOH Newport NC	5920am
0200	0300	USA, WEWN Birmingham AL	5810va
0200	0300	USA, WHRA Greenbush ME	5850na
0200	0300	as USA, WHRI Cypress Creek SC	7315am
0200	0300	mtwhf USA, WHRI Cypress Creek SC	5835am 7490am
0200	0300	USA, WINB Red Lion PA	9265am
0200	0300	USA, WRMI Miami FL	7385na
0200	0300	USA, WRMI Miami FL	9955am
0200	0300	USA, WTJC Newport NC	9370na
0200	0300	USA, WWCR Nashville TN	3215na 5070na
		5765na	5935na
0200	0300	USA, WWRB Manchester TN	3185na 5050na
		6890na	
0200	0300	mtwhfa USA, WWRB Manchester TN	5745ca
0200	0300	USA, WYFR/Family R Okeechobee FL	5985am 11855am
		6065na	9505na 9525na
0200	0300	Uzbekistan, CVC International	7355as
0200	0300	Zambia, Christian Voice	4965af
0200	0300	Taiwan, Radio Taiwan Intl	5950na 9680na
0215	0220	Vatican City, Vatican Radio	12070va
0215	0230	Nepal, Radio	3230as 5005as 6100as
		7165as	
0230	0258	Vietnam, Voice of	6175na
0230	0300	Sweden, Radio	6010na
0245	0300	twhf Albania, Radio Tirana	6115eu 7465eu
0245	0300	Myanmar, Radio	9730do
0250	0300	Vatican City, Vatican Radio	7305am 9610am

### 0300 UTC - 10PM EST / 9PM CST / 7PM PST

0300	0307	Croatia, Croatian Radio	7285na
0300	0320	Vatican City, Vatican Radio	7305am 9610am
0300	0330	Egypt, Radio Cairo	7270na
0300	0330	Myanmar, Radio	9730do
0300	0330	Philippines, Radio Pilipinas	11885va 15270va
		17665va	
0300	0330	s Swaziland, TWR	3200af
0300	0330	Thailand, Radio	5890na
0300	0330	USA, KJES Vado NM	7555na
0300	0330	USA, WBCQ Kennebunk ME	9330na
0300	0330	Vatican City, Vatican Radio	7360af
0300	0358	Germany, Deutsche Welle	7330as 9785as
0300	0400	Anguilla, University Network	6090am
0300	0400	Australia, ABC NT Alice Springs	2310do
		4835do	
0300	0400	Australia, ABC NT Katherine	5025do
0300	0400	Australia, ABC NT Tennant Creek	4910do
0300	0400	Australia, Radio 9660as	12080as 13670as
		15240pa	15415as 15515as 17750va

21725va			
0300	0400	Bulgaria, Radio	7400na 9700na
0300	0400	twhf Canada, CBC NQ SW Service	9625na
0300	0400	Canada, CFRX Toronto ON	6070na
0300	0400	Canada, CFVP Calgary AB	6030na
0300	0400	Canada, CKZN St John's NF	6160na
0300	0400	Canada, CKZU Vancouver BC	6160na
0300	0400	China, China Radio Intl	6190na 9460as
		9690na	9790na 11770as 13620as
		15110as	15120as
0300	0400	Costa Rica, University Network	5030va 6150va
		7375va	9725va
0300	0400	Cuba, Radio Havana	6000na 6180na
0300	0400	Germany, Deutsche Welle	9480as
0300	0400	Guyana, Voice of	3291do
0300	0400	Japan, Radio Japan/NHK World	21610pa
0300	0400	Malaysia, RTM/Trax FM	7295as
0300	0400	Malaysia, RTM/Voice of Malaysia	6175as
		9750as	15295as
0300	0400	vi Namibia, Namibian BC Corp	3270do 3290do
		6060do	6175do
0300	0400	New Zealand, Radio NZ Intl	15720pa
0300	0400	DRM New Zealand, Radio NZ Intl	17675pa
0300	0400	North Korea, Voice of Korea	7140as 9345as
		9730as	
0300	0400	vi Papua New Guinea, Wantok R. Light	7120va
0300	0400	Russia, Voice of	5995me 6240na 7350na
		13665na	15425na
0300	0400	vi Rwanda, Radio	6055do
0300	0400	Singapore, MediaCorp Radio	6150do
0300	0400	South Africa, Channel Africa	3345af 7390af
0300	0400	Sri Lanka, SLBC	6005as 9770as 15745as
0300	0400	Taiwan, Radio Taiwan Intl	5950na 15215as
		15320as	
0300	0400	s UK, BBC World Service	6195as
0300	0400	UK, BBC World Service	3255af 6005me
		6145af	6190af 7130af 7160af
		9410as	9750af 11760as 15320as
		15360as	17760as 17790as 21660as
0300	0400	USA, American Forces Radio	4319usb 5446usb
		5765usb	6350usb 7811usb 10320usb
		12133usb	13362usb
0300	0400	USA, KAIJ Dallas TX	5755na
0300	0400	USA, KTBN Salt Lake City UT	7505na
0300	0400	USA, KWHR Naalehu HI	17655as
0300	0400	USA, Voice of America	4930af 6080af
		15580af	
0300	0400	USA, WBCQ Kennebunk ME	5110na 7415na
0300	0400	USA, WBOH Newport NC	5920am
0300	0400	USA, WEWN Birmingham AL	5810va
0300	0400	USA, WHRA Greenbush ME	5850na
0300	0400	mtwhf USA, WHRI Cypress Creek SC	5835am 6110am
		7520am	
0300	0400	as USA, WHRI Cypress Creek SC	7315am
0300	0400	USA, WINB Red Lion PA	9265am
0300	0400	twhfa USA, WRMI Miami FL	7385na
0300	0400	sm USA, WRMI Miami FL	9955am
0300	0400	USA, WTJC Newport NC	9370na
0300	0400	USA, WWCR Nashville TN	3215na 5070na
		5765na	5935na
0300	0400	USA, WWRB Manchester TN	3185na 5050na
		6890na	
0300	0400	mtwhfa USA, WWRB Manchester TN	5745ca
0300	0400	USA, WYFR/Family R Okeechobee FL	6065na 11740am
		9505na	9985am
0300	0400	Uzbekistan, CVC International	13685as
0300	0400	Zambia, Christian Voice	4965af
0300	0400	vi Zimbabwe, ZBC Corp	5975do
0300	0500	vi/mtwhf UK, Sudan Radio Service	7120af
0315	0330	t Ecuador, HCJB Global	9745va
0330	0335	Bahrain, Radio Bahrain	6010as
0330	0345	t Ecuador, HCJB Global	6065va
0330	0358	Hungary, Radio Budapest	6035na
0330	0358	Vietnam, Voice of	6175am
0330	0400	Sweden, Radio	6010na
0330	0400	UK, BBC World Service	11665af
0330	0400	twhf USA, WBCQ Kennebunk ME	9330na
0345	0400	twhf Albania, Radio Tirana	6115eu 7465eu

### 0400 UTC - 11PM EST / 10PM CST / 8PM PST

0400	0427	Czech Rep, Radio Prague	5990na 6200na
		7345na	
0400	0430	Australia, Radio	9660as 12080as 13670as
		15240pa	15515as 17750va 21725va
0400	0430	mtwhf France, Radio France Intl	7270af 7315af
		9805af	
0400	0430	as USA, WWRB Manchester TN	5745ca
0400	0456	Romania, Radio Romania Intl	6115va 9515na
		9690va	11895va
0400	0457	Germany, Deutsche Welle	5905af 7225af
0400	0500	Anguilla, University Network	6090am

0400	0500	Armenia, CVC International	15515as		
0400	0500	Australia, ABC NT Alice Springs	4835do	2310do	
0400	0500	Australia, ABC NT Katherine	5025do		
0400	0500	Australia, ABC NT Tennant Creek		4910do	
0400	0500	Canada, CBC NQ SW Service	9625na		twhf
0400	0500	Canada, CFRX Toronto ON	6070na		
0400	0500	Canada, CKZN St John's NF	6160na		
0400	0500	Canada, CKZU Vancouver BC	6160na		
0400	0500	China, China Radio Intl	6190na	9460as	
		13620as	15120as	17725as	
0400	0500	Costa Rica, University Network	5030va	6150va	
		7375va	9725va		
0400	0500	Cuba, Radio Havana	6000na	6180na	
0400	0500	Germany, Deutsche Welle	6180af	9565af	
		15445af			
0400	0500	Guyana, Voice of	3291do		
0400	0500	Malaysia, RTM/Trax FM	7295as		
0400	0500	Malaysia, RTM/Voice of Malaysia	9750as	6175as	
		15295as			
0400	0500	Namibia, Namibian BC Corp	3270do	3290do	vl
		6060do	6175do		
0400	0500	New Zealand, Radio NZ Intl	15720pa		
0400	0500	New Zealand, Radio NZ Intl	17675pa		DRM
0400	0500	Nigeria, Radio/Kaduna	6090do		
0400	0500	Papua New Guinea, Wantok R. Light		7120va	vl
0400	0500	Russia, Voice of	7150na	7255na	
		9840na	12030na	13655na	
0400	0500	Rwanda, Radio	6055do		vl
0400	0500	Singapore, MediaCorp Radio	6150do		
0400	0500	South Africa, Channel Africa	3345af		
0400	0500	Turkey, Voice of	6020va	7240va	
0400	0500	Uganda, Radio	4976do	5026do	vl
0400	0500	UK, BBC World Service	3255af	6005af	
		6190af	6195eu	7120af	7160af
		11665af	11760as	12095af	15310as
		15360as	15575as	17760as	17790as
		21660as			
0400	0500	UK, BBC World Service	6010na		DRM
0400	0500	Ukraine, Radio Ukraine Intl	5820na	9515as	
0400	0500	USA, American Forces Radio	4319usb	5446usb	
		5765usb	6350usb	7811usb	10320usb
		12133usb	13362usb		
0400	0500	USA, KAIJ Dallas TX	5755na		
0400	0500	USA, KTBN Salt Lake City UT	7505na		
0400	0500	USA, KWHR Naalehu HI	17655as		
0400	0500	USA, Voice of America	4930af	4960af	
		6080af	9885af	15580af	
0400	0500	USA, WBCQ Kennebunk ME	5110na	7415na	
0400	0500	USA, WBOH Newport NC	5920am		
0400	0500	USA, WEWN Birmingham AL	5810va	5850va	
0400	0500	USA, WHRA Greenbush ME	5850na		
0400	0500	USA, WHRI Cypress Creek SC	5835am	7490am	mtwhf
0400	0500	USA, WHRI Cypress Creek SC	7315am		as
0400	0500	USA, WMLK Bethel PA	9265eu		
0400	0500	USA, WRMI Miami FL	7385na		thwhf
0400	0500	USA, WRMI Miami FL	9955am		sm
0400	0500	USA, WTJC Newport NC	9370na		
0400	0500	USA, WWCR Nashville TN	3215na	5070na	
		5765na	5935na		
0400	0500	USA, WWRB Manchester TN	3185oc	5050na	
		6890na			
0400	0500	USA, WYFR/Family R Okeechobee FL	6065na		
		6855na	7780va	9505na	9715na
0400	0500	Uzbekistan, CVC International	13685as		
0400	0500	Zambia, Christian Voice	4965af		
0400	0500	Zimbabwe, ZBC Corp	5975do		vl
0430	0445	Israel, Kol Israel	7545va	9345va	17600va
0430	0457	Czech Rep, Radio Prague	9890na		
0430	0500	Australia, Radio	9660as	12080as	13670as
		15240pa	15415as	15515va	17750va
		21725va			
0430	0500	Nigeria, Radio/Ibadan	6050do		
0430	0500	Nigeria, Radio/Kaduna	4770do		
0430	0500	Nigeria, Radio/Lagos	3326do	4990do	
0430	0500	Swaziland, TWR	3200af	4775af	
0430	0500	USA, WWRB Manchester TN	5745ca		a
0445	0500	Italy, RAI Intl	5965af	6120af	7170af

**0500 UTC - 12AM EST / 11PM CST / 9PM PST**

0500	0507	twhf	Canada, CBC NQ SW Service	9625na	
0500	0530	mtwhf	France, Radio France Intl	9805af	11995af
			13680af		
0500	0530		Germany, Deutsche Welle	6180af	7285af
			9755af	12045af	15410af
0500	0530	vl	Rwanda, Radio	6055do	
0500	0530		Vatican City, Vatican Radio	7360af	9660af
			11625af		
0500	0555		South Africa, Channel Africa	7240af	9685af
0500	0557		Netherlands, Radio	6165na	
0500	0559		New Zealand, Radio NZ Intl	15720pa	
0500	0559	DRM	New Zealand, Radio NZ Intl	17675pa	

0500	0600		Anguilla, University Network	6090am	
0500	0600		Armenia, CVC International	15515as	
0500	0600		Australia, ABC NT Alice Springs	4835do	2310do
0500	0600		Australia, ABC NT Katherine	5025do	
0500	0600		Australia, ABC NT Tennant Creek		4910do
0500	0600		Australia, Radio	9660as	12080as
			15160as	15240pa	15515as
			17750va		
0500	0600		Bhutan, BBS	6035as	
0500	0600		Canada, CFRX Toronto ON	6070na	
0500	0600		Canada, CKZN St John's NF	6160na	
0500	0600		Canada, CKZU Vancouver BC	6160na	
0500	0600		China, China Radio Intl	5960na	6190na
			7220af	11880as	15350as
			17505va	17540as	17725as
			17725as		17855as
0500	0600		Costa Rica, University Network	5030va	6150va
			7375va	9725va	
0500	0600		Cuba, Radio Havana	6000na	6060na
			6180na	9550va	9600va
			11760va		11760va
0500	0600		Germany, CVC International	9430af	
0500	0600		Guyana, Voice of	3291do	
0500	0600		Japan, Radio Japan/NHK World	6110na	5975eu
			7230eu	15195as	17810as
			21755pa		
0500	0600		Malaysia, RTM/Trax FM	7295as	
0500	0600		Malaysia, RTM/Voice of Malaysia	9750as	6175as
			15295as		
0500	0600	vl	Namibia, Namibian BC Corp	3270do	3290do
			6060do	6175do	
0500	0600		Nigeria, Radio/Ibadan	6050do	
0500	0600		Nigeria, Radio/Kaduna	4770do	6090do
0500	0600		Nigeria, Radio/Lagos	3326do	4990do
0500	0600		Nigeria, Voice of	15120af	
0500	0600	vl	Papua New Guinea, Wantok R. Light		7120va
0500	0600		Russia, Voice of	7150na	7255na
			9840na	13665na	7350na
0500	0600		Singapore, MediaCorp Radio	6150do	
0500	0600		Swaziland, TWR	4775af	6120af
0500	0600	vl	Uganda, Radio	4976do	5026do
0500	0600	DRM	UK, BBC World Service	3255af	6005as
0500	0600		UK, BBC World Service	6190af	6195af
			7160af	7160af	9410eu
			9440eu	11665af	11695as
			11765af	11955as	11760as
			15575as	17640af	17760as
			17790as		
			21660as		
0500	0600	mtwhf	UK, BBC World Service	15420af	
0500	0600	vl/ mtwhf	UK, Sudan Radio Service	9525af	
0500	0600		USA, American Forces Radio	4319usb	5446usb
			5765usb	6350usb	7811usb
			10320usb		
			12133usb	13362usb	
0500	0600		USA, KAIJ Dallas TX	5755na	
0500	0600		USA, KTBN Salt Lake City UT	7505na	
0500	0600		USA, KWHR Naalehu HI	11565as	13650as
0500	0600		USA, Voice of America	4930af	6080af
			9885af	15580af	
0500	0600		USA, WBCQ Kennebunk ME	5110na	7415na
0500	0600		USA, WBOH Newport NC	5920am	
0500	0600		USA, WEWN Birmingham AL	5850va	7570va
0500	0600		USA, WHRA Greenbush ME	5755na	
0500	0600	mtwhf	USA, WHRI Cypress Creek SC	5835am	7490am
0500	0600	as	USA, WHRI Cypress Creek SC	7315am	
0500	0600		USA, WMLK Bethel PA	9265eu	
0500	0600		USA, WRMI Miami FL	9955am	
0500	0600		USA, WTJC Newport NC	9370na	
0500	0600		USA, WWCR Nashville TN	3215na	5070na
			5765na	5935na	
0500	0600		USA, WWRB Manchester TN	3185oc	5085na
0500	0600		USA, WYFR/Family R Okeechobee FL	6855na	
			7520va		
0500	0600		Uzbekistan, CVC International	13685as	
0500	0600		Zambia, Christian Voice	5915al	6065af
0500	0600	vl	Zimbabwe, ZBC Corp	5975do	
0525	0600	vl	Ghana, Ghana BC Corp	3366do	4915do
0530	0600		Thailand, Radio	13770eu	
0545	0600	vl	Rwanda, Radio	6055do	

**0600 UTC - 1AM EST / 12AM CST / 10PM PST**

0600	0615	as	South Africa, TWR	11640af	
0600	0620		Vatican City, Vatican Radio	4005eu	7250eu
0600	0630		Australia, Radio	9660as	12080as
			15160as	15240pa	15515as
			17750va		17750va
0600	0630	mtwhf	France, Radio France Intl	7315af	9865af
			11995af	13680af	15160af
0600	0630		Germany, Deutsche Welle	7240af	7285af
			9565af	12045af	
0600	0630		USA, Voice of America	6080af	6105af
			9885af	15580af	
0600	0645	mtwhf	South Africa, TWR	11640af	
0600	0700		Anguilla, University Network	6090am	
0600	0700		Armenia, CVC International	15515as	
0600	0700		Australia, ABC NT Alice Springs		2310do

0600	0700	4835do		
0600	0700	Australia, ABC NT Katherine	5025do	
0600	0700	Australia, ABC NT Tennant Creek	4910do	
0600	0700	Australia, CVC International	15335as	
0600	0700	Canada, CFRX Toronto ON	6070na	
0600	0700	Canada, CFVP Calgary AB	6030na	
0600	0700	Canada, CKZN St John's NF	6160na	
0600	0700	Canada, CKZU Vancouver BC	6160na	
0600	0700	China, China Radio Intl	6115na	11750af
		11770as	11880as	13645as
		15350as	15465as	15140as
		17710as		17505va
0600	0700	Costa Rica, University Network	5030va	6150va
		7375va	9725va	11870va
0600	0700	Cuba, Radio Havana	6000va	6060va
		6180na	9550va	9600va
				11760va
0600	0700	Germany, CVC International	11720af	
0600	0700	Germany, Deutsche Welle	6140eu	
0600	0700	Ghana, Ghana BC Corp	3366do	4915do
0600	0700	Guyana, Voice of	3291do	
0600	0700	Japan, Radio Japan/NHK World		7230eu
		11690va	11715eu	11740as
				17870pa
0600	0700	Liberia, ELWA	4760do	
0600	0700	Malaysia, RTM/Trax FM	7295as	
0600	0700	Malaysia, RTM/Voice of Malaysia		6175as
		9750as	15295as	
0600	0700	Namibia, Namibian BC Corp	3270do	3290do
		6060do	6175do	
0600	0700	New Zealand, Radio NZ Intl	9765pa	
0600	0700	New Zealand, Radio NZ Intl	9890pa	
0600	0700	Nigeria, Radio/Ibadan	6050do	
0600	0700	Nigeria, Radio/Kaduna	4770do	6090do
0600	0700	Nigeria, Radio/Lagos	3326do	4990do
0600	0700	Nigeria, Voice of	15120af	
0600	0700	Papua New Guinea, Wantok R. Light		7120va
0600	0700	Russia, Voice of	11575eu	17665oc
0600	0700	Sierra Leone, SLBS 3316do		
0600	0700	Singapore, MediaCorp Radio	6150do	
0600	0700	Solomon Islands, SIBC	5020do	9545do
0600	0700	South Africa, Channel Africa	7240af	15255af
0600	0700	Swaziland, TWR	4775af	9500af
0600	0700	UK, BBC World Service	1296eu	
0600	0700	UK, BBC World Service	6005af	6190af
		6195eu	7160eu	9410eu
		11940af	12095eu	11765af
		15360as	15420af	11955as
		17760as	17790as	15575as
				17640af
0600	0700	USA, American Forces Radio	4319usb	5446usb
		5765usb	6350usb	7811usb
		12133usb	13362usb	10320usb
0600	0700	USA, KAIJ Dallas TX	5755na	
0600	0700	USA, KATN Salt Lake City UT	7505na	
0600	0700	USA, KWHR Naalehu HI	11565as	13650as
0600	0700	USA, WBCQ Kennebunk ME	5110na	7415na
0600	0700	USA, WBOH Newport NC	5920am	
0600	0700	USA, WEWN Birmingham AL	5850va	7570va
0600	0700	USA, WHRA Greenbush ME	7465na	
0600	0700	USA, WHRI Cypress Creek SC	5835am	
0600	0700	USA, WHRI Cypress Creek SC	7315am	7490am
0600	0700	USA, WMLK Bethel PA	9265eu	
0600	0700	USA, WRMI Miami FL	9955am	
0600	0700	USA, WTJC Newport NC	9370na	
0600	0700	USA, WWCR Nashville TN	3215na	5070na
		5765na	5935na	
0600	0700	USA, WWRB Manchester TN	3185oc	5085na
0600	0700	USA, WYFR/Family R Okeechobee FL	5945am	
		6000am	7780va	9860na
		11630va		11580af
0600	0700	Vanuatu, Radio	4960do	
0600	0700	Yemen, Rep of Yemen Radio	9780me	
0600	0700	Zambia, Christian Voice	5915al	6065af
0600	0700	Zimbabwe, ZBC Corp	5975do	
0605	0620	Austria, Radio Austria Intl	17870me	
0605	0630	Austria, Radio Austria Intl	17870me	
0630	0656	Romania, Radio Romania Intl	7180va	9690va
		15135va	17780va	
0630	0700	Australia, Radio	9660as	12080as
		15160as	15240pa	13670as
		17750va		15515as
0630	0700	UK, BBC World Service	11795af	
0630	0700	USA, Voice of America	6080af	9885af
		15580af		
0630	0700	Vatican City, Vatican Radio	7360af	9660af
		11625af		
0635	0700	Austria, Radio Austria Intl	17870me	
0645	0700	Austria, Radio Austria Intl	17870me	

0700	0757	DRM	Netherlands, Radio	7300eu
0700	0800		Anguilla, University Network	6090am
0700	0800		Australia, ABC NT Alice Springs	2310do
			4835do	
0700	0800		Australia, ABC NT Katherine	5025do
0700	0800		Australia, ABC NT Tennant Creek	4910do
0700	0800		Australia, CVC International	15335as
0700	0800		Australia, CVC International	15335as
0700	0800		Australia, Radio	9660as
			13630as	9710as
			17750va	15160pa
				15240pa
				15415as
0700	0800		Canada, CFRX Toronto ON	6070na
0700	0800		Canada, CFVP Calgary AB	6030na
0700	0800		Canada, CKZN St John's NF	6160na
0700	0800		Canada, CKZU Vancouver BC	6160na
0700	0800		China, China Radio Intl	11785eu
			13645as	15465as
			17790as	17490eu
				17540as
0700	0800		Costa Rica, University Network	5030va
			7375va	9725va
				11870va
0700	0800		Germany, CVC International	15640af
0700	0800		Germany, Deutsche Welle	6140eu
0700	0800	vl	Ghana, Ghana BC Corp	3366do
0700	0800		Greece, Voice of	12105eu
0700	0800		Guyana, Voice of	3291do
0700	0800		Liberia, ELWA	4760do
0700	0800		Liberia, Star Radio	9525af
0700	0800		Malaysia, RTM/Trax FM	7295as
0700	0800		Malaysia, RTM/Voice of Malaysia	6175as
			9750as	15295as
0700	0800		Myanmar, Radio	9730do
0700	0800	vl	Namibia, Namibian BC Corp	3270do
			6060do	6175do
0700	0800		New Zealand, Radio NZ Intl	9765pa
0700	0800	DRM	New Zealand, Radio NZ Intl	9890pa
0700	0800		Nigeria, Radio/Ibadan	6050do
0700	0800		Nigeria, Radio/Kaduna	4770do
0700	0800		Nigeria, Radio/Lagos	3326do
0700	0800		Nigeria, Voice of	15120af
0700	0800	DRM	Papua New Guinea, Wantok R. Light	7120va
0700	0800		Russia, Voice of	11615eu
0700	0800	irreg/vl	Sierra Leone, SLBS 3316do	
0700	0800		Singapore, MediaCorp Radio	6150do
0700	0800	vl	Solomon Islands, SIBC	5020do
0700	0800	vl	South Africa, Channel Africa	9620af
0700	0800	Sat/Sun	Swaziland, TWR	4775af
0700	0800		Swaziland, TWR	6120af
0700	0800		Taiwan, Radio Taiwan Intl	9500af
0700	0800		UK, BBC World Service	5950na
0700	0800	DRM	UK, BBC World Service	1296eu
0700	0800	mtwhf	UK, BBC World Service	15400af
0700	0800		UK, BBC World Service	5875eu
			6195eu	6190af
			11760me	7320eu
			11955as	9410eu
			15575as	11795eu
			17790as	11940af
				15360as
				15420af
0700	0800		USA, American Forces Radio	4319usb
			5765usb	6350usb
			12133usb	7811usb
				5446usb
				10320usb
0700	0800		USA, KAIJ Dallas TX	5755na
0700	0800		USA, KATN Salt Lake City UT	7505na
0700	0800		USA, KWHR Naalehu HI	11565as
0700	0800		USA, WBCQ Kennebunk ME	5110na
0700	0800		USA, WBOH Newport NC	7415na
0700	0800		USA, WEWN Birmingham AL	5920am
0700	0800		USA, WHRA Greenbush ME	5850va
0700	0800		USA, WHRI Cypress Creek SC	7570va
0700	0800		USA, WHRI Cypress Creek SC	7465na
0700	0800		USA, WHRI Cypress Creek SC	5835am
0700	0800	twhfa	USA, WHRI Cypress Creek SC	7315am
0700	0800		USA, WMLK Bethel PA	7490am
0700	0800		USA, WRMI Miami FL	9265eu
0700	0800		USA, WTJC Newport NC	9955am
0700	0800		USA, WWCR Nashville TN	9370na
0700	0800		USA, WWRB Manchester TN	9370na
0700	0800		USA, WYFR/Family R Okeechobee FL	3215na
			5765na	5935na
			9985af	5070na
0700	0800		USA, WWRB Manchester TN	3185oc
0700	0800		USA, WYFR/Family R Okeechobee FL	5085na
			7455na	6855na
			9985af	7780va
				9495am
				9715na
0700	0800	vl	Vanuatu, Radio	4960do
0700	0800		Zambia, Christian Voice	5915al
0730	0745	mtwhfa	Vatican City, Vatican Radio	4005eu
			7250eu	6185eu
			9645eu	11740eu
				15595va
0730	0800	mtwhfa	Australia, HCJB Global	11750pa
0730	0800		Bulgaria, Radio	9500eu
0730	0800		Pakistan, Radio	11900eu
0745	0800	s	Albania, TWR Europe	17835eu
0745	0800	s	Monaco, TWR Europe	11865eu
				9800eu

**0700 UTC - 2AM EST / 1AM CST / 11PM PST**

0700	0705	Croatia, Croatian Radio	9470oc	11690oc
0700	0706	UK, BBC World Service	6005af	
0700	0730	France, Radio France Intl	11725af	15605af
0700	0730	Slovakia, Radio Slovakia Int	13715oc	15460oc

**0800 UTC - 3AM EST / 2AM CST / 12AM PST**

0800	0825	Malaysia, RTM/Voice of Malaysia	6175as	
		9750as	15295as	
0800	0827	Czech Rep, Radio Prague	7345eu	9860eu
0800	0830	Australia, ABC NT Katherine	5025do	
0800	0830	Australia, ABC NT Tennant Creek		4910do

0800	0830		Liberia, ELWA	4760do	
0800	0830		Myanmar, Radio	9730do	
0800	0830		Pakistan, Radio	15100eu	17835eu
0800	0845	a	Guam, TWR/KTWR	11840pa	
0800	0900	smtwhf	Albania, TWR Europe		11865eu
0800	0900		Anguilla, University Network	6090am	
0800	0900		Australia, ABC NT Alice Springs	4835do	2310do
0800	0900		Australia, CVC International	15335as	
0800	0900	mtwhfa	Australia, HCJB Global	11750pa	
0800	0900		Australia, Radio	5995va	9710va
			12080as	13630va	15415as
			15415as		17750va
0800	0900		Canada, CFRX Toronto ON	6070na	
0800	0900		Canada, CFVP Calgary AB	6030na	
0800	0900		Canada, CKZN St John's NF	6160na	
0800	0900		Canada, CKZU Vancouver BC	6160na	
0800	0900		China, China Radio Intl	9415as	11785eu
			11880as	15350as	15465as
			17540as		17490eu
0800	0900		Costa Rica, University Network	5030va	6150va
			7375va	9725va	11870va
0800	0900		Germany, CVC International	15640af	
0800	0900		Germany, Deutsche Welle	6140eu	
0800	0900	vl	Ghana, Ghana BC Corp	3366do	4915do
0800	0900	mtwhf	Guam, TWR/KTWR	11840pa	
0800	0900		Guyana, Voice of	3291do	5950do
0800	0900		Indonesia, Voice of	15150al	9525as
					11785pa
0800	0900		Liberia, Star Radio	9525af	
0800	0900		Malaysia, RTM/Trax FM	7295as	
0800	0900	s	Monaco, TWR Europe	9800eu	
0800	0900	mtwhf	Monaco, TWR Europe	9800eu	
0800	0900		New Zealand, Radio NZ Intl	9765pa	
0800	0900	DRM	New Zealand, Radio NZ Intl	9890pa	
0800	0900		Nigeria, Radio/Ibadan	6050do	
0800	0900		Nigeria, Radio/Kaduna	4770do	6090do
0800	0900		Nigeria, Radio/Lagos	3326do	4990do
0800	0900		Papua New Guinea, Catholic Radio	4960do	
0800	0900		Papua New Guinea, NBC	4890do	
0800	0900	vl	Papua New Guinea, Wantok R. Light		7120va
0800	0900		Russia, Voice of	15195as	17495oc
			17805oc		
0800	0900	DRM	Russia, Voice of	12060eu	
0800	0900	irreg/ vl	Sierra Leone, SLBS	3316do	
0800	0900		Singapore, MediaCorp Radio	6150do	
0800	0900	vl	Solomon Islands, SIBC	5020do	9545do
0800	0900	vl	South Africa, Channel Africa	9620af	
0800	0900		South Korea, KBS World Radio	9640eu	9570as
0800	0900		Swaziland, TWR	6120af	9500af
0800	0900		Taiwan, Radio Taiwan Intl	9610as	
0800	0900	DRM	UK, BBC World Service	1296eu	
0800	0900		UK, BBC World Service	5875eu	6190af
			6195eu	7320eu	11760va
			11940af	12095eu	15285as
			17885af	21470af	21660as
0800	0900	mtwhf	UK, BBC World Service	15400af	17830af
0800	0900	Sat/Sun	UK, BBC World Service	15575as	17830af
0800	0900	f	UK, Bible Voice	5945eu	
0800	0900	a	UK, Bible Voice	5945eu	
0800	0900	s	UK, Bible Voice	5945eu	
0800	0900		USA, American Forces Radio	4319usb	5446usb
			5765usb	6350usb	7811usb
			12133usb	13362usb	10320usb
0800	0900		USA, KAIJ Dallas TX	5755na	
0800	0900		USA, KNLS Anchor Point AK	6150as	
0800	0900		USA, KTBN Salt Lake City UT	7505na	
0800	0900		USA, KWHR Naalehu HI	9930as	11565as
0800	0900		USA, WBOH Newport NC	5920am	
0800	0900		USA, WEWN Birmingham AL	5850na	
0800	0900		USA, WHRA Greenbush ME	7465na	
0800	0900	twhfa	USA, WHRI Cypress Creek SC	5835am	
0800	0900		USA, WHRI Cypress Creek SC	7315	an
			7490am		
0800	0900		USA, WMLK Bethel PA	9265eu	
0800	0900		USA, WRMI Miami FL	9955am	
0800	0900		USA, WTJC Newport NC	9370na	
0800	0900		USA, WWCR Nashville TN	3215na	5070na
			5765na	5935na	
0800	0900		USA, WWRB Manchester TN	3185oc	5085na
0800	0900		USA, WYFR/Family R Okeechobee FL	6855na	7455na
			7455na		5950na
0800	0900	vl	Vanuatu, Radio	4960do	
0800	0900		Zambia, Christian Voice	5915al	6065af
0805	0900	mtwhf	Guam, TWR/KTWR	15170as	
0815	0850	a	Albania, TWR Europe		11865eu
0815	0850	a	Monaco, TWR Europe		9800eu
0830	0900		Australia, ABC NT Katherine	2485do	
0830	0900		Australia, ABC NT Tennant Creek		2325do

0900	0915	s	UK, Bible Voice	5945eu	
0900	0920	smtwhf	Albania, TWR Europe		11865eu
0900	0920	s	Monaco, TWR Europe		9800eu
0900	0920	mtwhf	Monaco, TWR Europe		9800eu
0900	0930	mtwhfa	Australia, HCJB Global		11750pa
0900	0945	s	UK, Bible Voice	5945eu	
0900	1000		Anguilla, University Network	6090am	
0900	1000		Australia, ABC NT Alice Springs	4835do	2310do
0900	1000		Australia, ABC NT Katherine	2485do	
0900	1000		Australia, ABC NT Tennant Creek		2325do
0900	1000		Australia, CVC International	11955as	
0900	1000		Australia, Radio	9580va	9590va
0900	1000		Bhutan, BBS	6035as	
0900	1000		Canada, CFRX Toronto ON	6070na	
0900	1000		Canada, CFVP Calgary AB	6030na	
0900	1000		Canada, CKZN St John's NF	6160na	
0900	1000		Canada, CKZU Vancouver BC	6160na	
0900	1000		China, China Radio Intl	9415as	15210as
			15350as	17490eu	17690as
					17750as
0900	1000		Costa Rica, University Network	5030va	6150va
			7375va	9725va	11870va
0900	1000		Germany, Deutsche Welle	6140eu	17700as
			21780eu		
0900	1000		Guyana, Voice of	3291do	5950do
0900	1000	Sat/Sun	Italy, IRRS	9310eu	13840eu
0900	1000		Malaysia, RTM/Trax FM	7295as	
0900	1000	vl	Namibia, Namibian BC Corp	3270do	3290do
			6060do	6175do	
0900	1000		New Zealand, Radio NZ Intl	9765pa	
0900	1000	DRM	New Zealand, Radio NZ Intl	9890pa	
0900	1000		Nigeria, Radio/Ibadan	6050do	
0900	1000		Nigeria, Radio/Kaduna	4770do	6090do
0900	1000		Nigeria, Radio/Lagos	3326do	4990do
0900	1000		Papua New Guinea, Catholic Radio	4960do	
0900	1000	vl	Papua New Guinea, Wantok R. Light		7120va
0900	1000	DRM	Russia, Voice of	17495oc	17665oc
0900	1000	vl	Russia, Voice of	11615eu	
0900	1000	vl	Rwanda, Radio	6055do	
0900	1000	irreg/ vl	Sierra Leone, SLBS	3316do	
0900	1000		Singapore, MediaCorp Radio	6150do	
0900	1000	vl	Solomon Islands, SIBC	5020do	9545do
0900	1000	vl	South Africa, Channel Africa	9620af	
0900	1000	DRM	UK, BBC World Service	1296eu	
0900	1000	mtwhf	UK, BBC World Service	15400af	15575as
			17830af		
0900	1000		UK, BBC World Service	5975as	6190af
			6195as	7320eu	9470eu
			11760me	11940af	12095eu
			15485eu	17760as	17790as
			21470af	21660as	17885af
0900	1000	Sat/Sun	UK, BBC World Service	15575as	17830af
0900	1000		USA, American Forces Radio	4319usb	5446usb
			5765usb	6350usb	7811usb
			12133usb	13362usb	10320usb
0900	1000		USA, KAIJ Dallas TX	5755na	
0900	1000		USA, KTBN Salt Lake City UT	7505na	
0900	1000		USA, KWHR Naalehu HI	9930as	11565as
0900	1000		USA, WBCQ Kennebunk ME	5110na	7415na
0900	1000		USA, WBOH Newport NC	5920am	
0900	1000		USA, WEWN Birmingham AL	5850na	
0900	1000		USA, WHRI Cypress Creek SC	7315am	7520am
0900	1000		USA, WRMI Miami FL	9955am	
0900	1000		USA, WTJC Newport NC	9370na	
0900	1000		USA, WWCR Nashville TN	3215na	5070na
			5765na	5935na	
0900	1000		USA, WWRB Manchester TN	3185oc	5085na
0900	1000		USA, WYFR/Family R Okeechobee FL	6885na	7455na
			7455na		9460va
0900	1000	vl	Vanuatu, Radio	4960do	
0900	1000		Zambia, Christian Voice	5915al	6065af
0930	1000		Australia, HCJB Global	15360as	
0930	1000		Lithuania, Radio Vilnius	9710eu	

**1000 UTC - 5AM EST / 4AM CST / 2AM PST**

1000	1027		Czech Rep, Radio Prague	9955am	15710as
			21745af		
1000	1030		Mongolia, Voice of	12085as	
1000	1030		UK, BBC World Service	5975as	15285as
			21660as		
1000	1057		Netherlands, Radio	6040as	9795as
			12065as		
1000	1059		New Zealand, Radio NZ Intl	9765pa	
1000	1100		Anguilla, University Network	11775am	
1000	1100		Australia, ABC NT Alice Springs	4835do	2310do
1000	1100		Australia, ABC NT Katherine	2485do	
1000	1100		Australia, ABC NT Tennant Creek		2325do
1000	1100		Australia, CVC International	11955as	
1000	1100		Australia, HCJB Global	15430as	

**0900 UTC - 4AM EST / 3AM CST / 1AM PST**

0900	0900		USA, WBCQ Kennebunk ME	5110na	7415na
0900	0915	vl	Ghana, Ghana BC Corp	3366do	4915do

1000	1100		Australia, Radio	9580va	9590va	15415as
1000	1100	DRM	Austria, CVC International		9760eu	
1000	1100		Canada, CFRX Toronto ON		6070na	
1000	1100		Canada, CFVP Calgary AB		6030na	
1000	1100		Canada, CKZN St John's NF		6160na	
1000	1100		Canada, CKZU Vancouver BC		6160na	
1000	1100		China, China Radio Intl		5955as	7135as
			7215as	13590as	13720as	15190as
			15210as	15350as	17490eu	17690as
			17750as			
1000	1100		Costa Rica, University Network	5030va	6150va	
			7375va	9725va	11870va	13750va
1000	1100		Guyana, Voice of	3291do	5950do	
1000	1100		India, All India Radio		13710oc	15020as
			15235as	17510pa	17800as	17895pa
1000	1100	Sat/Sun	Italy, IRRS	9310eu	13840eu	
1000	1100		Japan, Radio Japan/NHK World		6120na	
			9695as	11730as	17585va	17720me
			21755oc			
1000	1100		Malaysia, RTM/Trax FM		7295as	
1000	1100	DRM	New Zealand, Radio NZ Intl		9890pa	
1000	1100		Nigeria, Voice of	15120af		
1000	1100		North Korea, Voice of Korea	6185as	6285am	
			9850as			
1000	1100		Papua New Guinea, Catholic Radio		4960do	
1000	1100		Papua New Guinea, NBC		4890do	
1000	1100	vl	Papua New Guinea, Wantok R. Light		7120va	
1000	1100		Singapore, MediaCorp Radio		6150do	
1000	1100	vl	Solomon Islands, SIBC		5020do	9545do
1000	1100	vl	South Africa, Channel Africa		9620af	
1000	1100	DRM	UK, BBC World Service		1296eu	
1000	1100		UK, BBC World Service		6190af	6195as
			7320eu	9470eu	9740as	11760me
			11940af	11945as	15485eu	15575as
			17640eu	17790as	17885af	21470af
1000	1100	Sat/Sun	UK, BBC World Service		17830af	
1000	1100		USA, American Forces Radio	4319usb	5446usb	
			5765usb	6350usb	7811usb	10320usb
			12133usb	13362usb		
1000	1100		USA, KAIJ Dallas TX		5755na	
1000	1100		USA, KNLS Anchor Point AK		6150as	
1000	1100		USA, KTVN Salt Lake City UT		7505na	
1000	1100		USA, KWHR Naalehu HI		9930as	11565as
1000	1100		USA, WBCQ Kennebunk ME		5110na	7415na
1000	1100		USA, WBOH Newport NC		5920am	
1000	1100		USA, WEWN Birmingham AL		5850na	
1000	1100		USA, WHRI Cypress Creek SC		7315am	7520am
1000	1100		USA, WRMI Miami FL		9955am	
1000	1100		USA, WTJC Newport NC		9370na	
1000	1100		USA, WWCN Nashville TN		5070na	5765na
			5935na	9985na		
1000	1100		USA, WWRB Manchester TN		3185oc	5085na
1000	1100		USA, WYFR/Family R Okeechobee FL		5950na	
			6855na	6890na	7455na	9460va
1000	1100		Zambia, Christian Voice		5915al	6065af
1030	1045	mtwhf	Ethiopia, Radio	5990af	7110af	9704af
1030	1045		Israel, Kol Israel	15760eu	17535eu	
1030	1058		Vietnam, Voice of	7285as		
1030	1100		Australia, HCJB Global		15400as	
1030	1100		Iran, Voice of the Islamic Rep		15460as	17660as
1030	1100	Sat/Sun	Italy, IRRS	9310va		
1030	1100		UK, BBC World Service		9605as	11750as
			15285as	15545as		
1030	1100	s	UK, Bible Voice	5950as		

**1100 UTC - 6AM EST / 5AM CST / 3AM PST**

1100	1105		Pakistan, Radio	15100as	17835as	
1100	1127		Iran, Voice of the Islamic Rep		15460as	17600as
1100	1128		Vietnam, Voice of	9840as	7220as	7285as
1100	1130		Australia, HCJB Global		15400as	
1100	1130	mtwhf	UK, BBC World Service		6130am	
1100	1200		Anguilla, University Network		11775am	
1100	1200		Australia, ABC NT Alice Springs		4835do	2310do
1100	1200		Australia, ABC NT Katherine		2485do	
1100	1200		Australia, ABC NT Tennant Creek			2325do
1100	1200		Australia, CVC International		13635as	
1100	1200		Australia, Radio	5995va	6020va	9475as
			9560pa	9580va	9590va	12080as
1100	1200	Sat/Sun	Canada, CBC NQ SW Service		9625na	
1100	1200		Canada, CFRX Toronto ON		6070na	
1100	1200		Canada, CFVP Calgary AB		6030na	
1100	1200		Canada, CKZN St John's NF		6160na	
1100	1200		Canada, CKZU Vancouver BC		6160na	
1100	1200		China, China Radio Intl		5955as	5960na
			9570as	11650as	11795as	13590as
			13645as	13665eu	13720as	17490eu
1100	1200		Costa Rica, University Network	5030va	6150va	
			7375va	9725va	11870va	13750va
1100	1200	s	Germany, Universal Life		6055me	
1100	1200	Sat/Sun	Italy, IRRS	9310eu	15735eu	

1100	1200		Japan, Radio Japan/NHK World		6120na	
			9695as	11730as		
1100	1200	vl	Libya, Voice of Africa		17725af	21695af
1100	1200		Malaysia, RTM/Trax FM		7295as	
1100	1200		New Zealand, Radio NZ Intl		13840pa	
1100	1200	DRM	New Zealand, Radio NZ Intl		9890pa	
1100	1200		Nigeria, Voice of	15120af		
1100	1200		Papua New Guinea, Catholic Radio		4960do	
1100	1200		Papua New Guinea, NBC		4890do	
1100	1200	vl	Papua New Guinea, Wantok R. Light		7120va	
1100	1200		Singapore, Radio Singapore Intl		6080as	
			6150as			
1100	1200	vl	South Africa, Channel Africa		9620af	
1100	1200		Taiwan, Radio Taiwan Intl		7445as	
1100	1200	DRM	UK, BBC World Service		1296eu	
1100	1200	Sat/Sun	UK, BBC World Service		5875am	6130am
1100	1200		UK, BBC World Service		6190af	6195as
			7320eu	9470eu	9740as	11760me
			11940af	11945as	15485eu	15575as
			17640eu	17790as	17830af	17885af
			21470af			
1100	1200	Sat/Sun	UK, Bible Voice	5950as		
1100	1200		USA, American Forces Radio	4319usb	5446usb	
			5765usb	6350usb	7811usb	10320usb
			12133usb	13362usb		
1100	1200		USA, KAIJ Dallas TX		5755na	
1100	1200		USA, KTVN Salt Lake City UT		7505na	
1100	1200		USA, KWHR Naalehu HI		9930as	11565as
1100	1200		USA, WBOH Newport NC		5920am	
1100	1200		USA, WEWN Birmingham AL		5850na	
1100	1200		USA, WHRI Cypress Creek SC		5875am	7315am
1100	1200		USA, WINB Red Lion PA		9265am	
1100	1200		USA, WRMI Miami FL		9955am	
1100	1200		USA, WTJC Newport NC		9370na	
1100	1200		USA, WWCN Nashville TN		5070na	5765na
			5935na	15825na		
1100	1200		USA, WWRB Manchester TN		3185oc	5085na
1100	1200		USA, WYFR/Family R Okeechobee FL		5950na	
			6890na	7780na	11725am	11725na
			11830na			
1100	1200		Zambia, Christian Voice		5915al	6065af
1115	1130	mtwhf	UK, Bible Voice	5950as		
1130	1145		UK, BBC World Service		7135as	11920as
1130	1157		Czech Rep, Radio Prague		11640eu	17545va
1130	1200	mtwhfa	Australia, HCJB Global		15430as	
1130	1200	a	Germany, Universal Life		6055me	
1130	1200		Guam, AWR/KSDA	15260as		
1130	1200	mtwhf	UK, BBC World Service		5875am	6130am
1130	1200		Vatican City, Vatican Radio		15595va	17765va
1138	1200	s	Greece, Voice of	9420eu	17525va	
1157	1200		Greece, Macedonias Radio		9935eu	

**1200 UTC - 7AM EST / 6AM CST / 4AM PST**

1200	1215	f	UK, Bible Voice	5950as		
1200	1230		France, Radio France Intl		15275af	17815af
			21620af			
1200	1257		Netherlands, Radio		11675na	
1200	1259		Canada, Radio Canada Intl		7105as	9665as
1200	1259	DRM	New Zealand, Radio NZ Intl		9890pa	
1200	1300		Anguilla, University Network		11775am	
1200	1300		Australia, ABC NT Alice Springs		4835do	2310do
1200	1300		Australia, ABC NT Katherine		2485do	
1200	1300		Australia, ABC NT Tennant Creek			2325do
1200	1300		Australia, CVC International		13635as	
1200	1300		Australia, Radio	5995va	6020va	9475as
			9560pa	9580va	9590va	
1200	1300	Sat/Sun	Canada, CBC NQ SW Service		9625na	
1200	1300		Canada, CFRX Toronto ON		6070na	
1200	1300		Canada, CFVP Calgary AB		6030na	
1200	1300		Canada, CKZN St John's NF		6160na	
1200	1300		Canada, CKZU Vancouver BC		6160na	
1200	1300		China, China Radio Intl		5955as	7250as
			9460as	9730as	9760as	11650as
			11690as	11980as	12080as	13655eu
			13790eu	17490eu		
1200	1300		Costa Rica, University Network	9725va	11870va	
			13750va			
1200	1300		Germany, CVC International		15715me	
1200	1300	Sat/Sun	Germany, Universal Life		6045me	
1200	1300	Sat/Sun	Italy, IRRS	9310af	15735eu	
1200	1300	f	Italy, IRRS	15750va		
1200	1300	vl	Libya, Voice of Africa		17625af	17660af
			17670af	17675af	17680af	
1200	1300		Malaysia, RTM/Trax FM		7295as	
1200	1300		New Zealand, Radio NZ Intl		13840pa	
1200	1300		Nigeria, Voice of	15120af		
1200	1300		Papua New Guinea, Catholic Radio		4960do	
1200	1300		Papua New Guinea, NBC		4890do	
1200	1300	vl	Papua New Guinea, Wantok R. Light		7120va	
1200	1300		Singapore, Radio Singapore Intl		6080as	

1200	1300	vi	6150as				
1200	1300		South Africa, Channel Africa	9620af			
1200	1300		South Korea, KBS World Radio		9650na		
1200	1300		Taiwan, Radio Taiwan Intl	7130am			
1200	1300		UAE, AWR Africa	1514Oas			
1200	1300	DRM	UK, BBC World Service	1296eu			
1200	1300		UK, BBC World Service	5975as	6190af		
			6195as	7320eu	9470eu	9660am	
			9740as	9750am	11760me	11895as	
			11940as	15310as	15485eu	15575as	
			17640eu	17790as	17830af	17885af	
			21470af				
1200	1300		Ukraine, Radio Ukraine Intl	9925eu			
1200	1300		USA, American Forces Radio	4319usb	5446usb		
			5765usb	6350usb	7811usb	10320usb	
			12133usb	13362usb			
1200	1300		USA, KAIJ Dallas TX	5755na			
1200	1300		USA, KNLS Anchor Point AK	6150as	6915as		
1200	1300		USA, KTNB Salt Lake City UT	7505na			
1200	1300		USA, KWHR Naalehu HI	11565as	12130as		
1200	1300		USA, Voice of America	9645va	9760va		
			11705va	11730va	15190va		
1200	1300		USA, WBOH Newport NC	5920am			
1200	1300		USA, WEWN Birmingham AL	9955na			
1200	1300		USA, WHRA Greenbush ME	15665na			
1200	1300		USA, WHRI Cypress Creek SC	7520am	9660am		
1200	1300		USA, WINB Red Lion PA	9265am			
1200	1300		USA, WRMI Miami FL	9955am			
1200	1300		USA, WTJC Newport NC	9370na			
1200	1300		USA, WWCR Nashville TN	5070na	5765na		
			5935na	15825na			
1200	1300		USA, WWRB Manchester TN	9385na			
1200	1300		USA, WYFR/Family R Okeechobee FL	7780na	6890na		
			11530am	11970na			
1200	1300	DRM	Vatican City, Vatican Radio	13770am			
1200	1300		Zambia, Christian Voice	5915al	6065af		
1215	1300		Egypt, Radio Cairo	17835as			
1230	1258		Vietnam, Voice of	9840as	12020as		
1230	1300		Bangladesh, Bangla Betar	7185as			
1230	1300		Bulgaria, Radio	11700eu	15700eu		
1230	1300		Thailand, Radio	9810oc			
1245	1300	s	Australia, HCJB Global	15430as			
1255	1258		Finland, YLE/Radio Finland	13715do	15400do		
1257	1300		Greece, Voice of	9935eu			

**1300 UTC - 8AM EST / 7AM CST / 5AM PST**

1300	1300		Germany, CVC International	15715me			
1300	1330		Egypt, Radio Cairo	17835as			
1300	1350	s	Italy, IRRS	15735as			
1300	1356		Romania, Radio Romania Intl	15105eu	17745eu		
1300	1359		Poland, Polish Radio	5975eu	9525eu		
1300	1400		Anguilla, University Network	11775am			
1300	1400		Australia, CVC International	13635as			
1300	1400		Australia, Radio	5995va	6020va	9560as	
			9580va	9590va			
1300	1400	Sat/Sun	Canada, CBC NQ SW Service	9625na			
1300	1400		Canada, CFRX Toronto ON	6070na			
1300	1400		Canada, CFVP Calgary AB	6030na			
1300	1400		Canada, CKZN St John's NF	6160na			
1300	1400		Canada, CKZU Vancouver BC	6160na			
1300	1400		China, China Radio Intl	5955as	7300as		
			9570na	9655as	9730as	9765as	
			9870as	11760as	11885na	11900as	
			11980as	13610eu	13790eu	15230na	
1300	1400		Costa Rica, University Network	9725va	11870va		
			13750va				
1300	1400		Germany, Deutsche Welle	6140eu			
1300	1400		Germany, Overcomer Ministries		6110na		
1300	1400	vi	Libya, Voice of Africa	17625af	17660af		
			17670af	17675af	17680af		
1300	1400		Malaysia, RTM/Trax FM	7295as			
1300	1400	DRM	New Zealand, Radio NZ Intl	7145pa			
1300	1400		New Zealand, Radio NZ Intl	5950pa			
1300	1400		Nigeria, Voice of	15120af			
1300	1400		North Korea, Voice of Korea	7570eu	9335na		
			11710na	12015eu			
1300	1400		Papua New Guinea, Catholic Radio		4960do		
1300	1400		Papua New Guinea, NBC		4890do		
1300	1400	vi	Papua New Guinea, Wantok R. Light		7120va		
1300	1400		Singapore, Radio Singapore Intl		6080as		
			6150as				
1300	1400	vi	South Africa, Channel Africa	9620af			
1300	1400		South Korea, KBS World Radio		9570na		
			9770as				
1300	1400	DRM	UK, BBC World Service	1296eu			
1300	1400		UK, BBC World Service	5975as	6190af		
			6195as	7320eu	9470eu	9740as	
			11760me	11895as	11940af	15310as	
			15420af	15485as	15575as	17640eu	
			17790af	17830af	17885af	21470af	
1300	1400		USA, American Forces Radio	4319usb	5446usb		

			5765usb	6350usb	7811usb	10320usb	
			12133usb	13362usb			
1300	1400		USA, KAIJ Dallas TX		5755na		
1300	1400		USA, KTNB Salt Lake City UT		7505na		
1300	1400		USA, KWHR Naalehu HI		12130as		
1300	1400		USA, Voice of America		9645va	9760va	
			11705va				
1300	1400	w f	USA, WBCQ Kennebunk ME		9330na		
1300	1400		USA, WBOH Newport NC		5920am		
1300	1400		USA, WEWN Birmingham AL		9955na		
1300	1400		USA, WHRA Greenbush ME		15665na		
1300	1400		USA, WHRI Cypress Creek SC		6095am		
1300	1400	Sat/Sun	USA, WHRI Cypress Creek SC		11785am		
1300	1400		USA, WINB Red Lion PA		13570am		
1300	1400		USA, WRMI Miami FL		7385na		
1300	1400		USA, WTJC Newport NC		9370na		
1300	1400		USA, WWCR Nashville TN		7465na	9985na	
			13845na	15825na			
1300	1400		USA, WWRB Manchester TN		9385na		
1300	1400		USA, WYFR/Family R Okeechobee FL		5865as		
			7495as	7780as	11560na	11855na	
			11970na				
1300	1400		Zambia, Christian Voice		5915al	6065af	
1305	1320	m	Austria, Radio Austria Intl		6155va	13730va	
			17855va				
1305	1330	Sat/Sun	Austria, Radio Austria Intl		6155me	13730va	
			17855va				
1315	1330	twhf	Austria, Radio Austria Intl		17855va		
1330	1357	a DRM	Czech Rep, Radio Prague		6065na		
1330	1400		Guam, AWR/KSDA		15260as		
1330	1400		India, All India Radio		9690as	11620as	
			13710as				
1330	1400		Laos, National Radio		7145as		
1330	1400		Sweden, Radio	7420va	11550va	15240va	
1330	1400	DRM	Sweden, Radio	7275eu			
1330	1400		Turkey, Voice of	11735va	12035va		
1335	1400	Sat/Sun	Austria, Radio Austria Intl		6155va	13730va	
			17855va				
1345	1400	mtwhf	Austria, Radio Austria Intl		6155va	13730va	
			17855va				

**1400 UTC - 9AM EST / 8AM CST / 6AM PST**

1400	1415	t h	Germany, Pan American BC		13645me		
1400	1415	vi	Seychelles, FEBA	7150as			
1400	1427		Czech Rep, Radio Prague		11600as	13580na	
1400	1427	f DRM	Czech Rep, Radio Prague		9750na		
1400	1430		Australia, Radio	5995va	6080va	7240as	
			9590va				
1400	1430	f	Guam, TWR/KTWR	9975as			
1400	1430		Thailand, Radio	9830oc			
1400	1430		Turkey, Voice of	11735va	12035va		
1400	1430		UK, BBC World Service		9470eu		
1400	1500		Anguilla, University Network		11775am		
1400	1500		Australia, CVC International		13635as		
1400	1500		Bhutan, BBS		6035as		
1400	1500	Sat/Sun	Canada, CBC NQ SW Service		9625na		
1400	1500		Canada, CFRX Toronto ON		6070na		
1400	1500		Canada, CFVP Calgary AB		6030na		
1400	1500		Canada, CKZN St John's NF		6160na		
1400	1500		Canada, CKZU Vancouver BC		6160na		
1400	1500		China, China Radio Intl		5955as	7300as	
			9460as	9700eu	9765as	9795eu	
			9870as	13675na	13685af	13740na	
			15230na	17630af			
1400	1500		Costa Rica, University Network		9725va	11870va	
			13750va				
1400	1500		France, Radio France Intl		5920as	7180as	
			9580af	15615af			
1400	1500		Germany, CVC International		15715me		
1400	1500		Germany, Deutsche Welle		6140eu		
1400	1500	a	Germany, Overcomer Ministries			17810eu	
1400	1500		Germany, Overcomer Ministries			6110eu	
			13810va				
1400	1500	a	Greece, Voice of	9420eu	17525va		
1400	1500	mtwh	Guam, TWR/KTWR	9975as			
1400	1500		India, All India Radio		9690as	11620as	
			13710as				
1400	1500		Japan, Radio Japan/NHK World			7200as	
			9875as	11840oc			
1400	1500		Jordan, Radio		11690na		
1400	1500		Libya, Voice of Africa		17660af	17725af	
			17850af	21695af			
1400	1500		Malaysia, RTM/Trax FM		7295as		
1400	1500		Netherlands, Radio		9345as	12080as	
			15595as				
1400	1500	DRM	New Zealand, Radio NZ Intl		7145pa		
1400	1500		New Zealand, Radio NZ Intl		5950pa		
1400	1500		Nigeria, Voice of	15120af			
1400	1500		Oman, Radio Oman		15140as		
1400	1500	vi	Papua New Guinea, Wantok R. Light			7120va	
1400	1500		Singapore, MediaCorp Radio		6150do		



1400	1500	vi	South Africa, Channel Africa	9620af		
1400	1500		Taiwan, Radio Taiwan Intl	15265as		
1400	1500	DRM	UK, BBC World Service	7320eu		
1400	1500		UK, BBC World Service	5975as	6190af	
			6195as	9410eu	9740eu	11760as
			11895as	11920as	11940as	12095af
			15485eu	17830eu	17885af	21470af
1400	1500	DRM	UK, BBC World Service	7320eu		
1400	1500	Sat/Sun	UK, Bible Voice	11695as		
1400	1500		USA, American Forces Radio	4319usb	5446usb	
			5765usb	6350usb	7811usb	10320usb
			12133usb	13362usb		
1400	1500		USA, KAIJ Dallas TX	9480na		
1400	1500		USA, KJES Vado NM	11715na		
1400	1500		USA, KNLS Anchor Point AK	6150as		
1400	1500		USA, KTBN Salt Lake City UT	7505na	15590na	
1400	1500		USA, KWHR Naalehu HI	9930as		
1400	1500		USA, Voice of America	4930af	6080af	
			7125va	9695va	11655va	11885va
			12150va	15205va	15580af	17895af
1400	1500		USA, WBCQ Kennebunk ME	9330na		
1400	1500		USA, WBOH Newport NC	5920am		
1400	1500		USA, WEWN Birmingham AL	9955na		
1400	1500		USA, WHRA Greenbush ME	15665na		
1400	1500		USA, WHRI Cypress Creek SC	6095am	9840am	
1400	1500	Sat/Sun	USA, WHRI Cypress Creek SC	11795am		
1400	1500		USA, WINB Red Lion PA	13570am		
1400	1500		USA, WRMI Miami FL	7385na		
1400	1500		USA, WTJC Newport NC	9370na		
1400	1500		USA, WWCR Nashville TN	7465na	9985na	
			13845na	15825na		
1400	1500		USA, WWRB Manchester TN	9385na		
1400	1500		USA, WYFR/Family R Okeechobee FL		7580as	
			11560as	11565na	11855na	13695na
			17760na			
1400	1500		Zambia, Christian Voice	5915al	6065af	
1415	1430		Nepal, Radio	3230as	5005as	6100as
			7165as			
1430	1445	s	Germany, Pan American BC	13645as	13820as	
1430	1459	DRM	Canada, Radio Canada Intl	7240eu		
1430	1500		Australia, Radio	5995va	6080va	7240as
			9475as	9590va	11660pa	
1430	1500		Myanmar, Radio	5986as		
1430	1500	DRM	South Korea, KBS World Radio		9770eu	
1430	1500		Sweden, Radio	11550va	15240va	
1430	1500		UK, BBC World Service	7465eu		

### 1500 UTC - 10AM EST / 9AM CST / 7AM PST

1500	1510	mtwhfa	Turkmenistan, Turkmen Radio	5015eu		
1500	1515	vi	Seychelles, FEBA	7150as		
1500	1527		Czech Rep, Radio Prague	7385na	15160na	
1500	1528		Vietnam, Voice of	9550va	9840va	12020va
			13860va			
1500	1530		Guam, AWR/KSDA	12105as		
1500	1530		UK, BBC World Service	17885af	15420af	
			15460va			
1500	1545		Sweden, IBRA Radio	7340as		
1500	1550	DRM	New Zealand, Radio NZ Intl	7145pa		
1500	1550		New Zealand, Radio NZ Intl	5950pa		
1500	1557		Canada, Radio Canada Intl	9635as	11870as	
			11975as			
1500	1557		Netherlands, Radio	9345as	12080as	
			15595as			
1500	1558		Libya, Voice of Africa	17660af	17725af	
			17850af	21695af		
1500	1559		Germany, Deutsche Welle	6140eu		
1500	1559		Germany, Overcomer Ministries		17815na	
1500	1600		Anguilla, University Network	11775am		
1500	1600		Australia, CVC International	13635as		
1500	1600		Australia, Radio	5995va	6080va	7240as
			9475as	9590va		
1500	1600	Sat/Sun	Canada, CBC NQ SW Service	9625na		
1500	1600		Canada, CFRX Toronto ON	6070na		
1500	1600		Canada, CFVP Calgary AB	6030na		
1500	1600		Canada, CKZN St John's NF	6160na		
1500	1600		Canada, CKZU Vancouver BC	6160na		
			China, China Radio Intl	5955as	7160as	
			7325as	9435eu	9525eu	9785as
			9870as	13685af	13740na	13630af
1500	1600	DRM	China, China Radio Intl	9750eu		
1500	1600		Costa Rica, University Network	9725va	11870va	
			13750va			
1500	1600		Germany, CVC International	11830af		
1500	1600	s	Italy, IRRS	9310eu		
1500	1600		Japan, Radio Japan/NHK World		6190as	
			7200as	9505va	9875as	
1500	1600		Jordan, Radio	11690na		
1500	1600	DRM	Luxembourg, Radio Luxembourg		7295eu	
1500	1600		Malaysia, RTM/Trax FM	7295as		

1500	1600		North Korea, Voice of Korea	7570eu	9335na	
			11710na	12015eu		
1500	1600	vi	Papua New Guinea, Wantok R. Light		7120va	
1500	1600	DRM	Romania, Radio Romania Intl	7340eu		
1500	1600		Russia, Voice of	7260as	7350as	9660as
1500	1600		Singapore, MediaCorp Radio	6150do		
1500	1600	vi	South Africa, Channel Africa	9620af		
1500	1600		South Africa, Channel Africa	17770af		
1500	1600		UAE, AWR Africa	11670as		
1500	1600	DRM	UK, BBC World Service	5870eu		
1500	1600		UK, BBC World Service	5875eu	5965as	
			5975as	6190af	6195as	7465eu
			9410eu	9740as	9810as	11820eu
			11920as	11940af	12095eu	15105af
			15400af	17830af	21470af	
1500	1600	f DRM	UK, China BS VT Digital	9710eu		
1500	1600	vi/ mtwhf	UK, Sudan Radio Service	15575af		
1500	1600		USA, American Forces Radio	4319usb	5446usb	
			5765usb	6350usb	7811usb	10320usb
			12133usb	13362usb		
1500	1600		USA, KAIJ Dallas TX	9480na		
1500	1600		USA, KJES Vado NM	11715na		
1500	1600		USA, KTBN Salt Lake City UT	7505na	15590na	
1500	1600		USA, KWHR Naalehu HI	9930as		
1500	1600		USA, Voice of America	4930af	6080af	
			7125va	9645va	11890va	12150va
			13735va	15205va	15580af	17895af
1500	1600		USA, WBCQ Kennebunk ME	9330na		
1500	1600		USA, WBOH Newport NC	5920am		
1500	1600		USA, WEWN Birmingham AL	9450na		
1500	1600		USA, WHRA Greenbush ME	15665na		
1500	1600		USA, WHRI Cypress Creek SC	9840am	11795am	
			13760am			
1500	1600		USA, WINB Red Lion PA	13570am		
1500	1600		USA, WRMI Miami FL	9955na		
1500	1600		USA, WTJC Newport NC	9370na		
1500	1600		USA, WWCR Nashville TN	9985na	12160na	
			13845na	15825na		
1500	1600	s	USA, WWRB Manchester TN	11920va		
1500	1600		USA, WWRB Manchester TN	9385na		
1500	1600		USA, WYFR/Family R Okeechobee FL		6085as	
			11855na	12010as	15210na	
1500	1600		Zambia, Christian Voice	4965af		
1500	1600	f DRM	Taiwan, Radio Taiwan Intl	9770eu		
1505	1600		Canada, Radio Canada Intl	9610am		
1505	1600	DRM	Canada, Radio Canada Intl	9800na		
1515	1530		Vatican City, Vatican Radio	11850va	13765va	
1530	1545		India, All India Radio	9425as		
1530	1600		Bangladesh, Bangla Betar	4750as		
1530	1600		Iran, Voice of the Islamic Rep	6160as	7330as	
1530	1600	mha	UK, Bible Voice	12035as		
1530	1600		USA, Voice of America	6110va	7175va	
			9760va	15460va		
1530	1600		Vatican City, Vatican Radio	9310va	11850va	
			13795va			
1545	1600	s	Germany, Pan American BC	13820me		
1551	1600	DRM	New Zealand, Radio NZ Intl	9890pa		
1551	1600		New Zealand, Radio NZ Intl	9870pa		

### 1600 UTC - 11AM EST / 10AM CST / 8AM PST

1600	1605		Canada, Radio Canada Intl	9610am		
1600	1605	DRM	Canada, Radio Canada Intl	9800na		
1600	1615		Pakistan, Radio	6215va	7530va	11570va
1600	1620	mtwh	Moldova, Radio DMR Pridnestrovye		6235eu	
1600	1627		Iran, Voice of the Islamic Rep	6160as	7330as	
1600	1628	s	Hungary, Radio Budapest	6025eu	9565eu	
1600	1628		Vietnam, Voice of	7280va	9550va	9730va
			11630va	13860va		
1600	1630	h	Germany, Pan American BC	13820me		
1600	1630		Guam, AWR/KSDA	9585as	12065as	
1600	1630		Myanmar, Radio	9730do		
1600	1630	Sat/Sun	Swaziland, TWR	6070af		
1600	1630		USA, Voice of America	11890va	15205va	
1600	1640	f	Moldova, Radio DMR Pridnestrovye		6235eu	
1600	1658		Germany, Deutsche Welle	6170as	9795as	
			11695as			
1600	1700		Anguilla, University Network	11775am		
1600	1700		Australia, CVC International	13635as		
1600	1700		Australia, Radio	5995va	6080va	7240as
			9475as	9710va	11660pa	
1600	1700	a	Canada, CBC NQ SW Service	9625na		
1600	1700		Canada, CFRX Toronto ON	6070na		
1600	1700		Canada, CFVP Calgary AB	6030na		
1600	1700		Canada, CKZN St John's NF	6160na		
1600	1700		Canada, CKZU Vancouver BC	6160na		
1600	1700		China, China Radio Intl	7150af	7255eu	
			9435eu	9525eu	9570af	
1600	1700		Costa Rica, University Network	11870va	13750va	
1600	1700		Egypt, Radio Cairo	11740af		
1600	1700		Ethiopia, Radio	5990af	7110af	7165af
			9560af	9704af		

1600	1700		France, Radio France Intl	7170af	9730af
			11615af	15160af	
1600	1700		Germany, CVC International	11830af	
1600	1700	s	Germany, Overcomer Ministries		17815na
1600	1700		Jordan, Radio	11690na	
1600	1700		Malaysia, RTM/Trax FM	7295as	
1600	1700		New Zealand, Radio NZ Intl	9870pa	
1600	1700	DRM	New Zealand, Radio NZ Intl	9890pa	
1600	1700		North Korea, Voice of Korea	9990va	11545af
1600	1700	vl	Papua New Guinea, Wantok R. Light	7120va	
1600	1700		Russia, Voice of	4965as	4975as
			7260eu	7305as	7320eu
1600	1700		Taiwan, Radio Taiwan Intl	11550as	11955sa
1600	1700		UK, BBC World Service	3255af	3915af
			5875eu	5975as	6190af
			7465eu	9410eu	9740as
			11820eu	11920as	12095eu
			15400af	21470af	15105af
1600	1700	DRM	UK, BBC World Service	1296eu	5875eu
1600	1700	vl/ mtwhf	UK, Sudan Radio Service	15575af	
1600	1700		USA, American Forces Radio	4319usb	5446usb
			5765usb	6350usb	7811usb
			12133usb	13362usb	
1600	1700		USA, KAIJ Dallas TX	9480na	
1600	1700		USA, KJES Vado NM	11715na	
1600	1700		USA, KTBN Salt Lake City UT	15590na	
1600	1700		USA, KWHR Naalehu HI	9930as	
1600	1700		USA, Voice of America	4930af	6080af
			13600va	13795af	15445va
			17640va	17715af	17805af
1600	1700		USA, WBCQ Kennebunk ME	9330na	
1600	1700		USA, WBOH Newport NC	5920am	
1600	1700		USA, WEWN Birmingham AL	9450va	15785va
1600	1700		USA, WHRA Greenbush ME	17650na	
1600	1700		USA, WHRI Cypress Creek SC	9840am	15285am
1600	1700		USA, WINB Red Lion PA	13570am	
1600	1700	smtwhf	USA, WMLK Bethel PA	9265eu	
1600	1700		USA, WRMI Miami FL	9955am	
1600	1700		USA, WTJC Newport NC	9370na	
1600	1700		USA, WWCR Nashville TN	9985na	12160na
			13845na	15825na	
1600	1700		USA, WWRB Manchester TN	9385na	11920va
			15250af		
1600	1700		USA, WYFR/Family R Okeechobee FL	6085am	
			11565na	11830na	12010as
			17690af	17760na	18980va
1600	1700		Zambia, Christian Voice	4965af	
1605	1620	m	Austria, Radio Austria Intl	13675na	
1605	1630	Sat/Sun	Austria, Radio Austria Intl	13675na	
1615	1630	twhf	Austria, Radio Austria Intl	13675ca	
1615	1700	Sat/Sun	UK, BBC World Service	11860af	15420af
			17885af		
1630	1700		Swaziland, TWR	6070af	
1630	1700	Sat/Sun	Swaziland, TWR	6130af	
1630	1700	mtwhf	UK, BBC World Service	15420af	
1630	1700	s	UK, Bible Voice	9460me	
1635	1700	Sat/Sun	Austria, Radio Austria Intl	13675na	
1640	1650	mtwhfa	Turkmenistan, Turkmen Radio	4930eu	
1640	1700	mtwhf	UK, Bible Voice	9460me	
1645	1700	m	Austria, Radio Austria Intl	13675na	
1645	1700	twhf	Austria, Radio Austria Intl	13675na	
1645	1700	mtwhf	Swaziland, TWR	6130af	
1645	1700	f	Sweden, IBRA Radio	7250as	
1645	1700		Tajikistan, Tajik Radio	7245as	
1645	1700	a	UK, Bible Voice	9460me	

**1700 UTC - 12PM EST / 11AM CST / 9AM PST**

1700	1715	mtwhf	Swaziland, TWR	6130af	
1700	1715	mtwhf	UK, Bible Voice	9460me	
1700	1720	mtwh	Moldova, Radio DMR Pridnestrovye		6235eu
1700	1727		Czech Rep, Radio Prague	5930eu	15710af
1700	1730		France, Radio France Intl	11615af	
1700	1730		Germany, Deutsche Welle	3995eu	
1700	1730		Jordan, Radio	11690na	
1700	1730	mtwhf	UK, United Nations Radio	7170va	9565va
			17810va		
1700	1740	f	Moldova, Radio DMR Pridnestrovye		6235eu
1700	1745		UK, BBC World Service	6005af	9630af
1700	1750		New Zealand, Radio NZ Intl	9870pa	
1700	1750	DRM	New Zealand, Radio NZ Intl	9890pa	
1700	1800		Anguilla, University Network	11775am	
1700	1800		Australia, CVC International	13635as	
1700	1800		Australia, Radio	5995va	6080va
			9475as	9580va	9710va
			11880pa		
1700	1800	a	Canada, CBC NQ SW Service	9625na	
1700	1800		Canada, CFRX Toronto ON	6070na	
1700	1800		Canada, CFVP Calgary AB	6030na	
1700	1800		Canada, CKZN St John's NF	6160na	
1700	1800		Canada, CKZU Vancouver BC	6160na	
1700	1800		China, China Radio Intl	7150af	7205eu

1700	1800		Costa Rica, University Network	11870va	13750va
1700	1800		Egypt, Radio Cairo	11740af	
1700	1800		Germany, CVC International	15680af	
1700	1800	s	Germany, Universal Life	5775va	
1700	1800	fs	Italy, IRRS	9310va	
1700	1800		Japan, Radio Japan/NHK World		9535va
			11970eu	15355af	
1700	1800	DRM	Japan, Radio Japan/NHK World		9770eu
1700	1800		Malaysia, RTM/Trax FM	7295as	
1700	1800		Nigeria, Voice of	15120af	
1700	1800	vl	Papua New Guinea, Wantok R. Light		7120va
1700	1800		Russia, Voice of	6125as	7125as
			7320eu	9470me	
1700	1800		South Africa, Channel Africa		15235af
1700	1800		Swaziland, TWR	3200af	
1700	1800		Taiwan, Radio Taiwan Intl	11850af	
1700	1800	DRM	UK, BBC World Service	1296eu	5875eu
1700	1800		UK, BBC World Service	3255af	3915as
			5975as	6190af	6195eu
			9410eu	9740as	11665eu
			12095af	15400af	21470af
1700	1800	Sat/Sun	UK, Bible Voice	9460me	
1700	1800	vl/ mtwhf	UK, Sudan Radio Service		11705af
1700	1800		USA, American Forces Radio	4319usb	5446usb
			5765usb	6350usb	7811usb
			12133usb	13362usb	
1700	1800		USA, KAIJ Dallas TX	9480na	
1700	1800		USA, KTBN Salt Lake City UT	15590na	
1700	1800		USA, KWHR Naalehu HI	9930as	
1700	1800		USA, Voice of America	6080af	13710af
			15580af		
1700	1800	Sat/Sun	USA, Voice of America	4930af	
1700	1800		USA, WBCQ Kennebunk ME	9330na	18910na
1700	1800		USA, WBOH Newport NC	5920am	
1700	1800		USA, WEWN Birmingham AL	9450va	15785va
1700	1800		USA, WHRA Greenbush ME	17650na	
1700	1800		USA, WHRI Cypress Creek SC	9840am	15285am
			15650am		
1700	1800		USA, WINB Red Lion PA	13570am	
1700	1800	smtwhf	USA, WMLK Bethel PA	9265eu	
1700	1800		USA, WRMI Miami FL	9955am	
1700	1800		USA, WTJC Newport NC	9370na	
1700	1800		USA, WWCR Nashville TN	9985na	12160na
			13845na	15825na	
1700	1800		USA, WWRB Manchester TN	9385na	11920va
			15250af		
1700	1800		USA, WYFR/Family R Okeechobee FL	13695na	
			17555na	21680na	
1700	1800		Zambia, Christian Voice	4965af	
1705	1800		Canada, Radio Canada Intl	9610am	
1705	1800	DRM	Canada, Radio Canada Intl	9800na	
1715	1730		Vatican City, Vatican Radio	4005eu	7250eu
			9635eu	9645eu	
1715	1800	t	UK, Bible Voice	9460me	
1730	1800		Guam, AWR/KSDA 9980me		
1730	1800		Liberia, ELWA	4760do	
1730	1800		Philippines, Radio Pilipinas		11720va
			17720va		
1730	1800		Slovakia, Radio Slovakia Int	5915eu	6055eu
1730	1800		Swaziland, TWR	9500af	
1730	1800	s	UK, Bible Voice	9730me	
1730	1800		USA, Voice of America	4930af	11815af
1730	1800	mtwhf	USA, Voice of America	17730af	
1730	1800		Vatican City, Vatican Radio	9755af	11625af
			13795af		
1745	1800		India, All India Radio	7410eu	9445af
			9950eu	11620eu	11935af
			15075af	15155af	17670af
1751	1800		New Zealand, Radio NZ Intl	11725pa	
1751	1800	DRM	New Zealand, Radio NZ Intl	11675pa	

**1800 UTC - 1PM EST / 12PM CST / 10AM PST**

1800	1815	t	UK, Bible Voice	9460me	
1800	1815	a	UK, Bible Voice	7210me	
1800	1827		Czech Rep, Radio Prague	5930eu	9400va
1800	1828		Vietnam, Voice of	5955eu	7280va
1800	1830		South Africa, AWR Africa	3215af	3345af
			11830af		
1800	1830		UK, BBC World Service	9740as	
1800	1830	Sat/Sun	USA, Voice of America	4930af	
1800	1830		USA, Voice of America	6080af	11975af
			13710af	15580af	17895af
1800	1850	DRM	New Zealand, Radio NZ Intl	11675pa	
1800	1856		Romania, Radio Romania Intl	7120eu	9640eu
1800	1857		Netherlands, Radio	6020af	7395af
			9895af	11655af	
1800	1859		Poland, Radio Polonia	6015eu	7130eu
1800	1900		Anguilla, University Network	11775am	
1800	1900	mtwhf	Argentina, RAE	9690eu	15345eu
1800	1900		Australia, Radio	6080va	7240as

1800	1900		9500as	9580va	9710va	11880pa	
1800	1900		Canada, CFRX Toronto ON	6070na			
1800	1900		Canada, CFVP Calgary AB	6030na			
1800	1900		Canada, CKZN St John's NF	6160na			
1800	1900		Canada, CKZU Vancouver BC	6160na			
1800	1900		Canada, Radio Canada Intl	7185af	9610am		
			11875af	13650af	17740af		
1800	1900	DRM	Canada, Radio Canada Intl	9800na			
1800	1900		China, China Radio Intl	6100eu	7100eu		
1800	1900		Costa Rica, University Network	11870va	13750va		
1800	1900		Germany, CVC International	9490af			
1800	1900		Germany, Universal Life	5775va			
1800	1900		India, All India Radio	7410eu	9445af		
			9950eu	11620eu	11935af	13605af	
			15075af	15155af	17670af		
1800	1900	fs	Italy, IRRS	9310va			
1800	1900		Liberia, ELWA	4760do			
1800	1900		Malaysia, RTM/Trax FM	7295as			
1800	1900		New Zealand, Radio NZ Intl	11725pa			
1800	1900		North Korea, Voice of Korea	7570eu	12015eu		
1800	1900	vi	Papua New Guinea, Wantok R.	Light	7120va		
1800	1900		Philippines, Radio Pilipinas	11720va	15190va		
			17720va				
1800	1900		Russia, Voice of	6125as	7105eu	7125as	
			7270va	7295as	7320eu	11510af	
1800	1900	Sat/Sun	Russia, Voice of	6055eu	6175eu		
1800	1900		Swaziland, TWR	3200af	9500af		
1800	1900		Taiwan, Radio Taiwan Intl	3965eu			
1800	1900	DRM	UK, BBC World Service	1296eu	5970eu		
1800	1900		UK, BBC World Service	3255af	5875eu		
			5955as	6190af	6195eu	7465eu	
			9410eu	11955as	12095af	15400af	
			17830af	21470af			
1800	1900	a	UK, Bible Voice	9730me			
1800	1900		USA, American Forces Radio	4319usb	5446usb		
			5765usb	6350usb	7811usb	10320usb	
			12133usb	13362usb			
1800	1900		USA, KAIJ Dallas TX	9480na			
1800	1900		USA, KTBN Salt Lake City UT	15590na			
1800	1900	smtwhf	USA, WBCQ Kennebunk ME	7415na			
1800	1900		USA, WBCQ Kennebunk ME	9330na	18910na		
1800	1900		USA, WBOH Newport NC	5920am			
1800	1900		USA, WEWN Birmingham AL	9450va	15785va		
1800	1900		USA, WHRA Greenbush ME	17650na			
1800	1900		USA, WHRI Cypress Creek SC	9840am	15285am		
			15650am				
1800	1900		USA, WINB Red Lion PA	13570am			
1800	1900	smtwhf	USA, WMLK Bethel PA	9265eu			
1800	1900		USA, WRMI Miami FL	9955am			
1800	1900		USA, WTJC Newport NC	9370na			
1800	1900		USA, WWCR Nashville TN	9985na	12160na		
			13845na	15825na			
1800	1900		USA, WWRB Manchester TN	9385na	11920va		
			15250af				
1800	1900		USA, WYFR/Family R Okeechobee FL	7240va			
			7345va	13695na	17535na	17555na	
			18980va				
1800	1900		Yemen, Rep of Yemen Radio	9780me			
1800	1900		Zambia, Christian Voice	4965af			
1815	1900		Bangladesh, Bangla Betar	7185eu			
1830	1845		Israel, Kol Israel	6985va	9345eu		
1830	1845		Sweden, IBRA Radio	9529af			
1830	1900		Bulgaria, Radio	7400eu	9400eu		
1830	1900		Sweden, Radio	6065eu			
1830	1900		Turkey, Voice of	6055eu			
1830	1900		UK, BBC World Service	6005af	9630af		
1830	1900	s	UK, Bible Voice	9730me			
1830	1900	h	UK, Bible Voice	9460me			
1830	1900		USA, Voice of America	4930af	6080af		
			11975af	13710af	15580af	17895af	
1845	1900	mtwhfa	Albania, Radio Tirana	6170eu			
1845	1900		Congo, RTV Congolaise	4765af	5985af		
1845	1900	a	UK, Bible Voice	7210me			
1851	1900	DRM	New Zealand, Radio NZ Intl	15720pa			

**1900 UTC - 2PM EST / 1PM CST / 11AM PST**

1900	1903		Bahrain, Radio Bahrain	6010as			
1900	1905		Canada, Radio Canada Intl	9610am			
1900	1905	DRM	Canada, Radio Canada Intl	9800na			
1900	1915		Congo, RTV Congolaise	4765af	5985af		
1900	1928		Vietnam, Voice of	7280va			
1900	1930		Germany, Deutsche Welle	7245af	9735af		
			11690af	12025af	15275af		
1900	1930	s	Germany, Universal Life	5775me			
1900	1930		Philippines, Radio Pilipinas	11720va	15190va		
			17720va				
1900	1930	s	UK, Bible Voice	6015eu			
1900	1930	a	UK, Bible Voice	7260af	9460me		
1900	1945		India, All India Radio	7410eu	9445af		
			9950eu	11620eu	11935af	13605af	
			15075af	15155af	17670af		

1900	1950	DRM	New Zealand, Radio NZ Intl	15720pa			
1900	1950		New Zealand, Radio NZ Intl	11725pa			
1900	1957		Netherlands, Radio	7120af	7395af		
			9895af	11655af	17725na	17810af	
1900	1957	Sat/Sun	Netherlands, Radio	15315na	15525na		
			15525na	17725na			
1900	2000		Anguilla, University Network	11775am			
1900	2000		Australia, Radio	6080va	7240as	9500as	
			9580va	9710va	11880pa		
1900	2000		Canada, CFRX Toronto ON	6070na			
1900	2000		Canada, CFVP Calgary AB	6030na			
1900	2000		Canada, CKZN St John's NF	6160na			
1900	2000		Canada, CKZU Vancouver BC	6160na			
1900	2000		China, China Radio Intl	7295va	9440va		
1900	2000		Costa Rica, University Network	11870va	13750va		
1900	2000		Eqt Guinea, Radio Africa	15190af			
1900	2000		Germany, CVC International	9490af			
1900	2000	vi	Ghana, Ghana BC Corp	3366do	4915do		
1900	2000		Italy, IRRS	9310va			
1900	2000		Liberia, ELWA	4760do			
1900	2000		Malaysia, RTM/Trax FM	7295as			
1900	2000	vi	Namibia, Namibian BC Corp	3270do	3290do		
			6060do	6175do			
1900	2000		Nigeria, Radio/Ibadan	6050do			
1900	2000		Nigeria, Radio/Kaduna	4770do	6090do		
1900	2000		Nigeria, Radio/Lagos	3326do	4990do		
1900	2000		Nigeria, Voice of	15120af			
1900	2000		North Korea, Voice of Korea	7100af	9975va		
			11535va				
1900	2000		Papua New Guinea, Catholic Radio	4960do			
1900	2000		Papua New Guinea, NBC	4890do			
1900	2000	vi	Papua New Guinea, Wantok R. Light	7120va			
1900	2000		Russia, Voice of	6175eu	7105eu	7290eu	
			7335af	11510af			
1900	2000	irreg/ vi	Sierra Leone, SLBS 3316do				
1900	2000	vi	Solomon Islands, SIBC	5020do	9545do		
1900	2000	vi	South Africa, Channel Africa	3345af			
1900	2000		South Korea, KBS World Radio		7275eu		
1900	2000		Swaziland, TWR	3200af			
1900	2000		Thailand, Radio	7155eu			
1900	2000	vi	Uganda, Radio	4976do	5026do		
1900	2000	DRM	UK, BBC World Service	1296do			
1900	2000		UK, BBC World Service	3255af	5875eu		
			5955as	6005af	6190af	6195eu	
			9410eu	9630af	11955as	12095af	
			15400af	17830af			
1900	2000	Sat/Sun	UK, Bible Voice	9470me			
1900	2000		USA, American Forces Radio	4319usb	5446usb		
			5765usb	6350usb	7811usb	10320usb	
			12133usb	13362usb			
1900	2000		USA, KAIJ Dallas TX	9480na			
1900	2000		USA, KJES Vado NM	15385na			
1900	2000		USA, KTBN Salt Lake City UT	15590na			
1900	2000		USA, Voice of America	4930af	4940af		
			6080af	11975af	13710af	15580af	
1900	2000		USA, WBCQ Kennebunk ME	7415na	9330na		
			18910na				
1900	2000		USA, WBOH Newport NC	5920am			
1900	2000		USA, WEWN Birmingham AL	9450va	15785va		
1900	2000		USA, WHRA Greenbush ME	17650na			
1900	2000		USA, WHRI Cypress Creek SC	9840am	13760am		
			15285am				
1900	2000		USA, WINB Red Lion PA	13570am			
1900	2000	smtwhf	USA, WMLK Bethel PA	9265eu			
1900	2000		USA, WRMI Miami FL	9955am			
1900	2000		USA, WTJC Newport NC	9370na			
1900	2000		USA, WWCR Nashville TN	9975na	12160na		
			13845na	15825na			
1900	2000		USA, WWRB Manchester TN	9385na	11920va		
			15250af				
1900	2000		USA, WYFR/Family R Okeechobee FL	3230af			
			6020af	6085am	7160va	7395af	
			13695na	15115af	15565va	17535na	
			17555na	18980va			
1900	2000		Zambia, Christian Voice	4965af			
1900	2000	vi	Zimbabwe, ZBC Corp	5975do			
1915	2000	f	UK, Bible Voice	9470me			
1930	2000	Sat/Sun	Germany, Pan American BC	5850me			
1930	2000		Iran, Voice of the Islamic Rep	6010eu	6255va		
			7320af	9855af	11695af		
1930	2000		Lithuania, Radio Vilnius	6250eu			
1930	2000		Serbia, International Radio Serbia		6100eu		
1930	2000		Slovakia, Radio Slovakia Int	5915eu	7345eu		
1930	2000	s	UK, Bible Voice	7260af			
1935	1955		Italy, RAI Intl	6035eu	9760eu		
1945	2000	mtwhfa	Albania, Radio Tirana	7465eu			
1945	2000	vi	Rwanda, Radio	6055do			
1945	2000	a	UK, Bible Voice	6015va			
1945	2000		Vatican City, Vatican Radio	9800am			
1951	2000	DRM	New Zealand, Radio NZ Intl	11675pa			
1951	2000		New Zealand, Radio NZ Intl	17675pa			

## 2000 UTC - 3PM EST / 2PM CST / 12PM PST

2000	2015	s	Germany, Pan American BC	5850me		
2000	2015	a	UK, Bible Voice	6015va		
2000	2025		Israel, Kol Israel	7545va	15640va	
2000	2027		Iran, Voice of the Islamic Rep	6010eu	6255va	
			7320af	9855af	11695af	
2000	2028		Hungary, Radio Budapest	3975eu	6025eu	
2000	2030		Egypt, Radio Cairo	15375af		
2000	2030	f	Germany, Pan American BC	5850me		
2000	2030		Lithuania, Radio Vilnius	6250eu		
2000	2030		South Africa, AWR Africa	9655af		
2000	2030		Swaziland, TWR	3200af		
2000	2030		Turkey, Voice of	6055eu		
2000	2030	s	UK, Bible Voice	6015va		
2000	2030		Vatican City, Vatican Radio	7365af	9755af	
			11625af			
2000	2057		Netherlands, Radio	7120af	11655af	
			15525na	17725na	17810af	
2000	2057	Sat/Sun	Netherlands, Radio	15315na	15525na	
			17725na			
2000	2058		Germany, Deutsche Welle	6145af	9735af	
			9830af	12025af	15275af	
2000	2059	mtwhf	Spain, Radio Exterior Espana	9680af	11680af	
2000	2100		Anguilla, University Network	11775am		
2000	2100		Australia, ABC NT Alice Springs		2310do	
			4835do			
2000	2100		Australia, ABC NT Katherine	2485do		
2000	2100		Australia, ABC NT Tennant Creek		2325do	
2000	2100		Australia, Radio	6080va	7240as	9500as
			11650pa	11660pa	11880pa	
2000	2100		Canada, CFRX Toronto ON	6070na		
2000	2100		Canada, CFVP Calgary AB	6030na		
2000	2100		Canada, CKZN St John's NF	6160na		
2000	2100		Canada, CKZU Vancouver BC	6160na		
2000	2100		China, China Radio Intl	5960eu	7170eu	
			7190eu	7285eu	7295va	7295va
			9440va	9600eu	11640af	13630af
2000	2100		Costa Rica, University Network	13750va		
2000	2100		Eqt Guinea, Radio Africa	15190af		
2000	2100		Germany, CVC International	7285af		
2000	2100	vl	Ghana, Ghana BC Corp	3366do	4915do	
2000	2100		Indonesia, Voice of	9525eu	11785eu	
			15150al			
2000	2100		Italy, IRRS	5775eu		
2000	2100		Liberia, ELWA	4760do		
2000	2100		Malaysia, RTM/Trax FM	7295as		
2000	2100	vl	Namibia, Namibian BC Corp	3270do	3290do	
			6060do	6175do		
2000	2100		New Zealand, Radio NZ Intl	17675pa		
2000	2100		Nigeria, Radio/Ibadan	6050do		
2000	2100		Nigeria, Radio/Kaduna	4770do	6090do	
2000	2100		Nigeria, Radio/Lagos	3326do	4990do	
2000	2100		Nigeria, Voice of	15120af		
2000	2100		Papua New Guinea, Catholic Radio		4960do	
2000	2100		Papua New Guinea, NBC	4890do		
2000	2100	vl	Papua New Guinea, Wantok R. Light	7120va		
2000	2100		Russia, Voice of	5955as	6145eu	7105eu
			7290eu	7330eu		
2000	2100	vl	Solomon Islands, SIBC	5020do	9545do	
2000	2100	vl	South Africa, Channel Africa	3345af		
2000	2100	vl	Uganda, Radio	4976do	5026do	
2000	2100	DRM	UK, BBC World Service	1296eu		
2000	2100		UK, BBC World Service	3255af	5875eu	
			6005af	6190af	6195eu	9630af
			12095af	15400af	17830af	
2000	2100		USA, American Forces Radio	4319usb	5446usb	
			5765usb	6350usb	7811usb	10320usb
			12133usb	13362usb		
2000	2100		USA, KAIJ Dallas TX	9480na		
2000	2100		USA, KJES Vado NM	15385na		
2000	2100		USA, KTBN Salt Lake City UT	15590na		
2000	2100		USA, WBCQ Kennebunk ME	7415na	9330na	
			18910na			
2000	2100		USA, WBOH Newport NC	5920am		
2000	2100		USA, WEWN Birmingham AL	9450va	15785va	
2000	2100		USA, WHRI Cypress Creek SC	11765am	15285am	
2000	2100		USA, WINB Red Lion PA	13570am		
2000	2100	smtwhf	USA, WMLK Bethel PA	9265eu		
2000	2100		USA, WRMI Miami FL	9955am		
2000	2100		USA, WTJC Newport NC	9370na		
2000	2100		USA, WWCR Nashville TN	9975na	12160na	
			13845na	15825na		
2000	2100		USA, WWRB Manchester TN	9385na	11920va	
			15250af			
2000	2100		USA, WYFR/Family R Okeechobee FL	3230af		
			5745va	5810va	6855va	7300va
			7580va	15115af	15195af	
2000	2100		Zambia, Christian Voice	4965af		
2000	2100	vl	Zimbabwe, ZBC Corp	5975do		
2005	2100		Syria, Radio Damascus	9330eu	12085eu	
2025	2045		Italy, RAI Intl	6010va		
2030	2045		Thailand, Radio	9535eu		

2030	2058		Vietnam, Voice of	7280va	9550va	9730va
			13860va			
2030	2100		Cuba, Radio Havana		9505va	11760va
2030	2100		Sweden, Radio	6065va	7420va	
2030	2100		USA, Voice of America		4930af	6080af
			7595as	11975af	13710af	15580af
2030	2100	Sat/Sun	USA, Voice of America		4940af	
2045	2100		India, All India Radio		7410eu	9445eu
			9910oc	9950eu	11620eu	11715oc
2045	2100	DRM	Vatican City, Vatican Radio		9800am	
2050	2100		Vatican City, Vatican Radio		4005eu	5885eu
			7250eu			

## 2100 UTC - 4PM EST / 3PM CST / 1PM PST

2100	2120		Vatican City, Vatican Radio	4005eu	5885eu	
			7250eu			
2100	2127		Czech Rep, Radio Prague	5930va	9430va	
2100	2130	mtwhfa	Albania, Radio Tirana	7530eu		
2100	2130		Australia, ABC NT Katherine	2485do		
2100	2130		Australia, ABC NT Tennant Creek		2325do	
2100	2130		Austria, AWR Europe	9830af		
2100	2130	a	Canada, CBC NQ SW Service	9625na		
2100	2130		China, China Radio Intl	11640af	13630af	
2100	2130		Cuba, Radio Havana	9505va	11760va	
2100	2130		Italy, IRRS	5775eu		
2100	2130		USA, Voice of America	7595as		
2100	2130	DRM	Vatican City, Vatican Radio	9800na		
2100	2145		Nigeria, Radio/Ibadan	6050do		
2100	2159		Canada, Radio Canada Intl	5850eu	9770eu	
2100	2159	smtwhf	Germany, Overcomer Ministries		7310eu	
2100	2159	Sat/Sun	Spain, Radio Exterior Espana	6125eu	11625af	
2100	2200		Anguilla, University Network	11775am		
2100	2200		Australia, ABC NT Alice Springs		2310do	
			4835do			
2100	2200		Australia, Radio	9500as	9660as	11650pa
			11695pa	12080as	13630as	15515as
2100	2200		Belarus, Radio	7360eu	7390eu	7420eu
2100	2200		Canada, CFRX Toronto ON	6070na		
2100	2200		Canada, CFVP Calgary AB	6030na		
2100	2200		Canada, CKZN St John's NF	6160na		
2100	2200		Canada, CKZU Vancouver BC	6160na		
2100	2200		China, China Radio Intl	7190eu	7285eu	
			9600eu			
2100	2200		Costa Rica, University Network		13750va	
2100	2200		Eqt Guinea, Radio Africa	15190af		
2100	2200		Germany, Deutsche Welle	7280af	9615af	
			11690af			
2100	2200	vl	Ghana, Ghana BC Corp	3366do	4915do	
2100	2200		Guyana, Voice of	3291do	5950do	
2100	2200		India, All India Radio	7410eu	9445eu	
			9910oc	9950eu	11620eu	11715oc
2100	2200		Japan, Radio Japan/NHK World		6035va	
			6090eu	6180eu	11855ca	17825na
			21670pa			
2100	2200		Liberia, ELWA	4760do		
2100	2200		Liberia, Star Radio	11960af		
2100	2200		Malaysia, RTM/Trax FM	7295as		
2100	2200	vl	Namibia, Namibian BC Corp	3270do	3290do	
			6060do	6175do		
2100	2200	DRM	New Zealand, Radio NZ Intl	15720pa		
2100	2200		New Zealand, Radio NZ Intl	17675pa		
2100	2200		Nigeria, Radio/Kaduna	4770do	6090do	
2100	2200		Nigeria, Radio/Lagos	3326do	4990do	
2100	2200		North Korea, Voice of Korea	7570eu	12015eu	
2100	2200		Papua New Guinea, Catholic Radio		4960do	
2100	2200		Papua New Guinea, NBC	4890do		
2100	2200	vl	Papua New Guinea, Wantok R. Light	7120va		
2100	2200	vl	Rwanda, Radio	6055do		
2100	2200	irreg/vl	Sierra Leone, SLBS3316do			
2100	2200	vl	South Africa, Channel Africa	3345af		
2100	2200		Syria, Radio Damascus	9330eu	12085eu	
2100	2200	DRM	UK, BBC World Service	1296eu		
2100	2200		UK, BBC World Service	3255af	3915as	
			5875eu	5965as	6005af	6125as
			6190af	6195va	9480eu	9650eu
			11675am	15400af		
2100	2200		USA, American Forces Radio	4319usb	5446usb	
			5765usb	6350usb	7811usb	10320usb
			12133usb	13362usb		
2100	2200		USA, KAIJ Dallas TX	9480na		
2100	2200		USA, KTBN Salt Lake City UT	15590na		
2100	2200		USA, Voice of America	6080af	15580af	
2100	2200		USA, WBCQ Kennebunk ME	7415na	9330na	
			18910na			
2100	2200		USA, WBOH Newport NC	5920am		
2100	2200		USA, WEWN Birmingham AL	6890va	15785va	
2100	2200		USA, WHRI Cypress Creek SC	9660am	11765am	
2100	2200		USA, WINB Red Lion PA	13570am		
2100	2200		USA, WRMI Miami FL	9955am		
2100	2200		USA, WTJC Newport NC	9370na		
2100	2200		USA, WWCR Nashville TN	9975na	12160na	

2100	2200	13845na USA, WWRB Manchester TN 15250af	15825na 9385na	11920va
2100	2200	USA, WYFR/Family R Okeechobee FL 5810va 7580va	5745va 6855va 15195af 15565af	7300va
2100	2200	Zambia, Christian Voice	4965af	
2100	2200	vi	Zimbabwe, ZBC Corp	5975do
2115	2200	Egypt, Radio Cairo	9990af	
2115	2200	USA, WYFR/Family R Okeechobee FL		11875af
2130	2156	Romania, Radio Romania Intl	6055va 7145va 9755va	6115va
2130	2200	Australia, ABC NT Katherine	5025do	
2130	2200	Australia, ABC NT Tennant Creek		4910do
2130	2200	mtwhfa	Canada, CBC NQ SW Service	9625na
2130	2200	Guam, AWR/KSDA	9720as	
2130	2200	DRM	Netherlands, Radio	9800na
2130	2200	Turkey, Voice of	9525va	
2130	2200	USA, Voice of America	7405as	

### 2200 UTC - 5PM EST / 4PM CST / 2PM PST

2200	2210	Syria, Radio Damascus	9330eu	12085eu
2200	2228	Hungary, Radio Budapest	6025eu	9535af
2200	2230	India, All India Radio	7410eu	9445eu
		11715oc	9950eu	11620eu 11715oc
2200	2230	Papua New Guinea, NBC	4890do	
2200	2230	South Korea, KBS World Radio		3955eu
2200	2230	Turkey, Voice of	9525as	
2200	2245	Egypt, Radio Cairo	9990eu	
2200	2257	DRM	Netherlands, Radio	15425na
2200	2258	DRM	New Zealand, Radio NZ Intl	15720pa
2200	2259	New Zealand, Radio NZ Intl	17675pa	
2200	2300	Anguilla, University Network	6090am	
2200	2300	Australia, ABC NT Alice Springs	4835do	2310do
2200	2300	Australia, ABC NT Katherine	5025do	
2200	2300	Australia, ABC NT Tennant Creek		4910do
2200	2300	Australia, Radio	13620as 15240pa 15515va	13630pa 17785va 15230va
2200	2300	Belarus, Radio	7360eu	7490eu
2200	2300	Bulgaria, Radio	7400eu	9400eu
2200	2300	smtwhf	Canada, CBC NQ SW Service	9625na
2200	2300	Canada, CFRX Toronto ON	6070na	
2200	2300	Canada, CFVP Calgary AB	6030na	
2200	2300	Canada, CKZN St John's NF	6160na	
2200	2300	Canada, CKZU Vancouver BC	6160na	
2200	2300	DRM	Canada, Radio Canada Intl	9800na
2200	2300	China, China Radio Intl	5915as	7170eu
2200	2300	Costa Rica, University Network		13750va
2200	2300	Eq Guinea, Radio Africa	15190af	
2200	2300	vi	Ghana, Ghana BC Corp	3366do 4915do
2200	2300	Guyana, Voice of	3291do	
2200	2300	vi	Malaysia, RTM/Trax FM	7295as
2200	2300	vi	Namibia, Namibian BC Corp	3270do 6060do 6175do
2200	2300	Nigeria, Radio/Kaduna	4770do	6090do
2200	2300	Nigeria, Radio/Lagos	3326do	4990do
2200	2300	Papua New Guinea, Catholic Radio	4960do	
2200	2300	vi	Papua New Guinea, Wantok R. Light	7120va
2200	2300	irreg/ vi	Sierra Leone, SLBS3316do	
2200	2300	vi	Solomon Islands, SIBC	5020do 9545do
2200	2300	Taiwan, Radio Taiwan Intl	15600eu	
2200	2300	DRM	UK, BBC World Service	1296eu
2200	2300	UK, BBC World Service	5955as 5975am 6195as 9650eu	5965as 9480eu
2200	2300	Ukraine, Radio Ukraine Intl	5830eu	
2200	2300	USA, American Forces Radio	4319usb 5765usb 12133usb	5446usb 10320usb
2200	2300	USA, KAIJ Dallas TX	9480na	
2200	2300	USA, KTBN Salt Lake City UT	15590na	
2200	2300	USA, Voice of America	7120va 11725va 15185va	7405as 15290va
2200	2300	mtwhf	USA, WBCQ Kennebunk ME	5110na 18910na
2200	2300	USA, WBCQ Kennebunk ME	7415na	9330na
2200	2300	USA, WBOH Newport NC	5920am	
2200	2300	USA, WEWN Birmingham AL	7560va	9975va
2200	2300	USA, WHRI Cypress Creek SC	7490am	9660am
2200	2300	USA, WINB Red Lion PA	13570am	
2200	2300	USA, WRMI Miami FL	7385na	
2200	2300	USA, WTJC Newport NC	9370na	
2200	2300	USA, WWCR Nashville TN	7465na	9985na
2200	2300as	USA, WWRB Manchester TN	3185na	
2200	2300	USA, WYFR/Family R Okeechobee FL		21525af
2200	2300	Zambia, Christian Voice	4965af	
2205	2230	Italy, RAI Intl	6090as	
2230	2257	Czech Rep, Radio Prague	5930na	9435af
2230	2300	Guam, AWR/KSDA	15320as	

2230	2300	Papua New Guinea, NBC	9675do	
2230	2300	Sweden, Radio	6065eu	
2230	2300	USA, Voice of America	13755va	7230va 9780va
2245	2300	India, All India Radio	11620as 11645as	9705as 9950as
2259	2300	New Zealand, Radio NZ Intl	17675pa	
2259	2300	DRM	New Zealand, Radio NZ Intl	17675pa

### 2300 UTC - 6PM EST / 5PM CST / 3PM PST

2300	0000	Anguilla, University Network	6090am	
2300	0000	Australia, ABC NT Alice Springs	4835do	2310do
2300	0000	Australia, ABC NT Katherine	5025do	
2300	0000	Australia, ABC NT Tennant Creek		4910do
2300	0000	smtwhf	Canada, CBC NQ SW Service	9625na
2300	0000	Canada, CFRX Toronto ON	6070na	
2300	0000	Canada, CFVP Calgary AB	6030na	
2300	0000	Canada, CKZN St John's NF	6160na	
2300	0000	Canada, CKZU Vancouver BC	6160na	
2300	0000	China, China Radio Intl	5915as 6040na 6145as	5990am 11970na
2300	0000	Costa Rica, University Network	9550va	
2300	0000	Cuba, Radio Havana		13750va
2300	0000	Egypt, Radio Cairo	11950eu	
2300	0000	Guyana, Voice of	3291do	
2300	0000	India, All India Radio	11620as 11645as	9705as 9950as
2300	0000	Malaysia, RTM/Trax FM	7295as	
2300	0000	vi	Namibia, Namibian BC Corp	3270do 3290do
2300	0000	6060do	6175do	
2300	0000	DRM	New Zealand, Radio NZ Intl	15720pa
2300	0000	DRM	New Zealand, Radio NZ Intl	17675pa
2300	0000	Papua New Guinea, Catholic Radio	4960do	
2300	0000	Papua New Guinea, NBC	9675do	
2300	0000	vi	Papua New Guinea, Wantok R. Light	7120va
2300	0000	irreg/ vi	Sierra Leone, SLBS3316do	
2300	0000	Singapore, MediaCorp Radio	6150do	
2300	0000	vi	Solomon Islands, SIBC	5020do 9545do
2300	0000	Turkey, Voice of	5960va	
2300	0000	UK, BBC World Service	5985as 6170as	3915as 5965as 9480eu 11945as
2300	0000	USA, American Forces Radio	5765usb 6350usb	4319usb 5446usb 7811usb 10320usb
2300	0000	12133usb	13362usb	
2300	0000	USA, KAIJ Dallas TX	9480na	
2300	0000	USA, KTBN Salt Lake City UT	15590na	
2300	0000	USA, Voice of America	7120va 11725va 15185va	7405va 15290va
2300	0000	USA, WBCQ Kennebunk ME	5110na 9330na	7415na
2300	0000	USA, WBOH Newport NC	5920am	
2300	0000	USA, WEWN Birmingham AL	7560va	9975va
2300	0000	USA, WHRA Greenbush ME	5850na	
2300	0000	USA, WHRI Cypress Creek SC	7315am	7490am
2300	0000	USA, WINB Red Lion PA	9265am	
2300	0000	mtwhf	USA, WRMI Miami FL	7385na
2300	0000	Sat/Sun	USA, WRMI Miami FL	9955am
2300	0000	USA, WTJC Newport NC	9370na	
2300	0000	USA, WWCR Nashville TN	5070na 9985na 13845na	7465na
2300	0000	smtwhf	USA, WWRB Manchester TN	5745ca
2300	0000	Zambia, Christian Voice	4965af	
2300	2315	Nigeria, Radio/Kaduna	4770do	6090do
2300	2315	Nigeria, Radio/Lagos	3326do	
2300	2315	USA, WYFR/Family R Okeechobee FL		11875af
2300	2330	Australia, Radio	13670pa 15230pa	17555na 17575am 12680as 13630pa 15240va 17785va
2300	2330	DRM	Germany, Deutsche Welle	9800na
2300	2330	USA, Voice of America	15150va	6180va 7205va
2300	2356	Romania, Radio Romania Intl	7105va 9610va	6055va 6155va 9755va
2315	2330	Croatia, Croatian Radio	7285sa	
2330	0000	Australia, Radio	9660as 13670pa 15230pa 17785va 17795va	12080as 13620pa 15415va 17750va
2330	0000	Burma, Dem Voice of Burma	5955eu	
2330	0000	Lithuania, Radio Vilnius	7325na	
2330	0000	USA, Voice of America	11665va 13640va	6180va 7205va 15150va
2330	2357	Czech Rep, Radio Prague	5930na	7345na
2330	2358	Vietnam, Voice of	9840as	12020as
2330	2359	DRM	Sweden, Radio	9800na
2335	0000	Sun/Mon	Austria, Radio Austria Intl	9870sa
2343	2358	twhfa	Austria, Radio Austria Intl	9870sa

## Monitoring the Air Show Experience Equipment and Schedules

In this month's lead feature on page 8 we covered the crack military flight demonstration teams and where to find the frequencies they use for air-ground coordination and other communications. Now we turn to two other important considerations for successful monitoring – Where and when can you find an air show in your area and what equipment is required to listen in?

### MT Air Show Equipment List

I am frequently asked which scanner I recommend for air show monitoring. While I don't have a favorite, I have prepared the list in Table One as a purchase guide of receivers that meet all the requirements as outlined below.

#### Not Just Any Old Scanner Will Do

Some scanners currently being marketed and almost all older scanners on the used market are *not* suited for air show monitoring. There are certain requirements your air show radio has to meet in order to successfully monitor the two major military aerial demonstration teams – the Blues and T-Birds.

If you are going to a Thunderbird show, you will need a scanner that can monitor the 138-150 MHz military land mobile band in the AM mode. Most of the older Uniden scanners cannot be used for air show monitoring due to their lack of independent transmission mode selection.

You also need a scanner that has the 225-400 MHz military aeronautical band in it. Most of the action (especially the Blues) will be heard in this military UHF portion of the spectrum. Adding this criterion to the mix of possible radios again narrows down our choice for air show scanners even further.

Information below includes current Grove Enterprises stock codes/prices (if carried by Grove) for the items indicated, but the price does not include shipping or taxes (if applicable). Prices are subject to change without notice, so be sure to call the Grove order department at 800-438-8155 or visit the Grove website at [www.grove-ent.com](http://www.grove-ent.com) for current pricing.

#### Air Show Listening Tip

If you are going to use a handheld scanner at the air show, there is another purchase you should consider: an extra set of charged batteries. Murphy's law applies here and nothing is worse than having your batteries die halfway through the show with no replacements.

**TABLE ONE:  
MILITARY AIR SHOW CAPABLE RECEIVERS**

Handheld Unit	Grove #	Price
Alinco DJ-X7	SCN03	\$169.95
Alinco DJ-X10T	SCN01	\$319.95
Alinco DJ-X2000T	SCN10	\$519.95
AOR AR-8200 Mk III	SCN51	\$579.95
Icom IC R-3	SCN07	\$349.95
Icom IC R-5	SCN02	\$199.95
Icom IC R-20	SCN20	\$509.95*
Uniden BR-330T	SCN30	\$259.95
Uniden BCD-396T	SCN47	\$524.95**

Note: The Uniden BC-296D has been on our list for several years, but has now been discontinued by Uniden.

Base/Mobile Unit	Grove #	Price
AOR AR-5000A+3B	RCV44P	\$2569.95
AOR AR-8600 Mk II	SCN11	\$889.95
JRC NRD-545	RCV21DS	\$1799.95

(Must order the optional ACC11DS VHF-UHF converter at \$349.95)

Uniden BCD996T SCN48 \$524.95\*\*  
 \*\* Includes APCO-digital/trunk capability  
 Note: The Uniden BC-796D has been on our list for several years, but has now been discontinued by Uniden.

Computer Receivers	Grove #	Price
Icom PCR-1500	RCV15	\$599.95
Icom IC-R1500	RCV25	\$599.95 (remote head for stand alone ops)
Icom PCR-2500	RCV35	\$729.95
Icom IC-R2500	RCV52	\$899.95 (remote head for stand alone ops)
WinRadio		
WR-1550e	RCV47-E	\$549.95
WR-1550i	RCV47-I	\$499.95
WR-3150e	RCV48-E	\$1849.95
WR-3150i-DSP	RCV48-I	\$1849.95

WR-3500e	RCV49-E	\$2395.95
WR-3500i-DSP	RCV49-I	\$2395.95
WR-3700e	RCV50-E	\$2895.95
WR-3700i-DSP	RCV50-I	\$2895.95

Professional Receiver Grove # Price  
 Icom R-9500 Unit has not been FCC type accepted at press deadline. Pricing available when FCC accepted.

**TABLE TWO: MILITARY DEMONSTRATION TEAMS**

#### 2006 PERFORMANCE SCHEDULE

Note: If security levels increase in a base to Threat Condition "Bravo" or above, many military installations will not have public air shows. Consequently, demonstration schedules dates listed below are subject to change or cancellation without notice.

#### Demonstration Group Abbreviations:

- BA ..... Navy Blue Angels
- CF18 ..... Canadian Forces CF-18 Hornet Demonstration Group
- GK ..... Army Golden Knights
- SB ..... Canadian Snowbirds
- SW ..... Army Silver Wings
- TB ..... Air Force Thunderbirds

#### Base Abbreviations

- AB ..... Air Base
- ACC ..... Air Combat Command
- AFAF ..... Air Force Auxiliary Field
- AFB ..... Air Force Base
- ARB ..... Air Reserve Base
- CFB ..... Canadian Forces Base
- JRB ..... Joint Reserve Base
- MCAS ..... Marine Corps Air Station
- NAF ..... Naval Air Facility
- NAS ..... Naval Air Station
- TBD ..... To Be Determined

Dates	Group: Locations
Mar 10	BA: NAF El Centro, CA
Mar 17-18	BA/GK: Davis Monthan AFB, AZ; GK: Titusville, FL
Mar 24	BA: Tyndall AFB, FL
Mar 24-25	GK: Punta Gorda, FL; TB/GK: Luke AFB, AZ
Mar 31-Apr 01	BA: MacDill AFB, FL; TB: Point Mugu NB, CA
Apr 14-15	BA: NAS Corpus Christi, TX; TB/GK: Eglin AFB, FL
Apr 21-22	BA: MCAS Beaufort, SC; GK: Charleston AFB, SC/Wilmington, NC; TB: Barksdale AFB, LA
Apr 28-29	BA: Vidalia, GA; TB: Langley AFB, VA
May 05-06	BA/GK: Offutt AFB, NE; TB/GK: Fort Lauderdale, FL



Photo courtesy Thunderbirds



Photo courtesy Golden Knights

May 12 BA/GK: Seymour Johnson AFB, NC  
 May 12-13 TB/GK: McGuire AFB, NJ  
 May 18-20 GK: Andrews AFB, MD  
 May 19-20 BA: La Crosse, WI; GK: Ft. Jackson, SC; SB: To be confirmed; TB: Andrews AFB, MD  
 May 23 BA: U.S. Naval Academy, MD; SB: Penticton, BC  
 May 26-27 BA: Millville, NJ; SB: Brandon, MB; TB/GK: Wantagh (Jones Beach), NY  
 May 27 GK: Charlotte, NC  
 May 30 TB: U.S. Air Force Academy, Colorado (By Invitation Only Show)  
 Jun 02-03 BA/GK: Rockford, IL; CF18: Southport, MB; SB: Portage-la-Prairie, MB; TB: Davenport, IA  
 Jun 06 SB: Kapuskasing, ON  
 Jun 09-10 BA: Tinker AFB, OK; GK: Travis AFB, CA; SB/CF18: Bagotville, QC; TB: Sacramento, CA  
 Jun 13 SB: Dalhousie, NB  
 Jun 16-17 BA: Fargo, ND; CF18Ottawa, ON; GK: Muncie, IN; SB: Moncton, NB; TB: Pittsburgh, PA  
 Jun 20 SB/CF18: Owen Sound, ON  
 Jun 23-24 BA: North Kingstown, RI; SB/CF18: St. Thomas, ON; TB: Galway, Ireland  
 Jun 26 TB: Krzesiny Air Base, Poland  
 Jun 27 SB: Kingston, ON  
 Jun 28 TB: Mihail Kogalniceanu, Romania  
 Jun 29-30 GK: Binghamton, NY  
 Jun 30 SB: Cobourg, ON; TB: Ankara, Turkey  
 Jun 30-Jul 01 BA: Battle Creek, MI; CF18/GK: Evansville, IN  
 Jul 01 SB: Canada Day Flypast, Ottawa, ON; TB: Graf Ignatievo, Bulgaria  
 Jul 04 SB: Evansville, IN; GK: Ft. Bragg, NC; TB: Aviano AB, Italy  
 Jul 06 SB: Calgary Stampede Flypast Calgary, AB  
 Jul 07 SB/CF18: Moose Jaw, SK  
 Jul 07-08 BA/GK: Camp Grayling/Ypsilanti, MI; TB: Evreux Field, France  
 Jul 13 CF18: RAF Fairford, United Kingdom  
 Jul 14-15 BA/GK: McConnell AFB, KS; GK: Gary, IN; TB/CF18: RAF Fairford, United Kingdom  
 Jul 18 SB: The Pas, MB  
 Jul 21 BA: Pensacola Beach, FL; SB: Fort McMurray, AB  
 Jul 21-22 GK: Peoria, IL  
 Jul 22 SB: Edmonton Grand Prix Flypast Edmonton, AB  
 Jul 25 SB: Fort St. John, BC; GK: Ionia, MI; TB: Cheyenne, WY  
 Jul 25-28 GK: Sioux City, IA  
 Jul 28-29 BA: Bozeman, MT; SB/CF18: Peace River, AB; TB/GK: Dayton, OH  
 Aug 01 SB: Prince George, BC  
 Aug 04-05 BA: Seattle, WA; GK: Janesville, WI; SB/CF18: Lethbridge, AB  
 Aug 10-12 SB/CF18: Abbotsford, BC  
 Aug 11-12 BA/GK: Hillsboro, OR; GK: Al-

Aug 15 toona, PA; TB: Niagara Falls, NY  
 SB: Snowbirds Fly for CHILD, Kelowna, BC; TB/GK: Atlantic City, NJ  
 Aug 18-19 SB/CF18: Saskatoon, SK; GK: Eau Claire, WI; TB/GK: Chicago, IL  
 Aug 25-26 BA: Indianapolis, IN; GK: Kansas City, MO; SB/CF18: St. Catharines, ON; TB/GK: Otis ANGB, MA  
 CF18: Brantford, ON; SB: Candiac, QC  
 Aug 29 BA: St. Louis, MO; SB/CF18: Toronto, ON; TB/GK: Cleveland, OH  
 Sep 01-03 SB: Flypast of the Captain Michael VandenBos School Toronto, ON  
 Sep 04 TB: Minot AFB, ND  
 Sep 08 BA: NAS Oceana, VA; GK: Window Rock, AZ; SB/CF18: Halifax, NS  
 Sep 08-09 SB: Reno, NV  
 Sep 14-16 TB: Hickam AFB, HI  
 Sep 15 BA/GK: NAS Brunswick, ME  
 Sep 15-16 SB: Tucumcari, NM  
 Sep 19 BA/GK/SB: Millington, TN; TB/GK: El Paso, TX  
 Sep 22-23 SB: Fayetteville, AR  
 Sep 26 BA/SB: Salinas, CA; TB: Columbus, OH  
 Sep 29-30 BA: San Francisco, CA; SB: Houston, TX; TB/GK: Pope AFB, NC  
 Oct 06-07 SB: Year End Show Moose Jaw, SK  
 Oct 12 BA/GK: MCAS Kaneohe Bay, HI;

Oct 20-21 TB/GK: Miramar MCAS, CA  
 BA/GK: Fort Worth (Alliance), TX; GK: Richmond, VA; TB: Moody AFB, GA  
 Oct 27-28 BA/GK: Muskogee, OK; TB: New Orleans, LA  
 Nov 03-04 BA: Jacksonville Beach, FL; TB/GK: NASA Cape Canaveral, FL  
 Nov 09-10 BA: NAS Pensacola, FL  
 Nov 10-11 Nellis AFB, NV

**Think "HF" Using  
a Handheld Scanner  
or HT was Not Realistic?**

Check out  
[www.PerformanceHF.com](http://www.PerformanceHF.com)  
A Tuned Multiband Antenna  
for Handheld Use.  
It Performs!

Performance HF, Inc.  
11925 Meriden Lane  
San Diego, CA 92128  
(858) 487-8050

**Letters to the Editor continued from page 5**

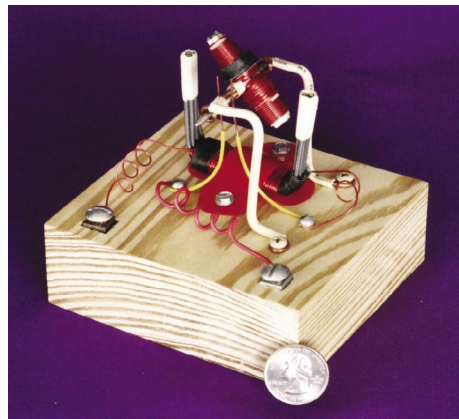

us pictures of her motors (shot by her husband Greg), and here they are! Should we pester Greg and Judy for the plans?!

**Help Needed: Lost CW Gadget**

"I used to work at the Comm Center in Laurel, MD, many years ago. During my few years working there I had to pleasure of meeting quite a few influential people in the hobby such as the Hallicrafter Collector and others ...

"There is one that I wish I could remember ... This particular ham used to come into the Comm Center quite often with new gadgets that he made. After he became a silent key his XYL brought the last of his items for us to sell on our consignment shelf. I bought one of the items he made and have not been able to find it. It is probably under some stuff in the box that is behind that other stuff.

"He built it inside a cabinet that resembled a Heathkit cabinet and, as all his items were, was very well made with great craftsmanship. This device allowed the user to connect to the receiver speaker and when the CW signal matched a certain

frequency it would reproduce a CW sound in its speaker without any QRM. I used it quite a bit and miss it.

"I have been looking and asking at local hamfests and on the Internet to no avail.

"You are providing a great service to several hobbies and the world community. Keep up the great work."

- de N3DNQ

N3DNQ mentioned looking for this same accessory in another letter printed in the February *Letters*. Steve Harper sent this suggestion in response:

"In the February issue of *MT*, N3DNQ wrote about finding an add-on BFO to enable to listen to SSB signals. I purchased an inexpensive (\$11) kit from Ten Tec just for that purpose. It took me about a half hour to wire it. Later, enclosing it in a small plastic 'project box' and attaching a 9V battery with Velcro™ to the outside, I had a device that worked quite well. I would just hold it against the outside of the radio, not clip anything to the antenna. The Grundig FR200 radio I used it with would drift like crazy, but with something more stable it would require less attention. The Ten Tec part is 1050 Universal BFO."

Great suggestion, Steve. Thanks to all our readers, and we hope you enjoy this month's special coverage of air show monitoring.

This column is open to your considered comments. Opinions expressed here are not necessarily those of *Monitoring Times*. Your letters may be rephrased or shortened for length and clarity. Please mail to *Letters to the Editor*, 7540 Hwy 64 West, Brasstown, NC 28902, or email [editor@monitoringtimes.com](mailto:editor@monitoringtimes.com)  
Happy monitoring!  
- Rachel Baughn, KE4OPD, Editor

## The IRS – Where are They Now?

In past years many federal monitors had frequencies in their scanners for the Treasury Department and one of its most notable divisions, the Internal Revenue Service. They were a fairly busy operation to monitor, often without any encryption. Various divisions of the Treasury and IRS used both VHF and UHF frequencies for their law enforcement communications. But then something happened.

Sometime in the late 1990s, many of the radio frequencies used by the IRS seemed to go silent. Looking back, this seemed to occur about the same time that various reforms in the IRS organization were signed into law. The IRS Restructuring and Reform Act of 1998 may have changed what the various divisions of the IRS were responsible for and may have changed their radio communications needs.

This is also the time that cellular phones were starting to become an integrated part of business and government communications. While cell phones would have never completely replaced Treasury Department land-mobile radio communications, it is clear that they would drastically reduce the amount of routine radio traffic heard on the Treasury, IRS and most other federal government frequencies.

Shortly after these frequencies seemed to go silent, the Treasury Department also entered into a plan to consolidate and restructure their radio communications system. They had originally started a pilot project to develop their own integrated wireless network; however, they have since joined forces with the Justice Department's IWN project, about which I have written in past *Fed Files* columns.



But where are the Treasury and IRS communications today? The only thing I have actually confirmed as being active within the IRS lately is the Treasury Inspector General for Tax Administration or TIGTA. You can find out more about TIGTA at their web site, [www.treas.gov/tigta/](http://www.treas.gov/tigta/). TIGTA was created when the 1998 IRS Restructuring and Reform act was passed. Although I am certain there are other divisions of the Treasury still active, no one seems to know what they are using for radios.

What about frequencies? In my area of Portland, Oregon, TIGTA has two frequencies that they are heard using. One is a repeater on 164.5375 MHz with 172.6375 MHz input and the other is also a repeater, but on 165.9500

MHz with 167.0000 MHz as the input. I have also received information (unconfirmed) that TIGTA may be using 165.3375 MHz as a tactical frequency. What is interesting about these frequencies is that they were not previously known as Treasury Department allocations.

It's clear that Treasury Department communications are out there, but they may have begun to shift frequencies, perhaps in anticipation of the future Integrated Wireless Network. So, keeping in mind that the Treasury and IRS communications could have moved, here is a list of previously known Treasury/IRS frequencies, along with the new ones I have found. Please check these out and see if anything is active in your area:

- 163.1250
- 164.1000
- 164.2500
- 164.5375
- 165.9125
- 165.9500
- 166.2000
- 166.4625 - Treasury common
- 166.5375
- 166.5875
- 166.9750
- 167.0000 - Nationwide assignment
- 167.1000
- 167.1500
- 167.9750
- 172.6375
- 173.0250
- 173.8625
- 411.5250
- 411.5500
- 412.2250
- 414.3250
- 414.7000
- 414.9000 - Nationwide assignment
- 415.0000 - Nationwide assignment
- 415.1000 - Nationwide assignment
- 415.4250
- 415.5500
- 415.7250 - Nationwide assignment
- 415.8000
- 415.8750
- 416.8000 - Nationwide assignment
- 417.6500
- 418.1000
- 418.1750 - Nationwide assignment
- 418.2000 - Nationwide assignment
- 418.2250 - Nationwide assignment
- 418.2500 - Nationwide assignment

### ☒ National Parks Service Moving to Digital

One segment of federal communications that has begun to move toward digital communications is the National Parks Service, a

division of the Department of the Interior. While it's expected that more and more park law enforcement and public safety channels will become digital, it's not clear how much of the park support and maintenance type traffic will be moving that way. Remember that the new federal frequency requirements do not mandate the use of digital radios: only that the channels be narrowband.



I recently received updates to some National Parks radio frequencies from Ben Russell. Ben wrote, "Everything marked P25 is confirmed as digital. The Rangers repeater at Valley Forge is no longer used for dispatching. Due to budget issues, the park did away with its own dispatcher. Montgomery County 911 now dispatches the Rangers on the county's 800 MHz trunked system. The 'Park Net' is still frequently used as a unit-to-unit channel, though. I live right across the river from Valley Forge. I can't say I have monitored any substantial traffic on the VFNHP maintenance channel in years, though. They probably use Nextel or other cell phones more often than anything. Sorry I don't have a lot of the repeater inputs..."

Thanks much for your efforts, Ben. Here are some of the updated National Parks Service frequencies and their uses:

- 172.4000 Allegheny Portage Railroad National Historical Site - Repeater (managed w/Johnstown Flood National Monument)
- 171.7000 Allegheny Portage Railroad National Historical Site - Repeater input
- 164.5750 Delaware Water Gap National Recreation Area
- 166.3000 Delaware Water Gap National Recreation Area
- 166.3500 Delaware Water Gap National Recreation Area
- 166.7750 Delaware Water Gap National Recreation Area
- 166.9000 Delaware Water Gap National Recreation Area - Rangers
- 166.9500 Delaware Water Gap National Recreation Area
- 168.4750, P25 Delaware Water Gap National Recreation Area - North Repeater
- 170.0500, P25 Delaware Water Gap National Recreation Area - South Repeater
- 172.4000 Fort Necessity National



- 171.7000 Battlefield - Repeater  
Fort Necessity National Battlefield - Repeater input
- 164.7250, P25 Gettysburg National Memorial Park - Repeater
- 166.2750, P25 Gettysburg National Memorial Park - Repeater input
- 172.4000, P25 Hopewell Furnace National Historical Site - Repeater
- 171.7000, P25 Hopewell Furnace National Historical Site - Repeater input
- 164.6750 Independence National Historical Park
- 172.4750 Independence National Historical Park
- 164.7500, P25 Independence National Historical Park - Maintenance Repeater
- 164.1250, P25 Independence National Historical Park - Operations Repeater
- 164.7250, P25 Independence National Historical Park - Ticketing Repeater
- 171.6500, P25 Independence National Historical Park - Ranger Dispatch Repeater
- 172.4000 Johnstown Flood National Monument - Repeater (managed w/Allegheny Portage)
- 171.7000 Johnstown Flood National Monument - Repeater input
- 164.4750 Steamtown National Historical Site
- 168.5500 Upper Delaware Scenic and Recreational River
- 164.5750 Upper Delaware Scenic and Recreational River - Repeater
- 167.9500 Upper Delaware Scenic and Recreational River - Repeater Input
- 164.4250, P25 Valley Forge National Historical Park - Maintenance
- 165.4375, P25 Valley Forge National Historical Park - Rangers Park Net Repeater

tory at the DoE wrote, "We used to run monthly HF nets on Wednesdays like all of the other federal agencies. About 80% of these nets were plain old unencrypted RTTY (radio teletype). We had some encrypted tests using KW-7's and a little voice net. We had two simultaneous nets; net A/C which was a combined east coast net with stations, Oak Ridge, Savannah River, etc and net B which had the western US stations, Nevada Test Site, Idaho National Lab, Lawrence Livermore Labs and others."

Here are some HF frequencies used by the Department of Energy (DOE). All frequencies are in kilohertz (kHz):

2286.0	7780.0
3335.0	7900.0
4479.0	8013.5
5308.0	9918.0
5751.0	11555.0
5947.0	14657.0
6803.0	17397.0
7428.0	18416.0
7700.0	

I had also asked about some Department of Energy facilities that I had not been able to find any information about. A couple of kind readers passed along this information about the DoE facility in Kansas City, Missouri.

The DoE is housed with some other federal agencies in the Bannister Federal Complex, and they have recently moved to a UHF Motorola trunked radio system:

Kansas City DoE / Bannister Federal Complex  
System ID = 00d2  
406.1875 MHz  
406.9875 MHz  
407.3000 MHz  
407.5875 MHz  
407.9875 MHz  
409.7750 MHz

Here is info on the Bannister Federal Complex and the agencies it serves: [www.gsa.gov/bannisterfedcomplex](http://www.gsa.gov/bannisterfedcomplex).

## ☒ Department of Energy Follow Up

A few additional items of interest have followed the publication of the September 2006 *Fed Files* column featuring some of the Department of Energy radio systems around the country.

I recently spoke to a public safety officer who told me about some special training they had just completed in dealing with the nuclear materials and weapons transportation convoys that could potentially pass through the state. The training specifically mentioned the fact that the DoE convoys maintained constant communications with their control center and that they were "never out of range." Sounds like HF to me...

I also received some additional information about the shortwave or HF system that is used by the Department of Energy. I mentioned the SECOM HF radio system in the column, but was informed that most of the communications on that system is digital polling data and not voice, although the system has voice capabilities.

In addition to the SECOM HF system, the DoE also has an HF system called ERS, or Emergency Radio System. Station KAL-24 is at the national field headquarters in Germantown, MD. A *Fed Files* reader with some personal his-

Seneca radio as the next big thing in federal communications. According to some posts, Seneca represented a whole new communications system for federal use that would be completely unmonitorable.

In 1998 there was a press release on the Motorola web site that talked about the joint project between Motorola and Harris Corporation and how it was going to offer new abilities to do data transmission in the field, including fingerprint information and photos. The release



also stated that 500 of the Astro-Seneca radios were to be delivered to the FBI for initial testing and

acceptance. The press release seemed to indicate that the Seneca part of the radio was the encryption system built by Harris.

However, since this first release of information from the manufacturers, there has been nothing about these radios and their actual use in the field. Did they ever get issued and used? Current searches of information on the Internet show that nothing new has been made available since this early press release. Many industry web sites have offered recycled versions of the Motorola press release, all dating from 1998 or 1999. And several radio hobby related web sites offer some scanner listener "matter-of-fact" comments about the Astro-Seneca radios and their capabilities, but no current information about the radios or their use by any federal agency.



One possibility is that the whole project is classified and information is not available publicly. Since the events of 9/11 and the new push by the federal government towards communications interoperability, the Seneca platform may have fallen by the wayside. Perhaps the Seneca encryption standard is being used for secure communications over APCO 25 radio systems.

If any *Monitoring Times* readers can supply any additional information or opinions on the Astro-Seneca radio, please pass them along to us at the *Fed Files*. We strive for accuracy in our presentations.

Next time we'll tackle another Fed Files Myth, the Secret Service and the "Suit Radio"!

## Longwave Resources

✓ **Sounds of Longwave** CD or Audio Cassette (please specify) featuring WWVB, Omega, Whistlers, Beacons, European Broadcasters, and more!  
**\$13.95** postpaid

✓ **The BeaconFinder** A 65-page guide listing Frequency, ID and Location for hundreds of LF beacons and utility stations. Covers 0-530 kHz.  
**\$13.95** postpaid

**Kevin Carey**  
**P.O. Box 56, W. Bloomfield, NY 14585**

## ☒ Fed Files Myths and Legends

All during the years I have been monitoring federal communications, there have been all sorts of rumors, stories, myths and legends about federal radio systems that have been passed from person to person and written about in various publications. Many of these stories are interesting, but when you start really digging into the background of these rumors, you often find that it's very difficult to get much hard information behind these stories.

So, I thought I would try to present what I like to call the "Fed Files Myths and Legends" to you to see if we can generate some more information on how these stories got started. It's not my intention to "bust" these myths, but simply to try and see if there is any solid information out there and let you make up your own minds.

### What's the skinny on Seneca?

The first myth I want to tackle is the "SENECA" radio. Years ago I started seeing posts on the Fedcom mail list referring to the

## Hi-Rails, Track Permits, and More Terminology

**A** reader wrote to ask about the rubber-tired vehicles that he sometimes sees going down the track.

Railroads and rail transit systems all over the world use a variety of rubber-tired vehicles that also have retractable flanged wheels that allow them to operate on tracks. These vehicles are used for track inspection, signal maintenance, and a variety of tasks that simply require getting to a remote location easily reachable only by rail.

In North America, these are called hi-rail (for highway-rail, sometimes also spelled hi-rail) vehicles. They range from pickups and SUVs all the way up to heavy dump trucks and mobile cranes.

In a few cases, such vehicles are even used for light switching; rail transit systems often use them for emergency towing of light rail or subway cars when the electric supply fails or has to be shut off for maintenance or other reasons. Rail transit systems also sometimes use hi-rail vehicles equipped with hydraulic lifts for catenary and tunnel maintenance.

### Brandt Unit

The mother of all hi-rail vehicles is prob-



*A Union Pacific employee in Colorado locks down the flanged guide wheels on his hi-rail truck.*



*A Norfolk Southern Brandt unit maneuvering railcars with track components into place for unloading by crane. Note that the unit is equipped with a hydraulic arm that can be used either as a lightweight crane or as a cherry-picker to lift personnel to work on lineside equipment.*

ably the Brandt Unit ([roadrail.brandt.ca](http://roadrail.brandt.ca)), a purpose-built vehicle utilizing components from heavy-duty tractors used for 18-wheelers on the highway. The Brandt units come with a full-sized railroad knuckle coupler and air compressor for operating the air brakes on rail cars.

One of these Brandt Units can easily move or switch two or three loaded rail cars – or several more empties. These units, built in Canada, were originally designed for switching on light density freight rail lines. For example, a shortline operator may have two or more of these lines not directly connected to each other. If none of the lines has enough traffic to justify its own switch engine, sending a switch engine from one line to another would require routing it via a Class I railroad, which would be both expensive and time consuming.

Instead, a Brandt Unit can do the switching on one line, then retract its rail wheels and head to the next location by the most direct highway route.

In addition to shortline operators, Brandt units have also been purchased by major railroads for specialized maintenance work. For example, I've watched a Norfolk Southern (NS) Brandt Unit deliver components of a prefabricated switch loaded on two special flatcars. Rather than having an expensive switch engine present while the flatcars were slowly and carefully unloaded by a contractor's crane, the Brandt Unit moved the cars into place.

Once the work was done, the Brandt Unit spotted the cars in a nearby siding (to be picked up by the next local freight), then headed to the nearest grade crossing. There it changed to highway mode and headed to the next assignment

by road, immediately freeing up the railroad for other traffic.

### Unimog

A popular hi-rail vehicle for transit systems is the Unimog, a medium duty four-wheel drive truck manufactured in Europe by the Daimler Chrysler Corp. Unimogs are used in Europe by military services (some of which have hi-rail versions), by regional and local governments and a variety of construction and utility companies. (For military services, the Unimog is somewhat analogous to the U.S. Humvee.)

Daimler Chrysler has only recently begun seriously promoting Unimogs in the U.S. But, a number of transit systems, such as Denver's RTD, have had Unimogs for years.

For hi-rail switching or towing use, Unimogs are often given extra ballast weight to increase their traction, if they are not already weighted down by other on-board equipment such as cranes, compressors, or generators.

### Radio aspects

So, what does all this have to do with railroad radio?

These vehicles and their operation create a disproportionate amount of radio traffic – including some unique messages that apply only to them.

Hi-rail vehicles typically use their flanged wheels only to guide the vehicle and keep it on the rails; the traction is still provided by the rubber tires. (There are a few exceptions.)

As these vehicles are relatively light (compared to locomotives and full-sized railcars), they usually do not activate occupancy circuits of signal systems, including grade crossing signals and gates.

Railroads and rail transit systems detect track occupancy through track circuits. An electric current is fed into the two rails. If a car, locomotive, or complete train occupies the track, then the axles complete the circuit and the system knows there is something on the track. (The actual technology that can sense trains approaching a grade crossing and even determine how fast they are approaching is much more complicated.)

Many hi-rail vehicles have the wheels on the hi-rail axles insulated so that they do not complete the track circuits. As these vehicles cannot reliably activate these circuits, it's important that the operators know that the circuits will not be activated. And, that also lets such a vehicle stop on the tracks near a crossing without closing the gates. Signal maintainers who need



*A Norfolk Southern Brandt unit has set out now empty cars used to deliver track components and is heading to the next road crossing to get off the tracks.*

to test track circuits carry special jumper cables for this purpose.

The bottom line is that, even in signaled territory, hi-rail vehicles have to be given track authority by radio. And, even the heavy hi-rail equipment that can be detected cannot be detected until the flanged wheels are down, so the vehicle has to have track authority before it ever even pulls into the grade crossing.

### ☒ "Rusty rail mode"

This is also related to track circuits: When the first train enters a line that has been dormant for a long time – months or more – it may get an order from the dispatcher to operate in "rusty rail mode" or some similar wording.

This reminds the crew that due to rust on the rails, a short train, particularly if consists only of an engine without cars, may not make a good connection through the track circuits at grade crossings. Therefore, the train has to approach all road crossings at a speed slow enough to enable its crew to observe if the electric grade crossing equipment (flashing lights or flashing lights and gates) is working properly. The crew has to be able to stop short of the crossing if the equipment is not triggered.

That rusty rail order usually lifted after a few trains have operated on the line and all crossing equipment is observed as working.

### ☒ Altamont Press update

Altamont Press, mentioned in my previous column, has resumed operation under new ownership – and railfan timetables are once again available either directly ([www.altamontpress.com](http://www.altamontpress.com)).



*Norfolk Southern Brandt unit getting off the rails at a road crossing. Note that the unit is equipped with a hydraulic arm that can be used either as a lightweight crane or as a cherry-picker to lift personnel to work on lineside equipment.*

com) or through dealers, including many hobby shops.

New owner David Curlee is offering existing editions of five timetables prepared by previous owner Rob Carlson before his death. Curlee, who was an editor and contributor for timetables produced by Carlson, plans to offer updated editions of three timetables in 2007. The 18<sup>th</sup> edition of the *California* timetable should be available about the time you read this.

New versions of two currently out-of-print timetables should appear later in the year. Edition 5 of the *Mountain Plains* timetable (which includes the Powder River Basin and which has been much sought-after during the last year) is scheduled for release in the May/June time period. Edition 8 of the *Northwest* timetable (which includes Alaska) should appear around September/October.

These timetables not only provide listings of radio channels for each line in the area covered but also list named locations and mileposts for each line. And, as noted in the previous column, these timetables bring together data on the lines of all railroads operating in the region covered.

### ☒ "O.S." reports

If you look at the sample track warrant form printed with my June 2006 column, you will notice that there is space at the bottom for a number of "O.S." reports to be recorded.

What is O.S.? It's a location report, another formal type of communication between trains and the dispatcher.

O.S. originally stood for "on sheet." In the days before computers, dispatchers maintained large multi-column train sheets that recorded the status of various trains in their territories. As each train passed or arrived at a location staffed by an operator, the operator would report back – first by telegraph and later by telephone – that the train had left the previous track segment. That report was then recorded "on sheet" at a particular location as of that time.

O.S. reports are now given by the train crew itself by radio and still play an important role.

First, let's recap: A track warrant can either be directional ("Proceed from A to D ...") or to work a given territory ("Work between A and D ...").

If a train is given authority to work a particular territory, it can change direction and maneuver within that territory as much as is required without further contacting the dispatcher. This also precludes another train from entering that territory. (In an emergency, the dispatcher can revoke the original track warrant and issue a new one which allows one train to come to the aid of another that has broken down.)

But, if a train is given directional authority, it may proceed in one direction only, and even backing up a short distance would require authority from the dispatcher. That works fine for through trains that do not do any switching along the way.

Let's take our example of a train with authority to proceed from A to D, where A is milepost 0 and D is milepost 127. Before our first train has reached D, the dispatcher is now anxious to get a second train out of A in the same

direction.

The dispatcher could find out by radio where the first train is, give it a new track warrant (that supersedes the old warrant) for a shorter territory, then grant a warrant to the second train.

However, a simpler procedure is to just get an O.S. report. The dispatcher will ask for the O.S. – and the train will respond, "Train A142, engine 5252 O.S. milepost 67 at 1:42 p.m." That means that the entire train is now by milepost 67. (Crews know how long their train is and, for example, if their train is less than a mile long and the engine has just passed milepost 68, they can safely report that the entire train is past milepost 67.)

Like a track warrant, the O.S. report is read back – this time by the dispatcher – along with proper identification of the employees involved. Once the train confirms that the dispatcher has correctly recorded the report, it becomes official.

The dispatcher can now issue a track warrant to the second train, "Proceed from A to milepost 65..." without having to revoke the warrant issued to the first train. Or, the dispatcher can issue authority to track inspector or other worker in a hi-rail vehicle to operate behind the first train.

O.S. has also acquired a secondary meaning – "on site" – within the limits of a junction or crossing of two railroads (interlocking), as in "The engine (or car) is still within the O.S." That would mean that the engine or other equipment is at a location that is fouling two or more routes. The limits of such a location typically extend only a few hundred feet at most, rather than the mile or more lengths of typical signaled blocks.

If the signal system detects, through its track circuits, that a piece of equipment is still within the O.S. (limits) of an interlocking, the interlocking will remain locked, preventing the dispatcher from setting up a new route through that area.

## MT READERS ONLY

To access the restricted website for the month starting March 1, go to [www.monitoringtimes.com](http://www.monitoringtimes.com), click on the key, and when prompted, enter "mtreader" under the user name. Your password for March is "shann- wick" – Check in each month for new material!



### Books by Ernest H. Robl:

*THE BASIC RAILFAN BOOK*

*UNDERSTANDING INTERMODAL*

*THE POWDER RIVER BASIN*

Detailed descriptions at

<http://www.robl.w1.com>

# New England Beacons

One region that doesn't seem to get a lot of press in longwave circles is New England. With the exception of some very active listeners who live there, I don't get many loggings of New England beacons, even from listeners in adjoining states. We've written about the possible reasons for this before, and it is believed that two factors come into play. First, the ground conductivity in much of New England is poor due to the rocky terrain found there. This could reduce the efficiency of transmitting antennas used at the beacon sites.

Second, and probably more important, is the fact there are comparatively few beacons operating in New England. The FAA's *Airport/Facility Directory* makes this point clear, as it lists only four beacons in Rhode Island, five in Connecticut and eight in Vermont. (Massachusetts and Maine have considerably more beacons, but their numbers are still well below the statistics of many other states.)

This month, we'll focus on New England beacons as worthy DX targets. (Remember that a station needn't be far away to be considered DX — only rare.) The beacons listed below were taken from a past issue of the *Airport/Facility Directory*. These booklets can be obtained from the pilot shops at many airports and can be a useful resource for longwave monitoring. Sectional maps are also good (and interesting to look at), although they may not have all beacons marked, and do not list them in a directory-style format.

Each *Airport/Facility Directory* covers a specific region of the USA, and is updated several times per year as changes warrant. You might want to see if your local airport has any obsolete copies they can part with, although purchasing a new one at around \$4.55 will not set you back too far. One source for online ordering of this publication is [www.sportys.com/pilotshop/charts/afd.cfm](http://www.sportys.com/pilotshop/charts/afd.cfm).

How many of the stations listed below can you hear? I would be interested in receiving logs from as many listeners as possible, and will present them in a future issue of *Monitoring Times*. Please share what type of antenna and receiver you use, how long you've been exploring the longwaves, and any other details that might be of interest to *MT* readers. Shack/operator pictures are always welcome!

### Connecticut

238	MMK	Meridan
244	HF	Hartford
257	TBY	Waterbury
362	OX	Oxford/Waterbury
388	BD	Windsor Locks

### Maine

216	LRG	Lincoln/Millinocket
221	RQM	Rangeley
227	BG	Bangor
236	XQA	Squaw/Greenville
240	LE	Lewiston
251	MVM	Machias
257	FVE	Frenchville
260	EPM	Eastport
260	ESG	Eliot
272	OLD	Oldtown
278	BST	Belfast
278	PQ	Presque Isle
330	BH	Bar Harbor
334	RM	Rockland
344	LNT	Milnot/Millinocket
348	BUP	Burnham/Pittsfield
349	SF	Sanford
356	SUH	Spruce Head/Rockland
366	AU	Augusta
394	PW	Portland
399	RL	Waterville

### Massachusetts

194	TUK	Nantucket
205	ORE	Orange
220	IHM	Mansfield
227	TAN	Taunton
230	BA	Westfield
248	AC	Nantucket
251	SKR	Shaker Hill/Woburn
257	FFF	Plymouth
269	TOF	Topsfield
274	EW	New Bedford
279	CQX	Chatham
279	RS	Dunca/Worcester
332	BE	Bedford/Stow
342	HY	Hyannis-Barnstable
346	LI	Hull (Logan)
365	FIT	Fitchburg
368	IMR	Marshfield
370	DXT	Dalton
375	BO	Milton (Logan)
382	LQ	Lynn (Logan)
389	PVC	Provincetown
395	GBR	Great Barrington
397	OW	Norwood
402	LW	Lawrence
417	EK	Gozzr/Worcester

### New Hampshire

216	CO	Concord
233	CNH	Claremont
260	ESG	Rollins/Rochester
276	LAH	Hanover/Lebanon
281	HXX	Hornbrook/Berlin
338	DRY	Derry
359	AS	Chern/Nashua
379	IVV	White River/Lebanon
386	GMA	Mt. Washington/Whitefield

### Rhode Island

216	BID	Block Island
241	SFZ	Central/Pawtucket
335	PV	Rench/Providence
356	AR	Armin/Providence

### Vermont

221	DYO	Smuto/Rutland
224	VWD	Mt. Snow/West Dover
242	EFK	Newport
265	SXD	Springfield
268	VKN	Mt. Mansfield/Montpelier
353	LLX	Lyndonville
375	JRV	Morrisville
382	BT	Burlington



Beacon SXD/265 kHz, in Springfield, VT

## Locating Your Catch

Often, FAA beacons will be identified with only a "name," not the actual town or city of the station. A case in point is OGY/414 kHz. It is listed in some publications as "Bridge NDB, NY, NY." The name "Bridge" does not give you much useful information, but the listing also includes geographic coordinates, which are useful, if you know how to use them.

In the old days (i.e., pre-Internet/pre-GPS) you'd need to obtain a U.S. Geologic Survey map of the area and cross-reference the coordinates to get an exact fix for the station. Now, several online tools can do the job for you. One especially useful site may be found at: [www.artscipub.com/repeaters/maplatlong.asp](http://www.artscipub.com/repeaters/maplatlong.asp). After entering the coordinates, a detailed map appears, and it allows you to zoom in on the image to pinpoint the location. You can even get an aerial view of the location in many cases. The information on the site is primarily geared toward U.S. and Canadian locations, and can be a very useful tool for serious DXers.

## News Flashes

I've just received word of a new Lowfer beacon operating on 188 kHz (CW). It is run by amateur radio operator W2ZM in Penn Yan, NY. At this point, I do not have an ID for the station or the format of its transmissions, but it has been heard well near Rochester, NY. I hope to have more details soon and will pass them along next month.

On a related note, the ARRL 500 KC Experimental Group for Amateur Radio (WD2XSH) [www.500kc.com/](http://www.500kc.com/) is encouraging listeners to submit reception reports of group members' operations between 505 and 508 kHz. A majority of the group's 21 participants are now believed to be active.

Finally, I am very excited to tell you about a project that has been kept "under wraps" until now. Along with writing columns for *MT*, I've also been busy writing a new book called *Listening to Longwave*, which has just been released by Universal Radio, Inc. An effort was made to cover every major area of the longwave hobby, in the hopes of making the book useful to both beginners and more advanced LW listeners. More details can be found online at: [www.universal-radio.com/catalog/books/0024.html](http://www.universal-radio.com/catalog/books/0024.html).

That's it for March. See you next month!

## Focus on Cupido Radio

Some of the biggest DX challenges to North American pirate radio hobbyists come from Europirate transmitters. The DX challenge of listening for low powered radio signals from the other side of the Atlantic Ocean is fascinating.

This month we focus on one of the more widely heard examples of the Europirate family. **Cupido Radio** is based in the Netherlands. Rinus, the station operator, says that his station is named after the Roman god Cupid. In English this translates to Radio Cupid, but in Dutch the station name is Cupido Radio. When not building radio transmitters, Rinus also spends time raising fish in a nearby pond.

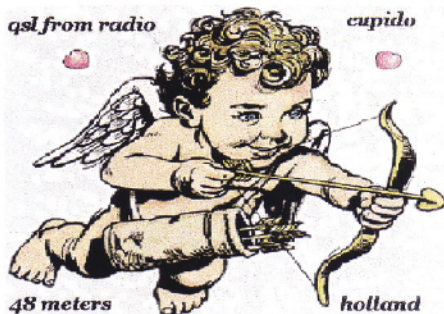

Rinus' equipment is quite professional as pirate stations go. He uses a Behringer 7 channel mixer and a Yamaha rev 100 for voice effects while producing his shows. All of this goes out via a greatly modified sk10 transmitter and an amplifier to raise his effective power output to about 175 watts. All of this is fed to an inverted V antenna mounted on a 13 meter tower.

Rinus operates on frequencies in the 48 and 19 meter band. Some of his 15070 kHz broadcasts have been more widely heard in North America than his ordinary 48 meter broadcasts are. If you hear him, you can send reports to Rinus via an e-mail address of [cupido radio@hotmail.com](mailto:cupidradio@hotmail.com) or you can write to him at PO Box 9, POG62G Oldebroek, The Netherlands.

Another Europirate being widely heard in North America on frequencies such as 6220 kHz is **Mystery Radio**. If you hear them, their e-mail address for reception reports is [Mysteryradio@googlemail.com](mailto:Mysteryradio@googlemail.com)

A good source for Europirate information is a message board hosted by Alfred Zoer at **Radio Alpha Lima International**. It is found at [www.alfalima.net/forum](http://www.alfalima.net/forum)

### ☒ Pirates at Fest

As usual, Festmeisters John Figliozzi and Richard Cuff of the Winter Shortwave Listen-



Pirate radio presenters at the Fest

ers Festival in Kulpville, PA, have announced that there will be discussions of pirate radio and unlicensed broadcasting among the many events at this year's Fest. As we cover elsewhere in *MT* this month, the Fest has been expanded to three days of radio hobby fun. This year's dates for the big annual radio monitoring family reunion are March 8-10, 2007. You can download a Fest registration form from the event's web site at the [www.swlfest.com/](http://www.swlfest.com/)

### ☒ Al Muick in Sudan

As you read in the excellent November *MT* article on the United Nations radio effort in Sudan, Al Muick is the Chief Engineer of UN Radio in Sudan. He has also been on loan to the UN mission in Haiti. Veteran DXer and prominent DX Historian Jerry Berg points out that Al is the same guy who was the director of the old Free Radio Campaign more than 25 years ago during the 1970s. The *FRC* was the first organized group of pirate radio DXers in North America. Many veteran pirate DXers will remember the pioneering work that Al once did in the North American DX hobby.

### ☒ What We Are Hearing

*Monitoring Times* readers heard more than two dozen different North American pirates this month. You can hear them too, if you use some simple techniques. Pirate radio stations never use regularly announced schedules, but shortwave pirate broadcasting increases noticeably on weekends and major holidays. You sometimes have to tune your dial up and down through the pirate radio band to find the stations, but more than 95% of all North American shortwave pirate broadcasts are heard on 6925 kHz, plus or minus 30 or 40 kHz.

**Ann Hoffer Radio**- This pirate plays music by the singer Ann Hoffer. (None)

**Bowling League**- This new pirate has thus far

been heard via **WBNY** relays. They operate a rock oldies format with ads and comedy. (Try Belfast)

**Captain Morgan**- Twilight Zone television audio, rock music, comedy, and holiday fare are heard on their programs. (None, says to send loggings to the Free Radio Network web site)

**Grasscutter Radio**- Despite the station name, rock music dominates their shows. Sometimes they schedule joint broadcasts with **Sunshine Radio**. (Uses [grasscutterrado@yahoo.com](mailto:grasscutterrado@yahoo.com))

**Ground Zero Radio**- Their rock music is always laced with themes related to nuclear explosions and parody ads. (Uses [gzrsw@yahoo.com](mailto:gzrsw@yahoo.com))

**KBLK**- Their slogan is "The Voice of Black Oppression," so their content is more political than most pirates. (None)

**KIPM**- Rumors of Alan Maxwell's demise at this station have proven to be false. His elaborate "Illuminati" existential dramas are among the most complex productions in pirate radio history. (None known)

**MAC Shortwave**- Paul Star's authentic and professionally produced replica of the old top 40 rock format has been using 3276, 6850, and 6925 kHz lately. (Uses [macshortwave@yahoo.com](mailto:macshortwave@yahoo.com))

**Radio Free Euphoria**- The purpose of Captain Ganja's stations has always been advocacy for marijuana. He does it with humor. (Belfast)

**Radio Ice Cream**- After a barking dogs interval signal, this new one programs rock music and talks about the delight that children have when they get ice cream and pizza. (Belfast)

**Random Radio**- Their eclectic format ranges from rock to jazz, and it is spiced with old time radio commercials. (None; asks for reports via the FRN web site)

**Sunshine Radio**- The unusual feature of this rock music station is that the announcer is a woman, a rarity in shortwave pirate radio. (Uses [grasscutterrado@yahoo.com](mailto:grasscutterrado@yahoo.com))

**Radio Three**- Sal Amoniac has returned with rock music on the third in a sequence of pirates named after numbers. (Belfast)

**Take It Easy Radio**- This station urges a lifestyle implicit in their station name. Their format is heavily Eagles rock music and other soft rock selections. (Merlin)

**The Crystal Ship**- The Poet's "Voice of the Blue States Republic," still uses highly variable frequencies such as 1710, 3320, 3346, 3275, 6875, 6925, and 9057 kHz. The format is rock music mixed with left wing politics. They are thinking of marketing CDs of their broadcasts for a nominal fee. (Belfast and uses [tcshortwave@yahoo.com](mailto:tcshortwave@yahoo.com))

**Undercover Radio**- Dr. Benway's rock music comes to us "from the middle of nowhere." (Uses [undercoverradio@gmail.com](mailto:undercoverradio@gmail.com))

**United Patriot Militia Bingo**- This parody of the long-busted **KSMR** Kentucky militia radio clandestine station still makes an occasional appearance on the pirate bands. (None)

**Voice of Captain Ron Shortwave**- Captain Ron mixes rock music with DX commentary. (Uses [captainronswr@yahoo.com](mailto:captainronswr@yahoo.com))

**Voice of the Lutefisk**- Per a QSL, Chris Lobdell found that this Europirate, sometimes with North American relays, is named after a dried codfish fish recipe in Norway. (Uses [votl\\_radio@yahoo.com](mailto:votl_radio@yahoo.com))

Continued on page 61

## Get on the Bus as CW Goes Gently Away

**F**or me, approaching the subject of this month's column came up in a rather ironic way.

The ironic event was when I settled down on the evening of December 15<sup>th</sup> (16<sup>th</sup> UTC) to copy the *ARRL Bulletin* off the air in CW, a habit I have made for many years as a way of keeping my copying skills sound. After the standard preamble, I wrote the following words down as I copied the 599 signal beaming down to NJ from Newington, CT:

"FCC to Drop Morse Testing for All Amateur License Classes"

WHAT?!!!

I have written on the subject of the code requirement many times in this and other columns and I have probably approached the subject from every angle at one time or another. Once the International Telecommunications Union dropped the expectation of code proficiency in July 2003 at the World Radio Conference, I figured it would just be a matter of time before the US followed suit. Switzerland immediately dropped the code requirement and was quickly followed by the United Kingdom, Belgium, Germany, Austria, Norway, New Zealand, Netherlands, Australia, Ireland, Canada, and others.

While the various no-code dominoes fell around the world, the Federal Communications Commission conducted several rounds of public comment related to various petitions both for and against dropping the code requirement. I knew of the strong efforts of organizations such as FISTS, The International Morse Preservation Society, and its thousands of members to rally support to keep code in the rules. I didn't think the Morse Code requirement would go quietly into the night in the good old U.S. of A.

And then, almost as an afterthought, tied to a correction of a procedural error related to the new "Omnibus" frequency guidelines (see below), Fox Charlie Charlie kissed Morse Code on the forehead and bid it a fast goodbye. Off the books with scarcely a whimper.

And here I was, copying down this historic information by way of the very mode that was going to be most affected by the change: CW.

### This is a Good Thing!

I have related my own hate/love relationship with the code mode in this column several times. To put it briefly once more: in those years during which I climbed the amateur radio licensing ladder through to the Extra Class Code test, I absolutely hated CW and never used it on the air. Back in those days you took three code exams – 5 wpm to get Novice & Technician Class, 13

wpm to get General Class, and 20 wpm for the Extra Class.

However, once I passed that final code test, freed from the burden of training to pass those various tests, I grew to love the CW mode. In the "good old days" when you heard a 1x2 Extra callsign on the air, you more or less assumed you were dealing with somebody who knew their way around a code key. Perhaps that is why. No longer burdened by the needing to study to build up speed, it was possible to just sit back and have some fun communicating via Morse Code. Similarly, it is just possible that this newfound freedom from the code test that the current FCC ruling provides might allow some folks to learn to love the code in and of itself as I did.

On the other hand, many very proficient hams who are a true asset to the amateur radio community have been stymied by the code test and have been reluctant to upgrade. With the elimination of the code requirement, these hams will be in a position to both enjoy more of ham radio and to contribute more to it.

Think of all the modes of operation available to the amateur radio community – CW, RTTY, Phone (both SSB and AM), FM, Slow and Fast Scan TV, and, of course, the growing number of digital modes. The argument that CW required a special test while all those other modes did not, failed to hold water over time. The idea that requiring someone to learn CW as a way of "keeping the Riff Raff" off the ham bands was always specious. Probably the largest single growth spurt ham radio ever received was on the heels of the CB radio boom in the '70s. The majority of the folks who came over from the "Cowboy Band" became just as disciplined in their operating habits as the rest of the amateur radio community. I know this because I am one of those '70s CB folks. (By the way, whatever happened to C.W. McCall anyway?)\*

### Other differences to expect

So, let's take a look at how the CW testing changes will change your ability to play radio.

First and most interesting is that ALL Technician Class hams will receive the HF privileges afforded, up until now, to Tech-Plus hams. Those being: CW only on 3525-3600 kHz, 7025-7125 kHz, 21025-21200 kHz; CW, RTTY and Data on 28000-28300 kHz; and, finally, CW and SSB on 28300-2,500 kHz. Techs remain limited to 200 Watts PEP output on those frequencies. Of course, this is in addition to the VHF/UHF privileges shared by Techs of all stripes up until this point.

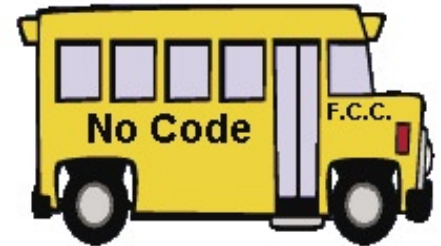

There is no grandfathering for folks currently holding a Novice Class license. Those Novices who remain keep all their existing privileges but get nothing new. It would be in any Novice's interest to upgrade to take advantage of the increased access to the ham radio world higher class licenses offer. There are also no changes to the General Class, the discontinued Advanced Class, or the Extra Class operators' privileges brought about by dropping the code requirement.

If you have passed the General Class theory element (element 3), you do not automatically get those higher HF privileges just because the code element was dropped. You need to take your Certificate for Successful Completion of Examination (CSCE) for the General Class element to an upcoming V.E. testing session, pay the appropriate fee, and have the V.E. Team process your paperwork. Remember that any outstanding CSCE is only good for 365 days from the time it was issued, so make haste to avoid needing to sit for the test again.

By the way, if you happen to hold a Technician Class license that was issued prior to March 21, 1987, and can provide proof of the date to your V.E. Team, you can also be processed for the General Class ticket. This is because, up until that point in time, there was no difference between the Technician Class theory and the General Class theory exam elements. Why sit for a test you don't have to take?

And let me remind you all: even though you no longer need to pass the CW test to get on the air, it has ALWAYS been permissible to use CW on any band you are licensed to operate on with the only notable exception being the five USB only channels that currently make up our small but active 60 meter band. Just because you didn't take a code test doesn't mean you won't be welcome to give your fist a twist with the rest of us CW ops.

CW is no longer part of the testing procedures, but it is still fun and I am sure it will be part of ham radio for many years to come.

## ☒ Get On The Bus

I had heard mention of the "Omnibus" rulings related to frequencies being published in the Federal Register in November of last year. The rulings listed took effect on the same day that the announcement to take steps to drop Morse Code, December 15<sup>th</sup> 2006. I have to admit I scarcely noticed – and not just because I was picking my jaw up off of my operating desk when I heard that the CW test was going bye-bye.

Being a full privileged Extra Class ham, I simply printed out the new band plan and got back to business. One of the simple pleasures of achieving ham radio's highest license has always been no longer needing to pay nearly as much attention to where on the bands you are operating. Extras get it all! I let the "Omnibus" sort of pass me by at the time, but will address it now as it makes for some exciting changes for folks who are still climbing up the amateur radio license tree.

The "Omnibus" rulings, known formally as WT Docket 04-140, did a great deal of tweaking to the assigned amateur bands to better reflect the current state of the ham radio community. Let me try to unpack those changes in a way that will help folks figure out what it all means, given their particular class of license.

Perhaps the biggest change in the group comes on 80 meters band. Now Extra Class phone privileges extend down to 3600 kHz (150 kHz more), Advanced Class extends down to 3700 kHz (75 kHz more) and General Class folks can use phone down to 3800 kHz (50 kHz more). The CW, RTTY and Digital segment shrinks slightly, only going up to 3600 kHz.

40 Meters also gets revamped a bit. Extra Class and Advanced Class operators now have phone privileges that extend down to 7125 kHz (a 25 kHz gain for both classes). General Class operators can work phone down to 7175 kHz (a 50 kHz expansion of phone privileges). As with 80 meters, the CW, RTTY and Digital line of demarcation is now down slightly to 7125 kHz.

A modest change occurs on 15 meters for general Class ops. They can now work phone down to 21275 kHz (a gain of 25 kHz over the old rules.)

Novices and Technician Class folks get a bit of a boost on 10 Meters. They can now operate CW, RTTY and Digital modes from 28000 kHz through 28300 kHz. Interestingly enough, this makes all non-phone privileges equal for all classes of license on the 10 meter band. Mighty sporting of the folks at the FCC to do this. Look for some intense competition in future 10 Meter contests thanks to this.

But that is not all the FCC has done to make things more fun for Novice and Technician Class folks. They have also extended CW privileges on par with those of General Class and Advanced Class operators on 80 Meters (3525 – 3600 kHz), 40 Meters (7025 – 7125 kHz) and 15 Meters (21025 – 21200 kHz). Remember how I said that being free of code testing might give folks the opportunity to enjoy CW? This little gift from the FCC just might go a long way toward making that possible.

No changes occur on the 160, 30, 20, 17, or 12 Meter HF bands for any of the current license classes. Likewise all the ham bands

above 10 meters in the VHF/UHF range remain unchanged in all aspects.

## Oops!

Such a comprehensive restructuring of the amateur radio bands came off largely without a hitch. Only one little hiccup in the rulings surfaced – that being language that inadvertently limited J2D emissions to a bandwidth of just 500 Hz. For those of you who haven't memorized the FCC emissions codes, J2D refers to data sent by modulating an SSB transmitter. A number of popular and very effective digital modes such as PACTOR III, Olivia and MT63 would have been rendered impossible had the rule been allowed to stand as written. The problem with the language was quickly spotted and the FCC juggled the wording to make things right in short order.

## ☒ One Final Wish

I would like to see the FCC grandfather any remaining Novice Class folks to Technician Class and any remaining Advanced Class folks to Extra Class. People who maintain these classes of license and who are still interested in the hobby deserve the jump, as the tests they passed at the time were certainly on par with the current Tech and Extra exams. Further, this would streamline our overall licensing system down to just three classes, more in keeping with amateur radio practice in most countries.

Every now and again I hear some curmudgeon on the air talking about the death of amateur radio. I just have to shake my head and giggle at such short sightedness. The FCC has taken steps to make ham radio more accessible and to make the use of our allotted frequencies more practical. These new rulings may serve to bring a lot of new faces into new places in the ham radio world. We ain't dead... We ain't even tired yet.

Have fun. I'll see you on the bottom end of 40 meters.

\* For the answer, see [http://en.wikipedia.org/wiki/C.W.\\_McCall](http://en.wikipedia.org/wiki/C.W._McCall)

## UNCLE SKIP'S CONTEST CALENDAR

### ARRL International DX Contest (SSB)

Mar 3 0000 UTC - Mar 4 2400 UTC

### Oklahoma QSO Party

Mar 10 1400 UTC - Mar 11 0200 UTC  
Mar 13 1400 UTC - 2000 UTC

### North American Sprint (RTTY)

Mar 11 0000 UTC - 0400 UTC

### Wisconsin QSO Party

Mar 11 1800UTC - Mar 12 0100 UTC

### 10-10 International Mobile Contest

Mar 17 0001UTC - 2359 UTC

### Virginia QSO Party

Mar 17 1800 UTC - Mar 19 0200 UTC

### CQ WW WPX Contest (SSB)

Mar 24 0000 UTC - Mar 25 2359 UTC

### QRPARCI Spring Homebrewer Sprint

Mar 26 0000 UTC - 0400 UTC

## Outer Limits continued from Page 59

**WBNY-** Commander Bunny still touts the rodent revolution as a clandestine broadcast parody. Lately he has commented frequently about monkeys both via digital SSTV mode broadcasts and in his normal audio. (Belfast)

**WDDR-** Rock music has always been a staple on this veteran pirate. (Belfast and uses [ericblair@wddr1027.com](mailto:ericblair@wddr1027.com))

**WHJR-** Better known as "Hey Joe" radio, its signature tune is a rock rendition with that title. (Uses [heyjoe5925@gmail.com](mailto:heyjoe5925@gmail.com))

**WHYP-** The James Brownyard was the announcer at licensed low power WHYP-AM in North East, PA, for many years. Some of his old airchecks are mixed with well produced pirate humor on this veteran station. (Belfast and uses [whypradio@gmail.com](mailto:whypradio@gmail.com))

**World Domination Radio-** Also using WMDR call letters, this new pirate at first mainly identified itself during its shows, often over rock music tunes. Like WBNY, it promotes the rodent revolution. (None)

**WTPR-** Otherwise known as Tire Pressure Radio, this one features detailed discussions of the woe that listeners will face for either listening to the show, or for not keeping proper inflation in their car tires. (None)

## ☒ QSLing Pirates

Reception reports to pirate stations require three first class stamps for USA maildrops or \$2 US to foreign locations, especially in Europe. The cash defrays postage for mail forwarding and a souvenir QSL to your mailbox. Letters go to these addresses, identified above in parentheses: PO Box 1, Belfast, NY 14895; PO Box 109, Blue Ridge Summit, PA 17214; PO Box 69, Elkhorn, NE 68022; PO Box 146, Stoneham, MA 02180; and PO Box 293, Merlin, Ontario N0P 1W0. Unfortunately, PO Box 69, Elkhorn, NE 68022 is no longer a valid address.

Some pirates prefer e-mail, bulletin logs or internet web site reports instead of snail mail correspondence. The best bulletin for submitting pirate loggings with a hope that pirates might QSL is now the e-mailed *Free Radio Weekly* newsletter, still free to contributors via [yukon@tm.net](mailto:yukon@tm.net). A few pirates will sometimes QSL reports left on the Free Radio Network web site, at [www.frn.net](http://www.frn.net) on the internet.

## ☒ Thanks

Your loggings and news about unlicensed broadcasting stations are always welcome via 7540 Highway 64 W, Brasstown, NC 28902, or via the e-mail address atop the column. We thank this month's valuable contributors: Jerry Berg, Lexington, MA; Artie Bigley, Columbus, OH; Ralph Brandi, Middletown, NJ; Dean Burgess, Manchester MA; Richard Cuff, Allentown, PA; Gerry Dexter, Lake Geneva, WI; Rich D'Angelo, Wyomissing, PA; John Figliosi, Halfmoon, NY; Bill Finn, Philadelphia, PA; Harold Frodge, Midland, MI; William T. Hassig, Mt. Prospect, IL; Vince Havrilko, Mountain Home, ID; Harry Helms, Smithville, TX; John Herkimer, Caledonia, NY; Don Jensen, Kenosha, WI; Ed Kusalik, Coaldale, Alberta; Chris Lobdell, Stoneham, MA; Greg Majewski, Oakdale, CT; George Maroti, Mount Kisco, NY; A. J. Michaels, Blue Ridge Summit, PA; Mark Morgan, Cincinnati, OH; John Poet, Belfast, NY; Martin Schoech, Eisenach, Germany; John Sedlacek, Omaha, NE; and Dan Srebnick, Aberdeen, NJ.

## An Abbreviated Antenna Dictionary

Selecting the antenna you need sometimes requires an understanding of a number of technical terms. This month let's cover some terms that may help you become a bit more comfortable in understanding antennas and their performance.

### Some Simplified Antenna-Related Terms

**Bandwidth:** The frequency range over which an antenna is designed to perform.

**Element:** Electrically functional part of an antenna.

**Feedpoint:** The place in an antenna's circuit where RF current from the transmitter is introduced to the antenna.

**Feed point impedance:** The impedance (opposition to RF current flow) offered to RF current flow at the terminals where the current is fed to the antenna. For best results this impedance should be equal in value to that of the antenna feed line.

**Feed Line:** Sometimes called "transmission line," or "lead in." This is the cable connecting the antenna to the transmitter, receiver, or to the antenna-system matching device.

**Gain:** The relative signal output from an antenna. As compared with a lower gain antenna, an antenna with higher gain will produce more received-signal output from a passing wave, or launch, in some direction radio waves of greater intensity for a given level of RF current. Directional characteristics of an antenna are often more important for reception than is gain.

**Ground plane:** A set of elements at the bottom of a vertical antenna element. These elements complete the antenna as

a resonant circuit, and eliminate the need for mounting the antenna's vertical element at ground level.

**Ground:** Antenna systems may require direct connection to the ground (earth). For efficient operation these connections are made low-impedance by putting conductors, such as radials, in the ground. Performance of antennas near the ground is affected by reflection from the ground. Where the ground conductivity is low, conductors may be placed on or near the ground under the antenna. Note that RF grounds are not the same as the safety grounding, third-wire system used in AC power wiring.

**RF:** radio frequency.

**Radiation pattern:** A graphical representation of the distribution of how an antenna launches its waves during transmission, or responds to incoming waves during reception. Horizontal radiation patterns show an antenna's responsiveness in the compass directions. Vertical radiation patterns show an antenna's responsiveness at vertical angles from ground level to straight up.

### And Some Antenna Types

**Isotropic Antenna:** The isotropic antenna exists only in the minds of folks who work with antennas. It is considered to be an infinitely-small point in space which radiates or receives radio waves equally well from all directions. This antenna is used, via mathematical modeling, to rate real antennas in terms of gain or radiation and reception patterning. The rating results in gain values reported in decibels (dB).

A real antenna with a gain of 3 dB, has 3 dB of gain more than an isotropic antenna would have if calculated for the same point from the isotropic antenna as was done

for the real antenna. The 3 dB represents a doubling of power, 6 dB represents four times the power, 9 dB is six times the power, and so on: a doubling of power for each 3 dB added.

**Dipoles:** These inexpensive and easily-constructed antennas have useful gain levels, and, in most installations, minimally directional radiation patterns. They are frequent choices for all-around communications work. Occasionally the half-wavelength dipole is used as a reference antenna instead of the isotropic. An antenna's gain compared to a dipole is reported in dB<sub>d</sub>, and is 2.1 dB lower in value than when comparing an antenna to the isotropic (dB).

The half-wavelength dipole antenna can be fed in various ways including center-fed (the Hertz dipole), end-fed (as with the J-antenna, and the Zepp antenna), and off-center feeding (as with the Windom).

Adding a second element close and parallel to the first element, and connected to that element at each end gives the folded dipole with increased bandwidth. Inverted-V antennas are generally half-wavelength dipoles held aloft at the center by a single mast, with ends drooping to near the earth.

Dipoles are often mounted as "slopers": antennas whose element runs from a single high mast at an angle down to near the earth. Dipoles can be as short as a quarter wavelength and yet perform well. These shorter antennas have a very similar radiation pattern to the half wavelength dipoles, but with lower gain levels.

Although the dipoles just discussed may be mounted with their elements vertical, they are typically mounted with elements horizontal. Antennas with their elements oriented vertically typically have omnidirectional horizontal radiation patterns. Common ground-mounted vertical antenna designs, in order of increasing gain and increasingly low vertical-angle radiation, include the Marconi, grounded vertical quarter-wavelength antenna, the half-wavelength, and 5/8 wavelength. These antennas are utilized with underground radials or near the ground with above-ground radials.

Common vertical antennas using ground planes and mounted well above ground level, also in order of increasing gain and increasingly low angle vertical radiation, are the quarter-wavelength, half-wavelength, 5/8 wavelength, and the collinear designs.

**Multiband Antennas:** These antennas are designed to function on more than one band. Multiple band coverage can be accomplished by such means as adding extra elements, trap circuits, or tunable coils to the main antenna element.

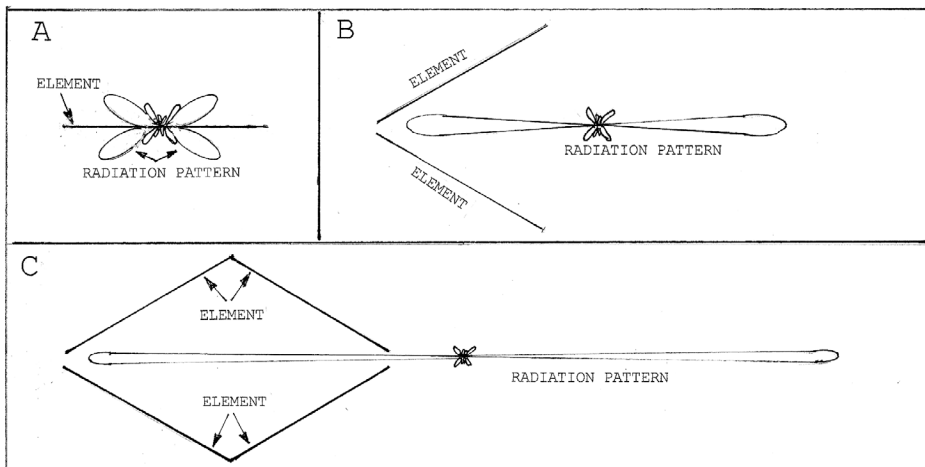

Fig. 1. Antenna element diagrams showing horizontal radiation patterns for a resonant long-wire beam (A), a resonant V-beam (B), and a resonant rhombic beam (C). B and C are bi-directional, while A has main lobes in four directions.



**This Month's Interesting Antenna-Related Web site:**

If you'd like to learn more antenna terminology here are a couple of antenna-term glossaries:

[www.interfacebus.com/Antenna\\_Terms.html](http://www.interfacebus.com/Antenna_Terms.html)  
[www.dxzone.com/cgi-bin/dir/jump2.cgi?ID=12488](http://www.dxzone.com/cgi-bin/dir/jump2.cgi?ID=12488)

**Beam Antennas:** Radio waves can be focused somewhat like the beam of a flashlight is focused. Antennas which are designed to focus or direct their responsiveness in a particular direction or directions are known as "beam antennas." Beams can improve reception both by increasing the received strength of weak signals and by diminishing received interference in off-beam directions.

Perhaps the most common is the Yagi, or Yagi-Uda antenna that is composed of two or more dipole elements. A popular variation on the same general design uses square (quadrilateral) shaped loops as its elements, and is known as the "cubical quad."

**Log-periodic** antennas are wide-band devices. For example, some models cover several shortwave bands with one antenna. The log-periodic dipole array (LPDA) is a useful wide-band beam.

**Long-Wire Beams:** A wire a wavelength or more in length functions as a long-wire beam: (fig. 1A). A V antenna made of two long-wire beams produces a more directional radiation pattern by combining

the lobes of the long-wire beams (fig. 1B). Putting two long-wire V antennas mouth to mouth (romantic antennas?) creates the legendary, even more directional rhombic beam (fig. 1C). These beams can be designed as resonant or non-resonant.

The Beverage, or wave antenna is a long wire stretched twelve feet or so above the earth. Its sharp directivity is obtained from its functioning as a leaky transmission line rather than as a long-wire antenna.

Of course there are many more antenna-relevant terms than we can cover here, but those above should give you a good start in understanding antenna terminology. Check the sites in the box for more.

nearby circuit. Thus, the resonant frequency of tuned circuits, including resonant antennas, can be determined.

Tunnel-dippers and FET dippers are more recent variants on this device. A signal generator provides a signal of known frequency, and sometimes known amplitude, for use in alignment of radio receivers.

**This Month:**

What is an "antenna farm?" (A) a farm where tall trees are grown to use as antenna masts. (B) a think tank at a radio engineering company where new antenna designs bloom and grow. (C) a company in a rural setting that manufactures antennas. (D) none of the above.

You'll find an answer to this month's riddle, another riddle, another antenna-related web site and much more in next month's issue of *Monitoring Times*. 'Til then, Peace, DX, and 73.

## RADIO RIDDLES

**Last Month:**

I asked: "OK, we know what an 'antennascope' is, so now what is the 'grid-dip meter' or the 'signal generator' mentioned above?"

Well, both of the devices in question are essentially miniature, very weak signal transmitters. The grid-dip meter can be held close to a circuit whose resonant frequency is unknown. As the device is then tuned, its meter may show a dip in its grid current, indicating that its frequency is the same as that of the

### Antenna Designer

New Version 2.1 for Microsoft Windows 95 and 98

Computer program helps you design and build 17 different antennas from common materials. Based on Antenna Handbook by W. Clem Small.

**Only \$39.95**

\$5 S/H on all orders  
CA residents add 8.5%  
Shipped on CD ROM

Send check or money order to:

Small Planet Systems  
623 Mangels Avenue  
San Francisco, CA 94127

[www.smallplanetssystems.com](http://www.smallplanetssystems.com) 415-337-9394

# Radio Shack PRO-84+ NASCAR RACING SCANNER.. WITH EXTRAS!



Be ready for the 2007 racing season with this powerful, accessory-packed scanner package. Not only do you receive the popular PRO-84 (like Uniden BC92XLT) with its 25-54, 108-174, 406-512 and 806-956 MHz (less cellular) frequency coverage, but it's factory preprogrammed to receive NASCAR Nextel and Busch Series racing frequencies right out of the box! Stores up to 200 channels in memory!

Want to hear local activity—racers, press, law enforcement, ham repeaters, aircraft and boats, even government agencies, but don't know their frequencies? Just press the Signal Stalker key, and it will pick up those nearby signals and even show their frequencies! A list of drivers and their frequencies, standard antenna, belt clip and manual are included. Runs on 6 VDC from 2 AA alkaline or rechargeable NiCd or NiMH cells (not included).

Not only that, but we provide a professional padded headset with individual left and right volume controls, 1" stub antenna to restrict reception to trackside, and a cigarette lighter/battery charger, all at no extra cost!

**FEATURES**

- 200-channel memory (20 channels per bank, 10 banks total)
- Service search: weather, police, fire, air, marine and HAM
- 5KHz, 6.25KHz, 12.5KHz step
- One priority channel in each bank (10 priorities total)
- Backlit keypad for use in low light



**INCLUDES  
Professional  
Headset!**

**Order SCN52  
Only  
\$89<sup>95</sup>\***

## GROVE

800-438-8155

828-837-9200 fax: 828-837-2216

[WWW.GROVE-ENT.COM](http://WWW.GROVE-ENT.COM)

order@grove-ent.com  
7540 Highway 64 West  
Brasstown, NC 28902

\* plus \$8.95 Priority Mail or UPS Ground shipping in the US

## The T-0 Now Recapped and “Re-Rectified”

**D**uring last month’s work session on our Trans-Oceanic B600, I departed from my usual procedure of not powering up a radio until I had completely recapped it. I wanted to find out if the electrolytic capacitors could be saved. The reason: the connections to the main electrolytic can, a multi-section unit containing four capacitors, were half buried under other wiring and looked as if they’d be a bear to disconnect and move. Not only that, but I wasn’t sure where I’d find room for the four individual capacitors that would be required for replacement (although other restorers have done this).

And so I powered up the radio via a combination isolation transformer and Variac. The isolation transformer would remove the danger of shock hazard from this a.c.-d.c. radio; the Variac would allow me to apply power gradually. I started with 10 volts, then increased the voltage by ten every ten minutes. If the electrolytic still had life in it, this would give it an opportunity to slowly “reform” (rebuild its internal electrolytic insulating film).

At full line voltage, the d.c. output of the selenium rectifier reached the specified 105 volts and the set came to life – at least on the broadcast band. I was able to pick up several stations and, though the audio was a bit distorted, I was relieved to note the absence of the raw a.c. buzz that would signal a bad electrolytic filter cap. I was unable to pick up signals on any of the other bands using my short basement antenna.

### ☒ Replacing the Paper Caps

This month’s work began with the usual wholesale capacitor replacement – concentrating, in this case, on the paper caps only. I was delighted to see that a good number of disc ceramic capacitors (which almost never need replacement) had been used – reducing the number of paper caps in the set. In fact, there were only eight – five of which were the infamous “Black Beauties,” known as “bumblebee capacitors” by



*This will give you an idea of the crowded wiring conditions encountered when changing out capacitors. A replacement unit is seen between the two disc ceramic caps and under a couple of resistors.*

the guitar amp folks who seem to have developed a cult around them (see last month’s column).

Working slowly and carefully around the packed wiring, I first replaced the “bumblebees” one by one. Curious to see if these capacitors would live up to their troublesome reputation, I tested each one on my Sprague capacitor checker – which indicates both capacity and insulation resistance.

I found that several of the units seemed to show capacities that were about 25 percent off. One gave no capacitance indication at all. *None* of them passed the leakage test, all reading off the meter’s ohms scale in the wrong direction. The three non-bumblebee caps didn’t test much better. They, too, had to be rejected for too low a leakage resistance. I had to wonder how it was that the radio had operated at all during my preliminary test last month!

### ☒ Why Replace a Good Rectifier?

Next on the agenda was replacement of the selenium rectifier with a modern silicon diode. Even though the rectifier had been working in last month’s test, it would have to go. These rectifiers have not been used in radio circuits for years, and any that are still installed are old enough to be quite ready to fail.

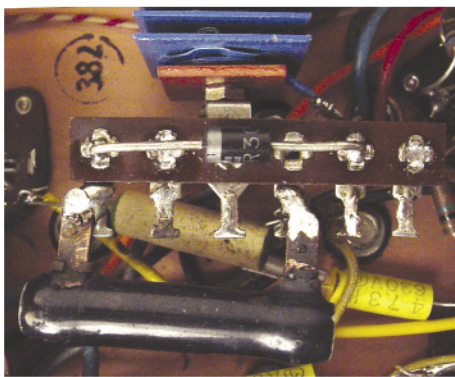

*Here you see the new terminal strip attached to the mounting screw of the now disconnected selenium rectifier. The diode atop the strip is a 3-ampere, 400-volt unit. The shiny, dark component below it is the added 70-ohm power resistor.*

A failing selenium rectifier will emit a noxious odor suggestive of something having died in the walls. Believe it. It happened to me when I was entertaining a visitor I wanted to impress and before I had enough experience to be able to explain the cause.

But that’s not even the *best* reason for changing out the rectifier. Like all a.c.-d.c. radios, the Trans-Oceanic operates with very low plate and screen voltages on the tubes and there isn’t a lot of tolerance for a decrease. But as selenium rectifiers age, their d.c. resistance begins to increase and even become erratic – reducing voltages throughout the set. To complicate the issue, the tube filament string – which needs to run on d.c. – also operates off the rectifier output. It is quite critical that these low-voltage filaments operate at their proper ratings.

### ☒ Compensating for Lower Resistance

There is a small complication that needs to be dealt with when a selenium diode is replaced by a silicon one. The resistance of the silicon unit will be significantly lower than that of the selenium unit. Unless this is compensated for, voltages will be too high – which will be especially destructive to the tube filaments, seriously reducing tube life.

Researching this issue on the internet, I found that one restorer suggested inserting a 47-ohm 5-watt resistor in series with the 130-ohm power resistor already in series with the rectifier – then checking the tube filament voltages and adjusting the resistance accordingly. Another person reported that he had simply added a 100-ohm series resistor and let it go at that.

I hadn’t anticipated the need to order a selection of 5-watt resistors in advance, so I was forced to take pot luck in my junk box. After a bit of scrounging, I found a fairly small wire-wound resistor that measured 70 ohms and would definitely carry at least 5 watts. This would at least split the difference between the recommendations.

I needed to add a terminal strip to support the diode and new resistor. The most obvious idea was to remove the selenium rectifier and use its mounting hole to secure the strip. But the head of the rectifier mounting screw (which was one of those extra-length fasteners that seem to have been favored by the Zenith engineers) was inaccessible – trapped behind the loudspeaker.

The latter would have been very difficult to remove, so I opted for leaving the firmly-secured rectifier in place and slipping the terminal strip and a second nut onto its mounting screw. That wasn’t much of a problem because the screw threads protruded at least a half an inch from the rectifier body.

Wiring the diode and added resistor to the strip, I connected them into the circuit in place of

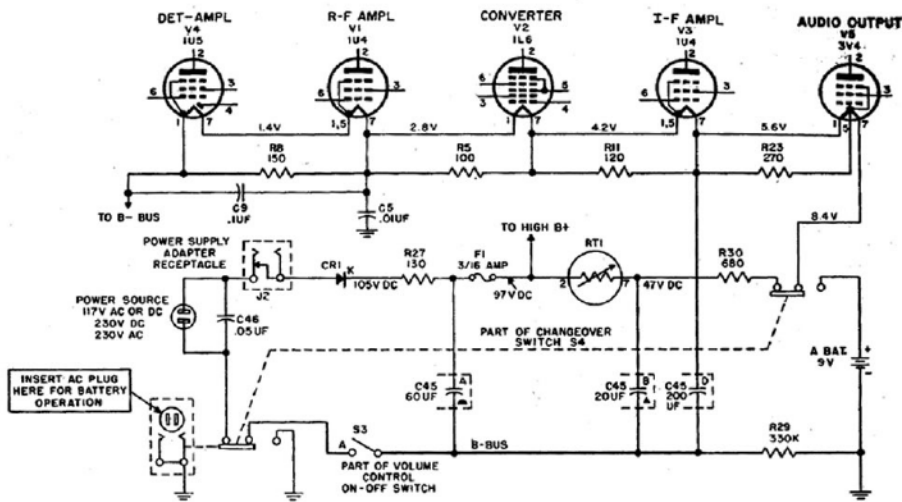

This is the clearest schematic of the 600 series filament circuit I've ever seen. It's for the R-520 military version, which uses almost identical circuitry. The regulator unit is the circled symbol just to the right of fuse F1 (the latter is not present in the civilian version). The power transfer switch is set for a.c. operation.

the now-disconnected selenium unit. Of course I was careful to wire the positive (banded) end of the diode to the same circuit point where the positive end of the selenium unit had been connected.

### ⊠ A Disappointing Test with an Easy Fix

With the Variac (set for full line voltage) and isolation transformer still in place, I crossed my fingers, punched up the broadcast band, and switched the set on. My ears were immediately assailed by a loud a.c. buzz, although the set was definitely picking up stations. Seriously disappointed, I figured that the reforming job on the electrolytics hadn't held and I was now in for the tedious job of disconnecting the can and replacing it with four individual units.

I was trying to be philosophical about this, when my eye was drawn to the newly-installed terminal strip and a problem became apparent. I suppose I shouldn't tell this story on myself, but I had accidentally used the one lug that was grounded through the terminal strip's mounting screw as a tie point between the original and added resistors. All the terminal lugs look the same from the top, of course, so it's an easy mistake to make – particularly when one's concern is to get the wiring securely and neatly done. So when you happen to be in this situation, keep your wits about you and don't follow my poor example!

Completing the fix and turning on the set again, I was gratified to hear clear signals coming in all over the broadcast band. These were free of the buzz and also of the distortion noticed during last month's initial test. I could also now hear signals coming in on some shortwave bands using my few feet of basement antenna. These had been absent during last month's test.

### ⊠ Checking Voltages

But before doing too much listening, I checked to see how the filament voltage had responded to my insertion of the 70-ohm resis-

tor. Ideally, the voltage across the entire series filament string should be 8.4 volts – the sum of the rated filament voltages. I measured just a tad under 8.5 volts – perfect!

By the way, when checking the voltages specified on a T-O schematic, do *not* use the chassis ground as your negative. Be sure instead to use the separate B- bus. The Howard Sams schematic that I have indicates a connection to the B- bus with the conventional radio ground symbol. A connection to actual chassis ground is shown by a symbol that looks like the business end of a common garden rake.

Another schematic of mine, that looks like an actual Philco drawing, shows the B- bus as a bold wire running throughout the radio with the connections made to it by other wires indicated by the usual dots. Look for the key given in your schematic and be sure you understand the conventions used! Of course the T-O, like any high-quality a.c.-d.c. set, uses a bus wire to carry B- because otherwise one side of the a.c. line would have to be connected directly to the chassis.

### ⊠ Substituting for the Rare 50A1

This completes the basic work that would need to be done on any 500- or 600-series Trans-Oceanic prior to attempting realignment or any other repair. One extra issue that has to be dealt with in the 600 series is the presence of the 50A1 current regulator tube. This tube was introduced with the 600 series to solve a problem that had come up involving the miniature tubes and selenium rectifier introduced with the 500 series: notably erratic oscillator operation when line voltage was low – sometimes caused by malfunctioning of the rectifier.

The purpose of the 50A1 was to keep the current through the filament string close to the rated 50 mA – even for line voltages that might vary between 90 and 130. If your 50A1 is present and has electrical continuity between pins 2 and 7, you are in good shape. If it is missing, you are not likely to find a replacement except in a parts

set. This is a very rare bird indeed.

A simple and effective solution for a missing or open 50A1 was outlined by Ludwell Sibley in his very useful article "Restoring the Later Transoceanics." The article appeared in the May 1995 issue of *Radio Age*, which is the newsletter of the Mid-Atlantic Antique Radio Club. Lud suggested restoring continuity by bridging a 1000-ohm, 3-watt resistor across pins 2 and 7 of the 50A1 socket and wiring a 9.1-volt, 1-watt Zener diode (1N4739) across the entire filament string. Connect the cathode (banded end) to pin 7 of the 3V4 audio output tube and the anode to pin 1 of the 1U5 detector/amplifier.

Of course, ordinarily there might not be a little over 9 volts across these pins for the Zener to regulate, so it's best not to increase the size of the rectifier series resistance when switching from a selenium to a silicon diode. This should provide enough extra voltage across the filament string for the Zener to operate properly within its working range, regulating the voltage at a constant 9.1.

Other writers have noted that this little bit of extra voltage across the string is beneficial, improving the sensitivity of the set and the reliability of the oscillator without seriously shortening tube life. And actually, the filament string *does* receive 9 volts when operated on battery power.

I'll be looking forward to seeing you next time, when I hope to report on the realignment and reassembly of our B600.

## JOIN THE AWA

### Antique Wireless Association

The original and largest historical radio-collector group

• Publishes *The AWA Journal*, Marc Ellis, Editor, with:

- Battery and AC receiver restoration
- Vacuum-tube history and collecting
- Old-time amateur-radio contests
- Communications receivers
- Free want-sell-swap ads
- Early television
- Horn loudspeakers
- News of U.S. and foreign clubs



• Produces the famous annual Rochester meet

• Maintains unique radio-TV museum

Membership is only \$20 per year in U.S.; \$25.00 elsewhere.

Mail check to:

AWA Membership - P.O. Box 421, Dept. 2 Bloomfield, NY 14469-0421

<http://www.antiquewireless.org>

[awamembership@rochester.rr.com](mailto:awamembership@rochester.rr.com) (585) 392-3088

FREE  
SAMPLE  
COPY!

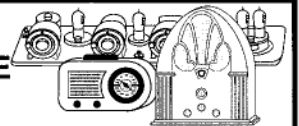

## ANTIQUE RADIO CLASSIFIED

Antique Radio's Largest-Circulation  
Monthly Magazine

Articles - Classifieds - Ads for Parts & Services

Also: Early TV, Ham Equip., Books,

Telegraph, 40's & 50's Radios & more...

Free 20-word ad each month. Don't miss out!

1-Year: \$39.49 (\$57.95 by 1st Class)

6-Month Trial - \$19.95. Foreign - Write.

A.R.C., P.O. Box 802-P14, Carlisle, MA 01741

Phone: (978) 371-0512; Fax: (978) 371-7129

Web: [www.antiqueradio.com](http://www.antiqueradio.com)

## Operational Amplifiers

By Ian Poole

Operational amplifiers form one of the most useful building blocks for any analogue audio project, and they are also very useful as comparators in switching applications. In addition to this, they are exceedingly easy to use and – the clincher – op-amps can be bought for just a few cents each.

In view of all these advantages, op-amps are an ideal building block for many projects in the shack. They enable many circuits to be constructed using fewer components, and they also offer a high level of performance.

### Op-amp basics

The operational amplifier is basically a very high gain, very high input impedance amplifier with a relatively low output impedance. Unlike many other forms of traditional amplifier, the operational amplifier is what is known as a differential amplifier. The output is proportional to the difference between the two inputs that are present. In comparison, the output from a traditional amplifier is proportional to the voltage between the input and ground.

The circuit symbol for an operational amplifier consists of a triangle as shown in Figure 1. The two inputs are designated by “+” and “-” symbols. This is because signals appearing on the “+” input appear at the output in the same phase, whereas signals present at the “-” input appear at the output inverted or 180 degrees out of phase. As a result of this, the “+” input is known as the non-inverting input, and the “-” input is called the inverting input.

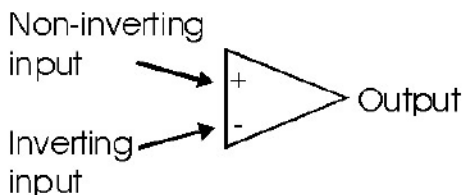

Figure 1 Operational amplifier circuit symbol

In many circuit diagrams where op-amps are used, the supply rails will not be shown. Unlike the rails in a more traditional circuit using discrete transistors (where the rails form an integral part of the circuit), the supply rails do not form such an integral part of the circuit and can be assumed to be connected. Sometimes a small table giving the IC pin numbers and the rails to which they are connected is given. This can considerably simplify the circuit diagram,

making it far more readable.

The power for the operational amplifier is generally supplied as a positive rail and also a negative rail. Often voltages of +15V and -15V are used, although this will vary according to the application and the actual chip used.

### Op-Amp Gain

The gain of the operational amplifier is very high. Typically, the gain may be upwards of 10,000. While levels of gain may be too high for use on their own, the application of feedback around the operational amplifier enables the circuit to be used in a wide variety of applications, from very flat amplifiers, to filters, oscillators, switches, and much more.

While the gain of an op-amp is very high at low frequencies, it falls as the frequency increases. Take the example of the famous 741 operational amplifier: Its frequency response starts to fall at a frequency of only 10 Hz!

### Slew rate

With the very high gains they possess, it is hardly surprising that operational amplifiers can be prone to oscillate – a feature that could be very annoying and difficult to overcome satisfactorily within a circuit. To overcome this problem, a capacitor known as a compensation capacitor is added within the IC itself, or occasionally it may be an external component. This presence of this capacitance combined with the limited drive currents means that the output of the amplifier is only able to change at a limited rate, even when a large or rapid change occurs at the input.

This maximum output change speed is known as the slew rate. Figures are quoted in volts per second, and it means that if an op-amp had a slew rate of 1 volt per second, the output could only change by a volt in a second regardless of how big the input change was. It would therefore take three seconds to respond to an input change that warranted an output change of three volts. In reality, op-amps are a whole lot faster than this and a typical general purpose device may have a slew rate of 10V/microsecond.

The figures for slew rate change are dependent upon the type of operational amplifier being used. Low power op-amps may only have a slew rate of a volt per microsecond, whereas there are fast operational amplifiers capable of providing slew rates of 1000V/microsecond.

### Offset null

One of the minor problems with an operational amplifier is that they have a small DC offset. Although small, it is quoted in the data-sheets for the particular operational amplifier in question, because when using high gains, it can start to become significant. For critical applications, it is possible to null this using an external potentiometer connected to the three offset null pins.

### Operational amplifier circuits

Operational amplifiers can be used in many different circuits from amplifiers to filters, and oscillators to switches. However, in terms of amplifiers there are two basic configurations that can be used. One is termed the inverting amplifier. In this case, the output is the inverse or 180 degrees out of phase with the input. The other is termed the non-inverting amplifier, where the output is in the same sense or in phase with the input.

Both operational amplifier circuits are widely used and they find applications in different areas. When an operational amplifier or op-amp is used as a non-inverting amplifier, it only requires a few additional components to create a working amplifier circuit.

### Non-inverting amplifier

The basic non-inverting operational amplifier circuit is shown in Figure 2. In this circuit the signal is applied to the non-inverting input of the op-amp. However, the feedback is taken from the output of the op-amp via a resistor to the inverting input of the operational amplifier where another resistor is taken to ground. The

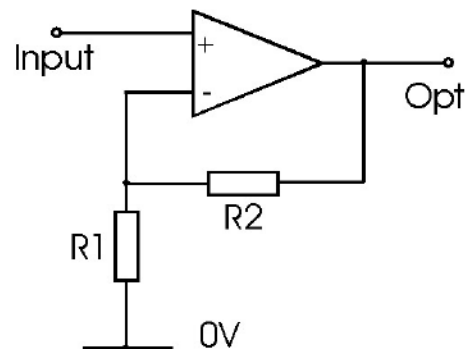

Figure 2 Basic non-inverting operational amplifier circuit

amount of feedback is determined by the potentiometer effect of these two resistors, and hence they control the gain of the overall circuit.

The gain of the non-inverting circuit for the operational amplifier is easy to determine. There is a simple calculation and the basis of this hinges around the fact that the voltage at both inputs is the same. This arises from the fact that the gain of the amplifier is exceedingly high. If the output of the circuit remains within the supply rails of the amplifier, then the output voltage divided by the gain means that there is virtually no difference between the two inputs.

As the input to the op-amp draws no current, this means that the current flowing in the resistors R1 and R2 is the same. The voltage at the inverting input is formed from a potential divider consisting of R1 and R2, and as the voltage at both inputs is the same, the voltage at the inverting input must be the same as that at the non-inverting input. This means that  $V_{in} = V_{out} \times R1 / (R1 + R2)$ . Hence the voltage gain of the circuit (which is  $V_{out} / V_{in}$ ) can be calculated from the simple formula below:

$$A_v = 1 + R2 / R1$$

As an example, an amplifier requiring a gain of eleven could be built by making R2 47k ohms and R1 4.7k ohms.

### ☒ AC coupling

Text books tend to show the basic operational amplifier circuits without any AC coupling. Often it is not necessary to include this, but when there are any DC offsets, it is necessary to use AC coupling. When it is necessary to do this, it is not only necessary to include the AC coupling capacitor, it is also necessary to ensure that the non-inverting has a DC path to earth for the very small input current that is needed.

This path can be introduced simply by inserting a high value resistor, R3 in the diagram, to ground as shown below. The value of this may typically be 100k ohms or more. If this resistor is not inserted, the output of the operational amplifier will be driven into one of the voltage rails.

It is also necessary to ensure that the coupling capacitor has a low value of leakage current. Unfortunately, electrolytic capacitors are not always very good and tantalum types are often safer to use.

When inserting a resistor in this manner, it should be remembered that the capacitor-resistor combination forms a high pass filter with a

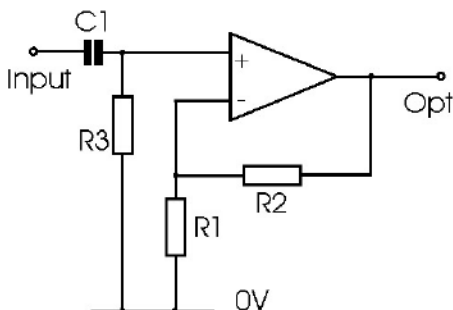

Figure 3 Basic non-inverting operational amplifier circuit with capacitor coupled input

cut-off frequency. The cut-off point occurs at a frequency where the capacitive reactance is equal to the resistance.

### ☒ Inverting operational amplifier circuit

The second basic circuit configuration for operational amplifiers is the inverting style. As the name implies, the output signal is inverted, i.e. 180 degrees out of phase with the input. The circuit is shown in Figure 4 and it simply consists of a resistor from the input terminal to the inverting input of the circuit, and another resistor connected from the output to the inverting input of the op-amp. The non inverting input is connected to ground.

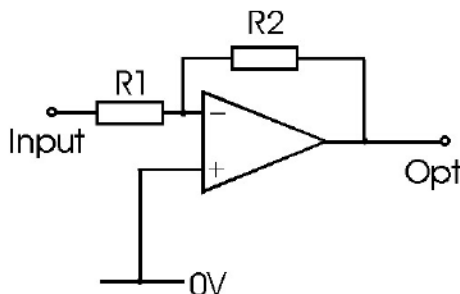

Figure 4 Basic inverting operational amplifier circuit

In this circuit, the non inverting input of the operational amplifier is connected to ground. As the gain of the operational amplifier itself is exceedingly high and the output from the amplifier is a matter of a few volts, this means that the difference between the two input terminals is exceedingly small and can be ignored.

As the non-inverting input of the operational amplifier is held at ground potential, this means that the inverting input must be virtually at earth potential (i.e. a virtual earth). This fact gives rise to the name, "virtual earth," that is sometimes used in association with this form of amplifier. It is very useful for audio mixer applications, as it enables several inputs to be summed very easily. This is simply achieved by having several input resistors (R1) in parallel, each connected to the op-amp and to their respective input source.

The gain of the circuit can be determined quite easily. As the input to the op-amp draws no current, this means that the current flowing in

the resistors R1 and R2 is the same. Using Ohms law  $V_{out} / R2 = -V_{in} / R1$ . Hence, the voltage gain of the circuit  $A_v$  can be taken as:

$$A_v = - R2 / R1$$

The negative sign indicates that the output is in the opposite sense or phase to the input.

As an example, an amplifier requiring a gain of ten could be built by making R2 47k ohms and R1 4.7k ohms.

It is often necessary to know the input impedance of a circuit such as this. A circuit with a low input impedance may load the output of the previous circuit and may give rise to effects such as changing the frequency response if the coupling capacitors are not large.

It is very simple to determine the input impedance of an inverting operational amplifier circuit. It is simply the value of the input resistor R1. This is because the inverting input is at earth potential as we saw earlier, and this means that the resistor is connected between the input and earth.

### ☒ Summary

These are but three examples of operational amplifier circuits. As one might expect, there are many more ways in which operational amplifiers can be used, and we may look at more in a future issue. In the meantime, there are more circuits and much more information about radio and electronics topics that can be found at Radio-Electronics.Com ([www.radio-electronics.com](http://www.radio-electronics.com))

### Read a Good Label Lately?

You could learn a lot! Look at your MT label before you throw your wrapper away - it tells you how many issues you have left in your subscription. If two or less, renew right away to avoid missing an issue. Keep those MTs coming and we guarantee you'll learn a lot!

**WARNING:** If you get a neon yellow wrapper on your magazine, don't throw it away: That is your renewal notice! Cut the card out of the wrapper and send it in with your payment. You'll get two notices and then it expires. So take care, don't let your subscription die!

# FREE SPEECH RADIO WBCQ Shortwave

7.415 - 9.330 - 5.110 - 18.910

wbcq.com

spacetransmissions.com



We are the only free speech  
shortwave station on the planet



## KAITO KA009 Dynamo & Solar Powered Radio

By Ken Reitz

**A**s radio fans, our expectations soar when we come near a radio designed to tune the AM & FM bands, four shortwave bands, the NOAA weather band, the Aircraft band and VHF-TV band. If that same radio can be powered by rechargeable NiMH batteries, a hand-cranked dynamo *and* solar panels, we might be excused for drooling.

The KA009 from Kaito USA sets out to do all of the above in a case weighing in at just over a pound and selling at just over \$40!

### ☒ The Versatile KA009

The first thing you'll encounter when you open the box on this little radio is that it's wrapped in bubble-wrap and sealed in a heavy-duty, zip-lock, plastic bag. Don't throw it away! It makes a great all-weather protector for a radio which is small enough and light enough to take camping or backpacking.

The KA009 is in a one-piece molded plastic case which includes a substantial handle. The front of the radio features a 2" high and 2-1/2" wide analog dial panel on which is displayed an incredible 10 bands. The layout is clean and the alternating black and light blue lines makes identifying which band you're on quite easy. The print is big enough and clear enough for even older eyes to see easily. A slightly darker blue slide-rule dial pointer indicates the frequency tuned.

This radio uses a minimum of space on controls. There are only two knobs: a main conventional tuning knob and below it a smaller volume control. Below these knobs and the tuning dial are three multi-function slide switches controlling an amazing 14 functions.

At the upper left of the front panel are three LEDs. The first two indicate the status of the internal batteries. When the red "Lo" LED is lit, it means the NiMH batteries need to be charged. When the green "Hi" LED is lit, it indicates the NiMH batteries are charged. A third LED glows red when a strong signal is properly tuned and it also lights when the internal batteries are being charged.

The back of the radio houses a conventional 26" fold-over, telescoping whip antenna and

the solar panel, as well as the "hide-away" dynamo hand crank.

The left cabinet panel has a headphone jack which doubles as an antenna connection for the external 46" flexible antenna which is included. Below that is a white LED bulb with a controlling on/off switch just below it. The light throws a good deal of light, certainly enough to be used as an emergency flashlight.

### ☒ Putting a Charge into the KA009

The biggest feature on this radio is its four way power supply. The KA009 can use three AA alkaline batteries (not included); three built-in NiMH batteries (included) which are charged by a hand-cranked dynamo, a solar panel built-in to the back panel or a plug-in AC adapter (included).

The wall adapter is also a battery charger for the NiMH internal batteries. The owner's manual suggests that the first time you charge the internal battery you should charge it for at least 25 hours, but not more than 35 hours. A full charge will give you 10 hours of continuous playing time. To charge the batteries by the solar panel, simply turn off the main power switch and set the radio with the solar panel facing the sun. The manual suggests you'll need 12 hours of direct sunlight for a full charge.

It's not practical to use the hand-crank

dynamo to fully charge the internal batteries: you'll only get 10 minutes playing time with every two minutes on the crank. You'll need to be on the crank 6 minutes for a half hour and 12 minutes for a full hour. If you've ever cranked one of these radios, it's pretty much a chore after the first 60 seconds.

The manual is a little uncertain about the NiMH battery pack life span. It states that the pack may be recharged from at least 500 times to as many as 1,000 times. The real worth of the dynamo is during emergencies when commercial power is down, it's totally overcast, and your home supply of AA batteries has been depleted. In other words: a hurricane, ice storm, tornado aftermath or similar weather disaster.

### ☒ Tuning with the KA009

Before assessing the tuning capabilities of this radio, it's helpful to put it in its place. Its main role is to provide emergency reception of local AM, FM, TV or NOAA weather frequencies in times of power outages caused by severe weather or other regional calamities. With that in mind, it does a very creditable job. The KA009 is prepared for emergencies.

The aspirations of the radio go far beyond that role and that's exactly where it starts to run into trouble. Performance on all bands is pretty much what you'd expect from a small analog tuned radio. It's not a star performer on any band, but it does exactly what it says it will: tune the AM, FM, WX, TV and continuous shortwave from 4-26 MHz.

You can only expect so much from any analog tuned portable, but for the air craft band to be really useful it really needs a squelch control. Without it you'll be forever playing with the volume control and having to put up with band noise in between transmissions. Of course, the analog tuning means you'll be guessing when trying to locate local towers and ATS transmissions. Further, there's substantial receiver overload when overhead planes key-up, and I was able to pick up the local sheriff's office on one popular Air frequency.

I found there was consider-



*The KA009 from Kaito USA could be the inexpensive, all-in-one, camping/survival radio you've been looking for. It tunes AM/FM/WX/TV/AIR and 4 SW bands from 4-26 MHz continuous coverage. Available in graphite gray, red and blue. (Courtesy: Kaito USA)*

able ingress from local FM broadcasters on the TV bands, which is not uncommon in this type of analog radio. FM broadcasts are received as monaural despite the included stereo ear buds.

Tuning on the AM and FM bands was pretty close to reality. But, tuning on the shortwave bands was considerably off, which is also not uncommon in small analog tuned radios. Listeners are forced to use intuition, the fingers of a safecracker, and ESP to know where to tune.

Since tuning is continuous from 4 to 26 MHz, you might be able to tune the 40, 20, 17, and 15 meter ham bands, but there's no BFO available to tune in SSB transmissions. You'll have to step up to the KA1101, KA1102 and KA1103 for SSB capability, phase lock loop tuning, digital displays and a bigger price tag.

The audio from the miniscule 2" speaker is adequate for emergency listening, but would surely get tiresome for any length of time.

And, finally, despite the abundance of "free" power, there's no provision for a dial light, which leaves you pretty much guessing as you tune around in the darkness of a power outage.

#### Kaito KA009

##### Manufacturer Specifications

Size: 5.5" H x 6.5" W 2.25" D

Weight: 1 pound (with 3 NiMH batteries)

##### Tunes:

AM (530-1710 kHz)

FM (88-108 MHz)

Air (118-137 MHz AM mode)

NOAA WX: 162.400/162.425/162.475 /162.50/162.525/162.55 (continuous coverage)

TV1: Channels 2-6

TV2: Channels 7-13

SW1: 4 MHz-9 MHz

SW2: 9 MHz-14 MHz

SW3: 14 MHz-19 MHz

SW4: 19 MHz-26 MHz

Audio Output: 200 mW peak power using built-in speaker.

Headset jack: 3.5 mm (monaural earbuds included).

External DC supply socket: 6 mm (positive center). External AC adapter (included) charges batteries and powers the radio. 6 Hours charging: 72 hours playing.

Internal DC supply: 3 NiMH batteries 600 mAh (included); hand-crank dynamo; solar panel on back of radio also charges the batteries. 12 hours of sun charging gives you 6-8 hours playing, depending on volume level.

Antenna: Built-in 24" telescoping whip for AM/FM/TV/WX/SW. 46" flexible wire antenna plugs into headphone jack for SW reception. Internal AM ferrite bar antenna.

This product is made in China.

#### Bottom Line

The KA009 is a capable emergency radio which can also serve as a daily use general coverage radio. The versatile four way power supply means you'll never worry about batteries in a real emergency. The enormous tuning capability means you can tune in local emer-

gency broadcasts on NOAA WX radio, local VHF-TV stations, local AM and FM stations, and listen to the powerhouse shortwave broadcasters. It shouldn't be your only radio, but it can definitely be your emergency radio.

The competition to the KA009 is the Grundig FR-300 (see *MT* Oct. 2005) and the Grundig FR-200 (see *MT* October 2002). The fact that the KA009 combines the features of both the FR-200 and FR-300 in one radio gives the edge immediately to the KA009. The one thing the FR-300 does which the KA009 doesn't is allow the charging of a variety of cell phone batteries using the hand crank and an included adaptor. That's a great feature which Kaito might consider adding to a future edition of the KA009.

I've always thought this type of radio

was a great present to introduce a youngster to radio. There are lots of knobs and switches, interesting bands to tune in and potential experiments to be tried with the solar panel, the hand-crank, and the LED light. It's the kind of radio which could kindle the interests of the young into going deeper into a hobby you already enjoy. And, it's tough enough to take the kind of knocking a kid might give it.

The KA009 is available in graphite gray, a brilliant blue, and what can only be described as emergency red. It comes with a wall mount power supply, rechargeable NiMH batteries, ear buds and 46" flexible external antenna. On the Kaito home page, the list price is \$54.95. It's a new model and not yet widely available, but I did find it at 21<sup>st</sup> Century Solar for \$41.99: [www.21st-century-solar.com](http://www.21st-century-solar.com)

# Welcome to the Micro Standard!

*Once again, Alinco engineers have redefined miniature electronics technology. With its leading edge "credit card" size radios, Alinco proves performance and quality can be found in micro-size receivers. Now, you can put all the action on fire, public safety, aircraft, weather, Amateur Radio and many other exciting frequencies right into your pocket with this trio of high performance wide band receivers.*

### DJ-X7T Wide Range Pocket Size Communications Receiver

**100KHz to 1.3GHz\* Triple conversion AM/NFM; double conversion WFM, plus FM, SW, and TV**

Super small "credit card" size delivers AMAZING audio quality in a size and weight (as thin as 14.5 mm, as light as 103g) that you can take almost anywhere. Easy to read illuminated LCD, 1,000 memory channels, five operating modes, three different antenna modes, easy to program with free downloadable software (optional cable required), cable-clone, and a long-lasting Lithium ion battery! Standard adapter charges the Li-Ion battery AND operates with AC power, even at the same time, so you can listen while charging.

### DJ-X2000T Multimode Wide Range "Intelligent Receiver"

**100KHz to 2.15GHz\***

Experience monitoring on a whole new level with the DJ-X2000T "Intelligent Receiver". This triple conversion handheld receiver offers many unique features such as Flash Tune™ which locks onto nearby signals, Transweeper™ "bug" detector, and Channel Scope™ spectrum display. It also has 2000 memory channels, alphanumeric labeling, RF frequency counter, digital sound recorder, and receives AM, WFM, NFM, LSB, USB, CW and FM stereo.\*\* Super extras include an on-line "help" feature, 20 scan programs, computer programmable capabilities (download free software from Alinco website), CTCSS decode, two level attenuator, field strength meter, and more!

### DJ-X3TD Multimode Wide Range Communications Receiver

**100KHz to 1.3GHz\***

**WFM mono and stereo\*\*, NFM, AM**

Small but powerful triple conversion receiver with excellent audio, SMA flex and internal ferrite bar antennas, large easy-to-read display, 700 memories, NiMH battery, four scan modes, and dry cell battery pack. Computer programmable with free control software from [www.alinco.com](http://www.alinco.com)

**WWW.ALINCO.com**

Distributed In North America by Ham Distribution, Inc., 15 South Trade Center Pkwy, #B5, Conroe, Texas, 77385.  
 Phone: 936-271-3366. Fax: 936-271-3398. email: [Alinco@consolidated.net](mailto:Alinco@consolidated.net)  
 Specifications subject to change without notice or obligation. \*Cellular blocked in USA. Unblocked versions available to qualified users, documentation required. \*\*Optional stereo headphones required.

## Kaito KA1102 vs Sangean ATS-505P Comparing Two Portables Around \$100

This month we will continue our *First Look* at the battle of the low end shortwave portables. In the February 2007 edition of this column, we compared the Kaito KA1102 (Grove RCV02 \$79.95) with the Eton S350DL (Grove RCV04 \$99.95). After the smoke cleared, the Kaito KA1102 came out on top.

So, in this edition of *MT First Look* we will put the winner of that competition in a head to head with the next challenger – the Sangean ATS-505P (Grove RCV07 \$109.95). But, before we travel down this new path, let's do a review of the champ from our last competition.

### KAITO KA1102

#### Inside the Box

The first thing I noticed when I took the radio out of the box was its size. Dimensions are 5.62 inches (143mm) x 3.46 inches (88 mm) x 1.12 inches (28.5 mm) and it weighs 9.8 oz. (280 grams), excluding the three batteries. This radio can be thrown into a briefcase or purse for travel.

Accessories included in the box include a carrying pouch, operating manual (plus a simple operating guide), AC adapter, three Ni-MH rechargeable batteries, stereo earphones, external antenna (SW/FM only), and a wrist strap with stand support. The manual was okay. I have seen better: There was no explanation to the beginner as to what shortwave is, etc. The typeset is a bit small due to the small size of the manual itself, but it is logically laid out.

#### On-the-Air Testing

During our testing we used the venerable Sony 2010 as our benchmark receiver. The first noticeable improvement was in FM broadcast band reception. It beat the 2010 hands down when using only the whip antennas. But we did notice some images on the lower frequencies from the high end of the band. Shortwave sensitivity was much better on the 2010.

The receiver has good audio, not great, but given the size of the speaker (2.6 inches) it was interesting to hear some reasonable audio from such a small package. There was a noticeable audio improvement when I moved to headphones. But this is not a line-out jack as the instruction manual indicates. The audio levels change using the volume control. I did notice that at times, depending on signal strength, the narrow AM filter

had a detrimental effect on the received audio.

Receiver selectivity was surprising good for this price range. I was particularly pleased with the FM selectivity, which is usually an afterthought in a low-end receiver. But what really surprised me about the 1102 was the inclusion of SSB reception capability, but there is a negative here also (see below).

This is a dual conversion receiver. While that is good, we noticed more images when we connected it to an external antenna when compared to the same setup for the Sony 2010. AM reception was good (see negatives below), but FM reception was better on this radio than on the Sony 2010. Shortwave reception was about equal to the other radio, but the Sony was slightly better on the higher shortwave bands.

And for those that like tuning around, there was no chugging when tuning the 1102 like you have with the older Sony.

#### The 1102 Negatives

As I have said many times, no radio is perfect. And we are talking about a \$79.95 portable, so the Kaito has a few skeletons in its closet.

Tuning SSB signals is a chore. Since there seemed to be some confusion by at least one reader of my last review, let me try to explain this situation about tuning in SSB signals on the Kaito.

Yes, there is an SSB button on the side of the receiver. When you press that button you will be able to decode the SSB transmission for receiving. If you release that button, the receiver will revert back to the AM mode and you will now longer be able to receive the tuned SSB signal.

In order to change from the AM mode and put the Kaito into the SSB mode without having to hold the SSB button, you have to go through a convoluted 5-step procedure to keep it in that

mode. And there is no USB/LSB; instead, the radio uses SSB fine tuning control to hone in SSB signals.

The learning curve for this radio is much steeper than the 2010 or even the Sangean radio reviewed in this article. What makes this more difficult is the much smaller screen used by this radio. If you are near-sighted, you will not have a pleasurable experience using the Kaito KA1102.

AM reception compared to the Sony/Sangean was not as good and was probably the result of a smaller ferrite loop coil inside the radio compared to the other two radios. The external antenna on the Kaito only works on the shortwave/FM bands, so AM broadcast band reception is not as good as the other two radios.

I did note a bit of synthesizer noise while tuning around; the Sangean reviewed below has none. This is probably a direct result of the tuning methods used by the two portables.

There are few other quirks we noted, but this didn't effect overall reception.

Table 1 is a listing of manufacturer specs and key features.

#### Table 1: Kaito KA1102 Manufacturer Specs/Key Features

**Frequency Coverage:**  
Medium Wave 520-1710 kHz with 1/9/10 kHz steps – selectable  
Shortwave 3.00-29.99 MHz with 1/5 kHz steps – selectable  
FM Band 70.0-108.0 MHz with 10/50/100 kHz steps – selectable  
**Conversion:** MW & SW dual conversion  
**Bandwidths:** Wide-Narrow AM/SW, Mono/stereo selectivity for FM  
**Freq/Meter Conversion:** SW meter band indicator/conversion  
**Attenuator:** Local-DX switch  
**Tuning Options:** Digital frequency readout with manual tuning/speed change tuning/auto scan/memory scan/direct tuning and SSB fine tuning control  
**Memory Locations:** 190 random presets pages 1-6; band preset pages 7-9; ATS preset page 0, has Auto tune/Auto memory  
**Indicators:** LED light signal strength (AM/SW four levels/FM three levels), includes a stereo reception indicator, battery level indicator  
**Clock function:** 12/24 hour selectable, Sleeping time direct entry 1-99 minutes  
**Audio Control:** Push button  
**Tone select:** News/music switch, FM stereo bass (earphones only)  
**Backlighting:** Display/keyboard light  
**Antennas:** Telescopic antenna for FM and shortwave and built in ferrite bar antenna for AM,



Overall rating: 2-1/4 stars





plus external jack.  
**External Jacks:** Earphone jack (stereo on FM), antenna jack, both are 3.5 mm diameter jacks  
**Speaker:** 2.6 inches (66 mm) in diameter  
**Power Source:** Battery 3 AA rechargeable Ni-MH batteries (recharging time 1-9 hours); external power: DC 6V 300mA; includes an AC-DC adapter

**MT First Look Rating (0-10 scale)**  
**KAITO KA1102 RECEIVER**

Audio Quality .....	6
Audio Levels .....	6
Back light/Display .....	6
Battery Life .....	7
Dynamic Range .....	5
Ease of use .....	6
Feature Set .....	7
Keyboard/Button/Control Layout .....	7
Sensitivity .....	
AM-5, FM-6, SW AM-5, SW SSB-4	
Selectivity .....	
AM-6, FM-6, SW AM-6, SW SSB-4	
Overall Construction .....	8
Overall Reception .....	7
Overall Manual .....	5

**SANGEAN ATS-505P**

**Inside the Box**

The first thing that becomes obvious is the Sangean ATS-505P is much bigger than the Kaito. The 505P is 8.43 inches wide (214 mm) x 5.04 inches high (128 mm) x 1.5 inches deep (38.5 mm). While the Kaito is smaller, it does have a smaller footprint than the portable we tested last month – the Eton S350DL. And the 505P weighs more than the Kaito – 1 lbs. 13 ounces (840 grams). Again, this unit is lighter than the S350DL, but heavier than the Kaito.

Accessories included in the box included an operating manual, AC adapter, a soft pouch, stereo earbuds, a built-in whip antenna (SW/FM only), and a reel antenna

The manual is good, well laid out, and easy to read, and the radio is pretty easy to operate.

The audio is good but there are no separate controls for treble and bass like the S350DL. During my test I noted no synthesizer noise.

The LCD display is very nice, sharp, and has good contrast when viewed from a various angles. Backlit illumination can be turned on or off.

I like the various tuning methods that the 505 is capable of. Not only does the 505 have direct tuning via the keypad (like the Kaito), but it also has a two-speed tuning knob (the Kaito doesn't have a tuning knob), manual tuning using the up/down buttons (the Kaito has that), scan tuning (which is useless in SSB modes and marginal in the AM mode), meter-band carousel selection, memory tuning (45 presets: 18 on two pages for shortwave, nine each on MW, LW, and FM). The Kaito has 190 memories (10 pages of 19 each and page 9 is for SSB use).

AM, FM and SW reception is good, with the AM and FM reception a little bit better on the Kaito. You get FM stereo reception with the stereo earbuds, a nice dual zone 12/24 hour clock, alarm with sleep delay, and a neat travel power lock so the radio does not inadvertently come on while it is packed away.

**The 505P Negatives**

There are also negatives with this radio. First and foremost, the SSB filter bandwidth is way too wide. While I can't confirm it for sure, it seems almost as wide as the AM filter. And another major irritant – this radio chugs during tuning (the audio is being muted). Using larger steps reduces the chugging, but that is not something I like in my portables. I like turning the tuning knob, but the chugging while doing so is frustrating.

I like the big keys on this radio and it makes it easy to see, but they seem slow to react. You can't tap the button and move on: you have to hold it down momentarily. This took some getting used to. There is no handle, no signal strength indicator, and the clock display is not independent of the frequency display.

Finally, I was not impressed with the SSB sensitivity. It is pretty close to the Kaito, but like most portables, if you are really interested in prowling the ham bands or the utility frequencies, this radio will be a disappointment. Yes, I heard the louder stuff, but twice during our test, the 20 meter ham band during late afternoon was nearly dead (only one loud signal heard).

Table 2 is a listing of manufacturer specs and key features.

**Table 2: Sangean ATS-505P Manufacturer Spec/Key Features**

**Frequency Coverage:**  
 Long Wave 153-279 kHz  
 Medium Wave 520-1710 kHz  
 Shortwave 1.711-29.999 MHz  
 FM band 87.5-108 MHz  
**Conversion:** Double  
**Attenuator:** Local-DX switch  
**Bandwidths:** All modes fixed at one bandwidth for each mode.

**Tuning Options:** See text above  
**Memory Locations:** 45 presets: 18 on shortwave-two pages, nine each on MW, LW, and FM)  
**Indicators:** None-level battery reserve indicator, no signal strength indicator  
**Clock function:** Digital clock with selectable 12/24 hour format, wake-up timer (use as radio-play alarm clock) and sleep timer.

**Audio Control:** Rotary volume control  
**Tone Select:** A music/news switch  
**Antennas:** Telescopic antenna for FM and shortwave and built in ferrite bar antenna for AM/LW, plus external jack shortwave only.  
**External:** Jacks 3.5 mm earphone socket (stereo), external antenna, and power plug.  
**Power Source:** 6 volts (center pin negative), 4 AA batteries (not included) or AC Adapter (included)

*Note: Published specs subject to change*

**Bottom Line – Head-to-Head**

As I mentioned in my last review, manufac-



**Overall rating: 2-1/4 stars**



turers have come a long way in the last decade in improving the under \$100 portable radios, and that is quite evident when we tested both these radios. I can see some distinct markets for both these radios.

The Kaito will have a wide appeal to the traveler. You get a lot of bang for the buck using this radio, including SSB reception. I was particularly pleased with the FM reception on the 1102.

I like the tuning flexibility of the Sangean, and its mode selection is definitely easier than the Kaito's. Overall, its audio was better, but that is a function of speaker and case size.

But who won, you ask?

I have called this a draw. It really depends on what you want to use the radio for, what you are used to in your radios, and where you will use the radio. Bottom line, both radios offer a lot of listening for the buck, especially in the shortwave broadcast bands.

**MT First Look Rating (0-10 scale)**  
**SANGEAN ATS-505P RECEIVER**

Audio Quality .....	7
Audio Levels .....	7
Back light/Display .....	7
Battery Life .....	7
Dynamic Range .....	5
Ease of use .....	7
Feature Set .....	7
Keyboard/Button/Control Layout .....	7
Sensitivity .....	
AM-5, FM-6, SW AM-5, SW SSB-3	
Selectivity .....	
AM-6, FM-6, SW AM-6, SW SSB-3	
Overall Construction .....	8
Overall Reception .....	7
Overall Manual .....	6

**LED Light Bulbs**

*Burn the midnight oil at your monitoring station without burning up your power bill!*

- **Energy Efficient:** 3 watts
- **Economical:** Run it for 12 hrs/day for a whole year for about 80 cents!
- **Durable:** 60,000 hour bulb life
- **Versatile:** Reading light, porch light, ambient light
- **Quality:** 36 white LEDs, broad beam of light, never gets hot, 2-year warranty

Available in 120 V (#VVP) & 12 V (#12P)  
 \$44<sup>95</sup> Incl. FREE U.S. Shipping

C. CRANE COMPANY

**FREE CATALOG!**  
 800-522-8863 • ccrane.com

## SDR-14's Real Time Spectrum Recording

For years, governments have been recording the entire radio frequency spectrum twenty-four hours a day, seven days a week. The method used may be surprising to many people. Think about the enormity of the task: recording every transmission that occurs on every frequency, twenty four hours a day! Not even banks of thousands of receivers could do this seemingly impossible job. So how is it done?

Let's look at a conventional receiver. Assume you are tuned to 20 MHz. However, the band pass of the circuitry allows a band of frequencies into the receiver, not just 20 MHz, but a few tens of kHz on either side of 20 MHz. This is referred to as the receiver's bandwidth. To minimize interference, filters are used to narrow the reception range.

Now imagine a receiver that has a bandwidth hundreds of megahertz in width. In essence, you would be listening to all transmissions in that hundred megahertz of frequency at the same time. Just think of the giant mess of whistles and howls that would result! But what if you could digitally record this entire spectrum of frequencies, then later, as though it were just happening, "tune" through the recording to hear individual transmissions?

This is not science fiction. This is the reality of sophisticated government receiving equipment around the world and in space. And this equipment has been in use for nearly two decades. From longwave to cellphone to microwave frequencies, they capture it all!

At some later date, if a "person of interest" is being sought in a certain geographic area, all the transmissions from this region can be replayed. Computers analyze the transmissions for keywords, phrases, or names. This method is sometimes referred to as "vacuuming the spectrum" – sucking up and recording all trans-

missions in an entire frequency spectrum.

In the movie version of Tom Clancy's "Clear and Present Danger," US federal agents used just such a system to find and then listen to cellphone conversations from a drug lord. Wide spectrum recordings were analyzed for the suspect's cellphone calls. Listening to these resulted in nailing down his location.

### Equipment Required

If you have the worth of a small country or own an oil well, you may be able to afford the total radio spectrum "vacuum" station equipment: super fast, liquid nitrogen cooled, Cray-like computers attached to racks of electronic equipment using advanced device technology. If you really want total coverage, add an antenna system that blankets the Earth and orbits above the Earth. Now *that's* a monitoring shack!

Using a PC and under \$1100 worth of hardware, we cannot expect to have the huge spectrum capture of the government equipment. But we can get a very useful mini-spectrum capture capability.

RF Spaces' software definable radio, SDR-14 ([www.rfspace.com](http://www.rfspace.com)), capable of receiving 0.1 to 30 MHz, was introduced and reviewed in this column in 2005. SpectraVue is the software that is used to operate the SDR-14. You can download SpectraVue for free at [www.moetronix.com/spectravue.htm](http://www.moetronix.com/spectravue.htm). The new version, 2.20, now allows you to record a 190 kHz wide bandwidth, centered at any frequency from 0.1 to 29.810 MHz.

That means every signal in the selected 190 kHz, regardless of the frequency or if it was being listened to during recording, can

### SDR-14 FFT Spectrum Analyzer - Digital Receiver

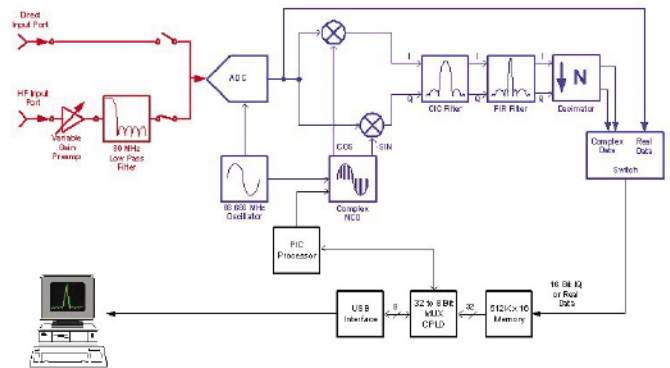

Figure 2 - Block diagram of the SDR-14. Notice the difference between the direct input connector and the 0.1 to 30 MHz input.

be played back! For example, the SDR-14 can receive and record to your computer all signals in 190 kHz of the phone portion of the 20 meter ham band. Once received and stored, the software can "play back" the frequency spectrum, "tuning around" in different frequencies in the captured spectrum file. Every signal in the captured spectrum can be demodulated and listened to as if it were a live, off-air signal.

Using the SDR-14 in this mode is amazing! The fidelity of the demodulated "recorded" signal is excellent, as good as the original.

### Overview of the SDR-14

Let's do a quick overview of the SDR-14. For a more detailed look, see the *Computers & Radio* column in the February 2005 issue of *Monitoring Times* (also now available on the restricted MT Readers-Only site).

Figure 1 shows the SDR-14's front panel. This diminutive receiver has only four connections: power, USB port, 0.1 to 30 MHz antenna connection and a direct input connection. Looking at the block diagram of the SDR-14, we can see that the difference between these inputs is the inclusion of an amplifier stage and a low pass filter. These additional stages are required to use the SDR-14 as a shortwave receiver.

Power is supplied by an included "wall wart" which attaches to a connector on the back panel. Also on the back panel is the location of the USB connector, which is how the SDR-14 communicates with the PC.

SpectraVue version 2.20 provides de-



Figure 1 - The amazingly capable SDR-14 from RF Space. Small, simple, but powerful!

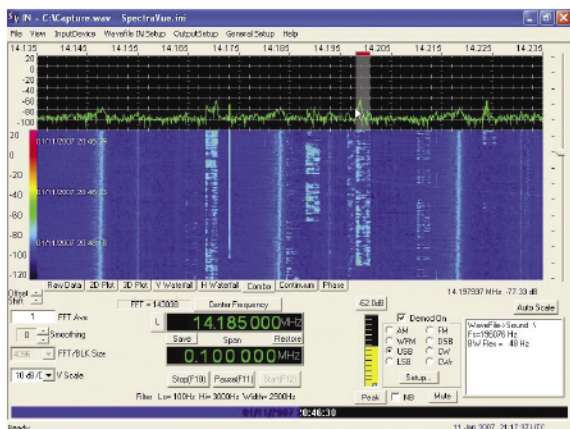

**Figure 3 - The SDR-14 & SpectraVue main screen. Capturing of the entire phone portion of the 20 meter ham band is in progress.**

modulation of USB, LSB, AM, FM, WFM, CW, CWr and DSB. Another new feature is continuously adjustable bandwidth filters.

Clearly, the PC requirements are a function of the SDR-14 hardware needs and the requirements of the SpectraVue software. Its minimum PC requirements are spartan. Just about any Pentium III 800 MHz, 256MB RAM, AGP video card, 18 bit sound card, with a USB port running Windows 98 will result in useful operation. The recommended system is a Pentium 4, 2.2 GHz with 512 MB RAM, AGP 4X video card, 16 bit sound card running Windows XP.

The basic SpectraVue program occupies under 5.5 megabytes of hard drive space. However, since we are interested in spectrum recording, the free hard drive space will define how many minutes of recording is possible. The hard drive storage required for 2 minutes of spectrum recording is about 10 megs.

We'll try some vacuuming with a 1 GHz Pentium III, 512M RAM and with a 200G hard drive running Windows XP. Our goal is to use the SDR-14 with SpectraVue to obtain an off-air digital recording of all the signals occupying a 190 kHz wide swath of the 20-meter ham band. Then, using SpectraVue, we'll play back the "recording" as if it was currently happening, tuning in each signal which was present in the frequency spectrum at the time of the recording.

It's like freezing a piece of radio spectrum for future use.

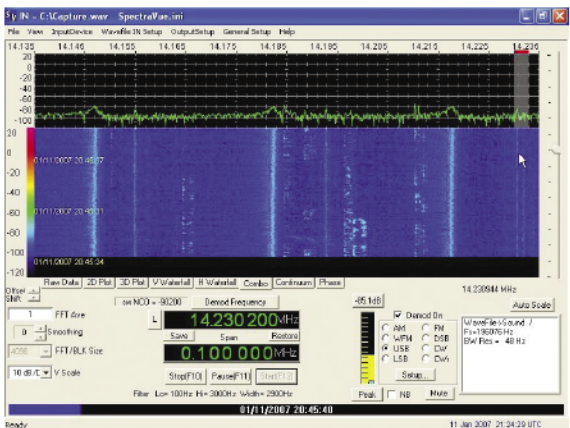

**Figure 4 - Tuning and listening to a RTTY signal at 14.235 MHz, from a spectrum capture file.**

## ☒ Set-Up Screens

Before we actually run the spectrum scan recording, we have to connect the SDR-14 and set a few parameters in SpectraVue. The SDR-14 connects simply and easily via the USB port. Once connected and the included radio driver software installed, then SpectraVue is started. This program has a number of important screens accessed from the main Operating & Signal Display screen.

In Figure 3 we have chosen to display the signals in "Combo" mode, which shows both the real-time signal input spectrum (top) and a waterfall display extended in time (bottom). Dropdown menus for Input Device, SDR-14 Setup, Output Setup and General Setup are available at the top of this screen. The General Setup is primarily used to customize the display and control functions of SpectraVue, such as choice of display units and screen colors.

Since our first task is to capture a piece of radio spectrum, we select "SDR-14" from the Input Device menu. Next, pull down the SDR-14 Setup screen. This display holds critically important receiver controls, such as Filter Bandwidth. For our purpose of spectrum vacuuming we need to set this at its maximum, 190 kHz. Larger bandwidths are available, but they will not allow signal demodulation.

RF amplifier and IF amplifier gains, as well as the sampling rate of the analog to digital converter, are also set on this screen. All three have to be set to their maximum level for our purpose.

Finally, via the Output Setup menu, enable wave file capture of the "RF Data to Wave File." This saves the spectrum that we are about to record to a file on the hard disk. The size of the recording is not set in "time" but in file size. We have chosen to limit the capture file size to 10 Megabytes, about two minutes of recording time. It will be saved as "Capture.wav".

Before we leave this screen, it is a good idea to make sure the "Output to Soundcard" box is checked. Now we can listen to signals on the PC's speakers.

## ☒ Ready to Record

Return to the main screen and set the "Center Frequency" to the 20 meter phone band, 14.185 MHz. Then click "Start" and off we go! The spectrum is being recorded. See Figure 3.

On the waterfall display, SSB (single sideband) voice transmissions appear as vertical bands of broken horizontal lines. In Figure 3 the cursor is positioned above one of these SSB transmissions. The gray area around the cursor indicates the frequency being demodulated - what we are tuned to and therefore hearing. Here it is an SSB transmission at 14.200 MHz. However, we can tune

our "demodulation" frequency to any frequency from 14.090 to 14.280 MHz.

We can see in Figure 3 that the SDR-14 is receiving six or more SSB transmissions. We will have the ability to tune and listen to each of them in our recording. The program places a time and date stamp on the left side of the waterfall display. Once the recording size reaches our file size limit of 10 MB, the capture process stops.

## ☒ Will It Work?

Using the "Input Device" menu we now select "Wave File." This causes the "Wavefile IN Setup" menu to be shown. On this menu we select the name and location of the file we just captured. Returning to the main screen, we now click Start.

We can tune to any signal and listen to it as if we are receiving live off-air transmissions. Then tune to another signal and listen to that one. We are actually tuning around the 20 meter ham band that we might have captured minutes, days, or even years ago! The quality and fidelity of the decoded audio are amazingly good.

If we tune higher to 14.235 MHz we see a RTTY signal. This RTTY signal is shown in Figure 4 as two close vertical narrow lines. Tuning to this frequency sends the demodulated audio to a RTTY decoder. This can produce readable text just as if we were listening to a live off-air transmission.

Closer examination of the recorded spectrum display allows us to listen to signals that we missed in real time. I spent an hour looping the spectrum recording and investigating all the signals it contained ... And all this information was provided from just two minutes of spectrum recording.

## ☒ Try It Yourself

What do I think of this product? In a word ... fantastic! Although I have been associated with spectrum capture in the government sector, having one operate at home on a PC is great. I'm going to look for a good price on a 500 Gig hard drive, then suck up a few hours of spectrum.

You don't need an SDR-14 to play back a spectrum recording if you already have a spectrum capture file from an RF Space SDR-14. All you need is SpectraVue 2.20, which you can download for free from [www.moetronix.com/spectravue.htm](http://www.moetronix.com/spectravue.htm). We've done the spectrum recording for you. Using the current password found in this issue, go to the "MT Readers Only" site using the link at [www.monitoringtimes.com](http://www.monitoringtimes.com), or go directly to [www.monitoringtimes.com/mtssubscriber/mtsdr14capture.wav](http://www.monitoringtimes.com/mtssubscriber/mtsdr14capture.wav) and download the actual 10meg capture file that I used for this article. A high speed Internet connection will make this part quicker, but it can be done on dial-up with patience.

Follow the instructions that we have covered above and you will be tuning around this 190 kHz of 20 meters, listening to hams from the Bahamas and Boy's Club ham stations ... all vacuumed up from the radio spectrum weeks ago.

# What's NEW

Tell them you saw it in *Monitoring Times*

## 2007 Super Frequency List on CD by Jorge Klingenfuss

This extraordinary CD is the most comprehensive in the world, covering shortwave broadcasting, clandestine and utilities services worldwide – frequencies, call signs, locations, schedules and much more! More than 100 global monitoring experts submit loggings each year, providing approximately 10,000 entries for the broadcasting section alone!

Another 10,000 loggings for utilities are included as well. Special appendices provide nearly 1000 abbreviations and thousands of previously active frequencies for historical reference. Browse and search in milliseconds for specific frequencies, countries, stations, languages, call signs, and times as well. An additional section on digital data decoding includes the shareware program *Radioraft*, and hundreds of WAVECOM digital data decoder screenshots, such as the International Committee of the Red Cross in the Afghanistan and Iraq war zones.

A powerful word search runs under Windows 3.1/95/98/2000/ME/NT/XP/. Entering the words - AUS - SSB - reveals all SSB frequencies of stations in Australia. If you enter - ICRC - you get all the frequencies of the International Committee of the Red Cross worldwide. Enter - dig - r - and see all the digital data transmission and teleprinter frequencies of coastal radio stations. Or enter - ale - USAF - to see all the U.S. Air Force stations using the Automatic Link Establishment (ALE) digital data system.

An extraordinary, up to date, shortwave database on a disk. \$34.95 from Grove Enterprises (800-438-8155; [www.grove-ent.com](http://www.grove-ent.com); 7540 Hwy 64 West, Brass-town, NC 28902).



## 2007 Shortwave Frequency Guide

In this digital age of instant, pushbutton access to information, it's reassuring to know that someone still publishes exhaustive, comprehensive frequency lists in print form for those of us who still use our thumbs.

This 11th edition of the *Shortwave Frequency Guide* by Joerg Klingenfuss is an indispensable tool for all listeners to the global, high frequency spectrum through 26 MHz.

Listed in order by frequency and again alphabetically by country, information includes call signs, station identifications and locations, modes and corresponding frequencies for utilities; for broadcasters (international, domestic and clandestine), additional columns provide schedules, target countries and languages.

This information-packed compendium contains nearly 20,000 listings as well as excellent, informative, background pages on shortwave listening.

Available from *MT* advertiser Universal Radio, Inc. (6830 Americana Parkway, Reynoldsburg, OH 43068-4113; 800-431-3939; [www.universal-radio.com](http://www.universal-radio.com)) or by special order from Klingenfuss Publications, Hagenloher Str. 14, D-72070 Tuebingen, Germany. Web site: [www.klingenfuss.org](http://www.klingenfuss.org).

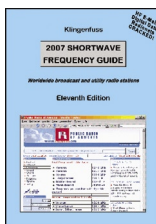

## 2007/2008 Guide to Utility Radio Stations

For the stalwart shortwave utilities aficionado who needs the ultimate reference for identifying the myriad voice and data signals encountered in the high frequency spectrum, no printed volume outdoes the *Klingenfuss Guide to Utility Radio Stations*.

This 2007 biennial edition offers nearly 600 pages of infor-

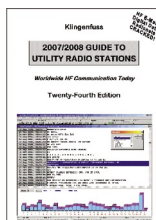

mation on worldwide HF communications, including frequencies, services, call signs, locations, modes and corresponding frequencies. For targeting purposes, cross references are listed by country and service.

A sampling of the listed services includes aeronautical, diplomatic, military, maritime, Red Cross, meteorological, federal agencies, law enforcement, press, terrorists, and UN.

Fully half of this publication provides superb reference information such as identifying users by call signs, worldwide weather broadcast schedules, data transmissions (including hundreds of screen shots), Q codes, emission designators, station class designations, and radio communications abbreviations.

Separate fold-out pages show maritime duplex frequencies and sub-bands, and global air routes and areas.

This fine collection for the utilities monitor leaves little to be desired.

Available from Universal Radio or Klingenfuss Publications (contact information same as for preceding item).

— *Klingenfuss reviews by*  
Bob Grove

## World Radio TV Handbook 2007

The 2007 *World Radio & TV Handbook* 61<sup>st</sup> edition was recently released during a time that most radio hobbyists consider the middle of the prime listening season. This edition, like past issues, remains the ultimate and most respected radio reference book for the worldwide listening audience for shortwave, FM, TV, medium wave, and long-wave.

The 61<sup>st</sup> edition begins with *WRTH Receiver Reviews* and *Active Antennas* with a focus on three software-defined receivers, as well as the latest news on the digital radio revolution in *Digital Update*.

This year, *WRTH* continues its look into the future of world broadcasting with *The Future of Radio II*, a fascinating feature that will likely draw as much enthusiasm as its predecessor. David Ricquish of the Radio Heritage Foundation,

follows with *Broadcasting in the Pacific*, a nostalgic look at broadcasting from the islands.

George Jacobs features the *HF Broadcast Reception* and propagation conditions to expect during 2007 with *Most Suitable Frequencies* to complement your bandscanning for the year.

Taken from active monitoring, the *National* and *International* radio sections appear to be as accurate as possible, thanks to an international contributing staff. Information on seasonal frequency adjustments may be viewed at [www.wrth.com](http://www.wrth.com). Posting this updated station frequency information between annual issues continues to be a successful solution for hobbyists seeking new frequencies as they become available.

The *Clandestine and Other Target Broadcast* section features stations broadcasting mostly politically motivated content, and is comprised of nine pages of worldwide stations that have been actively monitored by contributors. The *Frequency List* contains worldwide medium wave listings, followed by the by-frequency *Shortwave Stations of the World, Broadcast in English, DRM International Broadcasters*, and world television. An extensive *Reference* section will assist the radio listener through many hours of listening and viewing periods.

*World Radio TV Handbook* 2007 continues to set the radio reference standard. It remains the most comprehensive and authoritative source available to guide the listener. Bravo to Mr. Hardyman and his dedicated staff.

WRTH 2007 (BOK-03-07) is available from Grove Enterprises ([www.grove-ent.com](http://www.grove-ent.com) or 1-800-438-8155) for \$26.95 plus S/H.

— *Gayle Van Horn*

Books and Equipment for announcement or review should be sent to What's New, c/o *Monitoring Times*, 7540 Highway 64 West, Brassstown, NC, 28902. Press releases may be faxed to 828-837-2216 or emailed to Rachel Baughn, [editor@monitoringtimes.com](mailto:editor@monitoringtimes.com).

# AOR SR2000 Frequency Monitor

## Seeing is Believing!

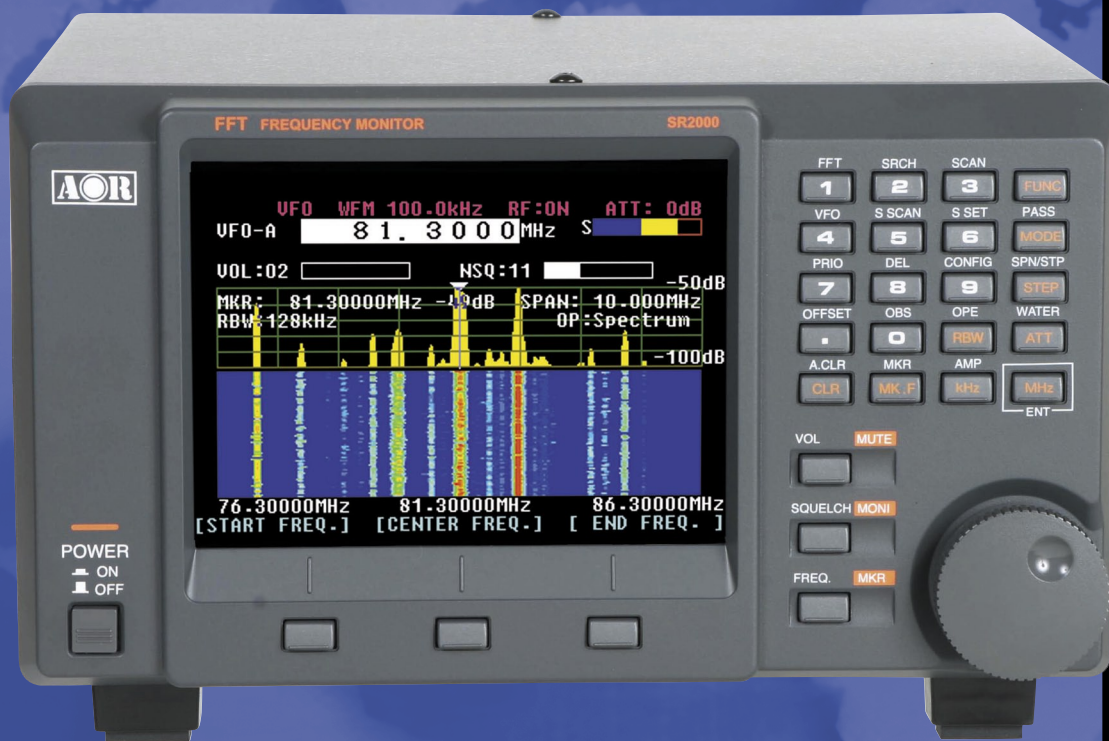

**The SR2000 is an ultra-fast spectrum display monitor with a high quality triple-conversion receiver**

*AOR puts the power of FFT (Fast Fourier Transform) algorithms to work in tandem with a powerful receiver covering 25 MHz ~ 3 GHz continuous.*

*The result is a compact color spectrum display monitor that's ultra-sensitive, incredibly fast, yet easy to use. The SR2000 is perfect for base, mobile or field use and can also be used in combination with a personal computer. It's another example of why so many Federal and State law enforcement, military units, surveillance agencies, government users, hospitals, RF labs, News Media and monitoring professionals rely on AOR, the Serious Choice in Advanced Technology Receivers.*

**High Speed FFT Search**  
– Scans 10 MHz in as little as 0.2 seconds!  
Instantly detects, captures and displays transmitted signals.

- FFT (Fast Fourier Transform) high speed display
- Displays up to 10MHz of spectrum bandwidth
- 5 inch TFT color LCD display
- Waterfall (time) display function
- High speed FFT search quickly captures new signal transmissions
- Versatile color display uses state of the art digital signal processing
- Average or peak value readings
- Frequency coverage: 25MHz ~ 3GHz (no gaps)
- Ultra-stable, high-sensitivity triple-conversion receiver
- AM/NFM/WFM/SFM receive modes
- 1000 memory settings (100ch x 10 memory banks)
- Easy menu-driven operation
- PC control through serial port (or optional USB interface)

## SR2000

**Standard Accessories:**  
AC adapter, control cables



**AOR U.S.A., Inc.**  
20655 S. Western Ave., Suite 112, Torrance, CA 90501, USA  
Tel: 310-787-8615 Fax: 310-787-8619  
info@aorusa.com http://www.aorusa.com

Authority on Radio Communications

*Specifications are subject to change without notice or obligation. Product intended for use by government or authorized users in the USA, documentation required.*

# Stock Exchange

**LINE ADS**

NON-COMMERCIAL SUBSCRIBER RATES: \$.25 per word. All merchandise must be personal and radio-related.  
 COMMERCIAL, NON-SUBSCRIBER, AND MULTIPLE SALES RATES: \$1.00 per word. Commercial line ads printed in bold type.

Ads for Stock Exchange must be received 45 days prior to publication date. All ads must be paid in advance to Monitoring Times.  
 Ad copy must be typed for legibility.

**1-3/4" SQUARE DISPLAY AD:**

\$50 per issue if camera-ready copy or, \$85 if copy to be typeset. Photo-reduction \$5 additional charge. For more information on commercial ads, contact Beth Leinbach, 828-389-4007.

**Subscribe to MT for as little as \$15.50 (U.S. Second Class Mail)**

7540 Hwy. 64 W.; Brasstown, NC 28902  
 1-800-438-8155 US and Can.; 828-837-9200; Fax 828- 837-2216  
 e-mail order@grove-ent.com

	6 months	One Year	Two Years	Three Years
US Rates	<input type="checkbox"/> \$15.50	<input type="checkbox"/> \$28.95	<input type="checkbox"/> \$51.95	<input type="checkbox"/> \$76.95
US 1st Class	<input type="checkbox"/> \$30.00	<input type="checkbox"/> \$57.95	<input type="checkbox"/> \$112.00	<input type="checkbox"/> \$168.00
Canada Surface*	<input type="checkbox"/> \$20.50*	<input type="checkbox"/> \$39.50*	<input type="checkbox"/> \$75.95*	<input type="checkbox"/> \$112.95*
Foreign International*	<input type="checkbox"/> \$30.75*	<input type="checkbox"/> \$58.50*	<input type="checkbox"/> \$114.95*	<input type="checkbox"/> \$171.50*
Electronic Subscription		<input type="checkbox"/> \$19.95	<input type="checkbox"/> \$38.90	<input type="checkbox"/> \$57.85

\*All payments must be in U.S. Funds drawn on a U.S. Bank!

Attention all those wanting to know what's going on with ham radio in the New Orleans area, check out: <http://groups.yahoo.com/group/GNOAmateurRadio/>

Blogs offer an opportunity for columnists to share information that does not make their columns. The news might be too timely for deadline, too short, confined to a small geographical area, too far away to be heard in North America, or even off the columnist's regular "beat." Bookmark these blogs for frequent visits! We'll be adding more blogs in the near future.

- MT: AMERICAN BANDSCAN  
<http://americanbandscan.blogspot.com/> - by Doug Smith
- MT: EDITOR'S DESK  
<http://mt-editor.blogspot.com/> - by Rachel Baughn
- MT: FED FILES  
<http://mt-fedfiles.blogspot.com/> - by Chris Parris
- MT: MILCOM  
<http://mt-milcom.blogspot.com/> - by Larry Van Horn
- Larry's Monitoring Post  
<http://monitor-post.blogspot.com/> - by Larry Van Horn
- MT: SHORTWAVE  
<http://mt-shortwave.blogspot.com/> - by Gayle Van Horn
- MT: UTILITY WORLD  
<http://mt-utility.blogspot.com/> - by Hugh Stegman

**Time to Renew?** Your label will tell you how many issues remain in your subscription. When it's time to renew, your MT will arrive with a bright yellow cover sheet with the renewal form. Renew by the second notice to avoid missing an issue!

**Join the Club!**

Open to hobbyists worldwide, the **CANADIAN INTERNATIONAL DX CLUB** is Canada's national, general coverage radio club serving members since 1962.

For a free sample of our monthly electronic newsletter, **Messenger**, please e-mail CIDX at:

[cidxclub@yahoo.com](mailto:cidxclub@yahoo.com)  
 Web: [www.anarc.org/cidx/](http://www.anarc.org/cidx/)

**HUGE 100 PAGE CATALOG**

- Shortwave & Ham Gear
- Scanners & RTTY/FAX
- Antennas & Accessories
- Radio Books & CDs.

Send \$1 to **Universal Radio**  
 6830 Americana Pkwy.  
 Reynoldsburg, OH 43068  
 Tel. 800 431-3939  
[www.universal-radio.com](http://www.universal-radio.com)

**C Ku Satellite Equipment**

Big Dish • FTA Dish • Parts  
 LNBs • Switches • Feeds  
 Shortwave • Ham Gear  
 CB Radios • Scanners  
 Antennas • Cables • Accessories  
 Books • Electronic Parts  
**Dave's Hobby Shop**  
 600 Main • Van Buren, AR  
 479-471-0751  
[www.daveswebshop.com](http://www.daveswebshop.com)

**Listening In**

That's what we do and who we are!  
 Since 1974

Acclaimed worldwide as one of the top publications for radio listeners. Get a free sample of our electronic monthly magazine and see for yourself.

E-mail us and mention this ad

**Ontario DX Association**  
 155 Main St.N., Apt. 313  
 Newmarket, Ontario L3Y 8C2 Canada  
 E-mail: [listeningin@rogers.com](mailto:listeningin@rogers.com)  
[www.odxa.on.ca](http://www.odxa.on.ca)

**Satellite Dish Parts**

Residential and Commercial  
 Get it all with just one call!



**Melts snow and ice!**  
 Simply attach to your existing dish—works on metal dishes up to 1.2m!

[www.icezapper.com](http://www.icezapper.com)  
[www.skyvision.com](http://www.skyvision.com)

800-500-9275

Cumbre DX is the world's best shortwave DX publication. We feature news and loggings that you just won't find elsewhere. But the best part about Cumbre DX is that it is absolutely

**FREE!**

Send and email to [cumbredx@yahoo.com](mailto:cumbredx@yahoo.com) or visit our website at [www.cumbredx.org](http://www.cumbredx.org) to subscribe.

Alinco ..... 69

Antique Radio..... 65

Antique Wireless ..... 65

AOR..... Cover 2, 75

C Crane..... 71

Carey, Kevin ..... 55

CIDX ..... 76

Communications Electronics..... 27

Computer Aided Technology ..... 25

Cumbre DX ..... 76

Dave's Hobby Shop..... 76

Electronic Specialty Products..... 21

Grove Enterprises ..... 19, 63, Cover 3

Hauser, Glenn ..... 39

ICOM ..... Cover 4

Nil-Jon..... 19

ODXA ..... 76

Performance HF..... 53

Popular Communications ..... 17

Prime Time Shortwave ..... 37

Robl, Ernest ..... 57

Skyvision ..... 76

Small Planet Systems ..... 63

Universal Radio ..... 5, 76

WBCQ ..... 67

WiNRADiO ..... 1

# GROVE



## Your Source for Radio Scanners, Receivers, Accessories, and Publications

Established in 1979 by well-known communications expert Bob Grove, Grove Enterprises has become a world leader in radio monitoring equipment, accessories, and publications.

If you decide you don't like a product, Grove Enterprises doesn't penalize you for it. There is NO restocking fee so long as you call our toll free number for a return authorization within fifteen days of shipment and the item is returned in new condition. Once the item is received we will give you credit toward another item or issue a full refund (less shipping charges). Software cannot be returned if opened.

That's it! No hassle! No negotiations! Just call 1-800-438-8155 and our friendly staff will assist you with a return authorization number.

**Grove means service and quality. You won't find better customer service anywhere.**

**JRC** NRD-545 RCV21DS \$1799.95

### AOR

AR-5000A Plus 3 RCV44P \$2569.95  
AR-8600II RCV11 \$889.95

**GE** SUPERADIO III RCV5 \$54.95

### SANGAN

ATS-505P RCV7 \$109.95  
ATS-909 RCV8 \$239.95  
ATS-818Acs RCV18 \$184.95

**KAITO** KA1102 RCV2 \$79.95

### ICOM

R75 RCV32 \$609.95  
PCR1500 RCV15 \$499.95  
R1500 RCV25 \$599.95  
PCR2500 RCV35 \$729.95  
R2500 RCV52 \$899.95

**ETON** E1XM RCV34 \$499.95  
S350 DELUXE RCV4 \$99.95  
E5 RCV10 \$149.95  
G4000A RCV23 \$149.95

## WiNRADiO

WR-3150 (External)	RCV48-E	\$1849.95
WR-3150 (Internal)	RCV48-I	\$1849.95
WR-3500 (External)	RCV49-E	\$2395.95
WR-3500 (Internal)	RCV49-I	\$2395.95
WR-3700 (External)	RCV50-E	\$2895.95
WR-3700 (Internal)	RCV50-I	\$2895.95
WR-G303e	RCV46E	\$549.95
WR-G303e w/pro demodulator	RCV46EP	\$699.95
WR-G303i	RCV46	\$449.95
WR-G303i w/ pro demodulator	RCV46-P	\$549.95
WR-G313 (Internal)	RCV31	\$949.95
WR-G313 (External)	RCV31-E	\$1149.95
WR-G305i	RCV53	\$519.95
WR-G305i w/pro demodulator	RCV53P	\$619.95
WR-G305e	RCV53E	\$619.95
WR-G305e w/pro demodulator	RCV53EP	\$719.95
WR-G315 (Internal)	RCV54	\$1,899.95
WR-G315 (External)	RCV54E	\$2,049.95

### WiNRADiO Accessories

WR-DNC-3500 Frequency downconverter	CVR02	\$189.95
AX-07B flexible VHF/UHF antenna	ANT47	\$24.95
AX-37A wide-band log-periodic antenna	ANT28	\$389.95
AX-71C discone antenna	ANT01	\$89.95
AX31-B Antenna	ANT 4	\$119.95
AX-91M magnetic antenna base	ANT48	\$24.95
Mounting Clamps for AX-71C	ACC71	\$14.95
USB Adaptor	ACC 2	\$49.95
Client Server Option-1000/1500 Series	ACC 14C	\$99.00
Client Server Option-3000 Series	ACC14B	\$399.00
Client Server Option-G313 Series	ACC14D	\$149.95
G303 Professional Demodulator	SFT20	\$179.95
G305 Professional Demodulator	SFT40	\$199.95
PCMCIA PC Card	ACC 28	\$89.95
Data Cable for 1500/3000 receiver	CBL 3	\$9.95
FSK Decoder	DEC 1	\$349.95
Portable Power Supply (external units only)	PWR 5	\$189.95
Digital Suite	SFT 15	\$85.00
Advanced Digital Suite Upgrade	SFT 15U	\$85.00
Advanced Digital Suite	SFT 15A	\$179.95
World Radio Database Manager	SFT 16	\$85.00
Trunking Software	SFT 23	\$89.95

### Shipping/ Handling Charges

Total Order	Shipping Charges
\$1-\$29.99	\$3.00
\$30-\$49.99	\$6.95
\$50-\$99.99	\$8.95
\$100-\$399.99	\$12.95
\$400-\$899.99	\$16.95
\$900-\$1499.99	\$20.95
\$1500-\$1999.99	\$24.95
\$2000-\$2499.99	\$28.95
\$2500+	\$32.95

Make sure to  
visit us on the  
web to get  
the latest and  
greatest deals!

# GROVE

**(800) 438-8155**

Grove Enterprises, Inc. - [www.grove-ent.com](http://www.grove-ent.com)

(800) 438-8155; (828) 837-9200; fax: (828) 837-2216

7540 Hwy 64 W; Brasstown, NC 28902 - email: [order@grove-ent.com](mailto:order@grove-ent.com)

0.01 to 3299.999 MHz\*\* Coverage • Record and Save Audio in WAV Format • USB Cable Connection

# WHO SAYS THE WORLD IS ROUND?

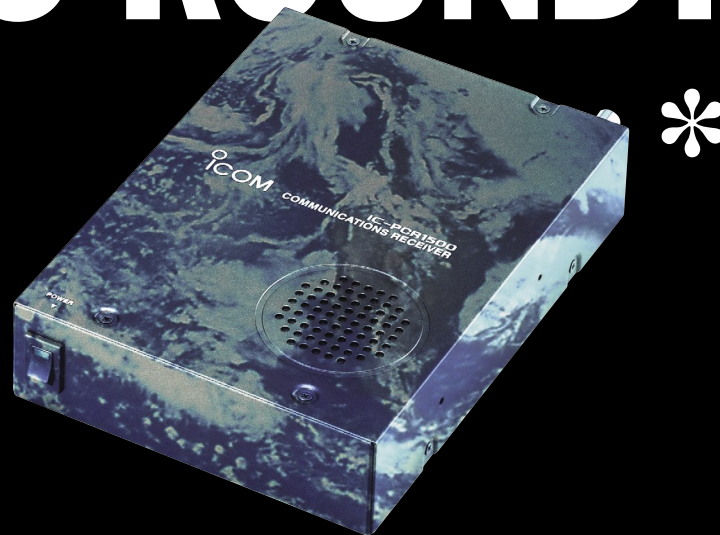

## **NEW** IC-PCR1500

PC Controlled Wideband Receiver

**NOW AVAILABLE**



Also now available: **IC-R1500**

A remote control head allows you to take the radio mobile. Cable included. No PC required, but you may connect the R1500 to a PC when not using the control head. Your choice. Visit your authorized Icom dealer today.

**For free literature:**  
425.450.6088 or  
[www.icomamerica.com](http://www.icomamerica.com)

\* Neat, look huh? It's just advertising. The radio is actually black. Very attractive, yes. But black. If we had put a black radio on this ad, the headline would not have been as quick to read. So we made up this look. Black is nice. Think of it as seeing the world from the night side. It's still there. You just can't see it. Can't get over it? If you send us \$5000.00 USD, we'll make up the radio look just like this for you. Is it worth it? Not to most people. But you're not most people. Are you? E-mail [icom@icomamerica.com](mailto:icom@icomamerica.com) with "worldPCR" in the subject line for more info. \*\* Cellular frequencies blocked.

©2006 Icom America Inc. The Icom logo is a registered trademark of Icom Inc. All specifications are subject to change without notice or obligation. 8760

 **ICOM**<sup>®</sup>