

Volume 18, No. 8

August 1999

U.S. \$3.95

Can. \$6.25

Printed in the United States



**Sneak Preview:
Uniden BC245XLT
TrunkTracker II**

Monitoring Times

Your Personal
Communications Source

*When
Minutes
Matter*

*****5-DIGIT 06410 S11 P1
EXPIRATION DATE : 03/01/2000
THOMAS J SOKIRA
69 MANOR DR
CHESHIRE CT 06410-2615



**Maryland State Police
Medevac Communications**

**NEW
FEATURE
Frequency
Blocks**



Download

Supported by Radio Manager for Windows for downloading recorded frequencies to a computer

sale **\$799**
SAVE \$100



APS105

The New APS105 Pre Selector can be interfaced to increase the Xplorer's sensitivity up to 10x.

Downloading to a PC is easy just interface to a computer with the supplied PC download cable and all recorded data is saved for future reference



Radio Checks

The Xplorer is ideal for radio quick checks. Just key the radio and the Xplorer instantly displays the frequency, and either CTCSS, DCS, LTR, DTMF, Signal Strength, or Deviation.



EXPLORE THIS !!!

- 30MHz - 2GHz Nearfield Test Receiver*, sweeps entire range in less than 1 second
- Lock out up to 1000 individual frequencies
- Frequency Blocks allows the user to preselect up to ten different frequency ranges to Lock In/Out
- Two line character LCD displays frequency and either CTCSS, DCS, LTR, DTMF, Signal Strength, or Deviation
- Automatically record up to 500 frequencies in memory with number of hits and time and date
- Internal speaker, Audio earphone/headphone jack
- Built-in PC interface for downloading memories to a computer
- 800 feet pick up distance from 5 watt UHF radio
- Manually record CTCSS, DCS, LTR, DTMF, Signal Strength, and Deviation to memory
- Locks onto strong signals in less than 1 second
- Automatic or manual hold

OPTODIRECT 800-327-5912
OPTOELECTRONICS®

5821 Northeast 14th Avenue • Ft. Lauderdale, FL • 33334
Telephone 954-771-2050 Fax 954-771-2052 Email sales@optoelectronics.com
www.optoelectronics.com

*Cellular frequencies blocked except for FCC approved users



*Xplorer Test Receiver includes:
TA100S, PC download cable,
Download software, Power Supply,
Operators Manual*



NEW IC-R75 HF RECEIVER

**Cutting edge technology
for today's serious DX'er,
yet easy & affordable
for a casual listener.**

*A large display and
well spaced keys,
knobs & dials helps
make it easy to work
the compact 'R75*

fading in AM broadcasts. Optional **Digital Signal Processing (DSP)** noise reduction in the AF stage converts analog SSB, AM and FM signals to crisp, clear audio output (you'll hear the difference on the 'R75's **large front mounted speaker**). Further tailor the 'R75 to meet your listening needs by installing **up to two optional filters**.

There's much more. Plan to test drive a surprisingly affordable new IC-R75 at your authorized ICOM dealer's showroom soon.

Hear MORE of what's out there. Pick up more amateur, marine and shortwave broadcasts. The new 'R75 covers from **0.03 – 60.0 MHz*** – wider than most other HF receivers.

Pull out the weak signals. The IC-R75 sports a remarkable arsenal of signal detection weapons, ready for your command:

A **triple conversion** receive system rejects image and spurious signals. An **automatic notch filter** reduces interference by minimizing "beat" and "howl" signals. Use **Twin Passband Tuning (PBT)** to zero in on signals by shaping the IF passband. ICOM's all new **Synchronous AM detection (S-AM)** technology reduces signal

ICOM brings you the BEST in wide band receivers



*Computer
not included.*

IC-PCR1000

**The original "World
in a Little Black
Box".** 100% PC hardware
external. Impressive 0.01 – 1300

MHz* wide band reception, all modes. Listen to your favorite broadcasts while working in foreground applications. Designed for Windows® 3.1 or 95.

"The PCR1000 has something to intrigue and satisfy everyone. This is a fun product." – *QST, 7/98*



IC-R8500

The expert's choice. 0.5 – 2000 MHz*; commercial grade; all mode; IF shift; noise blanker; audio peak filter (APF); 1000 memory channels; built-in CI-V command control and RS-232C port for PC remote control with ICOM software for Windows®.

"If you want a receiver that is both a superior world band radio and a solid scanner, the new Icom IC-R8500 is the best choice."

– *Passport to World Band Radio, 1998*



IC-R10 (left) Advanced performance and features. 0.5 – 1300 MHz*; all mode; alphanumeric backlit display; attenuator; 7 different scan modes; beginner mode; 1000 memory channels; band scope; includes AA Ni-Cds and charger.

IC-R2 (right) Excellent audio, tiny package. 0.5 – 1300 MHz*; AM, FM, WFM; easy band switching; CTCSS decode; 400 memory channels; priority watch; MIL SPEC 810 C/D/E; weather resistant; includes 2 AA Ni-Cds and charger.



IC-PCR100

A little different look, a little fewer features, a little lower price. Enjoy 0.01 – 1300 MHz* wide band reception on AM, FM and WFM. Outstanding performance. Designed for Windows® 95 or 98. Download the full version software today: www.icomamerica.com



*Computer
not included.*

ICOM
www.icomamerica.com

*Cellular frequencies blocked; unblocked versions available only to FCC approved users.

©1999 ICOM America, Inc. 2380 116th Ave NE, Bellevue, WA 98004 • 425-454-8155. The ICOM logo is a registered trademark of ICOM, Inc. Questions? Contact your authorized ICOM dealer, or contact ICOM America Tech Support through the HamNet forum on CompuServe® at 75540.525 (e-mail: 75540.525@compuserve.com) All specifications subject to change without notice or obligation. CompuServe is a registered trademark of CompuServe, Inc. Windows is a registered trademark of Microsoft Corporation. R75/RCVR499Y

Monitoring Times

Vol. 18, No. 8 August 1999

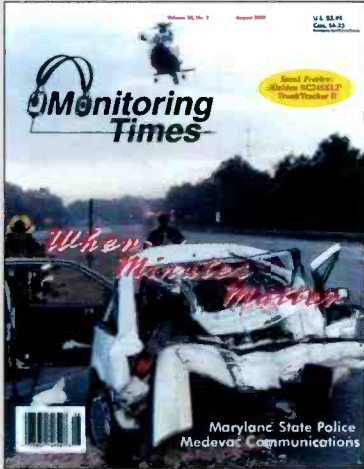

Cover Story

When Minutes Matter

By Alan Henney

In 1968 Adam Cowley, founder of Maryland's shock trauma system, documented the importance of beginning emergency medical treatment within the "golden hour." Two years later the Maryland State Police agreed to make one helicopter available for medical transport, and thus began one of the most extensive medevac programs in the country.

Today, more than 4,000 patients are flown each year by eleven helicopters operating out of eight bases. The article beginning on page 8 provides a comprehensive communications profile of this modern, state-run medevac system.

Cover photo: MSP Trooper helicopter flies out a crash victim from US Route 301 in 1995. Photo by Tom Yeatman.

Building Your Own Weather Station 16

By Ken Reitz

Radio and an interest in weather have always seemed to go together, whether it's for purposes of radio propagation or as a severe weather spotter. Although you can set up your own satellite receiving station to see weather patterns from space (see July *MT*), a simple home weather station can be very effective in charting your local weather. *MT*'s comprehensive *Guide to Weather Broadcasts* on page 19 completes the radio connection.



The New VOA: The Audience Weighs In 20

By Mark B. Lewis



In the spring of 1998 the Voice of America made its biggest change in 50 years with its 24-hour *VOA News Now*. A year later, what is the audience assessment of the new approach? Methods of program delivery have also undergone a radical change.

Improvements to the Sony 2010 22

By Steve Johnston

The Sony ICF-2010 has been one of the most successful portable shortwave radios in history. But that doesn't mean there isn't room for a few simple improvements. Here are four simple projects for better portability, better sound, increased AM filter options, and an adjustable attenuator for use with an external antenna.

Sneak Preview:

The Uniden BC245XLT TrunkTracker II is a huge leap forward in scanner technology. Thanks to "The Scanning Report" (p.26), *MT* readers get a head start in understanding the features and functions of this much-anticipated scanner. Next month Rich Barnett will cover the 245's innovative approach to scanner programming.

Reviews:

The **Grundig Yacht Boy 300PE** - Magne Tests, p.90. The **AR16 Wide Ranger** - Scanner Equipment, p.92. **VisualRadio** - Computers & Radio, p.88. The **Zinwell ZDX-9111** satellite DVB receiver - The Launching Pad, p.66. The **MFJ-1026 Noise Canceling Signal Enhancer** and **Radio Shack's tuner control cleaner** - *MT* Reviews, p.96.

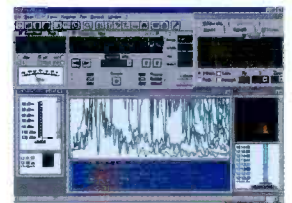



MONITORING TIMES
 (ISSN: 0889-5341;
 Publishers Mail
 Agreement #1253492)
 is published monthly by
 Grove Enterprises, Inc.,
 Brasstown, North
 Carolina, USA.

Copyright © 1999 Grove Enterprises, Inc.
 Periodicals postage paid at Brasstown, NC,
 and additional mailing offices. Short excerpts
 may be reprinted with appropriate credit.
 Complete articles may not be reproduced
 without permission.

Address: P.O. Box 98, 7540
 Highway 64 West,
 Brasstown, NC 28902-
 0098
 Telephone: (828) 837-9200
 Fax: (828) 837-2216 (24 hours)
 Internet Address: www.grove-ent.com or
 e-mail: mt@grove-ent.com
 Editorial e-mail: mteditor@grove-ent.com
 Subscriptions: order@grove-ent.com

Subscription Rates: \$23.95 in US; \$36.50
 Canada; and \$55.45 foreign elsewhere, US
 funds. Label indicates last issue of subscrip-
 tion. See page 63 for subscription information.

Postmaster:
 Send address changes to *Monitoring Times*,
 P.O. Box 98, Brasstown, NC 28902-0098.

Disclaimer:
 While *Monitoring Times* makes an effort to
 ensure the information it publishes is accu-
 rate, it cannot be held liable for the contents.
 The reader assumes any risk for performing
 modification or construction projects pub-
 lished in *Monitoring Times*. Opinion or
 conclusions expressed are not necessarily the
 view of *Monitoring Times* or Grove Enter-
 prises. Unsolicited manuscripts are accepted.
 SASE if material is to be returned.

Owners

Bob and Judy Grove
judy@grove-ent.com

Publisher

Bob Grove, W8JHD
bgrove@grove-ent.com

Managing Editor

Rachel Baughn, KE4OPD
mteditor@grove-ent.com

Assistant Editor

Larry Van Horn, N5FPW

Art Director

Belinda McDonald

Advertising Svcs.

Beth Leinbach
 (828) 389-4007
beth@grove-ent.com

DEPARTMENTS

Washington Whispers	4	American Bandscan	76
Communications	6	<i>IDing that unID</i>	
Scanning Report	26	Outer Limits	77
<i>The BC-245XLT - What's it all about?</i>		<i>Jimmy the Weasel Denies Bust</i>	
Service Search	29	Below 500 kHz	78
<i>Emergency Medical Allocations</i>		<i>Surfin' for LW Sites</i>	
Utility World	30	PCS Front Line	80
<i>Globe Wireless Jumps the Morse Ship</i>		<i>Who Pays for that Cellular Call?</i>	
Digital Digest	33	Experimenters Workshop	82
<i>Robust Romania</i>		<i>Tools & Techniques</i>	
Global Forum	34	Antenna Topics	84
<i>Arne Skoog 1913-1999</i>		<i>Antennas Designed for Reception</i>	
QSL Report	38	On the Ham Bands	86
<i>Hot August QSLs</i>		<i>Is It High Enough?</i>	
English Lang SW Guide	40	And More!	87
Propagation Conditions	60	<i>GMRS Rule Changes</i>	
<i>ELF/VLF/LF Propagation Modes - 2</i>		Computers & Radio	88
Programming Spotlight	61	<i>Seeing is Believing with VisualRadio</i>	
<i>Summer Heat: Sport and Controversy</i>		Magne Tests	90
Satellite Radio Guide	62	<i>Grundig Yacht Boy 300PE</i>	
The Launching Pad	66	Scanning Equipment	92
<i>Zinwell DVB Satellite Receiver</i>		<i>AOR AR16 Portable Scanner</i>	
Beginner's Corner	68	Ask Bob	94
<i>Radio Tools from Office Supply</i>		<i>Two radios, one antenna</i>	
View from Above	70	Review	96
<i>Seasonal Satellite Viewing</i>		<i>MFJ Noise Canceler / RS Cleaner</i>	
The Fed Files	72	What's New	98
<i>US Fish and Wildlife Service</i>		Letters	101
Plane Talk	75	Stock Exchange	102
<i>Travel with the Flying Pig</i>		Advertisers Index	102
		Closing Comments	104
		<i>In Opposition to "Technospeak"</i>	

EDITORIAL STAFF

Correspondence to columnists may be mailed c/o *Monitoring Times*; any request for a reply should include an SASE.

Frequency Manager	Gayle Van Horn	gayle@grove.net
Frequency Monitors	Mark J. Fine	fineware@erols.com
	Dan Roberts	
Program Manager	Jim Frimmel	frimmel@star-telegram.com
American Bandscan	Doug Smith, W9WI	w9wi@bellsouth.net
And More!	Jock Elliott KB2GOM	lightkeeper@sprintmail.com
Antenna Topics	W. Clem Small, KR6A	clemsmal@bitterroot.net
Beginner's Corner	T.J. Arey, WB2GHA	tjarey@home.com
Below 500 kHz	Kevin Carey, WB2QMY	lowband@gateway.net
Computers and Radio	John Catalano	j_catalano@conknet.com
Digital Digest	Stan Scalsky	sscalsk@mail.ameritel.net
	Mike Chace	
Experimenter's Wkshp	Bill Cheek	bcheek@comtronics.net
Federal File	Larry Van Horn, N5FPW	larry@grove-ent.com
K.I.S. Radio	Richard Arland, K7SZ	k7sz@juno.net
Magne Tests	Lawrence Magne	
Milcom	Larry Van Horn N5FPW	larry@grove-ent.com
On the Ham Bands	Ike Kerschner, N3IK	N3IK@hotmail.com
Outer Limits	George Zeller	George.Zeller@acclink.com
PCS Front Line	Dan Veeneman	dan@decode.com
Plane Talk	Jean Baker, KIN9DD	jeanandbob@erols.com
Programming Spotlight	John Figliozi, KC2BPU	jfiglio1@nycap.rr.com
Propagation	Jacques d'Avignon	monitor@rac.ca
QSL Corner	Gayle Van Horn	gayle@grove.net
Satellite Radio Guide	Robert Smathers	roberts@nmia.com
Scanning Equipment	Bob Parnass, AJ9S	parnass@megsinet.net
Scanning Report	Richard Barnett	ScanMaster@aol.com
SW Broadcasting	Glenn Hauser	wghauser@yahoo.com
SW Broadcast Logs	Gayle Van Horn	gayle@grove.net
The Launching Pad	Ken Reitz, KS4ZR	ks4zr@firstva.com
Utility World	Hugh Stegman, NV6H	driver8@netcom.com
View from Above	Lawrence Harris	Lawrence@itchycoo-park.freemove.co.uk
Washington Whispers	Fred Maia, W5YI	fmaia@cwixmail.com



WASHINGTON WHISPERS

By Fred Maia, W5YI
fmaia@cwixmail.com

• **“Rock and a Hard Place Department.”** Radio and TV stations find themselves in a quandary. The Emergency Alert System (EAS), a digital data network that links stations together in times of severe weather or other emergencies, has been in place for a couple of years.

It replaced the tone-based Emergency Broadcast System (EBS.) But the company that holds the patent on EAS, Quad Dimension, wants royalty payments from all users.

Stations don't want to pay hundreds of dollars annually for a system they thought they had already bought, and many have therefore ignored the legal notices. The FCC requires these stations to use EAS, and they'll be heavily fined if they don't. Either way, station owners appear to lose money. The Society of Broadcast Engineers is working on an amicable solution.

• **The United States is not the only country that has problems with low-power unlicensed broadcast stations.** Israeli air traffic controllers (ATCs) staged a one hour strike on May 25th to protest increased ground-to-air communication system interference by pirate radio stations in the area.

The ATCs closed Ben Gurion International Airport for the hour and urged pirate radio station operators to stop interfering with control tower frequencies, otherwise they would cause an air disaster. There have already been several near collisions.

The police say that there are about 100-150 pirate radio stations in Israel with most of them concentrated around Tel Aviv where the airport is situated. The micropower stations make high profits and cost little to operate. They return to the air quickly from a different location once they are raided. To add to the problem, the Israeli justice system seldom sends station owners to jail and the fines are small.

A meeting between the ministers of police, communications and transport was held to discuss the issue.

• **Telecommunications regulatory agencies all over the world are looking at ways to reduce the requirement for ham operators to learn high speed Morse code.** International Amateur Radio law requires unspecified manual telegraphy proficiency

when operating on the high frequency ham bands below 30 MHz.

Germany has converted their Class “A” beginning license, which requires 6 word-per-minute (wpm) code proficiency, to a full privilege Class “1” license. Argentina has reduced their 10 wpm General Class and 15 wpm Superior class to 7 wpm. Canada is proposing to let their no-code “Basic” ham operators use the entire 10-meter HF band once they pass 5 wpm.

Now comes word that the United Kingdom will introduce a 100-watt all band/all privilege Amateur Radio license this fall for Class “B” (code free) operators who pass a 5 wpm telegraphy exam. New Zealand is considering doing away with all Morse examinations. Applicants will be able to upgrade to HF privileges by simply proving that they have completed 25 CW (code) contacts.

And the United States could be next! The Federal Communications Commission is considering whether to reduce the top 20 wpm code speed to just 5 wpm. And the current six license class structure could be reduced to only three. The FCC decision could come at any time ...even before the next issue of *Monitoring Times*!

The next step will be to eliminate the Morse code knowledge requirement entirely. This is expected to happen in a couple of years.

• **The U.S. is in danger of running out of area codes and phone numbers.** The United States now has almost twice as many area codes as in 1991. Industry officials project the need for 30 new codes a year unless changes are made. The goal is to postpone the scrapping of our 10-digit system, with three digits for the area code and seven for the local number. Adding additional digits would require a prohibitive overhaul of our telephone system.

But there really is no shortage. The bottom line is that of the nearly one billion allocated phone numbers, nearly two-thirds are still unused! There are already four numbers allotted for every man, woman and child in the country.

The FCC intends to do something about it. See the PCS Front Line column on page 80 for the details.

• **The FCC is investigating the \$3 billion “10-10” dial-around phone industry.** These services allow callers to choose a long distance company for individual calls by “dialing around” their current long distance carrier. There have been complaints that charges by 10-10 services exceed those advertised.

• **It is back to square one for the FCC’s campaign to crack down on telephone “slamming.”** MCI Worldcom challenged the FCC’s ruling in federal court that would have allowed consumers a 30 day “no pay” period while phone customers challenged disputed “slamming” ...the practice of illegally changing long distance service from one carrier to another without permission.

MCI wanted the rules suspended to give the commission more time to consider an industry plan to address the problem. AT&T, MCI WorldCom, Sprint and associations representing smaller long-distance companies support creating a third-party group to handle consumers’ slamming complaints. The FCC received a record 20,000 slamming complaints in 1998.

• **Does a private (or public) e-mail letter that contains annoying content violate federal law?** A section of the Communications Decency Act of 1996 says it is a federal crime to transmit a “...communication which is obscene, lewd, lascivious, filthy or indecent with intent to annoy, abuse, threaten or harass another person.”

ApolloMedia, the San Francisco owner of <<http://www.annoy.com>> believes the law violates free speech and is therefore unconstitutional. Annoy.com lets people post their opinions anonymously to public officials. The site is well done but some of the content is very rough indeed!

A California district appeals court upheld the law after interpreting it to ban only obscene material ...defined as smut which portrays sexual activity in a disgusting manner. It was left to local juries to determine – based on community standards – when indecent content crosses the line. ApolloMedia appealed that ruling.

By refusing to issue an opinion, on April 19th the U.S. Supreme Court, unanimously affirmed the lower courts ruling. Annoy.com says it will continue to do business.

NIL-JON ANTENNAS

High-Performance, Compact and Rugged

www.nil-jonant.com
To Order: 1-877-9NILJON
Made in the U.S.A.

Highly acclaimed in MT's June "Scanning Report" column by Richard Barnett!
Your Satisfaction Guaranteed!



HD-TV-VHF/UHF-FM-F

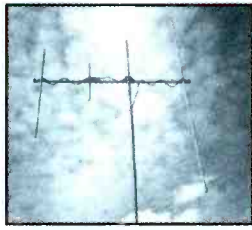

HD-SCANNER-WB-OMNI-F

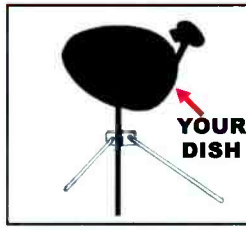

HD-TV/FM-S.OMNI-F

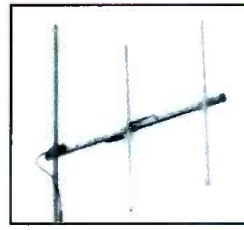

HD-146-V3-U

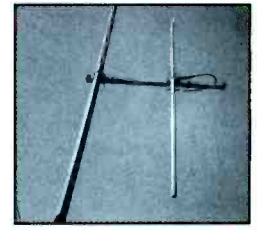

HD-6M or 10M-WB-OMNI-U

NO TUNING NECESSARY

CATEGORY/MODEL	FREQ/COV	DESCRIPTION	CONN.	dB GAIN	DIMENSIONS BOOM LG EL	WEIGHT (LBS)	WINDLOAD (SQ FT)	POWER RATING	SHIPPING WEIGHT
BROADCAST TV/FM-SCANNER									
HD-TV-VHF/UHF-FM-F	TV CHNL'S 2-69 FM-Stereo	Compact, Long Range, Full Coverage TV VHF/UHF/FM The ultimate antenna for the new digital high definition Television (HDTV) Broadcast, VHF low 10dB, Hi 12dB, UHF 21dB	F	Nominal (See left)	88" 108"	7.5	1.5	N/A	12.5 LBS.
HD-SCANNER-WB-OMNI-F	25-1300 MHZ	Long Range, Continuous Coverage Top or Side *** Mount to Mast/Tower *** no add'l hardware needed (Still Omnidirectional) Unique "Steerable Omnidirectional" Mount Almost Anywhere onto Wall or Mast (*** [On/In Rooftop/Antic/Existing Satellite Dish Mast Mount/Side of House/Closet/Etc.])	F	Nominal 6.2 dB	67" 90"	7.5	1.9	N/A	12.5 LBS.
HD-TV/FM-S.OMNI-F	TV CHNL'S 2-69 FM-Stereo	Unique "Steerable Omnidirectional" Mount Almost Anywhere onto Wall or Mast (*** [On/In Rooftop/Antic/Existing Satellite Dish Mast Mount/Side of House/Closet/Etc.])	F	Nominal 5.2 dB	N/A 30" [ant 19"(h) x 40"(w) x 3"(d)]	1.0	0.2	N/A	3.0 LBS.
HAM-VHF YAGI									
HD-146-V3-U	142-150 MHZ	End Mnt. 3 ele. Vert. using mast/tower for reflector. Detailed, easy to follow, stacking instructions included for even higher gain!	U	12 (15 dB if stacked)	36" 36"	3.5	0.4	600 W	6.5 LBS.
HAM-WB-OMNI VERTICALS - SIDE ARM MOUNT WITH HARDWARE INCLUDED									
HD-10M-WB-OMNI-U	26.9-30 MHZ	Top or side mount 3.1 (HAM) dB: 10.6 (CB LINGO) dB	U	3.1 dB	72" 204"	5.5	1.6	1000 W	10.5 LBS.
HD-6M-WB-OMNI-U	50.0-54 MHZ	Top or side mount	U	3.1 dB	42" 108"	3.5	0.9	1000 W	8.5 LBS.

OUTSIDE OHIO	OHIO (7% SALES TAX INCLUDED)
\$279.95	\$298.14
\$154.95	\$165.75
\$93.95	\$99.47
\$24.95	\$26.35
\$134.95	\$143.35
\$149.95	\$160.45
\$134.95	\$143.35

TO ORDER:

Check or M.O.: Make out to 'Nil-Jon' & send to Nil-Jon Antennas, 29462 Lorain Rd., N. Olmsted, OH 44070 [state model(s) on memo of check/M.O.]
Credit Card: Call **24 hr. TOLL FREE 1-877-9NILJON (1-877-964-5566)** with M.C./Visa/Discover/American Express Acct. #
Internet: www.nil-jonant.com **Email:** niljonant@ameritech.net

Prices include S&H in Continental U.S.

Business & Data Communications Antennas Also Available! (Call/See Website)

Info Line: 440-777-9460 MWFSa 11 AM - 6 PM EST

DEDICATED TO THE SCANNING AND SHORTWAVE ENTHUSIAST. WE'RE MORE THAN JUST SOFTWARE!

NEW!! JUST RELEASED!
VERSION 7.5

SCANCAT GOLD for Windows "SE"

Since 1989, The Recognized Leader in Computer Control

Once you use SCANCAT with YOUR radio, you'll NEVER use your radio again WITHOUT SCANCAT!

SCANCAT supports almost ALL computer controlled radios by AOR, DRAKE, KENWOOD, ICOM, YAesu and JRC (NRD) Plus PRO-2005/6/35/42 (with OS456/535), Lowe HF-150, and Watkins-Johnson.

SCANCAT GOLD FOR WINDOWS "SE" (Surveillance-Enhanced)

FEATURES

- Selective Sound Recording using PC-compatible sound card. "Point & Shoot" playback by individual hits.
- Demographic search for frequency co-ordination and 2-way Usage Analysis.
- Detailed logging to ASCII type files with DATE, TIME, Sig Str, Air Time.
- 6 New Sweep Analysis Functions.
- Exclusive "MACRO" control by frequency of Dwell, Hang, Resume, Sig, Threshold and even 6 separate programmable, audible alarms.
- Command line options for TIMED ON/OFF (Unattended) logging/searches.
- Run as many as 6 different CI-V addressable radios as "Master/Slave"
- New! Scheduling/Recording Functions.

With Scancat Gold for Windows "SE", your spectrum never looked so good! Load virtually "any" database and Scancat "SE" will examine your database, plot each and every frequency, no matter what the range, and "paint" the entire analysis on your screen.

SEVERAL GRAPHICAL ANALYSIS MODES AVAILABLE

IF THAT ISN'T ENOUGH, try this... Multicolored, 3-D "Spatial Landscape".

- By Signal Strength per frequency in a "histograph".
- By Signal Strength plotted in individual dots.
- By Number of hits per frequency in a "histograph".

SCANCAT GOLD "SE"... \$159.95 + s & h UPGRADE SCANCAT GOLD V7.5 "SE"... \$59.95 + s & h

SCANCAT'S WINDOWS FEATURES

- Unattended Logging of frequencies
- Scan Create Disk Files.
- Spectrum Analysis to Screen OR Printer.
- Supports ParCon, Mr Scanner, and Betty Bearcat CD Roms
- Scan VHF & HF Icom's Simultaneously.
- LINK up to 100 Disk files or ranges.
- MULTIPLE search filters for Diskfile Scanning.
- New -- Programmable Favorite Frequency "Quick Buttons"
- Search by CTCSS & DCS tones with OS456/535 or DC440 (ICOM only).
- INCLUDES several large shortwave and VHF/UHF databases
- UNIQUE database management system with moveable columns. Even SPLIT columns into doubles or triples for easy viewing of ALL important data on one screen.
- Exclusive "SLIDE RULE" tuner. Click or "skate" your mouse over/ur Slide Tuner to change frequencies effortlessly! OR use our graphical tuning knob.

SCANCAT GOLD FOR WINDOWS (NON-"SE").....\$99.95 + s & h UPGRADE TO V7.5\$29.95 + s & h

All the features you EXPECT from a true Windows application such as:

- VERSATILE "Functional" spectrum analysis NOT just a "pretty face". Spectrum is held in memory for long term accumulation. Simply "mouse over" to read frequency of spectrum location. "CLICK" to immediately tune your receiver. You can even accumulate a spectrum from scanning DISKFILES of random frequencies!
- DIRECT scanning of most DBASE, FOXPRO, ACCESS, BTRIEVE files WITHOUT "importing".

*\$5 U.S. \$7.50 FOREIGN

HOKA CODE-3 USA Version

"The Standard Against Which All Future Decoders Will Be Compared"

Many radio amateurs and SWLs are puzzled! Just what are all those strange signals you can hear but not identify on the Short Wave Bands? A few of them such as CW, RTTY, Packet and Amtor you'll know - but what about the many other signals?

There are some well known CW/RTTY Decoders but then there is CODE-3. It's up to you to make the choice, but it will be easy once you see CODE-3. CODE-3 has an exclusive auto-classification module that tells YOU what you're listening to AND automatically sets you up to start decoding. No other decoder can do this on ALL the modes listed below - and most more expensive decoders have no means of identifying ANY received signals! Why spend more money for other decoders with FEWER features? CODE-3 works on any IBM-compatible computer with MS-DOS with at least 640kb of RAM, and a CGA monitor. CODE-3 includes software, a complete audio to digital FSK converter with built-in 115V ac power supply, and a RS-232 cable, ready to use.

CODE-3 is the most sophisticated decoder available for ANY amount of money.

26 Modes included in STANDARD package include:

- Morse *
- RTTY/Baudot/ Murray *
- Sitor CQ/R 625/476-4
- ARQ - Navtex *
- AX25 Packet *
- Facsimile all RPM (up to 16 gray shades at 1024 x 768 pixels *
- Autospac - Mk's I & II
- DUP-ARQ Attrac
- Twinplex
- ASCII *
- ARQ6-90/98
- SI-ARQ/ARO-S
- SWED-ARQ-ARQ-SWE
- ARQ-E/ARQ1000
- ARQ-N-ARQ1000
- Duplex Variant
- ARQ-E3-CCIR519 Variant
- POL-ARQ 100 Baud
- Duplex ARQ
- TDM242/ARQ-M2/4-242
- TDM342/ARQ-M2/4
- FEC-A
- FEC100A/FEC101
- FEC-S - FEC1000
- Simplex
- Sports Info 300 baud ASCII
- Hellsreiber- Synchron/Asynch *
- Sitor - RAW (Normal Sitor but without Synchron)
- ARQ6-70
- Baudot F788N
- Pactor *
- WEFAX *

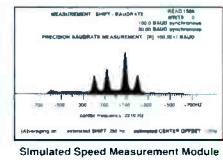

Simulated Speed Measurement Module

EXTRA OPTIONS

- Piccolo \$85.00
- Coquelic \$85.00
- 4 special ARQ & FEC systems: TORQ-10/11, ROU-FEC/ RUM-FEC, HC-ARQ (ICRC), HNG-FEC \$115.00
- SYNOP decoder \$85.00

PROFESSIONAL CODE-3 DECODER

\$595.00 + s & h
Includes: ALL Modes, Plus Oscilloscope*, ASCII Storage, Auto Classify*, and PACTOR* Options
with ALL EXTRA OPTIONS \$795.00 + s & h

ALSO AVAILABLE

CODE-30 COMM & CODE-300 GOVT. DSP-BASED Decoders \$2 CALL \$5

CODE 3 - GOLD VHF/SW DECODER

\$425.00 + s & h
includes POCSAG & ACARS Plus * Modes/Options with ALL EXTRAS MODES/OPTIONS \$395.00 + s & h

Now Available - Stridsberg Engineering Multicoders - "Call for Quantity Pricing" <http://www.scancat.com/mltclpr.html>



FREE FREQ FILES

WEB ADDRESS - www.scancat.com

FREE DEMOS

Order direct or contact your favor ite dealer

COMPUTER AIDED TECHNOLOGIES P.O. Box 18285 Shreveport, LA 71138

Phone: (318) 687-4444

FAX: (318) 686-0449

InfoTech Support: (318) 687-2555 (9 a.m. - 1 p.m. Central M-F)

Orders Only 888-SCANCAT 888-722-6228

Historic QSLs in good hands

The Committee to Preserve Radio Verifications (QSLs) was established in 1986 to give a home to private QSL collections and rescue some radio history that might not be valued by the family of an elderly or deceased hobbyist. Until recently, this growing, computer-indexed collection has been housed at the Christian Science Monitor's Boston headquarters.

The collection now has a new and very appropriate home at the Library of American Broadcasting (LAB) on the campus of the University of Maryland in College Park. Some of the LAB's holdings include the Arthur Godfrey collection, more than 3,000 books, 25,000 photographs, and thousands of pamphlets, recordings, commercials, and scripts. LAB operates in conjunction with its sister project, the National Public Broadcasting archives.

Curator Charles Howell says, "We ... are honored to serve as your repository. The Committee for the Preservation of Radio Verifica-

tions QSL Collection is an outstanding example of the impact that dedicated individuals can have in preserving the radio heritage of our nation and indeed the world."

The CPRV collection currently contains about 30,000 QSLs, 40 percent of which date from before 1949. Recent significant additions have been the collections of Hank Holbrook, Howard Kemp, and Alvin Sizer.

For information on how to participate in the preservation program, contact Jerry Berg, CPRV chairman, 38 Eastern Ave, Lexington, MA 02421, (781) 861-8481.

CIA Encryption Challenge

Jim Sanborn is an artist who believes "it's important that every piece of artwork holds one's attention for as long as possible." He's succeeded in holding the attention of at least one CIA employee for as much as 400 hours with his sculpture entitled "Kryptos." The sculpture, etched with 865 characters, was erected outside the CIA cafeteria in 1990, but it was



only in February of this year that David Stein, a CIA physicist, deciphered all but 97 of the letters on the left side of the puzzle.

The first of June, Jim Gillogly, a California computer scientist for Mentat, Inc., solved the exact same section in about 9 days, using a software program he had written.

Retired CIA cryptographer Ed Scheidt taught the artist how to encode his message. Sanborn



[See www.grove-ent.com/hmpgmt.html for more events and club info]

Aug 14, 15: Waseca, MN, Special Event Station

A special event station will operate from the Waseca County Fairgrounds using vintage E.F. Johnson transmitters, using SSB, AM, and CW. HF operation planned for 0800 and 2100 CDT on 3885, 7290, 14286, 21400, 29000 kHz AM. SSB operation on 3900, 7260, 14250, 21350, 28400 kHz. CW operation on 3700, 7125, 14050, 21150, 28050 kHz. Callsign WA0CJU/9ALD (Edgar Johnson's call)

Aug 15: Lexington, KY

Bluegrass Amateur Radio Society is sponsoring the Central Kentucky ARRL hamfest and computer show at the National Guard Armory adjacent to the Lexington, KY, airport. For more information contact John Barnes KS4GL, KS4GL@juno.com or call 606-253-1178 evenings. Dealer sales, indoor flea market, forums, refreshments. 8am-4pm; admission \$6.

Aug 20, 21, 22: York, PA, Special Event Station

A station to celebrate the 250th birthday of York County, PA, will be operated by the York Co ARC Aug 20-22 on 7.250, 14.250, 21.250 and 28.500 MHz. The first 2,500 QSLs of these or any contact with club station WKY3ORK between Feb 10, 1999, to Dec 31, 1999, will receive a gold parchment award displaying the history of York

Co. and signed by four commissioners. Send your QSL or photocopy of your logs with 3 IRC (or \$3 US) to KC3TL, Pete deVolpi, 408 Hillside Ave, New Cumberland, PA 17070-3036.

Aug 21: Longview, WA

Lower Columbia A.R.A. / 8th Annual Ham Radio, Computer, & Electronic Equipment Swap Meet / LCARA, POB 906, Longview, WA, 98632. Bob Morehouse, KB7ADO, (360) 425-6076 eves. Location: Cowlitz Co. Expo Center; Talk-in on 147.26+, pl 114.8. 9am-1pm. Admission \$3. RVs \$12. Email to KB7ADO@aol.com or see flyer at www.qsl.net/nc7p/

Aug 21, 22: Huntsville, AL

The annual, friendly Huntsville Hamfest is located at the Von Braun Center's South hall; flea market, dealers, seminars, VE testing, banquet, and much more. For more information, call (205) 534-7175, write to Huntsville Hamfest, P.O. Box 12534, Huntsville, AL 35815, visit <http://www.hamfest.org>, or email to Scotty Neustadter, W4WW, scotty@airnet.net

Aug 22: St. Charles, MO

Hamfest 1999, sponsored by the St Charles ARC, will be located at Blanchette Park in St Charles, 6:30am to 1pm; talk-in 146.67. Demonstrations by ATV, AMSAT, and Bob Heil (tentative). Flea market, free admission, free forums, food concessions. Contact Ken Kieser

314-428-4383 kfeiser@aol.com or visit <http://www.qth.com/wb0hsi/>

Sept 3-5: Bridgeport, WV

National Radio Club convention at the Holiday Inn (304-842-5411). Convention registration \$35 to host William Swiger, One Casey Lane, Bridgeport, WV 26330, 304-842-4635.

ODXA Essay Contest

To celebrate the 25th anniversary of the Ontario DX Association, radio listeners around the world; listeners of international shortwave, mediumwave, FM, scanning, amateur radio; listeners of all ages and levels of experience; all are invited to participate in a special essay contest.

The up to 1000 word essay is to be on "Radio in my life." Tell about the importance of radio to you, how it has contributed to your life, why you love radio...

All essays will be published in a booklet to be available at Radio Fest 99, September 24-25 in Oakville, Canada. All entrants will receive a complimentary copy of the booklet. First prize will be a portable shortwave radio.

Entries must be submitted by e-mail or by printed *typewritten* copy and received no later than September 1, 1999. E-mail to: dxontario@compuserve.com or mail to: Ontario DX Association, P.O. Box 161, Station A, Willowdale, Ontario M2N 5S8, Canada

says the puzzle is layers on top of layers, and all parts must be solved before discovering the final solution. The sculpture itself is also multilayered, created out of granite, quartz, lodestone, copper and water.

Presumably CIA computers could uncover the full text in a matter of hours or days, but this is an off-hours challenge to anyone wanting to undertake it. You, too, can try your hand at it; both parts of the encoded text can be found at ABCNews.com, or better yet, go to <http://www.und.nodak.edu/org/crypto/crypto/general.crypt.info/Kryptos/>. The only copy of the solution is locked in a CIA safe.

Illegal to Sell Cell-Capable Radios?

A hobbyist named Frank put up his Radio Shack Pro-2022 scanner with full 800 MHz coverage for sale through the internet auction site eBay Inc. He freely disclosed in his ad that the radio had cellular coverage and that monitoring cellular frequencies is illegal.

Three days later, eBay canceled the auction, saying, "The item you have listed does not appear to be consistent with eBay guidelines," – i.e., selling illegal items. Says Frank, "I thought it was legal to sell a radio that is capable, but illegal to listen to the band. Especially since it was manufactured for the USA in 1993, before the law of 1994. – The same with cordless phone freq... It is illegal to listen to cordless phones, but almost every radio receives 40-50 MHz."

According to Chapter 119 of the US Criminal Code, you may not send through the mail, send or carry in interstate or foreign commerce, manufacture, assemble, possess or sell, or place any advertisement for any device whose design renders it primarily useful for the purpose of surreptitious interception of protected communications. The critical word here is *primarily*. eBay of course has the right to play it safe!

World's largest ground plane

Liberty Labs of Kimbalton, Iowa, has finished construction of the world's largest ground plane for antenna calibration. It measures 80 meters long by 50 meters wide, about the same amount of land as a football field. It cost half a million dollars to build but can be rented for a couple of days (with their technical staff to assist) for far less than it would cost to build your own antenna test chamber.

Satellite access to networks

Congress is very close to revising communications law and copyright protections to allow satellite broadcasters to provide local news, weather, and sports broadcasts, and they have clarified the conditions under which satellite customers may be permitted to receive programming from distant network affiliates. Both houses have passed what the Senate is calling

the Home Viewers Improvement Act; minor differences in the two bills remain to be resolved. Some viewers now receiving distant network affiliates were due to have network programming cut off on June 30th.

Quechuan Indians turn to shortwave

In one of the most remote, impassable regions of the Andes mountains live thousands of Quechua people who rely upon radio for news, personal messages, and entertainment. The Quechua people make up nearly 62 percent of the population of Bolivia, and they have long dreamed of having their own radio station. Finally, they do.

According to an article in *Radio World* by station director Eldon Porter, Radio Mosoj Chaski began broadcasting exclusively in Quechua on April 12 from Cochabamba, Bolivia, using the frequency 3310 kHz. The transmitter, built by Omnitronix (800-446-6648) in North Wales, Pennsylvania, is the first 10 kW solid state tropical band transmitter in the world.

Industry study finds potential link to cancer

"We're now in gray area ... the best thing to do is let the public know about the findings so that they can make their own judgment," said George Carlo, in a commendable statement. Carlo is chairman of the industry-funded Wireless Technology Research group which found possible connections both in biological tests and statistical analysis between cellular phone use and cancer.

Elizabeth Jacobsen of the Food and Drug Administration told the *Washington Post*, "These results seem to have been done well – the question now is 'okay, we've got a result. What do we do with it?'" The results indicate the need for more study, but no regulatory action is planned at this time, she said.

"Communications" is compiled by Rachel Baughn, editor, from clippings submitted by our readers. Reporters this month include Anonymous, NH and NY; Harry Baughn, NC; Chet Copeland, DC; Roger Cravens, GA; Paul Forel, email; Maryanne Kehoe, GA; Kevin Klein, WI; Henning Knudsen, DW; John Lemay, email; Joe Miller, PA; David Parsons, AZ; Doug Robertson, CA; Harold Sellers, ON; Walter Szczepaniak, PA; Peter Szerlag, email; Larry Van Horn, NC; Dan Veeneman, MD; we also drew material from the ARRL newsletter and the W5YI newsletter.

RadioCom

DSP, CAT and Signal Decoder

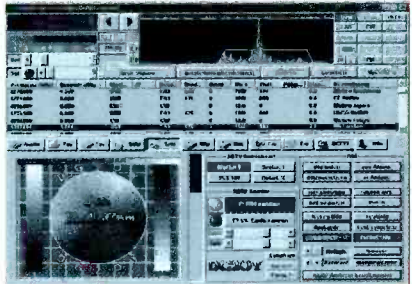

DSP-filter-synthesizer, Computer Aided Tuning and decoder of digital and analog signals: CW, FAX, RTTY, SITOR, SSTV for AOR, ICOM, KENWOOD, NRD, YAESU and more. Transmitting possible with TX-version. CD-ROM with ISAC-modem starting at \$170.00. Download DEMO

COMPUTER INTERNATIONAL

207 South US-27
 St. Johns, MI 48879
 Tel/FAX: 1-877-977-6918 (toll free)
 E-mail: computer@email.mintcity.com
<http://computer-international.virtualave.net>



Rave Review
Pop Comm
April '96

SEE US ON THE WEB!
www.vikingint.com

Professional 10 HOUR RECORDER

"BUILT LIKE A BATTLESHIP"



- Heavy duty commercial recorder - NOT improvised from consumer models
- 12, 14, and 16 hour models also available
- BUILT-IN voice activation (add \$30)
- Applications information included
- Dimensions: 11.5 x 7.0 x 2.75"

SPECIAL
Monitoring
Times Price..

\$159

FREE
SPECIAL EQUIPMENT
CATALOG!

COD's OK. Calif. residents add tax. Sorry, no credit cards. Free catalog USA only; other countries \$5. Free shipping to 48 contiguous states on prepaid orders.

Viking International

Factory Direct Phone: (415) 468-2066 • Fax: (415) 468-2067 "Since 1971"

150 Executive Park Blvd. #4600 San Francisco, CA 94134

When Minutes Matter

Maryland State Police Helicopters



By Alan Henney

"It's in Montgomery County," proclaims dispatcher Steven Risso seconds after answering the phone. To Risso's left, lifting the headset to his ear, sits Maryland state trooper Sgt. Tony Galloway. For a moment, the dimly lit room is silent except for the clicking of Galloway's computer keyboard as he retrieves the map grid for the accident scene. Galloway hits the speed dial button to Trooper 8's hangar and feeds the landing zone location and coordinates to the waiting air crew.

Meanwhile, Risso has completed the medevac request form and adjusts his telephone headset. "Hi, it's SysCom," he says to the nurse at Suburban Hospital, "Trooper 8 is en route to Rockville for an auto accident, they'll see you in about 10 minutes." Moments later Trooper 8 is airborne and the helicopter's location, along with seven other helicopters, is tracked on a blurry projection TV screen across the room.

More than 8,000 public safety helicopter missions each year begin in a similar manner at this communications facility operated by the Maryland Institute for Emergency Medical Service Systems (MIEMSS) on the campus of University of Maryland at Baltimore. When this center, known as SysCom (systems communication), receives a request, usually from one of the county's "central alarms," it dispatches a helicopter from one of eight Maryland bases. SysCom also helps coordinate flights for other area medevac providers (listed elsewhere in this article).

How It All Started

Maryland was the first and remains one of the few states to operate such an extensive medevac program. The program's foundation is based on research conducted by the late R. Adams Cowley, a trauma surgeon and founder of Maryland's shock trauma system. In 1968, Cowley

evaluated the effects of sustained uncorrected shock in trauma patients. Cowley discovered that if internal bleeding were stopped and the underlying shock was reversed within the first hour – what he eventually dubbed the "golden hour" – patient survival rates increased significantly.

In 1961 Cowley opened the nation's first shock-trauma center at the University of Maryland campus in Baltimore, but many patients couldn't get there in time.

Cowley looked for faster ways to bring hospital-like care to the critically injured within that first hour. He considered military-style mobile operating rooms and tractor trailers that could meet ambulances halfway. But the most viable solution was modeled after the army's success in Korea and Vietnam where battlefield casualties were flown by helicopters staffed by medics to front-line MASH units.

The Maryland State Police acquired its first aircraft in 1954. It was a Stinson L-5 airplane based at Rutherford Field in Woodlawn. In 1960 the agency purchased its first helicopter, a piston-powered Hiller H-12E helicopter, for airborne surveillance and transport only.

It wasn't until the late 1960s that Cowley approached the state police with an idea. In a television interview, Cowley said he initially faced reluctance when he proposed that the state police helicopter take on medical missions. That reluctance turned to support when the project received federal funds.



Fire fighters help load trauma patient into a Maryland State Police Trooper helicopter. N92MD - Aerospatiale SA365N-1 Dauphin.

The Federal Highway Safety Act of 1968 paved way for what would become the first civilian medevac program in the country. On June 2, 1969, the Maryland State Police in conjunction with the University of Maryland Hospital received a federal grant for a project entitled "Helicopter Patrol."

It officially began on March 18, 1970, with a



By Alan Henney.

Maryland State Police Trooper (flying as Trooper 2) on display at Hyattsville VFD's open house. N61MD - 1993 Eurocopter AS 365 N2 Dauphin.

single Bell Jet Ranger 206A helicopter based at the Valley MSP barrack for 10 hours during the day. At other hours it was available on an on-call basis from the 175th National Guard hangar at Glenn L. Martin State Airport. The helicopter flew all of its patients to what would eventually become the University of Maryland's Shock Trauma Center in Baltimore. The Jet Rangers would become the helicopter used to provide medevac services in Maryland for the next 25 years.

The first year the helicopter flew 197 patients. About 88 percent of them survived. The project was a success. That success allowed the program to expand to its current size of eight bases with 11 helicopters. More than 4,000 patients are flown each year. In its first 25 years the aviation division flew 61,000 patients, and 152,000 police missions, for a total of almost 140,000 flight hours.

The program has had three fatal crashes – all Bell Jet Rangers – each of which killed the onboard pilot and paramedic. The most recent crash, on Jan. 19, 1986, led to new safety procedures, stricter standards for pilots, an airborne flight-following system for the helicopters, and the purchase of the American EuroCopter (Aerosptable) SA365N1 and SA365N2 Dauphin helicopters. The Dauphins cost \$5.5 million each and their high-pitched, high-powered whine distinguishes them from the traditional helicopter sound.

The Dauphin helicopters offer increased range and speed over the Jet Rangers. The Dauphin travels at about 180 mph, compared with the Jet Ranger's 115 mph. The Dauphin's range is 500 miles, 300 miles more than the Jet Ranger. The Dauphin can lift more than the older helicopters, enabling the crew to transport as many as six people plus extra medical equipment. Two patients can be transported side by side in the Dauphin, unlike the stacked configuration that was sometimes used in the Jet Ranger. The first of 11 Dauphins was placed in service on May 18, 1989.

Patients have never been charged for the air transport. Budget cuts in the late 1980s eventually led to the creation of a motor vehicle tag fee in October 1991. Approximately 70 percent of the aviation division's \$16 million operating budget now comes from this \$8 annual motor vehicle registration tax which also supports area-wide trauma centers and the EMS communication system.

The MSP aviation division consists of 159 total personnel, including 44 trooper/flight paramedics, 56 uniform and civilian pilots and 59 additional support staff.

WINRADIO®

The Pioneers of PC Radio

From internal card based radios to portable external units, from low-cost single-channel receivers to sophisticated high-end multi-channel systems, we have it all!



WINRADIO internal - hide it inside your PC! No external cables or power supplies!



(computer not included)

WINRADIO external – we also have a PCMCIA adaptor, and a rechargeable battery pack option for true portability.



WINRADIO software is still unparalleled in the industry. Download our demo software from the Web and check out our virtual control panel with *Spectrum Scope* and *Visitune!*

• **Version 3.0 Software** is now available. Existing 1000/1500 receiver series users are invited to upgrade. As usual, for free! Check out our Web site.

• **XRS** (eXtended Radio Specification) brings an entirely new dimension to PC radio. Our new version 3.0 software is fully XRS compatible.



Expand the power of your WinRadio with our exciting software options:

• **WINRADIO Digital Suite** software is used for decoding WEFAX, HF fax, packet, ACARS, DTMF, CTCSS and also for signal classification, audio spectrum analysis, squelch controlled playback and recording.

• **WINRADIO Database Manager** integrates large frequency databases within a WinRadio receiver.

www.winradio.com

info@winradio.com

Dealer inquiries invited.

WinRadio, Visitune and XRS are trademarks of WinRadio Communications.



By Alan Henney

Delaware State Police Trooper 2 searches surf for missing swimmer who drowned off Rehoboth Beach, De. Paramedics and lifeguards tried to resuscitate the man without success after he was pulled from the ocean about an hour later. Aug. 23, 1998. N165SP - 1989 Bell 206L-3 (Long Ranger III).

MSP Trooper Helicopter Radio Controller

Just what frequencies has the Maryland State Police programmed into the radios of its Trooper helicopters? During the Jet Ranger days the answer was simple – most of the MSP channels, several med channels and, in what little channel space remained, a few local police and fire frequencies. Although the helicopter radio system, which was controlled by a Global Wulfsberg Systems C-1000 Communications Management Controller, was user-programmable, it was limited to only 30 preprogrammed channels.

Preprogrammed channel plans varied somewhat throughout the state to accommodate communication with various agencies. On a regular basis scanner listeners heard a helicopter pilot or medic come up on a jurisdiction's primary fire or police channel only to have the dispatcher refer the crew to a "working" frequency which hadn't been preprogrammed. After the helicopter crew finally entered that frequency into its radio, all too often they were missing the repeater input, or even worse, a coded squelch tone.

The Global Wulfsberg Systems C-5000 Communications Management Controller has eliminated much of the radio confusion in the MSP helicopters. The \$5,100 controller holds 350 preprogrammed memory channels. No longer does the pilot have to be a scanner enthusiast to find a frequency. Each channel can include independent transmit/receive frequencies and CTCSS/DCS, a three-digit channel number plus room for an eight-character channel descriptor. The C-

5000 can be programmed using a hand-held programmer or through the keypad.

The C-5000 does for the civilian helicopter what large-scale integrated equipment has long done for the military. The C-5000 interfaces with and simultaneously provides a single tuner for up to three transceiver systems and eliminates the need for separate tuners for each radio. Each transceiver system can consist of up to three radios, allowing operation of nine radios by a single C-5000 controller. Two independent microphone inputs and two independent balanced audio outputs allow simultaneous use of two radios from a single control.

The C-5000 incorporates three digital voice recorders which allow playback of the last 15 to 20 seconds of a conversation from each of the three transceiver systems. The C-5000 is capable of simulcast, cross-band relay, relay/simulcast, repeater and cross-band full duplex operation across as many as three channels simultaneously. In addition, the C-5000 can interface with the most common types of commercial or military voice encryption equipment including Motorola DVP/DES, GE's Voice Guards, Transcript International KY-58, and others.

The C-5000's screen displays two lines of information which explain the mode of operation using bluish white electroluminescent lighting. On the keypad, 12 push-buttons carry numerals and letter codes which represent the available functions.

Global Wulfsberg Systems manufactures more than 90 percent of the aviation community's FM radios. Global Wulfsberg radios such as the RT-138F, RT-30, RT-406F Flexcomm, and the TR-9600F Flitecomm are a familiar sight in many public safety helicopter panels.

Table 1 is the channel plan used throughout Maryland by the Trooper helicopters. Next to the frequency is the mode; "s" for simplex, "d" for duplex, or "r" for repeater. In the case of duplex or repeater operation, UHF inputs are the standard offset (5 MHz higher for 450-470 or 3 MHz higher for 470-512 MHz). Listed to the right of the CTCSS/DCS tone is the eight-character channel tag that appears on the C-5000's display.

Each of the state's 23 counties has been numbered in alphabetic order for EMS reporting purposes (same number used in the channel tag). The list starts with Maryland State Police (MSP) channels, followed by county law enforcement, fire, and EMS channels for each of the state's counties. Miscellaneous federal, state and municipal police departments are then listed followed by state police frequencies for West Virginia (WVSP), Virginia (VSP), Delaware (DSP), and Pennsylvania (PSP). Selected county frequencies for those adjacent states are then included along with the standard med channels.



By Tom Yeatman

One of the original US Park Police helicopters lands near Riverdale, Md, on the northbound lanes of the Baltimore-Washington Parkway at the Riverdale Road exit to evaluate victims injured in a crash involving a tour bus and a car. July 30, 1980.

The long-awaited UNIDEN BC245XLT is HERE!

This hand-held communications marvel has stunned the scanner marketplace with its dual trunking capabilities! Imagine scanning through conventional channels as well as both Motorola and GE-Ericsson EDACS channels simultaneously, stopping to hear any communications—your choice—on any of these systems!

With land, sea, and air frequency coverage of 29-54, 108-174, 406-512, and 806-956 MHz (less cellular), and 300 memory channels in 10 banks, this potent Bearcat even offers a nine-pin cable connector to permit downloading of computer databases. The information-packed LCD display is backlit for easy night viewing.

Factory pre-programmed search ranges target active police, fire/emergency, air, marine, and weather channels. Standard features included:

- individual channel lockout
- search
- channel-selectable delay
- data skip
- 10 priority channels
- three-day memory backup without batteries or power
- and lightning-fast Turbo Scan.

***This is the new scanner
standard by which all
others will be compared.
Order now!***

Order SCN 35

\$229⁹⁵

plus \$12 UPS shipping or US Priority Mail



GROVE

GROVE ENTERPRISES, INC.

1-800-438-8155 US and Canada
828-837-9200 • FAX 828-837-2216
7540 Highway 64 West • Brasstown, NC 28902-0098
e-mail: order@grove-ent.com
www.grove-ent.com

TABLE 1: MSP TROOPER HELICOPTER CHANNEL PRESETS

Ch#	Freq	M	[Tone]	Display	Use/Agency	Ch#	Freq	M	[Tone]	Display	Use/Agency
001	39.1000	s	[None]	A01 MSP1	Statewide	078	460.0750	r	[192.8]	12Shrif2	Harford Co
002	39.2600	s	[110.9]	A02 MSP2	MARNIS/College Park Q	079	460.3000	r	[192.8]	12SPMARS	Harford Co PMARS
003	39.0800	s	[110.9]	A03 MSPW	McHenry	080	460.6000	r	[136.5]	12 Fire1	Harford Co
004	39.2400	s	[110.9]	A04 MSPC	Cumberland	081	460.5750	r	[136.5]	12 Fire2	Harford Co
005	39.3400	s	[110.9]	A05 MSP0	Hagerstown	082	460.6250	r	[136.5]	12 Fire3	Harford Co
006	39.4000	s	[110.9]	A06 MSPB	Frederick	083	159.0900	r	[103.5]	13 PD 1	Howard Co
007	39.5200	s	[110.9]	A07 MSPG	Westminster	084	155.5950	r	[103.5]	13 PD 2	Howard Co
008	39.4200	s	[110.9]	A08 MSPA	Waterloo	085	155.3700	s	[103.5]	13 PD 3	Howard Co
009	39.3200	s	[110.9]	A09 MSPN	Rockville	086	155.1150	r	[103.5]	13 PD 5	Howard Co Coord Ch
010	39.3000	s	[110.9]	A10 MSPL	Forestville	087	154.2500	r	[103.5]	13 Fire1	Howard Co
011	39.0600	s	[110.9]	A11 MSPH	Waldorf	088	154.2200	s	[103.5]	13 Fire2	Howard Co
012	39.3800	s	[110.9]	A12 MSPT	Leonardtown	089	154.1750	s	[103.5]	13 Fire3	Howard Co
013	39.2800	s	[110.9]	A13 MSPU	Prince Frederick	090	159.2100	r	[103.5]	14Sherif	Kent Co
014	44.7400	s	[110.9]	SysCom	Med-evac Coord	091	33.9800	s	[None]	14 Fire1	Kent Co
015	47.6600	s	[100.0]	Heli Med	Med-evac Med Consults	092	33.8400	s	[None]	14 Fire2	Kent Co
016	155.1900	s	[110.9]	Pil-Med1	Helo Pilot-to-Medic 1	093	494.7125	r	[156.7]	15Rockvl	Montgomery Co
017	465.0500	s	[110.9]	Pil-Med2	Helo Pilot-to-Medic 2	094	494.8625	r	[156.7]	15Bethes	Montgomery Co
018	155.7300	s	[None]	Repeater	Vehicular RP talkaround	095	494.9125	r	[156.7]	15SilSpg	Montgomery Co
019	155.4750	s	[None]	NLEEF	National Law Enfo	096	495.3125	r	[156.7]	15Wheatn	Montgomery Co
020	39.2400	s	[146.2]	B04 MSP5	Tactical	097	495.3375	r	[156.7]	15Germnt	Montgomery Co
021	39.6000	s	[179.9]	B05 MSPV	Berlin	098	495.3625	r	[156.7]	15 PD 6	Montgomery Co
022	39.7800	s	[110.9]	B06 MSPE	Salisbury	099	495.3875	r	[156.7]	15 PD 7	Montgomery Co
023	39.9600	s	[110.9]	B07 MSP1	Easton	100	495.4125	r	[156.7]	15 PD 8	Montgomery Co
024	39.8000	s	[110.9]	B08 MSPS	Centreville	101	153.9500	r	[156.7]	15 F 7/1	Montgomery Co
025	39.1400	s	[110.9]	B09 MSPJ	Annapolis	102	154.1600	r	[156.7]	15 Fire2	Montgomery Co
026	39.0400	s	[110.9]	B10 MSPP	Glen Burnie	103	155.5200	s	[156.7]	15 Fire3	Montgomery Co
027	39.8400	s	[110.9]	B11 MSPF	North East	104	155.3400	s	[156.7]	15 EMS 1	Montgomery Co
028	39.9200	s	[110.9]	B12 MSP4	Tactical	105	153.9500	r	[156.7]	15 River	Montgomery Co
029	39.2400	s	[127.3]	B13 MSPM	JFK Highway	106	494.6875	r	[127.3]	16 PD 1	Pr George's Co
030	39.4400	s	[110.9]	B14 MSPR	Golden Ring	107	494.5375	r	[127.3]	16 PD 2	Pr George's Co
031	39.3400	s	[127.3]	B15 MSPD	Bel Air	108	495.1375	r	[127.3]	16 PD 3	Pr George's Co
032	39.6200	s	[110.9]	B16 MSP3	Pikesville HQ	109	495.0875	r	[127.3]	16 PD 4	Pr George's Co
033	155.1900	s	[173.8]	MSP Hi B	Barrack to Barrack	110	494.5625	r	[127.3]	16 PD 5	Pr George's Co
034	151.0400	r	[173.8]	MSP Hiwy	JFK Memorial Highway	111	494.8875	r	[127.3]	16 PD 6	Pr George's Co
035	154.2800	s	[None]	Fire MA1	Fire Mutual Aid	112	494.9375	r	[127.3]	16 PD 7	Pr George's Co
036	154.2950	s	[None]	Fire MA2	Fire Mutual Aid	113	494.7375	r	[127.3]	16 PD 8	Pr George's Co
037	33.7800	s	[82.5]	01 Fire1	Allegany Co	114	494.3125	r	[210.7]	16 PD 9	Pr George's Co
038	33.6800	s	[82.5]	01 Fire2	Allegany Co	115	495.2125	r	[192.8]	16 PD 10	Pr George's Co
039	155.2800	s	[None]	01 EMS	Allegany Co	116	495.0125	r	[127.3]	16 Fire1	Pr George's Co
040	460.0500	s	[114.8]	02 Metro	Baltimore PMARS	117	494.8375	r	[127.3]	16 Fire2	Pr George's Co
041	154.0100	s	[114.8]	02 Fire1	Anne Arundel Co Disp	118	494.7875	r	[127.3]	16 Fire3	Pr George's Co
042	154.3400	s	[114.8]	02 Fire2	Anne Arundel Co Patch	119	495.0625	r	[127.3]	16 Fire4	Pr George's Co
043	39.5600	s	[None]	03 PD	Baltimore Co Patch	120	39.5000	s	[None]	17Sherif	Queen Anne's Co
044	46.4600	s	[None]	03 Fire1	Baltimore Co Disp	121	46.1400	s	[None]	17 Fire1	Queen Anne's Co
045	46.2800	s	[None]	03 Fire2	Baltimore Co Patch	122	46.0800	s	[None]	17 Fire2	Queen Anne's Co
046	39.2800	s	[110.9]	04Sherif	Calvert Co/MSPU	123	39.4600	s	[None]	18Shrif1	St Mary's Co
047	33.8200	s	[None]	04 Fire1	Calvert Co	124	39.7000	s	[None]	18Shrif2	St Mary's Co
048	33.6000	s	[None]	04 Fire2	Calvert Co	125	33.9400	s	[None]	18 Fire2	St Mary's Co
049	39.5800	s	[None]	05Sherif	Caroline Co	126	33.7200	s	[None]	18 Fire1	St Mary's Co
050	33.7000	s	[118.8]	05 Fire1	Caroline Co	127	46.1800	s	[None]	19 Fire1	Somerset Co
051	33.4400	s	[118.8]	05 Fire2	Caroline Co	128	46.2400	s	[None]	19 Fire2	Somerset Co
052	39.8800	s	[None]	06Sherif	Carroll Co	129	39.4800	s	[None]	20Sherif	Talbot Co
053	33.9400	s	[None]	06 Fire1	Carroll Co	130	33.9000	s	[118.8]	20 Fire1	Talbot Co
054	33.9200	s	[None]	06 Fire2	Carroll Co	131	33.6400	s	[118.8]	20 Fire2	Talbot Co
055	39.9400	s	[94.8]	07Shrif1	Cecil Co	132	33.6800	s	[118.8]	20 Fire3	Talbot Co
056	39.9000	s	[94.8]	07Shrif2	Cecil Co	133	33.6600	s	[118.8]	20 Fire4	Talbot Co
057	46.1800	s	[94.8]	07 Fire1	Cecil Co	134	39.1800	s	[136.5]	21Shrif1	Washington Co
058	46.2600	s	[94.8]	07 Fire2	Cecil Co	135	39.6000	s	[136.5]	21Shrif2	Washington Co
059	46.4000	s	[94.8]	07 Fire3	Cecil Co	136	33.8600	s	[77.0]	21 Fire1	Washington Co
060	46.3000	s	[94.8]	07Singly	Singerly FD; Elkton	137	33.8400	s	[77.0]	21 Fire2	Washington Co
061	155.5350	r	[156.7]	08Shrif1	Charles Co	138	33.8000	s	[77.0]	21 Fire3	Washington Co
062	155.6100	r	[156.7]	08Shrif2	Charles Co	139	453.7500	r	[103.5]	22Sherif	Wicomico Co
063	155.6400	r	[156.7]	08Shrif3	Charles Co	140	33.9800	s	[None]	22 Fire1	Wicomico Co
064	158.7750	s	[162.2]	08 Fire1	Charles Co	141	33.8000	s	[None]	22 Fire2	Wicomico Co
065	155.0850	s	[162.2]	08 Fire2	Charles Co	142	39.1800	s	[None]	23Sherif	Worcester Co
066	39.5800	s	[None]	09Sherif	Dorchester Co	143	46.3800	s	[None]	23 Fire1	Worcester Co
067	46.0600	s	[None]	09 Fire1	Dorchester Co Patch	144	46.4400	s	[None]	23 Fire2	Worcester Co
068	39.0200	s	[110.9]	10Sherif	Frederick Co	145	46.3600	s	[None]	OC Fire1	Ocean City
069	46.3400	s	[None]	10 Fire2	Frederick Co	146	154.0250	s	[146.2]	OC Link	Ocean City Patch
070	46.4200	s	[None]	10 Fire1	Frederick Co	147	154.3100	r	[156.7]	BC Fire1	Baltimore City
071	46.2400	s	[None]	10 Fire3	Frederick Co	148	154.3250	s	[156.7]	BC HEAT	Baltimore City
072	154.8900	s	[None]	10 ATR	Frederick Co Adv.Tac Res	149	453.1000	r	[127.3]	TF HT KB	Toll Fac; Harbor Tunnel/ Key Bridge
073	39.1800	s	[82.5]	11Sherif	Garrett Co	150	453.5750	r	[127.3]	TFBayBrg	Toll Fac; Lane Bridge
074	33.8800	s	[None]	11 Fire1	Garrett Co	151	453.9750	r	[127.3]	TFNiceBr	Toll Fac; Nice Bridge
075	33.9600	s	[None]	11 Fire2	Garrett Co	152	453.5750	r	[167.9]	TF FMTun	Toll Fac; Ft McHenry Tunnel
076	155.2800	s	[186.2]	11 EMS	Garrett Co						
077	460.3750	r	[192.8]	12Shrif1	Harford Co						

TABLE 1: MSP TROOPER HELICOPTER CHANNEL PRESETS, CONTINUED

Ch#	Freq	M	Tone]	Display	Use/Agency	Ch#	Freq	M	Tone]	Display	Use/Agency
153	453.5750	r	[173.8]	TF Hatem	Toll Fac; Hatem Bridge	222	153.7850	s	[100.0]	Min F-8	Mineral Co WV Fire
154	151.3250	s	[114.8]	DNRFore	DNR; Forestry	223	155.8050	r	[100.0]	Min Shrf	Mineral Co WV Sheriff
155	39.2200	s	[110.9]	DNRMarin	DNR; Marine Police	224	46.1000	s	[None]	Pres F-1	Preston Co WV Fire
156	166.5125	s	[103.5]	P40 Ops	Camp David	225	155.2350	s	[None]	Pres EMS	Preston Co WV EMS
157	453.2000	r	[114.8]	PDBCityW2	Baltimore PD Citywide	226	39.9800	s	[None]	Pres Shf	Preston Co WV Sheriff
158	453.8000	r	[162.2]	PDAberde	Aberdeen PD	227	45.8800	s	[None]	Tuck F-1	Tucker Co WV Fire
159	453.5500	r	[136.5]	PDBelair	Bel Air PD	228	155.2350	s	[None]	Tuck EMS	Tucker Co WV EMS
160	453.3000	r	[141.3]	PDCambrg	Cambridge PD	229	39.9000	s	[None]	Tuck Shf	Tucker Co WV Sheriff
161	460.1750	r	[127.3]	PDCumber	Cumberland PD	230	46.1000	s	[None]	Clrk F-1	Clarke Co Va Fire
162	154.9500	r	[156.7]	PDEaston	Easton PD	231	39.2000	s	[None]	Clrk Shf	Clarke Co Va Sheriff
163	155.7900	r	[123.0]	PDElhton	Elkton PD	232	460.5750	r	[94.8]	Ffx Fire	Fairfax Co Va Fire
164	494.3125	r	[423]	PD FDK 1	Frederick City PD 1,2	233	46.3800	s	[146.2]	Loudn FD	Loudoun Co Va Fire
165	494.3625	r	[423]	PD FDK 3	Frederick City PD 3,4	234	39.7800	s	[118.8]	Loud Shf	Loudoun Co Va Sheriff
166	494.4125	r	[423]	PD FDK 5	Frederick City PD 5,6	235	33.7000	s	[None]	Som Fire	Somerset Co Pa Fire
167	460.2250	r	[261]	PDHDG Hi	Havre de Grace PD	236	155.1750	s	[77.0]	Som EMS	Somerset Co Pa EMS
168	495.2375	r	[156.7]	PDRockvl	Rockville PD	237	45.1000	s	[None]	Som Shrf	Somerset Co Pa Sheriff
169	460.3750	r	[141.3]	PD Sby 2	Salisbury PD	238	33.7400	s	[None]	Bed Fire	Bedford Co Pa Fire
170	460.0750	r	[141.3]	PD Sby 1	Salisbury PD	239	155.2200	s	[82.5]	Bed EMS	Bedford Co Pa EMS
171	166.9250	r	[127.3]	USPP 2	US Park PD	240	45.1400	s	[None]	Bed Shrf	Bedford Co Pa Sheriff
172	166.7250	r	[127.3]	USPP 1	US Park PD	241	46.1600	s	[186.2]	Fkln F-1	Franklin Co Pa Fire
173	167.0750	r	[127.3]	USPP 3	US Park PD	242	462.9750	d	[156.7]	Fkln M10	Franklin Co Pa EMS
174	151.2800	r	[118.8]	MNCPP 1	Md Pk PD; Mont Co	243	45.5200	s	[186.2]	Fkln PD1	Franklin Co Pa Police
175	151.3400	s	[118.8]	MNCPP 2	Md Pk PD; Mont Co	244	46.1800	s	[186.2]	Adms F-1	Adams Co Pa Fire
176	461.7750	r	[141.3]	JHop Sec	Hopkins Hosp Security	245	46.2600	s	[186.2]	Adms F-3	Adams Co Pa Fire
177	464.1750	r	[025]	Bayv Sec	Bayview Hosp Security	246	462.9500	d	[186.2]	Adms M9	Adams Co Pa EMS
178	42.2600	d	[151.4]	WVSP MB1	mob to base; p/w 42.1	247	45.5000	s	[186.2]	Adms PD1	Adams Co Pa Police
179	42.1000	d	[151.4]	WVSP BM1	base to mob; p/w 42.26	248	33.8800	s	[186.2]	York F-2	York Co Pa Fire
180	42.2600	d	[167.9]	WVSP MB2	mob to base; p/w 42.1	249	33.5600	s	[186.2]	York F-3	York Co Pa Fire
181	42.1000	d	[167.9]	WVSP BM2	base to mob; p/w 42.26	250	462.9750	d	[186.2]	York M10	York Co Pa EMS
182	159.0000	r	[127.3]	VSPFairf	Ffx-Arl Cos	251	155.4150	s	[None]	York PD3	York Co Pa Police
183	159.1350	r	[167.9]	VSP PW	Loud-Pr Wm Cos	252	155.6250	r	[192.8]	York PD4	York Co Pa Police
184	154.6650	s	[167.9]	VSP Tac	Tactical	253	33.7800	s	[None]	Fire Del	Delaware Statewide Disp
185	154.6650	r	[123.0]	DSP 1 NC	New Castle Co	254	156.1650	r	[103.5]	NCCPD1/2	New Castle Co De Police
186	154.9350	r	[123.0]	DSP2Kent	Kent Co	255	155.1150	r	[103.5]	NCCPD3/4	New Castle Co De Police
187	154.7550	r	[123.0]	DSP3 Sus	Sussex Co	256	154.7550	r	[123.0]	Sux PD's	Sussex Co De Mun Police
188	154.8600	s	[None]	DSP SWEN	Statewide Emer Net	257	to 300 future use				
189	45.0200	s	[None]	DSP AvCm	Aviation Comm HQ	301	463.0000	d	[127.3]	Med 1-A	
190	155.5800	d	[186.2]	PSP A AD	Ch A; Adams, Lancaster, Somerset; p/w 154.95	302	463.0250	d	[127.3]	Med 2-A	
191	155.6700	d	[186.2]	PSP B FR	Ch B; Franklin, Avondale; p/w 155.91	303	463.0500	d	[127.3]	Med 3-A	
192	155.5050	d	[186.2]	PSP C YK	Ch C; York, Fulton, Bedford; p/w 155.85	304	463.0750	d	[127.3]	Med 4-A	
193	154.6650	d	[186.2]	PSP D CM	Ch D; Cumberland, Carlisle; p/w 158.91	305	463.1000	d	[127.3]	Med 5-A	
194	154.7550	s	[186.2]	PSP M/M	Statewide Mobile to Mobile	306	463.1250	d	[127.3]	Med 6-A	
195	39.5400	S	[None]	VA SIRS	Statewide Interdept Radio Sys	307	463.1500	d	[127.3]	Med 7-A	
196	155.3550	s	[146.2]	Lifelion	Lifelion Medevac, Hershey Pa	308	463.1750	d	[127.3]	Med 8-A	
197	155.2050	s	[146.2]	York TC	York Hospital Direct	309	462.9500	d	[127.3]	Call 1A	
198	413.3750	r	[127.3]	ADW PD	Andrews AFB Police	310	462.9750	d	[127.3]	Call 2A	
199	154.2050	s	[77.0]	DC Fire4	Wash DC Fire	311	463.0000	d	[146.2]	Med 1-B	
200	154.1900	s	[77.0]	DC Fire5	Wash DC Fire	312	463.0250	d	[146.2]	Med 2-B	
201	154.4300	r	[173.8]	AlexFire	Alexandria Va Fire	313	463.0500	d	[146.2]	Med 3-B	
202	154.1300	r	[127.3]	ARL Fire	Arlington Co Va Fire	314	463.0750	d	[146.2]	Med 4-B	
203	151.9550	s	[127.3]	GERMS	Georgetown Univ EMS	315	463.1000	d	[146.2]	Med 5-B	
204	462.9750	d	[203.5]	MedSTAR	MedSTAR Medevac, DC	316	463.1250	d	[146.2]	Med 6-B	
205	33.9000	s	[None]	BERK F-1	Berkeley Co WV Fire	317	463.1500	d	[146.2]	Med 7-B	
206	155.3400	s	[None]	BERK EMS	Berkeley Co WV EMS	318	463.1750	d	[146.2]	Med 8-B	
207	453.5250	r	[141.3]	BERK Shf	Berkeley Co WV Sheriff	319	462.9500	d	[146.2]	Call 1B	
208	46.1400	s	[None]	Grant F1	Grant Co WV Fire	320	462.9750	d	[146.2]	Call 2B	
209	33.8800	s	[None]	Grant F2	Grant Co WV Fire	321	463.0000	d	[167.9]	Med 1-C	
210	37.2800	s	[None]	GrantShf	Grant Co WV Sheriff	322	463.0250	d	[167.9]	Med 2-C	
211	46.1400	s	[123.0]	Hamp F-1	Hampshire Co WV Fire	323	463.0500	d	[167.9]	Med 3-C	
212	155.4000	s	[None]	Hamp EMS	Hampshire Co WV EMS	324	463.0750	d	[167.9]	Med 4-C	
213	37.2800	s	[None]	Hamp Shf	Hampshire Co WV Sheriff	325	463.1000	d	[167.9]	Med 5-C	
214	46.1400	s	[None]	Hrdy F-1	Hardy Co WV Fire	326	463.1250	d	[167.9]	Med 6-C	
215	155.2800	s	[None]	Hrdy EMS	Hardy Co WV EMS	327	463.1500	d	[167.9]	Med 7-C	
216	37.2800	s	[None]	Hrdy SHF	Hardy Co WV Sheriff	328	463.1750	d	[167.9]	Med 8-C	
217	153.8600	r	[162.2]	Jeff F-1	Jefferson Co WV Fire	329	462.9500	d	[167.9]	Call 1C	
218	153.8150	s	[162.2]	Jeff PD4	Jefferson Co WV Police	330	462.9750	d	[167.9]	Call 2C	
219	155.3850	s	[123.0]	Jeff EMS	Jefferson Co WV EMS	331	463.0000	d	[192.8]	Med 1-D	
220	153.8900	s	[162.2]	Jeff Riv	Jefferson Co WV River	332	463.0250	d	[192.8]	Med 2-D	
221	155.8350	r	[100.0]	Min F-10	Mineral Co WV Fire	333	463.0500	d	[192.8]	Med 3-D	
						334	463.0750	d	[192.8]	Med 4-D	
						335	463.1000	d	[192.8]	Med 5-D	
						336	463.1250	d	[192.8]	Med 6-D	
						337	463.1500	d	[192.8]	Med 7-D	
						338	463.1750	d	[192.8]	Med 8-D	
						339	462.9500	d	[192.8]	Call 1D	
						340	462.9750	d	[192.8]	Call 2D	
						341	to 350 future use				

TABLE 2: MARYLAND MED CHANNEL AND TONE CODE ASSIGNMENTS

<u>Jurisdiction</u>	<u>Tone</u>	<u>Meds</u>	<u>Region</u>
Allegany	A	7	I
Anne Arundel	C	4, 8	III
Baltimore	C	4, 8	III
Baltimore City	C	2, 3	III
Calvert	A	3	V
Caroline	A	1	IV
Carroll	C	4, 8	III
Cecil B	5	IV	
Charles	C	8	V
Dorchester	C	5	IV
Frederick	B	6	II
Garrett	B	3	I
Harford	C	4, 8	III
Howard	C	4, 8	III
Kent C	6	IV	
Montgomery	A	2, 5	V
Prince George's	B	1, 7	V
Queen Anne's	C, A	6, 1	IV
Saint Mary's	B	4	V
Somerset	A	4	IV
TalbotA	1	IV	
Washington	C	1	II
Wicomico	B	2	IV
Worcester	A	4	IV
Region V (areawide)	D	1, 2, 5	V

Call 1=Region III only
Call 2=Regions I, II, IV, V

Tone A=127.3
Tone B=146.2
Tone C=167.9
Tone D=192.8



By Tom Yeatman.

Maryland State Police Trooper helicopter lands on school ball field to fly out burn victim. N57MD - 1988 Aerospatiale SA365N-1 Dauphin.

TABLE 3: WASHINGTON [DC] HOSPITAL CENTER MEDSTAR HELICOPTER CHANNEL PRESETS

By contrast to the MSP Trooper helicopters, the two MedSTAR helicopters use the Flexcomm RT series transceivers, with the three individual channel plans listed below. (* denotes channels selected at power-up.)

RT1					RT2						
Channel	Freq	M	[Tone]	Display	Use/Agency	Channel	Freq	M	[Tone]	Display	Use/Agency
A01/01	47.4200	s	[None]	ARC Comm	American Red Cross	A01/01	155.2800	s	[186.2]	Allegany	Allegany Co Md EMS
A02/02	33.8200	s	[None]	Calvert	Calvert Co Md Fire	A02/02	154.0100	s	[114.8]	AnneArund	Anne Arundel Co Md Fire 1
A03/03	46.1000	s	[None]	Clark Cty	Clark Co Va Fire	A03/03	154.2650	s	[127.3]	ArlNoVa	Arlington Co/No Va Fire Mutual Aid
A04/04	39.5000	s	[None]	Colonial	Colonial Beach Va Fire	A04/04	154.3850	r	[None]	Caroline	Caroline Co Va Fire
A05/05	46.5000	s	[146.2]	Fauquier1	Fauquier Co Va Fire 1	A05/05	158.7750	s	[162.2]	Charles1	Charles Co Md Fire 1
A06/06	46.4800	s	[146.2]	Fauquier2	Fauquier Co Va Fire 2	A06/06	155.0850	s	[162.2]	Charles2	Charles Co Md Fire 2
A07/07	45.8800	s	[None]	Fire Muta	Western Va Fire Mutual Aid	A07/07	155.3400	s	[None]	City Hosp	Martinsburg WV City Hospital
A08/08	46.4200	s	[None]	Frederk1	Frederick Co Md Fire 1	A08/08	154.1750	s	[None]	Conemaugh	Conemaugh MedStar
A09/09	46.3400	s	[None]	Frederk2	Frederick Co Md Fire 2						Medevac, Johnstown Pa
A10/10	46.3800	s	[146.2]	Loudoun1	Loudoun Co Va Fire 1	A09/09	154.1900	r	[77.0]	DC Fire 1	DC Fire 1
A11/11	46.2200	s	[146.2]	Loudoun2	Loudoun Co Va Fire 2	A10/10	154.2350	s	[77.0]	DC Fire 2	DC Fire 2
A12/12	46.3200	s	[146.2]	Loudoun3	Loudoun Co Va Fire 3	A11/11	154.2800	s	[77.0]	DC Fire 3	DC Fire 3
A13/13	46.2200	s	[146.2]	LoudTac2	Loudoun Co Va Fire 2 (again!)	A12/12	154.2050	s	[77.0]	DC Fire 4	DC Fire 4
A14/14	46.2800	s	[146.2]	LoudTac4	Loudoun Co Va Fire 4	A13/13	154.4150	r	[156.7]	Fredbrg 1	Fredericksburg Va Fire 1
A15/15	46.4000	s	[146.2]	Loud6 EMS	Loudoun Co Va Fire 6	A14/14	158.8350	r	[203.5]	Fredbrg 2	Fredericksburg Va Fire 2
A16/16	38.7000	s	[None]	Quant Rge	Quantico Marine Corps Va Range	A15/15	151.9550	s	[127.3]	GERMS	Georgetown Univ DC EMS
A17/17	46.1400	s	[None]	QueenAnn1	Queen Anne's Co Md Fire 1	A16/16	155.3400	s	[156.7]	Healthnet	HealthNet WV Medevac
A18/18	46.0800	s	[None]	QueenAnn2	Queen Anne's Co Md Fire 2	A17/17	155.7600	r	[412]	KingGeoCo2	King George Co Va Fire 2
A19/19	33.9400	s	[None]	SaintMary	Saint Mary's Co Md Fire	A18/18	155.7600	r	[412]	KingGeoCo1	King George Co Va Fire 1
A20/20	44.7400	s	[110.9]	SysCom	SysCom *	A19/19	155.7600	s	[412]	KingGeoFG	King George Co Va Fire Tac
A21/21	39.5400	s	[None]	Va Law	Va Statewide Interdept Radio Sys	A20/20	155.3850	s	[118.8]	Lifeguard	Life-Guard Medevac, Roanoke Va
A22/22	33.9800	s	[None]	Wicomico	Wicomico Co Md Fire	A21/21	155.3550	s	[146.2]	Lifelion	Life Lion Medevac, Hershey Pa

TABLE 3, CONTINUED

A22/22	156.8000	s	[None]	Marine 16	Marine Ch. 16
A23/23	157.1000	s	[None]	Marine 22	Marine Ch. 22
A24/24	156.3000	s	[None]	Marine 6	Marine Ch. 6
A25/25	154.2800	s	[None]	Metro	Metro DC Fire Mutual Aid
A26/26	153.9500	s	[156.7]	Mont CH1	Montgomery Co Md Fire 1
A27/27	154.1600	s	[156.7]	Mont CH2	Montgomery Co Md Fire 2
A28/28	155.3400	s	[156.7]	Mont EMS1	Montgomery Co Md Fire 5
A29/29	155.1450	s	[None]	MorganCo	Morgan Co WV Fire
A30/30	155.3400	s	[None]	MorganFG	Morgan Co WV Fireground
A31/31	155.4750	s	[None]	Nat-Law	Nat Law Enfo Emer Freq
A32/32	164.8250	s	[None]	National	National/Dulles Airports Fire
B01/33	155.2950	s	[85.4]	Northstar	Northstar Medevac, Newark NJ
B02/34	154.2650	s	[127.3]	Nova	No Va Fire Mutual Aid
B03/35	155.2350	s	[123.0]	Orange Co	Orange Co Va Rescue
B04/36	155.3850	s	[100.0]	PennStar1	PennSTAR Medevac, Philly Pa Ch. 1
B05/37	155.3550	s	[100.0]	PennStar2	PennSTAR Medevac, Philly Pa Ch. 2
B06/38	155.4000	s	[100.0]	PennStar3	PennSTAR Medevac, Philly Pa Ch. 3
B07/39	154.3700	s	[114.8]	PrinceWm1	Prince William Co Va Fire 1
B08/40	154.3250	s	[114.8]	PrinceWm2	Prince William Co Va Fire 2
B09/41	154.4450	s	[114.8]	PrinceWm3	Prince William Co Va Fire 3
B10/42	150.0750	s	[None]	Quantico1	Quantico Marine Corps Va Fire 1
B11/43	149.3500	s	[None]	Quantico2	Quantico Marine Corps Va Fire 2
B12/44	155.1600	s	[None]	SARMutAid	Search & Rescue Mutual Aid
B13/45	155.4000	s	[None]	Southstar	Southstar Medevac, Gibbsboro NJ
B14/46	156.1950	r	[136.5]	Spotsylva	Spotsylvania Co Va Fire
B15/47	154.1750	s	[192.8]	Stafford	Stafford Co Va Fire
B16/48	155.2650	s	[103.5]	Stat	STAT Medevac, West Mifflin Pa
B17/49	154.2950	s	[None]	VAFireMut	Fire Mutual Aid
B18/50	154.6650	s	[None]	VAPolTac	VSP Tactical
B19/51	155.2050	s	[None]	Statewide	Va Statewide/Port Ch. 2 *

RT3

Channel	Freq	M	[Tone]	Display	Use/Agency
A01/01	462.9750	s	[94.8]	AirCare	AirCare Medevac, Falls Church Va
A02/02	462.9500	s	[203.5]	Children	Childrens Nat'l Med Ctr DC
A03/03	460.5750	r	[94.8]	Fairfax1	Fairfax Co Va Fire 1
A04/04	460.6000	r	[94.8]	Fairfax2	Fairfax Co Va Fire 2
A05/05	460.6250	r	[94.8]	Fairfax3	Fairfax Co Va Fire 3
A06/06	453.9000	r	[100.0]	Guthrie	Guthrie One Medevac, Sayre Pa
A07/07	462.9750	d	[203.5]	MedSTAR	MedSTAR Medevac, DC *
A08/08	462.9500	d	[100.0]	Nitegale	Nightingale Medevac, Norfolk Va
A09/09	462.9750	d	[156.7]	UVA Blake	UVA/Blakey Ridge
A10/10	462.9500	d	[127.3]	UVA Cart	UVA/Carter's Mt
A11/11	462.9500	d	[156.7]	UVA Ellio	UVA/Elliot's Knob
A12/12	462.9500	d	[151.4]	UVA Winc	UVA/Winchester 1
A13/13	462.9750	d	[151.4]	UVA Winc2	UVA/Winchester 2
A14/14	462.9500	d	[192.8]	VA EOC Ch. 1	Virginia EOC Ch. 1
A15/15	462.9750	d	[192.8]	VA EOC C2	Virginia EOC Ch. 2
A16/16	464.4750	r	[82.5]	Wash Adv	Washington Adventist Hosp, Takoma Pk Md

Medevac Services in Maryland and Nearby Areas

Some of the better known medevac services in Maryland and adjacent states appear in an uncut version of this article, available for download at a modest price on the Grove website at www.grove-ent.com/MTARTICLES. Much of the aircraft description comes from the www.landings.com webpage – an excellent reference for such purposes. Check the Seaox Air-Medical homepage, www.seaox.com/listing.html, for a list of medevac services by state. The common helipad frequency, 123.05, is standard among most services listed.

Special thanks to those who contributed to this listing:

Allen Cole, Ben Sager, Chuck Byam, Mary Ann Himes, Clinton Burley, Dave Milsted, Dave Purcell, David Clark, Duane K. Spencer, E. Nevin Steffy, George R. Thomas, Greg Guise, Jack McCartan, Jim Burke, John Wilson, Joseph Cardani, Pete A. Piringer, Peter Vieth, Spencer Stevenson, Steven Risso, Thomas E. Brandt, Wolfgang Boernert.

Alan Henney (henney@doubled.com) is the co-author of the Washington-Baltimore Scanner Almanac and general editor of the Capitol Hill Monitors newsletter.

Note to U.S. consumers only: It is unlawful to import, manufacture, or market cellular-capable or cellular-restorable scanners into the U.S.

We have Scanners with 800 MHz coverage!

AOR AR-5000/3+, 7000, 3000, 8200
Yupiteru MVT-9000, 7100, 8000

OPTOELECTRONICS OptoCom, Xplorer, R11
nearfield receivers

WinRadio WR-1000i (Clearout)

New Welz/Standard WS-2000 (very tiny)

ICOM R9000/8500/100 R10/2 PCR1000/100

Alinco DJ-X10

Icom R-10

500KHz ~ 1300MHz coverage
 AM/NFM/WFM/USB/LSB/CW Modes
 100 x 10 banks = 1000 memories
 Computer Control Interface
 Selectable Step Size
 True SSB (Lower and Upper)



We do Modifications for your Scout!
All Orders Shipped Expedited

RADIOWORLD INC.

(416)667-1000 4335 Steeles Ave W.
 (416)667-9995 (fax) sales@radioworld.ca Toronto, ONT
www.radioworld.ca Canada M3N 1V7

A keep-it-simple guide to Building Your Own Weather Station

By Ken Reitz KS4ZR

Weather and radio have been a natural combination since the dawn of the wireless age. In the earliest part of this century weather reports were routine traffic traded between ships and shore stations. Hobbyists tuning in were the first to know when bad weather was on the way.

Today a national network of radio stations peppers the whole country for the sole purpose of disseminating weather information to the public. Billions of dollars a year trade hands in the field of weather related electronics. With the availability of The Weather Channel, NOAA Weather Radio and the Internet, more and more Americans are becoming interested in meteorology.

Setting Up Your Own Weather Station

Until recently, having sophisticated weather instruments that not only recorded daily weather statistics but could chart them in a customized data base, was reserved only for government and educational institutions. The rapid development of computer technology has made it possible for individuals to have their own dream weather station for less than the price of a good scanner radio.

These systems are widely available from many mail order catalog companies, including Radio Shack (see chart 1) and it's a good idea to shop for price. There may be as much as \$200 difference between nearly identical systems. Look to discount electronic catalogs for good deals, but pay attention to shipping fees and what's not specifically included.

Still, you don't have to invest a lot of money to have a very useful home weather station. Most hardware and discount stores sell inexpensive "weather stations" which consist typically of three analog gauges indicating temperature, barometric pressure and relative humidity (see photo). These units cost around \$20-30. While not weather service grade, they are useful for home purposes.

These units are shipped with the barometer uncalibrated. To calibrate your barometer call your local airport and get the current official barometric pressure reading (they may call it the altimeter reading). There is an adjustment on the back of the barometer which may be turned by hand to make the needle read the proper pressure. Once that's set it's ready to operate.

When you take a reading tap the glass with your finger to make sure it's reading the current pressure. Look for a barometer with a resettable pointer. This is a needle on the inside of the glass which is turned freely by a knob on the front of the gauge. When you line up the pointer with the current reading, the pointer stays where you set it while the barometer rises or falls. On your next reading you'll be able to see if the pressure is going up or down relative to where pointer was. Now reset the pointer by lining it up with the new reading.

It's good practice to recalibrate your barometer in the summer and in the winter to be as accurate as possible. It's particularly important to recalibrate it when a tropical system is headed your way. If you're a ham and you need to give barometric readings to a hurricane watch net, you must have a recently calibrated barometer or your information is useless.



Inexpensive simplicity. With this weather station I can read barometric pressure; current temperature; yesterday's high and this morning's low. Don't forget to calibrate your barometer with the one at your local airport.

The cheapest item you can buy for your weather station is a rain gauge. Every department and hardware store sells them, typically under \$5. They might not be as accurate as those at the National Weather Service (NWS), but they will give you an adequate reading. Place your rain gauge in the open, away from sheltering building and trees. Empty and record the results after every rainfall. For measuring snow, use a yard stick and take measurements immediately after the snow storm subsides. Measure at least three separate locations in an open, unprotected area and determine the average of the three for your "official" measurement.

The next cheapest item you'll buy for your weather station is a digital indoor/outdoor minimum/maximum reading thermometer. Once again the micro chip comes to the rescue and makes possible an inexpensive but very accurate weather instrument. Radio Shack has such a thermometer which it routinely discounts in its sales catalogs for around \$15. Wireless remote reading thermometers cost roughly twice that. Just remember when you're installing it to put the sensor out of direct view of the sun.

Wind Speed and Direction

A wind speed indicator, or anemometer, and a wind direction indicator are useful weather instruments to have at home. The most important is the wind direction indicator. If you're familiar with the normal wind patterns at your location you can make your own local forecasts by watching the barometer and wind direction. Measuring wind speed is more fun than important.

The cheapest and most effective wind direction device is the old fashioned windsock. A common sight at all airports, they are typically a long nylon cloth tube fixed at one end to a hoop which is hung by a harness on a post in the ground. The wind fills the windsock and rotates it to show wind direction. Many discount stores sell colorful windsocks in the flag and banner department. A good one will last years and typically cost \$10-20. The cheapest alternative is to take a few strips of plastic surveyor's tape about 4' long and tack them to the top of a six foot 2 x 4

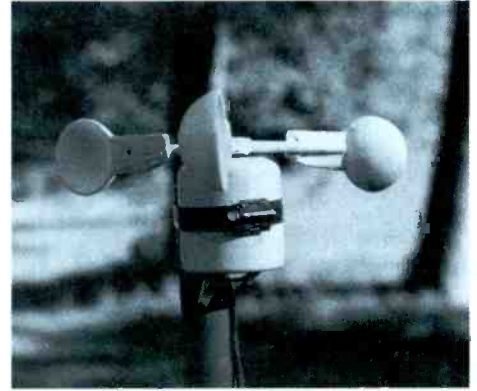
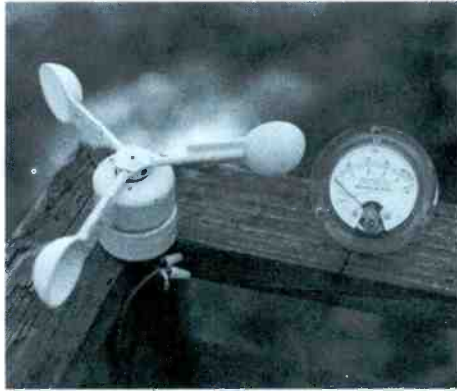

stuck in the ground. The fluttering strips will show you where the wind's coming from.

Learning to read the movement of the windsock can turn it into a relative wind speed indicator as well. But, whether a wind is 10-15 mph or 15-20 mph isn't as relevant as knowing from which direction the wind is blowing.

There are several designs for building your own anemometers, two of which are listed in chart 4. Fair Radio Sales (listed in the Catalog Companies section of Chart 1), sells the dc motor and voltmeter required for the project and has a schematic in their catalog for building an anemometer. The key with this type of anemometer is that the motor must have smooth bearings that turn easily. Cheap motors will typically have sleeve bearings which will not work as well.

That's the easy part. Building the wind cups to drive the motor may prove a lot more difficult. I've used everything from metal ladles with the handles cut off, to plastic tablespoons. It's a great place to be creative and you can while away weeks trying to come up with a design which won't take a hurricane to actually move!

With your instruments in place you can easily calculate the wind chill (winter) or heat index (summer) using charts 2 and 3. For an accurate reading you'll have to be able to read the outside relative humidity and be able to estimate wind speed.

Eyes in the Sky

Using home electronics to capture weather satellite imagery used to provide primitive results at best. Unless you were using very expensive professional equipment or had the skill to "homebrew" your own receiving gear, grainy facsimile reproductions were the best you could expect. Now, with the combination of sensitive receiving equipment and top grade consumer computers with laser printers, professional reproductions in your own home are typical.

Again, many companies make outstanding consumer weather satellite reception equipment all of which is readily available. And, if you shop

CHART 1: RESOURCES

Electronic Weather Station Manufacturers

Davis Instruments
3465 Diablo Avenue, Hayward, CA 94545-2778; 800-678-3669
www.davisnet.com
Peet Bros. Co., Inc.
1308 Doris Avenue, Ocean, NJ 97712; 800-872-7338
www.peetbros.com
Oregon Scientific, Inc.
18383 SW Boone's Ferry Road, Portland, OR 97224; 800-853-8883
www.oregonscientific.com

Catalog Companies

Wind & Weather
The Albion Street Water Tower
P.O. Box 3230, Mendocino, CA 95460; 800-922-9463
www.windandweather.com
Professional and consumer grade weather instruments and many other weather related items.
Fair Radio Sales Co.
P.O. Box 1105, Lima, OH 45802; 419-223-2196
www.fairradio.com
Electronic surplus. Has dc motor and voltmeter for wind speed indicator.
Damark International
7101 Winnetka Avenue N., Minneapolis, MN 55440-9437; 800-827-6767
www.damark.com
Discount catalog company often sells brand name electronic weather stations at deeply discounted prices.

Weather Facsimile Program and Modem

Tigertronics, Inc.
P.O. Box 5210, Grants Pass, OR 97527; 800-822-9722
www.tigertronics.com

NOT JUST FOR RACING!

RE2000^{Alpha} Racing Scanner

Program this revolutionary scanner on your computer... by the scanner keypad... or let us do it for you!

The RE2000^{Alpha} Racing Scanner comes pre-programmed, has Alpha-Numeric Display and is PL/DPL Private Line Compatible!

CALL FOR CURRENT PRICE!

PC Programming Kit **\$29⁹⁵**

FOR INFORMATION OR TO PLACE YOUR ORDER, CALL
1.800.272.7111
Visit us on the web at www.racingelectronics.com

HOW YOU CAN HELP YOUR COMMUNITY:

JOIN SKYWARN!

The public safety and welfare of each community entails jobs we can all do. The National Weather Service provides a valuable public service by training interested citizens in the skills necessary to be useful in the event of a weather emergency. Called the SkyWam program, training classes usually start before the beginning of the severe weather season in the spring.



While many SkyWam members are amateur radio operators, it's not a requirement. All you need is an interest in weather and a desire to know more. Those who are hams can participate in other related activities such as the Amateur Radio Emergency Service (ARES) which often work closely with the SkyWam program in establishing an emergency communications service in the event that weather disrupts normal communications modes.

Some SkyWam groups establish an official SkyWam amateur radio station which uses a call sign assigned by the FCC. The 2 x 3 call starts with WX followed by the call district number where the weather service office (WSO) is located (0-9) and the three letter NWS WSO identifier. So, if you hear the call sign WX4AKQ on the air, that means a severe weather condition exists in the eastern Virginia region served by the Wakefield, Virginia, WSO.

To learn more about SkyWam's Severe Storm Spotters program, or to find out when classes will be held in your area, call your local NWS field office. If you have access to the Internet go to www.skywarn.net.

around, you'll pick up some good bargains. Still, these systems aren't cheap.

If buying and setting up your own weather satellite receiving system seems too expensive or difficult, similar results can be had by using a very inexpensive modem and your current shortwave radio. Readily available programs allow you to tune in satellite imagery and weather charts transmitted by the NWS for ships at sea (see chart 4).

The cheapest way to access the most weather information is via the Internet. Forget the commercial sites; go right to the source of the information on NOAA's Interactive Weather Information Network (IWIN) at <http://iw.in.nws.noaa.gov/iwin/main.html>. At this site



State Information via the Interactive Weather Information Network shows forecasts, data and watches, satellite and radar imagery, and current weather information at the local airport for any listed location.

you'll be given a choice of options depending on your computer's capabilities.

Once you have the graphics version you want, you will see a map of the U.S. on which various states may be in different colors depending on the types of weather advisories being issued at that moment. By clicking on your state you'll see your own IWIN page. You may want to book mark this page so that you can go directly to it when you need to have updated weather information for your region in a hurry.

Among the information options available are "Warnings and Advisories," "State and Zone Forecasts," satellite and radar imagery, and much more. The most interesting is the "Forecast Discussion" area. Here you'll be able to eavesdrop on the weather forecasters as they swap info and ideas about what's happening and what may be about to happen. The discussions are in text and each forecaster has his or her own style of writing. It's an excellent opportunity to get some insight into how daily and long term forecasts are made. You'll have to get used to reading their weather shorthand.

Get Started!

Once you get your minimum/maximum reading thermometer, barometer and rain gauge set up you should consider getting a small book in which you can make weather notes. I've kept an unofficial weather journal for the last seven years and have recorded record lows (-18 degrees F), highs (102 degrees F), barometric pressure (a high of 30.85 inches and a low of 29.25 inches), single rainfall (8" during remnants of Hurricane Fran), and single snowfall (15 inches). From my handwritten entries I can get monthly and yearly rainfall data, average temperature highs and lows, etc.

So, put your weather station together, sign up for a SkyWam class (see sidebar) and you'll add a new and interesting facet to your radio hobby.

CHART 2: WIND CHILL

www.nws.noaa.gov/er/lwx/wxcalc/wndchill.htm

		Equivalent Temperature (°F)																
		25	30	35	40	45	50	55	60	65	70	75	80	85	90	95	100	
W	5	32	27	22	16	11	6	0	-5	-10	-15	-20	-26	-31	-36	-42	-47	-52
	10	22	16	10	3	-3	-9	-15	-22	-27	-34	-40	-46	-52	-58	-64	-71	-77
4	15	16	9	2	-5	-11	-18	-25	-31	-38	-45	-51	-58	-65	-72	-78	-85	-92
	20	12	4	-3	-10	-17	-24	-31	-39	-46	-53	-60	-67	-74	-81	-88	-95	-103
S	25	8	-1	-7	-15	-22	-29	-36	-44	-51	-59	-66	-74	-81	-88	-96	-103	-110
	30	6	-2	-10	-18	-25	-33	-41	-49	-56	-64	-71	-79	-86	-93	-101	-109	-116
M	35	4	-4	-12	-20	-27	-35	-43	-52	-60	-67	-74	-82	-89	-97	-105	-113	-120
	40	3	-5	-13	-21	-29	-37	-45	-53	-60	-69	-76	-84	-92	-100	-107	-115	-123
P	45	2	-6	-14	-22	-30	-38	-46	-54	-62	-70	-78	-85	-93	-102	-109	-117	-125

CHART 3: HEAT INDEX

www.nws.noaa.gov/er/lwx/wxcalc/heatindx.htm

Heat Index Chart (Temperature & Relative Humidity)

		Temperature (°F)																				
		80	81	82	83	84	85	86	87	88	89	90	91	92	93	94	95	96	97	98	99	100
70%	70	100	100	100	100	100	100	100	100	100	100	100	100	100	100	100	100	100	100	100	100	100
	75	100	100	100	100	100	100	100	100	100	100	100	100	100	100	100	100	100	100	100	100	100
80%	70	100	100	100	100	100	100	100	100	100	100	100	100	100	100	100	100	100	100	100	100	100
	85	100	100	100	100	100	100	100	100	100	100	100	100	100	100	100	100	100	100	100	100	100
90%	70	100	100	100	100	100	100	100	100	100	100	100	100	100	100	100	100	100	100	100	100	100
	95	100	100	100	100	100	100	100	100	100	100	100	100	100	100	100	100	100	100	100	100	100
100%	70	100	100	100	100	100	100	100	100	100	100	100	100	100	100	100	100	100	100	100	100	100
	100	100	100	100	100	100	100	100	100	100	100	100	100	100	100	100	100	100	100	100	100	100

CHART 4: FURTHER READING

Articles on home-brewing weather instruments.

Popular Electronics' Electronics Hobbyists Handbook (Fall 1994) *

"Portable Barometer" By Anthony Caristi. Pages 51-56

"Relative Humidity Gauge" By Anthony Caristi. Pages 84-88, 106

"Build An Anemometer" By Bob Simcox. Pages 98-101

Popular Electronics (February 1996)*

Think Tank "Weather Circuits" By John Vacono. Pages 67-69

Has schematics on building an anemometer and wind vane.

*Gernsback Publications, Inc., 500-B Bi-County Blvd., Farmingdale, NY 11735, 516-293-3000

Monitoring Times:

"Cheap Earth Thrills: a \$30 Fax Program and Interface" By John Catalano (January, 1994 pages 96-97)

"HF Fax on a Shoestring" By Brian Webb (August, 1996 pages 13-15)

Contact MT about ordering article reprints.

MT'S GUIDE TO WEATHER BROADCASTS

By Larry Van Horn

Frequencies below are expressed in kHz, all times in UTC.

- 490 USCG NAVTEX [SITOR-B]
- 518 USCG NAVTEX [SITOR-B]
- 2054. NOJ-USCG Kodiak, AK [FAX] 0400/1000/1800/2200
- 2182 USCG Medium frequency calling channel-call up for 2670 kHz broadcasts [USB]
- 2187.5 USCG Future medium frequency calling channel-call up for 2670 kHz broadcasts [USB]
- 2500 WWV-Fort Collins, CO [AM] 8-9 min past Atlantic High Seas, 10 min past Pacific High Seas
WWVH-Kihei, Maui Island, HI [AM] 48-51 min past Pacific High Seas
- 2670 USCG Medium frequency voice broadcasts [USB]
- 4125 NWS Alaska Weather Broadcasts
- 4209.5 USCG NAVTEX [SITOR-B]
- 4210.5 WNU-Globe Wireless Slidell, LA [SITOR-B] Gulf/Caribbean Offshore Forecasts 0350/1550/2150, Eastern/Central Pacific Tropical Cyclone Bulletin 0820, Gulf of Mexico/Caribbean Sea Tropical Cyclone Bulletins 0220/0520/0820/1120/1420/1720/2020/2320
- 4211.5 KFS-Globe Wireless Half Moon Bay, CA [SITOR-B] Pacific High Seas Weather 2250, Eastern/Central Pacific Tropical Cyclone Bulletin 0520/1120/1720/2320
- 4212.5 WOO-ATT Manahawkin, NJ [SITOR-B] Weather broadcasts H+20 (Even Hours)
- 4214 ZSC-Global Wireless Cape Town, South Africa [SITOR-B] South Africa weather forecast and nav warning 0930/1730
- 4215.5 WOM-ATT Ft. Lauderdale, FL [SITOR-B] Weather broadcasts H+40 (Even Hours)
- 4216 KPH-Globe Wireless Point Reyes, CA [SITOR-B] Pacific High Seas Weather 0510/1910
- 4217.5 KMI-ATT Inverness, CA [SITOR-B] Weather broadcasts H+20 (Odd Hours)
- 4235 NMF-USCG Boston, MA [FAX] 0230/0800
- 4298 NOJ-USCG Kodiak, AK [FAX] 0400/1000/1800/2200
- 4316 NMG-USCG New Orleans, LA [USB] 0330/0500/0930/1130/1600/1730/2200/2330
- 4317.9 NMG-USCG New Orleans, LA [FAX] 0000/0600/1200/1800
- 4346 NMC-USCG Point Reyes, CA [FAX] 0245/0815/1100/1415/2015
- 4363 WOM-ATT Ft. Lauderdale, FL [USB] National Weather Service Forecasts 1300/2300
- 4387 WOO-ATT Manahawkin, NJ [USB] National Weather Service Forecasts 1200/2200
- 4402 KMI-ATT Inverness, CA [USB] National Weather Service Forecasts 0000/1200
- 4426 NMN-USCG Chesapeake, VA [USB] 0330/0500/0930
- NMC-USCG Point Reyes, CA [USB] 0430/1030
- 5000 WWV-Fort Collins, CO [AM] 8-9 min past Atlantic High Seas, 10 min past Pacific High Seas
WWVH-Kihei, Maui Island, HI [AM] 48-51 min past Pacific High Seas
- 6314 NMF-USCG Boston, MA [SITOR-B] 0030 ice/0140
- 6315.5 KFS-Globe Wireless Half Moon Bay, CA [SITOR-B] Pacific High Seas Weather 2250, Eastern/Central Pacific Tropical Cyclone Bulletin 0520/1120/1720/2320
- 6320 KPH-Globe Wireless Point Reyes, CA [SITOR-B] Pacific High Seas Weather 0510/1910
- 6322 ZSC-Global Wireless Cape Town, South Africa [SITOR-B] South Africa weather forecast and nav warning 0930/1730
- 6326 KEJ-Globe Wireless Hoolehua Radio [SITOR-B] Eastern/Central Pacific Tropical Cyclone Bulletin 0220/1420/2020
- 6327.5 WOM-ATT Ft. Lauderdale, FL [SITOR-B] Weather broadcasts H+40 (Even Hours)
- 6328.5 WOO-ATT Manahawkin, NJ [SITOR-B] Weather broadcasts H+20 (Even Hours)
- 6334 WCC-Globe Wireless Chatham, MA [SITOR-B] North Atlantic High Seas Weather 0440/1240/1640
- 6340.5 NMF-USCG Boston, MA [FAX] 0230/0800/1430/1600 ice/1810 ice/2005
- 6436.4 KFS-Globe Wireless Half Moon Bay, CA [SITOR-B] Pacific High Seas Weather 2250, Eastern/Central Pacific Tropical Cyclone Bulletin 0520/1120/1720/2320
- 6501 NMN-USCG Chesapeake, VA [USB] 0330/0500/0930/1130/1600/2200/2330
- NOJ-USCG Kodiak, AK [USB] 0203/1645
- NMO-USCG Honolulu, HI [USB] 0600/1200
- NRV-USCG Agana, Guam [USB] 0930/1530
- 8416.5 NMF-USCG Boston, MA [SITOR-B] 0030 ice/0140/1218 ice/1630
- NMC-USCG Point Reyes, CA [SITOR-B] 0005/1800
- NMO-USCG Honolulu, HI [SITOR-B] 0130/0430/0730/1330/2030
- 8417.5 KFS-Globe Wireless Half Moon Bay, CA [SITOR-B] Pacific High Seas Weather 2250, Eastern/Central Pacific Tropical Cyclone Bulletin 0520/1120/1720/2320
- 8422.5 KPH-Globe Wireless Point Reyes, CA [SITOR-B] Pacific High Seas Weather 0510/1910
- 8424 WCC-Globe Wireless Chatham, MA [SITOR-B] North Atlantic High Seas Weather 0440/1240/1640
- 8425.5 WNU-Globe Wireless Slidell, LA [SITOR-B] Gulf/Caribbean Offshore Forecasts 0350/1550/2150, Eastern/Central Pacific Tropical Cyclone Bulletin 0820, Gulf of Mexico/Caribbean Sea Tropical Cyclone Bulletins 0220/0520/0820/1120/1420/1720/2020/2320

- 8427 KPH-Globe Wireless Point Reyes, CA [SITOR-B] Pacific High Seas Weather 0510/1910
- 8431.5 ZSC-Global Wireless Cape Town, South Africa [SITOR-B] South Africa weather forecast and nav warning 0930/1730
- KMI-ATT Inverness, CA [SITOR-B] Weather broadcasts H+20 (Odd Hours)
- 8432.5 WOM-ATT Ft. Lauderdale, FL [SITOR-B] Weather broadcasts H+40 (Even Hours)
- 8433.5 WOO-ATT Manahawkin, NJ [SITOR-B] Weather broadcasts H+20 (Even Hours)
- 8459 NOJ-USCG Kodiak, AK [FAX] 0400/1000/1800/2200
- 8502 NMG-USCG New Orleans, LA [USB] 0330/0500/0930/1130/1600/1730/2200/2330
- 8503.9 NMG-USCG New Orleans, LA [FAX] 0000/0600/1200/1800
- 8526.4 KFS-Globe Wireless Half Moon Bay, CA [SITOR-B] Pacific High Seas Weather 2250, Eastern/Central Pacific Tropical Cyclone Bulletin 0520/1120/1720/2320
- 8663.4 KEJ-Globe Wireless Hoolehua Radio [SITOR-B] Eastern/Central Pacific Tropical Cyclone Bulletin 0220/1420/2020
- 8682 NMC-USCG Point Reyes, CA [FAX] 0245/0815/1100/1415/2015/2300
- 8722 WOM-ATT Ft. Lauderdale, FL [USB] National Weather Service Forecasts 1300/2300
- 8749 WOO-ATT Manahawkin, NJ [USB] National Weather Service Forecasts 1200/2200
- 8764 NMN-USCG Chesapeake, VA [USB] 0330/0500/0930/1130/1600/1730/2200/2330
- NMC-USCG Point Reyes, CA [USB] 0430/1030/1630/2230
- NMO-USCG Honolulu, HI [USB] 0005/0600/1200/1800
- NMF-USCG Boston, MA [FAX] 0230/0800/1430/1600 ice/1810 ice/2005
- 9982.5 KVM70-NWS Honolulu, HI [FAX] 0533/1150/1733/2350
- 10000 WWV-Fort Collins, CO [AM] 8-9 min past Atlantic High Seas, 10 min past Pacific High Seas
WWVH-Kihei, Maui Island, HI [AM] 48-51 min past Pacific High Seas
- 11090 KVM70-NWS Honolulu, HI [FAX] 0533/1150/1733/2350
- 12579 NMF-USCG Boston, MA [SITOR-B] 0030 ice/0140/1218 ice/1630
- NMO-USCG Honolulu, HI [SITOR-B] 0130/0430/0730/1330/2030
- NRV-USCG Agana, Guam [SITOR-B] 0500/1500/1900/2315
- 12580.5 KFS-Globe Wireless Half Moon Bay, CA [SITOR-B] Pacific High Seas Weather 2250, Eastern/Central Pacific Tropical Cyclone Bulletin 0520/1120/1720/2320
- 12585.5 KPH-Globe Wireless Point Reyes, CA [SITOR-B] Pacific High Seas Weather 0510/1910
- 12589.0 WCC-Globe Wireless Chatham, MA [SITOR-B] North Atlantic High Seas Weather 0440/1240/1640
- 12589.5 WCC-Globe Wireless Chatham, MA [SITOR-B] North Atlantic High Seas Weather 0440/1240/1640
- 12590.0 KPH-Globe Wireless Point Reyes, CA [SITOR-B] Pacific High Seas Weather 0510/1910
- 12600 KPH-Globe Wireless Point Reyes, CA [SITOR-B] Pacific High Seas Weather 0510/1910
- 12601 ZSC-Global Wireless Cape Town, South Africa [SITOR-B] South Africa weather forecast and nav warning 0930/1730
- 12602.5 KFS-Globe Wireless Half Moon Bay, CA [SITOR-B] Pacific High Seas Weather 2250, Eastern/Central Pacific Tropical Cyclone Bulletin 0520/1120/1720/2320
- 12607.5 WNU-Globe Wireless Slidell, LA [SITOR-B] Gulf/Caribbean Offshore Forecasts 0350/1550/2150, Eastern/Central Pacific Tropical Cyclone Bulletin 0820, Gulf of Mexico/Caribbean Sea Tropical Cyclone Bulletins 0220/0520/0820/1120/1420/1720/2020/2320
- 12611.5 KEJ-Globe Wireless Hoolehua Radio [SITOR-B] Eastern/Central Pacific Tropical Cyclone Bulletin 0220/1420/2020
- 12624.5 WCC-Globe Wireless Chatham, MA [SITOR-B] North Atlantic High Seas Weather 0440/1240/1640
- 12630 KMI-ATT Inverness, CA [SITOR-B] Weather broadcasts H+20 (Odd Hours)
- 12631 WOM-ATT Ft. Lauderdale, FL [SITOR-B] Weather broadcasts H+40 (Even Hours)
- 12632 WOO-ATT Manahawkin, NJ [SITOR-B] Weather broadcasts H+20 (Even Hours)
- 12730 NMC-USCG Point Reyes, CA [FAX] 0245/0815/1100/1415/2015/2300
- 12750 NMF-USCG Boston, MA [FAX] 1430/1600 ice
- 12788 NMG-USCG New Orleans, LA [USB] 0330/0500/0930/1130/1600/1730/2200/2330
- 12789.9 NMG-USCG New Orleans, LA [FAX] 0000/0600/1200/1800
- 13072.5 KFS-Globe Wireless Half Moon Bay, CA [SITOR-B] Pacific High Seas Weather 2250, Eastern/Central Pacific Tropical Cyclone Bulletin 0520/1120/1720/2320
- 13083 KMI-ATT Inverness, CA [USB] National Weather Service Forecasts 0000/1200
- 13089 NMN-USCG Chesapeake, VA [USB] 1130/1600/1730/2200/2330
- NMC-USCG Point Reyes, CA [USB] 0430/1030/1630/2230
- NMO-USCG Honolulu, HI [USB] 0005/1800
- NRV-USCG Agana, Guam [USB] 0330/2130
- 13092 WOM-ATT Ft. Lauderdale, FL [USB] National Weather Service Forecasts 1300/2300
- 14300 Amateur Radio: Maritime Mobile Service Network (Secondary) [USB]

- 14313 Amateur Radio: Maritime Mobile Service Network (Primary) [USB]
- 14325 Amateur Radio: Hurricane Net [USB]
- 15000 WWV-Fort Collins, CO [AM] 8-9 min past Atlantic High Seas, 10 min past Pacific High Seas
WWVH-Kihei, Maui Island, HI [AM] 48-51 min past Pacific High Seas
- 16135 KVM70-NWS Honolulu, HI [FAX] 0533/1150/1733/2350
- 16806.5 NMF-USCG Boston, MA [SITOR-B] 1218 ice/1630
- NMC-USCG Point Reyes, CA [SITOR-B] 0005/1800
- NRV-USCG Agana, Guam [SITOR-B] 0500/1500/1900/2315
- 16816 ZSC-Global Wireless Cape Town, South Africa [SITOR-B] South Africa weather forecast and nav warning 0930/1730
- 16817 WCC-Globe Wireless Chatham, MA [SITOR-B] North Atlantic High Seas Weather 0440/1240/1640
- 16817.5 KPH-Globe Wireless Point Reyes, CA [SITOR-B] Pacific High Seas Weather 0510/1910
- 16829.5 KFS-Globe Wireless Half Moon Bay, CA [SITOR-B] Pacific High Seas Weather 2250, Eastern/Central Pacific Tropical Cyclone Bulletin 0520/1120/1720/2320
- 16834.5 WNU-Globe Wireless Slidell, LA [SITOR-B] Gulf/Caribbean Offshore Forecasts 0350/1550/2150, Eastern/Central Pacific Tropical Cyclone Bulletin 0820, Gulf of Mexico/Caribbean Sea Tropical Cyclone Bulletins 0220/0520/0820/1120/1420/1720/2020/2320
- 16842.5 KEJ-Globe Wireless Hoolehua Radio [SITOR-B] Eastern/Central Pacific Tropical Cyclone Bulletin 0220/1420/2020
- 16870 KMI-ATT Inverness, CA [SITOR-B] Weather broadcasts H+20 (Odd Hours)
- 17151.2 NMC-USCG Point Reyes, CA [FAX] 0245/0815/1100/1415/2015/2300
- 17211.4 KFS-Globe Wireless Half Moon Bay, CA [SITOR-B] Pacific High Seas Weather 2250, Eastern/Central Pacific Tropical Cyclone Bulletin 0520/1120/1720/2320
- 17242 WOM-ATT Ft. Lauderdale, FL [USB] National Weather Service Forecasts 1300/2300
- 17314 NMN-USCG Chesapeake, VA [USB] 1130/1600/1730/2200/2330
- NMC-USCG Point Reyes, CA [USB] 1630/2230
- 19692.5 ZSC-Global Wireless Cape Town, South Africa [SITOR-B] South Africa weather forecast and nav warning 0930/1730
- 20000 WWV-Fort Collins, CO [AM] 8-9 min past Atlantic High Seas, 10 min past Pacific High Seas
- 22376 NMO-USCG Honolulu, HI [SITOR-B] 0130/2030
- NRV-USCG Agana, Guam [SITOR-B] 0500/1500/1900/2315
- 22377.5 KFS-Globe Wireless Half Moon Bay, CA [SITOR-B] Pacific High Seas Weather 2250, Eastern/Central Pacific Tropical Cyclone Bulletin 0520/1120/1720/2320
- 22425.5 WOM-ATT Ft. Lauderdale, FL [SITOR-B] Weather broadcasts H+40 (Even Hours)
- 22527 NMC-USCG Point Reyes, CA [FAX] 0245/0815/1100/1415/2015
- 22738 WOM-ATT Ft. Lauderdale, FL [USB] National Weather Service Forecasts 1300/2300
- 23331.5 KVM70-NWS Honolulu, HI [FAX] 0533/1150/1733/2350
- 26105 KEJ-Globe Wireless Hoolehua Radio [SITOR-B] Eastern/Central Pacific Tropical Cyclone Bulletin 0220/1420/2020
- 26125.4 KFS-Globe Wireless Half Moon Bay, CA [SITOR-B] Pacific High Seas Weather 2250, Eastern/Central Pacific Tropical Cyclone Bulletin 0520/1120/1720/2320

Frequencies below are expressed in MHz.

- 137.3000 Russian polar orbiting Meteor 3 satellite APT transmissions
- 137.4000 Russian polar orbiting Okean-4/Sich-1 satellite APT transmissions
- 137.5000 NOAA polar orbiting weather satellite APT transmissions
- 137.6200 NOAA polar orbiting weather satellite APT transmissions
- 137.8500 Russian polar orbiting Resurs 1 satellite APT transmissions
- 156.8000 USCG VHF Voice calling-initial call up for Channel 22A broadcasts (channel 16) [NFM]
- 157.1000 USCG VHF Voice broadcasts (Channel 22A) [NFM]
- 162.3625 National Weather Service (future NOAA weather assignment) [NFM]
- 162.3750 National Weather Service (NOAA weather assignment) [NFM]
- 162.4000 National Weather Service (NOAA weather assignment) [NFM]
- 162.4250 National Weather Service (NOAA weather assignment) [NFM]
- 162.4375 National Weather Service (future NOAA weather assignment) [NFM]
- 162.4500 National Weather Service (NOAA weather assignment) [NFM]
- 162.4750 National Weather Service (NOAA weather assignment) [NFM]
- 162.5000 National Weather Service (NOAA weather assignment) [NFM]
- 162.5125 National Weather Service (future NOAA weather assignment) [NFM]
- 162.5250 National Weather Service (NOAA weather assignment) [NFM]
- 162.5500 National Weather Service (NOAA weather assignment) [NFM]
- 162.5750 National Weather Service (NOAA weather assignment) [NFM]
- 1691.000 NOAA GOES geostationary satellite WEFAX transmissions

Listeners interested in a comprehensive list of weather facsimile radio broadcasts can find that information at: <http://ourworld.compuserve.com/homepages/HFFAX/hffax.htm>

The NEW VOA

The Audience Weighs In

By Mark B. Lewis

The Voice of America is engaged in a serious journalistic gamble with its audience and its future. At the same time, America's principal international radio station is chalking up an impressive success story.

Of these two developments, consider first the gamble causing nervousness among the broadcasters and upsetting foreign listeners:

In the spring of 1998, VOA trumpeted "the first change in format in two decades" when it changed its English language news format to a faster-paced, CNN-like presentation of news and features. *VOA News Now* was initiated as a new, 24-hour, all news program available on both shortwave and satellite.

A quickened pace means that news and features are tighter and shorter, not read faster. "Think short and write short" is the axiom. VOA still adheres to the practice of reading the news at 13-15 lines a minute.

How is the new program doing?

Initial negative reactions from listeners around the world suggested that new is not always better nor an improvement. Resistance to change, of course, is not unusual for long-time radio listeners. And positive reactions now have begun to come in; the overall pattern is now one of "mixed reactions," according to VOA's Audience Mail Unit.

Former VOA Director Evelyn S. Lieberman announced the debut of the new program with a flourish. It was her first big programmatic change since taking over in March 1997.

"*VOA News Now*," she declared, "will follow the sun, so that everywhere in the world listeners will have access to live radio news as day breaks in their region." There was a promise that the new format will not mean the elimination of some of VOA's most popular programs.

Four months later, Lieberman got bad news from VOA's audience mail unit. The report said:

"An overwhelming majority of the letters from listeners have been negative. Many listeners liken the 24-hour format to that of an audio CNN, others complain of a lack of variety and of missing individual English programs."

The major disapproving reactions to the new format can be summarized like this: The news is "too abbreviated." "News, news, news - we get enough news around the clock. Some of your

best programs have been terminated"... "The new format and contents are the same as those of all other radio stations. Boring. I can't consider you as the Voice of America anymore. Goodbye to you"... "The mediocrity of CNN-by-radio is not what we need"... "It's simply not worthwhile to switch on for a parsimonious four minutes of science."

In more colorful language: "It's like you took off *McNeil-Lehrer* and substituted with *Oprah*"... "This new program is like listening to *Ted Mack's Amateur Hour* with boring interviews like the one I just heard called 'The Last Day of School.'"

The News Hour Rationale

Why did Lieberman shift to the faster-paced format? She justified the change as a response to surveys of foreign listeners. The surveys "forced us to rethink." According to VOA, there is a trend in its research indicating that listeners to English broadcasts want an average of 30 minutes of listening.

Listeners made it clear, Lieberman said, that they want programming that is shorter and tailored to their needs. The faster-paced format is ideal for today's faster-paced listeners, she claimed. "Times and technology are changing, and so must we." Whether the surveys asked listeners if they want and need 24 hours of news around the clock in English is not known, and

the rhetoric did not address this question.

Yet, Lieberman may have a point. The faster-paced format may be right for the listening span of listeners in certain areas of today's world where the pace of life as a whole has increased enormously. And she is certainly right about improved technology; satellite relays to VOA's overseas affiliates have improved the sound quality. Moreover, the new format may improve VOA's long-standing image of being slow and stodgy and in need of a "new sound." The BBC recently announced plans to start a 24-hour, all news network early next year for public radio stations in the U.S. with a format of shorter, tighter news items.

Positive reactions arriving at VOA from foreign listeners generally say they "like" the new format but offer no specific reasons. Nevertheless, VOA officials believe that, over time, *News Now* will develop "informed citizens of the world," and they regard the faster-paced format of shorter news items as especially appealing to youth. They may be right. However, it is too soon to tell whether less detail in shorter news and features may adversely affect their credibility. Foreign listeners have their backs up about shortened business news reports and science features, in particular. But some urge VOA to "stay focused on what you do best - news."

The new format has an important asset in the eyes of VOA editors. As the program is live all the time and flexible, fast-breaking news can be reported immediately. Gone are the days of more than 50 years of block programming, much of it on tape, when the program had to be interrupted for breaking news with "We interrupt this program for a bulletin from..."

VOA denies that its new format of tighter, shorter news and features presented by two anchors is an imitation of CNN or any other American broadcasting organization.

Popular VOA shows like *Press Conference USA*, *Encounter* and the one-hour *Talk to America* remain on the air. But popular American music programs via shortwave on the worldwide English network have taken a big hit since *VOA News Now* began. They have vanished or have been sharply cut, and foreign listeners are disappointed. Even some veteran VOA staffers regret what's happened to music, because they have always regarded American music as an



A little over a year ago, former VOA Director Evelyn S. Lieberman took a big gamble with the biggest program format change in 50 years.

entry to VOA for new listeners.

As the new format of *VOA News Now* is reviewed and debated internally, VOA would do well to recall the opinion of legendary broadcaster Edward R. Murrow. He suggested that the listeners are the best critics and "the only judges" of what constitutes good radio. If the Murrow principle applies, VOA cannot ignore widespread negative audience reactions to *News Now*. While it's too soon to evaluate the new program fully, the Voice of America has taken a big gamble that will be resolved over time only by its listeners.

Catching New Audiences with Local Nets

The project with a brighter shine in the current VOA constellation is called the **Affiliates Network**. Remarkably, 1155 radio and television stations around the world, including the volatile Balkans, are now publicly affiliated with the Voice of America. They receive daily VOA news and features either in their local languages or in English for live broadcast to their local audiences. The material is attributed on the air to VOA. The latest member of the affiliates network is a station in Macedonia which joined on January 4, 1999.

To join the Affiliates Network, foreign stations must sign a contract with VOA, agreeing to use a specified number of hours of VOA news and features each day. Some of the affiliates are government-owned stations but most are privately-owned. The affiliates take the material live for direct, unedited broadcast on their air. They must use the news-related material within two hours.

Some stations have rejected affiliation; some want music but no news and features. Nevertheless, the VOA Affiliates Network has been a stunning organizational achievement, and 80 to 90 percent of the VOA affiliates are complying with their contracts, VOA claims. The VOA affiliate in Athens uses 20 hours of VOA programming a day. And affiliates in Finland and the Central Asian Republic of Kyrgyzstan have just increased the number of hours they use *VOA News Now* each day.

Drawing on his successful experience in US network broadcasting, former VOA Program Director Sid Davis conceived and formally organized the satellite-affiliated network in 1992. The first affiliate was a big station in Sao Paulo, Brazil. Today, there are 96 affiliates in Uruguay, 83 in Bolivia, 66 in Chile. In Eastern Europe, 40 stations in Russia, 40 in Romania and 25 in Poland are VOA affiliates. In the Balkans, 30 stations in Yugoslavia had been

The 30 VOA affiliates in Yugoslavia were ordered by the Milosevic government in Belgrade, last November, not to rebroadcast any international news program, including VOA programming. Twenty-nine of them complied.



The VOA's busy news room

receiving VOA news in the Serbian language, and there are 50 affiliates in Bosnia and 10 in Croatia.

The Far East has 78 affiliates in Indonesia, 16 in Thailand. Currently, over 50 stations in China receive VOA tapes. On the African continent, 39 stations are VOA affiliates. Nigeria, Africa's most populous nation, currently has only one VOA affiliate.

VOA says 20 percent of its listeners are English-speaking, principally in Africa. According to VOA, an estimated worldwide audience of 83 million people listen weekly to its broadcasts of international, regional and US news in 52 languages.

Why have almost 1200 radio stations around the world (40 of them are also TV stations) become VOA "partners"? VOA's current Program Director, Myrna Whitworth, offers four reasons: VOA reports are respected and recognized as straight, objective news. VOA can provide programming not available to local stations. Identification of VOA by local stations improves their own visibility. And becoming a VOA affiliate doesn't cost a local station a cent.

The Affiliates Network is not without cost to American taxpayers. VOA not only provides the programming but also provides its affiliates with the equipment, if needed, to get the programming off the satellite – a satellite dish and receiver. A satellite package, including installation and shipping, costs between \$4,000 and \$5,000. If VOA feels that an affiliate is not complying with its contract, the satellite equipment is removed. This happened most recently with a station in Guatemala in 1996.

"Holes" in the Net

The Affiliates Network has its own difficulties. Whitworth, who effectively directed the project through its early years, is the first to acknowledge its major problem: How to verify that the affiliates are actually using the VOA news and features. "The monitoring system is imperfect," she says.

Surveys of what the affiliates are using are imprecise. United States Information Service posts abroad don't monitor affiliate stations daily. VOA language service chiefs are in daily contact with program managers of the affiliates, but they can't be certain of what's being broadcast on local air.

VOA's regional offices around the world can help monitor, according to Whitworth, and

they're being encouraged to do so. There is an Affiliates Office in Prague and another planned for Africa in the Ivory Coast.

They might examine two other issues: Are the affiliates carrying the news from VOA even when the news might not please or might contradict local governments? Are any of the VOA affiliates so politically partisan that listeners would tie VOA to that political view? – a realistic issue in Africa and in Serbian affiliates.

The 30 VOA affiliates in Yugoslavia were ordered by the Milosevic government in Belgrade, last November, not to rebroadcast any international news program, including VOA programming. Twenty-nine of them complied. Milosevic shut down the best-known independent station and VOA affiliate in Belgrade, Radio B-92. VOA affiliates in Bosnia and Croatia continued to carry VOA programming during the war against the Milosovic government.

Affiliate stations can be shut down by war or local government decree or changes in the ownership of stations. War shut down the VOA affiliate in Sierra Leone and the manager fled. The affiliate in Liberia was gutted by rebel forces. On the other hand, the owner of VOA's affiliate in Kinshasa, Congo (formerly Zaire) created a larger network of more VOA affiliates in that country, and the owner of a big VOA affiliate in Mwanza, Tanzania, did the same thing in the last eight months.

There is a concern among foreign affairs specialists, including some who worked at VOA, that concentration on satellite relays to affiliates could result in the eventual replacement of medium wave and shortwave broadcasting by VOA. That would be a mistake, it is argued. Medium wave has the advantage of clear reception. Shortwave is central to the purpose of VOA, e.g., to communicate directly with audiences over the heads of their governments and media. Satellite gets into a country, too, but a dish is needed.

On balance, the VOA Affiliates Network is a plus for the United States in our overall shrinking communications program with the world. It extends VOA's reach, and it is certainly innovative. Although not all is bliss, the successful organization and growth of VOA's network of affiliates underscores its future potential.

Perhaps a similar forecast can be projected for VOA's new worldwide English program, *VOA News Now*. For now, it's a question-mark, even though more positive reactions from overseas listeners are reportedly on the rise. Time will tell.

.....

The author is a retired Foreign Service Officer who served in the Middle East, India and Africa. He was a VOA correspondent in the Middle East and covered the White House for VOA during the Eisenhower presidency. He was Assistant Director of USIA in charge of African programs.

Improvements to the Sony ICF-2010 Receiver

by Steve Johnston, WD8DAS

The Sony ICF-2010 (ICF-2001D) AM/FM/SW/AIR receiver is one of the most successful portable communications radios in history. It combines handy operating features with solid performance in a portable package. In many respects it represents the modern version of the famous Zenith Trans-Oceanic portables of the 40s, 50s and 60s.

I bought my first Sony 2010 over ten years ago, mainly to take advantage of the benefits of synchronous AM detection. Over time I became "addicted" to listening to AM signals using sync detection, and today I often find it painful to listen to skywave AM signals on a typical envelope detector. The sync detector in the 2010 still holds a leadership position in its field. In fact, I was so impressed with the Sony sync detector that I went on to build add-on sync detectors for my other communications receivers.

This article describes four simple modifications for the ICF-2010 which can help this great radio become even more useful...

- A handy handle for the radio
- A "medium" AM bandwidth to supplement the existing "narrow" and "wide" bandwidths
- An adjustable attenuator/protection device for use when connecting an external antenna
- Replacement of the audio output coupling capacitor for better sound on the internal speaker

Get a handle on it!

The ICF-2010 is a portable radio, but unlike most portables, it has no built-in

handle. The unit is shipped with a shoulder strap, but I never put it to use. Instead, I choose to pull the back cover off the radio and mount an aluminum handle on the top panel of the radio. Two holes drilled in the otherwise blank top of the radio provide simple attachment for a kitchen cabinet drawer-pull.

These handles, also known wire-pulls, are available in various sizes and in materials such as wood, plastic, and aluminum. My choice was a 4 by 1 inch aluminum pull, but feel free to pick what looks and feels good to you. Reinforce the mounting holes by providing washers under the screws to spread the pressure of the handle across a wider area of the plastic top. You can see the handle in **Photo 1**.

Medium Bandwidth Filter

I found the stock AM filter choices to be too wide when listening to stations suffering adjacent-channel interference, or too narrow for acceptable audio fidelity. The wide ceramic filter is identified as CFW1 and the narrow filter is marked as CFW2. Since the narrow filter is used for SSB, I considered the replacement of the wide filter with a device with tighter characteristics, but then I'd be stuck with the reduced audio response even when listening to strong stations in the clear.

I finally decided to add another filter with a response between the two stock filters which could be switched in as needed. Toko America (phone 847-635-3200) produces several lines of ceramic filters for



PHOTO 1: *Installing a handle makes the 2010 more portable.*

455 kHz IFs. The easiest to purchase seems to be the CFM2 line, which can be ordered in -6 dB bandwidths from 4 kHz to 10 kHz from Digi-Key Electronics at (phone 800-344-4539). I selected the 4 kHz device CFM2-455A (Digi-Key # TK-2330-ND). Cost is just a couple dollars each.

In my two 2010 receivers I tried two techniques to implement the additional filter. The first was to lift the circuit board off its mounts, remove the existing wide filter CFW1 from the main board, and connect it and the new "medium" filter to a DPDT (double pole double throw) toggle switch

mounted through a blank area on the plastic top of the radio. The wipers of the switch were then connected to the empty filter connection on the board using miniature coax cable such as RG-174/U.

With the 2010 in "wide" mode, flipping the switch one way puts the stock filter in line, and the other way selects the new medium filter. This design is shown in **Figure 1**. It worked very well, but I had a nagging sense that a better way was possible.

My second 2010 was also modified to include the additional filter, but in this case

I used diode-switching to parallel the new filter onto the existing board connections. In this way all three filters – wide, medium, and narrow – will be switched in the same fashion. This technique also offers better isolation between filters and stops filter "blow-by." This approach is shown in **Figure 2**.

Like the first plan, a DPDT toggle switch is mounted in a blank area on the top of the radio. Unlike the first design, this switch is switching direct current (dc) to activate the desired filter instead of radio frequency (RF).

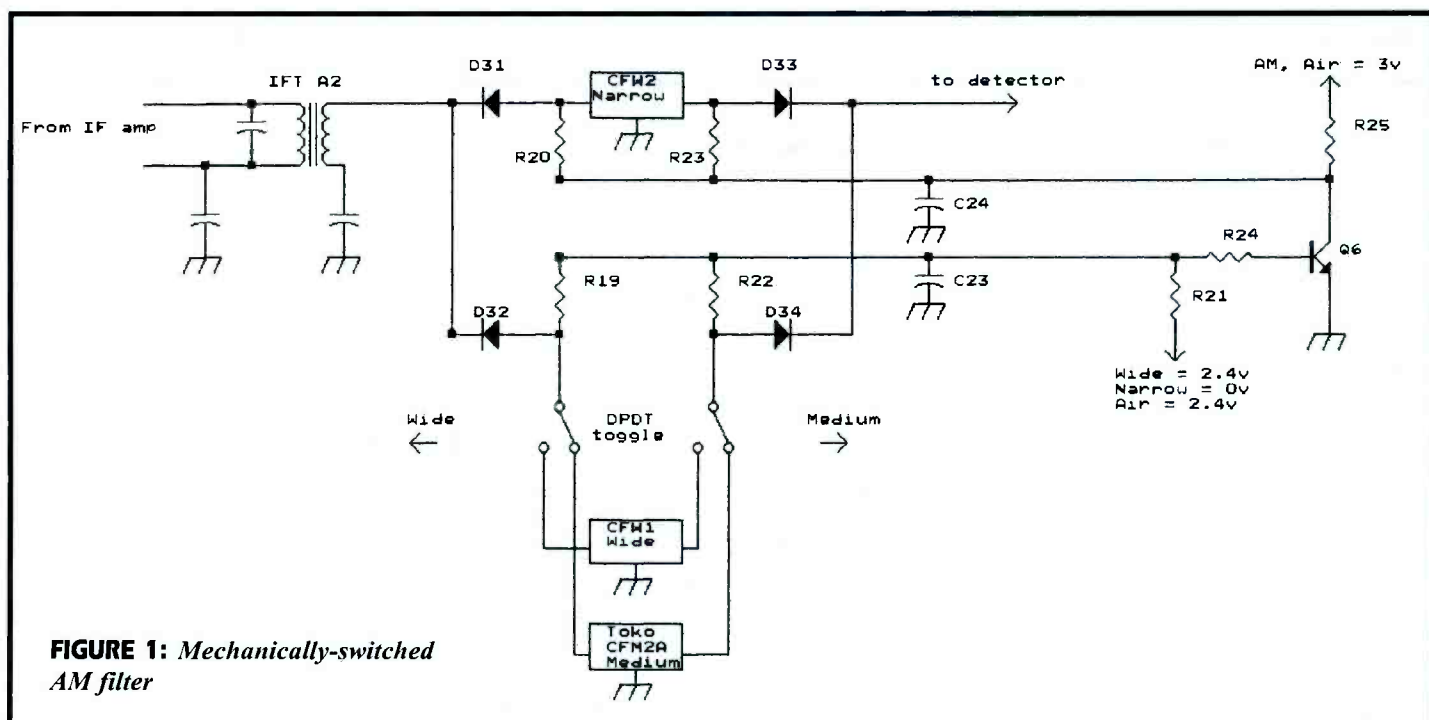

FIGURE 1: Mechanically-switched AM filter

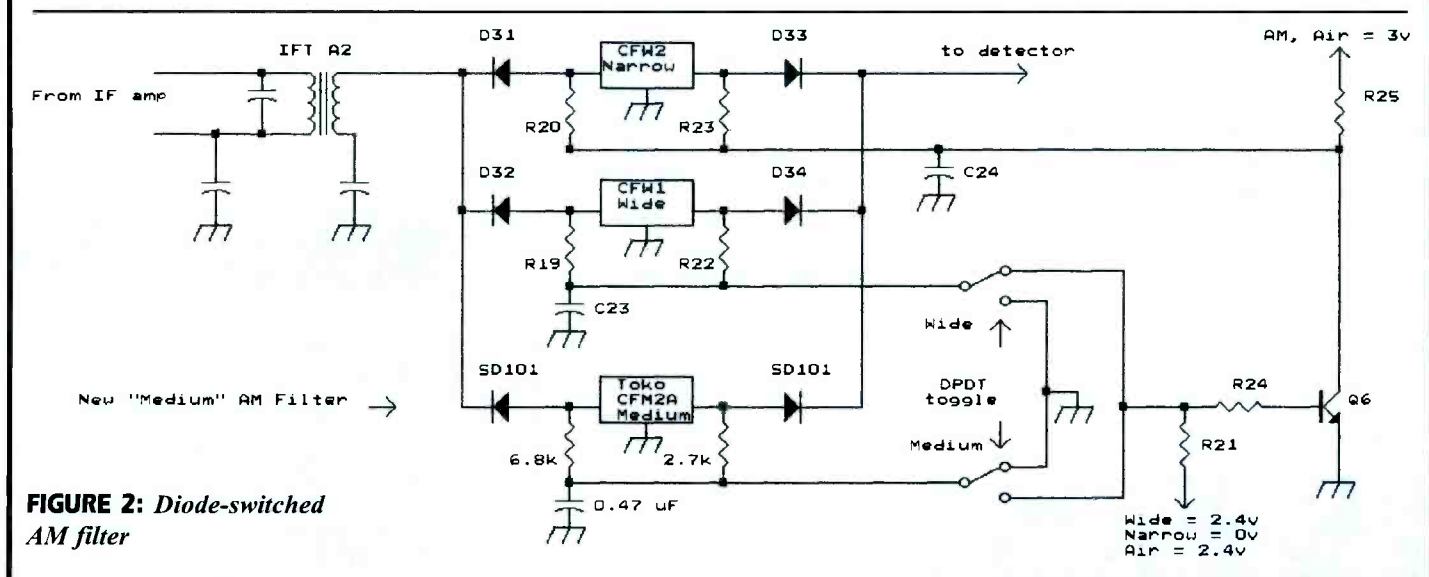
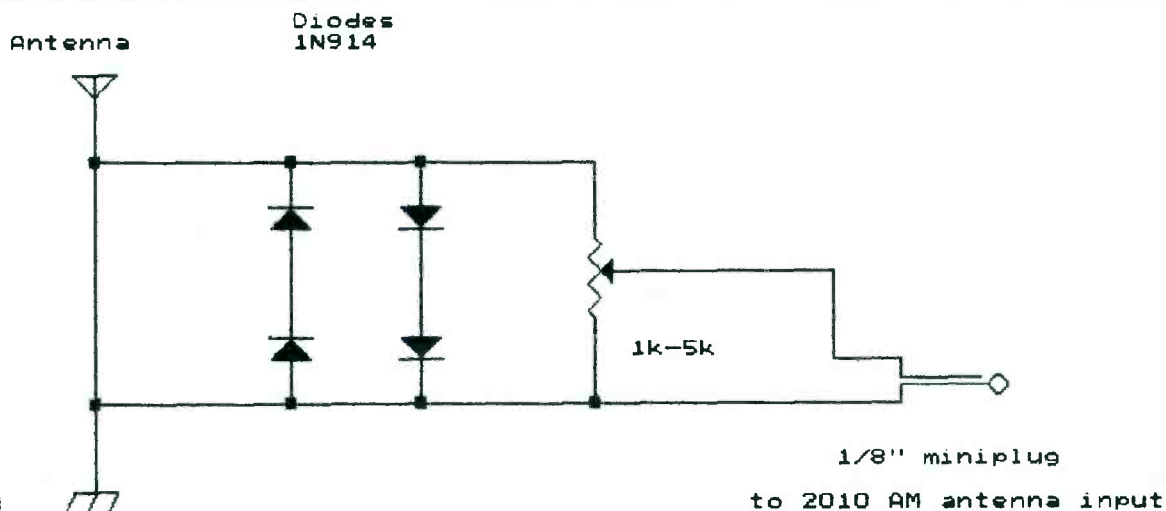

FIGURE 2: Diode-switched AM filter

FIGURE 3:
Antenna attenuator/protector



The 2010 uses the equivalent of the common 1N914 switching diode to choose the stock filters. Some improvement is possible by replacing them with Schottky diodes such as the SD101A (available from Digi-Key as number SD1010A-ND). In my case I used the Schottky diodes to add the Toko 4 kHz filter. The tiny size of the Toko filter makes it possible to mount it directly to the main circuit board of the receiver. You don't even need to pull the board off its mounts!

As shown in Figure 2, the DC control signal which originally selected the wide filter now is routed to the top-panel toggle switch. The switch then sends it back down to forward-bias the desired filter, the new medium or stock wide. The deselected filter is firmly cut out of the circuit by applying ground to its diodes.

External Antenna Accessory

As a portable receiver, the ICF-2010 is designed for a sensitive antenna input which can be overloaded by the strong signals or even damaged by static discharges when using an external antenna. Early 2010s seemed to be particularly prone to this trouble.

My bedside 2010 is equipped with a short wire antenna running about 20 feet out the window to a nearby tree. Even this modest antenna can blow the doors off the radio in today's world of powerful signals, so I built a simple attenuator/protector out of a 1000 ohm potentiometer and a couple of back-to-back diodes. See Figure 3 for details.

Adjust the potentiometer to the desired level – I almost always end up with the pot at mid-scale. Beyond its role as an adjustable level control, the resistance of the pot has the additional benefit of draining static charges which can accumulate on an antenna. The back-to-back diodes will clip any surges which might still make it through and protect the 2010's input stage.

More Bass from the Stock Speaker

The 2010 has an internal speaker of surprising quality and it produces a respectable sound. I found it possible to improve the already good distortion and bass output of the radio's output section by upgrading the speaker coupling capacitor C301 on the Jack Board from a polarized electrolytic 470 μF @ 6.3V to a 2200 μF @ 6.3V bi-polar electrolytic (Digi-Key's #P1148-ND just fits the space

available). The increased capacitance helps the low-end response, and the bi-polar nature of the new cap helps the distortion.

Further improvements could undoubtedly be made by working backward through the audio chain, replacing the standard electrolytics with bi-polar units better suited to audio.

Summary

The ICF-2010 is clearly a favorite receiver. Part of the reason I've become so attached to the model is its versatile nature – I find it useful as a test receiver in the shop, a vacation/travel radio, a receiver to accompany low-power portable ham transmitters, as well as a quality medium- and shortwave broadcast receiver. If you, too, are a 2010 enthusiast, I believe you'll be pleased with the mods described in this article.

Software for the Shortwave Listener...

SWBC Schedules - Broadcast frequencies and programs, updated weekly+..... \$35/year
 Smart R8 Control - Smart control for the Drake R8/R8A/R8B..... \$25 DOS/\$40 WIN/\$60 WIN95
 Smart NRD Control 32 - for the NRD-535..... \$60 WIN95
 Smart Kenwood Control 32 - for the R-5000..... \$60 WIN95
 Smart Lowe Control 32 - for the HF-150..... \$60 WIN95
 Smart Audio Control - Audio scope and spectrum analyzer for your PC..... \$25 DOS/\$35 WIN95
 SWBC Interval Signals - Turn your PC into a virtual shortwave receiver..... \$5 DOS/\$30 WIN

Fineware

11252 Cardinal Drive * Remington, VA 22734-2032
 fineware@erols.com * www.erols.com/fineware/

What have we done for you lately?

Tripled the amount of information on the MT website, that's what. Our site is a great companion to your printed copy of MT, including a constantly-updated glossary of terms and web links mentioned in the magazine, spectrum allocations; clubs, links, events, frequencies, and much more! It's all at www.grove-ent.com/hmpgmt.html

Big Savings on Radio Scanners

COMMUNICATIONS ELECTRONICS INC.

Now...Monitor trunked radio broadcasts
Save big on Bearcat 235XLT or BC895XLT trunk tracking radio scanners from CEI. Visit CEI on the web at www.usascan.com for our 30th anniversary special savings. To get your free fax-on-demand catalog, dial 734-663-8888 from the telephone handset on your fax machine for instructions. Get many free benefits such as extended warranty coverage on new scanners when you use your Communications Electronics Platinum Plus Master Card® issued by MBNA. No annual fee. Call 1-800-523-7666 anytime. Mention offer Q3K1 to request yours today.

DISTRIBUTOR'S COUPON EXPIRES 09/15/99 #9908M2

SAVE \$125 on one BC895XLT
Save \$125 when you purchase your Bearcat 895XLT scanner directly from Communications Electronics Inc., P.O. Box 1045, Ann Arbor MI 48106 USA. Telephone orders accepted. Call 1-800-USA-SCAN. Mention offer CE18. TERMS: Good only in USA & Canada. Only one coupon is redeemable per purchase and only on specified product.

Bearcat® 895XLT-A Radio Scanner
Mfg. suggested list price \$729.95/Special \$319.95
300 Channels • 10 banks • Built-in CTCSS • S Meter
Size: 10-1/2" Wide x 7-1/2" Deep x 3-3/8" High
Frequency Coverage: 29,000-54,000 MHz., 108,000-174 MHz., 216,000-512,000 MHz., 806,000-823,995 MHz., 849,0125-868,995 MHz., 894,0125-956,000 MHz.

The Bearcat 895XLT is superb for intercepting trunked communications transmissions (see BC235XLT description) with features like TurboScan™ to search VHF channels at 100 steps per second. This base and mobile scanner is also ideal for intelligence professionals because it has a Signal Strength Meter, RS232C Port to allow computer-control of your scanner via optional hardware and 30 trunking channel indicator annunciators to show you real-time trunking activity for an entire trunking system. Other features include Auto Store - Automatically stores all active frequencies within the specified bank(s). Auto Recording - This feature lets you record channel activity from the scanner onto a tape recorder. CTCSS Tone Board (Continuous Tone Control Squelch System) which allows the squelch to be broken during scanning only when a correct CTCSS tone is received. For maximum scanning enjoyment, order the following optional accessories: P5001 Cigarette lighter power cord for temporary operation from your vehicle's cigarette lighter \$14.95; PS002 DC power cord - enables permanent operation from your vehicle's fuse box \$14.95; MB001 Mobile mounting bracket \$14.95; EX711 External speaker with mounting bracket & 10 feet of cable with plug attached \$19.95. The BC895XLT comes with AC adapter, telescopic antenna, owner's manual and one year limited Uniden warranty.

Bearcat® 3000XLT-A Radio Scanner
Mfg. suggested list price \$699.95/Special \$329.95
400 Channels • 20 banks • Twin Turbo Search/Scan
Frequency Transfer • VFO Control • Automatic Store
10 Priority Channels • Selectable Mode • Data Skip
Frequency step resolution 5, 12.5 & 25 KHz.

Size: 2-3/4" Wide x 1-1/2" Deep x 7-3/8" High
Frequency Coverage: 25,000-549,995 MHz., 760,000-823,995 MHz., 849,0125-868,995 MHz., 894,0125-1,300,000 MHz.
The Bearcat 3000XLT is the ideal handheld radio scanner for communications professionals. This handheld scanner scans at 100 channels per second and searches at a rate up to 300 steps per second. A selectable attenuator eliminates annoying intermodulation from adjacent frequencies in highly populated areas. Selectable AM, Wide FM and Narrow FM modes allow you to change the default receiving mode of the BC3000XLT. For maximum scanning pleasure, order the following optional accessories: UA502 Cigarette lighter power cord for temporary operation from your vehicle's cigarette lighter \$14.95; LC3000 Deluxe swivel leather carrying case \$49.95; BP2500 rechargeable nickel-cadmium battery pack for up to five hours of dependable use \$39.95; ANTMBNC Magnetic mount scanner antenna with BNC jack and 12 feet of cable \$29.95. ANTGBNC Glass mount scanner antenna with BNC cable \$29.95. The BC3000XLT comes with AC adapter, belt clip, flexible rubber antenna, earphone, owner's manual and one year limited Uniden warranty. Order today.

TrunkTracking Radio

DISTRIBUTOR'S COUPON EXPIRES 09/15/99 #9908M2

SAVE \$100 on one BC235XLT
Save \$100 when you purchase your Bearcat 235XLT handheld scanner directly from Communications Electronics Inc., P.O. Box 1045, Ann Arbor MI 48106 USA. Telephone orders accepted. Call 1-800-USA-SCAN. Mention offer CE12. TERMS: Good only in USA & Canada. Only one coupon is redeemable per purchase and only on specified product.

Bearcat® 235XLT-A TrunkTracker
Mfg. suggested list price \$429.95/CEI price \$269.95
300 Channels • 10 banks • Trunk Scan and Scan Lists
Trunk Lockout • Trunk Delay • Extra battery & charger
10 Priority Channels • Programmed Service Search
Size: 2-1/2" Wide x 1-3/4" Deep x 6" High
Frequency Coverage: 29,000-54,000 MHz., 108-174 MHz., 406-512 MHz., 806-823,995 MHz., 849,0125-868,995 MHz., 894,0125-956,000 MHz.

The Bearcat TrunkTracker BC235XLT, is the world's first scanner capable of tracking a selected radio transmission as it moves across a trunked radio system. Now it's easy to monitor fleets and subfleets in analog trunked radio systems. The BC235XLT can also work as a conventional scanner. This 300-channel, programmable handheld scanner provides scanner users with uninterrupted monitoring capabilities of Type I, II, III and hybrid trunking systems. Now it's easy to continuously monitor conversations even though the message is switching frequencies. The BC235XLT comes with AC adapter, CRX120 battery charger, one rechargeable long life ni-cad battery packs, belt clip, flexible rubber antenna, earphone, owner's manual and one year limited Uniden warranty. The BC235XLT when ordered from CEI now features built-in attenuator feature. Not compatible with AGEIS, ASTRO, EDACS, ESA's and LTR systems. Call CEI at 1-800-USA-SCAN to order your Bearcat TrunkTracker now.



VHF/GMRS/CB Radios

Have fun and use our CB, GMRS, shortwave and commercial radios to keep in touch with the world, friends and family.
Cobra 148GTL-A3 SSB CB/SPECIAL \$114.95
Cobra 29WXST-A CB with sound tracker technology \$149.95
Maxon HCB40WX handheld CB with 10 weather ch. \$69.95
RELM MPV32-A 5 watt VHF handheld transceiver \$299.95
RELM RH256NB-A 25 watt VHF mobile transceiver \$284.95
RELM RMV60B-A 60 watt VHF mobile transceiver \$549.95
Uniden GRANTXL-A SSB CB Mobile \$124.95
Sangean ATS818CS-A shortwave receiver \$199.95
Sangean ATS800-A2 shortwave receiver \$49.95

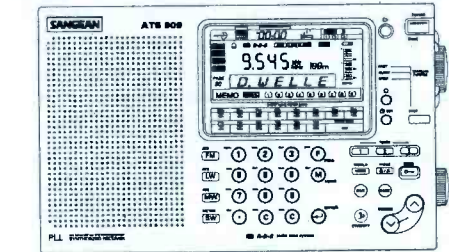

Sangean ATS909-A2 Shortwave Receiver
Mfg. suggested list price \$399.95/Special \$219.95
Size: 8-1/4" Wide x 1-1/2" Deep x 5" High
Frequency Coverage: LW: 153-513 KHz.; MW: 520-1710 KHz.; SW: 1711-29999 KHz.; FM: 87.5-108.0 MHz.

Now, monitor the world on the most advanced shortwave receiver available from CEI. The Sangean ATS909 features 306 memories. Also features automatic tuning to automatically find all local stations with the push of a button, five tuning methods, eight character alphanumeric display, upper and lower single side band reception. Radio Data System (RDS) automatically shows station call letters on RDS equipped FM stations. RF Gain control, adjustable sleep timer, 42 world city times, dual time system, selectable manual tune steps, wide/narrow filter reduces adjacent station interference. Battery & Signal Strength indicator, 9KHz./10 KHz. switch. Lighted LCD Display, Lock Switch, separate audio recorder output & stand-by control jacks allows user to program tape recorder to turn on at three different times. Uses 4 AA batteries. When you order the ATS909 from us, you'll get a complete package deal including external AC adapter, portable antenna, carrying case and limited one year Sangean warranty. Call 1-800-USA-SCAN to order your shortwave radio.

Radio Scanners

Monitor fire, police, weather, marine, medical, aircraft and other transmissions with your radio scanner from CEI.
AOR 5000+3G-A Desk receiver/government orders only . \$1,949.95
AOR8200B-A wideband handheld scanner \$519.95
Bearcat 9000XLT-A 500 channel base/mobile scanner \$344.95
Bearcat 3000XLT-A 300 channel handheld scanner \$329.95
Bearcat 895XLT-A 300 ch. TrunkTracker base scanner \$319.95
Bearcat 760XLT-A 100 channel base/mobile scanner \$179.95
Bearcat 560XLA-A base/mobile 16 channel scanner \$69.95
Bearcat 245XLT-A 300 channel TrunkTracker II scanner \$269.95
Bearcat 235XLT-A 300 channel TrunkTracker scanner \$269.95
Sportrac 150-A 100 channel handheld with 800 MHz. \$144.95
Bearcat 80XLT-A2 50 channel handheld scanner \$109.95
Bearcat 60XLT-A 30 channel handheld scanner \$79.95
Bearcat BCT12-A2 information mobile scanner \$144.95
Bearcat BCT7-A information mobile scanner \$149.95
ICOM PCR1000-A1 computer communications scanner \$399.95
ICOM R10-A1 handheld wideband communications set \$339.95

NEW/RELM® MPV32-A Transceiver
Mfg. suggested list price \$515.00/Special \$299.95

Looking for a great hand-held two-way transceiver? Law enforcement depends on the RELM MPV32 transceiver for direct two-way communications with their fire or police department, civil defense agency or ham radio repeater. The MPV32 is our most popular programmable frequency agile five watt, 32 channel handheld transceiver that has built-in CTCSS. This feature may be programmed for any 50 standard EIA tones. Frequency range 136,000 to 174,000 MHz. The full function, DTMF compatible keypad also allows for DTMF Encode/Decode and programmable ANI. Weighing only 15.5 oz., it features programmable synthesized frequencies either simplex or half duplex in 2.5 KHz. increments. Other features include PC programming and cloning capabilities, scan list, priority channel, selectable scan delay, selectable 5 watt/1 watt power levels, liquid crystal display, time-out timer and much more. When you order the MPV32 from CEI, you'll get a complete package deal including antenna, 700 ma battery (add \$20.00 to substitute a 1000 ma battery), battery charger, belt clip and user operating instructions. Other useful accessories are available. A heavy duty leather carrying case with swivel belt loop part #LCMP is \$49.95; rapid charge battery charger, part #BCMP is \$69.95; speaker/microphone, part #SMMP is \$54.95; extra high capacity 1000 ma. ni-cad battery pack, part #BPMP1 is \$79.95; extra 700 ma. ni-cad battery pack, part #BPMP7 is \$59.95; cloning cable part #CCMP is \$34.95; PC programming kit, part #PCKIT030 is \$224.95. A UHF version with a frequency range of 450-480 MHz. part #MPU32 is on special for \$299.95. Your RELM radio transceiver is ideal for many different applications since it can be programmed with just a screwdriver and programming instructions in less than 10 minutes. Programming is even faster with the optional PC kit. The programming instructions part #PIMPV is \$19.00. Call 1-800-USA-SCAN to order.

#PIMPV is \$19.00. Call 1-800-USA-SCAN to order.

Buy with confidence

It's easy to order from us. Mail orders to: Communications Electronics Inc., P.O. Box 1045, Ann Arbor, Michigan 48106 USA. Add \$19.00 per weather station or radio product for UPS ground shipping, handling and insurance to the continental USA unless otherwise stated. Add \$12.00 shipping for all accessories and publications. Add \$12.00 shipping per antenna. For Canada, Puerto Rico, Hawaii, Alaska, Guam, P.O. Box or APO/FPO delivery, shipping charges are two times continental US rates. Michigan residents add state sales tax. No COD's. Satisfaction guaranteed or return item in unused condition in original packaging within 61 days for refund, less shipping charges. 10% surcharge for net 10 billing to qualified accounts. All sales are subject to availability, acceptance and verification. Prices, terms and specifications are subject to change without notice. We welcome your Discover, Visa, American Express, MasterCard, IMPAC or Eurocard. Call anytime 1-800-USA-SCAN or 800-872-7226 to order toll-free. Call 734-996-8888 if outside Canada or the USA. FAX anytime, dial 734-663-8888. Dealer and international inquiries invited. Order from Communications Electronics Inc. today and save.
Price schedule effective August 1, 1999 AD 08001999MT © 1999 Communications Electronics Inc.

For credit card orders call 1-800-USA-SCAN

Communications Electronics Inc. Emergency Operations Center
e-mail: cei@usascan.com
www.usascan.com

PO Box 1045, Ann Arbor, Michigan 48106-1045 USA
For information call 734-996-8888 or FAX 734-663-8888

Richard Barnett
ScanMaster@aol.com

The Bearcat 245 - What's it all About?

The Bearcat 245 is such a huge leap forward in scanner technology that we wonder why Uniden didn't call it the 2450. Then again, we wondered why they called the last model in the series the 235 as if it were a slight upgrade from the BC-230 portable. You can't argue with success, though. The 235, and its Radio Shack brethren the PRO-90 and PRO-91, have become one of the most well received designs in portable scanning history. And why shouldn't it? The 235 was the industry's first trunking scanner. It achieved what had been the Holy Grail of the hobby.

The 245's advancements are so numerous we'll cover the radio in two columns. This month, we'll take a look at all aspects of the radio other than its all-new SmartScanner technology, which is a completely unique take on scanner programming.

Note: This editor did participate in the development of some aspects of the scanner.

1. The Basics

The BC-245XLT is a 300 channel scanner nicknamed the "TrunkTracker II," which indicates that it's a second generation unit that now tracks two major trunking systems, Motorola and Ericsson. It is the exact same case (or "tool") as the BC-235 and it covers the same frequency ranges.

The display is new, as it has a RR icon and an "M" and an "E" icon to indicate the type of trunking you've selected (Motorola or Ericsson). The display also flashes "Bc-245" when you first turn on the device. When you are trunk scanning, the word "Id SCAN" scrolls across the display, rather than just "SCAN."

The radio comes complete with an updated trunking frequency guide that includes Ericsson systems and logical channel numbers (LCN's).

2. GE/Ericsson trunktracking

Ever since the first 235 hit the market customers in cities such as Denver, Hartford and Oakland have been asking, "where's the radio for us?" These cities and many others are served by EDACS trunked systems which the 235 could not track. The 245 does track EDACS and does so beautifully.

Following the convention of using the

control channel (just as actual system radios do) to obtain instructions, the 245 locks onto the EDACS data signal and follows the action (excluding private and interconnect calls). Unlike Motorola trunking, you need to enter the EDACS system frequencies in a particular (logical channel number or LCN) order.

With the 245, EDACS trunking operates almost exactly the same as Motorola trunking. You can set delay, lockout groups, scan your Scan List, search the system, etc. The interface is very intuitive.

3. EDACS operation with either Decimal or AFS talkgroup programming

Uniden has added a terrific feature for EDACS operation that we like so much we wish there were a way to incorporate it into Motorola tracking. You can enter and search an EDACS trunking system at either the System, the Agency, or the Fleet level. It's called "AFS" mode and it's really a kick. The radio will also allow you to control EDACS trunking using the "decimal" convention as well. Talkgroups in decimal mode and AFS mode are available on the Internet and soon in many frequency guides.

The radio defaults to AFS mode. After you've entered the frequencies for an EDACS system in their proper order and you put the radio into Search mode, you'll begin to see and hear activity from talkgroups described on the display such as 02-011 or 08-042. This is known as "System Level" searching. Any group that is active on the system will be heard. Groups will range from 01-xxx through 15-xxx, although many systems do not use all the possible "Agency" groups.

What you'll soon discover is that, for the most part (it's not foolproof), one of these Agency groupings (from 1 to 15) will be comprised of the police department, one the fire department, one miscellaneous governmental services, etc. Each EDACS system manager can program the radios to his or her own liking, but the breakout by agency or type of service is quite typical.

What you'll next realize when operating

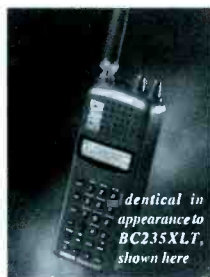

the 245 is that, if the city police use a variety of 02 groups for example, then you can further break down the structure in a simple hierarchical way, such as:

- 02 POLICE Agency
- 02-01 POLICE Patrol fleet
- 02-011 POLICE Patrol East subfleet (or talkgroup - using the term interchangeably)
- 02-012 POLICE Patrol West subfleet etc.

Thus, with the BC-245, you can EDACS trunk search at the system level (all talkgroups), or at any one of the levels shown above. By entering "02 decimal Enter" into the radio, you'll hear all of the 02 groups only. If this Agency level searching is too broad, you can enter 02-01 and then hear all the police patrol groups. If you enter 02-012, you'll hear only that specific Police Patrol West talkgroup. Remember, each EDACS system varies by the whim of the system manager, but this gives you the general idea.

4. Multiple-system trunktracking and conventional scanning

After super-scannists heard that the 245 would track EDACS systems, the next question on everyone's mind was, "Would it track more than one system?" The answer: a resounding "Yes!" The 245 will track up to 10 trunked systems at one time, in any combination of EDACS and Motorola systems. There's no limitation. And to answer your followup question, yes, the 245 will trunktrack and conventional scan at the same time.

Here's a quick breakdown of the answers to all the critical questions:

- A. "Multi-track" up to 10 trunked systems at one time
- B. These systems can be any mix of Motorola and EDACS, on any bands
- C. You can either trunk scan or trunk search these systems at the same time (one or the other)
- D. You can trunktrack and scan conventional frequencies at the same time
- E. You can enter conventional frequencies in the same bank as a trunked system
- F. The scanner remembers where each control channel is located for each programmed trunked system so that as the

radio moves from one bank to the next, there is no "down-time" as the radio searches for the control channel. It's practically instantaneous.

5. Motorola trunktracking on VHF, UHF, 800 and 900 MHz

It now doesn't matter which band you want to Trunktrack. While the 235 and 895 limited you to 800 MHz operation, the 245 will track EDACS and Motorola at VHF, UHF, 800 and 900 MHz. All Motorola systems outside of 800 MHz are Type II which means you'll never have to enter a fleet map (as you do with some older 800 MHz systems). When you press and hold the trunk key to assign a bank as a trunking bank, you go through a menu and select:

- Type I 800 MHz
- Type II 800 MHz (default)
- Type II 900 MHz
- Type II VHF
- Type II UHF
- EDACS

If you wish to trunktrack a Motorola VHF or UHF system (they're pretty rare outside of federal and military installations), you'll need to also enter the "base" and "offset" frequency which, like fleet maps, will quickly find their way to the Internet.

6. PC Up/downloadable, controllable, cloneable

The 245 comes equipped with an RS232C port on the side of the unit. The port is similar in look to what you see on a PCMCIA card. Uniden also supplies a cable which fits the radio and, on the other end, has a standard DB-9 connector which plugs right into the serial port of your PC.

With third-party software, you are able to completely program the scanner, just as you can with the BC-895. The command set is almost exactly the same for the 245 as it is for the 895, with a few additions to support the new features. Unlike other portable scanners which are only programmable, the 245 is fully controllable from your PC. And, even better, there is built-in functionality that allows you to clone the programming from one 245 to another!

7. Upgraded Service Search

There is now a new Service Search selection: Railroad. Once you select it (you see an RR icon on the display) the radio will begin scanning through the designated rail frequencies used in Canada and the U.S. Upon reception of a transmission the display will flip-flop between the frequency and the American Association of Railroads channel assignment.

This is not a basic search at 5 kHz intervals in the 160 and 161 MHz band. The intervals are at the proper 15 kHz for the best performance. UHF rail channels are also included. All other service searches remain the same.

8. Auto Backlighting Upon Opening of the Squelch

If you press and hold the light key the radio will now enter the Auto Light mode. Whenever the squelch opens the display backlighting will light for 4 to 5 seconds. This of course is great for night operation, particularly in a mobile setting.

9. Motorola trunking status bit functionality

One of the few complaints the super-buffs had with the 235 was that you could not set the status bit for Motorola trunking systems. This topic has been covered by others in greater detail, but here's the gist of the problem: On Motorola systems there is a method by which specialized types of communications utilize unique talkgroup numbers. Thus, an emergency call on a trunked system will occur on a unique talkgroup from its primary assignment. To units within the radio system,

this is transparent.

If you're in search mode with a 235, you'll hear the call; it will just show up on a different talkgroup number. However, if you've programmed the primary talkgroup number into your Scan List memory and you're scanning, you'll miss that call.

Not with the 245. The radio defaults to "Status Bit ON out of the box." (You'll need to turn it off if you're trying to figure out the proper fleet map of a Motorola Type I trunking system.)

Note to U.S. consumers only: It is unlawful to import, manufacture, or market cellular-capable or cellular-restorable scanners into the U.S.

EXPORT ALL OVER THE WORLD

boger electronics *Let's make winners*

Fastest Windows™ -Remote-Software
for AOR- and ICOM-Receivers!
Speed up to 19 steps/sec.

Scanners, Modifications and more ...
Visit our WebSite at <http://www.boger.de>

Grundesch 15, D-88326 Aulendorf, Germany
phone: (+49) 7525/451 fax: (+49) 7525/2382
e-mail: bogerfunk@t-online.de

TrunkTrac®

New Version 5.2

TrunkTrac, the first, and one of the most sophisticated trunk tracking technologies available, is now even better. New pricing and additional features make TrunkTrac your best choice if you're serious about tracking Motorola Type I, II, III, and Hybrid systems. TrunkTrac now supports the BC895XLT, PCR1000, R7000, R7100, R8500, R9000, and the RS Pro 20xx series with an OS456/535 board installed.

Competing products cost more, don't decode the control channel, can't deal with Type I fleet maps, and won't properly decode many Type II talk groups. TrunkTrac's patented technology let's you do all that and much more. TrunkTrac consists of easy to use menu driven software, an FCC Class B approved signal processing board you plug into an ISA slot in your PC, a serial interface, and a discriminator buffer for your scanner. Everything you need, including cables, is supplied. With TrunkTrac you'll have access to Private Call and Interconnect activity and can follow up to four systems at once. Any combination of VHF/UHF/800/900 MHz systems, including FED-SMR trunking, is supported. TrunkTrac lets you assign a 35 character alpha tag (up to 1000/system) to all IDs. You can set Lockouts, Personality Files, Scan Lists, and much more. TrunkTrac lets you log system activity to an ASCII file for database import and traffic analysis. We think you'll like TrunkTrac so much it comes with a 30 day money back guarantee. And For a limited time, when you purchase TrunkTrac, we will install the discriminator mod in your scanner for free. **TrunkTrac ver 5.2.....\$297.95**

Scanner Master PO Box 428, Newton Highlands, MA 02161 1-800-722-6701
www.scannermaster.com

10. 100 Talkgroups per trunked system.

The BC-235 provided five "Scan Lists" with 10 memory positions each for trunked system operation. The BC-245 doubles that with 10 X 10 trunked memories per system.

11. Priority in trunking mode

You can now set priority in your trunking banks, just as you do in your conventional ones. Here's how: After you've set up your Scan List, press the Priority key to activate it. The radio will default to setting the first "channel" in each of your Scan List as a priority.

Since each trunking bank holds 10 Scan Lists of 10 memory channels each, that means channel 1 (or 1-1), 11, 21, on through 91 are all default priorities. You can adjust which talkgroup in each List is the priority by pressing and holding the Priority key. It's very similar to conventional priority although there is no "interrupt" during the transmissions. Priorities are checked in between transmissions.

12. Frequency Find Mode

One of the best ways to demonstrate the necessity and power of a trunking scanner is to watch how frequencies change during a conversation. Motorola systems, which use "transmission trunking," change frequency only when there is a pause of approximately three seconds between replies (there is a "hang time" built in). Ericsson systems, however, change frequencies with each release of the microphone. This is known as "message" trunking.

Uniden has incorporated a fun and enlightening feature known as "frequency find" mode which vividly demonstrates the frequency hops. When a talkgroup is active in trunk mode, you can press the LIMIT key once to display the frequency on which that particular conversation is occurring. You can also press and hold the LIMIT key for two seconds and the scanner will alternately flash active talkgroups and frequencies during all trunked radio communications.

Maybe this radio should've been called the 24,500! We'll have more on the BC-245 in upcoming issues. The radio should be available this month.

Frequency and Talkgroup File - Florida

Brian Cathcart, otherwise known as the "Scannerdude," lives in South Florida and publishes some of the most comprehensive scanning guides you'll ever find. It's very

complicated radio territory in Florida, with loads of trunking systems, but Brian makes it all understandable. You can find out more about Brian's publications by contacting him at scannerdude@juno.com. With his permission, here's just a snippet from one of his books:

(Note: "r" stands for repeater, "s" for simplex)

PALM BEACH COUNTY SHERIFF'S OFFICE

(all CTCSS 103.5 Hz unless otherwise noted)

CH1 - 154.845r	North "Alpha" zone (input 155.580)
CH2 - 154.725r	Central "Baker" zone (input 155.715)
CH3 - 154.815r	West "Delta" zone (input 155.550)
CH4 - 154.785r	South "Charlie" zone (input 155.520)
CH5 - 154.650r	Countywide tactical (input 155.610)
CH6 - 155.370s	Intercity channel
CH7 - 155.190r	PBIA Airport units (input 158.970)
CH8 - 153.875r	Simulcast of CH5 (input same as CH5)
CH9 - 153.980r	Future South dispatch channel (input 155.805)
CH10 - 158.850r	Main Jail (CTCSS 156.7, input 155.655)
CH11 - 158.850r	Courthouse (input 155.655)
CH12 - 155.730s	TAC1
CH13 - 155.835s	TAC2
CH14 - 155.850s	TAC3
Stockade	158.850s (CTCSS 127.3)
MDT ("Digi")	154.755r (input 155.490)
Radio Shop	453.550r

PALM BEACH COUNTY FIRE-RESCUE

(all CTCSS 71.9 Hz unless otherwise noted)

TAC 1 - 154.355r	Used by units out of station but not on call [input 151.205]
TAC 2 - 154.070r	Battalions 1, 2, 3-North (stations 33, 34). 6 [input 151.280]
TAC 3 - 154.385r	Brush fires, large incidents, and special events [input 151.475]
TAC 4 - 154.190r	Battalions 3-South (stations 31, 32, 35, 37, 38), 4, 5 [input 151.400]
TAC 5 - 154.145s	Fireground channel/Canal Point (Battalion 7) dispatch TAC 6 - 153.950s = Brush-fire fireground channel
TAC 7 - 154.265s	Intercity channel ("IC Fire")
TAC 8 - 155.340s	H.E.A.R. (Hospital Emergency Ambulance Radio) channel PBIA Airport Crash-Rescue/Airport Operations - 153.800r [input 151.040]
COMMAND 1 - 453.150r	Dispatch/Paging channel [DPL 271]
COMMAND 2 - 453.750r	Administration / COMMAND 1 back-up / Volunteer Division [DPL 271]

Palm Beach County is currently building an 800-MHz Motorola Astro APCO-25 digital trunked system. The Sheriff, Fire-Rescue, and County services will all use the system, but it will be run mostly in analog mode (except for sensitive Police communications). It is planned to be online in December of 2000.

West Palm Beach and Boynton Beach are currently the only agencies with trunked radio systems. Riviera Beach, Palm Beach, and Palm Beach Gardens all use the West Palm Beach trunked system. Here are some of the more active talkgroups:

WEST PALM BEACH (WPB) TRUNKED SYSTEM - Motorola Type II

Frequencies

853.5875*
856.4375*
857.4375*
858.4375*
853.5375
854.9625
856.7125
856.9625
857.7125
857.9625
858.7125
858.9625
859.2125
859.7125
859.9625
860.7125

Talkgroups

1616	WPB Police CH A - North
1648	WPB Police CH B - South
1680	WPB Police CH C - Info/Teletype
1712	WPB Police CH D - TAC 1 (Primary Car-to-Car)
1744	WPB Police CH E - TAC 2
1776	WPB Police CH F - TAC 3
1808	WPB Police CH G - CID
3216	WPB Fire TAC-A - Fire Main Dispatch
3248	WPB Fire TAC-B
3280	WPB Fire TAC-C
3312	WPB Fire TAC-D
3344	WPB Fire TAC-E
3376	WPB Fire TAC-F - Fire Prevention
3408	WPB Fire TAC-G - Fire Administration
16016	Riviera Beach Police CH A - Patrol 1 (Main)
16048	Riviera Beach Police CH B - Patrol 2
16080	Riviera Beach Police CH C - Information/Teletype
16112	Riviera Beach Police CH D - TAC 1
16144	Riviera Beach Police CH E - TAC 2
17616	Riviera Beach Fire CH A - Main Dispatch
17648	Riviera Beach Fire CH B - MEDIC
17680	Riviera Beach Fire CH C - TAC 1
17712	Riviera Beach Fire CH D - TAC 2
21616	PB Gardens Police simulcast from CH 1 - 855.2125, Police main
21648	PB Gardens Police simulcast from CH 2 - 856.2125, Police secondary
21680	PB Gardens Police TAC 1
21712	PB Gardens Police TAC 2
21744	PB Gardens Police TAC 3
22128	PB Gardens Police/Fire Special ops

Note: Currently Palm Beach Gardens Fire Department is dispatched by Palm Beach County Fire-Rescue, and uses their VHF radio system. These talkgroups have been reserved for them should they ever fully switch to the WPB system.

22032	PB Gardens Fire Main
22064	PB Gardens TAC 1
22096	PB Gardens TAC 2
22128	PB Gardens Fire/Police Special ops
22160	PB Gardens Fire Prevention
22192	PB Gardens Fire Training
22416	Palm Beach Police A
22448	Palm Beach Police B
22480	Palm Beach Police C
22512	Palm Beach Police D
22704	Palm Beach Fire A
22736	Palm Beach Fire B
22768	Palm Beach Fire C
22800	Palm Beach Fire D
22832	Palm Beach Fire E

Emergency Medical Allocations

This month's *Service Search* column takes an in-depth look at the new Emergency Medical and Special Emergency frequency allocations currently being licensed by the Federal Communications Commission. Scanner listeners should be listening

for newly allocated splinter channels (VHF 7.5 kHz/UHF 6.25 kHz) to become active in their areas. (Frequencies MHz unless otherwise noted.)

Emergency Medical Allocations

150.7750	Mobile	
150.7825	Mobile	Bandwidth not to exceed 11.25 kHz
150.7900	Mobile	
150.7975	Mobile	
150.8050	Mobile	
155.3250	Base or mobile	
155.3325	Base or mobile	Bandwidth not to exceed 11.25 kHz
155.3400	Base or mobile	
155.3475	Base or mobile	Intersystem Mutual Aid/Bandwidth not to exceed 11.25 kHz
155.3550	Base or mobile	
155.3625	Base or mobile	Bandwidth not to exceed 11.25 kHz
155.3850	Base or mobile	
155.3925	Base or mobile	Bandwidth not to exceed 11.25 kHz
155.4000	Base or mobile	
155.4075	Base or mobile	Bandwidth not to exceed 11.25 kHz
220.9025	Base/221.9025	Mobile <Channel 181>
220.9075	Base/221.9075	Mobile <Channel 182>
220.9125	Base/221.9125	Mobile <Channel 183>
220.9175	Base/221.9175	Mobile <Channel 184>
220.9225	Base/221.9225	Mobile <Channel 185>

[Note: For frequencies between 453-463 MHz, mobiles will utilize frequencies 5 MHz higher than the base/mobile frequencies listed below]

453.03125	Base or mobile	Bandwidth not to exceed 6 kHz
453.04375	Base or mobile	Bandwidth not to exceed 6 kHz
453.08125	Base or mobile	Bandwidth not to exceed 6 kHz
453.09375	Base or mobile	Bandwidth not to exceed 6 kHz
453.13125	Base or mobile	Bandwidth not to exceed 6 kHz
453.14375	Base or mobile	Bandwidth not to exceed 6 kHz
453.18125	Base or mobile	Bandwidth not to exceed 6 kHz
453.19375	Base or mobile	Bandwidth not to exceed 6 kHz
460.5250	Base or mobile	
460.53125	Base or mobile	Bandwidth not to exceed 6 kHz
460.5375	Base or mobile	Bandwidth not to exceed 11.25 kHz
460.54375	Base or mobile	Bandwidth not to exceed 6 kHz
460.5500	Base or mobile	
460.55625	Base or mobile	Bandwidth not to exceed 6 kHz
460.5625	Base or mobile	Bandwidth not to exceed 11.25 kHz
460.56875	Base or mobile	Bandwidth not to exceed 6 kHz
462.9500	Base or mobile	<Med 9>
462.95625	Base or mobile	<Med 91> Bandwidth not to exceed 6 kHz
462.9625	Base or mobile	<Med 92> Bandwidth not to exceed 11.25 kHz
462.96875	Base or mobile	<Med 93> Bandwidth not to exceed 6 kHz
462.9750	Base or mobile	<Med 10>
462.98125	Base or mobile	<Med 101> Bandwidth not to exceed 6 kHz
462.9875	Base or mobile	<Med 102> Bandwidth not to exceed 11.25 kHz
462.99375	Base or mobile	<Med 103> Bandwidth not to exceed 6 kHz
463.0000	Base or mobile	<Med 1>
463.00625	Base or mobile	<Med 11> Bandwidth not to exceed 6 kHz
463.0125	Base or mobile	<Med 12> Bandwidth not to exceed 11.25 kHz
463.01875	Base or mobile	<Med 13> Bandwidth not to exceed 6 kHz
463.0250	Base or mobile	<Med 2>
463.03125	Base or mobile	<Med 21> Bandwidth not to exceed 6 kHz
463.0375	Base or mobile	<Med 22> Bandwidth not to exceed 11.25 kHz
463.04375	Base or mobile	<Med 23> Bandwidth not to exceed 6 kHz
463.0500	Base or mobile	<Med 3>
463.05625	Base or mobile	<Med 31> Bandwidth not to exceed 6 kHz
463.0625	Base or mobile	<Med 32> Bandwidth not to exceed 11.25 kHz
463.06875	Base or mobile	<Med 33> Bandwidth not to exceed 6 kHz
463.0750	Base or mobile	<Med 4>
463.08125	Base or mobile	<Med 41> Bandwidth not to exceed 6 kHz
463.0875	Base or mobile	<Med 42> Bandwidth not to exceed 11.25 kHz
463.09375	Base or mobile	<Med 43> Bandwidth not to exceed 6 kHz
463.1000	Base or mobile	<Med 5>
463.10625	Base or mobile	<Med 51> Bandwidth not to exceed 6 kHz
463.1125	Base or mobile	<Med 52> Bandwidth not to exceed 11.25 kHz
463.11875	Base or mobile	<Med 53> Bandwidth not to exceed 6 kHz
463.1250	Base or mobile	<Med 6>
463.13125	Base or mobile	<Med 61> Bandwidth not to exceed 6 kHz
463.1375	Base or mobile	<Med 62> Bandwidth not to exceed 11.25 kHz
463.14375	Base or mobile	<Med 63> Bandwidth not to exceed 6 kHz
463.1500	Base or mobile	<Med 7>
463.15625	Base or mobile	<Med 71> Bandwidth not to exceed 6 kHz
463.1625	Base or mobile	<Med 72> Bandwidth not to exceed 11.25 kHz

463.16875	Base or mobile	<Med 73> Bandwidth not to exceed 6 kHz
463.1750	Base or mobile	<Med 8>
463.18125	Base or mobile	<Med 81> Bandwidth not to exceed 6 kHz
463.1875	Base or mobile	<Med 82> Bandwidth not to exceed 11.25 kHz
463.19375	Base or mobile	<Med 83> Bandwidth not to exceed 6 kHz
2726 kHz	Base or mobile	
3201 kHz	Base or mobile	
2000-3000 kHz	Fixed	
33.02	Base or mobile	One-way paging on secondary basis
33.06	Base or mobile	One-way paging on secondary basis
33.10	Base or mobile	One-way paging on secondary basis
35.02	Mobile	Also available to Industrial/Business Pool co-equal basis
35.64	Base	One-way paging to mobile receivers only
35.68	Base	One-way paging to mobile receivers only
37.90	Base or mobile	
37.94	Base or mobile	
37.98	Base or mobile	
43.64	Base	Low power (under 10 watts) digital transmissions
43.68	Base	One way paging to mobiles only
45.92	Base or mobile	
45.96	Base or mobile	
46.00	Base or mobile	
46.04	Base or mobile	
47.42	Base or mobile	Reserved for assignment only to national organizations eligible for disaster relief operations.
47.46	Base or mobile	
47.50	Base or mobile	
47.54	Base or mobile	
47.58	Base or mobile	
47.62	Base or mobile	
47.66	Base or mobile	
152.0075	Base	One-way paging to mobile receivers/Intersystem/25 kHz bandwidth
155.1600	Base or mobile	
155.1675	Base or mobile	Bandwidth not to exceed 11.25 kHz
155.1750	Base or mobile	
155.1825	Base or mobile	Bandwidth not to exceed 11.25 kHz
155.2050	Base or mobile	
155.2125	Base or mobile	Bandwidth not to exceed 11.25 kHz
155.2200	Base or mobile	
155.2275	Base or mobile	Bandwidth not to exceed 11.25 kHz
155.2350	Base or mobile	
155.2425	Base or mobile	Bandwidth not to exceed 11.25 kHz
155.2650	Base or mobile	
155.2725	Base or mobile	Bandwidth not to exceed 11.25 kHz
155.2800	Base or mobile	
155.2875	Base or mobile	Bandwidth not to exceed 11.25 kHz
155.2950	Base or mobile	
155.3025	Base or mobile	Bandwidth not to exceed 11.25 kHz
157.4500	Base or mobile	One way paging to mobile receivers/25 kHz bandwidth/Power 30 watts or less
163.2500	Base or mobile	One way paging to mobile receivers/25 kHz bandwidth
220.8025	Base/221.8025	Mobile <Channel 161>
220.8075	Base/221.8075	Mobile <Channel 162>
220.8125	Base/221.8125	Mobile <Channel 163>
220.8175	Base/221.8175	Mobile <Channel 164>
220.8225	Base/221.8225	Mobile <Channel 165>
220.8275	Base/221.8275	Mobile <Channel 166>
220.8325	Base/221.8325	Mobile <Channel 167>
220.8375	Base/221.8375	Mobile <Channel 168>
220.8425	Base/221.8425	Mobile <Channel 169>
220.8475	Base/221.8475	Mobile <Channel 170>
453.0250	Central control, fixed base, or mobile	
453.03125	Base or mobile	Bandwidth not to exceed 6 kHz
453.0750	Central control, fixed base, or mobile	
453.1250	Central control, fixed base, or mobile	
453.1750	Central control, fixed base, or mobile	
458.0125	Mobile	
462.9375	Mobile	
467.9375	Mobile	

Globe Wireless Jumps the Morse Ship

In February of this year, the labor-saving Global Maritime Distress and Safety System (GMDSS) became compulsory on most large, oceangoing vessels. At that point, Morse code telegraphy (CW) became optional. Shippers took the opportunity to cut their payrolls, and Morse consoles ashore became rather quiet places.

In June, one of the last holdouts jumped ship. This was Globe Wireless, operator of an extensive, worldwide network of high-frequency (HF) coastal stations, many of them proud and historic facilities thus saved from the junk heap. According to several company insiders, CW had simply stopped paying its way, and the time had come.

At Globe's four remaining Morse stations (historic ones all), traffic lists and weather broadcasts abruptly stopped. It was announced, tersely, that all HF transmitters and receivers at all stations would shut down all Morse services on 12 July, 1999.

Predictably, this got the Internet rumor machine going, and next thing we knew Globe was supposedly axing its narrowband direct printing (NBDP) services as well. Had this been true, Telex, news, and weather, all in SITOR (Simplex Teleprinting Over Radio) would have closed.

But, at press time, I have been told by a number of sources, in and out of Globe, that this just isn't going to happen. The closures affect only straight CW, and the musical dits and dahs of these old call signs will still be washing over the planet, albeit only as identifiers in SITOR sync markers.

GlobeEmail

Globe Wireless, a descendent of several other radio companies with a combined history back to 1912, continues to expand its electronic mail system. Right now it's all HF, though a recent merger with a satellite mail provider will probably lead to the addition of leased geosynchronous capability.

The GlobeEmail user sits at a standard personal computer, running plain old Windows software that looks like any office e-mail system. The shipside version appears to offer traditional, narrowband Telex as a choice, but on wideband channels the hardware can pass real e-mail, with a full character set and binary attachments. It moves at speeds up to 2400 baud, which is smoking for HF.

Higher speeds are gained with a hot-rod Globe implementation of Clover-II, itself a high-end descendant from the original mode developed by hams and perfected by HAL Communications, an Illinois company. Clover uses every trick in the computer programmer's book to optimize its transmission parameters, on the fly, in real time. For some years now it's been amazing people with its absolute refusal to give up in noisy conditions that would slow SITOR down to practically nothing. On the air, Clover is J2D (single-sideband audio-keyed data) emission, with a very distinctive trill sometimes called a "canary." The amateur versions are easily decoded with high-end hobby gear, but GlobeEmail probably is not.

The Globe network is evolving, but the accompanying tables show its locations and frequencies as of June. May you have fair seas until next month.

Globe Radio Network

Call	Name	Transmit location	Operator / Comments
8PO	Barbados Radio	Caribbean	Barbados External Telecom
A9M	Bahrain Radio	Arabian Gulf	Bahrain Telecom Co.
KEJ	Hawaii Radio	Kahalelani, HI	New station - 1995
KFS/KPH	Dixon Relay Station	Dixon, CA	Formerly Voice Of America
KFS	Palo Alto Radio	Palo Alto, CA	Moving to Dixon
KHF	Guam Radio	Agaña, GM	Barrigada mountain site
KPH	San Francisco Radio	Rio Vista, CA	New site, near Dixon
HLF	Seoul Radio	Republic of Korea	New acquisition - 1998
LFI	Rogaland Radio	Norway	Replaces LGB for radiotelex
LSD836	Argentine Radio	Buenos Aires	New station - 1998
SAB	Goteberg Radio	Sweden	Telia Mobitel
VCT	Tors Cove Radio	Newfoundland, Canada	Stratos Mobile Networks
VIP	Perth Radio	Perth, Australia	Historic NASA tracking site
WCC	East Coast Radio	Delaware	Former Cape Cod Radio, MA
WLC	Rogers City Radio	Rogers City, MI	Great Lakes coverage
WNU	Slidell Radio	Pearl River, LA	First stn was United Fruit Co.
ZLA	Awanui Radio	New Zealand	Rebuilt old stn on historic site
ZSC	Cape Town Radio	South Africa	Telkom SA (RSA phone co.)
???	Planned	China	Mentioned on web page
???	Planned	Malta	Mentioned on web page
???	Planned	Philippines	Mentioned on web page

Published Globe Frequencies

The shore station transmits on the first of the duplex pair, the ship on the second. All are in kilohertz (kHz), NBDP or wideband digital.

SHORE	SHIP	SHORE	SHIP	SHORE	SHIP
8PO		22377.5	22285.5	8426.5	8386.5
4214.5	4176.5	26125.4	25141.5	8435.0	8395.0
6330.5	6284.5			12610.5	12508.0
8433.0	8393.0	KHF		16825.0	16702.0
12615.5	12513.0	6316.5	6265.0		
12680.4	12376.5	8420.0	8380.0	VIP	
16841.5	16718.5	12629.0	12527.0	4213.0	4175.0
17155.4	16569.5	16869.0	16751.0	8419.0	8379.0
19696.5	18886.0	19687.0	18876.5	12582.0	12479.5
19741.4	18862.5	22425.0	22333.0	12584.0	12481.5
22461.4	22187.5			16809.5	16686.0
		KPH		22383.0	22291.0
A9M		4216.0	4178.5		
4219.0	4181.5	6320.0	6269.0	WCC	
8541.0	8302.5	8422.5	8382.5	6334.0	6297.0
12756.5	12403.5	8427.0	8387.0	8424.0	8384.0
17066.5	16557.5	12585.5	12483.0	12589.5	12487.0
19726.0	18853.5	12590.0	12487.5	12624.5	12522.5
		12600.0	12497.5	12598.0	12495.5
HLF		16817.5	16694.0	16817.0	16693.5
4273.5	4188.5			WNU	
6344.0	6298.5	LFI		4210.5	4172.5
8473.0	8371.5	1930.0	2653.0	4336.4	4200.5
8497.0	8374.5	4262.0	4194.5	6327.0	6281.0
12712.0	12469.0	6467.0	6250.5	6431.4	6256.5
12727.0	12472.0	8683.5	8326.5	8425.5	8385.5
17079.0	16678.5	12678.0	12415.5	12607.5	12505.0
19910.0	18823.4	16926.0	16572.5	12670.4	12406.5
				16834.5	16711.5
KEJ		LSD836		22451.8	22220.5
6326.0	6275.0	4326.0	4160.5		
8663.4	8338.5	8459.0	8311.5	ZLA	
12611.5	12509.0	12736.0	12379.5	4211.0	4173.0
16842.5	16719.5	16976.0	16560.5	6315.0	6263.5
26105.0	25177.0	19706.0	18850.5	8417.0	8377.0
				12580.0	12477.5
KFS		SAB		16807.5	16684.0
4211.5	4173.5	4259.0	4166.5	19736.4	18859.5
6315.5	6264.0	6326.5	6275.5		
6436.4	6253.5	8434.5	8394.5	ZSC	
8417.5	8377.5	12624.0	12522.0	4214.0	4176.0
8526.4	8323.5	16851.5	16728.5	6322.0	6271.0
12580.5	12478.0	19708.0	18847.5	8431.5	8391.5
12602.5	12500.0			12601.0	12498.5
13072.4	12382.5	VCT		16816.0	16692.5
16829.5	16706.5	6324.0	6273.0		
17211.4	16608.5	6329.5	6283.5		

Hugh Stegman

Abbreviations used in this column

AFB	Air Force Base	FEC	Forward Error Correction teleprinter system
AM	Amplitude Modulation	FEC-A	European FEC teleprinter system
ARQ	Automatic Repeat Request teleprinter system	M/V	Motor Vessel
ARQ-M2	Two-channel ARQ teleprinter system	MFA	Ministry of Foreign Affairs
AWACS	Airborne Warning and Control System	MWARA	Major World Air Route Area
CAMSLANT	Coast Guard Area Master Station, Atlantic	NATO	North Atlantic Treaty Organization
COMMSTA	Communications Station	Ops	Operations
CP	Command Post	RN	Royal Navy
CQ	General call: "Hello all stations"	RSA	Republic of South Africa
CW	Morse code telegraphy ("Continuous Wave")	RTTY	Radio Teletype
EAM	Emergency Action Message, coded military orders	SAM	Special Air Mission
		UK	United Kingdom
		Unid	Unidentified
		US	United States
		VHF	Very High Frequency, 30-300 MHz
		VIP	Very Important Person
		VOLMET	Flying weather, loosely from French

All transmissions are USB (upper sideband) unless otherwise indicated. All frequencies are in kHz (kilohertz) and all times are UTC (Coordinated Universal Time).

- 288.0 HH-Nondirectional radio beacon at Hoek van Holland lighthouse, in CW at 0916. (Ary Boender-Holland)
- 288.5 YM-Nondirectional radio beacon at IJmuiden lighthouse, in CW at 0917. (Boender-Holland)
- 296.0 GR-Nondirectional radio beacon at Goeree lighthouse, in CW at 0916. (Boender-Holland)
- 3195.0 "R"-Russian Navy single-letter CW channel marker, Ustinov, at 1810. (Takashi Yamaguchi-Japan)
- 3320.0 North Korean female numbers in powerful AM, using the Radio Pyongyang transmitter, couldn't find a parallel, at 1500. (Yamaguchi-Japan)
- 3322.0 R-Russian Navy single-letter CW channel marker, Ustinov, also loud-readable 2 kHz down on beat with Radio Pyongyang, at 2015. (Yamaguchi-Japan)
- 3535.0 Unid station repeating "SBID" in CW, over and over, at 1814. (Yamaguchi-Japan)
- 3595.0 4XZ, Haifa Radio, Israeli Navy, CW markers on new frequency, at 1723. (Yamaguchi-Japan)
- 4472.0 Palm Leaf-US military, working WAR 46, National Joint Alternate CP, and Moonbeam, at 0553. (Jeff Haverlah-TX)
- 4575.0 V-Russian Navy single-letter CW channel marker, Khiva, at 1959. (Yamaguchi-Japan)
- 4622.0 U7AF-Unknown station with CW markers at 1341. (Yamaguchi-Japan)
- 4646.0 V-Russian Navy single-letter CW channel marker, Khiva, at 1959. (Yamaguchi-Japan)
- 4660.0 Unid station with marker "VVV CQ 466.16" in CW, at 1600. (Yamaguchi-Japan)
- 4663.0 Tashkent Volmet-Uzbekistan, Russia, with flying weather, also on 10090, at 1710. (Yamaguchi-Japan)
- 4724.0 Lajes Global-US Air Force Global High Frequency System, Azores, in patch for an unknown station, at 0653. (Paul Bunyan-MO)

- 5245.0 MRC01-Royal Air Force, UK, air traffic control with many planes, at 1040. (Boender-Holland)
- 5422.0 Lincolnshire Poacher, British intelligence, Cyprus, parallel on 6485 and 8464, with numbers at 1900. (Yamaguchi-Japan)
- 5692.0 Rescue 1500-US Coast Guard HC-130, over Bermuda and making a patch to Atlantic Air Command Center via CAMSLANT Chesapeake. Said that the weather was deteriorating badly in a medical emergency aboard M/V *Dark Shield*, making it harder for parachute jumpers to reach the ship, at 0716. (Allan Stern-FL)
- 5696.0 Commsta Kodiak-US Coast Guard, Alaska, working Coast Guard 1703, a C-130 out of Sacramento, regarding arrival time, at 0704. (Perron-MD) Rescue 1500-US Coast Guard, in rescue with M/V *Dark Shield*, went to 5692 for the patch via CAMSLANT, at 0714. (Stern-FL)
- 6215.0 Unid-North Korean female numbers in powerful AM, a rare appearance on this international maritime calling and distress frequency, at 1400. (Yamaguchi-Japan)
- 6379.0 4XZ, Haifa Radio, Israeli Navy, with CW marker, also on 10046, at 1541. (Yamaguchi-Japan)
- 6485.0 Unid-Lincolnshire Poacher, British intelligence, Cyprus, with numbers at 1900. (Yamaguchi-Japan)
- 6575.0 HNC1-Mossad, Israel, a special deep-cover mission-specific broadcast on a frequency also used by Radio Pyongyang's European beam, at 1435. (Yamaguchi-Japan) *Never heard of HNC1. Very nice catch! -Hugh*
- 6658.0 VLB-Mossad, Israel, with abnormal callup "VLB54B26F26T5812" in phonetics for 5 minutes at 1445. MIW2-Mossad, another day at 1515. Also KPA2, Mossad, at 1715. (Yamaguchi-Japan)
- 6730.0 SAM 300-US Air Force VIP flight, in patch to US State Department Operations, then went to Mystic Star F-311 (11220), at 0244. (Perron-MD)
- 6880.0 Gronko 1-Possible callsign of Italian Navy aircraft near Canary Islands, with position report for Tavola 2, at 0204. Tavola 2 made radio checks in English with a US station who was using the NATO trigraph "3-G-Y," then made Italian chatter with Delfina, at 0222. (Perron-MD)
- 6885.0 Unid-"Numbers" station repeating "All stations this is Guangzhou. We are waiting for your messages" in powerful AM and Mandarin Chinese, also on 10750, at 1600. (Yamaguchi-Japan)
- 6900.0 Lincolnshire Poacher, British intelligence, Cyprus, numbers at 2000. (Yamaguchi-Japan)
- 6912.0 The Russian Man-Russian intelligence, numbers in powerful AM at 1615. (Yamaguchi-Japan) *Yeah, this network can throw some*

Clip and mail this ad along with your payment or call us to subscribe or renew to *Monitoring Times*!

Subscribe to *MT* for as little as \$12.95 (U.S. Second Class Mail)



7540 Hwy. 64 W.; Brasstown, NC 28902

1-800-438-8155 US and Can.; 828-837-9200; Fax 828- 837-2216

e-mail order@grove-ent.com

US Rates	6 months	One Year	Two Years	Three Years
US 1st Class	□ \$12.95	□ \$23.95	□ \$45.95	□ \$67.95
Canada Surface*	□ \$28.45	□ \$54.95	□ \$107.95	□ \$160.95
Foreign International*	□ \$19.95*	□ \$36.50*	□ \$69.95*	□ \$103.95*
	□ \$28.95*	□ \$55.45*	□ \$108.95*	□ \$162.45*

*All payments must be in U.S. Funds drawn on a U.S. Bank!

Name _____ Address _____

City _____ State _____ Zip _____ - _____ Country _____

CC# _____ Exp. Date _____

Signature _____

If you are currently a subscriber to *Monitoring Times*, please check your label to determine the expiration date of your subscription. MasterCard, Visa, and Discover Card accepted!

- serious photons around. -Hugh
- 6945.0 The Czech Lady-Russian intelligence Czech-speaking "voice" with numbers in AM, at 1250. (Boender-Holland)
- 6959.0 Unid-Lincolnshire Poacher, UK intelligence, Cyprus, with numbers and musical tune, at 2245. (Ben Loveless-MI)
- 6970.0 The Counting Station-US Central Intelligence Agency, with numbers in reduced-carrier AM, also on 9070, at 1800. (Yamaguchi-Japan)
- 6993.0 Air Force Two-US Air Force SAM 31681, a C-9C with the Vice-President and wife aboard, making patch to SAM CP via Andrews VIP, MD, at 0051. (Paul Bunyan-MO)
- 6998.0 ORA-Bogus callsign of unid CW station, with continuous loop repeating message, "ORA SOS SOS MASSACRI IN KOSOVO BT ORA," a strong and very professional-sounding signal, at 2250. (Geoff Halligey-UK) *Almost certainly our Italian bootlegger friend HWK7 again.* -Hugh
- 7002.0 "V"-Russian Navy single-letter CW channel marker, Khiva, at 1306. Went to 3658 kHz at 1400. (Yamaguchi-Japan)
- 7039.0 "C," "K"-Russian Navy single-letter CW channel markers, Moscow and Khabarovsk, loud but with a dirty, hummy signal and interfering with amateurs, at 1637. (Yamaguchi-Japan)
- 8020.0 "D-1-P" - Unid NATO trigraph, probably US military, with EAM, bad interference from data signal on channel, at 0601. (Haverlah-TX)
- 8037.0 N1G-US Army National Guard, control station for Wisconsin Guard net, working numerous stations, at 1818. Also 4857, 4957, and 5847. (Bunyan-MO)
- 8058.0 SAM 31681-US Air Force VIP flight, enroute to Lajes Air Base in the Azores, calling Andrews VIP, no answer, at 0250. (Bunyan-MO)
- 8188.0 Swedish Rhapsody station-Yet another weird European numbers station, in progress at 1237. (Boender-Holland)
- 8190.0 Architect-Royal Air Force, Upavon, UK, at 1245. (Boender-Holland)
- 8437.0 4XZ, Haifa Radio, Israeli Navy, with CW marker, also on 10046, at 2358. (Yamaguchi-Japan)
- 8453.0 FUG-French Navy, La Regine, France, with RTTY test at 1030. (Boender-Holland)
- 8465.0 VLB-Mossad, Israel, with abnormal callup "VLB16R54B28D1399" in phonetics for 5 minutes at 1445. VLB2-Mossad, Israel, different day, also on 5629, also at 1445. (Yamaguchi-Japan)
- 8495.0 "C," "K"-Russian Navy single-letter CW channel markers, Moscow and Khabarovsk. Once again, K was powerful but with a distinctive hum, at 2030. (Yamaguchi-Japan)
- 8574.0 LBG-Rogaland Radio, Norway, CW traffic list at 1022. (Boender-Holland)
- 8642.0 MGJ-RN Faslane, UK, with RTTY bulletins at 1028. (Boender-Holland)
- 8650.0 SPE42-Szcecin Radio, with CW marker at 1026. (Boender-Holland)
- 8743.0 HSA, Bangkok Radio, Thailand, weather in English and Thai, at 1222. (Yamaguchi-Japan)
- 8894.0 Niamey & Algiers-Both ground stations in the air route net AFI-2 (Africa MWARA), working aircraft at 0114 USB. (Perron-MD)
- 9016.0 Shado 404-US Air Force, attempting several urgent health and welfare patches into the Tinker AFB/Oklahoma City area after a huge tornado. McClellan tried many calls over commercial and Defense Switched Network before reporting the switch was probably down. McClellan wished Shado 404's crew all the best for their families, and went back to 8992 kHz, at 0224. (Haverlah-TX)
- 9023.0 SAM 60204-US Air Force VIP flight, along with SAM 90300, a C-20, both working Andrews VIP, MD, on Mystic Star F-467, at 1412. (Bunyan-MO)
- 9120.0 Nightwatch-US Strategic Command airborne CP, working Venus 7 on "Hotel Fox." (HF). Also did an unheard signal check on "Sierra," probably VHF, at 2045. (Bunyan-MO)
- 9251.0 Lincolnshire Poacher-numbers from British intelligence, Cyprus, in progress at 2143. (Boender-Holland)
- 9264.0 4XZ-Israeli Navy, Haifa, with CW marker at 0200. (John Maky-AR)
- 10202.0 SAM 56973-US Air Force, a C-137C with US first lady Hillary Clinton and daughter Chelsea aboard, working Andrews VIP enroute to Egypt, at 0333. (Bunyan-MO)
- 10240.0 The English Man-Weird English speaking numbers voice, from Russia in AM, at 2112. (Boender-Holland)
- 10352.0 CIO-Mossad, Israel, with abnormal callup "CIO33F46P14L1388" in phonetics for 5 minutes, at 0845. (Yamaguchi-Japan)
- 10536.0 CFH-Canadian Forces, Halifax, NS, with weather in RTTY at 0842. (Boender-Holland)
- 10596.0 1OYF-Unknown station, calling BBNZ in CW, then 5-letter code groups in Cyrillic Morse, at 1010. (Boender-Holland)
- 10780.0 JV 870-US Navy C-9 flight enroute Jacksonville, FL, getting weather from Cape Radio, Cape Canaveral, FL. Followed by a patch via the Cape to Patrick AFB Base Ops, who refused landing permission for gas 'n' go. Sent to MacDill, farther south, for fuel, then back up to Jacksonville. All this at 2302. (Stern-FL)
- 10871.0 "C," "S," "P"-Russian Navy single-letter CW channel markers, Moscow, Arkhangelsk, and Kaliningrad, at 0634. (Boender-Holland)
- 11175.0 Navy 49676-US Navy VP-3C, with CINCLANT (Commander in Chief, Atlantic) aboard, at 0208. JGO 85-US Joint Guard Operations aircraft, patch via Ascension to CP, at 0302. (Perron-MD) NATO 49-an E-3 AWACS, in patch via Thule to US Air Force, Europe, at 0400. (Perron-MD)
- 11270.0 The Russian Man-Russian intelligence numbers in AM, at 0820. (Boender-Holland)
- 11387.0 Bombay Volmet-India, flying weather at 1020. Calcutta Volmet-India, flying weather at 1035. (Yamaguchi-Japan)
- 11554.0 The Polytone Station, probably Russia, with weird tones at 0600. (Boender-Holland)
- 12178.7 WGY908-Federal Emergency Management Agency Alternate Net Control, Denver, CO, in signal checks with WWJ71 (Federal Highway Administration, WI), WWJ85 (FHWA, IA), and WWJ98 (FHWA, ID) on what they called "F-41," at 1501. Went to F-35 (11045.0) to check there too, at 1513. (Bunyan-MO)
- 12984.0 4XZ, Haifa Radio, Israeli Navy, with CW marker, also on 10046, at 0009. (Yamaguchi-Japan)
- 13024.5 ASK-Karachi Radio, Pakistan, with a hand-sent CW marker at 0748. (Yamaguchi-Japan)
- 13161.0 HLS-Seoul Radio, South Korea, with Beethoven's "Ode to Joy" between phone patches, at 0009. (Yamaguchi-Japan)
- 13454.0 The Polytone Station, probably Russia, with weird tones at 0620. (Boender-Holland)
- 14654.0 The Polytone Station, probably Russia, with weird tones at 0640. (Boender-Holland)
- 14750.0 CIO-Mossad, Israel, with abnormal callup "CIO33F46P14L1388" in phonetics for 5 minutes at 0745. (Yamaguchi-Japan)
- 14890.0 The Russian Man-Russian intelligence numbers in AM, at 0800. (Boender-Holland)
- 15016.0 Shark 75-US Air Force, probably a C-130, in patch to Raymond 9 (Air Combat Command, Howard AFB, Panama) to relay arrival weather from Lobo (Howard CP), at 2135. (Perron-MD) *I've read that this mission is moving to Puerto Rico.* -Hugh
- 15094.0 SAM 60203-US Air Force VIP flight, enroute to Hickam AFB, HI, in radio checks with Andrews VIP on F-382, then went to F-467 (9023), at 0339. (Bunyan-MO)
- 15650.0 The Counting Station- US Central Intelligence Agency, numbers in reduced-carrier AM, at 0104. (Gary Neal-TX)
- 15993.0 Unid-probably The Spanish Lady, Russian intelligence, with numbers in AM at 0107. (Neal-TX)
- 16193.2 RFQPA-French Air Force, Djibouti, with code groups for RFFUGO (French Air Force, Eascadachas, Orange) in ARQ-M2, at 0855. (Hall-RSA)
- 17463.0 Unid-FAPSI (Russian government comm and intelligence office. -Hugh) with RTTY numbers on "link 10163," at 0858. (Hall-RSA)
- 17474.7 GSLMDRS-Boustane, New Delhi, India, with code groups in ARQ, marked "Most Immediate to BEDEL (Cairo?) - AT ONCE," at 1520. (Hall-RSA)
- 18003.0 Reach 3076-US Air Force Air Mobility Command transport, with patch via Andrews to Hilda West (AMC control center at Scott AFB, IL), at 1730 (Bunyan-MO)
- 18006.0 Notebook-US Air Force, with secure data for Andrews Global, on this discrete frequency, at 1818. (Bunyan-MO)
- 18024.0 Militian?-Possible callsign of US military aircraft, passing data to Andrews Global on this discrete frequency plus 15097, 17973, and 18006. This might have had something to do with Operation Allied Force, which was just starting then, at 1915. (Bunyan-MO)
- 18026.7 YKJWL-Egyptian Embassy, Bamako, with Arabic ARQ traffic to MFA Cairo (routing code KDKTXKE), unlisted frequency for them, at 1650. (Hall-RSA)
- 18055.0 DFZG-Serbian MFA, Belgrade, encrypted messages in RTTY, at 1617. (Hall-RSA)
- 18360.0 RFGW-French MFA, Paris, with nine pages of code groups to embassies, in FEC-A, at 0630. (Hall-RSA)
- 18972.0 DFZG-MFA, Belgrade, encrypted messages in RTTY, at 0851. (Hall-RSA)
- 20556.6 P6Z-MFA, Paris, with message to all embassies in FEC-A, at 1615. (Hall-RSA)



Stan Scalsky
sscalsk@mail.ameritel.net

Mike Chace

Robust Romania

This month we profile the Ministry of Foreign Affairs (MFA) of Romania, which transmits from the capital Bucharest to many of its embassies and consulates worldwide.

For many years the Romanians have used a relatively simple but interesting home-brewed system which has been named ROU-FEC (Forward Error Correction). ROU-FEC (also called RUM-FEC by some decoder manufacturers) is available as standard on all Hoka and Wavecomm decoders.

What makes ROU-FEC so interesting is its incredible robustness. One can tune in a relatively weak signal, accompanied by heavy static, fading and other disturbances, and still receive superb error-free text. The reason? Like most other FEC digital systems, ROU-FEC sends message data together with information that allows the received data to be checked for correctness. However, it also spreads each individual bit of data across a period of time, in a known pattern or interleave. Hence, a brief burst of noise may corrupt one portion of the message, but the decoder can still recover the message because the individual data bits are separated in time.

What makes ROU-FEC so different from other FEC systems is the length of the interleave – 128 bits to be precise. The drawback of separating the bits of a message over time? A time-lag in decoding, as a good decoder has to wait for each bit over a span of 128 bits. To make up for some of these delays, ROU-FEC sends data at the relatively fast speeds of 164.5 and 218.3 baud.

Facts and Frequencies

MFA Bucharest uses a “fictitious” or “tactical” call sign of V5G, which doesn’t conform to International Telecommunications Union call sign assignments. V5G broadcasts to lists of embassies designated by two- or three-digit identifiers using 164.5 baud ROU-FEC.

These broadcasts, in Romanian and English, and frequently including news, occur daily on a number of frequencies and are easy to copy in the US and throughout the world. The embassies are more elusive, replying or sending their own traffic on separate frequencies invariably using 218.3 bd

ROU-FEC.

Table 1 contains a list of commonly used frequencies for MFA Bucharest.

Table 2 shows a typical message from V5G to a list of embassies. Note the signature “:” lead-in to a new message.

Table 1: MFA Bucharest

All frequencies kHz
10557 11427 13446 13483 13879 14681
14688 15833 16332 16342 17478 18762
18552 19391 19400 19989

Table 2: Typical V5G message

:
v5g v5g v5g msg nr. 567 qft 1 fr p: 1 2 3 4
5 6 7 8 9 11
12 13 14 15 16 17 18 19 20 22 25 29 31 35
36 38 39 40 42
48 50 52 53 56 57 59 61 62 70 73 75 76 77
78 81 82 83 85

ministerul afacerilor externe
nr. h-02/15132 din 29.12.1995/16,00
radiograma - circulara
domnule sef de misiune,
referitor la procedura de preschimbare
de catre cetatenii
romani aflati temporar in straintatate a
pasapoartelor simple
a caror valabilitate a expirat, va reamintim
urmatoarele:
[and so on]
567

Decoding the system

As a beginner, decoding ROU-FEC can be tricky for three main reasons. Firstly, remember the long interleave. On Hoka decoders, text won’t appear on-screen for about 10 seconds after the signal is tuned-in, so don’t expect instant results.

Secondly, ROU-FEC is sensitive to mark level (the “M” key for Hoka users). Most transmissions use the default M=0 setting.

Thirdly, a technique called bit-masking is often used, making a message in the clear look like scrambled garbage with the wrong mask selected. Hoka users fortunately have the “>” and “<” keys to increment or decrement the mask by 1 bit. Once you’ve tuned-in a ROU-FEC signal, here’s a pretty fool-proof method of making ROU-FEC work

on Hoka decoders.

1. Listen for the transmission to go into idle condition denoted by the change from a rough, scrambled sound to a steady, repeating rhythm.
2. If you see no text being printed and the two-headed vertical arrow symbol in the upper left of the screen illuminated, you’re set.
3. If you see a continuous stream of the letter “r” being printed, press the “M” key to select the correct mark level, and you’re set.
4. If you see a continuous stream of a letter other than “r”, the signal is being sent with a bit-mask. Press the “>” key to increase the bit-mask by one until the same result as 2) above is achieved. A bit-mask of 24 is most common, but 16, 15, 18, and 11 have also been used.
5. If none of the above produce clear text, the message is encrypted.

If you catch a signal in mid-stream, our advice is to first let text appear to remove the decoding delay, keep the mark level setting at 0, and then set the bit mask to 24. If no plain-text is seen, press M to set mark-level to 1, leaving the bit mask at 24. After the decoding delay, plain-text should be seen. If not, you’ll have to cycle through all 32 bit-masks with mark level set to 0, and then again with it set to 1.

Happy monitoring!

Motron PO Box 2748
Eugene, Oregon 97402
ELECTRONICS (800) 338-9058

DTMF Decoder/Display w/ASCII Conversion
DTMF & Rotary Test Decoder
TxID Transmitter FingerPrinter Board & Software
TxID TxPorter Mobile Adaptor
DTMF to ASCII & ASCII to DTMF Transceiver
Remote Relay Controllers & Relay Boards
Custom OEM Design & Manufacturing
Product Catalog With Full Color Photos
Available Online At:
Http://www.motron.com/
Information also available by Phone or Fax:
Tel: (541) 687-2118 Fax: (541) 687-2492

Arne Skoog 1913-1999

Arne Skoog, a pioneer in international broadcasting and the DX community, passed away on June 7, 1999, in his beloved home province of Jamtland.

In 1948, Arne, then a young engineer at Radio Sweden, founded *Sweden Calling DXers* as a way of keeping listeners in touch with news in the world of international radio. Shortwave came into its own during the Second World War, and after the war shortwave listening became a popular hobby. But hobbyists needed access to the latest news, and Arne felt the best place for them to find out was on a shortwave station.

Many hobbyists say they remember Arne presenting *Sweden Calling DXers*, which is curious, since he never did. Arne wrote the scripts, which were read by colleagues, first by the English Service, and then in all of Radio Sweden's languages – except, ironically, Swedish.

Initially Arne gathered all his own news for the program, but soon listeners were writing in with material for the program. Almost immediately a written version of the program scripts was being mailed out to everyone who contributed. At its height there were between 1500 and 2000 names on the list, and they constituted a "Who's Who" of the shortwave community.

When Arne retired in 1978, on the program's 30th anniversary, George Wood (who wasn't even born in 1948) took over. But changing times and new Radio Sweden management led to radical changes with the introduction of satellite broadcasting in the 1980s.

The mailing list was discontinued, and the program became a twice-a-month English-only program called *MediaScan*, which concentrated more and more on satellite DXing and general Scandinavian media news.

Arne passionately objected to the changes and tried to find support to reverse them, but Arne was no Luddite fighting the advance of technology. An engineer at heart, he embraced the arrival of the



personal computer, and while he had dismissed satellite broadcasting as inferior to shortwave, Arne hailed the arrival of broadcasting over the Internet.

Arne Skoog was also one of the founders of the Swedish DX Federation and the European DX Council.

In his retirement, Arne turned to his second pastime, violin-making, for which he was quite respected. He taught many courses in the skill.

Radio Sweden invites those who have been touched by the pioneer broadcaster and DXer to send their comments to its discussion board: Radio Sweden Talkback. (R. Sweden website via John Norfolk)

Merlin Network One Goes Bust

For one week in May, MNO cut back its extensive SW schedule to 24 hours, one frequency at a time. Then it was gone after May 28, except for one remaining paid program – ironically, not rock music and not British – the misogynistic Roy Masters' *Foundation for Human Understanding* also heard on American MW stations. Mike Barraclough observed this at 1600-1700 M-F only via Skelton 6175. MNO's satellite service is apparently continuing and they are talking about putting the network out on the internet.

We thought it would be interesting to see how and if Eric Wiltsher explained the drastic cuts – he had been such a promoter of SW, though always regarding it as secondary.

Then came word from Wiltsher via Voice of America *Communications World* that he was leaving Merlin, but his *Media Zoo*, mainly about satellites, would continue through June 30. SW will re-expand, but only with programs which are paid for. At press time nothing had come back.

It appears that MNO was greatly overextended, using up spare BBC transmitter time, and eventually it had to crash.

ANTARCTICA I received a nice full-data, signed QSL card and form letter from LRA36. The cover even had penguin stamps and a station cachet postmark. The schedule is listed as M-F 1800-2100 UT, Sa/Su 1700-1900 UT. However, Sunday June 6 I tuned by and found them up at 2215 with a soccer game relay (same one being carried by RAE-15345), announcements and ID at 2220, then open carrier to 2236 off. This is a good reason to check for extended operations on weekends (John Cobb, GA, *World Of Radio*) 15476

ARGENTINA New SW feeder outlet 5400.0 LSB heard at 1105-1210* with Feeling FM 100.7, Buenos Aires and the next day at 1058-1103 with R. Rivadavia. After 1211 back on 15820 (Takayuki Inoue Nozaki, Japan)

R. Fósil, Rosario, 6988.1v, previously on 6950, Sun 2200-0100/0200 Mon, says it's a "fun" station playing "fossilized music of the '70s" (Nicolás Eramo, Argentina, *Conexión Digital*)

BENGAL EAST and WEST [non] *Jiban Tarango* (English: "Wave of Life") is a pentecostal program from IBRA Radio in Stockholm, via Tashkent, Uzbekistan, 1330-1355, 240 kW 130° on 15470 (winters around 7400). Despite frequent references to the Qur'an and Islamic traditions, these are Christian programs, with an address in Calcutta (Dr. Hansjörg Biener, Germany, *BC-DX*)

BOLIVIA A recent addition to my Patepluma website is a 1 meter square military map of Bolivia that I purchased there in 1985. The map was scanned to 21 different jpeg files totaling about 10.5 megs. It is very detailed and should be a help to anyone DXing Bolivia. Goto my website at <http://www.swl.net/patepluma> and follow the link from the main menu (Don Moore)

CANADA 6070 - CFRX: Previous chief engineer Clive Eastwood says the CFRX transmitter is a Bauer 707 1 kW unit with 4-400C's in modulator and final stage. The 707 features a silicone oil-filled modulation transformer and overload relays that set a flag when one trips. The call letters CFRB stand for Canada's First

Rogers Batteryless, as the table top radio that runs off AC mains is a Canadian invention (Bill Sitzman, *Cumbre DX*)

The recent temporary off-air spell of CFRX in early May has attracted some attention. I contacted Steve Canney, current president of the ODXA and QSL manager of the station (not a representative of CFRX or CFRB). Here are Steve's comments:

"If anyone wants info on CFRX, they can see it on our web page www.durhamradio.com/odxa/cfrb.html. The antenna is a single vertical and isn't even near the big CFRB antennas. There used to be two phased verticals focusing on the northern parts of Ontario but that antenna died many years ago.

"For some reason, the circuitry for the voice IDer didn't kick in but it cut the CFRB audio, leaving an open carrier for about a week. That's like having the mic on and leaving the studio for a week! Ian (the site engineer) only goes out to the site on Tuesdays... Because CFRX isn't a big priority, they don't regularly monitor at the downtown location – even though they have an R-5000 receiver ... bought specifically to monitor CFRX. It takes people like us to call them, and even then, they wouldn't be rushing out there unless the site was on fire! (via John Grimley, *Cumbre DX*)

CENTRAL AFRICAN REPUBLIC R. MINURCA had transmitter trouble but resumed 9900 kHz with 500 watts from Bangui, in addition to low power on 9500 and 5900. Reports are wanted from anywhere abroad. 9900 was to be boosted

to 1 kW in June, and hopefully to 20 kW in preparation for presidential elections tentatively scheduled for Sept. Reception reports will be confirmed with a QSL card (David Smith, Radio MINURCA, B.P. 2732, Bangui, Centrafrique or smith2.unep@un.org via Georges Lessard, DEVMEDIA, via Don Moore)

CHINA [non] CRI confirms Cuba frequencies. I (finally) received a response from the China Radio International engineering department, for

*All times UTC; All frequencies kHz; * before hr = sign on, * after hr = sign off; // = parallel programming; + = continuing but not monitored; 2 x freq = 2nd harmonic; A-99=summer season, Mar-Oct; [non] = Broadcast to or for the listed country, but not necessarily originating there.*

an e-mail inquiry about the relay frequencies [5990, 9570]. "The two frequencies are testing via Cuba; we hope you send comments on the reception and programings. Sincerely, English Service" (Maryanne Kehoe, GA, *Cumbre DX*)

COLOMBIA FARC clandestine VoZ de la Resistencia, 6240 heard at 1515 and "2015-2100" with better signal in Popayán than in Cali (Yimber Gaviria, Colombia)

R. Patria Libre: On May 20, [Colombian media] quoted a Colombian army press release saying that the army had busted an ELN "communications center," including transmitter, studio equipment, tapes, coax cable, antenna wire and batteries, in the vicinity of the little town of Santa Ana, located in a mountainous area of northwestern Antioquia Department, in an area controlled during the past sesquidecade by the Carlos Alirio Buitrago guerilla front, which, in mid-May, was forced to disperse following an army onslaught. One day later, another cable identified the transmitter site as that of R. Patria Libre, the ELN radio station which was set up by the Spanish priest Manuel Pérez, who was the organization's leader at that time. It had been around 6250 (Henrik Klemetz, Sweden, NU via DSWCI *DX Window*)

COSTA RICA RFPI has given up on carrying Pacifica News, due to \$2000 cost for affiliation required, and 3-4 hours of downloading it took to get the half-hour show. Instead, RFPI is starting its own production, *Progressive Network News*, M-F at 2200, repeated at 0130; includes Kosovo report and Chiapas news. RFPI-produced programs uploaded by 2300 weekdays to <http://www.rfpi.org/webcast.html> (RFPI *Mailbag*)

(Ulis Fleming) Notes from a visit here: 5119 - Radio Alajuela is still putting out a harmonic but it is much weaker than before.

6075 - Estereo 88 claimed to be on shortwave when I spoke to them, but I did not hear them during my entire stay in Costa Rica. The Director of Control Nacional de Radio tells me that he is unaware of them having a license for shortwave.

6105 - Radio Universidad is operating irregularly with station personnel seemingly ignorant of the shortwave operation. Their signal is weak even in Costa Rica.

Radio Reloj is off shortwave for the moment. Reloj stopped using 6006 a few years ago due to an RFI complaint from a local shotgun-carrying woman. The same woman has now complained about 4831 so the station has taken it off as well. The station plans to return to shortwave soon. This per Melvin Murrillo, Director of Control Nacional de Radio (Ulis Fleming, *Cumbre DX*)

5954.1 - Radio Casino daily now, but always weak. Sign on with anthem at 1030 give or take a few minutes and always heard with a single male announcer. Always with local music programs from sign on until typical fade at 1050 or so. Usually on 5954.16 on my radio, but has been as high as 5954.3. Runs open carrier from shortly after 1000 until sign on (Hans Johnson, FL, *Cumbre DX*) Running less than 1 kW. They are only allowed to broadcast from 1030 to 0000 UT. On August 18th they will be celebrating their 54th anniversary (Ulis Fleming, *ibid.*)

CUBA RHC's *DXers Unlimited* was playing the tape backwards, at 0330 one Wed in May but was forwards at 0130 (George Thurman, TX, *Review Of International Broadcasting*) Dead giveaway station is still using reel-to-reel tape and no one is paying attention; any secret messages heard?

[non] For info on the administrative and programming crisis at Radio Martí visit http://poliscl.home.mindspring.com/crisis_at_radio_marti.html (Armando F. Mastrapa, *rec.radio.shortwave* via John Norfolk, OK)

R. Martí, Delano, on new 21500 at 2100-2200 only; checked this around 2150 and Cuban bubble jamming had already attacked it. However, due to larger skip distances on higher bands, I expect Cuba cannot skywave-jam this; should have used this band long ago, but IBB can only be dragged kicking and screaming into 13m! I'm not really complaining, since that means less QRM to other stations (gh)

ECUADOR 4815v - Radio El Buen Pastor: Jim Travis & Jerry Adams reported that the Collins 820-D1 is now back to 1000 watts. The modulation is more consistent since they installed a GRL 440 AGC amplifier ahead of the 220 MHz STL. They also found the main filter capacitor in the 3200 V power supply disconnected! The three of us will have to find replacement servomotors for PA tuning and loading, as both indicated open windings. Collins built the rig as if it were a piece of aviation or military gear. Mechanical tuning would have been much simpler. All of the contractors which start the various power supplies are 24-Vdc, while most transmitters employ 120 or 240-Vac units, much more available at local electrical suppliers. The station's current schedule is 1200-1500 and 2200 to 0300 (Bill Sitzman, *Cumbre DX*)

ETHIOPIA [non] V. of Oromo Liberation, 15715 via Germany in Oromo/Amharic, 1700-1800 on Thu, Fri, Sun, or "SBO" in Oromo for *Sagalee Bilisumma Oromoo*, has RealAudio archive at http://www.visafric.com/Dimtisi_hafash.htm (BBC Monitoring)

FINLAND [non]. You can read YLE's weekly Latin news broadcast on the CBC's web site at: <http://www.cbc4kids.ca/general/whats-new/latin-news/mainlatin.html> Also includes an English translation and interesting comments. CBC Radio's overnight service carries YLE, which explains the connection. Example:

JACQUES CHIRAC FINNIAM VISITAVIT - Praesidens Francogalliae Jacques Chirac die Lunae in Finniam venit cum praesidente Martti Ahtisaari de rebus Europaeis collocuturus. Postridie eius diei Chirac diurnariis narravit Finniam et Francogalliam consultationes inituras esse, quibus systema defensionis Unionis Europaeae commune adumbraretur. Paavo Lipponen, primus minister Finniae, ait suam patriam, quamquam membrum consociationis NATO non esset, omnia sua ad Europam defendendam facere velle.

Nuntii Latini via YLE can be heard on SW near the end of the their 1/2 hour English broadcast, in the case of NAM, Saturdays at UT 1253 on 15400 & 17670. Also on CBC Radio Mondays at 3:53 AM local time. Also available in Real Audio at their website <http://www.yle.fi/fbc/latini/recitatio.html> (Ivan

Grishin, Oshawa, *Review Of International Broadcasting*)

FRANCE RFI English service after 1200 on 15195 was noted with lots of audio artifacts; sounded nearly like a "Real Audio" feed. I hope that the usage of MPEG with low data rates for broadcast purposes will not escalate. These artificial noises are much more unpleasant than natural white noise, hum, crackling and so on (Kai Ludwig, Germany)

GERMANY Deutsche Welle revamps *DW Plus* magazine. The June 1999 issue contains extensive editorials telling readers that it is endeavouring "to inform you even more fully and vividly about DW-tv and DW-radio's programmes." There is a problem, however, in that there is absolutely no information given at all about DW's non-German shortwave programs! No schedules, no details, nothing! (Bob Padula, *Electronic DX Press*)

Deutsche Welle black-out. June 4 the DW radiohouse at Cologne suffered a complete main power failure, resulting in a loss of all transmissions for nearly 12 hours. The main power switching facilities in the basement caught fire after a short-circuit. Nobody was injured (Ostdeutscher Rundfunk Brandenburg via Kai Ludwig, Germany)

GREECE V. of Greece at 0000-0350 to NAM is on 12105 ex-15630, but still //11645, 9420, 7450 (Joe Hanlon, PA, *World Of Radio*)

IRAN [non] R. Iran of Tomorrow now has a web site <http://www.ri-ot.com> with audio; broadcasts daily 1700-1730 on 5830 (A. Khatarni)

ISRAEL Kol Israel changed beaming of 11605 in English at 0400 to favor WNAW at 334°, the same as in Hebrew on 15640 at 2115-0500. Additional changes in KI broadcasts to WNAW are expected in the next broadcast season beginning 1 November (George J. Poppin, Technical Monitor, San Francisco, *World Of Radio*)

KOSOVO [non] As from Friday 11th June, a Radio Netherlands transmitter in Flevo is carrying two hours of programming from Radio 21, the exiled Albanian-language station from Pristina, capital of Kosovo. The transmissions are arranged in cooperation with Press Now, an organization set up to support the independent media in the former Yugoslavia. The transmitter will be on the air at 1827-2025 UTC on 9495 beamed to Eastern Europe. Radio Netherlands is "not" responsible for the content of these programmes. QSLs are not available. An English newscast is included at approximately 2015 (Andy Sennitt, *swprograms*, std disclaimer) Blocked here by WHRI, longtime user of 9495 (gh, OK)

LITHUANIA On May 7, Lithuanian Radio added about an hour of broadcasts daily via the Sitkunai HF station in Central Lithuania. Broadcasts are compiled from 1st and 2nd Home Service programs, and are on the air Monday to Friday 1330-1435, Saturdays and Sundays 1330-1425. The frequency is 9555.

On April 1, 1999, the station installed a new 100 kW Continental 418F transmitter which replaced the old 50 kW unit. The new transmitter is now used for all HF broadcasts originating from Sitkunai, i.e. daily 0900-1200 (carrying Lithuanian Radio), Sat 1330-1325 (Lithuanian Radio), and Sun 1200-1425 (Universelles Leben and Lithuanian Radio).

Broadcasts before 1330 are beamed at 259 degrees via newly installed curtain antenna HR2/2.5 (which is non-reversible), but after 1330 they are routed to the old curtain antenna HR4/4.5 and beamed at 79 degrees (the old antenna is reversible and can operate both at 79 and 259 degrees). Because the old antenna can not handle 100 kW of power, the output power of the transmitter is reduced to 50 kW after 1330. Broadcasts starting at 1330 are meant for listeners in Russia and Belarus; therefore the majority of the programming is not in Lithuanian. (Sigitas Zilionis)

MALTA [non] Voice of Mediterranean on Suns via Santa Palombara, Italy, 11770 in English retimed to 0800-0900 (ex-0930) (Edwin Southwell, UKoGBaNI, DSWCI *SW News* via BC-DX) On usual 11770, and //via unID site 9815 (Rumen Pankov, Ivo Ivanov in *Panview*, via BC-DX)

It was reported already a while ago, but I assume it is still the case, that VoM has no circuit outputs; they not even had a feed to the closed DW transmitters; instead the tapes were taken to the site and played there, according to a German press feature in some cases after a treatment with the scissors. So it is rather likely that 9815 originates from Prato Smeraldo too (Kai Ludwig, Germany)

MONGOLIA VOM 1500-1530 English is being heard here on the second harmonic, 19440 (Ian Wadman, UKOGBANI, June World DX Club *Contact*)

NAMIBIA NBC now has its own website at <http://natradio.iml.org.na/> which is so personality-oriented that there are photos of the board members, profiles of the on-air personalities, but nothing about how you can actually tune them in! (Andy Sennitt, DSWCI *DX Window Caught in the Web*)

DX Listening Digest

More broadcasting information by country compiled
by Glenn Hauser

Review of International Broadcasting

SW Programming, opinion, equipment, satellite monitoring.

Samples \$2.50 each (outside North America US \$3 or 6 IRCs)

10 issue subscriptions \$26 in USA, or both for \$49

Glenn Hauser, Box 1684-MT, Enid, OK 73702

NEW ZEALAND [non] Whilst enjoying RNZI's classical music on *Cadenza*, at 0126 on 17675 (despite – not because of – the rolling fades some diehard SWLs say add to the experience), a far greater problem appeared out of nowhere: Dr Gene Scott. By 0127 R. Nederland's ID signal joined him to mess with RNZI. This was on the Yachtboy 400, which was connected to an external outdoor antenna, but not overloaded until this moment.

Unplugged it in favor of indoor reel-out antenna, and still the mix though somewhat lessened. Only by going to the whip alone did it disappear, but RNZI's signal level also dropped too much. This was doubtless mixing produced within the receiver, and I soon figured out the unwitting culprits: RN which had just opened Dutch on 11865 from Bonaire; and KAIJ 5810 Dallas, which when summed, equal 17675. Oh, for valve receivers! (gh)

NICARAGUA [non]. AWR Costa Rica, 15459.5, heard on a Sat until 2331* with program produced in Nicaragua; any further info? (Harald Kuhl, Denmark) Heard the same day, also on //13750 with Managua programs from 2300 including *Así es Nicaragua* from 2320. Address is Apartado Postal 92, Managua; or radventista@netport.com.ni (Yimber Gaviria, Colombia, *Noticias DX*)

PERU R. Amistad is a new SW station in Lima on 4655, heard at 2300-0500. Contact info: Sr. Manuel Mejía Barboza, Radio Amistad, Manzana I 11 Lote 6, Calle 22, Urbanización Mariscal Cáceres, San Juan de Lurigancho, Lima, Perú. Phone: 51-1-392-3640 E-mail to me and I will pass it on: alfca@mailexica.com (Alfredo Cañote, Perú, *Conexión Digital*)

R. Sudamérica, 5523.3, 2230-2310 June 4, reactivated after sabotage of its equipment last December. Now using new Slogan: "Radio Sudamérica, la Inmortal" (Rafael Rodríguez R., Bogotá, Colombia)

6955.5 at 0430, Rdif. Paratón, Huarmaca, now here ex-6676 with chicha music and frequent timechecks, heard past 0530. Thanks to Peter Grenfell who alerted me after chasing pirates as usual (Paul Ormandy, Oamaru, New Zealand, *hard-core-dx*)

RUSSIA In mid-April, Pavel Mikhailov, the editor and presenter of *VoR DX Klub*, my DX friend since 70s was hospitalized after a heart attack. His program was missing the following four weeks (Rumen Pankov, Bulgaria, *BC-DX*)

The Voice of Russia will celebrate its 70th anniversary on October 29th. During the coming months they will be broadcasting special programs, "about the history of our radio station, our veterans and aspiring journalists, announcers and technicians. In our anniversary programs we'll be reading from your letters so that we all have a better chance to know what our listeners really think about our work. The winners will be awarded special prizes and souvenirs bearing our company's logo." More info, and an online contribution form, can be found at http://www.vor.ru/forum/forum_eng.html (Andy Sennitt, DSWCI *DX Window Caught in the Web*)

SEYCHELLES Government has a reclamation project in Mahé; flat new land to be created for housing in the bay where FEBA masts are located, affecting its broadcasting (FEBA via Worldwide DX Club via *BC-DX*)

SPAIN REE sked shows News in Catalan/Galician/Basque, which used to be several times a day, only at 2200-2230 Mon-Sat, on 7270, 7275, 9595, 9765-CR, 11880-CR, 15110-CR, 15170, 17575. And the special Spanish program for Equatorial Guinea is Mon-Sat 1600-1700 on 15375, 17755 (BBC Monitoring)

SRI LANKA Here are the actual REGISTRATIONS for the new IBB (US Int'l Broadcast Bureau) Iranawila relay. The project is much belated. The original test planned dates for November 1997 (!) The list shows up to four transmitters at a time. The station didn't carry tests with the regular program, except some rare tone tests.

At present a lot of the listed transmissions are coming from different IBB sites in A99, like from Ekala, the other Sri Lanka site; Germany, Morocco, Greece, Spain, Philippines, Thailand, and UKoGBaNI.

Voice of America				Radio Liberty			
kHz	UTC	Lang	Deg	kHz	UTC	Lang	Deg
5955	1330-1500	KHME	073	6035	0100-0130	URDU	356
6120	1500-1600	VIET	073	7115	0100-0300	ENGL	334
7130	2200-2230	KHME	073	7130	2230-2330	VIET	073
7140	0030-0100	HIND	356	7215	1400-1800	ENGL	356
7235	0300-0430	FARS	332	7255	0400-0600	ARAB	310
7265	0200-0230	DARI	356	7275	0130-0200	PASH	356
9505	2330-0000	BURM	057	9535	1230-1330	LAO	065
9590	1600-1700	BANG	033	9595	1800-1900	TURK	310
9605	1800-2100	ARAB	299	9680	1700-1900	FARS	340
9720	1130-1230	BURM	057	11875	0800-1000	RUSS	356
15185	1330-1430	URDU	340	15205	1300-1400	RUSS	356
15245	1500-1545	UZBE	340				
7155	0430-0630	PERS	332	7245	2100-0000	RUSS	356
9615	1600-1700	PERS	334	9625	2300-0000	KAZK	340
9660	0200-0400	UZBK	340	9680	1600-1700	TUKM	340
9715	0000-0100	KYRG	356	9745	0100-0200	KAZK	348
11815	0600-0800	RUSS	356	11825	1700-1800	UZBK	340
11855	1100-1200	KAZK	332	11875	1000-1100	RUSS	356
11925	1900-2000	TABA	340	15205	1100-1300	RUSS	356
15340	1500-1600	KYRG	356	15355	1200-1300	KYRG	332
15355	1300-1400	UZBK	340	15370	1400-1500	TUKM	340

(IBB via Uwe Volk, *BC-DX*)
 Clandestine: Voice of the Tigers: They have been on for a few months, 7460 at 0100-0230, 7382 at 1400-1530, all Tamil and unjammed. Probably 1-2 kW located in the north of the country. (Victor Goonetilleke, Sri Lanka, 4S7VK, UADX, via RNMN via *BC-DX*)

THAILAND Or Sor (Dusit Palace) 0330 sign-on, into usual weekday morning sequence of English-language nursery rhymes and children's songs performed

by Singaporean or Malaysian-sounding choir. Station has a very eclectic taste in music. The King of Thailand is well known to be a jazz enthusiast, which probably explains the large amount of jazz played. Fair on approx 6149.5, but // 1332 and 104.0 MHz probably give useful reception over a larger radius, especially in the evening when the channel is swamped by Singapore on 6150. Usual sked remains 0330-0500 and 0900-1200 Tues-Sat and 0230-0500 Sun, but occasional minor variations often noted (Alan Davies, Bangkok, *Electronic DX Press*)

UKRAINE RUI, 9560, 0000-0058: English news, commentary, local pops, choral church music. Fair. Much weaker on //5905, 6020. 9560 covered by R. Budapest *0058 (Brian Alexander, PA, *World Of Radio*)

UK o G B a N I Radio Free London has been making it to Michigan on 15069. Try 03-05. Heard 15069kHz 0411-0530 clear IDs, British rock music, fading up and down, barely audible at 0230, 0540. Claimed 24 hour test, 70 watts. My first decent Euro-pirate reception. Also heard another night at 0300-0430 (Larry Russell, MI, MARE) Also my first Euro-pirate, faded in briefly at 0522-0530 on 15068.66 (Volodya Salmani, Victoria, BC) 15070 used to be a prime BBC frequency they were forced to vacate; helps to be illegal

UNITED NATIONS The 21st Session of the UN Committee on Information ended on May 14. Kensaku Hogen, Under-Secretary-General for Communications and Public Information, said in his closing statements that the UN Department of Public Information is committed to improving its international radio broadcasting capacity. The question of resources, however, is key. For the development of a shortwave radio broadcast capacity, the estimated cost would be at least \$4 million a year for several years, to be provided from extrabudgetary sources. He added that so far no UN Member State has offered to contribute resources. A pilot project will not be launched before the question of its financing is resolved. The UN Committee on Information will meet again later this year for discussing a report about the improvement of the UN's internet activities (Harald Kuhl, Germany, *Cumbre DX*)

USA 11900 - WWBS has changed their schedule so that they will reach Europe during the day. They are now testing at 1000-1200 UT on Sat and Sun. They are also being sued in a WGTG-type lawsuit. A local recording studio is claiming damages due to RFI from WWBS, but hasn't been able to demonstrate any loss. The station continues to run low power pending a resolution of the case (Hans Johnson (c) *Cumbre DX*)

Art Bell is suing WWCR and the Ted Gunderson program for defamation and slander during a Dec 1997 broadcast. Check out the court documents at <http://www.artbell.net/court/tencomp.html> (Ullis Fleming, Hans Johnson, *Cumbre DX*) How can any radio station possibly police everything said on a presumably live call-in show or be held responsible for it? (gh) The suit also names Ted Gunderson, who leased airtime for his radio program on WWCR, and David Hinkson, a frequent guest on Gunderson's program for falsely stating that Mr. Bell had been indicted for child molestation (Kim Elliott, VOA *Communications World* via John Norfolk)

Following the resignation of Randi Steele from WBCQ, Al Weiner posted his own hate speech policy at <http://wbccq.net>. Discussing it on *Al Weiner Worldwide*, UT Sat 0000-0100 on 7415, Al made it clear that Brother Stair was OK, but some other programmers were pressing the boundary. Anita McCormick called in to say that it did not go far enough to satisfy her or Randi (gh)

WINB turned out to be the one on 13800, ex-13790; sked is now: 1500-2100 13800, 2100-2400 13790, 0000-0500 11950 (Gayle Van Horn)

Instead of *Spectrum* June 13, a pilot of Wayne Green's *You Can!* aired at 0300 UT Sun on the Omega Radio Network via WWCR 5070; see <http://waynegreen.com> (Chet Copeland, DC) I listened to the first few minutes. Nothing about ham or radio but Wayne pontificating that virtually everything in current society is fraudulent (gh)

World Of Radio on WWCR: Thu 2030 15685, Sat 1130 12160, Sun 0230 and 0630 5070, Mon 0501 3210, Tue 1230 15685.

VENEZUELA Ecos del Torbes: received an interesting E-mail from Bill Sitzman, who runs an engineering firm near Rochester, and says he is a big fan of EdT. He notes, "we have seen as high as 0.25 mv/m (250 microvolts) with an average of 0.1 mv/m on our Potomac Instruments FIM-41 field strength meter. The modulation is always loud and clear. We consider YVOC to be the jewel of the Tropical Band!" (Don Moore, NU via DSWCI *DX Window*)

VIETNAM The Voice of Vietnam finally has a proper official website of its own with current frequencies for the external service. To access the schedule in all languages go to <http://www.vov.org.vn/docs1/english/history/international.html> and click on the programme button, which actually leads to the frequency schedule. This site also functions as a Website for the VoV domestic services (Andy Sennitt, DSWCI *DX Window Caught in the Web*)

English program schedule; currently heard at 1700-1728 on 12070 via Russia; 1800-1828, 1900-1928, 2030-2058 on 13740 (Edwin Southwell, England)

Daily: *News and Current Affairs* followed Mon, Tue, Thu, Fri by *Press Review*. Final items are:

- Mon - *Vietnam Land and People*
- Tue - *Vietnam Culture and Sports*
- Wed - *Letter Box & Talk of the Week*
- Thu - *Vietnam Economy; Business Forum*
- Fri - *Rural Vietnam*
- Sat - *Weekly Review; Historical Events; Music*
- Sun - *Sunday Show* (via Southwell)

YUGOSLAVIA BBCM heard 7200 go off the air at the precise moment that the Stubline site was bombed at 1108 UTC on 25th May – and the RTS domestic service has not been subsequently heard on shortwave at all (Dave Kenny, June 7, *World Of Radio*)

Until the Next, Best of DX and 73 de Glenn!!

Broadcast Loggings



Gayle Van Horn

0050 UTC on 11800

ITALY: RAI. News item on former Italian Foreign Minister Prodi becomes head of European Union. (Bob Fraser, Cohasset, MA)

0054 UTC on 9855

LITHUANIA: Radio Vilnius. Commentary on the Lithuanian basketball team, and report on pianist Gabriella Controvida. (James C. Lindberg, Burnsville, MN)

0100 UTC on 6987

PERU: Radio San Miguel. Andina music to station slogan. Peru's **Radio Super Sensacion** 6675, 0500 to ID of Huancabamba. (Jordi Brunet, Fraga, Spain/*Hard Core DX*)

0231 UTC on 17895.14

PAKISTAN: Radio Pakistan. Supposed slow-speed English news until 0244. ID, "general overseas service of Radio Pakistan" to short tones, presumed 0245*. Signal strength erratic at times, gaining strength at 0240, // 15485.22. (Mark Fine, Remington, VA) Urdu service 0500 1460 to 0700*. (Paul Ormandy, Oamaru, New Zealand/*HCDX*) Station noted 1100, 15531 with English news; 1600 on 15468. (Gerald Edwin Gentry, USA).

0300 UTC on 4885

BRAZIL: Radio Voz do Coracao Imaculado. (Ex **Radio Carajas**) Portuguese. Catholic station with text, // 770 AM kHz. (Marcio R.F. Bertoldi, San Carlos, SP Brazil/*HCDX*) Brazil's **Radio Globo** 11805, 2106 fair signal. (Zacharias Liangas, Thessoloiniki, Greece/*HCDX*)

0304 UTC on 4919

ECUADOR: Radio Quito. Spanish. News, commentary, phone calls and remote. Ad string to public service announcement for "Servicio Nacional" to ID "Radio Quito la Voz de la Capital." (Harold Frodge, Midland, MI)

0333 UTC on 4835

GUATEMALA: Radio Tezulutlan. Announcer in presumed Indian dialect Quechua. Marimba music to station ID and 0336* Radio **Buenas Nuevas** 4799.7, 0331-0333* (Frodge, MI)

0418 UTC on 15240

AUSTRALIA: Radio. *The World Today* magazine show on Asian and world topics. "ABC Radio" ID at 0430. Audible 155155, 0437-0447, // 15240. (Frodge, MI) Live cricket match 13605, 1005. (Fraser, MA)

0431 UTC on 15375

CHILE: Radio Voz Christiana. Rousing contemporary Christian music tunes. Spanish sermon text to ID at 0435 "esta es Radio Voz Christiana." (Frodge, MI; Mark Veldhuis, Borne, Netherlands/*HCDX*) 17680, 2120-2125, // 21550. (Frodge, MI)

0445 UTC on 5019.85

COLOMBIA: Ecos del Atrato. Spanish. 50's era pop tunes to items on Colombia and Caracol network ID, // 5076.80 (Karl van rooy, Netherlands/*HCDX*) Colombia's **La Voz del Guaviare** (presumed) 6035, 0050-0100 Spanish vocals, interviews, covered 0100 by VOA. (Danielle Canonica, Switzerland/*HCDX*/*The Four Winds*) **La Voz del Illano, Villavicencio** 6115, 0017. (Brunet, Spain/*HCDX*)

1045 UTC on 3315

PAPUA NEW GUINEA: Radio Manus. Regional news to island music. (Gentry, USA)

1234 UTC on 9525

INDONESIA: (Java) Voice of. Indonesian. Sounded like an evening wrap-up of news of Asian interest, gamelan background music (great!) Station ID 1244, items about Jakarta, music intro for two popular Indo Krongcong tunes. Closing local interest bits to clear station ID, frequency, address, and background interval signal to 1259*. Good signal of SIO=434. (Gayle Van Horn, Brasstown, NC)

1527 UTC on 17730

ANTIGUA: Deutsche Welle Antigua relay. German. News of Kurdish leaders' trial in Turkey. (Dexter Anderson, Westerly, RI)

1700 UTC on 6980

SOMALIA: Radio Mogadishu. Arabic. Newscast and Somalian music. Noted Koran recitations prior to 1700. ID goes something like, "Radio Mogadishu ida odka shaalika jumhurida Somalia...meterband." I presume this is the pro-Aidid station previously logged on 11204, signal good after 1800. (Jari Savolainen, Kuusankoski, Finland/*HCDX*)

1820 UTC on 11675

RUSSIA: Voice of. *Commonwealth Update*-on increase in consumer goods and volume of trade with the CIS. (Fraser, MA)

1900 UTC on 11605

ISRAEL: Kol Israel. Report on the inquiry into the continuing occupation of South Lebanon. (Fraser, MA)

1950 UTC on 3905

INDONESIA: (Irian Jaya) RRI-Merauke. Indonesian. Westernized pop tune to brief lady announced text, "song-of-the-coconut-island" interval signal. SIO=253. **RRI Ternate (Moluccas)** audible 3344.80, 2055 with Islamic music to 2059, interval signal to ID, // **RRI-Manado (Sulawesi)** 3214.80, // **RRI-Gorontalo (Sulawesi)** 3264.75. (van rooy, NLD/*HCDX*)

1955 UTC on 11402

ICELAND: Rikisutvarpid. News in Icelandic. Signal is USB+carrier. (Liangas, GRC/*HCDX*)

2000 UTC 3985

ITALY: IRRS. New program *New Dimensions Radio*, fair quality SIO=342. (Liangas, GRC/*HCDX*/*TFW*)

2004 UTC on 2310

AUSTRALIA: ABC/Alice Springs. ABC network news // 2325 **Tennant Creek**. *2130, 4910 ABC/Tennant Creek into English national news // 5025 (van rooy, NLD/*HCDX*)

2033 UTC on 4902

SRI LANKA: SLBC. Hindu vocal music program to station item, 2048* (van rooy, NLD/*HCDX*) Noted also 1030, 11835 English to Asia. (Gentry, USA)

2103 UTC on 11720

BULGARIA: Radio. World news to weather forecast. Station ID to program Bulgarian Developments. (Frodge, MI) *Keyword Bulgaria* show 11700, 2350. (Fraser, MA)

2130 UTC on 15550

GUAM: AWR/KSDA. Asian service discussion on the current Christian pop scene, noting Nashville as an influence. (Dale Fisher, Cleveland, OH)

2132 UTC on 17675

NEW ZEALAND: RZ Intl. English news to ID and into Mailbag program. (Veldhuis, NLD/*HCDX*) **BBC** news relay 9700, 1000. (Fraser, MA)

2137 UTC on 7105

BELARUS: Radio Minsk. News on Belarus banks and European topics to ID. Schedule at 2156, // 7210. Heard 0312-0317+, 11670 English news and Belarus cultural items, better in LSB to avoid 11675 interference. (Frodge, MI)

2146 UTC on 15140

ECUADOR: HCJB. Spanish children's program. "Canned" ID 2200, / / 21455 USB. (Veldhuis, NLD/*HCDX*) *Ham Radio Today* 17660, 1930. (Fraser, MA) Ecuador's **Voz del Upano** 0015-0105, 4870 Spanish cultural program. (Michael Schnitzer, Hassfurt, Germany/*HCDX*)

2235 UTC on 13640

TURKEY: Voice of. *Topic of the Day* feature, focusing on modern Cyprus. (Fraser, MA)

2245 UTC on 6520.2

PERU: Radio Paucartambo. Quechua. Several IDs, mentions of Cusco to religious format. Relatively good signal of SINPO=24322 & 34323. (Schnitzer, Germany/*HCDX*)

2245 UTC on 4905.05

BRAZIL: Radio Araguaia. Portuguese. Clear ID as "Araguaia" to pop music program, local ads. (Ruud Voz, Utrecht, Netherlands/*HCDX*) Brazil's **Radio Difusora do Amazonia** 2337, 4805. (Brunet, Spain/*HCDX*)

2258 UTC on 3265

INDONESIA: (Sumatra) RRI-Bengkulu. Indonesian. "Coconut" interval signal to 2302. Station ID to news beginning with item on Timor and Kosovo. Item from Bali and economic update, // **RRI-Bandar Lampung (Sumatra)** 3395.10, // **RRI Medan (Sumatra)** 4766, // *Voice of* 15125. (van rooy, NLD/*HCDX*/*TFW*)

2310 UTC on 6025

BOLIVIA: Radio Illimani. Spanish political talk "gobierno central...en la capital La Paz. (Canonica, SWI)

2330 UTC on 4826.38

PERU: Radio Sicuani. Spanish. First time station logged, noting mentions of "Sicuaní, Cuzco, Peru" by announcer. Choral national anthem, programming resumed. (Voz, NLD/*HCDX*/*TFW*)

2330 UTC on 21485

IRAN: VOIRI. Arabic. Koran recitation at tune-in, // 17560, verified as Iran. (Ormandy, NZ/*HCDX*)

Thanks to our contributors — Have you sent in YOUR logs?
Send to **Gayle Van Horn**, c/o *Monitoring Times* (or e-mail gayle@grove.net)
English broadcast unless otherwise noted.

Hot August QSLs



Have you logged Belgium's RTBF yet? Radio-Television Belge de la Communauté Française was inaugurated February 1, 1999, and is the broadcasting organization of the French-speaking community in Belgium. RTBF aims at listeners in Africa and consists of relays from RTBF's domestic radio channels.

Transmitting via Deutsche Telekom facilities in Juelich, Germany, RTBF continues to be easily heard with a distinctive native African instrument interval signal at sign on, followed by a French/English identification into French programming. The station's French website, with links to programming and frequencies, may be found at www.rtbf.be/ Email relinr.r@rtbf.be

Bill Wilkins of Springfield, Missouri, verified RTBF in 22 days with an English report (RTBF returned his IRCs) while my

French report received a response in 27 days with enclosures of one dollar and souvenir postcards. Station address: 1044 Brussels, Belgium. If you're looking for an interesting station to log which verifies promptly, tune in to RTBF!

RTBF broadcasts on the following French schedule; broadcasts may be one hour later in winter.

0257-0459	Monday-Friday	9490 kHz
0427-0459	Saturday/Sunday	9490
0500-0806	Sunday	17580
0500-0712	Monday-Friday	17580
0500-0959	Saturday	17580
0957-1206	Monday-Friday	21540
1000-1117	Saturday	21540
1057-1117	Sunday	21540
1457-1712	Sunday-Friday	17800
1557-1712	Saturday	17800

(BBC Monitoring/BELRX002)

ANTIGUA

Deutsche Welle, 9640 kHz. Full data card of Wertachtal transmitter site, form signature of Horst Scholz-Transmission Management. Received in 364 days after follow-up English reports from original report. (Randy Stewart, Springfield, MO)

ARGENTINA

RAE, 15345 kHz. Full data station logo card signed by Mrs. Perla Damurri. Received in 179 days after my original email report, with apology included within personal letter. Station address: C.C. 555, Correo Central, 1000 Buenos Aires, Argentina. (Cristian Mocanu, Romania/Cumbre)

BRAZIL

Radio Clube Paranaense, 6040 kHz. Full data personal letter signed by Vicente Mickasz-Superintendente. Received in 32 days for a Portuguese report and one dollar. Station address: Rua Rockefeller 1311, Prado Velho, 80230-130 Curitiba PA, Brazil. (Danielle Canonica, Switzerland)

Radio Marumby, 9665 kHz. Full data QSL certificate signed by Pb. Claudiney Nunes, Coordenador Radio e Jornalismo. Received for a Portuguese report and one IRC. Station address: Gerencia Radio, Gides Mission Brios da Hora, Rua Joaquim Nunes 244, Caixia postal 4, CEP 88340.000 Cambori. (Mauno Ritola, Finland/Cumbre)

COASTAL RADIO

CW Station-WOO, 4387 kHz USB. Full data Ocean Gate Radio card signed by John R. Morgan. Received in 85 days for an English utility report, one dollar and souvenir postcard. Station address: P.O. Box 550, Manahawkin, NJ 08050. (Frank Hillton, Charleston, SC)

COSTA RICA

Radio For Peace Int'l, 15049 kHz. Verification letter via email from James Latham-Station Manager. Received in six days for an email report. Email: info@rfpi.org (Stewart, MO)

GREECE

Radio Free Iraq-via Kavala, Greece, 7110 kHz. Full data Letter of Verification on RFE/RL letterhead, signed by David Walcutt-Broadcast Operations Liaison. Received in 15 days for an English report and two mint stamps. Station address: c/o Radio Free Europe/Radio Liberty, 1201 Connecticut Ave., N.W., Washington, DC 20036. (Wilkins, MO)

LEBANON

High Adventure Radio, 11530 kHz. Full data paper QSL signed by Gary Hull, plus schedule. Received in 55 days for a taped report and one dollar. Report sent to Box 53379, Limassol, Cyprus; QSL mailed from Metulla, Adventure Radio, P.O. Box 77, Metulla, Israel, or via email to: radio98@hotmail.com (Stewart, MO)

MEDIUM WAVE

KTBK 1700 kHz AM. Full data QSL letter signed by Hubert (Hue) Beavers, noting first day of regularly scheduled operation with scanned photo of station

tower under construction. Letter states they were on night power (700 watts) 5/8 wave antenna. Station address: 3632 Blossom Trail, Plano, TX 75074. (Patrick Griffith-NONNK, Federal Heights, CO)

WEZO 950 kHz AM. Partial data verification on letterhead, signed by David Lane-Chief Engineer. Received in 13 days for an AM report and SASE (used for reply). Station address: 500B Forman Bldg., Midtown Plaza, Rochester, NY 14604. (Harold Frodge, Midland, MI)

WPHT 1210 kHz AM. QSL card and letter signed by Sam A. Virgillo-Technician, plus key chain. Enclosed two QSL cards with photo of the old WCAU in 1950. Received in 21 days for a taped tentative report. Station address: City Avenue & Monument Rd., Philadelphia, PA 19131. (Patrick Martin, Seaside, OR)

WSAI, 1530 kHz. Partial data coverage map and letter signed by Dave Mason-Operations Manager. Received in 7 days for an AM report, three mint stamps and address label. Station address: 1111 St. Gregory St., Cincinnati, OH 45202. (Wilkins, MO)

WTTM 1680 kHz AM. Black and white certificate signed by Anthony A. Gervasi-Sr. Vice President. Received in 30 days for a taped report. Station address: 619 Alexander Rd.-Third Floor, Princeton, NJ 08540. (Martin, OR)

WXXI 1370 kHz AM. Sticker and partial data verification letter signed by Jeanne Fisher-Vice President. Received in 10 days for an AM report and a SASE (used for reply). Station address: 280 State St., Rochester, NY 14624. (Frodge, MI)

Radio One, Dar es Salaam, 1440 kHz AM. Full data card showing three lions. Received in 11 months, 52 days after email reminder to radio1@ipp.co.tz (the address on their web-page is incorrect). Card states you can use itv@intafrika.com, power is 10 kW into a n/d antenna. Station address: Box 4374, Dar-es-Salaam, Tanzania. (Martin Elbe, Denmark/Hard Core DX)

NORTHERN MARIANA ISLANDS

Voice of America via Tinian, 11995 kHz. Full data National Archives scenery card unsigned. Received in 38 days for an English report. Station address: 330 Independence Ave., S.W.-Room 4605, Washington, DC 20547. (Wilkins, MO)

PUERTO RICO

Armed Forces Radio & TV via Isabela, 6458.5 kHz. Partial data email letter from Wayne E. Eternicka-Broadcast Operations Specialist. Received in one day for an email report. I asked him to make the verie site-specific, and he kindly added a sentence to his form letter as, "this letter serves as confirmation of your May 8, 1999, reception of Armed Forces Radio and Television from our Puerto Rico location at 6458.5 kHz." Email address: eternicka@mediacen.navy.mil(Stewart, MO)

SOUTH AFRICA

Trans World Radio, 7215 kHz. Full data Sentech antenna card signed by Kathy Otto, plus schedule. Received in 7 weeks for an English report. Station address: Sentech (Pty) Ltd., Shortwave Services, Private Bag X06, Henyedew 2040, South Africa. (Wilkins, MO)

POCKET POWER!

New From ICOM! The Ultra-Compact R2!

Never before has so much scanning power been packed into such a tiny radio, and at such an affordable price! This six-ounce pocket monitoring post offers continuous 485 kHz-1300 MHz (less cellular) frequency coverage in AM, WFM, and NFM modes. The triple-conversion superheterodyne design assures high sensitivity and sharp selectivity, allowing up to 400 channels to be stored in 8 banks.

Other features include CTCSS tone squelch search and decode, signal-overload attenuator, tuning knob with selectable steps, noise blanker, priority, and multiple scan functions at a fast 30 channels per second. Sleep timer, automatic shutoff, earphone jack. Computer port allows second-radio cloning and database management. Two AA NiCd cells and charger included—or you can use replaceable alkalines!



Order WBR28 Only \$219⁹⁵ Please add \$12 UPS shipping or US Priority Mail

New! AOR AR16B

This new, 2-1/2" wide, receiving dynamo offers a wide 500 kHz-1300 MHz frequency coverage (less cellular), AM/WFM/NFM modes, and 500 memory channels in 5 banks. Select 12 different frequency steps from 1 to 100 kHz for the manual tuning dial or search mode, and scan or search at 20 steps per second.

Featuring excellent sensitivity (0.35 microvolts), signal strength indicator, backlit LCD display and keypad, loud and crisp audio, automatic squelch level, and computer interface capability, this tiny marvel even comes with high density NiMH rechargeable batteries and charger. Alkaline AA cells may be used as well.



Order WBR29 Only \$219⁹⁵ Please add \$12 UPS shipping or US Priority Mail

Full coverage units with voice descrambling (speech inversion) available to government agencies and cellular service providers only. Order WBR29-G for only \$229⁹⁵.

GROVE

GROVE ENTERPRISES, INC.

1-800-438-8155 US and Canada; 828-837-9200 • FAX 828-837-2216

7540 Highway 64 West • Brasstown, NC 28902-0098

e-mail: order@grove-ent.com; World Wide Web: www.grove-ent.com

HOW TO USE THE SHORTWAVE GUIDE

0000-0100 twhfa USA, Voice of America 5995am 6130ca 7405am 9455af
 ① ② ⑤ ③ ④ ⑥ ⑦

Convert your time to UTC.

Broadcast time on ① and time off ② are expressed in Coordinated Universal Time (UTC) – the time at the 0 meridian near Greenwich, England. To translate your local time into UTC, first convert your local time to 24-hour format, then add (during Daylight Savings Time) 4,5,6, or 7 hours for Eastern, Central, Mountain or Pacific Times, respectively. Eastern, Central, and Pacific Times are already converted to UTC for you at the top of each page.

Note that all dates, as well as times, are in UTC; for example, a show which might air at 0030 UTC *Sunday* will be heard on *Saturday* evening in America (in other words, 8:30 pm Eastern, 7:30 pm Central, etc.).

Find the station you want to hear.

Look at the page which corresponds to the time you will be listening. On the top half of the page English broadcasts are listed by UTC time on ①, then alphabetically by country ③, followed by the station name ④. (If the station name is the same as the country, we don't repeat it, e.g., "Vanuatu, Radio" [Vanuatu].)

If a broadcast is not *daily*, the days of broadcast ⑤ will appear in the column following the time of broadcast, using the following codes:

Day Codes

s Sunday
 m Monday
 t Tuesday
 w Wednesday
 h Thursday
 f Friday
 a Saturday

In the same column ⑤, irregular broadcasts are indicated "tent" and programming which includes languages besides English are coded "vl" (various languages).

Choose the most promising frequencies for the time, location and conditions.

The frequencies ⑥ follow to the right of the station listing; all frequencies are listed in kilohertz (kHz). Not all listed stations will be heard from your location and virtually none of them will be heard all the time on all frequencies.

Shortwave broadcast stations change some of their frequencies at least twice a year, in April and October, to adapt to seasonal conditions. But they can also change in response to short-term conditions, interference, equipment problems, etc. Our frequency manager coordinates published station schedules with confirmations and reports

from her monitoring team and *MT* readers to make the Shortwave Guide up-to-date as of one week before publication.

To help you find the most promising signal for your location, immediately following each frequency we've included information on the target area ⑦ of the broadcast. Signals beamed toward your area will generally be easier to hear than those beamed elsewhere, even though the latter will often still be audible.

Target Areas

af: Africa
 al: alternate frequency (occasional use only)
 am: The Americas
 as: Asia
 au: Australia
 ca: Central America
 do: domestic broadcast
 eu: Europe
 me: Middle East
 na: North America
 om: omnidirectional
 pa: Pacific
 sa: South America
 va: various

Consult the propagation charts.

To further help you find a strong signal, we've included a chart on page 60 which takes into account conditions affecting the audibility of shortwave broadcasts. Simply pick out the section of the chart for the region in which you live and find the line for the region in which the station you want to hear is located. The chart indicates the optimum frequencies (in megahertz-MHz) for a given time in UTC. (Users outside North America can use the same procedure in reverse to find best reception from North America.)

Choose a program or station you want to hear.

Some selected programs appear on the lower half of the page for prime listening hours – space does not permit 24-hour listings. Our program manager changes the stations and programming featured each month to reflect the variety available on shortwave, though BBC programs are almost always included.

Occasionally program listings will be followed by "See X 0000." This information indicates that the program is a rerun, and refers to a previous summary of the program's content. The capital letter stands for a day of the week, using the same day codes as in the frequency listing (see above), and the four digits represent a time in UTC.

MT MONITORING TEAM

Gayle Van Horn
 Frequency Manager
gayle@grove.net

Jim Frimmel
 Program Manager
frimmel@star-telegram.com

Jacques d'Avignon
 Propagation Forecasts
 Ontario, Canada
monitor@rac.ca

Mark Fine, VA
fineware@erols.com

Dan Roberts, CA

SWL PROGRAMS

JIM FRIMMEL, PROGRAMMING MANAGER

Sundays

0021 Radio Exterior de Espana: "Radio Waves"
 0045 BBC (am/eu): "Waveguide" (4)
 0045 BBC (am/eu): "Write On"
 0110 HCJB (am): "DX Partyline"
 0121 Radio Exterior de Espana: "Radio Waves"
 0130 Glenn Hauser via RFP: "Continent of Media"
 0136 Radio Havana Cuba: "DXers Unlimited"
 0200 Kim Elliott via WWCR #3: "Communications World ABC"
 0200 Glenn Hauser via RFP: "World of Radio"
 0230 Glenn Hauser via WWCR #3: "World of Radio"
 0245 Radio Bulgaria: "Radio Bulgaria Calling"
 0258 Vatican Radio: "On-the-Air"
 0300 Marie Lamb via WHRI (Angel 2): "DXing with Cumbre"
 0300 Radio Mexico Intl: "DXperience"
 0300 WWCR #3 (Tennessee): "Spectrum (live)"
 0323 Voice of Turkey: "DX Corner" (biweekly)
 0330 Australia, Radio: "Feedback"
 0336 Radio Havana Cuba: "DXers Unlimited"
 0409 HCJB (am): "DX Partyline"
 0508 Vatican Radio: "On-the-Air"
 0521 Radio Exterior de Espana: "Radio Waves"
 0536 Radio Havana Cuba: "DXers Unlimited"
 0600 Marie Lamb via KWHR (Angel 3): "DXing with Cumbre"
 0630 Glenn Hauser via WWCR #3: "World of Radio"
 0704 Radio Vlaanderen Intl: "Radio World"
 0836 Radio Korea: "Multiwave Feedback"
 0905 BBC (am/eu): "Waveguide" (4)
 0905 BBC (am/eu): "Write On"
 0930 Glenn Hauser via RFP: "Continent of Media"
 0930 Italy (AWR): "Wavescan"
 1000 Glenn Hauser via RFP: "World of Radio"
 1030 Marie Lamb via KWHR (Angel 4): "DXing with Cumbre"
 1038 Radio Korea: "Multiwave Feedback"
 1045 WWCR #3 (Tennessee): "Ask WWCR"
 1045 BBC (af): "Waveguide" (4)
 1045 BBC (af): "Write On"
 1134 Radio Vlaanderen Intl: "Radio World"
 1147 Radio Bulgaria: "Radio Bulgaria Calling"
 1200 WRMI (Florida): "Wavescan"
 1207 Radio Canada Intl: "The Mailbag"
 1230 BBC (as): "Waveguide" (4)
 1230 Italy (AWR): "Wavescan"
 1230 BBC (as): "Write On"
 1238 Radio Korea: "Multiwave Feedback"
 1300 Marie Lamb via KWHR (Angel 4): "DXing with Cumbre"
 1335 Radio Canada Intl: "The Mailbag"
 1336 Radio Canada Intl: "The Mailbag"
 1354 Vatican Radio: "On-the-Air"
 1400 Kim Elliott via WRN1 (Internet): "Communications World ABC"
 1603 Marie Lamb via WHRA (Angel 5): "DXing with Cumbre"
 1636 Radio Korea: "Multiwave Feedback"
 1637 Radio Canada Intl: "The Mailbag"
 1700 WWCR #1 (Tennessee): "Ask WWCR"

continued on page 41

FREQUENCIES

0000-0100	Anguilla, Caribbean Beacon	6090am				0000-0030	Thailand, Radio	9655af	9690af	11905af	
0000-0100 vl	Australia, ABC/Katherine	5025do				0000-0030	UK, BBC World Service	3915as	7110as	11945as	17615as
0000-0100 vl	Australia, ABC/Tent Creek	4910do				0000-0100	UK, BBC World Service	5965as	5970sa	5975am	6175am
0000-0100	Australia, Radio	9660pa	12080va	15240pa	17580va			6195as	9410as	9590am	9915sa
		17750as	17795va	21740va				12095sa	15310as	15360as	17790as
									5905eu	6020eu	6090eu
0000-0015	Cambodia, Natl Radio Of	11940as				0000-0100	Ukraine, R Ukraine Intl	5810na			
0000-0100	Canada, CBC N Quebec Svc	9625do				0000-0100	USA, KAIJ Dallas TX	15590am			
0000-0100	Canada, CFRX Toronto	6070do				0000-0100	USA, KTVN Salt Lk City UT	17625am	17775al		
0000-0100	Canada, CFVP Calgary	6030do				0000-0100 vl	USA, KVOH Los Angeles CA	17510as			
0000-0100	Canada, CHNX Halifax	6130do				0000-0100	USA, KWHR Naalehu HI	7215as	9770as	11760as	15185as
0000-0100	Canada, CKZN St John's	6160do				0000-0030	USA, Voice of America	15290as	15290as	17735as	17820as
0000-0100	Canada, CKZU Vancouver	6160do						5995am	6130ca	7405am	9455af
0000-0100	Costa Rica, RF Peace Intl	6975am	15050am	21460am		0000-0100 twfha	USA, Voice of America	9775am	11695ca	13740am	
0000-0027	Czech Rep, R Prague Intl	11615na	13580na			0000-0100	USA, WBCQ Monticello ME	7415na			
0000-0100	Ecuador, HCJB	9745na	12015na	21455va		0000-0100	USA, WEWN Birmingham AL	5825na	13615na		
0000-0030	Egypt, Radio Cairo	9900am				0000-0100	USA, WGTG McCaysville GA	5085am	9400am		
0000-0100 vl	Guatemala, Radio Cultural	3300do				0000-0100	USA, WHRA Greenbush ME	7580na			
0000-0100	Guyana, GBC/Voice of	5950do				0000-0100	USA, WHRI Noblesville IN	5745na	7315na		
0000-0045	India, All India Radio	7410as	9705as	9950as	11620as	0000-0100	USA, WINB Red Lion PA	11950am			
		13625as				0000-0100	USA, WJCR Upton KY	7490na	13595as		
0000-0015	Japan, Radio/NHK	6155eu	6180eu	9665af	11705na	0000-0100 m	USA, WRMI/R Miami Intl	9955am			
		11815as	13650as			0000-0100	USA, WRNO New Orleans LA	7355na			
0000-0100	Liberia, LCN/R Liberia Int	5100do				0000-0100	USA, WSHB Cypress Crk SC	9430na	15285ca		
0000-0100	Malaysia, Radio	7295do				0000-0100	USA, WWCN Nashville TN	5070na	7435na	9475na	13845na
0000-0100	Malaysia, RTM Sarawak	7160do				0000-0100	USA, WYFR Okeechobee FL	6085na	9505na		
0000-0100 vl	Malaysia, RTM KotaKinabalu	5980do				0000-0030 vl	Vanuatu, Radio	4960do			
0000-0100	Namibia, NBC	3270af	3289af			0015-0100	Japan, Radio/NHK	6155eu	6180eu	9665af	11705na
0000-0100	Netherlands, Radio	6165na	9845na			0030-0100	Austria, R Austria Intl	9655na			
0000-0100	New Zealand, R NZ Intl	17675va				0030-0100	Iran, VOIRI	9022am	9795ca	11970na	
0000-0100	North Korea, R Pyongyang	11845am	13650am	15230am		0030-0000	Lithuania, Radio Vilnius	9855am			
0000-0100 vl	Papua New Guinea, NBC	9675do				0030-0100 vl	Solomon Islands, SIBC	5020do			
0000-0100	Russia, IBC Tamil	9355as				0030-0100	Sri Lanka, Sri Lanka BC	6005as	9730as	15425as	
0000-0100	Singapore, R Corp Singapore	6150do				0030-0100	Thailand, Radio	9655as	11905as	15395na	
0000-0100	Spain, R Exterior Espana	15385na				0050-0100	Italy, RAI Intl	9675na	11800na	15240na	

SELECTED PROGRAMS

Sundays

- 0000 Czech Rep, Radio Prague: News.
- 0000 New Zealand, Radio NZ Intl: RNZ News.
- 0000 Spain, R Exterior de Espana: News.
- 0004 Czech Rep, Radio Prague: The Magic Carpet.
- 0006 New Zealand, Radio NZ Intl: Future Indicative.
- 0008 Spain, R Exterior de Espana: Window on Spain.
- 0009 Egypt, Radio Cairo: Egyptian Songs.
- 0015 Egypt, Radio Cairo: News.
- 0021 Spain, R Exterior de Espana: Radio Waves.
- 0033 Spain, R Exterior de Espana: Poparama.
- 0035 New Zealand, Radio NZ Intl: Time will Tell.
- 0037 Austria, R Austria Intl: Postbox.
- 0050 Italy, RAI: News.

Mondays

- 0000 Egypt, Radio Cairo: Egyptian Music.
- 0000 Canada, N Quebec Svc: News.
- 0000 New Zealand, Radio NZ Intl: RNZ News.
- 0000 USA, WBCQ, Monticello ME: Radio Newyork International (live).
- 0003 North Korea, R Pyongyang: News.
- 0004 Czech Rep, Radio Prague: Letter from Prague.
- 0005 Egypt, Radio Cairo: Islamic Civilization.
- 0005 Canada, N Quebec Svc: Onstage.
- 0009 Czech Rep, Radio Prague: From the Weeklies.
- 0012 Spain, R Exterior de Espana: Visitors Book.
- 0015 Egypt, Radio Cairo: News.
- 0018 Czech Rep, Radio Prague: The Arts.
- 0020 Spain, R Exterior de Espana: Window on Spain.
- 0030 Austria, R Austria Intl: News from Vienna.
- 0033 Austria, R Austria Intl: Report from Austria.
- 0037 Netherlands, Radio: Sincerely Yours.
- 0044 Spain, R Exterior de Espana: Radio Club.
- 0050 Italy, RAI: News.
- 0055 Netherlands, Radio: Sounds Interesting.

Tuesday-Saturday

- 0000 Australia, Radio: RA News.
- 0000 Czech Rep, Radio Prague: News.
- 0000 Japan, Radio: News.

- 0000 Spain, R Exterior de Espana: The News from Spain.
- 0000 USA, WBCQ, Monticello ME: The Hour of the Time (live).
- 0003 North Korea, R Pyongyang: News.
- 0004 Czech Rep, Radio Prague: Current Affairs.
- 0005 Australia, Radio: Asia Pacific.
- 0015 Egypt, Radio Cairo: News.
- 0015 Japan, Radio: 44 Minutes.
- 0030 Austria, R Austria Intl: News from Vienna.
- 0030 Ecuador, HCJB Quito (am): Focus on the Family.
- 0030 Lithuania, Radio Vilnius: Local Scene.
- 0030 Netherlands, Radio: News.
- 0033 Austria, R Austria Intl: Report from Austria.
- 0034 Spain, R Exterior de Espana: Press Review.
- 0035 Iran, Voice of: News.
- 0038 Netherlands, Radio: Newslines.
- 0042 Lithuania, Radio Vilnius: Local Scene.
- 0050 Italy, RAI: News.
- 0050 Spain, R Exterior de Espana: A Spanish Course by Radio.

Tuesdays

- 0016 Czech Rep, Radio Prague: Spotlight.
- 0033 Spain, R Exterior de Espana: Entertainment in Spain.

Wednesdays

- 0016 Czech Rep, Radio Prague: Talking Point.
- 0030 North Korea, R Pyongyang: Feature Report.
- 0030 Australia, Radio: The Religion Report.
- 0039 Spain, R Exterior de Espana: Kaleidoscope.

Thursdays

- 0017 Czech Rep, Radio Prague: HistoryCzech.
- 0030 Spain, R Exterior de Espana: Spanish Music.
- 0030 Netherlands, Radio: News.
- 0038 Netherlands, Radio: Newslines.
- 0039 Spain, R Exterior de Espana: As Others See Us.

Fridays

- 0018 Czech Rep, Radio Prague: Postbag.
- 0025 Czech Rep, Radio Prague: Music.

- 0030 Spain, R Exterior de Espana: Spanish Music.
- 0039 Spain, R Exterior de Espana: EU Forum.

Saturdays

- 0000 USA, WBCQ, Monticello ME: Allan Weiner Worldwide.
- 0017 Czech Rep, Radio Prague: Postbag.
- 0032 Spain, R Exterior de Espana: Arts Review.

SWL Programs, continued from page 40

- 1737 Radio Vlaanderen Intl: "Radio World"
- 1830 Marie Lamb via KWHR (Angel 3): "DXing with Cumbre"
- 1936 Radio Korea: "Multiwave Feedback"
- 1937 Radio Vlaanderen Intl: "Radio World"
- 2000 Kim Elliott via WBCQ: "Communications World ABC"
- 2031 Radio Canada Intl: "The Mailbag"
- 2105 BBC (am/eu): "Waveguide" (4)
- 2105 BBC (am/eu): "Write On"
- 2108 Radio Korea: "Multiwave Feedback"
- 2200 Marie Lamb via WHRI (Angel 1): "DXing with Cumbre"
- 2208 Radio Korea: "Multiwave Feedback"
- 2230 Marie Lamb via WHRA (Angel 5): "DXing with Cumbre"
- 2231 Radio Vlaanderen Intl: "Radio World"
- 2300 Marie Lamb via WHRI (Angel 2): "DXing with Cumbre"
- 2300 Radio Mexico Intl: "DXperience"
- 2300 Glenn Hauser via RFP1: "World of Radio"

Mondays

- 0131 Radio Canada Intl: "The Mailbag"
- 0230 Radio Korea: "Multiwave Feedback"
- 0330 WRMI (Florida): "Wavescan"

continued on page 43

FREQUENCIES

0100-0200	Anguilla, Caribbean Beacon	6090am				0100-0200	Singapore, R Corp Singapore	6150do			
0100-0200 vl	Australia, ABC/Katherine	5025do				0100-0130	Slovakia, R Slovakia Intl	5930na	7300ca	9440sa	
0100-0200 vl	Australia, ABC/Tent Creek	4910do				0100-0200 vl	Solomon Islands, SIBC	5020do			
0100-0200	Australia, Radio	9660pa	12080va	15240pa	15415as	0100-0200	Spain, R Exterior Espana	15385na			
		17580va	17750as	17795va	21740va	0100-0200	Sri Lanka, Sri Lanka BC	6005as	9730as	15425as	
0100-0200	Canada, CBC N Quebec Svc	9625do				0100-0130	Switzerland, Swiss R Intl	9885am	9905am		
0100-0200	Canada, CFRX Toronto	6070do				0100-0200	UK, BBC World Service	5970sa	5975am	6175am	6195as
0100-0200	Canada, CFVP Calgary	6030do						9410as	9590am	9915sa	11955as
0100-0200	Canada, CHNX Halifax	6130do						15280as	15310as	15360as	17790as
0100-0200	Canada, CKZU St John's	6160do				0100-0200	USA, KAIJ Dallas TX	5810na			
0100-0200	Canada, CKZU Vancouver	6160do				0100-0200	USA, KTNB Salt Lk City UT	7510na			
0100-0129	Canada, R Canada Intl	5960na	9535am	9755am	11715am	0100-0200	USA, KWHR Naalehu HI	17510as			
		13670am				0100-0200	USA, Voice of America	7115as	7200as	9635as	11705as
0100-0156	China, China Radio Intl	9570na						11725as	11820as	15250as	17740as
0100-0200	Costa Rica, RF Peace Intl	6975am	15050am	21460am		0100-0130 twfa	USA, Voice of America	5995as	6130am	7405am	9455af
0100-0200	Cuba, Radio Havana	6000na	9820na	11705na	13605na			9775am	13740am		
0100-0127	Czech Rep, R Prague Intl	7345na				0100-0200	USA, WBCQ Monticello ME	7415na			
0100-0200	Ecuador, HCJB	9745na	12015na	21455va		0100-0200	USA, WEWN Birmingham AL	5825na	13615na		
0100-0145	Germany, Deutsche Welle	6040na	6145na	9640am	11810na	0100-0200	USA, WGTG McCaysville GA	5085am	6890am		
		13720am				0100-0200	USA, WHRA Greenbush ME	7580na			
0100-0200 s	Germany, Good News World	9855eu				0100-0200	USA, WHRI Noblesville IN	5745na	7315na		
0100-0130 m	Germany, V O Deliverance	9855na				0100-0200	USA, WINB Red Lion PA	11950am			
0100-0200 vl	Guatemala, Radio Cultural	3300do				0100-0200	USA, WJCR Upton KY	7490na	13595as		
0100-0200	Guyana, GBC/Voice of	5950do				0100-0130 mtwhf	USA, WRMI/R Miami Intl	9955am			
0100-0130	Hungary, Radio Budapest	9560na				0100-0200	USA, WRNO New Orleans LA	7355na			
0100-0200	Indonesia, Voice of	9525va				0100-0200	USA, WSHB Cypress Crk SC	9430na	15285ca		
0100-0130	Iran, VOIRI	9022am	9795ca	11970na		0100-0200	USA, WWCR Nashville TN	3215na	5070na	7435na	13845na
0100-0110	Italy, RAI Intl	9675na	11800na	15240na		0100-0200	USA, WYFR Okeechobee FL	6065na	9505na	15165as	
0100-0200	Japan, Radio/NHK	9660me	11860as	11870me	15570as	0100-0130	Uzbekistan, R Tashkent	9375as	9530as	9715as	
		15590as	17685pa	17835sa	21670pa	0100-0127	Vietnam, Voice of	7250va			
0100-0200	Kenya, Kenya BC Corp	4885do				0105-0120	Croatia, Croatian Radio	9925na			
0100-0200	Liberia, LCN/R Liberia Int	5100do				0115-0145 vl	Libya, Voice of Africa	15235va	15415va	15435va	
0100-0200	Malaysia, Radio	7295do				0129-0200	Canada, R Canada Intl	5960na	9755am		
0100-0200 vl	Malaysia, RTM Kota Kinabalu	5980do				0129-0200 sm	Canada, R Canada Intl	9535am	11715am	13670am	
0100-0200	Namibia, NBC	3270af	3289af			0130-0200	Slovakia, AWR Europe	11660as			
0100-0125	Netherlands, Radio	6165na	9845na			0130-0200	Sweden, Radio	13625as			
0100-0200	New Zealand, R NZ Intl	17675va				0130-0200 twhfa	USA, Voice of America	5995am	6130am	9455af	
0100-0200 vl	Papua New Guinea, NBC	9675do				0130-0200 a	USA, WRMI/R Miami Intl	9955am			
0100-0200	Philippines, FEBC R Intl	15450as				0140-0150	Greece, Voice of	7450na	9420na	11645na	12015na
0100-0200	Russia, Voice of Russia WS	7180na	9665na	12050na	15520na	0140-0200	Vatican City, Vatican R	9650au			
		15595na				0145-0200	Albania, R Tirana Intl	6115na	7160na		

SELECTED PROGRAMS

Sundays

- 0100 Italy, RAI: Letter from Italy.
- 0100 Switzerland, Swiss Radio Intl: World Radio Switzerland.
- 0100 Ecuador, HCJB Quito (am): Latin and International News.
- 0100 USA, WBCQ, Monticello ME: Radio Free New York (live).
- 0102 Croatia, Croatian Radio: News.
- 0111 Russia, Voice of: Music and Musicians.
- 0115 Germany, Deutsche Welle: Inside Europe.
- 0145 Albania, Radio Tirana: News.

Mondays

- 0100 Switzerland, Swiss Radio Intl: World Radio Switzerland.
- 0100 Germany, Deutsche Welle: News.
- 0100 Australia, Radio: RA News.
- 0100 Ecuador, HCJB Quito (am): Latin and International News.
- 0110 Australia, Radio: Awaye.
- 0112 Switzerland, Swiss Radio Intl: Swiss Scene.
- 0140 Vatican State, Vatican Radio: Focus on the Church.
- 0145 Albania, Radio Tirana: News.
- 0150 Vatican State, Vatican Radio: The Background.

Tuesday-Saturday

- 0100 Australia, Radio: RA News.
- 0100 Canada, RCI Montreal: RCI News.
- 0100 Ecuador, HCJB Quito (am): News.
- 0100 Germany, Deutsche Welle: News.
- 0100 Hungary, Radio Budapest: News.
- 0100 Russia, Voice of: News.
- 0100 Slovakia, R Slovakia Intl: Slovakia Today.

- 0100 Switzerland, Swiss Radio Intl: World Radio Switzerland.
- 0100 USA, WWCR #3 Nashville TN: The Stan Solomon Show (live).
- 0100 Vietnam, Voice of Vietnam: News.
- 0102 Croatia, Croatian Radio: News.
- 0105 Hungary, Radio Budapest: Hungary Today.
- 0105 USA, WGTG, McCaysville GA: American Freedom Network.
- 0106 Germany, Deutsche Welle: NewsLink.
- 0110 Ecuador, HCJB Quito (am): Studio 9.
- 0111 Canada, RCI Montreal: Spectrum.
- 0111 Russia, Voice of: Commonwealth Update.
- 0145 Albania, Radio Tirana: News.

Tuesdays

- 0100 USA, WBCQ, Monticello ME: The Hour of the Time (live).
- 0132 Russia, Voice of: Folk Box.

Wednesdays

- 0110 Australia, Radio: The National Interest.
- 0130 Germany, Deutsche Welle: Insight.
- 0130 Ecuador, HCJB Quito (am): El Mundo Futuro.
- 0132 Russia, Voice of: The Jazz Show.

Thursdays

- 0130 Germany, Deutsche Welle: Living in Germany.
- 0130 Ecuador, HCJB Quito (am): Ham Radio Today.

Fridays

- 0130 Germany, Deutsche Welle: Spotlight on Sport.
- 0130 Ecuador, HCJB Quito (am): Woman to Woman.
- 0140 Vatican State, Vatican Radio: United Nations Radio.

Saturdays

- 0100 USA, WBCQ, Monticello ME: Friday Night Live.
- 0130 Ecuador, HCJB Quito (am): Musica del Ecuador.
- 0132 Russia, Voice of: Moscow Yesterday and Today.

HAUSER'S HIGHLIGHTS
GUAM: KSDA

Wavescan is not aired via South Africa, Slovakia or Germany, but this is the A-99 schedule of Wavescan via KSDA, mostly new frequencies (Sundays):

UTC	kHz
1000-1030	11560
1030-1100	11795
1230-1300	15330
1330-1400	11705
1330-1400	11750
1430-1500	9355
1530-1600	11930
1600-1630	9355
1730-1800	11560
1730-1800	11965
2130-2200	15550
2330-2400	11775

(Panview, Bulgaria) Audible but poor here on 15330 at 1230 (gh, OK)

FREQUENCIES

0200-0300	Anguilla, Caribbean Beacon	6090am							0200-0300	Singapore, RCorp Singapore	6150do				
0200-0300 twfba	Argentina, RAE	11710am							0200-0300 vl	Solomon Islands, SIBC	5020do				
0200-0300 vl	Australia, ABC/Katherine	5025do							0200-0300	South Korea, R Korea Intl	7275sa	11725sa	11810sa	15575na	
0200-0300 vl	Australia, ABC/Tent Creek	4910do							0200-0300	Sri Lanka, Sri Lanka BC	6005as	9730as	15425as		
0200-0300	Australia, Radio	9660pa	12080va	15240pa	15415as				0200-0300	Taiwan, Radio Taipei Intl	5950na	9680na	11740	11745va	
		15515va	17580va	17750as	21725pa						11825pa	15345as			
0200-0210	Bangladesh, Bangla Betar	4880as							0200-0300	UK, BBC World Service	5970sa	5975am	6175am	6185am	
0200-0230 smwfa	Belarus, R Minsk	7210va	11670va								6195eu	9410me	9770af	9915sa	11955as
0200-0300	Bulgaria, Radio	9400na	11700na								15280as	15310as	15360as	17790as	
0200-0300	Canada, CBC N Quebec Svc	9625do							0200-0300	USA, KAIJ Dallas TX	5810na				
0200-0300	Canada, CFRX Toronto	6070do							0200-0300	USA, KTVN Salt Lk City UT	7510na				
0200-0300	Canada, CFVP Calgary	6030do							0200-0300 vl	USA, KVOH Los Angeles CA	9975am				
0200-0300	Canada, CHNX Halifax	6130do							0200-0300	USA, KWHR Naalehu HI	17510as				
0200-0300	Canada, CKZN St John's	6160do							0200-0300	USA, Voice of America	4960af	7115as	7200as	9635as	
0200-0300	Canada, CKZU Vancouver	6160do									11705as	11820as	15250as	17740as	17820as
0200-0229	Canada, R Canada Intl	9535am	9755am	11715am	13670am				0200-0300	USA, WBCQ Monticello ME	7415na				
0200-0300	Costa Rica, RF Peace Intl	6975am	15050am	21460am					0200-0300	USA, WEWN Birmingham AL	5825va				
0200-0205	Croatia, Croatian Radio	9925na							0200-0300	USA, WGTG McCaysville GA	5085am	6890am			
0200-0300	Cuba, Radio Havana	6000na	9820na	11705na	13605na				0200-0300	USA, WHRA Greenbush ME	7580na				
0200-0300	Ecuador, HCJB	9745na	12015na	21455va					0200-0300	USA, WHRI Noblesville IN	5745na	7315sa			
0200-0300	Egypt, Radio Cairo	9475na							0200-0300	USA, WINB Red Lion PA	11950am				
0200-0245	Germany, Deutsche Welle	9615as	9690as	11945as	11965as				0200-0300	USA, WJCR Upton KY	7490na	13595as			
		13690as	15560as						0200-0300	USA, WRNO New Orleans LA	7355na				
0200-0300	Germany, Overcomer Ministr	9860na							0200-0300	USA, WSHB Cypress Crk SC	7535na	9430na			
0200-0300	Guyana, GBC/Voice of	5950do							0200-0300	USA, WWCR Nashville TN	3215na	5070na	5935na	7435na	
0200-0300 irreg	Iraq, Radio Iraq Intl	11785am							0200-0300	USA, WYFR Okeechobee FL	6065na	9505na			
0200-0300	Kenya, Kenya BC Corp	4935do							0210-0215 thfa/vl	Kyrgyzstan, Kyrgyz Radio	4010do	4050do			
0200-0300	Malaysia, Radio	7295do							0215-0220	Nepal, Radio	5005as	7165as			
0200-0230	Myanmar, Radio	7185do							0229-0300 sm	Canada, R Canada Intl	9535am	9755am	11715am	13670am	
0200-0300	Namibia, NBC	3270af	3289af						0230-0300	Albania, R Tirana Intl	6115na	7160na			
0200-0300	New Zealand, R NZ Intl	17675va							0230-0300	Austria, R Austria Intl	9655na	9870ca			
0200-0300 vl	Papua New Guinea, NBC	9675do							0230-0300	Hungary, Radio Budapest	9840na				
0200-0300	Philippines, FEBC R Intl	15450as							0230-0245	Pakistan, Radio	9640as	11930as	15455as	17660as	17895as
0200-0256	Romania, R Romania Intl	9510na	9570na	11725au	11740na				0230-0300 vl	Philippines, R Pilipinas	11885as	15120as	15270as		
		11810as	17735as						0230-0300	Sweden, Radio	9495na				
0200-0300	Russia, Voice of Russia WS	7180na	9665na	12020na	15520na				0230-0257	Vietnam, Voice of	7250va				
		15595na							0250-0300	Vatican City, Vatican R	7305am	9605am			

SELECTED PROGRAMS

Sundays

- 0200 Bulgaria, Radio: News.
- 0200 Cuba, Radio Havana Cuba: International News.
- 0235 Bulgaria, Radio: Timeout for Music.
- 0236 Cuba, Radio Havana Cuba: The World of Stamps.
- 0245 Cuba, Radio Havana Cuba: Music.
- 0250 Vatican State, Vatican Radio: With Heart and Mind.
- 0258 Vatican State, Vatican Radio: On-the-Air.

Mondays

- 0200 Canada, RCI Montreal: CBC Radio News.
- 0204 Canada, RCI Montreal: Tapestry.
- 0206 Germany, Deutsche Welle: Weekend Review II.
- 0215 Germany, Deutsche Welle: Marks and Markets.
- 0215 Taiwan, Radio Taipei Intl: Jade Bells and Bamboo Pipes.
- 0230 Cuba, Radio Havana Cuba: Breakthrough.
- 0250 Vatican State, Vatican Radio: And So They Came to Rome.

Tuesday-Saturday

- 0200 Canada, RCI Montreal: CBC Radio News.
- 0200 South Korea, Radio Korea Intl: News.
- 0200 Russia, Voice of: News.
- 0200 Argentina, RAE: News.
- 0211 Canada, RCI Montreal: Spectrum.
- 0230 Albania, Radio Tirana: News.

Tuesdays

- 0211 Russia, Voice of: Science and Engineering in the Commonwealth.
- 0232 Russia, Voice of: Kaleidoscope.
- 0246 Albania, Radio Tirana: Feature Program.
- 0255 Vatican State, Vatican Radio: As Romans Turn.

Wednesdays

- 0205 USA, KWHR Naalehu HI: Music.
- 0215 Taiwan, Radio Taipei Intl: Music Box.
- 0250 Vatican State, Vatican Radio: The Rome Report.

Thursdays

- 0241 Albania, Radio Tirana: Albanian Press Review.
- 0245 Albania, Radio Tirana: Musical Program of the Week.
- 0250 Vatican State, Vatican Radio: The Pope and the People.
- 0254 Vatican State, Vatican Radio: Pilgrim City.

Fridays

- 0211 Russia, Voice of: Science and Engineering in the Commonwealth.

- 0401 Radio Vlaanderen Intl: "Radio World"
- 0407 Radio Canada Intl: "The Mailbag"
- 0500 Glenn Hauser via WWCR #1: "World of Radio"
- 0530 Kim Elliott via WWCR #1: "Communications World ABC"
- 0700 Glenn Hauser via RFPI: "World of Radio"
- 0905 BBC (as): "Waveguide" (4)
- 0905 BBC (as): "Write On"
- 1000 WWCR #1 (Tennessee): "Spectrum" (repeat)
- 1040 All India Radio: "DX-ers Corner" (2/4)
- 1500 Glenn Hauser via RFPI: "World of Radio"
- 1545 KTWR (Guam): "Pacific DX Report"
- 1840 All India Radio: "DX-ers Corner" (2/4)
- 1900 Glenn Hauser via RFPI: "Continent of Media"
- 2130 All India Radio: "DX-ers Corner" (2/4)
- 2135 Radio New Zealand Intl: "Mailbox" (biweekly)

Tuesdays

- 0900 KTWR (Guam): "Pacific DX Report"
- 1230 Glenn Hauser via WWCR #1: "World of Radio"
- 1246 Radio Sweden: "MediaScan" (1/3)
- 1346 Radio Sweden: "MediaScan" (1/3)
- 1355 FEBC (Philippines): "DX Dial"
- 1746 Radio Sweden: "MediaScan" (1/3)
- 1900 Glenn Hauser via RFPI: "World of Radio"
- 2000 Polish Radio: "Polish Radio DX Club"

- 0230 Albania, Radio Tirana: News.
- 0250 Vatican State, Vatican Radio: Then and Now.

Saturdays

- 0211 Russia, Voice of: Moscow Mailbag.
- 0232 Russia, Voice of: Audio Book Club.
- 0250 Vatican State, Vatican Radio: Echoes of an Era.

SWL Programs, continued from page 41

- 2111 Radio Havana Cuba: "DXers Unlimited"
- 2300 Radio Mexico Intl: "DXperience"
- 2311 Radio Havana Cuba: "DXers Unlimited"
- 2340 All India Radio: "DX-ers Corner" (2/4)

Wednesdays

- 0140 Radio Havana Cuba: "DXers Unlimited"
- 0146 Radio Sweden: "MediaScan" (1/3)
- 0246 Radio Sweden: "MediaScan" (1/3)
- 0300 Glenn Hauser via RFPI: "World of Radio"
- 0335 Radio Havana Cuba: "DXers Unlimited"
- 0346 Radio Sweden: "MediaScan" (1/3)
- 0535 Radio Havana Cuba: "DXers Unlimited"
- 0730 HCJB (eu): "Ham Radio Today"
- 0930 HCJB (pac): "Ham Radio Today"
- 1100 Glenn Hauser via RFPI: "World of Radio"
- 1315 FEBC (Philippines): "DX Dial"
- 1720 Polish Radio: "Polish Radio DX Club"
- 1735 Radio New Zealand Intl: "Mailbox" (biweekly)
- 1820 Argentina, RAE: "DX-ers Special"
- 1930 HCJB (eu): "Ham Radio Today"
- 2100 Glenn Hauser via WBCQ: "World of Radio"
- 2112 Radio Budapest Intl: "Radio Budapest DX Blockbuster"

continued on page 47

FREQUENCIES

Table listing radio frequencies and stations. Columns include frequency (e.g., 0500-0600), station name (e.g., Anguilla, Caribbean Beacon), and time zone (e.g., 6090am).

SELECTED PROGRAMS

Sundays

- 0500 Cuba, Radio Havana Cuba: International News.
0500 South Africa, Channel Africa: News.
0500 USA, WBCQ, Monticello ME: The Tom and Daryl TVRO Radio Show.

Mondays

- 0500 Vatican State, Vatican Radio: To the Ends of the Earth.
0500 Vatican State, Vatican Radio: News from the African Church.
0506 Germany, Deutsche Welle: Mailbag North America (4/5).

Tuesday-Saturday

- 0500 Spain, R Exterior de Espana: The News from Spain.
0500 South Africa, Channel Africa: News.
0505 South Africa, Channel Africa: Dateline Africa.

Tuesdays

- 0500 Vatican State, Vatican Radio: A Room with a View of the Vatican.
0515 Vatican State, Vatican Radio: Ask the Abbot.
0521 Vatican State, Vatican Radio: African News Panorama.

Wednesdays

- 0500 Vatican State, Vatican Radio: The Rome Report.
0500 Vatican State, Vatican Radio: The Environment.
0510 Vatican State, Vatican Radio: News from the African Church.

Thursdays

- 0500 Vatican State, Vatican Radio: News of the Church.
0500 Vatican State, Vatican Radio: The Pope and the People.
0505 Vatican State, Vatican Radio: Pilgrim City.

- 0523 Vatican State, Vatican Radio: Communication Update.
0530 Germany, Deutsche Welle: Living in Germany.
0539 Spain, R Exterior de Espana: As Others See Us.

Fridays

- 0500 Vatican State, Vatican Radio: Then and Now.
0500 Spain, R Exterior de Espana: Spanish Music.
0530 Germany, Deutsche Welle: Spotlight on Sport.
0539 Spain, R Exterior de Espana: EU Forum.

Saturdays

- 0500 Vatican State, Vatican Radio: By the Way...
0500 Vatican State, Vatican Radio: News.
0506 Vatican State, Vatican Radio: Roundtable Discussion.
0532 Spain, R Exterior de Espana: Arts Review.

HAUSER'S HIGHLIGHTS
UKRAINE: RUI KIEV

Table with columns: kHz, UTC, Azimut, Zones CIRAF. Includes schedule from May 24 and specific frequency/time/azimuth data for Ukraine.

FREQUENCIES

0700-0800	Anguilla, Caribbean Beacon	6090am			
0700-0800 vl	Australia, ABC/Katherine	5025do			
0700-0800 vl	Australia, ABC/Tent Creek	4910do			
0700-0800	Australia, Radio	9660pa	12080va	15240pa	15415as
		15515va	17580va	17750as	21725pa
0700-0726	Belgium, R Vlaanderen Intl	9925eu	15195eu		
0700-0800 vl	Botswana, Radio	4820do	4830do	7255do	
0700-0800	Canada, CFRX Toronto	6070do			
0700-0800	Canada, CFVP Calgary	6030do			
0700-0800	Canada, CHNX Halifax	6130do			
0700-0800	Canada, CKZN St John's	6160do			
0700-0800	Canada, CKZU Vancouver	6160do			
0700-0800	Costa Rica, RF Peace Intl	6975am			
0700-0705	Croatia, Croatian Radio	9470va	13820af		
0700-0727	Czech Rep, R Prague Intl	9880eu	11600eu		
0700-0800	Ecuador, HCJB	11730eu	15115pa	21455va	
0700-0800	Eqg Guinea, Radio Africa	15186af			
0700-0800	Germany, Deutsche Welle	6140eu			
0700-0800 s	Germany, Good News World	13740as			
0700-0800	Germany, Sunrise Radio	5850eu			
0700-0800	Germany, Voice of Hope	5975eu			
0700-0800	Germany, Overcomer Ministr	13810au			
0700-0800 vl	Ghana, Ghana BC Corp	3366do	4915do		
0700-0800	Guyana, GBC/Voice of	5950do			
0700-0800 as	Italy, IRRS	7120va			
0700-0800	Kenya, Kenya BC Corp	4885do	4935do		
0700-0800 vl	Lesotho, Radio	4800do			
0700-0715	Liberia, LCN/R Liberia Int	5100do			
0700-0800	Malaysia, Radio	7295do			
0700-0800	Malaysia, RTM Sarawak	7160do			
0700-0800	Malaysia, Voice of	6175as	9750as	15295as	
0700-0800 mtwhf	Monaco, Trans World Radio	6045eu	9870eu		
0700-0705	New Zealand, R NZ Intl	11905va			
0700-0800 vl	Nigeria, Radio/Ibadan	6050do			
0700-0800 vl	Nigeria, Radio/Kaduna	4770do			
0700-0800 vl	Nigeria, Voice of	7255af	15120va		
0700-0800	Palau, KHBN/Voice of Hope	9965as	9985as	13840as	15725as
0700-0730 vl	Papua New Guinea, NBC	9675do			
0700-0756	Romania, R Romania Intl	15340af	17745af		
0700-0800	Russia, Voice of Russia WS	17495au	17625au	17665au	21790au
0700-0800	Sierra Leone, SLBS	3316do			
0700-0800	Singapore, RCorp Singapore	6150do			
0700-0730	Slovakia, R Slovakia Intl	9440au	15460au	17550au	
0700-0800 vl	Solomon Islands, SIBC	5020do			
0700-0730 mtwhf	Swaziland, Trans World R	4775af	6100af	9500af	
0700-0720 a	Swaziland, Trans World R	4775af	6100af	9500af	
0700-0705 s	Swaziland, Trans World R	4775af	6100af	9500af	
0700-0800	Taiwan, Radio Taipei Intl	5950na			
0700-0800	UK, BBC World Service	6005af	6190af	7145af	9410eu
		9740as	11760me	11765af	11835af
		11940af	11955pa	12095eu	15310as
		15360as	15400af	15485eu	15565eu
		15575as	17640au	17760as	17790as
		17830af	21660as		
0700-0715 as	UK, BBC World Service	17885af			
0700-0800	USA, KAIJ Dallas TX	5810na			
0700-0800	USA, KTBN Salt Lk City UT	7510na			
0700-0800	USA, KWHN Naalehu HI	11565as	17780as		
0700-0800	USA, WEWN Birmingham AL	5825va			
0700-0800	USA, WHRA Greenbush ME	11565af			
0700-0800	USA, WHRI Noblesville IN	5745na	7315sa		
0700-0800	USA, WJCR Upton KY	7490na	13595as		
0700-0800	USA, WRNO New Orleans LA	7395na			
0700-0800	USA, WSHB Cypress Crk SC	13650af			
0700-0800	USA, WWCR Nashville TN	2390na	3210na	5070na	5935na
0700-0745	USA, WYFR Okeechobee FL	7355eu	9985eu	13695va	
0700-0800 vl	Vanuatu, Radio	4960do			
0700-0800	Zambia, Christian Voice	6065af			
0700-0800	Zambia, Natl BC Corp	6165do	6265do		
0700-0800 vl	Zimbabwe, Zimbabwe BC	4828do	5012do		
0705-0710 s	Croatia, Croatian Radio	5945eu	7365eu	9830eu	
0706-0800	New Zealand, R NZ Intl	9700va			
0715-0800	UK, BBC World Service	15575af	17885af		
0725-0800	Myanmar, Radio	9730do			
0730-0800	Austria, R Austria Intl	6155eu	13730eu	15410eu	17870eu
0730-0800	Georgia, Georgian Radio	11910eu			
0730-0750	Greece, Voice of	7475eu	9420eu	11645eu	15630eu
		17700au			
0730-0800 vl	Papua New Guinea, NBC	4890do			
0730-0735 mtwhf	Swaziland, Trans World R	4775af			
0730-0800	Switzerland, Swiss R Intl	15545af	17685af	21750af	
0740-0800	Guam, TWR/KTWR	15200as			
0800-0900	Anguilla, Caribbean Beacon	6090am			
0800-0830 vl	Australia, ABC/Katherine	5025do			
0800-0830 vl	Australia, ABC/Tent Creek	4910do			
0800-0900	Australia, Radio	5995pa	9710pa	11650va	12080va
		13605va	15515va	21725pa	
		4820do	4830do	7255do	
0800-0900 vl	Botswana, Radio	4820do			
0800-0900 vl	Canada, CBC N Quebec Svc	9625do			
0800-0900	Canada, CFRX Toronto	6070do			
0800-0900	Canada, CFVP Calgary	6030do			
0800-0900	Canada, CHNX Halifax	6130do			
0800-0900	Canada, CKZN St John's	6160do			
0800-0900	Canada, CKZU Vancouver	6160do			
0800-0900	Costa Rica, RF Peace Intl	6975am			
0800-0805	Croatia, Croatian Radio	13820au			
0800-0900	Ecuador, HCJB	11730eu	15115pa	21455va	
0800-0900	Eqg Guinea, Radio Africa	15186af			
0800-0900	Germany, Deutsche Welle	6140eu			
0800-0900	Germany, Sunrise Radio	5850eu			
0800-0900	Germany, Voice of Hope	5975eu			
0800-0900	Germany, Overcomer Ministr	13810au			
0800-0900	Guam, TWR/KTWR	15200as	15330as		
0800-0900	Guyana, GBC/Voice of	5950do			
0800-0900	Indonesia, Voice of	9525va			
0800-0900 as/vl	Italy, IRRS	7120va			
0800-0900	Kenya, Kenya BC Corp	4885do	4935do		
0800-0900 vl	Lesotho, Radio	4800do			
0800-0900	Liberia, LCN/R Liberia Int	5100do			
0800-0900	Malaysia, Radio	7295do			
0800-0825	Malaysia, Voice of	6175as	9750as	15295as	
0800-0900 vl	Malaysia, RTM KotaKinabalu	5980do			
0800-0900 s	Malta, VO Mediterranean	11770eu			
0800-0820 mtwhf	Monaco, Trans World Radio	6045eu	9870eu		
0800-0830	Myanmar, Radio	9730do			
0800-0900	N Marianas, KFBS Saipan	11650as	15380as		
0800-0900	New Zealand, R NZ Intl	9700va			
0800-0900 vl	Nigeria, Radio/Ibadan	6050do			
0800-0900 vl	Nigeria, Radio/Kaduna	4770do			
0800-0900	Nigeria, Radio/Lagos	3326do			
0800-0900	Palau, KHBN/Voice of Hope	9955as	9985as	13840va	15725as
0800-0900 vl	Papua New Guinea, NBC	4890do			
0800-0900	Russia, Voice of Russia WS	15490au	17495au	17625au	21790au
0800-0900	Sierra Leone, SLBS	5980do			
0800-0900	Singapore, RCorp Singapore	6150do			
0800-0900	South Korea, R Korea Intl	9570au	13670eu		
0800-0900	UK, BBC World Service	6190af	9740as	11940af	11955pa
		12095eu	15310as	15360as	15400af
		15485eu	15565eu	17640eu	17760as
		17790as	17830af	21660as	
		15575as	17885af		
0800-0900 as	UK, BBC World Service	5810na			
0800-0900	USA, KAIJ Dallas TX	9615as			
0800-0900	USA, KNLS Anchor Point AK	7510na			
0800-0900	USA, KTBN Salt Lk City UT	11565pa	17780as		
0800-0900	USA, KWHN Naalehu HI	11775as	13610as	15150as	
0800-0900	USA, WEWN Birmingham AL	5825va			
0800-0900	USA, WHRA Greenbush ME	11565af			
0800-0900	USA, WHRI Noblesville IN	5745na	7315sa		
0800-0900	USA, WJCR Upton KY	7490na	13595as		
0800-0900	USA, WRNO New Orleans LA	7395na			
0800-0900	USA, WSHB Cypress Crk SC	9845pa	9860eu		
0800-0900	USA, WWCR Nashville TN	2390na	3210na	5070na	5935na
0800-0900 vl	Vanuatu, Radio	4960do			
0800-0900	Zambia, Christian Voice	6065af			
0800-0900	Zambia, Natl BC Corp	6165do	6265do		
0800-0900 vl	Zimbabwe, Zimbabwe BC	4828do	5012do		
0804-0820	Pakistan, Radio	15530eu	17835eu		
0805-0810 mtwhf	Croatia, Croatian Radio	5945eu	7365eu	9830eu	
0815-0900 f	Seychelles, FEBA Radio	15460as			
0820-0830 t	Kyrgyzstan, Kyrgyz Radio	4010do	4050do		
0820-0850 s	Monaco, Trans World Radio	6045eu	9870eu		
0830-0900 vl	Australia, ABC/Alice Spgs	2310do			
0830-0900 vl	Australia, ABC/Katherine	2485do			
0830-0900 vl	Australia, ABC/Tent Creek	2325do			
0830-0900	Australia, Radio	17750as			
0830-0900	Austria, R Austria Intl	21650as	21765as		
0830-0900	Georgia, Georgian Radio	11910me			
0830-0900 vl	Solomon Islands, SIBC	5020do			
0830-0900	Switzerland, Swiss R Intl	9885as	13685as		
0845-0900 mtwhf	USA, WRMI/R Miami Intl	9955am			

FREQUENCIES

Table with columns for frequency, time, and station names. Includes entries for various countries like Anguilla, Australia, Canada, Germany, etc.

SELECTED PROGRAMS

Sundays

- 1100 BBC (AE/AF/AS): Newsdesk.
1130 BBC (AE): In Praise of God.
1130 BBC (AF): Play of the Week.
1130 BBC (AS): Everywoman.
1130 BBC (AS): Play of the Week (EAs).
1130 Sweden, Radio: Sounds Nordic (2/4).

Monday-Friday

- 1100 Australia, Radio: RA News.
1100 Germany, Deutsche Welle: News.
1100 Papua New Guinea, NBC: News.
1100 Singapore, R Singapore Intl: News.
1103 North Korea, R Pyongyang: News.
1110 Australia, Radio: Asia Pacific (repeat).
1131 Sweden, Radio: News.

Mondays

- 1109 Singapore, R Singapore Intl: Business and Market Report.
1117 North Korea, R Pyongyang: Music.
1126 North Korea, R Pyongyang: Commentary.
1130 North Korea, R Pyongyang: Music of the Korean People's Army.
1133 North Korea, R Pyongyang: The Spirit of Socialist Korea.
1140 North Korea, R Pyongyang: Commentary.
1142 Sweden, Radio: SportScan.

Tuesdays

- 1115 North Korea, R Pyongyang: Music.
1121 North Korea, R Pyongyang: The Immortal Story.

- 1126 North Korea, R Pyongyang: Truth Idea.
1146 Sweden, Radio: MediaScan (1/3).

Wednesdays

- 1106 Germany, Deutsche Welle: NewsLink.
1109 Singapore, R Singapore Intl: Business and Market Report.
1115 North Korea, R Pyongyang: Music.
1120 North Korea, R Pyongyang: The Reminiscences of the Great Leader.
1139 North Korea, R Pyongyang: The Great Man of the Century.

Thursdays

- 1110 Singapore, R Singapore Intl: Business and Market Report.
1115 Singapore, R Singapore Intl: Living.
1117 North Korea, R Pyongyang: Music.
1122 North Korea, R Pyongyang: Words of the Great Leader.

- 1127 North Korea, R Pyongyang: Music.
1147 Sweden, Radio: HeartBeat (3).

Fridays

- 1113 North Korea, R Pyongyang: Music.
1121 North Korea, R Pyongyang: Immortal Ideas of the Great Leader.
1131 North Korea, R Pyongyang: Music.
1135 Australia, Radio: Life Matters.
1138 North Korea, R Pyongyang: The Great Man of the Country.

Saturdays

- 1103 North Korea, R Pyongyang: News.
1105 Papua New Guinea, NBC: Top of the Pops.
1113 North Korea, R Pyongyang: Music/Commentary.
1130 North Korea, R Pyongyang: All People Free.
1130 Singapore, R Singapore Intl: News.
1135 North Korea, R Pyongyang: Music.

HAUSER'S HIGHLIGHTS

RUSSIA: RADIOSTANTSIYA TIKHIY OKEAN (PACIFIC OCEAN),

from Vladivostok, in Russian:

0130-0215 21820
0715-0800 7210, 7490, 10344-USB, 12055, 12070, 15490
1800-1845 7120, 7170, 9825, 12065

The 0715 broadcast is reportedly relayed only on weekends on 5940, 7320, 9530, 9600 (BBC Monitoring)



FREQUENCIES

1200-1300	Anguilla, Caribbean Beacon	11775am			
1200-1300 vi	Australia, ABC/Alice Spgs	2310do			
1200-1300 vi	Australia, ABC/Katherine	2485do			
1200-1300 vi	Australia, ABC/Tent Creek	2325do			
1200-1300	Australia, Radio	5995pa	6020pa	9580va	11650va
		17750pa	21820as		
1200-1300 vi	Botswana, Radio	4820do	4830do	7255do	
1200-1300	Brazil, R Nacional Bras	15445am			
1200-1215	Cambodia, Natl Radio Of	11940as			
1200-1300 vi	Canada, CBC N Quebec Svc	9625do			
1200-1300	Canada, CFRX Toronto	6070do			
1200-1300	Canada, CFVP Calgary	6030do			
1200-1300	Canada, CHNX Halifax	6130do			
1200-1300	Canada, CKZN St John's	6160do			
1200-1300	Canada, CKZU Vancouver	6160do			
1200-1229	Canada, R Canada Intl	9660as	13650na	15195as	17765na
		17820na			
1200-1256	China, China Radio Intl	6950pa	7265pa	9715as	9945pa
		11660as	11675pa	11980as	15180as
1200-1300	Ecuador, HCJB	12005ca	15115am	21455va	
1200-1300	Eqt Guinea, Radio Africa	15186af			
1200-1300	France, Radio France Intl	9805eu	11600as	15155eu	15195eu
		15540af			
1200-1300	Germany, Deutsche Welle	6140eu			
1200-1300	Germany, Sunrise Radio	5850eu			
1200-1300 vi	Ghana, Ghana BC Corp	4915do			
1200-1300	Guyana, GBC/Voice of	5950do			
1200-1230	Iran, VOIRI	13710as	15255pa	15430me	17565as
		21510as			
1200-1300	Jordan, Radio	11690eu			
1200-1300	Kenya, Kenya BC Corp	4935do			
1200-1300 vi	Lesotho, Radio	4800do			
1200-1300	Malaysia, Radio	7295do			
1200-1300 vi	Malaysia, RTM KotaKinabalu	5980do			
1200-1300	Mongolia, Voice of	12015au			
1200-1300	N Marianas, KFBS Saipan	11650as	15380as		
1200-1300	N Marianas, KHBI Saipan	9355as			
1200-1225	Netherlands, Radio	6045eu	9860eu		
1200-1205 occsnal	New Zealand, R NZ Intl	9700va			
1200-1300 vi	Nigeria, Radio/Ibadan	6050do			
1200-1300 vi	Nigeria, Radio/Kaduna	4770do			
1200-1300	Palau, KHBN/Voice of Hope	9955as	9965as	9985as	13840va
		15725as			
1200-1300 m-a/vi	Papua New Guinea, NBC	4890do			
1200-1300	Poland, Polish R Warsaw	6095eu	7270eu	9525eu	11820eu
1200-1300	Sierra Leone, SLBS	5980do			
1200-1300	Singapore, R Singapore Int	6015as	6150as		
1200-1230	Switzerland, Swiss R Intl	15315eu			
1200-1300	Taiwan, Radio Taipei Intl	7130as	9610au		
1200-1300 as	Tanzania, Radio	5050af			
1200-1300	UK, BBC World Service	5965am	6190af	6195va	9410eu
		9515am	9580as	9740as	11760me
		12095eu	15220am	15280as	15310as
		15575me	17640eu	17705as	17830af
					17885af
					21660af
1200-1300	USA, KAIJ Dallas TX	5810na			
1200-1300	USA, KTBN Salt Lk City UT	7510na			
1200-1300	USA, KWHR Naalehu HI	9930as	11565pa		
1200-1300	USA, Voice of America	6160as	9355as	9645as	9760as
		11715as	15160as	15240as	15425as
1200-1300	USA, WEWN Birmingham AL	7425na	15745eu		
1200-1300	USA, WHRI Noblesville IN	6040na	9495am		
1200-1300	USA, WJCR Upton KY	7490na	13595as		
1200-1300 s	USA, WRMI/R Miami Intl	9955am			
1200-1300	USA, WRNO New Orleans LA	7395na			
1200-1300	USA, WSHB Cypress Crk SC	6095am	11660am		
1200-1300	USA, WWCR Nashville TN	5070na	7435na	12160na	13845na
1200-1245	USA, WYFR Okeechobee FL	5850eu	5950na	6015na	17750na
1200-1228	Uzbekistan, R Tashkent	5060as	5975as	6025as	9715as
		11905as	15295as	17775as	
1200-1300	Zambia, Christian Voice	6065af			
1200-1300	Zambia, Natl BC Corp	6165do	6265do		
1200-1300 vi	Zimbabwe, Zimbabwe BC	4828do	5012do		
1204-1216 mtwhf	UK, BBC Caribbean Report	6195ca	15220ca		
1204-1216 as	UK, BBC World Service	15220am			
1206-1300 occsnal	New Zealand, R NZ Intl	6100va			
1215-1300	Egypt, Radio Cairo	17595as			
1229-1300	Canada, R Canada Intl	9640na	13650na	17765na	17820na
1230-1300	Austria, R Austria Intl	6155eu	13730na		
1230-1300	Bangladesh, Bangla Betar	7185as	9548as		
1230-1300	Finland, YLE/R Finland	15400am	17670am		
1230-1300	Guam, AWR/KSDA	15330as			
1230-1300	Italy, AWR Europe	11800eu			
1230-1300	South Korea, R Korea Intl	9570as	9640om	13670as	
1230-1300	Sri Lanka, Sri Lanka BC	6005as	9730as	15425as	
1230-1300	Sweden, Radio	17895as	21810as		
1230-1300	Thailand, Radio	9655as	9885as	11905as	
1230-1300	Turkey, Voice of	17560va	17830as		
1230-1257	Vietnam, Voice of	12019as	13740as		
1240-1250	Greece, Voice of	17525af			
1245-1300	USA, WYFR Okeechobee FL	5950na	11830na	17750na	

SELECTED PROGRAMS

Sundays

- 1200 France, Radio France Intl: News.
- 1219 France, Radio France Intl: Asia File.
- 1230 Finland, Radio: News/Weather.
- 1233 France, Radio France Intl: Club 9516.
- 1235 Finland, Radio: Capital Cafe.

Monday-Friday

- 1200 Brazil, Radiobras: Brazilian Panorama.
- 1200 France, Radio France Intl: News.
- 1225 France, Radio France Intl: Review of the French Newspapers.
- 1230 Finland, Radio: News/Weather.
- 1238 Finland, Radio: Compass North.

Mondays

- 1231 France, Radio France Intl: Sports Magazine.
- 1232 France, Radio France Intl: RFI Europe.
- 1244 Finland, Radio: Finnish Press Review.
- 1245 France, Radio France Intl: Arts in France.
- 1250 France, Radio France Intl: Insight.

Tuesdays

- 1232 France, Radio France Intl: Books.
- 1237 France, Radio France Intl: Discovery.
- 1244 Finland, Radio: Finnish Press Review.
- 1246 France, Radio France Intl: Land of France.
- 1251 France, Radio France Intl: Echoes from Africa (biweekly).

Wednesdays

- 1232 France, Radio France Intl: France Today.
- 1234 France, Radio France Intl: Power and Policy.
- 1239 France, Radio France Intl: RFI Europe.
- 1247 France, Radio France Intl: Letter from a Listener.
- 1250 France, Radio France Intl: Land of France.

Thursdays

- 1231 France, Radio France Intl: Sports.
- 1233 France, Radio France Intl: The Bottom Line.
- 1239 France, Radio France Intl: Planet Earth (biweekly).
- 1246 Sweden, Radio: Horizon (4/5).
- 1247 France, Radio France Intl: Letter from a Listener.
- 1250 France, Radio France Intl: North/South (biweekly).
- 1254 Finland, Radio: Finnish Press Review.

Fridays

- 1234 France, Radio France Intl: Weekend.

Saturdays

- 1200 France, Radio France Intl: News.
- 1200 Brazil, Radiobras: The Best of Brazilian Popular Music.
- 1223 France, Radio France Intl: Focus on France.
- 1226 France, Radio France Intl: Review of the French Newspapers.
- 1230 Finland, Radio: News/Weather.
- 1231 France, Radio France Intl: Spotlight on Africa.
- 1246 France, Radio France Intl: French Lesson.
- 1251 France, Radio France Intl: Letter from a Listener.
- 1253 Finland, Radio: Nunti Latini.

Longwave Resources

✓ **Sounds of Longwave** 60-minute Audio Cassette featuring WWVB, Omega, Whistlers, Beacons, European Broadcasters, and more!
\$11.95 postpaid

✓ **The BeaconFinder** A 65-page guide listing Frequency, ID and Location for hundreds of LF beacons and utility stations. Covers 0-530 kHz.
\$11.95 postpaid

Kevin Carey
P.O. Box 56, W. Bloomfield, NY 14585

FREQUENCIES

1300-1400	Anguilla, Caribbean Beacon	11775am				1300-1400	Singapore, R Singapore Int	6015as	6150as		
1300-1400 vl	Australia, ABC/Alice Spgs	2310do				1300-1330	South Korea, R Korea Intl	9570as	9640om	13670as	
1300-1400 vl	Australia, ABC/Katherine	2485do				1300-1400	Sri Lanka, Sri Lanka BC	6005as	9730as	15425as	
1300-1400 vl	Australia, ABC/Tent Creek	2325do				1300-1400	Taiwan, Radio Taipei Intl	15125as			
1300-1400	Australia, Radio	5995pa	6020pa	9580va	11650va	1300-1400 as	Tanzania, Radio	5050af			
		17750pa	21820as			1300-1330	Turkey, Voice of	17560as	17830eu		
1300-1400 vl	Botswana, Radio	4820do				1300-1400	Uganda, Radio	4976do			
1300-1320	Brazil, R Nacional Bras	15445am				1300-1400	UK, BBC World Service	5965am	5990as	6190af	6195va
1300-1400 vl	Canada, CBC N Quebec Svc	9625do						9410eu	9515am	9740as	11760me
1300-1400	Canada, CFRX Toronto	6070do						15220am	15310as	15420af	15485eu
1300-1400	Canada, CFVP Calgary	6030do						17640eu	17705as	17830af	17885af
1300-1400	Canada, CHNX Halifax	6130do				1300-1400	USA, KAIJ Dallas TX	5810na			
1300-1400	Canada, CKZN St John's	6160do				1300-1400	USA, KJES Vado NM	11715na			
1300-1400	Canada, CKZU Vancouver	6160do				1300-1400	USA, KNLS Anchor Point AK	9615as			
1300-1400 mtwhf	Canada, R Canada Intl	17765na	17820na			1300-1400	USA, KTNB Salt Lk City UT	7510na			
1300-1400 s	Canada, R Canada Intl	13650na	17800na			1300-1400	USA, KWHR Naalehu HI	9930as	11565pa		
1300-1330	China, China Radio Intl	6950pa	7265pa	7405na	9570va	1300-1400	USA, Voice of America	6160as	9355as	9645as	9760as
		9945pa	11660as	11675pa	11980as			11715as	15160as	15425as	
1300-1329	Czech Rep, R Prague Intl	13580eu	17485as			1300-1400	USA, WEWN Birmingham AL	11875na			
1300-1400	Ecuador, HCJB	12005ca	15115am	21455va		1300-1400	USA, WHRI Noblesville IN	6040na	15105am		
1300-1330	Egypt, Radio Cairo	17595as				1300-1400	USA, WJCR Upton KY	7490na	13595as		
1300-1400	Eqt Guinea, Radio Africa	15186af				1300-1400 s	USA, WRMI/R Miami Intl	9955am			
1300-1329	Germany, Deutsche Welle	6140eu				1300-1400	USA, WRNO New Orleans LA	7395na			
1300-1400 a	Germany, Good News World	15330as				1300-1400	USA, WSHB Cypress Crk SC	9430na	9495am		
1300-1400	Germany, Sunrise Radio	5850eu				1300-1400	USA, WWCR Nashville TN	9475na	12160na	13845na	15685na
1300-1400 vl	Ghana, Ghana BC Corp	4915do	6130do			1300-1400	USA, WYFR Okeechobee FL	11550as	11830na	11970na	13695na
1300-1400	Guyana, GBC/Voice of	5950do						17750na			
1300-1400	Jordan, Radio	11690eu				1300-1400	Zambia, Christian Voice	6065af			
1300-1400	Kenya, Kenya BC Corp	4935do				1300-1400	Zambia, Natl BC Corp	6165do	6265do		
1300-1400 vl	Lesotho, Radio	4800do				1300-1400 vl	Zimbabwe, Zimbabwe BC	4828do	5012do		
1300-1310	Liberia, LCN/R Liberia Intl	5100do				1315-1325 mtwhfa	Bhutan, Bhutan BC Service	5030do			
1300-1400	Malaysia, Radio	7295do				1325-1400	Germany, Voice of Hope	15715as			
1300-1400 vl	Malaysia, RTM KotaKinabalu	5980do				1330-1400	Austria, R Austria Intl	13730am			
1300-1400	N Marianas, KFBS Saipan	9670as	11650as			1330-1400	Canada, R Canada Intl	9535as	9640as	11795as	11935eu
1300-1400	N Marianas, KHBI Saipan	9355as						15325eu			
1300-1400 occsnal	New Zealand, R NZ Intl	6100va				1330-1356	China, China Radio Intl	7405na	9570va	9945pa	11660as
1300-1400 vl	Nigeria, Radio/Ibadan	6050do						11675pa	11715pa	11980as	15180as
1300-1400 vl	Nigeria, Radio/Kaduna	4770do				1330-1400	Guam, AWR/KSDA	11705as			
1300-1400	Palau, KHBN/Voice of Hope	9955as	9965as	9985as	13840va	1330-1400	India, All India Radio	9545as	11620as	13710as	
		15725as				1330-1400	Sweden, Radio	9435as	15240na	17505as	
1300-1400 vl	Papua New Guinea, NBC	4890do				1330-1400	UAE, Radio Dubai	13630eu	13675eu	15395eu	21605eu
1300-1356	Romania, R Romania Intl	9690eu	15390eu	15445eu	17720na	1330-1400	Uzbekistan, R Tashkent	5060as	5975as	6025as	9715as
1300-1400 as	S Africa, Channel Africa	11720af	17860af	21530af				11905as	15165as	17750as	
1300-1400	Sierra Leone, SLBS	5980do				1330-1357	Vietnam, Voice of	9730eu	9840eu		
						1345-1400	Vatican City, Vatican R	15500as	17550as		

SELECTED PROGRAMS

Sundays

1300	Canada, RCI Montreal: World Report.
1300	USA, KNLS Anchor Point AK: Music/News/Commentary.
1311	Canada, RCI Montreal: This Morning (hour 1).
1330	Austria, R Austria Intl: News from Vienna.
1330	Canada, RCI Montreal: RCI News.
1330	Sweden, Radio: Sounds Nordic (2/4).
1336	Canada, RCI Montreal: The Mailbag (RCI).
1349	Romania, Radio Romania Intl: Romanian by Radio.

Monday-Friday

1300	Romania, Radio Romania Intl: Radio Newsreel.
1300	Canada, RCI Montreal: CBC Radio News.
1306	Canada, RCI Montreal: This Morning.
1310	Brazil, Radiobras: Brazilian Reporter.
1330	Sweden, Radio: Sixty Degrees North.
1330	Canada, RCI Montreal: RCI News.
1331	Sweden, Radio: News.
1340	Canada, RCI Montreal: Spectrum.

Mondays

1315	Romania, Radio Romania Intl: Pro Memoria.
1330	Canada, RCI Montreal: RCI News.
1340	Romania, Radio Romania Intl: Romanian Itineraries.
1347	Sweden, Radio: SportScan.
1352	Romania, Radio Romania Intl: Sports Roundup.

Tuesdays

1315	Romania, Radio Romania Intl: Business Club.
1325	Romania, Radio Romania Intl: Inside Romania.

1331	Romania, Radio Romania Intl: Romanian Literature.
1341	Romania, Radio Romania Intl: Romanian Hits.
Wednesdays	
1315	Romania, Radio Romania Intl: Society.
1325	Romania, Radio Romania Intl: Youth Club.
1346	Sweden, Radio: Money Matters.
1353	Romania, Radio Romania Intl: Sports Roundup.

Thursdays

1315	Romania, Radio Romania Intl: Citizens of the Same Country.
1325	Romania, Radio Romania Intl: Romanian Musicians.
1335	Romania, Radio Romania Intl: Partners in a Changing World.
1346	Sweden, Radio: GreenScan (2).

Fridays

1315	Romania, Radio Romania Intl: A Time for the Future.
1325	Romania, Radio Romania Intl: The Skylark.
1335	Romania, Radio Romania Intl: Listeners' Letterbox.
1335	Sweden, Radio: Review of the Nordic Newsweek.
1352	Romania, Radio Romania Intl: The Listeners Club.
1354	Romania, Radio Romania Intl: Sports Roundup.

Saturdays

1300	Romania, Radio Romania Intl: Radio Newsreel.
1315	Romania, Radio Romania Intl: World of Culture.
1330	Canada, RCI Montreal: RCI News.
1330	Sweden, Radio: Sweden Today (2).
1337	Romania, Radio Romania Intl: Inside Romania.

1337	Canada, RCI Montreal: Venture Canada.
1348	Romania, Radio Romania Intl: Bucharest along the Centuries.

HAUSER'S HIGHLIGHTS

INDIA: ALL INDIA RADIO

Effective to 31 October 99, English:

UTC	Target	kHz
1000-1100	As/Au	11585 11735 13700 15020 17387 17840
1330-1500	As	9545 11620 13710
1745-1945	Eu/Af	7410 9635 9950 11620 11935 13780 15075 15200
2045-2230	Au/Eu	7150 7410 9650 9910 9950 11620 11715
2245-0045	As	7410 9705 9950 11620 13625

(AIR Web Page via World DX Club *Con-tact*)

GRUNDIG

Gives you the World

Grundig leads shortwave radio into the new Millennium!

When radio was introduced, back in the 1920's — to pluck voices and music out of the air — people thought it was magic. With Grundig, it still is! No other manufacturer rivals Grundig for *"that European sound."* Voices have an *"in-the-room"* quality and clarity — even from half a world away.

German-engineered quality... German-engineered sound... when people think of shortwave, they think of Grundig. Grundig has specialized in shortwave since the late 1950's, and in North America, shortwave radios are all we sell.

Critics reviews of Grundig models include *Best of Category .. Superior Performance... Ergonomically Better... Superb Sound Quality... An Excellent Choice*

We listen, too.

We're very good at listening — to our customers. Our engineers design each model so it's easy, intuitive, and convenient to use. Critics call this *"great ergonomics!"* And Grundig models always deliver top performance for the price. Critics call this *"bang for the buck."*

GRUNDIG

The Latest in Technology

Rated Best in Its Class.

Grundig's Yacht Boy 400PE has received rave reviews from the shortwave press for combining a wealth of sophisticated features in a sleek titanium-look package that doesn't cost a fortune. It incorporates features found on stationary shortwave systems that cost thousands, such as outstanding audio quality, precise 1 kHz increment tuning, up/down slewing, frequency scanning, signal strength indication, and single-sideband signal demodulation.

But the advantage mentioned most often in the reviews is its ease of use for the novice listener. In moments you can listen to foreign broadcasts beamed to North America.

Soon, you will be scanning the airwaves to tune in exotic music programs and sports events from faraway locales. The YB-400PE even picks up shortwave amateur (ham radio) broadcasts and shortwave aviation/military frequencies (cockpit-to-tower communications). The possibilities for family fun, education, and enjoyment are boundless.

For travel or home use, Grundig adds a dual-time travel clock with snooze and sleep timer. The FM band is stereophonic with your headphones. The lighted LCD panel is easy to read in the

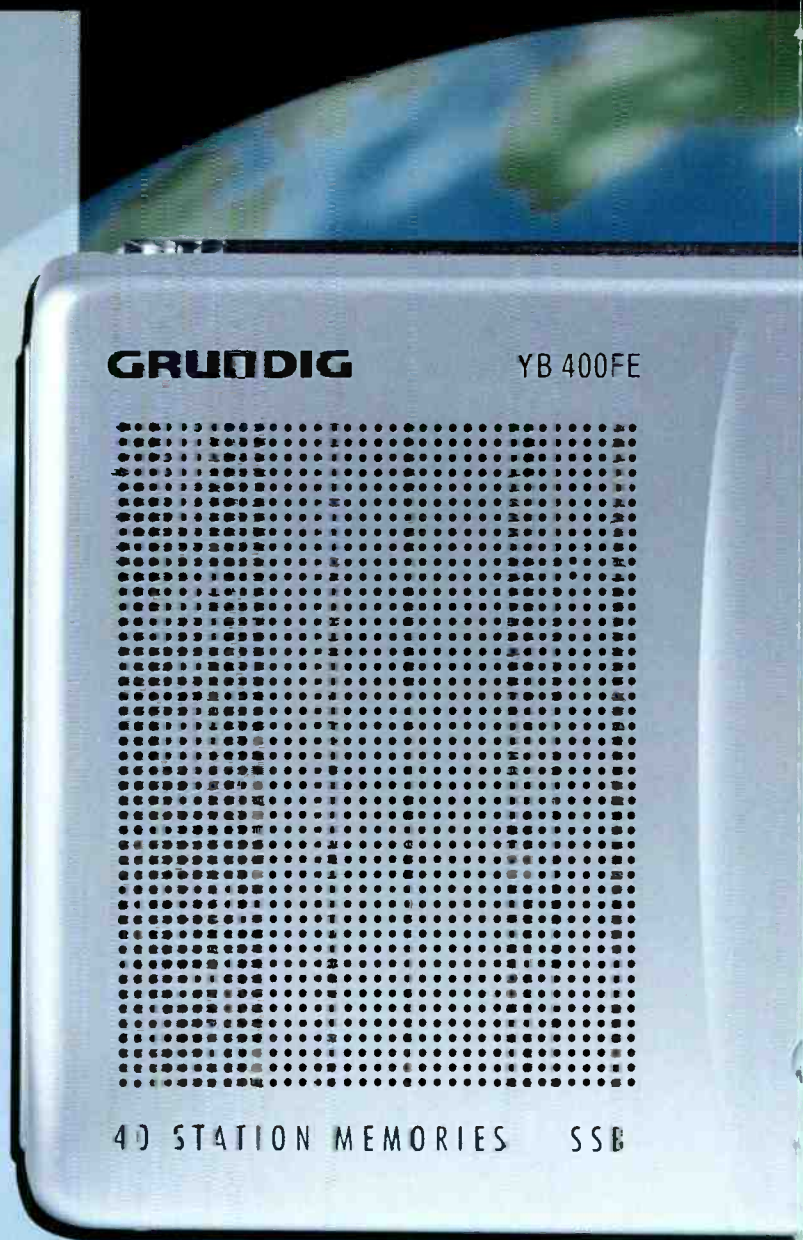

Yacht Boy 400PE

The Best in Value!



dark. Comes with a form-fitting pouch, integral telescoping antenna and advanced external antenna on a compact reel, carry-strap, ac-adaptor, ear-phones and complete instructions.

Made by Germany's Grundig

World leader in shortwave radios, the 400PE measures just 7-3/4"L x 4-1/4"H x 1-1/4"W; weighs only 20 oz. It slips easily into your carry-on for travel and fits on a nightstand, office credenza or yacht cabin console. One-year warranty

Grundig's Yacht Boy 400PE Named Editor's Choice.

Passport To World Band Radio is regarded as the leading authority of the shortwave industry. Here's what their testing expert wrote about the Grundig Yacht Boy 400PE:

"Best performance for price size category, and among the choicest portables of any size, at any price."

"The 400's FM performance is right up there with the very best among world band radios."

Please call our shortwave hotline and talk to the experts: 800-872-2228.

Grundig sets the standard for customer service.

Grundig supports the industry's only Toll-free Shortwave Hotline. Consumers and dealers can call 1-800-872-2228 in the United States or 1-800-637-1648 in Canada weekdays from 9am to 4pm Pacific Time. You can speak with a real live shortwave expert, not an automatic message machine. Grundig even answers questions for those who own other brands, for whom no such toll-free hotline service is available!

Grundig warranty service is the best.

Any problems? We fix them fast. Dealers know that customers will be taken care of! Dealer support service is first-rate, too. Remember, all we sell in North America are shortwave radios. We specialize! We do it best!

Watch this space for Grundig's biggest product announcement in years!

Shortwave enthusiasts and Grundig dealers will have an extra-special reason to celebrate the new millennium—the most important Grundig product announcement in years!

GRUNDIG
made for you

FREQUENCIES

1400-1500	Anguilla, Caribbean Beacon	11775am			
1400-1500 vl	Australia, ABC/Alice Spgs	2310do			
1400-1500 vl	Australia, ABC/Katherine	2485do			
1400-1500 vl	Australia, ABC/Tent Creek	2325do			
1400-1430	Australia, Radio	5995as	6180va	9580va	11650va
		17750pa			
1400-1500 vl	Botswana, Radio	4820do	4830do	7255do	
1400-1500 vl	Canada, CBC N Quebec Svc	9625do			
1400-1500	Canada, CFRX Toronto	6070do			
1400-1500	Canada, CFVP Calgary	6030do			
1400-1500	Canada, CHNX Halifax	6130do			
1400-1500	Canada, CKZN St John's	6160do			
1400-1500	Canada, CKZU Vancouver	6160do			
1400-1500 s	Canada, R Canada Intl	13650na	17800na		
1400-1456	China, China Radio Intl	7405na	9535as	9700as	11675as
		11825as	13685af	15110af	15125af
1400-1500	Costa Rica, RF Peace Intl	21460am			
1400-1500	Ecuador, HCJB	12005ca	15115am	21455va	
1400-1500	Eq Guinea, Radio Africa	15186af			
1400-1500	France, Radio France Intl	11910as	17560va	17680as	
1400-1500	Germany, RTE Radio	15625eu			
1400-1500	Germany, Sunrise Radio	5850eu			
1400-1500	Germany, Voice of Hope	15715as			
1400-1500 vl	Ghana, Ghana BC Corp	4915do	6130do		
1400-1500	Guyana, GBC/Voice of	5950do			
1400-1500	India, All India Radio	9545as	11620as	13710as	
1400-1430	Israel, Kol Israel	15650va	17535va		
1400-1500	Japan, Radio/NHK	9505na	11730as	11880me	
1400-1500	Jordan, Radio	11690eu			
1400-1500	Kenya, Kenya BC Corp	4935do			
1400-1500 vl	Lesotho, Radio	4800do			
1400-1500	Malaysia, Radio	7295do			
1400-1500	Malaysia, RTM Sarawak	7160do			
1400-1500 vl	Malaysia, RTM KotaKinabalu	5980do			
1400-1430	Mexico, Radio Mexico Intl	9705am			
1400-1500	N Marianas, KFBS Saipan	9465as	9495as	9670as	
1400-1500 occsnal	New Zealand, R NZ Intl	6100va			
1400-1500 vl	Nigeria, Radio/Ibadan	6050do			
1400-1500 vl	Nigeria, Radio/Kaduna	4770do			
1400-1415	Pakistan, Radio	9645do			
1400-1500	Palau, KHBN/Voice of Hope	9955as	9965as	9985as	13840va
		15725as			
1400-1500 vl	Papua New Guinea, NBC	4890do			
1400-1500	Philippines, FEBC R Intl	11995as			
1400-1500	Russia, Voice of Russia WS	12005as	12025as	15550as	
1400-1455 as	S Africa, Channel Africa	11720af	17860af	21530af	
1400-1500	Sierra Leone, SLBS	5980do			
1400-1500	Singapore, RCorp Singapore	6150do			
1400-1500	Sri Lanka, Sri Lanka BC	6005as	9730as	15425as	
1400-1500	Switzerland, Swiss R Intl	9575as	17670as		
1400-1500	Taiwan, Radio Taipei Intl	15125as			
1400-1500 as	Tanzania, Radio	5050af			
1400-1430	Thailand, Radio	9655as	9830as	11905as	
1400-1500	Uganda, Radio	4976do			
1400-1500	UK, BBC World Service	3990as	6190af	6195as	9515am
		9740as	11865am	11940af	12095eu
		15310as	15485eu	15565eu	15575ma
		17705as	17830af	17840am	21470af
					21660af
1400-1500	USA, KAIJ Dallas TX	13815na			
1400-1500	USA, KJES Vado NM	11715na			
1400-1500	USA, KTVN Salt Lk City UT	7510na			
1400-1500	USA, KWHR Naalehu HI	9930as	11565pa		
1400-1500	USA, Voice of America	6160as	7125as	7215as	9645as
		9760as	15160as	15255va	15395as
			15160as	15255va	15425as
1400-1500	USA, WEWN Birmingham AL	11875na			
1400-1500	USA, WGTG McCaysville GA	9370al			
1400-1500	USA, WHRI Noblesville IN	6040na			
1400-1500	USA, WJCR Upton KY	7490na			
1400-1500 irreg	USA, WMLK Bethel PA	9465am			
1400-1500	USA, WRNO New Orleans LA	7395na			
1400-1500	USA, WWCR Nashville TN	9475na	12160na	13845na	15685na
1400-1500	USA, WYFR Okeechobee FL	11550as	11830na	11970na	17750na
1400-1405	Vatican City, Vatican R	15500as	17550as		
1400-1500	Zambia, Christian Voice	6065af			
1400-1500	Zambia, Natl BC Corp	6165do	6265do		
1400-1500 vl	Zimbabwe, Zimbabwe BC	4828do	5012do		
1410-1420	Greece, Voice of	9425eu	15630eu		
1415-1420	Nepal, Radio	5005as	7165as		
1430-1500	Australia, Radio	5995as	6180va	9500as	9580va
		11650va	11660as	17750pa	
1430-1500	Guam, AWR/KSDA	11980as			
1430-1500	Guam, TWR/KTWR	15330as			
1430-1500	Netherlands, Radio	9890as	12075as	15590as	
1430-1500	S Africa, RTE Radio	21745af			
1430-1500	Slovakia, AWR Europe	17525as			

SELECTED PROGRAMS

Sundays

- 1400 Israel, Kol Israel: News.
- 1400 Japan, Radio: News.
- 1400 Switzerland, Swiss Radio Intl: World Radio Switzerland.
- 1405 Australia, Radio: Books and Writing.
- 1410 Japan, Radio: Asia Weekly.
- 1411 Japan, Radio: Asian Top News.
- 1412 Switzerland, Swiss Radio Intl: Swiss Scene.
- 1421 Japan, Radio: Asian Music.
- 1427 Israel, Kol Israel: Top Stories.
- 1430 Switzerland, Swiss Radio Intl: Rendez-vous with Switzerland.
- 1430 Netherlands, Radio: News.
- 1437 Japan, Radio: Asian Music.
- 1437 Netherlands, Radio: Sincerely Yours.
- 1455 Netherlands, Radio: Sounds Interesting.

Monday-Friday

- 1400 Israel, Kol Israel: News.
- 1400 Switzerland, Swiss Radio Intl: World Radio Switzerland.
- 1430 Netherlands, Radio: News.
- 1438 Netherlands, Radio: Newslines.
- 1445 Japan, Radio: Asia in Focus.

Mondays

- 1430 Switzerland, Swiss Radio Intl: Rendez-vous with Switzerland.
- 1432 Russia, Voice of: Folk Box.
- 1434 China, China Radio Intl: Changzhou Reports.
- 1445 China, China Radio Intl: Idioms and Their Stories.
- 1454 Netherlands, Radio: Research File.

Tuesdays

- 1400 Switzerland, Swiss Radio Intl: World Radio Switzerland.
- 1428 Israel, Kol Israel: Top Stories.
- 1455 Netherlands, Radio: Music 52-15.

Wednesdays

- 1425 Israel, Kol Israel: Science Watch.
- 1455 Netherlands, Radio: Documentary.

Fridays

- 1413 Israel, Kol Israel: Current Cultural Events in Israel.
- 1430 Switzerland, Swiss Radio Intl: Rendez-vous with Switzerland.
- 1455 Netherlands, Radio: A Good Life.

Saturdays

- 1400 Israel, Kol Israel: News.
- 1410 Israel, Kol Israel: The Week in Review.
- 1415 Switzerland, Swiss Radio Intl: The Name Game (1).
- 1420 South Africa, Channel Africa: This is Your World.
- 1425 China, China Radio Intl: Report on Developing Countries.
- 1430 China, China Radio Intl: China Scrapbook.
- 1430 Netherlands, Radio: News.
- 1435 China, China Radio Intl: Music from China.
- 1438 Netherlands, Radio: Europe Unzipped.
- 1454 Netherlands, Radio: Weekend.

Macintosh Software

SHORTWAVE NAVIGATOR FREQUENCY VALET • UTCLOCK

FREQUENCIES/PROGRAMS/COMPUTER CONTROL
(DRAKE • KENWOOD • JRC)

SEND \$2 FOR DEMO DISK TO:
DX COMPUTING • 232 SQUAW CREEK RD.
WILLOW PARK, TX 76087

IT'S BACK AND BETTER THAN EVER

The Worldwide Shortwave Listening Guide

Edited by John Figliozzi

A "must" reference for every shortwave program listener!

\$8.99 at all Radio Shack stores.
Catalog No. 62-1335





FREQUENCIES

1500-1600	Anguilla, Caribbean Beacon	11775am				1500-1600	Palau, KHBN/Voice of Hope	9955as	9965as	9985as	15725as
1500-1600 vl	Australia, ABC/Alice Spgs	2310do				1500-1600 vl	Papua New Guinea, NBC	4890do			
1500-1600 vl	Australia, ABC/Katherine	2485do				1500-1600	Philippines, FEBC R Intl	11995as			
1500-1600 vl	Australia, ABC/Tent Creek	2325do				1500-1600 vl	Russia, Voice of Assria	6005me	9480me		
1500-1600	Australia, Radio	5995as	6180va	9500as	9580va	1500-1600	Russia, Voice of Russia WS	4730me	4940me	4975me	7325me
		11650va	11660as	17750pa				9480eu	9730eu	11500as	12070me
1500-1600 vl	Botswana, Radio	4820do				1500-1530	S Africa, Channel Africa	17770af			
1500-1600 vl	Canada, CBC N Quebec Svc	9625do				1500-1600	Seychelles, FEBA Radio	11600as			
1500-1600	Canada, CFRX Toronto	6070do				1500-1600	Sierra Leone, SLBS	5980do			
1500-1600	Canada, CFVP Calgary	6030do				1500-1600	Singapore, RCorp Singapore	6150do			
1500-1600	Canada, CHNX Halifax	6130do				1500-1600	Sri Lanka, Sri Lanka BC	6005as	9730as	15425as	
1500-1600	Canada, CKZN St John's	6160do				1500-1600 as	Tanzania, Radio	5050af			
1500-1600	Canada, CKZU Vancouver	6160do				1500-1600	Uganda, Radio	4976do			
1500-1600 s	Canada, R Canada Intl	13650na	17800na			1500-1600	UK, BBC World Service	5975as	5990as	6190af	6195as
1500-1556	China, China Radio Intl	7160as	9785as	13685af	15125af		9410eu	9515am	9740as	11860af	11940af
1500-1600	Costa Rica, RF Peace Intl	15050am	21460am				15220am	15310as	15400af	15420af	15485eu
1500-1600	Ecuador, HCJB	12005ca	15115am	21455va			17705as	17830af	17840am	21470af	21490af
1500-1600	Eq Guinea, Radio Africa	15186af				1500-1600	USA, KAIJ Dallas TX	13815na			
1500-1600	Germany, Sunrise Radio	5850eu				1500-1600	USA, KTVN Salt Lk City UT	15590na			
1500-1530	Germany, Voice of Hope	15715as				1500-1600	USA, KWHR Naalehu HI	9930as	11565pa		
1500-1600 vl	Ghana, Ghana BC Corp	4915do	6130do			1500-1600	USA, Voice of America	7125as	7215as	9645as	9700me
1500-1600	Guyana, GBC/Voice of	5950do						15205va	15255va	15395as	
1500-1600	Japan, Radio/NHK	7200as	9505na	9750as	11730as	1500-1600	USA, WEWN Birmingham AL	11875na	15745eu		
1500-1600	Jordan, Radio	11690eu				1500-1600	USA, WGTG McCaysville GA	9370af	9400am		
1500-1600	Kenya, Kenya BC Corp	4935do				1500-1600	USA, WHRI Noblesville IN	13760na	15105sa		
1500-1600 vl	Lesotho, Radio	4800do				1500-1600	USA, WINB Red Lion PA	13800am			
1500-1510	Liberia, LCN/R Liberia Intl	5100do				1500-1600	USA, WJCR Upton KY	7490na	13595as		
1500-1600	Malaysia, Radio	7295do				1500-1600 irreg	USA, WMLK Bethel PA	9465am			
1500-1600	Malaysia, RTM Sarawak	7160do				1500-1600	USA, WRNO New Orleans LA	7395na			
1500-1600 vl	Malaysia, RTM KotaKinabalu	5980do				1500-1600	USA, WWCR Nashville TN	9475na	12160na	13845na	15685na
1500-1530	Mexico, Radio Mexico Intl	9705am				1500-1600	USA, WYFR Okeechobee FL	11830na	17750na		
1500-1530	Mongolia, Voice of	9720as	12015as			1500-1600	Zambia, Christian Voice	6065af			
1500-1600	Myanmar, Radio	5986do				1500-1600	Zambia, Natl BC Corp	6165do	6265do		
1500-1600	N Marianas, KFBS Saipan	9465as	9495as	9670as		1500-1600 vl	Zimbabwe, Zimbabwe BC	4828do	5012do		
1500-1600	Netherlands, Radio	9890as	12075as	15590as		1530-1540	Bangladesh, Bangla Betar	4880as	15520as		
1500-1600 occsnal	New Zealand, R NZ Intl	6100va				1530-1600	Georgia, Georgian Radio	6180me			
1500-1600 vl	Nigeria, Radio/Ibadan	6050do				1530-1600	Guam, AWR/KSDA	9355as	11920as		
1500-1600 vl	Nigeria, Radio/Kaduna	4770do				1530-1600	Iran, VOIRI	7250as	11680as	13605as	15150as
1500-1600 vl	Nigeria, Voice of	7255af	15120va			1530-1600	Tanzania, Radio	5050af			
1500-1600	North Korea, R Pyongyang	3560as	9640va	9975me	11335am	1545-1600 sh	Bangladesh, Bangla Betar	4880as	15520as		
		11735am	13650va			1545-1600 m	Guam, TWR/KTWR	15330as			
						1550-1600 a	Vatican City, Vatican R	12065om	13765au	15500au	

SELECTED PROGRAMS

Sundays

- 1500 Canada, RCI Montreal: RCI News.
- 1500 Japan, Radio: News.
- 1506 Canada, RCI Montreal: This Morning (hour 3).
- 1510 Japan, Radio: Hello from Tokyo.
- 1520 China, China Radio Intl: China Snapshots.
- 1525 China, China Radio Intl: Report on Developing Countries.
- 1535 China, China Radio Intl: Song of the Week.
- 1545 China, China Radio Intl: Voices from Other Lands.

Monday-Friday

- 1500 Australia, Radio: RA News.
- 1500 Japan, Radio: News.
- 1500 USA, Voice of America: News.
- 1511 China, China Radio Intl: News about China.
- 1515 Japan, Radio: Asian Top News.
- 1520 China, China Radio Intl: Current Affairs.
- 1530 Netherlands, Radio: News.
- 1538 Netherlands, Radio: Newslines.

Mondays

- 1525 Netherlands, Radio: Press Review.
- 1525 China, China Radio Intl: Press Clippings.
- 1530 China, China Radio Intl: China's Open Windows.
- 1534 China, China Radio Intl: Changzhou Reports.
- 1545 China, China Radio Intl: Idioms and Their Stories.
- 1555 Netherlands, Radio: EuroQuest.

Tuesdays

- 1525 Netherlands, Radio: Press Review.
- 1534 China, China Radio Intl: Press Clippings.
- 1539 China, China Radio Intl: Orient Arena.
- 1545 China, China Radio Intl: Voices from Other Lands.
- 1554 Netherlands, Radio: A Good Life.

Wednesdays

- 1505 Australia, Radio: Asia Pacific.
- 1530 Australia, Radio: The Religion Report.
- 1545 China, China Radio Intl: Learn to Speak Chinese.

Thursdays

- 1554 Netherlands, Radio: Research File.

Fridays

- 1525 Netherlands, Radio: Press Review.
- 1525 Japan, Radio: Music Beat.

- 1533 China, China Radio Intl: Press Clippings.
- 1537 China, China Radio Intl: Life in China.
- 1544 China, China Radio Intl: Global Review.

Saturdays

- 1520 China, China Radio Intl: Chinese Folktales.
- 1525 China, China Radio Intl: Report on Developing Countries.
- 1530 China, China Radio Intl: China Scrapbook.
- 1535 China, China Radio Intl: Music from China.

SWL Programs, continued from page 47

Saturdays

- 0005 BBC (as): "Waveguide" (4)
- 0005 BBC (as): "Write On"
- 0030 Australia, Radio: "Feedback"
- 0136 Kim Elliott via VOA (News Now): "Communications World (A)"
- 0230 Marie Lamb via KWHR (Angel 3): "DXing with Cumbre"
- 0245 Radio Bulgaria: "Radio Bulgaria Calling"
- 0300 Glenn Hauser via RFPI: "Continent of Media"
- 0330 Glenn Hauser via RFPI: "World of Radio"
- 0336 Kim Elliott via VOA (News Now): "Communications World (B)"
- 0338 Voice of Turkey: "DX Corner" (biweekly)
- 0415 WRMI (Florida): "Wavescan"
- 0500 Marie Lamb via WHRI (Angel 1): "DXing with Cumbre"
- 0500 Marie Lamb via WHRI (Angel 2): "DXing with Cumbre"
- 0530 Glenn Hauser via WRN1: "World of Radio"

- 0536 Kim Elliott via VOA (News Now): "Communications World (A)"
- 0600 Marie Lamb via KWHR (Angel 3): "DXing with Cumbre"
- 0605 Australia, Radio: "Feedback"
- 0710 HCJB (eu): "DX Partyline"
- 0730 Marie Lamb via WHRI (Angel 1): "DXing with Cumbre"
- 0730 Marie Lamb via WHRI (Angel 2): "DXing with Cumbre"
- 0845 WWCR #3 (Tennessee): "Ask WWCR"
- 0910 HCJB (pac): "DX Partyline"
- 0936 Kim Elliott via VOA (News Now): "Communications World (B)"
- 0940 FEBC (Philippines): "DX Dial"
- 1100 Glenn Hauser via RFPI: "Continent of Media"
- 1130 Glenn Hauser via RFPI: "World of Radio"
- 1130 Glenn Hauser via WWCR #1: "World of Radio"

continued on page 59

FREQUENCIES

1600-1700	Algeria, R Algiers Intl	11715af	15160me	1600-1700	Sierra Leone, SLBS	5980do		
1600-1700	Anguilla, Caribbean Beacon	11775am		1600-1700	South Korea, R Korea Intl	5975om	9515af	9870af
1600-1700 vl	Australia, ABC/Alice Spgs	2310do		1600-1700	Swaziland, Trans World R	9500af		
1600-1700 vl	Australia, ABC/Katherine	2485do		1600-1615	Switzerland, Swiss R Intl	9575as	17670as	
1600-1700 vl	Australia, ABC/Tent Creek	2325do		1600-1700	Tanzania, Radio	5050af		
1600-1700	Australia, Radio	5995as	6180va	1600-1645	UAE, Radio Dubai	13630eu	13675eu	15395eu
		11650va	11660as	1600-1700	Uganda, Radio	4976do		21605eu
		4820do	4830do	1600-1700	UK, BBC World Service	3915as	5975as	5990as
1600-1700 vl	Botswana, Radio	4820do				9410eu	9515am	9740as
1600-1700 vl	Canada, CBC N Quebec Svc	9625do				12095eu	15400af	15485eu
1600-1700	Canada, CFRX Toronto	6070do				17830af	21470af	21660af
1600-1700	Canada, CFVP Calgary	6030do		1600-1700	UK, Merlin Network One	6175eu		
1600-1700	Canada, CHNX Halifax	6130do		1600-1700	USA, KAIJ Dallas TX	13815na		
1600-1700	Canada, CKZN St John's	6160do		1600-1700	USA, KTNB Salt Lk City UT	15590na		
1600-1700	Canada, CKZU Vancouver	6160do		1600-1700	USA, KWHR Naalehu HI	9930as		
1600-1656	China, China Radio Intl	9565af	9870af	1600-1700	USA, KWHR Naalehu HI	6035af	6110as	6160as
1600-1700	Costa Rica, RF Peace Intl	15050am	21460am	1600-1700	USA, Voice of America	7215as	9645as	9700as
1600-1627	Czech Rep, R Prague Intl	5930eu	21745af			15205va	15225af	15255va
1600-1630	Ecuador, HCJB	12005ca	15115am	1600-1700	USA, WEWN Birmingham AL	11875na	13615na	
1600-1700	Eq Guinea, Radio Africa	15186af		1600-1700	USA, WGTG McCaysville GA	9370af	9400am	
1600-1700	Ethiopia, Radio	7165af	9560af	1600-1700	USA, WHRA Greenbush ME	17650af		
1600-1700	France, Radio France Intl	11615af	11995af	1600-1700	USA, WHRI Noblesville IN	13760na	15105sa	
		17605af		1600-1700	USA, WINB Red Lion PA	13800am		
		6140eu	6170as	1600-1700	USA, WJCR Upton KY	7490na	13595as	
		11810af	15135af	1600-1700 irreg	USA, WMLK Bethel PA	9465am		
1600-1645	Germany, Deutsche Welle	9875as		1600-1700	USA, WRNO New Orleans LA	7395na		
		15105va		1600-1700	USA, WSHB Cypress Crk SC	18915af		
1600-1700 s	Germany, Good News World	5850eu		1600-1700	USA, WWCN Nashville TN	9475na	12160na	13845na
1600-1700	Germany, Sunrise Radio	13810me		1600-1700	USA, WYFR Okeechobee FL	11830na	15600na	15695eu
1600-1700	Germany, Overcomer Ministr	4915do	6130do			17750na	21525af	
1600-1700 vl	Ghana, Ghana BC Corp	9355as	11920as	1600-1615 a	Vatican City, Vatican R	12065om	13765au	15500au
1600-1700	Guam, AWR/KSDA	15330as		1600-1700	Zambia, Christian Voice	3330af	4965af	
1600-1630 as	Guam, TWR/KTWR	5950do		1600-1700	Zambia, Natl BC Corp	6165do	6265do	
1600-1700	Guyana, GBC/Voice of	7250as	11680as	1600-1630 vl	Zimbabwe, Zimbabwe BC	4828do	5012do	
1600-1630	Iran, VOIRI	11690eu	13605as	1615-1700 a	UK, BBC World Service	9515am	11860af	
1600-1630	Jordan, Radio	4935do	15150as	1615-1700 a	UK, BBC World Service	9515am		
1600-1700	Kenya, Kenya BC Corp	6280me		1615-1630	Vatican City, Vatican R	4005eu	5883eu	7250eu
1600-1700	Lebanon, Voice of Hope	4800do	9985me			15595eu		9645eu
1600-1700 vl	Lesotho, Radio	7295do		1630-1700	Austria, R Austria Intl	6155va	13730va	15240va
1600-1700	Malaysia, Radio	9465as	9495as	1630-1657	Canada, R Canada Intl	6140as	7150as	
1600-1700	N Marianas, KFBS Saipan	9890as	12075as	1630-1700	Egypt, Radio Cairo	15255af		
1600-1625	Netherlands, Radio	6100va	15590as	1630-1700 s	Seychelles, FEBA Radio	11695as		
1600-1650 occsnal	New Zealand, R NZ Intl	6050do		1630-1700	Slovakia, R Slovakia Intl	5920eu	6055eu	7345eu
1600-1700 vl	Nigeria, Radio/Ibadan	4770do		1630-1657	Vietnam, Voice of	9730eu	9840eu	
1600-1700 vl	Nigeria, Radio/Kaduna	7255af	15120va	1630-1700 vl	Zimbabwe, Zimbabwe BC	3306do	4828do	
1600-1700	Nigeria, Voice of	7230do	11570me	1645-1700	Germany, Deutsche Welle	6140eu		
1600-1630	Pakistan, Radio	17510me	15464me	1645-1700	Tajikistan, Radio	7245as		
		9965as		1645-1700 smwf	UK, BBC World Service	11860af		
1600-1700	Palau, KHBN/Voice of Hope	4890do	9730eu	1650-1700 mtwhf	New Zealand, R NZ Intl	6145va		
1600-1700 vl	Papua New Guinea, NBC	9675me	12005as					
1600-1700	Russia, Voice of Russia WS	6150af	12070me					
1600-1630	S Africa, Channel Africa							

SELECTED PROGRAMS

Sundays

- 1600 Vatican State, Vatican Radio: The Backgrounder.
- 1600 Germany, Deutsche Welle: News.
- 1600 USA, KWHR Naalehu HI: USA Radio News.
- 1600 USA, Voice of America: Nightline Africa.
- 1602 USA, KWHR Naalehu HI: 20 The Countdown Magazine.
- 1606 Germany, Deutsche Welle: Religion and Society.
- 1606 USA, Voice of America: All About English.
- 1615 Pakistan, Radio: Slow Speed News.
- 1615 Germany, Deutsche Welle: Arts on the Air.
- 1630 USA, Voice of America: News (Special English).
- 1640 USA, Voice of America: Words and their Stories (Special English).
- 1645 USA, Voice of America: People in America (Special English).

Monday-Friday

- 1600 Australia, Radio: RA News.
- 1600 Czech Rep, Radio Prague: News.
- 1600 USA, KWHR Naalehu HI: USA Radio News.
- 1600 USA, Voice of America: News.
- 1600 USA, WGTG, McCaysville GA: Patriot Radio News Hour.
- 1602 Vatican State, Vatican Radio: News.
- 1605 Czech Rep, Radio Prague: Current Affairs.
- 1605 USA, KWHR Naalehu HI: Music.
- 1606 USA, Voice of America: All About English.

- 1615 Vatican State, Vatican Radio: News.
- 1630 Germany, Deutsche Welle: Africa Report.
- 1630 USA, Voice of America: Africa World Tonight.
- 1630 USA, Voice of America: News (Special English).

Mondays

- 1616 Czech Rep, Radio Prague: Spotlight.
- 1640 USA, Voice of America: Development Report (Special English).
- 1645 USA, Voice of America: This is America (Special English).

Tuesdays

- 1615 UAE, Radio Dubai: Music.
- 1616 Czech Rep, Radio Prague: Talking Point.
- 1640 USA, Voice of America: Agriculture Report (Special English)
- 1645 USA, Voice of America: Science in the News (Special English)

Wednesdays

- 1616 Czech Rep, Radio Prague: HistoryCzech.
- 1640 USA, Voice of America: Science Report (Special English).
- 1645 USA, Voice of America: Exploration (Special English).

Thursdays

- 1616 Czech Rep, Radio Prague: Economic Report.
- 1640 USA, Voice of America: Science Report (Special English).
- 1645 USA, Voice of America: The Making of a Nation (Special English).

Fridays

- 1600 Vatican State, Vatican Radio: Mass in English.
- 1616 Czech Rep, Radio Prague: Postbag.
- 1640 USA, Voice of America: Environment Report (Special English).
- 1645 USA, Voice of America: American Mosaic (Special English).

Saturdays

- 1600 Czech Rep, Radio Prague: News.
- 1600 Australia, Radio: RA News.
- 1605 Australia, Radio: Melisma (Part 2).
- 1606 Czech Rep, Radio Prague: Let's Go.
- 1606 Germany, Deutsche Welle: Talking Point.
- 1606 USA, Voice of America: All About English.
- 1615 Germany, Deutsche Welle: Spectrum.
- 1625 China, China Radio Intl: Report on Developing Countries.
- 1630 USA, Voice of America: News (Special English).
- 1645 USA, Voice of America: American Stories (Special English).

FREQUENCIES

1700-1800	Anguilla,Caribbean Beacon	11775am			
1700-1800 vl	Australia, ABC/Alice Spgs	2310do			
1700-1800 vl	Australia, ABC/Katherine	2485do			
1700-1800 vl	Australia, ABC/Tent Creek	2325do			
1700-1800	Australia, Radio	5995sa	6180va	9500as	9580va
		9660va	11880va		
1700-1730	Azerbaijan, R Dada Gorgud	9165me			
1700-1800 vl	Botswana, Radio	4820do	4830do	7255do	
1700-1800 vl	Canada, CBC N Quebec Svc	9625do			
1700-1800	Canada, CFRX Toronto	6070do			
1700-1800	Canada, CFVP Calgary	6030do			
1700-1800	Canada, CHNX Halifax	6130do			
1700-1800	Canada, CKZN St John's	6160do			
1700-1800	Canada, CKZU Vancouver	6160do			
1700-1756	China, China Radio Intl	7150af	7405af	9570af	9745af
		11910af	15300af		
1700-1800	Costa Rica,RF Peace Intl	15050am	21460am		
1700-1727	Czech Rep, R Prague Intl	5930eu	21745af		
1700-1800	Egypt, Radio Cairo	15255af			
1700-1800	Eq Guinea, Radio Africa	15186af			
1700-1730	France, Radio France Intl	15210af	17605af		
1700-1730	Georgia, Georgian Radio	11910eu			
1700-1800	Germany, Deutsche Welle	6140eu			
1700-1800 a	Germany, Good News World	11795va			
1700-1800	Germany, Sunrise Radio	5850eu			
1700-1800	Germany,Overcomer Ministr	3965me	13810me		
1700-1800 vl	Ghana, Ghana BC Corp	3366do	4915do		
1700-1800	Guyana, GBC/Voice of	5950do			
1700-1800 vl	Italy, IRRS	3985va			
1700-1800	Japan, Radio/NHK	7110eu	9535na	9825as	15355af
1700-1800	Kenya, Kenya BC Corp	4935do			
1700-1800	Lebanon, Voice of Hope	6280me	9985me		
1700-1800 vl	Lesotho, Radio	4800do			
1700-1800	Malaysia, Radio	7295do			
1700-1800	N Marianas, KFBS Saipan	9465sa			
1700-1800 mtwhf	New Zealand, R NZ Intl	6145va			
1700-1800 vl	Nigeria, Radio/Ibadan	6070do			
1700-1800 vl	Nigeria, Radio/Kaduna	4770do			
1700-1800	Nigeria, Radio/Lagos	3326do			
1700-1800	Palau, KHBN/Voice of Hope	9955sa	9965as		
1700-1800 vl	Papua New Guinea, NBC	4890do			
1700-1800	Poland, Polish R Warsaw	6095eu	7285eu	9525eu	
1700-1756	Romania, R Romania Intl	15270eu	15380eu	17735eu	17865eu
1700-1800	Russia,Voice of Russia WS	7300eu	9480eu	9720eu	9775eu
		11510af	12065af		
1700-1800 smwhfa	Russia,Voice of Russia WS	9820eu	11675eu		
1700-1730	S Africa, Channel Africa	17860af			
1700-1800	Sierra Leone, SLBS	5980do			
1700-1800	Tanzania, Radio	5050af			
1700-1800	Uganda, Radio	4976do			
1700-1800	UK, BBC World Service	3255af	3915as	5975as	6005af
		6190af	7160as	9410eu	9510as
		9740as	11995me	12095eu	15400af
		15485eu	17830af	17840am	15420af
1700-1800	USA, KAIJ Dallas TX	13815na			
1700-1800	USA, KTVN Salt Lk City UT	15590na			
1700-1800	USA, KWHR Naalehu HI	9930as			
1700-1800	USA, Voice of America	6110as	6190as	7125as	7170as
			9645as	9700me	15255va
			15395as	15410af	15445af
			5990as	6045as	7150as
			9770as	11870as	9550as
1700-1800 mtwhf	USA, Voice of America	11875na	13615na		
1700-1800	USA, WEWN Birmingham AL	9370af	9400am		
1700-1800	USA, WGTG McCaysville GA	17650af			
1700-1800	USA, WHRA Greenbush ME	13760na	15105na		
1700-1800	USA, WHRI Noblesville IN	13800am			
1700-1800	USA, WINB Red Lion PA	7490na	13595as		
1700-1800	USA, WJCR Upton KY	9465am			
1700-1800	USA, WMLK Bethel PA	7395na			
1700-1800	USA, WRNO New Orleans LA	18915af			
1700-1800	USA, WWSB Cypress Crk SC	9475na	12160na	13845na	15685na
1700-1800	USA, WWCR Nashville TN	15695eu	17555eu		
1700-1727	USA, WYFR Okeechobee FL	12070eu			
1700-1800	Vietnam, Voice of	3330af	4965af		
1700-1800	Zambia, Christian Voice	6165do	6265do		
1700-1800	Zambia, Natl BC Corp	3306do	4828do		
1700-1800 vl	Zimbabwe, Zimbabwe BC	15235va	15415va	15435va	
1715-1800 vl	Libya, Voice of Africa	3200af			
1715-1800	Swaziland, Trans World R	5910eu	9925eu	11840af	13670eu
1730-1756	Belgium, R Vlaanderen Intl	6080me			
1730-1800 as	Georgia, Georgian Radio	11965as			
1730-1800	Guam, AWR/KSDA	6020af	7120af	11655af	
1730-1800	Netherlands, Radio	11720as	11890as	15190as	
1730-1800	Philippines, R Pilipinas	12130af			
1730-1800	S Africa, AWR Africa	6065eu			
1730-1800 mtwhfa	Sweden, Radio	9590eu			
1730-1800 s	Sweden, Radio	12045as	15310as		
1730-1800 s	UK, BBC World Service	13765af	15570af	17550af	
1730-1800	Vatican City, Vatican R	7185eu	7462eu	9548eu	15520eu
1745-1800	Bangladesh, Bangla Betar	3315do	3345do	7410af	9635af
1745-1800	India, All India Radio	9950eu	11620eu	11935af	13780af
					15200af

1800-1900	Anguilla,Caribbean Beacon	11775am			
1800-1900 mtwhf	Argentina, RAE	15345eu			
1800-1900 vl	Australia, ABC/Alice Spgs	2310do			
1800-1900 vl	Australia, ABC/Katherine	2485do			
1800-1900 vl	Australia, ABC/Tent Creek	2325do			
1800-1900	Australia, Radio	6080pa	7240va	9500as	9580va
		9660va	11880va		
1800-1900	Bangladesh, Bangla Betar	7185eu	7462eu	9548eu	15520eu
1800-1900 vl	Botswana, Radio	4820do	4830do		
1800-1900	Brazil, R Nacional Bras	15265eu			
1800-1900	Canada, CFRX Toronto	6070do			
1800-1900	Canada, CFVP Calgary	6030do			
1800-1900	Canada, CHNX Halifax	6130do			
1800-1900	Canada, CKZN St John's	6160do			
1800-1900	Canada, CKZU Vancouver	6160do			
1800-1900	Costa Rica,RF Peace Intl	15050am	21460am		
1800-1830	Egypt, Radio Cairo	15255af			
1800-1900	Eq Guinea, Radio Africa	15186af			
1800-1900	Germany, Deutsche Welle	6140eu			
1800-1900	Germany, Sunrise Radio	5850eu			
1800-1830 s	Germany, Universal Life	11830af			
1800-1900	Germany,Overcomer Ministr	3965eu			
1800-1900 vl	Ghana, Ghana BC Corp	3366do	4915do		
1800-1815	Greece, Voice of	7450eu	9425eu	17705na	17765sa
1800-1900	Guyana, GBC/Voice of	5950do			
1800-1900	India, All India Radio	7410af	9635af	9950eu	11620eu
		11935af	13780af	15200af	
1800-1900 vl	Italy, IRRS	3985va			
1800-1900	Kenya, Kenya BC Corp	4935do			
1800-1900	Kuwait, Radio	11990am			
1800-1900	Lebanon, Voice of Hope	6280me	9985me		
1800-1900 vl	Lesotho, Radio	4800do			
1800-1815	Liberia,LCN/R Liberia Int	5100do			
1800-1900	Malaysia, Radio	7295do			
1800-1900	N Marianas, KFBS Saipan	9465sa			
1800-1900	N Marianas, KHBI Saipan	13820as			
1800-1830	Netherlands, Radio	6020af	7120af	11655af	
1800-1850 mtwhf	New Zealand, R NZ Intl	6145va			
1800-1900 vl	Nigeria, Radio/Ibadan	6050do			
1800-1900 vl	Nigeria, Radio/Kaduna	4770do			
1800-1900	Nigeria, Radio/Lagos	3326do			
1800-1900 vl	Nigeria, Voice of	7255af	15120va		
1800-1900	North Korea, R Pyongyang	4405as	6575eu	9335eu	11710am
		13760am			
1800-1900	Palau, KHBN/Voice of Hope	9965as			
1800-1900 vl	Papua New Guinea, NBC	4890do			
1800-1900	Philippines, R Pilipinas	11720as	11890as	15190as	
1800-1900	Russia,Voice of Russia WS	7300eu	7330eu	9480eu	9720eu
		9775eu	9820eu	9865eu	11510af
		11985eu	12025af	12065af	
		5960af	6100af		
1800-1830	S Africa, AWR Africa	17870af			
1800-1830	S Africa, Channel Africa	3316do			
1800-1900	Sierra Leone, SLBS	5020do			
1800-1900 vl	Solomon Islands, SIBC	9200va			
1800-1900	Sudan, Radio Omdurman	9500af			
1800-1830	Swaziland, Trans World R	3200af			
1800-1900	Swaziland, Trans World R	5050af			
1800-1900	Tanzania, Radio	6035af	7415af	9760af	11975af
1800-1900	UK, BBC World Service	13820as	15410af	15580af	17895af
					9770me
1800-1900	USA, KAIJ Dallas TX	13815na			
1800-1900	USA, KJES Vado NM	15385na			
1800-1900	USA, KTVN Salt Lk City UT	15590na			
1800-1900	USA, KWHR Naalehu HI	17510as			
1800-1900	USA, Voice of America	6035af	7415af	9760af	9770me
		11975af	13820as	15410af	15580af
		13820as	15410af	15580af	17895af
1800-1900	USA, WEWN Birmingham AL	9370af	9400am		
1800-1900	USA, WGTG McCaysville GA	17650af			
1800-1900	USA, WHRA Greenbush ME	13760na	15105na		
1800-1900	USA, WHRI Noblesville IN	13800am			
1800-1900	USA, WINB Red Lion PA	7490na	13595as		
1800-1900	USA, WJCR Upton KY	9465am			
1800-1900	USA, WMLK Bethel PA	7395na			
1800-1900 irreg	USA, WRNO New Orleans LA	18915af			
1800-1900	USA, WWSB Cypress Crk SC	9475na	12160na	13845na	15685na
1800-1900	USA, WWCR Nashville TN	15665eu	17555eu		
1800-1845	USA, WYFR Okeechobee FL	12070eu			
1800-1900 vl	Vanuatu, Radio	4960do			
1800-1827	Vietnam, Voice of	9730eu	9840eu		
1800-1900	Yemen, Rep of Yemen Radio	9780do			
1800-1900	Zambia, Christian Voice	3330af	4965af		
1800-1900	Zambia, Natl BC Corp	6165do	6265do		
1800-1900 vl	Zimbabwe, Zimbabwe BC	3306do	4828do		
1830-1900	Ascension Is,RTE Radio	17885af			
1830-1900	Georgia, Georgian Radio	11760eu			
1830-1900 s	Germany, Universal Life	11785af			
1830-1900	Netherlands, Radio	6020af	7120af	9895af	11655af
		13700af	17605af	21590af	
1830-1900 w	Philippines, FEBC R Intl	9465eu			
1830-1900	Slovakia, R Slovakia Intl	5920eu	6055eu	7345eu	
1830-1900	Turkey, Voice of	9670eu	11765eu	13695eu	
1830-1900 as	USA, Voice of America	7170af	11940af	15525af	
1830-1900 as	USA, Voice of America	7170af	11940af	15525af	
1840-1850	Greece, Voice of	9375af	12105af		
1851-1900 mtwhf	New Zealand, R NZ Intl	11695va			
1855-1900 as	New Zealand, R NZ Intl	11695va			

FREQUENCIES

Table with columns for frequency ranges (e.g., 1900-2000, 2000-2100), station names (e.g., Anguilla, Caribbean Beacon; Algeria, R Algiers Intl), and frequency values in MHz (e.g., 11775am, 11715af). Includes a small 'M' logo at the top center.

FREQUENCIES

Table with columns for frequency range, country/station, and frequency values. Includes entries for Anguilla, Caribbean Beacon; Australia, ABC/Alice Spgs; Botswana, Radio; Bulgaria, Radio; Canada, CBC N Quebec Svc; Costa Rica, RF Peace Intl; Cuba, Radio Havana; Ecuador, HCJB; Egypt, Radio Cairo; Eqt Guinea, Radio Africa; Germany, Deutsche Welle; Ghana, Ghana BC Corp; Guyana, GBC/Voice of; Hungary, Radio Budapest; India, All India Radio; Iraq, Radio Iraq Intl; Italy, IRRS; Japan, Radio/NHK; Kenya, Kenya BC Corp; Lesotho, Radio; Liberia, LCN/R Liberia Int; Malaysia, Radio; Namibia, NBC; New Zealand, R NZ Intl; Nigeria, Radio/Ibadan; Nigeria, Radio/Kaduna; Nigeria, Radio/Lagos; North Korea, R Pyongyang; Palau, KHBN/Voice of Hope; Papua New Guinea, NBC; Romania, R Romania Intl; Serbia, Radio Yugoslavia; Sierra Leone, SLBS; Solomon Islands, SIBC; South Korea, R Korea Intl; Spain, R Exterior Espana; Swaziland, Trans World R; Syria, Radio Damascus; Taiwan, Radi Taipei Intl; Turkey, Voice of; UK, BBC World Service; Ukraine, R Ukraine Intl; USA, KAIJ Dallas TX; USA, KTNB Salt Lk City UT; USA, KWHR Naalehu HI; USA, Voice of America; USA, WBCQ Monticello ME; USA, WEWN Birmingham AL; USA, WGTG McCaysville GA; USA, WHRA Greenbush ME; USA, WHRI Noblesville IN; USA, WINB Red Lion PA; USA, WJCR Upton KY; USA, WRMI/R Miami Intl; USA, WRNO New Orleans LA; USA, WSHB Cypress Crk SC; USA, WVCR Nashville TN; USA, WYFR Okeechobee FL; Vanuatu, Radio; Zambia, Christian Voice; Zambia, Natl BC Corp; Zimbabwe, Zimbabwe BC; Belarus, R Minsk; Armenia, Voice of; Egypt, Radio Cairo; UK, BBC Caribbean Report; UK, BBC World Service; Albania, R Tirana Intl; Australia, ABC/Tent Creek; Australia, Radio.

Table with columns for frequency range, country/station, and frequency values. Includes entries for Austria, R Austria Intl; Austria, R Austria Intl; China, China Radio Intl; Czech Rep, R Prague Intl; Guam, AWR/ KSDA; Hungary, Radio Budapest; Iran, VOIRI; Moldova, R Moldova Intl; South Korea, R Korea Intl; Sweden, Radio; UK, BBC Calling Falklands; USA, Voice of America; USA, Voice of America; Uzbekistan, R Tashkent.

2200 UTC

Table with columns for frequency range, country/station, and frequency values. Includes entries for Anguilla, Caribbean Beacon; Australia, ABC/Katherine; Australia, ABC/Tent Creek; Australia, Radio; Canada, CBC N Quebec Svc; Canada, CFRX Toronto; Canada, CFVP Calgary; Canada, CHNX Halifax; Canada, CKZN St John's; Canada, CKZU Vancouver; Canada, R Canada Intl; China, China Radio Intl; Costa Rica, RF Peace Intl; Egypt, Radio Cairo; Eqt Guinea, Radio Africa; Ghana, Ghana BC Corp; Guyana, GBC/Voice of; India, All India Radio; Iran, VOIRI; Italy, RAI Intl; Liberia, LCN/R Liberia Int; Malaysia, Radio; Mexico, Radio Mexico Intl; Namibia, NBC; New Zealand, R NZ Intl; Nigeria, Radio/Ibadan; Nigeria, Radio/Kaduna; Nigeria, Radio/Lagos; Palau, KHBN/Voice of Hope; Papua New Guinea, NBC; Sierra Leone, SLBS; Solomon Islands, SIBC; Swaziland, Trans World R; Syria, Radio Damascus; Taiwan, Radio Taipei Intl; Turkey, Voice of; UK, BBC World Service; USA, KAIJ Dallas TX; USA, KTNB Salt Lk City UT; USA, KWHR Naalehu HI; USA, Voice of America; USA, WBCQ Monticello ME; USA, WEWN Birmingham AL; USA, WGTG McCaysville GA; USA, WHRA Greenbush ME; USA, WHRI Noblesville IN; USA, WINB Red Lion PA; USA, WJCR Upton KY; USA, WRMI/R Miami Intl; USA, WRNO New Orleans LA; USA, WSHB Cypress Crk SC; USA, WVCR Nashville TN; USA, WYFR Okeechobee FL; Vanuatu, Radio; Zambia, Natl BC Corp; Canada, R Canada Intl; Belgium, R Vlaanderen Intl; Cuba, Radio Havana; Czech Rep, R Prague Intl; USA, Voice of America; Greece, Voice of; India, All India Radio; Vatican City, Vatican R; Anguilla, Caribbean Beacon.

ELF/VLF/LF Propagation Modes - Part 2

All the transmissions in the basement of the spectrum are vertically polarized, except as noted last month in the case of the Clam Lake/Republic US Navy system where the antennas are horizontal. The LF broadcasters and the various naval transmitters worldwide use extremely high power; it is not unheard of for these stations to "pump" between .5 to 5 MW.

However, the antenna systems at these frequencies have a very low efficiency and the power that is finally radiated is very small. On a frequency of 100 kHz, even a quarter-wave vertical antenna would be about 2400 feet high! Obviously that's quite an impossible feat, so there is a great loss of power in the antenna, loading coil, and ground system of all these stations.

When we "cruise" this section of the spectrum, many assume that the signal received is via the groundwave propagation mode. In daylight, that is the mode of choice for a signal in the 200 to 500 kHz band to follow to reach your simple receiver and antenna. Distant stations in that band are not normally heard during the daytime, especially if the complete path is in daylight.

Marine and air navigation beacons can normally be heard from a distance of about 100 miles in daylight using simple antennas and receivers. Even if you increase the antenna size and operate from a very quiet location, you will not be receiving signals from much further beacons.

In the 10 to about 100 kHz range, the signal strength of the signals received in daylight and at nighttime is approximately the same. The noise level varies depending on the time of day and the season, but most of the time if you hear a signal at night, you will also hear it during the day. There seems to be very little difference in reception in that part of the spectrum, and you will hear the various high power armed forces transmitters "chirping" away 24 hours a day.

Now let's look at propagation in the slice between 100 and 500 kHz. I am excluding from this segment the ship/coastal station operations that are located in the 450 to 500 kHz - there are very few such operations left on the air since the advent of the satellite-based GMDSS (Global Maritime Distress & Safety System).

You will still find some very interesting stations here: ITU region 1 (European) broad-

OPTIMUM WORKING FREQUENCIES (MHz)

For the Period 15 August to 14 September 1999 Flux=191 SSN=149

Predictions prepared using ASAPS for Windows®

UTC	00	01	02	03	04	05	06	07	08	09	10	11	12	13	14	15	16	17	18	19	20	21	22	23
TO/FROM US WEST COAST																								
SOUTH AMERICA	26	24	23	21	18	16	14	14	14	14	13	13	13	16	21	23	24	23	24	25	26	26	26	25
WESTERN EUROPE	10	10	10	9	9	9	10	10	9						13	15	16	15	14	14	15	14	13	11
EASTERN EUROPE (P)		11	11	12	13	13	12								13	15	16	16	16	15	14			
MEDITERRANEAN	18	18	17	17	15	14	13	12							15	16	17	18	19	19	19	19	19	18
MIDDLE EAST (P)	14	14	15	17	16	14									13	14	16	17	17	17	16	15	14	14
CENTRAL AFRICA	22	21	20	19	17	15	13	13							15	16	18	20	21	21	21	21	21	22
SOUTH AFRICA	17	15	14	13	12	13	14	13	13						16	18	19	20	21	22	22	22	22	20
SOUTH EAST ASIA (P)	19	19	19	19	18	16									10	11	11	12	14	16	18	19	20	18
FAR EAST	19	19	19	19	18	16	14	13	11	11	10	10	10	10	10	11	13	14	14	14	14	16	18	19
AUSTRALIA	28	29	28	28	26	23	21	18	17	16	16	15	15	14	14	17	17	16	14	15	20	28	29	28
TO/FROM US MIDWEST																								
SOUTH AMERICA	23	21	18	16	14	13	13	12	12	12	12	12	14	19	21	22	22	22	23	23	23	24	23	23
WESTERN EUROPE	12	11	11	11	11	11	11	10	10						14	15	16	17	17	17	16	16	16	15
EASTERN EUROPE	11	10	10	11	12	12									14	15	15	16	17	16	16	14	13	11
MEDITERRANEAN	18	17	16	15	13	12	11								16	17	18	19	19	19	19	19	18	18
MIDDLE EAST (P)	15	14	15	15	14	13									14	15	17	18	18	19	19	17	16	15
CENTRAL AFRICA	24	22	20	18	16	15	15	14	14						17	19	19	20	21	21	21	22	22	23
SOUTH AFRICA	17	15	14	13	12	13	15	15	14	14					15	18	19	20	20	21	22	22	23	22
SOUTH EAST ASIA (P)	18	18	17	16											10	11	12	15	17	18	20	20	19	17
FAR EAST	18	18	18	17	15	13	12	11	10	10	10	10	11	12	14	15	14	14	14	14	15	16	18	18
AUSTRALIA	25	25	24	23	20	18	16	15	14	14	14	14	13	14	17	17	16	15	14	15	20	24	24	25
TO/FROM US EAST COAST																								
SOUTH AMERICA	19	17	16	14	13	13	12	12	12	11	10	11	16	18	19	19	20	21	21	21	21	21	21	21
WESTERN EUROPE	12	12	11	11	11	10	11	12	12	11	13	15	16	17	18	18	18	17	17	17	16	16	15	13
EASTERN EUROPE	11	10	11	11	12	12	12	11					15	16	17	17	17	17	18	17	16	15	13	12
MEDITERRANEAN	17	17	17	16	15	14	14	13	13				15	17	18	19	20	20	20	20	21	21	21	19
MIDDLE EAST (P)	16	15	15	15	14	13							16	17	18	19	20	20	20	20	19	17	16	16
CENTRAL AFRICA	23	22	20	18	17	16	16	16	15	15	19	24	25	26	26	27	27	27	27	27	27	26	27	26
SOUTH AFRICA	17	15	14	13	12	13	17	16	15	15	17	23	25	26	26	27	27	28	28	28	27	25	22	20
SOUTH EAST ASIA (P)	18	17	16	15									13	15	17	19	20	21	21	21	20	19	17	16
FAR EAST	19	19	17	16	15	13	12	11	11	11	12	12	14	15	15	15	15	15	15	15	15	16	18	19
AUSTRALIA	27	25	22	19	17	15	15	15	15	14	14	14	16	18	17	16	15	15	15	15	15	20	28	27

Unfavorable conditions: Search around the last listed frequency for activity.
(P) denotes circuit across polar auroral zone; reception may be poor during ionospheric disturbances.

casters, lowfers, and air/marine navigation beacons. If you live on the East Coast of North America, chances are that in summer you will not hear the broadcasters. Maybe in the dead of night you might catch a few sentences between static crashes. But come winter, when the complete path between you and Europe becomes dark by mid to late afternoon in eastern North America, chances are

that you will hear the Icelandic station on 189 kHz and the BBC on 198 kHz.

If you are participating in a DXpedition in a very RF quiet environment, you might also hear Algeria, Turkey, Germany, Ireland and a few others. If you live on the West Coast of North America, you might hear some Russian broadcast stations in the same frequency slice, but there are very few.

SUMMER HEAT: Sport and BBC Controversy

It's summer and we turn our attention to much loved leisure pursuits – like sports and criticizing the BBC.

■ LIVE SPORT

Sportsworld on *BBC World Service*, UTC Saturdays 1405 to 1700, Sundays 1605 to 1700
Grandstand on *Radio Australia*, UTC Saturdays 0210 to 0800, UTC Sundays 0305 to 0800

Radio Sport on *Radio New Zealand International (RNZI)*, UTC Saturdays and Sundays 0200 to 0500

Given the “sports crazy” nature of nearly all cultures, it would at first seem surprising that there isn't more time devoted to live sport by international broadcasters. But once one understands better the “big business” nature of sport all over the world, the reason becomes quite clear.

Broadcasting rights for sport are both aggressively and expensively pursued and jealously guarded. Since most international broadcasters remain tax-supported public service broadcasters, their ability to bid against more wealthy private broadcasters and pay increasingly exorbitant rights fees are greatly restricted. Furthermore, the American private shortwave broadcasters survive by charging program producers for air time, not by paying for product. So they are not likely to be big players in this environment, either.

The rights retained by the **BBC**, the **Australian Broadcasting Corporation** and **Radio New Zealand** are largely legacies held from the days when they were virtually the sole broadcasting entities in their respective nations. Who knows how much longer they will be able to hold on to them? Fortunately for us, while they do, we can hear stirring descriptions of soccer, rugby, cricket and Aussie rules football matches – much of which is and will remain otherwise unavailable to us here in North America via any other media.

Even where broadcasters have an Internet presence and hold the radio broadcast rights, they usually have been effectively barred from broadcasting the same game descriptions over the Internet. Therefore, shortwave often remains the international listener's only point of access.

Although **Sportsworld** does as its name

implies – cover sports all over the globe – its primary focus is on the British Isles. English and Scottish Premier League soccer is broadcast from August to May, rugby in winter, cricket in summer and full coverage of all the main national events, like Wimbledon tennis, the Oxford-Cambridge boat race and the various horse racing fixtures, among others.

Grandstand and **Radio Sport** are more finely focused on South Pacific sporting events. At this time of year, **Grandstand** features “The Match of the Day” in Australian Rules Football on Saturdays and the Australian Rugby League on Sundays. Their respective seasons will wrap up with a series of play-offs among the top eight teams in each, culminating in each sport's Grand Final held in late September.

Radio Sport concentrates almost exclusively on the New Zealand national passion – rugby in all its forms. Some attention is paid to cricket and a few other interests, but the clear preference is for rugby. The newest wrinkle is an international competition named the Super 12 League, comprised this year of teams from South Africa, Australia and New Zealand who play in a season running from February to May. If rugby's your game, then I would suggest that **RNZI** is your station.

For *BBC World Service* frequencies for your area, consult *MT's Shortwave Guide*. **Grandstand** on *Radio Australia* is broadcast on special frequencies: 9660, 12080, 17580 and 21725 kHz. If you live in North America, 17580 kHz has been giving best results. **Radio Sport** on *RNZI* has been heard consistently well in North America on 17675 kHz. *RNZI* also preempts regular programming for live coverage of key rugby and cricket matches. A schedule of these preemptions is regularly updated at <<http://www.rnzi.com>>.

Also, if you are somewhat confused as to the nature of these sports and their rules and league structures, there are numerous sites on the Internet that can serve to educate you. Simply utilize your favorite search engine to reach an omnibus site or access local newspapers in the country in which your interests lie.

■ Is The BBC “Dumbing Down”?

Much has been made lately, in some listener forums, about the changes that have

been taking place at the *BBC World Service*. Some of the controversies, which seem to come one after another, have involved the transition to five regional streams followed by a change to three streams, reorganization of the news department, presentation of the news, the accents of the news readers, the adequacy of the director-general, the contracting for some programming from outside producers, the closing of language services, the redirection of resources from shortwave to the Internet and placement on local AM and FM stations. Through all of this lies the nagging suspicion on the part of some that within the BBC lies a conspiracy of some sort – either one of ill will or incompetence or both.

Yet, when I listen to the World Service I still hear comprehensive news coverage, insightful analysis, superior drama, wide ranging and topical documentaries and features. I happen to like some of the newer programs like **Jazzmatazz** and **The Works**. In short, I still hear what I've always heard from the BBC – unparalleled coverage of our world.

On top of that, there are more opportunities to listen. In addition to shortwave, I hear the BBC a couple of times a day on my local *NPR* affiliate and can access a live stream or archived programs via the Internet.

That is not to say that I don't have my own quibbles with the Beeb. I don't like shortwave frequencies leaving the air, by plan, in mid-program. Coordination between the BBC's program continuity people and *Merlin Communications*, the spun-off privatized entity that now owns and runs the transmitters, remains generally abysmal.

I, like others, miss several programs that were inexplicably dropped. The decision to seasonally and inconsistently shift the broadcast times of some programs also seems unnecessarily confusing and inconvenient. I think some of the new programs – like **Westway** – are ill-conceived and rather boring.

But none of this amounts to a giant “dumbing down” of the service. I never liked everything on the *World Service* and I don't now! What it all comes down to is that when I size up the whole situation I still hear what I've always heard – the best darn radio service on the planet. Isn't that the bottom line?

Next month, a column you can sing and hum to. Until then, good listening!

SATELLITE RADIO GUIDE



INTERNATIONAL SHORTWAVE BROADCASTERS (via satellite)

By Larry Van Horn, MT Assistant Editor

WRN One English to North America

Galaxy 5, 125 degrees West, transponder 6 (TBS) 3.820 GHz, V-Pol, audio subcarrier 6.80 MHz. WRN program details can be heard at 0625, 1525 and 1955 Eastern. Program information is also available on TBS Text page 204. You can reach WRN by email at online@wrn.org or through their website on the internet at <http://www.wrn.org>. Many programs can also be heard in Canada on CBC *English Overnight*. WRN is relayed 24 hours a day on many cable systems via the CSPAN Audio One Network. All times are U.S. Eastern Time and all programs in English.

ET	Station
0000	Radio Telefis Eireann (RTE) – Dublin, Ireland (Irish Collection)
0100	Swiss Radio International – Berne, Switzerland
0130	Monday-Friday: Channel Africa – Auckland Park, South Africa Saturday: <i>The Way Ahead and New Horizons</i> Sunday: Glenn Hauser's <i>World of Radio</i>
0200	Polish Radio – Warsaw, Poland
0230	Radio Vlaanderen International – Brussels, Belgium (Brussels Calling)
0300	Radio Australia – Melbourne, Australia
0400	Voice of Russia – Moscow, Russia
0430	Radio Canada International – Montreal, Canada (Monday-Friday) Saturday: <i>Network Plus and Health Watch</i> Sunday: United Nations Radio: <i>World in Review and Scope</i>
0500	Radio Prague – Prague, Czech Republic
0530	Radio Vlaanderen International – Brussels, Belgium (Brussels Calling)
0600	Swiss Radio International – Berne, Switzerland
0630	YLE Radio Finland – Helsinki, Finland
0700	Radio Australia – Melbourne, Australia
0800	Radio Telefis Eireann (RTE) – Dublin, Ireland
0900	Radio Prague – Prague, Czech Republic
0930	Radio Sweden – Stockholm, Sweden
1000	Monday-Saturday: Channel Africa – Auckland Park, South Africa Sunday: <i>Voice of America Communications World</i> – Washington, DC USA
1030	Radio Vlaanderen International – Brussels, Belgium (Brussels Calling)
1100	Radio France International – Paris, France
1200	Monday-Friday: <i>Caribbean Tempo</i> from CANA Radio Saturday: Glenn Hauser's <i>World of Radio</i> Sunday: <i>Norden This Week and Health Watch</i>
1215	Monday-Friday: Vatican Radio – Vatican City (World News)
1230	Radio Austria International – Vienna, Austria
1300	Monday-Friday: Radio Slovakia International – Bratislava, Slovakia Saturday: Radio New Zealand International – Wellington, New Zealand Sunday: Radio Denmark – Copenhagen, Denmark (Copenhagen Calling)
1330	Radio Telefis Eireann (RTE) – Dublin, Ireland
1400	Radio Vlaanderen International – Brussels, Belgium (Brussels Calling)
1430	Kol Israel – Jerusalem, Israel
1500	Radio Budapest – Budapest, Hungary
1530	Radio Sweden – Stockholm, Sweden
1600	Swiss Radio International – Berne, Switzerland
1630	Polish Radio – Warsaw, Poland
1700	Radio Telefis Eireann (RTE) – Dublin, Ireland
1900	Kol Israel – Jerusalem, Israel
1930	Swiss Radio International – Berne, Switzerland
2000	Radio Australia – Melbourne, Australia
2030	Monday-Friday: Radio Slovakia International – Bratislava, Slovakia Saturday: United Nations Radio: <i>World in Review and Scope</i> Sunday: <i>Network Plus and Health Watch</i>
2100	YLE Radio Finland – Helsinki, Finland

2130	Radio Sweden – Stockholm, Sweden
2200	Radio Prague – Prague, Czech Republic
2230	Radio Austria International – Vienna, Austria
2300	Polish Radio – Warsaw, Poland
2330	Radio Budapest – Budapest, Hungary

WRN Two Multi-Lingual to North America

Galaxy 5, 125 degrees West, transponder 6 (TBS) 3.820 GHz, V-Polarization, Audio subcarrier 6.2 MHz. Note that some programs listed below are subject to pre-emption without notice. All times are U.S. Eastern Time.

ET	Station
0000	World Radio Network from National Public Radio
0600	YLE Radio Finland – Helsinki, Finland (News in Finnish). On Saturdays a phone-in for children in Finnish until 0630.
0610	YLE Radio Finland – Helsinki, Finland (Easy listening music with announcements in Finnish and English)
0630	YLE Radio Finland – Helsinki, Finland (News of the past 24 hours in Finnish)
0700	Interval signal
0800	Raidio na Gaeltachta (News in Irish)
0900	Radio Prague – Prague, Czech Republic (Programming in Czech)
0927	Interval signal
1000	YLE Radio Finland – Helsinki, Finland (Regional broadcasts from various parts of Finland in Finnish)
1030	YLE Radio Finland – Helsinki, Finland (News in Finnish)
1100	YLE Radio Finland – Helsinki, Finland (Variable programming in Finnish—often light music)
1200	Radio Prague – Prague, Czech Republic (Programming in Spanish)
1300	Voice of Russia – Moscow, Russia (Russian Programming)
1400	Radio Vlaanderen International – Brussels, Belgium (Brussels Calling with Dutch programming)
1430	Identification tone
1630	Radio Austria International – Vienna, Austria (German Programming)
1700	Radio Budapest – Budapest, Hungary (Hungarian Programming)
1800	Polish Radio – Warsaw, Poland (Polish programming)
1830	YLE Radio Finland – Helsinki, Finland (Devotional programming in Finnish)
1855	YLE Radio Finland – Helsinki, Finland (News in Finnish)
1900	YLE Radio Finland – Helsinki, Finland (News of the past 24 hours in Finnish)
1925	YLE Radio Finland – Helsinki, Finland (News in Swedish)
1930	YLE Radio Finland – Helsinki, Finland (French programming)
1945	YLE Radio Finland – Helsinki, Finland (Light music in Finnish)
2030	YLE Radio Finland – Helsinki, Finland (Easy listening music). Announcements partially in English. Saturdays a phone-in for children in Finnish
2100	YLE Radio Finland – Helsinki, Finland (Documentaries and Theater of the Air in Finnish). Sunday: Classical music with a preview in English.
2200	YLE Radio Finland – Helsinki, Finland (English programming)
2230	Identification tone
	Friday: <i>Voice of America Communications World</i> – Washington, DC USA
2300	Interval signal
2330	Radio Austria International – Vienna, Austria (German programming)

WRN One English to Europe

Astra 1B, 19 degrees East, transponder 22 (VH-1) 11.538 GHz, V-Polarization, audio subcarrier 7.38 MHz. All programs in English and WRN program information can be heard daily at 0125 and 2025 UTC. Program information is also available on VH-1 Text page 222, 223, 224.

SATELLITE RADIO GUIDE



INTERNATIONAL SHORTWAVE BROADCASTERS / SCPC SERVICES

WRN Two Multi-Lingual to Europe

Hotbird-4, 13 degrees East, transponder 121 (Quantum TV) 10.933 GHz, H-Polarization, audio subcarrier 7.74 MHz.

WRN3 German to Europe

Astra 1B, 19 Grad Ost, Transponder 16 (Sky Movies), 11.436 GHz vertikal, Audio Tonunterträger 7.38 MHz und Astra Digital Radio (ADR) Astra 1C, Transponder 33 (ZDF), 10.964 GHz horizontal, auf Monokanal B, 7.56 MHz. Alle Programme auf Deutsch.

WRN to Eastern Europe, Middle East and Africa

WRN1 & 2 may be received throughout Africa and the Middle East via satellite on Intelsat 707 at 1 degree West.

The signal can be picked on DVB receivers such as those manufactured by Nokia, Humax etc). The service is on C-band and antennas of 3 meters in diameter are required. The receiver setting are as follows: 3.9115 GHz, Right-hand Circular-Pol, Symbol Rate 8.022 Mbaud, FEC 3/4, MPEG2. From the menu select audio stream "WRN1" and listen to the left channel for WRN1 and the right for WRN2.

In Africa WRN1 is available on the MultiChoice DSTV service which is available in many parts of Africa via the Panamsat 4 satellite at, 68.5 degrees East. Tune into audio channel 51 in Southern Africa and to audio channel 25 in other parts of the continent. Contact a Multichoice dealer in your area for details of how to subscribe.

In North Africa and the Middle East WRN2 (which largely carries WRN1 Europe) and can be tuned in via Eutelsat Hot Bird at 13 degrees East using a dish of 60 to 90 cm in diameter. The frequency is 10.933 GHz (horizontal polarization) audio subcarrier 7.74 MHz on Quantum 24 TV.

LOCAL RELAYS

WRN can be heard overnight in South Africa from 0000 to 0500 local time on SAfm 104-107 daily. SAfm is also available via an analogue satellite channel on Panamsat 4 (68 degrees East) 12.664 GHz (horizontal polarization) audio 7.2 MHz

WRN will soon be heard again in the Middle East on 954 kHz AM from 2000-0500 UTC. Further locals relays on FM are planned.

WRN One English to Asia-Pacific

AsiaSat-2, 100.5 degrees East, 4.000 GHz, Vertical-Polarization, MPEG2 DVB, Symbol Rate 28.125 Mbaud, FEC 3/4, Select "WRN" from audio menu.

WRN Two Multi-National to Asia-Pacific

AsiaSat-2, 100.5 degrees East, 4.000 GHz, Vertical-Polarization, MPEG2 DVB, Symbol Rate 28.125 Mbaud, FEC 3/4, Select "WRN" from audio menu and listen to the right hand audio channel.

Single Channel Per Carrier (SCPC) Services

By Robert Smathers
roberts@nmia.com

An SCPC transmitted signal is transmitted with its own carrier, thus eliminating the need for a video carrier to be present. Dozens of SCPC signals can be transmitted on a single transponder. In addition to a standard TVRO satellite system, an additional receiver is required to receive SCPC signals.

The frequency in the first column is the 1st IF (typical LNB frequency) and the second column frequency (in parentheses) is the 2nd IF (commercial receiver readout) for the SCPC listing. Both frequencies are in MHz.

GE-2 Transponder-Vertical 13 (C-band)

1178.70 (81.3) NASA space shuttle audio

GE-3 Transponder-Horizontal 13 (C-band)

1207.90 (52.1) Wisconsin Voice of Christian Youth (VCY) America Radio Network-religious programming
1204.25 (55.75) Wisconsin Voice of Christian Youth (VCY) America Radio Network-religious programming

1201.50 (58.5) Wisconsin Voice of Christian Youth (VCY) America Radio Network-religious programming
1201.30 (58.7) Wisconsin Voice of Christian Youth (VCY) America Radio Network-religious programming

Galaxy 6 Transponder 1-Horizontal (C-band)

1443.80 (56.2) Voice of Free China (International Shortwave Broadcaster) Taipei, Taiwan
1443.60 (56.4) KBLA-AM (1580) Santa Monica, CA-Radio Korea
1443.40 (56.6) Voice of Free China (International Shortwave Broadcaster) Taipei, Taiwan
1438.30 (61.7) WWRV-AM (1330) New York, NY-Spanish religious programming and music, ID-Radio Vision Christiana de Internacional

Galaxy 6 Transponder 3-Horizontal (C-band)

1404.80 (55.2) KOA-AM (850)/KTLK-AM (760) Denver, Colo-news and talk radio/Rockies MLB radio network
1404.60 (55.4) WGN-AM (720) Chicago, IL-news and talk radio/Cubs MLB radio network

INTRODUCING

DIRECT FREQUENCY READOUT SCPC AUDIO RECEIVER

FULL COMMERCIAL FEATURES



UNIVERSAL SCPC-200 AUDIO RECEIVER

- EASY DIRECT FREQUENCY TUNING - 50 TO 90 MHz (LCD)
- DIRECT TRANSPONDER TUNING (LCD DISPLAY)
- LARGE MEMORY BANK- 50 CHANNELS
- C AND KU BAND AGILE - 950 - 1450 MHz
- AUTOMATIC LNB DRIFT COMPENSATION (ADC)
- COMPANDING, 1:1, 2:1, 3:1 (AUTOMATIC)
- BANDWIDTH, WIDE / NARROW
- AUTOMATIC TUNING INDICATORS
- DIGITAL FREQUENCY LOCK-ON (DFL)

- SERVICE NAME ON LCD DISPLAY
- MICROPROCESSOR FREQUENCY DISPLAY
- SPEAKER AND LINE OUTPUTS, HIGH QUALITY AUDIO
- COMMERCIAL DIGITAL SYNTHESIZER
- 6 BUTTON KEY PAD FOR FAST TUNING
- BASEBAND 70 MHz OUTPUT
- BUILT IN U.S.A. BY THE LEADING SCPC MANUFACTURER
- FULL 16 CHARACTER LCD DISPLAY
- DOES NOT DISABLE VIDEO WHEN IN USE

INTRODUCTORY PRICE \$399.00 plus S & H — CALL: 1 - 614 - 866-4605

UNIVERSAL ELECTRONICS, INC.
Communications Specialists

4555 GROVES RD., SUITE 12, COLUMBUS, OH 43232
(614) 866-4605 FAX (614) 866-1201

SATELLITE RADIO GUIDE



SINGLE CHANNEL PER CARRIER (SCPC) SERVICES

1404.40 (55.6)	Illinois News Network/W MVP-AM (1000) Chicago, IL—"ESPN Radio 1000"/White Sox MLB radio network	1383.10 (76.9)	KIRO-AM (710) Seattle, WA—news and talk radio/Mariners MLB radio network	1005.50 (54.5)	Canadian Broadcasting Corporation (CBC) Radio-North (Yukon) service	
1404.20 (55.8)	Tribune Radio Networks/Wisconsin Radio Network	1382.60 (77.4)	Soldiers Radio Satellite (SRS) network—U.S. Army information and entertainment radio	Solidaridad 1 Transponder 1-Vertical (C-band)		
1402.90 (57.1)	USA Radio Network	1382.30 (77.7)	Motor Racing Network (occasional audio) NASCAR racing	1447.90 (52.1)	Antenna Radio Noticias/Dodgers Radio Network (Spanish language)	
1402.70 (57.3)	WLAC-AM (1510) Nashville, TN—news and talk/Road Gang trucker program (overnight)	1382.00 (78.0)	Occasional audio	1447.60 (52.4)	Antenna Radio Noticias	
1402.20 (57.8)	NorthWest Ag News Network - Agriculture info for the Pacific Northwest	1381.60 (78.4)	KEX-AM (1190) Portland, OR—news and talk radio/Forest Dragons football radio network	1447.20 (52.8)	La Grande Cadena Raza	
1402.00 (58.0)	Occasional audio	1381.40 (78.6)	Occasional audio	1447.00 (53.0)	XEMZA-AM 560, Manzanillo, Mexico	
1401.80 (58.2)	For the People Radio Network with Chuck Harder - talk radio format	1381.20 (78.8)	KJR-AM (950) Seattle, WA- sports talk radio	Anik E1 Transponder 21-Horizontal (C-band)		
1401.50 (58.5)	Agrinet Ag info/USA Radio Network	1377.10 (82.9)	In-Touch-reading service	1036.70 (63.3)	In-store music	
1399.00 (61.0)	Sports Byline USA/Sports Byline Weekend	1376.00 (84.0)	Kansas Audio Reader Network-reading service	1037.00 (63.0)	In-store music	
1398.80 (61.2)	Talk Radio Network (TRN) - talk radio format	Galaxy 6 Transponder 4-Vertical (C-band)			1037.50 (62.5)	In-store music
1398.50 (61.5)	Occasional audio	1376.00 (64.0)	Data Transmissions	SBS5 Transponder 2-Horizontal (Ku-band)		
1398.30 (61.7)	WSB-AM (750) Atlanta, GA- news/talk/Atlanta Braves MLB radio network	Galaxy 6 Transponder 6-Vertical (C-band)			1013.60 (80.4)	Wal-Mart in-store network
1398.00 (62.0)	Occasional audio	1347.00 (53.0)	WCRP-FM (88.1) Guayama, PR- Spanish language religious programming	1013.20 (80.8)	Wal-Mart in-store network	
1397.80 (62.2)	Occasional audio	Anik E2 Transponder 1-Horizontal (C-band)			1012.80 (81.2)	Sam's Wholesale Club in-store network
1397.50 (62.5)	Minnesota Talking Book Radio Network-reading service for the blind	1446.00 (54.0)	Canadian Broadcasting Corporation (CBC) Radio-North (Quebec) service	1004.50 (89.5)	Wal-Mart in-store network	
1397.10 (62.9)	Wisconsin Radio Network/Wisconsin college sports	Anik E2 Transponder 7-Horizontal (C-band)			1004.00 (90.0)	Wal-Mart in-store network
1396.90 (63.1)	KRLD-AM (1080), Dallas, Ft. Worth, TX - Texas State Network/Rangers MLB radio network	1326.00 (54.0)	Canadian Broadcasting Corporation (CBC) Radio-North (Eastern Arctic) service	1003.60 (90.4)	Sam's Wholesale Club in-store network	
1396.70 (63.3)	Radio America Network/Business News Network	Anik E2 Transponder 13-Horizontal (C-band)			1003.20 (90.8)	Wal-Mart in-store network
1396.40 (63.4)	Georgia News Network (GNN)-network news feeds	1206.00 (54.0)	Canadian Broadcasting Corporation (CBC) Radio-North (MacKenzie) service	RCA C5 Transponder 3-Vertical (C-band)		
1396.00 (64.0)	WHO-AM (1040) Des Moines, IA-talk radio/Iowa News Network	1205.00 (54.5)	Canadian Broadcasting Corporation (CBC) Radio-Occasional feeds/events	1404.60 (55.4)	Wyoming News Network-network news feeds	
1395.80 (64.2)	WTMJ-AM (620) Milwaukee, WI-talk radio/Brewers MLB radio network	Anik E2 Transponder 17-Horizontal (C-band)			1400.60 (59.4)	Learfield Communications
1395.60 (64.4)	WGST-AM/FM (640/105.7) Atlanta, GA ID Planet Radio-news and talk radio	1126.00 (54.0)	Canadian Broadcasting Corporation (CBC) Radio-North (Western Arctic) service	1400.40 (59.6)	Learfield Communications/MissouriNet	
1395.40 (64.6)	Michigan News Network-network news feeds/Tigers MLB radio network	1125.50 (54.5)	Canadian Broadcasting Corporation (CBC) Radio-North (Newfoundland and Labrador) service	1400.20 (59.8)	Occasional audio	
1395.00 (65.0)	Occasional audio	Anik E2 Transponder 23-Horizontal (C-band)			1400.00 (60.0)	Learfield Communications
1394.70 (65.3)	WJR-AM (760) Detroit, MI-news and talk radio/Michigan News Network/Tigers MLB radio network	1006.00 (54.0)	Societe Radio-Canada (SRC) Radio-AM Network	1396.60 (63.4)	Kansas Information Network/Kansas Agnet-network news feeds	
1385.40 (74.6)	WDUQ-FM (90.5) Pittsburgh, PA - Jazz format	Anik E2 Transponder 1-Vertical (C-band)			1396.40 (63.6)	Liberty Works Radio Network - talk radio
1384.60 (75.4)	WDUQ-FM (90.5) Pittsburgh, PA - Jazz format	1126.00 (54.0)	Canadian Broadcasting Corporation (CBC) Radio-North (Western Arctic) service	1396.20 (63.8)	MissouriNet/St Louis Cardinals MLB radio network	
1384.40 (75.6)	KOA-AM (850)/KTLK-AM (760) Denver, CO-news and talk radio sports/Rockies MLB radio network	1125.50 (54.5)	Canadian Broadcasting Corporation (CBC) Radio-North (Newfoundland and Labrador) service	1396.10 (63.9)	MissouriNet	
1384.20 (75.8)	WSB-AM (750) Atlanta, GA - news/talk/Braves MLB radio network	Anik E2 Transponder 7-Vertical (C-band)			1395.90 (64.1)	Western Montana Radio Network/Red River Farm Network
		1006.00 (54.0)	Societe Radio-Canada (SRC) Radio-AM Network	1395.70 (64.3)	MissouriNet/Kansas City Royals MLB radio network	
		Anik E2 Transponder 13-Vertical (C-band)			1386.40 (73.6)	Learfield Communications
		1126.00 (54.0)	Canadian Broadcasting Corporation (CBC) Radio-North (Western Arctic) service	1386.20 (73.8)	Radio Iowa/Iowa college sports	
		1125.50 (54.5)	Canadian Broadcasting Corporation (CBC) Radio-North (Newfoundland and Labrador) service	1384.60 (75.4)	Capitol Radio Network	
		Anik E2 Transponder 17-Vertical (C-band)			1384.00 (76.0)	Occasional audio/ABC Direction Network-network news feeds
		1006.00 (54.0)	Societe Radio-Canada (SRC) Radio-AM Network	1383.80 (76.2)	Occasional Audio/Stam Soloman Radio Show (occ)	
		Anik E2 Transponder 23-Vertical (C-band)			1383.40 (76.6)	Capitol Radio Network
		1126.00 (54.0)	Canadian Broadcasting Corporation (CBC) Radio-North (Western Arctic) service	1382.90 (77.1)	MissouriNet	
		1125.50 (54.5)	Canadian Broadcasting Corporation (CBC) Radio-North (Newfoundland and Labrador) service	1382.50 (77.5)	Virginia News Network-network news feeds/	
		Anik E2 Transponder 1-Vertical (C-band)			1382.10 (77.9)	Learfield Communications/MissouriNet
		1006.00 (54.0)	Societe Radio-Canada (SRC) Radio-AM Network			

Grove invites you to join our search for . . .

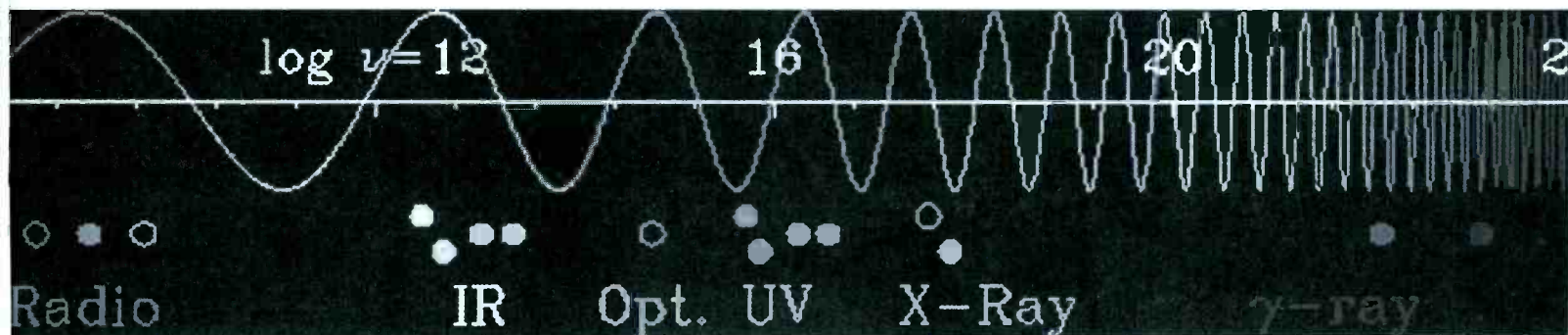

SIGNALS FROM DEEP SPACE!

In the background hiss, amidst the noise, there it is! An unfamiliar—yet long sought—signal. It's just a pulse, but it's somehow different from the rest. It has the characteristics of artificial origin—it's the signal that scientists have been seeking for decades. Will you be the first human to see and hear it?

The coordinated Search for Extra-Terrestrial Intelligence (SETI) is one of man's most ambitious scientific undertakings, and is of incalculable historic importance. Join this visionary team of more than 1000 amateur scientists worldwide who are looking for radio signals arriving from the depths of space.

Grove provides everything you need to get started: a quality receiver (choose from models shown below), low-noise amplifier, feedhorn, power supply, interconnect cable, power/signal splitter, SETI League Technical Manual, full SETI League membership, shareware, newsletter, and e-mail privileges. All you need to supply is an empty TVRO dish and your computer.

Choose one of these fine receivers:

ICOM R8500 receiver



Order # WBR 1: \$1,499.95

AOR AR5000 Plus



Order # WBR 12-P: \$2,095.95

AOR AR7000



Order # WBR 8: \$1,299.95

WiNRADiO WR1500e
Order # WBR5E: \$549.95



WiNRADiO WR3100e
Order # WBR26E: \$1,895.95

Complete your package from items listed below:

ACC 169	1300-1500 MHz feedhorn	\$79.95
ACC 170	0.37 dB NF LNA	\$179.95
BOK 109	SETI League Technical Manual	\$10.00
CBL 10	50' RG-8/U low-loss cable with silver/gold-plated N connectors	\$59.95
MBR 1	SETI League membership (FREE with full system order)	\$50.00
PWR 21	120 VAC/15 VDC @ 500 mA power supply	\$9.95
SPL 3	Power/Signal splitter	\$39.95

For complete information on a receiver, visit our website:
www.grove-ent.com/widebandreceivers.html or see Grove's printed catalog



GROVE

GROVE ENTERPRISES, INC.

1-800-438-8155 US and Canada

828-837-9200 • FAX 828-837-2216

7540 Highway 64 West • Brasstown, NC 28902-0098

e-mail: order@grove-ent.com

www.grove-ent.com

Zinwell ZDX-9111 DVB Satellite Receiver

If you're not familiar with some of the brand names in the Digital Video Broadcast (DVB) receiver market, you're not alone. In the U.S. this is an emerging market segment in the field of satellite TV. However, many of these receivers have sold in the tens of thousands under various labels in Europe and Asia where the DVB standard is widely used. This month I'll take a look at the Zinwell ZDX-9111 DVB satellite receiver.

Unlike traditional analog C and Ku-band receivers, DVB receivers have a narrow focus. They cannot receive analog satellite signals; have no provision for an actuator (dish drive) motor; and cannot operate a polarizing motor on a feed horn, though they can operate the solid state switching of an LNBF (Low Noise Block-converted Feed horn). Most are capable of receiving only those signals which are transmitted via satellite in the MPEGII digital mode and unencrypted. They cannot receive General Instrument's DigicipherII MPEGII signals

You may be asking, "Well, what can they receive?!" It turns out that there are hundreds of channels of unencrypted programming (known as "Free-To-Air" or FTA) on nearly every satellite which can be seen from any point in North America. Most programming is not of the cable TV variety, but the backhaul, niche and network programming which has always been the fun part of having a big dish.

The reason for the increased popularity of this type of transmission is price. Compressed digital transmission costs a fraction of old-style analog transmission, and that's important to marginally financed broadcasters involved with ethnic or niche programming.

Most DVB receivers have many features in common and share a very similar physical appearance. A look at the photos of the Zinwell product will remind many readers of similar DVB receivers I've reviewed in this column. Where these receivers tend to differ most is in the on-screen features controlled by the receiver's software. And, as with any new piece of electronic gear, there's a learning curve, during which every consumer learns the idiosyncracies of a particular piece of gear.

Elegantly Simple

The Zinwell receiver is smaller (14" w x 10" d x 3" h) than any similar receiver; is very

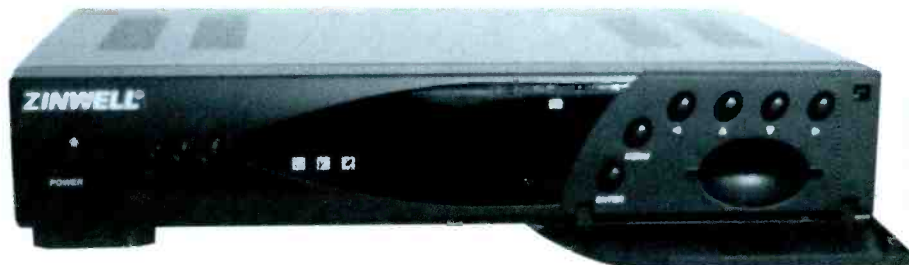

Courtesy Ken Reitz

Zinwell MPEGII FTA digital receiver. Note drop down door with access to receiver function buttons. Smart card slot has no internal card reader.

lightweight (a scant 5-1/2 lbs); and, thanks to its solid state surface mount technology, runs very cool. The front panel controls are hidden behind a drop down door which also contains a slot for a smart card even though there is no internal provision for a smart card reader. On the back panel consumers will find a choice of signal ports with which to feed the TV: a channel 3/4 modulator, an S-video output, and an RCA jack for video output to your VCR.

My criteria for a good remote control is this: Can the receiver be operated from a distance, at odd angles or bounced off the walls and ceilings? This is particularly important on DVB receivers because the viewer is expected to enter the necessary data regarding reception parameters into the receiver via the remote control. This task is made very difficult if the remote doesn't perform well. The Zinwell remote control has the best transmitting capability of any that I've used. It's also well balanced and has a logical layout. The round rubber buttons have a very positive feel and are well spaced for adult fingers.

The Zinwell, like all MPEGII receivers, can receive MPEGII signals on either the C or Ku-band in linear or circular polarity. The difference here is how easy it is to tune. The user's manual is well written and easy to follow with an abundance of charts and diagrams explaining how to use the receiver and



Courtesy Ken Reitz

Back panel of Zinwell receiver shows lay out typical of most MPEGII receivers. The left hand side shows three ways to feed your TV set: RCA video out, S-video out, or channel 3/4 modulator.

what all the buttons and ports are for. Once your system is up and running it won't take more than an hour to master entering the data needed to receive programming. Once entered it stays in the internal memory until rewritten.

To find the transponder frequencies and symbol rates needed to tune in, you need to have access to www.lyngsat.com which has the most complete and up-to-date list of transmission parameters for FTA transmissions. One interesting addition to the Zinwell user's guide are the five pages of footprint charts, though most charts printed are for Asia and the Pacific.

Using the Zinwell-9111

There are several ways to set up the Zinwell-9111. If you already have a C-band satellite TV system you'll need only a 950-1450 MHz splitter to feed both your analog and the Zinwell receivers. Take the RCA video output from the Zinwell and input it at your VCR. Take the channel 3/4 out from your analog satellite receiver and put it into your VCR's VHF antenna input and tune the VCR to channel 3 or 4. Now set your TV to tune either channel 3 or 4 and your analog signals come straight through. To access the Zinwell signals, simply press the *aux video* button on your VCR's remote; if you've turned your dish to a satellite and channel which has MPEGII programming and entered the data into the receiver, the Zinwell programming comes right up.

If you are using a motorized dish you must run the dish to the satellite on which the digital programming you'd like to receive is located. Once the dish is there you can switch to the Zinwell and call up the channel you're looking for by pressing the "program list" button on the remote and scrolling down to

the channel you want.

One very interesting use of the Zinwell receiver is in a very inexpensive, stand-alone, DBS-style configuration. What you'll need is a small 4.5 to 5 foot dish, a C-band LNBF, and the Zinwell receiver. By setting the system up on Panamsat 5 – a powerful C-band satellite – you'll be able to tune in the world of foreign broadcast satellite TV. It's like shortwave listening with pictures! I'll devote the October Launching Pad to this topic.

■ Joys of Digital Reception

A few words about digital reception are in order. Unlike analog reception, there's no way to visually detect the presence of a digital signal, but, once the signal is acquired, it's perfect. The signal is either there or it isn't. No more sparklies or other on-screen artifacts. On the Zinwell there is a red LED on the front panel which lights up behind the small icon of a satellite dish. When the receiver locks onto a digital signal that light disappears.

The audio on the Zinwell is unbeatable. It's the same quality as you'll get from your CD player. The reason I mention this is that there are many audio subcarriers found on certain satellites you'll want to tune in. Some of my favorites are the programs found on Voice of America feeds on GE-2 channel 11 which include VOA's new *Music Mix*, *VOA News Now* and others. I also enjoy the classical programming on Hispasat and audio from three Deutsche Welle services. Tuning in these services is just as easy as tuning the video. There's even a separate list for radio channels.

I've been watching FTA MPEGII signals for over a year and in that time the number of available channels has doubled. It's clear that this mode of transmission is gaining in popularity with programmers. But, the best thing about FTA MPEGII viewing, especially with the Zinwell, is that it's relatively cheap. For well under \$400 you'll be able to see and hear programming available nowhere else. Adding the Zinwell receiver to your current TVRO system will more than double your viewing action. Installing a stand-alone MPEGII system is a great way to get started in satellite TV reception for a minimum expense.

For more information about the Zinwell ZDX-9111 receiver call Tim Heinrichs of Direct Marketing Source at 888-591-4416. You can visit their website and look at their list of DVB services at www.dmsiusa.com. You may also write for more information at 2668 Forest Glen Drive N.E. Marietta, GA 30066-1485.

■ Mailbag

In the June issue of *MT* I looked at the possibilities of tuning in several satellites without using a dish drive citing an article written twenty years ago by TVRO pioneer Bob Cooper. "Coop," as he is known to his friends in the satellite TV business, is alive and well and living in New Zealand where he publishes *SatFACTS*, a monthly trade magazine about TVRO issues in Asia and the Pacific. He also publishes *Coop's Technology Digest* which is "...Published as a confidential industry newsletter ten times each year..."

I asked him if *MT* subscribers could take a sample look at his publications and he



Courtesy Ken Reitz

Zinwell remote control. Light-weight, well laid out and easy to use, this remote outperformed any other MPEGII receiver with its ability to access the receiver at odd angles and distances.

replied, "...we do have...subscribers in 54 countries...but then we have 'small countries' out here! Recent but randomly selected copies of *SatFACTS* (can be sent) airmail...to any address US\$8 in US currency (or check or VISA/Mastercard charge)...We will also include a copy of *Coop's Technology Digest* as well..." Bob Cooper advises that they have a website: www.satfacts.kwikkopy.co.nz where you'll also find his email address and an order form.

As if to emphasize the point, I also received an email note from Roger Woodward of Australia who writes: "...I have had an arrangement like this for some time here in Sydney... I have a motorised 3 metre mesh dish with 3 C-band Polarotor type feeds installed (as well an L-Band dipole feed). They normally are arranged with the prime focus positioned feed looking at Palapa C2 (113 E), another positioned next to this looking at Asiasat 3S (105.5 E) and the 3rd looking at Asiasat 2 at 100E... It all works quite well and I rarely need to move the dish!..."

Are We Alone?

That question has haunted humankind since first we realized that the points of light in the night sky are other suns. Today we have the technology to seek a definitive answer! *The SETI League* is participatory science. We are the international grass-roots organization dedicated to privatizing the Search for Extra-Terrestrial Intelligence. Together, hundreds of members in dozens of countries are keeping alive the quest for our cosmic companions. Learn how you can join this team of ordinary citizens in completing the research which Congress wouldn't let NASA finish.



The SETI League, Inc.
433 Liberty Street, PO Box 555
Little Ferry NJ 07643 USA
Phone (201) 641-1770
Fax (201) 641-1771
Web <http://www.setileague.org/>
email join@setileague.org

a membership-supported, nonprofit [501(c)(3)]
educational and scientific organization

Searching for Extra-Terrestrial Intelligence

Radio Tools from the Office Supply Store

We are often defined by those things we find essential for daily living. Everywhere I go, my brief case carries a magnifying glass, compass, chess set, fifty feet of nylon rope, a CIA letter opener, a *Farmer's Almanac* and a bible. Why? Just in case!

Things are the same around each person's listening post. We all have accoutrements that are unique and useful to us. I cannot *prove* that my Marvin the Martian statue improves DXing but I am personally convinced of it!

Over time, we all discover a few accessories that will not be found in most radio equipment catalogs but which become an essential part of our way of conducting radio business nonetheless. Eccentricity and superstition aside, there are a number of practical non-radio accessories that will make life in your shack worth living. Most of these essentials can be found at any of those large office supply stores that seem to have popped up every other corner around our country. (Question: Have we reached the point where more people are working in office supply stores than in offices?)

World Globe

If you are a shortwave listener, you are in the business of tracking down signals from all over the world. The quickest source of information may be a world map or atlas, but the best and most accurate (for radio users) source remains the good old world globe. Yep, just like the one you used to get in trouble for spinning too fast in grade school. The names of the countries may have changed, but the land masses remain the same. The globe is helpful in giving you a fine graphical representation of distances and paths that signals have to traverse to hit your receiver.

On the top of most world globes you will find a small metal disk. The technical name for this disk is a rosette. (Feel free to use this information to impress your friends.) This disk is usually calibrated in hours and marked for zones of light and darkness. You can use this information to plot the best time of day to try and grab a country by finding out when your listening post and the country in question are both in relative darkness – usually the best time to listen.

With a globe you can see why you are

better off trying to grab stations in the South Pacific early in the morning instead of early in the evening. If your rosette does not have such markings you can hold your globe up to a light bulb. In this experiment the light bulb becomes the sun and you can actually see the patterns of light and darkness that affect listening.

In addition to these practical radio applications, you can put a globe to use just like any other map. You can determine the locations of countries and their surrounding environment. Better than most maps, countries can be projected to relative scale because of the globe's curved surface. Most maps leave you thinking that Greenland is bigger than North America because of the flat projection of the earth's surface.

If your desk is too cluttered for a decent-sized globe, take heart in the fact that we live in the computer age. Several software makers sell globe projection software that can also do the trick. You may even find these software packages at that self-same office supply super store as you'll find the more traditional world globe.

These programs may be good but you can't take your hand and spin them real fast like you did in grade school. Buy yourself the real thing. It makes a great conversation piece and, if you're not careful, you just might learn something.

Calculator

They didn't have fancy titles such as "learning disability" when I went through school. I was simply "dumb" when it came to math. Oh, I would get the right answer, but it would take forever to work it out. After day after day of spending recess to finish my math work, I grew to hate it a lot.

Over the years I have come to terms with this problem, largely due to the invention of the electronic calculator. The pocket calculator allowed me to get free of simple arithmetic tasks, allowing me to study and fall in love with many of the more advanced con-



cepts in mathematics. Anyone who has ever tried to figure out the square root of a number in long hand is very happy that calculators came along (with the exception of slide rule designers).

As a radio hobbyist, you no doubt keep some sort of log. Your log can become more than a collection of old memories. A log book can be made subject to some basic statistical analysis that will allow you to determine your listening patterns. Take your handy calculator and figure out the average number of hours you listen in a session ... in a month ... in a year. Adds up doesn't it, *Compadre?*

You can compute the best length (in feet) for a halfwave dipole antenna by dividing 492 by the frequency in megahertz (MHz). What's that? You only know the frequency in kilohertz (kHz)? No sweat; divide that puppy by 1000. Megahertz back to kilohertz? Multiply by 1000. With a calculator handy it is probably faster than moving the decimal points on a piece of paper.

In the event you really want to delve into electronics theory and witchcraft, a calculator is essential to wading through the various formulas that can assist you on your quest.

You can buy a calculator for simple math functions at any discount store for around three dollars. You can move up from there into the "scientific" calculators that have many common formulas already preprogrammed. Pick up one that suits your taste and, as you fiddle with it, you will discover many uses around your radio shack.

If you really want to get into the thick of things, programmable graphical plotting calculators can be purchased for under \$100 that will let you perform just about any function you can imagine. My current favorite is the Texas Instruments TI-83. It's got buttons on it I have yet to figure out, but that is half the fun.

■ Dual Time Watch or Clock

Another product of our "digital" age is a whole crop of watches with zillions of bells and whistles. One company really stands when it comes to gizmos for versatility at reasonable cost. CASIO makes watches that not only tell time but also tell temperature, windspeed, and pulse rate in addition to the more mundane functions of day and date.

Several models at modest prices sport a feature that should put them on the wrists of every radio hobbyist in the world. These watches can be set to tell the time in two different time zones, one of which can be set to a twenty four hour format. In other words, you can walk around with local time and Coordinated Universal Time (UTC, GMT, ZULU, etc.) strapped to your wrist, ready for DXing. No longer must you remember how to convert back and forth between the two time zones, forgetting to change your conversion formula during Daylight Savings Time. I am partial to the Casio "Tri-Graph" series, but many of their other watches will give you the essential dual-time function.

If you want something larger for your wall, check out the clocks from MFJ Enterprises. They are designed for the cost-conscious radio hobbyist. MFJ advertises in many radio hobby publications or you can reach them directly at 1-800-647-1800 or their website www.mfjenterprises.com

■ File Cards

Long before computers were so commonplace in the home, most radio people made use of file cards to get their record management in order. For many folks this still remains the cheapest and easiest way to track and catch all those exciting stations, no matter what facets of the radio hobby they are interested in.

Even if you do use a computer for your main record keeping, you can still set up a

nice little "hit" list using good old fashioned 3x5 cards. By doing this you can leave the computer turned off during listening and avoid running up against all that interference it can generate in your receiver.

Take 24 file cards and mark them with the UTC hours. Then take a source such as *Passport to World Band Radio*, the *World Radio TV Handbook* or MT's own "Shortwave Guide" and list the names and frequencies of the stations you are seeking on the cards that correspond with their various broadcast periods. You now have a handy guide for tuning that allows you to decide how to carve up your listening sessions.

Scanner users can also benefit greatly from a good set of file cards. Now that scanning receivers can be programmed to store hundreds of frequencies, what better way to keep track of things than a short stack of file cards giving pertinent information in frequency groups of ten or twenty or fifty per card (depending on how your scanner's banks are structured)? This is much more manageable than a long list, and the problem is really too small to dedicate a computer to the task.

Broadcast band DXers might want to have one card for each of the 10 kHz spaced frequencies to allow for better signal hunting and tracking.

Someday, flying a computer might become simple enough that such mundane tasks as frequency lists can be managed without taking up more than half of your listening time. For now, file cards remain the quickest tool for the task.

■ Graph Paper

This is another handy tool that may someday find itself fully replaced by the computer (or at the very least by one of those higher end calculators I mentioned above). But most of us will take a shot with plain old graph paper first. Graph paper gives you a resource to plot information graphically instead of in columns of numbers.

Many radio hobbyists take their first shot at using graph paper by tracking the solar flux patterns given at 18 minutes past the hour over radio station WWV and WWVH 1.5, 5, 10, 15 and 20 MHz. In graphing this information, you begin to get a feel for how the sun has a direct effect on your ability to listen.

Graph paper is also a wonderful tool for creativity. You can use its squares to aid you in laying out straight lines for most anything you want to design. You can lay out a floor plan for your listening post, or perhaps the placement of components on a circuit board. I even keep it around my desk just for doodling when I am doing something else. Graph

paper remains a limitless resource waiting for your next great idea!

As you can see, sometimes the things we surround ourselves with when we are listening can make monitoring more fun than ever. Maybe next time you are on your way to the local electronics outlet you'll find yourself taking a quick turn through the local office supply store. Who knows, you may just come up with the next great system for tracking the elusive Radio Freedomia. Have fun!

FREE SAMPLE COPY!

ANTIQUE RADIO CLASSIFIED

Antique Radio's Largest-Circulation Monthly Magazine

Articles - Classifieds - Ads for Parts & Services
Also: Early TV, Ham Equip., Books, Telegraph, 40's & 50's Radios & more...

Free 20-word ad each month. Don't miss out!

1-Year: \$39.49 (\$57.95 by 1st Class)
 6-Month Trial - \$19.95. Foreign - Write.
 A.R.C., P.O. Box 802-P14, Carlisle, MA 01741
 Phone: (978) 371-0512; Fax: (978) 371-7129
 Web: www.antiqueradio.com

Products that make the difference!

★ ★ ★ ★

High Performance MW Loop Antenna
Award winning antenna. Tunes 530 to 1700 kHz with features unlike any other antenna including regeneration and 3 to 1 gear reduction drive!

Pocket Loop Antenna + PRM
Air-core loop antenna that collapses to fit in your pocket. Ideal for portables and travelers. Tunes 530 kHz to 23 MHz. The PRM (P.L. accessory) provides regeneration to >10 MHz.

BCB Rejection Filter
Ideal filter to eliminate BCB interference.

Shortwave Preamp
Extremely low noise and high immunity to overload (ip3 = +34 dBm). Includes BCB rejection filter. 10 dB gain 1.75 to 30 MHz.

Broadband Preamp
Same high performance as the SW Preamp but without the BCB rejection filter. Response: 100 kHz to 30 MHz. 10 dB gain

Earth Monitor
ELF receiver that receives 50 Hz to 15 kHz. Hear tweaks, whistlers, dawn chorus and other natural radio signals from planet Earth!

IF Filters and Receiver Upgrades
455 kHz and now 450 kHz IF filters! Receiver upgrades maximize performance!

Kiwa Electronics

612 South 14th Ave., Yakima WA 98902

<http://www.kiwa.com> (full catalog)
kiwa@wolffnet.com
 509-453-5492 or 1-800-398-1146 (orders)
 FAX: 509-966-6388

Seasonal Satellite Viewing

During the weeks around the summer solstice, the north polar regions remain in semi-permanent sunshine, so from May to July all the WXSATs (weather satellites) are in full bloom (i.e., transmitting visible-light imagery) at local midnight.

Meteor 3-5 currently travels northbound during northern-hemisphere nights, so, although it is not transmitting for most of the pass, as it crosses the terminator into polar sunshine we hear the transmission start abruptly. Figure 1 was one such occasion during an early June pass at about 0400 UTC when the WXSAT was traveling northbound over the eastern Atlantic.



FIG 1: Meteor 3-5 0358 UTC June 3, 1999

The image shows the southeastern coast of Greenland on the left and the north Atlantic on the right. Such images of Greenland reveal the seasonal melting of parts of the ice sheets at this time of year – a melting that always follows the same pattern. My own picture collection of Meteor images of Greenland goes back to the mid-eighties, and the coastline then appeared much as it does today.

Although Meteor WXSATs do not usually transmit APT at night, fortunately the NOAAs do. Summer southbound passes of NOAA-14 occur during the early hours so we see a few minutes of visible-light imagery before the transmission switches to the near infrared channel.

Morning passes of NOAA-15 are spectacular. Because the satellite crosses the equator later in the morning than NOAA-12, the sun is higher and the satellite's sensors catch more sun-glitter – the reflection of the sun off local areas of sea. This phenomenon has also been reported for Fengyun-1C (see later).

Resurs 01-N4 continues to transmit not only during the sunlit portion of its pass, but

also for a few minutes prior to entering the day portion of its orbit. I have recorded many evening transmissions (northbound into sunlight) in which the image content is essentially black; only the bars and gray scale are seen at either side of the image. Near the end of the transmission, the satellite has reached the north polar region where the picture recovers.

■ FengYun-1C

The new Chinese polar orbiting meteorological satellite FY-1C was launched from the Tai Yuan Satellite Launch Center on May 10, 1999, using a Long March 4 vehicle. Imagery was successfully received during the first orbit from ground stations located in Beijing and Urumqi, China, and from other suitably equipped ground stations around the world. One such station was that operated by Dave Wright, an RF engineering partner at Dartcom, a UK-based company that manufactures meteorological and remote sensing ground stations.

Data from the infrared channels was scheduled to be activated within a few days of press deadlines for *MT*. It is normal for a period of stabilization lasting several days to be required to allow processes such as out-gassing to be performed. After this period, further cooling of the hardware can take place without contaminants settling on the cooled surfaces.

Dave reported that the new satellite was transmitting image telemetry on 1700.5 MHz, with a 1.3308 Mbit data rate. "The infrared bands 3, 4, and 5 are off for the first few weeks, but the remaining 7 channels are working well." There appear to be some sensor optics problems as there are horizon-



FIG 2: FengYun 1-C HRPT composite image of UK from Dave Wright

tal shift differences on bands 6, 7, 8, 9, and 10 – the worst error being on Band 7. Dave noted that there seemed to be another problem where sun glitter occurs – the imaging system seems to get overloaded and takes a while to recover.

Dartcom sent a collection of images obtained in early June during the satellite's passes over Europe.

Figure 2 shows Britain as seen from FY-1C's scanner in an image composite from bands 1, 2 and 9. The satellite produces image data from 10 channels, permitting the scientific study of China's resources, as well as routine weather forecasting. China has established a computing facility that processes not only FengYun data, but also that from the NOAA WXSATs. The FY-1 meteorological satellite data processing system consists of two IBM S/1 front-end computers, two IBM 4381-P03 main processors, and several image processors.

For those (such as me) without the necessary hardware to receive high resolution picture telemetry (HRPT), the satellite can still be monitored by tuning to its 180.008 MHz transponder. I have been able to hear the signal on many passes over the UK.

WEB ADDRESSES:

Dartcom site: <http://www.dartcom.co.uk>
Official Chinese FengYun 1-C site: <http://nsmc.cma.gov.cn/engindex.htm>
China's FengYun computing facility: <http://nsmc.cma.gov.cn/pcsyatem.htm>
[Note the spelling 'pcsyatem' – probably a Chinese typographical error instead of 'pcsystem'.]

■ Free tracking software

Those who regularly check out satellite web sites may know that a number of well-established freeware and shareware programs have been available for some years. David Taylor only recently took up the challenge of writing satellite predictions software, yet his program **WXTrack** seems to be as up-to-date as any.

His initial motivation arose as a result of the low winter illumination that leaves WXSAT visible-light images looking rather

“washed out.” Without software enhancement, winter images are not easy to identify, particular for beginners. David wrote his program to produce accurate map displays based on the Turbo Pascal software originally made available by Dr T S Kelso (see web link below). David extended it using Borland’s Delphi, and has produced an impressive program.

The main screen (see figure 3) comprises three sections – *setup*, *world map* and *ground path*. The first option – *setup* – allows the selection of satellites that are to be displayed in the main *world map* screen. These satellites are identified from the list of satellites in the Kepler element files also displayed on this screen. The other option in this section is for the prediction of passes, and allows the selection of specific passes already identified on-screen. With this information you can use the ground path option to produce a picture of the image content for any future pass of any satellite.

The *world map* is impressive, allowing the simultaneous display of several satellite footprints, as well as that of the sun. The actual display can be *real-time*, or set manually. When set to *manual*, the time shown can be changed (for example, to that of a time-stamped file known to contain a satellite pass) and will show satellites above the local horizon at the specified time.

Data for a specific satellite can be set to display real-time information on the status line. For the selected satellite, a graphical picture of the predicted ground track can be produced using the *make picture* option. This uses the database – one of the downloads referred to during the download procedure.

David’s software suite uses Borland’s Delphi 4 runtime library modules for their operation, and links are provided for each module. Note that downloading comprises several parts, but using a 48kb/s line, I collected the necessary files within about 10 minutes.

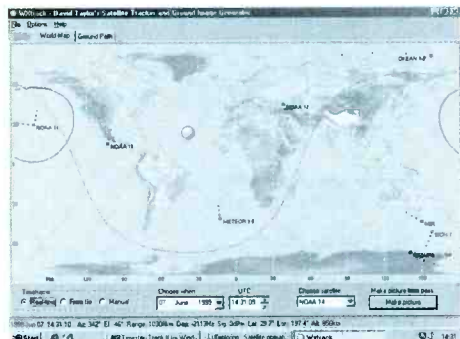

FIG 3: Screen display for David Taylor’s WXTrack program

The other program available from David’s web site is *SatSignal*. This program uses the sound (wave) file of an APT signal, produced by *WXSAT* or similar recording program, and then decodes it. The result is a perfectly synchronized image from Resurs and Meteor satellites, as well as from the NOAAs.

WEB SITES:

WXTrack: <http://www.davidtaylor.freeseerve.co.uk/software/wxsat.htm>
 Dr T S Kelso <http://www.celestrak.com/>
 A selection of other sites for tracking software (freeware and shareware):
 Tracksat: <http://www.hsv.tis.net/~wintrak>
 STS Orbit Plus: <http://www.dransom.com>
 Footprint: <http://www.riglib.demon.co.uk>

WXSAT launches

The next in the series of Okean oceanographic research satellites was scheduled for launch in late June. If its operation follows that of previous satellites in the series (currently Okean 1-7 and Sich-1), we can expect to receive short periods of telemetry on 137.40 MHz. Transmissions appear to be mostly over western Europe, but have occasionally been reported over the Americas.

GOES-L Launch Delayed

Steve Arnett of the Satellite Analysis Branch, NOAA/NESDIS/SSD, advised NOAA WXSAT monitors that the launch of NOAA’s next geostationary weather satellite GOES-L had been delayed until no earlier than June 26, 1999. A firm date was set to be announced pending the results of the Failure Review Board convened after the May 4th Delta-III launch failure. A “flight constraint” remained in effect for the upper stage engines that are common to both GOES and Delta III launch vehicles. After the engine constraint is lifted, approximately ten days are required to complete the normal engineering process leading to a successful launch.

Home page for announcements: <http://www.osd.noaa.gov/>

There has been a steady flow of severe weather arriving from the Pacific ocean, crossing continental USA. As the summer hurricane season approaches, all eyes will be on the image flow from GOES-W, positioned at 135 west longitude. Figure 4 shows the latest infrared light image just received via Meteosat-7 as a rebroadcast image. Recent images have often shown at least one storm center, together with dust clouds. It’s a busy world out there!



FIGURE 4: GOES-W infrared image at 1400 UTC June 9, 1999

FREQUENCIES

NOAA-14 transmits APT on 137.62 MHz
 NOAA-12 and -15 transmit APT on 137.50 MHz
 NOAAs transmit beacon data on 137.77 or 136.77 MHz
 Meteor 3-5 transmits APT on 137.30 MHz when in sunlight
 RESURS 1-4 transmits APT on 137.85 MHz
 Okean-4 and Sich-1 sometimes transmit APT briefly on 137.40 MHz
 GOES-8 and GOES-10 use 1691.0 MHz for WEFAX

KEEP YOUR C-BAND SYSTEM RUNNING STRONG!

Free Buyer’s Guide

BEST VALUES ON...

- Receivers, including 4DTV
- Dish Movers & LNBs, all kinds
- Tune-up Kits, Tools & Parts
- Skypac® Programming
- Toll Free Technical Help

1010 Frontier Dr.
 Fergus Falls, MN 56537

Fax: 218-739-4879
 Int’l: 218-739-5231

800-543-3025
www.skyvision.com

Skyvision



US Fish and Wildlife Service Profile

As we continue to move deeper into solar cycle 23, signals in the VHF low band (30-50 MHz) will start to propagate over great distances. Starting in the late fall and into the winter months, F-layer skip will become more prominent on the VHF low bands. One of the more interesting targets low band listeners shoot for is the U.S. Fish and Wildlife Service (USFW).

Fish and Wildlife personnel make extensive use of the VHF low band and high band government frequencies. To aid low band DXers in identifying USFW activity, we have included an extensive list of USFW stations in table 2 of this column.

The mission of the U.S. Fish and Wildlife Service is to conserve, protect, and enhance fish and wildlife and their habitats, especially for those species that are migratory or endangered. The Service employs approximately 7,500 people at facilities across the country including a headquarters office in Washington, D.C., seven regional offices (see table 1), and nearly 700 field units and installations. Among these are national wildlife refuges and fish hatcheries, ecological field offices, and law enforcement (Senior Resident Agent) offices.

Over the last 10 years, the service has slowly migrated to the VHF high band. About 40 percent of the service's older low band allocations have been shifted to the VHF high band. Some additional areas to search for USFW communications in your local area would include public safety interagency frequencies and state game warden frequencies.

The Fed File would like to extend a special thanks to Mark Cobbleddick in Virginia. Without Mark's help, our extensive frequency list for the USFW would not have been possible.

■ MT's Government Master File

We continue our exploration of the VHF-high government frequency band, started in the December 1998 issue of the *Fed Files*, by profiling the 166.0-166.9875 MHz range in Table 3 [ON PAGE 79]. See you in two months for another edition of *MT's The Fed Files*; until then, good hunting.



TABLE ONE: US FISH AND WILDLIFE REGIONS

Region 1	California, Hawaii, Idaho, Nevada, Oregon, Washington
Region 2	Arizona, New Mexico, Oklahoma, Texas
Region 3	Illinois, Indiana, Iowa, Michigan, Minnesota, Missouri, Ohio, Wisconsin
Region 4	Alabama, Arkansas, Florida, Georgia, Kentucky, Louisiana, Mississippi, North Carolina, Puerto Rico, South Carolina, Tennessee
Region 5	Connecticut, DC, Delaware, Maine, Maryland, Massachusetts, New Hampshire, New Jersey, New York, Pennsylvania, Rhode Island, Vermont, Virginia, west Virginia
Region 6	Colorado, Kansas, Montana, Nebraska, North Dakota, South Dakota, Utah, Wyoming
Region 7	Alaska

TABLE TWO: US FISH AND WILDLIFE SERVICE FREQUENCIES

VHF-Low Band Frequencies	State Transmitter Location		Comments/Channel ID (PL tone)
Freq	Call sign	User Group	
34.23	KA9365	Region 3	US Transportable Repeater Repeater input/output 34.83 (91.5 Hz)
34.25	KOJ600	Desert NWR	NV Las Vegas Repeater input/output 34.81
34.25	KOJ626	Desert NWR	NV Corn Creek Repeater input/output 34.81
34.25	KOJ627	Pahrnagat NWR	NV Pahrnagat NWR Repeater input/output 34.81
34.41	KOC610	Charles M. Russell NWR	MT Anton Butte Repeater output/input 34.81
34.41	KOC626	Benton Lake NWR	MT Benton Lake Repeater output/input 34.81
34.41	Unknown	Medicine Lake NWR	MT Medicine Lake Repeater output/input 34.81
34.43	KIE628	J.N.Ding Darling NWR	FL Sanibel Island Repeater input/output 34.83 (110.9 Hz)
34.43	KG7710	Ntl Law Enforcement TC	GA Glynco USFW Law Enforcement Training
34.43	KIE602	Okfenokee NWR	GA Camp Cornelia Repeater input/output 34.83 (114.8 Hz)
34.43	KIE645	Savannah Headquarters	GA Savannah Repeater input/output 34.83 (203.5 Hz)
34.43	KKF601	Delta NWR	LA Venice Repeater input/output 43.83 (114.8 Hz)
34.43	KIE641	SRA Office	MD Cambridge Repeater input/output 34.83
34.43	Unknown	Tamarac NWR	MN Rochert Repeater input/output 34.83 (91.5 Hz)
34.43	KIE639	SRA Office	PA Harrisburg Senior Resident Agent Office/LE-5 Repeater input/output 34.83
34.43	KAC628	Lake Andes NWR	SD Radar Hill Repeater input/output 34.83 (173.8 Hz)
34.43	KIE627	Dismal Swamp NWR	VA Suffolk Repeater input/output 34.83/LE-5 (127.3 Hz)
34.43	KIE638	SRA Office	VA Richmond Senior Resident Agent Office Repeater input/output 34.83 (127.3 Hz)
34.77	Unknown	Nationwide	US Interior Department
34.79	Unknown	Nationwide	US Interior Department
34.81	KIE673	SRA Office	AL Montgomery Senior Resident Agent Office/LE-4
34.81	KMC602	San Luis NWR	CA Los Banos
34.81	KMC603	Kern/Pixley NWRs	CA Delano
34.81	KMC615	Humboldt NWR	CA Humboldt Bay
34.81	Unknown	Sacramento NWR	CA Willows Headquarters for several NWRs
34.81	KAC625	Arapaho NWR	CO Larand
34.81	KOJ601	Alamosa NWR	CO Alamosa
34.81	KOJ602	Monte Vista NWR	CO Mount Vista
34.81	Unknown	Hotchkiss Fish Hatchery	CO Hotchkiss
34.81	Unknown	Hawaii/Pacific NWRs	HI Statewide
34.81	KEC670	Boston Area Office	MA Boston LE-13
34.81	KOC604	Medicine Lake NWR	MT Medicine Lake Repeater input/output 34.41
34.81	KOC610	Charles M. Russell NWR	MT Anton Butte Repeater input/output 34.41
34.81	KOC617	Charles M. Russell NWR	MT Peck Point Repeater input/output 34.41
34.81	KOC626	Benton Lake NWR	MT Benton Lake Repeater input/output 34.41
34.81	KOC635	Bowdoin NWR	MT Bowdoin
34.81	KOC640	Billings Office	MT Billings Flying Biologists/FlyBio-6
34.81	KOC693	Benton Lake NWR	MT Knees Repeater input/output 34.41
34.81	Unknown	Charles M. Russell NWR	MT Statewide NWR Air Operations
34.81	KK3415	Aberdeen Wetlands	NE Statewide Field Survey and Acquisition Crews
34.81	KCC603	SRA Office	NH Concord Senior Resident Agent Office/LE-5
34.81	KOJ600	Desert NWR	NV Las Vegas
34.81	KOJ626	Desert NWR	NV Corn Creek
34.81	KOJ627	Desert/Pahrnagat NWR	NV Pahrnagat
34.81	Unknown	Desert NWR	NV Hayford Peak Repeater output/input 34.25
34.81	KA9331	Mobiles	OR Statewide OR Coop Wildlife Research Unit
34.81	KOC605	William Finley NWR	OR Bruce
34.81	KK3410	Mobiles	RI Kingdon Area Law Enforcement/LE-13
34.81	KIE643	Sachuest Point NWR	RI Middletown
34.81	KK3415	Aberdeen Wetlands	SD Statewide Field Survey and Acquisition Crews
34.81	KA8859	Region 6	US Flying Biologists/FLYBIO-6
34.81	KA8860	Region 6	US Archaeologist/ARCH-6
34.81	KA8861	Region 1	US LE-1
34.81	KA8862	Region 6	US LE-6
34.81	KA8864	Region 4	US LE-4
34.81	KA8869	Region 1	US Flying Biologists/FLYBIO-1
34.81	KA9338	Region 3	US Engineering Surveys

TABLE TWO, CONTINUED

VHF-Low Band Frequencies					VHF-Low Band Frequencies						
Freq	Callign	User Group	State	Transmitter Location	Comments/Channel ID (PL tone)	Freq	Callign	User Group	State	Transmitter Location	Comments/Channel ID (PL tone)
34.81	KG7702	North Prairie Research Ctr	US	West of 100 West Long	Wildlife Research	34.83	KEC670	Boston Area	MA	Boston	LE-13
34.81	KK3383	Nationwide	US		Engineering Surveys	34.83	KA9369	Mobiles	MD	Statewide	Division of Wildlife Services
34.81	KK3385	Mobiles	US	Denver	Predator-Ecology Center	34.83	KIE611	Baltimore Area	MD	Baltimore	LE-5
34.81	KK3433	Region 3	US		LE-3	34.83	KIE641	Blackwater NWR	MD	Cambridge	Repeater output/input 34.43 (127.3 Hz)/LE-5
34.81	KK3435	Region 5	US		LE-R5	34.83	KIE650	Williamsburg Area	MD	Williamsburg	Repeater output/input 34.43/LE-5
34.81	Unknown	Nationwide	US		Interior Department						
34.81	KOJ619	Logan Office	UT	Logan	Denver Predator/Ecology Center						
34.81	KA9331	Willapa NWR	WA	Ilwaco		34.83	KGB696	Eastern Neck Is NWR	MD	Easter Neck Is NWR	F-2 (127.3 Hz)
34.81	KOC614	Toppenish NWR	WA	Toppenish		34.83	KGB697	Glenn L. Martin NWR	MD	Glenn L. Martin	
34.81	KOC615	McNary NWR	WA	Conboy Lake		34.83	KGB698	Patuxent Research Cntr	MD	Laurel	F-2 (127.3 Hz)
34.81	KOC616	McNary NWR	WA	Burbank		34.83	KGB699	Blackwater NWR	MD	Blackwater	(127.3 Hz)
34.81	KOC646	Little White Salmon Hatch	WA	Cook	Little White Salmon Fish Hatchery	34.83	KCC600	Moose Horn NWR	ME	Calais	
34.81	KOC647	Little White Salmon Hatch	WA	Willard	Little White Salmon Fish Hatchery	34.83	KQC601	Seney NWR	MI	Seney	
34.83	KK3382	Mobiles	AL	Statewide	Division of Wildlife Services Field Activities/100 watts	34.83	KQC602	Shiawassee NWR	MI	Saginaw	
34.83	KK3388	Mobiles	AL	Statewide	Ecological Services	34.83	KQC603	Pendills Creek Fish Hatch	MI	Pendills Creek	National Fish Hatchery
34.83	KIE615	Wheeler NWR	AL	Decatur		34.83	KQC606	Hiawatha Fish Hatch	MI	Brimley	National Fish Hatchery
34.83	KIE623	Eufaula NWR	AL	Eufaula		34.83	KAC600	Sherburne NWR	MN	Princeton	
34.83	KIE656	Bon Secour NWR	AL	Gulf Shores		34.83	KAC601	Sherburne NWR	MN	Zimmerman	
34.83	KIE673	SRA Office	AL	Montgomery	Senior Resident Agent Office/LE-4	34.83	KAC608	Morris Wetlands	MN	Benson	
34.83	KKF606	Felsenthal NWR	AR	Crossett		34.83	KAC610	Fergus Falls Wetlands	MN	Fergus Falls	
34.83	KKF613	Holla Bend NWR	AR	Russellville		34.83	KAC611	Rice Lake NWR	MN	McGregor	
34.83	KKF615	Big Lake NWR	AR	Big Lake		34.83	KAC622	Litchfield Wetlands	MN	Litchfield	(91.5 Hz)
34.83	KKF618	Wapanocca NWR	AR	Wapanocca		34.83	KAC624	Big Stone NWR	MN	Odessa	
34.83	KKF626	Wapanocca NWR	AR	Turrell		34.83	KAC626	Detroit Lakes Wetlands	MN	Detroit Lakes	
34.83	KFF636	Holla Bend NWR	AR	Holla Bend		34.83	KSC624	Agassiz NWR	MN	Middle River	
34.83	KKF640	White River NWR	AR	Dewitt		34.83	KSC630	Tamarac NWR	MN	Rochert	Repeater output/input 34.43 (91.5 Hz)
34.83	KKF641	White River NWR	AR	Big Island Chute		34.83	KSC638	Mingo NWR	MO	Puxico	
34.83	KKF642	White River NWR	AR	St. Charles		34.83	KK3382	Mobiles	MS	Statewide	Division of Wildlife Field Services
34.83	KKF643	White River NWR	AR	White River Levee		34.83	KK3388	Mobiles	MS	Statewide	Ecological Services
34.83	KKF644	White River NWR	AR	Jacks Bay		34.83	KIE619	Sandhill Crane NWR	MS	Gautier	
34.83	KGB692	Bombay Hook NWR	DE	Smyrna		34.83	KIE649	Sandhill Crane NWR	MS	Fontainebleau	
34.83	KGB693	Prime Hook NWR	DE	Milton		34.83	KKF604	Noxubee NWR	MS	Noxubee	Repeater input/output 164.625
34.83	KIE600	Loxahatchee/Hobe NWR	FL	Loxahatchee		34.83	KKF614	Yazoo NWR	MS	Hollandale	
34.83	KIE607	St. Marks NWR	FL	St. Marks		34.83	KKF638	Hillside NWR	MS	Hillside	
34.83	KIE608	Chassahowitzka NWR	FL	Chassehowitzka	Headquarters for several refuges	34.83	KA9367	McKinney Lk Fish Hatch	NC	Hoffman	
34.83	KIE618	Lake Woodruff NWR	FL	DeLeon Springs		34.83	KIE605	MacKay Island NWR	NC	Knotts Island	National Fish Hatchery
34.83	KIE625	St. Vincent NWR	FL	St. Vincent	Base 1	34.83	KIE606	Pea Island NWR	NC	Pea Island	
34.83	KIE628	J.N.Ding Darling NWR	FL	Sanibel Island	Repeater output/input 34.43 (110.9 Hz)	34.83	KIE614	Mattamuskeet NWR	NC	New Holland	
34.83	KIE633	St. Marks NWR	FL	Mounds		34.83	KIE624	Pee Dee NWR	NC	Wadesboro	
34.83	KIE647	National Key Deer WR	FL	Big Pine Key		34.83	KIE660	Pungo NWR	NC	Plymouth	
34.83	KIE654	St. Vincent NWR	FL	St. Vincent	Base 2	34.83	KIE679	Alligator NWR	NC	Manteo	NC Marine Resource Center
34.83	KG7710	Ntl Law Enforcement TC	GA	Glynco	USFW Law Enforcement Training	34.83	KA8863	Lostwood NWR	ND	Kenmare	
34.83	KIE602	Okefenokee Swamp NWR	GA	Camp Cornelia	Repeater output/input 34.43 (114.8 Hz)	34.83	KK3396	Mobiles	ND	Statewide	LE-6/45 watts
34.83	KIE621	Piedmont NWR	GA	Round Oak		34.83	KAC605	J. Clark Salyer NWR	ND	Upham	
34.83	KIE645	Savannah NWR	GA	Savannah		34.83	KAC606	Tewaukon NWR	ND	Cayuga	
34.83	KIE645	Savannah NWR	GA	Eulonia	Repeater output/input 34.43 (203.5 Hz)	34.83	KAC607	Audubon NWR	ND	Cole Harbor	
34.83	KK3437	Mobiles	IA	Statewide	Fishery Management	34.83	KAC614	Kulm Wetlands	ND	Kulm	
34.83	KSC627	DeSoto NWR	IA	Missouri Valley		34.83	KSC622	Arrowwood NWR	ND	Edmunds	
34.83	KSC639	Union Slough NWR	IA	Titonka		34.83	KSC631	Upper Souris NWR	ND	Foxholm	
34.83	KSC620	Crab Orchard NWR	IL	Cartersville		34.83	KSC633	Chase Lake Prairie Project	ND	Woodworth	North Prairie Wildlife Research
34.83	KSC621	Muscatatuck NWR	IN	Seymour		34.83	KSC634	North Prairie Center	ND	Jamestown	North Prairie Wildlife Research
34.83	KAC612	Quivira NWR	KS	Quivira		34.83	KSC637	Des Lacs NWR	ND	Lostwood	Repeater output (control 408.525)
34.83	KAC613	Quivira NWR	KS	Quivira		34.83	KG7708	Mobiles	NE	Statewide	Wildlife Research Field Parties
34.83	KAC615	Flint Hills NWR	KS	Hartford		34.83	KK3415	Mobiles	NE	Statewide	Aberdeen Wetland Office
34.83	KK3391	Cameron Prairie NWR	US	Gibbstown		34.83	KAC617	Hastings Wetlands	NE	Kearney	
34.83	KIE674	SRA Office	LA	Sidell	Senior Resident Agent Office/LE-4	34.83	KAC618	Hastings Wetlands	NE	Hastings	
34.83	KKF601	Delta NWR	LA	Cubits Gap	Repeater output/input 34.43 (114.8 Hz)	34.83	KSC623	Crescent Lake NWR	NE	Ellsworth	
34.83	KKF603	Sabine NWR	LA	Sulphur/Hackberry		34.83	KSC632	Valentine NWR	NE	Valentine	
34.83	KKF608	Lacassine NWR	LA	Lake Arthur		34.83	KSC601	Nashua Fish Hatchery	NH	Nashua	National Fish Hatchery
34.83	KKF612	Marksville Office	LA	Marksville	Headquarters for several NWRs	34.83	KCC602	Laconia Offices	NH	Laconia	Division of Fisheries Service
34.83	KKF617	Catahoula NWR	LA	Jena		34.83	KCC603	SRA Office	NH	Concord	Senior Resident Agent Office/LE-5
34.83	KKF634	D'Arbonne NWR	LA	Monroe		34.83	KEC662	Edwin Forsythe NWR	NJ	Barnegat	
34.83	KKF649	Tensas River NWR	LA	Tallulah		34.83	KEC665	Brigantine NWR	NJ	Oceanville	
34.83	KKF651	Upper Ouachita NWR	LA	Stevenson		34.83	KGB695	Great Swamp NWR	NJ	Basking Ridge	
34.83	KCC606	Great Meadows NWR	MA	Concord		34.83	KEC661	Target Rock NWR	NY	Huntington	
34.83	KCC607	Univ of Mass Coop	MA	Mt Lincoln		34.83	KEC663	Morton MWR	NY	Sag Harbor	
34.83	KCC610	Parker River NWR	MA	Newburyport		34.83	KEC664	Wertheim NWR	NY	Shirley	
						34.83	KEC667	Iroquois NWR	NY	Basom	
						34.83	KEC668	Iroquois NWR	NY	Iroquois	

TABLE 2, CONTINUED ON PAGE 74

THE FED FILES: TABLE TWO, CONTINUED

34.83	KQC600	Ottawa NWR	OH	Oak Harbor		34.83	KA8865	Sea Lamp Project	US	Marquette	Field Operations
34.83	KG7708	Mobiles	OK	Statewide	Wildlife Research Field Parties	34.83	KA8866	Sea Lamp Project	US	Ludington	Field Operations
34.83	KK3384	Natl Environment Center	PA	Philadelphia/Tinicum		34.83	KA9332	Environmental Protection	US		Spill Clean Up
34.83	KF7407	Mobiles	PA	Statewide	Pennsylvania Coop Wildlife Research	34.83	KA9338	Region 3	US		Engineering Survey/ESURV-3
34.83	KIE639	SRA Office Region 5	PA	Eliendale/Harrisburg	Repeater output/input 34.43/LE-5	34.83	KF7401	Mobiles	US		Biologists Field Operations/TENNBIO
34.83	KGB694	Erie NWR	PA	Guys Mills		34.83	KG7702	N Prairie Research Center	US	West of 100 west	Field Operations
34.83	KK3410	Narragansett Office	RI	Kingston	LE-13	34.83	KG7708	Mobiles	US	NE/OK/TX	Wildlife Research Field Parties
34.83	KIE601	Sachuest NWR	RI	Middletown		34.83	KK3380	Region 3	US		Population Management/POPMGT-3
34.83	KIE643	Ninigret NWR	RI	Kingston		34.83	KK3383	Mobiles	US		Engineering/Cadastral Survey
34.83	KIE603	Carolina Sandhills NWR	SC	McBee		34.83	KK3386	Region 4	US		Division of Wildlife Services
34.83	KIE609	Cape Romain NWR	SC	Moores Landing		34.83	KK3415	Aberdeen Wetlands	US		Field Survey and Acquisition Crews
34.83	KIE610	Cape Romain NWR	SC	Bulls Island		34.83	KK3433	Region 3	US		LE-3
34.83	KIE620	Santee NWR	SC	Summerton		34.83	KK3435	Region 5	US		LE-R5
34.83	KIE644	National Fish Hatchery	SC	Orangeburg		34.83	Unknown	Region 3	US		Flying Biologists/FLYBIO-3
34.83	Unknown	Savannah NWR	SC	Onslow Island	Repeater output/input 34.43 (203.5 Hz)	34.83	Unknown	Region 3	US	Transportable Repeater	Repeater output/input 34.23 (91.5 Hz)
34.83	Unknown	Savannah NWR	SC	Pinckney Island	Repeater output/input 34.43 (203.5 Hz)	34.83	KK3433	Region 3	US		Division of Fishery Services
34.83	KK3415	Mobiles	SD	Statewide	Aberdeen Wetland Office1	34.83	Unknown	Region 3	US		2 watts (127.3 Hz)
34.83	KAC602	Waubay NWR	SD	Waubay		34.83	Unknown	Region 3	US	Laconia NH	Repeater output/input 34.43/F-2 (127.3 Hz)
34.83	KAC603	Lacreek NWR	SD	Martin		34.83	KK3406	Division of Wildlife Svcs	VA	Statewide	
34.83	KAC627	Madison Wetlands	SD	Madison		34.83	KIE622	Back Bay NWR	VA	Virginia Beach	
34.83	KAC628	Lake Andes NWR	SD	Radar Hill	Repeater output/input 34.43 (173.8 Hz)/LE-6	34.83	KIE627	Dismal Swamp NWR	VA	Suffolk	Repeater output/input 34.43/F-2 (127.3 Hz)
34.83	KSC629	Sand Lake NWR	SD	Columbia		34.83	KIE629	Chincoteague NWR	VA	Assateague Island	
34.83	KIE604	Cross Creek NWR	TN	Dover		34.83	KIE632	Yorktown Area	VA	Yorktown	LE-5
34.83	KIE612	Reelfoot NWR	TN	Walnut Log		34.83	KIE636	Mason Neck NWR	VA	Woodbridge	
34.83	KIE626	Hatchie NWR	TN	Sunnyhill		34.83	KIE638	SRA Office	VA	Richmond	Repeater output/input 34.43/F-2/LE-5 (127.3 Hz)
34.83	KIE631	Tennessee NWR	TN	Paris		34.83	KIE642	Presquie NWR	VA	Hopewell	
34.83	KIE652	Hatchie NWR	TN	Hillsville		34.83	KIE651	Chesapeake Bay Office	VA	West Point	Repeater output/input 34.43/F-2/LE-11 (127.3 Hz)
34.83	KG7708	Mobiles	TX	Statewide	Wildlife Research Field Parties	34.83	KIE678	Eastern Shore VA NWR	VA	Kiptopeke	
34.83	KKF605	Aransas NWR	TX	Austwell		34.83	KOD600	Horicon NWR	WI	Mayville	
34.83	KKF607	Anahuac Headquarters	TX	Anahuac	Headquarters for several refuges	34.83	KQC605	Natl Fishery Research Lab	WI	French Island	NFRL-3
34.83	KKF616	Hagerman NWR	TX	Sherman		34.83	KQC609	Lake Mills Fish Hatchery	WI	Lake Mills	National Fish Hatchery
34.83	KKF623	Brazoria NWR	TX	Angleton		34.83	KSC625	Necedah NWR	WI	Necedah	
34.83	KKF630	Attwater Prairie	TX	Eagle Lake		34.83	KSC626	Horicon NWR	WI	Mayville	
34.83	KKF647	Chicken NWR	TX	Clam Lake	Headquarters for several refuges	34.83	KSC635	Iron River Fish Hatchery	WI	Iron River	National Fish Hatchery Survey and Maps Branch
34.83	KKF647	McFadden Marsh NWR	TX	Clam Lake		34.85	KK3394	Region 4	US		Interior Department
34.83	KKF650	San Bernard NWR/Brazoria NWR	TX	Freeport		34.85	Unknown	Nationwide	US		
34.83	KA8859	Region 6	US		Flying Biologists/FLYBIO-6	40.39	KKF637	Choctaw NWR	AL	Choctaw	
34.83	KA8861	Region 1	US		LE-1	40.39	KKF609	Choctaw NWR	AL	Jackson	
34.83	KA8864	Region 4	US		LE-4	40.39	Unknown	Nationwide	US		Interior Department
						40.57	KQC687	Region 1	US		Engineering & Survey
						40.73	KQC687	Region 1	US		Refuges/Wildlife Law Enforcement
						49.86	Unknown	Region 4	US		Coordinator/LE-4

FREE CATALOG

Tune In On Telephone Calls!

Packed with great books for radio communications & electronics hobbyists.

- ★ FREQUENCIES
- ★ MODIFICATIONS
- ★ REPAIRS
- ★ TROUBLESHOOTING

Everything you're looking for!

Largest selection of how-to & info books for scanner, CB & ham radio fans, beginners to experienced monitors.

CRB RESEARCH BOOKS
 PO Box 56-M, Commack NY US 11725
 PHONE: 516-543-9169
 FAX: 516-543-7486
 ONLINE: <http://www.crbbooks.com>

Animal Tracking Frequencies

30.03 (L-1), 30.06 (L-2), 30.07 (L-3), 30.17 (L-4), 30.18 (L-5), 30.19 (L-6), 30.20 (L-7), 30.21 (L-8), 30.22 (L-9), 30.23 (L-10), 30.24 (L-11) 30.25 (L-12), 164.4375 (H-1), 164.4625 (H-2), 164.4875 (H-3), 164.5125 (H-4), 164.5375 (H-5), 164.5625 (H-6), 164.5875 (H-7), 164.6125 (H-8), 164.6375 (H-9), 164.6625 (H-10), 164.6875 (H-11), 164.7125 (H-12)

Fish Tracking Frequencies

30.01 30.02 30.03 30.04 30.05 30.06 30.07 30.17 30.18 30.19 30.20 30.21 30.22 30.23 30.24 30.25 30.26 30.27

Support Aircraft Frequencies

122.900 122.925

VHF High Band Frequencies

162.025 162.6125 163.075 163.100 163.125 163.150 163.175 163.4375 164.100 164.200 164.250 164.625 164.675 164.725 164.750 164.775 164.800 166.275 166.300 166.325 166.6375 166.7375 166.750 166.7625 166.7875 166.8125 166.8375 166.8625 166.8875 166.900 166.9125 166.925 166.9375 166.9625 166.9875 167.0125 167.0375 167.0625 167.0875 167.1125 167.1375 167.1625 168.075 168.150 168.225 168.300 168.350 168.400 168.525 168.575 168.675 168.750 169.025 169.125 169.175 169.400 169.550 169.650 169.700 169.800 169.900 170.050 170.100 170.550 171.100 171.4062 171.450 171.650 171.675 171.750 172.300 172.425 172.450 172.475 172.525 172.600 172.650 172.675 172.725 173.7375 173.7625

UHF Frequencies

401.650 408.525 408.625 408.675 410.625 411.700 411.950 414.825 415.025 417.250 417.625 417.775 417.950 419.825 419.875 419.975

Travel with the Flying Pig

Welcome aboard! Now admit it, wouldn't it be really great to be able to see videos of airports with heavy runway and ramp action and to listen to the air traffic control (ATC) communications without any annoying narration to spoil the transmissions?

Well, wish no longer, for Flying Pig Airliner Videos offer all of this at a reasonable cost at The Flying Pig Airliner Shop, located at P.O. Box 69, Kingston, MA 02364; phone is (781) 585-5796. Or visit them on the Web at www.airportworld.com. All of their videos are only \$19.95. Here are our reviews of two videos:

■ LCY - London City Airport

For busy airliner action at London's City Airport, this video is an eye-opener. LCY was built on an unused dock on the Thames River and is only eight miles from the very center of London! The liveries of the various airlines are as fascinating and numerous as the airlines themselves. LCY is in VHS format and is 90 minutes in length.

To quote the Flying Pig's description, "Business Airport of Choice - London's East End. This video takes you to London England's BUSY airport to watch regional airline aircraft in action. You will feel as if you were there yourself at all the best locations to watch take-offs, landings, loading, ramps taxings, and more!"

After seeing the London City Airport video, I have to agree. I enjoyed watching the continuous takings off and landings of the various regional aircraft from companies such as Alitalia, CityJet, KLM UK, Luxair, Sabena, Air France and others, as well as listening to ATC transmissions [whose frequency is 118.075 MHz]. The photography and sound quality are excellent.

There was only one drawback in the whole video and that was an occasionally burst of wind blowing over the microphone. However, it was not constant and wasn't overly distracting.

■ Hong Kong - Kai Tak International Airport

Although Kai Tak is now closed, this 120-minute, two-cassette video made in 1998 features a fantastic view of an extremely busy airport. You can hear the ATC transmissions undisturbed by narration, for which Flying Pig Videos is known and respected. One of

the most familiar features of Kai Tak was the "Checkerboard Landing" for Runway 13, which is presented in great detail.

Well over 50 airlines were represented at Kai Tak and just about every jet aircraft imaginable is seen in these two videos. The action is continuous and fascinating! It's hard to believe that you are really watching a video because you actually feel as if you are actually there, enjoying the action.

The Kai Tak videos are extremely well produced and professionally presented, as are all Flying Pig Videos.

Visit their website for more information on their current list of available videos or write to them and request a catalogue.

■ A Visit to Poland's ATC

Our next stop is Warsaw, Poland, where we will visit with Krzysztof (Christopher) Zbigniew Kosarzycki, who works in Warsaw ATC Training Centre as an Air Traffic Control Instructor and Chief of ATC Simulators. His official title is Head of Training Systems and Technical Support Unit. His explanation of Air Traffic Control is an interesting comparison to controller Kristina H's lively account of ATC in the US (June '99 MT).

In his own words, Krzysztof says, "The Air Traffic Control Simulators are devices which give future controllers the possibility to train in an environment similar to their future workplaces, and to gain knowledge and skills needed in this kind of work. It is also possible to use the simulators in refreshment training for active controllers" (i.e., to keep their skills up to date).

"We can divide the simulators into three categories, depending on scope of the exercises:

- Procedural simulators (limited to communication and workplaces).
- Radar simulators (with visualization of traffic on computer display).
- Tower-radar simulators (full visualization up to 360 degrees of the airfield and vicinity of the airfield, simulated radar systems, and possibility of integrated radar-tower exercises).

"Air traffic control services may be divided into three basic parts. At ATCC in Warsaw, it looks like this:

1. Aerodrome Control Tower (TWR)

At Okecie Tower we have four positions:

- GD Controller (Ground) – responsible for aircraft ground movements.
- TWR Controller – responsible for giving

takeoff and landing clearances and maintaining separation in the vicinity of the airport.

- Assistant – exchanging information between TWR and other ATC services and controlling vehicles crossing runways.
- Clearance delivery – takes ATC clearance for each flight from ACC (*Area Control, which would be the Air Route Traffic Control Centers in the US-jb*) and passes this by radio to requests from flight crews and works with the 'flight plan' database on the Flight Specialist Workstation. This terminal is a part of the flight plan processing system.

The controller (on the tower or an operator like Flight Data Specialist in ACC) can print a flight progress strip for a specific flight (independently of the normal automatic way), change the flight plan existing inside the system (for different airway), and 'launch' the flight plan (the system is waiting for a departing a/c and looks for its specific transponder code), and print strips on other control sectors like Approach, ACC.

2. Approach Control (APP)

Approach Control keeps separation between planes arriving and departing from Warsaw. In general, all civil aircraft in radius of 100 km (kilometers) from Okecie are under control of APP. Approach is equipped with a modern radar system made by Westinghouse.

- Approach Controller - responsible for separation and navigation advisory for planes which arrive and depart from Okecie.
- Director - responsible for vectoring planes for the final (*approach-jb*).
- Assistant - provides coordination.

3. Area Control (ACC)

Area Control service controls all civil aircraft flying over Polish controlled airspace. On ACC, the majority of air traffic flow is generated by overflights.

- ACC Radar Controller - he provides separation between airplanes in his sector.
- Planning Controller - provides help for radar controller making backup of present situation on flight progress strips and makes coordination for aircraft entering and leaving our airspace.
- Assistant - Helps controllers and works on the Flight Specialist Workstation.

Krzysztof says that Air Traffic Control and computers are the main parts of his job and fortunately, both are his hobby! Thanks, Krzysztof!

That's all for today. See you in September. Until then, 73 and out.

IDing that unID

In all radio monitoring hobbies, hearing something is only half the battle. Figuring out what you just heard is the other half! When identifying a shortwave DX target, you have interval signals, languages, and program schedules to work with. On the domestic AM/FM/TV bands, the goal is the same but the tools are different.

The best way to identify a domestic band station is to hear the "legal ID." Hearing "This is AM-650, WSM, Nashville" is usually conclusive proof that you are, in fact, listening to WSM. Unfortunately, most DXers aren't that lucky! You will usually have to settle for something other than a blatant call-letter identification announcement. But with care, you can be just as certain of the identity of your latest DX catch.

Next to an identification announcement, local commercials are the best way to identify a DX station. Virtually all AM stations and a majority of FM stations are businesses; they have to sell commercials locally to make money. These commercials contain a variety of clues.

In smaller cities, the address of the advertiser is often part of the commercial. In larger cities, often an advertiser will mention several suburbs in which they have locations. The name of the advertiser can be a clue too; "The Bank of New England" probably isn't in Georgia.

Local news is also a good way to identify your DX catch. Street addresses, names of neighborhoods, and suburbs are frequently mentioned. It could be profitable to learn the names of the governors of bordering states. A bit of time spent browsing maps of major cities in nearby states could also be valuable.

Don't forget to pay attention to time announcements. If it's 7:30 where you are, and your DX target just aired the "8:25 News," you know you're tuned to a station in the next time zone to the east. Note that Arizona and most of Indiana don't go on Daylight Savings Time.

When DXing TV in the evening, a network program "out of sync" with your local network affiliate is a good sign of something coming in from a different time zone. (Unless that program is out of sync by just a few seconds to a minute or two – in which case, you should look to Canada as a probable target area.) By the way, the TV DXer can

CHML-900 has an excellent signal in many parts of the Northeast. Allen Renner received this verification "QSL" for his reception early this year.

benefit by having a second TV available to check for parallel programming on their local affiliates.

Regional accents have largely disappeared from major stations. They're still often heard on smaller outlets. You can't prove the station you're hearing isn't in the South if the announcer doesn't have a Southern accent. But if she *does* have one, it's rather unlikely the station is in Minnesota.

Foreign-language broadcasts can also suggest or eliminate certain stations as likely possibilities. A Spanish-language station is far more likely to be in Texas than in Nebraska, and one broadcasting in Korean is more likely Chicago than Wausau. You should, however, consider accents and languages a guide rather than conclusive proof. Unusual programming has turned up where one would least expect it.

Bits and Pieces

- The most powerful AM station in the Western Hemisphere is no more... According to *Trans World Radio Magazine*, their 500,000 watt transmitter PJB-800 on Bonaire in the Netherlands Antilles, will be shut down sometime in 1999. It will be replaced by a 100,000 watt unit and a directional antenna. The high cost of electricity was cited as the reason. I suspect PJB will still be easily DXable after reducing power; the new antenna will favor Cuba, and much of the US is in the same direction.

- Pat Griffith in Colorado thought he'd settle once and for all the question of whether his local Radio Disney stations were KADZ-1550 and KDDZ-1690, or KDDZ-1550 and KADZ-1690. He wrote a letter to the stations asking them to confirm which call sign went with which frequency. The reply had it the first way on the letterhead – and once each way in the text. Pat says, "It appears that they

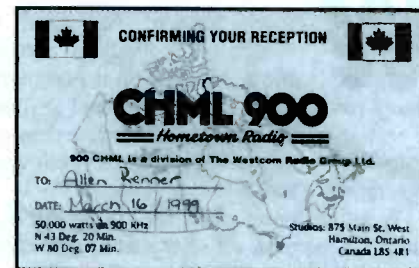

are as confused as the rest of us are!"

- If you're DXing in Europe, or if you're interested in knowing what the AM band looks like across the Atlantic, you may want to look at Herman Boel's *Long and Medium Wave Stations in Europe, North Africa, and Middle East*. Some stations not found in the *World Radio-TV Handbook* are listed, and additional programming information is available. Best of all, it's free for the downloading from <http://come.to/dxing>. If you're not on the Internet, you can order a printed copy for \$10 from Herman Boel, Roklijf 10, B-9300 Aalat, Belgium.

- After 65 years, the Mutual radio network is no more. On April 18, Westwood One, who bought the Mutual name in the 1980s, ceased to provide Mutual programming. On the same date, most NBC Radio broadcasts were also terminated, though weekday morning NBC newscasts will continue. Internet reports say the common belief that Mutual was founded to carry the *Lone Ranger* radio show are not true. (Thanks to Robert Thomas in Connecticut for the news item)

- Allen Renner in western Pennsylvania sent a copy of his CHML-900 QSL. With CBF-690 off the air, Allen also heard WJOX Birmingham, Alabama, and Radio Progreso from Cuba. Allen's other catches include CHTN-720 Charlottetown, Prince Edward Island, and KADZ (or is it KDDZ?) Arvada, Colorado. Speaking of CBF-690 being off the air, its sister station CBM-940 also left the air in mid-May. The Canadian government is still considering applications to replace these two powerhouse stations.

Have you received a verification you're particularly proud of? Do you have some interesting hints for identifying your DX catches? Let us know. Write me at Box 98, Brasstown NC 28902-0098, or by email to w9wi@bellsouth.net. Good DX!

Jimmy the Weasel Denies FCC Bust

Despite references earlier this year to an FCC bust of Jimmy the Weasel in several pirate radio publications, including *Monitoring Times*, Jimmy is still heard on shortwave via **WRX**. Although not maintaining a frantic and almost daily schedule, as he did earlier in the year, Jimmy has repeatedly denied over the air that his station suffered a visit from enforcement authorities.

MT hears this month direct from Jimmy: "I have stated many times that pirates are sorry and that their listeners are even sorrier. But, fear not, when you print your retraction in a future issue, Jimmy will forgive your being sorry. Jimmy the Weasel cannot be busted."

No record of a **WRX** enforcement action has thus far materialized in FCC announcements, although delays are common in such actions. Meanwhile, Jimmy's shouts of "Your Stinkin' Mama," "Y2K," and a capella singing remain audible.

■ WBCQ Schedule

Ex-pirate and licensed broadcaster Alan Weiner of **WBCQ** sends in the station schedule. They remain active on old pirate frequency 7415 kHz with a good signal, using 1600-0300 UTC most days. Some pirate fare is mixed in with Brother Stair's *Overcomer Ministry* and Kim Andrew Elliott's *VOA Communications World*, so the fare is eclectic here.

■ Radio San Miguel

Dr. Zaius notes that Peruvian pirate **Radio San Miguel**, active on 6987.1 kHz, can now be reached via Radio San Miguel El Faique, Distrito El Faique, Provincia de Huancabamba, Departamento de Piura, Peru. This one is an extremely tough catch; try for it around local sunset.

Another tough one, Europirate **Europe 41**, says that their address is now PO Box 520112, DE-44207, Dortmund, Germany. They say that they are on daily for four hours at 1800 UTC on 7460 kHz.

■ Shortwave Pirate Activity

North American pirate radio stations heard by our readers last month all used frequencies within 500 kHz of 6955 kHz, typically from two or three hours before sunset until at least 0500 UTC. Morning and afternoon broadcasts increase on the weekends. Programming

formats and contact maildrops (when known) are listed. We're still experiencing summertime propagation conditions, meaning that the 43 meter band opens later and stays open later than during the winter.

Blind Faith Radio- Album cuts from the 60's and 70's dominate their shows. (Merlin)
Crazy Elmo's Radio World- A new one with CERW call letters, rock music, parodies, pirate discussions, and relays of other pirates. (crazyelmo@youpy.com e-mail)

Free Hope Experience- Major Spook is back with his elaborate parody sketches. (Blue Ridge Summit)

Free Radio America- Rock and political commentary are The Don's staples. (None, requests posts to FRN web site)

Jerry Rigged Radio- Like most pirates, rock music is their focus. (Providence)

Numbers Parody- The Mexican food numbers station has returned, this time also featuring wines in the secret message codes. (None)

Radio Beaver- Bucky Beaver's light hearted Canadian pirate advocacy is frequently amusing. (Merlin)

Radio Eclipse- Steve Mann mixes rock music with commentaries on pirate radio. (Providence)

Radio Free London- This Europirate, using 15068.5 kHz, has been making it to North America around 0000-0100 UTC. (rflsw@usa.net e-mail)

Radio Free Speech- Bill O. Rights discusses liberty and plugs pirate radio. (Belfast)

Radio Fusion Radio- Their pop music is distinctive because of the announcer's computer synthesized voice. (Providence)

Radio Metallica Worldwide- Dr. Tornado's 15 kW transmitter punches out a tremendous signal for his rock music and commentary. (Blue Ridge Summit)

Radio Three- Sal Amoniac airs pop tunes. (None, occasionally QSL's logs in *The ACE*)

Radio Tornado Worldwide- They parody Radio Metallica and/or **WRX**. (None; try *ACE* logs)

Radio USA- Mr. Blue Sky, on for over 15 years, still transmits punk rock and comedy. (Belfast)

Riccochet Radio- Rick O'Shay's parodies include a whack at Dr. Laura. (None)

Scream of the Butterfly- Classic rock from 30 years ago is their trade mark. (Providence)

SWRS- This European pirate relay is still widely heard on 3905, 6195, 11470, and 21450 kHz, with the latter two best in North America. They changed their address; try the second listed here. (Wuppertal or Milano)

Voice of Prozac- Their female announcers promote "The Relaxation Station." (Pittsburgh)
WACK Radio- Their slick classic rock format is highly professional. (Uses 888-959-8177 toll free)

WHYP- This memorial to the late James Brownyard features old Lake Erie weather

WHYP-The James Brownyard Memorial Station

forecasts. (whyp1530@yahoo.com e-mail)

WMFQ- They promote QSL's in pirate radio, and have been verifying. (Providence)

WMPR- Many have heard the powerful signal of this techno dance music station, but none have verified it. (None)

WRMI- No, this isn't a Jeff White clone; it's Radio Michigan International, a new rock pirate. (None)

WRX- As we see above, Jimmy the Weasel is still here. (Manomet)

WSRR- Dr. Love's Solid Rock Radio often features soul or rap music, but not always. (Belfast)

WWRB- A new one with techno rock and parodies. (Lula)

Reception reports to pirate stations require 3 first class stamps for USA maildrops or \$2 US to foreign addresses. Send your letters to PO Box 1, Belfast, NY 14711, PO Box 28413, Providence, RI 02908; PO Box 109, Blue Ridge Summit, PA 17214; PO Box 25302, Pittsburgh, PA 15242; PO Box 11522, Huntsville, AL 35814; PO Box 24, Lula, GA 30554; PO Box 1464, Manomet, MA 02345; PO Box 293, Merlin, Ontario N0P 1W0; SWRS c/o Play DX, Via Davarnzati 8, IT-20158, Milano, Italy; and Postfach 220342, 42373 Wuppertal, Germany.

■ Thanks!

Your input is always welcome via PO Box 98, Brasstown, NC 28902, or via the e-mail addresses atop the column. We appreciate material sent in this month by John T. Arthur, Belfast, NY; Shawn Axelrod, Winnipeg, Manitoba; Artie Bigley, Chicago, IL; Radio Bob, Lula, GA; Ranier Brandt, Hofer, Germany; Jerry Coatsworth, Merlin, Ontario; Ross Comeau, Andover, MA; Joe Filipkowski, Providence, RI; Bill Finn, Philadelphia, PA; Ulis Fleming, Glen Burnie, MD; Harold Frogde, Midland, MI; Paul Giffin, San Francisco, CA; William Hassig, Mt. Prospect, IL; Vince Havrilko, Beale AFB, CA; Maryanne Kehoe, Atlanta, GA; Dave Kirby, Willowick, OH; R. H. Lankard, Tucson, AZ; Zacharias Liangas, Italy; Ben Lovell, Bloomfield Hills, MI; Greg Majewski, Oakdale, CT; C. Mamani, Santiago, Chile; Armando Mastrapa, New York, NY; Bill McLintock, Minneapolis, MN; Big Mike, Belfast, NY; Joe Oldenborg, Appleton, WI; Mike Prindle, New Suffolk, NY; Al Quaglieri, Albany, NY; Martin Schoech, Merseburg, Germany; Lee Silvi, Mentor, OH; DJ Stevie, Basel, Switzerland; Jimmy the Weasel, Manomet, Alan Weiner, Kennebunk, ME; MA; Niel Wolfish, Toronto, Ontario; John Young, Butte, MT; and Dr. Zaius.

Surfin' for LW Sites

The World Wide Web is an excellent resource for longwave information. There have been many additions and corrections since the last list of websites I published, so here is an update on sites carrying significant longwave material. The list is not meant to be all-inclusive. If you have favorites that you feel should be listed, please drop me a line with the details.

It never fails that as soon as I publish such a list I get inquiries from those trying (unsuccessfully) to access a web site. Web addresses are subject to frequent change, and it's possible that some of the sites listed here may have changed their addresses since press time – or may have ceased operation entirely. The addresses given here were tested and then “cut and pasted” directly from my web browser into the manuscript. If a particular address does not work, all I can suggest is to do a search that includes some key words for the site you are looking for.

■ Updated Listing of WWW Longwave Sites:

<http://www.xuser.com/~daled/navaid/>
Dale's Beacon page. Overview of commercial beacon systems, both LF and VHF. Includes pictures of beacon installations.

<http://members.aol.com/RKDX/longwave-home.html>

Robert Kramer's longwave page. Lots of LF loggings, news of DX stations heard, links to other LW and MW sites

<http://mike.nh.ultranet.com/html/hobby.html>

Mike's Hobby Page. Information on LW activity with an emphasis on Part 15 (license free) transmitting.

<http://www.lwca.org/>

Longwave Club of America (LWCA). This is probably the biggest LW site on the net. Widely varied information on all facets of Longwave operation. Includes a message board. *Highly recommended.*

<http://www.datasync.com/~rocker/longwave.htm>

Ray Rocker's LW page. Heavy emphasis on Loggings, updates on unidentified stations.

<http://dybka.home.mindspring.com/jill/radio/longwave.html>

Jill's Longwave Page. Maintained by Jill Dybka, a frequent contributor to *Below 500 kHz*. Includes addresses for many beacons,

QSL information, Beacon listings and links to other LW resources.

<http://members.aol.com/DJLBEACON1/beaconpg.html>

Darwin Long's DJL Radiobeacon Page. Complete description of “DJL”, Mr. Long's radiobeacon operating on 188 kHz from Ventura County, CA. Includes photos of the beacon, antenna system and coverage patterns. Also a list of the beacons heard by Mr. Long.

<http://web.inter.nl.net/hcc/Shortwave/>
The European LF Beacon List. The name says it all. Very complete.

<http://w4u.eexi.gr/~sv1xv/lw.html>
Kostas Krallis' beacon page. Heavy emphasis on beacons in Greece and Europe. Links to numerous other LW sites ranging from natural radio to building your own LF transmitter.

<http://www.gem.net/~berri/wun/>
Worldwide Utility News page. First class site with in-depth news and information about all types of Ute stations—LF through HF. Includes scores of related links.

http://www.unetsul.com.br/py2p11/ndb_list.htm

Marcus Ramos' South American NDB Page. May take a while to load (depending on your connection speed), but worth it. Perhaps the most complete listing of S. American and African NDBs on the Internet.

<http://www.provcomm.net/pages/joe/>
Joseph Cooper's (VE3FMQ) Homepage. Contains interesting articles written by Mr. Cooper on receiving antennas, AM DXing, and Beacon DXing. Also includes a discussion of Canadian Lowfer operation.

<http://www.triax.com/vlfradio/natradio.htm>

Stephen P. McGreevy's Natural Radio Site. THE place on the web for information on all aspects of Natural Radio. Also includes an online version of “The Art of NDB DXing,” a respected series by Sheldon Remington on maximizing weak signal reception. *Highly recommended.*

<http://www.computerpro.com/~lyle/>
Lyle Koehler's LF Experimental Page. An excellent source of information for those interested in the license-free “Lowfer” band (160-190 kHz). Includes plans for a simple LF transmitter, PC-based identifier and many other projects. Detailed discussion on



transmitting antenna design and efficiency. *Highly recommended.*

■ Loggings

This month, we have two contributors of loggings. The first is Greg Heath (NY). Greg is a commuter pilot who uses non-directional beacons to “shoot” instrument approaches into airports in Canada and the Northeastern U.S. When on the ground, he uses a Yaesu FT-840 receiver with a 400-foot dipole up between 40 and 80 feet. The antenna is fed with 450 ohm ladder line.

Our second contributor is Alan Gale (UK). Alan uses a Wandel & Goltermann SPM-3 selective level meter along with a Datong FL3 audio filter. His antennas are of the loop variety (Wellbrook 40 meter and 1 meter) – both mounted outside.

From his location in Northwest England, Alan is able to hear several high power Canadian beacons, although US beacons seem to be more elusive. Many of these stations were heard in early June between 0230 and 0330 UTC, which shows us that we shouldn't assume that the warmer months are a time to put away the headphones!

See you in September

LONGWAVE LOGGINGS

Freq.	ID	Location	Logged By
219	AL	Albany, NY	G.H. (NY)
276	YHR	Chevery, PQ	A.G. (UK)
280	QX	Gander, NF	A.G. (UK)
332	YFM	La Grande, PQ	G.H. (NY)
340	YY	Mont Joli, PQ	A.G. (UK)
340	YY	Mont Joli, PQ	G.H. (NY)
347	YG	Charlottetown, PEI	A.G. (UK)
351	YKQ	Fort Rupert, PQ	G.H. (NY)
356	AY	St Anthony, NF	A.G. (JK)
356	HEU	Schenectady, NY	G.H. (NY)
360	PN	Port Menier, PQ	G.H. (NY)
360	PN	Port Menier, PQ	A.G. (UK)
366	YMW	Maniwaki, PQ	G.H. (NY)
385	NA	Natashquan, PQ	A.G. (UK)
390	JT	Stephenville, NF	A.G. (UK)
396	JC	Rigolet, NF	A.G. (UK)
404	YSL	St Leonard, NB	A.G. (UK)
414	BC	Baie Comeau, PQ	A.G. (UK)
414	BC	Baie Comeau, PQ	G.H. (NY)
516	YWA	Petawawa, ON	G.H. (NY)

TABLE THREE, FEDERAL FREQUENCY ALLOCATIONS: 166-166.9875 MHZ

166.0000	Air Force, Bureau of Reclamation [Nationwide], Coast Guard, Energy, Forest Service (Region 6), IRS, Navy, Veterans Administration	166.6125	Indian Affairs [Nationwide], BLM [Nationwide], Geologic Survey, Interior [Nationwide], Post Office, State, USIA
166.0125	(No reported activity)	166.6250	(No reported activity)
166.0250	FHWA [Nationwide], Maritime Administration, National Marine Fisheries Service, National Ocean Service [Nationwide], NOAA [Nationwide], National Weather Service [Nationwide], Railroad Transportation Test Center	166.6375	Air Force, Indian Affairs, BLM, Bureau of Reclamation, Energy, Fisheries and Wildlife, Interior [Nationwide], NPS, Secret Service, TVA
166.0375	(No reported activity)	166.6468	Low power, non-voice 5 kHz bandwidth splinter frequency (after January 1, 2005)
166.0500	FBI, Geologic Survey, NESDIS (Commerce), NOAA, National Ocean Service, National Marine Fisheries Service, NPS, NSF [Nationwide], Post Office, Secret Service [Input Oscar/Tango/Mike], Transportation	166.6500	Low power, non-voice up to 11 kHz bandwidth splinter frequency (after January 1, 2005)
166.0625	(No reported activity)	166.6531	Low power, non-voice 5 kHz bandwidth splinter frequency
166.0750	Coast Guard, Energy, FBI, Geologic Survey, National Weather Service	166.6562	Low power, non-voice 5-10 kHz bandwidth splinter frequency (until January 1, 2005)
166.0875	FAA and Interior [Nationwide]	166.6583	Low power, non-voice 5 kHz bandwidth splinter frequency (until January 1, 2005)
166.1000	Air Force, Army, FAA, Labor, NASA, National Institutes of Health, State, Supreme Court, US Courts	166.6593	Low power, non-voice 5 kHz bandwidth splinter frequency (after January 1, 2005)
166.1125	(No reported activity)	166.6625	Low power, non-voice up to 11 kHz bandwidth splinter frequency (after January 1, 2005)
166.1250	Customs, Energy, EPA, Environmental Research Laboratories [Nationwide], FAA, FBI, Forest Service (Regions 4/5), Geologic Survey, National Marine Fisheries Service, NOAA Aircraft Ops Center	166.6656	Low power, non-voice 5 kHz bandwidth splinter frequency (after January 1, 2005)
166.1375	Army	166.6750	Agriculture [Nationwide], Agriculture Research Service, Animal and Plant Health Inspection Service, Customs, Forest Service (Region 2/4/5), NASA, Soil Conservation Service, Veterans Administration
166.1500	BLM, Coast Guard, Commerce [Nationwide], Energy, Environmental Research Laboratories, NBS, National Marine Fisheries Service, National Ocean Service [Nationwide], NOAA [Nationwide], National Weather Service	166.6875	Agriculture [Nationwide]
166.1625	(No reported activity)	166.7000	FBI, WHCA [November-Nationwide]
166.1750	Air Force, FAA [Nationwide], Geologic Survey, National Weather Service [Nationwide], Transportation [Nationwide]	166.7125	(No reported activity)
166.1875	(No reported activity)	166.7250	Indian Affairs, BLM [Nationwide], Bureau of Mines [Nationwide], Bureau of Reclamation, Interior [Nationwide], NPS, National Science Foundation
166.2000	Air Force, Army, BLM, Bureau of Reclamation, Corps of Engineers, Customs, Energy, FAA, FBI, FCC, FRS, Forest Service (Region 4), GSA, IRS, Labor, Navy, Post Office, Secret Service, USIA, Veterans Administration, WHCA	166.7375	BLM, Customs, Fisheries and Wildlife [Nationwide], NPS
166.2125	(No reported activity)	166.7500	Army, BLM, Bureau of Reclamation [Nationwide], Corps of Engineers, Energy, FBI, Fisheries and Wildlife, Geologic Survey, Interior [Nationwide], NPS, Navy, Veterans Administration
166.2250	Air Force, Army, Coast Guard, Corps of Engineers, Customs, Energy [Nationwide], FLETC, GSA, FRA (Transportation), Forest Service (Region 1/4), NASA, NBS (Commerce), Navy, Post Office, TVA, Veterans Administration	166.7625	BLM, Fisheries and Wildlife [Nationwide], Geologic Survey, NPS
166.2375	Interior [Nationwide]	166.7750	BLM [Nationwide], Interior [Nationwide], NPS [Nationwide]
166.2500	Air Force, Army, Energy, FAA, Forest Service (Region 1), Labor, NASA, Navy, Post Office, TVA, Veterans Administration [Several civilian fire departments are licensed here by the FCC, see Grove FCC CD-ROM]	166.7875	BLM, FHWA, Fisheries and Wildlife [Nationwide], NPS
166.2625	(No reported activity)	166.8000	Bureau of Indian Affairs (Interior), Bureau of Land Management (Interior), Bureau of Reclamation (Interior-Nationwide), Energy Department, Geologic Survey, Interior Department [Nationwide], Office of Surface Mining (Interior), Secret Service
166.2750	Indian Affairs, Bureau of Prisons, Bureau of Reclamation, Customs, Energy, FBI, Fish and Wildlife, Geologic Survey, NPS, Post Office, TVA	166.8125	BLM, Fisheries and Wildlife [Nationwide], Geologic Survey, NPS
166.2875	(No reported activity)	166.8250	BLM, Bureau of Reclamation [Nationwide], Energy, FBI, Geologic Survey, HHS, Interior [Nationwide], National Institutes of Health, NPS, TVA, Veterans Administration
166.3000	Indian Affairs, BLM, Bureau of Reclamation, Customs, Fish and Wildlife, Interior [Nationwide], NPS, Post Office	166.8375	BLM, Fisheries and Wildlife [Nationwide], NASA [Nationwide], NPS
166.3125	Interior [Nationwide]	166.8500	Indian Affairs, BLM, Bureau of Reclamation [Nationwide], Energy, FBI, Interior [Nationwide], NPS [Nationwide], National Science Foundation
166.3250	Indian Affairs, BLM, Bureau of Reclamation, Energy, Fish and Wildlife, Interior [Nationwide], NPS, TVA	166.8625	BLM, Fisheries and Wildlife [Nationwide], NPS
166.3375	Interior [Nationwide]	166.8750	ATF, Indian Affairs, BLM, Bureau of Reclamation, Customs, FBI, Interior [Nationwide], NPS, TVA
166.3500	Army, BLM, Bureau of Reclamation, GSA, Interior [Nationwide], NPS, Post Office	166.8875	BLM, Fisheries and Wildlife [Nationwide], Geologic Survey, NPS
166.3625	Interior [Nationwide]	166.9000	Indian Affairs, BLM, Bureau of Reclamation, Coast Guard, Fisheries and Wildlife, Interior [Nationwide], NPS
166.3750	Indian Affairs, BLM, Bureau of Reclamation, Customs, FBI [Nationwide], FRA (Transportation), Forest Service (Region 1/4), Interior [Nationwide], NPS [Nationwide], Navy, Post Office, TVA, Veteran Administration	166.9125	BLM, Fisheries and Wildlife [Nationwide], Geologic Survey, Interior [Nationwide], NPS
166.3875	(No reported activity)	166.9250	Army, Indian Affairs, BLM, Bureau of Reclamation, FBI, Fisheries and Wildlife, Interior [Nationwide], NPS, Post Office
166.4000	Secret Service [Nationwide-Golf]	166.9375	BLM, Fisheries and Wildlife [Nationwide], Geologic Survey, Interior [Nationwide], NPS
166.4125	(No reported activity)	166.9500	Bureau of Reclamation, GSA, Geologic Survey, Interior [Nationwide], NPS, Post Office, Veterans Administration
166.4156	Low power, non-voice 5 kHz bandwidth splinter frequency (until January 1, 2005)	166.9625	BLM, Fisheries and Wildlife [Nationwide], Geologic Survey, Interior [Nationwide], NPS
166.4187	Low power, non-voice 5-10 kHz bandwidth splinter frequency (until January 1, 2005)	166.9750	Indian Affairs, BLM, FBI, Forest Service (Region 1), Interior [Nationwide], IRS, NPS, Post Office, Veterans Administration
166.4218	Low power, non-voice 5 kHz bandwidth splinter frequency	166.9875	BLM, Fisheries and Wildlife [Nationwide], NPS
166.4250	Low power, non-voice up to 11 kHz bandwidth splinter frequency (after January 1, 2005)		
166.4281	Low power, non-voice 5 kHz bandwidth splinter frequency (after January 1, 2005)		
166.4375	Coast Guard, Customs [Nationwide], EPA [Nationwide], FBI, INS, National Marine Fisheries Service		
166.4500	(No reported activity)		
166.4625	Treasury Common [Nationwide]: ATF, Customs, IRS, Secret Service, WHCA; Coast Guard [Nationwide], DEA [Nationwide], FBI [Nationwide], INS [Nationwide], Marshals Service [Nationwide]		
166.4750	(No reported activity)		
166.4875	Air Force, Army, BLM, Coast Guard, Customs, Energy [Nationwide], FBI, Forest Service (Region 4), NASA, Navy, Secret Service		
166.5000	(No reported activity)		
166.5125	WHCA [Sierra-Nationwide]		
166.5250	NASA [Nationwide]		
166.5375	ATF [Nationwide], Customs, IRS		
166.5500	(No reported activity)		
166.5625	Agriculture [Nationwide], Agriculture Extension Service/Research Service, Air Force, Animal and Plant Health Inspection Service, Coast Guard, Customs, Forest Service (Region 2/4/5/6/9/10), Secret Service, Smithsonian Institute		
166.5750	Forest Service (Region 2/8), Soil Conservation Service		
166.5875	Coast Guard [Nationwide], Customs, Forest Service (Region 2/4/5), Geologic Service, INS, IRS, Secret Service [Nationwide], Treasury [Nationwide]		
166.6000	Customs		

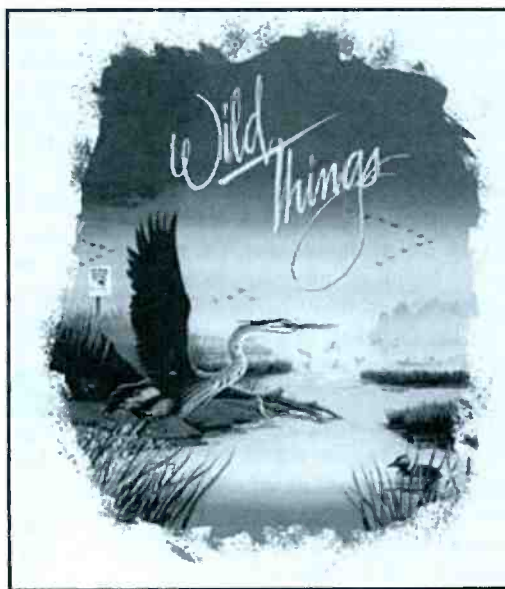

Who Pays for that Cellular Call?

Since the introduction of cellular telephone service in the United States in 1983 the subscriber has always had to pay for airtime, even when receiving a call. Many wireless subscribers don't give out their number the way they do for a wired phone, fearing they will have to pay for unwanted calls. Other subscribers keep their phone turned off unless placing a call.

Under a Notice of Proposed Rulemaking (NPRM) recently issued by the Federal Communications Commission (FCC), all that may change. The FCC is seeking comments on a billing policy termed Calling Party Pays (CPP) under which the person calling a cell phone would pay the airtime charges rather than the cell phone's owner.

The FCC's NPRM is a process to gather information prior to issuing a Report and Order (R&O). The FCC is seeking comments and recommendations on how best to remove regulatory and legal barriers to CPP and establish a national standard. Several issues need to be decided, including how to inform callers that they will be charged.

Under one plan, callers dialing a CPP subscriber will hear an automatic recording informing them of the charges they will incur. If they are calling from a payphone, an alternate means of payment would be offered, such as a credit card or third party billing.

Another plan would give CPP subscribers a separate area code, allowing callers to easily recognize when they'd be paying for the call. This plan could require callers to use long distance (1+ number) dialing to imply an additional toll charge. It would also require current wireless subscribers who wanted CPP to change their phone number, which is not a popular idea.

A more complicated question is how to actually bill the caller. Should the FCC require the local telephone company to add CPP charges to the monthly invoice, and collect the money on behalf of wireless providers? How would such a requirement fit in with the FCC's stated path of deregulation? Even if the FCC did require it, how would the wireless company manage to get all the billing information (termed *call detail records*) to the proper local telephone company?

The wireless industry has long sought CPP, assuming it will increase wireless us-

age. Incoming calls currently account for less than 20 percent of all wireless calls, the assumption being that subscribers are reluctant to give out their phone number. With CPP such persons would presumably be more willing to give out their number, making wireless services more competitive with traditional wireline phones.

Wireless providers also like CPP because it opens up another pocket to pay for airtime. One FCC Commissioner openly voiced concern about whether market competition could prevent wireless companies from "price gouging" wireline callers.

Despite CPP being common in Europe, it's not clear how popular it will be in the United States. Many newer PCS subscribers already have the first minute of incoming calls free, and with the growing popularity of single rate plans CPP may be more of a hassle than a convenience. Although CPP subscribers would presumably be able to specify numbers that will not be CPP, such as parents, children's schools, and close friends, many people have a wireless phone to make it easier for others to reach them, and adding a CPP barrier may take away some of that sense of connectedness.

■ New Area Codes

The explosive growth of cell phones, faxes, pagers, and other telephone-based products and services is rapidly exhausting the supply of three-digit area codes.

In 1984 a total of 125 area codes were in use. As of June 1, 1999, there were 215 active NPAs in the United States alone, with more than 50 additional International and Service codes in use. California alone is expected to have 41 area codes in 2002, up from just 13 in 1992. Nationwide, almost 70 new area codes are expected to go into service by the end of next year. Some demand estimates project that all 680 usable area codes could be assigned within ten years.

1996	11	150
1997	32	182
1998	24	206
1999 (planned)	31	237
2000 (planned)	37	274

In 1947, AT&T established the current ten-digit numbering scheme, termed North American Numbering Plan (NANP), with each telephone number made up of three parts. The first three digits are the Numbering Plan Area (NPA), otherwise known as the area code, which identifies the geographic region in which the subscriber resides. The second set of three digits is the exchange, which specifies the telephone company central office handling the subscriber. The last four numbers identify the line serving the subscriber.

(828) 837 - 9200
NPA Exchange Line

This plan worked well for half a century, when most homes had only one telephone and a single telephone company served the entire country. The introduction of cellular telephone companies in the 1980s and competitive local exchange carriers (CLECs) in the 1990s have repeatedly exhausted NPAs and made area code splits and overlays commonplace.

With the Telecommunications Act of 1996 Congress gave the FCC jurisdiction over area codes. The FCC, in turn, has delegated to the states decisions about when and how to introduce new area codes. Area codes themselves are assigned and managed by an independent group called the North American Numbering Plan Administrator.

Each NPA has 792 possible exchanges, since exchanges cannot start with a zero or a one, or end in 11. Telephone companies are assigned one or more exchanges, with each exchange having 10,000 possible line numbers.

NPAs are exhausted when all of the 792 exchanges are assigned to a telephone company, *not* when each exchange has run out of their 10,000 lines. Most exchanges have thousands of lines that are not in use, but because of the way current telephone switches are designed, these idle lines cannot be used by a different telephone company.

U.S. NPAS IN SERVICE

Year	New	NPAs
1990		115
1991	4	119
1992	4	123
1993	2	125
1994	1	126
1995	13	139

There are two options when an NPA is exhausted. The NPA may undergo a geographic split, where the physical service area is divided into two or three smaller pieces and each piece is assigned a different area code. One piece keeps the original area code, and everyone in the other areas has to get new stationery and business cards.

The other option is called an overlay, where existing customers within the NPA keep their original area code but new customers receive numbers in a new NPA. This requires every caller to always dial ten digits, even if the destination is right next door. At present the entire state of Maryland and cities in Colorado, Florida, Georgia, and Texas have 10 digit dialing. Some cities in California and Pennsylvania are transitioning to 10 digit dialing.

In the near term, several options are being debated to ease NPA exhaustion. The most promising is a technique called Number Pooling, in which telephone companies receive numbers in blocks smaller than 10,000. This requires significant computer software changes in telephone switches, but promises to greatly increase the efficiency of existing exchanges.

If we do eventually run out of area codes, one or more digits may have to be added to every telephone number. Such a change could cost upwards of \$150 billion and take a decade to complete.

■ New Spectrum Allocation

As covered in earlier *PCS Frontline* columns, the FCC is under a mandate from Congress to auction parts of the radio spectrum. The latest block of frequencies to come under scrutiny are the UHF television channels 60 through 69, between 746 MHz and 809 MHz. Under their NPRM process, the FCC is seeking comment on what services should be allowed in this band and how to segment and license the blocks.

The FCC has tentatively set aside two blocks of 12 MHz for public safety use, and suggested the two remaining blocks of 18 MHz be paired for two-way wireless communication similar to PCS, cellular, and Specialized Mobile Radio (SMR). They have left open the possibility for the band to be used for some kind of broadcasting as the existing television station owners transition to digital TV service.

Frequency Band	UHF Channels	Bandwidth	Type of Service
746 MHz to 764 MHz	60, 61, 62	18 MHz	Commercial
764 MHz to 776 MHz	63, 64	12 MHz	Public Safety
776 MHz to 794 MHz	65, 66, 67	18 MHz	Commercial
794 MHz to 806 MHz	68, 69	12 MHz	Public Safety

746 MHz to 806 MHz Band Plan

	746 MHz	764	776	794	806					
Old TV	60	61	62	63	64	65	66	67	68	69
New	C			PS		C			PS	

C = Commercial
PS = Public Safety

If you're in the market for a new scanner, keep in mind the public safety blocks in this band could soon be carrying police, fire, and medical radio traffic, so look for either a full-coverage receiver or one that covers 764 MHz to 806 MHz.

■ Global System for Mobiles

Wireless providers in the United States using the Global System for Mobiles (GSM) standard got some good news and some bad news earlier this year. The good news is that GSM will gain coverage in several major cities over the next year or two. In April of this year the FCC completed the reaction for C block PCS licenses, and GSM operator Cook Inlet/VoiceStream PCS had the high bid for Chicago, Dallas, Omaha, and several other cities in Illinois, Texas, Arizona and Louisiana. Other cities added by GSM operators include Detroit, St. Louis, Buffalo, Rochester, and Cleveland, bringing GSM to 98 of the top 100 markets.

There are more than 3.6 million GSM customers in the United States, with 600,000 added in the first quarter of 1999.

All told, the 17 day auction (number 22 for the FCC) sold 302 licenses and raised a total of almost \$413 million in bids for the U.S. Treasury.

As for the bad news, GSM is losing coverage in the 10th largest market in the country. Sprint Spectrum, the first PCS operator in the United States and profiled in the October 1996 *PCS Frontline*, is shutting down.

American Personal Communications started Sprint Spectrum in the Washington, D.C., and Baltimore, Maryland, area in November 1995, partnered with Sprint. Sprint PCS subsequently bought out APC in January 1998 and extended their nationwide Code Division Multiple Access (CDMA) network to the area two months later.

Rather than continue to operate two rival

and incompatible networks in the same market, all 100,000 Spectrum customers will be transitioned to Sprint PCS by November 1999. The GSM network infrastructure will be shut down soon afterward.

Sprint PCS has 3.35 million customers, having added 763,000 in the first quarter of 1999.

Nextel, the Specialized Mobile Radio (SMR) carrier, added 415,000 customers in the same period, bringing their customer total to more than 3 million. AT&T Wireless reported 378,000 new customers, with more than one million Digital OneRate and 10 million total subscribers.

That's all for this time around. More information is available on my website at <http://www.decode.com>, including updates on the Iridium, Globalstar, and Orbcomm satellite constellations. I welcome electronic mail at dan@decode.com. Until next time, happy monitoring!

GORDON WEST HAM TEST PREP TAPES BOOKS • SOFTWARE • VIDEOS

Prepare for your ham test with "Gordo" WB6NOA as your personal instructor.

- **THE THEORY** on audio cassettes
 - No-Code Technician (4 tapes) ... **\$19.95**
 - General Class (2 tapes) **\$ 9.95**
 - Advanced Class (4 tapes) **\$19.95**
 - Amateur Extra Class (4 tapes) **\$19.95**
- **THE CODE** on audio cassettes
 - Learning CW (6 tapes) **\$29.95**
 - General Class CW (6 tapes) **\$29.95**
 - Extra Class CW (6 tapes) **\$29.95**

Add \$3.00 shipping charge - 3 Day Service
VISA, MasterCard, Discover & AMEX Accepted

The W5YI Group, Inc.
P.O. Box 565101 • Dallas, TX 75356

Call Toll Free **1-800-669-9594**

Tools and Techniques for the Experimenter

Precision tools and high falutin' test equipment cost a fortune, but I'm not sure there is a correlation between results and costs. Over the years, my mainstay tools consisted of chewing gum, earwax, fingernail clippers, string, and screwdrivers. This article is for serious experimenters on a budget.

The digital age reduces requirements for costly analog equipment like scopes, signal generators, etc. Digital technology affords acceptable results in less time at lower cost. Experimenting in radio is easier than ever.

■ The Workbench

It starts with an ample workbench, preferably not the heirloom dining table. Our workbench should handle spills of glue, coffee, mustard, jelly, chemicals, and nuclear materials without disturbing the domestic tranquility.

My favored bench is homemade (cheap), 8 ft. long by 30 in. wide by 40 in. high, with a frame of 2x4s and a surface of 3/4 inch plywood, covered with a fine-weave carpet strip. See Figure 1. An 8 ft. by 30 in. sheet of masonite or smooth paneling can supplant the carpet, if desired. A dark surface minimizes annoying glare from overhead lighting.

If the bench will be in the garage, the back of it can be nailed to wall studs, to eliminate rear legs. 2x4s are fine for the front legs. This bench easily supports two to three hundred pounds.

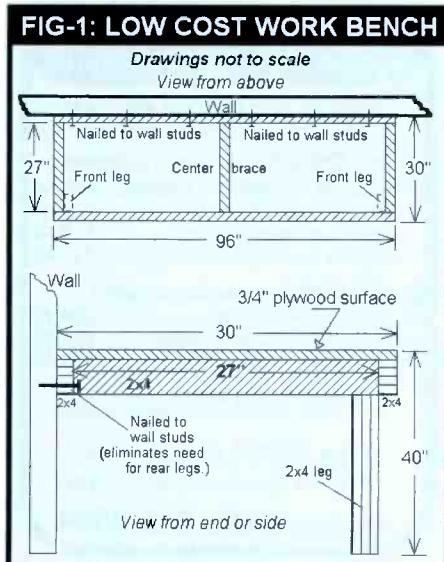

If the bench won't be attached to a wall, then use five 4x4s for the legs; one in each corner, and one in the middle along the back edge to afford plenty of leg room and still be sturdy. Don't nail the legs to the frame. Instead, drill a deep 1/4-inch pilot hole and screw a 5-inch lag bolt (with a 1 in. washer) through the 2x4 frame into each 4x4 leg.

Size isn't critical, if it's large enough, but height deserves attention! My least favorite bench is 30 inches high (office chair height.) I prefer 40 in. because I can work at it while standing, or pull up a barstool as needed.

■ Stocking the Bench

A productive workbench resembles a hardware store, stocked with tools, equipment, materials, and supplies. Table 1 lists ideas for selected materials and supplies for the innovative experimenter. This list is neither complete nor inclusive. Add to and delete from it to suit your tastes.

TABLE 1: BENCH SUPPLIES	
ADHESIVES	METAL & PLASTIC WORK
Super glue	Nibbling tool
Epoxy: 5-min	Files: flat, rattrail, jeweler
Epoxy: regular	Emory cloth & sandpapers
Silicone rubber	100 to 1000 grits
Spray adhesive	Steel wool: coarse & fine
Hot glue gun; glue sticks	Tin snips: small
SOLVENTS/LUBES/COATINGS	Kacto knife & blades
Alcohol, isopropyl	Benttop scroll saw
Naphtha (lighter fluid)	Oreml Moto-tool & bits
Acetone	Oreml drill press stand
Machine oil (3in1)	3/8" drill & bits
Light lubricant (WD-40)	Brushes: wire, bristle, etc.
Fingernail polish, clear	Propane torch
Fingernail polish, red	POWER
FASTENERS	Power supplies:
Hook 'n Loop (Velcro)	Variable 0-18v, 2 ea
Nuts, bolts & screws	Fixed: 5v/8v/12v
Electrical tapes in colors	Batteries, ass't
MISCELLANEOUS	Battery holders: various
Breadboards: 2 or 3	VISION AIDS
Perfboard	Flourescent shop light
Pinline sockets	Swing-arm lamp
Magnets, ass't	Mini-Mag flashlight
Popsicle or corndog sticks	Magnifiers, various
Cotton swabs	Head-worn magnifier
Cotton rags	Magnifying lens
Heat shrink tubing	Microscope, handheld
Cork: sheet or mat	Jeweler's loupe
	Microscope: pocket; 30x

■ Equipment

A digital volt-ohm meter is vital. I won't rehash meters, but Radio Shack's "PC Interface Digital Multimeter," #22-168, is a "best value."

Probably out of habit, I wouldn't be caught dead lacking a frequency counter, but I hardly ever use 'em anymore. If you just have to have one, the above "PC Interface Digital Multim-

eter" has a 20 MHz counter built in. If that's not good enough, then Radio Shack's #22-306 might do. Otherwise, check out Optoelectronics, Startek, GoldStar, and B+K Precision.

Oscilloscopes are like frequency counters; I wouldn't be without one, but it's rarely used. Don't spend the money without first trying Radio Shack's \$100 "ProbeScope," #RSU11910486. If you use it more than occasionally, then a \$500-\$1500 bench scope might be justified. Consult your shrink first.

Signal generators? Mine gather dust. Signals on the airwaves can be used for the same purpose.

Spectrum analyzers? The better part of a year's wages might buy a used one. After the novelty wears off, it'll make a great conversation piece. Forget it. Besides, you already have an S/A that I'll be telling you about.

Etc, etc, etc ... the experimenter bench needs almost none of this stuff - just a decent volt-ohm meter (or two), a few power supplies, and a spare scanner will do. A scanner?! Well, sure, a scanner is a frequency counter, signal generator, and spectrum analyzer, all in one low priced package. Certain receivers like WiNRADiO and the Icom PCR-1000 also come with spectrum analysis software, but that's icing on the cake.

So long as you have a multimeter, a spare scanner, and DC power, then the remaining requisite is (what else?) a personal computer. Many bench applications are well served by 486 or 386 machines, but Pentium 133/up is preferred. A host of DOS and Windows software is available to make a PC perform most any task, limited only by the imagination. Properly equipped with a spare serial port or two and perhaps an add-on analog-to-digital (A/D) converter board, there just isn't much a PC can't do ... at much lower cost. That's why the bench probably doesn't need more sophistication than a multimeter and a scanner.

■ Test Equipment Idea

A spare scanner radio can serve as a signal generator. Scanners have at least two digitally tuned local oscillators. Find those oscillators; trace their paths to the receiver's mixers; and then tap the mixer inputs to output jacks on the case of the scanner. Figure 2 illustrates the concept. You'll have to study the VCO/PLLMixer design to determine the frequency ranges, but that will come.

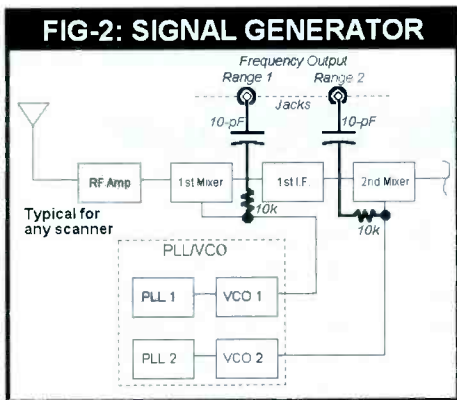

Then, with any given frequency programmed into the scanner, there are at least two stable, accurate output frequencies; in effect, a programmable signal generator.

Caveat: tapping the mixer inputs will almost certainly affect the operation of the scanner, so don't do this to your main/favorite monitoring radio. Start with an old surplus rig that's seen better days.

After you understand the processes, you can build (cheap) digital add-on circuits to divide or multiply frequencies to get whole new ranges of frequencies. A scanner can be the sophisticated heart and brains of homebrewed test equipment.

Tools

Page 167 of Radio Shack's 1999 Catalog is a good reference for a variety of electronic hand tools. Here, we'll look at some esoteric tools that can spell a difference. My favorites include a dental plaque chisel; hemostats; and short-nosed scissors, all made of stainless steel. Figure 3 shows these gems that can be ordered from dental supply companies.

The plaque chisel is indispensable for precise gouging and cutting work on circuit boards, plastics, and even soft metals. Hemostats are standard, except this pair is small, but heavy duty. I've never seen anything like the scissors

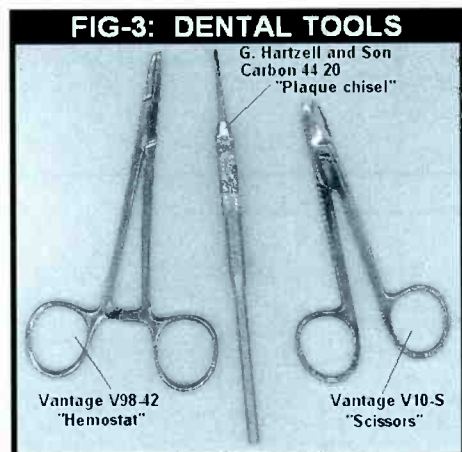

— they cut everything from stout wire to thin gauge sheet metal like shielding compartments in radios.

Another of my favorites is a tool for measuring wire diameters in the American Standard Wire Gauge. Mine's over 30 years old. I forgot the source, but it's a steel disk, about 3-1/4 in. dia., with 37 calibrated slots around the circumference to measure AWG wire gauges, from 0 to 36 (0.325" to 0.005"). I use mine less for wire and more to measure thickness and diameter of materials. (My desk notepaper is 0.0056" thick.) Yes, I know, a micrometer caliper does it "better." But a good caliper is expensive. A wire gauge and a companion spark plug gap gauge serve most purposes.

First acquired as a "science toy," my pocket laser pointer pen became an awesome tool. It's a superb indicator of "flatness" of materials. Positioned from the side, the bright red streak directed across a surface, makes high and low areas obvious. Even minuscule dust particles stand out like sore thumbs when illuminated from the side by laser light. A laser pointer establishes straight lines between two points, whether on a circuit board or across the neighborhood.

A cordless power screwdriver sweetens the experimenter's life. Assortments of flatblade; Phillips; Allen; and star drivers are a must, as are a 1/4 in. drive shaft and set of 1/4 in. hex sockets, especially the smaller sizes. Likewise, a set of drill bits with a smattering of sizes between 0.04 in. and 3/8 in. is mandatory.

Xacto knives, scalpels, and other precision cutting edges can be kept razor-sharp with honing steels, especially the kind impregnated with diamond dust. I keep my dental plaque chisel so sharp that it can trim a fat solder joint or even cut a wire stub with only a gentle downward pressure. It can scrape the ink off a magazine page without damaging the paper. Sharpness is important to the experimenter.

Tips & Techniques

Simple ideas go a long way. Clear fingernail polish is a good sealer for lettering on circuit boards and chassis. It is also a good insulator or barrier between two bare wires or solder joints. Colored fingernail polish is perfect for polarity markings, wire IDs, etc. Never buy fingernail polish, though. The ladies of your domicile regularly throw out half full bottles. Don't ask why — just beg for their castoffs and keep a supply on the bench.

A sharp chisel-blade Xacto knife can trim melted and drilled plastic surfaces to near-original condition.

Did you know that 1-cc of water weighs exactly 1 gram? A precision balance can be made from jar or tin can lids, string, and scraps

of wood. Plastic syringes and other cheap volumetric devices can measure out calibrated amounts of water on one side of a balance to closely approximate the weight of an unknown object on the other side. Accuracies to +/- 0.1g (0.0035 oz) are readily possible.

A hot-glue gun is indispensable. Actually, the substance is a melted plastic that acts like glue, but is easier to remove and yet bonds well to most surfaces. I use it for "injection plastic"; cable "ties"; PC board bindings; crack and hole sealant; and a hundred other things. The guns and glue sticks come in at least two sizes (0.5 in. and 0.3 in.), but the smaller is preferred for most applications.

Hot glue and pinline sockets make great custom plugs and sockets. Try finding a mini 13-pin mating plug and socket with wire bundle lengths to meet your exact needs! Make your own with pinline sockets and hot glue. Figure 4 shows how pinline strips can hold a mini-circuit and conveniently plug into a mating socket strip. After the circuit proves up, seal it in hot glue for a high-reliability molded plug or socket!

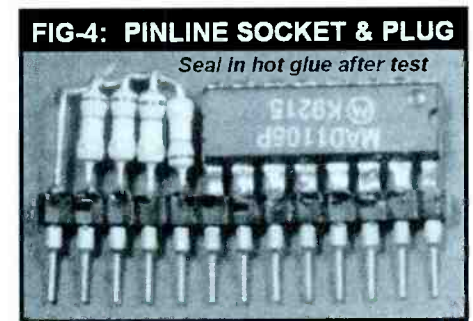

Conclusion

This article was intended to arouse your creative juices. Now share your ideas with me and we'll expound on some in coming articles. It really is possible to create great things out of almost nothing.

Please note my new permanent e-mail and web addresses. Support for this and all my columns is freely available by e-mail. If you're not computerized, please include an SASE with postal requests.

E-mail: bccheek@comtronics.net
 WWW: <http://www.comtronics.net>
 FAX: (619) 578-9247
 Postal: PO Box 262478; San Diego, CA 92196-2478

Caveat: Modification may void your warranty or FCC certification.

Antennas Specifically Designed for Reception

In working with antennas it is useful to know about the principle of antenna reciprocity. In practical terms this principle says that *an antenna tends to behave similarly whether it is utilized for transmitting or for reception*. Thus the patterning of an antenna's responsiveness for reception is the same as its patterning of transmitted signal strength. Other variables such as its gain and its feedpoint impedance are also the same for transmitting or reception. In fact, many two-way radio stations utilize the same antenna for both reception and transmission.

It is desirable that an antenna used for receiving present us with maximum signal output from the desired station and a minimum of received noise. On the other hand, many antennas used for transmitting must handle much higher power levels than those handled by receive-only antennas. Transmitting antennas should also have characteristics which help put a useful level of signal strength into the desired distant antenna. Nor should they waste signal energy by radiating it in directions where no communication is desired.

Thus, despite the fact that one antenna often serves well for both transmitting and receiving, receiving antennas have different jobs to do than do transmitting antennas. In fact, we may find that some antennas which would not satisfy the requirements for a good transmitting antenna may yet be excellent receiving antennas. With this in mind let's check out some receive-only antenna designs.

■ The Beverage Antenna

The Beverage (fig. 1A) is a very directional, low-gain (i.e., low responsiveness to signals) antenna which is useful at frequencies up to the lower portion of the high-frequency band. This antenna is known as a top performer when digging signals out of noise and interference.

Its secret is that it is so directional that noise and interference coming from directions other than that of the desired signal produce very little output from the antenna. Unless there is significant noise coming from the same direction as the desired signal, the antenna's sharp directivity leaves the signal relatively in the clear. Because you hear mainly the desired signal, the antenna's low gain is sufficient to provide good reception. Technically, this means that this antenna furnishes your receiver with a very favorable signal-to-noise ratio (S/N).

One down side of the Beverage is that it must be quite long – at least a significant fraction of a wavelength and preferably a few wavelengths long. This ranges from a few hundred feet on HF to *miles* on the LF and lower bands. Unfortunately, most of us don't have the real estate needed to erect this excellent receiving antenna.

Another problem in using this antenna is that it is useful only in the two directions in which the wire ends point, or, for the terminated design, *one* of those directions (fig. 1B).

But if you do have the time, money and real estate needed to put a Beverage into use – plus the need for a long-term, dedicated-direction receiving antenna – then the Beverage can be a good choice. *The longer the better* is a general rule for this antenna, although some writers give maximum lengths as short as two wavelengths.

The antenna should be about 5 to 15 or so feet above the ground, but some report good results from Beverages laid directly on the ground.

Run the antenna in a line directly toward, or away from, the station you want to receive. Left unterminated the antenna will be directional directly off either end in the directions the wire runs (bidirectional). If terminated with a resistor as in fig. 1B, then the antenna will be unidirectional as shown.

Typical terminating-resistor values vary from perhaps 300 ohms to 1000 ohms. The resistance value for your particular antenna can be determined by tuning in a signal from the undesired direction (opposite the arrow in fig. 1B) and varying the termination resistance for minimum signal from the undesired station.

■ Table-Top Antennas

Resonant, table-top, loop antennas are almost legendary among AM broadcast band DXers for their ability to pull a desired signal out of noise and interference. Like the Bever-

FIG. 1. A bidirectional Beverage antenna (A), a unidirectional Beverage antenna (B).

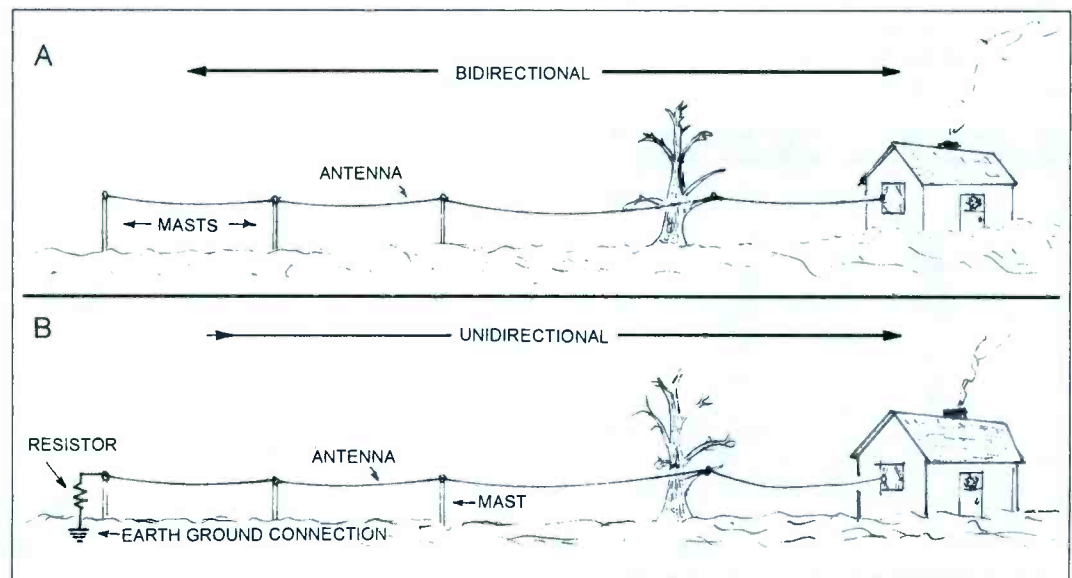

age antenna they have very low gain and depend on their favorable S/N for their popularity.

The low gain of table-top antennas such as loops and whips can be compensated for, to a degree, by adding a preamplifier and thus making them into "active antennas." On the down side we then risk the problems of intermod and desensitization in the presence of excessively strong signals. On the plus side, active antennas only two to three feet in length can often rival the performance of much longer outdoor antennas. This can be important where space for an antenna is limited.

■ Noise-Canceling Receiving Antennas

The basic idea behind noise-canceling antenna systems usually is to receive the desired signal on one antenna that is so designed and oriented as to respond maximally to the desired signal. Of course this antenna will also pick up some undesired noise. A second antenna is differently oriented and designed such that it will respond well to the noise, but not particularly well to the desired signal.

Hopefully then, the output from the noise antenna can be combined with the output of the signal antenna such that the noise signals from the two antennas are out of phase and will cancel each other. This leaves the desired signal somewhat in the clear.

These antennas are effective in some situations, but are infrequently covered in the literature. JPS Communications, P. O. Box 97757, Raleigh, NC, 27642-7757 manufactures an "Antenna Noise Canceler" unit which uses the noise antenna design. However, an announcement in last month's What's New? column indicates JPS is going out of the hobby radio business, so these may not be available much longer.

■ Radio Direction Finding Antennas

In general, radio direction finding (RDF) antennas are designed as receive-only antennas. One reason for this is that often the gain of RDF antennas is quite low. Also, their best direction-indicating precision is generally achieved by orienting them to the minimum signal (null) rather than to the strongest reception possible.

Due to this, if an RDF antenna is tuned for a precise direction indication in reception, it is tuned to the minimum signal; reciprocity tells us that if the antenna is then used for transmitting, it would send a *minimum* of signal to the station being monitored.

As recently discussed in my May column, null-oriented RDF antenna designs include the open-frame loop, loop plus sense-antenna, the goniometer, and the Adcock open-loop.

● RADIO RIDDLES ●

■ Last Month:

Last month I asked: "OK, so a repeater can be made from a piece of wire, but can an antenna be made from a piece of insulator?"

The answer is "yes." We have what are called "dielectric antennas" which utilize a piece of dielectric (an insulator) shaped as a lens or prism to collect and direct microwaves to the metal receiving element of the antenna (e.g., a satellite dish).

OK, so maybe I'm stretching it a bit; the antenna is not *all* insulator, just partly. By the way, there are also lenses made of metal which are used with microwave antennas to focus the received energy onto the receiving element of the antenna.

■ This Month:

Why is an antenna like the Beverage, which performs so well for reception, not also used for transmitting? Or is it? Or does it perhaps violate the principle of reciprocity?

You'll find an answer for this month's riddle, and much more, in next month's issue of *Monitoring Times*. Til then Peace, DX, 73



WORLD UTILITY NETWORK (WUN) FREQUENCY GUIDE ON CD-ROM!

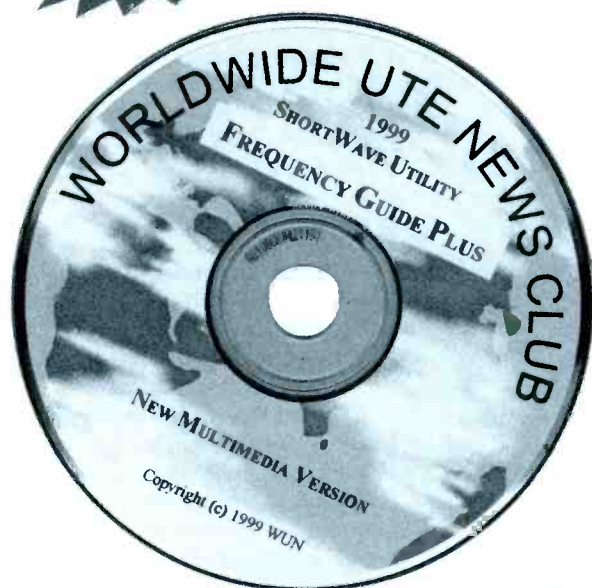

This information-packed CD is a bonanza for the shortwave utility listener! Offering over 30,000 current (1995-1999) frequency loggings up to 30 MHz, and includes past issues of Speedx and WUN newsletters, even hundreds of WAV files, digital mode samples, text pages and graphics, and much more!

The agile frequency database allows searching by several different keys—fast! Works on Windows 95, 98, and NT, and is mirrored in html for Internet browsers without Windows.

ORDER SFT 21 **Only \$28⁹⁵**

**Call Grove
Today to
Order!**

GROVE

Grove Enterprises, Inc.

7540 Highway 64 West, Brasstown, N.C. 28902

(800) 438-8155 US & Can.; (828) 837-9200

Fax (828) 837-2216

e-mail: order@grove-ent.com

World Wide Web: www.grove-ent.com

Is It High Enough?

Nearly every radio enthusiast asks the question, "Is my antenna high enough?" Depending on several factors, that query can have many answers.

Too often the poor novice is told "it is never high enough!" However, there are limits to everything, and in any antenna situation there are several factors that come into play.

■ Frequency

If your major interest is VHF, then higher is almost always better. VHF and higher frequencies are generally considered line of sight, (i.e., range is as far as the antennas of two communicating stations can see each other). Actually, though, the range will be a bit farther than optical line of sight.

The VHF/UHF ham living in a valley surrounded by high mountains is truly in a bad way because these higher frequencies react to solid structures very much like rays of light in that they are easily reflected and blocked by high surrounding structures or hills; consequently, range will be very limited unless the antenna can be elevated above the blocking obstruction.

But, as the antenna goes higher, the feed line becomes longer and losses in the feed line can result in few audible signals. To counter this, there are low loss feed lines available; however, as feed line loss goes down, cost goes up. A second solution to the problem of loss is to use open wire feed lines. Unfortunately, most hams do not want the added complication of transforming the high impedance of open wire lines to the 50 ohms required by their modern rigs.

So you can see that in many instances the cost of increasing the height and gain of an antenna and maintaining low transmission line losses can result in considerable cash outlay to the ham, and may not be worth the effort.

■ Medium to High Frequencies

The antenna books tell us that to get optimum results from an antenna at medium to high frequencies the antenna must be at least one half wavelength above ground. At 160 meters that comes out to 260 feet! Or in the case of a 40 meter antenna (perhaps the most popular band) that

height will be 66 feet, still a considerable distance above ground for the average ham.

The books are talking about obtaining a pattern from a dipole with maximum lobes in two directions (at right angles to the plane of the antenna). If our dipole is lower than one half wavelength then the pattern will be distorted (usually becoming omnidirectional). However, the antenna will still be useful for communications to some degree at any height above ground.

Of course, if we consider a vertical antenna at these frequencies, with its base at ground level, the antenna will function satisfactorily in most cases. Ground losses can play a big part in how a vertical antenna functions; consequently, a good radial ground system is extremely helpful when using this type of antenna. Elevating a vertical just a few feet above ground will improve performance and require far fewer radials.

At medium/high frequency the wave front being radiated is much larger than at VHF/UHF with the result that surrounding objects will have less effect on the antenna. In fact, at times low antennas at these frequencies work extremely well. One example of a very low antenna working in an exceptional manner is the case of W2EQS(SK) Charles O'Brien who had a 160 meter dipole at only 20 feet above ground and worked well over 100 countries on that band. I had a similar experience when as a Novice I had to use my mother's wash line as an antenna. Even though it was only 50 feet long and six feet above ground I was able to work hams all over the USA on 80 meters.

On these frequencies, line losses are not a

significant factor and inexpensive coax or ordinary lamp cord will prove satisfactory up to 20 meters or so.

In any case the important thing to remember is that the antenna must be properly matched to the transmitter. A transmatch will allow operation on all bands from 160 through ten meter with almost any antenna. Transmatches are available for VHF operation, too.

■ To Sum It Up

At VHF and above it is very important to elevate the antenna above nearby surrounding objects and minimize line loss for satisfactory communication. The MF/HF operator need not be overly concerned if optimum height cannot be achieved, as adequate performance can be realized even at low heights above ground.

In general, it is best to try something than to sit and worry about it. Yes, even if it is putting up a two meter antenna at five feet, you might be surprised; at least you will be operating within the parameters of the ham radio spirit!

■ Activity

So far this summer has been disappointing to me as far as VHF openings go. There were a few E^s openings to the midwest in mid May, but activity was scarce on two meters. Six fared a little better with one opening to the West Coast and several into Central America.

The HF bands are doing quite well and DX is becoming more regular on 15, 12 and 10 meters. Activity on 80 through 20 has been very high in spite of summer noise and a lot of DX is being worked on 40 meters.

■ Special Event Stations

Some time back I mentioned working for WAS (worked all states) by contacting special event stations. My goal of 50 states is very close, with only Alaska, Hawaii, Idaho, Utah and Nevada missing from my QSL collection. I might mention, that working special event stations is a very interesting past time, as many of their QSL cards or certificates provide information about the event and allow us to take a peek at a historic or social event with a little better understanding.



GMRS Rule Changes Opening doors raises a furor

On February 12, 1999, the Federal Communications Commission issued a series of changes to the rules that govern the General Mobile Radio Service (GMRS). FCC rules state that "GMRS is a land mobile radio service available to persons for short-distance two-way communications to facilitate the activities of licensees and their immediate family members."

GMRS allows communications with up to 50 watts transmitter power through repeaters on the following repeater pairs (the output channels may also be used for simplex communications):

Chan	Input MHz	Output MHz
1	467.550	462.550
2	467.575	462.575
3	467.600	462.600
4	467.625	462.625
5	467.650	462.650
6	467.675	462.675
7	467.700	462.700
8	467.725	462.725

In addition, GMRS also allows simplex communications with up to 5 watts power on the following frequencies, which are the same as Family Radio Service Channels 1-7:

Chan	Simplex MHz
1	462.5625
2	462.5875
3	462.6125
4	462.6375
5	462.6625
6	462.6875
7	462.7125

The new rules make three big changes (and a number of small ones) to GMRS, and both REACT (Radio Emergency Associated Communications Teams) International and PRSG (Personal Radio Steering Group), the national advocacy organization for personal licensees in the General Mobile Radio Service, have objected strenuously to at least a couple of them.

Corwyn Moore, administrator of the PRSG, says "the FCC has dismantled rules that kept GMRS from becoming a complete garbage band. When these matters were brought to the attention of the FCC, they didn't care." REACT calls the rule changes "a serious threat to providing help by radio."

Points of Protest

First (in rising order of controversy), the restriction on base-to-base communication has been lifted. Previously communication was only allowed from mobile-to-mobile or from base-to-mobile. Corwyn Moore feels that lifting this restriction will make it easier for GMRS to become more like what 11-meter Citizens Band is today.

Second, another rule change allows any GMRS licensee to operate on any GMRS repeater. Previously, with eight channel pairs to choose from, users could ask for two that would be assigned to them. By the old rules, you could also use the 462/467.675 repeater pair for emergencies and travelers assistance without being specifically licensed for that pair of frequencies.

Both REACT and PRSG expressed concern that indiscriminate use of repeaters for which no permission had been granted could result in repeaters being taken off the air.

Finally, another change made to the rules appears to restrict the use of the 462/467.675 repeater pair to emergency and travelers assistance only.

Previously, Part 95.29e of the FCC rules stated:

e) Mobile stations in a GMRS system licensed to an individual that is not specifically authorized for the 462.675 MHz/467.675 MHz channel pair may transmit on that channel pair with the following limitations:

- (1) The communications must be for the purpose of soliciting or rendering assistance to a traveler, or for communicating in an emergency pertaining to the immediate safety of life or the immediate protection of property; and
- (2) The frequency 467.675 MHz may be used only for the purpose of accessing and communicating through a mobile relay station transmitting on 462.675 MHz.

The new rule, however, states:

(e) Mobile stations in a GMRS system licensed to an individual are authorized to transmit on the 462.6750 MHz/467.6750 MHz channel pair with the following limitations:

- (1) [No change.]

(2) The frequency 467.675 MHz may be used only for the purposes of accessing and communicating through a repeater station transmitting on 462.675 MHz.

Mixed Messages

The change leaves many REACT teams wondering whether they can use the repeaters on this frequency pair for personal and team business. W. Robert Stone, REACT Chairman of the Board said, "Some teams even anticipate changing their .675 repeater to another frequency since they cannot afford to maintain one for .675 and another for personal communications. This would leave less chance, not more, of an answer for emergencies and travelers assistance than the FCC envisioned in their docket. It would also go contrary to the REACT idea of making emergency frequencies more usable for the public."

William Cross, program analyst for the FCC's Wireless Telecommunications Bureau, says, "The Commission's position is that we granted the users what they asked for, and now it seems what they asked for had unintended consequences."

Various users have asked the FCC to clarify its position, and this may be done in the near future.

Regardless of the outcome, the recent rule changes have made GMRS more attractive than ever before. For those who have experienced the convenience and crystal clear sound of Family Radio Service transceivers (which operate in the same frequency range), with or without repeaters, GMRS offers the potential of more range for personal and family communications.

Current GMRS license fees are \$75 for five years. To find out more about getting your license, phone 1-888-CALL-FCC. For additional information about GMRS, visit PRSG's website at www.provide.net/~prsg.

FLASH — as this issue was going to press, the FCC restored non-emergency use on the 462/467.675 repeater pair.

Seeing is Believing with VisualRadio

Let's continue with the new crop of programs aimed at radio monitoring. Last month it was RadioCom, a do-it-all program that almost makes existing monitoring software look like stone-age tools by comparison. Using all the capabilities of Windows 95/98 and fast Pentium processors, we saw RadioCom do everything: radio control, database, signal (digital modes) decoding and more. A very tough act to follow. This month, we'll look at VisualRadio (sorry for the pun) version 3.00.

The program controls many compatible receivers via a PC (they state a 386 as the minimum system, but I strongly suggest a Pentium). To use all its capabilities a sound card is essential. VisualRadio also provides a database with storage and retrieval and various scanning functions. However, today, many programs can provide these same functions. What makes VisualRadio different?

VisualRadio uses a very slick Windows 95 format to do its work, and more. The "more" is a number of graphical presentations of signal frequency, demodulated audio frequency and signal strength versus time. Just check out Figure One for a sample of what VisualRadio can do. The program also provides an audio recorder function which stores the demodulated output, voice, data, etc, on the computer's hard drive.

Seeing What Matters

Let's face it. The reason for most of our monitoring efforts is the modulation; either in the form of data or voice. Seeing what you're listening to adds a fascinating new dimension to monitoring. A few years ago we looked at a program, Audio Spectrum Pro, which displayed a spectrum (amplitude and frequency versus time) of audio feed to the input of the PC's sound card. Naturally, I immediately plugged the audio from my HF receiver into the program and was treated to a show "watching" a RTTY (radioteletype) station.

More recently, we checked out RecAll, which takes the input to the sound cards and stores it as a digital file on a hard drive. Do these functions sound familiar? VisualRadio attempts to combine these audio programs with monitoring control and database software.

VisualRadio can control many receivers:

AOR, Icom, JRC, Kenwood, Optoelectronics (Scout), Racal, R & S, Watkins Johnson, WinRadio and Yaesu. Check their website at <http://ourworld.compuserve.com/homepages/visualradio/> to see the latest models of supported receivers. Some websites state that VisualRadio can control WinRADiOs. After an hour of trying, I found out that it only supports internal, PC card WinRADiOs (1000 and 1500), but not their external versions.

Installation and Copy Protection

The program is supplied on three 3.5 inch high density disks. Installation is fast and easy. However, be aware that the program is copy protected and only allows two installations. This can be a problem when you are constantly upgrading to new computers, which seems to happen every six months in this crazy industry! More on this later.

VisualRadio's Help file is useful and will get you up and monitoring in minutes. The process is simple. First, enter the parameters for the computer/receiver's serial (coms) port interface. Then, select your receiver in the menu "Receiver - Select Receiver...". VisualRadio will create a link between your computer and receiver.

A Very Busy Figure One

The top portion of the screen displays the Control Panel which looks and acts like the front panel of a receiver. The frequency is set by left mouse clicking on the numeric display and typing in the new frequency. The Intelligent tuner function acts as a big old tuning knob controlled by the left mouse button, for down and up, respectively. Mode, squelch and similar functions are set from the panel to the right of the numbers. Using the radio control section of VisualRadio is simple, easy and intuitive.

There are so many different graphs and spectrums that can be displayed that I had a very hard time choosing which to show you. Figure One has lots of interesting information crammed onto one screen. Starting from the right we see a RF spectrum of amplitude versus frequency, that is centered around a NOAA weather station at 162.400 MHz. Below it we can see an amplitude versus time

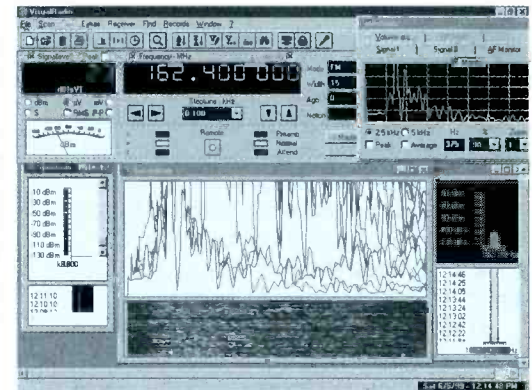

FIGURE 1

analysis. The amplitude is represented by different colors on this graph.

Monitoring: Hearing and Seeing

The large display in the lower center of Figure One is a three dimensional representation of the demodulated audio. Amplitude and frequency components are displayed and move "into" the display with the passing of time. Below it is a "picture" showing a color coded utilization of audio frequencies.

On the extreme left I've set up another frequency/amplitude display. Looking at the graph below we can see an hour:minute:second format. When a signal is present, a colored bar appears next to the time the signal was logged. The bar's color is representative of the signal's strength. This is just one of the very useful automatic time-stamped graphs available in VisualRadio.

Finally, the graph at the upper right gives a simple, instantaneous, amplitude versus frequency display of the demodulated audio, in this case the weatherman's voice. The choice, location and size of each graph is totally controlled by the user.

Due to space limitations, we have only shown a one-screen compacted version of these graphs. In practice, each graph can be viewed one at a time. It is then enlarged and occupies 75% of the screen and displays much more numeric and trace detail. VisualRadio's graphs are invaluable in presenting propagation variation, adjacent channel interference, searching for new stations and add a whole new way of looking at monitoring (that was the last pun, I promise).

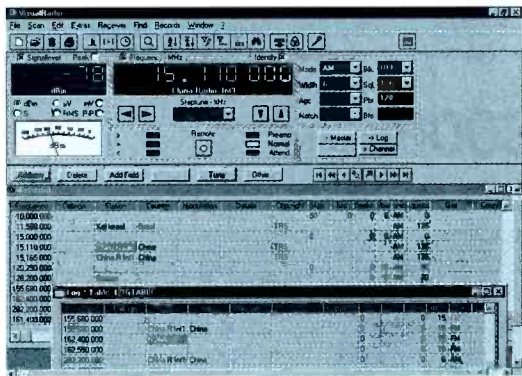

FIGURE 2

■ The Database

This Microsoft Access compatible database has so much promise: Master list, logging features, scanning between frequencies, and storing and scanning stations in “channels.” It’s all there. See Figure Two.

Using the buttons on the right (below the mode and squelch settings) allows you to get into the various base modes. They can also be accessed via one of the buttons near the top of the screen, and via a dropdown menu. Once the database is opened, editing functions are via mouse clicks and keyboard entries.

The number of fields in the database can be easily expanded. This allows users to customize the database to their needs and preferences. Once a station’s name has been entered into the database, it appears below the Control Panel frequency display when the it is selected. At the bottom of Figure Two you can see the open Master and Log files.

VisualRadio has so many different database functions and graphs; and each has so many different methods of access. Can you have too much of a good thing?

■ Using VisualRadio

I spent quite a lot of time with VisualRadio. I tried it on three different computer systems and a number of different radios, including WinRadio, Yaesus and ICOMs; both traditional receiver types and PC-based receivers.

For receivers which are not PC-based, such as Yaesu’s FRG-8800 or ICOM’s R-71, VisualRadio gives you a way into computer-controlled monitoring. Frequency spectrum displays, very helpful for finding signals in a frequency range, will also become available. And, of course, all the audio spectrum functions and presentations are also part of the package. VisualRadio really opens up new capabilities for traditional radio receiver users.

For PC-based receivers, for example WinRadio’s internal 1000 model, VisualRadio’s appeal is its audio spectrum

and recorder functions. The presentation of all functions is slicker on VisualRadio, as compared to the program which comes with the radio. Regardless of which radio I tested, the radio control and interface worked flawlessly.

■ The Recorder: A Great Idea -But

The recorder is a great function to have when you want to capture that special monitoring moment. However, using PC-based radios, I tried VisualRadio on three different computers: an HP Pavilion 3266, a home-made 233 MHz MMX Pentium and a Fujitsu LifeBook 160 MHz MMX Pentium laptop. All were running Windows 95. And, all experienced serious lock-up problems while using the Recorder function.

I emailed the author with my problems and was told “it is a problem with your (my) systems.” Three out of three? I don’t think so. The lock-up didn’t always occur. It seemed to happen at random times. But, in most cases, the only remedy was to restart VisualRadio. In extreme cases, I had to power down the computer. Even the three-fingered salute didn’t work! It seems that VisualRadio is bothered by running certain programs (internet browser, graphics program or MSWord) in the background.

During the times the recorder program was working, it muted the audio while recording. I couldn’t hear what was being recorded. I tried every known mixer setting on all three computers, with the same muted result. Also, I could not get the automatic recording function to work. Sound card installation and control has always been a pain on PCs. It appears that VisualRadio is just having their share of sound card quirks.

■ Summary - It’s a Great First Effort

First, I must say that a lot of time and effort must have gone into the creation of VisualRadio. It is a very ambitious effort. However, for me, the result was too complicated in operation. I must confess that I spent a whole weekend trying to get comfortable with the database mechanics of VisualRadio. In the end, I never did get use to the data entry and retrieval conventions.

I expended more time and effort on VisualRadio than I usually spend on a program. That’s because I believe that VisualRadio is an excellent concept. But, I could not get comfortable with the program and I experienced a number of real hardware problems.

Was it me? Maybe. Was it last month’s

spectacular performance of the do-everything RadioCom program? Perhaps. Was it my computer hardware? Come on – three different computers?! Was it just the PC-based receivers? Mmmm – in most cases, yes. Was it VisualRadio – ?

■ Version 4 is on its Way

VisualRadio is a great concept whose operation needs to be simplified, and it requires a bit more development. To be fair (and I’m *always* fair), VisualRadio version 4.0 was out by the time this column was published. I’m sure a number of these issues will have been resolved. We’ll do an update as soon as I receive it.

VisualRadio 4.0 is available in the USA from Computer International (207 South US-27, St. Johns, MI 48879-1903; <http://computer-international.virtualave.net>) for US\$140. In Europe it is available at 77 pounds sterling (plus shipping) from Simon Collins (simon.collins@cableinet.co.uk), who also provides a number of other programs of interest to radio monitors.

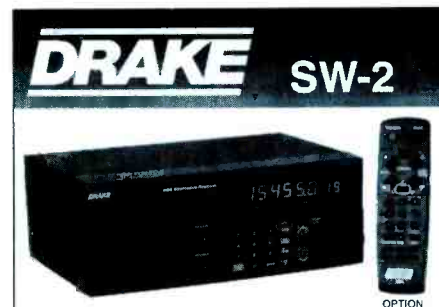

The Drake SW-2 provide continuous coverage from 100 to 30000 kHz in AM, LSB and USB modes. Tuning is easy via manual knob, up-down buttons or 100 memories. The sideband selectable synchronous tuning stabilizes fading signals. Other refinements include: RF gain, tuning bar graphs, huge 100 Hz LED readout, keypad and dimmer. The optional remote (shown) lets you operate this radio from across the room (Order #1589 \$48.95). All Drake receivers are proudly made in Ohio, U.S.A. and feature a one year limited warranty.
Regular Price ~~\$489.95~~ Sale ~~\$399.99~~ (+\$7 UPS)

The Drake SW-1 broadcast receiver also covers 100 to 30000 kHz, but in AM mode only. Features include: 1 kHz LED readout, keypad, RF Gain and 32 memories. Both models operate from 12 VDC or via the supplied AC adapter. A great starter radio!
Regular Price ~~\$249.95~~ Sale ~~\$199.99~~ (+\$7 UPS)

universal radio inc.
Quality Communications Equipment Since 1942

Universal Radio
6830 Americana Pkwy.
Reynoldsburg, OH 43068
◆ Orders: 800 431-3939
◆ Info: 614 866-4267
◆ FAX: 614 866-2339
www.universal-radio.com

Grundig Yacht Boy 300PE

Over the last few years VCRs have dropped in price, PCs have become cheaper and better – even low-tech TVs are now bargains. Yet, while some shortwave prices have moved up or down slightly for individual models, the bottom line is that world band radios cost about the same today as they did in 1995.

Much of the reason may be that world band radio is a niche market, with lower volume and less competition. But part of this is also due to the lack of much in the way of technical change.

Frustrating? You bet, because there would be nothing more welcome than a \$50 radio that performed like the Grundig Yacht Boy 400. Occasionally you hear about radios like these, but never actually come across one. Like Elvis sightings.

■ Many features for price, but SW tuning “hole”

Grundig’s new Yacht Boy 300PE, made attractive by an aluminum-colored paint finish, is no low-cost superstar, either. Yet, it is an attempt to bring decent quality to the under-\$100 range: \$99.95 street, to be exact. Made at a Grundig-controlled plant in China, the 300PE covers FM 87.5-108.1 MHz in 100 kHz or 200 kHz increments (in stereo through the earphone jack), 520-1710 kHz in 10 kHz increments or 522-1620 kHz in 9 kHz increments, and shortwave 2.3-7.3 kHz (SW1) and 9.5-26.1 MHz (SW2) in 5 kHz increments.

An American soldier once quipped that, in a country we won’t name out of respect, there are two types of women: those with teeth and moustaches, and those with no teeth and no moustaches. Similarly, a shortwave radio under \$100 has traditionally been either a decent radio with no accessories and few features, or a terrible radio with many accessories and features.

The 300PE improves upon this: It is a decent radio with a number of useful features and accessories – AC adaptor, batteries, plug-in length of outboard wire antenna, stereo earbuds, padded travel case, 24-hour clock, 10-90 minute sleep delay, elevation panel, travel power lock, illuminated dial, telescopic antenna that swivels and rotates, and a wide range of advanced tuning options.

Indeed, except for a tuning knob this radio has pretty much all you could want in the way of tuning features: keypad tuning, presets, frequency scanning and a meter-band selector button. However, there are some catches.

First, there is an antiquated “SW1/SW2” arrangement that requires pressing a carousel button (MW - SW1 - SW2 - FM) three times before you can

tune from a frequency above 9500 kHz to one below 7300 kHz. Second, there are only six presets for SW1 and another six for SW2 (plus six for FM and six for AM).

Third, the radio mutes for over one second when you tap a slew button to go to the next channel. This may not seem like a lot, but for those of us who do a lot of bandscanning this is definitely annoying. Still, reader feedback suggests this doesn’t bother many listeners.

Another catch is that while the LCD reads out the frequency correctly, it does so in the XX.XX MHz format for even channels, and XX.XX5 MHz format for odd ones. Too, if you key in an even channel in the usual kHz format (e.g., 5 - 9 - 6 - 0 kHz) the radio tunes one channel higher than that, in this example 5965 kHz. As to the LCD, it is designed to be read with good contrast head-on or from below, but loses contrast when viewed from above. The LCD shows the frequency or the time, but not both at the same time, although you can toggle between the two by pressing the mode button.

■ Weak-signal sensitivity highlights performance

As with the vast majority of under-\$100 models, the 300PE is single conversion, and sure enough you’ll find images; that is, strong signals being repeated 900 kHz lower down at reduced strength. However, for a single-conversion model image rejection is rela-



tively decent, although it is nowhere equal to that of almost any double-conversion receiver.

Selectivity, or adjacent-channel rejection, is wide, but acceptable – pretty much on a par with what is found with other models at or near this price point. Ditto audio quality, which is okay but lacking in low-frequency (“bass”) response.

But the 300PE’s real surprise is its superior sensitivity to weak signals. The 300PE does a nice job of receiving daytime signals, which tend to be relatively weak in all parts of the world, as well as weak evening signals which are commonly heard in the American Midwest and West. The FM band is also commendably sensitive to long-distance reception.

Of course, no amount of weak-signal sensitivity can help the 300PE receive stations in the upper end of the 41 meter band above 7300 kHz (although some of these can be tuned, at reduced strength, at the image frequency 900 kHz lower down), or the lower part of 31 meters below 9500 kHz. In the Americas the 40 meter ham band runs from 7000-7300 kHz, so most stations targeting this part of the world operate between 7305 kHz and 7560 kHz, and as shown in the Blue Pages of the 1999 *Passport to World Band Radio* there are a fair number of stations found in the 9350-9495 kHz range, as well.

Bottom line is that the Grundig Yacht Boy 300PE is the long-awaited successor to the now-discontinued Yacht Boy 305, which was

another single-conversion receiver with superior weak-signal sensitivity. For listeners west of the North American east coast – or in such weak-signal places as Hawaii, Alaska and the Caribbean – the 300PE is value priced for newcomers, as gifts or for a second radio.

Lextronix/Grundig and Drake Enter Joint Agreement

A few years back, the idea was raised that it would be mutually beneficial for Grundig and Drake to tie their fortunes together.

After all, the two companies' strengths strongly complement each other. Grundig, through its Lextronix North American affiliate, has been nothing short of masterful in its marketing of world band radios to the general public. Yet, Grundig's engineering has not always been world class.

Drake, on the other hand, has distinguished itself for half a century by turning out legendary products with top-notch engineering at

attractive prices. Yet, Drake has had to fight for sales because its ham-oriented dealer network has been shrinking over the years. Equally, it hasn't been set up to branch out much beyond its niche market.

So, according to Ron Wysong and Esmail Hozour – heads of Drake and Lextronix, respectively – in 1997 Drake and Lextronix quietly entered into a Joint Product Development Agreement to utilize the engineering/R&D talent of Drake, as well as Grundig, in the design and development of various premium receivers for the international world band market. These receivers will be marketed and distributed by Lextronix under the Grundig name.

The first product of this liaison will be the Grundig Satellit 800 Millennium, a beefy \$500 portable reminiscent of the former Grundig Satellit 600/650. Planned for introduction later this year, it reportedly will incorporate such Drake-designed features as synchronous selectable sideband, along with the sort of audio quality traditionally associated with Grundig. Other models, including the long-delayed Satellit 900, are scheduled to follow in due course.

Meanwhile, Drake has been rationalizing

its own product line, with pruning taking place in the lower echelons where Drake receivers might be going head-to-head with better-marketed Grundig receivers made with Drake expertise.

This equipment review is performed independently by Lawrence Magne and his colleagues in accordance with the policies and procedures of International Broadcasting Services, Ltd. It is completely independent of the policies and procedures of Grove Enterprises, Inc., its advertisers and affiliated organizations.

RADIO DATABASE INTERNATIONAL WHITE PAPER® reports contain virtually everything found during exhaustive tests of premium shortwave receivers and outdoor antennas. For a complete list, please send a self-addressed stamped envelope to RDI White Papers, Box 300M, Penn's Park PA 18943 USA; or go to www.passband.com.

RECEIVERS

R75 COMMUNICATIONS RECEIVER!

With the R71 and R72 now long gone, Icom has released their newest communications receiver, the R75! Offering continuous 30 kHz-60 MHz frequency coverage, twin passband tuning, computer compatibility, and all-mode reception (USB/LSB/CW/RTTY/NFM/AM/AM synch), this triple-conversion R75 is hot! Short-wave sensitivity is 0.16 microvolts (SSB), and image/spurious signal rejection is better than 70 dB! Store active frequencies in up to 99 memory channels, and activate the receiver with its clock/timer.

Selectivity is 2.1 kHz (SSB/CW) and 6 kHz (AM), and two optional filters are available. Audio output is a beefy 3 watts, and the receiver is powered either from a 12 VDC system or its AC adaptor (included). A noise blanker, two-level preamplifier, and alphanumeric display are additional perks with this new-generation receiver. An optional DSP unit provides custom sound processing.

ACCESSORIES

ACC 8	UT-102 Voice Synthesizer	\$57.95
ACC 16	UT-106 DSP Unit	\$139.95
ACC 74	CT-17 Level Converter	\$139.95
BRK 23	MB-5 Mobile Mounting Bracket	\$49.95



NEW PRODUCT SPOTLIGHT

ORDER RCV 32 **Only \$799⁹⁵** plus \$18 UPS shipping or US Priority Mail



800-438-8155 (US and Canada); 828-837-9200; 828-837-2216 (Fax)
7540 Hwy 64W; Brasstown, NC 28902
web: www.grove-ent.com; e-mail: order@grove-ent.com

AOR AR16 Portable Scanner

We were impressed with the tiny ICOM IC-R2 wide range scanner we reviewed in April 1999 *MT*. The IC-R2 has a competitor – the new AOR AR16. Termed the Wide Ranger, the AR16 is a shirt pocket portable which tunes 0.5 - 1300 MHz.

■ Simply Powered

Two AA batteries power the AR16 and our radio was furnished with two 1300 mA H NEXcell nickel metal hydride cells. The included Maha MH-C124S charger requires 18 - 22 hours to recharge the NEXcell batteries, but has room for four batteries and can charge older style 600 mA H NiCd cells in 9 - 12 hours. The IC-R2 is furnished with two 700 mA H AA NiCd batteries and a four cell, 7 hour wall charger.

Our AR16 emits a “pop” sound every few seconds in Manual mode. The pop coincides with a split second dip in current consumption, which implicates the battery saver circuit. Measurements indicate that our battery saver does not work.

■ Fundamentals

The AR16 covers the spectrum in 12 selectable step sizes of 1 to 100 kHz. AM, narrow FM, and wide FM detectors are provided.

Neither the IC-R2 nor AR16 has a full numeric keypad, which makes frequency entry a matter of stepping to the proper band, then twisting the VFO knob. The IC-R2’s “tuning accelerator” lets you tune to a frequency faster as you twist the knob faster. Tuning frequencies, especially in the 225 - 400 MHz military air band, takes much longer in the AR16 because it provides no acceleration.

The AR16 forces one to first select the proper band (bank) to tune the VFO. It took us two days to find a way to program 462.975 MHz into the AR16 because the minimalist manual supplied with our radio doesn’t contain a chart of the 25 pairs of band edges. Bob Grove reported the same frustration. The first 20 bands in our AR16 are factory programmed to specialty slivers of the spectrum, e.g., bank 13 was 462.55 - 462.75 MHz. We have to step to bank 23 to tune our first frequency, but how should we have known this?

The AR16 and IC-R2 provide 25 pairs of search limits, but you cannot program the AR16’s search limits without a computer and the proper software!

Frequencies and modes can be stored in 500 memory channels divided among five banks. Compare this to the IC-R2’s array of 400 channels in eight banks. Both the AR16 and IC-R2 permit you to scan only one bank of memory channels at a time. At 19 channels/second, our AR16 scans memory twice as fast as our IC-R2 (see bar graph). The channels may be locked out from the AR16 scan, but that hides them from manual access as well.

The AR16 squelch is automatic – a euphemism meaning you have no control over it. Our AR16 misses weak signals while scanning and, like other models, sometimes locks up on weak carriers we want to ignore. The lack of a squelch control limits our options. Pressing the side-mounted MONI button opens the squelch temporarily, but stops the scanning.

The AR16’s display and keypad are backlit via a timer and can be locked on. The AR16’s conventional volume control knob is easier to use than the IC-R2’s up and down pushbuttons. Using the internal speaker, our IC-R2 provides better audio than our AR16, which isn’t as clear and begins to distort at a lower level.

The IC-R2 has a wonderful CTCSS decoding squelch and tone finder, both features missing from the AR16. Early AR16 advertisements mention a speech descrambler, a feature deleted from the version approved by the FCC for sale to the public (AR16B).

Both the IC-R2 and AR16 memories can be downloaded with a computer by using an optional cable, level converter, and software. The AR16 setup is more powerful because a computer can control the radio. Software developers will appreciate that the AR16 command set is publicly documented on the AOR web page <http://www.aorusa.com>.

■ AR16 vs. IC-R2

If you’ve read this far, you know our



AR16 has shortcomings. On the plus side, our sample AR16 scans faster, has an easy to use volume knob, and can be controlled via computer if equipped with the proper options.

The IC-R2 is smaller, has faster tuning (a major advantage), an adjustable carrier squelch, CTCSS squelch, fewer memory channels per bank, a scan lockout scheme which permits manual channel selection, more rescanned delay options, and a belt clip. Our IC-R2 also has better audio, consumed less current, and has a working battery saver.

Both radios come equipped with similar antennas. The IC-R2 earphone jack is mounted atop the radio – more convenient for shirt pocket use than the AR16’s side mounted jack. The manuals for

AOR AR16 MEASUREMENTS

SERIAL NO. 050101

List price \$299

AOR USA, INC.

20655 S. Western Ave., Suite #112
Torrance, CA 90501

Weight: 5.4 ounces

Dimensions: 2.4 x 4.2 x 1.2 inches

Antenna jack: SMA 50 ohms

Frequency coverage (MHz):

0.5 - 1300 MHz (minus cellular phone bands) in steps of 1, 5, 6.25, 9, 10, 12.5, 15, 20, 25, 50, and 100 kHz.

Modes: AM, FM-N, FM-W

FM sensitivity:

(12 dB SINAD, 1 kHz tone, 3 kHz deviation, see charts)

Modulation acceptance: 8.6 kHz

Practical scan rate (approx.):

19 channels/sec.

Search rate (approx.):

22 steps/sec.

Audio output power (measured at earphone jack):

22 mW @ 10% distortion into 8 ohm load

Current consumption @ 6VDC:

0.4 μ A off

134 mA manual

135 mA scanning

173 mA open squelch, max. volume

30 mA additional for lamp

Battery saver ineffective (see text)

less sensitive

AR16 NFM SENSITIVITY
12 dB SINAD, 3 KHZ DEVIATION, Serial #050101

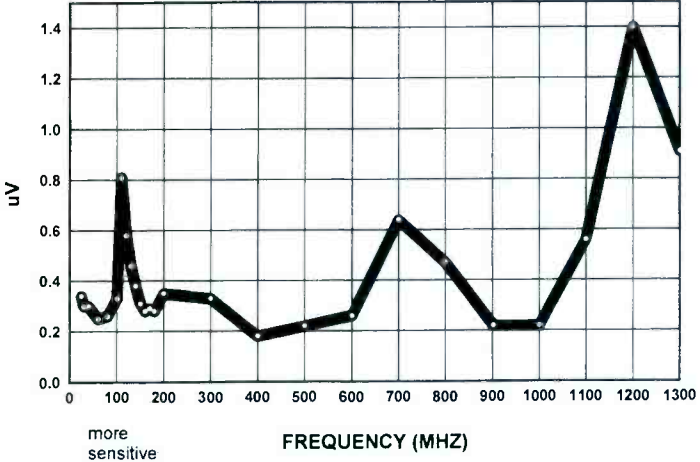

both radios need improvement, especially the AR16 manual that lacks a chart of band edges and an index or table of contents.

Harris RF-590 Receiver

Our mention of the ITT Mackay Marine 3031A premium receiver (April 1999 *MT*) evoked several letters from interested readers. Since writing that column, we obtained another premium receiver—a Harris RF-590. The RF-590 and its variants were built to military specifications and marketed primarily to government users, including the US Navy and the State Department. It is a double conversion receiver, with IFs of 40.455 and 0.455 MHz.

The RF-590 is built for 19" rack mounting and is a heavy, rugged radio. Inside, each stage is enclosed within a separate shielded box to minimize birdies. A large aluminum knob and numeric keypad permit tuning FM, AM, SSB, and CW signals in the 0 - 30 MHz spectrum. The frequency is shown down to 1 Hz on a bright blue vacuum fluorescent display.

Most of the RF-590s are equipped with 455 kHz Collins filters. AM bandwidths are 16, 6, and 3.2 kHz. The SSB bandwidth is 2.8 kHz and FM bandwidth is 16 kHz. We especially like the 1 kHz and 300 Hz CW band-

widths. A front panel squelch knob controls a noise operated squelch in FM mode and voice squelch in the other modes. The FM detector lets us snoop in the 29.7 - 30 MHz splinter during band openings.

The RF-590 has 100 memory channels and memory scanning. The rear panel has both pre- and post-filtered 0.455 MHz IF output jacks and oodles of other terminals that permit interfacing the radio with external devices. There are several options, including computer control, internal bandswitching preselector, ISB (independent side band), and high stability oven time base. None of the other RF-590 owners we've contacted have the noise blanker, and the list price of that option is rumored to be about \$2000!

The RF-590 provides four AGC settings, but lacks a notch filter, passband tuning, sync detector, and other conveniences found in upscale consumer models. Truth be told, our JRC NRD-535D is more sensitive. Nonetheless, operating the RF-590 is a pleasure that cannot be quantified and the audio is superb.

Harris Corp., still a major player in the

PRACTICAL MEMORY SCAN SPEED

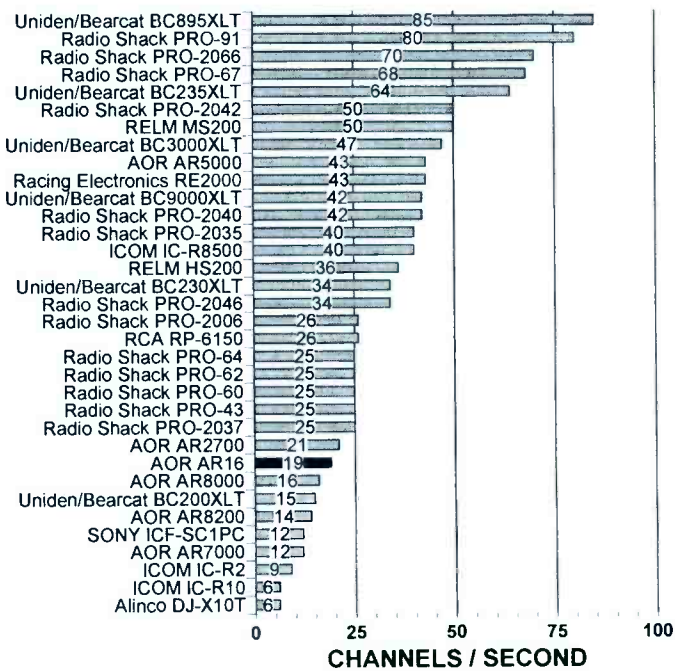

Notes:
1. Measurements made on one sample of each model.
2. Measured with memories programmed with unsorted frequencies in various bands and AM and NFM detection modes.
3. Measurements are approximate.

Copyright 1999, Bob Parnass, AJ9S

communications field, is located at 1680 University Ave., Rochester, NY 14610. Late 1980s vintage RF-590s are appearing on the used market as they are replaced by the newer RF-590A. You can find used RF-590s advertised by individuals and two Canadian surplus dealers on the Internet. Toronto Surplus and Scientific, <http://www.torontosurplus.com>, tel. (416) 490-8865, sells RF-590s and RF-590As.

W. J. Ford Surplus Enterprises, testequipment@falls.igs.net, tel. (613) 283-5195, sells surplus receivers, too. Visit their web site <http://www.falls.igs.net/~testequipment>.



RadioMap™

Transmitter sites in your area are researched and marked on a beautiful 8-1/2 x 11 full color plot. See FCC licensed sites from VLF through microwave including police, fire, cellular phone sites, business, industrial, broadcasters and selected FAA transmitter sites. Call signs, frequency assignments, and names provided. Ham radio stations not included.

You choose the map center location—your neighborhood, near your office, around sports stadiums—anywhere within the United States. We adjust map coverage for best readability, depending on transmitter site density.

Invaluable to radio professionals and hobbyists for identifying towers, sources of radio interference etc. Send nearest street intersection and check for \$29.95 payable to Robert Parnass.

Robert Parnass, M.S.
Radio Electronics Consulting
2350 Douglas Road, Oswego, IL 60543

Q. Which metal – brass, copper, steel, or aluminum – makes the best radio antenna? Doesn't a silk thread have greater strength than the same strand of steel? (Donald Choleva, Willoughby, OH)

A. There are some natural fibers, including spider webs, that are stronger for their size than steel, but they make lousy electrical conductors!

Let's assume that we are talking about whip antennas, not wire dipoles. Of the four metals, copper is the best conductor, followed by brass, steel, and aluminum. Since radio frequency energy flows on the outside of the conductor, some manufacturers have used strong steel whips plated with copper.

While this is an excellent choice, both because the copper is a better conductor and because it resists corrosion, the actual results of such experiments haven't justified the extra effort. Once the antenna is thick enough to provide rigidity, the relative resistances among the different metals isn't enough to affect signal strength perceptibly.

Q. With nothing around them but air, how are tall antenna towers erected? (Jim Ashe, Weymouth, MA)

A. There are several techniques. One is to actually assemble it piece by piece, with workers hauling it from the ground up, often in buckets, and with the aid of a "gin pole" (pulley on a tall pipe). Another is to fully assemble the sections on the ground, then lift them into place with a crane or even hoist them by helicopter.

Q. What is a "linear" in CB terms?

A. Short for "linear amplifier," a power magnification device which hooks to the antenna connector of a CB (or ham, or commercial) transceiver and, when the mike button is pushed, turns a low power transceiver into one of substantially higher power. Five watts to 100 is a typical application. They are illegal for CB.

According to *Car and Drive* magazine, there is an outfit in Citronelle, Alabama, called Train Built which manufactures a mobile CB

radio capable of radiating 22 kilowatts of transmit power (that's 22,000 watts!). Called "Big Girl," the potent rig runs off eight Leece-Neville 250 amp alternators to supply its thirsty 2000 amp current requirement!

An anonymous trucker boasted that when he gets in a road altercation with another driver he simply turns on his high-powered radio and disables the automotive electronics of the offending motorist. Pretty frightening stuff. FCC, where are you?

Q. Is there a clearing house for transcripts of shortwave broadcasts on science and technology? (Terrynce Ondola, Norwood, OH)

A. Yes and no. The Foreign Broadcast Information Service (FBIS) is a federal agency that translates foreign broadcasts and news publications into English language – some 100,000 every year – and retained them in the Government Publications Library (GPL) until about three years ago. More recent reports are now available on line through the World News Connection (WNC).

Unfortunately, the WNC is a subscription

Bob's Tip of the Month

Two Radios, One Antenna Two Antennas, One Radio

Is it possible to operate two radios from one antenna? Yes. Is it possible to connect two antennas to one radio? Yes. But there are catches.

Two radios from one antenna. This is the easiest task. Purchase a two-way TV splitter from Radio Shack, Wal-Mart, Grove, or any other source; just be sure it is wideband (they are typically marked 5-900 MHz, but operate beyond those limits as well). You will need adapters and short cable runs (RG59/U or RG6/U is fine for this) for the F connectors to attach to your receiver(s) or scanner(s).

Naturally, the antenna you attach to the input of the splitter determines the ultimate

performance; use the same antenna you would choose for just one radio. Since the signal is divided in half, there will be at least a 3 dB drop in strength at each output port, but for most purposes you won't notice the difference.

Two antennas into one radio. This is the toughest challenge because, unless they are properly spaced, they can actually reduce signal strengths! Even when you add a second identical antenna, no matter how superb they are, only a 3 dB improvement is possible.

But other factors besides gain come in – directivity and noise reduction, for example. At shortwave it is usually better to erect two antennas pointing in different directions, se-

lecting between them with a common antenna switch (CB, TV, or even a video game switch works well for this).

It is still possible to use two antennas simultaneously, however. If they are highly directional and point in different directions, or of two entirely different frequency ranges, so that signal cancellation is unlikely, you can use a splitter again, but "upside down." Instead of a signal splitter, it is now a signal combiner.

As with any new antenna system, plan ahead and test the results before permanently mounting everything in place. If all goes well, you will have improved reception; if it doesn't, it's summertime, and you got good exercise!

service managed by the University of Minnesota and available primarily to universities. You need a University of Minnesota ID and password to have access to these extensive files, including your topic: Science and Technology. Quarterly CD-ROMs are cut to make the task of researching these extensive files a little easier. You may wish to contact a nearby university to see what arrangements you can make to access this enormous database.

Q. After erecting the Grove Mini Skywire (which works very well), I was surprised to see there was a cutout half way from the center, making one of the dipoles shorter than the other. Checking with a friend, I discovered that his was exactly the same. What is the reason for this shortened element? (Andre Luis F. Santos, Fortaleza, CE, Brasil)

A. This intentional design makes use of the fact that at higher (even) harmonics, a dipole exhibits a high center-feedpoint impedance, mismatching the coax. A second, half-length element becomes a much better low impedance match on those frequencies, improving overall efficiency and signal delivery to the receiver. By having both elements in parallel, this automatic bandswitching feature insures a smoother, optimum performance over its entire receiving range.

Q. Many modern TV sets have a second audio program (SAP) feature; while I have the standard TV audio frequencies programmed into my scanner, where do I find the SAP frequencies? (Henry K. Poh, E. Northport, NY)

A. An excellent question, so good in fact I had to ask our intrepid American Bandscan columnist, Doug Smith. Here's what Doug says, and it sounds as if he knows what he's talking about!

SAP is very similar to FM's subsidiary carrier authorization (SCA), which is offset by typically 67 kHz from the center carrier frequency. SAP, however, is tuned at 78.67 kHz in the sound carrier's baseband, 4.5 MHz above the picture frequency.

SAP is Dolby (DBX) compressed, just like the left/right signal for TV stereo, for enhanced noise reduction. While it has the same audio quality, it is mono, not stereo. If you

attached a conventional FM SCA adaptor to the discriminator output of a TV receiver (or your scanner while receiving TV audio) and tuned it to 78.67 kHz, you would hear the SAP, albeit a little "flat."

Incidentally, there is another subcarrier at 102.27 kHz, but it is intended only for TV stations. Called the "Pro" channel, it is used for cuing reporters on remote, and relaying telemetry data from the transmitter back to the studio.

Thanks, Henry, for an interesting question, and Doug, for an interesting answer.

Q. When logging a distant short-wave station, which would be the correct way to show its reception if it's over the International Date Line – its UTC time the next day, or my local time and the current day for me? (Timothy Taylor, Erie, PA)

A. Referring to "How to Use the Shortwave Guide" at the beginning of our center section in each issue of *MT*, note the second paragraph: "...all dates, as well as times, are in UTC; for example, a show which might air at 0030 UTC Sunday will be heard on Saturday evening in America."

If you are recording your logs using UTC time, then, no matter where in the world you are located, if it's after 0000 UTC, it's the next day in your log!

Q. To avoid a conspicuously long run of coaxial cable from a satellite antenna, I buried it, but I notice a decrease in picture quality. Can coax be buried in the ground? Should it be run through plastic pipe to reduce attenuation? (Bill Calhoun, Claysville, PA)

A. Good coax is unaffected by its environment. You can bury it, pass it through solid metal, run it under water, with NO signal degradation. The fact that you experienced a change indicated something else happening. Perhaps it is a poor grade of coax with less than 100% shielding; it could have a permeable jacket allowing moisture intrusion; you may have a problem with connectors; perhaps the cable is damaged, even microscopically, allowing moisture intrusion; or an unrelated incident like change in received signal strength could be the culprit.

You do need to choose an outdoor-rated cable. Armoring the coax in a pipe is an additional precaution against damage (shovels,

sharp rock slices, crushing, etc.) and moisture intrusion. Be careful in the selection of the conduit, however; if water gets in and can't get out, that's worse on the coax than being in the ground which periodically dries. Be sure the two ends are either weatherproof or, better yet, leave them open, but facing downward to prevent rain intrusion, but allow "breathing" to dry out condensation.

While it makes no difference what pipe you put it in, a buried metal pipe would provide a lightning choke—additional protection against an outdoor lightning strike coming in to damage indoor equipment. But observe other lightning preventive techniques as well and select a weather-survivable pipe, fittings, and adhesive.

And finally, any exposed coax needs to be replaced periodically. Manufacturers say 10 years; sooner if severe weather conditions exist, and check your connectors, too.

Questions or tips sent to "Ask Bob," c/o MT are printed in this column as space permits. If you desire a prompt, personal reply, mail your questions along with a self-addressed stamped envelope (no telephone calls, please) in care of MT, or e-mail to bgrove@grove-ent.com. (Please include your name and address.) The current "Ask Bob" is now online at our WWW site: www.grove-ent.com

NEW, now on CD-ROM without software copy protection

VisualRadio



is a powerful RF and AF spectrum analysis / data management control

software for AOR, ICOM, KENWOOD, NRD, Watkins-Johnson, WinRADIO, YAESU and more. Download DEMO

Protocol for PCR1000/100 licensed by

Protocol
ICOM
Application

COMPUTER INTERNATIONAL

207 South US-27

St. Johns, MI 48879

Tel/FAX: 1-877-977-6918 (toll free)

E-mail: computer@email.mintcity.com

<http://computer-international.virtualave.net>



MFJ Shortwave Noise Canceller

By Bob Grove

While some communications receivers and transceivers are equipped with noise blankers, these circuits are met with mixed results. They are effective against many pulse noises, but not against sinusoidal (radio signal) interference. If a second (interfering) signal is right on top of the desired signal, resolving the situation with the receiver's controls is often hopeless.

But what if we can suppress the interfering signal before it ever enters the receiver, leaving the target station in the clear? We can do that. Directional antennas can null the undesirable signals, or we can adjust the phases of the signals arriving from two different antennas so that the interfering signal is attenuated or cancelled entirely. It is the latter process which is more practical, and utilized in a new generation of noise canceling accessories.

The most recent of such accessories to be debuted to the hobby radio market is the MFJ-1026 "Deluxe Noise Canceling Signal Enhancer." This 1.8-30 MHz phasing device compares signals from two different antennas, then may be manually adjusted to reduce or eliminate the noise signal by mixing the two out of phase.

The noises may be from any source: tools, TVs, appliances, other transmitters, lightning, power lines, fluorescent lamps, dimmers – any source of radio frequency interference.

While there may be some loss of the desired signal, the net result is better readability. Such measures are more an art than a science; while the technique and theory have been well established for most of this century, the outcome depends upon frequency, relative signal strengths, and the size and locations of the signal and noise antennas.

■ So, how well does it work?

Quite well, both for nulling and peaking signals. Since the MFJ-1026 works at radio frequencies, it makes no difference what mode or modulation is being transmitted – AM, SSB, CW, SSTV, RTTY, packet – it treats all of them the same, whether you are amplifying a desired signal, or attenuating interference.

Actual operation takes some getting used to, since the procedure is one of experimentation until you get it right. With some practice, however, the hunt-and-peck phasing routine comes naturally.

Four rotary controls and four pushbuttons come into play. Since this MFJ unit can be used with transmitting equipment, one of the controls adjusts transmit delay time, so it is initially set and forgotten. A telescoping whip antenna (included) can be used for the noise-sensing antenna, or a random wire may be



connected to the rear jack; a second coax connector is for the primary receiving antenna.

Although there are separate controls for phase switching, antenna gain, preamplifier, and power/bypass, the use of these soon becomes familiar and less daunting than may be first imagined. Signals may be enhanced either by increasing their strengths or by suppressing co-frequency interference; the first is easy, the second a little touchier. But it does work, and in many instances makes the difference between total obliteration and easy copy.

MFJ-1026, \$169.95 plus shipping from MFJ Enterprises, Box 494, Mississippi State, MS 39762, www.mfjenterprises.com, and from MFJ dealers.

Be an electronics repair genius with **Radio Shack's Tuner Control Lubricant**

By Ken Reitz KS4ZR

Dust is the enemy of electronics. No matter how often you clean, you can't keep dust from building up on the contacts of all the switches and potentiometers in the gear that lines the shelves of your listening post. After a few short years that dust builds up and it's not long before switches don't switch and volume controls have that annoying scratchy sound which blasts from your speakers.

Still, it's a throw-away world and manufacturers seem to be inviting us to do so and the electronics repair industry doesn't seem to be helping.

So, how much would you pay a repairman to fix that scratchy volume control on your old shortwave radio? Well, by the time you've paid the diagnostic bench fee, parts and labor, you could have made an extra payment on your car! Have you tried sending the unit

off for repairs? Better add shipping to the other charges and about eight weeks in down time!

There is a better way, and it doesn't involve taking a course in electronics repair or calling on your know-it-all brother-in-law. You *can* do the job yourself with Radio Shack's Tuner Control Cleaner & Lubricant (RS Catalog #64-4315).

That's right; I've actually used this stuff

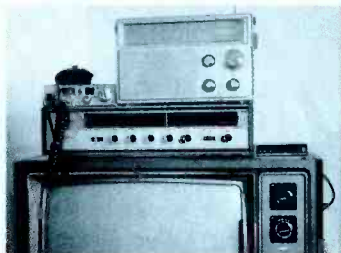

This TV, stereo, CB and portable radio were victims of years of unavoidable dust accumulation and were dumpster-bound. It would have cost hundreds of dollars to replace them, but, all were brought back to life thanks to Radio Shack's Tuner Control & Lubricant. Imagine what it can do for you!

in desperation to save otherwise dumpster-bound gear and it did the job! I have rejuvenated portable radios, old style TV sets, and stereo gear. I'm not ashamed to admit I even recovered the use of my old

CB radio with this stuff! I've used it on everything from Walkman®-type players to expensive car stereos. Imagine what that would have cost to repair! I've even cleaned up the controls on my Kenwood amateur radio transceiver.

Here's how to use it: Just disconnect the power from the unit to be repaired, remove the knobs from the offending switches or pots, pump one brief blast into the opening, replace the knob and rotate the pot or flip the switch vigorously for about 30 seconds. Wait about 5 minutes to dry and restart the gear. The switches should operate smoothly and the pots should no longer be scratchy. It's a miracle! Radio Shack says this product is "...non-flammable, reduces wear and is safe on plastics..." Just be sure to heed the label warnings on the back of the can.

■ Financial Independence

So, are you tired of mounting credit card debt from expensive electronic repair bills? Now you can take control of your financial

This is it! Radio Shack's Tuner Control Cleaner & Lubricant could be the best \$7.99 you ever spent!



destiny with this terrific product. You'd expect to pay \$30 for anything that actually works, but, now you can have your own can of Radio Shack's Tuner Control Cleaner & Lubricant for just \$7.99. That's right, for the price of a bottle of cheap wine, you can get years worth of listening pleasure from that mountain of old stereo gear growing in your hall closet!

But, wait, there's more! You'll not only get this extraordinary product with a generous amount of lubricant, but, you'll also receive, at no extra charge, a 4" flexible tube which allows you to spray into those hard to reach places. Why bother with expensive how-to courses and technical schools you'll never attend anyway? Save your money, save the landfill and do it yourself; it can't get better than this!

2000 edition of *Passport to World Band Radio* Order Now and Receive Free Shipping!



TIME TO UPDATE YOUR PASSPORT!

The world's best selling shortwave guide is now bigger and better! Edited by Lawrence Magne, Passport is the ultimate shortwave hobbyist's listening reference. At a glance, Passport's exhaustive chart shows world broadcasters by frequency and time, indicating station power and language as well.

Passport includes extensive chapters on program profiles, English language listening, catching clandestine and pirate broadcasters, receiver reviews and ratings, planning your listening post, and Internet Web radio. A powerful listening tool at a low, low price!

Order now—before the offer closes **September 30, 1999**—to receive your free shipping! Available end of October 1999.

ORDER BOK18-00 **Only \$19⁹⁵**

with FREE SHIPPING in US. (After September 30, the price will be \$19.95 plus \$5.95 shipping. For Canadian shipping, please add \$6.95 for surface printed mail, \$7.95 for Air Parcel Post in Canada, and \$13 for Air Parcel Post elsewhere.

GROVE

Grove Enterprises, Inc.
7540 Highway 64 West; Brasstown, N.C. 28902
(800) 438-8155 US & Can.; (828) 837-9200;
Fax (828) 837-2218;
e-mail: order@grove-ent.com
World Wide Web: www.grove-ent.com

WHAT'S NEW?

TELL THEM YOU SAW IT IN MONITORING TIMES

Plugged in 'n ready to go!



Sangean makes a snappy little (3" x 1.5" x 0.5"!) AM/FM radio that you can slip into your shirt pocket while you enjoy stereo sound through earbuds of surprisingly high quality. You can switch on the bass boost for best music reproduction, or leave it off for talk shows. FM mono is also selectable to avoid stereo hiss in marginal reception areas.

The SR-2 comes in black or yellow and it runs on one AAA battery (not included). At \$29.95 from Grove Enterprises (800-438-8155 or www.groveent.com) that little voice in your ear can keep you entertained while you power walk or bring you local news and weather when camping or when you're hunkered down in the hallway waiting out a storm warning!

The all-in-one scanner

No, this isn't another of those wide-band radios to cover dc-to-daylight or your backyard to Voice of Russia. Scanner folks are interested in happenings close to home, and that is just what a new line of Uniden scanners is designed to provide. The top of the line BC278CLT sports 12 scanner bands including 800



MHz and aircraft bands, 100 programmable channels, programmable search and service search, and five priority channels. But, in addition to these, it also provides an AM/FM radio with 20 presets, an alarm clock, and most importantly, it includes specific Area Message Encoding (SAME) which automatically alerts the user when there is a weather watch/warning in his specific county. The '278CLT is expected to be available in August at a suggested retail price of \$299.95.



Two other models are already available: the BC248CLT features 50 programmable channels, AM/FM radio with presents, alarm clock, one touch weather alert, and five priority channels at a retail price of \$179.95. The BC244CLT contains 30 programmable channels, alarm clock, 10 bands including public service bands, ham bands, and federal and military land mobile (\$159.99)

Safety on the Sea by Cellphone

Recreational boaters often operate close enough to shore that a cellular phone is the only "emergency radio" they have on board. But if the caller doesn't know exactly where he is, a cellular signal is useless for emergency direction-finding, unlike a VHF marine radio signal. Two solutions to this situation have come to our attention.

A GPS receiver solves the location problem, but just imagine cradling a cellphone on the shoulder, reading off GPS coordinates

to the Coast Guard or marine tow operator, all while trying to bail water! Garmin has wisely combined a number of features into one unit: the **NavTalk Cellular/GPS**. GPS performance is the same as the GPS III Plus with its on-screen mapping and navigation capability. The built-in analog cellular phone also includes numeric paging, one-touch dialing, and optional one-touch emergency service. With the push of the red '9' button, your location is transmitted and you're automatically connected to a response center which sends help to your location. The Garmin NavTalk is \$600 from Boat U.S. (www.boatus.com) or see www.garmin.com for a dealer in your area.



For the boater or traveler who doesn't need navigational help, **Snap-Track, Inc.** is developing a digital signal processing chip that can be installed into a cellular phone for about \$10. Using the GPS system, the chip will enable a search team to locate the caller within a 15-foot radius.

No phone-toting boater, hiker, or motorist should ever become complacent about safety, however; for once out of earshot of a cellular tower, this communications device is dead in the water.

Weathering the Storm

With a subtitle of *Tornadoes, Television, and Turmoil*, this



book by Gary A. England, Oklahoma's Emmy Award-winning weather forecaster, is both a memoir and a manual on reporting on severe weather – something we've already seen too much of in 1999.

As chief meteorologist for KWTW in Oklahoma City, England's career has paralleled the evolution of forecasting software and technology. Fifty-five spectacular color photographs of storms, hail, and tornadoes testify to the turbulent weather experienced by those who populate "tornado alley."

Weathering the Storm was published in 1997 by the University of Oklahoma press; it is 264 pages in paperback for \$16.95, or 225 pages hardcover for \$24.95. Check out amazon.com or other discounters for bargain prices.

Guide to Worldwide Weather Services

Now in its 19th edition, this traditional guide to weather radio services has shifted much of its attention to weather products and resources available on the internet. As author Joerg Klingenfuss puts it: "Superb meteorological products are only a mouse-click away from your forefinger. Dozens of national meteo services and hundreds of university departments make excellent products available free of charge – in colour! Direct reception of weather satellites is no longer essential, because 'near real-time' – i.e. just a few seconds or minutes later – it's all

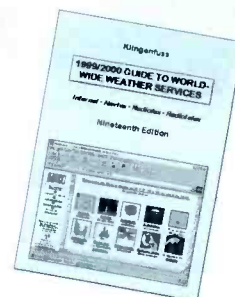

available on the World Wide Web.”

Listed are 225 Internet sites, 110 Navtex stations and 40 radiofax stations (with broadcast schedules), and 82 radiotelex stations – plus 338 sample charts, graphics and satellite pictures all from 1999. For anyone interested in the weather, this book is an up-to-date compilation of the very latest meteo data sources available worldwide. The *Guide* is available for 30 Euro from Klingenfuss Publications, Hagenloher Str. 14, D-72070 Tuebingen, Germany, e-mail klingenfuss@compuserve.com

Digital decoding on a budget

The new Wavecom W40PC Digital Signal Processing card for use inside a PC is a professional-grade digital data analyzer

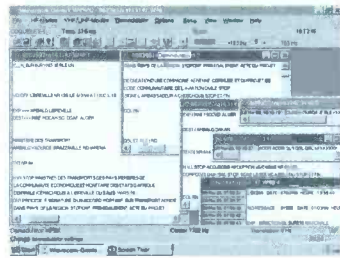

and decoder with more than 70 modes. It allows the decoding of all conventional and advanced data, fax, selcal and teleprinter systems used today on VLF, LF, MF, HF, VHF, UHF, SHF, and satellite.

By using a software environment already developed for the costly, professional W41PC DSP card, the brand new W40PC DSP is considerably less expensive. Klingenfuss, the only dealer shipping worldwide, is selling the Wavecom W40PC for 1,635 Euros, or nearly US\$1717.

For a full list of the modes, languages, signal analysis tools,

sample screen shots and more, visit Wavecom at www.wavecom.ch/ or go to the Klingenfuss website at <http://ourworld.compuserve.com/homepages/Klingenfuss>

Cop Talk!

For the dyed-in-the-wool police scanner buff, Laura Quarantiello's latest book should

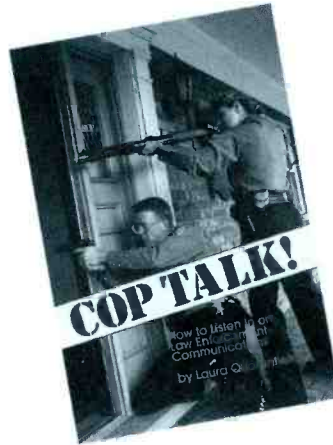

provide some interesting details about what goes on during a law enforcement officer's day – and how you can better understand the radio traffic.

Chapters evolve from setting up a listening post, through technical aspects of police radio systems, into the radio jargon you will encounter and what goes on behind the scenes.

A glossary of terms and forms is quite illuminating, including the complete Miranda warning, several sample ten codes, abbreviations and terms, and a general list of VHF/UHF frequency allocations.

\$14.95 from Bookworld, 1933 Whitfield Park Loop, Sarasota, FL 34243; phone (800) 444-2524.

The Covert Catalog 2000

Something bugging you? (Pun

Listening is only half the fun...
POPULAR COMMUNICATIONS is the other half.

If you enjoy radio communications in all its variety, you'll love *Popular Communications*

Since 1982 *Pop'Comm* has delivered thousands of pages of great reading for both the radio enthusiast and the professional communicator.

Name your favorite interest... *Popular Communications* is there for you. Whether you're into Short-wave Listening, Scanner Monitoring, searching out Pirate Radio broadcasters, CB Radio, Satellite Broadcasting, ACARS, or Ham Radio; you name it, we cover it, every month.

Popular Communications

Subscribe today and save over 54% off the newsstand price. Save even more with two or three year subs!

YES! Enter my Subscription to *Popular Communications* today!

Name _____
 Address _____
 City _____ State _____ Zip _____
 () Check () MasterCard () VISA () AMEX () Discover
 Card No. _____ Expires _____
 Signature _____

	USA	Canada/Mexico	Foreign Air Post
1 Year	<input type="checkbox"/> 25.95	<input type="checkbox"/> 35.95	<input type="checkbox"/> 45.95
2 Years	<input type="checkbox"/> 45.95	<input type="checkbox"/> 65.95	<input type="checkbox"/> 85.95
3 Years	<input type="checkbox"/> 65.95	<input type="checkbox"/> 95.95	<input type="checkbox"/> 125.95

Allow 6 to 8 weeks for delivery

FOR FASTER SERVICE FAX 1-516-681-2926

MT 98

Popular Communications 25 Newbridge Road, Hicksville, NY 11801 Telephone (516) 681-2922

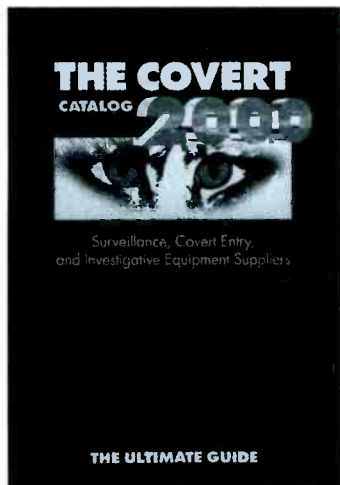

intended!) Lee Lapin's latest catalog graphically details the assortment of surveillance, intrusion, video and audio monitoring, entry, electronic countermeasures, and other equipment for espionage. Specific devices include pinhole video cameras, camouflaged listening and recording devices, night vision equipment, lock defeaters, universal garage door openers, bugs and taps, and more. Lapin does warn his readers that most of this stuff is illegal to own.

More than 200 pages list the sources for the equipment, mostly off shore. Since the FBI crack-down on the "Spy Shops," it has been difficult for both illegitimate and legitimate agencies to acquire much of the equipment described.

The Covert Catalog 2000 is \$34.95 plus \$5 shipping from Intelligence Incorporated, 3555 South El Camino Real, #309, San Mateo, CA 94403; phone (650) 559-0220, or visit their Web site at <http://www.intelligence.to> www.intelligence.to

Collector's Guide to Vintage Televisions

While radio collecting has been around for decades, the post-war emergence of TV sets has just begun to generate attention. This handy guide by Bryan Durbal and Glenn Bubenheimer contains all color plates and easy descriptions to help the prospective col-

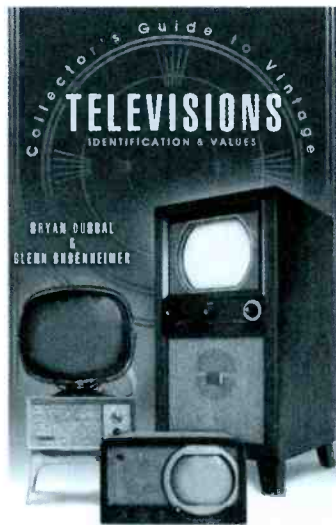

lector identify the bargains which are easy to spot in used merchandise outlets, flea markets, yard sales, and hamfests.

Rather than speculate on top prices for restored TVs, these authors have adopted a different tack – assuming the set is complete, but not working. This makes good sense, since TV sets are high-voltage devices, susceptible to catastrophic power supply failure, and restoration can be involved and expensive.

As a result of the lowball pricing, even the Philco Invictas are listed at \$200, while working sets on the market are over \$1000!

Collector's Guide to Vintage Televisions is \$15.95 plus \$2 shipping from Collector Books, PO Box 3009, Paducah, KY 42002-3009; ph. (800) 626-5420.

Serial Print Publication for Shortwave Listeners

The Australasian Shortwave Digest is a new venture by Bob Padula (Padula Books, Melbourne, Australia) designed to provide the most up-to-date shortwave schedules, reception conditions, and frequency planning for the Asia and Pacific area, as well as equipment and book reviews. Information will supplement the periodic *Australasian Shortwave Guide* and *Shortwave Guide to South East Asia*, also

produced by Padula Books.

Beginning July 25th, the monthly *Digest* will consist of a minimum of 8 pages. A subscription to the set of 6 issues for the remainder of 1999 is A\$15 (to Australian addresses); outside of Australia: A\$25, US\$15, or 20 International Reply Coupons. A free sample copy of the first edition will be sent on receipt of return postage: 45 cent stamp to Australian addresses or, elsewhere, 2 IRCs, or US\$2 or cash equivalent.

Contact Padula Books, 404 Mont Albert Road, Surrey Hills, Victoria 3127, Australia. Tel/FAX: +61 3 9898 290, bpadula@compuserve.com, <http://members.tripod.com/~bpadula/edxp.html>

Correction

We published an incorrect phone number for Cutting Edge Enterprises (Pocket Protector, June *What's New?*); their number should be 800-206-0115.



Business news and freebies

• Want to know how a particular radio dealer stacks up with its customers? Visitors to Rich Wells' website fill out a survey and rate the scanner dealers from whom they have purchased. It is interesting to compare what customers are saying about the different dealers around the country... Yes, you'll find Grove in there, too. Visitors also rate web sites. See http://strongsignals.net/html/dlr_srvy.htm

• According to Gerry KB0VOF of Denver, Colorado, Yaesu

Musen in Japan has bought Standard, the manufacturer of business radios. However, E-mail from Yaesu explained that Yaesu and Standard have "combined sales forces in Japan" but both will continue to manufacture their own equipment.

• Bob Parnass reports that third party IC-R2 and IC-Q7A software can be downloaded from: <http://home.t-online.de/home/Ingra-Beton/>

• "Shortwave Transmitter Countries" is the free online internet version of the publication TDP, the *Transmitter Documentation Project*, which provides information on all the shortwave radio broadcast transmitters installed all over the world, arranged in country order. You can access this new service from servers with different locations, so that you can choose the fastest one from your location. Select "Shortwave Transmitter Countries" from one of the following sites:

- * <http://www.ping.be/tdp/>
- * <http://www.transmitter.be>
- * <http://www.transmitter.org>

Books and equipment for announcement or review should be sent to "What's New?" c/o Monitoring Times, P.O. Box 98, 7540 Hwy 64 West, Brasstown, NC 28902

Press releases may be faxed to 828-837-2216 or e-mailed to mteditor@grove-ent.com.

LETTERS TO THE EDITOR

NEWS AND VIEWS FROM OUR READERS

Rachel Baughn, Editor

Computers and Radio

"In your *Closing Comments* column in the February issue of *Monitoring Times*, you note at the end, the 'positive news' that the decline in the sales of radios is leveling off. Further, you conjecture that the 'individuals who teethed on computers are looking for other electronic gratification.'

"I think that another point of view may also be relevant. That is, people with computers are looking for additional peripherals with which to expand their interest in computing. I would not admit this to any of my ham colleagues, but I consider a radio to be a computer peripheral.

"As a case in point, I have been following TAPR's (Tucson Amateur Packet Radio Corporation) efforts to produce a spread spectrum, high speed data transceiver. In the meantime, there are a few hams experimenting with wireless local area network (LAN) equipment to implement small computer networks extending over several miles.

"Of course, there are other associations between computers and radio, where the availability of computer equipment makes the radio aspect of the hobby more enjoyable. In this perspective, radio and computer technologies are complementary.

"Regardless of the point of view, I hope that Grove Enterprises will prosper and continue to serve the information needs of computer ... errr ... radio enthusiasts."

— Andrew Cornwall,
Wellington, Nova Scotia

MT's publisher, Bob Grove, has also recognized the complementary aspects of computers, radio, and the internet. To see the results of Bob's latest venture, visit the Grove home page at www.grove-ent.com and find out how to participate in the world's first *live video* auction — Who knows? One day you may buy your next radio over computer, auctioned off by Bob Grove!

On Behalf of Good Scanner Press

"Folks, I would like to propose that anyone reading about the use of scanners by private citizens to help police/emergency services kindly post a summary of the article along with the reference source e.g. newspaper name, location, date of article ... Of particular interest would be good news assistance provided by motor vehicle/mobile scanner users.

"I would also recommend that these not only be posted to the regular lists you subscribe to, but also to scan-legal@nomad.n-reading.ma.us (after subscribing). Perhaps one

of the major scanner/hobby communications magazines (*Monitoring Times*, *Popular Communications*, etc.) would also maintain an archive file of scanner good news for emailing to folks as the need arises.

"If a town/city, county, or state wants to enact a law that would prohibit the use of scanners in motor vehicles, the 'scanner good news' references would provide a good source for information to possibly prevent the action."

— Ken Windyka, Springfield, Massachusetts

Monitoring Times has always maintained a file on "good scanner press" compiled from clippings sent us by our readers. Over the years, I have copied the best of these on request, but it falls very far short of being a significant clearinghouse — and now, many of the clippings are too old. To compile a more impressive account would require someone willing to solicit and organize the responses. If someone wants to spearhead the project, we're willing to help.

Refraction versus Diffraction

"I am a many-years subscriber to your magazine and wish to congratulate you on a top-notch product.

"Your attention is called to an error in the June *Propagation Conditions* column on page 60. The article addresses 'Knife Edge Refraction,' which is incorrect. You obviously meant 'Knife Edge Diffraction.'

"*Refraction* involves the "bending" of an electromagnetic wave due to a change in the propagation velocity, such as for a light beam passing from air into glass. Lenses employ this principle (e.g., refraction telescope).

"*Diffraction* involves the interference pattern produced by an obstruction in the path of the electromagnetic wave. A scientist named Fresnell worked out the theory for knife-edge diffraction many years ago. A radio propagation knife-edge diffraction calculator can be downloaded from <http://sss-mag.com/prop.html>

— Arthur Herbig

Jacques d'Avignon admits, "You are absolutely correct in your correction. Sometime when I write, my French causes me some problems, English being my second language." (Scientific concepts are a second language for editors, too!—rb)

Hooking the kids

Last spring, Lane Griswold asked for a box of back issues of *MT* to use for a "show and

STOP! LOOK & Listen to This!

Alinco DJ-X10T — We've reinvented the multichannel receiver!

- 1200 memories plus two VFOs
- 100 KHz – 2 GHz coverage*
- WFM, NFM, AM, USB, LSB and CW modes
- Alphanumeric channel designations – up to 3 lines
- Multi-function Channel Scope™ display
- Internal "help" function
- PC programmable
- Beginner and Expert operating modes
- Automatic Memory Write Feature
- Auto timer on/off, internal clock
- Backlit display and keys



The Alinco DJ-S46 FRS radio will have YOU talking!



- NO License Needed
- Up to 2 mile range**
- 14 Channels
- FM Transmit/Receive
- NiCd, Alkaline or External Power
- Long Battery Life
- Self Storing Antenna
- Compact Size
- Simple Operation
- Lighted Display
- Accessory Ports
- Compatible with other FRS radios

Visit our web site!

Simple • Clean • Dependable

ALINCO
RADIO'S VALUE LEADER™

Dealer Inquiries Welcome

U.S.A. Alinco Branch: 438 Amapola Ave.
Suite 130 • Torrance, CA 90501

Phone: (310) 618-8616 • Fax: (310) 618-8758
Internet: <http://www.alinco.com>

*Cellular blocked. **Effective operating range varies due to terrain, channel use, batteries and other conditions

STOCK EXCHANGE

Monitoring Times assumes no responsibility for misrepresented merchandise.

Ads for **Stock Exchange** must be received 45 days prior to publication date. All ads must be paid in advance to *Monitoring Times*. **Ad copy must be typed for legibility.**

NON-COMMERCIAL SUBSCRIBER RATES: \$.25 per word — *Subscribers only!* All merchandise must be personal and radio-related.

COMMERCIAL, NON-SUBSCRIBER, AND MULTIPLE SALES RATES: \$1.00 per word. Commercial line ads printed in bold type.

1-3/4" SQUARE DISPLAY AD: \$50 per issue if camera-ready copy or, \$85 if copy to be typeset. Photo-reduction \$5 additional charge. For more information on commercial ads, contact Beth Leinbach, 828-389-4007.

OPTOCOM? OPTOSCAN? Nothing runs them like the new PROBE V5.0 Software. Let us tell you why. E-mail DataFiles@aol.com. DataFile, Inc., POB 20111, St. Louis, MO, 63123.

WINDOWS LOGGING SOFTWARE With QSL Imaging! — Throw away that old paper logbook and preserve your QSLs today with **DXtreme SWRLgold™** by DXtreme Software! Visit our Web site: www.dxtreme.com/dxtreme

AOR, UNIDEN, Products. Grand Opening Specials! LEE ELECTRONICS 800-578-6006 www.LeesElect.com

THE WORLD'S BEST SOURCE GUIDE for surveillance, TSCM, entry and investigative equipment from 15 countries. Now you have a friend in the diamond business! Never buy retail again. Exact specifications and ordering details. The **Covert Catalog2000** 220 pages, \$39.95 (MO, check, credit cards) includes priority shipping. Intelligence Incorporated 3555 S El Camino Real, San Mateo, CA 94403 or www.intelligence.to.

LEE ELECTRONICS, Bearcat, AOR Scanners and more. 800-578-6006 www.LeesElect.com

R-390A SERVICE / Rick Mish. Repair - Alignment - Touch up. Flat-rate \$350 including return shipping. 419-255-6220, 9am - 9pm ET.

ELECTRONIC COMPONENTS. Parts bonanza for manufacturers, engineers, hobbyists. Thousands of chip capacitors, resistors, transistors, ICs, diodes, plus valuable items such as signal strength meters, LCDs, hardware, much more! All at a fraction of the original cost. Grove Enterprises, Inc., 828-837-9200, order@grove-ent.com

FOR SALE: Philips DC-777 auto SW receiver, never used, new in box. \$300 OBO. 817-468-7787, e-mail: czechbob@yahoo.com

FOR SALE: JRC NRD-535 HF shortwave receiver, mint condition, used very little. Have original box, manuals, and accessories. Asking \$1000. 816-283-1990 pager.

FOR SALE: Drake R7, Drake DSR-1, Datong FL3, Grove SP-200, Marantz PMD201 recorder, Kenwood HS-5 headphones. Stan Mayo, 79 Halifax St., Winslow, Maine 04901.

INDEX OF ADVERTISERS

Alinco	101
Antique Radio Classified	69
Boger Electronics	27
C. Crane	Cover III
Communications Electronics	25
Computer Aided Technologies	5
Computer International	7, 95
CRB Research	74
DX Computing	53
Fineware	24
Glenn Hauser	35
Grove Enterprises 11, 39, 65, 85, 91, 97	
Grundig	Center Section
ICOM	1
Jacques d'Avignon	45
John Figliozzi	53
Kevin Carey	51
KIWA Electronics	69
Monitoring Times	31
Motron	33
Nil-Jon Antennas	5
OptoElectronics	Cover II, IV
Popular Communications	99
Racing Electronics	17
Radiomap	93
Radioworld Inc.	15
RDI White Papers	91
Sangean	Cover III
Scanner Master	27
SETI	67
Skyvision	71
Swagur Enterprises	103
Universal Electronics	63
Universal Radio	89
Viking International	7
W5YI	81
WINRADiO	9

Letters, continued from page 101

tell" in front of his daughter's class. "It will be well worth my presentation time if even one child gets 'hooked' on shortwave. I also have a DX-390 receiver, which I am going to donate to the school. The teacher said if I do this she will allocate 1 hour on Fridays to the students to listen to news of the world. Thank you once again for your donation."

See Lane's website at <http://www.users.uswest.net/~lgrswold> where he continues to promote shortwave listening. If you have a website for your radio hobby, send us the link, and we'll publish it in *Letters* for other readers to enjoy.

Transponder Guide?

Our appeal in the June issue raised up an author, and we may be close to finding a sponsor or two to fund the additional pages required to insert the transponder chart so many folks have asked for. Stay tuned; *MT* is well on its way to becoming the authoritative all-spectrum monthly monitoring guide!

— Rachel Baughn, editor

Your letters and comments are welcome at Letters to the Editor, P.O. Box 98, Brasstown, NC 28902, or email to mteditor@grove-ent.com.

Join the Club!

Open to hobbyists worldwide, the **CANADIAN INTERNATIONAL DX CLUB** is Canada's national, general coverage radio club serving members since 1962.

The **Messenger** features columns on AM/FM, shortwave, utilities, scanning, QSLing, pirates, ham radio and more. Send \$2 for a sample copy to:

CIDX

79 Kipps St., Greenfield Park,
Quebec, CANADA J4V 3B1
e-mail: ve2shw@rac.ca
Web: www.anarc.org/cidx/

CUMBRE DX

is the world's best DX publication. Every issue features news and loggings that you just won't find elsewhere.

But the best part about Cumbre DX is that it is absolutely **FREE!**

FOR YOUR FREE SAMPLE COPY,
SEND AN EMAIL TO:
cumbredx@yahoo.com

Visit us online at: www.cumbredx.org

ERGO Radio Software

Propagation & Path Evaluation, Receiver control (R8A, R8B, AR7030, RX-320, NRD535, HF-1000.) Database support. NEW! ERGO Lite.

Full information and demo at:
<http://members.home.net/creativexpress/>

Hand-Held Scanners!

MetroWest is your source for:

Hand-Held Scanners
Premium Battery Packs
Drop-In Chargers
Specialty Antennas
Books and More

SEND OR CALL FOR A FREE CATALOG: (708) 354-2125

MetroWest, Inc. 822 N. Spring LaGrange Park, IL 60526

ORDERS ONLY (800) 657-1475

SATELLITE RADIO BOOK & GUIDE

NEW BOOK covers all Audio Services, SCPC, Subcarriers, FM², Facsimile, Press Services, Weather Services. Simple how-to-receive instructions. **Satellite Radio Guide Included.** \$16.95 plus \$3 Priority Mail (\$19.95 total).

UNIVERSAL ELECTRONICS, INC.
4555 Groves Road, Suite 12
Columbus, OH 43232 (614) 866-4605

Guide To SURVIVAL COMMUNICATIONS

How to build complete communications systems. Covers shortwave radio, amateur radio, citizens band, scanners, federal, weather, alternate news, satellite radio, equipment sources. How to build alternate emergency power sources, solar, generators, backup batteries. 200 pages. \$24.00 Priority Mail. MC or Visa. Call Universal Electronics 800-241-8171.

R F P I THERMO MUGS

16-oz \$10 each, ppd



P.O. Box 20728 - M
PORTLAND, OR 97220

"Excellent in all areas!"

This is just one of the things our readers say about *DX Ontario*, the ODXA's monthly magazine for radio listeners.

Get a sample of our 40 page monthly magazine and see for yourself. Only \$3.50. 1999 is our 25th Anniversary!

Ontario DX Association

Box 161, Station A, Willowdale
Ontario M2N 5S8 Canada
E-mail: odxa@compuserve.com

Visit our web site at
www.durhamradio.ca/odxa



TIMESTEP

If you own an ICOM PCR1000, all you need for Weather pictures is an antenna, a preamplifier and a TIMESTEP interface for your computer.

If you would like to see colored weather images as they move across the United States and Europe, call or email us. It is easier than you may think. With a dish looking out a South facing window, a Feed, an LNA, a Timestep Receiver and Timestep Interface, your computer and you are ready to receive these kinds of images.

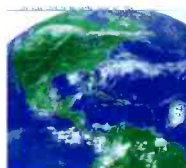

U.S. GOES/WEFAX IMAGE



Dish in window



Timestep GOES RECEIVER



Timestep interface



European WEFAX image

We have all you will need for INMARSAT except the Receiver

SWAGUR - TIMESTEP

Box 620035 - Middleton, WI 53562

Phone/Fax 608-592-7409

Email swagur@execpc.com

Web site www.swagur.com

HERE'S WHAT OUR READERS ARE SAYING ABOUT MT:

It has a little bit of everything, so no matter what part of the spectrum you monitor there is something for everybody! ... For a tech magazine it is easy reading. Seems to me you are constantly improving ... Wide range of well written articles and columns about listening (AM, FM, TV, SW and scanning) ... I read MT from cover to cover, usually the day I receive it.

Why hunt for it at the newsstand when it could be delivered to your box? See page 31 for how to subscribe.



P3500 DVB receiver (April MT reviewed)
Fastest Chan lock, best QPSK
S-Video, LNB Loopthru, SCART
PC upgradable, cable included,
UHF modulator out chan. 14-75
PID Enforce (even no PMT)
Price on sale \$309 + \$15 S/H
for USA, \$35 S/H for Canada.
Order Fax 888-731 1834
VISA/MC/AMEX or send mail to
PME, PO Box 23, Swormville, NY
14051-0023



By Bob Grove,
Publisher

In Opposition to "Technospeak"

The tendency to use jargon in place of legitimate language is becoming an increasing problem in our technocratic society, permeating the legal profession, confounding legislators, and puzzling consumers.

Whether or not it was the manipulative pundits of Madison Avenue who perpetrated this reign of technoterror decades ago (*Ivory Soap, 99 and 44/100 percent pure...pure what?? Duz does everything. Everything?!), we seem to be struck with it. Smacking of the claims of patent medicine and quackery of the nineteenth and early twentieth centuries, gluttonous hyperbole still accurately describes the advertising ploys of today. Snake oil salesman still slither.*

An *MT* reader ("Ryan") just related his disillusioning experience with a new Panasonic KX-TG200 series "Gigarange" (900 MHz/2.4 GHz) cordless telephone. "Digital Spread Spectrum Technology," the promotion on the box read. "Smart Channel Select (32 channels)" the boasting continued.

How could a conventional analog scanner ever overhear a conversation on a digital, spread-spectrum telephone dividing its information over 32 channels? Apparently quite easily. Ryan, a seasoned radio enthusiast who knows the difference between digital and analog communications, was astounded when he turned on his scanner and heard his own clear voice while using his new Panasonic cordless phone, which stayed on the same frequency for minutes at a time. Did someone at Panasonic get his signals crossed?

Let's look at Panasonic's first premise, "Digital," defined by the electronics industry as the use of discrete electrical signals (bits) rather than continuously variable signals (analog) to convey information. Is the Panasonic signal digital? No, it is analog.

And how about their second claim, "Spread Spectrum," defined by the industry as a much wider spectral bandwidth than that produced by normal methods of modulation. Is the modulation of the Panasonic phone spread spectrum? No, it is frequency hopping (perhaps "frequency loping" would be a more accurate description!).

So is Panasonic lying? Is this a classic example of fraudulent advertising? Or is it simply another excusable excess in modern marketing? Another product of virtually unregulated, zealous, competitive marketing foisted on a desensitized and understandably skeptical, immured, distrustful society?

Ryan reports that when he called the manufacturer to discuss his experience, the spokesperson became very defensive, saying that Panasonic made no claims that their product couldn't be overheard, and that any cordless phone

conversation can be heard on a scanner (which is untrue when you are using a cordless set that is truly digital).

How would Panasonic defend its misleading claims? Perhaps by saying that the digital reference was to its operational circuitry which uses a microprocessor controller, and that over a period of time, because of changing frequencies, the telephone spreads over more spectrum than single-channel phones. Is their hype misleading? Only to those who really know – or care – what "Digital Spread Spectrum" really means!

■ More meaningless jargon

We see this sort of hyperbole on every shelf in every store, and in virtually every ad. How can anyone legitimately claim "the lowest prices in the country," or "the largest assortment available," or "the finest ___ you can buy anywhere?" We have learned to accept this largesse as an artifact of our culture.

And what the heck is "Imodium?" "Silkience?" "Thermogenic diet formula?" Do creamy-skinned clients really float through the marble halls of the Ponds' Institute? So much meaningless jargon has joined the lexicon of commerce, and so much visual misrepresentation overwhelms our senses of reality that, in this era of instant communication, we have become uncommunicative. Sadly, we seem to accept this combination of exaggerated claims and undefined terminology with complacency.

Did Alexander Graham Bell hold up his telephone with pride and announce that he had discovered a "dynamic acoustico-electric transducer"? Or did Guglielmo Marconi demonstrate his radio system while describing it as an "electromagnetic emitter/detector"? The public may have been suitably impressed by the vernacular, but uninformed. It seems that now all a merchandiser needs to do is make a meaningless or unsubstantiated claim ("the most comfortable ride you will ever experience"), contrive an evocative name ("Whisper 2000XLR"), and a new legend is born!

There are many excellent, responsive agencies, both governmental and private, which you can contact with your indignation. Support independent consumer watchdogs like Consumer's Union (publisher of *Consumer Report*). Contribute to unbiased political reform groups like Common Cause. Tell the errant companies' public relations offices what you really think. Share your outrage with newspapers, magazines, and phone-in radio programs. Don't be afraid to be heard; your voice does make a difference.

Or, sit back and be misled by the market brokers who will get by with whatever claims they can in the name of profit.

News, News, News,
Weather
on SANGEAN
Radios Daily

Radio Land

Vol. 24, Issue 1

Published by C. Crane Company, Inc.

Every Month 1999-2000

Two Radios from SANGEAN Take the Americas by Storm

ATS 909, World's Most Advanced Portable World Band Receiver

The ATS 909 is acknowledged among users as best performing multi-band portable radio in the world today. Rated best new receiver of the year by *World Radio and TV Handbook 1997*. Excellent audio quality and receiver sensitivity, representing the high quality workmanship that went into design and manufacturing.

A single button automatically sets local AM/FM stations into memory based upon the station's signal strength.

Adjustable tuning increments allow precise tuning of stations. It also comes preprogrammed with

many popular SW stations. Each one of its 29 pages can be identified with an alpha description. If a station is using RDS, their call letters will automatically appear on the screen.

The antenna jack is grounded making it suitable for a two wire antenna system.

Additional Features: RF Gain Control, Round Volume Knob, 306 Memories, Upper & Lower SSB, 40Hz resolution on SSB, Priority Key, Headphone Jack, Three Timers, Light Button, 150kHz to 30,000kHz.

\$259.95



SANGEAN ATS-909

CCRadio Acclaimed as Best Tabletop AM Radio Made Today

Never before has a radio been specially designed for talk radio, news, sports and weather.

The audio has been specially tailored for the full rich sound of the human voice.

The CCRadio was jointly engineered by C. Crane Company, Inc. and SANGEAN to produce the highest AM performance, along with FM, Weather Band with Alert, and TV Audio Channels 2-13.

Full digital controls and micro-processor give accurate tuning. The radio has memory storage for 5-stations on each band. The audio quality on FM is excellent

from the 5" speaker.

Additional Features: Adjustable Bass and Treble. Display is lighted with on/off button. Simple one touch memory setting and recall. Rotary tuning knob with 1KHz fine tuning. Selectable light or loud alarm for NOAA WX Alert. Clock with alarm. Sleep timer. Auto Scan and Stop. Bright LCD display. Built-in headphone jack. External AM antenna screws. Wide base for stability. Operates on 4 optional "D" cell batteries that last over 250 hours, or plugs in to the wall with (included) AC cord.

\$159.95



C. Crane Company's CCRadio by SANGEAN

World's Largest Manufacturer of High Performance Radios

SANGEAN

AMERICA, INC.

Website: www.sangean.com

Enthusiastically Representing SANGEAN Radios for 14 yrs.



1-800-522-8863 (TUNE)

Website: www.ccrane.com

Call for FREE CATALOG

SCANTASTIC!



This is no ordinary PC controlled Receiver



TRUNKER

Using two Optocom receivers, Trunker software may be used for control channel trunk following of Motorola®. Also use TrunkTrac® with one Optocom for control channel monitoring.



REACTION TUNE®

Use the popular Scout/Mini Scout/Super Scout to capture and instantly Reaction Tune the Optocom to the frequency captured. Ideal for mobile use and finding unknown frequencies.

The Optocom computer controlled receiver is no ordinary receiver. The Optocom provides solutions to applications that previously required multiple receivers, external decoders, and receiver modifications. Some features of the Optocom have never before been seen on a communications receiver. Ever! With an Optocom, you'll be poised to meet the changing scanning world.

FEATURES

- Frequency range 25-520, 760-823.995, 849.005-868.995, 894.005-1300MHz (cellular blocked)
 - Triple conversion GRE receiver board
 - Scan conventional frequencies at 50 channels per second
 - Trunk track Motorola and LTR on any frequency band
 - Scan conventional and trunked frequencies simultaneously
 - Track EDACS systems with additional third party program (E-Trax)*
 - Built-in data slicer for decoding of FSK data
 - Discriminator audio input and output
 - Reaction Tune with Scout/Mini Scout/Super Scout
 - Decode CTCSS, DCS, LTR and DTMF
 - Motorola control channel monitoring with Trunker software and two Optocoms*
 - Motorola control channel monitoring with Trunk Trac*
 - Palm Pilot support for frequency and tone display*
 - Store and Scan 100 frequencies for use away from computer
 - Supported by other third party scanning programs
- *Optocom includes: Trakkstar software, Palm Pilot software, Radio Manger for Windova, antenna, serial cable, and power supply



PALM PILOT™

Interface the popular Palm Pilot™ Connected Organizer to display the frequency being scanned as well as decoding of CTCSS, DCS, and DTMF while in Store and Scan Mode. Software included. Ideal for mobile applications



TRAKKSTAR®

Using the supplied Trakkstar software the Optocom has the ability to scan conventional frequencies, as well as trunk follow both LTR and Motorola Trunk systems.

*Trunker, Trunk Trac, E-Trax, Scout, Computer, and Palm Pilot Connected Organizer not included.

Order Now!
\$499

OPTODIRECT 800-327-5912
OPTOELECTRONICS®

5821 NE 14th Avenue • Ft. Lauderdale, FL 33334

Telephone: (954) 771-2050 Fax: (954) 771-2052 Email: sales@optoelectronics.com

Prices and Specifications are subject to change without notice or obligation

Order Online at www.optoelectronics.com