



Monitoring Times®

A Publication of Grove Enterprises, Inc.

Beam Me Up, SAREX!

Talking with the Astronauts

- Brazilian Voices on Shortwave
- Remembering the Edison, NJ, Gas Explosion
- Sixty Minutes in Cairo

*Antenna
Season
Kick-off!*



OPTOELECTRONICS™

WILL TAKE YOU PLACES YOU ONLY DREAMED OF BEFORE

R10 AND R20 INTERCEPTORS

Selftuning near field receivers with signal strength indicators.

R10.....\$359.00

R20.....\$119.00



R10 Interceptor is the fastest way to pick up nearby two way radio transmission, no matter what the frequency is. The R10 is a totally unique instrument for two way communications test, security, surveillance, and recreational monitoring. Twin LED bargraph for signal strength and deviation are on the front panel. Audio output is suitable for tone decoding with the DC440. Earphone, antenna, internal NiCad batteries, and adapter are included.

R20 RF General purpose Signal Strength detector also can intercept AM signals for earphone monitoring. Its small size and low cost make the R20 useful for transmitter checking, RF room sweeping, and monitoring nearby AM transmissions. R20 comes with a 9V battery and a built-in antenna.

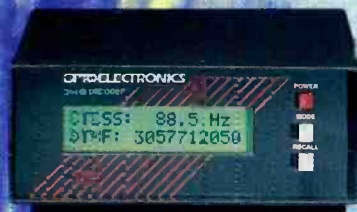

DC440 DECODER

Decodes DTMF, CTCSS, and DCS CIV compatible, optional nicad.

DC440.....\$259.00

Optonicads.....\$39.00

DC440 Decoder works with any receiver, service monitor or the R10 Interceptor to decode Subaudible tones (CTCSS) and codes (DCS) and Touch-tone (DTMF) characters. The display is a two line alpha numeric LCD with back light. Push-button switches control all functions from the front panel. CI-V serial interface supports computer controlled scanning with ScanStar Commercial software. NiCad battery pack is optional.

SCOUT 40

New frequency recorder-records up to 400 frequencies with 250 hits on each frequency and much more.

SCOUT.....\$449.00



Scout is much more than a counter, it is a frequency recorder with a 400 frequency memory. Up to 250 repeat hits are also stored with each frequency. Perfect for discrete, in the pocket frequency collection, or drive by monitoring. Exclusive "Reaction Tune" feature tunes an OS456 or Icom receiver instantly for monitoring. PC software is included to download frequencies and an optical CD, Spectrum for the Scout, can look them up in the FCC database. Rapid Charge, High Capacity Batteries, back lit LCD display, serial interface, beeper and pager style vibrator are included.

OPTOSCAN 456

Computer controlled interface. For use with the Radio Shack Pro 2005/6 Series Scanners.

OS456.....\$299.00



OptoScan 456 is the fastest computer controlled scanning system and the only one with Tone (CTCSS) Codes (DCS) and touch tone (DTMF) decoding standard. When installed in the highly regarded Pro-2005/6 receiver the OS456 is also much less expensive than any other computer controlled scanning system. Installation is easy with simple hand tools and only two solder connections. Supported by all popular Scanning Software.

ACCESSORIES

N100-FM Broadcast Band Notch Filter.....\$99.00

CF602-Cellular Band Pass Filter/Amplifier.....\$149.00

BLP70-Low Pass Filter.....\$36.00

BHP70-High Pass Filter.....\$40.00

CX12-RS232/CIV Interface Converter.....\$89.00

TA100S-Telescoping Whip Ant. with ENC connector.....\$12.00

DB32-Dual band VHF/UHF miniature antenna.....\$29.00

OPTOELECTRONICS™

ORDER LINE 8003275912

TEL: (305) 771-2050

FAX: (305)771-2052

5821 NE 14TH AVE, FORT LAUDERDALE, FL. 33334

VISA, MC, C.O.D., CASH OR MONEY ORDER-SHIPING

ADDITIONAL

ALL SPECIFICATIONS & PRICES ARE SUBJECT TO

CHANGE

WITHOUT NOTICE OR OBLIGATION.



Cover Story

Beaming the Astronauts into the Classroom

by Philip Chien

"How do astronauts go to the bathroom in space?" It's one of those questions we all have, but only children have the courage to ask. This interaction with children is one of the reasons the SAREX (Shuttle Amateur Radio EXperiment) has become so popular with the astronauts; almost 1/4 of them have now obtained their amateur radio licenses.

The capability for amateur radio has also meant the astronauts are available for amateur contacts—as time permits—worldwide. This article will show you how to set up a contact for your local school, or how to listen in on your scanner to the shuttle amateurs as they pass overhead. See page 9.

Brazilian Voices on Shortwave 16

by Valter Aguiar

To cover the enormous expanse of the Brazilian countryside, many domestic broadcast stations have resorted to shortwave radio to increase their audience. The side effect of this is a delightful challenge for the North American listener to pick up the local sports and music programming of our neighbor to the south.

Recollections of the Big Blast 20

by Louis Shirley

One year ago this month, a gas main in Edison, New Jersey, ruptured. The ensuing explosion and fire destroyed not only an apartment complex, but the peace of mind of the entire nation. With so many agencies involved and the origin of the blast initially unknown, it resulted in a scanning experience unlike any other the author has experienced.



Antenna Season Kick-off:

Elements of Antenna Selection 26

by Bob Grove

Bob Grove lays to rest some common misconceptions about antenna theory and performance.

Put Backbone in Your Dipole 28

by Wayne Mishler

In a dipole, the center connection is the key to it all; here's how to construct a connector that is electrically and mechanically sound.

Sixty Minutes in Cairo 30

by Chuck Hodell



What would a true DXer do with sixty minutes to spare in an Egyptian hotel? Check out the shortwave bands, of course!

Reviews:



"Move over, Radio Shack PRO-2035," says reviewer Bob Parnass, "the Bearcat BC9000XLT, Uniden's top of the line base scanner, is here and it's a winner." Check out the performance of this sensibly designed base scanner on page 100.

On the other hand, the shortwave receiver reviewed this month by Larry Magne doesn't stand up nearly as well. Though Sangean receivers have enjoyed a fine reputation, Magne says in recent years they've been falling farther behind in terms of performance, and the SG 789A is no exception.

DEPARTMENTS

Letters	4
Communications	6
Utility World	32
Scanning Report	36
<i>Beyond UHF</i>	
Beginner's Corner	40
<i>Parts Procurement</i>	
Shortwave Broadcasting	42
QSL Report	46
Shortwave Guide	47
Propagation Charts	76
Programming Spotlight	78
<i>VOA's Talk Radio</i>	
American Bandscan	80
<i>Books for the DXer</i>	
Federal File	82
<i>PostScripts</i>	
High Seas	84
<i>KFS Adds VCT</i>	
Satellite TV	86
<i>Sat-TV for News Hounds</i>	
Below 500 kHz	88
<i>Survey; Winter DX</i>	

On the Ham Bands	90
<i>Three Short Antennas</i>	
Outer Limits	92
What's New	94
Scanner Equipment	100
<i>Uniden BC9000XLT</i>	
Magne Tests	102
<i>Sangean 789A</i>	
Computers & Radio	104
<i>Mouse Power</i>	
DeMaw's Workbench	106
<i>Understanding Transmitters</i>	
Experimenter's Workshop	108
<i>Tape Recording Volume Control</i>	
Antenna Topics	110
<i>Selecting an Antenna</i>	
Ask Bob	112
<i>SW on a Scanner Antenna</i>	
Club Circuit	116
Special Events	117
DX Tests	117
Stock Exchange	118



MONITORING TIMES (ISSN: 0889-5341) is published monthly by Grove Enterprises, Inc., Brasstown, North Carolina, USA. Copyright © 1995. Second class postage paid at Brasstown, NC, and additional mailing offices. Short excerpts may be reprinted with appropriate credit. Complete articles may not be reproduced without permission.

Address: P.O. Box 98, 300 S. Highway 64 West,
Brasstown, NC 28902-0098
Telephone: (704) 837-9200
Fax: (704) 837-2216 (24 hours)
BBS: (704) 837-9200 (M-F 5:30 pm-8 am; 24 hours on weekends)

Subscription Rates: \$23.95 in US and \$34.00 US funds elsewhere; Call for new overseas air rates. Label indicates last issue of subscription

Postmaster:
Send address changes to *Monitoring Times*,
P.O. Box 98, Brasstown, NC 28902-0098.

Disclaimer:
While *Monitoring Times* makes an effort to ensure the information it publishes is accurate, it cannot be held liable for the contents. The reader assumes any risk for performing modification or construction projects published in *Monitoring Times*. Opinion or conclusions expressed are not necessarily the view of *Monitoring Times* or Grove Enterprises. Unsolicited manuscripts are accepted. SASE if material is to be returned.

Owners

Bob and Judy Grove

Publisher

Bob Grove, WA4PYQ

Editor

Rachel Baughn, KE4OPD

Art Director

John Bailey

Advertising Svcs.

Beth Leinbach
(704) 389-4007

Business Manager

Kelly Davis, KE4TAM

Editorial Staff

Frequency Manager ... Gayle Van Horn
Frequency Monitors ... David Datko
Program Manager ... Jim Frimmel
Beginner's Corner ... T.J. Arey, WB2GHA
Plane Talk ... Jean Baker, KIN9DD
Computers and Radio ... John Catalano
Below 500 kHz ... Kevin Carey, WB2QMY
Experimenter's Wkshp ... Bill Cheek
DeMaw's Workbench ... Doug DeMaw, W1FB
Federal File ... John Fulford, WA4VPY
Digital Digest ... Bob Evans
Ham DX Tips ... Rob Gerardi, N9LAG
SW Broadcasting ... Glenn Hauser
High Seas ... James R. Hay
Scanning Report ... Bob Kay
On the Ham Bands ... Ike Kerschner, N3IK
Propagation ... Jacques d'Avignon
Magne Tests ... Lawrence Magne

Communications ... Larry Miller
What's New? ... Larry Miller
Scanning Equipment ... Bob Parnass, AJ9S
Satellite TV ... Ken Reitz, KC4GQA
Antenna Topics ... W. Clem Small, KR6A
American Bandscan ... Doug Smith, W9WI
SW Broadcast Logs ... Gayle Van Horn
QSL Corner ... Gayle Van Horn
Utility World ... Larry Van Horn, N5FPW
Outer Limits ... George Zeller

Correspondence to columnists should be mailed c/o *Monitoring Times*. Any request for a personal reply should be accompanied by an SASE.

Can your multi-mode adapt to the changing world?



Ours can.



It seems good hardware is becoming an endangered species in multi-modes. Not so with AEA's PK-900. It is the hardware that allows the PK-900 to evolve, to grow as you do. We've given the PK-900 three dedicated processors and an innovative circuit design for power and flexibility.

Switch between radio ports with a keystroke using the dual simultaneous ports. Gateway from packet to AMTOR, packet to PACTOR, and packet to packet. Bounce packets off satellites using the optional 9600 bps modem.

The PK-900 has the same eight-pole Chebyshev bandpass filter as the acclaimed

PK-232MBX for superior HF performance. It has hardware-memory ARQ for reduced errors. The easy-to-read LCD panel keeps you informed of all activity at all times.

You want modems? The PK-900 offers twenty software selectable modems and there are optimized modems for AMTOR, PACTOR, 45 baud RTTY, and packet. There is even a TAPR disconnect header so you can plug in other modems.

Call AEA's Literature Request Line at (800) 432-8873 for more information, or call us direct at (206) 774-5554. See your favorite ham radio dealer for best prices.

The PK-900 is the natural selection.



Connect with us

The Forgotten Americans

■ “Thanks for the January issue’s feature article on Argentina. It’s interesting that the first radio station was probably in Argentina, not in the USA,” says Victor Garcia-Rivera of Fairfield, Ohio. “As a Latin American, I agree with the author that too frequently people in the USA ignore their Latin neighbors and are more concerned with events in Europe and Asia. United States natives should note that when they refer to themselves as ‘Americans,’ they exclude the millions of people who are also ‘Americans,’ such as Brazilians, Cubans, and anyone else who comes from this hemisphere.

“Here are the current winter times and frequencies for Radio Martí that you may find of interest.”

0600-1200 UTC	6030 kHz
1200-1400 UTC	9565 kHz
1400-2300 UTC	11930 kHz
1500-1800 UTC	11740, 11815 kHz
2300-0200 UTC	6010, 9525 kHz
0200-0400 UTC	6030 kHz
0400-0600 UTC	6004 kHz

Thanks, Victor. Since you expressed an interest in seeing more articles on broadcasting in the “Americas,” I know you’ll be pleased with the article on Brazil in this issue.

Super-Scanner from the Frozen North

■ It’s always a pleasure to hear from John Musgrove, wintered in Knight Inlet in British Columbia, Canada (pictured). In the winter John leaves the cramped quarters of his sailboat for a cabin built on a log raft in a small tidal-lagoon. A nearby lake is the head-pond for his 120 watt 12vdc hydro plant. Last summer we asked John about his “survival” gear. Here is what he listed: Lowe HF 150, PRO2006, Realistic CTR-76 tape recorder, two 6AH gel-cells, a 4-watt solar panel. The “home-base” has a Larsen 1/4 wave (with which he says he’s not satisfied) with RG214 cable for the PRO2006. A longwire for SW. A heavy (transmitting) 1:1 balun used for various dipoles. The “Hydro,” a 45 watt solar panel, and 8D 200+ amp hour deep-cycle battery.

Since receiving the *Scanner Modification Handbooks I and II*, John says, “my PRO2006 is a super-scanner now. The null-meter from my old RDF is now the center-tuning indicator for the PRO. Sitting on top of my PRO is my new S meter—the movement and upper half of an el-cheapo 2000 Ω /volt multimeter. To its right is a pair of boxed ex-VU meters

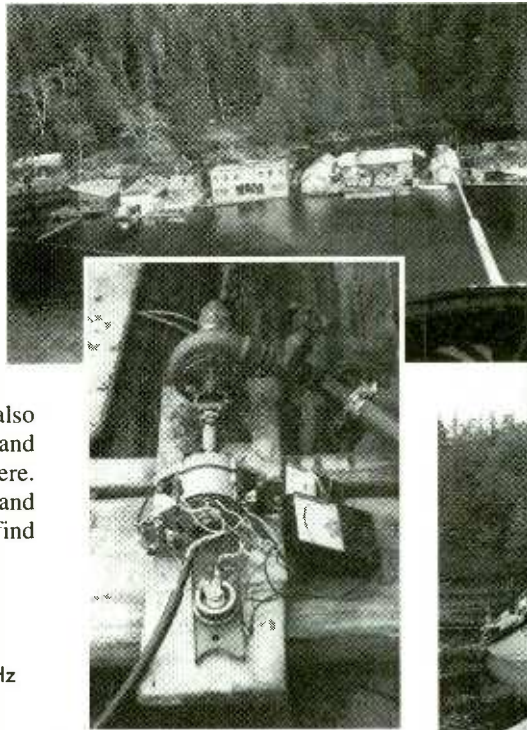

John Musgrove’s winter hideaway, near Knight’s Inlet, British Columbia (seen from the air), is a beachcombed cabin with homebrewed VHF and sloping longwire antennas. His homemade hydro “cost \$18 and lots of scrounging. It’s a bronze bilge pump from a 1944 diesel engine—run backwards and hitched directly to an alternator.”

from an old Marantz tape recorder. The left meter is to be a 12 vdc voltmeter; the right is a center-tuning meter. To the right of the read-out of the PRO are red and green LEDs - ‘Carrier On’ mod. Looks pretty—is useful, but the green LED is superfluous. I’ll add to this mod by adding a set-internal on/off switch.

“To the right of the PRO is an Archer FM preamp. The 120 vac transformer has been removed and 12 vdc run in. The RF traps are deleted and RF signals run, via a capacitor, directly to the amp transistor. Works very well below 300 MHz.

“My Lowe HF150 sits to the PRO’s left, with a tape-recorder between. The PRO’s 455 IF is tapped via a BNC connector on its rear and can be hitched to the HF150’s 50 Ω antenna jack.

“The squelch has been tightened on the PRO as per ‘Dr. Rigormortis.’ (Of course, ‘cell’ was the first mod!) Also the circuitry ‘tweaked’ on the PRO. All my dissatisfactions with the PRO are gone. I used to hate the sloppy squelch; was highly dissatisfied with its sensitivity; and wanted an ‘S’ meter.

“My PRO2006 also has an ‘event counter.’ This started life as a ‘Step Counter’ on an exercise machine. It was triggered by a magnet/inductor sensor which reverse biased an 0.005 volt signal circuit. Now it’s hitched to the PRO on a mod of Dr. Rigs’s ‘Event Counter’ mod. It reads up to 9990 events, beeps each event (can be defeated by snipping a diode), can be set to run backward. But it has a flaw! If no events happen in a 5 minute

period it gets bored and shuts off. It’s actually very useful on a busy channel if set at 60 min. After 60 minutes have passed it beeps for 5 secs and shuts down with the total events displayed, so you get events per hour.

“The PRO-2006 is keeping me amused. I hitched it, with the preamp, to the log-periodic yagi and listened to the police channels from nearly the whole length of Vancouver Island. Right now I’m back to my usual 1/4 wave ground plane. I pick up ‘Vancouver traffic’ (marine). So far, the record for distant reception of a boat to the south is 104 nautical miles — to the north 100 nautical miles. Not bad for 24 watt transmitters.”

What else does John do for amusement? He’s rereading the last twelve months of *MT!* “Lots of ‘meat’ in them!” says John.

DXers’ Aids Slipping Away?

■ Kevin Hecht of Devon, PA, suggests that Harold Bower’s unID on 15500 kHz (Dec p.14) was likely a relay of Dr. Gene Scott’s program via Novosibirsk, Russia, which was mentioned in Hauser’s Sept column, though not in *Passport*. He says such stations are notorious for radical seasonal frequency changes. “Magazines and handbooks cannot hope to be up-to-date because of the tremendous number of changes occurring all of the time and their production schedules. The fastest way to get up-to-date info remains via DX

(Continued on Page 114)

LOOK

Finest Available The FCC Frequency Almanac[®]

We Have Everyone's Numbers
and Everyone IS Talking.
Look and See Why!

- Direct From FCC Data Files.
- Covers All Land Mobile and Fixed Services Between 30MHz and 2GHz.
- Books For Each Of The Fifty States.
- From The Publishers of Frequency Directories for over 15 Years.
- One Book Per State, More Pages And Frequencies Than Other Directories!

\$24.95ea

CA, FL,
IL,
NY, TX

\$19.95ea

AK, AL, AR, AZ, CO,
CT, GA, ID, IN, IA,
KS, KY, LA, MA, MD,
MI, MN, MO, MS, MT,
NC, ND, NE, NJ, NM,
NV, OH, OK,
CR, PA, SC, TN,
UT, VA, WA, WI,

\$9.95ea

DE, HI, ME,
NH, PR&VI,
RI, SD, VT,
WV, WY,

Compare The Page Counts To Other Directories

State	Pages	State	Pages
AK	96	MT	136
AL	208	NC	334
AR	184	ND	115
AZ	176	NE	206
CA	829	NH	88
CO	224	NJ	272
CT	100	NM	94
DC	See MD	NV	96
DE	48	NY	504
FL	472	OH	480
GA	336	OK	230
HI	56	OR	127
IA	272	PA	464
IL	128	PR/VI	116
IN	520	RI	56
KS	320	SC	164
KY	252	SD	121
LA	223	TN	261
MA	212	TX	840
MD	231	UT	104
ME	152	VA	270
MI	120	VT	72
MN	365	WA	172
MO	292	WI	288
MS	280	WV	136
	170	WY	128

U.S. Scanner News

Published By
U.S. Scanner Publications

The ONLY national
monthly magazine
devoted entirely to the
hobby of VHF-UHF
monitoring.

**No Shortwave,
No Broadcast!!**

Each Month You Get:

- Outstanding feature articles
- In-depth, unbiased reviews
- Accurate frequency information
- The latest FCC actions
- Helpful scanning and technical hints
- Plus regular monthly columns

**1yr \$18.00; 2yr \$32.00;
3yr \$46.00**

Sample Copy
\$3.00 1st Class

1st Book Add:

\$3.95 S&H For 4th Class Or:

\$5.95 S&H For Priority Mail (2-3 Days)
(\$6.95 For CA, FL, IL, NY, TX)

For More Than 1 Book Add \$1.00 S&H Per Book



Same Day Shipping

Order By Phone or Send Check or Money Order To:

1-800-890-6999
US SCANNER PUBLICATIONS
PO BOX 14923
PORTLAND OR 97214-4923
FAX (503) 233-5176 (503) 230-6999



Talk to the Trees

■ The trees are growing well in Detroit's Upper Peninsula—perhaps too well. And the reason has nothing to do with the old staples of sun, fresh air and water. The growth—sometimes as much as 50% over normal—has to do with radio waves. The Navy's Extra Low Frequency (ELF) antennas, used to chat with submarines, apparently are stimulating faster tree growth.

"We didn't really know what would happen," said Dr. Glenn Mroz of Michigan Technological University in Houghton. "But we found that aspen, red maple, and red pine grow faster when exposed to ELF's magnetic fields." Mroz has been examining the phenomena over a ten year period, watching an area between 50 and 150 meters around the ELF antennas. The study has collected data both before and after the grid was installed in the wooded area.

Mroz says that aspen show up to a 50 percent increase in diameter and red pine up to ten percent. Scientists are stumped as to why the low frequency radio waves stimulate tree growth. What it's doing to people's bodies is unknown. The Upper Peninsula's 56-miles of ELF antennas were installed in 1989 amid much concern for human health and environmental impact.

Neither Rain Nor Sleet...

■ Postal workers are known for their ability to get the mail through, no matter what the weather or the obstacles in their path. Increasingly, the obstacles haven't been rain or snow, but attacks by thieves.

Britain's Royal Mail recently awarded a contract to CTL Radicom for a computer based two-way radio system called P.A.T.S.. The Personal Alarm Terrestrial System, installed in London, gives postal workers greater safety during their daily rounds.

Unmanned computers at a central dispatch office interrogate handheld Motorola Select 5 GP300 transceivers periodically throughout the day. If the postal carrier fails to click on or respond when interrogated, the system tries a second contact. If this fails to elicit the correct response, Royal Mail security officers are alerted. The radios also have an alarm button, as well as voice communications, which allow field workers the ability to communicate with the dispatch office.

Initial tests of the system have proved successful.

Unit 327, Will You Marry Me?

■ In between answering emergency calls, Bensley-Bermuda Volunteer Rescue Squad member Angela Wells found time to answer a call of a different type—a marriage proposal. Fellow rescue squad member James Redmond was following Wells in another ambulance when he decided the time was right.

Motoring along State Route 10 in Chesterfield County, Virginia, Redmond picked up the mike: "I called Unit 327 and asked them to switch to Tac 3A. I asked them to put Angela on, and when she got on I said, 'Angela, this is James. Will you marry me?' She didn't say anything for the longest time."

Angela Wells recalls thinking, "Oh, my Lord, this is over the air and everybody and his brother can hear this! I kind of sat there and cried ... I was sitting there stunned."

After a few anxious moments, Wells replied, but Redmond didn't understand her and asked for a repeat. "She said yes."

Angela Wells and James Redmond were married at the Second Baptist Church in Chester, and Redmond drove his bride to the reception at the Bensley-Bermuda Volunteer Rescue Squad station



in the same ambulance from which he proposed.

MurderScan I

■ The wrapping paper was hardly off Donna McGee's new PRO-2006 scanner when the first cordless phone conversation tumbled from the airwaves and into her living room.

"Are you sure you want to go through with this?" asked a man's voice. A woman replied that she was. "Do you really love me enough to kill for me?" asked the woman. "Yes, I do," said the man calmly. "Do you have any doubts?" The couple then talked about entry points and how the man could best enter the home and murder the woman's husband.

McGee and her family, who were listening, eventually recognized the identity of the callers. Jacqueline Lee Greene, 32, and Christopher Davis, 21, were arrested and charged with conspiracy to murder Greene's husband, James Kenneth Greene. The Sheriff's Department also charged Davis with criminal attempt to commit murder.

"It appears their motive was to collect the insurance money and get out of debt, and for them to continue their lives together," said Sheriff's Captain Joe Ball. There was nothing illegal in McGee's interception of the cordless conversation, according to Ball, "because it was a random scanning."

MurderScan II

■ When Cedar Rapids plastic surgeon Thomas Pauly killed himself by lethal injection, his life insurance policy topped out at \$750,000. The beneficiaries were his divorced wife of 24 years, Mary, and son, Greg. Two months after the death, Mary married Michael Von Smith and moved to Tampa, Florida.

It wasn't long after that the trouble started. The son, Greg, told *The Gazette of Iowa* that Von Smith became "progressively more abusive. He told my mother, 'You're not going to divorce me.'" Shortly thereafter, a neighbor listening to a scanner overheard Von Smith setting up a hit on his wife and stepson. The neighbor taped the calls and turned them in to police. Von Smith was arrested the following day, as was alleged hit-man Bradley McNeil.

1-900-SEX

■ Soldiers at Aberdeen Proving Grounds in Maryland are reportedly using the base phone patch

repeater to make calls to 1-900 sex numbers. 416.250 MHz has been heard, with users making the phones patches by giving their name and credit card information to the receiver who is making the hook-up. Radio Monitors of Maryland reports that a few listeners have taped these illicit conversations, which are apparently taking place without command approval.

FCC Sues for 3 Million

■ The FCC has notified Centel Cellular of North Carolina Limited Partnership of an apparent liability for forfeiture in the amount of \$3,000,000 for violating three of the Commission's rules governing tower construction, lighting, and marking.

Reportedly, Centel did not notify the FAA before constructing an antenna structure that penetrated the air safety zone of Greensboro/Piedmont Triad International Airport. Neither did it obtain FAA approval for the tower construction nor provide the required safety lighting on the tower.

"We consider these violations extremely serious because of the potential danger to aviation," says the FCC Notice. "Our concern in this instance is heightened because it appears that the licensee was negligent in preparing to construct this tower. We rely on the diligence of our licensees and we cannot countenance such a failure."

FCC Sued for 2.9 Million

■ A Los Angeles area two-way radio dealer and SMR operator is suing three employees of the FCC's Private Radio Bureau for violations under the Fourth, Fifth, and Eighth Amendments. The complaint by James A. Kay, Jr. alleges that W. Riley Hollingsworth of the Bureau's Licensing Division failed to act on his license applications and related petitions.

Kay claims that Hollingsworth dismissed 22 of his applications and failed to take timely action on his petitions, while others with later-filed applications were treated satisfactorily. The complaint also charges Terry L. Fishel of the Land Mobile Branch with violation of several FCC rules involving proof of service, ex parte presentations, requirements for referring decisions to the full commission and not attempting to resolve contractual disputes.

The third employee named in the suit, Anne Marie Wypijewski of the Licensing Division, is accused of sending copies of a letter written to Kay by Hollingsworth to six

private individuals, violating a federal law. Kay is asking a federal District Court for \$900,000 in consequential damages and \$2 million in punitive damages.

No Cucumbers Here

■ Minsk, the private Belarusian television company, has begun broadcasts to Western Europe, the European section of the Commonwealth of Independent States, and North America. One of the aims of the satellite broadcasting is to "show that Belarus is not a country of cucumbers, and that we also have something of which to be proud," according to a Radio Minsk report. Early observations showed Minsk TV transmitting on the Gorizont satellite at 11 degrees West, transponder frequency 1525 MHz.

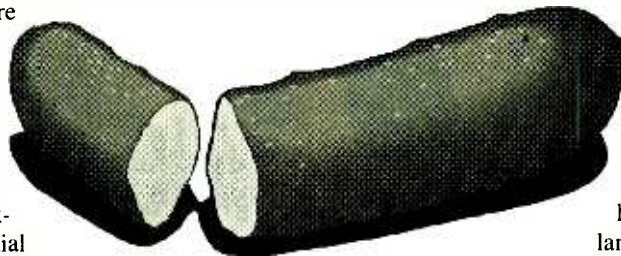

Ariane, Down in Flames

■ France Inter Radio in Paris reported that an Ariane rocket launched from Kourou crashed a quarter of an hour after launch. The rocket, sent up from the satellite launching station in French Guiana, was carrying PanAmSat-3, which was lost along with the rocket. Television Nacional de Chile was one of the services to be carried by the new satellite, which would have covered the Americas from the Antarctic to Alaska with a digitized and encoded signal.

Government at Work

■ In the 1980's, an agreement was made between the US and former Soviet Union to destroy all chemical weapon stockpiles by the year 2004. Of course, in typical government fashion, no one bothered to figure out how or by whom all this would get done. And thus begins our journey.

Congress delegated the US Army to ensure that citizens would be protected from any hazards associated with the storage and destruction of weapons at eight US stockpile locations. Notifying area residents of a problem fell to the Federal Emergency Management Agency (FEMA), who channeled funding for an alert and notification system to

Oregon's Emergency Management Agency. This agency formed the Oregon Chemical Stockpile Emergency Preparedness Program (CSEPP) in the state's north-central region near the Umatilla Army Depot.

24,000 residents live in the area, a region of steep-sided hills that pose a problem for radio communications. TRW has recently been awarded a contract to design a 160 MHz UHF system for alert and notification. Should a chemical weapons accident occur, signals would be transmitted from emergency dispatch centers to 10,000 field radios—one in each household and in schools and hospitals. The alert would also trigger 42 sirens and lighted road signs. The system should be delivered within one year.

Digital Weather Service

■ CommPower, Incorporated, of Camarillo, California, has been awarded a contract to design digital radio stations for the National Weather Service. The first prototype of the system will be tested by the end of 1995 at Weather Service headquarters located in Silver Spring, Maryland.

Should the system be approved, CommPower holds an option to install up to two hundred additional systems nationwide in 1997. The digital stations will include computer-generated voices, replaced some of the scripts read by on-air forecasters and the ability to broadcast emergency weather information to certain regions using a code.

The new equipment is sorely needed, as some employees of the Weather Service are using twenty-year-old equipment for forecasting.

"Communications" is written by Larry Miller with help from Laura Qaurantiello, Rachel Baughn, and the following readers who are members of the Communications Media Monitoring Team: Don Bishop, KS; Todd Bomer, N. Baltimore, OH; James T. Brown, Carmel, CA; Ron Bruckman, MD; Everett Eschen, North Liberty, IA; R. Johnson, White Deer, PA; Doug Robertson, Oxnard, CA; Brian Rogers, Allen Park, MI; David Simpson, UK; Richard A. Sklar, Seattle, WA; Lynn Snyder, Jonesborough, TN, and Jim Turner, Colorado Springs, CO. Our best wishes to regular contributor Dr. Ivan Mesmer, who has accepted the post of director at Radio Rus in Stavropol, Russia. We also consulted the following publications and we list their names in appreciation: BBC Monitoring *Summary of World Broadcasts*, *National Scanning*, *Radio World* and *W5YI Report*.

**Who has the largest known supply of
this famous model Realistic® scanner?**



We Do!

With no crystals needed, this fully-restorable unit delivers a wide range of frequencies not found on most scanners—including public service, broadcast FM, military bands and CB. Resists strong signal overload interference. Frequency range includes 25-520 and 760-1300 MHz (less

cellular—restorable). Rapid 26-channel-per-second scan and search complements this scanner's excellent interference immunity for metropolitan monitoring. Built-in speaker and telescoping antenna are included. Jacks provide for external speaker, tape recorder and DC adaptor.



 **Only \$369.95**
Plus \$8 Second Day Air Shipping
(In the U.S. only)

To place an order call **1-800-438-8155**
(US and Canada) or **704-837-9200**
or write to *Grove Enterprises, P.O. Box 98,*
Brasstown, N.C. 28902

Beaming the Astronauts Into the Classroom via

SAREX

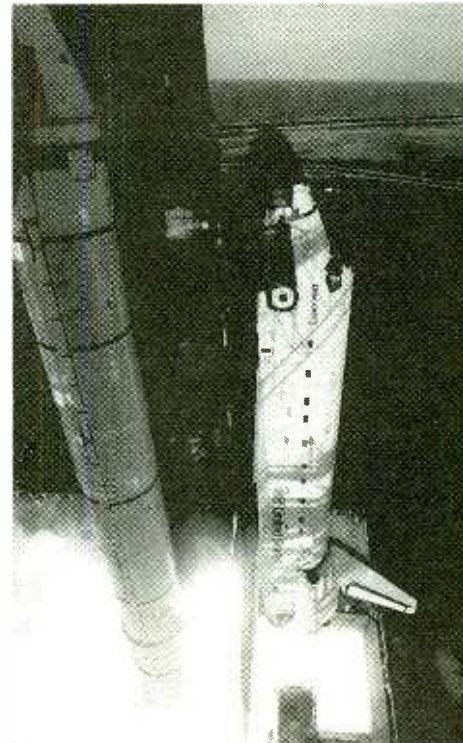
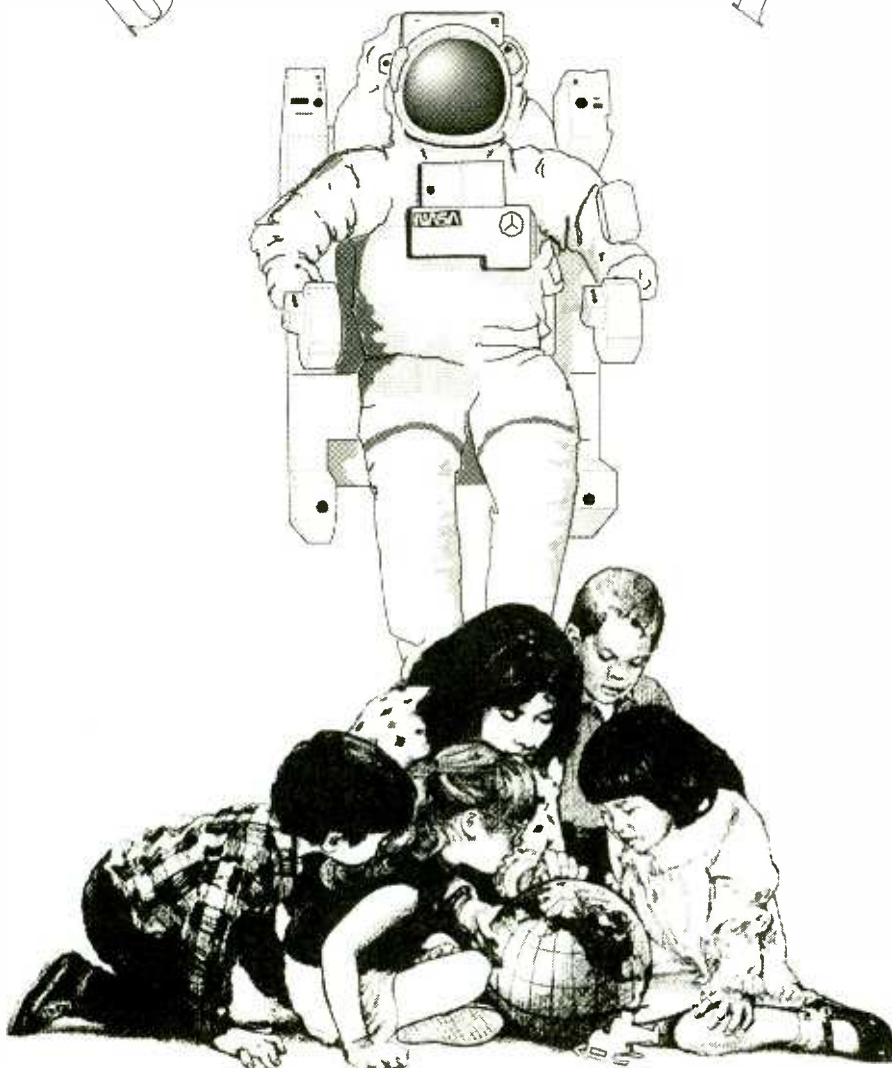

By Philip Chien KC4YER
E-Mail PCHIEN@IDS.NET

One of the most exciting contacts for an amateur radio operator has to be talking to an astronaut in space. The Shuttle Amateur Radio Experiment (SAREX) carries a handheld amateur radio transceiver on the space shuttle whenever an astronaut is interested and the crew's schedule permits. SAREX has flown over a dozen times and is typically flying on three or four missions each year. Approximately one fourth of the current astronaut corps have obtained their amateur licenses, primarily due to the efforts of astronaut ham Ken Cameron KB5AWP.

■ The Shuttle Goes to School

The popular SAREX experiment is sponsored by NASA's Office of Education, and education is SAREX's primary purpose. On each mission several preplanned educational contacts are scheduled within the crew's timeline. The astronaut will use the Motorola 300S transceiver to contact a ham radio operator at the school. Students at the school then ask the astronauts questions about their mission, experiments they're working on, or how they became astronauts. Typically the shuttle is above the horizon for about five to nine minutes and a dozen or so questions are answered before the shuttle gets out of range.



Astronaut Bill McArthur KC5ACR using the SAREX ham radio experiment during the STS-58 mission.

It's an incredible experience for the students and teachers at the school, the hams involved, and the astronaut.

One of the questions most often asked to astronauts is "How do you go to the bathroom in space?" and they've been asked it so often that they don't even blush when they answer! (For the record: Bob Cabana told one student "The urine is pumped overboard and the fecal matter is stored in containers as part of our waste control system, with odor and bacterial filters. When we fill up one container we put another one in and they end up coming back to Earth.")

Occasionally there are problems with the school contacts. The most common reason for an unsuccessful school contact is the astronaut being needed for some other duty on the shuttle. Since SAREX is a secondary payload it has lower priority than the mission's

primary payload for access to the astronaut's time. Other reasons for unsuccessful contacts include incorrectly configured equipment or the shuttle in a bad attitude with the antenna's pattern pointed away from the school. The crew's schedule includes time for backup opportunities in case things don't go right the first time, and virtually all of the school contacts are successful either on the first or second attempt.

In many cases the primary payload's orbital requirements will result in a flight profile which does not make good passes over the school. The passes may be in the middle of the night, or the school may be too far north or south of the flight path. In these cases a phone bridge is used. The shuttle contacts a prearranged ground station, typically in Hawaii, Texas, or Florida. From there the audio is transmitted via a phone conference call to a

ham close to the school. The school is typically patched in via a local ham radio repeater.

■ Signaling SAREX

If you want to participate in a SAREX contact it's extremely simple. Just contact a local school and talk to the education coordinator or head of the science department. It can be the school you graduated from, the school your kids go to, or just a school close to where you live or work. Ask them if they'd be interested—and it would be difficult to get a negative answer. The thrill of a successful contact makes it worth all of the effort. Teachers have described SAREX contacts as the most exciting parts of their professional careers, students are incredibly enthusiastic about talking to an astronaut in space, and the hams involved get great enjoyment out of helping out.

Contact the Amateur Radio Relay League's educational department and ask for a SAREX application. This is a simple two-page form with basic information on the school, its location, and your equipment.

While you're waiting for your application to be processed you should get your school interested in amateur radio and the space program. Optional (perhaps extra credit) amateur radio courses are an excellent way to get kids interested in ham radio, and NASA's education department will be glad to provide generic materials on the shuttle and its activities. Unfortunately, their SAREX information sheet is badly out of date, but it still has some good information.

A SAREX contact is a high visibility project which shows how amateur radio benefits the public at large, something which will hopefully be remembered the next time some zoning board wants to restrict outdoor antennas!

Education is the most important purpose for SAREX, but there is usually also time for the astronauts to make random contacts (QSOs) with hams around the world. If an astronaut has time available he or she can just pick up the radio and call CQ. For general contacts the shuttle will always transmit on 145.550 MHz in the two meter amateur radio band. While the transceiver only puts out 2.3 watts it is powerful enough to be heard on a handheld transceiver or scanner. Not surprisingly when an astronaut is available there are hundreds or thousands of hams trying to get through to the shuttle. At a typical shuttle altitude an astronaut can theoretically communicate with hams over an entire continent at once.



COPYCAT

The ONLY Commercially Available Computer Control Program
for the Universal M-7000 & M-8000

Also, supports AEA's PK-232 and the MFJ-1278



Features

- 32K Incoming Text Buffer
- Mouse Support (but not required)
- Runs on any 640K PC Compatible
- Pull Down Menus
- 20+ Programmable Macros
- On Line Help Screen

FINALLY, an IBM-compatible COMPUTER CONTROL PROGRAM for the M-7000 and M-8000. Let COPYCAT free you FOREVER from remembering all those buttons and keys. COPYCAT does it all! Simple "PULL-DOWN" menus control all functions. No more looking through complicated manuals or searching for buttons ALL commands are in plain English. *PLUS* COPYCAT has a fully editable text buffer, with cut & paste. Save/load/edit/print files. PROGRAMMABLE macros and much more. COPYCAT supports ALL the above units within ONE program. Simply select your unit from COPYCAT's EASY-TO-USE menu and GO!

COPYCAT \$69.95 (DEMO DISK \$5.00 Refundable with purchase)

(Be sure and order our serial adapter if you do not have the specially wired cable for the M-7000/8000)

SERIAL CABLE ADAPTERS FOR M-7000 AND M-8000 \$24.95.
SHIPPING/HANDLING \$5.00 (\$7.50 Foreign)



COMPUTER AIDED TECHNOLOGIES

P.O. Box 18285 Shreveport, LA 71138

Orders Only (318) 636-1234 - FAX (318) 686-0449 (24 hrs)

Live Tech Support - (318) 687-2555 (9 a.m. - 1 p.m. Central M-F) NiteTime BBS (SCANCAT File Area) (318) 631-3082 (7 p.m. - 6 a.m. Central)

Order direct or
contact your
favorite dealer

Weather Stations/Scanners/CB

COMMUNICATIONS ELECTRONICS INC.
Emergency Operations Center

New Weather Products Available

Now readers of *Monitoring Times* magazine may purchase weather forecasting and communications equipment directly from the Weather Bureau, a division of CEI. Order today and save.

Weather Stations

Now you can be your own weather reporter with the Davis Weather Monitor II. Our top-of-the-line weather station combines the most advanced weather monitoring technologies available into one incredible package. Glance at the display, and see wind direction and wind speed on the compass rose. Check the barometric trend arrow to see if the pressure is rising or falling. Push a button, and read indoor and outdoor temperature, wind chill, humidity and barometric pressure. Our package deal includes the new ultra high resolution 1/100 inch rain collector part #7852-K, and the external temperature/humidity sensor, part #7859-K. The package deal is order #DAV1-K for \$479.95 plus \$15.00 shipping. If you have a personal computer, when you order the optional Weatherlink computer software for \$139.95, you'll have a powerful computerized weather station at an incredible price. For the IBM PC or equivalent order part #7862-K. Apple Mac Plus or higher including PowerBook, order part number 7866-K.

The Weather Monitor II (7440-K) comes complete with 40 feet of cable, external temperature sensor with 25 feet of cable, junction box with 8 feet of cable, AC power adapter, detailed instruction booklet and one year limited factory warranty.



Davis Weather Monitor II 7440-K	\$334.95
Davis Weather Wizard III 7425-K	\$154.95
Davis Remote Display Unit 7815-K	\$84.95
Davis Rain Collector II 0.01" 7852-K	\$59.95
Davis Rain Collector II 0.2 mm 7852M-K	\$59.95
External Temperature/Humidity Sensor 7859-K	\$39.95
Davis Anemometer Mast Mount 7890-K	\$15.95
Weatherlink Software for IBM PC-Version 3.0 7862-K	\$139.95
Weatherlink Software for Apple-Version 3.0 7866-K	\$139.95
4-Conductor 40' (12.2 m) extension cable 7876-K	\$17.95
6-Conductor 40' (12.2 m) extension cable 7878-K	\$21.95
8-Conductor 25' (7.6 m) junction box cable 7880-K	\$14.95
8-Conductor 50' (15.2 m) junction box cable 7881-K	\$24.95
8-Conductor 100' (30.5 m) junction box cable 7882-K	\$44.95
Modem Adapter 25-pin for communications port 7870-K	\$9.95
Car/Boat/TV Lighter Cord 7873-K	\$9.95
2400 baud modem for Weatherlink MEXT-K	\$39.95
Talking weather line card - Call 313-994-9000 for demo ITI-K	\$489.95
Weatherlink language disks: Francaise, Deutsche, Italiana, Española 7863-K	\$24.95
Barometer, Indoor Hygrometer & Thermometer, Clock/Calendar BA888-K	\$99.95
Indoor-Outdoor Thermometer/Barometer & Hygrometer by OSI BA213-K	\$79.95
Thermometer with transparent calendar & clock display by OSI TC188-K	\$19.95
Thermometer with AM/FM clock radio by Oregon Scientific CR388-K	\$39.95
Indoor/Outdoor Thermometer with Juno Display by OSI JB880EX-K	\$24.95

Bearcat Scanners

Bearcat 9000XLT-K base/mobile	\$399.95
Bearcat 8500XLT-K1 CLOSEOUT	\$319.95
Bearcat 3000XLT-K handheld	\$379.95
Bearcat 890XLT-K base/mobile	\$228.95
Bearcat 860XLT-K base	\$168.95
Bearcat 760XLT-K1 base/mobile	\$188.95
Bearcat 700A-K info mobile	\$148.95
Bearcat 560XLA-K base/mobile	\$83.95
Bearcat 220XLT-K1 handheld/SPECIAL	\$208.95
Bearcat 178XLT-K base/WX alert	\$133.95
Bearcat 148XLT-K base/WX alert	\$88.95
Bearcat 80XLT-K handheld	\$168.95
Bearcat 60XLT-K handheld	\$88.95
Bearcat BCT7-K info mobile	\$168.95
Bearcat BCT2-K info mobile	\$138.95



Bearcat® 890XLT-K Radio Scanner

Mfg. suggested list price \$399.95/CE price \$228.95
200 Channels · 10 banks · Weather Alert Feature
Turbo Scan · VFO Control · Priority channels
Auto Store · Auto Recording · Reception counter
Frequency step resolution 5, 12.5 & 25 KHz
Size: 10-1/2" Wide x 7-1/2" Deep x 3-3/8" High

Frequency Coverage:

29,000 - 54,000 MHz (NFM), 108,000 - 136,995 MHz (AM)
137,000 - 173,995 MHz (NFM), 216,000 - 224,995 MHz (NFM),
225,000 - 399,995 MHz (AM) 400,000 - 512,000 MHz (NFM),
806,000 - 823,9875 MHz (NFM), 849,0125 - 868,9875 MHz (NFM)
894,0125 - 956,000 MHz (NFM).

The new Bearcat 890XLT gives you pure scanning satisfaction with amazing features like Turbo Scan to scan and search up to 100 channels per second. This base and mobile scanner is ideal for weather watchers because it has a built-in tone activated *Weather Alert Feature*. Other features include *Auto Store* - Automatically stores all active frequencies within the specified bank(s). *Auto Recording* - This feature lets you record channel activity from the scanner onto a tape recorder. You can even get an optional *CTCSS Tone Board* (Continuous Tone Control Squelch System) which allows the squelch to be broken during scanning only when a correct CTCSS tone is received. For maximum scanning enjoyment, order the following optional accessories: P8001 Cigarette lighter power cord for temporary operation from your vehicle's cigarette lighter \$14.95; P8002 DC power cord - enables permanent operation from your vehicle's fuse box \$14.95; MB001 Mobile mounting bracket \$14.95; BC002 CTCSS Tone Board \$54.95; EX711 External speaker with mounting bracket & 10 feet of cable with plug attached \$19.95. The BC890XLT comes with AC adapter, telescopic antenna, owner's manual and one year limited warranty from Uniden.

CB/GMRS Radios



Cobra
40 CHANNEL
25LTD WX CLASSIC
CB RADIO

A National Weather Service (NWS) receiver with automatic emergency broadcast activation has been added to the legendary Cobra 29 CB radio. The integrated NWS receiver in the Cobra 29LTDXW will automatically activate to receive emergency announcements about severe weather and travel conditions. A special tone-alert signal broadcast by the NWS activates the weather receiver and overrides any CB radio reception for monitoring the warning message. Cobra 29LTDXW-K CB/Weather Alert ... \$129.95
Cobra 25LTDXW-K CB/Weather Alert ... \$109.95
Cobra HH40-K1 CB 40 ch. Handheld \$89.95
Ranger RC12970-K 100 watt 10 meter. ... \$369.95
Ranger RC12950-K 25 watt 10 meter ... \$244.95
Uniden GMR100-K1 GMRS Handheld \$149.95
Uniden WASHINGTON-K SSB CB Base ... \$189.95
Uniden GRANTXL-K1 SSB CB Mobile \$129.95
Uniden PRO538W-K CB & Weather \$59.95



Talking Weather

Now your weather station can talk to callers. Call 313-994-9000 for a demonstration. The Talking Weather Station (TWS) from Innovative Tech Works, lets anyone phone your Davis Weather Monitor II and hear the weather. Here's how it works. You setup the TWS with the most IBM PC 80286 or faster compatible computers with a 40 MB hard disk. Requires MS-DOS version 5.0 or later with 1 MB of RAM. Add phone lines and your own personal messages or promotional advertising. Callers are automatically greeted with your voice giving them the weather and your messages. Several times a minute, the TWS software will poll the Weatherlink and will update the voice library files to make your spoken report. A single line card, order #ITI-K is only \$489.95. A two line card is order #IT2-K for \$939.95. A complete turnkey system for commercial use is available, order #ITPRO2-K starting at \$3,999.95.

VHF Transceiver

RELM® WHS150-K Transceiver
Mfg. suggested list price \$481.67/CE price \$339.95

Severe weather spotters depend on the RELM WHS150 transceiver for direct two-way communications with their police or fire department, civil defense agency or ham radio repeater. The WHS150 is our most popular programmable five watt, 16 channel handheld transceiver that has built-in CTCSS, which may be programmed for any 39 standard BIA tones. Frequency range 148.000 to 174.000 MHz. Will also work 144.000-148.000 MHz with altmp reduced performance. The full function, DTMF compatible keypad also allows for DTMF Encode/Decode and programmable ANL. Weighing only 15.5 oz., it features dealer programmable synthesized frequencies either simplex or half duplex in both 5.0 and 6.25 KHz increments. Other features include scan list, priority channel, selectable scan delay, selectable 5 watt/1 watt power level, liquid crystal display, time-out timer and much more. When you order the WHS150 from the Weather Bureau, you'll get a complete package deal including antenna, battery, belt clip and user operating instructions. Other accessories are available. A leather carrying case with swivel belt loop part #LCWHB is \$49.95; rapid charge battery charger, part #RCWHB is \$69.95; speaker/microphone, part #SMWHB is \$54.95; extra lithium battery pack, part #BP007 is \$59.95. The radio technician maintaining your radio systems must order programming instructions part #PI150 for \$18.00 to activate this radio. FCC license required for United States operation.

Other neat stuff

Grundig Satellit 700-K portable shortwave receiver with 512 memory & AC adapter	\$389.95
Grundig Yacht Boy 400-K1 digital portable shortwave receiver - 40 memory presets	\$189.95
Grundig Yacht Boy 250-K portable shortwave receiver	\$139.95
Sangean AT5800-K portable 20 memory shortwave receiver	\$69.95
Sangean AT5803A-K1 portable shortwave receiver w/AC adapter-9 memory/SPBQJL11	\$39.95
Sangean AT5808-K portable 4.5 memory shortwave receiver	\$159.95
Sangean AT5818CS-K portable shortwave receiver with cassette recorder	\$209.95
Uniden EXP9200K 900 MHz 2 line cordless phone	\$289.95
Uniden EXP9100K 900 MHz 1 line cordless phone	\$289.95
Cobay CP912K 900 MHz spread spectrum cordless phone	\$149.95
Bogen PR2000K Digital two-line advanced voice mail system & answering machine	\$279.95
Bogen PR0018K memory expansion module, doubles recording time to 36 minutes	\$79.95
FANS P161P-K 60 min/number caller ID, unattended call blocker, automatic paging	\$149.95
SNI ID200-K Bounce name/number caller ID, call, forward, to machine	\$89.95
ICOM GP22A-K1 handheld global positioning system (GPS)	\$499.95
WR200-K weather radio with National Weather Service storm alert	\$59.95
RELM WHS150-K VHF handheld 5 watt, 16 channel transceiver	\$339.95
RELM RH256NB-K VHF 25 watt, 16 channel synthesized transceiver	\$289.95
Ranger RC12950-K 25 watt 10 meter ham radio transceiver	\$239.95
Ranger RC12970-K 100 watt 10 meter ham radio transceiver	\$369.95
Uniden LDP1100STF-K Super VHF/UHF Laser/Laser Detector	\$139.95
MEK Map Expert CD Rom for IBM PC by Delorme Mapping	\$299.95
CB-Kit HamCall CD Rom for IBM PC by HPC/Hamster Publishing	\$39.95
ANTX-K VHF scanner/VHF transmitting antenna PL259 connector	\$29.95
ANTH8NC-K magnet mount scanner antenna w/BNC connector	\$29.95
ANTHM0TK-K magnet mount scan antenna w/Motorola plug	\$29.95
ANTHMF-K magnet mount scan antenna with PL259 connector	\$29.95
ANTSGNC-K glass mount scanner antenna with BNC connector	\$29.95
ANTSGMT-K glass mount scanner antenna with Motorola jack	\$29.95

Buy with confidence

It's easy to order from us. Mail orders to: Communications Electronics Inc., Emergency Operations Center, P.O. Box 1045, Ann Arbor, Michigan 48106 U.S.A. Add \$15.00 per radio or telephone product for U.P.S. ground shipping and handling in the continental U.S.A unless otherwise stated. Add \$10.00 shipping for all accessories and publications. Add \$10.00 shipping per antenna. For Canada, Puerto Rico, Hawaii, Alaska, P.O. Box, or APO/FPO delivery, shipping charges are two times continental U.S. rates. Michigan residents add state sales tax. No COD's. No returns or exchanges after 31 days. 10% surcharge for net 10 billing to qualified accounts. All sales are subject to availability, acceptance and verification. Prices, terms and specifications are subject to change without notice. We welcome your Discover, Visa, American Express or MasterCard. Call 1-800-WX-BUREAU to order toll-free. Call 313-996-8888 if outside the U.S.A. FAX anytime, dial 313-663-8888. For technical assistance to solve your communications problem, call the Communications Electronics technical support hotline for \$2.00 per minute at 1-900-555-SCAN. Scanner Distribution Center and CB logos are trademarks of Communications Electronics Inc. Sale dates 3/1/95-5/30/95 AD #020195GEN Copyright © 1995 Communications Electronics Inc.

For credit card orders call
1-800-WX-BUREAU

Weather Bureau

P.O. Box 1045, Ann Arbor, Michigan 48106-1045 U.S.A.
For information call 313-996-8888 or FAX 313-663-8888

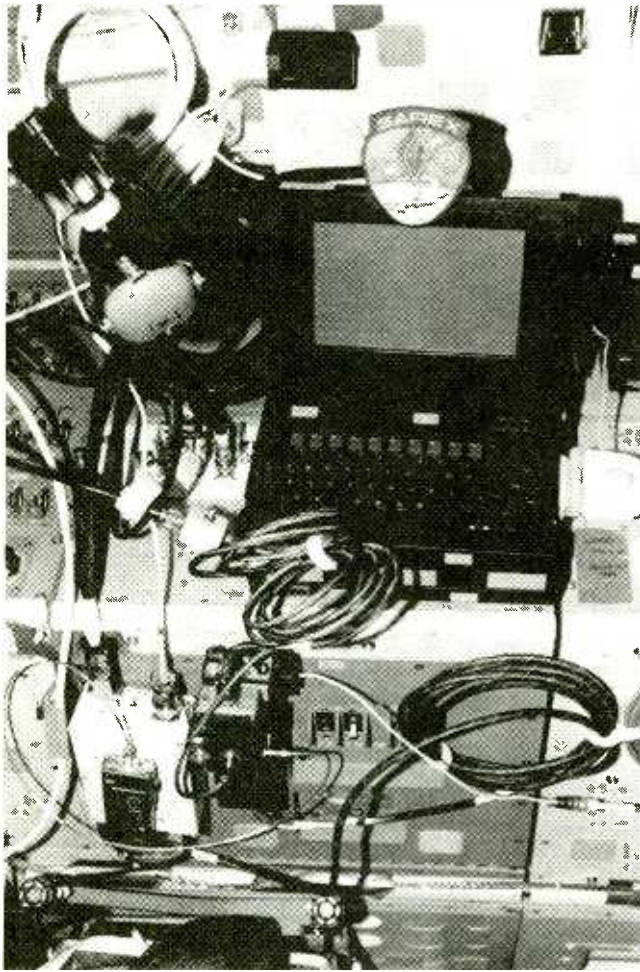

The photo shows most of the SAREX hardware in its packet and voice configuration during the STS-58 mission. Visible in this picture are the laptop MS DOS compatible computer which stores the call signs of hams who have contacted the shuttle via packet radio (notice the piece of duct tape on the right which has a handwritten worked 1496, heard +286), the noise cancelling headset, the white packet modem box with a microcassette recorder attached, and the handheld radio with its interface module. Plus, of course, a bunch of cables to wire everything together. Not visible in this photo is the window-mounted antenna, or any of the three licensed astronauts who used the radio during the 14 day life sciences mission in space.

To try to reduce the pileup the astronaut will select a receive frequency at random. For all areas except Europe the five frequencies the crew will listen to are: 144.91, 144.93, 144.95, 144.97, and 144.99 MHz. For Europe the frequencies are: 144.70, 144.75, and 144.80 MHz. These frequencies were chosen to avoid interference with other amateur operations. *Never* transmit on the 145.55 MHz shuttle downlink frequency—the only people listening will be other hams in your area.

On missions where there is enough power and space available additional amateur radio hardware can be carried. A small Heathkit HK-21 packet TNC is often used, with automated software. Bidirectional slow scan tele-

vision (SSTV) can be used if additional space is available. With SSTV the shuttle can transmit video from within the crew cabin or remotely controlled cameras within the cargo bay. It's also possible to transmit SSTV from the ground to the shuttle. Fast Scan amateur television is only available one way—from the ground to the shuttle and only by specially equipped stations. Table 1 shows the five different SAREX configurations.

■ Making a Shuttle Search

Making a SAREX random contact is a challenge, but something thousands of hams around the world have done. A bit of luck also helps. A couple of simple tricks will drastically increase your chances for a successful contact. The simplest thing to do is listen to the 145.55 MHz downlink before attempting to contact the shuttle. This will verify that the shuttle is above your horizon, and what mode the shuttle is in. If you don't hear anything the crew may be asleep, the shuttle may be facing the opposite direction, or there may be another reason why the rig isn't turned on. Quite obviously,

if you hear packet tones, don't try to call the shuttle via voice!

A more refined method is to determine when the shuttle will be over the horizon from your location. During shuttle missions NASA broadcasts information and status reports continuously via satellite on GTE Spacenet 2 located at 69 degrees West, Transponder 5 (channel 9). Many ham clubs around the country retransmit this signal on local repeaters. The public affairs officers will keep you apprised of the astronauts' wake/sleep schedule. Often the NASA Select video shows a computer generated map with the shuttle's location.

Another method to determine the shuttle's

location is to use a computer tracking program. AMSAT, the Radio Amateur Satellite Corporation, sells inexpensive satellite tracking programs for many different microcomputers. A set of parameters, the Keplerian elements, are needed for each object in orbit which you need to track.

For some passive satellites or the space shuttle on a microgravity research flight the Keplerians (or keps) remain relatively stable over long periods of time and do not need to be constantly updated. A spacecraft which performs a lot of maneuvers—like the shuttle on most missions—needs more frequent updates.

Keplerian elements are available from a variety of sources. During shuttle missions the latest keps are transmitted on the weekly shortwave AMSAT nets (Sunday 1800-2100 UT (International) 14.282 MHz USB, Tuesday 0130-0300 UT (USA) 3.840 MHz LSB). The Goddard Amateur Radio Club station, WA3NAN, in Greenbelt, Maryland, carries SAREX Bulletins and Shuttle Retransmission on 3860 kHz, 7185 kHz, 14295 kHz, 21395 kHz, 28650 kHz and 147.450 MHz (FM). In addition, keps are available on packet bulletin boards and via Internet at the anonymous ftp site archive.afit.af.mil in the directory pub/space.

If all else fails, here are three dial-in computer bulletin boards which usually have

TABLE 1: SAREX configurations

SAREX gets to fly often because of its flexibility. If the available space is limited or there isn't enough spare power available from the shuttle, a minimal configuration can be flown which doesn't require any power from the shuttle. If more space, crew time, and other resources are available then more sophisticated hardware can be included. The following are the current SAREX configurations.

- A voice, packet, SSTV
- B voice only
- C voice and packet
- D voice, packet, SSTV, and FSTV
- E voice, packet, SSTV, and FSTV (slightly different hardware)

All of the configurations use the handheld Motorola 300S radio and a window-mounted antenna. The packet configurations add a Heathkit HK-21 packet modem and share an IBM laptop computer with the shuttle mission's other small payloads. SSTV and FSTV configurations add a video digitizer, a circuit which converts the shuttle's synchronous video into normal NTSC composite video, and a small video recorder or camcorder.

ICOM IC-820H

Use your 820 to participate in the exciting world of amateur satellite communications!

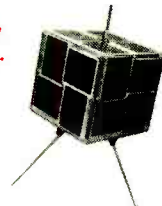

Dual-Band, All-Mode Transceiver for Terrestrial and Satellite Communications!

"Superior performance and features in a compact package"

—Satellite Times Test, Sept.-Oct. 1994

NEW!



Explore amateur radio's new frontier—satellite communications! Also ideal for terrestrial contacts. This new, all-mode, dual-band transceiver offers automatic crossband repeater, normal and reverse satellite communications tracking and doppler-shift compensation!

Order XCVR 01

Only **\$1649⁹⁵**

Plus \$16 UPS shipping (US)

License required to transmit:
Technician, General,
Advanced or Extra

FEATURES AND SPECIFICATIONS:

- Frequency coverage: 144-148/430-450 MHz
- SSB, FM, CW, 9600 baud packet
- 1 Hz tuning resolution plus RIT
- IF shift
- Normal/reverse satellite tracking memory
- Doppler compensation
- 10 crossband, 50 conventional memory channels
- Dual VFOs on both VHF and UHF
- Dual antenna jacks (SO-239 VHF / N UHF)
- Noise blanker
- Attenuator
- Programmable memory/mode select scan
- CW semi-break in and side tone
- Auto repeater function
- 45/6 watts power

RECOMMENDED ACCESSORIES:

PWR-4	PS-55 Style-matching power supply	\$344.95
PRE-6	AG25 144-148 MHz preamp	\$159.95
PRE-7	AG35 420-450 MHz preamp	\$164.95
MIC-1	HM-12 Hand microphone	\$53.95
MIC-2	SM-20 Desktop microphone	\$187.95
ACC-71	SP-20 external speaker	\$224.95
ACC-2	SP-3 external speaker	\$101.95
ACC-36	UT-36 voice synthesizer	\$55.95
ACC-74	CT-17 Ct-V level converter	\$122.95
ACC-83	MB-5 mobile mounting bracket	\$42.95
ACC-138	MB-23 carrying handle	\$11.95



GROVE ENTERPRISES, INC.

P.O. Box 98,
Brasstown, NC 28902

(800) 438-8155

Outside the US and Canada call:

(704) 837-9200

The Price Is Right

Bob's Bargain Bin offers new, demo's, and discontinued equipment at **substantial savings**. Most equipment has only slight cosmetic damage. All equipment comes with the Grove warranty, and most (except UDEM1, DEM1B, UDEM2) have the manufacturers's warranty. UPS ground shipping is included in the price, but if the item is returned for any other reason other than defectiveness, regular return shipping charges will be deducted from your refund.



**M200
Multimode
Decoder**
Only **\$220.95**
Order **UDEM2**

Other Terrific Values

UDEM1B	MD100 Decoderw/12V bat.	\$170.95
UDEM 1	MD100 Decoder	\$150.95
UPHN03	Uniden Exp-9100 phone	\$279.95
UPR150	Low PR-150 preselector	\$339.95
URCV02	Sony 2010	\$329.95
URCV04	Sangean ATS-803A	\$138.95
URCV07	Kenwood R-5000	\$1009.95
URCV08	ICOM R72A	\$665.95
URCV10	Sony SW-77	\$430.95
URCV11	Sony SW7600G	\$185.95

Watch those elusive beeps and tones automatically arrange themselves into readable sentences. This compact desktop decoder allows you to decode Morse code, RTTY, ASC11, and other types of code and read them off the display or your TV. Grove is proud to offer this versatile unit well under cost, you'll agree, the Price is Right!

Good Equipment at Great Prices!

To place an order or to request information about these or any of the other values in **Bob's Bargain Bin** call our order line at 1-800-438-8155 (US & Canada) or (704) 837-9200 (foreign).



Grove Enterprises
P.O. Box 98,
Brasstown, NC 28902

up-to-date elements: Celestial BBS, operated by TS Kelso, can be reached at 205-409-9280. The Johnson Space Center's BBS is 713-244-5625. The Marshall Space Flight Center's Spacelink BBS is 205-895-0028. The Goddard Space Flight Center's WA3AN amateur radio club operates a BBS at 301-286-4137. WA3AN can also be reached via packet, and by Internet at: WA3NAN@GSFC.NASA.GOV.

With most satellite tracking programs you enter your location's latitude and longitude which is stored. The Keplerians for the satellite you are interested in checking are either typed in or loaded from a disk file. You then enter a period of time and the computer determines when the spacecraft will be over your horizon. Depending on the program you may get a graphic representation, a table, or both. Table 2 shows a typical set of Keplerian elements and a printout for an excellent quality pass. Obviously the longer the shuttle stays above the horizon and the higher the elevation, the more likely it is that you'll be able to make a contact.

■ Equipment and Etiquette

Receiving the shuttle is easy—a simple rubber-duckie on a handheld transceiver or scanner can easily receive the signal. Transmitting a signal to the shuttle is much more difficult—since you're competing with hundreds of other hams trying to get through at the same time. If you have a beam antenna with a tracking rotor system, and have experience with the low altitude microsats, you'll increase your chances for getting through. On the other hand, I've successfully gotten through with a 45 watt mobile rig using a simple omni whip. High power is not necessary and it is considered quite tasteless to attempt to get



The ultimate in dedication. When you're an astronaut in space and don't have a notepad handy and your tape recorder runs out of tape this is how you keep track of the call signs of the hams on the ground you've worked—you write them on your leg!

TABLE 2: Typical SAREX pass printout

This set of predictions was generated on a Macintosh running the shareware Orbitrak program. Similar programs are available for other computers. Orbitrak lets you select which parameters you want to display and can display the output on the screen, create a printout, or a text file which can be transferred to another program.

The output was created during the STS-58 Spacelab Life Sciences-2 mission in October 1993. The location was Titusville, Florida, next to the Kennedy Space Center. The catalog number and International Designation are catalog values assigned to this particular object in space. The period is the length of time it takes for the shuttle to make one orbit around the Earth. The Apogee is the highest point in the shuttle's orbit and Perigee is the lowest point.

The eight columns in this output show the local time, the Mission Elapsed Time (the amount of time since the shuttle's launch) the azimuth and elevation for the shuttle once each minute, the shuttle's height above the Earth, and the shuttle's location above the Earth.

This particular pass lasted eight minutes, starting at 11:05 am on October 30th. The maximum elevation is 71.7 degrees, making it an excellent overhead pass. The higher the elevation, the less problems you will have with objects in the way and the longer the satellite will remain in view. For this pass the shuttle came over the horizon in the southwest and tracked almost overhead. It set in the northeast.

Orbitrak Track - 10/24/93 1940:34

Station: TITUSVILLE, FL
 Satellite: STS 58/SLS 2 *
 Catalog Number: 22869
 Int Des: 1993 065A
 Period: 90.02 Min
 Apogee: 285.58 km 177.45 sm 154.20 nm
 Perigee: 264.75 km 164.51 sm 142.95 nm

Time MM/DD/YY	EDT HH:MM:SS	MET Columbia	Az Deg	El Deg	Height km	North Lat	West Long
10/30/93	11:05:35 AM	+12d 00h 12m 25s	300.3	0.6	260.7	35.35	97.54
10/30/93	11:06:35 AM	+12d 00h 13m 25s	301.1	5.1	261.3	34.04	93.17
10/30/93	11:07:35 AM	+12d 00h 14m 25s	302.6	12.1	261.9	32.57	88.95
10/30/93	11:08:35 AM	+12d 00h 15m 25s	306.4	26.3	262.7	30.94	84.89
10/30/93	11:09:35 AM	+12d 00h 16m 25s	349.1	71.7	263.4	29.17	80.97
10/30/93	11:10:35 AM	+12d 00h 17m 25s	108.8	33.3	264.3	27.28	77.20
10/30/93	11:11:35 AM	+12d 00h 18m 25s	114.3	14.7	265.1	25.28	73.58
10/30/93	11:12:35 AM	+12d 00h 19m 25s	116.0	6.7	266.0	23.18	70.08
10/30/93	11:13:35 AM	+12d 00h 20m 25s	117.0	1.7	266.9	21.00	66.70

through by overpowering other stations.

If the shuttle is in voice mode then choose one of the uplink frequencies and transmit your call sign. It's easiest if your radio can be programmed for the off-shift frequency combinations. Or as an alternative, you can use a handheld to listen to the 145.55 downlink and transmit on a separate higher power radio. Use standard phonetics and state your call sign clearly. Do NOT call the shuttle constantly.

After a couple of tries, listen—if the astronauts hear your call sign they'll respond. Transcripts of the flight audio tapes have many partial call signs or unintelligible calls. The shuttle is a noisy environment, and stating your sign clearly will make it easier for the astronaut to understand. As a general rule the astronauts try to talk to as many hams

as possible, but if there's time the astronaut may talk to individuals for a while. If you hear the astronaut talking to somebody else, then wait until they're finished before continuing to contact the astronaut.

The shuttle's packet call sign is W5RRR-1. Your TNC should be in half-duplex mode (FULLDUP OFF) with CD active just like you do for normal VHF packet operations. If you can compensate for doppler shift, it is worth the extra effort. The bandwidth of the SAREX radio is +/-4 kHz; maximum doppler is around 3.3 kHz. If you can't compensate for doppler, your best chance for contact is when the shuttle is at peak elevation at your site.

You should be careful with the setting of two of your TNC's timers: DWAIT and FRACK. DWAIT is the time interval after your Carrier Detect light goes out and before your transmitter turns on. You want to make sure your connect requests and ACKs are contained in the 3-second FUDtimer window. If everybody runs the same DWAIT

(like the typical 0.1 - 0.5 second values used for terrestrial packet), then everybody will be transmitting at the same time. Part of the key to your success when uplink QRM is heavy is to pick a DWAIT that nobody else is using!

FRACK sets the time interval between your transmissions. After you send a frame, your TNC waits for the FRACK time, and then waits for the Carrier Detect signal to drop, then waits DWAIT, and then tries again. You should make sure your FRACK is at least 3 seconds so that you are not transmitting when the robot's FUDtimer decides it is time for it to transmit—if you are transmitting at the same time, you will miss any packets the shuttle is addressing to you and you won't have a successful QSO.

■ Verifying the Contact

Hams who make special contacts, especially with hams in other countries or unusual locations, like to trade postcards verifying their contacts. These QSL cards are treasured souvenirs, and ham astronauts will send QSL postcards to each of the hams they contact during their missions. If you've contacted an astronaut—or if you heard a SAREX transmission—you should send details of your contact or reception (frequency, time heard, call sign, your location) to the Amateur Radio Relay League with a self-addressed stamped envelope.

The astronauts try to keep track of the hams they contact, but call signs don't always get recorded. The tape recorder may run out of tape or be incorrectly set up. Some astronauts have gone to extraordinary efforts to record call signs when they run out of tape during a QSO pass. When Bill McArthur KC5ACR didn't have a convenient notepad available he just started writing call signs on the palm of his hand—and then on his leg! Later he found a notepad to make a more permanent record of the hams he talked to.

It does take several months to get your QSL card back, so be patient. Typically the QSL will be a color photo of the astronaut in orbit with his or her call sign. The QSLs are processed by amateur clubs which volunteer their time and resources.

During SAREX missions each astronaut gets a call home to their family and friends—typically via Australia. The Australian ground



Russian cosmonaut Sergei Krikalev U5MIR became the first person to fly on both the Russian space station Mir and space shuttle when he flew on the STS-60 mission. He was able to use ham radio from space on all of his missions. Here he is using the SAREX rig aboard Discovery's STS-60 mission while adjusting a camcorder.

station, Graham Ratcliff VK5AGR, is used to avoid taking up a pass over the continental U.S. which could be used for random QSOs. The astronaut's family is patched into the ground station via a fiber optic phone call which is connected to the shuttle via amateur radio. Astronaut Jeff Wisoff told his parents what Australia looked like from an altitude of 287 miles during his first spaceflight. Some astronauts have commented that with SAREX family conferences they have more of a feeling of privacy and higher quality connections than through the normal shuttle audio circuits.

■ Looking Ahead

The SAREX program is not static. Plans are underway to design an external antenna which would be mounted within the shuttle's cargo bay. NASA is obtaining a commercial Motorola radio for communications with the Russian space station Mir. That radio is also capable of operating within the amateur radio bands. The team is also looking at a battery-operated packet modem for missions where the amateur equipment cannot use power from the shuttle.

SAREX has been an incredibly successful program which has expanded well beyond what its planners had originally conceived. The astronaut corps are especially interested in SAREX's educational benefits, and amateur radio operators benefit by participating in the educational contacts as well as the random contacts. As long as schools want to use ham radio from space as part of their educational programs, SAREX will continue to thrive.

TABLE 3: Sources

For more information on SAREX school contacts:

Amateur Radio Relay League
attn.: Education Activities Department
225 Main St.
Newington, CT 06111
(203)-666-1541

For satellite tracking programs for a variety of microcomputers:

AMSAT
850 Sligo Ave.
Silver Spring, MD 20910-4703
301-589-6062

For information on the schedule of upcoming SAREX missions and astronaut activities:



NASA Headquarters
attn: Educational Activities
mail stop: FE
Washington, DC 20546
(202)-358-1977

Philip Chien
Earth News
252 Barton Blvd Suite 1201
Rockledge, FL 32955

Toll Free
1-800-666-0908
Pricing and Orders Only

Shortwave Radios

Sony	Sangean	Others
ICF-SW30	ATS606P	Drake R8
ICF-SW35	ATS803	Drake SW8
ICF-SW55	ATS808	ICOM, JRC
ICF-SW77	ATS818	Panasonic
ICF-SW100	ATS818CS	Lowe, Kenwood
ICF-SW7600C		AOR 3030
ICF-2010		Yaesu FRG-100

Yacht Boy 400  **Call For Special Pricing**  Satellit 700
GRUNDIG

Scanners

Bearcat	AOR	ICOM
SC150	AR1000XLT	R1
BC200XLT	AR3000A	R100
BC890XLT	AR8000A	R7000
BC2500XLT		R7100
BC8500XLT		R9000



Call For Other Models of AOR, Bearcat, ICOM

We are also factory authorized amateur dealers for Alinco, ICOM, Kenwood, Yaesu, Standard, MFJ Comet, Cushcraft, Diamond, Etc.

◆◆◆ **Call For Our Low Discount Prices** ◆◆◆

For info and tech help call (203) 666-6227
Out-of-state sales call 1-800-666-0908
Conn sales call (203) 667-9479
Hours: M-F 10 am - 6 pm Sat 10 am - 4 pm

LENTINI COMMUNICATIONS, INC.
21 Garfield St. Newington, CT 06111

 C.O.D.'s OK — SAME DAY SHIPPING 

Brazilian Voices on Shortwave



**Tired of commonly heard
signals on shortwave?**

**Brazilian stations
are always
present and
almost always
a challenge!**

By Valter Aguiar

Brazil is quite a large country—almost half of South America! Even though it has a total surface of over 8.5 million square meters, Brazilian population is not evenly distributed across the country, due to the presence of the Amazon forest and the dry regions in the Northeastern part of Brazil.

With such huge dimensions, it is very difficult to cover the whole country on medium wave. Brazil has therefore become over the years a natural breeding ground for the inception and growth of tropical and shortwave stations all through its territory.

It is true that nowadays there are some traditional stations leaving shortwave. Rádio Nacional in Rio de Janeiro—the most popular Brazilian radio station in the 1940's—has recently left shortwave and so have some other broadcasters. There are others which are turning to satellite, as well, like Rádio Bandeirantes in São Paulo and Rádio Aparecida. Even so, it is still very interesting to listen to the Brazilian stations on the

band, especially from the point of view of a foreign audience.

The first impact on the newcomer is the regional diversity. Local speech varies enormously from stations in the South to North and Northeast regions. So do the program contents and music, although some kinds of music can be heard throughout the country.

Programs broadcast on shortwave are usually rebroadcasts from mediumwave radio, apart from a few exceptions. Rádio Cultura in São Paulo, for instance, retransmits its FM programs over the 49 metre band, and MW on the other bands. Rádio Inconfidência in Belo Horizonte has specific programs on shortwave. The vast majority of stations, however, rebroadcast MW programs.

Radio audiences in Brazil, as in other countries, have considerable variations in taste and expectations. Even after the FM boom, there is still at least one AM station for each taste. For example, the listener can find Brazilian MW/SW stations specializing in each of the following broadcast topics:

■ Popular

These are stations with programs of a more popular appeal, to meet the taste of a wide number of listeners. Their characteristic is to present light programs, with short information content. In Brazil, it is usually said that these stations are "targeted to the average maid." It is a preconceived idea, for sure, but these stations are the most widely heard one in their regions.

■ News

Even some popular stations can be good news sources. There are, however, stations specialized in news broadcasting, such as CBN (Central Brasileira de Noticias—in English, Brazilian News Centre) in various state capitals in Brazil. Owned by the Globo network (the largest TV and radio network in Brazil), they broadcast only news 24 hours a day. CBN - São Paulo can be heard on the 31 shortwave meterband.

■ Soccer

Always a Brazilian passion, soccer is present in a large number of shortwave broadcasters. Some people say that the very quick style of reporting a soccer game by radio was invented in Brazil. In fact, it has been present in Brazilian radio since the 1930's.

It is surely very difficult for a foreigner to understand every word that Brazilian soccer speakers say. Here, too, the patient listener can find the regional differences between speakers in Brazil.

Differences go far beyond pronunciation and style! Most radio stations transmit one game at a time. In the State of Rio Grande do Sul, however, there are two major soccer teams—Grêmio and Internacional. They usually play different games, in different places, but at the same time. Rádio Gaúcha and Rádio Guaíba in Porto Alegre let us have the chance of hearing reports of both games simultaneously!

If you have some knowledge of Portuguese, it will be very interesting, too, to compare Brazilian soccer reports with those presented on shortwave by RDP in Portugal. They are completely different!

■ Religious

Brazil has always been a predominantly Catholic country and has one of the largest Catholic radio stations outside Vatican



R&B 840 BANDEIRANTES

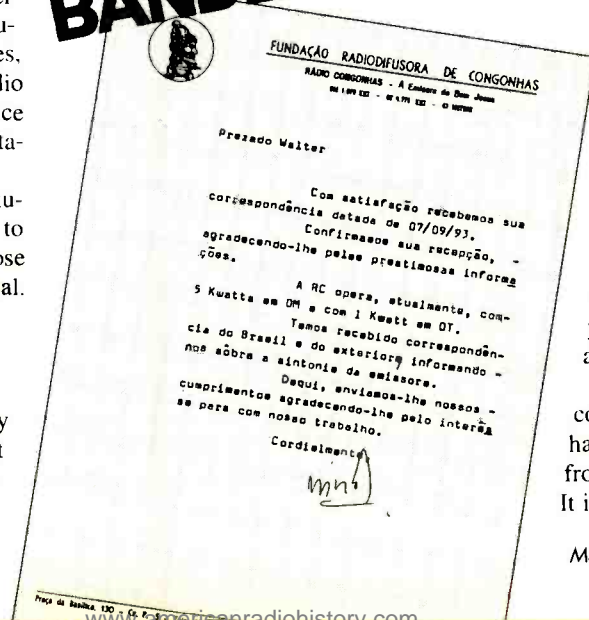

City, which is Rádio Aparecida. It is located in the State of São Paulo, in the city of Aparecida, where the image of Our Lady of Aparecida was found.

Rádio Aparecida has four frequencies on shortwave and is a regular presence for listeners in many parts of the world. It also has a DX program in Portuguese, called *Encontro DX*, broadcast each Saturday at 2200 UTC.

During the past few years, various other religions have widely grown in Brazil, reducing the number of Catholics (still the majority in the country). Religious (non-Catholic) radio stations and programs have grown in the same proportion and can be found all over the country, many of them on short and tropical wave.

■ Country Style

Country music is present in all "popular" radio stations, especially those from small towns in the countryside of São Paulo, Minas Gerais and other states. They have very characteristic programs with Brazilian country music—which is of course quite distinct from that heard in the USA.

In fact, there are two kinds of country music. The first one is more traditional and follows the same pattern of many years ago. Some people call it "the real Brazilian country music." To listen to this, tune in to Rádio Difusora de Poços de Caldas, Rádio Congonhas or to Rádio Aparecida on Saturdays, shortly before *Encontro DX*, among many others.

Some years ago, Brazil had a country music "boom." It became much more popular among the urban population and started to differ from that heard in the countryside. Instruments have been changed, voices are now different. There are even a couple of "country music singers" who recorded a Portuguese version of "My Way"! If you wish to know how this kind of music sounds, try to listen to stations in capital cities.

■ Correspondence and QSL's

Are you a QSL hunter? This is sometimes the most difficult part of hearing Brazilian radio stations. Some stations do have QSL cards, but most will reply to you in non-technical, often incomplete, acknowledgement letters in Portuguese.

Prepared cards are a good idea to get complete verifications, but this does not have the taste of receiving a personal letter from a station, though incomplete as a QSL. It is up to each listener to decide on which

should be the preferred way of getting in touch.

Portuguese should be used whenever possible. Spanish may be the next best option, but avoid using English, especially outside state capital cities. Report forms in Portuguese are available from many sources and this seems to be a good option for those who do not have a command of the language. It is often easier to receive a verification from smaller stations in the countryside than from large broadcasters in state capital cities, which receive a huge amount of mail every day.

As for regional stations all over the world, technical terms should also be avoided as much as possible. Try to be as specific as your language command permits. While collecting program data for reporting, try to include as many Portuguese words as you can.

Since most stations are commercial, some advertisements can be included. In tropical wave stations, it is more common to hear local advertisements for the town's butcher, car seller, and the like. But try to identify ads from the major announcers in Brazil, like Antarctica (beer), Bradesco (bank), Brahma Chopp (beer), Doril (medicine) and even a few ad-

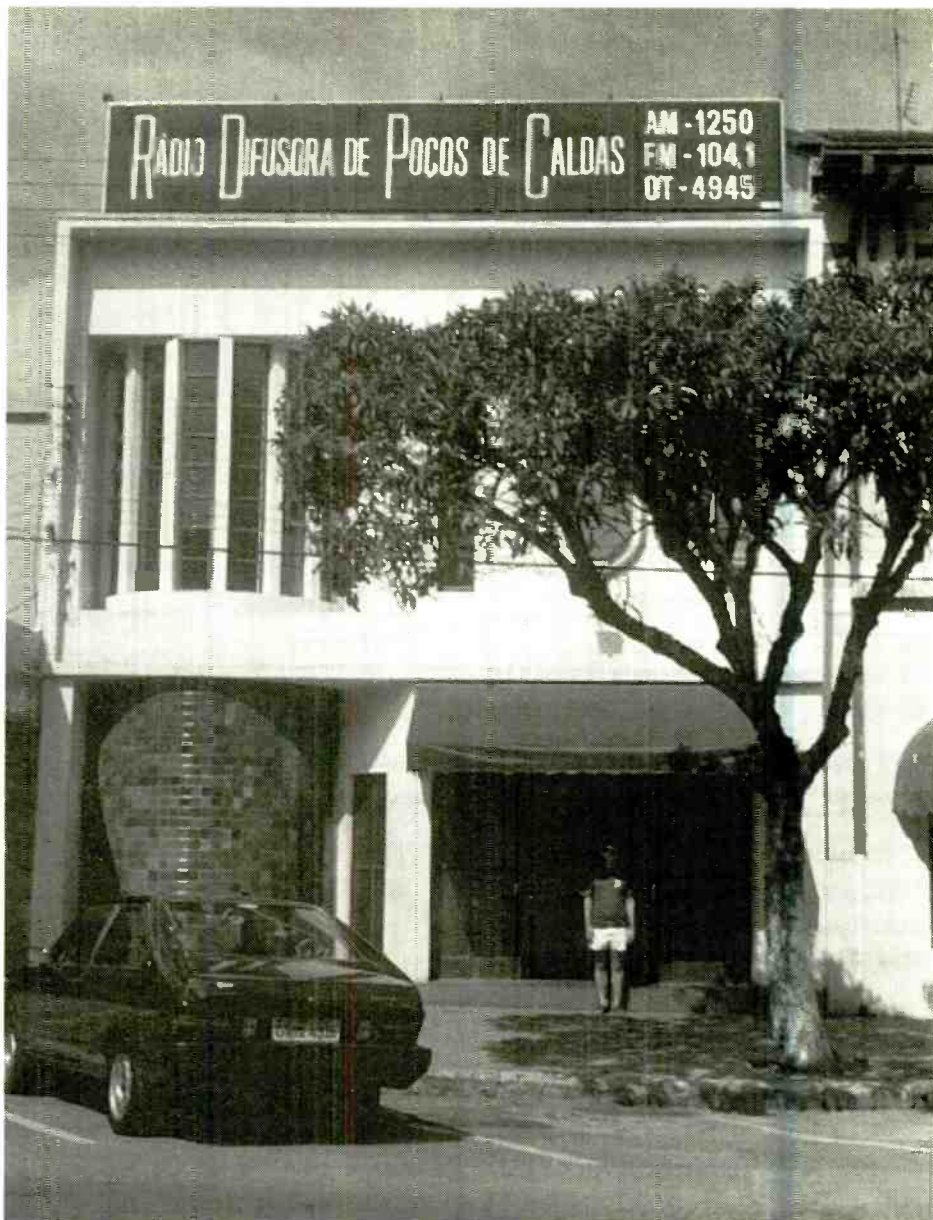

Rádio Difusora is located in the tourist city of Pocos de Caldas.

**MAGNETIC LONGWIRE
BALUN™**





- New! For SWL's using longwire antennas.
- Use coaxial cable from antenna to receiver.
- Low noise reception from 500 KHz to 30 MHz.

Your longwire may be up in the clear but the wire to the radio comes down near the computers, light dimmers, TV sets, fluorescent lights and other sources of noise. This noise is added to the signals you are trying to hear.

Add Palomar's MLB-1 balun to your antenna and use coaxial cable to your radio. Coax doesn't pick up noise. Reception is clearer and quieter. There is no loss of signal because the balun matches the antenna to the coax. Static charges go to ground, not through the radio.

Model MLB-1 \$39.95 + \$6 shipping/handling in U.S. & Canada. California residents add sales tax.

Send for **FREE** catalog that shows our complete line of antennas, preamplifiers, filters and more.

**PALOMAR
ENGINEERS**
BOX 462222, ESCONDIDO, CA 92046
Phone (619) 747-3343
FAX (619) 747-3346

vertisers well-known to the American audience, like Coca-Cola, Pepsi, McDonald's (in larger cities), etc.

Return postage should always be included with reports. Brazilian inflation rate may sometimes be under control, but the last years have shown frequent increases in postage costs. A few months ago, postal costs increased on a daily basis!

Typically, a single 20 g ordinary letter sent by airmail to any foreign country costs around US\$ 1.00. Be careful when including US notes with your reports, by ensuring they cannot be seen from outside the envelope. Registered mail is recommended.

To overcome the inflation problem, the Brazilian post has introduced a stamp with no value, valid for a 20 g airmail letter to abroad. The Universal Postal Union had in the past

forbidden the use of such stamps, but they are now approved and can be a good solution for those listeners who do not wish to include US dollar notes with their reports.

International Reply Coupons are accepted in major cities, but might be discarded in smaller towns, as in most parts of Latin America.

For all the above reasons—and many more—it is indeed a very interesting challenge to listen to shortwave stations from Brazil. Table I provides a list of some of the available stations, from both capital cities and smaller towns, with their frequencies and addresses. Identification words change so often in most stations that we decided not to include them, but just their program styles. So... direct your antenna to the South, and good listening!

TABLE 1 : Brazilian Stations on the Tropical and Short Waves

Rádio Aparecida (religious, popular)
SW/TW frequencies: 5035, 6135, 9630 and 11855 kHz
Address: Av. Getúlio Vargas, 185
12570-000 Aparecida/SP - Brazil

Rádio Bandeirantes (news, soccer, popular)
SW frequencies: 6090, 9645 and 11925 kHz
Address: Rua Radiantes, 13
05699-900 São Paulo/SP - Brazil

Rádio Bare (popular, soccer)
TW frequency: 4895 kHz
Address: Av. Santa Cruz Machado, 170
69078-000 Manaus/AM - Brazil

Rádio Brasil (popular, soccer)
TW frequency: 4785 kHz
Address: Av. Benjamin Constant, 1214 - 5.º andar
13010-141 Campinas/SP - Brazil

Rádio Brasil Central (popular, soccer)
SW/TW frequencies: 4985 and 11815 kHz
Address: Av. Presidente Costa e Silva - Jardim Bela Vista
74863-020 Goiânia/GO - Brazil

Rádio Canção Nova (religious)
SW/TW frequencies: 4825, 6105, 9675 and 11940 kHz
Address: Caixa Postal 57
2630-000 Cachoeira Paulista/SP - Brazil

Rádio CBN - Central Brasileira de Notícias (news 24 hours)
SW frequency: 9585 kHz
Address: Rua das Palmeiras, 315
01288-900 São Paulo/SP - Brazil

Rádio Clube (popular, soccer)
TW frequency: 3235 kHz
Address: Rua Paes Leme, 20
17500-150 Marília/SP - Brazil

Rádio Clube (popular)
TW frequency: 3245 kHz
Address: Caixa Postal 102
37002-970 Varginha/SP - Brazil

Rádio Clube Paranaense (soccer, popular, news)
SW frequencies: 6040, 9725 and 11935 kHz

Address: Al. Dr. Muricy, 926
80020-040 Curitiba/PR - Brazil

Rádio Congonhas (religious, country music)
TW frequency: 4775 kHz
Address: Praça da Basílica, 130
36404-000 Congonhas/MG - Brazil

Rádio Cultura (popular, soccer)
TW frequency: 3365 kHz
Address: Av. Espanha, 284
14801-130 Araraquara/SP - Brazil

Rádio Cultura (Brazilian popular music and news)
SW frequencies: 9615 and 17815 kHz
Re-transmission of FM broadcasts: 6170 kHz (classical music)
Address: Rua Cenzo Sbrighi, 378
05036-900 São Paulo/SP - Brazil

Rádio Cultura Fluminense (soccer, popular)
TW frequency: 4955 kHz
Address: Av. Aialr Ferreira, 201
28022-000 Campos dos Goytacazes/RJ - Brazil

Rádio Difusora (popular)
TW frequency: 4795 kHz
Address: Caixa Postal 18
79201-970 Aquidauana/MS - Brazil

Rádio Difusora (popular, soccer)
TW frequency: 4945 kHz
Address: Av. Francisco Salles, 96
37701-013 Poços de Caldas/MG - Brazil

Rádio Difusora (popular, soccer)
TW frequency: 4925 kHz
Address: Rua Dr. Souza Alves, 960
12020-030 Taubaté/SP - Brazil

Rádio Educação Rural (popular)
TW frequency: 4755 kHz
Address: Av. Mato Grosso, 530
79002-906 Campo Grande/MS - Brazil

Rádio Gaúcha (news, soccer)
SW frequencies: 6020 and 11915 kHz

Address: Rua Rádio e TV Gaúcha, 109
90859-900 Porto Alegre/RS - Brazil

Rádio Gazeta (popular, soccer)
SW frequencies: 5955 and 9685 kHz
Address: Av. Paulista, 900
01310-100 São Paulo/SP - Brazil

Rádio Guaíba (news, fine music, soccer)
SW frequencies: 6000 and 11785 kHz
Address: Rua Caldas Júnior, 219
90019-900 Porto Alegre/RS - Brazil

Rádio Inconfidência (news, popular, soccer)
SW frequencies: 6010 and 15170 kHz
Address: Caixa Postal 1027
30161-970 Belo Horizonte/MG - Brazil

Rádio Meteorologia Paulista (popular)
TW frequency: 4845 kHz (relays of Rádio Ternura FM at certain times of the day)
Address: Rua Capitão João Marques, 98-A, 89-B e 89-C
14940-000 Ibitinga/SP - Brazil

Rádio Nacional da Amazonia (popular, soccer)
SW frequencies: 6180, 11780, 15200 and 15445 kHz
Address: CLRN 702/703, Bloco B 16/18
78323-900 Brasília/DF - Brazil

Rádio Novas de Paz (religious)
SW frequency: 6080 and 9515 kHz
Address: Av. Paraná, 2120
82510-000 Curitiba/PR - Brazil

Rádio Record (popular, soccer)
SW frequencies: 6150, 9505, 11965 and 15135 kHz
Address: Av. Miruna, 713
04099-900 São Paulo/SP - Brazil

Rádio Retóico Federal (time pips, news, curiosities)
TW frequency: 4905 kHz
Address: Av. Presidente Vargas, 409 - 22.º andar
20071-003 Rio de Janeiro/RJ - Brazil

Rádio Universo (religious)
SW frequencies: 6060, 9565 and 11905 kHz
Address: Rua Sen. Alencar Guimarães, 97 - 5.º andar
80010-070 Curitiba/PR - Brazil

The **MODEL 930** is a low cost **DTMF DECODER** with a logging capacity of up to 2046 characters. For situations requiring greater storage, an on board R232 port directly interfaces to a PC or to a serial printer.



\$89.95

- A complete finished unit (**NOT A KIT**)
- Dimensions: 4" w X 2.875" h X 1.5" d
- 4 versions: single line display 1k RAM
 - single line display 4k RAM
 - two line display 1k RAM
 - two line display 4k RAM
- User programmable for inter sequence gap time and storage mode

- Large display (up to 32 characters)
- No limit on sequence length
- Local/remote control function
- Low current allows optional battery operation
- Scrolling
- **AND MORE.....**



AIE Corporation
P.O. Box 70 • 141 Granite Street
Batesburg, SC 29006 • (803) 532-9256
Orders Only: (800) 397-9256 • FAX: (803) 532-9258



SWLManager 1.0

Windows-Based SWL Database & Radio Control Software

"SWL Manager performed flawlessly. was up and running in 5 minutes, and was very easy to use."

"...SWL Manager is the best program around under \$45..."

John Catalano
M.T. 12/94

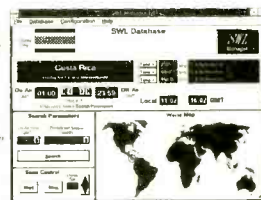

SWL Manager is designed to assist the Short Wave Listener determine which countries are broadcasting English speaking programs, including **FREQUENCY** and **BROADCAST** times.

The SWL Database contains **HUNDREDS** of broadcasts from over 50 countries world-wide, and the user has **FULL** control of the Database including **ADD**, **EDIT**, and **DELETE** functions.

Database size is limited only by available hard disk space. SWL Manager has built-in **TUNING & SCAN** control functions compatible with popular **KENWOOD**, **ICOM**, and **YAESU** HF Radios.

FEATURES

- **POWERFUL** Search capabilities, tells you which Countries are broadcasting **RIGHT NOW!**
- Displays Country Flag and Location of Broadcast Station Headquarters on World Map
- Displays Local and GMT Time
- **SIMPLE** to use with **ON-LINE HELP**
- Compatible with **POPULAR HF Radios**

\$19.95 + S & H

Credit Card Orders: (MC, Visa, Amex or Disc) call FSL at 800-242-4775. Ask for Product # 11669. SWL Manager 1.0 (800 # for orders ONLY. Use address below for ALL other info.)

FREE DEMO: On TQIR BBS (404) 921-8687. SWLMGR10.ZIP CompuServe: GO HAMNET, SWLMGR.ZIP

KC4ZGL HAM Software

1548 Cedar Bluff Trail
Marietta, GA 30062 USA
Internet: tony.contrada@atlwin.com

Recollections of the BIG BLAST

One year ago, a ruptured gas main in Edison, New Jersey, produced an explosion which killed one person, injured more than 100 and sent thousands fleeing for their lives as their apartments burned to the ground behind them. While newspapers in the area covered the horror and the loss that resulted from the explosion, scanner listeners sometimes were privy to another perspective on the event. Because, for whatever else it might have been, this was a major monitoring event.



By Louis Shirley

It was March 25, 1994. The fire had been so intense that 10 hours later the Search and Rescue teams (SAR) couldn't let their dogs search because of the heat still radiating from the ground. I overheard it said the temperature had reached 2000 degrees. One engineer said it would take days to figure out how many cubic feet of gas was burned during the 2-1/2 hours it took for workers to manually close the valve on the 36 inch diameter natural gas line.

The blast left a crater 50 foot deep by 120 by 60 wide. Eight apartment buildings were practically vaporized. Incredibly, out of 1500 residents, only one death resulted—a woman who suffered a heart attack while fleeing the fire.

Soot from the fire was found 10 miles away. People a mile away could feel the heat. Cars parked nearby were reduced to metal shells with only the steel belts left of their tires, and railroad ties 300 yards

away were burned. People suffered burns from the intense heat alone. Trees weren't just charred black—they were burnt to white ash from the intense heat. Buddy, that's hot.

■ A Major Monitoring Event

I live only five miles from the blast site, but as fate would have it, at midnight when the blast occurred I was sleeping so soundly that I never even heard all the rescue vehicles using the highway I live on to get to the blast site.

It wasn't until 10am that I attempted to drive to the site. Even using a county map (you should always carry one in your glove compartment) to find back roads to the site, every major intersection leading to it was blocked by police. At one roadblock, rather than detour, I entered an industrial complex right by the blockade. It turned out to be the site that the County Office of Emergency Management (OEM) was using as their Command Post (CP) for the Emergency Operations Center (EOC). I also found myself less than a mile from the blast site.

Twenty-five towns in the county supplied police, fire, and EMS support, and 43 law enforcement agencies provided police back-up. Both the size and uncertain cause of the blast provided a monitoring experience I have never encountered in emergency drills. My hunch is that many of the procedures I witnessed are a sign of things to come, which is why I am sharing this story now with *MT* readers.

My scanners were set to the Hazardous Materials (HazMat) frequency of 155.955/153.875 MHz as I drove out there; this is the main OEM channel. Ch 2 is 155.955 (simplex) for short distance communications. Eventually the HazMat units would switch to ch 5, 155.850. But my frequency counter quickly pointed out that everyone there was using cellular phones.

Fire units were using 33.820 when possible as this is the county fire channel. I was surprised to hear the New Jersey State Police on 155.955. The NJSP had people from the Governor's office with them and used Troop C trunking as they journeyed to the site.

Edison FD (Fire Dept.) used 33.560, repeated on 460.525. They were very active. The Edison Rescue Squad used 478.7125 and it, too, was quite active. I eventually removed it as less EMS action occurred, but I wouldn't be surprised if the PD (Police Dept) also used it for their handhelds while inside the site. For example, another town uses MED channels



The Edison FD van was used for press conferences until the OEM Command Post was set up closer to the site.

for narcotics surveillance, but they use a different PL from the rescue squad so that other users will not hear them. Another interesting thing Edison did was call TAC 1 on channel 1. But the PD stayed on 453.525, indicating a different PL may have been used in this case, too.

■ Two Important Tools: the Right Equipment and the Press

If you arrive at the scene late and have very little info on what has happened, try setting up shop close to the press. The press was there in force and were running cable feeds to the cameras. The person reporting was usually cued via wireless feeds or 450/455 radios. Some of the wireless mic frequencies found were: 177.000, 179.690, 180.600, 181.260, 183.400, 185.200, 203.500, 208.000.

When you are searching the 174-215 band for press wireless mics, you may also encounter up to seven TV audio signals. Here's one way to help you tell the difference. When you

hear a voice signal that breaks up and perhaps seems overmodulated, try switching to the WFM (wide band FM) mode. If the signal is now very clear and covers a large section of bandwidth (ex: 179.715-179.775) you have found a TV audio signal.

Most wireless mics will be found in the VHF band (see table 1 for more info) but how would one find communications on, say, the 26 MHz remote broadcast band, if one's scanner does not go that low?

Try the following. After I found a user on 26.150 with my PRO-2004, I wanted to walk around and find the signal's owner. Although my 2004 has been made portable, it was raining hard and I wanted something smaller to keep under my jacket. I programmed the 1st harmonic (which is double a freq) of 26.150 into my PRO-43: (26.150 + 26.150 = 52.300) and I used the AM mode. Using a harmonic will attenuate the signal strength to begin with, thereby helping you narrow the search area. I also closed the squelch so that only a strong signal would break through. As I closed in on the WNBC van, the squelch broke and I could faintly hear voices. While this method is not a cure-all for missing bands on your scanner, it will work to a point.

While we're on the topic of equipment, several types of antennas are a must. All that RF from everyone's radio will do your scanners in quick. Find which scanners work best on any given frequency and use them for those. Also don't forget to bring the old frequency counter. It really shone during this disaster!

Have extra batteries available or keep a good charge in the NiCDs that you use.

TABLE 1	
Remote pickup and wireless microphones	
<i>Search ranges:</i>	
25.870-26.470 (AM mode)	
174-215 MHz (NFM mode)	
<i>Plus these 8 FCC allocated frequencies:</i>	
169.445	169.505
170.245	170.305
171.045	171.105
171.845	171.905
These last 8 wireless mic freqs are very popular at night clubs during Karaoke night.	

THE DAY AFTER

One dead; hundreds escape hellish eruption . . .
Emergency response is quick and total . . . Central
Jersey worries about pipeline safety . . . Tenants face
rebuilding of lives. . . Black soot fell 10 miles away



I also brought along two 12-volt lead acid batteries to run my scanners and have installed two extra 12-volt outlets for my car battery to run extra gear. Having only one cigarette lighter outlet won't cut it when you need to recharge some NiCads and still want to run your scanner off the car battery.

■ Monitoring the Press

The next time you see those mega \$\$\$ vans the TV stations use, try to get a look inside. Here's a look inside WNBC as an example. These days the link to the studio is via cellular phone. As they raise the "mast" with its microwave feed (usually 3 or 9 GHz) the studio will help them position the microwave antenna dead-on for reception at the NY studio via that cellphone.

One fellow outside the van used 455.4125 to talk with the guy inside. Then I heard him use 161.670 as he watched the mast go up. Late that night I walked within 20 feet of the van and my counter picked off 180.600 as their wireless mic frequency. A Philly station used a cellphone to talk to its TV station while they also conversed on 455.6125.

If you are looking for TV press in the UHF band, try searching the following ranges: 450.050-450.925 and 455.050-455.925 for remote broadcast activity. I noted that almost all communications, other than that conducted on cellular phones, occurred here. The majority of the communication I found was in the 455 MHz band and in the simplex mode.

■ Action, Action Everywhere

While I found the press frequencies easily, the county's Emergency Management Command Center turned up some surprises. I've toured the mobile Command Post before and realized that they have radios that are capable of communicating with just about anyone. Our State's EMRAD (Emergency Management Radio) system was quiet, at least while I monitored. The system is tested monthly. 39.760 is the Statewide and Mutual Aid freq. 39.840 serves North Jersey, 39.800 serves Central Jersey, and 39.920 serves South Jersey. Tune in around 7pm on the third

TABLE 2

Low Power and Itinerants

30.840	462/467.775
33.120	462/467.800
33.140	462/467.825
33.400	462/467.850
35.020	462/467.875
35.040	462/467.900
42.980	462/467.925
43.040	464/469.500
151.625	464/469.550
154.570	
154.600	
457.525	
457.550	
457.575	
457.600	

Monday of the month to see if you can hear them test the system in your area.

While I expected to hear State Police activity on the EMRAD net, they popped up on the HazMat frequency instead. When there are numerous agencies involved with a disaster, you may find they have a common frequency they use, called a "Mutual Aid" channel. However, I have noticed the sharing of radios among agencies. This circumvents having some users on VHF while others are using UHF. I've found the FBI (Federal Bureau of Investigation) using a PD's radios as they worked together, and the DEA (Drug Enforcement Administration) loaning its radios to a county Narcotics Task Force for a joint operation.

The HazMat radios weren't the only county radios in use. The county Sheriff provide plenty of manpower inside the apartment complex area. Their main channel consists of 155.655/154.710, called ch 1, but they also use the 155.655 as their simplex talk-around channel.

Once inside, they quickly set up "Posts." These consisted of officers placed at numerous locations inside the apartment complex. There was only one access road to the apartments with woods and highway surrounding it on all sides; closing it off to the outside world was easy to do—and close it off they did!

Posts were instructed to switch to channel 5, 154.725 early on. This would free up the main channel. This is also common practice. It allows the officers short distance communications and at the same time limits interference from distant users. Don't expect to find special radios for occasional use these days; money is tight, fiscal budgets are tighter.

Having radios that operate on all the assigned frequencies for a town or county also allows different units to communicate with each other. A case in point was the Edison Public Works crews using their 155.760s frequency to deliver fuel to the emergency generators at the blast site. But I found out they also have the SPEN channels (State Police Emergency Network) as well. It was a simple matter of switching to 154.680 if they wished to talk with the Command Post inside the compound.

Having access to microfiche or an excellent frequency directory like *Police Call* (I carry an extra copy in my car) will allow you to quickly find a town's licensed channels. Program all of them in if you're not sure who uses what frequency, then keep notes.

Pay close attention to the name assigned to units on scene. Some of the ID's I heard

were: Incident Command, OEC, HazMat Base, OEM, Field Comm, TAC 1, Staging Area, Command Center, Lighting Command, and Response Team. Each of these units served a special purpose. If you hear "TAC 1" respond on UHF, then hear them on the VHF band, you've just learned something about their communications capabilities. A unit responding that "our portables only have two channels," narrows your searching greatly.

Here's another helpful tip. Once you know a little about the configuration of radios in use, set up your scanner banks as follows. Place those two portables' channels into bank 1. If the base station had five channels, they would go into bank 2. Perhaps another agency I was monitoring used four channels: these would go into bank 3. Should I want to monitor only the portables, all I need to do is shut off the other two banks, thereby eliminating unwanted conversations, and avoiding missing the ones I wanted to hear because my scanner had locked up on someone else's radio comm. This really makes life easier for the scannist who has only one scanner.

Another early county response was the County Police (previously called Parks Police) using 151.160/151.340, and my frequency counter confirmed the 151.340 as their input. But they, too, can switch to simplex on the output channel. I'll have more to say about the Parks PD later.

I could hear weather conditions being reported over 153.785 while the fire burned. Wind conditions can have a dire effect on fire fighters at the scene.

Everyone I monitored switched channels, and most more than once. The county OEM switched to their ch 5, 155.850, to free up the main channel. But I've found that the county jail also uses this frequency along with their licensed 154.650 frequency. This tells me that if the county is licensed to use a frequency, then even towns within the county can use this frequency.

One way to obtain information on your county radio system is to search the County Freeholders minutes. They will allocate monies for such a purchase. I was able to confirm the purchase of new radios for the county jail, model type, how many channels capable, options purchased and the cost. You can do the same type of search for your town or county.

Keep the above info in mind as you search for a "hidden" channel. It may simply be licensed to another user. This became apparent while I monitored Edison PD. Units on duty at the site used their 453.525 frequency, but would change to ch 2 and ch 6 once in a while. It turned out they were using

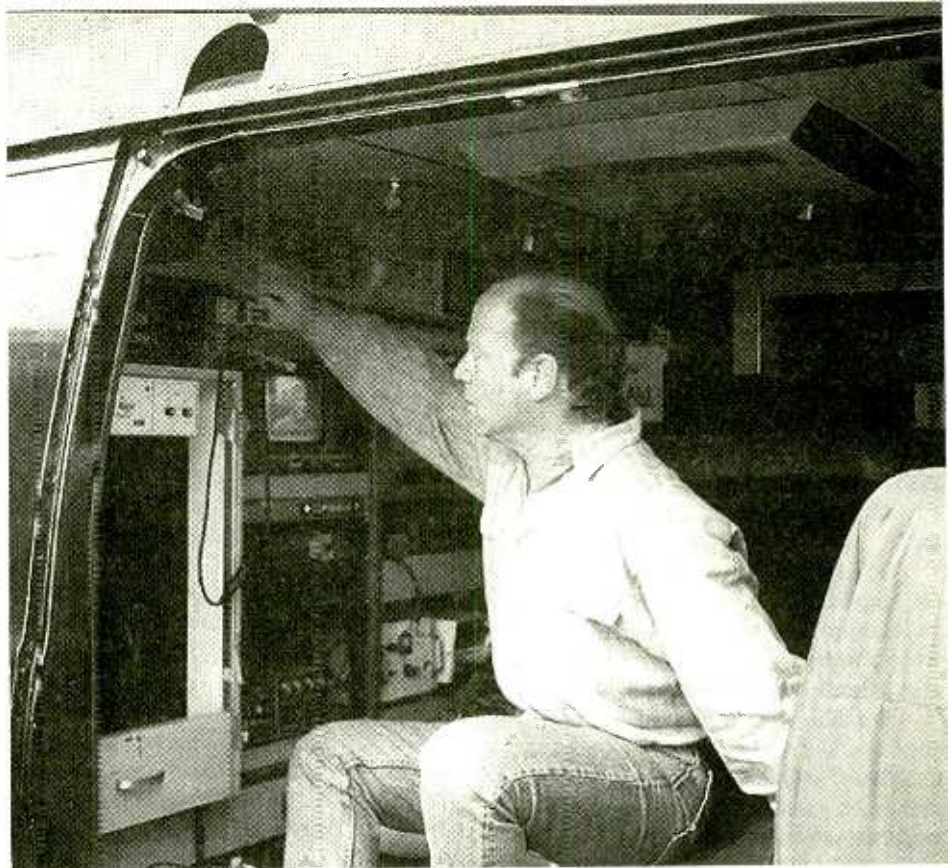

Don't miss the chance to peer inside a sophisticated mobile TV van, such as this one from WNBC.

Woodbridge PD's ch 2, 453.200, and ch 6, 453.750. I've noted several towns in my county doing the same thing.

■ Halt, Who Goes There?

The County Sheriff provided the internal support for the complex once they shut it off to the outside world. And "shut off" is not strong enough to describe it. Once the complex was secure, not even the press was allowed in, except for an elite few. Even the county arson squad video crew had a hard time accessing the site until someone said, "the

Prosecutor wants that video, let him in."

Security was so tight that a County Freeholder had to get special permission and an "escort" before getting in. The NJSP were inside and provided escorts via "Lt John"—the ID given to these officers. Their real identities were kept secret for security purposes. The Military, Jersey City PD, Watchung, Ramapo, and the county SAR (Search and Rescue) teams that were there with their dogs to look for human remains, also went through several very thorough checkpoints—and this just to get to the Command Center!

Moron 310 Garfield St Suite 4
PO Box 2748
Eugene, Oregon 97402

New! **DTMF & ROTARY TEST DECODERS**

TONE-MASTER™ TM-16A & TM-16A Plus

Decode and display DTMF from nearly any audio source; scanner, tape recorder, etc. And now decode and display either DTMF or Rotary digits from a telephone. TM-16a PLUS with RS-232 serial output includes Logger Software for optional automatic date/time/number logging using your IBM Compatible computer. Prices and specifications subject to change without notice.

TM-16A DTMF & Rotary Decoder \$179.00 TM-16a Plus with RS-232 output \$249.00

Shipping/Handling \$5 USA/Canada, \$15 Foreign. Premium shipping available for an additional charge. Visa, MasterCard, Discover & American Express Accepted. COD on Cash or Money Order basis only: \$5.

Orders: (800) 338-9058 Info: (503) 687-2118 Fax: (503) 687-2492

One disgruntled worker I spoke to later, stated that you were not to take pictures of anything, and you were not to observe the Prosecutor's people or anyone involved with evidence gathering. I would learn later that much more evidence than mere pipe was hauled away. Something interesting was going on inside, but what?

At night "light trucks" supplied "day-light." The litany for the changing of the guard went as follows: "Unit being relieved, turn on your overheads and proceed to the middle of the street; stand outside your car in the open where we can see you; all other units turn off your overheads and remain in your cars."

The mere words cannot reproduce the eerie feeling they produced. No one was to move around, the officer to be relieved must remain visible. There were no residents, everyone was evacuated. It felt like a war zone.

Once things inside the complex had settled down and all nonessential personnel had left, the Sheriff's Officers became "Posts" and performed guard duty. Again they switched frequencies to ch 6, 153.785. Posts would be called by TAC 1 or some of the others ID's listed earlier. Obviously SPEN 4 is a must for

your scanner, as it serves as the Statewide Interagency Frequency.

I turned off the Sheriff's main frequency, 155.655, early on but Central (County Sheriff's ID) would use it to talk to its Post inside the compound. The Sheriff also used SPEN 1 - 154.680, and SPEN 2 - 155.475; NJ State Police also made use of both of these frequencies. Generally all SPEN communication was low power, probably HT's.

■ Complications

The State Police Emergency Network frequencies (SPEN) were extremely important throughout the entire operation. For example, a fire sparked off on the Conrail property was called in on SPEN 1 by Woodbridge Police Dept. Everyone in the county uses SPEN 1 to talk to Conrail. All NJ PD's have SPEN radios.

To complicate matters further there was heating oil from a 2000 gallon tank at the Asphalt plant which was destroyed. The force of the explosion caused "projectiles," as one person called them, to perforate the walls of the building and went right through a computer and out another wall.

The DEPE (Department of Environmental Protection and Energy) showed up and used 151.190/159.300 and cellphones. I heard them mention a company called "Clean Harbors" taking care of the spill. Meanwhile the mobile DEPE units ("Air 1") drove around taking air samples to check for contaminants.

My freq counter picks off 151.340 in use at the site. This is the input for 151.160, the County Police. County personnel played a major role in all of this. A surprise was not hearing the County Road Dept (151.025/156.060) out there.

As the county gradually took control of internal affairs and safety was no longer in question, utility companies started sending in their personnel. The first to arrive was New Brunswick Electric. They used 173.250, but only supervisors had radios and cell phones.

While I was monitoring for activity, a friend, Rickey Stein ("Monitor the World" editor) had all the info waiting for me when I called him. Texas Eastern Transmission Corp, the company

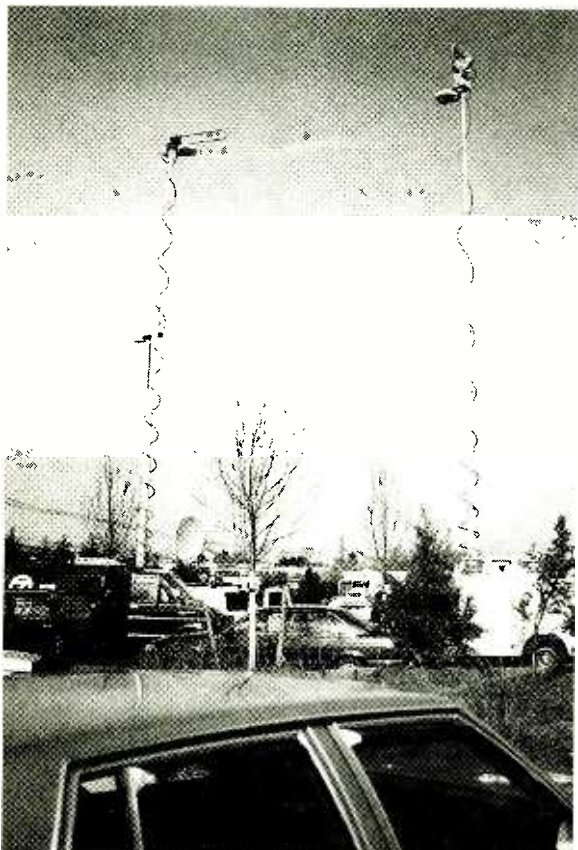

Set up near the press area if you can—you can't miss 'em!

TABLE 3

Edison (Middlesex County) Gas Explosion Profile

OEM	155.955/153.875
	154.725
	153.785
	155.850
	155.265
Sheriff	155.655/154.710
	453.475
	154.680
	155.475
Cnty MDT	501.0625
County PD	151.160/151.340
	151.190
Cnty Jail	154.650
	155.850
	154.680
Cnty DPW	151.025/156.060
Cnty Vans	857.2625
Hospitals	155.340
	155.220
Cnty Fire	33.820
Edison PD	453.525
	453.750
	453.200
	453.225
Rescue Sq	478.7125
DPW	155.760s
Fire	33.560
FD repeat	460.525
Red Cross	47.420
NJ DEPE	151.190/159.300
EPA Edison	164.450
FEMA NYC	139.825/143.000
FBI Newark	169.975/162.635
PSE&G	47.880
New Brunswick Electric	173.250
Texas Eastern Pipeline Co.	48.940
Buckeye Pipeline Co.	33.220

whose line exploded, used 48.940 as they worked on the line. Plenty of communications were heard day and night as KEC-442, their South Plainfield HQ, conversed with them.

Buckeye Pipeline is another company with lines nearby. They transport heating oil, diesel fuel, and jet fuel. Rick told me they were using 33.220 as they inspected their lines for any damaged caused by the blast.

■ Being Prepared

There are thousands of gas, oil, natural gas, etc. pipelines running all across this country, possibly in your backyard. Try searching the these bands for maintenance crews, 30.660-820, 31.320-760, 33.180-380, 48.560-49.500. Shell refineries in Seawaren, NJ, use 153.200/158.325 for day-to-day comms and drills. Try searching 153.035-680

and 158.145-445 in your area for activity, but keep in mind that your geographical area, together with FCC regulations, determine which user can use any given frequency.

A major event like this points out the need for a good database or microfiche. Monitoring the local PD is easy, but many other agencies will be using 2-way radios—hospitals, EMS, fire, press, gas and electric, telephone repair, Red Cross (47.420), and businesses. (Like the tow truck my counter caught at the scene helping remove burnt out cars on 157.515. Search these bands for towing operations: 150.815-965 and 157.470-515 by .015 spacing, and 452.5125-6125 by .025 spacing.)

Anytime something this big happens, expect to find private security firms supplementing local PDs. A private security firm helped the county patrol the perimeter. The company is called "SOS." They also used radios and could be monitored on 457.600. Itinerant frequencies are the preferred communication channels, see table 2. A security firm called "Allied Security" also provided guards at the entrance to the asphalt plant. They used cell phones (B18), but I did not notice radios. No listing was under that name in the fiche.

I noticed that some of those involved with the clean up of debris inside the compound used low band radios. One company on 43.100 was close enough for my counter to catch. Here are some allocations for Special Industry comm, 31.280-960, 35.280-860, 43.020-480, 47.440-680 by .040 spacing. Also search the VHF bands of 151.490-595, 152.465-990, 153.005-395 by .015 spacing.

Another find for my counter was the Mobile Telephone frequency of 157.800; the base uses 152.540. Together they form a full duplex pair called "Newark Mobile." I would never have looked there for communications, but a lot of businesses still use these frequencies.

■ Times They are A-Changin'

I had noticed that the use of 453.475 (County Hot Line), called ch 2, at the site. I first heard it Thursday when I arrived there, but thought nothing of it. It seemed scratchy and off frequency, but I monitored it on three different types of scanners. It wasn't until Saturday night that something different happened that shed some light.

That night there were communications on the Hot Line but this time my counter lit up with 151.160 as the input freq. He must have been right at the site and tripped my counter. I do not believe this was a simulcast (why

would they only use the output of the county PD channel?), but a 453.475/151.160 repeater system. Nothing has ever been said about such a configuration. It's unknown if any other configurations exist.

I certainly would never have looked in the VHF band for an input. The unit calling was a county PD unit. The channel was called ch 2. This certainly was a surprise, but in light of how they handled this disaster I have another surprise for you.

They had handled this "incident" in an odd fashion all along. This was no ordinary HazMat or OEM operation. I've sat through drills they've conducted in the past. I've listened to many fires, chemical spills, and responses by all the various units involved in this incident. In light of also having monitored the World Trade Center bombing incident, it leads me to make some observations about future monitoring.

No one knew exactly what had happened at the start. The blast was so great and could be seen from so far away, the apartments were just about vaporized by the intense heat. In light of today's political turmoil and terrorists, we saw a completely different approach this time. They handled the incident as a "terrorist bombing" right from the beginning. The FBI showed up extremely quickly. Intense security procedures were employed even long after all danger was removed. The press was denied access to the site. Communications made use of a hidden repeater system.

I think we all may see tighter security and some surprises at future disasters. We can no longer take things for granted; my county didn't. Anyone not getting to the location at the start may not be allowed near to it later. Being close enough to monitor meant adding certain well known federal frequencies to my disaster profile scanner.

Another harsh point is the absence of two-way radio communications by the EPA,

National Transportation and Safety Board, FEMA, and many other agencies I had in my scanners. The agencies were all there, but they used cell phones and pagers! From what I could see, the amount of cellular phone usage rivaled conventional two-way radio use—something for you to think about as you monitor a disaster—man-made or otherwise—in your neighborhood.

IMPROVED! SMART AC or SOLAR BATTERY CONTROLLERS

WILL NOT OVERCHARGE! FOR GEL-CELLS OR LEAD-ACID BATTERIES 6 TO 28V. 110/220 VAC, 50/60 HZ. HAS HILO CURRENT SWITCH, AUTO LOW VOLTAGE ALARM OUTPUT, REVERSE BATTERY PROTECTION, TRICKLE START-UP, QUICK CONNECT TERMINALS, SELF RESETTING FUSE.

BASIC KIT 6 TO 24V\$54.95; 28V\$64.95

OPTIONS: TRANSFORMER.....\$19.95
 AUTO LOW VOLT DISCONNECT GREAT FOR RV'S \$18.00
 ALL METAL ENCLOSURE\$ CALL
 ENCLOSURE WITH CUSTOM METER\$ CALL

CURTIS KEYSER KIT \$39.95
 INCL. AUDIO AMPLIFIER, IAMBIC KEYING, ADJUST SPEED.

ANTENNAS: TWIN-LEAD LADDER-LINE

MARCONI: 80 M -\$37.95; 180 M -\$44.95
 J-POLES: (2M, 6M, 220 MHZ)\$8.95 TO \$37.95
 "WINDOW" WITH 1:4 BALUN & 50' FEED LINE-\$89.95
 G5RV MULTIBAND ANTENNA (80 THRU 10M)\$44.95

P.O. Box 368
 E. HAMPSTEAD, NH 03826
 1-800-JADE-PRO
 FAX: 603-329-4499
 \$5.00 USA SHIPPING CHARGE

PUTTING THE AMATEUR BACK IN RADIO

PRO-2035
 Hyperscan
 Base & Mobile Scanner

\$379 Reg. \$449

1000 Channels
 UPS Shipping Included



PRO-62 \$244
HH-200 Channels

Pioneer Data, Inc.
 1515 N. Pacific Hiway
 Woodburn, OR 97071
 (503) 982-5115

TABLE 4

Special Industry	Petroleum Industry
31.280-31.960	30.660-30.820
35.280-35.860	31.320-31.760
43.020-43.480	33.180-33.380
47.440-47.680	48.560-49.500
by .040 spacing	153.035-153.680
	158.145-158.445
151.490-151.595	
152.465-152.990	
153.005-153.395	
by .015 spacing	

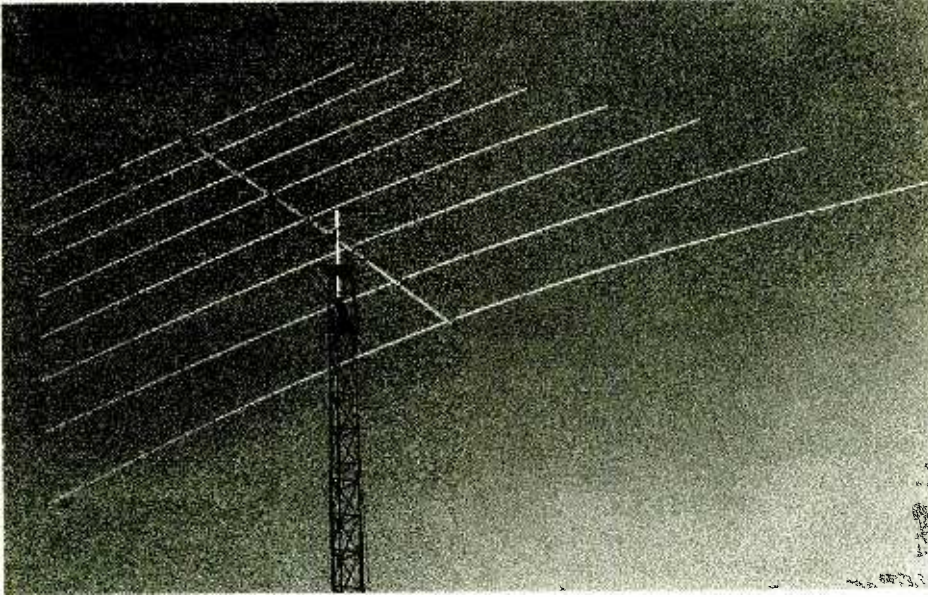

ELEMENTS

Of Antenna Selection, Performance And Design: Excerpts from *Antenna Factbook*

By Bob Grove

In no other realm of radio are there so many myths and misconceptions as in the subject of antennas. Over the next few months we will attempt to lay the mythmakers asunder as we explore the fascinating world of antennas. For those readers who want the complete edition, this series is extracted from my new *Antenna Factbook*.

We'll start the series this month by listing sixteen facts in an attempt to correct some of the most common antenna myths.

1. Except for very thin wires, most antennas are efficient radiators. Virtually all losses in an antenna system occur in the feedline.
2. A high standing wave ratio (SWR of 3:1, 6:1, etc.) merely indicates the presence of power reflections on the feedline due to impedance mismatch. If there are no losses in the feedline, all reflected transmitter power will be returned to and radiated by the antenna; for receiving systems, all captured signal power will be

returned to the receiver. If there is an impedance mismatch between the receiver and transmission line, however, reflected signal power will be returned to the antenna where it will be re-radiated back into space.

3. Reflected power does not flow back into the transmitter and cause damage or overheating. If damage occurs, it is due to mistuning the amplifier.
4. A low SWR reading only means that the transmitter, feedline, and antenna system are impedance-matched; it does not necessarily mean that everything is working properly. Corroded or intermittent connectors, ineffective grounds, lossy cable and other resistive elements can

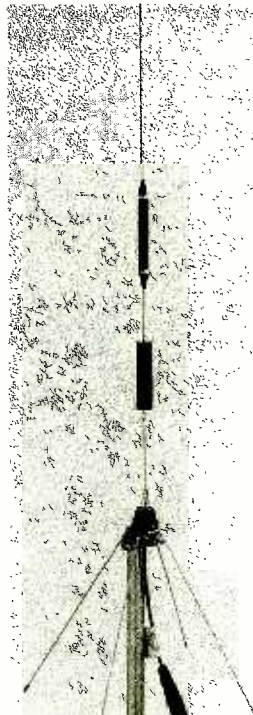

all give a deceptively low SWR. Unless an antenna is broadband by design, a low impedance maintained over a wide frequency range without retuning is particularly suspect.

5. Neither an antenna nor the feedline needs to be self-resonant (no inductive or capacitive reactances) to perform properly. Virtually any antenna and its feedline, no matter how reactive, can be brought to resonance by a transmatch (antenna tuner).
6. Using low-loss transmission line, and at frequencies below 30 MHz or so, signals experiencing an SWR of at least 3:1 and perhaps as high as 5:1 will be indistinguishable from signals produced by a perfect 1:1 impedance match.
7. Adjusting a transmatch at the radio position does not alter the reactance or impedance of either the antenna or the feedline; it brings the entire mismatched and reactive system into resonance by "conjugate matching," introducing reactance-cancelling capacitances and inductances of its own, so that the attached receiver or transmitter "sees" the desired resistive load.
8. A large antenna does not radiate more power than a small antenna, nor is more power radiated from a particular configuration (dipole, vertical, beam, quad, cage, bowtie, rhombic, loop, etc.). But a large antenna does radiate a more concentrated, directional field than a small antenna,

and it captures more signal energy during reception.

9. No transmission line needs to be a specific length if a transmatch is available. Adjusting the length of a feedline does not alter the SWR, just the impedance measured at the tuner/feedline connection.
10. High SWR in a coax feedline does not cause RF currents to flow on the outside of the line, nor will the coax radiate. High SWR on an open wire feedline will not cause the feedline to radiate just so long as the currents are balanced, wire spacing is small compared to wavelength, and there are no sharp bends.

11. Assuming low-loss feedline, an SWR meter will read the same at the antenna feedpoint, anywhere on the feedline, and at the transmitter.
12. Raising or lowering an antenna to adjust its feedpoint impedance has no significant effect on power radiated, only the shape of its elevation pattern.
13. A frequency meter or dip oscillator connected at the bottom of a feedline cannot measure the resonant frequency of the antenna; it measures only the combined resonance of the antenna plus the feedline.
14. A balun transformer on a transmitting antenna will match impedances correctly only if it is used within its power limitations; excessive current may saturate its core, wastefully heating the balun while giving a deceptive SWR reading.
15. A loading coil on a short antenna doesn't "add missing length by its turns"; it adds inductive reactance to cancel the capacitive reactance of the short antenna.
16. A transmatch doesn't "fool" the trans-

mitter or receiver into "thinking" it is connected to the correct impedance any more than an AC wall adaptor "fools" a radio into "thinking" it is getting 12 volts DC when it is plugged into 120 volts AC. In both cases power and impedance transformations really occur.

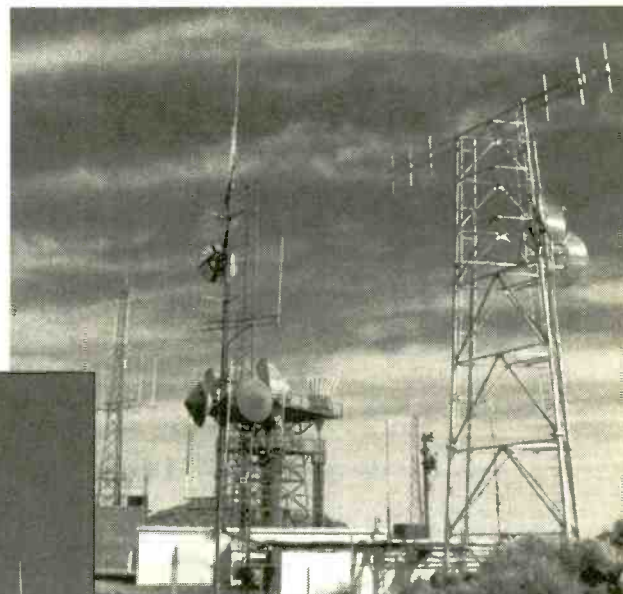
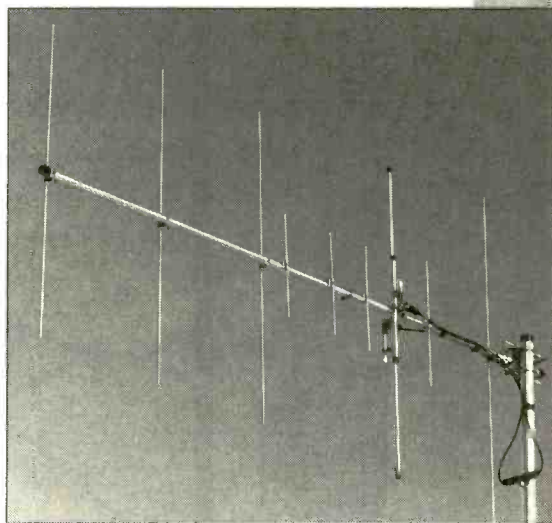

This month we have tackled some of the many myths surrounding the fascinating world of antennas for receiving and transmitting. Over the next few months we will present more facts to give you that extra measure of performance from your antenna installation.

Two Radios for the Price of One?

**NEW
FROM GROVE!**

Turn your Scanner into a Shortwave Radio Instantly!



SPECIFICATIONS:

Frequency coverage: 0-30 MHz on 114-144 MHz (CVR5) or 300-330 MHz (CVR6)

Sensitivity: 1 microvolt or better
Power required: 9 VDC battery or 12 VDC wall adaptor (Grove ACC171)



Shortwave Scanner Converter

Order CVR 5/CVR 6* Only \$99.95 each

Now you can hear global shortwave stations on your scanner—the BBC, Radio Moscow, the Voice of America, time and propagation announcements, spy numbers transmissions, pirate and clandestine broadcasts and more. And, if you own a tunable VHF/UHF receiver with SSB capability, you can listen in on intriguing voice communications as well!

Tune 4-22 MHz on any scanner capable of receiving the 118-136 MHz air band, or hear the entire 0-30 MHz range on scanning radios which offer AM mode from 114-144 MHz! Frequency steps remain the same as your scanner.

If your present scanning receiver has 300-330 MHz coverage, your display will provide direct shortwave frequency readout! Imagine, full-spectrum reception on your VHF/UHF receiver with this inexpensive accessory!

Order CVR 5 for any scanner with the 118-137 MHz aircraft band. Order CVR 6 for scanners with the 225-400 MHz aircraft band.*

Grove Enterprises, P.O. Box 98 Brasstown, NC 28902 (800) 438-8155; (704) 837-9200

Put **BACKBONE** in Your Dipole

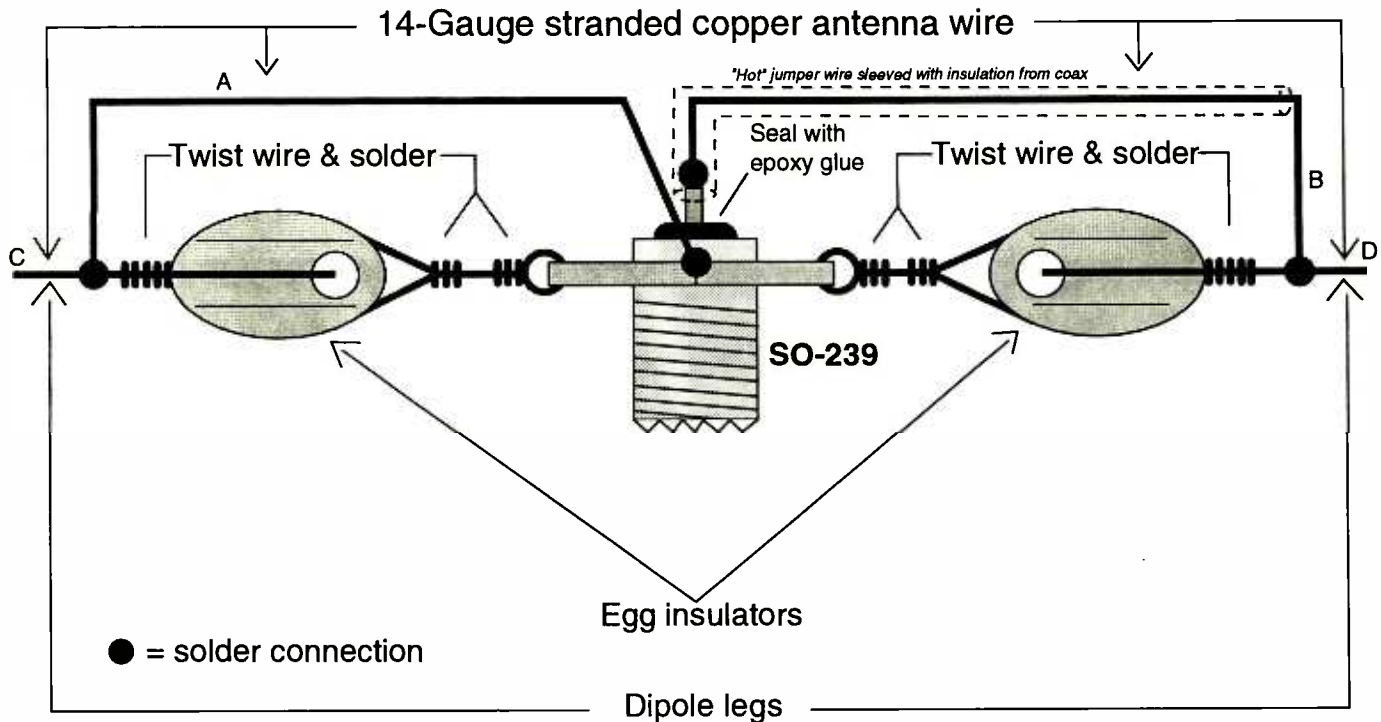

Connect insulators to screw holes in opposite corners of the SO-239 with short lengths of 14-gauge stranded antenna wire as shown. Make twists permanent by soldering. Solder one end of jumper wire A to either of the two remaining holes in the SO-239 base (ground) and other end to dipole

leg C. Sleeve jumper wire B with insulation from coax. Solder B to SO-239 center terminal (positive) and the other end to dipole leg D. Mix small amount of quick-dry epoxy glue and use it to seal top of SO-239. When dry, hang dipole by its ends and connect receiver to SO-239 using 50-ohm coax.

By Wayne Mishler

Dipole antennas are favorites because they work well and are easy and inexpensive to make. The toughest part of making a dipole is to design a good center connection. This is the backbone of the antenna and should be mechanically strong, electrically efficient, impervious to weather, and easily connected to coax.

Dipole centers are available commercially, but one of the best can be made from a simple SO-239 socket which of course connects directly to coax.

All of the materials needed are available at Radio Shack: an SO-239 chassis-mount socket (278-201), two mini-egg insulators (278-1335), and a roll of 14-gauge copper antenna wire (278-1329). You'll also need a small quantity of quick-dry epoxy glue to weatherproof the

SO-239, possibly two additional insulators for the antenna ends, and nylon cord for hanging the antenna.

■ Construction

Refer to the illustration. Note that the SO-239 has a square base with a hole at each corner for screws. You'll attach insulators to two of the holes on opposite corners of the SO-239, using short pieces of antenna wire, as shown in the illustration. Loop one end of a wire through an insulator and twist to secure it. Pass the other end of the wire through a corner hole in the SO-239 and again twist to secure it. Trim off excess wire and solder the twists to make them permanent. Repeat for the other insulator. NOTE: These wires are used for support only; it is not necessary to solder them to the SO-239.

Cut two 12-inch lengths of antenna wire. These will be used as jumper wires to connect the SO-239 to the two legs of the dipole. Tin one end of each jumper. Solder the tinned end of one jumper to the center terminal of the SO-239. Make sure it is a good electrical connection but don't overheat.

Remove a 12-inch length of insulation from coax and slip this over the jumper wire before connecting to a dipole leg as explained later. Insert the tinned end of the other wire into one of the remaining screw holes (your choice) in the SO-239 and solder. This is an electrical connection, so make sure it is a good one. Use plenty of heat. It is easy to get a "cold" solder joint here.

■ Connect the Dipole Legs

Cut the roll of antenna wire into two equal lengths. These will be the two legs of your dipole. Attach these wires to the insulators as shown in the illustration. Secure them by twisting and solder the twists for strength. Connect the jumper wire (with insulation) from the SO-239 center terminal to one of the dipole legs (again, your choice) and solder as shown. Likewise connect the other jumper

wire from the SO-239 screw hole to the other dipole leg and solder.

Mix a small amount of fast-dry epoxy glue. Quickly and thoroughly coat the center terminal of the SO-239. Completely cover the solder joint and the insulation material in which the solder terminal is supported. This forms a water-tight seal over the top of the connector, essential to keep moisture out of the coax. Do not allow any of the glue to get on or into the socket portion (threaded end) of the SO-239. Allow the glue to dry.

■ Hang and Enjoy

The two legs of the antenna can be terminated with insulators to simplify hanging. Attach nylon cord to the ends of the antenna and suspend it between two trees or roof supports. Keep it as far away from metal objects as possible. Connect your receiver to the SO-239, using 50-ohm coax. Tape the coax connection and coat the tape with silicon seal to keep out moisture.

In rain, ice, wind—anything *except lightning!*—you'll enjoy many hours of operation knowing the backbone of your all-weather dipole will endure.

As heard about on WHRI,
WINB, WWCR, Radio Copan
International

Reviewed by Larry Miller in April '93

Introducing---The New "TINY TENNA" Indoor Active Antenna

The "TINY TENNA" works on LW, MW, SW, VHF & UHF. It runs on a 9 volt battery or AC adapter. (not included) Great for travelers, vacationers, apartment or condo dwellers, etc..

No frills, nothing fancy...only pure performance and Made in the USA! Complete and easy hook-up for ALL Receivers! Satisfaction Guaranteed!

Special for "MT" Readers!
Only
\$19.95*

DWM Enterprises
1709 N. West Avenue
Jackson, MI 49202

*Plus \$4 US shipping,
\$5Canada/Mexico, \$6 DX.

CHECK OR MONEY ORDER ONLY, PLEASE. US FUNDS.

UNLOCK

FULL 800 MHZ

\$40

FREE CELLULAR FREQUENCY CHARTS

- 100s of satisfied customers
- Warranty & Service Plan Protection
- Same-day Service — FREE insured UPS return

PRO	BC
34,37	200
39	205
43	700A
46	760
2004,5,6	855
2022	890
2026	950
2030	2500

FOR DETAILS CALL:
508-768-7486

SHIP TO:
Cellular Security Group
106 Western Avenue,
Essex, MA 01929



LOOK

HAVE YOU SEEN

U.S. SCANNER NEWS

The ONLY national monthly magazine devoted entirely to the hobby of VHF-UHF monitoring. No Shortwave, No Broadcast!!

Each Month You Get:

- Outstanding Feature Articles
- In-depth, unbiased reviews
- Accurate frequency information
- The latest FCC actions
- Helpful scanning and technical hints
- Plus regular monthly columns

1YR \$18.00; 2YR \$32.00; 3YR \$46.00
Sample \$3.00 1st Class or \$1.00 3rd Class (4-6 wks)







Mail Check or Money Order or Call **1-800-890-6999**

US SCANNER PUBLICATIONS
PO BOX 14923
PORTLAND OR 97214-4923
(503) 230-6999 FAX (503) 233-5176

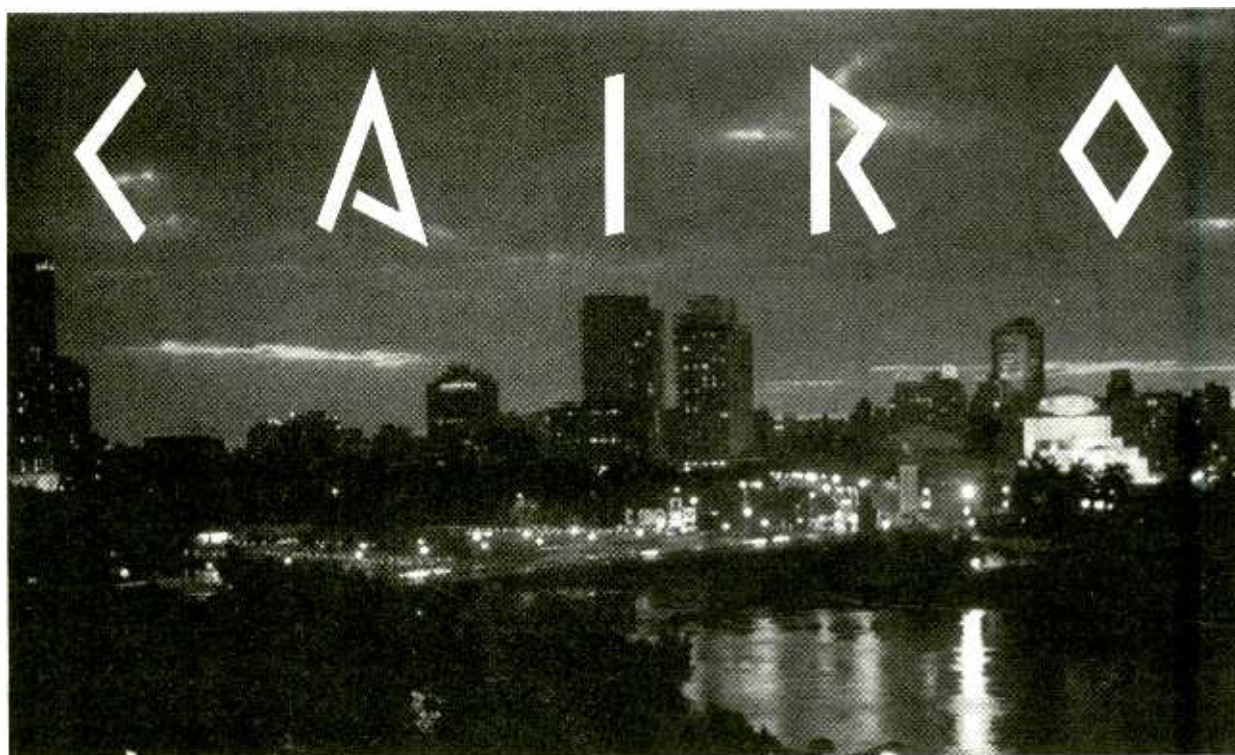
S I X T Y M I N U T E S I N



By Chuck Hodell, N8ADN

It's late on a Thursday afternoon in Cairo and I have a little time before joining a colleague for dinner. Out my window, at the Nile Hilton, I see the feluccas catching the winds as they sail down the Nile, and hear the cacophony of horns and sirens as the weekend starts in land of the Pharaohs. Since I have about an hour to kill before dinner, I decide to see how the shortwave bands are holding up during what is now the summer down cycle.

One of the real joys of being an avid shortwave listener is imagining that you are in one of the many countries you are able to hear on your radio. Exotic countries and cities leap from the speaker as you travel the dial. Sadly however, most shortwave listeners only get to hear stations from wondrous countries around the globe. How odd that here I am in Cairo trying to find a friendly voice in English to let me know what is happening in "my" world.

As a frequent business traveler to Egypt, I have afforded myself the luxury of bringing a small, portable shortwave radio with me for entertainment and news from home. As a ham I had hoped to get a reciprocal license in Egypt. But my hopes were dashed when I

learned that the United States does not have an agreement allowing for a temporary licenses here. It's probably for the better, anyway. Trying to pass my ICOM 735 and a dipole through Egyptian customs might have proved to be a bit of a challenge. And, as I have found, challenges are best avoided in Egypt.

The radio I purchased for my travels is a Realistic DX-380. It provides both excellent reception and a small appetite for AA batteries. That's a real selling point when given the choice of packing more weight or paying exorbitant prices in a foreign currency for batteries. It also helps that I talked my local Radio Shack dealer into a discount by comparing their price to the nearly identical Sangean model ATS-808.

From my room on the seventh floor of the Hilton, I am over a hundred feet above the street and facing West toward the pyramids and Sphinx at Giza. Spanning more than twenty feet from one end of my balcony to the other, the portable wire antenna I brought is ready for action. It is hanging from several eye-bolts placed near the top of the fifteen foot high marble walls of the balcony. I have

carefully run the wire through the sliding glass door opening and have actually managed to close the door without cutting the wire in half. With everything ready to go, and less than an hour of free time, how much can I really hear from a hotel room in Cairo? Let's find out.

Grabbing my latest copy of *Monitoring Times* (the only magazine I brought) I flip through to the listings for 1600 UTC. Egypt is actually three hours ahead of UTC so it is 7:00 pm in Cairo. This is usually a good time to follow the shadows and catch some DX.

The sun is starting to set over the Tower of Cairo and the Egyptian Museum as I enter my first frequency into the DX-380. 1-2-0-9-5 -- enter. With no hesitation the BBC jumps from my Sony headphones with the world news. It is a full scale reading on the S-meter (a seven on the 380's LCD panel). I guess the radio and antenna are doing a pretty good job.

After several minutes of local and national news, and a feature on gardening in England, I dial up my next choice in the shortwave guide: Radio Sweden. Almost as strong as the BBC, the Swedes are running a feature on windmills. That's about as far a stretch culturally as you can get from Cairo's noisy

Middleeastern chaos, but it is still fun to listen to.

Next on the hit list is Voice of America on 15245. They are broadcasting the news in "special English" which makes me want to try and find the non-existent fast forward control on the radio. I'm sure it is good for learning the language, but it is a tad painful for those of us just looking for the news. I wonder if they slow down the reel to reel decks with the bias control, or if the announcers are really able to talk that slow. With one more information age mystery to ponder, it is on to new shortwave horizons.

Wishing to stay on the North American continent for at least one more station, I enter 7150 and listen for Radio Canada International. The shortwave guide shows that frequency to be aimed at Asia which probably explains the rough copy. When I narrow the bandwidth with the slide switch on the side of the DX-380 I am able to hear a sports feature on the Commonwealth Games. Not bad, considering the distance and the transmitter's pattern.

Since I'm in Egypt it seems logical and neighborly to try and catch Radio Cairo on 15255. Needless to say, I can hear it from my location less than five miles away from what I believe to be the transmitter site (here, all such things must remain guesses). But it is in French and the splatter is causing it to sound a little rough. Oh well, I tried.

Jumping across the Mediterranean I find that Deutsche Welle is strong on 15595. Their story on holiday travel makes me wish my trip back to Washington was moved up a couple of days. I'm sure that the many German travelers I've seen in Cairo appreciate being able to copy it so easily.

Feeling a little bold with my successes so far, I decide to try and catch one of the American religious broadcasters. The strongest is WCSN from Scott's Corners, Maine, on 15665. After several minutes of listening to an audio feed from a video tape explaining the "Book



The author (left) and colleague Hig Roberts discover what it's like to be in an exotic location, listening for familiar voices on the radio.



Looking East, I can see the towers of Radio Cairo less than five miles away—probably too close for good reception.

of Revelations," I decide to try and find Vatican Radio on 6245 for the other side of the story. While I have a good copy on VR, my Italian is a little rough and I decide WCSN gets the "love gift."

With just a few minutes left, I punch in 15530 and find Radio France International full scale. Their "Science Notes" feature is on genetic screening and it is a very interesting piece, but I'm determined to find one more station before I run to dinner.

I set the DX-380 on the 49 meter band and start searching for one last station to log. It stops on 6100. A quick look at the shortwave guide shows that Radio New Zealand International should be at that frequency. Yet, the music doesn't sound at all like something from down under, so I decide to wait for an

ID. Several minutes later I think I hear the female announcer say Radio Belgrade in Yugoslavia. The little I understand seems to be a news story concerning Sarajevo—a rather sad end to my quick 60 minutes on the international shortwave bands from Cairo.

In all, I logged nine stations and managed to get enough information to stem my creeping homesickness. For anyone who travels, shortwave radio can prove to be a welcome change

of pace from business or sightseeing duties.

So with a few minutes to spare I head down the elevator to join my friend in the Italian restaurant at the Hilton. While the native Cairo residents enjoy smoking their sheeshas, we listen to an Egyptian folk singer doing his rendition of John Denver songs in broken English, all the while eating a pizza and drinking German beer. Ah, international travel . . . !

WHITE BOX™ ANTENNA



- New! Longwire antenna for SWL's.
- Low noise reception 500 KHz to 30 MHz.
- Complete ready to go.

Palomar's new White Box™ contains a complete 40' longwire antenna with end insulators, nylon support rope, and a Magnetic Longwire Balun. Not a kit—all components are connected and wires soldered. You just put it up and connect it to your radio with noise-free coaxial cable (not supplied).

Unlike other longwire and sloper antennas you can use coax for clearer low noise reception with no signal loss: The Magnetic Balun matches the antenna to your coax. Can be installed as a horizontal longwire or as a sloper.

Model WB-1 \$59.95 + \$6 shipping/handling U.S. & Canada. California residents add sales tax.



Send for **FREE** catalog that shows our complete line of antennas, baluns, preamplifiers and more.

PALOMAR ENGINEERS

BOX 462222, ESCONDIDO, CA 92046
Phone (619) 747-3343
FAX (619) 747-3346

'11177' stations. The big difference is that the RCF's messages did not have the 5-figure groups preamble. The 'callsigns' used are in some cases obvious dummies like 'CAZ', but in other cases they could be genuine (e.g. UXW or EWZ42). Some, but by no means all, were among the list of addresses used by RCF.

"Unfortunately, I did not become interested in these stations until just before RCF went off the air, so I never saw any messages transmitted by both RCF and one of the '11177' stations, which would have been proof positive. I believe that the '11177' stations are, in fact, some form of communication between the Russian MFA and its embassies.

- "The callsign sent by individual contact stations, and possibly also by broadcast stations (those which send in the 'blind'), is presumed to indicate the receiving station, *not* the transmitting station. However, so many monitors have reported 'KUL,' for example, as the callsign of the transmitting station, that it is too late now to change. (And anyway, it is much easier to refer to *KUL* than to *the station that always calls KUL*).
- "It has recently been suggested in some listening circles that these transmissions are messages which were sent by satellite from Moscow to central stations for retransmission to embassies within their areas. This would certainly explain the fact that the same message is frequently observed to be sent by several different stations in the course of a single day. Presumably, these are circulars being sent to all embassies.
- "The ten letters used for the last 5-letter group look like the top row of the keyboard of a typewriter intended for some non-English speaking country (typewriter, not teleprinter — apparently all teleprinters use the same keyboard). The odd arrangement of figures may merely be intended to make the letters I and O represent the figures 1 and 0."

■ Frequencies

John Doe has also provided this column with some of his intercepts of these RTTY number stations. I would be very interested in intercepts by other Ute World readers; you can forward them to the Brasstown address for inclusion in this column.

(1) Broadcasts

	Time	Frequency	Callsign Used/Notes
S	0715	10410.0	KUL repeated on 8165.0
	1100	18225.0	VKX repeated on ??????
S	1410	12193.0	KUL repeated on 10584.0
	1410	14980.0	RAU repeated on ???????
S	1500	14605.0	VKX repeated on 12180.0
	1840	6798.0	KUL repeated on 4873.0

(2) Individual Contacts

SS	0815	17422.0	URO in contact with 19185.0
	0815	19185.0	DCW in contact with 17422.0
SS	0825	16153.0	DKR
	0835	20042.0	FQX
	1005	18585.0	CAZ
S	1020	20170.0	GOD 100 baud RTTY
	1400	19842.0	RPR
	1415	14736.0	WFO
	1520	7538.0	DZR 100 baud RTTY
	1605	5775.0	VKS in contact with 6862.0
	1605	6862.0	VNB in contact with 5775.0
	1810	8062.0	RJA
	1835	7541.0	URO

Note 1: The callsign shown is sent many times by the broadcast stations, usually only once by the individual contact stations. In the latter case, at least, it is probably the callsign of the station being called, not that of the calling station.

Note 2: Unless otherwise stated, all transmissions are 75 baud RTTY. As a

general rule, broadcasts are normal polarity, 100 baud RTTY. Individual contact stations are normal polarity; all other transmissions are reversed polarity.

"These are only examples. It is obvious that for each of these individual contact stations, there must be another station, somewhere, in contact. In most cases, only one end of the contact has been identified. There are also bursts of activity at certain times (e.g. 1400-1430 and 1600-1630 UTC) where many stations have been heard, but actual starting times are uncertain. The total number of frequencies logged since the beginning of 1993 is well over 100.

"All these transmissions take place on Monday through Friday. Some marked 'S' above are on Saturday and a few marked 'SS' are on both Saturday and Sunday. The fact that a station is not marked 'S' or 'SS' does not necessarily mean that it is not active on these days, merely that I have not heard them yet."

I would like to thank John Doe for this first, indepth look at the KUL/YBU RTTY number stations, and I invite Ary Boender, Dave Batcho, and others of the Fidonet SWL net gang to drop by and let our readers know what you are hearing and what you have discovered.

■ HICOM is No More

I have been told by an extremely reliable source in the government that the U.S. Navy HICOM (High Command) network is no more. The entire network has been incorporated into the U.S. Air Force Global High Frequency System (GHFS). Look for even more interesting Navy traffic on USAF GHFS frequencies in the future.

And with that note, it's time to see what you have been hearing this month in the World of Utility listening. 73 de N5FPW from Brasstown.

Greatbooks on SCANNING and MORE!!

EMERGENCY RADIO! Norm Schrein
 Scanning News As It Happens 214 pages, \$14.95
 "Excellent..." Barry Goldwater "A winner..." 911 Magazine
 "Rates a 10!" Dispatch Magazine "Irresistable" Bill Cheek

SCANNERS & Secret Frequencies Henry Eisonson
 320 pages, \$19.95
 "Must reading..." Electronics Now "Useful, knowledgeable..." PopComm
 "A giant undertaking...authoritative" Monitoring Times "You can't miss!" ASG
 "Absolutely the best..." Norm Schrein "A high point!" RCMA

COMING SOON

ULTIMATE SCANNER Bill Cheek
 Scanner modifications - THREE ~250 pages, large format, \$24.95
 Bill Cheek is the master of scanner modification, Editor of World Scanning Report and author of Scanner Modification Manuals Volumes 1 & II.

TRAVELSCAN Henry Eisonson
 Good Frequencies Across America ~120 pages, \$7.95
 Handy pocket guide to scanning in every area of America. 100 top cities, plus every state and many federal agencies, speedtraps, recreation, MORE!

Beyond scanning, and HOT!

Cheating* at Blackjack D.D. Marks
 *and Advantage Play 230 pages, \$19.95
 "Get this one!" "Exceptional" Dalton
 "Must reading..." Schwartz Blackjack Forum "WOW!" Snyder

Underground Database 100 pages, large format, \$23.75
 Everything that's sort of legal. "Fascinating" ASG

Television GRAY Market Henry Eisonson
 Cable & satellite chips, descramblers, etc. 160 pages, \$23.75
 "Explores this shadowy fringe area in depth... good info." PopComm

INDEX Publishing Group, Inc. Add \$4/book s/h. CA add tax
 3368 Governor Drive, Suite 273M MO/check via mail, or call toll-free.
 San Diego, CA 92122 All credit cards
 619-281-2957 (editorial) Order line 800-546-6707

Abbreviations used in this column

AM	Amplitude Modulation	LDOC	Long Distance Operational Control
ARQ	Synchronous transmission and automatic repetition teleprinter system	LQA	Link Quality Analysis
ARQ-E3	Single channel ARQ teleprinter system	LSB	Lower Sideband
ARQ-M2	Multiplex ARQ teleprinter system with two data channels	MARS	Military Affiliate Radio Systems
ATC	Air Traffic Control	Meteo	Meteorology
CAMSLANT	Communications Area Master Station, Atlantic	MFA	Ministry of Foreign Affairs
CAMSPAC	Communications Area Master Station, Pacific	MHC	Mine Hunter, Coastal
CANFORCE	Canadian Forces	m/v	Motor Vessel
CG	Coast Guard	NORAD	North American Air Defense Command
CGC	Canadian Coast Guard	RAAF	Royal Australian Air Force
CNA	Central News Agency, Inc	RAF	Royal Air Force
COMSTA	Communications Station	RTTY	Radioteletype
CW	Continuous Wave (Morse Code)	SAM	Special Air Mission
DoD	Department of Defense	SAR	Search and Rescue
EAM	Emergency Action Message	SELSCAN	Selective Scanning
FAF	French Air Force	SITOR	Simplex teleprinting over radio
FF	French Forces	SITOR-A	Simplex teleprinting over radio, mode A
GHFS	Global HF System (USAF)	SITOR-B	Simplex teleprinting over radio, mode B
HF	High Frequency	SOC	Space Operations Center
HMAS	Her Majesty Australian Ship	U.S.	United States
HMCS	Her Majesty Canadian Ship	USAF	U.S. Air Force
ID	Identification	USB	Upper Sideband
IRNA	Islamic Republic News Agency	USCG	U.S. Coast Guard
		USCGC	U.S. Coast Guard Cutter
		U.S.S.	United States Ship
		WMEC	Medium Endurance Cutter

All frequencies in kilohertz (kHz), all times in UTC. All voice transmissions in English unless otherwise noted.

- 446.0 Nuevitas Radio, Cuba, working CLBR in CW at 0230. (Jim Navary-Colonial Heights, VA)
- 1692.0 La Coruna Radio, Spain, at 0723 in USB working unknown vessel (DMHC) on 2123 (duplex) for radiotelephone traffic after hailing on 2182.0. (Richard Baker-Austintown, OH)
- 2048.0 LAFU2 - m/v *Early My Bird* at 0437 in USB working FFU-Brest Radio, France, (duplex on 1635) after hailing them on 2182.0 for radiotelephone traffic. (Baker-OH)
- 2102.5 VX2212-Canadian CG cutter *Westford* working CGC *Yarmouth* in USB at 0155. (Navary-VA)
- 2182.0 Noted USCG stations NMF31-Group Portland, ME, and NMN13-Group Cape Hatteras, NC, in USB at various times with ship traffic (Baker-OH) *International Distress and Calling Channel-Larry*.
- 2206.0 CGBT-J.E. Bernier working CGC Sydney in USB at 0022, duplex with 2582. (Navary-VA)
- 2670.0 NMF2-USCG Group Woods Hole with SAR traffic in USB at 2328. (Baker-OH)
- 2678.0 NMP9-USCG Group Milwaukee with HF test on Great Lakes at 0858 in USB. (Baker-OH)
- 2795.0 ESA-Unidentified CW station with SITOR idler at 0337. (J.S. McDonald-BC Canada) *My notes show Tallin Radio, Estonia-Larry*
- 2830.0 NMF2-USCG Group Woods Hole with SAR traffic in USB at 0418. (Baker-OH)
- 2832.7 GNK1-Wick Radio, Scotland, with CW ID and SITOR idler at 0344. (McDonald-BC)
- 2872.0 Lufthansa 437 working Gander ATC in USB at 0638 (Selcal CGFJ). (McDonald-BC)
- 3016.0 Ascot 2314 working Shanwick ATC in USB at 0750. (Robin Hood-UK)
- 3024.4 USCGC *Seneca* working various merchant vessels in USB at 0224. (Navary-VA)
- 3029.0 ARIA 1 (Advanced Range Instrumentation Aircraft EC-18) and ARIA 2 working Abnormal 10 (Vandenberg AFB) with data transmission test at 3134.0
- 0543 in USB, duplex on 6889. (Baker-OH)
- Glenmore working Nightwatch 01 in USB at 0718. (Jeff Haverlah-Houston, TX)
- 3174.9 'V'-Single letter HF marker in CW at 2318. (Jack Dix-Yonkers, NY) *Looks like this SLHFM might be in eastern Russia based on propagation-Larry*.
- 3182.5 CW 5-figure number station (hand sent) at 2320. (Dix-NY)
- 4035.0 U.S. Army MARS, 9th district net at 0420 in USB. (Gordon Levine-Anaheim, CA)
- 4165.0 C102-Israeli Mossad number station in AM at 2149. (Dix-NY)
- 4375.0 VLRD-HMAS Townsville (Australian Navy) working control in USB at 1239. (Navary-VA)
- 4405.0 *Song of America* working High Seas operator with phone patch traffic in USB (duplex) at 0251. (Mike Adams-Hutto, TX)
- 4512.5 ETD3-Addis Ababa Air, Ethiopia, with 50 baud RTTY RY test tape at 2341. (Dix-NY)
- 4520.0 DoD Cape working SOC, also USS *Boone* and King 1/2 in USB at 1739. (Mike Comer-Titusville, FL)
- 4560.0 YHF2-Israeli Mossad number station in AM at 2101. (Dix-NY)
- 4721.0 IDR-Italian Naval Rome, Italy, working 3EW (probable French naval) in USB at 1721 in English. (Hood-UK)
- 4724.0 Steamcar working Thule GHFS at 0817 in USB regarding frequencies for Nightwatch, advised X-208, X-903. (Baker-OH) Aggregate requesting working frequencies for Nightwatch from McClellan GHFS, passed X-208 (3134) and X-209 (4742). (Pihale-MN) *New OR frequency, old was 4725-Larry*.
- 5149.0 CW 5-figure number station at 2257. (Dix-NY)
- 5306.0 'C'-Moscow, Russia, Single letter HF marker in CW at 2308. (Dix-NY)
- 5320.0 USS *Heron* (MHC-52) at 0458 working NOY-USCG Group Galveston with SAR traffic in USB. (Baker-OH)
- 5342.0 FDY-FAF Orleans, France, with V CW marker at 0006. (Dix-NY)
- 5399.5 USCG station Foxtrot Charlie at 0332 in USB working Charlie India and Charlie Papa. (Baker-OH) NMG-COMSTA New Orleans, LA, working Foxtrot Charlie and Foxtrot Charlie working Charlie Alpha in USB at 1210. (Harry Riddell-Rochester, NY)
- 5500.0 Yelda (?) 70 working 6J, U2 checking out data link in USB at 1150. (Riddell-NY)
- 5547.0 San Francisco ATC working Hawaiian 22 and New Zealand 6981 in USB at 0528. (Navary-VA)
- 5574.0 San Francisco ATC working Korean AOR 018 and Northwest 2 in USB at 1256. (Navary-VA)
- 5598.0 Air France 594 working New York ATC in USB at 0458. (Levine-CA)
- 5643.0 Tahiti ATC working New Zealand 1 in USB at 1058. (Navary-VA)
- 5649.0 Ice Air 614 (B-757) working Gander ATC in USB at 0327. (Navary-VA)
- 5661.0 Malta ATC working aircraft 6GAUH in USB at 1832. (Hood-UK)
- 5680.0 Plymouth Rescue working Rescue 51 in USB at 0158. (Navary-VA)
- 5696.0 NMN-CAMSLANT Chesapeake, NMF-COMSTA Boston, CAMSPAC San Francisco, and COMSTA Kodiak working various units in USB. (Levine-CA)
- 5750.0 English female 5-digit number station in AM at 0445. (Adams-TX)
- 5861.5 LYNX-Unidentified station with CW ID and SITOR idler at 2336. (Dix-NY) *This is the Ministry of Foreign Affairs in Lagos, Nigeria-Larry*.
- 6315.2 KFS-San Francisco Radio, CA, with SITOR-B weather traffic at 0516. (James Callaway-NV)
- 6343.7 WLO-Mobile Radio, AL, with SITOR-B weather traffic at 0144. (Callaway-NV)
- 6532.0 VR-BOR with emergency communications (low fuel) working Honolulu ATC in USB at 1050. (Navary-VA)
- 6535.0 Aeroflot 354 and Angola 650 working Dakar ATC in USB at 0438/0154 respectively. (Navary-VA)
- 6556.0 Cathay 261 (VR-HOR) working Calcutta ATC in USB at 1710. (McDonald-BC)
- 6640.0 Aeromexico 449 calling Mexico (Aeromexico LDOC), no reply in USB at 2355. (Navary-VA)
- 6675.0 Possible Russian fishing fleet net, one of them singing in LSB at 0110. (Rick Sumner-Olney, IL)
- 6683.0 SPAR 84 working Andrews in USB at 0120. (Haverlah-TX)
- 6693.0 R7P working unidentified station in USB, also Miniature. (Comer-FL)
- 6712.0 Lajes GHFS with 26 character EAM broadcast in USB at 0630. Also heard Croughton calling Mainsail and Offutt here with EAM broadcast. (Haverlah-TX) *New OR frequency, old was 6750-Larry*.
- 6715.0 HMCS Calgary working Vancouver Military in USB at 0340. (Navary-VA)
- 6727.0 Selscan type tones then SAM 28000 with 2850 working Andrews in USB at 1940. (Comer-FL) *Mystic Star-Larry*.
- 6730.0 USAF Executive Foxtrot 1 working Andrews in USB at 0352. (Navary-VA)
- 6739.0 USAF GHFS stations noted here include: MacDill, all in USB at various

- times. (Baker-OH) Selscan activity noted here at 0000. (Haverlah-TX) *New OR frequency, old was 6738-Larry.*
- 6745.0 VLB14-Israeli Mossad number station in AM at 0225, transmitting VLB14B05. (Summer-IL)
- 6750.0 U.S. Navy Foxtrot Tango net active on Charlie 3 in USB at 0722. (Haverlah-TX)
- 6779.0 German Navy ship DRAF-Moelders working DHJ-59 in USB at 0556. (Navary-VA)
- 6780.0 Sierra 2 working Bravo 4, Echo 4, Alpha 3, Charlie 2, Latin American accents — sounded like wargames in USB at 0255. (Navary-VA)
- 6785.0 P7S working P7SH in USB at 1228. (Riddell-NY)
- 6786.0 Spanish female 5-digit number station in AM at 0208. (Adams-TX)
- 6795.0 Spanish female 5-digit number station in AM at 0210. (Summer-IL)
- 6817.5 Bonal (?) working Bonal 6, mention of Bonal 10, helicopter, call sign Warrior, Det 4 and Det 12 in USB at 1315. Also Ready 1 working Bonal 6, mention of ship and shift to secondary frequency because of Spanish station interference. JTF4? (Riddell-NY) *My guess is Marines, Harry-Larry.*
- 6840.0 EZI2-Israeli Mossad number station in AM at 2201. (Dix-NY)
- 6933.0 Spanish female 5-digit number station in AM at 0200. (Summer-IL)
- 6993.0 SAM 200 working SAM Command via Andrews in USB at 2050. (Navary-VA) Andrews working Air Force 2 in LSB at 0633. (Comer-FL)
- 7527.0 Spanish female 5-digit number station in AM at 0010. (Summer-IL)
- 7535.0 NEXS-USS Emory S. Land, NGMN-USS Nitro and NDIB-Briscoe working Norfolk SESEF in USB at various times. (Navary-VA)
- 7783.5 USCG station Foxtrot Charlie working Charlie Foxtrot (0204) and NMG-COMSTA New Orleans (0224) in USB. (Baker-OH)
- 7959.2 9BC23-IRNA Tehran, Iran, with 50 baud RTTY English news bulletin at 1815. (Robert Hall-Capetown, South Africa)
- 8030.0 English female 5-digit number station in AM at 1809. (Dix-NY)
- 8040.0 SAM 972 working Andrews in USB at 2230. (Haverlah-TX)
- 8117.0 BMB-Taipei Meteo with CW weather in English at 1010. (Navary-VA)
- 8120.0 Mike Oscar working Raider in USB (probable USCG) at 1253. (Navary-VA)
- 8442.0 TCR-Istanbul Radio, Turkey, with CQ CW marker at 2001. (Dix-NY)
- 8458.0 German female 5-digit number station in AM at 1211. (Dix-NY)
- 8473.0 HLG-Seoul Radio, South Korea, with CQ CW marker at 2246. (Dix-NY)
- 8480.0 HZY-Ras Tannurah Radio, Saudi Arabia, with CQ CW marker at 1948. (Dix-NY)
- 8495.0 'C'-Moscow, Russia, single letter HF marker in CW at 1332. (Dix-NY)
- 8641.0 MIW2-Israeli Mossad number station in AM at 2149. (Dix-NY)
- 8843.0 Gulfstream 75RP working San Francisco ATC in USB at 2105. (Levine-CA)
- 8855.0 Porto Velho ATC calling American 900, told to try 5526. Manaus ATC working American 904, United 988 and American 924 at 0554. Brasilia ATC working Big A heavy 661 at 2133. All in USB. (Navary-VA)
- 8861.0 Iberia 6810 working Recife ATC in USB at 0019. Roberts ATC (Liberia) working African Express 36 in USB at 0105. (Navary-VA)
- 8879.0 Beira ATC (Mozambique) calling Dar-es-Salaam ATC in USB at 0344. Also noted Harare (Zimbabwe), Lilongwe (Malawi) Antananarivo, and Gander. ATCs. (Navary-VA)
- 8891.0 Baffin ATC working Lufthansa 8391 in USB at 2251. (Navary-VA)
- 8896.5 Various Peruvian ATCs working each other in Spanish, no aircraft heard in USB at 2115. (Navary-VA)
- 8903.0 N'Djamena ATC (Chad) working Speedbird 52 and Lufthansa 569 in USB at 0112. Also noted Kano (Nigeria), Luanda (Angola), Libreville and Kinshasa ATCs. (Navary-VA)
- 8924.0 Piarco LDOC working West Indian 427 in USB at 2302. (Navary-VA)
- Warsaw LDOC working aircraft SPL0A in USB at 0828. (Hood-UK)
- 8933.0 Springbok 267 working Johannesburg LDOC in USB at 0202. Ethiopian 834 working Luanda at 0240. (Navary-VA)
- 8942.0 Singapore ATC working Dynasty 60, Aeroflot 556 in USB at 1122. Also noted Hong Kong ATC. (Navary-VA)
- 8951.0 Ankara ATC passing clearance and weather to unidentified aircraft in USB at 2114. (Navary-VA)
- 8968.0 Badluck working McClellan GHFS with request for working frequencies for Nightwatch, passed X-210 (11229) and S-311 (11494) in USB at 1945. Also heard Andrews and Lajes GHFS here. (Pihale-MN) *New OR frequency, old was 8967-Larry.*
- 8971.0 S4JG (U.S. Navy general aircraft call sign) working Bluestar in USB at 2141. (Haverlah-TX)
- 8974.0 PJX-Dutch Navy working Sparrow 2 in USB at 1436. (Navary-VA)
- 8976.0 RAAF Darwin working RAAF Sydney in USB at 1310. (Navary-VA)
- 8983.0 Rescue 1710 (HC-130) at 1805 working NMN-CAMSLANT Chesapeake in USB. (Baker-OH) *New OR frequency, old was 8984-Larry.*
- 9003.0 Royal Jordanian LDOC Amman working Jordanian 23 in USB at 2228. (Navary-VA)
- 9007.0 CANFORCE Trenton Military working Hunter 04 with phone patch traffic in USB at 1756. (Baker-OH) *New OR frequency, old was 9006-Larry.*
- 9014.0 Darkstar working Chapter One, Speed, Sweep with lots of air-to-air combat chatter in USB at 1730. (Haverlah-TX)
- 9016.0 Glassjaw working McClellan with phone patches for airborne fighters in USB at 2002. (Haverlah-TX) Baglock working McClellan GHFS with databurst and USB communications at 2126. (Pihale-MN)
- 9017.0 Mash 72 (KC-135) with phone patch via Andrews on X-904 in USB at 1451. (Pihale-MN) *Interesting, after the GHFS switchover, wonder when they will move this one?-Larry.*
- 9027.0 SAM 972 working Andrews in USB at 0522. (Haverlah-TX)
- 9059.0 LOA burst noted here in USB at 0303. (Haverlah-TX)
- 9225.0 Berne LDOC working Saudi Air Force 911 in USB at 1640. Had tried 6643 and 8936, but bad interference. (Hood-UK)
- 10194.0 Sentry 58 working Trenton Military (CANFORCE) on sometimes common NORAD phone patch frequency, then moved to 13206. In USB at 1903. (Haverlah-TX)
- 10780.0 Antigua Radio working Aria 2 in USB at 1857. (Navary-VA)
- 10820.0 SYN2-Israeli Mossad number station in AM at 1847. (Dix-NY)
- 10959.9 3MA28-CNA Taipei, Taiwan, with 48 baud RTTY English news bulletin at 0756. (Hall-RSA)
- 11053.0 SAM 972 working Andrews with phone patches to Crossbow, Royal Crown (*Anybody know who this is?-Larry*), State Department, etc. In USB at 2308. (Haverlah-TX)
- 11175.0 Sentry 50 working McClellan GHFS at 2000 in USB. (Haverlah-TX) Also have monitored Andrews, Ascension, Offutt GHFS. (Pihale-MN) *New OR frequency, old was 11176-Larry.*
- 11178.0 RAF MPD working 72 (aircraft) and moved to frequency Kilo Papa in USB at 1840. (Navary-VA) *My records show 'KP' as 2641.0-Larry.*
- 11181.0 McClellan working Nightwatch sending data, in USB at 2123. (Haverlah-TX)
- 11202.0 Rescue 1501 (HC-130) working NMN-CAMSLANT Chesapeake with SAR communications in USB at 2246. (Baker-OH) *New OR frequency, old was 11201-Larry.*
- 11212.0 MKL-Pitreavie Air with CW weather information at 1305. (Navary-VA)
- 11226.0 Ironweed working Birdsnest and Claybird in USB at 1753. (Haverlah-TX)
- 11229.0 USAF Delco working Nightwatch 01 at 1747 in USB regarding status of Tinman and Snowman. (Baker-OH) Baglock working Nightwatch on X-210 in USB at 1948. (Pihale-MN)
- 11244.0 McClellan with an 'All Frequency Request' for Hickam GHFS, answered on 11175, in USB at 1705. (Haverlah-TX) *New OR frequency. Old was 11176-Larry.*
- 11300.0 TMA1128 working Nairobi ATC in USB at 2216. Also heard Asmara ATC (Eritrea) working Addis Ababa ATC. (Navary-VA)
- 11387.0 Calcutta VOLMET with aviation weather in USB at 1237. (Navary-VA)
- 11396.0 Perth ATC working Qantas 78 in USB at 1116. (Navary-VA)
- 11421.3 FJY5-FF Crozet Island with ARQ-E3 idler at 0937. (Hall-RSA)
- 11460.0 SAM 972 working Andrews in USB at 1653. (Haverlah-TX)
- 11494.0 Baglock working Nightwatch in USB at 1950 on S-311. (Pihale-MN)
- 11565.0 EZI2-Israeli Mossad number station in AM at 1802. (Dix-NY)
- 12229.0 MOSW called by TDSO with hand sent CW at 1444. (Dix-NY)
- 12661.5 UHY/UHS-Unidentified Russian coastal station with CQ CW marker at 1503. (Dix-NY) *Jack, I believe this is Murmansk, based on my observations-Larry.*
- 13330.0 Coast Guard 01 working Universal Houston in USB at 1356, moved to 17940, USCG commandant placed call to Coast Guard headquarters in Washington, D.C. Also heard MDF 07 (Mexican Air Force) working Universal at 1447 and Cedar Jet 224 working Cedar Base in Beirut at 1636. (Navary-VA)
- 13354.0 Zulu Lima Lima 31 working Honolulu ATC in USB at 2335. (Levine-CA)
- 14508.7 Zaire bank circuit with SITOR-A French traffic and some USB at 0941. (Hall-RSA)
- 14441.5 NNNOCNY-USCGC Campbell (WMEC-909) at 1715 in USB calling NNNONCG-USCG Systems Command, Alexandria, VA, with routine phone patch traffic on US Navy-Marine Corps MARS Afloat calling channel. (Baker-OH)
- 14585.9 RFTPA-FF Comelele N'Djamena, Chad, with ARQ-M2 5 letter groups to RFFHACT Montpellier at 0950. Also French traffic to RFFUGI Istres at 0959. RFTPG-COMELELE N'Djamena with French traffic to Aiscsoulgatsol and Istres at 0955. (Hall-RSA)
- 16280.4 RFLVM-FF Ugelarm Toulon, France, with ARQ-M2 French traffic to RFFISOM-Somme and others. (Hall-RSA)
- 16318.0 MFA Cairo, Egypt, with Arabic SITOR-A traffic at 0831. (Hall-RSA)
- 16355.3 DOR-MFA Sofia, Bulgaria, with 100 baud RTTY Bulgarian news bulletin at 0835. First time heard. (Hall-RSA)
- 16918.5 MTO-Royal Navy London, England, with 75 baud RTTY traffic at 0914. (Hall-RSA)
- 17015.8 'S'-Arkhangelsk, Russia, single letter HF marker in CW at 2002. (Dix-NY)
- 18023.0 Springbok 6234 working Berne LDOC in USB at 1335. (Dix-NY)

Beyond UHF

If you're a seasoned scanner buff, you probably can remember when the upper frequency limit of scanner radios stopped at 512 megahertz. The three basic bands were, VHF Low Band: 30 to 50 MHz, VHF High Band: 150 to 174 MHz, and the UHF Band: 450 to 512 MHz. A few scanner radios also offered the VHF air band, 108 to 135 MHz (AM).

In the old days, a 20 foot length of speaker wire thrown over a tree limb would capture all the local radio signals between 30 and 512 megahertz. If you lived in a strong signal area, you didn't even need to install a connector on the end of the wire. Just twist the strands together and push them into the old motorola connector.

As some of you already know, monitoring the 800 megahertz band isn't that easy. The higher frequencies are very unforgiving, and if you don't take a few precautions, your monitoring will be compromised.

The first mistake that most scanner buffs make is fooling themselves into thinking that they don't need a separate 800 megahertz antenna. Sure, you can monitor 800 megahertz signals with a dual band antenna, but nothing can compare to an antenna that has been specifically made for a particular band. If you're serious about monitoring the 800 megahertz band, you'll need a separate 800 megahertz antenna.

Installing a separate 800 megahertz antenna can be a hassle—no argument. You'll need to run another length of coax, drill another access hole into your listening area, and install connectors on the cable ends. For monitoring the 800 megahertz band, RG-6/U provides satisfactory results. There are other coax cables that exhibit lower loss characteristics, but they are more expensive and may be difficult to locate. The RG-6/U can be ordered from Grove Enterprises or purchased from your local Radio Shack store.

After the antenna and coax are installed, do not add an adapter or splitter to this line. The coax from your 800 megahertz antenna will feed directly into the antenna connector on your 800 megahertz scanner radio. It's important, so I'll say it again: Use one connector at the antenna and one connector at your scanner radio—no additional adapters, splitters or connectors of any type.

Placement of the 800 megahertz antenna will be critical. As I've already mentioned, high frequency signals are easily affected by natural and man made obstructions. You may need to experiment with several different antenna locations. Rooftop installations can be simplified by bringing along a small length of coax cable and a handheld scanner radio. Connect the scanner radio to the antenna and "test" the reception at several different rooftop locations.

Can't get on the roof? No problem. The same procedures can be followed to install attic mounted antennas or hidden indoor antennas. Simply pick an area, temporarily support the antenna in the desired place and then connect your scanner radio. If the signal quality is good, mount the antenna permanently.

Listeners living in weak signal areas may need to install a preamp. Don't buy an inexpensive, indoor preamp that installs at the rear of your scanner radio. The best choice is a low-noise, mast-mounted (outdoor) preamp. Outdoor, television antenna preamps can be utilized, but don't forget to check the following: 1) The frequency range of the preamp must encompass the frequencies that you're interested in monitoring; 2) Don't buy a television preamp that utilizes an FM trap. Since the



You can no longer expect one antenna to perform well on all the bands covered by today's scanners. If you're serious about monitoring 800 MHz signals, use a separate 800 MHz antenna, such as this Loop Yagi.

majority of scanner radio communications are transmitted in FM, the "trap" may prevent you from hearing specific frequencies.

IMPROVISE

Readers that are handy with a few basic hand tools can make an excellent 800 megahertz antenna from two metal clothes hangers. You'll also need a standard UHF bow tie antenna (Radio Shack Catalog #15-234) and four wire connectors.

The procedure is simple and straightforward. Make four cuts through the bow tie at approximately 4 inches from the center. Bend the coat hangers to the shape of the removed sections and attach with wire connectors. The finished project will extend the bow tie configuration to 13" from center on each side. To receive a free explanation and detailed drawing, send a #10 SASE to the Scanning Report, P.O. Box 98, Brasstown, NC 28902.

The best antenna and coax cable in the world can't deliver a strong signal if they are contaminated by moisture and dirt. Use a high quality sealant at the antenna connection (Radio Shack Catalog #278-1645), and routinely clean your inside connections. A very minimal amount of dirt and/or moisture can adversely affect your ability to monitor the 800 megahertz band.

Monitoring the new 800 megahertz band doesn't require expensive equipment or complicated procedures. All you need is an 800 megahertz antenna, a dedicated feed line, and a scanner radio capable of receiving the desired frequencies. If you haven't tried monitoring with a dedicated antenna and feed line, you're not hearing everything that's out there to hear.

■ Treasure Hunt

The majority of hand held scanner radios suffer from one common malady—low volume. The problem becomes especially troublesome when handhelds are used in a moving vehicle. Road noise, entering through open car windows, can make your handheld nearly impossible to hear.

The folks at Naval Electronics have the ideal solution. The HTS-2 is an amplified speaker that can be powered from your car battery or

from AA batteries. The unit provides one full watt of audio power. With the HTS-2 installed in your vehicle, you can open the windows, listen to your FM radio, and hear your scanner radio!

To win the HTS-2, answer the following clues:

1. In a 12 volt, negative ground, automotive electrical system, the positive battery wire is connected to the frame. True or False?
2. The HTS-2 will automatically adapt itself to a negative or positive ground electrical system. True or False?
3. Which wire has the largest diameter, #18 AWG or #16 AWG?
4. I ordered the Grove #ACC-47. What did I get?
5. When is the first day of Spring?

The HTS-2 is compact, lightweight, and can easily be installed in your vehicle with Velcro. The unit has an LED light, audio level adjustment and a tape trigger that can start and stop a tape recorder. If you wish to purchase one, the unit has recently been upgraded to the HTS-3. For more information, contact Naval Electronics, 5417 Jetview Circle, Tampa, Florida 33634, (813)-885-6091.

■ Frequency Exchange

We're in the air and flying over **Brisbane International Airport in Australia**. Since our contributor wishes to remain anonymous, we won't land. But as you already know, our lofty location will help us to hear the following:

Brisbane International Airport

Code: ABBN
 Elevation: 13 Feet ASL
 Runways: 01/19, 14/32
 Special notes: ... Frequent Bird Hazard

Air Traffic
 120.500 Tower
 121.700 Ground
 124.700 Approach/Departure
 125.600 Approach/Departure
 269.300 Approach/Departure
 281.400 Approach/Departure
 335.600 Tower

Flight Service

119.500 125.700
 120.300 126.000
 121.200 126.800
 123.900 379.500

The weather in **Hartford, Connecticut**, is cold during March, but it sure beats circling above an Australian airport. Our invitation is from Robin Phelen and she has also provided refreshments.

State Police

154.10	154.7025 Vehicle extender
154.6425 Vehicle extender	154.830 Vehicle extender
154.665 Primary	154.695 Security/Governor
154.6575 Vehicle extender	155.34 EMS
154.6875 Vehicle extender	156.21

According to Robin, the above frequencies are used by the State Police for special activities and troop to troop communications. Robin also provided the following fire frequencies.

153.14 Hartford	154.28 Springfield MA
154.145 Hartford	154.295 South Central
154.265 Hartford	

Roy Banks lives in **Eastern Massachusetts**, and he has provided the new 800 MHz frequencies for the State Police.

856.2125	857.7125	858.7325	859.9625
856.7125	857.7375	858.9625	859.9875
856.7375	857.9625	858.9875	860.2125
856.9625	857.9875	859.2125	860.7125
856.9875	858.2125	859.7125	860.7375
857.2125	858.7125	859.7375	860.9625
			860.9875

Carol Lewindowski lives in **Aberdeen, Maryland**, and her invitation included the following:

37.18 Police	153.86 City
37.30 Police	453.80 Police
153.815 City	458.80 Police

Aberdeen Proving Ground (Military)

36.69 Emergency	165.1875 Military Police
36.71 Emergency	165.5875 Military Police
165.0375 Ambulance	170.025 Range firing
165.0625 Security	173.4875 Unknown
165.0875 Military Police	173.5125 Unknown
	407.325 Fire

If we cross over the Chesapeake Bay, we can stop at the home of Gary Perkins in **Dover, Delaware**.

Dover Air Force Base

138.045	Flight line
163.5875	Maintenance
172.30	Security
173.5625	Medical
173.5875	Fire/Crash
413.10	Commander

Traveling north, our next stop is **Smyrna, Delaware**. The contributor is anonymous, so we can't stop for free snacks.

47.22 Delaware City Police	460.50 Wilmington Police
154.755 Milton Police	465.025 Wilmington Police
154.77 Wilmington Police	465.125 Wilmington Police
154.86 Delaware City Police	465.225 Wilmington Police
153.875 Delaware University Police	465.475 Wilmington Police
460.025 Smyrna Police	465.50 Wilmington Police

Fred Neuman lives in Philadelphia, but he frequently travels to rural **Potter County, Pennsylvania**. Here are Fred's favorite Potter County frequencies.

DON'T PANIC...

... if you haven't received your *Monitoring Times* by the beginning of the month. Postal delays do occur, and we must wait until the 10th of the month before sending replacements for lost issues.

Be patient and wait until the 10th; if you still don't have your *MT*, call us at 1-800-438-8155 and we will be happy to send a replacement.



America's #1 Scanning Magazine is

National Scanning Report



1-800-423-1331
 P.O. Box 360,
 Wagontown, PA
 19376

But don't take our word for it. Check it out yourself. \$3.00 cash will get you a sample copy rushed to you by First Class Mail. Or subscribe for just \$17.50 and you'll get a free custom frequency print-out for your county.

33.78 Fire
 33.98 Fire
 37.04 Coudersport Police

46.36 Fire
 154.815 Allegheny Twp Police
 155.475 Hector Twp Police

Another anonymous reader from **Wheeling, West Virginia**, sent in the following frequencies:

866.0125 ... Police/Fire
 866.5375 ... Police/Fire

866.9875 ... Police/Fire
 868.0125 ... Police/Fire

According to the contributor, the above frequencies have recently been assigned and operate under the call letters WPDW 471.

Ready for a party? Richard Campbell lives in **Dallastown, Pennsylvania**, and he has invited everyone to a scanner party. Instead of chips and pretzels, Rich has provided a snack bowl filled with frequencies.

33.88 York County Fire
 33.90 York County Fire

154.190 York City Fire
 155.625 York County Control
 156.57 York City Police

Did the Frequency Exchange pass by your home town? If so, we apologize, but we can't stop without an invitation. To invite everyone to your neck of the woods, and to see your frequencies in a future issue, send your favorite frequencies to the Frequency Exchange, P.O. Box 98, Brasstown, NC 28902.

Scanner Tips

In Hamilton, Canada, a 21-year-old college student was grabbed from behind. Fortunately, the student escaped and told police that she left visible scratches and red marks on her abductor's face and neck.

A cab driver, who was monitoring his scanner radio, recognized the description and the injuries of the wanted man. The cab driver told police that he had driven the man to a local bar. The suspect was arrested a few minutes later. (News clipping from Stan Fracis).

Cellular Scrambling

Qualcom, a company located in San Diego, California, has received a 1.48 million dollar government contract to develop a cellular phone encryption system.

The company has 12 months to develop a cellular phone that uses plug-in computer cards to encrypt or scramble conversations. The Code Division Multiple Access (CDMA) cellular phone could operate on any digital cellular phone system that uses Qualcom's technology.

With the Qualcom phone, special encryption equipment won't be necessary. The phone could be used for scrambled and unscrambled calls on a conventional cell phone system. As previously mentioned, the cellular carrier would only need to purchase and install Qualcom's technology. According to Qualcom, installation will be easy and the price affordable.

Several cellular phone companies are expected to announce plans to offer CDMA service by summer of '95. (News clipping from H. Struthers).

Cellular Phone Clones

Has your cellular phone been cloned? If you receive a cellular phone bill that contains hundreds of calls that you didn't make, it probably was.

It's easy to clone a cellular phone. Cellular bandits use a device that is similar to a frequency counter. When the instrument locks onto a cellular signal, it displays the phone's "electronic signature." The

electronic information can then be transferred to another cellular phone. The second phone becomes a clone that can be used to make calls that will be charged to your cellular phone number.

Capturing cellular phone signals is similar to catching radio transmissions with a frequency counter. Thieves position themselves as near as possible to the signal source and select an area that is saturated with multiple signals. The obvious choices are city highways and bridges that are jammed with morning and evening commuters. A cellular bandit, sitting in such a location, can catch hundreds of cellular signatures in just a few hours.

Protecting your cellular phone from the clones isn't easy. Most folks mistakenly believe that if they don't use their phones, the phone can't be cloned. Few people realize that a cellular phone transmits its electronic signature every few minutes. The transmissions are designed to identify where you are and who you are. Without them, the cellular phone company wouldn't know where to direct your incoming or outgoing calls.

What should you do? I have two suggestions: 1) Don't use your cellular phone unless it's an emergency; 2) Don't ride to or from work with your cellular phone activated—turn it off! If you still wish to be accessible, you can use a paging service to alert you to turn your phone on for important calls.

Were you cloned? If so, we would like to hear about it. Send your clone stories to the Scanning Report, P.O. Box 98, Brasstown, NC 28902.

Ten-Code Abolished

The "10-Code" is dead in Des Moines, Iowa. The 10-code was developed in the 1950's to shorten and clarify radio communications. Over the years, the Des Moines police developed a total of 99 individual 10-codes. To make life easier and much simpler, the Des Moines Chief of Police ordered dispatchers to use "plain English." Instead of using "10-35" to describe a robbery, the dispatcher simply says, "Robbery," by gun, knife, etc, and then provides the address.

The police officers in the street are reporting that they like the new system. "It's ridiculous to take perfectly clear English and encrypt it." One officer said, "Simply tell us what's happening and we'll respond."

TV Scanning

Did you know that television frequencies are grouped together into three different bands? There's a VHF low band, VHF high band, and UHF band. If you have a continuous coverage scanner radio, you can monitor the audio frequencies. For the best reception, don't forget to switch between narrow and wide band FM.

Here are a few of the frequencies that can be monitored. A complete list can probably be found in local frequency publications.

VHF LOW BAND		VHF HIGH BAND		UHF HIGH	
Chonnel	Audio	Chonnel	Audio	Chonnel	Audio
2 59.75	7 179.75	14 475.75
3 61.25	8 185.75	22 523.75
4 71.75	9 191.75	34 595.75
5 81.75	10 197.75	47 673.75
6 87.75	11 203.75	57 733.75
		12 209.75		
		13 215.75		

Can't find the complete list? No problem. Send \$2.00 dollars to the Scanning Report, P.O. Box 98, Brasstown, NC 28902, and I'll send you a complete list of television audio frequencies.

RAMSEY America's #1 Source For Hobby Kits

STONE GRABBER

Grab Touch-Tone numbers right off the air, phone or tape. A simple hook-up to any radio speaker or phone line is all that is required to instantly decipher touch-tone phone numbers or codes. A 256 digit memory stores decoded numbers and keeps its memory even in the event of power loss. An 8 digit LED display allows you to scroll through the memory bank to examine numbers. To make it easy to pick out number groups or codes, a "dash" is inserted between sets of digits that were decoded more than 2 seconds apart. A "central-office" quality crystal controlled decoder is used allowing rapid and reliable detection of numbers at up to 20 digits per second! For a professionally finished look, add our matching case set. Start cracking those secret codes tomorrow with the Tone Grabber!

TG-1 Tone Grabber kit	\$99.95
CTG Matching case set	\$14.95
TG-1WT Fully assembled TG-1 and case	\$149.95

SCA DECODER



Tap into the world of commercial-free music and data that is carried over many standard FM broadcast radio stations. Decoder hooks to the demodulator of FM radio and tunes the 50-100 kHz SCA subcarrier band. Many radios have a demod output, but if your radio doesn't, it's easy to locate, or use our FR-1 FM receiver kit which is a

complete FM radio with a demod jack built-in. These "hidden" subcarriers carry lots of neat programming-from stock quotes to news to music, from rock to easy listening-all commercial free. Hear what you have been missing with the SCA-1.

SCA-1 Decoder kit	\$27.95
CSCA Matching case set	\$14.95
FR-1 FM receiver kit	\$24.95
CRR Matching case for FR-1	\$14.95

BROADBAND PREAMP

Ever wish you could "perk up" your counter to read really weak signals? Or, how about boosting that cable TV signal to drive sets throughout the house, or maybe preamping the TV antenna to pull in that blacked out football game. And, if you're into small broadcasting, boost your transmitter power up to 100 mW! The PR-2 broadband preamp is the answer to all those needs as well as many others. You can use the PR-2 anywhere a high gain, low noise, high power amp is called for: digging out those weak shortwave signals or putting new life into that scanner radio-especially at 800 MHz. The PR-2 has a high power compression point, meaning that it does not overload easily-in fact many folks use it for boosting the power on their FM-10A stereo transmitters. Newly designed microwave MMIC chips from NEC in Japan enable the PR-2 to have gain all the way up to 2 GHz, although we only spec it to 1 GHz-believe it or not, the connector lead length is the limiting factor! Customers tell us the PR-2 outperforms professional lab units by the "big boys" that go for hundreds more. The PR-2 is the ideal general purpose amp you'll wonder how you got along without.

PR-2 Specifications: Gain: 25dB, Noise Figure: 2.5 dB, Input/Output Impedance: 50-75 ohms, Compression point: +18 dBm

PR-2 Broadband Preamp, Fully Wired and Tested **\$59.95**

AIRCRAFT RECEIVER

Tune into the exciting world of aviation. Listen to the airlines, big business corporate jets, hot-shot military pilots, local private pilots, control towers, approach and departure radar control and other interesting and fascinating air-band communications. You'll hear planes up to a hundred miles away as well as all local traffic. The AR-1 features smooth varactor tuning of the entire air band from 118 to 136 MHz, effective AGC, superheterodyne circuitry, squelch, convenient 9 volt operations and plenty of speaker volume. Don't forget to add our matching case and knob set for a fine looking project you'll love to show. Our detailed instruction manual makes the AR-1 an ideal introduction to two life-long, fascinating hobbies at once-electronics and aviation! See *Kit Planes* magazine (January 1991) or *Popular Electronics* (January 1993) for excellent product reviews of the AR-1.

AR-1 Aircraft Receiver Kit	\$29.95
C-AR Case and Knobset for AR-1	\$14.95

FOXHOUND DIRECTION FINDER

Locate hidden or unknown transmitters fast. The Foxhound direction finder connects to the antenna and speaker jack on any radio receiver, AM or FM from 1 MHz to 1 GHz. The antenna (a pair of dipole telescopic whips) is rotated until the Null meter shows a minimum. A pair of LEDs indicate to turn Left or Right. The Foxhound is ideal to use with a walkie-talkie, if you wish to transmit, go ahead, a built-in T/R switch senses any transmitted RF and switches itself out of circuit while you talk. It doesn't get any easier than this! We provide all parts except for a few feet of 1/2 inch PVC pipe available at any hardware store for a dollar or two. Add our matching case set for a complete finished unit. Be the one with the answers, win those transmitter hunts and track down those jammers, you'll do it all with your Foxhound.

DF-1 Foxhound direction finder kit	\$59.95
CDF Matching case set for DF-1	\$14.95
FHT-1 SlyFox Foxhound transmitter kit	\$129.95
FHID-1 Voice ID option	\$29.95
CFHT Heavy duty metal case set for FHT-1	\$29.95

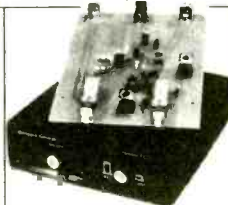

shortwave bands. An additional switch allows the selection of any two bands of interest, each 1 MHz wide. Set one range for daytime frequencies and one for nighttime when propagation is different, choose any two frequencies between 3 and 22 MHz. Frequencies are tuned on your AM radio, making it easy to log stations or set presets. A built-in antenna switch automatically switches the existing AM antenna to either the radio or converter, making hook-up easy and fast. As with many of our kits, a handsome matching case and knob set is available to put the finishing touches on your kit.

SC-1 Shortwave Converter Kit	\$27.95
CSC Matching Case and Knob Set	\$14.95

FM RECEIVER/TRANSMITTER

Keep an ear on the local repeater, police, weather or just tune around. These sensitive superhet receivers are fun to build and use. Tunes any 5 MHz portion of the band and have smooth varactor tuning with AFC, dual conversion, ceramic filtering, squelch and plenty of speaker volume. Complete manual details how the rigs work and applications. 2M FM transmitter has 5W RF out, crystal control (146.52 included), pro-specs and data/mike inputs. Add our case sets for a nice finish.

FM Receiver kit	\$34.95
Specify band: FR-146 (2M), FR-6 (6M), FR-10 (10M), FR-220 (220MHz)	
CFR Matching case set	\$14.95
FT-146 Two Meter FM trans kit	\$99.95

SCANNER CONVERTER

Tune in on the 800-950 MHz action using your existing scanner. Frequencies are converted with crystal referenced stability to the 400-550 MHz range. Instructions are even included on building high performance 900 MHz antennas. Well designed circuit features extensive filtering and convenient on-off/bypass switch. Easy one hour assembly or available fully assembled. Add our matching case set for a professional look.

SCN-1 Scanner converter kit	\$49.95
CSCN Matching case set	\$14.95
SCN-1WT Assembled SCN-1 and case	\$89.95

STEREO TRANSMITTER

Run your own Stereo FM radio station! Transmits a stable signal in the 88-108 MHz FM broadcast band up to 1 mile. Detailed manual provides helpful info on FCC regs, antenna ideas and range to expect. Latest design features adjustable line level inputs, pre-emphasis and crystal controlled subcarrier. Connects to any CD or tape player, mike mixer or radio. Includes free tuning tool too! For a pro look add our matching case set with on-board whip antenna.

FM-10A Stereo transmitter kit	\$34.95
CFM Case, whip ant set	\$14.95

INTERCEPTOR

The Interceptor will lock on instantly to the nearest transmitter and allow you to listen with perfect audio quality. Since the Interceptor does not have to search through all frequencies, those quick transmissions that are hopelessly lost on scanners are captured easily. The Interceptor does not need tuning, making it ideal for hands-free surreptitious monitoring of nearby transmissions. The Interceptor is complete self-contained with internal speaker and earphone jack for private listening. Included are: Nicad battery pack, AC/adaptor charger, antenna and earphone. Increase your security and awareness-intercept the communications around you with the Interceptor. Fully wired with 1 year warranty. Covers 30-200MHz frequency range, FM deviations from 5 kHz to 200 kHz.

R10 Interceptor, Fully Wired 1 year warranty **\$349.95**

SHORTWAVE CONVERTER

The SC-1 converter brings the sounds of the world right into your car radio or home stereo (set to AM broadcast band). Front panel push switches let you choose easily between regular AM radio and the

SCRAMBLER/DESCRAMBLER

Descramble most scramble systems heard on your scanner radio or set up your own scrambled communication system over the phone or radio. Latest 3rd generation IC is used for fantastic audio quality-equivalent to over 30 op-amps and mixers! Crystal controlled for crystal clear sound with a built-in 2 watt audio amp for direct radio hook-up. For scramble systems, each user has a unit for full duplex operation. Communicate in privacy with the SS-70. Add our case set for a fine professional finish.

SS-70 Scrambler/Descrambler kit	\$39.95
CSSD Matching case set	\$14.95
SS-70WT Fully assembled SS-70 and case set	\$79.95

DSP FILTER



FULLY WIRED & TESTED

What is DSP? DSP allows the "construction" of various filters of great complexity by using computer code. This allows us to have easy access to a variety of filters, each perfectly optimized for whatever mode we are operating. The DSP II has been designed to operate in 10 different modes. Four filters are optimized for reducing interference to SSB phone signals from CW, heterodynes

and random noise interference. Four more filters operate as "brick-wall" CW bandpass filters, the remaining two filters are designed for reliable recovery of RTTY and HF packet radio information signals. A single front panel switch selects any of these filters. Easy hookup to rigs speaker jack.

W9GR DSP Filter	\$299.95
12V DC Power Supply	\$11.95

ACTIVE ANTENNA



Cramped for space? Get longwire performance with this desktop antenna. Properly designed unit has dual HF and VHF circuitry and built-in whip antenna, as well as external jack. RF gain control and 9V operation makes unit ideal for SWLs, traveling hams or scanner buffs who need hotter reception.

The matching case and knob set gives the unit a hundred dollar look!

AA-7 Kit	\$28.95
CAA Matching case & knobset	\$14.95

AM BROADCAST TRANSMITTER

High quality, true AM broadcast band transmitter is designed exactly like the big commercial rigs. Power of 100 mW, legal range of up to 1/4 mile. Accepts line level inputs from tape and CD players and mike mixers, tunable 550-1750 kHz. Complete manual explains circuitry, help with FCC regs and even antenna ideas. Be your own Russ Limbaugh or Rick Dees with the AM-1! Add our case set for a true station look.

AM-1 Transmitter kit	\$29.95
CAM Matching case set	\$14.95

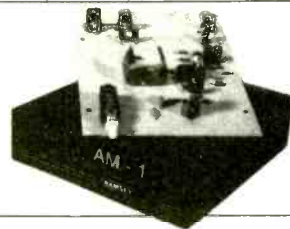

SHORTWAVE RECEIVER

Here's a complete shortwave radio guaranteed to inspire awe in any listener. Imagine tuning in the BBC, Radio Moscow, Radio Baghdad and other services with just a couple of feet of antenna. This very sensitive (about a microvolt!) receiver is a true superhet design with AGC, RF gain control and plenty of speaker volume. Smooth varactor diode tuning allows you to tune any 2 MHz portion of the 4 to 11 MHz frequency range, and the kit conveniently runs on a 9 volt battery. Add our matching custom case and knob set to give your radio a finished, polished, look. Amaze yourself and others-see how you can listen to the world on a receiver you built in an evening.

SR-1 Shortwave Radio Kit	\$34.95
CSR Case and Knob Set	\$14.95

ORDERS ONLY CALL 1-800-446-2295

(No tech info at this number)

TECH/ORDER/INFO 716-924-4560 FAX 716-924-4555

TERMS: Satisfaction guaranteed. Examine for 10 days. If not pleased return it in original form for refund. Add \$4.95 for shipping, handling and insurance. For foreign orders add 20% for surface mail. COD (U.S. only) add \$5.00. Orders under \$20 add \$3.00 NY residents add 7% sales tax. 90-day parts warranty on kit parts. 1-year parts and labor warranty on wired units.

RAMSEY ELECTRONICS, INC.
793 CANNING PARKWAY, VICTOR NY 14564

Parts Procurement

Back in the days when I was learning about electronics from my high school teacher, Col. "Blinky" Austell, scrounging parts for projects couldn't have been easier. My friend Nick Archer and I would hop on our bikes and head for the local trash dump. A few minutes of fetid searching would turn up an old TV chassis or two.

We would carry this booty back to my garage where we would spend a happy afternoon stripping the chassis of every part we could. We'd toss these resistors, transformers, diodes, capacitors, tubes and even the occasional transistor into shoeboxes in wait for the latest crop of

schematics to show up in magazines such as *Electronics Illustrated* (where I first read the teachings of a guy named Bob Grove).

Often we could discover enough stuff to build our projects without needing to tap our meager allowances (I come by being a cheapskate honestly). Once, our trash heap hunt turned up a full size rack containing the guts of a computer reel to reel tape

drive—just like those things you see in old science fiction movies. We had to split the loot with a couple of other people because it took more than the two of us to drag it away, but there was plenty to go around. I think I still have some components from that scrounging mission floating around the shack somewhere. I know the rack is currently mildewing in my mother-in-law's basement.

The first rule of parts procurement has remained the same throughout the history of electronics: NEVER THROW ANYTHING OUT!

Electronics has come a long way since the sixties when Nick and I went picking through trash heaps. Scrounging parts is not as easy as it once was. Consumer electronics, for the most part, has become a throw away universe. Most components are relatively inexpensive when you know where to shop (we'll get to that later). Often it is less expensive, in terms of time and aggravation, to purchase a part than it is to desolder it off an old circuit board. There are some notable exceptions that are important when you are building up your junk box for future projects. Let's take a look at a typical example.

I am out walking Pogo "The Computer Dog" one

morning. That I happen to schedule my turn to take Pogo for his walk on trash days is no accident. I remain watchful throughout my walk for obvious signs of cast off electrofluvia. One day I find a nice Sony ICF-9740W AM/FM table radio sitting in someone's open garbage can. Pogo has found a tree stump to sniff so I have a few minutes. I take out my trusty Leatherman tool and pop the back off the rig to see what I can see. I find the rig to be intact, but too bulky to lug for the rest of my walk.

First the knobs pop right off. Then four screws remove the entire circuit board, including its tuning capacitor. Two screws remove the six-inch speaker. Another two screws free the power transformer and line cord. Now I can toss the carcass back in the trash can and Pogo can explore further tree stumps. Meanwhile, I have pocketed some useful componentry. Old habits die hard.

At home, I test the speaker and find it to be fine. The circuit board provides a tuning capacitor and two potentiometers. None of the discrete components are of significant value so I'll put the board in my pile of other unstripped boards for future examination.

The power transformer is a small line voltage to 12 volt job that will go nicely in a power supply project down the line. The knobs will find their way into some project or other, no doubt one using the tuning capacitor or potentiometers. Five minutes work and a further ten minutes of testing has gifted me with what Radio Shack would charge me over twenty dollars for. Get the picture, Pal? You can save a bit of your coin of the realm by keeping your eyes open.

■ Safety Concerns

Parts scrounging is a lot of fun, but there are a few inherent dangers you must be aware of. First, pay attention to what you are doing. Cast off electronics are prone to having sharp edges or such items may reside in a pile of trash that contains objects with sharp edges. You don't want to mangle yourself while you are mangling the device in question.

Even dead electronics can present a few "live" components. Electrolytic capacitors can hold their charge for years. Touching such devices and providing them with a path to ground through your body can result in a trip to the emergency room where you can view all sorts of neat electronics devices—if you're conscious at the time. Carefully discharge such components by shunting them to a safe ground.

Also, be careful around old television picture tubes. If you crack or break the glass envelope on a TV tube it can shatter into thousands of pieces of glass shrapnel.

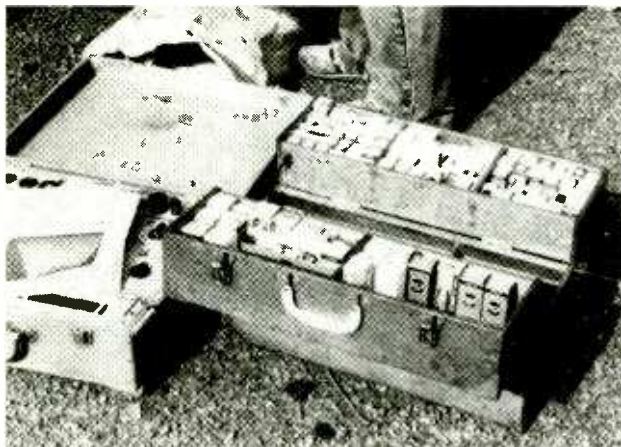

Hamfests are one source of used parts.

I don't mess with picture tubes unless I am wearing safety glasses.

Care and common sense go a long way when chasing after "preowned" parts.

■ Hamfests

The dedicated home brew person will attempt to frequent every hamfest within easy driving distance. Springtime is usually a time when hams come out of their shacks and congregate in parking lots and at fairgrounds. You will be totally amazed at the wide and varied assortment of electronics that will surface at such gatherings. Hamfests are full of new and surplus electronic stuff guaranteed to get you in the mood to melt some solder. Check with local ham organizations or keep an eye on the hamfest lists in major amateur radio publications such as *QST*, *CQ* and *73* magazine. Bring money and a bag to carry your swag.

■ Substitutions

Keep an eye out for opportunities to swap components for stuff you already have on hand. For example, your project may call for a resistor that is rated at 1/4 watt. Usually there is no reason why you can't swap in a resistor that you have lying around that has a higher power rating such as 1/2 or 1 watt.

Likewise, capacitors of the same design but with a higher voltage rating should not represent any problem in most designs. Semiconductor substitutions are often possible, too. You need to check out a good component substitution list. These can be found at many electronics supply houses. The time you take to discover how to use the parts you have on hand will save you a lot of money in the long run.

■ Beyond Radio Shack

I live in a part of the world where you can throw a rock in any direction and hit a Radio Shack consumer electronics store. When building up a project, Radio Shack is a place to find many of the more common components. There are, however, other sources that are well worth a look if you're building up something from any of the project columns here in the pages of *MT*.

As the old Ma Bell motto goes, let your fingers do the walking. Check out the Yellow Pages under the heading of Electronic Equipment & Supplies. There you will find the same resources that your local radio, TV, VCR service people use. By and large, these are friendly folks who will be more than willing to work with you. Not all outfits are willing to deal in small quantities of parts, so make a few phone calls first. Chances are you will find a company or two that will become regular resources for all of your needs.

If you live near a large metropolitan area, check for a heading something like Electronic Equipment & Supplies - Surplus. Surplus stores are the Valhalla for electronics hobbyists. To find a surplus outlet nearby is akin to uncovering a goldmine. You will find many of your parts needs at incredibly low prices.

If you have a little more time on your hands, there is nothing quite like mail order for getting your project pieces. Back when Nick and I were in business, we could find our harder to find parts in the Lafayette and Allied catalogs. Sadly, these catalogs are no longer around. On a brighter note, however, there are still a few outfits out there who live to serve the electronics hobbyist. Over the years I have come to trust a couple of companies.

Mouser Electronics
2401 Hwy 287 N.
Mansfield, TX 76063-4827
(800) 346-6873

Like the Allied catalogs of old, the Mouser book is just page after page of components. I have yet to run across a project that Mouser couldn't support. If it's not in their catalog, call them: they can probably find it. They have no minimum order restrictions.

JDR Microdevices
1850 South 10th Street
San Jose, CA 95112-4108
Sales (800) 538-5000
Tech support (800) 538-5002

Most folks have seen JDR's Computer catalog. They also have an electronic component catalog chock full of goodies. What sets these folks apart is their Technical Service department. You can call them up and brainstorm an idea, and they will help you pick the appropriate components. They also stock a small line of kits that are of interest to the radio hobbyist. They have no minimum order restrictions.

MCM Electronics
650 Congress Park Drive
Centerville, Ohio 45459-4072
(800) 543-4330

If Mouser is the modern Allied catalog, MCM has to be the new Lafayette. In addition to a full component line, they stock everything you need to keep all your consumer electronics up and running. They have an incomparable line of tools. They do have a \$20.00 minimum order policy.

■ Mail Order Surplus

If you weren't able to locate a local electronics surplus outlet, you might want to subscribe to . . .

Nuts & Volts Magazine
430 Princland Court
Corona, Ca 91719
(800) 783-4624

Available for as little as \$17.00 per year, each month you will receive about 150 large format pages chock full of electronic surplus resources, information and ideas. This magazine is published by hams who still enjoy the smell of solder. In it you will find dozens of commercial surplus operations and hundreds of small classified ads that are probably selling just what you need to get your projects done. You will also find articles that are truly inspirational to the tinker in each of us.

■ Acquired Skills

Parts scrounging requires patience and tenacity—skills that any radio monitor has in abundance. Most projects built up from a schematic are going to take more than a little planning. First, you will need to develop a complete parts list. With this list, your first stop is your own junk box. Gather what you can from your personal collection of electronic components. Next you may want to tap into a few friends' junk boxes. You each have components that the other person needs, so don't forget this resource. Trading parts with friends is common practice in the home brew world.

If there is a hamfest coming up soon in your area, waiting until you have a chance to peruse the tables at this get together should just about fill out your list. The few components still undiscovered can probably be found at your local Radio Shack and most definitely can be had from any of the mail order outfits mentioned above.

At this point it is not uncommon to discover that you have saved over 50% in project expenses. The money you save can go toward that next new receiver you are planning to purchase.

Project building is fun. With the information Old Uncle Skip has just provided, you may discover that gathering the parts for your next project can be a lot of fun as well.

Glenn Hauser, P.O. Box 1684-MT, Enid, OK 73702
fax: (405) 233-2948 ATT: Hauser

ALBANIA R. Tirana in Albanian at 2300 to America on 9766.1, 6121.2, 11744.7 (Wolfgang Büschel, Germany)

BANGLADESH R. Bangladesh, 1230-1300 English very close to nominal 13615—weak and low modulation, and 9650—interference; home service on 4879 has 1 or 2 minutes of English news at 1250, poor but signal improved drastically at 1300, // 15520 also heard, poor (David Norcross, GU)

BELARUS Mogilev, 10 kW has local program Mon-Fri, 0440-0500 on 6115, 5965; 1600-1640 on 11840, one hour earlier during DST (Martin Elbe, *Funk* via Büschel)

[non] R. Belarus Pgm I via Moscow-Balashika relay 1600-2300 on 15175, 17805, perhaps tests to America (Büschel)

BOSNIA-HERCEGOVINA R. B.-H., government station in Sarajevo, missing from SW since May, was heard again in mid-Dec on 7108 USB+carrier, 24h //MW 612 (BBC Monitoring) Clear at 1525 on new 7108.1, religion, music (Nikolai Pashkevitch, Moscow, R. Netherlands *Media Network*) 7108.1 USB monitored at 0800-0930*, *1000-, ham equipment? (Wolfgang Büschel, Stuttgart)

BULGARIA R. Bulgaria carries out regular bimonthly quizzes on the air; the most interesting entries will be awarded exciting prizes, such as a copy of Bojidar Dimitrov's fascinating book *Bulgarians-Civilizers of the Slavs*, a colorful R. Bulgaria T-shirt, a surprise souvenir (RB via Dave Jeffery, NY) RB sent very colorful, freaky card of green alien, radio waves buzzing from fingers (Steve Goldman, USENET via Thurman)

CANADA RCI's future is still uncertain; 5-year mandate expires 31 March 1996 (André Courey, RCI *Mailbag*) Waiting on Finance Minister Paul Martin to come up with budget in Feb or at latest end of fiscal year 31 March 1995

(Courey, a later *Mailbag* via Diane Mauer) Maggie Ackerbloom does the work of four people, handling 2500 letters per month (Courey)

CHILE As foretold here in Nov (gh) Ex-KGEI program director Pastor José Holowaty has entered into an agreement to purchase the former Voz de Chile site for only \$350,000—a price so low it would have been the same with or without the transmitters, 8 x 100 kW Harris, but really run at 50kW, last used 8 years ago. Could resume evangelizing former KGEI audience as early as mid-February as Radio América Internacional, but may take longer to fix up transmitters. One is in perfect condition; two need some little things such as tubes; others need more work as yet unknown, some needing parts due to previous cannibalism. Nine towers support curtains covering 22 acres aimed at all of the Americas, Europe, Africa but will concentrate on Latin America at first (Holowaty, interviewed on HCJB *The Latest Catch* and *DX Partyline*)

Radio Esperanza, Temuco, has new 5 kW transmitter on 6090 ex-1 kW and may expand to 24 hours; Spanish-only Christian station (Temuco caller to RN *Radio-Enlace*)

COLOMBIA R. Coringo, 2860 = 2 x 1430, 0944 with Mexican music; HJZI 15-50 on 3100 at 1028 quoting Bible (Fernando Vilorio, Venezuela) Harmonic on 3247.0, R. Ideal, Umbita, Boyacá, new pirate heard regularly around 0000, announcing 1650. On 5932.7, R. Cocorná, Antioquia, harmonic of 1483.1, around 2216-2300+ (Henrik Klemetz, Bogotá)

R. El Sol, pirate in Nariño area on 5873.6, heard Sat/Sun only at

2200-2300 (Klemetz, HCJB *DXPL*)

COSTA RICA TIAWR *Wavescan* times were decided just a few days before debut Jan. 1—Sun 0715 & 2315. But it's very unreliable—some or all frequencies may be off until program over at 2330, or it starts late. Best for us, when active, is 9725.

Program is from a script by Adrian Peterson, sent to different outlets and read by local announcers, so may not be identical on all. Actual frequency usage at TIAWR bears little resemblance to faxed sked, so check them all—5030, 6150, 7375, 9725, 13750. See also GUAM, SLOVAKIA, USA.

RFPI back on 19m but 15049.7 ex-15030, slightly stronger than before, distorted AM with carrier control, 1300-2400+; and back on 12150-USB 0000-1300+ but would be more useful on a lower frequency at night, perhaps 3.4 MHz area; meanwhile at 0800-1300, 12150 has been aimed at Australia, NZ. 17905 shifted to 17910-USB. *This Way Out*, militant gay/lesbian weekly newsmagazine, on trial run heard Sat. 2000, Wed 0400; may get different permanent timings from April. New QSL card expected in March once old design is exhausted (RFPI *Mailbags* & Diane Mauer) Programs—see SWG Highlights

CUBA RHC inserted residual -12 dB carrier to facilitate tuning to 9830 USB; this transmitter has 6.4 kHz bandwidth, so music is actually better than on our AM outlets (Arnie Coro, RHC *DXers Unlimited*)

CZECH REPUBLIC R. Prague reduced SW sked for financial reasons Jan 1—no longer using either Slovakia site, just Litomyshl here, leaving one transmitter at each Slovak site idle (Adrian Peterson, *World of Radio*) Supposed to be two at Litomyshl

(*WRTH*) English to us reduced to: 00 on 7345, 5930; 01 on 7345; 03 on 7345, 5930 (Eugene, RVI *Radio World* via Mauer)

R. Metropolis is a corporation owned by three Czech shareholders, staff of 15, to provide SW programs in Czech, English, German, Russian from early 1995, initial targets Europe and N. America; is fully commercial, no subsidies. Received 50 reception reports for first series of tests, proud of results, indicating their limited experience (Wolf Harranth, ORF, FIDO-net via Benelux DX Club via SWL List via Will Martin)

ECUADOR HCJB's 1995 QSL cards illustrate foods of Ecuador (HCJB)

GERMANY R. Netherlands added 7130, English to Europe at 1130 via Nauen starting in January (RNMN) see MADAGASCAR [& non] DW notified dear listeners that from Jan 1, Rwanda was back in service 0300-2200 replacing temporary S. African relay; Brazil relay was closed; as was the Königs Wusterhausen site inherited from E. Germany (via Wendel Craighead) Was one 100 kW.

GOA All India Radio, new Panaji site at same locations as old Emissora da Goa, is active in Hindi at 0325-0415 on 11855, 0430-0530 on 11730 (*DX Grapevine*, UDXL via Andy Sennitt, Internet via HCJB *TLC*) Reminds me, neighbor K7GOA is overloading and QRMing my SW reception (gh)

GUAM Contrary to initially publicized sked, AWR *Wavescan* on

All times UTC; all frequencies kHz. *Asterisk before/after, time station sign-on/sign-off; // parallel; + means continuing but not monitored; = 2 x indicates 2nd harmonic of following frequency.



Radio Canada
International

KSDA, 11980 heard UT Sun at 2300, not 2315, and announced only other airing as UT Sat 2300 on same; in this version, man and woman announcer took turns (gh) KSDA actively planning fourth transmitter, likely 100 kW, though 250 would be desirable (Adrian Peterson, Radio News Bulletin) see COSTA RICA

GUATEMALA R. Cultural Coatán, 4779.77, *1101 until blocked by Pyongyang at 1155; calls in canned opener sound like TGEC or TGET. May have tested ex-TGN 250-W transmitter in 1992 around 4800 per Wayne Berger, TGN. Patron saint of village is San Sebastián, fiesta date Jan 20. As of 1988, there was no public transport, no hotel, no gas station, no phone; I presume still that way (Takayuki Inoue Nozaki, *Relámpago DX Logging via Play-DX*) Certainly more than 250 W now, booming in at 1300* to return at 5:30 pm local (gh)

GUYANA We are thinking of restarting SW 5950, depending on funds for a new transmitter, not earlier than second quarter 1995 (S. Goodman, C.E., GBC via Yutaka Yamada, NM)

HONDURAS R. Albatross International, pirate show, from Feb 5 is on R. Copán Int'l 15675, Suns 2100; \$1 for QSL via P.O. Box 25302, Pittsburgh, PA 15242 (Pirate Mike, RAI)

INDIA New AIR frequencies too late for 1995 WRTH: Imphal 50 kW on 4775; Jaipur 3295 not 3345 or 4910, *0025 & *1430 (Olle Alm, Sweden via Andy Sennitt, RNMN) see also GOA

IRELAND Still no plans for SW, but RTE digital audio files are on Internet: <http://www.bess.tcd.ie/ireland/rte.html> Also in US only, concise news on phone 1-900-420-2411; sports 1-900-420-2412; corresponding numbers in UKOGBANI are: 039-111-301 and 302 (RNMN)

R. Dublin Int'l on 6915.5 ex-6910, best here at 0900-1030, with 800-W transmitter (Eugene, Belgium, RVI *Radio World* via Cline, Mauer)

ISRAEL Israel Radio continued SW into 1995, but after several delays, deleted English at 1400 and 2230, shortened 2000 to only 10 minutes, thus eliminating slots for features such as *Calling All Listeners* and *DX Corner* (gh & via Cline, Mauer, Southwell, Babbis, Hanolon, Rosenzweig via Thurman)

ITALY R. Mariquita (of the uncensored nude mascot) in Jan was on 3925 around 2000-200 Fri/Sat/Sun (Luigi Basso, QSL manager, *Play-DX*) Often 1915-2100 on 3924.3 (GIG, *Play-DX*)

IVORY CÔTE R. Côte d'Ivoire Fréquence Deux, 24 hours on 11920, entertainment in French and news on most hours or half-hours, includes daily English program 1833-1930 (BBCM) Theoretically, but has anyone heard 11920 for years?

JORDAN R. Jordan, in Arabic at 2030 on 7155 //7000 and 12000, both mixes? (Finn Krone, Denmark, DSWCI *SW News*) Maybe transmitter tuning defaults to even MHz when digits inadequately entered (gh)

KIRIBATI R. Kiribati, 9825, *0558v, 0600 BBC news, 0610 local news, 0618 local music. Signal here varies good-poor, sometimes ut QRM (David Norcross, GU)

KOREA, NORTH Jackpot: received from R. Pyongyang large 1995 calendar, hologram new year card (Bill McClintock, MN, HDJB *DXPL*)

LUXEMBOURG RTL closed SW 6090 & 15350 at the end of 1994 (Wolfgang Büschel, Germany)

MADAGASCAR In exchange for RN via Germany (q.v.), DW has new relay from here, 0500-0550 on 11765 in Portuguese, French (RNMN)

NEW ZEALAND RNZI's *Around the World with Rudi Hill* appeared Jan 10 to return Feb 7, so if 4-week pattern holds should recur the weeks of Mar 7, Apr 4, May 2 & 30, June 27, July 25, Aug 22, Sept 19, Oct 17, Nov 14, Dec 12. Tues 0930, Fris 0430; expect RNZI to descend to 6



MHz, such as 6100 again this southern winter (gh, W.O.R.)

NORWAY NRK on 5905 ex-6115/6120 at 0000 including English UT Mons (Joe Hanlon, PA) Better.

PARAGUAY La Voz del Chaco Paraguayo, Filadelfia, still plans SW, but government freq. office is in no hurry (Arnie Boschmann, station, HCJB *DXPL*)

PERÚ R. Luz Universal, Cuzco, has been on 6090 for several months, two hours in the morning, but no reports; has anybody heard us? (Dan Moot, stn, Urubamba, HCJB *TLC*) No time given; try 0900-1100 (Rich McVicar, *ibid.*) Heard 0920-0957, uptempo with ID 0954 (Ed Rausch, NJ, HCJB *TLC*) Address is Baptist Mid-Mission, Apartado 368, Cuzco (*TLC*)

Estación Láser, Rioja, on 3818 at 1043-1101; R. Soledad, Parcoy(?) on 4631 at 1001-1115 (Fernando Vilorio, Venezuela) Is 4632v; New Year's Eve at 2335 called listeners in Japan, Sweden, Finland. Chiclayo has new R. Latina on 4573.9-4573.3 variable, 0050-0130+, stronger on lower sideband. Since R. Paucartambo, 5894.7 has added FM 04.5, they'll probably leave SW (Henrik Klemetz, Colombia)

PHILIPPINES R. Pilipinas via VOA Tinang on new 11890 ex-21455, English 1900-1930, 250 kW //15190, 17840 (Bob Padula, KSDA *DX Asiawaves* via Büschel)

POLAND P.R. on 6000 ex-5995 including English 1800 and 2030 (Eugene, RVI *Radio World* via Cline, Mauer) 2030-2124* on new 6000 //6135, 7285, all weak with co-channel QRM (Brian Alexander, PA)

QATAR *QBS* confirms sked in Nov was: 0245-0700 on 7210, 0700-1300 on 15395 both targeted on Cairo, Rabat; 1300-1700 11750, 1700-2130 7210 on Paris, London (Hans Peter Tillmann, British DX club *Communication*) and by extension, Orlando, Chiapas (gh) 11749 at 1630 (Adolph Schwegeler, Germany, *op. cit.*)

RUSSIA Another odd religious program appears on Moscow transmitter, 9480 at 1800 on a Monday, *Radio Voice of the Martyrs*, "we talk about persecuted Christians," address in Germany, test announcements, English, French, German; then R. Intercontinental mentioned in another language, probably Armenian where this originates; a couple of other programs tested until 1830 (via Tim Hendel, FL W.O.R.)

V. of Russia W.S. - Joe Adamov said on *Moscow Mailbag* that VOR English dept. is down to 80 employees; the whole VOR employs 1200, once over 2000 (Kevin Hecht, PA)

My electronic music friend Sergei Tutov has a program on R. Nadezhda, early local Sundays at 12-1 am; takes calls and would be happy to hear from N. America, 011+7-095-233-7849 (Bruce Atchison, Alta.) One possible SW frequency UT Sat at 2100 is 11965 (Wolfgang Büschel)

R. Veritas Asia, Philippines, in Russian via Sverdlovsk 15130 at 1030-1125; via Khabarovsk 9560 at 2130-2225 (Benelux DX Club via Doug Dine via Diane Mauer)

RWANDA DW, English to W. Africa at 2100-2150 closes with Kigali site ID in French on 15270 (gh) At this time 9615 is also Kigali

DX Listening Digest

More broadcasting information by country compiled by Glenn Hauser

Review of International Broadcasting

SW Programming, opinion, equipment, satellite monitoring.

Samples \$2.50 each (outside North America US \$3 or 71RCs)
10 issue subscriptions \$25 in USA, or both for \$47
Glenn Hauser, Box 1684-MT, Enid, OK 73702

(Kevin Hecht, PA) Then dropped 15270; 9615, 9670, and 9690 all from here (Ed Rausch, NJ)

SAIPAN FEBC phoned appealing for donations to defray \$175,000 for typhoon repairs to KFBS (Gigi Lytle, TX) KFBS on new 5810 at 1800-1900 ex-9465 (Bob Padula, *Australian DX News*)

SAN ANDRÉS La Voz de las Islas harmonic item last month on 2200 must result from a new transmitter, as the Bogotá newspaper *El Espectador* reported previous installation at island's only independent station was destroyed in Oct by arson fire (Henrik Klemetz, Colombia)

SÃO TOMÉ VOA hopes to have SW relay on soon, 6, 7 and 9 MHz for Africa (Bill Whitacre, VOA, *Communications World*)

SLOVAKIA AWR, English at 0900-1000 on 9445 ex 9450 (Edwin Southwell, UK; Adrian Peterson, AWR) To avoid RTTY 9452 (Büschel) Includes DX programs *Wavescan* and *World DX News* Suns, also 2100-2200 on 6055; see COSTA RICA. *Wavescan* features run two weeks behind COSTA RICA, GUAM; but DX news section ran one week behind; confusing (gh)

SOUTH AFRICA New TWR relays mentioned last month are: English to W. Africa 0604-0700 on 11730; 1900-2100 9510 in Yoruba, Fulani, Hausa, Twi; 0332-0428 on 9500, 1804-1900 on 9525 in Swahili; plans 2100-2200 to W. Africa, S. America (ex-Bonaire!) (RNMN) Most confirmed but at first all in English (Brian Alexander, PA)

TAJIKISTAN Tajik R., Dushanbé, English on 7245 now easy at 0345-0400 with marginal QRM by R. Liberty; and 1645-1700 but from 1658 QRM by VOA Kavala opening (Büschel, Germany)

TURKMENISTAN Try 5015, 100 kW at 0100-2400, which now QSLs—address is Ul. Mollanetesa 3, 744000 Ashgabat (Olle Alm via Andy Sennitt, (RNMN))

UKOGBANI [non] BBC African Alternative, *Network Africa* originates from a different country the first Friday of each month, 0330 and 0600 on 9600 via Ascension (*BBC Worldwide* via George Thurman)

USA *World of Radio* time changes: WHRI, 13760, Fri 2101 ex-2129; WWCR, add Sat 0600 on 7435. Remember, during DST, shifts one UT hour earlier on WWCR but not on other SW outlets. Also DST shift on satellite, World Radio Network (gh) WRN plans to offer entire output, including *World of Radio* on Internet (*Sweden calling DXers* via Pete Costello via George Thurman) already running by mid-Jan; <http://power.hall.org/radio/wrn.html> (*Mediascan*)

WRMI, 9955 expanded Brother Stair to all-day, at least Saturday and Sunday; milking cash cow rather than serving SWLs (gh) Just another WRNO, selling time to anyone (Diane Mauer) Inaudible at 0100 UT Sun when *Viva Miami* supposed to be on including *Wavescan*, but faded in Sun at 1252 amid show, this time read by Jeff White (gh) Also heard at unpreviewed time of 2200 Sat, not 2300; and a week later on HRJA, 15675 Sat 2100 (Mauer) see COSTA RICA. Another week ended at 1245 (gh) First and main transmission of *Wavescan* always UT Sun 0100; 1230-1300 repeat time may change; and Sat 2200 was gap-filler of previous week's edition (Jeff White, WRMI via Tim Hendel)

KAIJ, Dallas, was on verge of being shut off after Christmas since transmitter operators had not been paid for several weeks, but kept going; later clashing with VOA during the 0000 hour on 13740 (George Thurman, IL) No Christian love lost between KCBI-FM and new owners; KCBI upset about use of their name and credit by Two If By Sea; and insisted FCC make involuntary call change, thus KAIJ (Rich D'Angelo, *Fine Tuning*) Address announced for KAIJ is P.O. Box 270879, Dallas, TX 75227 (N. Aoi, R. Japan *Media Roundup*) Cf. Feb p.44 for street and fax addresses.

VOA finally heard in Jan with *Communications World* UT Sun 0030 (Thurman) Had been running Special English at this time contrary to own publicity in November; confirmed on 13740, 11695, 9775, 9455, 7405, 6130, 5995. Surprised to find VOA on AM 5745 in French at 0600, outdoing private out-of-banders, maybe weekdays only (gh) 9670 in English at 1700-1800 is Thailand, 2 x 500 kW (John Vodenik)

Bethany-area leaders suggest the VOA 650-acre site should be a radio museum tourist attraction about VOA and Crosley; maybe also high school and senior citizens' center on site (RNMN) The control room is dark; transmitters are silenced; it is as quiet as a tomb. What a haunting experience to walk around here without those sounds that excited us with a sense of mission: the babble of languages launched around the world that sowed seeds of liberty, freedom, democracy and hope in countless minds. Bethany made a difference that still remains as history's witness (Dave Snyder, VOA Bethany manager's narrative report via Vodenik) Most likely Bethany site will become park/recreation center (Mark Meece, OH, ANARC) Antenna towers will be costly to demolish—lead-based paint must be sandblasted first, inside encapsulations. Most of staff became unemployed in mid-Jan (John Vodenik, OH) Tours of VOA Washington retimed to 45 mins. at 10:40 am, 1:40 and 2:40 pm Tue, Wed, Thu exc holidays; reservations at 202-619-3919 (George C. Mackenzie, VOA, USENET via Thurman)

VANUATU New SW transmitter plan delayed again, waiting for approval by Australian High Commission; 6100 and 3300 [sic?] still scheduled for new 10 kW supplementing 7260, 3945 (Bengt, Norway, RNMN) SW frequencies registered for 10 kW are 2485, 3330, 4960, 6100 (*DX Australia* via Arthur Cushen, RNMN) Northern Territory on 2485 already

VATICAN STATE The only SW frequency originating from within the Vatican, 6245, has gone off; now all are from Santa Maria di Galeria, Italy (Andy Sennitt, RNMN) Well, 6245 is still on the Jan-Mar schedule for Europe from 0500 in Polish. Mass in English, Sat 1600 on 9500, 11640 (gh)

VIETNAM [non] VOV expansion program includes relays in Russia to N. America and they're sparing no expense. If Russia doesn't want to relay them, they may buy Ukraine's Simferopol' Crimea site, off air since June from unpaid bills, say rumors (Ivan Kranoskiy, Armenia via Kevin Hecht)

VOV announced new service to N. America on 5940 at 0400-0600 (BBCM) Obviously impossible direct, and 5940 had been used by V. of Russia to us, but bad choice next to WWCR. Only night it was audible here, still carried VOR (gh) Began relay Jan 23, all in English, half-hour program repeated (Ed Rausch, NJ; Larry Shewchuk, Man.)

ZAMBIA Text of R. Christian Voice, 6065 jingle: "Bringing the people choice, breaking the chains that hold back the nation" (HCJB DXPL)

ZIMBABWE The two new SW transmitters at Guinea Fowl near Gweru cost \$40 million, radius of at least a sesquimegometer day or more at night. One is dedicated to Radio 2, mainly in vernaculars; the other educational Radio 4 0800-2000 weekdays, elsewhere Radio 3. SW ensures coverage of the whole country, whilst the FM network reaches only 70%. Radio 2 is on 6045 day, 7285 night; Radio 4 & 3, 3306 day, 4828 night. Plans are underway to install another pair of transmitters for Radio 1 and 3 on SW (*The Herald*, Harare via BBCM)

Until the next, Best of DX and 73 de Glenn!

Log of the Month

March's **LOG OF THE MONTH** was submitted by Nick Terrence of Huntington, New York. Thanks, Nick!

CZECH REPUBLIC: Radio Prague. English service at 0015 on 5930 kHz. Discussion and interviews on the virtues of

eating fresh fruits and vegetables, which are unaffordable in the Czech Republic. Students interview produce market workers and consumer reactions to market prices. Station identification at 0025 UTC.

- 0005 UTC on 6150
COLOMBIA: Caracol. Spanish. Regional news and commercials. Frequent "Caracol" IDs to Latin vocals. (Terrence, NY)
- 0005 UTC on 9705
PORTUGAL: Radio Portugal International. Portuguese. National newscast to station ID. Folk vocal music. // 9570 fair. (Stephen Rollins, Charlotte, NC)
- 0011 UTC on 15130
NORTH KOREA: Radio Pyongyang. Summary of global newspaper reports on the U.S./North Korean nuclear energy agreement. Continued news updates on their "dear leader." Lecture on socialism audible 13760 at 0004. (Gerald Brookman, Kenai, AK)
- 0015 UTC on 9710
CHINA: China Radio International. Weather report for six Chinese cities, to current affairs program. (Terrance, NY) Additional weather update heard on 9730 at 0410-0415. (Claude Turner, Chicago, IL; Bill Hassig, Mt. Prospect, IL)
- 0030 UTC on 9455
UNITED STATES: Voice of America. *Now Music* program. *Country Music USA* show on 9455//6130. *Africa World Tonight* heard on 15580 at 1845. (Frank Hillton, Charleston, SC)
- 0035 UTC on 9595
URUGUAY: Radio Monte Carlo. Spanish musical variety program *Aplauso Aplauso*, a listener call-in show. Station ID at 0100. (Ed Rausch, Cedar Grove, NJ)
- 0044 UTC on 6020
NETHERLANDS: *Newsline* program discussing Pakistani spies seek classified information on India's space program. (Gerry Le Strange, East Brunswick, NJ) Robert Chesal's program *Sounds Interesting*, heard on 6165 at 0050-0125. Howard Shannon's program *Bats, Balls and Baselines*, heard on 6020/6165 at 2350-0025. (Turner, IL)
- 0059 UTC on 5885
SWITZERLAND: Swiss Radio International. Interval signal to time tips at English sign-on at 0100. English world newscast. European news on Turkey and Greece audible on 9535 at 1115, to German service at 1130. (Terrance, NY) Monitored on 9905 at 0100-0200 with news and program features. (Turner, IL; Brookman, AK)
- 0100 UTC on 9955
UNITED STATES: Radio Miami International. English programming into Spanish last half hour. *Viva Miami* show featuring Miami's points of interest. *Mailbag* program with worldwide letters. (Leslie Edwards, Doylestown, PA)
- 0120 UTC on 4810
SOUTH AFRICA: SABC. Musak music tunes from the 1940's era. Station ID at 0200. (Terrance, NY) South Africa's *Radio 2000* audible on 4810 at 0208, with easy-listening and lite pop music to "Radio 2000" ID. (Harold Frodge, Midland, MI)
- 0130 UTC on 9745
ECUADOR: HCJB. Features, *Ham Radio Today* and *The Latest Catch*. (Brian Bagwell, St. Louis, MO) *Morning in the Mountains*, heard on 12005 at 1200. (Fraser, MA)
- 0159 UTC on 11725
CANADA: Radio Canada International. ID/frequency quote into news bulletins. *Spectrum* magazine program at 0210, devoted to business and economics. (Jim Moats, Ravenna, OH)
- 0212 UTC on 4950
ANGOLA: Radio Nacional de Angola. Portuguese. Afro pop and Spanish tunes heard to station ID. (Frodge, MI) Station monitored on 3374.9 at 0440 in Portuguese, // 4950 weaker quality. (Fred Houghton, Pittsburg, PA)
- 0225 UTC on 4960
HONDURAS: HRET. Spanish. Station ID to contemporary Christian vocals. (Frodge, MI)
- 0240 UTC on 9410
UNITED STATES: WEWN. *The Family* program presented by Fr. Ken Roberts, with a discussion on the sacraments in the Roman Catholic church. Excellent signal. (Moats, OH)
- 0245 UTC on 4600
BOLIVIA: Radio Perla de Acre. Spanish. Announcer's regional talk to great Bolivian guitar ballads. Bolivia's *Radio Tropical* noted on 4549.6 at 0255. (Houghton, PA)
- 0252 UTC on 21580
PHILIPPINES: Radio Pilipinas. Speech on the national power system in the Philippines. Noted on 15575 at 0247. (Brookman, AK) *Voice of America* relay station heard on 9760 at 1405. News and classical music program. (Moats, OH)
- 0315 UTC on 3396
ZIMBABWE: ZBC. English DJ with rock music format. News update briefs at 0340. No // freqs noted. (GVH/NC)
- 0355 UTC on 9560
ETHIOPIA: Radio Voice of Peace for Rwanda. Interval signal ID/location in English and French. Radio Amahoro ID in Kinyarwanda language. Station is funded by a group of Euro charitable organizations, and uses the transmitter of Radio Amahoro. (Rausch, NJ)
- 0447 UTC on 7385
COSTA RICA: Radio for Peace International. *Mailbag* program with fair signal quality. *Far Right Radio Review* at 0255. (Brookman, AK) *World of Radio* program noted on 7385 at 0405-0430. (Turner, IL)
- 0745 UTC on 7120
MONACO: Trans World Radio. IDs, scriptures, and religious vocals. (Don Taylor, Green Cove Springs, FL)
- 0945 UTC on 6160
GERMANY: Deutsche Welle. Wednesday's *Insight* program. Friday's African Service noted on 15270 at 2105-2112, with news and features. (Turner, IL) Heard on 7225 at 0422. (Brookman, AK)
- 1015 UTC on 6155
AUSTRIA: Radio Austria International. Concert by Vienna Philharmonic from Vienna's Musihrein. (Edwards, PA)
- 1035 UTC on 9700
NEW ZEALAND: Radio New Zealand International. *Pacific Beat* show of regional news and information. (Turner, IL)
- 1050 UTC on 13680
IRAQ: Radio Iraq International. English IDs to middle eastern music. International news program *Iraq Today* and Holy Koran recitations. (Rausch, NJ)
- 1130 UTC on 4799.8
GUATEMALA: Radio Buenas Nuevas. Spanish. Local music vocals to station ID at 1137. Excessive heterodyne interference. (Terrance, NY)
- 1150 UTC on 9860
AUSTRALIA: Radio Australia. Interview about new movie on Maories, *Once We Were Warriors*. 1200". (Bob Fraser, Cohasset, MA) Heard 0106 on 17795, 0201 on 17880. (Brookman, AK)
- 1200 UTC on 5965
CANADA: BBC relay. Play of the week, *A Thurber Carnival*. (Fraser, MA)
- 1233 UTC on 2310
AUSTRALIA: VL8A-Alice Springs. Rock music and interviews. Parallel VL8T-Tennant Creek heard on 2325 with slightly better signal quality. (Frodge, MI)
- 1435 UTC on 11705
JAPAN: Radio Japan/NHK. *Media Roundup* show of communications news and data, presented by Ayumi Hoshino. (Turner, IL) Noted 0501 on 9565, not in *Passport*. (Brookman, AK)
- 1610 UTC on 9550
RUSSIA: Voice of Russia. *Culture and the Arts* program on training actors. *Music At Your Request* show featuring the ballets of Adolphe Adam on 7150 at 2131. (Fraser, MA) Discussion on honoring World War II veterans, at 2020-2030 on 9550. (Turner, IL; Brookman, AK)
- 1721 UTC on 11730
INDIA: All India Radio. Regional music to news and programming commentaries, all in Indian dialects. (Le Strange, NJ)
- 1802 UTC on 15385
UNITED STATES: KJES. Religious service at tune-in. Bible scripture quotes with recitations. Station ID at 1830, with fair signal quality. (Moats, OH)
- 1858 UTC on 17605
NETHERLANDS ANTILLES: Radio Netherlands relay. Report on a trip on the Eurostar train from Paris to London under the Channel. // 9605, 15315 both good to excellent signal. (Fraser, MA)
- 1940 UTC on 17830
ASCENSION ISLANDS: BBC relay. *On the Move* show, with report on the Middle East Airlines of Beirut. (Fraser, MA)
- 1942 UTC on 9575
ITALY: RAI. Usual news style-including a report that the special prosecutor of a recent political scandal has resigned. Italian soccer commentary noted on 17780 at 1440. (Fraser, MA)
- 2000 UTC on 6065
ZAMBIA: Christian Voice. Station ID, "you are listening to Christian Voice program of *Celebration Praise* of contemporary Christian music." (Rausch, NJ)
- 2007 UTC on 6070
CANADA: CFRX. Traffic and weather update, car dealership commercial. Radiothon for Toronto Children's Hospital. (Moats, OH) *The World Today* show noted as, "Canada's most listened to news program," audible on 6070 at 2300. (Fraser, MA)
- 2050 UTC on 5882
VATICAN STATE: Vatican Radio. News update on the Pope's health and current affairs. (Tom Banks, Dallas, TX)
- 2055 UTC on 15270
RWANDA: Deutsche Welle relay. French. Interval signal to English relay site ID. World news programs *Euro Journal* and *African Highlights*. (Rausch, NJ; Banks, TX)
- 2100 UTC on 6055
SLOVAKIA: AWR. Multilingual identification into *Lifestyle Magazine* show, discussing substance abuse. Medium wave DX tips presented by Gordon Bennett at 2124. (Moats, OH)
- 2112 UTC on 11720
CUBA: Radio Havana Cuba. Interviews at a medical conference in Havana on blindness. (Fraser, MA) Additional monitoring noted as; 0005 on 11970, (Terrance, NY) 0412-0416 on 6000/9820, 2105-2112 on 6000/11720. (Turner, IL) Noted on 6010 at 0428. (Brookman, AK; Banks, TX)
- 2130 UTC on 7455
GUAM: KSDA. Bible scripture readings to 2200. Interval signal and station identification. (Rausch, NJ)
- 2218 UTC on 9850
TAIWAN: Voice of Free China. Newscast and program features to language program. (Turner, IL) Station via WYFR relay heard on 9680 at 0310. Classical music program, *Jade Bells and Bamboo Pipes*. Fair to good signal. (Moats, OH)
- 2245 UTC on 9670
UNITED STATES: Voice of the OAS. *The Americas Today* program featuring news of Central and South America. (Turner, IL)

Thanks to our contributors — Have you sent in YOUR logs?
Send to **Gayle Van Horn**, c/o *Monitoring Times*.
English broadcast unless otherwise noted.

Get 'em While You Can!

Due to the AM broadcast band expansion, due in 1995, Travelers Information Stations on 1610 and 1620 AM will soon disappear!

TIS stations are low-powered radio transmitters broad-

casting information to alert tourists of road hazards, availability of lodging, food, gasoline, and points of interest.

Get 'em while you can...it's later than you think!

BULGARIA

Radio Bulgaria, 9750/7455 kHz. Full data old Radio Sofia scenery/logo card, unsigned. Received in one year for an English report, cassette tape of programming, and 1 IRC. Station address: 4 Dragan Tsankor Blvd., 1040 Sofia, Bulgaria. (Walter Szczepaniak, Philadelphia, PA)

COAST GUARD

NCF-USCG Station, 2670 kHz. Full data prepared QSL card signed by T.C. Lee, plus verification letter enclosed. Received in 10 days for an English utility report and prepared QSL card. Station address: Commander, USCG Group Miami, 100 MacArthur Causeway, Miami Beach, FL, 33139. (Steve MacDonald, Port Coquitlam, B.C. Canada)

NMC11-USCG Station, 2670 kHz. Full data prepared QSL card signed by T.R. Ellis-RM1, plus personal letter enclosed. Received in 11 days for an English utility report and prepared QSL card. Station address: Commander, USCG Group Humboldt Bay, McKinleyville, CA 95521-9309. (McDonald, CAN)

GABON

Radio Japan Moyabi Relay Station, 11925 kHz. Full data color scenery card, signed by H. Kawamoto. Program schedule, English report form, and *Radio Japan News* included. Received in 22 days for an English report. Station address: Tokyo 150-01 Japan. (Randy Stewart, Springfield, MO)

INDONESIA

Irian Jaya: Radio Republik Indonesia - Wamena, 4867 kHz. Full data prepared QSL card stamped with station seal, and signed by Eliazar Kadmaerubun. Personal letter received from Yoswa Kumurawak, and a color



tourist postcard of the regional *Yali People* included. Received in 45 days after a second Indonesian follow-up report, one U.S. dollar, mint Indo stamps, and a preaddressed envelope (both used for return reply). Station/country verified in total of 2 years and four months. Station address: Stasiun Regional II-Wanema, Kotal Pos 110, (*Passport 94 & 95* report Kotal Pos 10) Kode Pos 99501, Wamena, Irian Jaya, Indonesia. (Gayle Van Horn, Brasstown, NC)

MEDIUM WAVE

WSAI-1530 AM. Confirmation letter only on station letterhead, signed by Russ Jackson-Operations. Received in 38 days for an English AM report. Station address: 1111 St. Gregory St., Cincinnati, OH 45202. (Szczepaniak, PA)

CJSB/CKQB-540 AM. Full data sheet signed by Jeff Ruck-Chief Engineer. Received in 10 days for an English AM report. Station address: 1504 Merivale Rd., Ottawa, ONT K2E 6ZE Canada. (David A. Gasque, Orangeburg, SC)

WNST-1600 AM. Full data sheet signed by William Halleron-Chief Engineer. Received in 22 days for an English AM report. Station address: P.O. Box 2324, Huntington, WV 25724-2324. (Gasque, SC)

WDAB-1580 AM. Partial data only in personal letter, signed by Michael Adamson. Station logo card, sticker, and pen included. Received in 9 days for an English AM report and SASE (not used). Station address: P.O. Box 25276, Greenville, SC 29616. (Harold Frodge, Midland, MI)

SHIP TRAFFIC

Bartolomeu Dias-CSAR, 156.65 MHz (Coal Carrier). Full data letter and photo of vessel. Received in 32 days for an English utility report and one U.S. dollar. Ship QSL address: Portline Transporters Naritimas Intl., Rua Actor, Antonio Silva 7-11 1600 Lisbon, Portugal. (Hank Holbrook, Dunkirk, MD)

New England Sun-WYZ4652, 156.65 MHz (Tugboat). Full data prepared QSL card verified. Received in 75 days for an English utility report, prepared QSL card, and mint stamps. Ship QSL address: Sun Transport Inc., P.O. Box 1078, Delaware Ave. & Green St., Marcus Hook, PA 19061-1078. (Holbrook, MD)

MSC Rita-3FEZ4, 156.65 MHz (Container/Cargo). Full data verification letter. Received in 56 days for an English utility report and one U.S. dollar. Ship QSL address: Mediterranean Shipping Co., 18 Chem Rieu, CH-1200 Geneva, Switzerland. (Holbrook, MD)

SWITZERLAND

Swiss Radio International, 11620 kHz. Full data city scenery card, unsigned. Received in 45 days for an English report. Station address: SSR, Giacomettistrasse 1, CH-3000 Berne 15, Switzerland. (Edouard Provencher, Biddeford, ME)

THAILAND

Radio Thailand, 15370 kHz. Partial data *Khon* masked players card, unsigned. Frequency schedule and personal letter from Mrs. Amporn Samosom-Chief of External Service. Received in 35 days for an English report, and one U.S. dollar. Address on letter as: c/o External Service, 236 Vibhavadi-Rangsit Rd., Din Dang, Kuay-Khwang, Bangkok 10400, Thailand. Report mailed to: Rajchadamnern Klang Rd., Phra Nakhom Region, Bangkok 10200, Thailand. (Stewart, MO)

TRAVELERS INFORMATION STATION (TIS)

WNRB-1610 AM kHz. Raleigh-Durham Int'l Airport. Full data prepared QSL card signed by Airport Director (name is illegible). Received in 10 days for an English report. Station address: c/o Raleigh-Durham Airport Authority, P.O. Box 80001, RDU Airport, NC 27623. (Mike Hardester, Jacksonville, NC)

WNVY-510 AM kHz, Maryland Dept. of Transportation. Full data prepared QSL card signed with note included. Received in 8 days for an English report and mint stamp. Station address: c/o State Highway Admin., P.O. Box 717, Baltimore, MD 21203-0717. (Holbrook, MD)

KID-771 AM kHz, Deep Creek, NC. Full data prepared QSL card signed by W. Eugene Cox. Received in 8 days for an English report and mint stamp. Station address: c/o Great Smoky Mt. National Park, Gatlinburg, TN 37738. (Holbrook, MD)

WCVN-597 AM kHz, New Market, VA. Full data prepared QSL card signed by Keith Gibson-Director, and folder on the park. Received in 12 days for an English report and mint stamp. Station address: c/o New Market Battlefield Historical Park, P.O. Box 1864, New Market, VA 22844. (Holbrook, MD)

UNITED STATES

Voice of America-Bethany Relay Sta., 7405/13740/17800 kHz. Full data "final day of broadcasting" QSL card, signed by John Vodenik. Received in 5 weeks for two English reports and \$4.00 to cover veri signer's printing cost. QSL address: c/o John Vodenik, 104 S. Forest Ave., Mason, OH 45040. (Thomas P. Risher, Whittier, CA; Don Dacus, Russellville, AR)

VENEZUELA

Ecos del Torbes, 4980 kHz. Full data national map card, unsigned. Received for a Spanish report. Station address: Apartado 152, San Cristobal 5001, Tachira, Venezuela. (Provencher, ME)

How to Use the Shortwave Guide

1: Convert your time to UTC.

Eastern and Pacific Times are already converted to Coordinated Universal Time (UTC) at the top of each page. The rule is: convert your local time to 24-hour format; add (during Standard Time) 5, 6, 7 or 8 hours for Eastern, Central, Mountain or Pacific Time, respectively.

Note that all dates, as well as times, are in UTC; for example, the BBC's "John Dunn Show" (0030 UTC Sunday) will be heard on Saturday evening (7:30 pm Eastern, 4:30 PM Pacific) in North America, not on Sunday.

2: Choose a program or station you want to hear.

Some selected programs appear on the lower half of the page for prime listening hours—space does not permit 24-hour listings except for the "Newswire" listing, which begins on the next page.

Occasionally program listings will be followed by "See X 0000." This information indicates that the program is a rerun, and refers to a previous summary of the program's content. The letter stands for a day of the week, as indicated below, and the four digits represent a time in UTC.

S: Sunday T: Tuesday H: Thursday A: Saturday
M: Monday W: Wednesday F: Friday

3: Find the frequencies for the program or station you want to hear.

Look at the page which corresponds to the time you will be listening. Comprehensive frequency information for English broadcasts can be found at the top half of the page. All frequencies are in kHz.

The frequency listing uses the same day codes as the program listings; if a broadcast is not daily, those day codes will appear before the station

name. Irregular broadcasts are indicated "tent" and programming which includes languages besides English are coded "vl" (various languages).

4: Choose the most promising frequencies for the time, location and conditions.

Not all stations can be heard and none all the time on all frequencies. To help you find the most promising frequency, we've included information on the target area of each broadcast. Frequencies beamed toward your area will generally be easier to hear than those beamed elsewhere, even though the latter will often still be audible. Every frequency is followed by one of these target codes:

am: The Americas	as: Asia
na: North America	au: Australia
ca: Central America	pa: Pacific
sa: South America	va: various
eu: Europe	do: domestic broadcast
af: Africa	om: omnidirectional
me: Middle East	

Consult the propagation charts. To further help you find the right frequency, we've included charts at the back of this section which take into account conditions affecting the audibility of shortwave broadcasts. Simply pick out the region in which you live and find the chart for the region in which the station you want to hear is located. The chart indicates the optimum frequencies for a given time in UTC.

HOT NEWS AND HOT SPOTS

Here's another roundup of broadcasting developments in areas of conflict, compiled by Glenn Hauser.

VOA continues facing major obstacles in constructing its new relay station in Chilaw, **SRI LANKA**. Anti-American area residents seem convinced it's really a spy station or will negatively impact the local economy. On *Media Network*, Victor Goonetilleke reports more demonstrations and sit-down strikes both at the site and in Colombo near the US embassy. A security post at the entrance was burnt down; government electricity supply to the site was interrupted by damage to new transformers, but there was no harm to the transmitting equipment and antennas of the station itself.

Opposition is spearheaded by the local Catholic church. The government wants to go ahead, since there is no technical reason not to, and the deal involves a lot of American aid, garment industry

quotas, etc., putting the government in a difficult situation. Meanwhile, VOA itself avoids discussing the matter. John Vodenik finds more credible info from the VOA site manager that transmitters were heavily damaged, and project may have to be canceled.

On the African scene: V. of the Broad Masses of **ERITREA** was on exactly 4000.0 when heard in Arabic at 1618-1659, says Finn Krone, *SWB*. **ETHIOPIA**'s Radio Fana (Torch) besides 6210 is heard on 9335 at 0330-0800, 1530-1730, no English, says Victor Goonetilleke, Sri Lanka on *RNMN*.

R. Free **SOMALIA** tested at 1300 on 13720, also plans to test on 9865, 9900, 9935, says Sam Voron via Arthur Cushen, *RNZI Mailbox*. BBCM says this station at Gaalkayco in the northeast was heard at 1330* on 13820; said they relayed the "national program of R. Somalia": 1000-1215 on 7215,

1600-1715 on 3920. And the *Jamhuriya* newspaper in Hargeisa reported that the Somali government has purchased a "high-powered" station for more than \$200K.

From Bukavu, **ZAIRE** for Rwanda, R. Agatashya (Swallow of Hope), used 6120 at 0600-1000, 1400-1800, with English programs on Wednesdays and Saturdays, but Swiss journalists pulled out of the project and was to close down at the end of 1994.

Former **YUGOSLAVIA**: R. Yugoslavia via Bijeljina, Bosnia, English at 0100-0130 on 6195 and new 7115 ex-9580, says the German AGDX Monitoring & Info Service via Büschel. In mid-Jan, RY announced it would stop broadcasting to N. America, because sanctions made it impossible to get spare parts, reports Ed Rausch, NJ, on *HCJB DXPL*. Marie Lamb said on *HCJB's TLC* that the station was subsequently missing from 7115.

Radio Bosnia-Hercegovina, government station at Sarajevo, had been missing from SW since May, but heard again in mid-December on 7108 USB+carrier, 24 hours //MW 612, per BBCM; it was clear at 1525 on new 7108.1 with religion and music, says Nikolai Pashkevitch, Moscow, on *RNMN*; same was monitored at 0800-0930* and after a break again from *1000, using ham equipment? per Wolfgang Büschel, Stuttgart.

Croatian Radio, Studio Zagreb First Program, monitored on 13830 24 hours; 13640 at 1230-1559; 11630 at 1559-1959; 9830 24h; 7370 at 1959-1230; 5920 at 0659-1559, 2059-2259; 5895 at 1559-0659; English news up to 7 minutes occurs at: 0703 exc. Sun at 0803; 0903 exc. Sun 1003; daily 1303, 2203, says BBC Monitoring, likely one hour earlier for DST from end of March.

MT Monitoring Team

Gayle Van Horn, Frequency Manager
North Carolina

Next Reporting Deadline
March 17, 1995

Jim Frimmel, Program Manager
Texas

Dave Datko
California

Jacques d'Avignon
Propagation Forecasts
Ontario, Canada

newsline

"Newsline" is your guide to news broadcasts on the air. • All broadcasts are world news reports unless followed by an asterisk, which means the broadcast is primarily national news. • All broadcasts are daily unless otherwise noted by the day codes.

<p>0000 UTC (7:00 PM EST, 4:00 PM PST) BBC Canada (North-Quebec) [S] China Radio Int'l Monitor Radio Int'l [T-A] Radio Australia Radio Bulgaria Radio Canada Int'l [S-M] Radio New Zealand Int'l [M-A] Radio Norway Int'l [S] Radio Prague Radio Thailand Radio Vilnius Spanish National Radio Voice of America (am) Voice of Russia WYFR [T-F] 0003 Radio Pyongyang 0009 0010 China Radio Int'l* Voice of America (ca) [T-A]* 0015 Radio Cairo 0030 All India Radio Radio Nacional de Venezuela [T-S] Radio Netherlands Int'l Radio Sweden [T-A] Radio Thailand [T-S] Radio Vlaanderen Int'l Voice of America (am) [T-A] (Special English) Voice of Russia 0050 RAI Italy</p> <p>0100 UTC (8:00 PM EST, 5:00 PM PST) BBC Canada (North-Quebec) Deutsche Welle FEBC (Philippines) HCJB KVOH [W] Monitor Radio Int'l [T-A] R Slovakia Int'l [A]* R Slovakia Int'l [S/T-F] Radio Australia Radio Havana Cuba [T-S] Radio Japan</p>	<p>Radio Korea Radio New Zealand Int'l [M-A] Radio Prague Radio Ukraine Int'l Radio Yugoslavia Spanish National Radio Swiss Radio Int'l Voice of America (am) Voice of Indonesia Voice of Russia WWCR #1 [T-A] 0110 Radio Australia [M-F]* Radio Havana Cuba [S/T-F]* Radio Japan [A]* 0130 BBC (as)* Radio Austria Int'l Radio Havana Cuba [T-S] Radio Netherlands Int'l Radio Sweden [T-A] Radio Tirana Voice of Russia 0145 BBC (ca) [T-A]* 0155 Voice of Indonesia</p> <p>0200 UTC (9:00 PM EST, 6:00 PM PST) BBC ("Newsdesk") Canada (North-Quebec) [S] Deutsche Welle Monitor Radio Int'l [T-A] Radio Australia Radio Budapest Radio Canada Int'l Radio Havana Cuba [T-S] Radio New Zealand Int'l [M-A] Radio Norway Int'l [M] Radio Romania Int'l Radio Yugoslavia RAE Argentina [T-A] Voice of America (am) [T-A] Voice of Myanmar (Burma) Voice of Russia 0203 Voice of Free China 0210 Radio Havana Cuba [T-S]* 0215 Radio Cairo Radio Nepal 0230 Radio Havana Cuba [T-A]</p>	<p>Radio Netherlands Int'l Radio Pakistan Radio Portugal Int'l [T-A] Radio Sweden [T-A] Radio Tirana Voice of Russia [T-A]</p> <p>0300 UTC (10:00 PM EST, 7:00 PM PST) BBC Canada (North-Quebec) Channel Africa China Radio Int'l Deutsche Welle KVOH [T-F] Monitor Radio Int'l [T-A] Radio Australia Radio Canada Int'l Radio Havana Cuba [T-S] Radio Japan Radio New Zealand Int'l [M-A] Radio Prague Radio Thailand Voice of America (af) [A-S] Voice of Russia WHRI [T-S] WINB [T-A] WWCR #3 [T-A] 0301 Voice of America (af) [M-F]* 0303 Voice of Free China 0309 BBC* 0310 China Radio Int'l* Radio Havana Cuba [S/T-F]* 0315 Radio Cairo Voice of Greece [S/H] 0320 Radio Philipinas [M-A] Vatican Radio 0330 BBC (af)* Radio Austria Int'l Radio Budapest Radio Dubai Radio Havana Cuba [T-A] Radio Nacional de Venezuela [T-S] Radio Netherlands Int'l Radio Prague Radio Sweden [T-A] Voice of America (af) [M-F] (Special English)</p>	<p>Voice of Russia 0340 Voice of Greece 0355 Radio Japan</p> <p>0400 UTC (11:00 PM EST, 8:00 PM PST) BBC ("Newsdesk") BBC (af) Canada (North-Quebec) Channel Africa China Radio Int'l Deutsche Welle Monitor Radio Int'l [T-F] Radio Australia Radio Canada Int'l Radio Havana Cuba [T-S] Radio New Zealand Int'l [A] Radio New Zealand Int'l [M-F]* Radio Romania Int'l Radio Tanzania Radio Ukraine Int'l Swiss Radio Int'l Voice of America (af) Voice of Russia Voice of Turkey WHRI [T-A] WINB [T-A] WWCR #1 [T-S] WWCR #3 [T-A] 0403 Radio Pyongyang 0410 China Radio Int'l* Radio Havana Cuba [T-S]* 0425 RAI Italy 0430 Radio Havana Cuba [T-A] Voice of Russia 0431 Voice of America (af) [M-F]* 0440 BBC (af) [A-M]* 0445 BBC (af) [T-F]*</p> <p>0500 UTC (12:00 AM EST, 9:00 PM PST) BBC ("Newshour") Canada (North-Quebec) Channel Africa China Radio Int'l Deutsche Welle HCJB</p>	<p>Monitor Radio Int'l [T-F] Radio Australia Radio Bulgaria Radio Cameroon Radio Havana Cuba [T-S] Radio Japan Radio New Zealand Int'l [S-F] Radio Norway Int'l [S] Spanish National Radio Voice of America (af) Voice of Israel Voice of Russia WHRI [A] WWCR #1 [T-A] 0510 China Radio Int'l* Radio Australia [M-F]* Radio Havana Cuba [T-S]* 0530 Channel Africa [S-F] Radio Austria Int'l Radio Dubai Radio Finland Radio Havana Cuba [T-A] Radio Romania Int'l Voice of Nigeria Voice of Russia 0555 Radio Japan [A]</p> <p>0600 UTC (1:00 AM EST, 10:00 PM PST) BBC BBC (af) [A-S]* BBC (af) [M-F] Canada (North-Quebec) Channel Africa Deutsche Welle Monitor Radio Int'l [T-F] Radio Australia Radio Canada Int'l [M-F] Radio Havana Cuba [T-S] Radio Japan Radio Korea Radio New Zealand Int'l [M-A] Radio Yemen Swiss Radio Int'l Voice of America (af) [A-S] Voice of America (me) Voice of Kenya Voice of Malaysia Voice of Russia 0601 Voice of America (af) [M-F]* 0603 Radio Pyongyang</p>
--	---	--	--	--

0609
BBC*

0610
Radio Havana Cuba [T-S]*

0627
BBC (af) [M-F]*

0630
Radio Austria Int'l [T-S]
Radio Havana Cuba [T-A]
Radio Yemen
Voice of Nigeria [M-F]
Voice of Russia

0632
Radio Romania Int'l

0645
Radio Romania Int'l
Voice of Nigeria [M-F]*

0655
Voice of Med. (Malta) [M-F]

0700 UTC
(2:00 AM EST, 11:00 PM PST)
BBC
Monitor Radio Int'l [T-F]
Papua New Guinea
Radio Australia
Radio Japan
Radio New Zealand Int'l [A-S]
Radio New Zealand Int'l [M-F]*
Radio Prague
Swiss Radio Int'l (eu)
Voice of Myanmar (Burma)
Voice of Russia
WWCR #3 [S]

0703
Radio Pyongyang
Voice of Free China

0710
Radio Australia [M-F]*

0730
BBC (af) [A]*
HCJB
Radio Netherlands Int'l
Radio Pakistan
Radio Prague
Radio Vlaanderen Int'l
Vatican Radio [M-F]
Voice of Greece [S/H]
Voice of Russia

0750
Radio New Zealand Int'l [M-F]*

0755
Radio Japan
Voice of Med. (Malta) [M-F]

0800 UTC
(3:00 AM EST, 12:00 AM PST)
BBC
KNLS
Monitor Radio Int'l [M-A]
Radio Australia
Radio Korea
Radio New Zealand Int'l
Radio Pakistan
Voice of Indonesia [A-H]
Voice of Malaysia
Voice of Russia

0803
Radio Pyongyang

0810
Radio New Zealand Int'l [M-F]*

0830
R Slovakia Int'l
Radio Austria Int'l [T-S]
Radio Netherlands Int'l
Voice of Russia [M-A]

0845
Radio Finland

0850
[A]

0855
Voice of Indonesia [A-H]

0900 UTC
(4:00 AM EST, 1:00 AM PST)
BBC
China Radio Int'l
Deutsche Welle
Monitor Radio Int'l [M-A]
Papua New Guinea [M]*
Radio Australia
Radio Finland
Radio Japan
Radio New Zealand Int'l [M-A]
Swiss Radio Int'l
Voice of Russia

0910
China Radio Int'l*
Radio Australia [M-F]*

0920
Voice of Greece [S/H]

0930
[S]
FEBC (Philippines)
Radio Netherlands Int'l
Voice of Russia

0940
Voice of Greece

0945
Deutsche Welle [M-F]*

0955
Radio Japan

1000 UTC
(5:00 AM EST, 2:00 AM PST)
All India Radio
BBC
China Radio Int'l
FEBC (Philippines) [M-F]*
HCJB
Monitor Radio Int'l
Papua New Guinea
Radio Australia
Radio Bulgaria
Radio New Zealand Int'l [S-F]
Radio Tanzania
Radio Vlaanderen Int'l [M-A]
Voice of America (as)
Voice of Kenya
Voice of Russia
WWCR #3 [A]

1010
China Radio Int'l*
Radio New Zealand Int'l [M-F]*

1030
Radio Austria Int'l [M-A]
Radio Dubai
Radio Netherlands Int'l
Voice of Nigeria
Voice of Russia

1045
Radio New Zealand Int'l [M-F]*
Voice of Nigeria [A-S]*

1100 UTC
(6:00 AM EST, 3:00 AM PST)
BBC ("Newsdesk")
Channel Africa
Deutsche Welle
Monitor Radio Int'l [M-A]
Papua New Guinea
Radio Australia
Radio Ghana [A-S]
Radio Japan
Radio Jordan
Radio Mozambique
Radio New Zealand Int'l
Radio Pakistan
Radio Singapore Int'l
Swiss Radio Int'l
Swiss Radio Int'l (eu)
Voice of America (as)
Voice of Israel
Voice of Russia
WHRI [A]
WYFR [M-A]

1103
Radio Pyongyang

1110
Radio Australia*

1120
Vatican Radio [M-A]

1130
Radio Korea
Radio Nacional de Venezuela [M-A]
Radio Netherlands Int'l
Radio Prague
Radio Singapore Int'l
Voice of Asia
Voice of Russia
WYFR [M-F]

1145
Deutsche Welle [M-F]*

1155
Radio Japan [M-F]

1200 UTC
(7:00 AM EST, 4:00 AM PST)
BBC
Canada (North-Quebec) [A-S]
China Radio Int'l
Monitor Radio Int'l [M-A]
Papua New Guinea
Radio Australia
Radio France Int'l
Radio New Zealand Int'l [H-T]
Radio Norway Int'l [S]
Radio Singapore Int'l
Radio Tashkent
Swiss Radio Int'l (eu)
Voice of America (as)
Voice of Russia
WHRI [A]
WWCR #1 [M-F]
WYFR [M-F]

1203
Radio Korea
Voice of Free China

1204
HCJB [M-F]

1209
BBC [W]*

1210
China Radio Int'l*

1230
HCJB [M-F]*

Radio Austria Int'l
Radio Bangladesh [S-M]
Radio Bulgaria
Radio Cairo
Radio Canada Int'l
Radio Finland [M-A]
Radio Netherlands Int'l
Radio Singapore Int'l
Radio Sweden [M-F]
Voice of Russia
Voice of Vietnam
WYFR [M-F]

1231
Radio France Int'l [T]*

1240
Voice of Greece

1258
Africa No. 1 (Gabon)

1300 UTC
(8:00 AM EST, 5:00 AM PST)
BBC ("Newshour")
Canada (North-Quebec) [A-S]
China Radio Int'l
KNLS
Monitor Radio Int'l [M-A]
Papua New Guinea
Polish Radio [A]
Polish Radio [M-F]*
Radio Australia
Radio Canada Int'l [M-F]
Radio Ghana
Radio Norway Int'l [S]
Radio Romania Int'l [M-A]
Radio Singapore Int'l
Radio Tanzania [A-S]
Swiss Radio Int'l
Voice of America (as)
Voice of Kenya
Voice of Russia
WWCR #1 [S]
WYFR [M-F]

1301
Radio Romania Int'l [S]

1303
Radio Pyongyang

1310
China Radio Int'l*
Radioabrás [M-F]

1324
HCJB [M-F]

1328
Radio Cairo

1330
All India Radio
FEBC (Philippines)
Radio Austria Int'l
Radio Canada Int'l
Radio Dubai
Radio Finland
Radio Netherlands Int'l
Radio Singapore Int'l
Radio Sweden [M-F]
Radio Tashkent
Radio Vlaanderen Int'l [S]
Radio Yugoslavia
Voice of America (as) (Special English)
Voice of Russia [M-A]
Voice of Turkey
Voice of Vietnam

1355
Radio Singapore Int'l

1400 UTC
(9:00 AM EST, 6:00 AM PST)
BBC
BBC (as) [M-F]*
Canada (North-Quebec) [S]
China Radio Int'l
Monitor Radio Int'l [M-A]
Radio Australia
Radio Cameroon
Radio Canada Int'l [S]
Radio France Int'l
Radio Ghana
Radio Japan
Radio Jordan [A]
Radio Korea
Radio Vlaanderen Int'l [M-A]
Voice of America (as)
Voice of Israel [S-H]
Voice of Russia
WWCR #1 [M-F]
WYFR [M-F]

1410
China Radio Int'l*
Radio Japan [M-F]*
1415
Radio Nepal

1424
HCJB [M-F]

1430
FEBC (Philippines)
Radio Canada Int'l
Radio Finland
Radio Nacional de Venezuela [M-A]
Radio Netherlands Int'l
Radio Romania Int'l [T-S]
Radio Sweden [M-F]
RTM Morocco [S]
Voice of Myanmar (Burma)
Voice of Russia

1431
Radio France Int'l [T]*
Radio Romania Int'l [M]

1435
Voice of Greece

1440
FEBC (Philippines) [S-F]*

1445
All India Radio
BBC (as) [M-F] (Special English)
Voice of Myanmar (Burma)

1455
Radio Japan [A]
Voice of Med. (Malta) [M-F]

1500 UTC
(10:00 AM EST, 7:00 AM PST)
BBC
BBC (af) [M-F]
Canada (North-Quebec) [A-S]
Channel Africa
China Radio Int'l
Deutsche Welle
Monitor Radio Int'l [M-A]
Radio Australia
Radio Canada Int'l [S]
Radio Japan
Radio Jordan
Radio Omdurman
Swiss Radio Int'l
Voice of America (as)
Voice of Russia

WWCR #1 [M-A]
 WYFR [A]
1503
 Radio Pyongyang
1510
 China Radio Int'l*
 Radio Japan [M-F]*
1525
 BBC (af) [S]*
 Radio Veritas [T-F]
1530
 All India Radio*
 Deutsche Welle [M-F]*
 FEBC (Philippines)
 Radio Austria Int'l
 Radio Netherlands Int'l
 Radio Portugal Int'l [M-F]
 Voice of Nigeria [M-H]
 Voice of Russia
 WYFR [M-F]
1540
 Radio Veritas [A-M]
1550
 Voice of Med. (Malta) [F]
1555
 Radio Japan [A]
 Radio Veritas [A-M]
 Voice of Med. (Malta) [M-H]

1600 UTC
(11:00 AM EST, 8:00 AM PST)
 BBC
 Canada (North-Quebec) [A-S]
 Channel Africa
 China Radio Int'l
 Deutsche Welle
 Monitor Radio Int'l [M-A]
 Polish Radio [A]
 Polish Radio [M-F]*
 Radio Australia
 Radio Canada Int'l [S]
 Radio France Int'l
 Radio Jordan
 Radio Korea
 Radio Pakistan
 Radio Tallinn [M-F]
 Radio Tanzania
 Voice of America (af) [A-S]
 Voice of America (as)
 Voice of Ethiopia
 Voice of Kenya
 Voice of Russia
 WRNO [W]
 WYFR [A]
1604
 HCJB [M-F]
1609
 BBC*
1610
 China Radio Int'l*
1612
 Vatican Radio
1630
 HCJB [M-F]*
 Radio Canada Int'l
 Radio Dubai
 Voice of America (af) [M-F]*
 Voice of America (as) (Special English)
 Voice of Ethiopia
 Voice of Russia
1645
 BBC (as)*

1700 UTC
(12:00 PM EST, 9:00 AM PST)
 BBC
 BBC (af)
 Canada (North-Quebec) [A]
 Channel Africa
 China Radio Int'l
 HCJB
 Monitor Radio Int'l [M-A]
 Radio Australia
 Radio France Int'l
 Radio Japan
 Radio New Zealand Int'l [M-F]*
 Radio Pakistan
 Radio Prague
 Radio Tirana
 Swiss Radio Int'l
 Voice of America (af)
 Voice of Russia
 WRNO [M-F]
 WWCR #3 [M-F]
1703
 Radio Pyongyang
1710
 China Radio Int'l*
 Radio Australia*
1715
 Vatican Radio
1725
 Radio New Zealand Int'l [F]*
1730
 Radio Netherlands Int'l
 Radio Romania Int'l
 Voice of Russia [S-F]
1740
 BBC (af)*
1745
 Radio Canada Int'l [M-F]
1755
 Radio Japan [A]
 Radio New Zealand Int'l [M-H]*

1800 UTC
(1:00 PM EST, 10:00 AM PST)
 All India Radio
 BBC ("Newsdesk")
 Canada (North-Quebec) [A]
 Monitor Radio Int'l [M-A]
 Polish Radio [A]
 Polish Radio [M-F]*
 Radio Australia
 Radio Cameroon
 Radio Mozambique
 Radio New Zealand Int'l [M-F]*
 Radio Norway Int'l [S]
 Radio Omdurman
 Radio Prague
 Radio Tanzania
 Radio Yemen
 Voice of America (af) [A-S]
 Voice of America (af) [M-F]*
 Voice of Kenya
 Voice of Russia
 WWCR #3 [M-F]
1815
 Radio Bangladesh
1830
 Radio Kuwait
 Radio Nacional de Venezuela [M-A]
 Radio Netherlands Int'l
 Radio Sweden [M-F]
 Radio Yemen
 Voice of America (af) [A-S]

(Special English)
 Voice of America (me) (Special English)
 Voice of Russia
1835
 Radio New Zealand Int'l [F]*
1840
 Voice of Greece [M-A]
1855
 Radio New Zealand Int'l [M-H]*
1857
 BBC (af) [M-F]*

1900 UTC
(2:00 PM EST, 11:00 AM PST)
 All India Radio
 BBC
 China Radio Int'l
 Deutsche Welle
 Monitor Radio Int'l [M-A]
 Radio Australia
 Radio Bulgaria
 Radio Japan
 Radio New Zealand Int'l
 Radio Portugal Int'l [M-F]
 Radio Romania Int'l [T-S]
 Radio Tirana
 Radio Vlaanderen Int'l
 Spanish National Radio
 Voice of America (as)
 Voice of Greece [M-A]
 Voice of Russia
 WHRI [M-F]
 WINB [M-F]
 WWCR #1 [M-F]
1901
 Radio Romania Int'l [M]
1910
 All India Radio [W]
 China Radio Int'l*
 Radio Australia [M-F]*
1930
 BBC (af) [S]*
 Deutsche Welle [T-F]*
 R Slovakia Int'l
 Radio Austria Int'l
 Radio Korea
 Radio Netherlands Int'l
 Radio Yugoslavia
 Voice of Russia
1933
 Deutsche Welle [M]*
1935
 RAI Italy
1955
 Radio Japan [T-W/S]

2000 UTC
(3:00 PM EST, 12:00 PM PST)
 BBC
 China Radio Int'l
 Deutsche Welle
 KVOH [A-S]
 Monitor Radio Int'l [M-A]
 Radio Australia
 Radio Budapest
 Radio New Zealand Int'l
 Radio Norway Int'l [S]
 Radio Portugal Int'l [M-F]
 Radio Tallinn [M/H]
 Swiss Radio Int'l
 Voice of America (af) [A-S]
 Voice of America (af) [M-F]*
 Voice of America (me)

Voice of Indonesia
 Voice of Israel
 Voice of Nigeria [M-F]
 Voice of Russia
 WHRI [M-F]
 WINB [M-F]
 WWCR #3 [S-F]
2003
 Radio Pyongyang
2007
 Radio Damascus [M-F]
2010
 China Radio Int'l*
 Radio New Zealand Int'l [S-H]*
2025
 RAI Italy
2030
 Polish Radio [A-S]
 Polish Radio [M-F]*
 Radio Finland
 Radio Netherlands Int'l
 Radio Thailand
 Voice of Russia [A-S]
2055
 Voice of Indonesia [M]
2057
 Radio Kuwait

2100 UTC
(4:00 PM EST, 1:00 PM PST)
 All India Radio
 BBC ("Newshour")
 China Radio Int'l
 Deutsche Welle
 KVOH [S]
 Monitor Radio Int'l [M-A]
 Radio Australia
 Radio Cameroon
 Radio Canada Int'l
 Radio Damascus [F]
 Radio Havana Cuba [M-A]
 Radio Japan
 Radio New Zealand Int'l [A-H]
 Radio Prague
 Radio Romania Int'l
 Spanish National Radio
 Voice of America (af)
 Voice of Russia
 Voice of Turkey
 WHRI [M-F]
 WINB [M-F]
 WWCR #3 [S]
2110
 China Radio Int'l*
 Radio Damascus [S-F]
 Radio New Zealand Int'l [S-H]*
2115
 BBC (ca) [M-F]*
2120
 Radio Cairo
2130
 Radio Austria Int'l
 Radio Cairo
 Radio Canada Int'l [A-S]
 Radio Havana Cuba [M-F]*
 Radio Nacional de Venezuela [M-A]
 Radio Riga Int'l [M-F]
 Radio Sweden [M-F]
 Voice of Russia
2145
 Radio Damascus [W]
 Radio Korea

2155
 Radio Canada Int'l [M-F]
 Radio Japan [A]

2200 UTC
(5:00 PM EST, 2:00 PM PST)
 All India Radio
 BBC
 Canada (North-Quebec) [A-S]
 China Radio Int'l
 Monitor Radio Int'l [M-A]
 Radio Australia
 Radio Budapest
 Radio Bulgaria
 Radio Canada Int'l
 Radio Havana Cuba [M-A]
 Radio Korea
 Radio New Zealand Int'l
 Radio Ukraine Int'l
 Radio Vlaanderen Int'l [M-F]
 Radio Yugoslavia
 RAI Italy
 Voice of America (as)
 Voice of Russia
2203
 Voice of Free China
2210
 China Radio Int'l*
2215
 All India Radio [M/W/F]
 Radio Cairo
2230
 Radio Havana Cuba [M-A]*
 Radio Sweden [M-F]
 Voice of America (as) (Special English)
 Voice of Israel
 Voice of Russia [M-F]
2240
 Radio Cairo
 Voice of Greece [S-F]

2300 UTC
(6:00 PM EST, 3:00 PM PST)
 AWR Latin America [H]*
 BBC ("Newsdesk")
 Monitor Radio Int'l [M-A]
 Radio Australia
 Radio Canada Int'l
 Radio Japan
 Radio New Zealand Int'l
 Radio Yerevan
 Voice of America (as)
 Voice of Russia
 Voice of Turkey
 WWCR #3 [S]
2303
 Radio Pyongyang
2315
 Radio Cairo
2330
 Radio Canada Int'l [A]
 Radio Finland
 Radio Netherlands Int'l
 Radio New Zealand Int'l [S-H]
 Radio Sweden [M-F]
 Voice of Russia
2335
 Voice of Greece [S-F]
2355
 Radio Japan



Now

The Company That Takes You Around The World Lets You Take The World Around With You.

The Drake SW8 – Finally, Professional Desktop Performance In An Affordable, Portable World Band Shortwave.

The company that has been setting the standards in premium-quality world band shortwave performance now puts top-of-the-line features and technology at your fingertips with the SW8... wherever you want to take it. Designed for both desktop use and easy portability, the

Drake SW8 includes many of the same features that have made Drake a perennial favorite of experts – superb audio, versatility, and the unique combination of professional quality and functional simplicity. So tune in the world and get the best of all worlds – quality and affordability, desktop

technology and portability.

The Drake SW8.

To order your SW8 direct, for more information, or for the dealer nearest you call:

1-800-968-7795

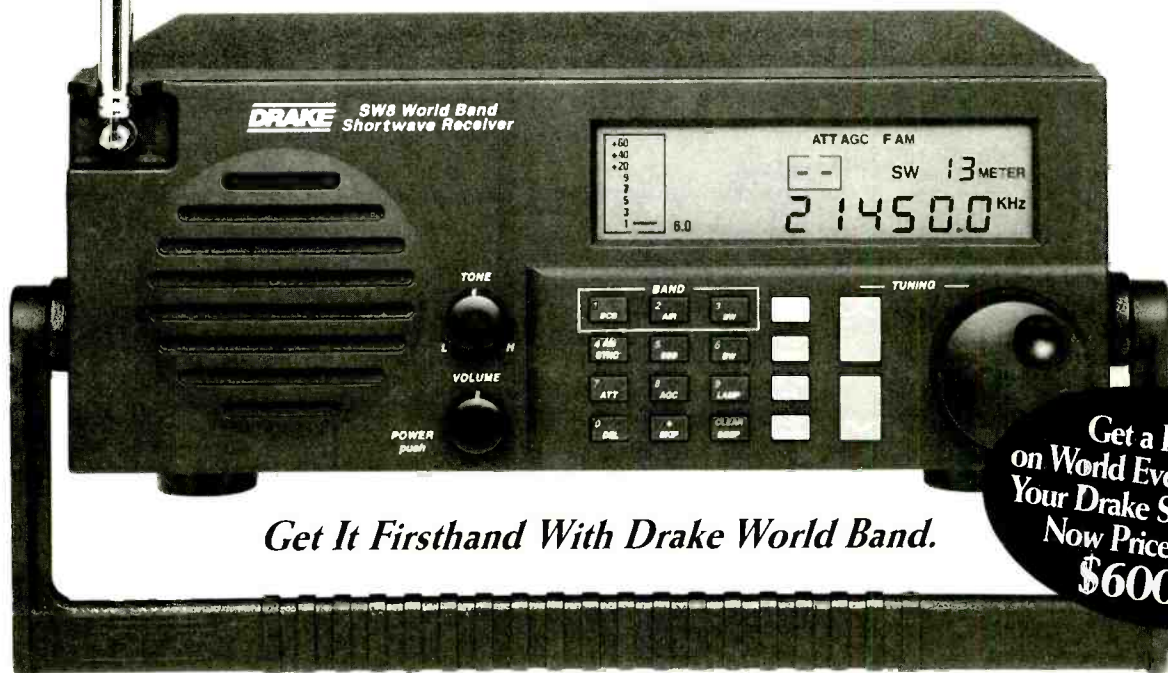

Get It Firsthand With Drake World Band.

Get a Handle on World Events... Order Your Drake SW8 Today. Now Priced under \$600.00

FREQUENCIES

0000-0100	Australia, ADF Radio	18735as			0000-0100	Spain, R Exterior Espana	9540na		
0000-0030	Australia, Radio	9610as	13745as	17750as	0000-0030	Thailand, Radio	9680af		
0000-0100 vl	Australia, VL8A Alice Spg	4835do			0000-0100	United Kingdom, BBC London	5965as	5970sa	5975na
0000-0100 vl	Australia, VL8K Katherine	5025do					7325na	9590na	9760as
0000-0100 vl	Australia, VL8T Tent Crk	4910do					11750na	11955as	9915sa
0000-0100	Bulgaria, Radio	7205na	9700na		0000-0015	United Kingdom, BBC London	6195as	7110as	7180as
0000-0015	Cambodia, Natl Voice of	11940as					11945as		9580as
0000-0100 vl	Canada, CBC N Quebec Svc	9625do			0000-0100	USA, KAIJ Dallas TX	5810am	13740am	
0000-0100	Canada, CFCX Montreal	6005do			0000-0100	USA, KTBN Salt Lk City UT	7510am		
0000-0100	Canada, CFRX Toronto	6070do			0000-0100	USA, KVOH Los Angeles CA	9785am		
0000-0100	Canada, CFVP Calgary	6030do			0000-0100	USA, KWHR Naalehu HI	17510as		
0000-0100	Canada, CHNX Halifax	6130do			0000-0100	USA, Monitor Radio Intl	7535na	9430ca	
0000-0100	Canada, CKZN St John's	6160do			0000-0100	USA, VOA Washington DC	9955am	9170as	7215as
0000-0100	Canada, CKZU Vancouver	6160do					9455am	6730as	9775am
0000-0100	Canada, RCI Montreal	5960na	9755na	11920na			11580am	1160as	11760as
0000-0100	China, China Radio Intl	9710na	11575af	11655na			15120am	15185au	15205am
0000-0100	Costa Rica, AWR Alajuela	5030ca	6150sa	7325am			17735as	17820as	15290as
0000-0100	Costa Rica, R Peace Intl	7385am	9400am	12150am	0000-0100	USA, WCSN Scotts Cor ME	9855eu		
0000-0100	Czech Rep, Radio Prague	5930na	7345na		0000-0100	USA, WEWN Birmingham AL	7425na		
0000-0030	Egypt, Radio Cairo	9900na			0000-0100	USA, WHRI Noblesville IN	7315am	9495am	
0000-0100	Ghana, Ghana Broadc Corp	3366do	4915do		0000-0100	USA, WINB Red Lion PA	11950na		
0000-0030 vl	Guatemala, AWR	5980ca			0000-0100	USA, WJCR Upton KY	13595na		
0000-0045	India, All India Radio	9705as	9950as	11745as	0000-0100 mtwhf	USA, WRMI/R Miami Intl	9955am		
		15145as		13750as	0000-0100	USA, WRN New Orleans LA	7355am		
0000-0100 vl	Italy, IRRS Milan	7125eu			0000-0100	USA, WWCR Nashville TN	5065am	5935am	7435am
0000-0100	Lebanon, Wings of Hope	6280me	9960me		0000-0044	USA, WYFR Okeechobee FL	6085na		
0000-0030 sm	Lithuania, Radio Vilnius	7150na			0015-0030 sm	USA, VOA Washington DC	11835am	15155am	
0000-0005 twrtfa	Lithuania, Radio Vilnius	7150na			0030-0100	Australia, Radio	13605as	13745as	13755as
0000-0100	Malaysia, Radio	7295do					15415as	17795pa	17860pa
0000-0100	Malaysia, RTM Kuching	7160do			0030-0055	Belgium, R Vlaanderen Int	6035na		
0000-0100	Malaysia, RTM/Kota Kinab	5980do			0030-0100	Ecuador, HCJB Quito	9745am	12005am	17490eu
0000-0030	Netherlands, Radio	6020na	6165na		0030-0100	Iran, VOIRI Tehran	7100na	9022na	21455eu
0000-0100 mtwhfa	New Zealand, R NZ Intl	15115pa			0030-0100	Netherlands, Radio	5905as	6020na	6165na
0000-0050	North Korea, R Pyonyng Int	11335na	13760na	15130na			9840na	11655na	
0000-0030 m	Norway, Radio Norway Intl	5905na	6115sa	6120na	0030-0100	Russia, Voice of	7105na	7165na	
0000-0100 mtwhfa	Palau, KHBN/Voice of Hope	11980as			0030-0100	Sri Lanka, SLBC Colombo	15425as		
0000-0100 vl	Papua New Guinea, NBC	4890do	9675do		0030-0100	Sweden, Radio	6065sa	6200sa	
0000-0100	Philippines, FEBC/R Intl	15450as			0030-0100	Thailand, Radio	9655as	11845af	11905as
0000-0100	Russia, Voice of	7105af	7125af	9750na	0045-0100	USA, WYFR Okeechobee FL	6065na		
		15425na	17570as	17890as	0050-0100	Italy, RAI Rome	9645na	11800na	

SELECTED PROGRAMS

Sundays

- 0030 Radio Australia: Correspondents' Report. A round-up of global stories with Hamish Robertson.
- 0030 Voice of America (am): Press Conference USA. Reporters interview an interesting personality on a subject in the news.
- 0030 Voice of America (ca): Press Conference USA. See S 0030.

Mondays

- 0010 Radio Australia: Network Asia. See S 2330.
- 0015 BBC: Special Feature. Early Versions (6th). See S 0445.
- 0030 Radio Australia: International Report. Overseas and local correspondents analyze regional and global issues and events.
- 0048 Radio Australia: Network Asia/Finance. Stock market and mercantile reports and the latest regional financial news.

Tuesdays

- 0004 Radio Prague: Current Affairs. People and events in the Czech Republic and editorial commentary.
- 0006 Monitor Radio Intl: Monitor Radio International. See M 1406.
- 0009 Radio Prague: Press Review. News items and editorial comment from the Czech newspapers.
- 0010 Radio Australia: Network Asia. See S 2330.
- 0011 Voice of Russia: News and Views. See S 0411.
- 0015 Radio Bulgaria: Today. Reports and analysis of current events in Bulgaria and the World. Press reviews from the weeklies on Monday.
- 0016 Radio Exterior de Espana: Panorama. A magazine program focusing on everything that's happening in Spain.
- 0020 Radio Exterior de Espana: Press Review. Review of the Spanish press.
- 0030 Radio Australia: International Report. See M 0030.
- 0030 Radio Bulgaria: Business and Finance. Economic news briefs and financial developments in Bulgaria.
- 0048 Radio Australia: Network Asia/Finance. See M 0048.

Wednesdays

- 0005 Radio Prague: Current Affairs. See T 0004.

- 0006 Monitor Radio Intl: Monitor Radio International. See M 1406.
- 0010 Radio Australia: Network Asia. See S 2330.
- 0012 China Radio Intl: News Analysis. See T 1212.
- 0012 Radio Prague: Press Review. See T 0009.
- 0016 Radio Exterior de Espana: Panorama. See T 0016.
- 0019 China Radio Intl: Current Affairs. See T 1219.
- 0022 Radio Exterior de Espana: Press Review. See T 0020.
- 0029 Radio Exterior de Espana: Review of the Spanish Economy. Spain's status in financial matters
- 0030 Radio Australia: International Report. See M 0030.
- 0046 Radio Thailand: Business News. A recap of the day's financial activity.
- 0048 Radio Australia: Network Asia/Finance. See M 0048.

Thursdays

- 0006 Monitor Radio Intl: Monitor Radio International. See M 1406.
- 0006 Radio Prague: Current Affairs. See T 0004.
- 0010 Radio Australia: Network Asia. See S 2330.
- 0011 Radio Prague: Press Review. See T 0009.
- 0022 Radio Exterior de Espana: Press Review. See T 0020.
- 0030 Radio Australia: International Report. See M 0030.
- 0048 Radio Australia: Network Asia/Finance. See M 0048.

Fridays

- 0005 Radio Prague: Current Affairs. See T 0004.
- 0006 Monitor Radio Intl: Monitor Radio International. See M 1406.
- 0010 Radio Australia: Network Asia. See S 2330.
- 0012 Radio Prague: Press Review. See T 0009.
- 0015 Radio Bulgaria: Today. Reports and analysis of current events in Bulgaria and the World. Press reviews from the weeklies on Monday.
- 0015 Radio Prague: Economic News. Czech financial reports.
- 0016 Radio Exterior de Espana: Panorama. See T 0016.
- 0022 Radio Exterior de Espana: Press Review. See T 0020.
- 0030 Radio Australia: International Report. See M 0030.
- 0034 Radio Vlaanderen Int'l: Press Review. See M 1406.
- 0038 Radio Netherlands: Newsline. See S 0337.
- 0046 Radio Thailand: Business News. See W 0046.

- 0048 Radio Australia: Network Asia/Finance. See M 0048.
- 0049 Radio Vlaanderen Int'l: Economics. Interview with a person in the field of business, finance, or consumerism.

Saturdays

- 0006 Monitor Radio Intl: Monitor Radio International. See M 1406.
- 0006 Radio Prague: Current Affairs. See T 0004.
- 0010 Voice of America (am): Newsline. See M 0410.
- 0010 Voice of America (as): Newsline. See M 0410.
- 0015 BBC: Feature. The Essential Qur'an (4th, 11th). David Craig explores the teachings of the Muslim holy book, its relationship with other religions, and its words on God.
- 0015 Radio Bulgaria: Today. Reports and analysis of current events in Bulgaria and the World. Press reviews from the weeklies on Monday.
- 0016 Radio Exterior de Espana: Panorama. See T 0016.
- 0022 Radio Exterior de Espana: Press Review. See T 0020.
- 0030 BBC: From the Weeklies. Review of the British weekly press.
- 0035 Radio Radio Sweden: A Review of the Newsweek. See F 1235.

Looking for a Good Antenna Handbook?

If you'd like a good source of information about antennas, you will be interested in THE ANTENNA HANDBOOK by Clem Small. Within its 200+, 8-1/2" x 11" pages, there is much material from past "Antenna Topics" columns plus a considerable amount of new material.

It is an excellent source of information for selecting, constructing, understanding, and utilizing your antenna system. Also covered are subjects like the history of antennas, odd and unusual antennas, signal propagation, factors affecting antenna performance, antenna accessories, and antenna troubleshooting.

THE ANTENNA HANDBOOK is available from Grove Enterprises, P.O. Box 98, Brasstown, NC 28902 for \$12.95 plus \$2 book rate postage (\$4.50 UPS)

FREQUENCIES

0100-0200	Australia, Radio	9580pa 11855as 15365pa 17750as	9610as 13605as 15415as 17795pa	9660pa 13755as 15510as 17860pa	11715as 15240pa 17715as 17880as	0100-0200 vl	Slovakia, AWR	7270as			
0100-0200 vl	Australia, VL8A Alice Spg	4835do				0100-0130	Slovakia, R Slovakia Intl	5930na	9440na		
0100-0200 vl	Australia, VL8K Katherine	5025do				0100-0200	South Korea, R Korea Intl	7550sa	15575na		
0100-0200 vl	Australia, VL8T Tent Crk	4910do				0100-0200	Spain, R Exterior Espana	9540na			
0100-0200 vl	Canada, CBC N Quebec Svc	9625do				0100-0200	Sri Lanka, SLBC Colombo	15425as			
0100-0200	Canada, CFCX Montreal	6005do				0100-0130	Switzerland, Swiss R Intl	5885na	6135na	9885na	9905na
0100-0200	Canada, CFRX Toronto	6070do				0100-0200	Ukraine, R Ukraine Intl	4780na	9620eu	9685na	9810na
0100-0200	Canada, CFPV Calgary	6030do						7405na			
0100-0200	Canada, CHNX Halifax	6130do						11870na			
0100-0200	Canada, CKZN St John's	6160do				0100-0200	United Kingdom, BBC London	5965as	5970sa	5975na	6175na
0100-0200	Canada, CKZU Vancouver	6160do						7325na	9590na	9760as	9915sa
0100-0130	Costa Rica, AWR Alajuela	5030ca	6150sa	7325am	9725am			11750na	11955as	15360as	17790as
0100-0200	Costa Rica, R Peace Intl	7385am	9400am	12150am		0100-0200	USA, KAIJ Dallas TX	5810am			
0100-0200	Cuba, Radio Havana Cuba	6000na	9830na			0100-0200	USA, KVOH Los Angeles CA	7415am			
0100-0127	Czech Rep. Radio Prague	7345na				0100-0200	USA, KWHR Naalehu HI	17510as			
0100-0200	Ecuador, HCJB Quito	9745am	12005am	17490eu	21455eu	0100-0200	USA, Monitor Radio Intl	7535na	9430na		
0100-0150	Germany, Deutsche Welle	6040na 9565na	6085na 9670na	6120na 9700na	6145na	0100-0200	USA, VOA Washington DC	5995am	6130am	7405am	9455am
								9775am	11580am	15120am	15205am
								15340as	17740as		
0100-0200 m	Guatemala, Radio Cultural	3300do				0100-0200	USA, WCSN Scotts Cor ME	7465eu			
0100-0200	Indonesia, Voice of	9675as	11752as			0100-0200	USA, WEWN Birmingham AL	7425na			
0100-0130	Iran, VOIRI Tehran	7100na	9022na			0100-0200	USA, WHRI Noblesville IN	7315am			
0100-0200 vl	Italy, IRRS Milan	7125eu				0100-0200	USA, WINB Red Lion PA	11950na			
0100-0110	Italy, RAI Rome	9645na	11800na			0100-0200	USA, WJCR Upton KY	13595na			
0100-0200	Japan, NHK/Radio	9565na 15195as	11840as 17810as	11860as 17845as	11910as	0100-0130 twhta	USA, WRMI/R Miami Intl	9955am			
0100-0130	Laos, Lao National Radio	7116as				0100-0200	USA, WRNO New Orleans LA	7355am			
0100-0200 smtwh	Malaysia, Radio	7295do				0100-0200	USA, WWCR Nashville TN	5065am	5935am	7435am	
0100-0200	Netherlands, Radio	5905as	7305as			0100-0200	USA, WYFR Okeechobee FL	6065na	5950na		
0100-0125	Netherlands, Radio	6020na	6165na	9840na	11655na	0100-0130	Uzbekistan, R Tashkent	5975eu	5995eu	7285as	9715eu
0100-0200 mtwhfa	New Zealand, R NZ Intl	15115pa						9740eu			
0100-0130 m	Norway, Radio Norway Intl	5905na	5910na			0100-0130 mtwhfa	Yugoslavia, Radio	6195na	7115na		
0100-0200 vl	Papua New Guinea, NBC	4890do	9675do			0130-0145	Albania, R Tirana Intl	9580na	11840na		
0100-0130	Philippines, FEBC/R Intl	15450as				0130-0200	Austria, R Austria Intl	9655na	9870sa	13730sa	
0100-0200	Russia, Voice of	5940na 7125na 7315as 17570as	6005as 7165na 9400me 17665as	6120na 7270na 9920me 17890as	7105na	0130-0150	Greece, Voice of	7448na	9420na	9935na	
						0130-0200	Netherlands, Radio	9860as	11655as		
						0130-0200	Sweden, Radio	9895au	11695as		
						0130-0200 m	USA, WRMI/R Miami Intl	9955am			
						0140-0200	Vatican State, Vatican R	5980as	7335as		

SELECTED PROGRAMS

Sundays

- 0108 Deutsche Welle: Inside Europe. A radio magazine offering a European perspective on events of the week.
- 0108 Radio Ukraine Int'l: Ukrainian Diary. The most important events in Ukraine during the past week.
- 0110 Radio Japan: This Week. A weekly variety show.
- 0110 Voice of America (am/ca): On the Line. A discussion of U.S. policies and contemporary issues.
- 0116 Radio Ukraine Int'l: Hello from Kiev. Weekly mailbag program of letter-reading, responses, and music.
- 0130 Voice of America (am/ca): Press Conference USA. See S 0030.

Mondays

- 0100 Radio Havana Cuba: Sunday Edition. RHC's two-hour magazine of features, reports, and music.
- 0100 WRNO: Ross Perot (live). The Texas billionaire and potential third party candidate conducts interviews and takes phone calls.
- 0100 WWCR #3: Full Disclosure (live). Glen Roberts.
- 0105 Swiss Radio Int'l: Newsnet. See S 0405.
- 0125 Radio Australia: Network Asia. See S 2330.
- 0130 Voice of America (am/ca): Issues in the News. See S 1133.
- 0145 BBC: Music Feature. Turning a Tune (5th, 12th, 19th, 26th). A musical tour of Ireland that explores the island's folk music heritage.

Tuesdays

- 0100 WRMI: Viva Miami! A magazine program hosted by Jeff White from and about Miami and Florida, that includes DX and international travel features and seasonal tropical weather updates.
- 0105 Swiss Radio Int'l: Newsnet. See S 0405.
- 0106 Monitor Radio Int'l: Monitor Radio International. See M 1406.
- 0109 Deutsche Welle: European Journal. See M 0224.
- 0109 Radio Ukraine Int'l: Ukraine Today. A program of news, interviews, and reports.
- 0110 Voice of America (am/ca): Report to the Americas. The latest news affecting the region, as well as a roundup of sports, financial news, and the weather forecast.

- 0112 Radio Yugoslavia: Commentary. Official state opinions about current events.
- 0115 Radio Japan: Current Views. See M 0515.
- 0116 Radio Exterior de Espana: Panorama. See T 0016.
- 0120 Radio Exterior de Espana: Press Review. See T 0020.
- 0120 Radio Japan: Spectrum. See M 0520.
- 0125 Radio Australia: Network Asia. See S 2330.
- 0130 BBC (as): South Asia Report. See S 1645.
- 0145 BBC (ca): Caribbean Report. Political and economic analysis in the Caribbean region and Caribbean affairs in Britain and other countries.

Wednesdays

- 0100 WRMI: Viva Miami! See T 0100.
- 0105 Swiss Radio Int'l: Newsnet. See S 0405.
- 0106 Monitor Radio Int'l: Monitor Radio International. See M 1406.
- 0109 Deutsche Welle: European Journal. See M 0224.
- 0110 Voice of America (am/ca): Report to the Americas. See T 0110.
- 0111 Voice of Russia: Focus on Asia and the Pacific. See T 1311.
- 0111 Radio Yugoslavia: Current Events. An in-depth look at the latest news.
- 0112 Radio Korea: Commentary. See M 1211.
- 0122 Radio Exterior de Espana: Press Review. See T 0020.
- 0125 Radio Australia: Network Asia. See S 2330.
- 0129 Radio Exterior de Espana: Review of the Spanish Economy. See W 0029.
- 0130 BBC (as): South Asia Report. See S 1645.
- 0138 Radio Netherlands: Newslines. See S 0337.
- 0145 BBC (ca): Caribbean Report. See T 0145.

Thursdays

- 0100 WRMI: Viva Miami! See T 0100.
- 0105 Swiss Radio Int'l: Newsnet. See S 0405.
- 0106 Monitor Radio Int'l: Monitor Radio International. See M 1406.
- 0109 Deutsche Welle: European Journal. See M 0224.
- 0110 Radio Ukraine Int'l: Ukraine Today. See T 0109.

- 0110 Voice of America (am/ca): Report to the Americas. See T 0110.
- 0115 Radio Japan: Current Views. See M 0515.
- 0122 Radio Exterior de Espana: Press Review. See T 0020.
- 0125 Radio Australia: Network Asia. See S 2330.
- 0125 Radio Ukraine Int'l: Closeup. Focus on current national issues.
- 0130 BBC (as): South Asia Report. See S 1645.
- 0145 BBC (ca): Caribbean Report. See T 0145.

Fridays

- 0100 HCJB (am): Studio 9. See HCJB 0500.
- 0100 WRMI: Viva Miami! See T 0100.
- 0106 Monitor Radio Int'l: Monitor Radio International. See M 1406.
- 0109 Deutsche Welle: European Journal. See M 0224.
- 0110 Radio Ukraine Int'l: Ukraine Today. See T 0109.
- 0110 Radio Yugoslavia: Current Events. See W 0111.
- 0110 Voice of America (am/ca): Report to the Americas. See T 0110.
- 0115 Radio Japan: Current Views. See M 0515.
- 0122 Radio Exterior de Espana: Press Review. See T 0020.
- 0125 Radio Australia: Network Asia. See S 2330.
- 0130 BBC (as): South Asia Report. See S 1645.
- 0138 Radio Netherlands: Newslines. See S 0337.
- 0145 BBC (ca): Caribbean Report. See T 0145.

Saturdays

- 0106 Monitor Radio Int'l: Monitor Radio International. See M 1406.
- 0110 Radio Yugoslavia: Current Events. See W 0111.
- 0115 Radio Japan: Current Views. See M 0515.
- 0122 Radio Exterior de Espana: Press Review. See T 0020.
- 0130 BBC (as): South Asia Report. See S 1645.
- 0130 BBC: Worldbrief. Roundup of the week's news headlines, plus everything from sport and finance to best-sellers and weather.
- 0135 Radio Radio Sweden: A Review of the Newsweek. See F 1235.
- 0145 BBC (ca): Caribbean Report. See T 0145.

FREQUENCIES

0200-0300 twhta	Argentina, RAE	11710am											
0200-0300	Australia, Radio	9580pa	9660pa	13605as	15240pa					13640as	15425na	17570as	17665as
		15365pa	15415as	15510as	17750as					17890as			
		17795pa	17860pa	17880as						7270as			
0200-0300 vl	Australia, VL8A Alice Spg	4835do				0200-0300 vl	Slovakia, AWR						
0200-0300 vl	Australia, VL8K Katherine	5025do				0200-0230	Sri Lanka, SLBC Colombo						
0200-0300 vl	Australia, VL8T Tent Crk	4910do				0200-0300	Taiwan, VO Free China			5950na	9680na	9765pa	11740ca
0200-0300 vl	Canada, CBC N Quebec Svc	9625do								11860as	15345as		
0200-0300	Canada, CFCX Montreal	6005do				0200-0300	United Kingdom, BBC London			5965as	5970sa	5975na	6135af
0200-0300	Canada, CFRX Toronto	6070do								6175na	7235me	7325na	9590na
0200-0300	Canada, CFVP Calgary	6030do								9760as	9915sa	11955as	15360as
0200-0300	Canada, CHNX Halifax	6130do				0200-0300	USA, KAIJ Dallas TX			5810am	13740am		
0200-0300	Canada, CKZN St John's	6160do				0200-0300	USA, KVOH Los Angeles CA			17510as			
0200-0300	Canada, CKZU Vancouver	6160do				0200-0300	USA, KWHR Naalehu HI			5850na	9430na		
0200-0300	Canada, RC1 Montreal	6120na	9535am	9755na	11725na	0200-0300	USA, Monitor Radio Intl			6130sa	7115as	7205as	7215as
		11845na	13720na			0200-0300	USA, VOA Washington DC			9455sa	9740as	11705as	15250as
0200-0300	Costa Rica, R Peace Intl	7385am	9400am	12150am		0200-0300	USA, WCSN Scotts Cor ME			15370as	17740as	21550as	
0200-0300	Cuba, Radio Havana Cuba	6000na	9830na			0200-0300	USA, WEWN Birmingham AL			7425na	9465me		
0200-0300	Ecuador, HCJB Quito	9745am	12005am	17490eu	21455eu	0200-0300	USA, WHRI Noblesville IN			7315am			
0200-0300	Egypt, Radio Cairo	9475na				0200-0300	USA, WINB Red Lion PA			11950na			
0200-0250	Germany, Deutsche Welle	6035as	6130as	7265as	7285as	0200-0300	USA, WJCR Upton KY			13595na			
		9515as	9615as	9690as	9815as	0200-0300 m	USA, WRMI/R Miami Intl			9955am			
		12045as				0200-0300	USA, WRNO New Orleans LA			7355am			
0200-0230	Hungary, Radio Budapest	6025na	9835na	11910na		0200-0300	USA, WWCR Nashville TN			5065am	5935am	7435am	
0200-0300 vl	Italy, IRRS Milan	7125eu				0200-0300	USA, WYFR Okeechobee FL			6065na	9505na		
0200-0300	Kenya, Kenya Broadc Corp	4935do				0200-0230	Yugoslavia, Radio			6195am			
0200-0300 smtwh	Malaysia, Radio	7295do				0230-0300	Albania, R Tirana Intl			9580na	11840na		
0200-0230	Moldova, R Moldova Intl	7190na				0230-0245	Pakistan, Radio			7290as	15190as	17705as	17725as
0200-0230	Myanmar, Radio	5990do								21730as			
0200-0230	Netherlands, Radio	5905as	7305as	9860as	11655as	0230-0300 twhta	Portugal, Radio			9570na	9705na	11840sa	
0200-0300 mtwhfa	New Zealand, R NZ Intl	15115pa				0230-0300	Russia, Voice of			5905na	9850as	12050na	15455ca
0200-0230 m	Norway, Radio Norway Intl	5905na	5910na	7450na	9560na	0230-0300	Sweden, Radio			6195na	6200na	7120na	
0200-0300 vl	Papua New Guinea, NBC	4890do	6155na	9510na	9570na	0250-0300	Vatican State, Vatican R			6095na	7305na		
0200-0300	Romania, R Romania Intl	5990na											
		11940na											
0200-0300	Russia, Voice of	5915na	5940na	5950na	6120as								
		7105na	7165eu	7180eu	7205eu								
		7225na	7225na	7270ns	7315eu								

SELECTED PROGRAMS

Sundays

- 0200 BBC: *Newsdesk*. World news and dispatches from overseas and UK correspondents.
- 0208 Deutsche Welle: *Commentary*. Guest commentary about a current event.
- 0216 Deutsche Welle: *Asia-Pacific Mailbag*. Listener mail from Asia-Pacific region is answered.
- 0230 BBC: *Features*. About Face (5th, 12th). Sarah Dickinson and Philip Bacon return with the third series of lively, informative interviews.
- 0230 Radio Australia: *Correspondents' Report*. See S 0030.

Mondays

- 0200 BBC: *Newsdesk*. See S 0200.
- 0208 Deutsche Welle: *Asia-Pacific Report*. Correspondent reports, interviews and background news from the Asia-Pacific region.
- 0210 Radio Australia: *Network Asia*. See S 2330.
- 0224 Deutsche Welle: *European Journal*. A review of major events in Europe and Germany through interviews, analyses and background reports.
- 0230 HCJB (am): *The Headlines of the Week*. Happenings in Ecuador and HCJB.
- 0230 Radio Australia: *International Report*. See M 0030.
- 0248 Radio Australia: *Network Asia/Finance*. See M 0048.

Tuesdays

- 0200 BBC: *Newsdesk*. See S 0200.
- 0206 Monitor Radio Int'l: *Monitor Radio International*. See M 1406.
- 0208 Deutsche Welle: *Asia-Pacific Report*. See M 0208.
- 0210 Radio Australia: *Network Asia*. See S 2330.
- 0210 Voice of America (am): *Focus*. See M 1310.
- 0210 Voice of America (as): *Newsline*. See M 0410.
- 0211 Voice of Russia: *Commonwealth Update*. Commonwealth of Independent States (CIS) developments.
- 0212 Radio Yugoslavia: *Commentary*. See T 0112.
- 0213 Radio Havana Cuba: *Spotlight on the Americas*. Comments by the RHC editorial desk.
- 0215 Voice of Free China: *Kaleidoscope*. Spotlight on life in Taiwan.

- 0224 Deutsche Welle: *European Journal*. See M 0224.
- 0230 BBC: *Quiz*. My Music (7th, 14th, 21st, 28th). See M 1215.
- 0230 Radio Australia: *International Report*. See M 0030.
- 0230 Voice of America (as): *VOA Tuesday Morning*. See S 0610.
- 0232 Voice of Free China: *Taiwan Economic Journal*. Focus on a topic dealing with business.
- 0248 Radio Australia: *Network Asia/Finance*. See M 0048.

Wednesdays

- 0200 BBC: *Newsdesk*. See S 0200.
- 0206 Monitor Radio Int'l: *Monitor Radio International*. See M 1406.
- 0208 Deutsche Welle: *Asia-Pacific Report*. See M 0208.
- 0210 Radio Australia: *Network Asia*. See S 2330.
- 0210 Voice of America (am): *Focus*. See M 1310.
- 0211 Voice of Russia: *Commonwealth Update*. See T 0211.
- 0224 Deutsche Welle: *European Journal*. See M 0224.
- 0230 Radio Australia: *International Report*. See M 0030.
- 0238 Radio Netherlands: *Newsline*. See S 0337.
- 0248 Radio Australia: *Network Asia/Finance*. See M 0048.

Thursdays

- 0200 BBC: *Newsdesk*. See S 0200.
- 0206 Monitor Radio Int'l: *Monitor Radio International*. See M 1406.
- 0208 Deutsche Welle: *Asia-Pacific Report*. See M 0208.
- 0210 Radio Australia: *Network Asia*. See S 2330.
- 0210 Voice of America (am): *Focus*. See M 1310.
- 0215 Voice of Free China: *Perspectives*. Issues facing the lives and conversations of Taiwanese people.
- 0224 Deutsche Welle: *European Journal*. See M 0224.
- 0230 Radio Australia: *International Report*. See M 0030.
- 0248 Radio Australia: *Network Asia/Finance*. See M 0048.

Fridays

- 0200 BBC: *Newsdesk*. See S 0200.
- 0206 Monitor Radio Int'l: *Monitor Radio International*. See M 1406.
- 0208 Deutsche Welle: *Asia-Pacific Report*. See M 0208.
- 0210 Radio Australia: *Network Asia*. See S 2330.
- 0210 Voice of America (am): *Focus*. See M 1310.

- 0211 Voice of Russia: *Commonwealth Update*. See T 0211.
- 0224 Deutsche Welle: *European Journal*. See M 0224.
- 0230 BBC: *Literature Feature*. A History of the Novel in Six Chapters (3rd, 10th, 17th, 24th). See H 1130.
- 0230 Radio Australia: *International Report*. See M 0030.
- 0248 Radio Australia: *Network Asia/Finance*. See M 0048.

Saturdays

- 0200 BBC: *Newsdesk*. See S 0200.
- 0200 HCJB (am): *On-Line*. A magazine program of music, politics, arts, and science in Europe.
- 0208 Deutsche Welle: *Commentary*. See S 0208.
- 0210 Radio Yugoslavia: *Current Events*. See W 0111.
- 0210 Voice of America (am): *Focus*. See M 1310.
- 0212 Deutsche Welle: *The Week in Germany*. A summary of the week's events in Germany by Deutsche Welle's Bonn correspondents.
- 0222 Deutsche Welle: *Economic Notebook*. See T 0332.
- 0230 BBC: *People and Politics*. Background to the British political scene.
- 0235 Radio Radio Sweden: *A Review of the Newsweek*. See F 1235.

This month's Selected Programming features news and in-depth news analysis programs from stations all across the globe.

Readers note "Programming Spotlight" (p.78) feature on VOA's *Talk to America* live call-in airs Mon-Fri at 1706 UTC (12:06 pm, EST), repeated at 1006 and 1206 UTC. The best reception for North American listeners is via the English to Africa service (17895, 15445, 15410 kHz).

FREQUENCIES

0300-0400	Australia, Radio	9580pa 15365pa 17860pa	9660pa 15415as 15510as 17795pa	13605pa 15240pa	0300-0400 vl 0300-0400	Slovakia, AWR Taiwan, VO Free China	6050af 5950na 15345as 11890na	7270as 9680na 9765pa 11745as		
0300-0400 vl	Australia, VL8A Alice Spg	4835do			0300-0400	Thailand, Radio				
0300-0400 vl	Australia, VL8K Katherine	5025do			0300-0330	United Kingdom, BBC London	5970sa 9760as 3255af 6190af 15310as	6135af 9915sa 5975na 9410me 9600af 11760as	7235me 15360as 6005af 9600af	7325na 15380as 6175na
0300-0400 vl	Australia, VL8T Tent Crk	4910do			0300-0400	United Kingdom, BBC London	9750sa 3255af 6190af 15310as			
0300-0400 vl	Bahrain, Radio	6010do			0300-0400	USA, KAIJ Dallas TX	5810am	13740am		
0300-0400 vl	Canada, CBC N Quebec Svc	9625do			0300-0400	USA, KTVN Salt Lk City UT	7510am			
0300-0400	Canada, CFRX Toronto	6070do			0300-0400	USA, KVOH Los Angeles CA	9785am			
0300-0400	Canada, CFPV Calgary	6030do			0300-0400	USA, KWHR Naalehu HI	17510as			
0300-0400	Canada, CHNX Halifax	6130do			0300-0400	USA, Monitor Radio Intl	5850na	9455af		
0300-0400	Canada, CKZN St John's	6160do			0300-0400	USA, VOA Washington DC	6035af 7405af	7105af 9575af	7280af 9885af	7340af
0300-0400 sm	Canada, CKZU Vancouver	6160do			0300-0400	USA, WCSN Scotts Cor ME	7465am			
	Canada, RCI Montreal	6000ca 9755ca	6120ca 11725ca	9535ca 11845ca	9725ca	0300-0400	USA, WEWN Birmingham AL	7425na		
0300-0400	China, China Radio Intl	9690na	9710na	11715na		0300-0400	USA, WHRI Noblesville IN	7315am	9495am	
0300-0400	Costa Rica, R Peace Intl	7385am	9400am	12150am		0300-0400	USA, WINB Red Lion PA	11950eu		
0300-0400 vl	Costa Rica, Faro del Carib	5055do			0300-0400	USA, WJCR Upton KY	13595na			
0300-0400	Cuba, Radio Havana Cuba	6000na	9820na		0300-0400	USA, WRNO New Orleans LA	7355am			
0300-0327	Czech Rep, Radio Prague	5930na	7345na		0300-0400	USA, WWCN Nashville TN	5065am	5935am	7435am	
0300-0400	Ecuador, HCJB Quito	9745am	12005am	17490eu	21455eu	0300-0400	USA, WYFR Okeechobee FL	6065na	950na	
0300-0330	Egypt, Radio Cairo	9475na				0300-0315	Vatican State, Vatican R	6095na	7305na	
0300-0350	Germany, Deutsche Welle	6045na 9650na	6085na	6120na	9535na	0308-0346	Zimbabwe, ZBC	3306do	4828do	
0300-0400	Guatemala, Radio Cultural	3300do				0315-0330 sh	Greece, Voice of	7448na	9420na	9935na
0300-0400 vl	Italy, IRRS Milan	7125eu				0320-0350	Vatican State, Vatican R	5865af	7360af	9725af
0300-0400	Japan, NHK/Radio	5960na 11920na 17845as	9565na 15210as	11885na 15230na	11895na 17810as	0330-0400	Austria, R Austria Intl	9870sa	13790sa	
0300-0400	Kenya, Kenya Broadc Corp	4935do				0330-0357	Czech Rep, Radio Prague	5930as	7345af	9440me
0300-0400 s	Lebanon, Wings of Hope	9960me				0330-0400	Hungary, Radio Budapest	5965na	9835na	11910na
0300-0400 smtwh	Malaysia, Radio	7295do				0330-0400 fas	Mongolia, R Ulan Bator	7290na	1200na	
0300-0330 tw	Mongolia, R Ulan Bator	7290na	12015na			0330-0400	Netherlands, Radio	6015na	6165na	
0300-0325	Netherlands, Radio	9860as	11655as			0330-0400	Swaziland, Trans World R	9500af		
0300-0400 mtwhfa	New Zealand, R NZ Intl	15115pa				0330-0400	Sweden, Radio	6200na	7120na	
0300-0400 vl	Papua New Guinea, NBC	4890do				0330-0400	Tanzania, Radio	5050af		
0300-0400	Russia, Voice of	4740eu 5950eu 7165na 7345na 9895as	4940eu 6035eu 7180na 9670as 12050na	5905na 6085eu 7105na 7225na 9850as 15425na	5940na 7105na 7270na 9880as	0330-0357	UAE, Radio Dubai	11945na 21485na	13675na 15400eu	17890eu
0300-0400	S Africa, Channel Africa	5955af	9585af			0330-0400	United Kingdom, BBC London	9610af 17790as 7448na	11730af 15280as	15575af
						0340-0350	Greece, Voice of	7448na	9420na	9935na
						0345-0400	Tajikistan, Radio	7245as		

SELECTED PROGRAMS

Sundays

- 0308 Deutsche Welle: Inside Europe. See S 0108.
0310 Radio Japan: Hello from Tokyo. The weekend magazine program.
0330 BBC: From Our Own Correspondent. BBC correspondents comment on the background to the news.
0337 Radio Netherlands: Newslines. Correspondent reports, interviews, and commentaries on current events.

Mondays

- 0300 Radio Havana Cuba: Sunday Edition. See M 0100.
0315 Voice of Free China: East Meets West. A program about cultural differences.
0325 Radio Australia: Network Asia. See S 2330.

Tuesdays

- 0300 Voice of America (af): Daybreak Africa. Magazine program of African news, sports, features, and correspondent reports.
0306 Monitor Radio Intl: Monitor Radio International. See M 1406.
0309 Deutsche Welle: European Journal. See M 0224.
0309 Radio Prague: Press Review. See T 0009.
0311 Voice of Russia: Newmarket. This program tells where and how to invest in Russia, how to sell your product, or start a business.
0315 Radio Japan: Radio Japan Magazine Hour. See M 1130.
0319 Radio Japan: News Commentary. See M 1519.
0325 Radio Australia: Network Asia. See S 2330.
0332 Deutsche Welle: Economic Notebook. The economic scene in Germany and around the world.
0334 Radio Prague: Current Affairs. See T 0004.

Wednesdays

- 0300 Voice of America (af): Daybreak Africa. See T 0300.
0306 Monitor Radio Intl: Monitor Radio International. See M 1406.

- 0309 Deutsche Welle: European Journal. See M 0224.
0312 China Radio Intl: News Analysis. See T 1212.
0315 Voice of Free China: Kaleidoscope. See T 0215.
0319 China Radio Intl: Current Affairs. See T 1219.
0325 Radio Australia: Network Asia. See S 2330.
0333 Deutsche Welle: Insight. A weekly analysis of major developments on the international scene.
0333 Voice of Free China: Taiwan Economic Journal. See T 0232.
0338 Radio Netherlands: Newslines. See S 0337.

Thursdays

- 0306 Monitor Radio Intl: Monitor Radio International. See M 1406.
0309 Deutsche Welle: European Journal. See M 0224.
0311 Radio Prague: Press Review. See T 0009.
0315 Radio Japan: Radio Japan Magazine Hour. See M 1130.
0319 Radio Japan: News Commentary. See M 1519.
0325 Radio Australia: Network Asia. See S 2330.

Fridays

- 0306 Monitor Radio Intl: Monitor Radio International. See M 1406.
0309 Deutsche Welle: European Journal. See M 0224.
0315 Radio Japan: Radio Japan Magazine Hour. See M 1130.
0319 Radio Japan: News Commentary. See M 1519.
0325 Radio Australia: Network Asia. See S 2330.

Saturdays

- 0308 Deutsche Welle: European Journal. See M 0224.
0330 Radio Japan: The Week in Review. Looking back at the events that made the news last week.
0335 Radio Radio Sweden: A Review of the Newsweek. See F 1235.

Budapest Spring Festival Sándor Laczkó

In this year's Budapest Spring Festival, which will be held from March 10 to April 2, the organizers have decided on two themes: the music of Bartók and the music of countries in Northern Europe. The choice of Bartók is an obvious one, since this year is the 50th anniversary of the composer's death. The choice of the second theme, "Northern lights," is also understandable, since the Hungarian language shares linguistic roots with the languages of two northern countries, Finland and Estonia. In recent years, Scandinavian music has also featured more prominently on concert programs in Budapest, with performances of two Nielsen symphonies. The Festival program also includes opera, ballet, theater, and arts.

Programs from the Festival can be heard in *Matrix* (0206 Sun, 0337 Sat) and *The Score* (0347 Tues 14th, 28th) during March.

FREQUENCIES

0400-0500	Australia, Radio	9580pa 15365pa 17860pa	9660pa 15415pa	13605as 17750as	15240pa 17795pa	0400-0430	Tanzania, Radio	5050af 9445na					
0400-0500 vl	Australia, VL8A Alice Spg	4835do				0400-0500	Turkey, Voice of	4976do	5026do				
0400-0500 vl	Australia, VL8K Katherine	5025do				0400-0415	Uganda, Radio	4780na	6055na	7150na	7180na		
0400-0500 vl	Australia, VL8T Tent Crk	4910do				0400-0500	Ukraine, R Ukraine Intl	7405na 11870na	9620na	9685na	9810na		
0400-0500	Bahrain, Radio	6010do				0400-0500	United Kingdom, BBC London	3255af 9410me	5975na	6005af	6190af		
0400-0500 vl	Canada, CBC N Quebec Svc	9625do				0400-0500	United Kingdom, BBC London	11760as 15575me	12095af	15280as	15310as		
0400-0500	Canada, CFCX Montreal	6005do				0400-0415	United Kingdom, BBC London	9610af					
0400-0500	Canada, CFRX Toronto	6070do				0400-0430	United Kingdom, BBC London	6175na					
0400-0500	Canada, CFVP Calgary	6030do				0400-0500	USA, KAIJ Dallas TX	5810am	9815am				
0400-0500	Canada, CHNX Halifax	6130do				0400-0500	USA, KTVN Salt Lk City UT	7510am					
0400-0500	Canada, CKZN St John's	6160do				0400-0500	USA, KVOH Los Angeles CA	7415am					
0400-0500	Canada, CKZU Vancouver	6160do				0400-0500	USA, KWHR Naalehu HI	9930as					
0400-0430	Canada, RCI Montreal	6150me	9505me	9670me		0400-0500	USA, Monitor Radio Intl	7535eu	9840af				
0400-0500	Costa Rica, R Peace Intl	7385am	9400am	12150am		0400-0500	USA, VOA Washington DC	5995eu	6040eu	6140af	6873af		
0400-0500	Cuba, Radio Havana Cuba	6000na	6180na	9820na		0400-0500	USA, WEWN Birmingham AL	7425na					
0400-0430	Ecuador, HCJB Quito	9745am	12005am	17490eu	21455eu	0400-0500	USA, WHRI Noblesville IN	7315am					
0400-0450	Germany, Deutsche Welle	6015af 7265as	6065af 9565af	7160af 9765af	7225af	0400-0500	USA, WINB Red Lion PA	11950eu					
0400-0500 twtfa	Guatemala, Radio Cultural	3300do				0400-0500	USA, WJCR Upton KY	13595na					
0400-0500 vl	Italy, IRRS Milan	7125eu				0400-0500 smtwhf	USA, WMLK Bethel PA	9465eu					
0400-0500	Kenya, Kenya Broadc Corp	4935do				0400-0500	USA, WRNO New Orleans LA	7395am					
0400-0500 s	Lebanon, Wings of Hope	9960me				0400-0500	USA, WWCR Nashville TN	5065am	5935am	7435am			
0400-0500 smtwh	Malaysia, Radio	7295do				0400-0445	USA, WYFR Okeechobee FL	6065na	9505na				
0400-0425	Netherlands, Radio	6015na	6165na			0400-0459	USA, WYFR Okeechobee FL	9770eu					
0400-0458 mtwhfa	New Zealand, R NZ Intl	15115pa				0415-0440	Italy, RAI Rome	5990me	7275eu				
0400-0500 vl	Papua New Guinea, NBC	4890do	9675do			0425-0500	Nigeria, FRCN/Radio	3326do	4990do				
0400-0430	Romania, R Romania Intl	5990na 11940na	6155na	9510na	9570na	0430-0500	Ecuador, HCJB Quito	12005am					
0400-0500	Russia, Voice of	5905eu 5940na 7105na 7300na 12050na	5920na 5950na 7165eu 7345na 15425na	5925eu 5965eu 7180na 9850as	5935na 6085eu 7270na 9895as	0430-0500	Russia, Voice of	4940as 9775as 11710as 15295as 17580af	4975as 9785eu 11765as 15360as 17610as	6000as 9865eu 12040eu 17560as 17620as	9705as 11675as 15160as 17570au 17675as		
0400-0500	S Africa, Channel Africa	5955af	9585af			0430-0500	Swaziland, Trans World R	3200af	5055af	7140af			
0400-0500 vl	Slovakia, AWR	6050as	9465af			0430-0500	Switzerland, Swiss R Intl	9905na					
0400-0430	Sri Lanka, SLBC Colombo	9720as	15425as			0430-0500	USA, VOA Washington DC	6035af	7280af	7340af	9575af		
0400-0500	Swaziland, Swazi Radio	6155af				0455-0500	Nigeria, FRCN/Voice of	7255af					
0400-0430	Swaziland, Trans World R	9500af				0459-0500	New Zealand, R NZ Intl	11900pa					
0400-0430	Switzerland, Swiss R Intl	6135eu	9885na	9905na									

SELECTED PROGRAMS

Sundays

- 0400 BBC: Newsdesk. See S 0200.
- 0405 Swiss Radio Int'l: Newsnet. An in-depth look at issues, events and people.
- 0407 Voice of Turkey: Review of the Turkish Press. Items of current interest in the Turkish newspapers.
- 0408 Radio Ukraine Int'l: Ukrainian Diary. See S 0108.
- 0410 Voice of Turkey: Outlook. An economy and finance update.
- 0410 WWCR #1: View from Europe. Harvey Thomas.
- 0411 Voice of Russia: News and Views. Russian views on news developments.
- 0430 Radio Australia: Correspondents' Report. See S 0030.
- 0445 BBC: Special Feature. Early Versions (5th). Michael Rosen tracks down some of the rare manuscripts in the British Library and looks at them with the experts.

Mondays

- 0400 BBC: Newsdesk. See S 0200.
- 0405 Swiss Radio Int'l: Newsnet. See S 0405.
- 0407 Voice of Turkey: Review of the Turkish Press. See S 0407.
- 0408 Deutsche Welle: European Journal. See M 0224.
- 0408 Radio Ukraine Int'l: Ukrainian Diary. See S 0108.
- 0410 Voice of America (af/eu): Newsline. News, correspondent reports, interviews, and opinion.
- 0411 Voice of Russia: News and Views. See S 0411.
- 0430 Radio Australia: International Report. See M 0030.
- 0432 Deutsche Welle: Africa in the German Press. What the German newspapers and weeklies have to say about Africa.
- 0445 BBC: Popular Music Feature. Replace a Disc (6th, 13th, 20th, 27th). A good deal for music lovers when Mike Read plays records lost by listeners and sends each a new copy.

Tuesdays

- 0400 BBC: Newsdesk. See S 0200.
- 0406 Monitor Radio Int'l: Monitor Radio International. See M 1406.
- 0407 Voice of Turkey: Review of the Turkish Press. See S 0407.
- 0408 Deutsche Welle: Africa Report. Reports and background to the news from Africa by Deutsche Welle correspondents.
- 0409 Voice of Turkey: Last Week. A recap of events affecting Turkey during the previous week.

- 0410 Voice of America (af/eu): Newsline. See M 0410.
- 0413 Radio Havana Cuba: Spotlight on the Americas. See T 0213.
- 0419 Voice of Turkey: History of the Turkish Press. Background on media organizations in Turkey.
- 0424 Deutsche Welle: European Journal. See M 0224.
- 0430 Radio Australia: International Report. See M 0030.

Wednesdays

- 0400 BBC: Newsdesk. See S 0200.
- 0405 Swiss Radio Int'l: Newsnet. See S 0405.
- 0405 Voice of Turkey: Review of the Turkish Press. See S 0407.
- 0406 Monitor Radio Int'l: Monitor Radio International. See M 1406.
- 0408 Deutsche Welle: Africa Report. See T 0408.
- 0410 Voice of America (af/eu): Newsline. See M 0410.
- 0411 Voice of Russia: News and Views. See S 0411.
- 0412 China Radio Int'l: News Analysis. See T 1212.
- 0419 China Radio Int'l: Current Affairs. See T 1219.
- 0424 Deutsche Welle: European Journal. See M 0224.
- 0430 Radio Australia: International Report. See M 0030.
- 0430 Voice of Turkey: Economic Panorama (biweekly). A brief look at the Turkish economy and tourism.

Thursdays

- 0400 BBC: Newsdesk. See S 0200.
- 0406 Monitor Radio Int'l: Monitor Radio International. See M 1406.
- 0407 Voice of Turkey: Review of the Turkish Press. See S 0407.
- 0408 Channel Africa: Historical Almanac. What happened on this date in the past.
- 0408 Deutsche Welle: Africa Report. See T 0408.
- 0410 Voice of America (af): Newsline. See M 0410.
- 0410 Voice of Turkey: Review of the Foreign Media. See W 2310.
- 0411 Voice of Russia: News and Views. See S 0411.
- 0424 Deutsche Welle: European Journal. See M 0224.
- 0430 Radio Australia: International Report. See M 0030.
- 0445 BBC: From Our Own Correspondent. See S 0330.

Fridays

- 0400 BBC: Newsdesk. See S 0200.
- 0405 Voice of Turkey: Review of the Turkish Press. See S 0407.
- 0406 Monitor Radio Int'l: Monitor Radio International. See M 1406.
- 0408 Deutsche Welle: Africa Report. See T 0408.
- 0409 Channel Africa: Dateline Africa. See W 0508.
- 0410 Voice of America (af): Newsline. See M 0410.
- 0424 Deutsche Welle: European Journal. See M 0224.
- 0430 Radio Australia: International Report. See M 0030.
- 0430 Swiss Radio Int'l: Business as Usual. Swiss economic news and business report.

Saturdays

- 0400 BBC: Newsdesk. See S 0200.
- 0405 Swiss Radio Int'l: Newsnet. See S 0405.
- 0405 Voice of Turkey: Review of the Turkish Press. See S 0407.
- 0408 Deutsche Welle: Commentary. See S 0208.
- 0411 Voice of Russia: News and Views. See S 0411.
- 0412 Deutsche Welle: Africa This Week. A weekly review of trends and events on the African continent.
- 0430 Swiss Radio Int'l: Swiss Scene. People and politics.
- 0445 BBC: Worldbrief. See A 0130.

Propagation Forecasting

Jacques d'Avignon
965 Lincoln Drive
Kingston On K7M 4Z3 Canada

Distributor for ASAPS, propagation software Compuserve 70531,140

EEB

NATIONS LARGEST RECEIVER OUTLET

EEB AHEAD OF THE PACK

BEARCAT

BC120XLT	\$144.95
SC150Y/B	\$194.95
BC148XLT-1 ⁽¹⁾	\$84.95
BC200XLT ⁽²⁾	\$219.95
BC220XLT ⁽¹⁾	\$229.95
BC760XLT ⁽³⁾	\$229.95
BC860XLT ⁽¹⁾	\$189.95
BC890XLT ⁽³⁾	\$244.95
BC8500XLT ⁽¹⁾	\$349.95

DRAKE

R8	\$969.00
SW8	\$589.95

GRUNDIG

YB400	\$199.95
SAT700	\$399.95

ICOM

R1(E) ⁽¹⁻⁴⁾	\$499.95
R100(E) ⁽¹⁻⁴⁾	\$719.95
R71A	\$1199.00
R7000 ⁽⁴⁾	\$1639.00
R7100 ⁽¹⁻⁴⁾	\$1539.00
R9000 ⁽⁴⁾	\$5649.00

JRC

NRD535	\$1249.00
NRD-535D	\$1699.00

KENWOOD

R5000	\$1029.00
-------	-----------

LOWE

HF150	\$599.95
HF225	\$749.95
HF225 Europa	\$995.95

PANASONIC

RFB45	\$169.95
RFB65	\$219.95

REALISTIC

PRO25 ⁽¹⁾	\$229.95
PRO43 ⁽¹⁾	\$299.95
PRO43 ⁽¹⁾⁽³⁾	\$349.95
PRO46 ⁽¹⁾	\$189.95
PRO51 ⁽¹⁾	\$259.95
PRO2026 ⁽¹⁾⁽³⁾	\$199.95
PRO2034 ⁽¹⁾	\$149.95
PRO2035 ⁽¹⁾	\$399.95
PRO2036 ⁽¹⁾	\$289.95
PRO2037 ⁽¹⁾	\$269.95

SANGEAN

ATS606P	\$169.95
ATS803A <i>Special!!</i>	\$149.95
ATS818	\$193.95
ATS818-CS	\$219.95

SONY

ICF-SW30	\$109.95
ICF-SW55	\$349.95
ICF-SW77	\$469.95
ICF-SW100	\$349.95
ICF-SW7600G	\$199.95
ICF-2010	\$349.95

WATKINS/JOHNSON

HF1000	\$3799.00
--------	-----------

YAESU

FRG100	\$599.95
--------	----------

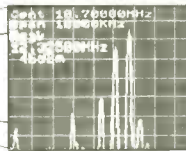
AOR**Interceptor System • AR3000A SDU5000**

Now you can intercept, scan, log, capture, see signals using techniques like the pros at a fraction of the cost.

AR3000A Specs - Wide Band

Receiver. • 0.1-2036MHz(1-4) • AM, FM, FMN, LSB, USB • 400 memory channels, 4 banks • Step 50Hz to 995kHz • Search up to 50 ch/sec • RS232 Compatible • GaAs Fet and Band Pass Filtered front-in • Power: 13.8VDC **NOTE:** AR3000A must be modified for 10.7MHz I.F. output. \$60 w/ purchase of SDU5000.

SDU5000 Specs -

Display Unit. INPUT 10.7MHz • Sweep width to 10MHz • Resolution 5/30kHz • Display 3.1" HQM simple matrix 16 color LCD • 50dB Dynamic range • Display refresh 2/sec • Composite Video Output •

Computer Control -PC.

RS232 at 9600 dps control all function of SDU and AR3000A, unlimited storage, frequency, memory, SDU display, store audio with sound blaster.

Video Output. NTSC or PAL composite video output • Record SDU display on VCR for analysis later • Show on any size monitor or add a modulator for T.V. display.

AR3000A \$1029 ♦ SDU5000A \$1029

♦ I.F. Mod w/ SDU5000 \$60.00 ♦

(includes return UPS of your AR3000A)

AOR**The New Concept - AOR**

made every effort to incorporate the latest technology in to this new scanner.

Several Patents pending.

- **Range:** .5 - 1900MHz usable to 100kHz(1-4)
- **Modes:** AM/NFM/WFM/USB/LSB/CW
- **Memories:** 50 ch. x 20 banks=1000 total
- **Size/Wt.:** 6.1 x 2.8 x 1.6 inch. 20 oz. batt. incl.

- Ferrite Rod antenna below 2MHz • Only portable scanner on U.S. market to have true SSB, both LSB & USB. • 4 level alpha numeric LCD read out frequency, mode, signal strength, band scope spectral display, battery low. • Computer control up/down load date* • Clone your memory banks with a friend, load 1000 memory channels in seconds.

*requires AR8000INF \$99.95

LIST \$799 EEB \$649.95

**SUPERADIO III**

At last a radio designed for AM broadcast! The Superadio III puts fun back into listening to standard broadcast.

Has large ferrite rod antenna, R.F. amp stage and 4 I.F. stages, wide/narrow filters, large speaker and bass & treble controls all add up to superior reception. Don't forget the FM band, it is equally impressive.



AT LAST!



- **Coverage:** 530 - 1700kHz: 88 - 108MHz (analog)
- **Antennas:** AM 7.8" ferrite rod; FM 35": whip & both ext.
- **Selectivity:** Wide & narrow • Audio Bass & Treble • AFC (FM) auto freq. control • **Speakers:** 6.5" woofer, 2" tweeter
- **AC power:** 120V 50/60Hz 6 "D" cell (not incl.) • **Size:** 12.5" w x 10.5" H x 4.5" D • **Weight:** w/o batt. 4.8 lbs.

The SUPERADIO III is becoming a favorite with AM DX'ers. The perfect addition to any radio room. All this fun and at only \$59.95

LIST \$69.95 EEB \$59.95

☆ By now you should have our 95 Catalog. If not...CALL/FAX/Write today!

☆ 96 Pages • SWL • Scanners • Amateur • 2-way • GPS •

Enlarged book section

FREE in the U.S., 3rd class (4 weeks), \$2 1st class (1 week). \$2 Can/Mex. \$5 elsewhere.

**ELECTRONIC EQUIPMENT BANK**

323 MILL Street NE
Vienna, VA 22180

*We accept VISA/MasterCard/American Express/Discover

ORDERS: 800-368-3270

Local Tech: 703-938-3350

FAX: 703-938-6911

*We ship via UPS, Federal Express and Mail

- Sorry, no-COD's
- Free Catalog in USA
- Prices Subject to change
- Prices do not include freight
- Returns subject to restock fee up to 20%

FREQUENCIES

0500-0600	Australia, Radio	9580pa 15365pa 17795as	9660pa 15415as 17860pa	13605as 17715pa 17750as	15240pa 17750as	0500-0502 0500-0600	Uganda, Radio United Kingdom, BBC London	4976do 3255af 6180eu 9600af 12095me 15420af 5810am	3955eu 6190af 9640na 15280as 15575me 9815am	5975na 6195eu 11760as 15310as 17885af	6005af 9410af 11955as 15360as
0500-0600 vl	Australia, VL8A Alice Spg	4835do				0500-0600	USA, KAIJ Dallas TX				
0500-0600 vl	Australia, VL8K Katherine	5025do				0500-0600	USA, KTVN Salt Lk City UT	7510am			
0500-0600 vl	Australia, VL8T Tent Crk	4910do				0500-0600	USA, KVOH Los Angeles CA	9785am			
0500-0600	Bahrain, Radio	6010do	9700na			0500-0600	USA, KWHR Naalehu HI	9930as			
0500-0600	Bulgaria, Radio	7335na				0500-0600	USA, Monitor Radio Intl	7535eu			
0500-0600	Canada, CFCX Montreal	6005do				0500-0600	USA, VOA Washington DC	5995eu 6873af 9665af 15205me	6035af 7170me 7405af 15600af	6040eu 6040eu 11825me	6140af 9530eu 12080af
0500-0600	Canada, CFRX Toronto	6070do				0500-0600	USA, WENW Birmingham AL	7425na			
0500-0600	Canada, CFVP Calgary	6030do				0500-0600	USA, WHRI Noblesville IN	7315am	9495am		
0500-0600	Canada, CHNX Halifax	6130do				0500-0600	USA, WINB Red Lion PA	11950na			
0500-0600	Canada, CKZU Vancouver	6160do				0500-0600	USA, WJCR Upton KY	13595na			
0500-0600	China, China Radio Intl 9595na					0500-0600 mtwhfa	USA, WMLK Bethel PA	9465eu			
0500-0600	Costa Rica, R Peace Intl	7385am	9400am	12150am		0500-0600	USA, WRNO New Orleans LA	7395am			
0500-0600	Cuba, Radio Havana Cuba	9820na				0500-0600	USA, WRWR Nashville TN	5065am	5935am	7435am	
0500-0600	Ecuador, HCJB Quito	9745na				0500-0600	USA, WYFR Okeechobee FL	5985na			
0500-0600 as	Eqt Guinea, R East Africa	9585af				0500-0545	USA, WYFR Okeechobee FL	9850eu			
0500-0550	Germany, Deutsche Welle	5960na	6045na	6120na	6185na	0500-0530	Vatican State, Vatican R	5865af	7360af	9725af	11625af
0500-0515	Israel, Kol Israel	7465na	9435na	17545as		0510-0520	Botswana, Radio	3356af	4830af	7255af	
0500-0600 vl	Italy, IRRS Milan	7125eu				0525-0600	Ghana, Ghana Broadc Corp	3366do	4915do		
0500-0600	Japan, NHK/Radio	5975eu 11740as	6025na 11885na	7230eu 15410as	9565as 17810as	0530-0600	Australia, Radio	9660do 17860pa 6015na 17870me	15510as 17880as 6155eu	15565as 17715as	15410me
0500-0600	Kenya, Kenya Broadc Corp	4935do				0530-0600	Austria, R Austria Intl	6120eu 11940af 17790af	9635af 15250af	11755me 15380af	
0500-0600 s	Lebanon, Wings of Hope	9960me				0530-0600	Finland, YLE/Radio	6120eu	9635af	11755me	
0500-0600 as	New Zealand, R NZ Intl	11900pa				0530-0600	Romania, R Romania Intl	1790af	15250af	15380af	17745af
0500-0505	Nigeria, FRCN/Radio	3326do	4990do			0530-0600	Russia, Voice of	5930as	11710as		
0500-0600	Nigeria, FRCN/Voice of	7255af				0530-0600	Swaziland, Trans World R	9500af	9650af		
0500-0530 m	Norway, Radio Norway Intl	5905na	5910na			0530-0600	UAE, Radio Dubai	15435as	17830as	21700as	
0500-0600 vl	Papua New Guinea, NBC	4890do	9675do			0535-0600	United Kingdom, BBC London	11735eu			
0500-0600	Russia, Voice of	5905eu 5950as 7165eu 7340na 9850na 13370as 7185af 17725me	5920eu 6000eu 7175eu 7345na 9865as 15295na 11900af	5925eu 6065as 7180eu 9600na 9895as 17735as	5940na 7105na 7270na 9705as 12050na 17890as	0550-0600 vl	Swaziland, Trans World R Liberia, Radio ELBC	6070af 7275do			
0500-0600	S Africa, Channel Africa	7185af									
0500-0553 f	Seychelles, FEBA Radio	17725me									
0500-0600 vl	Slovakia, AWR	9465af									
0500-0600	Spain, R Exterior Espana	9540na									
0500-0600	Swaziland, Swazi Radio	6155af									
0500-0530	Swaziland, Trans World R	5055af 9500af	6070af	7140af	7200af						

SELECTED PROGRAMS

Sundays

- 0500 BBC: Newshour. A comprehensive look at the major topics of the day, plus up-to-the-minute international and British news.
- 0508 Deutsche Welle: Inside Europe. See S 0108.
- 0550 Radio Japan: Viewpoint. Opinions of a guest personality.

Mondays

- 0500 BBC: Newshour. See S 0500.
- 0500 Radio Havana Cuba: Sunday Edition. See M 0100.
- 0510 Voice of America (af/eu): VOA Business Report. News from around the world affecting business and finance.
- 0515 Radio Japan: Current Views. A Radio Japan editorial.
- 0520 Radio Japan: Spectrum. Focus on a topic of interest in Japan.

Tuesdays

- 0500 BBC: Newshour. See S 0500.
- 0500 HCJB (am): Studio 9. World news, features and interviews with Ralph Kurtenback and Curt Cole.
- 0506 Monitor Radio Int'l: Monitor Radio International. See M 1406.
- 0506 Radio New Zealand Int'l: Checkpoint. See M 0507.
- 0509 Deutsche Welle: European Journal. See M 0224.
- 0510 Voice of America (af/eu): VOA Business Report. See M 0510.
- 0516 Radio Exterior de Espana: Panorama. See T 0016.
- 0523 Radio Exterior de Espana: Press Review. See T 0020.

Wednesdays

- 0500 BBC: Newshour. See S 0500.
- 0500 HCJB (am): Studio 9. See HCJB 0500.
- 0506 Monitor Radio Int'l: Monitor Radio International. See M 1406.
- 0508 Channel Africa: Dateline Africa. A news magazine program.
- 0509 Deutsche Welle: European Journal. See M 0224.
- 0510 Voice of America (af/eu): VOA Business Report. See M 0510.
- 0512 China Radio Int'l: News Analysis. See T 1212.

- 0515 Radio Bulgaria: Today. Reports and analysis of current events in Bulgaria and the World. Press reviews from the weeklies on Monday.
- 0515 Radio Japan: Current Views. See M 0515.
- 0519 China Radio Int'l: Current Affairs. See T 1219.
- 0520 Radio Japan: Spectrum. See M 0520.
- 0522 Radio Exterior de Espana: Press Review. See T 0020.
- 0529 Radio Exterior de Espana: Review of the Spanish Economy. See W 0029.

Thursdays

- 0500 BBC: Newshour. See S 0500.
- 0506 Monitor Radio Int'l: Monitor Radio International. See M 1406.
- 0506 Radio New Zealand Int'l: Checkpoint. See M 0507.
- 0509 Deutsche Welle: European Journal. See M 0224.
- 0510 Voice of America (af/eu): VOA Business Report. See M 0510.
- 0511 Voice of Russia: Commonwealth Update. See T 0211.
- 0515 Radio Japan: Current Views. See M 0515.
- 0522 Radio Exterior de Espana: Press Review. See T 0020.

Fridays

- 0500 BBC: Newshour. See S 0500.

- 0500 HCJB (am): Studio 9. See HCJB 0500.
- 0506 Monitor Radio Int'l: Monitor Radio International. See M 1406.
- 0509 Deutsche Welle: European Journal. See M 0224.
- 0510 Voice of America (af): VOA Business Report. See M 0510.
- 0511 Voice of Russia: Commonwealth Update. See T 0211.
- 0515 Radio Bulgaria: Today. Reports and analysis of current events in Bulgaria and the World. Press reviews from the weeklies on Monday.
- 0522 Radio Exterior de Espana: Press Review. See T 0020.

Saturdays

- 0500 BBC: Newshour. See S 0500.
- 0509 Deutsche Welle: European Journal. See M 0224.
- 0510 Channel Africa: Focus on Africa. Current events on the continent.
- 0510 Radio Japan: This Week. See S 0110.
- 0511 Voice of Russia: Commonwealth Update. See T 0211.
- 0515 Radio Bulgaria: Weekly Spotlight. The major political developments of the week with talks by prominent political figures.
- 0522 Radio Exterior de Espana: Press Review. See T 0020.
- 0554 Channel Africa: This Day in History. A look back on anniversary events.

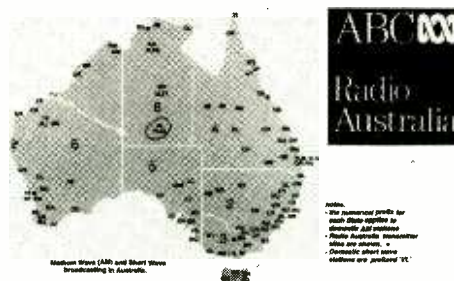

Our thanks to Donna Ellis of Spicewood, Texas, for sharing this QSL from Radio Australia.

FREQUENCIES

0600-0700	Australia, Radio	9660jo	11910pa	13755pa	15510as	0600-0700 vl	Slovakia, AWR	13715af		
		17715as	17880as			0600-0630 vl	Solomon Islands, SIBC	5020do	9545do	
0600-0630	Australia, Radio	13605as	15240pa	15415pa	17795as	0600-0700	South Africa, Channel Africa	15115pa		
0600-0700 vl	Australia, VL8A Alice Spg	4835do				0600-0700	South Korea, R Korea Intl	11945na		
0600-0700 vl	Australia, VL8K Katherine	5025do				0600-0700	Swaziland, Swazi Radio	6155af		
0600-0700 vl	Australia, VL8T Tent Crk	4910do				0600-0700	Swaziland, Trans World R	5055af	6070af	9500af 9650af
0600-0700	Bahrain, Radio	6010do				0600-0615	Switzerland, Swiss R Intl	3985eu	6165eu	
0600-0700	Canada, CFCX Montreal	6005do				0600-0630	Switzerland, Swiss R Intl	9885af	13635af	15340af
0600-0700	Canada, CFFX Toronto	6070do				0600-0615 s	Uganda, Radio	4976do	7110do	
0600-0700	Canada, CFVP Calgary	6030do				0600-0700	United Kingdom, BBC London	3955eu	6005af	6190af 6195eu
0600-0700	Canada, CHNX Halifax	6130do						9410af	9600af	9640na 11760as
0600-0700	Canada, CKZU Vancouver	6160do						11780eu	11940af	11955as 12095me
0600-0630 mtwhf	Canada, RCI Montreal	6050eu	6150eu	9760eu	11905me			15070af	15280as	15310as 15360me
0600-0700	Costa Rica, R Peace Intl	7385am	9400am	12150am				15400af	15420af	15575af 17790as
0600-0700	Cuba, Radio Havana Cuba	9820na				0600-0630	United Kingdom, BBC London	17885af		
0600-0700	Ecuador, HCJB Quito	9745na				0600-0700	USA, KAIJ Dallas TX	5810am	13740am	
0600-0700 as	Eqi Guinea, R East Africa	9585af				0600-0700	USA, KTBN Salt Lk City UT	7510am		
0600-0650	Germany, Deutsche Welle	6100af	9565af	11765af	13790af	0600-0700	USA, KVOH Los Angeles CA	9785am		
		15185af	17820af	21705af		0600-0700	USA, KWHR Naalehu HI	9930as		
		3316do	4915do			0600-0700	USA, Monitor Radio Intl	7535eu		
0600-0615	Ghana, Ghana Broadc Corp					0600-0700	USA, VOA Washington DC	3980eu	5995eu	6035af 6040eu
0600-0700 vl	Italy, IRRS Milan	7125eu						6060eu	6140af	6873eu 7170me
0600-0700	Japan, NHK/Radio	11860as	21610as					7325me	7405af	9530af 9665af
0600-0700	Kenya, Kenya Broadc Corp	4935do						11805af	11825af	11950af 12035af
0600-0700 vl	Kiribati, Radio	9825do						12080af	15205me	15600af
0600-0630	Laos, Lao National Radio	7116as				0600-0700	USA, WHRI Noblesville IN	7315am		
0600-0700 s	Lebanon, Wings of Hope	9960me				0600-0700	USA, WINB Red Lion PA	11950na		
0600-0700 vl	Liberia, Radio ELBC	7275do				0600-0700	USA, WJCR Upton KY	13595na		
0600-0700	Liberia, Radio ELWA	4760do				0600-0700	USA, WMLK Bethel PA	9465eu		
0600-0700 asmtwh	Malaysia, Radio	7295do				0600-0700	USA, WWCR Nashville TN	5065am	5935am	7435am
0600-0700	Malaysia, Voice of	6175as	9750as	15295as		0600-0700	USA, WYFR Okeechobee FL	5985na	7355eu	9680eu 9850af
0600-0700	Malta, V of Mediterranean	9765me				0600-0700	Vatican State, Vatican R	3945eu		
0600-0700 as	New Zealand, R NZ Intl	15115pa				0600-0700	Yemen, Yemeni Rep Radio	9780do		
0600-0630	Nigeria, FRCN/Radio	3326do	4990do			0604-0700	S Africa, Trans World R	11730af		
0600-0700	Nigeria, FRCN/Voice of	7255af				0630-0700	Australia, Radio	9580pa	9860pa	11880pa 15415as
0600-0700 vl	Papua New Guinea, NBC	4890do	9675do					21725as		
0600-0700	Russia, Voice of	5905eu	5930eu	6065as	7175na	0630-0700	Austria, R Austria Intl	6015na		
		7270na	7345na	9850as	9895as	0630-0700	Vatican State, Vatican R	5865af	7360af	9660af 11625af
		11710na	12050na	13370as	15230as	0645-0700	Romania, R Romania Intl	15250pa	15335pa	17720pa 17805pa
		17570na	17620as	17735af	17840as					
		17890as	21790as							

SELECTED PROGRAMS

Sundays

- 0610 Voice of America (eu): VOA Sunday Morning. News closeups in a magazine format.
- 0630 Radio Australia: Correspondents' Report. See S 0030.
- 0630 Radio Austria Int'l: Report from Austria. See S 0130.

Mondays

- 0605 Swiss Radio Int'l: Newsnet. See S 0405.
- 0608 Deutsche Welle: European Journal. See M 0224.
- 0615 Voice of Nigeria: Nigeria and Politics. Happenings on the Nigerian political scene.
- 0630 BBC: Feature. World Service Guide to the Information Superhighway (6th,13th,20th). See S 1401.
- 0630 Radio Australia: International Report. See M 0030.
- 0630 Radio Austria Int'l: Report from Austria. See S 0130.
- 0630 Radio Havana Cuba: Breakthrough. Arnie Coro's weekly science and technology update.

Tuesdays

- 0600 Voice of America (af): Daybreak Africa. See T 0300.
- 0606 Monitor Radio Int'l: Monitor Radio International. See M 1406.
- 0607 Radio New Zealand Int'l: Checkpoint. See M 0507.
- 0608 Deutsche Welle: Africa Report. See T 0408.
- 0610 Voice of America (eu): Newline. See M 0410.
- 0615 BBC: The World Today. See M 1645.
- 0615 Radio Havana Cuba: Spotlight on the Americas. See T 0213.
- 0624 Deutsche Welle: European Journal. See M 0224.
- 0630 BBC: Popular Music Feature. The Soul Show (7th,14th,21st,28th). NEW! Steve Edwards plays the best of modern soul from the USA and the UK.
- 0630 Radio Australia: International Report. See M 0030.
- 0630 Radio Austria Int'l: Report from Austria. See S 0130.
- 0630 Voice of America (eu): VOA Tuesday Morning. See S 0610.
- 0640 Radio Havana Cuba: Cuba Today. A slice of life in Havana.

Wednesdays

- 0606 Monitor Radio Int'l: Monitor Radio International. See M 1406.

- 0608 Deutsche Welle: Africa Report. See T 0408.
- 0611 Voice of Russia: Focus on Asia and the Pacific. See T 1311.
- 0615 BBC: The World Today. See M 1645.
- 0624 Deutsche Welle: European Journal. See M 0224.
- 0630 Radio Australia: International Report. See M 0030.
- 0630 Radio Austria Int'l: Report from Austria. See S 0130.
- 0640 Radio Havana Cuba: Cuba Today. See T 0640.

Thursdays

- 0600 Voice of Nigeria: West African Scene. A news magazine which reflects the events in the sub-region.
- 0606 Monitor Radio Int'l: Monitor Radio International. See M 1406.
- 0608 Deutsche Welle: Africa Report. See T 0408.
- 0615 BBC: The World Today. See M 1645.
- 0624 Deutsche Welle: European Journal. See M 0224.
- 0630 Radio Australia: International Report. See M 0030.
- 0630 Radio Austria Int'l: Report from Austria. See S 0130.
- 0640 Radio Havana Cuba: Cuba Today. See T 0640.

Fridays

- 0600 Voice of America (af): Daybreak Africa. See T 0300.
- 0606 Monitor Radio Int'l: Monitor Radio International. See M 1406.
- 0608 Deutsche Welle: Africa Report. See T 0408.
- 0611 Voice of Russia: Focus on Asia and the Pacific. See T 1311.
- 0615 BBC: The World Today. See M 1645.
- 0615 Radio Havana Cuba: Latin America Newline. News from the countries of Central and South America.
- 0624 Deutsche Welle: European Journal. See M 0224.
- 0630 Radio Australia: International Report. See M 0030.
- 0630 Radio Austria Int'l: Report from Austria. See S 0130.
- 0640 Radio Havana Cuba: Cuba Today. See T 0640.

Saturdays

- 0600 HCJB (am): On-Line. See HCJB 0200.
- 0611 Voice of Russia: Focus on Asia and the Pacific. See T 1311.
- 0615 BBC: The World Today. See M 1645.
- 0630 Radio Austria Int'l: Report from Austria. See S 0130.
- 0640 Radio Havana Cuba: Cuba Today. See T 0640.

THANK YOU ...
ADDITIONAL CONTRIBUTORS TO THIS
MONTH'S SHORTWAVE GUIDE:

John Babbis, Silver Spring, MD; Gerald R. Brookman, Kenai, AK; Carl Craig, Shelbyville, TN; Leslie Edwards, Doylestown, PA; Bob Fraser, Cohasset, MA; Paul R. Donegan, Glendale, CA; Mike Hardester, Jacksonville, NC; Marie Lamb, Brewerton, NY; Jim Moats, Ravenna, OH; E. Fred Moore, Lavalette, WV; Kent Plourde, Bristol, CT; W.H. Scarbrough, Knoxville, TN; Nick Terrence, Huntington, NY; Claude Turner, Chicago, IL; Loyd Van Horn, Brasstown, NC; NASWA *Journal*; *Fine Tuning*; *BBC Worldwide*; *BBC Summary of World Broadcasts*; Grove Enterprises BBS; Internet Shortwave Newsgroup via Larry Van Horn.

ICOM™ IC-R9000 Slave Receiver(s) Frequency Hand-Off

The DELTACOMM™ I-9000 (1-2000 MHz) communication manager and your MS-DOS computer gives you a custom interface integrated with optimized software that will not just control but will maximize the potential of your R9000. Here are a few (there are many more) examples of the advanced features DELTACOMM™ I-9000 has to offer.

- ★ Multiple slave receiver frequency hand-off. ★
- Database switching control for up to eight (8) antennas.
- CYBERSCAN™ for systems employing frequency hopping techniques.
- Spectrum log at speeds in excess of 2100* channels/minute.
- Characterize receiver with birdie log function. ★
- ★ Load a 100 channel memory bank in 14 seconds.
- Custom dual squelch detection interface for optimized speed.
- Priority channel sampled every 2.5 seconds. ★
- Selective control of tape recording by channel number. ★

Programmable signal strength threshold limits allow selective monitoring.

DELTACOMM™ I-9000 communication manager comes complete with Delta Research custom (CI-V) communication interface, UL listed power supply, manual and receiver interface cable for \$499.00 + \$10.00 (U.S.) or \$30.00 (foreign) S&H. For additional information on DELTACOMM™ communication managers for ICOM™ R7000, R7100, R71A, R72 and IC735, contact us. *Performance is proportional to video card, type of computer (286 or faster) and receiver squelch detection method.



Delta Research



Box 13677 • Wauwatosa, WI 53213 • FAX/Phone (414) 353-4567

Get A New Image

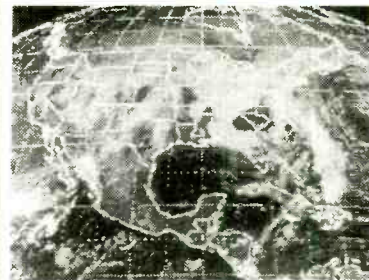

PC HF Facsimile \$99

PC HF Facsimile is a simple, yet comprehensive short-wave fax system for the IBM PC and compatibles. It includes an FSK demodulator, advanced signal processing software, tutorial audio cassette, and complete reference manual. Just plug the demodulator into a serial port, install the software and getting FAX is a snap.

PC SSTV \$149.95

PC Slow Scan Television is a complete system for sending and receiving full color amateur SSTV. The package includes an SSTV FSK modem, SSTV software, image capture utilities and reference manual. All popular formats are supported including Robot, Scottie, Martin and AVT. The system requires a 286, 386 or faster PC with VGA or super VGA display.

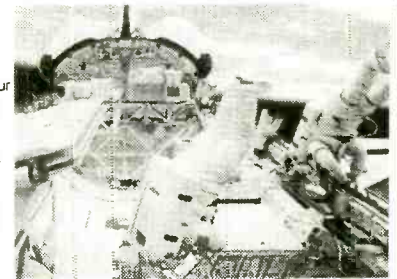

Have It All For Only \$199.95

For a limited time we are offering both software packages with a single FSK modem for under \$200. This combination offer will let you send and receive all the popular HF image transmission modes.

Call or write for our free catalog. Visa and Mastercard welcomed.

Software Systems Consulting

615 S. El Camino Real, San Clemente, CA 92672

Tel. (714) 498-5784 Fax. (714) 498-0568

NEW AT GILFER SHORTWAVE

RF systems

High quality, high performance antennas and accessories from the Netherlands.

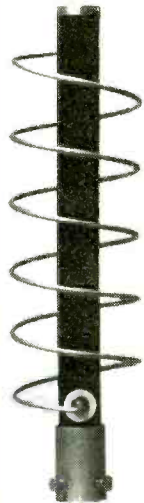

Magnetic Longwire Balun (shown at right) — Effectively isolates the antenna element from the coaxial feedline to reduce electrical noise.

MLB (Magnetic Longwire Balun only) \$59.95 (+\$4) Order #R02200
MLBA MK1 (12.5 meter longwire kit w/MLB) \$89.95 (+\$6) Order #R02201
MLBA NK2 (20 meter longwire kit w/MLB) \$109.95 (+\$6) Order #R02206

DX-7 Active Antenna (shown at left) — Compact helical HF receiving antenna covers 50 kHz — 35 MHz. Elliptical polarization helps minimize selective fading distortion. Mount indoors or outdoors.

DX-7 HF Active Receiving Antenna \$299.95 (+\$10) Order #R02207
IDX-7 Indoor Control Unit for DX-7 \$199.95 (+\$6) Order #R02209

Magnetic Transfer Antenna — A unique passive vertical antenna for outdoor use. Low noise and immune to the over-loading problems that can plague active antennas. Only 7 feet tall, but covers 500 kHz — 30 MHz; special GMDSS version covers 100 kHz — 25 MHz.

Magnetic Transfer Ant. (Standard version) \$229.95 (+\$10) Order #R02202
Magnetic Transfer Ant. (GMDSS version) \$229.95 (+\$10) Order #R02205

T2FD & DX Listener Antennas — T2FD is a broadband, low noise tilted, terminated folded dipole covering 3 — 35 MHz. DX Listener is a T2FD with extra indoor control unit which allows antenna to receive down to 100 kHz. Antenna length just 45 ft.

T2FD Antenna \$239.95 (+\$10) Order #R02211
DX Listener Antenna \$389.95 (+\$10) Order #R02212



Also in stock: DX-1PRO Active Antenna, SP-1 & SP-25 Antenna Splitters, and many other products from RF Systems!

NEW HOURS:
M-F 10am—8pm
Sat. 10am—5pm

GILFER SHORTWAVE

52 Park Avenue
Park Ridge, NJ
07656

TOLL FREE ORDER LINE: (800) GILFER-1
NJ & Technical: (201) 391-7887 • Fax: (201) 391-7433

FREQUENCIES

1100-1200	Australia, Radio	9510pa 13605as	9580pa 15170as	9710pa 15565as	9860pa	11980as 15265as 17860me	12015eu 15495as 21600af	13370as 17755me	15190as 17765na
1100-1200 vl	Australia, VL8A Alice Spg	2310do				1100-1115	Rwanda, Radio		
1100-1200 vl	Australia, VL8K Katherine	2485do				1100-1200	S Africa, Channel Africa		
1100-1200 vl	Australia, VL8T Tent Crk	2325do				1100-1200	Singapore, SBC Radio One		
1100-1200	Bahrain, Radio	6010do				1100-1200	Singapore, R Singapore Int		
1100-1200	Canada, CFCX Montreal	6005do				1100-1130	Sri Lanka, SLBC Colombo	15120as	17850au
1100-1200	Canada, CFRX Toronto	6070do				1100-1130	Switzerland, Swiss R Intl	6165eu	9885as
1100-1200	Canada, CFVP Calgary	6030do						9535eu	11640as
1100-1200	Canada, CHNX Halifax	6130do				1100-1102	Uganda, Radio		
1100-1200	Canada, CKZN St John's	6160do				1100-1200	United Kingdom, BBC London	7195do	
1100-1200	Canada, CKZU Vancouver	6160do						6190af	6195na
1100-1200	Costa Rica, AWR Alajuela	5030ca	6150am	7325am	9725am			9740na	11760me
1100-1200	Costa Rica, R Peace Intl	9400am	12150am					9515na	9410eu
1100-1130	Ecuador, HCJB Quito	9745pa	11925pa	21455pa		1100-1130	United Kingdom, BBC London	12095af	15070af
1100-1200	Ecuador, HCJB Quito	12005am	15115am	21455pa		1100-1200	USA, KAIJ Dallas TX	17640af	17830sa
1100-1130	Georgia, Radio	11815eu				1100-1200	USA, KTBN Salt Lk City UT	9700as	17885af
1100-1150	Germany, Deutsche Welle	15370af	15410af	17765af	17800af	1100-1200	USA, KWHR Naalehu HI	9930as	15400eu
		21600af				1100-1200	USA, Monitor Radio Intl	6095na	7395ca
1100-1110 as	Ghana, Ghana Broadc Corp	3366do	4915do			1100-1200	USA, VOA Washington DC	5985as	6110as
1100-1200 vl	Guatemala, AWR	5980ca				1100-1200		5990am	6165am
1100-1200	Iraq, Radio Iraq Intl	13680as				1100-1200		11915am	9615as
1100-1130	Israel, Kol Israel	15640na	15650eu	17575eu		1100-1200		15120am	15160as
1100-1200 vl	Italy, IRRS Milan	7125eu				1100-1200	USA, WEWN Birmingham AL	6000na	15425as
1100-1200	Japan, NHK/Radio	6120na	9610as	15295as		1100-1200 vl	USA, WHRI Noblesville IN	6040am	
1100-1200	Malaysia, Radio	7295do				1100-1200	USA, WJCR Upton KY	13595na	9850am
1100-1200	Malaysia, RTM Kuching	7160do				1100-1200	USA, WWCR Nashville TN	5065am	5935am
1100-1200	Malaysia, RTM/Kota Kinab	5980do				1100-1200	USA, WYFR Okeechobee FL	5950na	7355na
1100-1200	New Zealand, R NZ Intl	9700pa				1120-1130 mtwfta	Vatican State, Vatican R	11740af	15210af
1100-1105	Nigeria, FRCN/Radio	4990do	7285do			1130-1200 vl	China, China Radio Intl	8660as	11445as
1100-1150	North Korea, R Pyongyang	6576na	9977na	11335na		1130-1157	Czech Rep, Radio Prague	7345eu	9505eu
1100-1130 s	Norway, Radio Norway Intl	9590eu	11850eu			1130-1200	Iran, VOIRI Tehran	11790as	11930me
1100-1120	Pakistan, Radio	15625as	17900as			1130-1200	Netherlands, Radio	6045eu	7130eu
1100-1200 mtwhf	Palau, KHBN/Voice of Hope	9830as				1130-1200	South Korea, R Korea Intl	9650na	
1100-1200 vl	Papua New Guinea, NBC	4890do	9675do			1130-1200	Vietnam, Voice of	10059as	12025as
1100-1200	Russia, Voice of	7205eu	9470eu	9550eu	9680eu	1131-1152	Indonesia, RRI Sorong	4874do	15010as
		9800eu	11675eu	11710as	11835as	1145-1200	Rwanda, Radio	6055do	

SELECTED PROGRAMS

Sundays

- 1100 BBC: Newsdesk. See S 0200.
- 1130 Voice of America (as): Issues in the News. Members of the Washington press corps discuss current topics.
- 1130 Voice of America (ca): Studio One. Dramatized, semi-dramatized, and narrated documentaries. Subjects range from personality profiles to reviews of historic events.
- 1132 Radio Korea: Weekly News in Review. A look back at the week's news events.

Mondays

- 1100 BBC: Newsdesk. See S 0200.
- 1100 Monitor Radio Int'l: Monitor Radio Early Edition. The morning news magazine program is heard from 1000 UTC to 1500 UTC weekdays.
- 1100 Radio Japan: Radio Japan News Round. Thirty minutes of world, regional, and Japanese news.
- 1130 Radio Japan: Radio Japan Magazine Hour. The weekday magazine program.

Tuesdays

- 1100 BBC: Newsdesk. See S 0200.
- 1100 Radio Japan: Radio Japan News Round. See M 1100.
- 1106 Monitor Radio Int'l: Monitor Radio International. See M 1406.
- 1110 Voice of America (ca): Focus. See M 1310.
- 1111 Voice of Russia: Commonwealth Update. See T 0211.
- 1120 Radio Singapore Int'l: Business and Market Report. A roundup of financial and business news.
- 1130 Radio Japan: Radio Japan Magazine Hour. See M 1130.

Wednesdays

- 1100 BBC: Newsdesk. See S 0200.
- 1100 Radio Japan: Radio Japan News Round. See M 1100.
- 1106 Monitor Radio Int'l: Monitor Radio International. See M 1406.
- 1111 Voice of Russia: Commonwealth Update. See T 0211.
- 1130 Radio Japan: Asian Report. Current events in the Asia-Pacific region.
- 1130 Radio Japan: Radio Japan Magazine Hour. See M 1130.

Thursdays

- 1100 BBC: Newsdesk. See S 0200.

- 1106 Monitor Radio Int'l: Monitor Radio International. See M 1406.
- 1110 Voice of America (ca): Focus. See M 1310.
- 1111 Voice of Russia: Commonwealth Update. See T 0211.
- 1130 BBC: Literature Feature. A History of the Novel in Six Chapters (2nd, 9th, 16th, 23rd). The last four of this series which examines the development of the narrative book from the 17th century to the present.
- 1130 Voice of America (ca): VOA Thursday Morning. See S 0610.

Fridays

- 1100 BBC: Newsdesk. See S 0200.
- 1100 Radio Japan: Radio Japan News Round. See M 1100.
- 1106 Monitor Radio Int'l: Monitor Radio International. See M 1406.
- 1110 Voice of America (ca): Focus. See M 1310.
- 1111 Voice of Russia: Commonwealth Update. See T 0211.
- 1130 Radio Japan: Radio Japan Magazine Hour. See M 1130.

Macintosh Software

- Shortwave Navigator •
- Frequency Valet •

Frequencies/Programs
Computer Control
(Drake/Kenwood/JRC)

Send \$2 to demo disk to:
DX Computing
232 Squaw Creek Rd.
Willow Park, TX 76087

Saturdays

- 1100 BBC: Newsdesk. See S 0200.
- 1111 Voice of Russia: Commonwealth Update. See T 0211.

Donald Choleva of Euclid, Ohio, shared with us this QSL from radio Deutsche Welle.

FREQUENCIES

1200-1230	Australia, Radio	5995pa 9610as 2310do	6060pa 11800pa	6080pa 15565as	9580pa										
1200-1300 vl	Australia, VL8A Alice Spg	2310do				1200-1300	Singapore, SBC Radio One	15190af	15485eu	15495af					
1200-1300 vl	Australia, VL8K Katherine	2485do				1200-1300	Singapore, R Singapore Int	6155do							
1200-1300 vl	Australia, VL8T Tent Crk	2325do				1200-1300	South Korea, R Korea Intl	9530as							
1200-1300	Bahrain, Radio	6010do				1200-1230	Switzerland, Swiss R Intl	7180as							
1200-1300	Brazil, Radiobras	15445na				1200-1300	Taiwan, VO Free China	6165eu	9535eu						
1200-1215	Cambodia, Nat'l Voice of	11940as				1200-1300	United Kingdom, BBC London	7130au	9610as						
1200-1300	Canada, CFXC Montreal	6005do				1200-1300		5965na	6190af	6195na	9410eu				
1200-1300	Canada, CFRX Toronto	6070do				1200-1300		9515na	9740na	11750as	11760as				
1200-1300	Canada, CFVP Calgary	6030do				1200-1300		11940af	12095af	15070af	15220na				
1200-1300	Canada, CHNX Halifax	6130do				1200-1300		15310as	15575me	17640af	17705eu				
1200-1300	Canada, CKZN St John's	6160do				1200-1300		17830af	17885af	21660af					
1200-1300	Canada, CKZU Vancouver	6160do				1200-1300		5810am	9815am						
1200-1230 vl	China, China Radio Intl	8660as	11445as	15135as		1200-1300		7510am							
1200-1300	China, China Radio Intl	8425as	9715as	11660as	11795pa	1200-1300		9930as							
		15440pa				1200-1300		6095na	9425au	9455na	13625as				
1200-1300	Costa Rica, R Peace Intl	9400am	12150am	15050am		1200-1300		6110as	9645as	9760as	11715as				
1200-1300	Ecuador, HCJB Quito	12005am	15115am	21455pa		1200-1300		15160as							
1200-1300	France, Radio France Intl	9805eu	11615na	11840as	13625af	1200-1300 vl		6000na	9850am						
		15155eu	15195eu	15325af	15365na	1200-1300 s		13595na							
1200-1300 vl	Guatemala, AWR	5980ca				1200-1300		9955am							
1200-1240	Iran, VOIRI Tehran	11790as	11930me			1200-1300		5065am	5935am						
1200-1300	Iraq, Radio Iraq Intl	13680as				1200-1300		5950na	7355na	11830na	11970na				
1200-1300 vl	Italy, IRRS Milan	7125eu				1200-1230		6025eu	9715eu	13785eu					
1200-1300	Jordan, Radio	9560eu				1215-1300		17595as							
1200-1300	Malaysia, Radio	7295do				1220-1229 vl		4915do							
1200-1300	Malaysia, RTM/Kota Kinab	5980do				1230-1300		5995pa	6060pa	7260as	11800pa				
1200-1230 mw	Mongolia, R Ulan Bator	7290na	12015na			1230-1300		15655as							
1200-1230 ha	Mongolia, R Ulan Bator	7290na	12000na			1230-1300		6155eu	11780as	13730eu					
1200-1300	Netherlands, Radio	6045eu	7130eu			1230-1300		9650as	13615as	15520as					
1200-1206	New Zealand, R NZ Intl	9790pa				1230-1300		9770as	11740as						
1200-1230	Nigeria, FRCN/Radio	4990do	7285do			1230-1300		6150as	11730as						
1200-1300 mtwhf	Palau, KHBN/Voice of Hope	9830as				1230-1300		11735na	11740na	15400na					
1200-1230 a	Palau, KHBN/Voice of Hope	9830as				1230-1300		6130do	7295do						
1200-1300 vl	Papua New Guinea, NBC	4890do	9675do			1230-1300		6000eu	6060eu						
1200-1300	Russia, Voice of	5960eu	7160na	7205na	9470eu	1230-1300		9570as	11740as	13670eu					
		9540eu	9550eu	9680eu	9800eu	1230-1300		13775au	15120as	15240as					
		11655as	11675af	11710as	11760eu	1230-1300		10059as	12025as	15010as					
		11980eu	12015af	12065me	13370eu	1240-1250		9935af	11645af	15650af					

SELECTED PROGRAMS

Sundays

- 1210 Voice of America (as): Encounter. A discussion program presenting opinions on the issues facing America and the world.
- 1211 Voice of Russia: News and Views. See S 0411.
- 1216 Radio France Int'l: India Today. Correspondent reports and interviews on Indian affairs.
- 1227 Radio France Int'l: Counterpoint. A specific human rights issue is examined.
- 1230 Radio Australia: Report from Asia. A weekly roundup of Asian events.

Mondays

- 1200 Monitor Radio Int'l: Monitor Radio Early Edition. See M 1100.
- 1206 Voice of America (as): Talk to America. NEW! Live call-in program.
- 1211 Radio Korea: Commentary. Opinion on developments in Korea and worldwide.
- 1211 Voice of Russia: News and Views. See S 0411.
- 1215 BBC: Quiz. My Music (6th, 13th, 20th, 27th). A wide-ranging musical quiz.
- 1230 HCJB (am): Latin News. Regional news summary.
- 1230 Radio Australia: International Report. See M 0030.

- 1230 Radio Finland: Compass North. World and Finnish news, commentary and background reports.
- 1231 Radio France Int'l: RFI Europe. European press review focuses on current affairs in other countries of the region.
- 1240 Radio Finland: Economic Comments in the Finnish Press. Media coverage of business, finance and trade.
- 1245 Radio Finland: Business Monday. Summary of the previous week's business news.

Tuesdays

- 1206 Monitor Radio Int'l: Monitor Radio International. See M 1406.
- 1206 Voice of America (as): Talk to America. See M 1206.
- 1212 China Radio Int'l: News Analysis. Background on current news events.
- 1215 Voice of Free China: Kaleidoscope. See T 0215.
- 1219 China Radio Int'l: Current Affairs. An in-depth look at events and happenings in China.
- 1230 HCJB (am): Latin News. See HCJB 1230.
- 1230 Radio Australia: International Report. See M 0030.
- 1230 Radio Finland: Compass North. See M 1230.
- 1231 Radio France Int'l: France Today. Current happenings in France.
- 1232 Voice of Free China: Taiwan Economic Journal. See T 0232.
- 1233 Radio France Int'l: RFI Europe. See M 1231.
- 1240 Radio Finland: Finnish Press Review. Editorial opinion and reports on Finnish and world events.

Wednesdays

- 1206 Monitor Radio Int'l: Monitor Radio International. See M 1406.
- 1206 Voice of America (as): Talk to America. See M 1206.
- 1230 HCJB (am): Latin News. See HCJB 1230.
- 1230 Radio Australia: International Report. See M 0030.
- 1230 Radio Finland: Compass North. See M 1230.
- 1231 Radio France Int'l: RFI Europe. See M 1231.
- 1231 Radio France Int'l: RFI Europe. See M 1231.
- 1240 Radio Finland: Finnish Press Review. See T 1240.
- 1245 Radio Finland: Environmental News. Weekly look at

- environmental issues in Finland.
- 1247 Radio France Int'l: Land of France. A feature on life and times in France.

Thursdays

- 1206 Monitor Radio Int'l: Monitor Radio International. See M 1406.
- 1206 Voice of America (as): Talk to America. See M 1206.
- 1230 HCJB (am): Latin News. See HCJB 1230.
- 1230 Radio Australia: International Report. See M 0030.
- 1234 Radio France Int'l: RFI Europe. See M 1231.
- 1244 Radio France Int'l: The Americas Magazine. NEW! Focus on a subject relating to a country of the western hemisphere.
- 1249 Radio France Int'l: North/South (biweekly). Focus on a public activity in France.

Fridays

- 1206 Monitor Radio Int'l: Monitor Radio International. See M 1406.
- 1206 Voice of America (as): Talk to America. See M 1206.
- 1213 Radio Korea: Commentary. See M 1211.
- 1215 BBC: Special Feature. Russia's Runaway Revolution (2nd, 9th, 16th, 23rd). NEW! Tracing the reforms and restructuring of the new Russia during the last decade.
- 1230 HCJB (am): Latin News. See HCJB 1230.
- 1230 Radio Australia: International Report. See M 0030.
- 1231 Radio France Int'l: RFI Europe. See M 1231.
- 1235 Radio Radio Sweden: A Review of the Newsweek. Looking back at the week's newsevents.

Saturdays

- 1210 Voice of America (as): On the Line. See S 0110.
- 1211 Radio Korea: Commentary. See M 1211.
- 1228 Radio France Int'l: Spotlight on Africa. Correspondent reports and interviews on African affairs.
- 1230 Radio Australia: Background Report. In-depth reports examining a broad range of influences that shape our world.
- 1230 Radio Finland: Compass North. See M 1230.
- 1242 Radio Finland: Focus. A Review of Finland's top news stories.

**Guide to Shortwave Programs
1994 Edition**

Updated this year with over 20,000 program listings from more than 100 worldwide broadcasters, you can now enjoy a complete 24-hour-a-day listing of English-Language shortwave programs!

Only \$16.95
plus \$5 UPS

Grove Enterprises, Inc.
1-800-438-8155

FREQUENCIES

1300-1400	Australia, Radio	5995pa	7240as	9610as	11800pa	1300-1400	Singapore, R Singapore Int	9530as			
1300-1330	Australia, Radio	6060pa	6080as			1300-1330	Switzerland, Swiss R Intl	7250as	7480as	11640as	13635as
1300-1400 vl	Australia, VL8A Alice Spg	2310do				1300-1400	United Kingdom, BBC London	5990as	6190af	6195na	7110as
1300-1400 vl	Australia, VL8K Katherine	2485do						7180na	9410eu	9515na	9740na
1300-1400 vl	Australia, VL8T Tent Crk	2325do						11750as	11760me	11940af	12095af
1300-1400	Bahrain, Radio	6010do						15070af	15220na	15310as	15420af
1300-1320	Brazil, Radiobras	15445na						15575me	17640af	17705eu	17830af
1300-1330	Bulgaria, Radio	9770as	11740as					17885af	21660af		
1300-1400 vl	Canada, CBC N Quebec Svc	9625do				1300-1330	United Kingdom, BBC London	15105af			
1300-1400	Canada, CFCX Montreal	6005do				1300-1400	USA, KAIJ Dallas TX	5810am	9815am		
1300-1400	Canada, CFRX Toronto	6070do				1300-1400	USA, KJES Mesquite NM	11715na			
1300-1400	Canada, CFVP Calgary	6030do				1300-1400	USA, KNLS Anchor Point AK	7365as			
1300-1400	Canada, CHNX Halifax	6130do				1300-1400	USA, KTVN Salt Lk City UT	7510am			
1300-1400	Canada, CKZN St John's	6160do				1300-1400	USA, Monitor Radio Intl	6095na	9355as	9455na	13625as
1300-1400	Canada, CKZU Vancouver	6160do				1300-1400	USA, VOA Washington DC	6110as	9645as	9760as	11805as
1300-1400 mtwhf	Canada, RCI Montreal	6150na	11855na	17820na				15160as	15425as		
1300-1400	China, China Radio Intl	8425as	9715as	15440pa		1300-1400	USA, WEWN Birmingham AL	6000na	7425na	12160na	
1300-1400	Costa Rica, R Peace Intl	9400am	15050am			1300-1400	USA, WHRI Noblesville IN	6040am	15105am		
1300-1400	Ecuador, HCJB Quito	15115am	17890am	21455eu		1300-1400	USA, WJCR Upton KY	13595na			
1300-1330	Egypt, Radio Cairo	17595as				1300-1400 s	USA, WRMI/R Miami Intl	9955am			
1300-1330	Ghana, Ghana Broadc Corp	3366do	4915do			1300-1400	USA, WWCR Nashville TN	5065am	5935am		
1300-1400 vl	Guatemala, AWR	5980ca				1300-1400	USA, WYFR Okeechobee FL	5950na	9705na	11550na	11830na
1300-1400 vl	Italy, IRRS Milan	7125eu						11970na	13695af		
1300-1400 mtwhfa	Lebanon, Wings of Hope	9960me				1303-1310	Croatia, Croatian Radio	5895eu	7370eu	9830eu	13640eu
1300-1400	Malaysia, Radio	7295do						13830eu			
1300-1400	Malaysia, RTM/Kota Kinab	5980do				1307-1400 occsnal	New Zealand, R NZ Intl	6100pa			
1300-1325	Netherlands, Radio	6045eu	7130eu			1330-1400	Austria, R Austria Intl	15450as			
1300-1350	North Korea, R Pyongyang	9345as	11740as			1330-1400 s	Belgium, R Vlaanderen Int	13675na			
1300-1330 s	Norway, Radio Norway Intl	11730as	13800as	15190as	15605as	1330-1400	Canada, RCI Montreal	6150as	9535as		
1300-1400 mtwhf	Palau, KHBN/Voice of Hope	9830as				1330-1400	Costa Rica, R Peace Intl	6200am			
1300-1400 vl	Papua New Guinea, NBC	4890do	9675do			1330-1400	Finland, YLE/Radio	11735na	15400na	17740na	
1300-1400	Philippines, FEBC/R Intl	11995as				1330-1400 tw	Ghana, Ghana Broadc Corp	4915do			
1300-1355	Poland, Polish R Warsaw	6135eu	7145eu	7270eu	9525eu	1330-1400	India, All India Radio	13732as	15120as		
		11815eu				1330-1400	Netherlands, Radio	9895as	13700as	15150as	
1300-1400	Romania, R Romania Intl	9690eu	11790eu	11830eu	11940eu	1330-1400	Sweden, Radio	11650na	15240na		
		15365eu	15390eu	17745eu		1330-1400	Switzerland, Swiss R Intl	6165eu	9535eu		
1300-1400	Russia, Voice of	4740as	4795as	6000eu	6060eu	1330-1400	Turkey, Voice of	9675as			
		7160as	7205eu	7210eu	7295eu	1330-1355	UAE, Radio Dubai	13675eu	15320eu	15395as	21605as
		7335eu	9540na	9550eu	9680eu	1330-1400	Uzbekistan, R Tashkent	6020eu	9715eu	13785eu	
		9830eu	11710as	11765as	11865me	1330-1400	Vietnam, Voice of	10059as	12025as	15010as	
		12065na	13370as	15140eu	15150as	1330-1400	Yugoslavia, Radio	11835au	11865au		
		15265eu	15320eu	15460eu	15470me	1345-1400	Vatican State, Vatican R	11625as	12050as	15585pa	
		15480as	15560me	17720eu		1355-1400 vl	Liberia, Radio ELBC	7275do			
1300-1400	Singapore, SBC Radio One	6155do									

SELECTED PROGRAMS

Sundays

- 1300 BBC: Newshour. See S 0500.
- 1330 Radio Radio Sweden: In Touch with Stockholm (biweekly). A mailbag program with on-the-air link-ups.
- 1330 Radio Radio Sweden: In Touch with Stockholm (biweekly). See S 1330.

Mondays

- 1300 BBC: Newshour. See S 0500.
- 1300 Monitor Radio Int'l: Monitor Radio Early Edition. See M 1100.
- 1309 Radio Romania Int'l: News Commentary. Official remarks about selected events.
- 1310 Voice of America (as): Focus. The major figures and issues that shape our world.
- 1312 Radio Romania Int'l: Review of the Romanian Press. Articles appearing in the Romanian newspapers.
- 1330 Radio Finland: Compass North. See M 1230.
- 1345 Radio Finland: Business Monday. See M 1245.

Tuesdays

- 1300 BBC: Newshour. See S 0500.
- 1306 Monitor Radio Int'l: Monitor Radio International. See M 1406.
- 1310 Radio Canada Int'l: As It Happens. See M 2330.
- 1310 Voice of America (as): Focus. See M 1310.
- 1311 Voice of Russia: Focus on Asia and the Pacific. News and comments on events in the region.
- 1312 China Radio Int'l: News Analysis. See T 1212.
- 1319 China Radio Int'l: Current Affairs. See T 1219.
- 1340 Radio Finland: Finnish Press Review. See T 1240.

Wednesdays

- 1300 BBC: Newshour. See S 0500.
- 1306 Monitor Radio Int'l: Monitor Radio International. See M 1406.
- 1310 Radio Canada Int'l: As It Happens. See M 2330.
- 1310 Voice of America (as): Focus. See M 1310.

- 1311 Voice of Russia: Focus on Asia and the Pacific. See T 1311.
- 1330 Radio Finland: Compass North. See M 1230.
- 1340 Radio Finland: Finnish Press Review. See T 1240.
- 1345 Radio Finland: Environmental News. See W 1245.
- 1347 Radio Radio Sweden: Money Matters. Economic and financial trends.

Thursdays

- 1300 BBC: Newshour. See S 0500.
- 1305 Swiss Radio Int'l: Newsnet. See S 0405.
- 1306 Monitor Radio Int'l: Monitor Radio International. See M 1406.
- 1310 Radio Canada Int'l: As It Happens. See M 2330.
- 1310 Voice of America (as): Focus. See M 1310.
- 1311 Voice of Russia: Focus on Asia and the Pacific. See T 1311.
- 1318 China Radio Int'l: Current Affairs. See T 1219.
- 1333 China Radio Int'l: Focus. Looking at an issue of significance to China's development.
- 1340 Radio Finland: Finnish Press Review. See T 1240.

Fridays

- 1300 BBC: Newshour. See S 0500.
- 1306 Monitor Radio Int'l: Monitor Radio International. See M 1406.
- 1310 Radio Canada Int'l: As It Happens. See M 2330.
- 1310 Voice of America (as): Focus. See M 1310.
- 1311 Voice of Russia: Focus on Asia and the Pacific. See T 1311.
- 1312 Radio Romania Int'l: Review of the Romanian Press. See M 1312.
- 1318 Radio Romania Int'l: World of Trade '94. Recent trade developments with other countries.
- 1335 Radio Radio Sweden: A Review of the Newsweek. See F 1235.
- 1340 Radio Yugoslavia: Current Events. See W 0111.

Saturdays

- 1300 BBC: Newshour. See S 0500.
- 1308 Radio Romania Int'l: The Week. A summary of the past

- week's world news events.
- 1310 Voice of America (as): Focus. See M 1310.
- 1311 Voice of Russia: Focus on Asia and the Pacific. See T 1311.
- 1314 Radio Romania Int'l: In the Spotlight. Focus on Romanian politics.
- 1330 Radio Finland: Compass North. See M 1230.
- 1340 Radio Singapore Int'l: Regional Press Review. A review of editorials, comments, and headlines in the region's papers.
- 1342 Radio Finland: Focus. See A 1242.

HAUSER'S HIGHLIGHTS: IRAN/KURDISTAN/IRAQ

A hotbed of clandestine radio activity
For IRAN, V. of the Mojahed, of the National Liberation Army, announced new frequencies at 0700: 6175, 7180, 6005, 5450, 5150, 4670, 4150, 4250, 3850 kHz. But they constantly change due to jamming.
BBC Monitoring also reports V. of the Iranian Revolution heard again, in Kurdish until 1530* on 6410-6418 variable due to jamming, //3871.

And, the Voice of Iranian Kordestan (*Ira Dangi Irana*) was heard on 4280v at 0900-1030, 1530-1630, repeated at 0330-0430, in Kurdish and Persian; later also on 3760, not in sync, both were jammed.

Continued on Page 68

FREQUENCIES

Table with columns for frequency, country, call letters, and time. Includes entries for Australia, Canada, China, Europe, and various international stations.

SELECTED PROGRAMS

Sundays

- 1400 Israel Radio Int'l: Israel News Magazine. The latest world and Israel and regional news.
1401 BBC: Feature. World Service Guide to the Information Superhighway (5th, 12th, 19th). NEW! Nic Newman explains how the Internet works, its growing popularity, and how it is being exploited.

Mondays

- 1400 BBC (as): Dateline East Asia. Magazine program dealing with political and economic affairs of SE/NE Asia.
1406 Monitor Radio Int'l: Monitor Radio International. News, analysis, commentary, interviews and features in a magazine format.

Tuesdays

- 1400 BBC (as): Dateline East Asia. See M 1400.

- 1404 Radio Vlaanderen Int'l: Press Review. See M 1406.
1406 Monitor Radio Int'l: Monitor Radio International. See M 1406.
1408 Radio Vlaanderen Int'l: Belgium Today. Current affairs in Belgium.

Wednesdays

- 1400 BBC (as): Dateline East Asia. See M 1400.
1406 Monitor Radio Int'l: Monitor Radio International. See M 1406.
1406 Radio Vlaanderen Int'l: Press Review. See M 1406.

Thursdays

- 1400 BBC (as): Dateline East Asia. See M 1400.
1400 Israel Radio Int'l: Israel News Magazine. See S 1400.
1406 Radio Vlaanderen Int'l: Press Review. See M 1406.

- 1410 Voice of America (as): Asia Report. See M 1410.
1415 Radio Japan: Current Views. See M 0515.
1420 All India Radio: Press Review. Review of the Indian press.

Fridays

- 1400 BBC (as): Dateline East Asia. See M 1400.
1406 Monitor Radio Int'l: Monitor Radio International. See M 1406.
1410 Radio Vlaanderen Int'l: Belgium Today. See T 1408.

Saturdays

- 1405 Radio Vlaanderen Int'l: Press Review. See M 1406.
1410 Radio Japan: This Week. See S 0110.
1411 Voice of Russia: Newmarket. See T 0311.

International Callsign Directory

The most exhaustive list of tactical callsigns and their identifications ever assembled for shortwave and scanner listeners in a massive, 250 page directory!

Now only \$19.95 plus \$4 Ups. Order today from Grove Enterprises

FINALLY - NOW AVAILABLE IN THE USA
The Decoder that is the STANDARD of the European Continent.

HOKA CODE-3 USA Version

Many radio amateurs and SWLs are puzzled! Just what are all those strange signals you can hear but not identify on the Short Wave Bands? A few of them such as CW, RTTY, Packet and Amtor you'll know - but what about the many other signals?

There are some well known CW/RTTY Decoders but then there is CODE-3. It's up to you to make the choice, but it will be easy once you see CODE-3. CODE-3 has an exclusive auto-classification module that tells YOU what you're listening to AND automatically sets you up to start decoding. No other decoder can do this on ALL the modes listed below - and most more expensive decoders have no means of identifying ANY received signals! Why spend more money for other decoders with FEWER features? CODE-3 works on any IBM-compatible computer with MS-DOS with at least 640kb of RAM, and a CGA monitor. CODE-3 includes software, a complete audio to digital FSK converter with built-in 115V ac power supply, and a RS-232 cable, ready to use.

CODE-3 is the most sophisticated decoder available for ANY amount of money, and the best news of all, is that it is available from a United States dealer.

26 Modes included in standard package include:

- Morse
- RTTY/Baudot/Murray
- Sitor CCIR 625/476-4
- ARO - Navtex
- AX25 Packet
- Facsimile all RPM (up to 16 gray shades at 1024 x 768 pixels)
- Autospec - Mk I and II
- DUP-ARQ Artrac
- Twinplex
- ASCII
- ARQ6-90/98
- SI-ARQ/ARQ-S
- SWED-ARQ-ARQ-SWE
- ARO-E/ARQ1000 Duplex
- ARO-N-ARQ1000
- Duplex Variant
- ARQ-E3-CCIR519 Variant
- POL-ARQ 100 Baud
- Duplex ARQ
- TDM242/ARQ-M24-242
- TDM342/ARQ-M24
- FEC-A FEC100A/FEC101
- FEC-S + FEC1000 Simplex
- Sports info 30C baud
- ASCII
- Hellsreiber-Synch/Asynch
- Sitor + RAW (Normal Sitor but without Synch.
- ARQ6-70
- Baudot F788N
- Pactor
- WEFAX

Available as extra options

- Option 3 Piccolo...\$85.00
- Option 4 Coquelet...\$85.00
- Option 5 4 special ARQ & FEC systems TORQ-10/11, ROU-FEC/ RUM-FEC, HC-ARQ (IGRO) and HNG-FEC...\$115.00
- Option 6 SYNOP decoder...\$85.00

- All modes in typical baud rates with possibility of changing to any desired value of speed and shift.
- All options are available from the main menu, saving or loading to and from hard/floppy drive in bit form, means no loss of unknown signals!

• **HURRY!** For a limited time the Standard CODE-3 package includes FOUR options:

1. OSCILLOSCOPE 2. ASCII STORAGE 6. AUTO CLASSIFY 7. PACTOR

Live Support after the sale. Computer Aided Technologies is dedicated to customer support!

STANDARD CODE-3 PACKAGE \$595.00 ALL FOUR EXTRA OPTIONS - \$199.95

NOW AVAILABLE - CODE-30 DSP-Based Decoder with all above options. SCALL (318) 687-2555

(SHIPPING & HANDLING \$10.00) DEMO (SLIDE) DISK ONLY \$5.00 DEALER INQUIRIES INVITED

COMPUTER AIDED TECHNOLOGIES DEALERS

P.O. BOX 18285 - SHREVEPORT, LA 71138

ORDERS ONLY - (318) 636-1234 FAX (318) 686-0449 (24 Hrs)

Live Tech Support (318) 687-2555 - (9 a.m. to 1 p.m. Central M-F)

Nighttime BBS (SCANCAT File Area) (318) 631-3082 (7 p.m. - 6 a.m. Central)

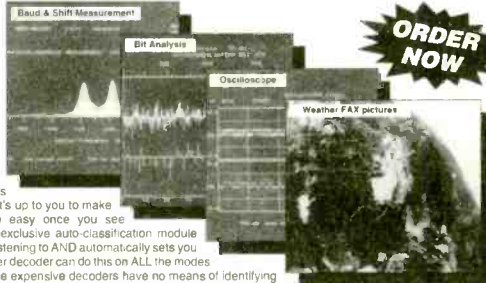

ORDER NOW

1995 GUIDE TO UTILITY RADIO STATIONS

13th edition • 568 pages • \$ 55 or DM 80

For decades, our annual best-seller *Guide to Utility Radio Stations* has been the international reference book for the really fascinating radio services on SW: aero, diplo, maritime, meteo, military, police, press, Red Cross, telecom, and UNO. The conflicts on the Balkan and in Africa and Asia are perfectly covered. 15,000 up-to-date frequencies from 0 to 30 MHz are listed, including the very latest frequencies used now during the sunspot minimum. We are the world leader in advanced teleprinter systems monitoring and decoding. This unique reference book lists just everything: abbreviations, addresses, call signs, codes, explanations, frequency band plans, meteoax and NAVTEX and press schedules, modulation types, all Q and Z codes, and much more. Thus, it is the ideal companion to the famous *Passport* or *WRTH* for the "special" stations on shortwave!

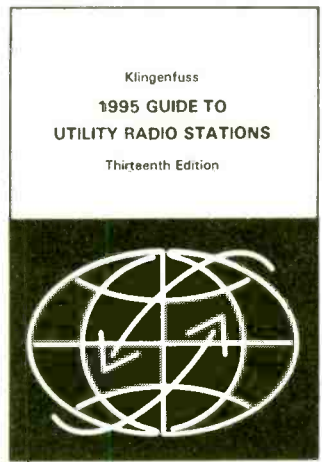

Klingenfuss
1995 GUIDE TO
UTILITY RADIO STATIONS
Thirteenth Edition

Further publications available are *Guide to Fax Radio Stations*, *Air and Metro Code Manual*, *Radioteletype Code Manual* and our unique *CD Recording of Modulation Types*. We have published our international radio books for 25 years. Please ask for our free catalogue with recommendations from all over the world. For a recent book review see *MT 2/1994* page 90. All manuals are published in the handy 17 x 24 cm format.

Do you want to get the **total information** immediately? For the special price of \$ 190 / DM 280 (you save \$ 40 / DM 60) you will receive all our manuals and supplements (altogether more than 1900 pages!) and our *Modulation Types Cassette*.

Our prices include surface mail postage worldwide (for airmail please add \$ 7 or DM 10). Payment can be by cheque or credit card - we accept American Express, Eurocard, Mastercard and Visa. Dealer discount rates on request. Please fax or mail your order to ☺

Klingenfuss Publications

Hagenloer Str. 14 • D-72070 Tuebingen • Germany
Fax 01149 7071 600849 • Phone 01149 7071 62830

A New Leader in Space Has Been Launched...

Are you looking for the best satellite news, information and ideas? *Satellite Times* covers every aspect of space communications--from commercial, military and broadcasts, to amateur, scientific, government and even private satellites.

Every bimonthly issue is filled with the most up-to-date topics and will bring you into a new era of monitoring, satellite monitoring!

Satellite Times

P.O. Box 98

Brasstown, NC 28902

Order Line 1-800-438-8155

Technical line (704) 837-7081

Toll line: (704) 837-9200

Fax line: (704) 837-2216

Subscription:

1 year: \$19.95 (6 issues) 1 year foreign surface: \$26.00
(U.S. funds) (6 issues) Call for air mail rates.

FREQUENCIES

1500-1600	Australia, Radio	5995pa 9710pa 11800pa	6060pa 9770as	6080pa 11660as	7260as 11695pa	1500-1600	Russia, Voice of	4740as 6035eu 7180eu 7295eu 7360eu 7330eu 7345na 7360eu 9575eu 9600eu 9635eu 9835na 9885na 11765as 11825af 12015eu 12065me 15205na 15465eu 15480as 21515af	4795as 6065as 7115na 7165eu 7330eu 7345na 9600eu 9635eu 9835na 9885na 11765as 11825af 12015eu 12065me 15205na 15465eu	4940as 5935eu	5935eu 7165eu 7345na 9635eu 11825af 15465eu	
1500-1600 vl	Australia, VL8A Alice Spg	2310do				1500-1600	S Africa, Channel Africa	7225af				
1500-1600 vl	Australia, VL8K Katherine	2485do				1500-1550	Seychelles, FEBA Radio	9810as	11870as			
1500-1600 vl	Australia, VL8T Tent Crk	2325do				1500-1600	Seychelles, FEBA Radio	11870as				
1500-1600	Bahrain, Radio	6010do				1500-1600	Singapore, SBC Radio One	6155do				
1500-1600 vl	Canada, CBC N Quebec Svc	9625do				1500-1600 vl	Slovakia, AWR	9455af				
1500-1600	Canada, CFCX Montreal	6005do				1500-1600	Sri Lanka, SLBC Colombo	9720as	15425as			
1500-1600	Canada, CFRX Toronto	6070do				1500-1530	Switzerland, Swiss R Intl	9885as	12075as	13635as		
1500-1600	Canada, CFPV Calgary	6030do				1500-1600	United Kingdom, BBC London	5990as	6190af	6195eu	9410eu	
1500-1600	Canada, CHNX Halifax	6130do				1500-1600		9515na	9660as	9740na	11705eu	
1500-1600	Canada, CKZN St John's	6160do				1500-1600		11750as	11940af	12095me	15070af	
1500-1600	Canada, CKZU Vancouver	6160do				1500-1600		15260na	15400eu	17830af	17840na	
1500-1600 s	Canada, RCI Montreal	11955na	17820na			1500-1530	United Kingdom, BBC London	21470af	15420af	17790af	21490af	
1500-1600	China, China Radio Intl	4200as	7405na	9335as		1500-1600	USA, KAIJ Dallas TX	13815am		15725am		
1500-1600	Costa Rica, R Peace Intl	6200am	9400am	15050am		1500-1600	USA, KTBN Salt Lk City UT	7510am				
1500-1600	Ecuador, HCJB Quito	6080do	15115am	17490eu	21455eu	1500-1600	USA, KWHR Naalehu HI	9930as				
1500-1550	Germany, Deutsche Welle	7195af 17800af	9735af	11965af	15145af	1500-1600	USA, Monitor Radio Intl	9355as				
1500-1600 mt	Guam, TWR/KTWR	11580as				1500-1600	USA, VOA Washington DC	6110as 9700as	7125as 9760as	7215as 15205me	9645as 15395as	
1500-1600	Iraq, Radio Iraq Intl	15250as				1500-1600	USA, WCSN Scotts Cor ME	15665eu				
1500-1600	Italy, AWR Europe	7230eu				1500-1600	USA, WEWN Birmingham AL	6000na	7425na			
1500-1600 vl	Italy, IRRS Milan	7125eu				1500-1600	USA, WHRI Noblesville IN	13760am	15105am			
1500-1600	Japan, NHK/Radio	9535na	9750as	11955as	15355af	1500-1600	USA, WJCR Upton KY	13595na				
1500-1600	Jordan, Radio	9560eu				1500-1600	USA, WWCR Nashville TN	12160am	13845am	15685am		
1500-1600 mtwhfa	Lebanon, Wings of Hope	9960me				1500-1600	USA, WYFR Okeechobee FL	11830na	15215na	17760ca		
1500-1600 vl	Liberia, Radio ELBC	7275do				1500-1600	Zambia, R Christian Voice	6065af				
1500-1600	Malaysia, Radio	7295do				1530-1600	Austria, R Austria Intl	6155eu	9880me	11780as	13730eu	
1500-1600	Malaysia, RTM Kuching	7160do				1530-1545	India, All India Radio	7140as	7412as	9910as	11670me	
1500-1600	Malaysia, RTM/Kota Kinab	5980do				1530-1600	Iran, VOIRI Tehran	9575as	11790as			
1500-1600	Maita, V of Mediterranean	11925eu				1530-1600	Netherlands, Radio	9895as	15150as			
1500-1515	Mongolia, R Ulan Bator	7290as	12000na			1530-1600 mtwhf	Portugal, Radio	21515me				
1500-1525	Netherlands, Radio	9895as	13700as	15150as		1530-1600	Russia, Voice of	5920eu 7150af	6005af 7205eu	6110af 9800eu	7130na	
1500-1600 occsnal	New Zealand, R NZ Intl	6100pa				1545-1600	Vatican State, Vatican R	9500as				
1500-1530	Nigeria, FRCN/Radio	4990do	7285do									
1500-1600	Nigeria, FRCN/Voice of	7255af										
1500-1550	North Korea, R Pyongyang	9325eu	9977na	13785eu								
1500-1600	Palau, KHBN/Voice of Hope	9965as										
1500-1600	Philippines, FEBC/R Intl	11995as										
1500-1530	Romania, R Romania Intl	11740as	11810as	15335as								

SELECTED PROGRAMS

Sundays

- 1505 Radio Canada Int'l: Sunday Morning (Centerpoint). A feature program segment of the CBC Sunday Morning program.
- 1511 Voice of Russia: News and Views. See S 0411.

Mondays

- 1506 Monitor Radio Int'l: Monitor Radio International. See M 1406.
- 1509 Deutsche Welle: Newsline Cologne. Worldwide current affairs program with a review of the German or European press.
- 1510 Radio Australia: Asia Focus. Reporting on the commercial interrelationships of the Asia/Pacific Region.
- 1510 Radio Japan: Today's Top News Asia. See M 1410.
- 1510 Voice of America (as/eu): Newsline. See M 0410.
- 1511 Voice of Russia: News and Views. See S 0411.
- 1515 Radio Japan: Radio Japan Magazine Hour. See M 1130.
- 1519 Radio Japan: News Commentary. An editorial opinion on the current news.
- 1530 Deutsche Welle: African News. News about and for African countries.

Tuesdays

- 1506 Monitor Radio Int'l: Monitor Radio International. See M 1406.
- 1509 Deutsche Welle: Newsline Cologne. See M 1509.
- 1510 Radio Australia: Asia Focus. See M 1510.
- 1510 Radio Japan: Today's Top News Asia. See M 1410.
- 1510 Voice of America (as/eu): Newsline. See M 0410.
- 1511 Voice of Russia: News and Views. See S 0411.
- 1512 China Radio Int'l: News Analysis. See T 1212.
- 1515 Radio Japan: Radio Japan Magazine Hour. See M 1130.
- 1519 China Radio Int'l: Current Affairs. See T 1219.
- 1519 Radio Japan: News Commentary. See M 1519.
- 1530 Deutsche Welle: African News. See M 1530.
- 1538 Radio Netherlands: Newsline. See S 0337.

Wednesdays

- 1506 Monitor Radio Int'l: Monitor Radio International. See M 1406.
- 1509 Deutsche Welle: Newsline Cologne. See M 1509.

- 1510 Radio Australia: Asia Focus. See M 1510.
- 1510 Radio Japan: Today's Top News Asia. See M 1410.
- 1510 Voice of America (as/eu): Newsline. See M 0410.
- 1511 Voice of Russia: News and Views. See S 0411.
- 1515 BBC: From Our Own Correspondent. See S 0330.
- 1515 Radio Japan: Radio Japan Magazine Hour. See M 1130.
- 1519 Radio Japan: News Commentary. See M 1519.
- 1530 BBC: Quiz. Quote, Unquote (1st, 8th, 15th, 22nd, 29th). Return of the quotation quiz with Nigel Rees.
- 1530 Deutsche Welle: African News. See M 1530.
- 1531 Radio Japan: Asian Report. See W 1130.

Thursdays

- 1506 Monitor Radio Int'l: Monitor Radio International. See M 1406.
- 1509 Deutsche Welle: Newsline Cologne. See M 1509.
- 1510 Radio Australia: Asia Focus. See M 1510.
- 1510 Radio Japan: Today's Top News Asia. See M 1410.
- 1510 Voice of America (as/eu): Newsline. See M 0410.
- 1511 Voice of Russia: News and Views. See S 0411.
- 1515 Radio Japan: Radio Japan Magazine Hour. See M 1130.
- 1519 Radio Japan: News Commentary. See M 1519.
- 1530 Deutsche Welle: African News. See M 1530.

Fridays

- 1506 Monitor Radio Int'l: Monitor Radio International. See M 1406.
- 1509 Deutsche Welle: Newsline Cologne. See M 1509.
- 1510 Radio Australia: Asia Focus. See M 1510.
- 1510 Radio Japan: Today's Top News Asia. See M 1410.
- 1510 Voice of America (as/eu): Newsline. See M 0410.
- 1511 Voice of Russia: News and Views. See S 0411.
- 1515 Radio Japan: Radio Japan Magazine Hour. See M 1130.
- 1519 Radio Japan: News Commentary. See M 1519.
- 1530 Deutsche Welle: African News. See M 1530.
- 1534 Deutsche Welle: Economic Notebook. See T 0332.

Saturdays

- 1509 Deutsche Welle: Africa in the German Press. See M 0432.
- 1511 Voice of Russia: News and Views. See S 0411.
- 1530 Radio Japan: The Week in Review. See A 0330.

HAUSER'S HIGHLIGHTS: IRAN/KURDISTAN/IRAQ

Continued from Page 65

BBC Monitoring says V. of the Struggle of Iranian Kordestan has been heard again after long absence at 1600-1645 on 4345.

On Media Network, Andy Sennitt gave new addresses for the official IRIB, received too late for the WRTH 95: PO Box 15875/1575, Teheran; fax is also new: 98-21-204-1050.

In SW Bulletin, Finn Krone in Denmark reports V. of the People of Kurdistan on 4050.0 in Kurdish at 1531; Arabic at 1600. More from BBCM:

V. of the Iraqi People, Communist Party station, at 1700-1800+ on 5830, 7085, 3910, and 0430-0530 on 3910, 7085—

—not to be confused with another station which uses same slogan, Republic of Iraq Radio, "from Baghdad," but believed really based in Jiddah, Sa'udi Arabia, now carried on Arabsat 1C. Audio lags behind shortwave //9560, so satellite is not feeding shortwave. On the air from 1300 to 0100 in Arabic and some Kurdish, Turkmen, announcing many other unconfirmed frequencies; 9670, 9980, 13670, 15135, 15235, 15580; and 9570 is an alternate.

FREQUENCIES

1600-1630	Australia, Radio	5995pa 9710pa 11800pa	6060pa 9770as	6080pa 11660pa	7260as 11695pa				
1600-1700 vl	Australia, VL8A Alice Spg	2310do							
1600-1700 vl	Australia, VL8K Katherine	2485do							
1600-1700 vl	Australia, VL8T Tent Crk	2325do							
1600-1700	Bahrain, Radio	6010do							
1600-1700 vl	Canada, CBC N Quebec Svc	9625do							
1600-1700	Canada, CFCX Montreal	6005do							
1600-1700	Canada, CFRX Toronto	6070do							
1600-1700	Canada, CFPV Calgary	6030do							
1600-1700	Canada, CHNX Halifax	6130do							
1600-1700	Canada, CKZU St John's	6160do							
1600-1700	Canada, CKZV Vancouver	6160do							
1600-1700 s	Canada, RCI Montreal	11955na		17820na					
1600-1700	China, China Radio Intl	4130as	11575as	15110af	15130af				
1600-1700	Costa Rica, R Peace Intl	6200am	9400am	15050am					
1600-1700	Ecuador, HCJB Quito	6080do	15350eu	21455eu					
1600-1700	Ethiopia, Radio	7165af	9560af						
1600-1700	France, Radio France Intl	6175eu 12015af	9485me	11615af	11700af				
1600-1650	Germany, Deutsche Welle	6170as 9585as	7225as 11795as	7305as 13790na	9525as				
1600-1700	Guam, AWR/KSDA	9370as							
1600-1615 mt	Guam, TWR/KTWR	11580as							
1600-1630 whfas	Guam, TWR/KTWR	11580as							
1600-1630	Iran, VOIRI Tehran	9575as		11790as					
1600-1700 vl	Italy, IRRS Milan	7125eu							
1600-1700	Jordan, Radio	9560eu							
1600-1630 mtwhfa	Lebanon, Wings of Hope	9960me							
1600-1700 vl	Liberia, Radio ELBC	7275do							
1600-1700	Malaysia, Radio	7295do							
1600-1625	Netherlands, Radio	9895as		15150as					
1600-1649 occsnal	New Zealand, R NZ Intl	6100pa							
1600-1700	Nigeria, FRCN/Radio	4990do		7285do					
1600-1700	Nigeria, FRCN/Voice of	7255af							
1600-1630	Pakistan, Radio	9435af 15555af	9470af 15675af	11570af 17660af	13590af				
1600-1700	Russia, Voice of	4740as 5950eu 6065as 7335as 7380as 12015eu	4975as 5965eu 7115na 7345na 7490eu 15105af	5905eu 6015eu 7180as 7350eu 9550na 15205na	5935na 6015eu 7205na 7370eu 9830af 15265af				
1600-1700	S Africa, Channel Africa	7225af							
1600-1700	Singapore, SBC Radio One	6155do							
1600-1700 vl	Slovakia, AWR	9455af							
1600-1700	South Korea, R Korea Intl	5975as						9870af	
1600-1630	Sri Lanka, SLBC Colombo	9720as							15425as
1600-1700	Swaziland, Trans World R	9500af							
1600-1645	UAE, Radio Dubai	11795af						13675eu	15435eu
1600-1700	United Kingdom, BBC London	3915as 9515na 12095af 17830af	6190af 9740as 15070af	6195eu 11750as 15260na	9410af 11940af 15400eu				
1600-1615	United Kingdom, BBC Looen	5990as 21470af						9660as	17705eu
1600-1700	USA, KAIJ Dallas TX	13815am							17840na
1600-1700	USA, KTVB Salt Lk City UT	15590am							
1600-1700	USA, KWHR Naalehu HI	6120as							
1600-1700	USA, Monitor Radio Intl	9355af						21640af	
1600-1700	USA, VOA Washington DC	3970af 9700as 13710af 15395as 17895af	6110as 9760as 15205as	7125as 11920af 15225af	9645as 12040af 15320af 17785af				
1600-1700	USA, WCSN Scotts Cor ME	15665eu							
1600-1700	USA, WEWN Birmingham AL	9455na							
1600-1700	USA, WHRI Noblesville IN	13760am						15105am	
1600-1700	USA, WINB Red Lion PA	15715eu							
1600-1700	USA, WJCR Upton KY	13595na							
1600-1700	USA, WRNO New Orleans LA	15420am							
1600-1700	USA, WWCN Nashville TN	12160am						12160am	13845am
1600-1700	USA, WYFR Okeechobee FL	11830na 21525af						15215na 21745eu	15685eu 17760na
1600-1700	Zambia, R Christian Voice	6065af							
1615-1700	United Kingdom, BBC London	5975as						9510as	9630af
1620-1630 mtwhf	Estonia, Estonian Radio	5925eu							15420af
1630-1700	Australia, Radio	6060pa 9860pa	6080pa 11660pa	7260pa 11695pa	9710pa 11800pa				
1630-1700	Austria, R Austria Intl	11780as							
1630-1700	Canada, RCI Montreal	7150as						9550as	
1630-1700	Egypt, Radio Cairo	15255af							
1630-1700	Liberia, Radio ELWA	4760do							
1630-1700	Russia, Voice of	7150na						7380as	9550eu
1640-1650 s	Rwanda, Radio	6055do							9890eu
1650-1700 mtwhf	New Zealand, R NZ Intl	6100pa							

SELECTED PROGRAMS

Sundays

- 1610 Voice of America (eu): Encounter. See S 1210.
- 1615 BBC: Features. See S 0230.
- 1630 Radio Australia: Report from Asia. See S 1230.
- 1645 BBC (as): South Asia Report. Regional daily current affairs program.

Mondays

- 1606 Monitor Radio Int'l: Monitor Radio International. See M 1406.
- 1610 Voice of America (as): Focus. See M 1310.
- 1630 Radio Australia: International Report. See M 0030.
- 1631 Radio France Int'l: RFI Europe. See M 1231.
- 1635 BBC: Classical Music Feature. What Is...? (6th, 13th, 20th, 27th). NEW! Peter Paul Nash looks at musical terms which crop up regularly and gets down to basics.
- 1645 BBC (as): South Asia Report. See S 1645.
- 1645 BBC: The World Today. Examines thoroughly a topical aspect of the international scene.

Tuesdays

- 1606 Monitor Radio Int'l: Monitor Radio International. See M 1406.
- 1610 Voice of America (as/eu): Focus. See M 1310.
- 1611 Voice of Russia: Focus on Asia and the Pacific. See T 1311.
- 1612 China Radio Int'l: News Analysis. See T 1212.
- 1619 China Radio Int'l: Current Affairs. See T 1219.
- 1630 Radio Australia: International Report. See M 0030.
- 1633 Radio France Int'l: RFI Europe. See M 1231.
- 1645 BBC (as): South Asia Report. See S 1645.
- 1645 BBC: The World Today. See M 1645.

Wednesdays

- 1606 Monitor Radio Int'l: Monitor Radio International. See M 1406.
- 1610 Channel Africa: News Watch. A magazine program of regional news.
- 1610 Voice of America (as/eu): Focus. See M 1310.
- 1615 BBC: Popular Music Feature. The Soul Show (1st, 8th, 15th, 22nd, 29th). See M 2315.
- 1626 Channel Africa: Business News. Financial and stock market happenings.
- 1630 Radio Australia: International Report. See M 0030.
- 1645 BBC (as): South Asia Report. See S 1645.
- 1645 BBC: The World Today. See M 1645.

Thursdays

- 1606 Monitor Radio Int'l: Monitor Radio International. See M 1406.
- 1610 Channel Africa: News Watch. See W 1610.
- 1610 Voice of America (as): Focus. See M 1310.
- 1615 BBC: Network UK. Issues and events affecting the lives of people throughout the UK.
- 1626 Channel Africa: Business News. See W 1626.
- 1630 Radio Australia: International Report. See M 0030.
- 1632 Radio France Int'l: RFI Europe. See M 1231.
- 1645 BBC (as): South Asia Report. See S 1645.

1645 BBC: The World Today. See M 1645.

Fridays

- 1606 Monitor Radio Int'l: Monitor Radio International. See M 1406.
- 1610 Voice of America (as): Focus. See M 1310.
- 1611 Voice of Russia: Focus on Asia and the Pacific. See T 1311.
- 1630 Radio Australia: International Report. See M 0030.
- 1631 Radio France Int'l: RFI Europe. See M 1231.
- 1640 Radio France Int'l: Made in France. A review of something very French.
- 1645 BBC (as): South Asia Report. See S 1645.
- 1645 BBC: The World Today. See M 1645.

Saturdays

- 1611 Voice of Russia: Focus on Asia and the Pacific. See T 1311.
- 1630 Radio Australia: Background Report. See A 1230.
- 1631 Radio France Int'l: Spotlight on Africa. See A 1228.
- 1645 BBC (as): South Asia Report. See S 1645.

FM Radio Card for PC
\$55 including S&H

With Windows & DOS Software & Antenna

Run Programs While listening to FM Radio 88-108 MHz on your speakers, headphones or soundcard.

Auto/Scan/Manual & Fine Tune. 10 Setable Freqs., Clock Alarm, on-Board Audio Amp software control volume

Min System: 286, DOS 3 or WIN 3.1. No IRQ/DMA used by radio

Send Check or MO to: Radio Accessories
P.O. Box 168, Melvin Village, NH 03850

RadioMap™

Transmitter sites in your area researched and marked on a beautiful 8-1/2 x 11 full color street map suitable for framing. See FCC licensed sites from VLF through microwave including police, fire, cellular phone sites, businesses, industrial, broadcasters, and selected FAA transmitter sites. Call signs, frequency assignments, and names provided. Ham radio stations not included.

You choose the map center location—your neighborhood, near your office, around sports stadiums—anywhere within the United States. We adjust map coverage for best readability, depending on transmitter site density.

Invaluable to radio professionals and hobbyists for identifying towers, sources of radio interference, etc. Send nearest street intersection and check for \$19.95 payable to Robert Parnass.

Robert Parnass, P.E.
Radio Electronics Consulting
2390 Douglas Road, Oswego, Illinois 60543

FREQUENCIES

1700-1715	Albania, R Tirana Intl	7155eu	9760eu		
1700-1800	Australia, ADF Radio	10375af	10429af	10458af	10650af
1700-1800	Australia, Radio	6060pa	6080pa	7260pa	9580pa
		9710pa	9860pa	11660pa	11695pa
		11880pa			
1700-1800 vl	Australia, VL8A Alice Spg	2310do			
1700-1800 vl	Australia, VL8K Katherine	2485do			
1700-1800 vl	Australia, VL8T Tent Crk	2325do			
1700-1800	Azerbaijan, Voice of	7160eu			
1700-1800	Bahrain, Radio	6010do			
1700-1800 vl	Canada, CBC N Quebec Svc	9625do			
1700-1800	Canada, CFCX Montreal	6005do			
1700-1800	Canada, CFRX Toronto	6070do			
1700-1800	Canada, CFVP Calgary	6030do			
1700-1800	Canada, CHNX Halifax	6130do			
1700-1800	Canada, CKZN St John's	6160do			
1700-1800	Canada, CKZU Vancouver	6160do			
1700-1800	China, China Radio Intl	4130as	7405af	9535as	11575af
1700-1800	Costa Rica, R Peace Intl	7385am	9400am	15050am	17905am
1700-1727	Czech Rep, Radio Prague	5930as	7345eu	9420me	
1700-1800	Ecuador, HCJB Quito	6080do	15490eu	17490pa	
1700-1800	Egypt, Radio Cairo	15255af			
1700-1800 vl	Eqt Guinea, Radio Africa	7200af			
1700-1730	France, Radio France Intl	9485as	11700af		
1700-1800	Iraq, Radio Iraq Intl	15250as			
1700-1800 vl	Italy, IRRS Milan	7125eu			
1700-1800	Japan, NHK/Radio	6150na	9535na	9580as	11930as
1700-1730	Jordan, Radio	9560eu			
1700-1713 mtwhfa	Lebanon, Voice of	6550eu			
1700-1730 vl	Liberia, Radio ELBC	7275do			
1700-1800	Liberia, Radio ELWA	4760do			
1700-1800 mtwhf	New Zealand, R NZ Intl	6100pa			
1700-1800	Nigeria, FRCN/Radio	3326do	4990do		
1700-1750	North Korea, R Pyongyang	9325eu	9640af	13785eu	
1700-1750	Pakistan, Radio	7485eu	11570eu		
1700-1800	Russia, Voice of	5905me	5950eu	6065as	7115eu
		7170eu	7180eu	7205eu	7325na
		7330eu	7345eu	7370eu	9505eu
		9530na	9550na	9575eu	9725as
		9860na	9890eu	11825na	15385as
1700-1800	S Africa, Channel Africa	7225af	15240af		
1700-1800 vl	Slovakia, AWR	7270as	9450as		
1700-1715	Swaziland, Trans World R	7120af			
1700-1730	Switzerland, Swiss R Intl	6205af	9885af	13635me	
1700-1720	Uganda, Radio	4976do			
1700-1800	United Kingdom, BBC London	3955eu	5975as	6005af	6180eu
		6195af	6195eu	9410eu	9510as
		9630af	9740as	11750as	11940af
		12095af	15070af	15400af	15420af
		17830af			
1700-1715	United Kingdom, BBC London	9515na	15260na		
1700-1745	United Kingdom, BBC London	3915as			
1700-1800	USA, KAIJ Dallas TX	13815am	15725am		
1700-1800	USA, KTBN Salt Lk City UT	15590am			
1700-1800	USA, KWHR Naalehu HI	7425as			
1700-1800	USA, Monitor Radio Intl	9355af	21640af		
1700-1800	USA, VOA Washington DC	5990eu	6045eu	6110as	7125as
		7215as	7235as	9525as	9645as
		9670af	9700eu	9760af	9770af
		11895af	11920af	11945af	12040af
		13710af	15205as	15395as	15410af
		15445af	17895af		
1700-1800	USA, WCSN Scotts Cor ME	17612af			
1700-1800	USA, WEWN Birmingham AL	9455na			
1700-1800	USA, WHRI Noblesville IN	13760am	15105am		
1700-1800	USA, WINB Red Lion PA	15715eu			
1700-1800	USA, WJCR Upton KY	13595na			
1700-1800 smtwhf	USA, WMLK Bethel PA	9465eu			
1700-1800	USA, WRNO New Orleans LA	15420am			
1700-1800	USA, WWCR Nashville TN	12160am	13845am	15685eu	
1700-1800	USA, WYFR Okeechobee FL	15566eu	17760na		
1700-1800	Zambia, R Christian Voice	6065af			
1705-1800	Ghana, Ghana Broade Corp	3366do			
1715-1730 mtwhf	Swaziland, Trans World R	7120af			
1715-1800	United Kingdom, BBC London	7160me			
1715-1730	Vatican State, Vatican R	7250eu	9645eu		
1730-1800	Netherlands, Radio	6020af	9605af	11655af	
1730-1800	Romania, R Romania Intl	9510af	9750af	11740af	11940af
1730-1800	Russia, Voice of	7105eu	7130me	7325as	7340eu
		9520na	9720eu	13670af	
		6065eu			
1730-1745	Sweden, Radio	7305af	9695af	9725af	11625af
1745-1800	Vatican State, Vatican R	7190eu	9647eu		
1745-1800 mtwhf	Bangladesh, Radio	5995eu	11935me	13610eu	15325eu
	Canada, RCI Montreal	17820eu			
		7412eu	9650me	9950me	11620eu
	India, All India Radio	11935af	13750as	15075me	

1800-1900	Algeria, R Algiers Intl	11715eu	11745eu	15205eu	15215eu
1800-1900	Australia, ADF Radio	10375af	10429af	10458af	10650af
1800-1900	Australia, Radio	6060pa	6080pa	9580pa	9860pa
		11660as	11695pa	11880pa	
1800-1900 vl	Australia, VL8A Alice Spg	2310do			
1800-1900 vl	Australia, VL8T Tent Crk	2325do			
1800-1900	Bahrain, Radio	6010do			
1800-1900	Bangladesh, Radio	7190eu	9647eu		
1800-1900	Brazil, Radiobras	15268eu			
1800-1900	Canada, CFCX Montreal	6005do			
1800-1900	Canada, CFRX Toronto	6070do			
1800-1900	Canada, CFVP Calgary	6030do			
1800-1900	Canada, CHNX Halifax	6130do			
1800-1900	Canada, CKZN St John's	6160do			
1800-1900	Canada, CKZU Vancouver	6160do			
1800-1900	Costa Rica, R Peace Intl	7385am	9400am	15050am	17905am
1800-1827	Czech Rep, Radio Prague	5930eu	7345eu	9420eu	
1800-1900	Ecuador, HCJB Quito	6080do	15490eu	21455eu	
1800-1830	Egypt, Radio Cairo	15255af			
1800-1900 vl	Eqt Guinea, Radio Africa	7200af			
1800-1830	Georgia, Radio	11815eu			
1800-1830	Ghana, Ghana Broade Corp	3366do	4915do		
1800-1900	India, All India Radio	7412eu	9650me	9950me	11620eu
		11935af	13750as	15075me	
1800-1900 vl	Italy, IRRS Milan	7125eu			
1800-1900	Kenya, Kenya Broade Corp	4935do			
1800-1900	Kuwait, Radio	11990na			
1800-1900	Liberia, Radio ELWA	4760do			
1800-1830	Netherlands, Radio	6020af	9605af	11655af	
1800-1849 mtwhf	New Zealand, R NZ Intl	6100pa			
1800-1830	Nigeria, FRCN/Radio	3326do	4990do		
1800-1830 m	Norway, Radio Norway Intl	5960eu			
1800-1855	Poland, Polish R Warsaw	6000eu	7270eu	7285eu	
1800-1900	Russia, Voice of	4740as	4940eu	5905me	5950eu
		5995eu	6055eu	6065as	6110me
		7105na	7105na	7180as	7205eu
		7345eu	7370eu	9505as	9530eu
		9550eu	9575eu	9860eu	9880eu
		9890eu	11825as	11945as	13670af
1800-1900 vl	Slovakia, AWR	9455af			
1800-1900 irreg	Sudan, Sudan Natl BC	9200af			
1800-1900	Swaziland, Trans World R	3200af			
1800-1845	Swaziland, Trans World R	9500af			
1800-1900	United Kingdom, BBC London	3955eu	6005af	6180eu	6190af
		6195eu	9410eu	9630af	9740as
		11955as	12095eu	15070af	15400af
		15420af	17830af		
1800-1830	United Kingdom, BBC London	5975as	7160me	9510as	11940af
1800-1900	USA, KAIJ Dallas TX	13815am	15725am		
1800-1900	USA, KJES Mesquite NM	15385na			
1800-1900	USA, KTBN Salt Lk City UT	15590am			
1800-1900	USA, KWHR Naalehu HI	13625as			
1800-1900	USA, Monitor Radio Intl	9355eu	9370eu	21640af	
1800-1900	USA, VOA Washington DC	4985af	6040eu	9700eu	9760eu
		11920af	12040af	13680af	13710af
		15580af	17800af	17895af	
1800-1900	USA, WCSN Scotts Cor Me	17612af			
1800-1900	USA, WEWN Birmingham AL	9455na			
1800-1900	USA, WHRI Noblesville IN	9495am	13760eu		
1800-1900	USA, WINB Red Lion PA	15715eu			
1800-1900	USA, WJCR Upton KY	13595na			
1800-1900	USA, WMLK Bethel PA	9465eu			
1800-1900	USA, WRNO New Orleans LA	15420am			
1800-1900	USA, WWCR Nashville TN	12160am	13845am	15685am	
1800-1845	USA, WYFR Okeechobee FL	15566eu			
1800-1900	USA, WYFR Okeechobee FL	17760na			
1800-1900	Yemen, Yemeni Rep Radio	9780do			
1800-1900	Zambia, R Christian Voice	6065af			
1830-1900	Moldova, R Moldova Intl	7235eu			
1830-1900	Netherlands, Radio	6015af	6020af	9605af	9860af
		9895af	15315af	17605af	
1830-1845	Rwanda, Radio	6055do			
1830-1900	Sweden, Radio	6065eu	9655af	13690me	
1830-1900	United Kingdom, BBC London	3255af			
1833-1900	Cote D' Ivoire, RDTV	11920do			
1840-1850	Greece, Voice of	15650af	17525af		
1845-1900	Armenia, Radio Yerevan	4810eu	4990eu	5930eu	6065eu
1845-1900 irreg s	Mali, RDTV Maliene	4783do	4835do	5995do	
1850-1900 mtwhfa	New Zealand, R NZ Intl	11910pa			

Your Name in Lights!
... or at least in ink within the *Monitoring Times* Shortwave Guide. Please send us your "best catches" on the worldwide shortwave bands — QSLs, that is — and we will try to use them in future issues of *MT*. Enclose SASE and your QSLs will be returned.

Computer Aided Scanning

a new dimension in communications from Datametrics



Now Radio Shack PRO 2006 owners for the first time have access to the exciting world of Computer Aided Scanning with the highly acclaimed Datametrics Communications Manager system. Computer Aided Scanning is as significant as the digital scanner was five years ago and is changing the way people think about radio communications.

- The Datametrics Communications Manager provides computer control over the Radio Shack PRO2006 receiver.
- Comprehensive manual includes step by step instructions, screen displays, and reference information.
- Powerful menu driven software includes full monitoring display, digital spectrum analyzer and system editor.
- Extends receiver capabilities including autolog recording facilities, 1000 channel capacity per file, and much more.
- Uses innovative Machine State Virtualizer technology (patent pending) hardware interface by Datametrics.
- Simple 4 step installation - no soldering or modification to normal receiver operations.

Datametrics, Inc

- Computer Aided Scanning system \$ 349
- PRO2006 receiver w/interface installed and CAS system \$ 749
- Manual and demo disk \$15
- Requires Radio Shack PRO 2006 receiver and IBM PC with 360K memory (640K for full channel capacity) and parallel (printer) port.

Send check or money order to Datametrics, Inc., 2575 South Bayshore Dr. Suite 8A, Coconut Grove, FL 33133. 30 day return privileges apply.

NEW! From The Leader in Computer Radio Monitoring

Introducing ScanStar Commercial Edition!

All features of the popular Professional Edition plus:

- o Multi-radio scanning, Search/slow (handoff) and peer strategies.
- o Use any combination of radio type or port. Port sharing for CI-V devices.
- o GUI command center shows activity, history and status of channels in real time. Quickly reconfigure as the action unfolds!
- o Priority system with 256 levels and selectable preemption.
- o High resolution VGA/53 graphics modes: 640X480, 800X600 & 1024X763
- o Mouse support in all screens (text & GUI) for fast, easy operation.
- o Independent scan windows allow simultaneous scanning of two programs, 4 radios!
- o Detail event logging for special applications, repeater usage recording, frequency coordination, etc. Data format & sample C program included.
- o 32 bit code for maximum performance on 386, 486 & Pentium processors.

Professional Edition features:

- o Tone controlled scanning & logging with Optoelectronics OS456 & DC440.
- o Scan multiple groups, banks and search ranges all at the same time!
- o Spectrum analysis with hardcopy on R7100, R9000, AR3000, NRD535 and OS456.
- o Monitoring Assistant for easy logging while you explore the bands.
- o Terminal window for TNC, modem, decoder, etc.
- o Background scanning allows you to perform other tasks while scanning.
- o Most features selectable per-channel, including lockout, tape, delay time, dwell time, sound squelch, PL & DPL tones, alarms for high priority channels and much more!
- o File size limited only by computer memory - no preset limits!
- o Comprehensive report printing and data logging

System Requirements:

IBM PC 386/486/586 with 4 MEG RAM, hard disk, VGA/53, mouse, serial port(s), DOS 5/6 or OS/2 2.1/3.0. Cables and level converters not supplied. Windows and 286 not supported.

Supports These Radios & Tone Readers:

OS456, DC440, R7100, R7000, R9000, FRG9600, AR3000, NRD535, NRD525, R8, MR8100

Commercial Edition \$129⁹⁷
Professional Edition \$79⁹⁷

Plus shipping, handling and state sales taxes. Call for upgrade info. 30 day money back guarantee. Call for details. Commercial Edition requires 386 or better.

Signal Intelligence
PO BOX 640891
San Jose CA 95164
1-408-926-5630

FREE DEMO COPY
Download from BBS, 2400-9600 N81, login as "guest"
1-408-258-6462

Who Says 800 MHz Coverage Is A THING OF THE PAST?



Order SCN15-C
Only \$1499⁹⁵

Plus \$20 2nd Day Air Shipping
(the SAME price as GROUND
from other companies!)

**Call Now—
Stock is Limited and
Moving Rapidly!**

Certainly not Grove Enterprises! Although cellular-capable scanners and converters can no longer be imported into or manufactured in the United States, Grove Enterprises is offering this special package while existing supplies last. The powerful **ICOM R7100** has still has the same great quality as before, but coming from the manufacturer it lacks the 800-900 MHz range (actual range now is 25-800 and 900-2000 MHz). But by adding the **GRE Super Converter**, the missing cellular range is restored for continuous 25-2000 MHz coverage!

The ICOM R7100's retail price of \$1850, with the addition of the \$94 Super Converter, would make most people's wallet smoke! But for a limited time, we have combined these fine receivers and converters—a value of \$1944 per package—and we are offering them to you for only \$1499.95 plus \$20 2nd Day Air shipping!



GROVE ENTERPRISES, INC.
P.O. Box 98, Brasstown, NC 28902
(800) 438-8155 (US and Canada) or
(704) 837-9200

FREQUENCIES

1900-1930	Albania, R Tirana Intl	7230eu	9730eu		
1900-2000 mtwhf	Argentina, RAE	15345eu			
1900-2000	Australia, Radio	6060pa 7260as 11660pa	6080pa 6150as 11880pa	7240pa 9860pa	
1900-2000 vl	Australia, VL8A Alice Spg	2310do			
1900-2000 vl	Australia, VL8K Katherine	2485do			
1900-2000 vl	Australia, VLBT Tent Crk	2325do			
1900-2000	Bahrain, Radio	6010do			
1900-1945	Bangladesh, Radio	7190as	9647eu		
1900-1930	Belgium, R Vlaanderen Intl	5910eu	9925af		
1900-1920	Brazil, Radiobras	15268eu			
1900-2000	Bulgaria, Radio	7305eu	9700eu		
1900-2000	Canada, CFCX Montreal	6005do			
1900-2000	Canada, CFRX Toronto	6070do			
1900-2000	Canada, CFPV Calgary	6030do			
1900-2000	Canada, CHNX Halifax	6130do			
1900-2000	Canada, CKZN St John's	6160do			
1900-2000	Canada, CKZU Vancouver	6160do			
1900-2000	China, China Radio Intl	6955af			
1900-2000	Costa Rica, R Peace Intl	9400am	15050am	17905am	
1900-1930	Cote D' Ivoire, RDTV	11920do			
1900-2000	Ecuador, HCJB Quito	6080do	15490eu	17490eu	21455eu
1900-2000 vl	Eq Guinea, Radio Africa	7200af			
1900-1950	Germany, Deutsche Welle	7110af 11785af 15145af	9665af 11810af 15425af	9670af 11865af	9765af 13790af
1900-1910	Greece, Voice of	6260eu	9380eu		
1900-1945	India, All India Radio	7412eu 11935af	9650me 13750as	9950me 15075me	11620eu
1900-2000 vl	Italy, IRRS Milan	7125eu			
1900-2000	Japan, NHK/Radio	6150as 11850au	7140au	9535na 9580au	
1900-2000	Kenya, Kenya Broadc Corp	4935do			
1900-2000	Kuwait, Radio	11990eu			
1900-2000	Liberia, Radio ELWA	4760do			
1900-1925	Netherlands, Radio	6015af 9895af	6020af 15315af	9605af 17605af	9860af
1900-2000 mtwhf	New Zealand, R NZ Intl	11910pa			
1900-1958 a	New Zealand, R NZ Intl	11910pa			
1900-2000	Nigeria, FRCN/Voice of	7255af			
1900-2000 vl	Papua New Guinea, NBC	4890do	9675do		
1900-2000	Romania, R Romania Intl	5995eu 7195eu	6105eu	6150eu	6190eu
1900-2000	Russia, Voice of	4740as 6110eu 7205eu 7345eu 9550eu 9890eu	5995eu 7150eu 7210eu 7400as 9575eu 11825as	6005as 7170eu 7275eu 9250eu 9800na 11945eu	6055eu 7180na 7340as 9530af 9860as 13670eu
1900-1915	Rwanda, Radio	15205af			
1900-2000 vl	Slovakia, AWR	6055af 9455as			
1900-2000	South Korea, R Korea Intl	5975as			
1900-2000	Spain, R Exterior Espana	9675af			
1900-2000	Swaziland, Trans World R	3200af	3240af		
1900-2000	Thailand, Radio	9655eu	9700eu	11855eu	11905eu
1900-1915	Uganda, Radio	4976do	5026do		
1900-2000	United Kingdom, BBC London	3255af 6190af 9630af 15070af	3955eu 6195eu 9740as 15400af	6005af 6180eu 11955as 17830af	6180eu 9410eu 12095me
1900-2000	USA, KAIJ Dallas TX	13815am	15725am		
1900-2000	USA, KTVN Salt Lk City UT	15590am			
1900-2000 as	USA, KVOH Los Angeles CA	17775am			
1900-2000	USA, KWHR Naalehu HI	13625as			
1900-2000	USA, Monitor Radio Intl	9335eu	9370eu	17510af	
1900-2000	USA, VOA Washington DC	3980eu 9700af 12040af 15445af	6040eu 9760af 13710af 15580af	9525pa 11920af 15180pa 17800af	15410af
1900-2000	USA, WCSN Scotts Cor ME	17612af			
1900-2000	USA, WEWN Birmingham AL	9455eu	15375		
1900-2000	USA, WHRI Noblesville IN	9495am	13760eu		
1900-2000	USA, WINB Red Lion PA	12160eu			
1900-2000	USA, WJCR Upton KY	13595na			
1900-2000	USA, WMLK Bethel PA	9465eu			
1900-2000 a	USA, WRMI/R Miami Intl	9955am			
1900-2000	USA, WRNO New Orleans LA	15420am			
1900-2000	USA, WWCR Nashville TN	11970am	13845am	15685am	
1900-2000	USA, WYFR Okeechobee FL	117760af			
1900-2000	Zambia, R Christian Voice	6065af			
1910-1920	Botswana, Radio	3356af	4830af	7255af	
1930-2000	Austria, R Austria Intl	5945eu	6155eu	9880me	13730af
1930-2000	Finland, YLE/Radio	6120eu	9730eu	11755eu	
1930-2000	Iran, VOIRI Tehran	9022eu			
1930-2000	Mongolia, R Ulan Bator	7290na	13650na		
1930-2000	Netherlands, Radio	6020af 11655af	9605af 15315af	9860af 17605af	9895af
1930-2000	Slovakia, R Slovakia Intl	5915eu	7345eu		
1930-2000	South Korea, R Korea Intl	7250eu			
1930-2000 a	Uganda, Radio	4976do	5026do		
1930-2000 s	USA, WRMI/R Miami Intl	9955am			
1930-2000	Yugoslavia, Radio	6100eu	9720af		
1935-1955	Italy, RAI Rome	7275eu	9575eu	11905eu	

1945-2000 t	Belarus, Radio Minsk	5940eu	7105eu	7210eu	7405eu
1959-2000 a	New Zealand, R NZ Intl	15115as			
2000UTC					
2000-2100	Australia, Radio	6060pa 9580pa 11855as	6080pa 9860pa 11880pa	6150pa 11660pa 11695pa	7260as 11695pa
2000-2100 vl	Australia, VL8A Alice Spg	2310do			
2000-2100 vl	Australia, VL8K Katherine	2485do			
2000-2100 vl	Australia, VLBT Tent Crk	2325do			
2000-2100	Bahrain, Radio	6010do			
2000-2100	Canada, CFCX Montreal	6005do			
2000-2100	Canada, CFCX Toronto	6070do			
2000-2100	Canada, CFPV Calgary	6030do			
2000-2100	Canada, CHNX Halifax	6130do			
2000-2100	Canada, CKZN St John's	6160do			
2000-2100	Canada, CKZU Vancouver	6160do			
2000-2100	China, China Radio Intl	4130as 11715na	8260as 15110af	9440af 17905am	9920eu
2000-2100	Costa Rica, R Peace Intl	9400am			
2000-2100	Ecuador, HCJB Quito	6080do			
2000-2100 vl	Eq Guinea, Radio Africa	7200af			
2000-2050	Germany, Deutsche Welle	5960eu	7285eu		
2000-2030	Ghana, Ghana Broadc Corp	3366do	4915do		
2000-2030	Hungary, Radio Budapest	3975eu	6110eu	7220eu	
2000-2100	Indonesia, Voice of	9675as	11752as		
2000-2030	Iran, VOIRI Tehran	9022eu			
2000-2030	Israel, Kol Israel	7405na 17575af	7465na	9435eu	11603na
2000-2100 vl	Italy, IRRS Milan	7125eu			
2000-2100	Kenya, Kenya Broadc Corp	4935do			
2000-2100	Kuwait, Radio	11990eu			
2000-2100	Liberia, Radio ELWA	4760do			
2000-2030	Lithuania, Radio Vilnius	9710eu			
2000-2025	Netherlands, Radio	6020af 11655af	9605af 15315af	9860af 17605af	9895af
2000-2050 mtwhf	New Zealand, R NZ Intl	11910pa			
2000-2005 f	New Zealand, R NZ Intl	11910pa			
2000-2005	Nigeria, FRCN/Radio	3326do	4990do		
2000-2100	Nigeria, FRCN/Voice of	7255af			
2000-2050	North Korea, R Pyongyang	6576eu	9345as	9640af	9977na
2000-2100 vl	Papua New Guinea, NBC	4890do	9675do		
2000-2030 mtwhf	Portugal, Radio	9780af	9815af	21515af	21655af
2000-2100	Russia, Voice of	4055eu 6055eu 7205eu 9490na 9800na 11675as 15205eu	4860eu 6085eu 7215eu 9515eu 9860na 11750na 15385na	5920eu 6110eu 7400eu 9530eu 9875na 12015na 15385na	5995eu 7170eu 7420na 9550eu 9890na 13670as
2000-2100 vl	Slovakia, AWR	6055eu	9455af		
2000-2100 vl	Solomon Islands, SIBC	5020do			
2000-2045 s	Swaziland, Trans World R	3240af			
2000-2030	Switzerland, Swiss R Intl	3985eu 9885af	6135af 11640af	6165eu 13635af	9770af
2000-2002	Uganda, Radio	4976do	5026do		
2000-2030	United Kingdom, BBC London	6190af 15070af	7160me 17830af	9630af	12095me
2000-2100	United Kingdom, BBC London	3255af 6195eu 11750sa	3955eu 6195eu 11955as	6005af 9410eu 15400af	6180eu 9740as
2000-2100	USA, KAIJ Dallas TX	13815am	15725am		
2000-2100	USA, KTVN Salt Lk City UT	15590am			
2000-2100 as	USA, KVOH Los Angeles CA	17775am			
2000-2100	USA, Monitor Radio Intl	7510eu	9355eu		
2000-2100	USA, VOA Washington DC	3980eu 9700eu 15205me	6040eu 9760af 15410af	7415af 13710af 15445af	9495eu 15160af 15580af
2000-2100	USA, WEWN Birmingham AL	9455na			
2000-2100	USA, WHRI Noblesville IN	9495am	13760eu		
2000-2100	USA, WINB Red Lion PA	12160eu			
2000-2100	USA, WJCR Upton KY	13595na			
2000-2100	USA, WMLK Bethel PA	9465eu			
2000-2100	USA, WRNO New Orleans LA	15420am			
2000-2100	USA, WWCR Nashville TN	11970am	13845am	15685am	
2000-2045	USA, WYFR Okeechobee FL	21525af			
2000-2100	USA, WYFR Okeechobee FL	13695af			
2000-2030	Vatican State, Vatican R	7355af	9645af	11625af	
2000-2030	Zambia, R Christian Voice	6065af			
2005-2100	Syria, Radio Damascus	12085eu	15095na		
2006-2100 f	New Zealand, R NZ Intl	15115pa			
2015-2045 s	Swaziland, Trans World R	3200af			
2025-2045	Italy, RAI Rome	7235me	9710me	11800me	
2030-2100	Egypt, Radio Cairo	15375af			
2030-2100	Netherlands, Radio	9860af	9895af		
2030-2100 mtwhf/a	Poland, KHBN/Voice of Hope	11980as			
2030-2100	Poland, Polish R Warsaw	6000eu	6135eu	7285eu	
2030-2100	Russia, Voice of	6185as 9550eu	7180eu 7260eu	9520eu	
2030-2050	Thailand, Radio	9655eu	9700eu	11835eu	11905eu
2030-2100	Vietnam, Voice of	10059as	12025as	15010as	
2045-2100	India, All India Radio	7412eu 11715pa	9910au 15225pa	9950eu	11620eu
2050-2100	Vatican State, Vatican R	3945eu	5882eu		
2051-2100 mtwhf	New Zealand, R NZ Intl	15115pa			

FREQUENCIES

2100-2200	Australia, Radio	6060pa 11855as	6080pa 11880pa	7240pa 11955pa	7260as	2200-2300	Australia, Radio	9580pa 11695pa 13755as	9610as 11855as 15365pa	9645as 11880pa 17795pa	9660pa 11955pa 17860pa
2100-2130 vl	Australia, VL8A Alice Spg	2310do				2200-2300 vl	Australia, VL8A Alice Spg	4835do			
2100-2130 vl	Australia, VL8K Katherine	2485do				2200-2300 vl	Australia, VL8K Katherine	5025do			
2100-2130 vl	Australia, VL8T Tent Crk	2325do				2200-2300 vl	Australia, VL8T Tent Crk	4910do			
2100-2115	Bahrain, Radio	6010do				2200-2230	Belgium, R Vlaanderen Int	5910eu	6030eu		
2100-2200 vl	Canada, CBC N Quebec Svc	9625do				2200-2300	Bulgaria, Radio	7105eu	9700eu		
2100-2200	Canada, CFCX Montreal	6005do				2200-2300	Canada, CFCX Montreal	6005do			
2100-2200	Canada, CFRX Toronto	6070do				2200-2300	Canada, CFRX Toronto	6070do			
2100-2200	Canada, CFVP Calgary	6030do				2200-2300	Canada, CFVP Calgary	6030do			
2100-2200	Canada, CHNX Halifax	6130do				2200-2300	Canada, CHNX Halifax	6130do			
2100-2200	Canada, CKZN St John's	6160do				2200-2300	Canada, CKZN St John's	6160do			
2100-2200	Canada, CKZU Vancouver	6160do				2200-2300	Canada, CKZU Vancouver	6160do			
2100-2200	Canada, RCI Montreal	5995eu 13650eu 17820eu	7260eu 13690eu	9725eu 15140eu	11945eu 15325eu	2200-2230	Canada, RCI Montreal	5995eu 13650eu 17820eu	7260eu 13690eu	11705as 15140eu	11945eu 15325eu
2100-2200	China, China Radio Intl	4130as	6950eu	8260as	9920eu	2200-2230	China, China Radio Intl	3985eu	7170eu		
2100-2130	China, China Radio Intl	11715af	15110af			2200-2300	Costa Rica, R Peace Intl	7385am	9400am	15050am	17905am
2100-2200	Costa Rica, R Peace Intl	7385am	9400am	15050am	17905am	2200-2300	Cuba, Radio Havana Cuba	6180na			
2100-2200	Cuba, Radio Havana Cuba	11720eu				2200-2227	Czech Rep, Radio Prague	5930eu	7345af	9420eu	
2100-2127	Czech Rep, Radio Prague	5930eu	7345eu	9420eu		2200-2245	Egypt, Radio Cairo	9900eu			
2100-2200	Egypt, Radio Cairo	15375af				2200-2300 vl	Eqt Guinea, Radio Africa	15190af			
2100-2150	Germany, Deutsche Welle	6185as 9690af 15270af	7225af 9765as	9615af 11785as	9670as 11810af	2200-2230	Hungary, Radio Budapest	3955eu	6110eu	7220eu	
2100-2200	India, All India Radio	7412eu 11715au	9910eu 15225au	9950eu	11620au	2200-2300	India, All India Radio	7412eu 11715au	9910eu 15225au	9950eu	11620au
2100-2200 vl	Italy, IRRS Milan	7125eu				2200-2230	Iran, VOIRI Tehran	9670au			
2100-2200	Japan, NHK/Radio	6035eu 11925eu	9560as	9580af	11800eu	2200-2300 vl	Italy, IRRS Milan	7125eu			
2100-2115	Japan, NHK/Radio	9660as	11915as			2200-2225	Italy, RAI Rome	9710as	11800as	15330as	
2100-2107	Kenya, Kenya Broadc Corp	4935do				2200-2300	Lebanon, Wings of Hope	9960me			
2100-2200	Lebanon, Wings of Hope	9960me				2200-2300	Malaysia, Radio	7295do			
2100-2200	Liberia, Radio ELWA	4760do				2200-2300	Malaysia, RTM/Kota Kinab	5980do			
2100-2125	Netherlands, Radio	9860af	9895af			2200-2300 mtwhfa	New Zealand, R NZ Intl	15115pa			
2100-2200 mtwhfa	New Zealand, R NZ Intl	15115pa				2200-2205	Nigeria, FRCN/Radio	3326do	4990do		
2100-2200	Nigeria, FRCN/Radio	3326do	4990do			2200-2230 s	Norway, Radio Norway Intl	5905sa	6120sa		
2100-2130 s	Norway, Radio Norway Intl	6015eu	9590eu			2200-2300 mtwhfa	Palau, KHBN/Voice of Hope	11980as			
2100-2200 mtwhfa	Palau, KHBN/Voice of Hope	11980as				2200-2300 vl	Papua New Guinea, NBC	4890do	9675do		
2100-2200 vl	Papua New Guinea, NBC	4890do	9675do			2200-2300	Russia, Voice of	5920eu	5965eu	5975na	5995eu
2100-2125	Poland, Polish R Warsaw	6000eu	6135eu	7285eu				6055eu	7135as	7150na	7180eu
2100-2200	Romania, R Romania Intl	5990eu	6105eu	6190eu	7105eu			7300eu	7320eu	7330eu	7350eu
2100-2200	Russia, Voice of	7195eu	9690eu					7380as	7400na	9550eu	9620na
		4055as	5905eu	5920eu	5965eu			9750na	9865af	9890as	
	5975eu	5995eu	6055eu	7170eu		2200-2215	Sierra Leone, SLBS	3316do			
	7180na	7205na	7230eu	7300eu	7320as	2200-2300 vl	Slovakia, AWR	7270af			
	7350as	7380eu	7400eu	9550eu	9620as	2200-2235 vl	Solomon Islands, SIBC	5020do	9545do		
	9795na	9865af	9890eu	13670na	15290na	2200-2205	Syria, Radio Damascus	12085na	15095na		
2100-2150	S Africa, Channel Africa	5960eu	7285eu			2200-2300	Taiwan, VO Free China	5810eu	9850eu		
2100-2115	Sierra Leone, SLBS	3316do				2200-2300	UAE, Radio Abu Dhabi	9605na	9770na	11885na	
2100-2200 vl	Slovakia, AWR	6055eu	7270af			2200-2300	Ukraine, R Ukraine Intl	4820eu	5940eu	6020eu	7150na
2100-2200 vl	Solomon Islands, SIBC	5020do	9545do					7180eu	7240eu	7405na	9620as
2100-2200	South Korea, R Korea Intl	6480eu	15575eu					9685na	9810eu	11870eu	
2100-2200	Spain, R Exterior Espana	6125eu				2200-2300	United Kingdom, BBC London	3955eu	5975na	6195eu	7110as
2100-2105	Syria, Radio Damascus	12085eu	15095na					9915sa	9915sa	11695as	11750sa
2100-2200	Turkey, Voice of	9400eu						11955as	15400eu		
2100-2110	Uganda, Radio	4976do	5026do			2200-2215	United Kingdom, BBC London	6180eu	9410me		
2100-2200	United Kingdom, BBC London	3255af	3915as	3955eu	5975na	2200-2300	USA, KAIJ Dallas TX	13815am	15725am		
		5990as	6005af	6160as	6180eu	2200-2300	USA, KTBN Salt Lk City UT	15590am			
		6195eu	7325eu	9410eu	9740as	2200-2300	USA, Monitor Radio Intl	7510eu	9430as	13625eu	13770sa
		11750sa	11955as	15400eu		2200-2300	USA, VOA Washington DC	6035as	7215as	9705as	9770as
2100-2200	USA, KAIJ Dallas TX	13815am	15725am					9890as	11760as	12080af	13710af
2100-2200	USA, KTBN Salt Lk City UT	15590am						15185au	15290as	15305as	17735as
2100-2200 s	USA, KVON Los Angeles CA	17775am				2200-2300	USA, WEWN Birmingham AL	17820as	9455na		
2100-2200	USA, Monitor Radio Intl	7510eu	9355na	13840au		2200-2300	USA, WHRI Noblesville IN	7425na			
2100-2200	USA, VOA Washington DC	6040eu	6125eu	7415af	9760eu	2200-2300	USA, WINB Red Lion PA	7315am			
		11870pa	13710af	15185pa	15205me	2200-2300	USA, WJCR Upton KY	11915eu			
		15410af	15445af	15580af	17725af	2200-2300 a	USA, WRMI/R Miami Intl	13595na			
		17735pa	17800af	21485af		2200-2300	USA, WRNO New Orleans LA	9955am			
2100-2200	USA, WEWN Birmingham AL	7435na	9455na			2200-2300	USA, WWCR Nashville TN	15420am			
2100-2200	USA, WHRI Noblesville IN	9495am	13760am			2200-2300	USA, WYFR Okeechobee FL	12160am	13845am	15685am	
2100-2200	USA, WINB Red Lion PA	11915eu				2200-2245	Yugoslavia, Radio	11580af			
2100-2200	USA, WJCR Upton KY	13595na				2200-2230	Croatia, Croatian Radio	6100na	6185eu		
2100-2200	USA, WMLK Bethel PA	9465eu				2203-2210	Belgium, R Vlaanderen Int	5920eu	7370eu	9890eu	13830eu
2100-2200	USA, WRNO New Orleans LA	15420am				2230-2300	Israel, Kol Israel	9935sa	7405na		
2100-2200	USA, WWCR Nashville TN	12160eu	13845am	15685am				15640sa			
2100-2200	USA, WYFR Okeechobee FL	7355eu	11580af	13695af		2230-2300	Lithuania, Radio Vilnius	9710eu			
2110-2200	Syria, Radio Damascus	12085na				2230-2300	Sweden, Radio	6065eu			
2115-2200	Egypt, Radio Cairo	9900eu				2240-2250	Greece, Voice of	9375au	9425au		
2115-2130	United Kingdom, BBC London	6110am	15390am	17715am		2245-2300	Ghana, Ghana Broadc Corp	3366do	4915do		
2130-2200	Australia, Radio	9580pa 11695pa	9610as 15365pa	9645as 17860pa	9660pa	2245-2300	India, All India Radio	9705as	9950as	11745as	13750as
2130-2200 vl	Australia, VL8A Alice Spg	4835do						15145as			
2130-2200 vl	Australia, VL8K Katherine	5025do				2245-2300 mtwhf	USA, Voice of the OAS	9670na	11835na	15155na	
2130-2200 vl	Australia, VL8T Tent Crk	4910do				2245-2300	Vatican State, Vatican R	6150as	7305as	9600au	11830pa
2130-2200 mt	Estonia, Estonian Radio	5925eu									
2130-2200	Iran, VOIRI Tehran	9670au									
2130-2200 as	Latvia, Radio	5935eu									
2130-2200 asmtwh	Moldova, R Dnestr Intl	9620eu									
2130-2200	Sweden, Radio	6065eu	9655eu								
2133-2145	Zimbabwe, ZBC	4828do									

FREQUENCIES

2300-2315	Armenia, Radio Yerevan	9480eu	11960eu		2300-0000 vi	Papua New Guinea, NBC	4890do	9675do			
2300-0000	Australia, Radio	9580pa	9610as	9645as	9660pa	2300-0000	Russia, Voice of	7125as	9620na	9685na	9750na
		9850as	11695as	11855as	13755as			12065na	13640as	15425na	17570as
		15365pa	17795pa	17860pa				17890as			
2300-0000 vi	Australia, VL8A Alice Spg	4835do				2300-0000	Turkey, Voice of	7185me	9445na	11710eu	
2300-0000 vi	Australia, VL8K Katherine	5025do				2300-0000	UAE, Radio Abu Dhabi	9605na	9770na	13605na	
2300-0000 vi	Australia, VL8T Tent Crk	4910do				2300-0000	United Kingdom, BBC London	5975na	6175na	6195as	7110as
2300-0000 vi	Canada, CBC N Quebec Svc	9625do						7180as	7325na	9580as	9590na
2300-0000	Canada, CFCX Montreal	6005do						9915sa	11750sa	11945as	11955as
2300-0000	Canada, CFRX Toronto	6070do						15340as			
2300-0000	Canada, CFVP Calgary	6030do				2300-2315	United Kingdom, BBC London	15400eu			
2300-0000	Canada, CHNX Halifax	6130do				2300-0000	USA, KAJJ Dallas TX	13740am	13815am		
2300-0000	Canada, CKZN St John's	6160do				2300-0000	USA, KTBN Salt Lk City UT	15590am			
2300-0000	Canada, CKZU Vancouver	6160do				2300-0000	USA, KWHR Naalehu HI	11980as			
2300-0000 as	Canada, RCI Montreal	9535am	9755na	11845na	11920na	2300-0000	USA, Monitor Radio Intl	7510eu	9430as	13625as	13770sa
		11940na				2300-0000	USA, VOA Washington DC	6035as	7215as	9705as	9770as
2300-2330 mtwhf	Canada, RCI Montreal	5960na	9535na	9755na	11845na			9890as	11760as	15185au	15290as
		11940na						15305as	17735as	17820as	
2300-0000	Costa Rica, R Peace Intl	7385am	9400am	15050am	17905am	2300-0000	USA, WCSN Scotts Cor ME	9855eu			
2300-0000	Ecuador, HCJB Quito	6080do				2300-0000	USA, WEWN Birmingham AL	7425na	9455na		
2300-0000	Egypt, Radio Cairo	9900na				2300-0000	USA, WHRI Noblesville IN	7315am			
2300-0000	Guam, AWR/KSDA	11980as				2300-0000	USA, WINB Red Lion PA	11915eu			
2300-0000 vi	Guatemala, AWR	5980ca				2300-0000	USA, WJCR Upton KY	13595na			
2300-0000	India, All India Radio	9705as	9950as	11745as	13750as	2300-0000 mtwtf	USA, WRMI/R Miami Intl	9955am			
		15145as				2300-0000	USA, WWCR Nashville TN	5065am	13845am		
2300-0000 vi	Italy, IRRS Milan	7125eu				2330-2345	Armenia, Radio Yerevan	9685na	11920na	11970na	
2300-0000	Japan, NHK/Radio	6055eu	6155eu	9560as	9580as	2330-0000	Austria, R Austria Intl	9870sa	13730sa		
2300-0000	Lebanon, Wings of Hope	9960me				2300-0000 mtwhf	Canada, RCI Montreal	5960na	9755na		
2300-0000	Malaysia, Radio	7295do				2330-0000	Finland, YLE/Radio	5990na	6015na	9680as	
2300-0000	Malaysia, RTM/Kota Kinab	5980do				2330-0000	Netherlands, Radio	6020na	6165na		
2300-0000 mtwhfa	New Zealand, R NZ Intl	15115pa				2330-0000	Sweden, Radio	11910as			
2300-2305	Nigeria, FRCN/Radio	3326do	4990do			2330-0000	Vietnam, Voice of	12025as	15010as		
2300-2350	North Korea, R Pyongyang	11700na	13650na			2335-2345	Greece, Voice of	9375sa	9425sa	11595sa	
2300-2330 s	Norway, Radio Norway Intl	6030as	6120as								
2300-0000 mtwhfa	Palau, KHBV/Voice of Hope	11980as									

SELECTED PROGRAMS

Sundays

- 2300 BBC: Newsdesk. See S 0200.
- 2330 BBC: Feature. World Service Guide to the Information Superhighway (5th, 12th, 19th). See S 1401.
- 2330 Radio Australia: Network Asia. John Westland hosts this program of in-depth interviews and information about world, regional and Australian issues.

Mondays

- 2300 BBC: Newsdesk. See S 0200.
- 2300 Radio Canada Int'l: The World at Six. Half hour news magazine from the CBC domestic radio network.
- 2306 Monitor Radio Int'l: Monitor Radio International. See M 1406.
- 2330 Radio Australia: Network Asia. See S 2330.
- 2330 Radio Canada Int'l: As It Happens. Live telephone interviews with newsmakers around the world.

Tuesdays

- 2300 BBC: Newsdesk. See S 0200.
- 2300 Radio Canada Int'l: The World at Six. See M 2300.
- 2306 Monitor Radio Int'l: Monitor Radio International. See M 1406.
- 2311 Voice of Russia: Commonwealth Update. See T 0211.
- 2330 Radio Australia: Network Asia. See S 2330.
- 2330 Radio Canada Int'l: As It Happens. See M 2330.
- 2330 Voice of America (as): VOA Wednesday Morning. See S 0610.
- 2338 Radio Netherlands: Newline. See S 0337.

Wednesdays

- 2300 BBC: Newsdesk. See S 0200.
- 2300 Radio Canada Int'l: The World at Six. See M 2300.
- 2306 Monitor Radio Int'l: Monitor Radio International. See M 1406.
- 2310 Voice of Turkey: Review of the Foreign Media. Items of interest to Turkey found in the media of other countries.
- 2330 Radio Australia: Network Asia. See S 2330.
- 2330 Radio Canada Int'l: As It Happens. See M 2330.

Thursdays

- 2300 BBC: Newsdesk. See S 0200.
- 2300 Radio Canada Int'l: The World at Six. See M 2300.
- 2305 Voice of Turkey: Review of the Turkish Press. See S 0407.
- 2306 Monitor Radio Int'l: Monitor Radio International. See M 1406.

- 2330 BBC: Quiz. Quote, Unquote (2nd, 9th, 16th, 23rd, 30th). See W 1530.
- 2330 Radio Australia: Network Asia. See S 2330.
- 2330 Radio Canada Int'l: As It Happens. See M 2330.

Fridays

- 2300 BBC: Newsdesk. See S 0200.
- 2300 Radio Canada Int'l: The World at Six. See M 2300.
- 2306 Monitor Radio Int'l: Monitor Radio International. See M 1406.

- 2310 Radio Australia: Asia Focus. See M 1510.
- 2330 Radio Canada Int'l: As It Happens. See M 2330.
- 2335 Radio Radio Sweden: A Review of the Newsweek. See F 1235.

Saturdays

- 2300 BBC: Newsdesk. See S 0200.
- 2310 Voice of America (as): VOA Sunday Morning. See S 0610.
- 2345 WWCR #1: Weekly Presidential Radio Address. Bill Clinton's weekly report to the nation.

HAUSER'S HIGHLIGHTS: COSTA RICA

Radio for Peace International programs on 17910-USB, 15050-AM, 12150-USB, 9400-USB, 7385 include:

Program

0600 *World of Radio*
1800, Sun 0200, 1000, 2300, Mon 0700
RFPI's Mailbag

Radio Democracy
Focus on Haiti
WINGS
Common Ground
University of the Air

Second Opinion
Vietnam Veterans Radio
Network
Dialogue--UPAZ News
Living Enrichment Center
My Green Earth
Making Contact
World Citizens Weekly
Commentary
Wisdom School of the Air or
Science & Spirit
Sound Currents of the Spirit

Days and Times

Tue 1900, Wed 0300, 1100, Fri 2000, Sat 0400, 1200,
1930, Sun 0330, 1130, Fri 2030, Sat 0430, 1230,
1930, Sun 0330, 1130

Tue 2000, Wed 0300, 1200, Sat 2030, Sun 0430, 1230
Tue 2030, Wed 0430, 1230, Sat 2100, Sun 0500, 1300
Tue 2130, Wed 0530, Thu 2030, Fri 0430, 1230

Tue 2200, Wed 0600
Tue, Wed, Thu 2230, Wed, Thu, Fri 0630, Fri, Sat 2300,
Sat, Sun 0700, 1500
Wed 1800, Thu 0200, 1000, Fri 2130, Sat 0530, 1330

Wed 2130, Thu 0530, Sat 2230, Sun 0630, 1430
Wed 2330, Thu 0730
Thu 1800, Fri 0200, 1000, Sun 2000, Mon 0400, 1200
Thu 2200, Fri 0600, Sun 1830, Mon 0230, 1030
Fri 1800, Sat 0200, 1000, 2000, Sun 0400, 1200
Fri 2330, Sat 0730, 1530

Sat 2130, Sun 0530, 1330

Sun 2030, Mon 0430, 1230



STARTEK INTERNATIONAL INC. FREQUENCY COUNTERS

FIND FREQUENCIES FAST with the StarTek ATH™ Series
Four AUTO TRIGGER & HOLD Models, TWO Priced Below \$200!!

NEW!
ATH-10



\$149.
\$179 value

MADE
IN
USA

ATH™ SERIES FEATURES:

- Easy to use - simple controls
- Ultra fast response time
- Extra BRIGHT LED digits
- AC or Battery operation
- Maximized sensitivity



\$189.
\$235 value

Optional #TA-9C Antenna

WARRANTY
5 Years Parts
1 Year Labor

BAND PASS FILTERS



ACCESSORIES

- #CS-90 Soft Case for all models.....\$12.
- #TZ-90 Telescope Elbow BNC antenna.....16.
- #T2-90-L Telescope Elbow BNC antenna.....12.
- #RD-150 150 MHz Rubber Duck antenna.....16.
- #RD-2750 27 & 50 MHz Rubber Duck antenna.....28.
- #RD-450 450 MHz Rubber Duck antenna.....16.
- #RD-800 Cellular phone band RD antenna.....29.
- #C6A ABOVE 7 items, SAVE \$30...99.**
- #M-207-IC Interface Cable MFJ ant. analyzers.....10.
- #P-110 200 MHz 1X-10X probe.....39.
- #LF-22 Low Pass, audio probe.....25.
- #DC-10 Direct, 50 CHM probe.....20.

FEATURES

	ATH-10	ATH-15	ATH-30	ATH-50
	\$149 reg \$179	\$189 reg \$235	\$249 reg \$299	\$289 reg \$339
FREQUENCY RANGE	1 MHz - 1200 MHz	1 MHz - 1500 MHz	1 MHz - 2800 MHz	5 Hz - 2800 MHz
AUTO TRIGGER & HOLD	YES	YES	YES	YES
SIGNAL BAR GRAPH	NO	YES	YES	YES
LOW BATTERY IND	NO	YES	YES	YES
ONE-SHOT & RESET	NO	OPTIONAL	YES	YES
HIGH LOW RANGE	NO	NC	NO	YES

OPTION #HST-15 is a high accuracy, high stability, time base upgrade that can be ordered with any ATH series model (0.2PPM TCXO).....**\$100.**

External readability distance with **BAND PASS FILTERS, \$49 ea.**

- #LP-60 CC - 6C MHz
- #HP-400 400 - 1500 MHz
- #BP-150 130 - 500 MHz
- #HP-800 800 - 2000 MHz

#BP-4 All 4 Filters \$189

Factory Direct
Order Lines

SAME DAY SHIPMENT
Orders & Information
305-561-2211

Orders Only
800-638-8050

FAX 305-561-9133



Model 1350

Economy Frequency Counter
1-1300 MHz, ±GT, Hold Sw.
(No ATH or Ser Graph)... **\$119.**

All instruments are true Pocket Size:
4" High x 3.5" Wide x 1" Deep, <14 cubic in.
and are shipped with factory installed Ni-Cad batteries and AC charger/adaptor. Antennas are optional.

STARTEK INTERNATIONAL INC.

398 NE 38th St., Ft. Lauderdale, FL 33334

Terms Shipping/handling charges U.S. & Canada 5% (\$5 min., \$10 max) Others add 15%. FL residents add 6% tax. COD fee \$5.
VISA, MC, Discover accepted. Prices & specifications subject to change without notice or obligation.

Propagation conditions: Eastern United States

How to use the propagation charts: Propagation charts can be an invaluable aid to the DXer in determining which frequencies are likely to be open at a given time. To use the propagation charts, choose those for your location. Then look for the one most closely describing the geographic location of the station you want to hear. The Sun Spot Number used this month for forecasting purposes is 14.

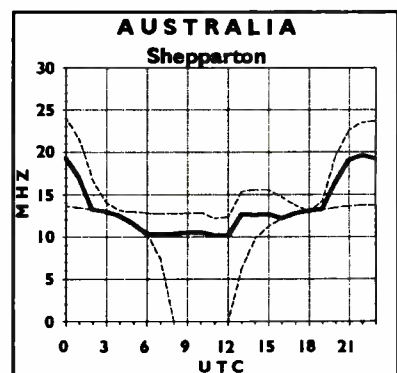
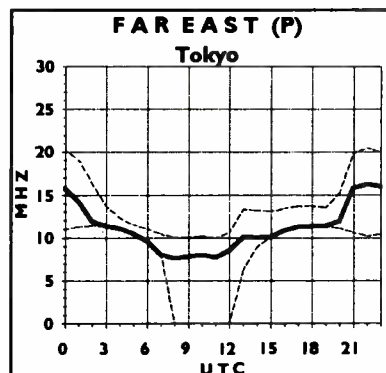
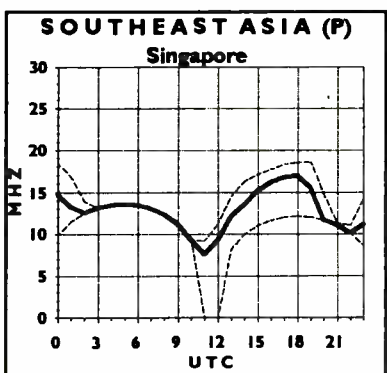
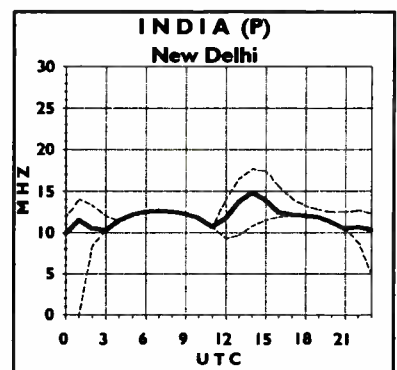
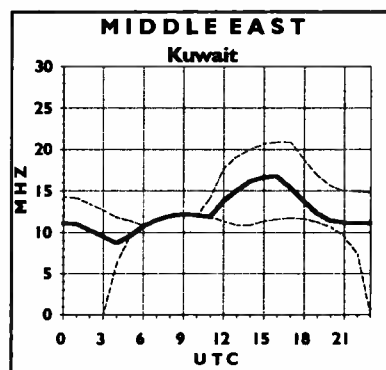
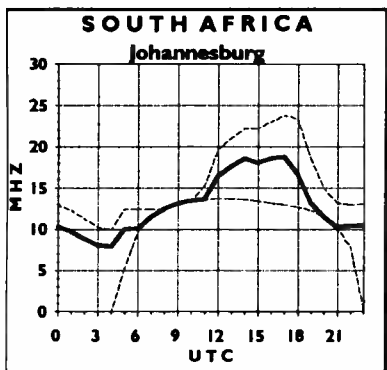
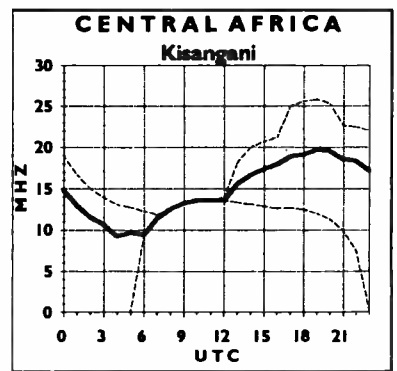
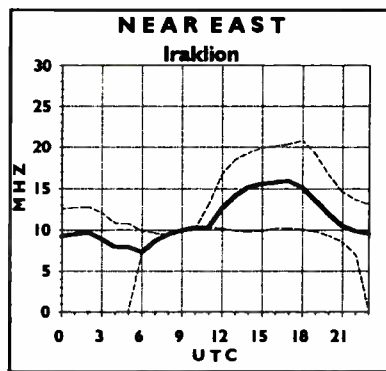
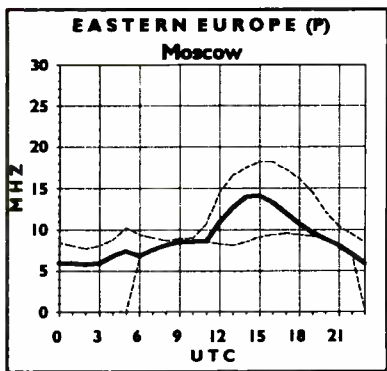
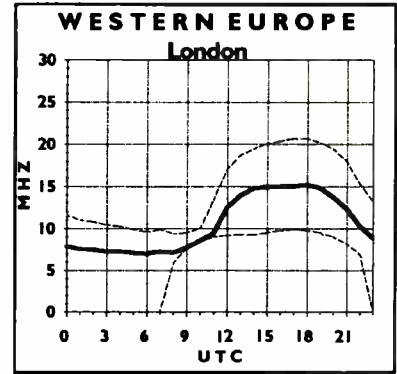
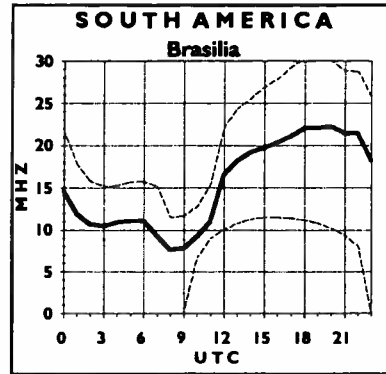
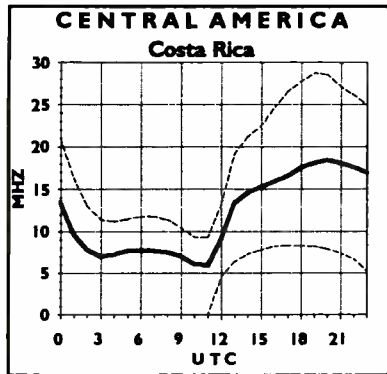

Propagation Conditions: Western United States

Once you've located the correct charts, look along the horizontal axis of the graph for the time you are listening. The top line of the graph shows the maximum usable frequency (MUF), the heavy middle line is the frequency for best reception, or optimum working frequency (OWF), and finally, the bottom line is the lowest usable frequency (LUF). You will find the best reception along the heavy middle line. Circuits labeled (P) cross the polar auroral zone. Expect poor reception on these circuits during ionospheric disturbances.

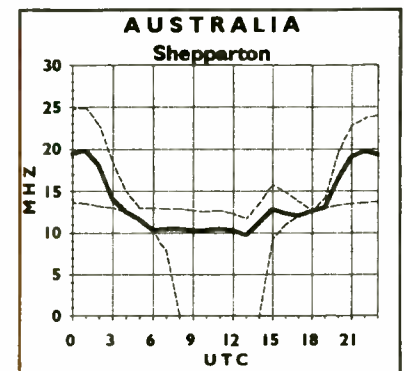
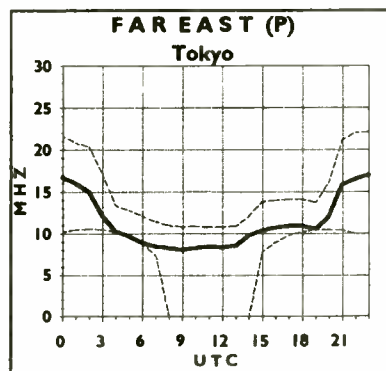
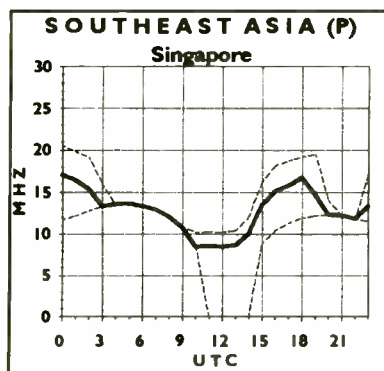
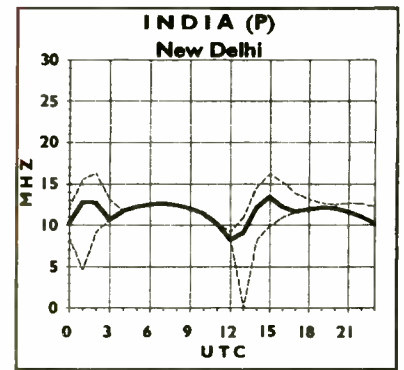
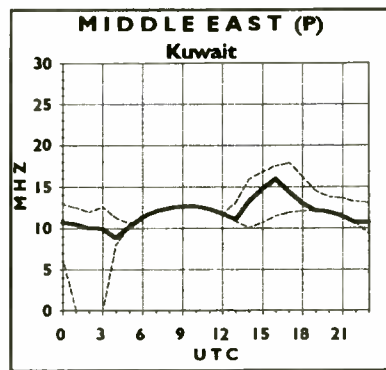
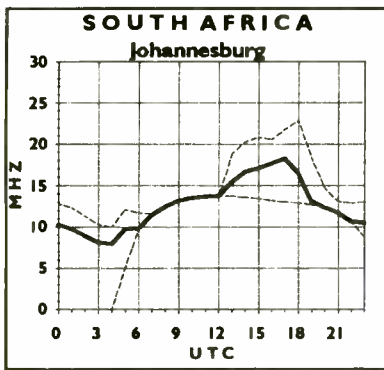
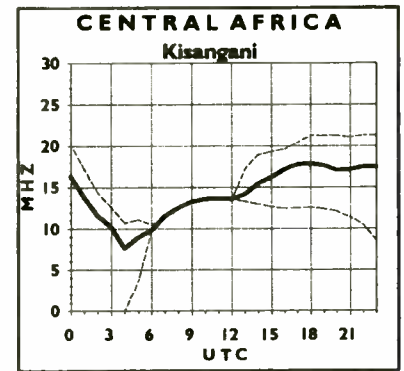
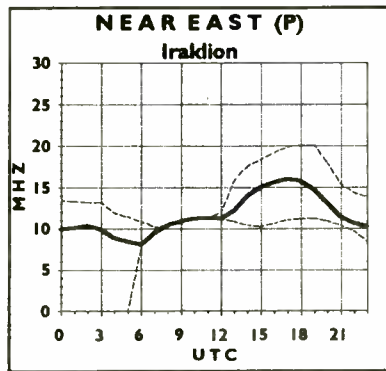
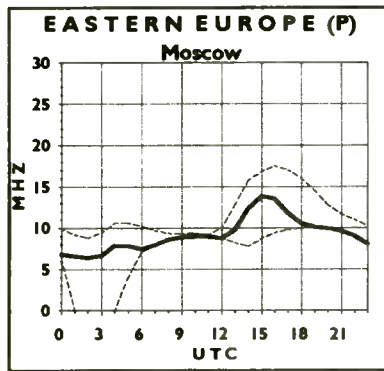
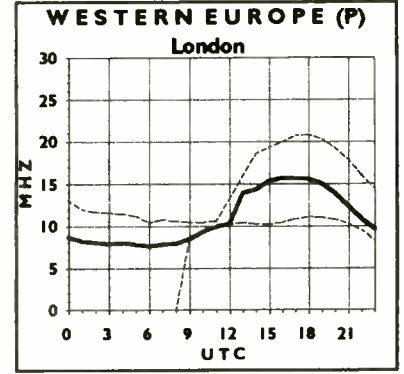
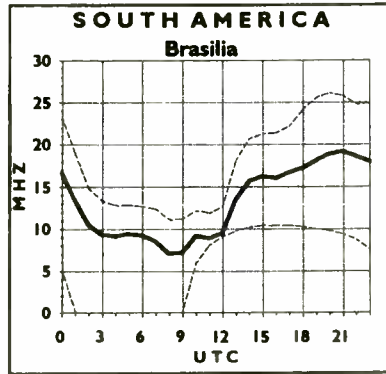
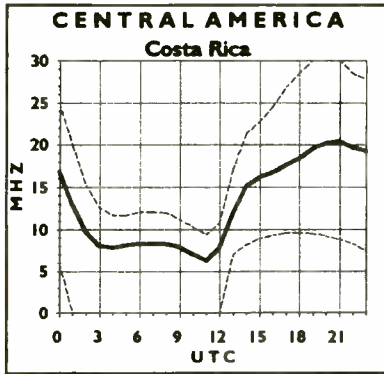

PROGRAMMING SPOTLIGHT

TOPICS OF INTEREST TO PROGRAM LISTENERS

VOA Inaugurates Talk Radio

By Jim Frimmel

Talk radio programming hit the shortwave bands big time on November 28, 1994, with the advent of the Voice of America's new *Talk to America* program. The popularity of this format on the AM band (mediumwave) seems to have convinced VOA's management that it could also work on shortwave radio. "The World's first and only daily radio talk show" as VOA calls itself, is "your direct connection to the United States."

The winning formula that the VOA concocted is a combination of a tremendous variety of talk topics, an offer to receive collect calls from around the world, and expert guests to field questions from listeners. Besides the collect calls, *Talk to America* accepts listener questions by fax and via the Internet. But, in keeping with VOA's charter which prohibits broadcasting exclusively to American listeners, calls from the United States are not accepted.

The 55-minute broadcast is aired live Mon-Fri at 1706 UTC (12:06 pm, EST), and is repeated at 1006 and 1206 UTC. The best reception for North American listeners is via the English to Africa service (17895, 15445, 15410 kHz).

The program is ably hosted by Barbara Klein and Meredith Buel. When a controversial issue is being covered, such as one dealing with U.S. foreign aid programs, guests may be of opposing views so as to present both sides of the argument.

■ Program Topics

Health issues have been a major topic of discussion to date, appropriately starting on December 1st with AIDS, the world's most serious health problem, and followed the next day by the subject of disabled people. A most interesting program on Alzheimer's Disease was aired on December 7th, and another health program on world diseases in general was heard on December 20th.

Programs on human rights issues, world culture, and the coverage of immigration to the U.S. and California's Proposition 187 were also heard during December.



Co-hosts Barbara Klein and Meredith Buel.

International peace issues were discussed in a program devoted to the resolution of world conflicts, and a program about charities rounded out the global topic agenda during December.

On the home front, *Talk to America's* coverage of things exclusive to the U.S. added a change of pace to the program's subject matter. An historical look at the roaring twenties and a conversation with Trudy Peterson of the National Archives in Washington provided some prerecorded holiday fare without calls from listeners.

More American programs ushered in the new year. One devoted to the political scene covered the subject of the future leaders of America, and the issue of multinational enterprises in the U.S. aired in early January. A most entertaining program was broadcast on January 6th to commemorate the birthday of the King of Rock and Roll—Elvis Presley.

In a program on the fate of the world's endangered species, the decline of Africa's wildlife (and other creatures worldwide), and efforts to save them, were discussed with the Director of Washington's National Zoo

■ Upcoming Programs

Unfortunately, there is no program guide to the multitude of topics covered by *Talk to America*. If you want to know the subject of a program you will have to tune in. However, on-the-air announcements of the following day's program content may be heard on the half hour (following a short news break) and

at the end of each program. This is understandable, considering that the program is live and includes special guests. (Even Larry King has his problems with scheduling due to breaking news events.) Perhaps VOA will consider announcements via the Internet at some future date.

■ On the Technical Side

Telephone connections are via satellite to enable conversations to be transmitted with the clarity of a local telephone call. This is strictly an English language broadcast and calls are accepted only in English. Most callers can be easily understood; however, there are occasions when a caller's accent gets in the way of the question.

The Voice of America is the international radio service of the U.S. Information Agency, broadcasting almost 1,000 hours a week in 45 languages. VOA's direct shortwave and medium wave broadcasts reach approximately 92 million listeners. This estimate does not include listeners who tune in VOA programs rebroadcast by over 1,100 affiliated radio stations around the world, greatly expanding VOA's listening audience. One in five listeners tunes in VOA Worldwide English, according to VOA.

VOA's telephone number for listeners to call in is 202-619-3111 (voice line).

■ Other Changes at VOA

VOA's *Communications World* has expanded from 20 to 30 minutes and has also been retimed to begin on the half-hour to satisfy the growing interest in the latest developments in computers and in telecommunications.

During *Communications World's* annual New Year's program, host Gene Reich and guest Kim Elliott, VOA's Director of Audience Research, speculated about the possibility of additional changes in the upcoming year. Both seemed to agree that additional changes might be made during 1995 to meet VOA's continuing effort to satisfy its international audience's endless demand for news and information. As they say on the radio, "Stay tuned..."

A Summary of "Talk to America" Topics

Topic	Guests
World Wide Refugee Situation	Lionel Rosenblatt - Refugees, Inc. Sylvana Fao - UNHCR
Making it in Nashville	Trisha Yearwood - country music star Lisa Gubernick - author
Alzheimers Disease	Erin Conners - American Health Assistance Foundation Dr. Don Price - Johns Hopkins Hospital
Cultural Potpourri	Peter Menzel - photographer and author Bela Fleck - musician and jazz and bluegrass pioneer
US Immigration Controversy	John Miller - Manhattan Project John "Jack" Martin - Center for Immigration Studies
Human Rights	Holly Berkhalter - DC Director of Human Rights Watch John O'Dea - DC Director of Amnesty International
Conflict Resolution	Vamik Volkan - psychiatrist Joseph Montville - former US career diplomat
Foreign Press Perception of US Politics	A panel of Washington-based journalists describe their coverage of issues stemming from the November elections.
A Vision of the Human Future in Space	Carl Sagan - distinguished astronomer and author discussing his latest book <i>Pale Blue Dot</i>
Media in US Courtrooms	Ephraim Margolin - attorney and lecturer Timothy Dyk - attorney for national broadcasters
Charity and Volunteerism in the US	Sara Melendez - The Independent Sector Colonel Leon Ferraez - The Salvation Army
Diseases of the Future	Laurie Garrett - author of <i>The Coming Plague</i> Prof. Philip K. Russell - Epidemiologist, NIH
New Wisdom from the Vatican	Deacon Chris Boumann discusses Pope John Paul II's book <i>Crossing the Threshold of Hope</i>
Marital Conflict	Dr. Clifford Notarius - author Dr. Concita Espino - marriage specialist
Holiday Music	VOA music personalities Judy Massa, Rich Kleinfeldt, and Ray McDonald discuss new holiday music releases
Other Than Christmas	Fr. Victor Potapov - Eastern Orthodox Priest Ayon Handy Clary - African American Holiday Foundation
Opera in Washington the US	Mary Hermann - Washington Ethical Society Martin Feinston - discusses his 15 seasons as Director of the Washington Opera
The Al Capone Era and A Trip to the National Archives	Lawrence Bergreen - Capone biographer Trudy Peterson - Deputy Archivist of the US
Provocative new play <i>Otabenga</i>	John Strand - playwright Michael Kahn - play director
Looking Toward Tomorrow	Dr. Gerald Barney - The Millennium Institute Walter Corson - Global Tomorrow Colation
The New Congress	Two political analysts examine the beginning of a new political order in the Republican-controlled US Congress
US Leaders of the Future	Barry Seamans - editor of <i>Time</i> magazine Chaka Fattah - Pennsylvania Congressman
Global Economy and Multi-National Enterprises	Nancy Ann Minn - White House Budget Official Dr. William Keller - Cong. Ofc of Tech. Assessment
American Youth Icon Turns 60	Fred Bergsten - Institute for Int'l Economics Prof. Michael O'Leary - Maxwell School of Citizenship
Saving Endangered Species	Jose Esposito - author of new Elvis Presley book Todd Morgan - of Presley's Graceland mansion Richard Block - World Wildlife Fund
Changing US Foreign Aid Policies	Nicholas Geogiadis - Washington University Michael Robinson - Deputy Director of the National Zoo Carol Lancaster - Deputy Administrator, AID
Expanding World Food Supplies through Biotechnology	Larry DiRida - Heritage Foundation Dr. Margaret Mellon - Union of Concerned Scientists
Life of a Superstar	Dr. Richard Herrett - EnvirAg Associates Greg Simon - Office of the V.P., The White House
The Threats of Radiation	Garth Brooks - country music recording artist discusses his career and rise to stardom Steve Klaidman - US Advisory Committee on Radiation Daryl Kimbell - Physicians for Social Responsibility

It's time you found out...

What over 185,000 people already know.

NOW YOU'RE TALKING!

was written with you, the reader, in mind.

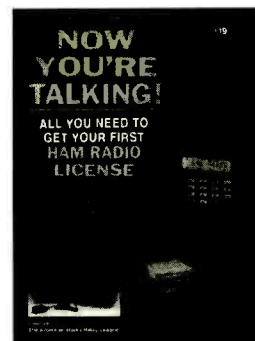

There's never been a more exciting time to get your Ham license. You can use Amateur Radio as a fun, friendly method of local communication, an invaluable tool in emergencies, or even experience the thrill of talking to Astronauts and Cosmonauts in orbit.

Whether you want to enter Amateur Radio as a Technician and choose to skip the code, or as a Novice licensee, *Now You're Talking* will provide you with the information you need in bite-size, easy-to-understand diagrams, photos and sketches, you'll be familiar with all the questions used to make up the FCC test...and you'll be ready for it.

In addition to study material that won't let you down, you'll find invaluable operating hints and tips you'll use once you pass your test. *Now You're Talking: All You Need to Get Your First Ham License* is the book you'll use even after you've passed your exam.

You can shop around for bargains, or you can join the thousands of licensed amateurs who have used *Now You're Talking* to pass their exam. Order your copy today:

Enclosed is \$19 plus \$4 for shipping (a total of \$23) or charge \$23 to my
 VISA Mastercard
 Discover American Express

**For more Information Call
1-800-326-3942**

Signature _____

Acct. No. _____

Expiration Date _____

Name _____

Address _____

City _____ State _____ Zip _____

MT

**THE AMERICAN RADIO RELAY LEAGUE
225 MAIN STREET
NEWINGTON, CT 06111**

Books for the Domestic DXer

Last month, I covered some of the hints and kinks of getting QSLs from AM/FM/TV stations. What I didn't cover was how to figure out where to send your reports. Those of you who DX shortwave probably already have a copy of the *World Radio-TV Handbook* or *Passport to World Band Radio*. You've probably also found that those publications, while excellent for shortwave DXing, aren't nearly as useful for the domestic bands. There are, however, several publications available to cover domestic AM/FM/TV stations.

■ Station lists

Only one reference I'm aware of covers all three domestic bands in one book. *The Broadcasting and Cable Yearbook* is published annually for station executives. It lists all U.S. and Canadian AM/FM/TV stations, including their frequency, power, programming format, mailing address, and other information. There's a wealth of other information in there as well—listings of cable systems, directories of equipment suppliers, etc. Of course, such a comprehensive listing comes at a price—in this case, several hundred dollars. If you're really that serious about DXing, you can write the address in the sidebar for more information. If you're not that serious, visit your local library. Many public libraries have a recent copy of the *Yearbook* in their reference section.

The National Radio Club's *AM Radio Log* is probably the best reasonably-priced DXer's reference. The 15th Edition is roughly 320 pages; it lists U.S. and Canadian AM stations, with frequency, power, programming, mailing addresses, and slogans. Listings are updated by users of the *Log* and members of the NRC, so they reflect what's actually on the air. Best of all, the price is only \$19.95 in the USA. (NRC members get a discount.) The address is elsewhere in this article. Send a 32-cent stamp for the NRC Information Catalog, which lists other DX-related publications of this organization.

A similar publication which covers both AM and FM is the International Radio Club of America's *AM-FM Almanac*. As of this writing, the 1994 edition was not yet ready, though it may be by the time you read this. Reprints of the 1991 edition were available for \$15

(USA). IRCA also publishes a Mexican AM log, especially useful for those in Texas and the Southwest.

M Street Journal also prints an AM/FM directory. It comes free to those who subscribe to their weekly newsletter, or can be purchased separately for \$30-40.

The standard reference for the FM DXer is Bruce Elving's *FM Atlas*. (\$14.95 USA) While it doesn't include mailing addresses, it does have all the other information in the IRCA and *M Street* publications. The *FM Atlas* also includes maps of all 50 states and 10 Canadian provinces, showing the locations of FM stations; it also provides estimates of the coverage areas of stations.

I AM A FAN OF RADIO CAYMAN

CHOICE
80.9 FM 91.9 FM
1555 AM 105.9 FM

Catch Radio Cayman on AM while you can. Their transmitter on 1205 kHz has already gone off the air, and the 1555 kHz transmitter will not be repaired when it fails. If you miss them on AM, you do still have another chance: their FM transmitters have been heard in the southeastern U.S. via E-skip.

All three domestic bands are covered by separate publications from Dajja Enterprises. These logs are similar in appearance to the *NRC Log* (indeed, Dajja's owner once compiled the *NRC Log*) but cover FM and TV as well.

The only TV-only database I'm aware of is the *Television and Cable Factbook*. This book is similar in size (and price!) to the *Broadcasting and Cable Yearbook*, but since it only covers TV, it can go into much greater detail. Indeed, each U.S. commercial station has its own page, including a coverage map. As with the *Yearbook*, only the most serious (and wealthy!) DXer will want to purchase one, but many public libraries have copies.

■ Other books

The library of a serious DXer should include a few books that don't immediately appear to be related to the hobby. These books should assist in identifying those catches that don't provide quite enough information for an immediate ID.

You should start with a good road atlas. I

use Rand McNally's, available at most convenience stores and bookstores. Other atlases (Gousha, AAA, etc.) are just as good. You'll often hear a short snippet of a commercial—let's say you're listening on 1150kHz and hear "Acme Plumbing, Montgomery County's Best, I-64 Exit 113." With an atlas, you can trace I-64, looking at each Exit 113 for a town with a station on 1150. It won't take long to find Mount Sterling, Kentucky, home of WMST-1150AM and the seat of Montgomery County.

During an FM/TV opening, a road atlas is also helpful for pinpointing other potential DX targets. If I'm receiving Cincinnati TV stations here in Nashville, my atlas tells me I should also be looking for Dayton and Columbus.

You should keep a copy of your local White Pages telephone directory near your DXing position. It's not unusual to hear full phone numbers with area code in ads. The area code map in the front of your phone book will give at least a rough idea of where your DX target is located.

■ Clubs and monthly publications

Last, but certainly not least, are the regular monthly publications. Of course, if you're reading this article, you're already getting the most important magazine for the DXer! But if you decide to become active in the domestic bands, you may want to consider membership in one of the specialized clubs for those who share your interest. Club bulletins keep you up to date with newly-licensed stations, changes in frequency and callsign, etc., as well as letting you know what other DXers in your area are hearing. Of course, they also help you meet others with whom you may want to discuss your hobby.

For AM DXers, there are two national clubs: the National Radio Club and the Inter-



Here's one that's too late to log. CFTR (680kHz) in Toronto, Ontario is still on the air, but it's no longer "All-Hits CFTR." The station now broadcasts an all-news format.

national Radio Club of America. Annual NRC membership is \$24 for new members in the USA, and includes an excellent "Introduction to Medium Wave DXing." IRCA annual membership is \$25. The two clubs are quite similar, with the IRCA having a slight West Coast emphasis, and the NRC slightly featuring the East.

The Worldwide TV-FM DX Association, as its name implies, serves both FM and TV DXers throughout North America. Annual membership is \$20 in the USA.

Don't forget your local DX club! Many local and regional clubs are listed in Club Circuit, near the back of each month's issue of *Monitoring Times*. These groups can be especially helpful with advice on local conditions and stations.

Publishers of Referenced Works For the Domenstic DXer

Broadcasting and Cable Yearbook
1705 DeSales Street, NW
Washington, DC 20036

Dajja Enterprises
P.O. Box 24
Cambridge, WI 53523-0024

FM Atlas *
Box 24
Adolph, MN 55701-0024

International Radio Club of America
9705 Mary NW
Seattle, WA 98117 (AM-FM Almanac)

International Radio Club of America
Box 1831
Perris, CA 92572-1831 (membership)

M Street Journal *
304 Park Avenue S., 7th Floor
New York, NY 10010

National Radio Club
Box 164
Mannsville, NY 13661-0164 (AM Radio Log)

National Radio Club
Box 118
Poquonock, CT 06064-0118 (membership)

Television and Cable Factbook
2115 Ward Court, NW
Washington, DC 20037

Worldwide TV-FM DX Association
Box 514
Buffalo, NY 14205-0514

* (Also available from Grove Enterprises)

Other suggestions?

Did I miss your favorite DXing reference? I'd like to know about it. Write at the Brasstown address, or by email at 72777.3143@compuserve.com. (Compuserve subscribers can address simply to 72777,3143)

Strange sounds

Reader H. Kelley in New Mexico sent in an article from the Albuquerque *Tribune*, regarding some very unusual programming on KAMX (1520kHz) and their FM station on 107.9 MHz. The stations adopted an all-sound effects format for several days, complete with commercials and requests! Sounds heard included sirens, dentist's drills, crowing roosters, and more.

No, this wasn't their permanent format. The station told the *Tribune* they would be adopting a new, hopefully more traditional, format later in the week. DXers should know that this is a common stunt for stations about to change programming. I've heard other stations air ticking clocks, construction noises,

and even covers of the 60's song *Louie, Louie* continuously for days!

Bits and Pieces

Two Caribbean stations frequently heard by U.S. DXers have made technical changes. The Caribbean Beacon on Anguilla (1610 kHz) has increased power from 50 kW to 200 kW and installed a directional antenna. DXers in my area report its signal has improved considerably. And Radio Vision Cristiana in the Turks and Caicos Islands has changed frequency from 535 kHz to 532 kHz. Speculation is that the new frequency will allow the station to be heard better on digital radios which won't tune to "non-standard" frequencies.

Long Island thieves have taken to a new target. *Inside Radio* reports that the exciter—a critical part of the transmitter—have been stolen from two radio stations while they were on the air. Obviously, the stations didn't stay on the air long after the theft! TV field crews have also been suffering a rash of camera thefts, throughout the U.S..

When it comes to effective multi-band DX antennas for limited space applications, it comes to the world class ALPHA DELTA DX-SWL family of High Performance SLOPERS!

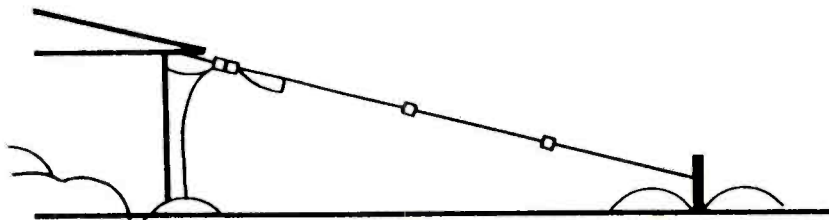

- Fully assembled, ready to use and built for long life. So strong, it can even be used to transmit—up to 2 kW!
- Superior multi-band performance on 13, 16, 19, 21, 25, 31, 41, 49, 60, 90, 120 meters plus the AM broadcast band (.5-1.6 MHz). All in a single compact antenna. Alpha Delta first!
- Efficient multi-band frequency selection by means of special RF choke-resonators—instead of lossy, narrow band traps.
- Overall length just 60 feet. Requires only a single elevated support—easier to install than a dipole.
- 50 ohm feedpoint at apex of antenna for maximum DX reception. A UHF connector is provided on the mounting bracket for easy connection to your coax.
- A top overall rating in Radio Database International's hard-hitting White Paper, "RDI Evaluates the Popular Outdoor Antennas."

- Model DX-SWL, AM broadcast thru 13 mtrs, 60' long\$69.95
- Model DX-SWL-S, as above but 90 thru 13 mtrs, only 40' long\$59.95

Both models are broadbanded and give excellent performance across the utility frequencies. Available from your local Alpha Dealer or direct. Add \$5.00 shipping and handling (U.S.A. only) Exports quoted.

ALPHA DELTA COMMUNICATIONS, INC.

P.O. Box 620, Manchester, KY 40962
Phone: (606) 598-2029 • FAX: (606) 598-4413



PostScripts

As we reported in last month's column, the United States hosted the Summit of the Americas in Miami, Fla., during December of 1994. I have finally compiled the monitoring reports that were submitted and here is a final summary of the radio traffic.

UNITED STATES SECRET SERVICE

Channel	Frequency	Use
165.375	Charlies	Main channel - DVP traffic
166.700	November	Peru Main Base
165.7875	Baker	Security Room
166.5125	Sierra	All DVP Traffic
164.400	Papa	"Broadside"
164.650	Tango	All DVP Traffic
165.2125	Mike	Security Room

"Alpha Bravo" - Aircraft Channels

366.00	S1-S3	
407.850	Yankee	Uplink to AF1

UHF Secret Service Repeater

415.650	Repeater Output
419.700	Repeater Input 103.5 HZ tone

Liaison with Civilian Aircraft

118.300	Miami Tower working AF1/AF2
119.450	Same
135.175	Miami Center working AF1/AF2/SAM28000

Feds Hide Behind Locals

Dade County, of which Miami is the county seat, uses the General Electric EDACS trunked system. EDACS stands for *Enhanced Digital Access Communications System*. This is the General Electric version of trunked radio. As has been mentioned in earlier columns, the federal agencies in some cities across the United States are starting to show up on 800 MHz trunked channels. Some are using business fronts, others are using sub-fleets on local government channels.

Dade County is using the following frequencies for their trunked system:

867.9125	866.3625	867.7625	866.3875
867.1375	867.3875	867.6625	866.6125
866.6375	866.1375	866.8875	866.8625
868.6125	—Control channel		
866.1125	—Control channel		

For the summit meeting there were two stand-alone repeaters on 868.3625 and 868.4125 MHz. These were running diplo-

matic protection traffic in both the clear and the encrypted modes. The subaudible tone used was 156.7 Hz.

The City of Miami Beach uses its own trunked system. They added a special police fleet for this event. There were four subfleets used. They were:

1-f (11F)	Tac 1 detail
2-f (11M)	Special event
3-f (12B)	X-ray channel
2-e (11L)	Motorcade passage

The State of Florida used its ASTRO system to supplement the federal and local communications. This presented an interesting problem. The State of Florida uses the Motorola ASTRO system of technology for its trunked system. Dade County and its affiliated cities use the General Electric system, and the federal agencies use conventional formats.

You could tell the really important security people at the Summit. They were the ones with three or more radios hanging from their belts—none of which could talk to the other!

■ C3I Data Links

No one has written in to help me with what is going on at the Salt Lake City Airport. It seems that this facility is going to be used as a *Command, Control, Communications, and Intelligence Center* (C3I). What is not known is who is the C3I information going to be used for (or against)

The C3I center in southern Florida is located in southwest Dade County, as has been discussed in previous issues. It is located next on the same property as NMA—the Coast Guard communications station. Next door is the receive site for the old KKN39 station, run by our old friends at the CIA. It sits on the old property of Zenith Technical Enterprises, which was the CIA company that ran the Bay of Pigs invasion.

I was down visiting the site a few weeks ago. The antennas have all been replaced since Hurricane Andrew. There are several data links going in down there. These will provide up and down links to data platforms in the sky. These data platforms could be airplanes or even satellites. The messages are employed in the various *Tactical Digital Links* (TADL). These incorporate the new data links that are being employed down there.

TADL ALPHA (Link 11). This is a duplex, real time, encrypted data transmission in either the UHF or the HF bands. These can be heard in the HF bands every day. The Link 11 equipped aircraft/warships can relay secure tactical sensor information in addition to weapon deployment and engagement status. If it is coupled with a central memory and processing unit, multiple stations can receive information or actively enter the network and send updated information.

TADL BRAVO. This highly directional, line of sight, microwave transmission is similar to microwave telephone communications links. The units must have very directional antennas pointed at each other. This method is used by ground based systems only.

TADL CHARLIE (Link 4). Link 4 is a simplex or duplex link used to exchange information with and control specially configured fighter aircraft. This enables the console operator at a surface or aircraft C3I complex to direct the aircraft remotely. In addition, data on target location and identity can be transferred from the fighter to the controlling unit who, in turn, can distribute that information on other TADL links.

TADL DELTA (Link 14). Link 14 is a simplex data transmission system providing non-digital TADL equipped surface platforms with data made available from TADL platforms. TADL Link 11 platforms can transmit this information in non-encrypted format. This raw data is then transcribed manually and presented to non-digital TADL platforms.

■ Stay Tuned for More Changes

The Clinton Administration has recently unveiled a plan to streamline and reinvent the federal government. This plan, led by Vice-President Gore, has called for the significant realignment and changes in the infrastructure of the federal government, specifically for the federal market for radio communications.

This plan calls for the merger of the Bureau of Alcohol, Tobacco, and Firearms (BATF), the Drug Enforcement Administration (DEA) into the Federal Bureau of Investigation (FBI). Congressional approval will be required if this plan is to be implemented. If it is passed, there could be a substantial impact on the

requirements and configurations of federal government radio systems.

First, there could be a reduction in the number of agents requiring radios, if the efforts of the three agencies are consolidated in terms of drug interdiction, organized crime, and high technology trafficking.

Second, a merger would have a very strong impact on the federal radio system and configuration. The DEA and the FBI are already at full capacity in their capabilities.

Taking into consideration the fact that this plan has not yet been presented to Congress, and the time needed for Congressional review, it is unlikely there will be any activity in the next two years. To merge the ATF and/or the FBI with the DEA will require the consent of several key congressional committees and broad legislation regarding this sensitive matter.

■ Logging the Feds

Scott Eckert, a loyal reader from Hickory, North Carolina, sent in the following intercepts from the Charlotte/Hickory, North Carolina area.

FEDERAL BUREAU OF INVESTIGATION

Channel	Designator	Output	Input
Alpha 5	Rptr-Charlotte	167.3875	162.6375
Alpha 7	Same	167.2875	162.6375
Unk	Same	167.4125	Unknown
Unk	Same	167.7875	Unknown

The callsign is KEV220. Charlotte Base is referred to as "220". The subaudible tone is 167.9 Hz. The 167.3875 and 167.2875 repeaters appear to be simulcast and share the same input frequency of 162.6375. Radio technicians have been monitored in the clear using the callsigns of "Clingman" and "Linville." Both of these are in the western North Carolina area, with Clingman being Clingman's Dome, the highest point in the Smoky Mountains.

Other frequencies he monitored are:

Frequency	Use
167.1750	Blue Ridge Parkway - Law Enforcement Repeaters
167.150	Smoky Mountains - Repeater Output
163.200	U.S. Marshalls Service
165.375	Secret Service - Charlotte Field Office - Primary
166.5875	Secret Service - Charlotte - Secondary
165.7875	Same
165.2375	U.S. Customs
418.625	DEA Charlotte
165.2875	ATF - Charlotte - Rptr Out
166.5375	ATF - Charlotte - Rptr In
414.750	Postal Inspectors - Charlotte
415.700	Air Force 1 - Phone Patch Downlink

As previously reported, the FBI repeaters are still being keyed up in the early morning hours. It is noted from 0030 to about 0400 hrs., EST. Monitoring the spectrum analyzer, all four of the South Florida FBI repeater outputs are being keyed at once. It is easy to find all of the frequencies—They are:

167.2625, 167.4375, 167.6625 and 169.750 MHz. No evidence of any input frequencies is being seen.

The mysterious data channels being heard in the Orlando, Fla., area are the control channels for the new 220 MHz trunking systems. Thanks to the Grove CD-ROM for confirming this. Systems have been licensed throughout the State of Florida and California, and being installed through the United States. The only thing being heard is the control channels. No evidence of any mobile or portables are being heard. This would be a great place to hide a covert system.

■ More Secret Service Freqs

Let's finish up this month with a look at some of the lesser known elements of the Secret Service. The main channel of their

training division at Beltsville, Md., is 414.8000 MHz. The Secret Service has an excellent technical security division. This translates into the electronic surveillance division. That's it for this month. 73's, John WA4VPY

SECRET SERVICE ELECTRONIC SURVEILLANCE DIV

Channel Use	Frequency
Primary Channel	164.4000
Electronic Tracking Units	408.5000
Electronic Tracking Units	408.9750
Radio Alarms	408.0000
Radio Alarms	411.0000
Electronic Surveillance	407.8000
Electronic Surveillance	406.2750

SECRET SERVICE UNIFORMED WHITE HOUSE DETAIL

Callsign	Designator	Chan No.	Frequency
Bandbox	Protection	One	414.9500
	Com.	Two	414.6750
	Training	Three	415.8750
	Tactical	Four	414.9750
Bookstore	Communications Cntr.		415.8000
	Protection Backup		406.4250
	Exec. Branch Backup		417.7500

The DRIG BBS is the premier source of information on Satellite Tracking, Satellite Imagery, NASA, Astronomy, Space Programs, AMAT Satellite Communications, Amateur Radio AND MORE!

Over 7 Gigabytes of files related to Satellites, Remote Sensing, Amateur Radio, Digital Signal/Image Processing, INTERNET NewsGroups, FidoMail, Weather Satellite Imagery, Direct Ku Band Satellite Downlink from Planet Connect and PageSat for Internet and FidoMail! Weather DOOR for National Weather, Radar Summaries, Weather Maps!

USE VISA/MASTERCARD/AMEX or Send Check for Subscription
P.O. Box 117088 Carrollton Texas 75011 - 7088
(214) 394 - 7438
 (214) 492 - 7747 fax
 Internet - info@drig.com
 Fidonet - 1:124/6509

ON-LINE SINCE 1985

KFS World Communications adds VCT

As promised, we'll start this month by looking at the new station opened by KFS World Communications in Newfoundland. Until recently, the company operated two stations, one in California (KFS) and the other in Louisiana (WNU). These stations offer service using CW and RTTY modes of operation. KFS World Communications has been spending money on improving their facilities, including new transmitters and amplifiers from Henry Radio and the addition of the new station at Tors Cove, Newfoundland, using the callsign VCT.

KFS offers an interesting radioteletype service through its three stations. Their main computer is connected by leased lines to the three stations and therefore messages are available to ships through any of the three stations. In most other systems, messages must be relayed from one station to another if the ship calls into a station other than that holding the message. The fact that all messages are available through the three stations offers to make communicating with ships more efficient, since the sender of the message need not know which of KFS's stations the ship would be monitoring.

Each station transmits an identical traffic list giving the callsigns of all ships for whom messages are being held. The ship may then call one of the three stations to retrieve their messages.

The original KFS station is located at Half Moon Bay in California and is the location of the computer which holds the messages waiting for ships. Leased lines connect it to WNU in Louisiana and WNU is controlled remotely from Half Moon Bay, except for the technical operators who are required to be on duty at the WNU transmitter site. These two stations offer coverage of the U.S. West Coast, Pacific Ocean, the Panama Canal, the Caribbean Sea, the Gulf of Mexico and the mid-Atlantic Ocean.

The new station at Tors Cove is operated by NewEast Wireless Telecom Inc.—the former Sea Link Ltd. It is also connected to Half Moon Bay and offers the same



Photo by Raymond Troth

Is RTTY on the way out? Not at the KFS Super-Station™ network, which just added a third station to facilitate Telex and e-mail maritime traffic in the Western Hemisphere.

radioteletype services remotely controlled from KFS. NewEast takes care of the technical operation of the station. Unlike the other two stations, no CW service is offered from Tors Cove.

The following are the frequencies to try for the radioteletype service of KFS World Communications.

KFS	WNU	VCT
4211.5 kHz	4210.5	4217.5
6315.5	6327.0	6329.5
8417.5	8425.5	8422.0
12580.5	12588.5	12610.5
16829.5	12607.5	16827.5
22377.5	16384.5	

Morse telegraphy (CW) service is also provided on the following frequencies

KFS	WNU	
436.0 kHz	0463.0	8570.0
2037.5	0500.0	8688.0
2061.5	2048.0	12826.5
4228.0	4294.0	12869.0
4274.0	4310.0	13011.0
6365.5	6389.65	17038.0
8444.5	6499.9	17117.6
8558.4	8525.0	22575.5
12695.5		22829.4
12844.5		
17026.0		
17184.5		
22515.0		
22581.5		

According to their licensing information, there are some facsimile frequencies which may be in use at WNU; however, I haven't

been able to verify this, so give them a try and let us know what you find.

- 8671.0 MHz
- 12669.0
- 17214.4
- 19718.4
- 26128.4

Finally, while digging through the licensing information, I also found some single sideband frequencies which are not currently in use, but which may show up one of these days.

KFS
2565.9 kHz

WNU			
2558.0	ssb	17238.3	ssb
4435.0	ssb	19764.0	ssb
13185.0	ssb	26105.1	ssb

Visual Morse

It would seem that radiocommunications is not the only method used by the folks at KFS. During the return voyage of the SS *Jeremiah O'Brien* from the fiftieth anniversary of D-Day celebrations in Normandy, the alds lamp was given some exercise. On the final leg of the *O'Brien's* trip back to San Francisco she passed within sight of the KFS receiving station south of Half Moon Bay. A KFS employee who was aboard the *O'Brien* decided with Walter Kane, an operator on duty at KFS, to attempt a flashing light contact.

Aboard the liberty ship this was not a problem since her alds lamp had been maintained in working order over the years. For Kane things weren't so easy. KFS had no facility for light signaling—how was he going to accomplish this? The solution was for Kane to drive his car across Highway 1 into the coastal range east of Half Moon Bay. A hilltop with a clear view provided a place for Kane to park. When the *O'Brien* hove into view Kane began flashing his headlights to gain the ship's attention. Rod Deakin, KFS Manager of Special Projects, who was aboard the *O'Brien*, established contact with Kane and then sent the message "Greetings Half Moon Bay, SS *Jeremiah O'Brien* — Happy to be home."

As for the code from the shore, Kane did

his best with the headlights and succeeded, even though his dots and dashes "were kind of funky." Not bad for a fellow who just wanted to prove that it could be done.

What did the company think of this? Here's what KFS Station Manager Dino Martins had to say. "We believe this to be the first commercial, peacetime use of signal lights to communicate between a ship and a public coast station. It was an interesting experiment. If other ships want to do it we may have to install a permanent signal lamp."

■ The final call...

On November 20, 1994, a fire broke out aboard the M/V *Polydoros* (P3QT4), a 900 foot, 57000 gross ton Cypriot bulk carrier laden with coal. Many listeners may have heard the traffic on 8 and 12 MHz Coast Guard frequencies. Several aircraft were involved in the search and rescue operation as well as a number of U.S. Coast Guard and other ships, including the tanker *Irving Canada*. Spread over several hours, the traffic was quite interesting to monitor.

Twenty five crew members were rescued from the ship and flown to Hyannis, Ma., where eight were treated for smoke inhalation. On the 21st four crewmembers were taken aboard a U.S. Coast Guard cutter, including the captain, while the cutter's crew fought the fire.

One aspect of the fire of which I was not aware was brought to my attention by a November 22 newspaper clipping sent in by Harry Baughn. The only fatality was that of the radio officer. His body was found slumped over the radiotelex equipment where he had succumbed to the smoke from the fire burning below. Before he died, the radioman managed to send a distress message by telex to Goteborg Radio (SAB) in Sweden. This message was relayed by the Swedish authorities to the U.S. Coast Guard in New York who launched the search for the disabled vessel.

The *Polydoros* is not equipped for satellite communications. Had there been no radio officer aboard the vessel — which would be permissible under the Global Maritime Distress and Safety System (GMDSS) — would the ships officers have been able to coordinate fire fighting activities and also communicate with search and rescue authorities?

While we can only ponder that question, I know for sure that 29 men owe their lives to the late Hipolito Elanga, their heroic radioman.

That HF frequencies can be reliable over long distances is shown by the *Polydoros'* radio officer sending his distress message to Sweden when his ship was only 225 miles off the American coast. Likewise, the SS *Jeremiah O'Brien* used KFS and WNU for communi-

cations throughout much, if not all, of her voyage.

While satellite communications offer a degree of privacy of communications hitherto unknown, one has to wonder about its reliability. Anik E-1 and E-2 were temporarily out of commission earlier this year, disrupting communications for up to a week as channels were shifted to other satellites and Anik E-1 restored to operation.

What if the same happens to an INMARSAT satellite? The possibility of pressing the "SOS" button on the INMARSAT equipment and having your position extracted from the ship's navigation equipment and transmitted directly to search and rescue authorities is attractive. Under test conditions the system has worked well; however, early experiences have shown that problems in aiming the satellite antenna on a dead ship can make rescue impossible. Until this type of problem is ironed out, and the cost of

redundant satellite stations is brought down, men like Elanga will be needed for a while yet.

The world's tanker fleets are many and varied; plans are to have a look at the petroleum industry in May. We'll profile the tankers and the stations which talk to them.

Until next time, enjoy the winter, keep listening, and don't forget to share the good loggings; other maritime monitors will be interested to know what is heard where.



**The New Realistic[®]
PRO2035 Scanner
Radio Shack
Phones**

Our 19th year of DISCOUNTS
Toll Free 800-231-3680
"If on sale, we are cheaper"
PRO2035 List \$449.99
Our Delivered Price \$385.00
We discount everything in the RS catalog

**22511 Katy Fwy.
Katy (Houston), TX 77450
1-713-392-0747 FAX 713-574-4567**

Low Loss Coax

Aids Scanner Reception



Why lose all your antenna gain within a poor grade of coax cable? The high loss of most cables can make your gain antenna into a loss antenna!

- ☆ Our **RF-9913** lowest loss 50 ohm cable is the best choice for scanner base antennas. Only 3.9 dB loss at 800 MHz. \$46 for 100ft (plus \$5.95 S&H).
- ☆ Our **RG-6/U** lowest loss 75 ohm cable is the next choice for scanner base antennas. Only 5.8 dB loss at 800 MHz. \$19 for 100ft (plus \$4.95 S&H).

1-800-950-WARE

Write for a FREE catalog (no calls please)



**PO Box 1478 Westford MA 01886
(508) 452-5555**

Advanced RF Design, Inc.

High Gain/ Low Noise Scanner Preamps Hear What You've Been Missing!

Model	Frequency Range (MHz)	Gain (dB)	NF (dB)	Power	Price
RXWB01	1 - 500	>20	<1.6	12V 15mA	\$40.00
RXWB02	0.1 - 1000	>30	<2.0	12V 45mA	\$85.00

BNC Connectors Standard, Add \$5.00 for N or UHF.
For more information or to place an order call us at:

(609) 448-0910 (9 AM to 9 PM (Eastern), 7 days a week)
MC, VISA, Check or MO accepted. Prices do not include S/H.

World Television for News-Hounds

Whether these times are truly more troubled than ever, or it only appears that way because 24 hour news channels have time to fill is a debate for the academics. It remains undebatable that Americans now have more access to more news sources than ever before.

Those connected to the world via satellite have sources which span the electronic gamut. From the electronic news service X*Press, which serves up its wares digitally via 9600 baud packet bursts, to the old familiar radio networks which helped usher in the news-age revolution seventy years ago, Americans appear to have an insatiable appetite for news.

Via satellite at any given moment of the day, news is available. From the twenty wire services of X*Press, to the dozen or more radio networks, to the world's television news services, TVRO users have an abundance of choices. Here we'll concentrate on the visual: World Television News for info-gluttons or the merely insomniac.

■ Newsgathering While You Sleep

The real news-hound hates to waste precious news-watching time sleeping. Yet, sleep one must. What to do? Set your VCR to record the "BBC News from London" on the Canadian satellite E1 channel 13 at 3:00 AM Eastern or the "BBC Breakfast News" at the same time on Galaxy 4 channel 9. Already we're having to make difficult decisions.

Now, when you get up in the morning, instead of tuning into our dreary American network morning fare with its gaggle of babbling celebrities, you can tune into England's twittering natterers.

■ The View From The East

For years NHK Tokyo has run its daily program of news from Japan called *Today's Japan* at 10:30 am on PBS. However, this fall PBS moved to its new home on Telstar 401 (97 degrees West) and is providing only one analog C-band channel for the TVRO set. *Today's Japan* was moved to the Ku side of T401 where viewers may glimpse a more in-depth, if sanitized, view of daily life in Japan.

The regular viewer becomes accustomed not only to the lovely face and voice of the show's anchor, but learns, through the news



Billboard for TFI from Moscow. The colorful minarets make the color bars at the bottom superfluous. (Courtesy John Locker)

stories, of the people, geography, and cultural customs of this ancient land. I am forced to admit that through years of watching I can actually recognize the names (and profiles) of Japan's leading Sumo wrestlers.

■ How About Those Rough Riders, Eh?

At 11:00 am it's time to switch back to the C-band LNB and run the dish over to Anik E1 (111.1 degrees West) for CBC Television's *Midday*. Canada, America's brother separated at birth, has a bountiful media garden growing on its two satellites. Anik (Inuit for "little brother") E1 is a text book on utilizing satellite channel capacity. Here are 18 C-band video channels, 25 Ku band video channels, 39 C-band FM audio subcarriers, 22 Ku-band FM audio subcarriers and 17 C and Ku band SCPC services. Whew!

Right now we're interested in the hour long *Midday*, a national news and features program dealing with issues of news, arts, entertainment and sports. Again, Americans get the opportunity to peer over the fence to watch Canadians be Canadians. What we see is a country very nearly as vast as our own with as complex and rich a cultural heritage as ours. On *Midday*, Americans discover the long lost relative was living next door all along.

■ Achtung, America!

The next stop on our world television junket is Germany. Direct from the Deutsche Welle's 24 hour service on Satcom C4 (135 degrees West) we have *News From Germany In English* at 2:00 pm. Here, not only do we get the news, business and sports reports about Germany, we also get the German view

of the European news. This provides an interesting contrast, not only to the British view, but to our own as well.

While not overly introspective, the Deutsche Welle reports even the less flattering events in that stolid country. Frequent viewers will see that absorbing Eastern Germany has been a difficult task, one which will take many years to get right; that ethnic diversity is still not an easy concept for Germans; that even a great financial powerhouse harbors a poor and homeless class.

■ Auntie Beeb's Final Words

At 6:00 pm we wrap up the European view of our daily dose with the last word from the BBC. Once again we fire up the Ku LNB for the only presentation of *The Seven O'clock News*. This national newscast is destined for Australia and we are provided a privileged view as it "bounces" across the North American continent on its way down under.

Now on Galaxy 7, Channel 10, of Telstar 401 (97 degrees West) this venerable news show is as dependable as Big Ben. Even the faces of the "presenters," as they're called in England, haven't changed in years; in fact, some would say their expressions haven't either!

■ MacNeil/Lehrer News Orgy

It's thoughtful, it's one hour but it seems like two (no commercials), it's in-depth, it's talking heads—in short it's everything you want to put the final glaze on your news-soaked brain: it's *The MacNeil/Lehrer News Hour*. You can leave the half-hour (it's really



The end of the Orion launch feed seen via Intelsat K by way of Anik E2. (Courtesy John Locker)

only 20 minutes with the commercials taken out), sound-bite-crazy, spin-doctored commercial network newscasts to the faint-hearted. On those newscasts you can't tell the news-making celebrities from the new-casting celebrities (they're all millionaires).

Instead we have Robin and Jim and a number of other "usual suspects" probing the well-fed and highly polished politicians and captains of industry. Here we get video essays from writers who apparently haven't been touched by the sound-bite virus and you won't catch yourself recognizing the footage of Bosnia from earlier in the day on *Midday* and *The Seven O'clock News*.

■ But Wait, There's More!

All of these newscasts have one thing in common. They are all in the clear: unscrambled. No fees. If you are multi-lingual there are even more programs from far more exotic regions: France's Antennae 2, Brazilian TV Network, RAI Italy, and RTP Internacional (Portugal)—all with native language newscasts. And don't forget the entire line-up of SCOLA programming which has been detailed in earlier columns.

This schedule of news presentations is designed to help make you a global citizen. A couple of weeks of this and you'll notice how little attention the rest of the world gives our political bickering and petty wrangling. You'll also notice that, by and large, most countries are in the same condition: we're all tax-weary, cash poor, intolerant, and eager to blame the current administration. England, Germany, America, Canada, and Japan—we're all eerily alike.

MAILBAG

• First to John Locker, our eyes on European skies. He was busy watching the new Orion satellite launch via Intelsat K and, sadly, watched the demise of PAS 3 on PAS 1. He writes, "...Meanwhile, Astra 1 D launched on the 1st November and I caught it testing on the 18th about 5 pegs off station...just under three weeks to geostationary position—not bad going, that!" (See John's latest photo contributions.)

• Bob Swett of Muskegon, MI, writes..."Recently I purchased a used STS Model MBS-LSR receiver, 8 ft. fiberglass dish, mount, actuator, LNA and downconverter for \$250..." The only problem, Bob says, is that the downconverter doesn't work. "...I called STS and they no longer have replacement downconverters for this model. It's an STS model 1002; the output frequency is 950-1410 MHz. My question is, why can't I use any LNB that has an output of 950-1450 MHz?"

There are two solutions to this problem. The first may be the cheapest and it is definitely preferred. There is one company which specializes in repairing defective TVRO components: PTS Electronics in Bloomington, IN (800-844-PTS1). They say the only equipment they don't repair is Amplica and Birdview. If they can repair your downconverter you should have years of viewing left in your system.

The second solution is to convert the current LNA/downconverter set-up to a modern LNB system. Typically these older systems featured an LNA attached to the feedhorn. The output of the LNA (at 3 GHz) was fed to the nearby downconverter via an RG-213 cable with "N" connectors. The output of the downconverter (in this case 950-1410 MHz) was sent to the house and into the back of the receiver. The "receiver" is really just a tuning device which tunes through the output of the downconverter.

To convert to a modern system: take the LNA off the feedhorn and replace it with any cheap, used, LNB (if this works, you can buy a nice new expensive one). Run a separate RG-6 cable from the receiver to the LNB. Providing that the voltage which powers the old LNB is the same that powers the new LNB, I believe this should work.

• Dennis Eksten, W9SS, of Loves Park, IL, writes, "...I have a C-band system using an old Drake ESR 240A 70 MHz system. Recently I tried to receive SCPC with no luck...Also want to add Ku band...Please recommend a used receiver having Ku...will the mesh on my 8' Beech Craft Electronics Fiberglass dish be suitable for 12 GHz Ku?"

OK, Dennis; getting SCPC from a 70 MHz system is tough to do. I was able to receive SCPC from an Amplica system by feeding the baseband output of the receiver into the antenna of a TV band radio. I got lots of signals, but there was an oppressive hum across the whole band.

Since it sounds as if you're headed toward "modernizing" your system let's pursue that instead. As with the previous reader all you need to do at the dish is replace the old 70 MHz LNA/Downconverter with a nice new LNB (\$50-80); the proper length of RG-8 coax from the LNB to the receiver (\$15-25); and a nice used receiver (\$50-150) and you're in business! Look for a receiver with a 70 MHz loop on the back (for cheap'n'easy SCPC), a C/Ku switch and two coax inputs.

Lacking that, look for one that has a "video inversion" switch. Ku is transmitted inverted to that of C-band. That's what the C/Ku switch does. It's a little more bother to have to shut off the set, unplug the C-band LNB and plug in the Ku LNB, and then flip the inversion switch and turn the receiver back on, but it works. Call all the dealers in your phone book and get quotes.

Virtually any dish will "work" on the Ku band—it just won't be very efficient. That's

why a nice solid aluminum dish is so great for Ku reception—nothing gets past the reflector! Dennis, you seem like an adventurous guy—why not replace the old reflector with a nice 7.5 foot spun aluminum dish that will bring in signals so hot they'll melt your TV screen?! Long's Electronics (800-633-4984) has lots of them for about \$50. With a crating and shipping charge you should have that in your backyard for about \$100. Your C-band signals will improve, too!

PORTABLE SATELLITE ANTENNA



Complete 3' KU Band System

For Free Information Package and Pricing

• Call 219-236-5776 • 

R.C. Distributing • PO Box 552 • South Bend, IN 46624

Satellite-TV

100% Satisfaction Guarantee

Systems from

\$499

Let Us Help You Select Your New Satellite TV Entertainment System

Over 1 Million Depend on Skyvision®

1-800-334-6455
Inr1 218-739-5231 Fax 218-739-4879

Skyvision, Inc.®

1050 FRONTIER DRIVE
FERGUS FALLS, MN 56537

INSTALL OR UPDATE YOURSELF!

FREE

64 Page Catalog/Buyer's Guide

- All Major Brands
- Complete Systems
- Accessories
- Huge Savings
- Easy Installation
- Complete Instruct.

SATELLITE COMMUNICATIONS EQUIPMENT



WHOLESALE TO THE PUBLIC!

- ✘ Uniden
- ✘ Drake
- ✘ All Major Brands
- ✘ C and Ku Systems
- ✘ SCPC Equipment
- ✘ INMARSAT Antennas
- ✘ Scanners & HF Receivers

- ✘ Echosphere
- ✘ Orbitron

NEW & USED EQUIPMENT

RMR Electronics Company

32 Mountain Home Road
Londonderry, NH 03053
(603) 434-7445

FREE TECHNICAL ADVICE: 6-11pm EST

The Survey Says...

The prime goal at *Below 500 kHz* is to keep the column geared toward the interests and needs of the readership. I enjoy receiving mail from many of you, and that helps a great deal in pointing me in the right direction. I am sure there are also many others with additional thoughts and suggestions that would make this column even better.

This month, I'm asking that you take the time to fill in a brief survey about *Below 500 kHz* and what you do and don't like. Of course, it's impossible to please everyone, but I promise to give serious consideration to all responses, and to use the information to keep the coverage of topics aimed at what most would like to see, along with a sprinkling of "fringe" topics now and then.

I appreciate your continuing interest in this column, and your responses will help to keep it the best longwave column around. To participate in the survey, just photocopy the survey, fill in your answers, and mail it to me at *Below 500 kHz*, P.O. Box 98, Brasstown, NC 28902. If you wish, you can use a separate sheet for additional comments and suggestions.

■ Wintertime DX

Perry Crabill (VA) is well known in longwave circles for his DXing achievements with beacons. Recently, Perry sent me an update on his latest progress. He has logged over 40 *new* stations since November—the best catch being **BUN** (375 kHz) from Buenaventura, Colombia (2442 miles). See Table 1 for a sampling of his intercepts.

Perry gives much of the credit for his new loggings to his Timewave DSP-59+ digital filter, which he uses in conjunction with a Drake R8 receiver and a loop antenna. The digital filter helps him to focus only on the desired signals and eliminate unwanted interference and noise.

Digital filters are really starting to catch on for longwave DXing. If you would like to get information on the Timewave unit, you can write the factory at 2401 Pilot Knob Road, St. Paul, MN 55120. Another popular manufacturer of digital filters is Ramsey Electronics. Their j•COM division makes the popular W9GR DSP II Filter. To request information on this unit, write them at 793 Canning Parkway, Victor, NY 14564.

BELOW 500 KHZ SURVEY

Name:

- Technical topics
- Construction projects
- Receiving Tips
- Antenna topics
- Medfer news (1620 to 1800 kHz)
- QSLs/Beacon photos
- Mini reviews of longwave products & publications

Monitoring Location:

- 1) What is your primary receiver for longwave reception?
- 2) What is your primary antenna for longwave reception?
- 3) How long have you been tuning below 500 kHz?
- 4) Have you ever operated a transmitter in the license-free 160-190 kHz band?
- 5) Of the time you spend monitoring, approximately what percentage is spent tuning the longwaves? (Please check one):

- less than 10%
- 25%
- 50%
- More than 70%

- 6) Please rank your longwave monitoring interests on a scale of 1 to 5 (with 5 indicating the highest interest).

- "Natural Radio" (0 to 20 kHz)
- OMEGA
- 10-150 kHz Military/Utilities
- GWEN
- License-Free "Lower" band (160-190 kHz)
- Beacons
- Maritime CW stations
- European Broadcast stations
- NAVTEX
- Other listening interests? (please write in)

- 7) Please rank your interest in the following sections of the *Below 500 kHz* column on a scale of 1 to 5 (again, with 5 indicating the highest interest).

- Mailbag/Reader news
- Loggings

- 8) What do you like most about the *Below 500 kHz* column?

- 9) Anything you'd like to see done differently?

- 10) What *other* publications do you read for monthly news on longwave monitoring?

- 11) How do you rate the technical level of *Below 500 kHz*? (please check one):

- Too simple
- Just right
- Sometimes too advanced
- Usually too advanced

- 12) How do you rate the timeliness of information in *Below 500 kHz*? (please check one):

- Excellent
- Good
- Fair
- Poor

- 13) How do you rate the accuracy of the information in *Below 500 kHz*? (please check one):

- Excellent
- Good
- Fair
- Poor

- 14) Any additional comments or suggestions (please use a separate sheet if necessary):

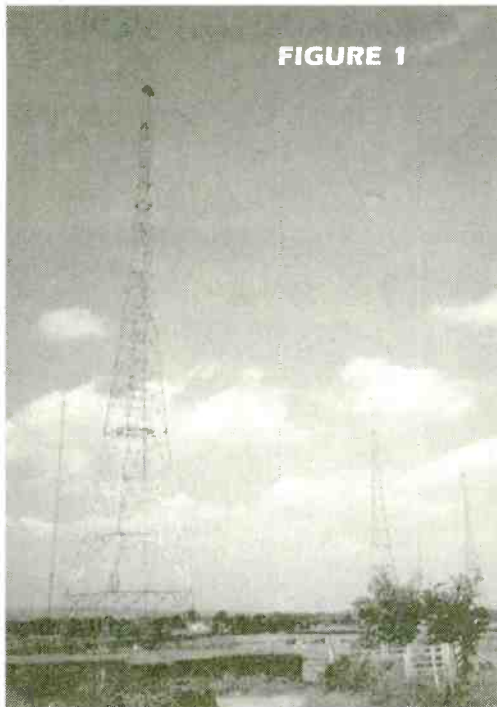

FIGURE 1

Station GBZ Transmitting Towers in Wales.

and similar scientific topics. Their book listing is a must for any Tesla enthusiast. To request a copy of their latest offerings, you can write them at P.O. Box 2001, 100 South Ridge Street #101, Breckenridge, CO 80424-2001.

■ Across the Pond

It was my pleasure to meet several *MT* readers at the *MT* Convention in Atlanta last October. One attendee, John H. Cobb Jr. (GA), was kind enough to share several photos he took of station GBZ in Criggion, Wales. This station is operated by the Royal Navy and transmits frequency-shift keying (FSK) data on a frequency of 19.6 kHz.

Figure 1 shows a few of the six 800-foot towers used to support the station's kite-shaped wire array. Three of the towers are self-supporting and three are guyed—with one corner of the array being anchored to a 1200-foot hill. Thanks, John, for sharing your photos.

■ ELF Anxiety

Ever since the Navy announced plans to construct their huge 76 Hz ELF transmitting site in Michigan's Upper Peninsula, concerns have been raised about the effects of the radio waves on human health and the environment. Indeed, the entire subject of electromagnetic radiation has received lots of attention as it relates to cellular phones, two-way radios, and even household electric wiring.

Zack Schindler (MI) sent along a clipping from the *Detroit Free Press* that announced the results of a 10 year study on tree growth near the 56 mile long ELF antenna. The study, led by Dr. Glenn Mroz of Michigan Technological University, found that aspen trees showed a 50% increase in diameter and red pine trees showed a more modest 10 percent increase. Mroz said he cannot explain why the ELF energy would cause the trees to grow faster.

■ Assorted Tesla Topics

Wherever longwave enthusiasts can be found, there are usually people interested in the turn-of-the-century experiments of Nikola Tesla. Tesla has been called "a man out of time," "a prodigal genius," and "the man who harnessed Niagara Falls." His many contributions to AC power generation, power transmission and wireless development are well documented, yet the general public has very little direct knowledge of him.

Twenty First Century Books specializes in publications dealing with Tesla's experiments

TABLE 1: Beacon Loggings		
FREQ.	ID	LOCATION
208	JYN	Goldsboro, NC
220	IHM	Mansfield, MA
221	BO	Bristol, TN
230	BES	Bennetsville, SC
233	HEM	Sparta, TN
234	RYD	Green Cove Springs, FL
236	VJ	Abingdon, VA
244	BA	Baranquilla, COLOMBIA
255	FYE	Somerville, TN
260	BNL	Barnwell, SC
263	BGF	Winchester, TN
267	HET	Henryetta, OK
272	CB	Columbus, OH
272	PIM	Pine Mountain, GA
278	HOC	Hillsboro, OH
279	OZL	Oneonta, NY
281	IL	Wilmington, NC
284	PDW	Evansville, IN
287	G	Winnipeg, Manitoba
296	HBZ	Heber Springs, AR
299	AVZ	Terrell, TX
304	Z	Aranas Pass, TX
305	DZM	Dumas, AR
308	HIL	Great Bend, KS
308	MC	Mason City, IA
317	R	Trenton, ONT
319	CH	Chicago Harbor Lt, IL
329	TAD	Trinidad, CO
338	UMP	Indianapolis, IN
339	OP	Thomaston, GA
341	CKM	Clarksdale, MS
353	LWT	Lewiston, MT
375	BUN	Buenaventura, COLOMBIA
382	DER	Alexander City, AL
392	AGZ	Wagner, SD
400	MDS	Madison, SD
400	HIV	Santo Domingo, DOM. REP.

The Worldwide Aeronautical Communications Frequency Directory

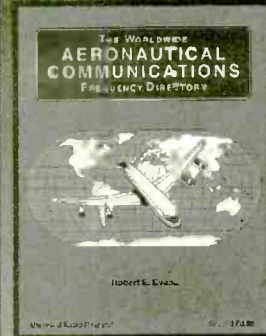

This new 250 page book by Robert Evans has quickly become the definitive reference for aeronautical DXers worldwide. Second Edition Only ... \$19.95 (+\$1)

The uncontested best book in the field. An invaluable source book. **Monitoring Times**

Comprehensive and fully informative. Applicable to the novice as well as to the advanced monitor. A book second to none. I could go all night with superlatives. **New Zealand DX Times**

Quite simply the best and most authoritative book on aircraft communications. **Short Wave Mag.**

This has to be the most complete treatise on HF, VHF and UHF voice and digital aircraft communications we have seen. Over 2350 discrete frequencies are given exhaustive attention with in-depth explanations of who, what, where and why various communications take place. A bargain at \$19.95. **Westlink Report**



Universal Radio

6830 Americana Pkwy.
Reynoldsburg, OH 43068
◆ Phone: 800 431-3939
◆ FAX: 614 866-2339

VLF CONVERTER



- Receives the entire 10 KHz to 500 KHz VLF band.
- Converts VLF to shortwave.
- Works with any shortwave receiver that has external antenna terminals.

Now you can hear the 1750 meter band, navigation beacon band, WWVB standard frequency broadcasts, ship-to-shore communications, and the European low frequency broadcast band just by tuning across 80 meters shortwave.

Connects between antenna and receiver. Turn It on and hear VLF; turn It off and hear normal shortwave signals.

Model VLF-A converts to 3510-4000 KHz or Model VLF-S converts to 4010-4500 KHz \$79.95 + \$6 shipping/handling U.S. & Canada. Requires 9-v battery (not supplied). Calif residents add sales tax.



Send for FREE catalog that shows our complete line of antennas, filters, preamplifiers and converters.

PALOMAR ENGINEERS
BOX 462222, ESCONDIDO, CA 92046
Phone: (619) 747-3343
FAX: (619) 747-3346

Three Short Antennas

Last summer at a local hamfest, several other hams and I had a rather lively conversation concerning antennas for the lower frequencies. My feeling was—and is—that anyone who can put up an antenna can operate any band.

The truth is, if you can get a conductor to accept a load (by using a transmatch or other loading method), you absolutely can operate any of the lower ham bands! True, it will be a compromise, and as such you cannot expect to work everything on the band whenever you like. But the important thing is that you will have fun.

For years the largest antenna I could put up was a 40 meter dipole. It did work on 80 and 160; all that had to be done was to tie the coax feed line (i.e., the inner and outer conductors) together and feed it via my transmatch to produce a nice top loaded vertical for the lower bands. In fact, I worked all continents on 80 while running only 50 watts. The ground system was a wire tacked under the rain gutter and run completely around the house.

For some reason, many hams resist using a transmatch—why, I don't know. But for those of you who want to work the lower bands without using a transmatch, here are some antenna ideas. Remember: short antennas have limited bandwidth, so you will need to trim the antenna to the center of the band you are interested in. As an example, the 30 foot long 3.9 MHz dipole will have 2:1 SWR only over about 25 kHz of the band. (This can be increased by use of a transmatch!)

These short antennas do perform very well and will give nearly equal performance, across their given bandwidth, to a full size antenna. Keep power level to 250 watts or so, using the coil information given. If you must run higher power you will need to use larger wire that is space wound (that is, the distance between the wires on the coil will be wider).

All of the antennas in tables 1, 2, 3, and 4

(see next page) will work, but you will need to carefully adjust the length of the end wires to put the resonant point within your desired portion of the band. To prune properly it is important to either measure the SWR at the antenna, or use a multiple of a half wavelength of 50 ohm coax to get an accurate reading at the transmitter end.

In order to calculate a halfwave of coax, you must take the velocity factor (VF) into account (VF is the speed a signal will travel in a particular conductor). The formula to calculate a half wavelength of coax is $491.8/f \times VF$. For example, to calculate a half wave of coax at 7.15 MHz using the popular RG8x coax, we would use a VF of .75. (A list of the VF of most popular coax cables is available in the *ARRL Antenna Manual*.) The length of our line would be $491.8/7.15 \times .75 = 51.587$, rounded off to 51.5 ft. If this is not enough line to reach the rig, simply multiply by 2 or 3, or whatever it takes.

If you choose to put the antennas up as an inverted vee, remember the frequency will be lower than stated. It is a good idea to add about 5 percent to the end wire length to allow exact pruning. The antennas were designed using the K5QY loaded dipole program and the ARRL single-layer coil winding calculator. Element wire is assumed to be 14 gauge, and coil wire is 18 gauge enamel (close spaced).

These antennas should work fine with rigs up to 250 watts CW. I have given the inductance so you can calculate coils that will



Fred N7MQC and his yf KB8QWL stopped by my home on their way to Georgia. The photo is a shot of them, their pickup, home made camper, and chief op and biggest ham of all, Bernie the pup. Fred is a first class homebrew artist, and I hope to show off some of his creations in future issues.

accept higher powers by increasing the spacing between turns and using a larger diameter coil and wire. Frequency can be changed by changing the length of the end wire or the number of turns on the coil. Try changing the end wire first.

■ Explanation of tables

Freq is, of course, the frequency of operation; **length** is the overall length "A"; "B" is the distance from the center of the antenna to the coil; and "C" is the distance from the end of the coil to the end of the antenna. **Ind** is the inductance of each coil (two coils are required as shown in dwg. 1), and **turns** is the number of close wound turns of 18 gauge enamel wire required to achieve the necessary inductance. Feed the antenna with 50 ohm coax; if you wish, a 1-to-1 balun may be used at the feed point.

Each table gives several antenna dimensions to allow you to customize an antenna for your particular situation. Use the longest length possible.

As you might expect there is a great deal more that could be said about building a short antenna. But this will get you started and allow you to build a decent loaded dipole.

Yes, you can use loaded dipoles to build yagi and other (for example, phased) gain antennas. How about a two element 40 meter yagi with only 20 foot elements? It is something to experiment with.

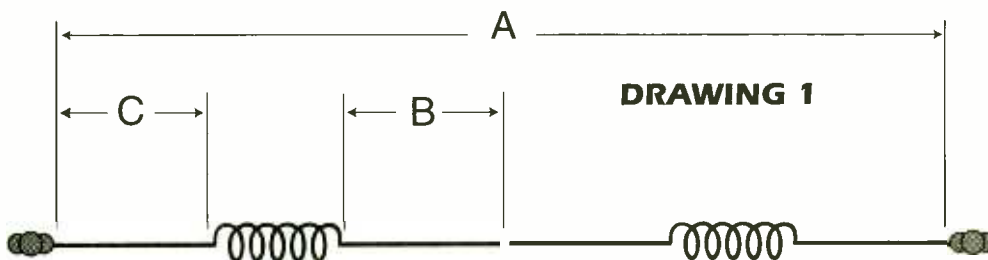

■ Gadget of the Month

Is there a ham anywhere who does not like gadgets?! At Christmas a co-worker received a neat calculator. No, it does not do all kinds of scientific functions automatically, or turn you into Mr. Wizard; it only adds, subtracts, multiplies, divides, and extracts square roots—

which is plenty for the average ham. It does have a clock, though, and that is the neat part.

I like to go on mini-DXpeditions, and keeping time for the log was always a problem. (I hate wrist watches and their funny little buttons you need to mess with to change time, etc). This little calculator has a great

clock built in and will display time in 24 hour format—perfect for log keeping. In addition, the unit has a built-in timer, to remind you to change bands, eat, go to sleep, or whatever. The plus for me is the calculator which will let me add up my scores for all those contests I enter in a portable or mobile mode.

Best of all, this handy gadget costs under ten bucks at most discount stores. Look for the Casio Time Face, QA-700. Try it, and I bet you'll like it!

The four tables mentioned earlier in this column follow.

73 de Ike, N3IK

Rob Leonard's Ham DX Tips

This is a month of change. Winter changes into spring, and likewise low band DX changes to openings on the higher frequencies. If you are an SWL, why not change to DXing some of the amateur frequencies? It can be quite rewarding. Here are a few tips to help you and longtime ham band DXers along the way:

DX CONTESTS On March 4th and 5th the ARRL DX Phone contest takes place to open the month, while the month closes with the CQ World Wide Prefix SSB Contest on 25 and 26 March. **NEW DX NETS** A new DX net with many DX stations from around the Pacific (as propagation allows), meets daily on 7230 kHz Lower Side Band at 1100 UTC. **GAZA** An amateur station using the call sign ZC6B has been active from Gaza, the area Israel has negotiated for Palestinian Self Rule. Though the call sign prefix block ZC has been assigned by the International Telecommunications Union to the United Kingdom, amateurs were granted the use of the ZC6 prefix when the UK administered Palestine from the 1920's to 1948. It is believed that this is why the prefix is now being used by an amateur located here. The Palestinian government has requested help in establishing amateur radio operations. Two Japanese amateurs JA1UT and JA3UB should have recently operated from here as JA1UT/GAZA. The two were asked to help establish a government sponsored amateur radio club station and train interested individuals in CW and international amateur radio rules and procedures. Meanwhile, ZC6B has been appearing regularly on 14234 kHz SSB around 1430 to 1600 UTC. The operator has given two QSL routes: either, Dr. Sami Tarazi c/o 7162 E. Kendall Drive, East Syracuse, NY 13057, or direct to, Dr. Sami Tarazi, Box 1008, Gaza, Palestine via Israel. At present, though, Gaza is not recognized as a DXCC official country. The most important thing is to log it, now! **HAWAII** Archie Chatterly, KH6CF, whose address is 1372 Uila St., Honolulu, HI 96818, appears on 3502 to 3504 kHz CW daily at 1045 UTC. **MALI** TZ6VV has been on 21270 kHz SSB daily, when the propagation is good, starting at 1500 UTC. His QSL manager is AA0GL, Marshall Reece, 5831 SE 53rd St., Tecumseh, KS 66542. **ST HELENA ISLAND** Napoleon had to be exiled to travel to this remote South Atlantic Island, but luckily you can travel there via amateur radio! To do so look for ZD7JP on 21340 kHz SSB, when that band is open, starting at 1900 UTC. QSL requests go to QSL manager: N5FTR, William Loe Schman, 717 Milton, Angleton, TX 77515. **SPRATLEY ISLAND** DU9RG and several other Philippine amateurs have been making plans to possibly operate from the Philippine-controlled area of these remote reefs and islands starting around April 10th to 15th. The call sign assigned is DU0UK. If the Philippine military okays the operations from an island they control, check the DX nets for more reports on their plans. **SWEDEN** To promote Sweden's bid to host the 2002 winter Olympics, the Jemtland Amateur Radio Club of Sweden will be operating special events station 7S30WG until June. While the station has operated on all modes and HF bands, when possible, it has been frequenting 14010 to 14030 kHz CW starting at 1300 UTC. QSL requests should be sent to: SM3CVM Lars, Aronsson, Lillfjellv 62, S-81371 Osterdud, Sweden. **USA** Late March is the start of the VHF DXing season, and once again yours truly, N9LAG, will be active on or above 50.125 MHz when six meters propagation is favorable. If we are fortunate enough to make contact please send your QSL requests to PO Box 91, Benton, IL 62812 ONLY, no other address! **ZAIRE** Part of the UN relief effort is 9Q51Y whose home call sign is LA91Y. He will be here till the end of March, active on the bands 40 to 10 meters SSB and CW. He also hopes to be active from Rwanda if possible. QSLs would be sent to the Academic Radio Club, LA1K, Studpost 250, N-7034 Trondheim, Norway. 9Q5EXV is on 14083 kHz RTTY starting at 1530 UTC most days. QSL to: F2VX, Gerard DeBelle, 4 Le Haut d'yvrac, F-33370 Tresses, France.

Here's a hope that March winds find you and your antenna faring well. 73 de Rob N9OAG.

TABLE 1

Freq.	Length	A	B	C	Ind.	Turns
1.850	120'	120'	35'	25'	108	47
1.850	80'	80'	25'	15'	191	75
1.850	60'	60'	15'	15'	198	81
1.850	40'	40'	10'	10'	288	106

TABLE 2

Freq.	Length	A	B	C	Ind.	Turns
3.9	80'	80'	25'	15'	29	41
3.9	60'	60'	15'	15'	36	47
3.9	30'	30'	8'	7'	85	73

TABLE 3

Freq.	Length	A	B	C	Ind.	Turns
3.6	80'	80'	25'	15'	38	38
3.6	60'	60'	15'	15'	44	44
3.6	30'	30'	8'	7'	100	100

TABLE 4

Freq.	Length	A	B	C	Ind.	Turns
7.15	40'	40'	15'	5'	26	39
7.15	30'	30'	10'	5'	30	42
7.15	20'	20'	5'	5'	32	45

Note: Table 1 coils wound on 2" I.D. PVC pipe with 18Awg enamel closewound. Tables 2-4 wound on 1" I.D. PVC pipe with 18Awg enamel closewound.

**FREE
SAMPLE
COPY!**

ANTIQUE RADIO CLASSIFIED

*Antique Radio's Largest-Circulation
Monthly Magazine*

Articles - Classifieds - Ads for Parts & Services
Also: Early TV, Ham Equip., Books,
Telegraph, 40's & 50's Radios & more...
Free 20-word ad each month. Don't miss out!

1-Year: \$29.95 (\$47.95 by 1st Class)
6-Month Trial - \$16.95. Foreign - Write.

A.R.C., P.O. Box 802-P9, Carlisle, MA 01741

Or Call: (508) 371-0512



Pirate Activity Record Broken Again in 1994

Richard T. Pistek, operator of the very active **North American Pirate Radio Service**, recently asked me to identify the "golden age" of pirate broadcasting. Dick was thinking about the first half of the 1980's, when North American pirate radio began to evolve into what we see today. In response to Richard, I think that there are more creative pirate radio stations on the air right now than at any prior time in the history of shortwave radio.

At least in terms of volume, there is no question that pirate activity has never been as high as it has been during the last several months. Although the exact tabulation is still in progress, *Monitoring Times* has found that at least 215 different North American shortwave pirate stations were heard by DXers during 1994, and were published as logs in DX bulletins or magazines. This was the first time that the annual station count has exceeded 200.

As we see in logs submitted by our readers this month c/o PO Box 98, Brasstown, NC 28902, a majority of active pirates have moved down to the 43 meter pirate band. The main frequency in use has been 6955 kHz, but it pays to tune around +/- 40 kHz or so when you are tuning for unlicensed broadcasts. There still is activity in the traditional 41 meter band on 7 MHz frequencies, but this increasingly is heard during daylight hours when powerful international broadcasters are silent in this range.

■ Trummel's Little Black Book

Kirk Trummel of Springfield, MO, has created several detailed databases that contain very useful information for pirate and clandestine DXers. His latest one, the *Little Black Book*, is a comprehensive 29 page listing of maildrop correspondence addresses used by hundreds of active pirate and clandestine stations worldwide. Kirk also maintains detailed and updated bandscans of the 41, 43, and 49 meter pirate bands. These scans include all known broadcast and utility stations that operate on frequencies that are commonly utilized by pirates.

Kirk's databases and lists can be downloaded directly from the ACE section of the ANARC computer BBS at (913) 345-1978. He offers hard copies for sufficient return postage. If you're interested in these services, Kirk can be reached c/o ACE, PO Box 11201, Shawnee Mission, KS 66207. \$2.00 in a different envelope to the same address will get you a sample copy of *The ACE* bulletin, where Kirk often prints news about updates to his lists.

■ The Three Radio USAs

Despite a February 1992 bust of the station's alleged operator, the veteran **Radio USA** remains on the air for a second decade of operations. Regular *MT* readers will be familiar with a phony version of the station, **Radio USA (fake)**. The bogus station has

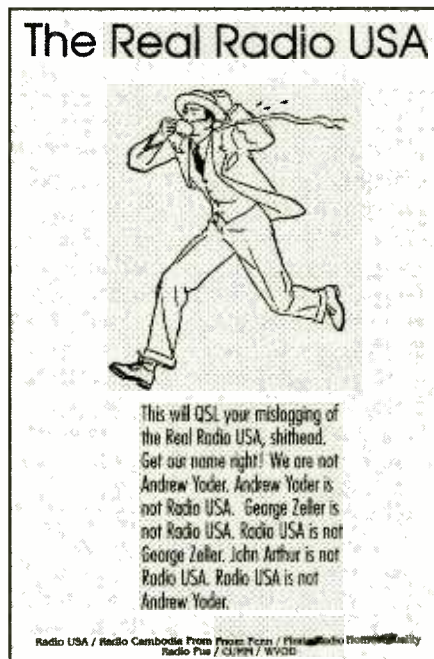

Of the three Radio USAs, here's the real (fake) one.

often been a nuisance jammer in the past, but lately it has been producing regular shows. Plus, many surprised DXers recently received the fake station's "Real" QSL that we picture this month, which arrived in response to logs printed in *The ACE* bulletin.

ACE pirate loggings editor Kirk Trummel (see above) pulled a switcheroo on the phony station in December, changing their name in his column to **Radio Is Not Radio**. Kirk's unusual move did not go unnoticed among pirate stations. A genuine **Radio Is Not Radio** has now appeared (see log below). No, there is nothing wrong with your radio. We currently have three versions of Radio USA: Mr. Blue Sky's original version, the (fake) version that calls itself "The Real Radio USA," and the new parody Radio Is Not Radio version that pokes fun at both.

■ Iran Clandestine QSL

Longtime *MT* reader Robert Ross of London, Ontario, reports that he snagged a recent QSL from the Voice of Human Rights and Freedoms for Iran. It took 15 months for his verie to arrive, but it came with a station flag, sticker, and detailed information sheet from Manou Chehr Ganji, the Secretary General. Rob was astonished to find two 20 franc notes in the envelope!

The station is obviously well financed. Their articulate propaganda enclosures with QSL's have led many to suspect that USA intelligence agencies are associated with this operation. Rob used their traditional address of 18 Bis Rue Violet, 75015 Paris, France.

Thanks also go to Michael Csontos of Lima, NY, who sends in an article from *The Free China Journal* on the continuing pirate station controversy in Taiwan. Numerous political opposition pirate stations are still struggling with the Taiwanese government. Oddly enough, Taipei's taxicab drivers are among the pirates' biggest supporters.

■ Best QSL?

Regular *MT* contributor Barry Williams of Enterprise, AL, asks about the best pirate QSL that I have ever received. Actually, all of them are very welcome collectors items. But, my most unique unlicensed broadcast verification came directly from the FCC!

I was lucky enough to be listening to **WHBH** (Hillbilly Heaven) on February 23, 1990, at the precise moment when the station was busted by FCC. Agent Ellington of the feds turned on the transmitter to announce that the station was being closed down by the authorities. My reception report to FCC headquarters in Washington for the bust broadcast was verified by Dennis J. Everett of the Field Operations Bureau!

How about you? Do you have a favorite unusual pirate verification QSL? Let us know so that we can cover the most interesting ones in future columns.

■ What We Are Hearing

Maildrop addresses used by North American pirates reported by our readers this month include PO Box 452, Wellsville, NY 14895; PO Box 605, Huntsville, AL 35804; PO Box 109, Blue Ridge Summit, PA 17214; PO Box 28413, Providence, RI 02908; PO Box 2024,

Faribault, MN 55021; PO Box 293, Merlin, Ontario NOP 1W0; PO Box 386, 5900AJ Venlo, Netherlands; SW Kamnarsvagen 13D:220, S-22646 Lund, Sweden; and PO Box 220342, 42373 Wuppertal, Germany. Reports to USA addresses should include three 32¢ stamps inside the envelope for forwarding. Foreign maildrops need \$1 US for return postage.

Black Rider Radio- 7473 at 0230. This station features a very diverse playlist including rock, world revolutionary music, and Desi Arnaz songs. So far it has normally been relayed by **KDED**. Addr: Wellsville. (Dick Pearce, Brattleboro, VT; Williams)
Caribbean Sound System- 6955 at 1800. Count Whip transmits his music from a cruise ship sailing through the tropics. Addr: Stoneham. (Pearce)
CFBN- 7375 at 2230. Although "Fly By Night Radio" advertises itself as "Canada's Worst Pirate," its return with a rock music show and a loon interval signal was welcome after a long dormant period. Addr: Wellsville. (Ross)

CUMM- 6955 at 2300. Unfortunately we are still waiting for information on how to contact this relatively new operation that advocates self-gratification. Addr: None. (Williams)
Heavy Dude Radio- 6955 at 0130. Mr. Heavy Dude operates a Europirate heard here via a North American relay. They claim to be the heaviest rock station on Earth. Addr: Lund. (Williams)

KDED- 7470 at 2345. You never have to worry about which musical artists you will hear on the Voice of the Grateful Dead. Addr: Wellsville. (William Hassig, Mt. Prospect, IL)
KICK- 6955 at 1615. Last month when we pictured the KICK QSL, nobody logged the station. This month we have no picture, but Pete Moss' holiday show with a Jacques Cousteau parody was widely heard. Addr: Huntsville. (Ross)

KTVI- 7470 at 0145. Emanuel Goldstein normally programs rock music, but a recent show featured commentary on the situation in Haiti. Addr: Faribault. (Pearce)

Laser Hot Hits- 7415 at 1630. This Europirate rocker has been heard via a North American relay on numerous occasions. They use distinctive laser sound effects during recorded promo jingle identifications. Addr: Merlin. (Ross)

North American Pirate Relay Service- 6955 at 2300. Aside from numerous relays of other pirates, Richard T. Pistek's holiday shows somehow featured an interview with the Outer Limits columnist in *Monitoring Times*. Where did they get that? Addr: Wellsville. (Pearce, Williams)

One Voice Radio- 7414 at 1500. Joe's approach to pirate radio is a calm magazine digest discussion of helpful medical tips. Jesse heard advice on how to lose body fat. Addr: Merlin. (Jesse Rose, Hampton, VA)

Pirate Radio Insanity- 6955 at 2045. A marathon pirate fest using this name operated during summer 1994 and New Years 1995, including some canned promotional announce-

ments from this station that publicized the event. Addr: None. (Williams)

Radio Airplane- 6960 at 0400. Captain Eddy broadcasts rock music from an aircraft in flight, complete with sound effects. His request for racy pictures instead of 32¢ stamps with letters was amusing. Addr: Wellsville. (Pearce)

Radio Albatross- 15675 at 2100. Jeff White of **Radio Copan International** advises that the relays of this new pirate are being aired on UTC Sundays in February, not Tuesdays as advertised in press notices from Albatross. (Jeff White, Miami, FL)

Radio Azteca- 6955 at 2330.

Bram Stoker seems to produce about one new DX parody show per month, and he never runs out of hilarious creativity. He also solicits jokes through the mail from listeners. Addr: Wellsville. (Hassig, Williams, Pearce)

Radio Beaver- 7375 at 2330. The squeaky-voiced Bucky Beaver recently parodied Halloween station **WBST** around the New Years holiday, oddly enough. They are an overtly Canadian station. Addr: Merlin. (Ross)

Radio City- 7415 at 1700.

This is one of the more entertaining Europirates that uses

North American relays, featuring an odd mix of novelty music, comedy, and unexpected segments like old Studebaker car ads. Addr: Wuppertal. (Rose)

Radio Doomsday- 6955 at 0400. Nemesis' self-reported 1994 suicide turned out to be greatly exaggerated. His 1995 shows mix rock, pirate radio discussions, and relays of other stations. Addr: Wellsville. (Gigi Lytle, Lubbock, TX, Williams)

Radio Garbanzo- 6955 at 2345. Longtime pirate Fearless Fred and sidekick Harry P. Ness are active again. Barry said that their Drunks Against Meddling Mothers and Jeffrey Dahmer Barbecue Sauce ads were hilarious. Addr: Wellsville. (Williams)

Radio Is Not Radio- 6955 at 0330. I guess we have seen everything now. They parody the imposter who claims to be the "Real" Radio USA. Addr: Providence. (Zeller)

Radio Lollipop- 7415 at 1700. This strange Europirate produces shows of pop and rock music for an audience of small children. Their announcer talks in English, but with a German accent. Addr: Wuppertal. (Ross)

Radio Perfekt- 6955 at 1730. Here's another European pirate that has established a relay relationship with North American transmitters. A male announcer with a thick German accent programs a country music format. Addr: Venlo. (George Zeller, Cleveland, OH)

Radio USA- 6956 at 0100. Mr. Blue Sky has made it on the air in 1995, the station's eleventh year of operations. Addr: Wellsville. (Zeller)

Radio USA (fake)- 7375 at 2145. Their "Nazi

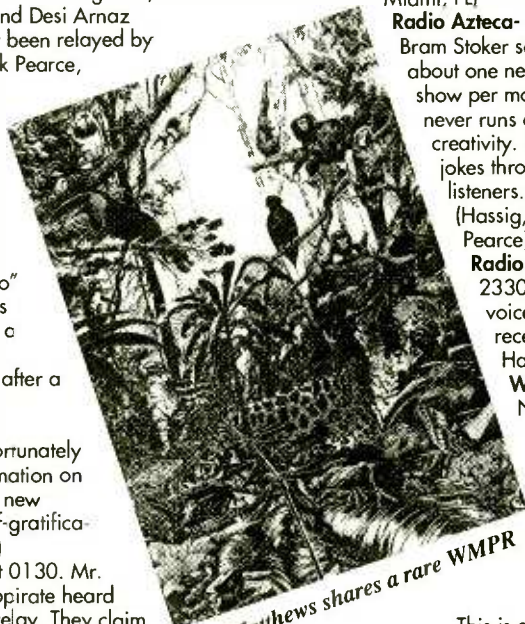

Bill Matthews shares a rare WMPR QSL.

Christmas" show of martial music was hosted by an imposter posing as the editor of this column. We'll stick with this station name for a while to avoid confusion, despite their logo QSL that we picture this month. Addr: None, but verifies logs in *The ACE* bulletin. (Zeller)

Solid Rock Radio- 7415 at 1645. Dr. Love has developed quite a few fans among pirate DXers. He mixes his own rock and soul music shows with radio discussions and relays of other pirate stations. Addr: Wellsville. (Ross)

Up Against the Wall Radio- 7414 at 2245. They still emphasize 1960's leftist rock music and opinion, but they have been adding more comedy to the lineup lately. Addr: Wellsville. (Pearce)

Voice of Bono- 6955 at 0115. Gary Daniels has emerged from hibernation with his rock music programming. However, he needs to replace his now defunct maildrop. Addr: Baltimore no longer valid. (Nick Terrence, Huntington, NY, Pearce)

Voice of Laryngitis- 6957 at 0630. Genghis, Stanley, and all the Huxleys are back with new 1995 shows. Gigi says that every one of their broadcasts has at least one bit that makes her laugh so hard that she has to hold her sides. Addr: Wellsville. (Lytle)

WKLX/WRQI Relay- 1620 at 0345. Somebody has been putting out a pretty good medium wave pirate signal that features live relays of two Rochester, NY, oldies rock commercial stations. The identity of the pirate transmitter is unknown. Addr: None. (Ross)

WLIS- 6955 at 1615. Jack Boggan still cranks out shortwave station interval signal music in a hit tunes format, sometimes assisted by verification signer Charles Poltz. All of his many QSL designs include at least one picture of famous shortwave broadcast personality Ian MacFarland. Addr: Blue Ridge Summit. (Ross)
WMPR- 7414 at 2300. Well known Radio Korea personality Bill Matthews snagged the rare QSL from the station that we print this month. Addr: Wellsville. (Bill Matthews, Columbus, OH)

HamCall CD-ROM

US & International Callsign Lookup
 Over 1,130,000 listings and 105 Countries

Includes U.S. Clubs & Military Stations.
 ICALL DOS & windows program looks up: name, address, expiration date, birth year, license class, county, lat/long, area code, time zone, elevation, beam heading & distance between U.S. stations. Grid Square. Retrieve by any data element on PC, call, name and zip on the MAC. Hundreds of new programs are on this disc. For a larger collection of software



ask about the Electronics Software Compendium CD-ROM
 • No hard disk required • Print Labels • Export to hard/disk or floppy • TSR runs from text window • Updated every April & Oct • Standing orders accepted • Dealer discount for 6 or more • Latest public domain PC software. Same low price of \$50.00 plus \$5.00 shipping.

New CD-Rom Electronics Software Compendium

The Electronics Software Compendium is a collection of programs and data files that pertain to electronics, broadcasting, amateur radio and SWL activity. Over 15,000 files in total. The disc is updated and issued annually in April. Over 200 megabytes of PC and 30 megabytes of MAC software. Send your order to Buckmaster Publishing, \$25.00 plus \$5.00 shipping. Checks accepted.

BUCKMASTER
 Route 4, Box 1630 • Mineral, VA 23117
 703:894-5777 • 800:282-5628
 703:894-9141 (Fax)
 Internet: info@buck.com

Audio Booster for Handhelds



Undoubtedly you've seen the ads for Naval Electronics' HTS-2 Audio Booster. There is now a new version, the HTS-3.

The HTS-2—and presumably the HTS-3—is primarily designed for use by hams, thus the prefix "HT." It's supposed to plug into the handheld audio output jack and amplify the output to punch through noisy environments such as inside a vehicle. Also advertised is the included "Tape Trigger" that automatically turns a tape recorder on and off whenever there's audio.

So now there's a new HTS out. What's the difference between the two models? When we called the company, we were told that there was no difference in the product and no difference in the price. But there was a change in price.

So how about the differences between the two models? We'll find out soon when we put together the results of a hands-on comparison. Meanwhile, you can do your own review by ordering an HTS-3 from your favorite scanner or amateur dealer. Grove lists it at \$29.95 plus \$5.50 shipping.

Yacht Boy 400 Mod

Worldcom Technology announced a new high-performance modification/enhancement service for owners of the Grundig Yacht Boy 400 receiver. The mods add narrow bandwidth filters to improve the radio's ability

to separate closely-spaced stations, true SSB reception, and an internal antenna booster. Any or all of the mods may be chosen.

The package starts with a basic service charge of \$24.95 which covers check-out, opening and closing of the radio, frequency-display alignment, peak-tuning of the radio for best sensitivity, post-service burn-in and insured return shipping anywhere in the US. Add to this the cost of the desired option(s).

The first option is an extra-narrow AM/SSB filter to replace the narrow filter that is standard on the radio. With a bandwidth of 2.5 to 2.7 kHz, this filter is much narrower than the present narrow filter, which is typically 4.4 kHz wide. The filter also provides true SSB reception, since it is only wide enough to accept one SSB signal at a time. Accommodating the new power of this function requires modifying the tone switch so that it will also function as the USB/LSB switch when the BFO is on. Add \$90.00 for this option.

For more mods and information call 407-466-4640 or write Worldcom Technology at P.O. Box 3364, Ft. Pierce, FL 34948.

Trucker Antenna

Everhardt Antennas, who manufactures the popular Grove ANT4 mobile scanner antenna, has recently released a trucker's version designed especially to match the four-foot CB antenna normally used on truck cabs. The fiberglass whip, called the MS-CB, is made to thread into a standard 3/8 by 24 base. Frequency response nicely covers low, high, UHF and 800 MHz land mobile services.

Retail price is \$14.99 plus shipping. For more information or to order, contact Marvel Communications Company, 6000-D Old Hemphill Road, Ft. Worth, Texas 76134.

—B.G.

Free Classifieds!

Like most of you, we like anything that's free, so when Bill Blyleven, president of *The Trading CIRC*—"IT" told us about his no-cost classified advertisements for electronic equipment, we were intrigued. This free service currently has over one hundred subscribers, with the list growing daily.

Each issue runs about three pages so far, and is sent out every two weeks. Ad categories include scanners, ham equipment, shortwave solid state, shortwave tube, CB, marine, wanted, help wanted, help needed, Hi-Fi Stereo, parts, computers, video, books and more. Subscriptions to *The Trading CIRC*—"IT" cost \$5 for two issues, \$10 for 4 issues, \$25 for 13 issues or \$45 for 26 issues.

As always, the classifieds themselves are free. Bill says he'll be accepting photo ads starting January 1st. If you're intrigued, too, contact *The Trading CIRC*—"IT", 86 Victoria Street, S. Kitchener, Ontario, Canada N2G 2A9.

Police Call Detail Edition

Each year, *Police Call* publisher Gene Hughes puts out a special directory for Southern California scanner listeners. Hiding in the shadow of *Police Call Volume 9* is the *Southern California Detail Edition*—112 pages

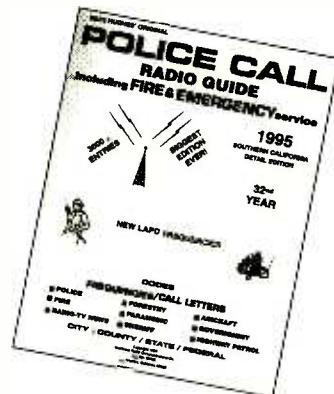

of rock-solid information on fire and emergency services in the southern half of the left coast. This companion volume takes mere listings and explodes them into detailed facts on services in the counties of Los Angeles, Imperial, Orange, Riverside, San Bernardino, San Diego, Ventura, and Baja.

Open to page 68, for instance, and you see Riverside County's trunked system broken down into usage areas, plus the sheriff's unit numbering system. Right on its heels are frequencies for the county's flood control, hospital, local government, medical net, parks, roads, and transit agencies. That's followed by a breakdown of county fire stations: numbering system, location, and frequencies.

The local community section is next, an alphabetical listing of communities within the county and their frequencies. Each county is treated this way, packing everything you need to know about an area into a few pages, eliminating the need to hunt through an entire directory for relevant frequencies.

As always with Gene Hughes, the information is cutting-edge current and the book contains an indispensable guide similar to that found in its big brothers, the nationwide volumes. The only negatives to be found in this directory are small indeed: nevertheless, we wish the local community listings contained unit numbering info like that provided for the bigger city and county departments. We also wish the book came pocket-sized, so it could be easily tucked away between uses.

Police Call Southern California Detail Edition retails for \$9.95 and is available from local dealers, or may be ordered from California Radio Communications Co., P.O. Box 35102, Los Angeles, CA 90035.

—L.Q.

Traveler's Guide to Pennsylvania

The best frequencies come from those listeners that are in the trenches with their radios busily searching for activity. Rich Szumski is one of those listeners. His 1995 edition of the *Traveler's Guide to Frequency Monitoring* is an eight page, corner-stapled list of Pittston Township, Pennsylvania, and surrounding areas. Covering police, fire, and aircraft, the list also gives zones and station numbers, as well as an eclectic mix of other information such as the Goodyear blimp and football team frequencies.

Though it's basic and not your usual glossy type-set book, this list does the job anyway. To order, send \$3.50 to Rich Szumoki, 199 Winter Street, Pittston City, Pennsylvania 18640 or call 717-655-3311 for more information.

New Uniden CB



Uniden America Corporation doesn't believe that Citizen's Band Radio is dead. Just to prove it, the world's largest manufacturer of CB's has just expanded their line with the PC 76XLW. Billed as a "high performance, professional CB radio," the 76XLW is targeted at the professional driver who relies on a dependable, high quality CB in his dash.

Featuring an AM CB chassis, multiple controls for clearer reception and transmission, the PC 76XLW also receives National Weather Service channels and includes a weather alert feature for automatic warning of service weather. The unit also features NB/ANL, S/Rf/SWF meter, RF Gain and SWR control, PA system, RX/TX indicator, an antenna warning LED, plus instant

channel 9.

The PC 76XLW is available from Uniden America Corporation, 4700 Amon Carter Blvd, Fort Worth, Texas, 76155 or call (817) 858-3300 for more information.

WRTH 1995

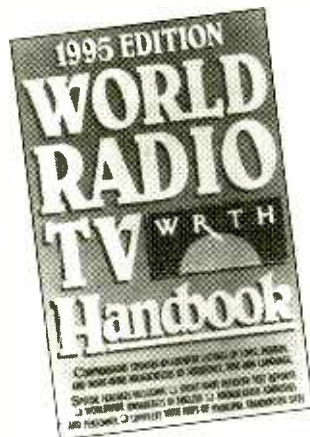

When you've been doing a column about new products as long as I have—some fourteen years when you count the years before I joined *Monitoring Times*—you establish a kind of seasonal hobby rhythm. This has its good point and its bad: rhythm, as you know, can lull you to sleep.... "It's January: it must be WRTH time."

It's the *World Radio TV Handbook*—I mean, what new can you say about it? This book changes less than the face of Mount Rushmore. Rolling in at 600-plus pages, it is first and foremost a by-country listing of shortwave radio stations, addresses, personnel, and frequencies. The second major part covers world television in much the same manner. At the back are a couple of articles, a frequency cross-reference, a couple of equipment reviews, and slam, bang, the book is done.

There's no major complaint about the book's data. But this big, old, warm and fuzzy is very predictable, despite the technological advances heralded by the editor in the front of the book. ("We are gathering," says Andy Sennitt, "an increasing proportion of our data through the

Internet and other on-line networks.")

The 1995 WRTH remains a must-have for the shortwave listener, as comfortable and necessary as a pair of well-worn slippers on a cold winter night. The *World Radio TV Handbook* is now priced at \$24.95 plus \$6 UPS shipping from Grove.

Remaking Radio

The 1980's and early 90's saw dramatic regulatory and economic changes in the world of commercial radio. Programming shifted and management and operations were impacted by the upheaval. Author Vincent M. Ditingo, former senior editor of radio for *Broadcasting and Cable* magazine, examines the new direction of radio broadcasting in his book *The Remaking of Radio*.

Published by Focal Press, the 160-page book looks at radio's fiscal dynamics, the financial boom and emerging entrepreneurs, the AM dilemma, industry realignment, the syndinets, electronic marketplace, digital factor, other technological applications, and radio the 21st century. Ditingo's perspective helps business and media professionals, those considering media careers, and those interested in the current path of commercial radio.

Considering the future of radio, with its changing ownerships, satellite programming, digital formats and information technology, *The Remaking of Radio* is a vital and necessary look at the present and future. The book is available for \$24.95 from Focal Press, 313 Washington Street, Newton, MA 02158-1626 or order toll-free 1-800-366-2665.

Vintage Manuals

Like many experienced radio hobbyists, Pete Markavage was frustrated by the lack of manuals for used equipment and accessories he found at yard sales, hamfests and flea markets, so he started collecting—with a vengeance!

With a collection of thousands

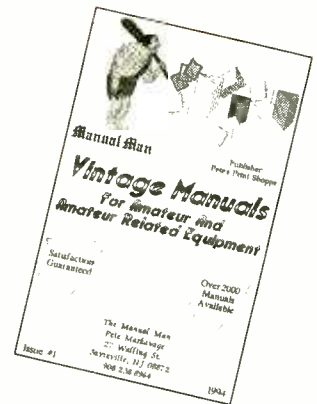

of different equipment manuals, "The Manual Man" now offers originals and reprints through his catalog, "Vintage Manuals for Amateur and Amateur Related Equipment."

For your free copy, send two 32-cent postage stamps to The Manual Man, 27 Walling St., Sayreville, NJ 08872.

— B.G.

Mobile Cellular Systems

No question about it—cellular telephones are here to stay. Now a multi-billion-dollar industry, cell phones permeate the automotive aftermarket industry, and the airwaves as well. They are a cultural phenomenon and a boon to business.

But for the technically-inclined and the engineer, a single source of detailed information has been hard to find. William C.Y. Lee, vice president of technology at Pac-Tel Cellular, has filled this void with *Mobile Cellular Telecommunications Systems*, a solid, information-packed encyclopedia of cellular design data.

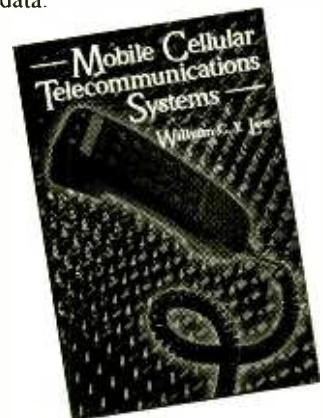

Not for the mathematically-queasy, this tome is much more than a superficial, descriptive glance at the industry; rather, it is an intense and comprehensive reference work covering every aspect of cellular telecommunications.

Cell-site planning, loading and hand-off design, complete specifications for mobile and base installations, frequency utilization, CDMA standards, range computation, antenna design, interference, digital control and speech systems, even a specifications list for the various cell systems used around the world, including microcells. And all solidly-mathematically based for design, analysis and maintenance of cellular systems.

For the telecommunications planner or system engineer, this is the one book to have on the reference shelf. The book is \$60 plus approximately \$7 shipping and handling from McGraw Hill, Blue Ridge Summit, PA 17294-0701; 800-722-4726.

— B.G.

Antennas from the Master

They say that Lew McCoy, W1ICP, is a living legend in amateur radio. After four decades in the hobby, including more than thirty years with the American Radio Relay League, Lew more than deserves the title. This veteran has written about all facets of amateur radio for years, but his first book is about one of his favorite topics: antennas. *Lew McCoy on Antennas* takes the reader through the basics about antennas, from standing wave ratio, antenna gain, line loss, and transmatches, through the various types of antennas like dipoles, multiband beams, and quads.

Mac's book doesn't come across like a college text; instead the technical material is presented casually, in a way designed to be non-intimidating. The subtitle tells it all: "Pull Up a Chair and

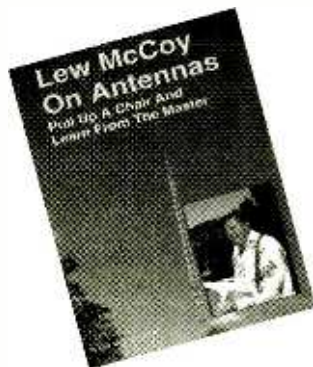

Learn From the Master." If you have attended one of Mac's countless lectures or read some of his articles, you already know how the master teaches.

Lew McCoy on Antennas is published by CQ Communications and retails for \$15.95. Order from your local ham dealer or direct from the publisher 1-800-853-9797 or write CQ, 76 North Broadway, Hicksville, NY 11801.

Scrambled Phones from Uniden



Uniden America Corporation of Fort Worth, Texas, recently announced seven new multi-channel cordless models of its resurgent Extend A Phone line of products. The shining feature of the line is voice scrambling, available on the high security models known as the DX419, DX355, and DX424.

Uniden is also expanding its 10-channel line-up with the addition of the XC302 and XC305 compander units. The XC345, at the top of the line, will be available with dual keypads, speaker-phone, and auto channel scan,

plus one touch dialing. The EXP901, a lower cost 900 MHz model, is also available with monitor, intercom, and 20 number memory.

For more information contact Uniden America, 4700 Amon Carter Blvd., Ft. Worth, Texas 76155, or call 817-858-3300.

Laser Radar Detectors

We've all been there: out on the highway, trucking along, letting the speed edge over 55 ... when all of a sudden red and blue lights are flashing in the rear-view. Zapped by highway patrol radar, we're another statistic for the ticket book.

Apparently, Uniden America also knows the feeling, because they have expanded their laser/radar detector line with two new units for 1995. The LRD 1995 is a compact 3-band, X, K and laser detector. It offers many features such as signal strength meter, three distinct audio tones and three separate LED's that are usually only available in higher priced models. The LED's serve a dual purpose, also functioning as warning lamps to indicate the strength of the received signal. The alarm rate increases as the radar approaches.

Also available is the LRD 2150—a four-band radar/laser detector that alerts drivers to the searching beams of X, K, Ka SuperWideband, and laser. Four different audio tones help to identify the detected band, accompanied by four LED's for visual warning. The LRD 2150 features the Uniden Phantom Systems Technology to help protect against the Radar Detector Detection devices being used in some states. Signal strength meter, automatic mute, city/highway settings and more are standard on the 2150.

The LRD 1995 and LRD 2150 list for \$129.95 and \$199.95, respectively, from Uniden America Corporation, 4700 Amon Carter Blvd., Ft. Worth, Texas 76155 or call 817-858-3300.

Amateur Radio Scholarships

The Foundation for Amateur Radio, Inc.—a nonprofit organization from Washington, DC—has announced plans to administer 56 scholarships to assist licensed radio amateurs. The Foundation is composed of over 75 local area amateur radio clubs and fully funds five of these scholarships with the income from grants and its annual Hamfest. The remaining fifty-one are provided by the Foundation without cost to the donors.

If you're a licensed radio amateur you may compete for these awards if you plan to pursue a full-time course of studies beyond high school, or are enrolled at an accredited university, college, or technical school. According to the Foundation, the awards range from \$500 to \$2000, with preference given in some cases to residents of specified geographical areas or the pursuit of certain study programs.

For additional information and an application form, write prior to April 30, 1995 to FAR Scholarships, 6903 Rhode Island Avenue, College Park, MD 20740.

Follow-Ups

We have a new phone number for Autek Research, manufacturer of the RF-1 SWR meter mentioned in the January issue: 1-813-886-9515.

For free "Towers to Eternity" book from TransWorld Radio (see February), the number to call is 919-460-3700.

Books and equipment for announcement or review should be sent to "What's New?" c/o Monitoring Times, P.O. Box 98, 300 S. Hwy 64 West, Brasstown, NC 28920.

AR 8000

The New Concept - AR8000 shocks the market. AOR made every effort to incorporate the latest technology in to this new scanner.

• SPECIFICATIONS •

- Range: .5 - 1900MHz usable to 100kHz
- Modes: AM/NFM/WFM/USB/LSB/CW
- Stepsize: 50Mz to 999.995kHz
- Sensitivity(μ V): 30 to 1000MHz
SSB .2 AM 1.0 NFM .35 WFM 1.0
- Filters: (kHz) SSB 4 AM/NFM 12 WFM 180
- Memories: 50 ch. x 20 banks=1000 total
- Size/Wt.: 6.1 x 2.8 x 1.6 inch.
20 oz. batt. incl.

* Cell blocked for all, but Approved agencies.



- Covers .5-1900MHz*
- Ferrite Rod antenna below 2MHz
- Only portable scanner on U.S. market to have true SSB, both LSB & USB. Others attempt SSB using a BFO, but are difficult to tune and produce poor SSB audio.
- 4 level alpha numeric LCD read out frequency, mode, signal strength, band scope spectral display, battery low, remote and more
- Computer control up/down load data, will add a new dimension to the world of scanning.
- Clone your memory banks with a friend, load 1000 memory channels in seconds

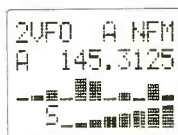

The Latest From AOR Products Available at a Dealer Near You!

NEW

SDU 5000

The Spectral Display Unit adds a new dimension to the signal interception hobby. Imagine seeing stations above and below your

receiving frequency. Usually the transmissions are short, perhaps 1 or 2 seconds. What are the chances of you being tuned to the exact frequency at the instant of transmission? Very slim. With an SDU you can watch for stations to pop up over a 10MHz window, then zero in. The SDU 5000 offers features unheard of only a year ago.



- Δ Frequency coverage up to 10MHz
- Δ Display - 3.1" HQM Simple matrix color LCD
- Δ Resolution: 5 or 30kHz selectable
- Δ Input: 10.7MHz
- Δ 50dB Dynamic range
- Δ Screen refresh 2/s
- Δ Composite video out
- Δ Full computer control
- Δ Video output NTSC or Pal display, on TV or record

on VCR Δ RS232 9600bps Δ Instant receiver set from cursor via RS232 Δ Store image on disc or your video recorder Δ Menu driven system makes SDU5000 simple to operate Δ SDU5000 is designed to work with the AR3000A (modified with a 10.7MHz output) using RS232 link with or without a computer. Other receivers with 10.7MHz IF output but digital linking may not be straight forward.



Electronic Distributors Co.

325 Mill Street, N.E.
Vienna, VA. 22180

Phone: 703 938 8105 FAX: 703 938 4525

Exclusive North and South American Distributors.



AR8000 Interface

Computer Interface for the AR8000

- Δ Low Power, powered by your serial port
- Δ No Drain on the batteries in the radio
- Δ Light weight, perfect for Laptop use
- Δ As small as a DB-25 Connector
- Δ Hi-Tech Surface mount design for reliability
- Δ 100% Shielded cable to receiver for reduced interference
- Δ PC Software included for Windows and DOS
- Δ Manual included
- Δ Detailed Programers documentation available
- Δ Designed and Manufactured in the USA
- Δ Optional 100% shield computer cable from AR8000INF to computer for reduced interference

Unlike some of the European devices sold today, this unit is smaller, lighter, and makes no power demands on your receiver. With the extra shielding and smaller size there is less chance of additional interference leaking into your radio. The AR8000INF is also the only interface that is upgradeable for use with the optional Tape recorder controller due first quarter '95.



OptoElectronics DC440 decoder

Review by Lee Reynolds, KD1SQ

Over the last few years, OptoElectronics has been busily building a growing range of frequency counters, test bench equipment and signal interception devices. With all these devices on the scanner listener's plate it's easy to overlook some less obvious items, such as the OptoElectronics DC440 decoder. This little box claims to decode PL (CTCSS) tones, touch (DTMF) tones, and digitally controlled squelch (DCS)* signals, and to even make the data available to your favorite scanner control program. Does it? The answer is an emphatic "Yes"!

The DC440 is a small box (4.5"W x 2"H x 4"D) that sits next to your scanner. The front panel sports a small electroluminescent (EL) display capable of showing two lines of up to 16 characters and three pushbuttons controlling unit power, decoder mode and display data recall. The rear panel has jacks for power, audio input and data. Connection to your scanner is a fairly simple task if you have a moderate level of ability with a soldering iron. A stereo headphone jack and a couple of resistors and capacitors have to be added to the scanner to provide the proper squelch signal and discriminator audio outputs for the DC440.

The manual is well written, easily understandable, and explains clearly how to modify a number of the more popular scanners for use with the DC440. As a side note, OptoElectronics' technical support has been consistently helpful and knowledgeable whenever called upon with a question or a problem concerning the DC440.

In operation, the DC440 is easy to use and has a number of selectable modes of operation. These are: DECODE ALL in which the DC440 will decode and display all signals received, CTCSS DECODE for PL decoding only, CTCSS PERIOD MODE which causes the DC440 to accurately measure the frequency of a CTCSS tone (you can tell your local police department if their tone is off by a Hertz or two!), DCS DECODE in which DCS codes only are monitored and, lastly, DTMF DECODE mode for displaying any touch tone signals being sent.

In practice, the user will usually select the catch-all mode of DECODE ALL in which the DC440 will display and decode all signals that it can interpret. Of particular use to the scanner listener is the '440's rapid lock-up and display of CTCSS frequencies—having this data available is extremely valuable when trying to identify a particular transmitter or make sense of a busy trunking system's user pattern.

Your reviewer has been using the DC440 at his listening post for the past six months and has had time to really put the box through its paces. So far, the DC440 has performed flawlessly in conjunction with an ICOM R-7000 receiver. Initial setup was fairly easy requiring a careful reading of the modification in-

structions and a quick visit to the local Radio Shack for the required components. Modification time itself was on the order of 30 minutes. Connection of the DC440 and setting of DCS code polarity and squelch detect polarity (via jumpers inside the DC440) took another ten minutes.

That was the beginning of a beautiful friendship—since then it has proven to be one of the most useful scanner accessories in the shack when it comes to trying to identify a transmitter or to perform signal traffic analysis. One nice trick is to see which unidentified stations share PL tone or DCS code systems in common with known stations, or similarly, to match base and mobile stations on multi-user repeaters. Decoding ability is consistently reliable on all but the weakest signals.

The DC440 also has the ability to communicate with other devices via a built-in CI-V** interface. Decode modes, squelch open/closed, decoded data, DC440 status—all can be controlled or interpreted via this port. You can even turn the display backlight on and off under software control!

A number of software packages are available that work with the DC440: OptoElectronics' own TONELOG software is one, Sam Dunhams' Scan*Star software line is another. Please note—if you intend to use the CI-V interface of your DC440 with a PC you will need to have available either the ICOM CT-17 or the OptoElectronics CX12 level converter to connect between your PC's COM port and the DC440.

To summarize—the DC440 is an extremely useful add-on for any scanner if you want to be able to easily decode any of the signalling systems present on many radio systems. The only negative thing about the DC440 is that the EL display is hard to read unless viewed directly on.

Installation and setup are not quite as easy as just plugging in the supplied 9vdc power cube and turning it on, but this should not deter you from considering purchase of it. It performs very well. Should you choose to use the DC440 in conjunction with a computer you will have a scanning tool that is hard to improve upon.

The DC440 lists for \$259 from OptoElectronics, 5821 NE 14th Ave, Ft. Lauderdale, Florida 33334; 800-327-5912.

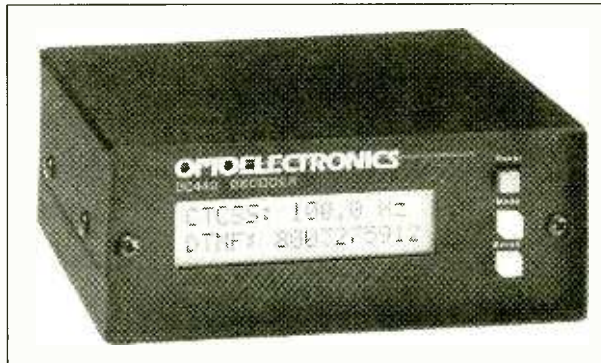

*PL(CTCSS), DTMF (Touch Tones) and DCS are all commonly used methods of signalling between, identifying, or controlling stations.

**CI-V is a communications method, developed by the ICOM company, that enables receivers, transmitters and transceivers to exchange data between themselves and other devices, including computers.

SCANCAT 5.0 and SCANCAT-PRO!

Since 1989, The Proven Leader In Computer Control

Once you use the newest version of the SCANCAT 5.0 or SCANCAT-PRO computer program with your radio, you will never operate your radio again without it! SCANCAT controls the following radios:

- AOR 2500, 3000, 3000A, 3030
- DRAKE R-8
- ICOM R-71, R-7000, R-7100, R-9000
- JRC NRD-525, NRD-535
- KENWOOD R-5000, TS-50, TS-440, TS-450, TS-850
- YAESU FT-757GX, FRG-100, FRG-9600
- REALISTIC PRO-2005/6



Most ICOM and Kenwood radios - consult your radio's owners manual.

SCANCAT 5.0 FEATURES

- Create frequency databases
- Scan between ANY frequencies
- Up to 400 frequencies per file (unlimited with SCANCAT-PRO)
- Scan by ANY increment and delay
- Share any radio's file
- Faster Performance
- QUICKTERM built-in TNC comm program with programmable macros

AOR / KENWOOD 450-850 / DRAKE / YAESU • ICOM • NRD535

- Must have squelch detect cables for ICOM and YAESU (not required for R-7100, R-9000 ICOM OR YAESU FRG-100)
- Auto signal detection/scan stop
- Auto logging to disk files
- Spectrum analysis
- Save/load radio's memories to disk

SCANCAT-PRO ADDITIONAL FEATURES

- Multiple scanning banks
- Comma delimited conversion
- D-Base file support
- Unlimited file sizes
- Dual radio simultaneous scanning and Opto 3C440 support with ICOM radios
- OptoScan 456 search by CTCSS/DSC tone and Decode DTMF tones

SCANCAT comes ready to run ALL supports radios within only ONE program. SCANCAT makes your listening hobby a breeze! Plus, the included SCANPORT allows you to convert your favorite BBS, D Base files, or columnar frequency lists to a running SCANCAT file.

Requires a 640K MS-DOS computer w/RS-232C serial port - hard disk recommended for SCANCAT-PRO. **Manufacturer's interface not included.**

CALL or WRITE for FREE information or our \$5.00 FULLY OPERATIONAL DEMO DISK (includes shipping/handling). DEMO price refunded with purchase. FOR A LIMITED TIME, if you ORDER NOW, we'll include as a BONUS, FOUR SCANCAT FREQUENCY FILES!

- | | | | | | |
|-----------------------|---------|------------------|---------|---------------------------------|----------------------------------|
| SCANCAT 5.0 | \$49.95 | UPGRADE | \$24.95 | OPTOScan456 kit | \$299 (\$10 s/h) |
| SCANCAT-PRO | \$79.95 | from any version | | Order OS456 board & SCANCAT-PRO | combined and receive a free \$15 |
| SQUELCH DETECT CABLES | \$24.95 | | | frequency disk. | |
- PLUS \$5.00 SHIPPING & HANDLING \$7.50 FOREIGN Order direct or contact your favorite dealer.

COMPUTER AIDED TECHNOLOGIES

P.O. Box 13285 Shreveport, LA 71138

Orders Only (318) 636-1234 - FAX (318) 686-0449 (24 hrs)

Live Tech Support - (318) 687-2555 (9 a.m. - 1 p.m. Central M-F)

Nighttime BBS (SCANCAT File Area) (318) 631-3J82 (7 p.m. - 6 a.m. Central)



FREE DEMO ON BBS

INTRODUCING THE UNIVERSAL M-400

A totally new concept in code / tone readers!



- Baudot
- Sitor A/B
- ASCII
- Swed-ARQ
- FEC-A
- FAX
- POCSAG
- GOLAY
- ACARS
- DTMF
- CTCSS (PL)
- DCS (DPL)

- A RTTY-reader and tone-decoder in one!
- Easy to read two-line 40 character LCD.
- No computer or monitor required.

Forget the limitations you have come to expect from most "readers". The self-contained Universal M-400 is a sophisticated decoder and tone reader offering an exceptional range of capabilities. The SWL will be able to decode Baudot, SITOR A & B, FEC-A, ASCII and SWED-ARQ. Weather FAX can also be decoded to the printer port. The VHF-UHF listener will be able to copy the ACARS VHF aviation teletype mode plus GOLAY and POCSAG digital pager modes. Off-the-air decoding of DTMF, CTCSS (PL) and DCS is also supported. The M-400 can even be programmed to pass only the audio you want to hear based on CTCSS, DCS or DTMF codes of your choosing. The M-400 can run from 12 VDC or with the supplied wall adapter. The American-made Universal M-400 is the affordable accessory for every shortwave or scanner enthusiast.

Only \$399.95 (+\$6 UPS).

Universal Radio
6830 Americana Pkwy.
Reynoldsburg, OH 43068

- ◆ Orders: 800 431-3939
- ◆ Info.: 614 866-4267

FREE CATALOG

This huge 100 page catalog covers everything for the shortwave, amateur and scanner enthusiasts.

Request it today!

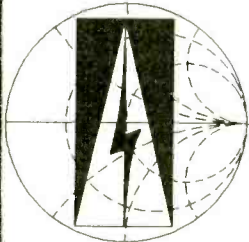

Austin Antenna

"The World Leader in Multiband Technology"

Manufacturers of multi-band Land Mobile, Microwave, and Scanner Antennas for Government Agency operations, Drug and Law Enforcement operations, Communications at the Kennedy Space Center and major networks such as NBC and ESPN.



The Ultimate Omnidirectional Multiband Station Antenna



New Innovation brings New Dimensions for Portables!



Specira

Superb Performance! with Maximum Versatility for Mobile and Base Station



Send \$1.00 for an Austin Scanner Antenna User's Guide [a regular \$3.95 value]

Austin Antenna 10 Main Street, Gonic, N.H. 03839 (603) 335-6339

The Uniden Bearcat BC9000XLT Scanner

Move over, Radio Shack PRO-2035: the Bearcat BC9000XLT, Uniden's top of the line base scanner, is here and it's a winner.

The BC9000XLT has 500 channels divided into 20 banks of 25 channels. Uniden literature bills the BC9000XLT as a continuous coverage scanner, but the 25 - 1300 MHz frequency coverage excludes 550 - 760 MHz and the cellular phone bands. Users may choose a tuning step size of 5, 12.5, 25, or 50 kHz. AM, NFM, and WFM modes are selectable.

Frequencies or memories can be selected using a large, ribbed tuning knob, which is easier to grip than the knob on the Radio Shack PRO-2035.

■ Memory Organization: Unusual But Effective

The following parameters can be selected for each of the BC9000XLT's 500 channels:

- frequency
- lockout
- 2 second rescan delay
- mode (AM, NFM, WFM)
- 0 - 99 activity counter
- attenuator
- aux. device (tape recorder) control
- CTCSS tone (if fitted with the BC005 option)

Channels programmed with a frequency of 0.0000 are considered "empty" and, unlike the PRO-2035, are automatically locked out so no time is wasted scanning them.

The BC9000XLT's bank arrangement is unconventional because there are two types of memory banks: lettered banks and numbered banks.

Lettered banks, labeled A through J, are full featured and contain channels 1 - 250. A 16 character alphanumeric tag (e.g., "Oswego PD f1") can be programmed with each channel. One priority channel can be designated for each lettered bank. Numbered banks 1 - 0 (i.e., 1 - 10) contain channels 251 - 500 and do not support alpha tags or priority channels.

The small bank size of 25 channels is much more suitable for scanning than the PRO-2035's banks of 100 channels, especially for



monitoring trunked systems. If you want to scan a 10 channel trunked system, you can dedicate one bank to the purpose, program the 10 repeater output frequencies into 10 memory channels, and lock out the remaining memories in that bank. Fewer channels are wasted in a smaller bank.

You can step through the memory channels one by one to see which ones are locked out, or press two keys and the large LCD (liquid crystal display) shows the status of all 25 channels in the current bank. For example:

```
Bank E P** *_L*_L  
LL* _*****L
```

A single character is used to represent each channel, "*" for each programmed channel, "_" for an empty channel, "L" for a locked out channel, and "P" for the priority channel.

Although we couldn't verify it, the Twin Turbo™ feature allows the BC9000XLT to scan at 100 channels per second—twice as fast as the PRO-2035. The older BC8500XLT has two scan speeds, but the new model has only one. To attain such a high scan rate, the BC9000XLT scans the channels within each bank in order of frequency, not channel number. You can see the effect by enabling a single bank, opening the squelch, and pressing the SCAN key repeatedly. This may frustrate listeners who program trunked system frequencies in descending order—a trick which makes it easier to follow conversations on some Motorola systems.

■ Search Features

The BC9000XLT has but a single search bank compared with the 10 search banks in

the PRO-2006 and PRO-2035. Up to 50 frequencies can be locked out during a search—a very desirable feature, useful for skipping birdies and unwanted paging frequencies within a targeted search range.

There are no preprogrammed Weather or Service Search facilities, features better suited for mobile and portable scanners.

Search speed is specified at a zippy 300 steps per second when the 5 kHz step size is selected and 100 steps per second when using larger steps.

One of the best features of the BC9000XLT is Auto Store, which allows one to specify search limits and destination memory banks. A frequency found active during the search will be stored into the next empty memory channel (i.e., a channel set to 0.0 MHz), unless the same frequency is already programmed into any of the 500 channels. No duplicates will be stored, in contrast the PRO-2035, whose Auto Store writes the same frequencies over and over again into several channels.

■ Performance

The BC9000XLT tested (serial number 45000061), is slightly more sensitive than our Radio Shack PRO-2006 except in the 460 MHz range, and does not exhibit the dynamic range problems of the PRO-2035 we reviewed.

Some owners of the older BC8500XLT model found that digital circuitry within the BC8500XLT interfered with reception when using an indoor antenna. Our BC9000 hears an internally generated noise near even MHz boundaries between about 110 and 440 MHz (e.g., 110, 112, 114, ... MHz) when using an indoor antenna located in the same room.

This was not a problem when using an outdoor antenna.

Other 8500XLT complaints include poor sensitivity, "hissy" audio, and inability to select reception modes independent of the frequency. Good news! The BC9000XLT has fixed these shortcomings.

Our BC9000XLT's image rejection is not quite as good as the old Radio Shack PRO-2004, and to a lesser extent, the PRO-2006. Using an Antenna Specialists AV-801 antenna mounted at 20 feet, the BC9000XLT hears strong cellular phone signals in the 360 - 385 MHz section of the military air band. Steve Donnell noticed and wrote about the same phenomenon in the earlier BC8500XLT (see Steve's "Mod House" column in the Sept/Oct 1994 *National Scanning Report*). It's a good bet that the BC9000XLT circuitry is similar and uses the same local oscillator frequencies for both the high portion of the military air and 800 MHz bands, merely switching in a different front end filter. Weak cellular phone signals appear near 1005 MHz, too.

Setting the step size to 12.5 kHz, we used the powerful Auto Store to find allocations in the 163 - 174 MHz range. Besides catching interesting FBI and DOE frequencies, we heard images from strong fire, police, and business signals in the lower part of the VHF-high band. The sum of the image plus actual frequency is approximately 322.6 MHz for the half dozen images heard.

Still, the BC9000XLT's image problem is mild in comparison to simpler receivers using 10.7 or 10.8 MHz first IF. Those receivers experience strong images throughout their tuning range.

The priority feature works well and doesn't chop up transmissions on the non-priority channels quite as much as on the PRO-2006. Audio output is good, but as with most base scanners, an external speaker aimed at the operator works better than the top mounted speaker which points at the ceiling. The BC9000XLT includes a switchable high-cut (i.e., low pass) audio filter. We prefer to leave it off.

Our BC9000XLT is not equipped with the CTCSS option so we couldn't test it.

■ Defects and Omissions

The squelch has to be set much higher when tuning the 800 MHz range on our scanner. By opening the squelch, it was clear that the white noise on this band is at a much lower level than other bands and we hope the uneven gain distribution is due only to poor alignment. Luckily, there is no annoying "pop"

sound when the squelch closes, as some BC8500XLT owners report.

How much current does the BC9000XLT require when operating from 12 VDC? What are the IF frequencies? Sensitivity specs? We don't know because the supplied English/Spanish operating guide failed to include meaningful specifications.

A mistake in the guide's Auto Store section (pg. 18, step 7) caused 15 minutes of fumbling to get the Auto Store feature working. It instructs us to press the wrong key, whereas it should have read "Press SRC to begin the Auto Store." Except for the missing specifications, the operating guide is adequate.

A small frequency guide is supplied with the BC9000XLT and other new Uniden models. We didn't find the minimalist listings for Illinois useful, although they may be of value to a newcomer or traveler.

The selectable attenuator—a great idea—is rated at 15 dB, but the amount of attenuation varies greatly at different frequencies. Using a calibrated attenuator for comparison, we found the BC9000XLT's attenuator diminished signals by 15 dB at 155 MHz, but only 3 dB at 460 MHz and 7 dB at 858 MHz. The 3 dB figure means the attenuator has almost no effect in the 460 MHz range. There is no way to disable attenuation on all channels at the same time with a single keystroke—something you'd want to do if you took the scanner mobile or changed antennas.

Strong birdies on 147.09 and 147.11 MHz will interfere with ham radio repeaters on or near those frequencies.

■ External Design a Strong Point

Although it wasn't built in Texas, just about everything on the BC9000XLT is big. It is housed in a steel cabinet and has a plastic front panel. Two massive, flip-down feet are rubber padded and allow the scanner to tilt. The prominent tuning knob is easy to grip and turn.

Controls are grouped logically. Most of the front panel real estate is used for controls instead of squeezing dozens of identically shaped gray keys close together as in the PRO-2006. The BC9000XLT's keys are sized generously, and different shapes and colors distinguish keys of different functions.

Colored LEDs (light emitting diodes) are recessed into nine of the keys and light up when the associated function is active. If the BC9000XLT stops on a signal while scanning, a yellow LED flashes for the duration of the transmission—very useful for telling at a glance which receiver is hearing a signal

when using several receivers concurrently.

The large amber display has three back-light settings: bright, dim, and off. To prolong its life, we recommend users turn the back-light off when the BC9000XLT is operated unattended for long periods of time.

It can be operated from 117 VAC using the supplied "wall wart" power supply, or mobile using the MB001 mobile mounting bracket and PS001 or PS002 DC power cord options.

■ Conclusion

If you want a new, premium grade scanner and don't require a computer interface, consider the BC9000XLT. Image reception is about the only blemish on this otherwise great scanner and the other technical problems were minor. The BC9000XLT is arguably the most feature rich and sensibly designed base scanner of the current crop.

Its strongest points include several right-sized memory banks, excellent Auto Store feature, availability of a CTCSS decoder, alphanumeric tags, and ease of use. The most difficult part of this review is returning the BC9000XLT.

Hopefully, a future model will include the ability to follow conversations in trunked systems, more alpha-tagable search banks, an S-meter, and a computer interface. Instead of the high cut audio filter, a more useful feature would be a switchable audio compressor or automatic audio volume control circuit to equalize the volume between soft spoken dispatchers and louder stations. At a minimum, Uniden should include detailed specifications. Owners and potential owners want to read them.

Look for the BC9000XLT at Grove Enterprises and other MT advertisers. Call for current pricing.

MIL-SPEC COMMUNICATIONS

Scanners by:
AOR
Uniden
Radio Shack

Catalog: \$2

**Specializing in the
Collins R-390A and
other fine military
receivers.**

MIL-SPEC COMMUNICATIONS
P.O. Box 461
Waketield, RI 02880
(401) 783-7106

Special Closeout:
BC200 - Cellular
Capable - \$275

■ Sangean SG 789A Compact Portable

The year was 1985. The place, Paris. The weather, ideal.

And there I was, strolling hand-in-hand with my wife along the Seine River, when the romantic bubble popped. I had just spotted a new model of shortwave radio in a nearby store window.

It was called the Sangean ATS-803, and I'd never seen it before. In fact, I'd never even heard of the manufacturer. So I bought it and went straight back to the hotel. It turned out to be quite a radio, even if it ruined our little romantic interlude.

■ Good Radio Quickly Made Better

When I got back to the States, I found that nobody else had heard of Sangean, either. So when I reviewed the ATS-803, it was real news. And good news, too.

I gave it high marks, but found a couple of things wrong with its performance. Never mind, because Sangean paid attention and immediately corrected them, then renamed the radio the ATS-803A. Ten years later, that radio is still the best one Sangean makes, and the company tells me that it continues to sell well. Next to the Sony ICF-2010, that's probably the longest product cycle for a shortwave portable. And no wonder. They're both great radios.

■ Sangean Expands into China

Sangean has since grown from a small operation along a Taipei street into the world's largest manufacturer of shortwave radios. They now have three factories in Taiwan, and they've only just recently opened another plant in the People's Republic of China. They're reportedly planning to inaugurate a fifth factory, also in China.

Shortwave is still their stock in trade, although most of what they make is sold under other brand names, such as Radio Shack. But they now manufacture other types of radios, as well, and they're also under contract to produce satellite gear for Siemens.

We've tested any number of Sangean products made in Taiwan, but this time we decided to take a look at their first shortwave radio out of China. It's the compact SG 789A portable,

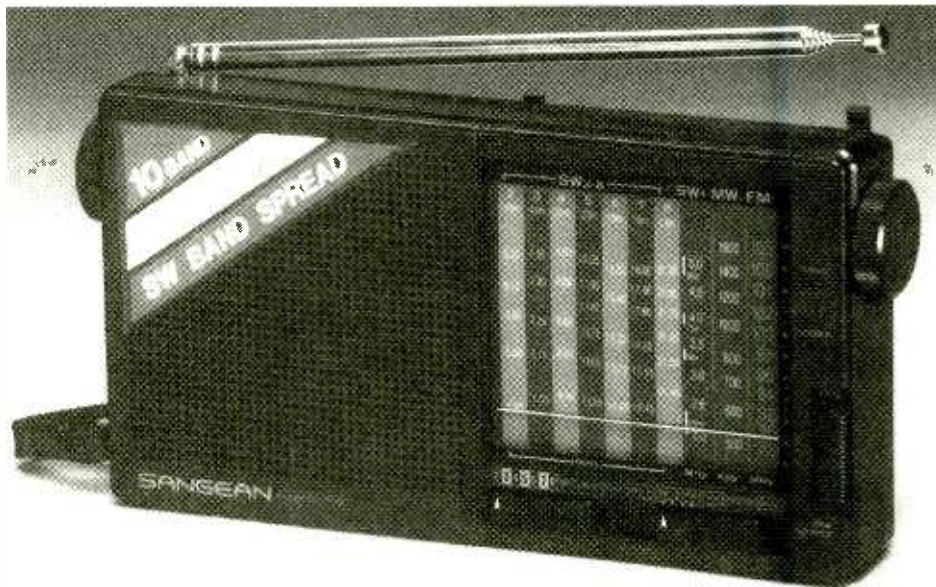

which we just got fresh out of the first shipment, and it lists for \$69.95.

■ Dated Technology, Incomplete Shortwave Coverage

It has needle-and-dial analog frequency readout, and only has single conversion. It covers FM, expanded-band AM, and shortwave, plus it allows for stereo reception through headphones. Incredibly, though, its shortwave coverage doesn't include the 13 MHz (22 meter) band. That important band has been in existence for some 15 years, now!

However, operation is straightforward. The only controls are a couple of bandswitches, an on-off switch, a stereo switch, volume control, and tuning knob. Basically, you just turn it on and dial to what you want to hear, so you can hardly go wrong. But as it doesn't have a digital readout, it's something of a hit-and-miss proposition.

■ Pedestrian Performance

The results are pretty basic, too. Sensitivity to weak signals is about what you'd expect, but all sorts of unwanted gibberish and squeals tend to come in to make shortwave sound like...well, like what shortwave used to sound like in the old days.

Adjacent-channel rejection (selectivity) is

mediocre. And there are images, or "ghosts," of stations 900 kHz away. All this means that the station you want to hear has a good chance of being bothered by voices and music from other stations.

The audio quality is okay for voice, but for music it doesn't have much bass response.

■ Build Quality Seems Good

More importantly, the real concern we have with Chinese-made products is how well they'll hold up. As we've pointed out in past issues of *MT*, many shortwave radios made in China have been poorly made. Yet, recently there have been some high-quality radios coming out of that country. Grundig's Yacht Boy 400 is an outstanding case in point.

It's too early to be certain how well Sangean's Chinese-made products will hold up. However, it's not an academic point, as Sangean reportedly expects to move most of its shortwave production to China in the near future. But our unit worked without a hiccup, and eyeballing the radio's innards didn't reveal any potential problems, either.

Indeed, while Sangean's products from all its plants are increasingly in the technological backwater, its quality control has always been above average. If anyone would be able to turn out a well-built Chinese radio, you would

think it would be Sangean, and very possibly this is what's happening.

■ "Made in China" not Necessarily Drawback

From this and other observations, a pattern appears to be forming. For now, at any rate, what we're finding is that non-name-brand radios made in China are almost invariably poorly made. But Chinese radios with major brand names, such as Grundig and Sangean, are coming out quite well. One—Radio Shack's DX-375—seems to be somewhere in the middle.

The bottom line is that Chinese consumer electronics is evolving into a serious industry, with products of much better quality than in the past. For consumers, that's great news.

... For Sangean, too. This means that it can turn out products with good build quality at a low production cost. Unfortunately, it doesn't do a thing for the fact that most Sangean shortwave radios are technologically wanting, and don't perform as well as they could, or should, against increasingly savvy competition.

■ Bottom Line: Forget It!

Not long after those carefree days in Paris, Sangean models were among the best to be found, and that's how it made its reputation. But in recent years they've been falling farther and farther behind in terms of performance, and the SG 789A is no exception. Its performance and technology are straight out of the 1960s, and isn't worth buying at any price.

After all, you can get any of a number of passable off-brand Chinese analog portables that may not be quite as well made—but which perform just as well—for around half the price of the Sangean SG 789A. It's just not good value.

This equipment review is performed independently by Lawrence Magne and his colleagues in accordance with the policies and procedures of International Broadcasting Services, Ltd. It is completely independent of the policies and procedures of Grove Enterprises, Inc., its advertisers and affiliated organizations.

Award Winning Antenna



Winner of the 93/94 WRTM award for the most innovative design. High performance MW Loop tunes 530 to 1700 kHz with features unlike any other antenna!

Kiwa Electronics
612 South 14th Ave., Yakima WA 98902
☎ 509-453-KIWA or 1-800-398-1146

NOTE ON ADVERTISEMENT BELOW:
As of 4/26/94 it became unlawful to market cellular-capable receivers in the U.S. Atlantic Ham Radio assures us it will give a full refund and hold customers harmless from shipping expenses if a purchased unit is returned to the vendor by U.S. Customs.

800MHz Coverage

We have scanners with 800MHz Coverage!

Models available include:

ICOM R9000, R7100, R1, R100,
IC-2SRA; Kenwood RZ-1;
Yupiteru MVt7100, 7000, 8000;
AOR AOR-8000

ATLANTIC HAM RADIO LTD.

(416)636-3636 368 Wilson Ave
(416)631-0747 Downsview, ON
All US orders shipped UPS Air Canada M3H1S9



A "NEW" CONCEPT IN ACTIVE ANTENNAS!

AN ADVANCED INDOOR ACTIVE ANTENNA THAT REJECTS MAN-MADE NOISE AND PULLS IN SIGNALS LIKE A 100-FOOT OUTDOOR ANTENNA FOR JUST \$99.95! The NXL-250 accomplishes this by using a scaled-down (1-ft. dia.) Faraday-shielded loop, a decades-old noise-fighting antenna design, adjustably-mounted on an attractive metal case containing a high-gain amplifier which is tunable from 540 kHz to 30 MHz for additional interference reduction. THIS RESULTS IN THE BEST INDOOR SHORTWAVE/MEDIUMWAVE ANTENNA YOU CAN BUY! The NXL-250 comes with a shielded output cable terminated in an RCA phono plug, PL-259,

Other products and services:
ACTION TAPE CONTROLLER—Plugs into your scanner and tape recorder. Activates recorder only when scanner picks up something, recording whatever it receives. Unlike similar devices this one is in a real nice case, and it needs NO BATTERIES nor AC power! Only \$27.95.
MINI-BOOSTER: E-Z install inside your radio. Boosts signals picked up by radio's telescoping antenna by ten-fold! Available for many model radios. Prices range from \$34.95 for ATS-803/DX-440 to \$49.95 for Drake SW8.
 Add \$4.00 shipping per order for above items.
WE MODIFY RADIOS! See our "Soup-Up" ad, page 107 of this issue.
WE REPAIR BROKEN RADIOS! See the classified

WORLD COM TECHNOLOGY
P.O. BOX 3364, Ft. Pierce, FL 34948
(407) 466-4640

RADIO DATABASE INTERNATIONAL WHITE PAPER® reports contain virtually everything found during exhaustive tests of premium shortwave receivers and outdoor antennas. These are available in the U.S. from Grove Enterprises, Universal Radio and EEB. Elsewhere: Sheldon Harvey Radio Books, 79 rue Kipps St, Greenfield Park PQ, J4V 3B1 Canada; Lowe Electronics, Chesterfield Road, Matlock, Derbyshire DE4 5LE, England; and IBS, 5-31-6 Tamanawa, Kamakura 247, Japan. For a complete list of available reports, please send a self-addressed stamped envelope to RDI White Papers, Box 300M, Penn's Park PA 18943 USA.



Why in the World Don't YOU Subscribe?

Monitoring Times is published by Grove Enterprises, Inc. To order *MT* or to request a **FREE** Grove catalog, Call **1-800-438-8155** or mail in subscription form to **Grove Enterprises, PO Box 98, Brasstown, NC 28902**

US Subscription	Canadian/Foreign (US Funds/Surface Mail)	Methods of Payment
<input type="checkbox"/> 1 yr \$23.95	<input type="checkbox"/> 1 yr \$34.00	<input type="checkbox"/> Check/Money Order
<input type="checkbox"/> 2 yrs \$45.95	<input type="checkbox"/> 2 yrs \$65.95	<input type="checkbox"/> Mastercard
<input type="checkbox"/> 3 yrs \$67.95	<input type="checkbox"/> 3 yrs \$97.45	<input type="checkbox"/> Visa
		<input type="checkbox"/> Discover Card

Monitoring Times

Name _____
 Address _____
 City _____ State _____ Zip _____
 Country _____

Words into Actions—Mouse Power

To me, the bus mouse is still one of the best, useful and inexpensive accessories I have added to my computer system.

Recently a reader, David D. of Pennsylvania, wrote a very nice letter expressing how much he enjoyed this column, but reminding me that although I have been lauding the merits of bus mice and how they free up serial ports, I have not given any information on their installation. Well, David, and all the other readers for whom he speaks, this month we will change that situation.

■ Getting a Mouse into Windows

Let's look at installing a bus mouse in both Windows and DOS environments. A driver program should have been included with your mouse and interface card. Use this disk for the following instructions. If you did not get one, contact the manufacturer. Alternatively, if the mouse is Microsoft bus mouse compatible (most are) then you can use the bus driver included in your Windows program and available for DOS in most Microsoft (and many others) DOS programs which use a mouse.

OK. For Windows you can do this a number of ways. I think the easiest is the following:

0. Shut off computer. Unplug from wall. Open and install bus mouse interface card.

Connect mouse to card. Close computer and plug in.

1. From DOS, using the CD command, get into the Windows directory.
2. Run the "SETUP" program. See Figure 1.
3. Change the mouse selection to a bus mouse compatible driver as in Figure 2. Or choose the "OTHER - Manufacturers' Software..." selection to copy the driver which came with your mouse into Windows.
4. Choose "Accept ..." on the first setup screen. This as your new Windows setup file.
5. To make sure your mouse test is valid, change to root directory and shut off your computer.
6. After waiting about 15-20 seconds, turn on the computer and go into Windows as you normally do. Then your bus mouse should be operational.

■ A Role Reversal: DOS May Be Trickier!

Some install driver programs will also

FIGURE 2

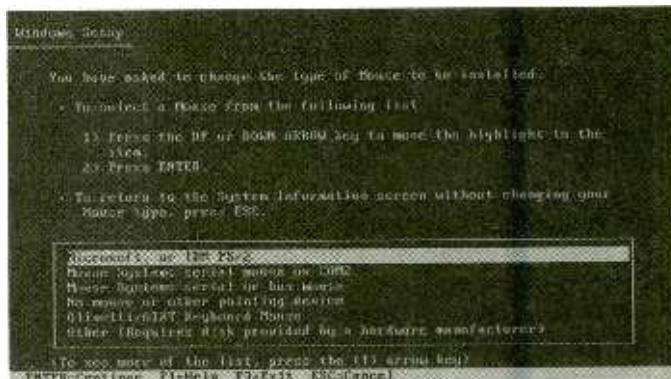

MOUSE driver selection screen from SETUP program.

allow you to choose the type of mouse you are using. In this case, changing from a serial mouse to a bus mouse is as easy as running the "INSTALL" or "SETUP" program on your mouse driver disk, or hard drive directory, and choosing the bus mouse option.

If your mouse drive install program does not have this feature, then try the procedure below:

0. Using the DOS COPY command make a copy of your AUTOEXEC.BAT and CONFIG.SYS files on a floppy. Having file copies of your last working version (before you try any upgrade or change) is a good habit to cultivate.
1. Make a directory called BUSMOUSE on your C hard drive using the MD command. (C:MD BUSMOUSE)
2. Copy your bus mouse driver software, included with bus mouse, into this directory. Note - Sometimes by running the "INSTALL" program on the bus mouse driver disk all this is done for you. However, the program may name the directory something different. No problem. Just write down the name of the directory which contacts the mouse driver, and the driver's program name which actually starts the driver.

CAUTION!!!!

Make sure you know how to use EDLIN, or a similar program before you go any further. ONLY change entries having to do with the MOUSE. If you do anything else you could find a nasty surprise when you try to use a program at a later date, or worse. If you run into a major problem with your system after you try installing your

FIGURE 1

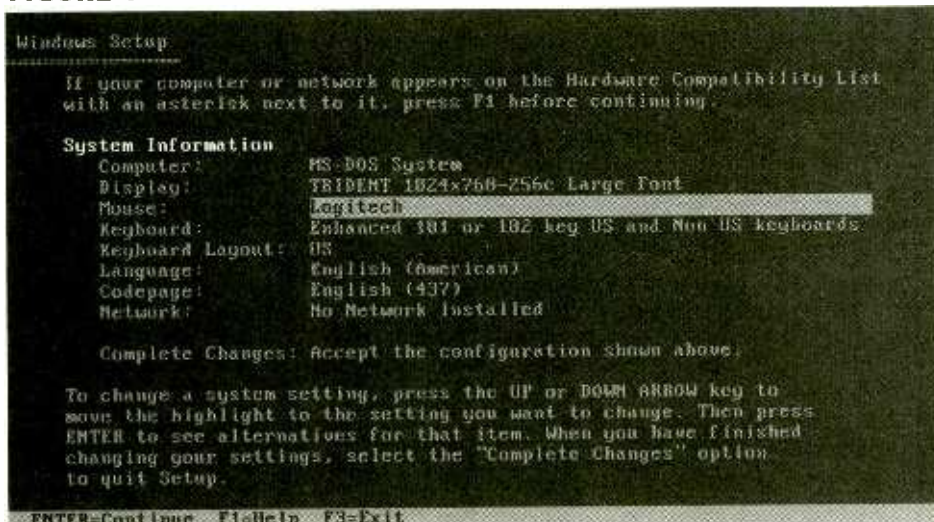

MS Windows 3.1 SETUP program. Main Menu. Notice MOUSE selection option.

bus mouse, all is not lost if you are willing go back to your original, non-bus mouse configuration. We'll cover this at the end.

3. Now using a program like EDLIN, which comes with DOS and whose simple commands are listed in your DOS manual, perform the following:

FIGURE 3

```

B:\>EDLIN AUTOEXEC.BAT
End of input file
*
1:SET BLASTER=A220 17 D1 74
2:SET SOUND=D:\MSDIPRO
3:D:\SEBFRONSHP-SET /R:12 /VOC:12 /CD:12 /FH:12 /LINE:12
4:PECHO OFF
5:PROMPT $P$G
6:PATH D:\EXCEL;D:\HARMIN;C:\QEMM;C:\DOS;C:\TOOLS;D:\grovedb
7:SET TEMP=C:\DOS
8:REM DOS\BOSSHELL
9:C:\qemu\loadhi C:\bin\mscdex.exe /A:\mscd001 /R: /E /U
10:SET BUCKDIR=E:\
11:REM C:\MOUSE1\setspeed /P2 /FC:\MOUSE1\mousepro.fll
12:SET MOUSE=C:\BUSMOUSE
13:C:\BUSMOUSE\MOUSE.COM
14:PATH C:\BUSMOUSE
15:SET TZ=EST5EDT
  
```

DOS EDLIN list of AUTOEXEC.BAT file. Statement numbers 11 through 14 are of interest for bus mouse installers (see text).

a. Get a list of your AUTOEXEC.BAT file by typing EDLIN AUTOEXEC.BAT and then hit the enter key.

b. At the "*" prompt enter the letter L and hit enter. This will give you a list of your AUTOEXEC file, which the computer uses to determine what hardware and software accessories you have installed, and where. Take a look at Figure 3. This is an actual EDLIN listing of my AUTOEXEC.BAT file.

c. Usually you will find a line that starts with the word "SET". This sets the location of a device or software driver. For this application we should see SET MOUSE=. After the equal sign will be the hard drive and the directory where the mouse driver can be found. In our example we should change it to read, SET MOUSE=C:\BUSMOUSE. This is statement number 12 in Figure 3.

d. We must then find a line which tells the computer which program to run for driving the mouse. In our case this must be changed to C:\BUSMOUSE\MOUSE.COM, where MOUSE.COM is the actual bus mouse driver program. See Figure 3, statement 13. The original serial mouse driver statement can be seen in statement 11. The REM, at the beginning of the statement tells the computer to treat the statement as a comment and not a command. This REM method takes very little memory, but is a handy way of keeping your serial mouse driver info in place in case you ever want to return to it in the future. Again, substitute your software's names where appropriate.

e. Sometimes there is also a PATH statement which gives the computer the location of files. If you are replacing a serial mouse, replace its PATH information with your new bus mouse drive and directory information. See Figure 3, statement number 14. Again, DO NOT change anything else in this file!

f. Save the changes you have made by

using entering "E" at the "*" prompt if you are using EDLIN. Your old AUTOEXEC.BAT file will be saved as AUTOEXEC.BAK and your changes will become the new AUTOEXEC.BAT file.

g. After you are sure that the changes are saved, shut off, or re-boot your computer. I always make sure with a cold (shut off) start. This is necessary so that the changes you have just made are recognized by the computer, which only happens when it is started up.

Disaster Control

Sometimes the CONFIG.SYS file is used for doing the same things as we have done in the AUTOEXEC.BAT file. So if your serial mouse works, but your bus mouse does not, repeat the above procedure on your CONFIG.SYS file.

With the best will in the world, things can still go ..., shall we say, *awry* (how's that for self control?!). If the unthinkable happens after you try the above, stay cool. We can get back to where we started, without a bus mouse, if you followed my advice and made a copy of your original AUTOEXEC.BAT and CONFIG.SYS files. Using the COPY command or a program like PC TOOLS, just copy the original files on floppy disk into the directory where they existed on the hard drive—usually drive C's root directory. This will replace the ones we put the bus mouse particulars into with the originals. Re-boot the system and everything should be where we started. (Except for our frustration level!)

If enough of you write to me with your computer system modification horror stories we might start a contest! However, using these methods I have added bus mice to two of my computers without a problem.

In the coming months we will be back to looking at radio monitoring software and related computer products. My spies tell me the guys who have brought us some landmark monitoring software have been very busy get-

ting their next generation products bug-free and ready for release. Meanwhile, if you see any that you think we would be interested in discussing in this column, send me the details.

On reflection, freeing up the second serial port by using my bus mouse has made my life much easier. FAX decoders, Hoka Code 3 and other important monitoring devices now have a home port (sorry!). That old saying, "You can never be too thin or have too much money," needs to be updated to add, "or have too many serial ports."

GREAT SWBC SOFTWARE!

NEW! SWBC Database and Logging Utility
 Contains thousands of changeable records for SWBC radio stations with their frequencies, schedules, languages, countries. This program prints logging reports for submission to your favorite clubs. With the data entered only once, logging reports can be printed in different formats with only a keystroke. Specify IBM compatible 3.5 or 5.25 disks. **Only \$29⁹⁵**

SWBC Station Database
 Contains thousands of changeable radio station records. Sorts by station, frequency, schedule, language, country or continent. **Only \$19⁹⁵**

DX-SWL Program Database
 Radio station schedules and frequencies for all SWL programs on shortwave. Don't miss your favorite shows! **Only \$9⁹⁵**

Working demo disks available (3-1/2" only) \$3⁹⁵ Each
 Specify program(s) when ordering.

Orchid City Software
 P.O. Box 18402
 West Palm Beach, FL 33416
 All payments in US funds only.

Save on **ALL Radio Shack** Scanners & Radios WITH MANUFACTURERS WARRANTY IN U.S. (copy available on req.)

3 WAYS TO SAVE

1^o FREE SHIPPING & HANDLING 48 STATES

2^o BIG PRICE REDUCTION

3^o NO TAX COLLECTED 49 STATES

NEW PRO-62 \$300
 Triple-conversion, 200 ch. Hyperscan, 800 MHz, VHF (Hi & Lo), UHF, AIR, AM/FM, keylock, backlight.

\$259 with NI-CAD batteries \$259

CALL 1-800-433-SAVE FREE: Since 1981 9-5 Central Mon.-Fri.

The Difference Is The Price
USRADIO®
 USRadio 377 Plaza, Granbury, Tx. 76048

Understanding Transmitters (without a license)

It is helpful to have a basic understanding of how transmitters operate. Not only is the subject interesting, but basic knowledge of the circuit functions will help you to troubleshoot equipment you may own.

This article provides a stage-by-stage description of a simple AM transmitter for use under Part 15 of the FCC Rules and Regulations. No license is required provided the dc input power to the final amplifier does not exceed 100 mW (1/10th watt). The antenna must be no longer than 3 meters (10 feet) in order to comply with the regulations. The short antenna and low power restrict the reliable signal distance to one half mile or less, typically.

■ Transmitter Circuit

Figure 1 shows the circuit for a simple AM transmitter. Q1 and Q2 comprise what is known as a MOPA (master oscillator, power amplifier) transmitter. In this example Q1 functions as a VFO (variable frequency oscill-

lator) to establish the operating frequency over a range of 1400 to 1600 kHz. C1 is used to select the frequency (one on which no broadcast station is operating).

The signal from Q1 is routed to amplifier Q2 which uses an L network (C2 and L2) to match the 720-ohm Q2 collector impedance to a 50-ohm antenna. C2 is adjusted for maximum output signal with the antenna connected to the transmitter. RFC2 prevents the RF current from flowing to ground via the +12-V supply line.

Q2 operates essentially as a Class C RF amplifier for highest efficiency. A slight amount of forward bias (positive voltage) is applied to the Q2 base through T1. The bias makes the transistor easier to excite with the low output energy from Q1. RFC1 prevents the RF energy at the base of Q2 from being lost to ground along the supply line from T1.

■ Applying Tone Modulation

U1 of Figure 1 operates as a multivibrator.

It generates an 850-Hz tone that modulates the transmitter signal. The RF portion of the transmitter operates continuously, but U1 is keyed on and off to provide an MCW (modulated continuous wave) transmitted signal. This technique eliminates the need to have a BFO (beat frequency oscillator) in the AM receiver that is used to receive the MCW signal. A BFO would be needed to obtain a beat note for regular CW signals.

Diode D1 allows only the positive half of the modulating signal to reach the base of Q2. This ensures an upward swing of the transmitted signal because it increases the effective forward bias at Q2. A more linear and better sounding output signal results because of D1.

The method shown in Figure 1 for applying an audio tone to the transmitted signal is known as "base modulation," which can be equated to grid modulation in a vacuum-tube transmitter. A more efficient transmitter would have the modulation applied to the Q2 collector. Base modulation is used in this transmitter to minimize the parts count and to simplify the circuit. The tone frequency generated by U1 may be changed by altering the value of the 0.1- μ F capacitor at pin 2.

Voice modulation may be applied to this transmitter by replacing U1 with a two-transistor audio amplifier (e.g., two 2N2222s) or a single 741 op amp. No other changes would be necessary to accomplish this.

■ Construction Tips

The Figure 1 circuit can be built on a piece of perforated circuit board. It is important to keep all component leads and connection wires as short and direct as practicable. This will help to prevent unwanted spurious oscillations. Short, direct leads also minimize stray inductance, which can reduce the gain of an RF amplifier by causing what is known as "degeneration."

■ What About an Antenna?

I'll take the liberty of momentarily invading Clem Small's territory to describe a suitable antenna for the Figure 1 transmitter. Keep in mind that the radiating portion of the antenna must not exceed 10 feet. The radiator can be made from wire, metal downspout or aluminum tubing.

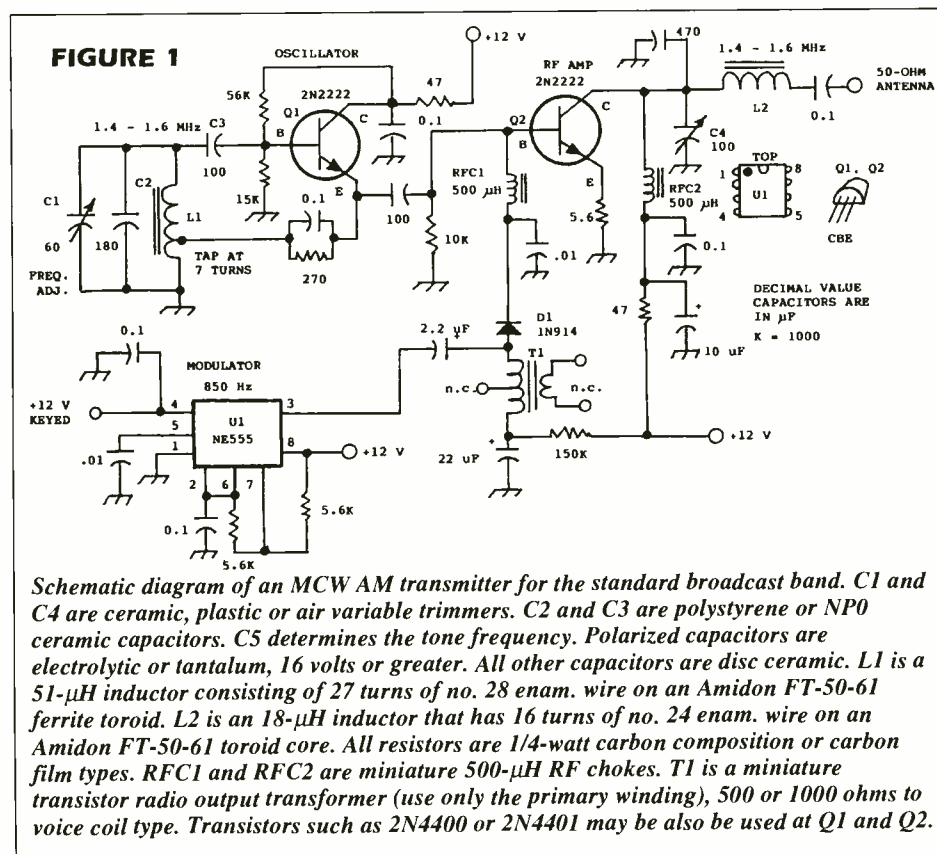
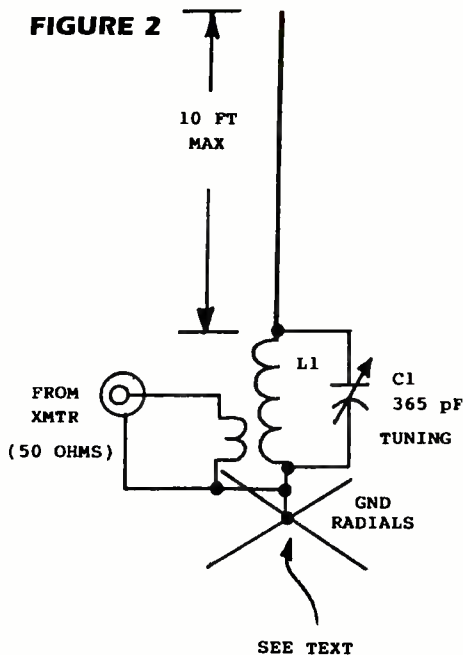

FIGURE 2



Details for a 3-meter-long legal antenna for use with the circuit in Figure 1. C1 is a 365-pF variable capacitor. A 600-pF mica compression trimmer may be used. C1 is tuned for maximum radiated signal as observed by means of a receiver S meter. L1 is a 56- μ H coil. Wind 52 turns of no. 14 insulated wire on a 2-inch OD coil form. Allow 6 inches for coil-form length. PVC pipe is suitable for use as a coil form. The coil requires 341 inches of wire for the dimensions given here. The input link for the coil consists of 6 to 8 turns of no. 14 insulated wire over the grounded end of the main winding. See text for details about the ground system.

Figure 2 contains details for the antenna. A high-Q tuned circuit is used at the base of the antenna. It is tuned to the chosen operating frequency by means of C1. The transmitter is connected to the tuning network with RG-58 coaxial cable (50 ohms). A quality earth ground is needed for best results.

A few wire radials (4 to 16 of them) can be laid on the ground to improve the antenna efficiency. The radials should be as long as possible, consistent with the available space in your yard. A permanent installation can be made by burying the radial wires 2 to 3 inches in the soil. If you can't install radials, try using your metal fence and cold-water pipes for a ground system.

■ Finding the Parts

The toroid cores specified for this project are available from Amidon Associates, Inc., 3122 Alpine Ave., Santa Ana, CA 92704 (catalog avail.). The remainder of the components are available from Mouser Electronics, 2401 Hwy. 287 N., Mansfield, TX 76063-4827. Call 1-800-346-6873 for catalog. Check the various surplus electronics catalogs to

locate alternative sources for the parts.

■ Closing Comments

You may be wondering what you might do with this transmitter after you build it and get it percolating. One useful application would be a Morse code practice set. Simply monitor the transmitter signal with your standard AM radio. Groups within a 1/2 mile radius can practice code (or simply communicate with code) by sending messages to one another.

Also, some experimenters use this type of transmitter as a beacon for others to listen for in the standard AM broadcast band. They assign non-amateur radio call letters to their beacons (using a code wheel or diode matrix), such as their initials. I have used DDM as an identifier, for example.

Two of these transmitters may be used to set up an intercom between buildings on your property if you replace the tone generator with a microphone and speech amplifier. You may also want to see what kind of DX you can work by communicating with other experimenters who are using the broadcast band under the Part 15 rules. But if nothing more, building and testing the Figure 1 circuit will be educational and fun.

Personal Code Explorer™
Only \$99

★ Novices
★ SWLs
★ Veterans

Receive Digital Signals

Copies MORSE, RTTY, FAX, SITOR, PACKET, from your receiver to IBM/PC. Easy to use and install. No TNC needed! Extensive manual.

On-Screen Scope

Software/hardware package that does it all!
Personal Code Explorer - \$99 S&H \$4
Call-Write-Order (414) 241-8144 MC/VISA.
Microcraft Box 513M, Thiensville, WI 53092

Award Winning Filters

Japan Radio Drake SW-8
NRD 535 Sony ICF-2010
NRD 525 Yaesu FRG-100

Kiwa high performance filter kits are designed to improve the above receivers and more. We specialize in custom filter bandwidths using our proven Filter Module technology and Premium Grade filters for outstanding performance.

★ Winner of the 1994 W7TH award for the most innovative design of accessory equipment.

Kiwa Electronics
612 South 14th Ave., Yakima WA 98902
☎ 509-453-KIWA or 1-800-398-1146

VIDEO SYNC GENERATOR

Restores Horizontal and Vertical Sync Lines from Distorted Analogue Video Formats

For Free Information Package on Completed Units and Pricing
• Call 219-236-5776 •
R.C. Distributing • P.O. Box 552 • South Bend, IN 46624

"SOUP UP"
Your Radio!

Now there's no need to buy a more expensive radio to get better performance, because we can install new features and add incredible performance to the radio(s) that you already own! Just think of the DX stations you will be able to hear with a truly narrow (2.7 kHz wide) filter for dramatic separation of closely-spaced SW stations, sharper narrow FM filters, an internal high-gain antenna booster, better MW sensitivity, smoother tuning, alignment and more! You decide what new features/improvements you want with prices starting at \$29.95! These "soup up" specials are available for all popular SW portables. For more information send a 32 cent stamp and tell us what radios you own, or call (407) 466-4640

Worldcom Technology
P.O. Box 3364, FT Pierce, FL 34948

JAVIATION

Carlton Works, Carlton Street, Bradford. BD7 1DA. U.K.
Telephone: 011 44 1274 732146 Fax: 011 44 1274 722627
CompuServe: 100117,535 Internet: info@javiation.demon.co.uk

YUPITERU VT-125 & VT-225

Yupiteru have established themselves as the leading manufacturer of scanners in recent years. The VT-125 & VT-225 are two compact, handheld "airband" only receivers with exceptional performance.

The VT-125 is no larger than the palm of your hand, covers 108-142MHz, and has 30 memory channels. It is supplied with 3 x AA nicad batteries and can also be powered from an external 12v supply.

The slightly larger VT-225 has wider frequency coverage to include the UHF aviation bands. 100 memory channels and 10 search banks. Supplied with 4 x AA nicad batteries the '225 can also be powered from an external 12 volt source.

If you would like further information on these or any products please feel free to contact us.

WIDE RANGE COVERAGE SCANNERS & HF RECEIVERS FROM ALINCO-AOR-ICOM-LOWE-RADIO SHACK/REALISTIC-SIGNAL-SONY-UNIDEN-YUPITERU

Tape Recording and Volume Controls

Pipe dreams — it seems like there is always something circulating the grapevine that's either plumb weird or downright impossible or both. A fellow approached me not long ago asking why didn't I design a modification for VCR's to record the radio spectrum from LF through UHF so that he could later connect the VCR to his favorite receiver and tune around to see what he'd missed. Nice idea. Perpetual motion machines are very nice, too. So are Brooklyn Bridges, beachfront property in Nevada, and no taxes.

It's true, though, that a VCR is a *wide-band* recorder, and might be pressed into service with the right add-on front-end to record and store a few hundred kilohertz or maybe a couple of megahertz for later playback. Assuming the VCR can record and play back a spectrum of 100-kHz to 1 or 2-MHz, you sure could run amok with AM Broadcast to your heart's content. But wait a minute: Let's dispense with the pipe-dreams and take a quick analysis of reality.

Suppose you wanted to record the spectrum of DC to 1000-MHz for one minute. If we loosely consider each hertz to be one bit, and 8-bits to the byte, then we're looking at a volume of data equal to 1-gigabit or 125-megabytes per second! Multiplied by 60 seconds, you'd need storage capability of 7.5-gigabytes to hold meaningless data. I say "meaningless" because that's the space required to hold just frequency data. If it's intelligent signals you want, too, then the storage requirement increases by several orders of magnitude. No hard disk, CD-ROM, nor recording tape in the world can handle that size of a job. Aside from very tiny slices, the RF spectrum is not recordable and storable with the tools available today.

■ Audio Taping

It's hard enough to manage recording and playing back the *audio* spectrum, which is where we'll focus this month. Many receivers now come with built-in TAPE REcording facilities, but you'd be surprised at those which do not, including most handheld radios of all types, consumer broadcast receivers, TV's, budget scanner and shortwave receivers. No matter: the popular TAPE REC feature, which probably adds \$10 to the retail price of some receivers, can be added to your

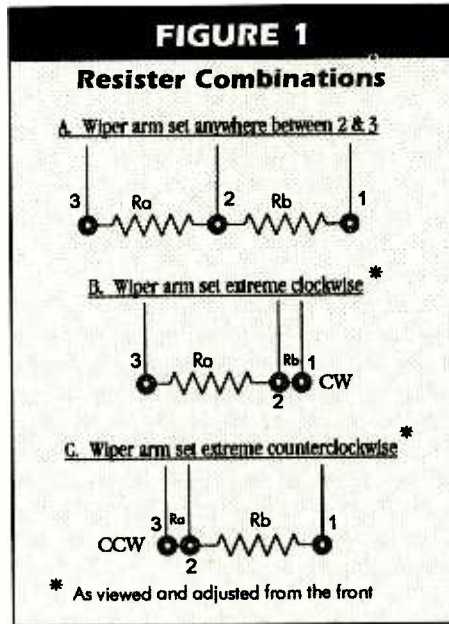

own for less than a buck—or maybe for free if you have a capacitor and an RCA phono jack laying around.

See the diagram for how to do the job: it's incredibly easy. The hardest part may be drilling the " " hole for the RCA jack. The specified 1- μ F/35-v capacitor isn't terribly critical. Most anything between 0.01- μ F and 10- μ F will do, with larger values offering better treble (high-frequency) response than lower values. I suspect there is a point of diminishing returns with values larger than 0.1- μ F, but I use 1- μ F/35-v to be consistent.

In a word, just find the **Volume Control**; identify the three lugs as shown; identify the one of two end lugs that's *grounded* and then connect a coupling capacitor to *the opposite end lug*. If you're not sure which lug is grounded, connect one lead of an ohmmeter to circuit or chassis ground and the other—one at a time—to the end lugs. The ohmmeter will indicate a short circuit when you hit the grounded one. Route the (-) output of the capacitor to an RCA phone jack installed somewhere out of the way.

If the distance between the capacitor and the RCA jack is more than 3" (give or take an inch), then use a mini shielded coax such as RG-177/u or even microphone cable (Radio Shack #278-512) with the shield grounded to carry the signal from the capacitor to the

output jack. Shielded cable minimizes pickup of stray noise and interference, and ensures a clean signal for the recorder.

Note for Handhelds: RCA jacks don't fit on handheld radios very readily. Use either a $\frac{1}{8}$ " or a $\frac{3}{32}$ " phone jack where space comes at a premium.

Proper grounding minimizes hum and other obnoxious side effects. If the jack is installed in the metal chassis, the shield of the mic cable or coax from the capacitor should be grounded to the shell of the jack, but **not** at the Volume Control. On the other hand, if the jack is installed in a plastic case, then the ground lug of the volume control must be connected to the ground lug of the jack, either by a wire or preferably via the shield of a coax or mic cable.

■ What You Need to Know

Many of you dear readers can just glance at the schematic diagram and quickly implement the TAPE REC modification to most any receiver. I am going to use this opportunity, however, to explain a related subject for those not so astute in electronics: *potentiometers* and *audio gain control*. Study the physical diagram (Figure 2) for a moment to get an idea of the construction and operation of a potentiometer, sometimes incorrectly called a *variable resistor*. You'll see a shaft, slip ring, wiper arm, resistive coating and terminals—one for each end of the resistive layer and one for the wiper arm. This arrangement permits a variety of resistor combinations, simplified in Figure 1, above.

■ Explanation

The examples at (B) and (C) are unique (*one position of each*), but the example at (A) has almost unlimited combinations where *Ra* and *Rb* each vary inversely from zero to maximum ohms as the shaft is rotated. The max CW rotation of (B) depicts a short circuit between pins 1 & 2 (*Rb* = 0 Ω) while (C) shows the short circuit of the CCW rotation between pins 2 & 3 (*Ra* = 0 Ω). At (B), *Ra* between either or both of pins 1 & 2 and 3 is maximum while at (C), *Rb* between either or both of pins 2 & 3 and 1 is maximum.

If a weak audio signal from the receiver's detector is fed to Lug 1 with Lug 3 grounded,

as is usually the case, then (B) admits maximum signal into the audio amplifier. On the other hand, (C) allows no signal into the audio amplifier by virtue of the short circuit between 2 & 3. In this manner, a constant signal into Lug 1 can be continuously varied from zero to maximum at Lug 2. (A) is representative of all other settings of the potentiometer, from very low output at Lug 2 to almost maximum.

■ Back to Tape Recording

Ever wonder how recorded signals are independent of the Volume Control? Now you know — The signal for recording is tapped at some point *before* the variable part of the Volume Control.

Some receivers employ dedicated preamplifiers for feeding the TAPE REC jack, but this really isn't as necessary to the hobbyist as it is to the consumer who might stick something in the jack. A dedicated preamplifier isolates the signal at the jack from the main receiver circuitry. We can do just fine without that extra goodie, because signals straight out of the detector or discriminator stages are just right for most tape recorders anyway. So one of the easiest and most recognizable places to access a recordable signal is at the *ungrounded end lug* of a Volume Control.

Don't just take the signal from the wiper arm, where its strength will vary with the setting. You don't want a situation where the phone rings, so you turn down the volume and vaporize the rest of the recording. The "high" lug of the Volume Control offers a stable, non-variable signal that's ideal for recording.

■ More About Pots

I said earlier that "pots" (*potentiometers*) were incorrectly called "*variable resistors*," but that depends on how they're wired. Indeed, a pot is a variable resistor if, and only if, one end lug is not used in the circuit. Then, indeed, the active end lug and wiper arm

function as a variable resistor. It's always safest to call them potentiometers to avoid embarrassment.

There are many kinds of potentiometers, of course, but the hobbyist is mostly concerned with two: the larger kind normally used as Volume and Squelch controls, and a much smaller variety usually found on circuit boards. These generally require a small screwdriver for adjustment, and are called "trimpots" or "trimmers." You will occasionally find two-legged varieties of trimpots, properly called variable resistors, but most are the three-legged type with the same pinout as shown for the larger style.

Trimmers are extremely useful to the experimenter for determining the best resistor to use in a given circuit. A design may call for a resistor of 4.7-kΩ to 10-kΩ, depending on a desired effect. Temporarily wire in a trimmer; adjust it for the desired result; and then remove it; measure its resistance; and substitute a 5¢ fixed resistor. Save the \$1 trimpot for another use.

■ Confusion Factors

Naturally, Murphy's Law will strike. Remember: as a potentiometer is rotated, resistance decreases between one end lug and the middle lug, at the same time as it increases between the middle lug and the other end lug. Which direction of rotation does what can be a massive confusion factor. The physical diagram shows you what's what, if you collect your wits and orientation. The view of the potentiometer is from the rear to show as much detail as possible, but most of the time we adjust them from the front. Direction of

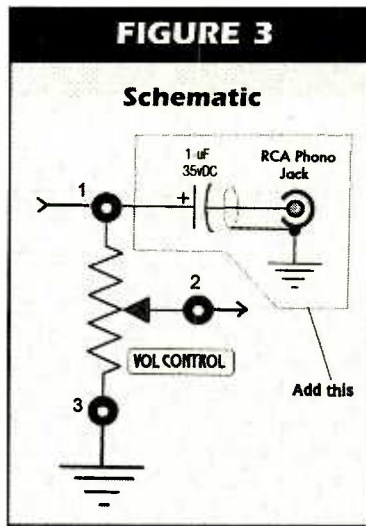

rotation depends on whether you're viewing the dang thing from the front or the rear, see?

If in doubt, connect one lead of an ohmmeter to an end lug and the other lead to the middle lug; then rotate the pot, observing the effect. To measure a pot of unknown value, always connect the ohmmeter across the end lugs and you won't have to worry about the position of the

wiper arm. Keep in mind, however, the value of a pot can be accurately measured *ONLY* when at least two of its three lugs are out of circuit...not connected to anything. In-circuit resistance paralleled with the pot will cause inaccurate measurements.

We can dig deeper into recording, gain, gain controls, etc, if you guys want. Let me know. Meanwhile, take cheer: Spring's just around the corner!

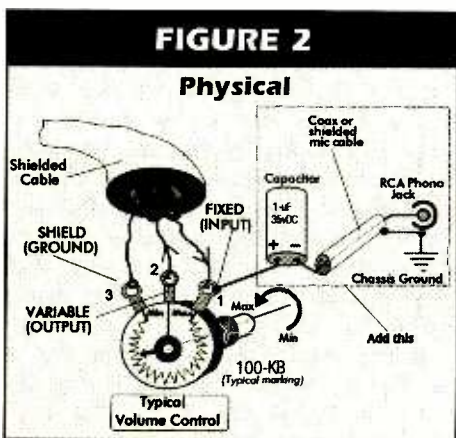

The World of Ham Radio Callsign Jan 95 Database

You can have the latest US and Foreign callsigns available: 20,000+ software files for amateur radio. AmCall auto-logging station log book included with every CD. Over 1,350 Radio Mods. The latest space photos. The newest releases of amateur software. 1,100 images of lost & missing children. Thousands of SWL frequencies. Published every JAN/MAY/SEP. Special rates for clubs, FTP, BBS, & PBBS sysops. DOS & Windows compatible. Can you afford to be without the biggest & best CD for amateur radio? Subscribe and get 3 issues for \$99 US, \$109 Foreign. Single issues \$39 plus shipping: USA \$3, Overnight USA \$10, Foreign Air Mail \$5. AmSoft, PO Box 666, New Cumberland, PA 17070-0666 USA. FAX 717-938-6767

\$39 CD-ROM

VISA
MasterCard

AmSoft 717-938-8249

PROFESSIONAL 10 HOUR RECORDER. Built like a BATTLESHIP.

- Special Monitoring Times price \$149
- BUILT-IN voice activation add \$25
- Also available: 12, 14 and 16 hour models
- NOT "improvised" from a consumer model
- Heavy duty commercial recorder
- Full one year warranty
- Dimensions 11.5 x 7 x 2.75

Recorders come with full applications info for scanners, etc.

VIKING INTERNATIONAL
SINCE 1971
150 Executive Park Blvd. #4600
San Francisco, CA 94134
Phone: (415) 468-2066
Fax: (415) 468-2067

FREE 32 page special equipment catalog!

No shipping charges on prepaid orders. COD's OK. Cal. residents add tax. Sorry, no credit cards (all they "do" is increase prices—)

Selecting an Antenna, Part 1

A simple wire antenna, mounted as high and in-the-clear as you can manage, will often do a remarkably good job of bringing in shortwave signals that you want to monitor. For VHF and UHF reception, a simple whip antenna attached directly to your receiver will be satisfactory in many cases. On the other hand, there are times when we want to pull an elusive signal out of the noise, or to bring almost-intelligible signals up to solid-copy levels.

If you know a bit about antennas you may be able to accomplish these goals easier than you think. So this month we embark on a three-part series which covers things you need to know in order to select the best antenna for your communications job.

■ Some Important Antenna Characteristics

GAIN: Antenna gain refers to the amount of signal output a receiving antenna produces as compared to the output produced by a "standard reference antenna" receiving the same signal. There are two commonly used standard reference antennas: the isotropic antenna, and the halfwave dipole antenna.

The result of the comparison between the antenna being evaluated and either one of the standard reference antennas is reported in decibels (dB). Reporting gain values as so many "dBi" indicates the isotropic antenna was used as the standard, and reporting gain in "dBd" indicates that the halfwave dipole standard was used.

For the same amount of antenna gain, dBi values are always 2.1 dB higher than dBd values, so don't be fooled by high dBi values; just subtract 2.1 from them to compare them to dBd values. For interpreting dB values in general, remember that a difference in antenna gain of one dB is almost unnoticeable; 3 dB is easily noticeable, and is half of an S-unit; 6 dB is a full S-unit and indicates a very sizable difference between antennas.

Please note that gain is not a cure-all for weak-signal problems. When we discuss signal-to-noise ratio next month you will see that going to an antenna with higher gain, yet with no change in directionality compared to your present antenna, may not improve your weak-signal reception.

DIRECTIONALITY: Directionality and

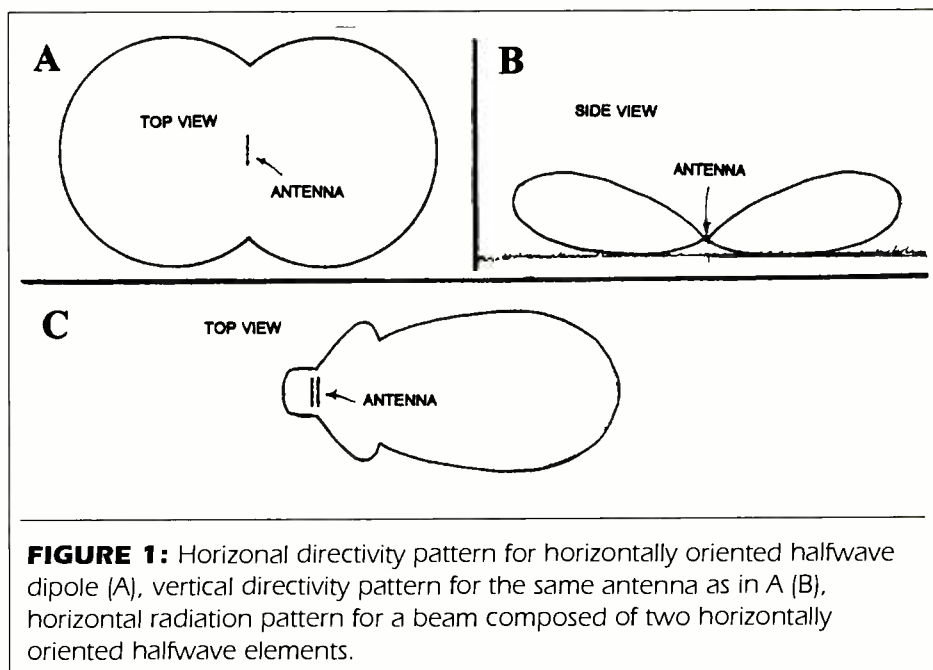

FIGURE 1: Horizontal directivity pattern for horizontally oriented halfwave dipole (A), vertical directivity pattern for the same antenna as in A (B), horizontal radiation pattern for a beam composed of two horizontally oriented halfwave elements.

gain are intimately related in most antenna designs. Directionality is generally achieved by configuring an antenna's elements to form directional characteristics (for both transmitting and receiving), such that it focuses its responsiveness in a specific direction or directions.

Notice in fig. 1C that, when two halfwave dipoles are arranged in a beam-antenna configuration, their pattern is quite different than that for a single halfwave dipole (fig. 1A). Notice also that, not only does the beam antenna focus its response toward certain directions, it reduces its response in other directions.

This reduction of responding in off-beam directions means that interference (electrical noise, unwanted signals, etc.) from those directions is attenuated. With this reduction in noise input the beam antenna receives the desired signal with a much improved signal-to-noise ratio (except in unusual situations where received noise is received predominantly from the same direction as the desired signal). This point will be discussed further next month.

DIRECTIVITY PATTERNS: Directivity patterns are figures that graphically show the responsiveness of an antenna in different directions from that antenna. Conveniently,

these patterns are identical whether the antenna is receiving or transmitting. Some examples of directivity patterns are shown in fig. 1.

The farther out from the antenna (the center of the figure) that we find the outline of the directivity pattern, the more responsive is the antenna in that particular direction. Directivity patterns are often given for both the horizontal (fig. 1A) and vertical responsiveness of an antenna (fig. 1B).

POLARIZATION: "Signal polarization" refers to the orientation of a radio signal's electrical field with respect to the earth. Because the signal's electrical field is determined by electron flow in the antenna's elements we generally find that an antenna with its main elements oriented vertically with respect to the earth produces vertically polarized signals and that the antenna itself is described as "vertically polarized." Similarly, an antenna with its main elements horizontally oriented will produce horizontally polarized waves and is itself described as "horizontally polarized." Of course, signals may also be polarized at any angle between horizontal and vertical.

Polarization of signals or antennas may be classified as "linear," "circular," or a variant of circular polarization called "elliptical."

Examples of linearly polarized antennas are the straight wire, halfwave dipole, and the quarterwave groundplane. Circularly polarized antennas include the helical beam and the crossed-dipole design.

When a linearly polarized antenna is used to receive a linearly polarized signal it is important that they be of somewhat the same angle of polarization. If the antennas are completely "cross polarized," as would be true when receiving a horizontally polarized signal with a vertically polarized antenna, the received signal is greatly attenuated. Antennas with circular and elliptical polarizations respond reasonably well to signals with any linear polarization (vertical, horizontal or angles in between). Thus, circularly-polarized antennas are useful for reception in situations where received-signal polarization varies across time as it does in satellite work and skywave HF reception. The helical beam or crossed-dipole design are often chosen for satellite work at VHF and higher frequencies.

At HF, circularly-polarized antennas tend to be too large to be practical, and so on that band a technique called "antenna-polarization diversity" is more likely to be utilized than is circular polarization for reception of signals whose polarization varies over time. Diversity reception will be covered in an upcoming "Antenna Topics" column.

Next month we will discuss some additional concepts, such as antenna bandwidth and signal-to-noise ratio, which are useful in working with antennas. In May, we will discuss how to evaluate antennas for various applications in terms of the characteristics which we've covered.

■ Certification as an Antenna Technician

Did you know that, if you are sufficiently knowledgeable in antenna technology, you can be certified as an antenna technician? The International Society of Electronic Technicians (ISCET) offers certification in antenna technology as well as many other electronic and communication specializations, such as radio communications, consumer electronics, medical electronics, appliance repair, and more.

They are even authorized to award their embodiment of the old FCC First-Class Radiotelephone Operator's License; you old-timers out there thought that license was gone forever, didn't you? You can even use your expired FCC First Class as the basis of qualifying for their current First-Class License. For more information write or call: ISCET, 2708 West Berry St., FT. Worth, TX 76109-2356 (817-921-3741)

■ New Phone/Address for Autek

Readers trying to follow up on January's review of the Autek Resesearch RF Analyst

will discover that the phone number is no longer valid. Here is the new phone number and address to contact: Autek Research, P.O. Box 8772, Madeira Beach, FL 33738; For phone orders, 813-886-9515.

R A D I O R I D D L E S

■ Last Month:

I said that, in the Radio Society of Great Britain's *Radio Communication Handbook*, 4th edition, one may find the statement: "There are two basic types of aerials ... the Hertzian ...and the Marconi... ." Then I asked you: "Are most antennas really just variations on these two types?" and "What are Hertz and Marconi antennas, anyhow?"

The answer to the first question is "yes, sort of." As a rule we can say that a Hertzian antenna is any halfwave dipole antenna and a Marconi is any quarterwave vertical antenna using an earth ground at its base. Historically most antenna designs have evolved from some variation on one of these two designs. There are exceptions to this generalization—loop antennas being an obvious example.

But if you look at most antenna designs you will find one or more Hertzian halfwave elements (as in the common Yagi antenna), or a vertical, quarterwave Marconi element using an earth or conductive "ground," as in many rooftop-mounted VHF and UHF mobile antennas.

A further interesting fact from radio history is that the Marconi antenna design was itself evolved by Marconi from the Hertzian design; thus most antennas today can trace their heritage all the way back to Heinrick Hertz and his wonderful halfwave dipole antenna!

■ Last Month:

Speaking of aerials, what three fields are present near a radiating antenna—two of them being quite strong very near the antenna?

We'll have the answer to this month's riddle and much more in next month's issue of *Monitoring Times*. 'Til then, Peace, DX, and 73.



Motron
ELECTRONICS

310 Garfield St Suite 4
PO Box 2748
Eugene, Oregon 97402

New Low Price!
\$59.00

DTMF Decoder

The TDD-8X features a large 8-digit LED display and decodes all 16 DTMF digits. The 104 character memory is viewed, without loss of data, by scrolling either left right. Although a computer is not required, the serial ASCII output allows for automatic logging of decoded number groups. ToneLog™, our IBM/Compatible logging software, is included with each TDD-8X.



TDD-8X Assembled & Tested PCB \$59.00
CAB-1 Audio & Computer Cables 20.00

PMK-1 Plastic Mounting Kit \$15.00
PS-12 12VDC AC Power Adaptor 10.00

Visa, MasterCard, American Express, Discover and Government Purchase Orders accepted.
 COD on Cash or Money Order basis only.
 Minimum Government Purchase Order: \$99.
 S/H: \$6 USA/Canada; \$15 Foreign COD: \$5.
 Premium Shipping available at additional charge





Info: (503) 687-2118 Orders: (800) 338-9058 Fax: (503) 687-2492

Q. Why are S-meters so "optimistic" in their readings? (Jack Belck, Glen Carbon, IL)

A. The debate over what constitutes an "S9 signal" has raged for decades. Years ago, several manufacturers chose a signal level of 50 microvolts for S9, with 6 dB intervals between S units.

Keep in mind, however, that when you turn on your receiver and tune in a signal, you want to see a strong indication. It's to the manufacturer's advantage for the meter to swing upward, giving the erroneous impression that the receiver is doing a terrific job.

Not only that, but in amateur radio and CB, it is traditional to provide an exaggerated signal report to the recipient on the air. After all, it makes him feel better and makes you the good guy. With an optimistic S-meter, you can do it with a clear conscience!

Q. After installing a new thermostat, my shortwave reception on some frequencies is terrible. What can I do? (Peter Krochmaluk, North York, Ont.)

A. A thermostat is nothing more than a temperature-sensitive switch; there is no reason it should continue to make noise after it closes or opens its contacts. Even that noise is easily subdued by connecting a small capacitor (0.05-0.1 mfd, 100 volts or more) across the switch contacts or across the two control wires.

Q. Are NEXRAD weather maps received from shortwave or satellites? What frequencies? (Lou Homes, Bridgeport, CT)

A. NEXRAD is an acronym for "next generation radar," the latest weather-forecasting radar maps shown on TV by your local weather man.

Since it is terrestrial radar, neither satellite imagery nor shortwave transmission is involved. The digital information is conducted by telephone line to the broadcasting station.

Q. After a reviewer points out deficiencies in a set, why don't they correct it? (Jack Belck, Glen Carbon, IL)

A. The design and production of a high-volume, price-competitive radio is a lengthy, costly process. After the prototype is tested in the lab, decisions are made regarding cost-cutting compromises.

Ordering parts is tricky; pricing points are typically at 100, 250, 1000, 5000, 10,000 parts and multiples on up. When you stock 10,000 filters and an independent reviewer decides he doesn't like your choice, you sometimes have to bite your tongue and hope that not everyone agrees with him!

Q. What are the actual frequencies assigned to the CB channels? (W7BMI)

A. Originally consisting of 23 channels between 26.965 and 27.235 MHz, there are now 40 channels extending to 27.405 MHz. They are as follows:

Ch	Freq kHz	Ch	Freq kHz
1	26965	21	27215
2	26975	22	27225
3	26985	23	27255
4	27005	24	27235
5	27015	25	27245
6	27025	26	27265
7	27035	27	27275
8	27055	28	27285
9	27065	29	27295
10	27075	30	27305
11	27085	31	27315
12	27105	32	27325
13	27115	33	27335
14	27125	34	27345
15	27135	35	27355
16	27155	36	27365
17	27165	37	27375
18	27175	38	27385
19	27185	39	27395
20	27205	40	27405

(Source: Bob Grove's *Shortwave Directory*, 8th edition)

Q. Right after your "cellular restoration" for the Realistic PRO-23 and PRO-51 was printed (July 1996 MT), Radio Shack recalled the radios. About that time the price of the PRO-2006 went down to \$359.99, the same as Grove

Bob's Tip of the Month

Shortwave Reception on a Scanner Antenna

Many scanner listeners would like to sample the shortwave frequencies without having to erect an additional outside antenna; it can be done easily as suggested by Walter Brown of Waikiki, Honolulu.

By connecting the shortwave radio to the disconnected coax from the outside scanner antenna, the entire coax becomes a

random-length shortwave antenna.

The disadvantages of such an antenna are that it is vulnerable to electrical noise pickup from household appliances, and it is shielded by the dwelling from some arriving signal paths.

But for a makeshift antenna, it works; and, in some cases, it works well.

Questions or tips sent to "Ask Bob," c/o MT, are printed in this column as space permits. If you desire a prompt, personal reply, mail your questions along with a self-addressed stamped envelope (no telephone calls, please) in care of MT.

Enterprises.

Are MT, Grove Enterprises, and Radio Shack squabbling about something and we customers are the beneficiaries? Who is the "mystery buyer" in California who purchased the remaining inventory

of PRO-2006s? (Ken Ballweg, Denver, CO)

A. Looks suspicious, doesn't it? The truth is that Grove Enterprises and MT both have an excellent relationship with Radio Shack. They know our reputation for integrity and accuracy, so when we published the cellular restoration procedure, which rendered the radios to be in violation of the FCC proscription against cellular-capable and cellular-restorable scanners, they were forced to recall them.

So far as the cellular-restorable PRO-2006 goes, it is one of the most successful scanners of all time, but it was discontinued and liquidated by Radio Shack in time to introduce the non-cellular-restorable PRO-2035. I don't know of any "mystery buyer" in California, but I do know that Grove Enterprises purchased every remaining 2006 it could find nationwide and they are nearly gone.

Do You Have Questions?

Bob Has Answers!

Get the answers from the expert on scanner and shortwave monitoring. Bob Grove's Scanner and Shortwave

Answer Book is a great addition to your reference library.

Order BOK5
\$12.95

Plus \$2 Bookrate or
\$4.50 UPS

Grove Enterprises
P.O. Box 98
Brasstown, N.C. 28902
1-800-438-8155

What is the sun up to?

By Jacques d'Avignon, MT Propagation columnist

In the past few months the sun has decided to become very quiet and clear its face of those "ugly" sunspots! This is not very good news for the shortwave listeners around the world. We depend on the sun's activity and the action on the ionosphere to be able to hear the international broadcasters. The sunspot number is steadily dropping and broadcasters are scurrying to find the proper frequency to get their message to the listeners.

Presently it is a circus (or a zoo) on the 49 meter band (6.0 MHz) where everyone is trying to find a clear spot to broadcast to North America in the 0000 to 0500 UTC time slot. It is interesting to note that many broadcasters actually changed frequencies at the first of the year—between the normal frequency change times of March/April and September/October.

However, there are only so many frequencies available in the 41 and 49 meter bands. Some European broadcasters are now broadcasting on the 41 meter band, just above the amateur band in Europe and in the ham band in North America, which is causing some interference. This situation will continue for another year at least.

The minimum of cycle 22 is now forecasted to occur between December 1995 and July 1996, so the broadcasters will have another winter season to live under these conditions of very bad radio propagation conditions. With the renewal of interest in HF by many users on a worldwide scale, we should be seeing some interesting situations develop of interference

between the various users.

We have to realize that a band that is strictly allocated to one service in one area of the world may be allocated to a totally different service somewhere else. The best example of this situation is the use of the 41 meter band: in Europe it is legally used for broadcasting. In North America we use it, also legally, for amateur operations. We are bound to see some interference on many frequencies in these bands over the next 18 to 24 months.

Another area where we should be expecting some interference is at the top end of the 75 meter band. In Europe it is used for "domestic" broadcasting; in North America it is the top end of the 80 meter amateur band. In the late evening hours in Eastern North America, it is not unusual to hear the BBC or the Deutsche Welle coming in "loud and clear" in that part of the spectrum.

For the next few months, before the noise starts again with the onset of summer in the northern hemisphere, you should try and concentrate your listening to the lower frequencies, especially at night. This low sunspot period should also be used by all DXers to hone their skills in pulling the elusive station from the noise. It is also a good time to try out various antennae and ensure that your equipment is in top shape. There are always two sides to a coin!

Good DX, no matter what!

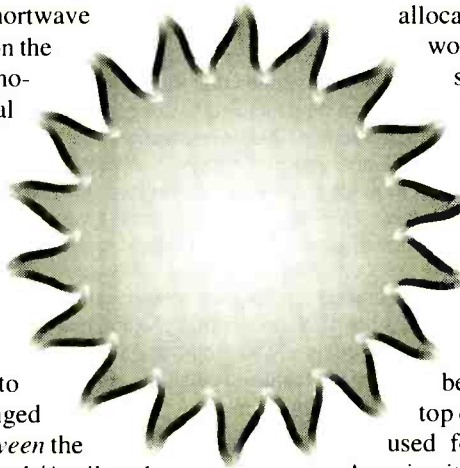

(Continued from page 4)

programs like *Media Network*, *Media Roundup*, *World of Radio*, and *DX Party Line*.

"Many stations, such as Radio Australia, have dropped their communications programs, because of 'lack of general interest.'" Kevin is right that to keep these excellent resources

for SWLs and DXers, we should write to express our appreciation for them to avoid their cancellation.

He makes one final suggestion: "If you want your local sunrise and sunset data, buy the 1995 *World Almanac* or similar reference which lists sunrise and sunset info that can be converted to your local time."

Solutions to Pesky Pagers

■ Robert Wallenburg of Metairie, Louisiana, responded to Bob Grove's call (in his Dec 94 "Ask Bob" column) for input on the problem of receiver intermod in metro areas. Robert says, "as you pointed out, the high-power, nearly continuous duty, paging stations on frequencies like 152.24, 152.48, 157.74, 158.100, and 158.700 MHz on VHF, the eight paging channels at UHF (462.750-462.925 MHz), and the 40 channels at 929 MHz (929.0125-929.9875 MHz) are major causes of intermod problems.

"I've tried various methods to deal with the problem, such as:

1. LC filters
2. Helical resonator filters
3. 1/4 wave and 3/4 wave cavity filters
4. 2 pole and 4 pole monolithic crystal filters at VHF
5. Various types of directional antennas
6. Various receivers

"None of these alternatives have proven to be a satisfactory solution. Filters typically narrow the receiver front end bandwidth which defeats the purpose of a multi-band, wide-band scanner, and a directional antenna in mobile service is not very practical.

"There is a continuing problem in New Orleans (and other major port cities) that may be of interest to you and your readers. The high power paging transmitters in the 157-158 MHz range are causing *serious interference to marine stations* operating in this same range. Vessel-to-vessel communications on marine channel 67 (156.375 MHz, designated for use in New Orleans instead of the usual channel 13) has been so disrupted that the Mississippi River Pilots Associations and other marine interests have contacted their congressional representatives, resulting in the local FCC office conducting field investigations and a recent meeting between marine interests, the Coast Guard, paging operators, and several radio dealers. I question the commission's wisdom in having increased authorized power levels for paging stations. The Business Radio Service's 157.740 MHz went from 75 watts to 350 watts, and the Public Mobile Service's authorized power levels increased to 1400 watts ERP.

"My best suggestion is to have the scanner manufacturers (and marine radio manufacturers) do what some commercial manufacturers did on certain models many years ago—get rid of the receiver RF amplifier. If the IF gain is increased by a like amount and a double-balanced mixer is used in conjunction with track-tuning of the front end coils, the intermod rejection capacity of the receiver can be improved dramatically.

"The R7100 uses four switched track-tuned front end filters and a double-balanced mixer below 1025 MHz, whereas the PRO-2006 uses seven switched front end filters (not track-tuned) and a double balanced mixer to cover its entire range. Both receivers, however, use multiple active amplifiers before the first mixer and even though the amplifiers may be especially selected for best dynamic range (GaAS-FET in the R7001) it does result in increased susceptibility to mixer overload (which itself is inherently non-linear by design).

"I don't know if my suggestion is practical in a wide-band receiver that has lots of L.O. spurious but I know it worked well for the older crystal controlled commercial receivers. The sensitivity/noise figure may suffer somewhat, but the ambient noise level at most frequencies below 174 MHz (and even below 470 MHz in metro areas, especially in the mobile environment) oftentimes negates the benefits of a highly sensitive receiver with a low internal noise figure.

"On the other hand, I'd be glad to see someone come out with a relatively inexpensive multi-stage helical resonator of LC circuit (or ?) of small size that can be manually tuned with a single knob. I've used multi-stage filters before but individual tuning of each stage (typically three) was required, which is an inconvenience at best. A signal generator of the L.O. of another receiver may be needed to align the filter.

"I'm of course, interested in any solutions that others may be using," adds Robert.

Short Shorts

■ Paul Justnaes, "EX-hostage," wrote after we published his account of being trapped in Kuwait City (Dec 94),

"The story in Kuwait and Iraq taught me about friendship, despair, and love, and about being 'disposable'—not worth anything in the great political war game. Four months in that hostile environment was enough.

"I still have some emotional problems reading about it. There is more to be told, such as communication with Sweden by shortwave through the guerilla organizations. There are people still living in Iraq that will lose their lives if we talk about it. It is one thing to be in the middle of it, another to sit in front of your TV watching a 'Nintendo war.' You could turn the TV off—we could not turn things off!

Paul Justnaes, Norway

I am looking for someone that has an ICOM IC-R9000 Communication Receiver to come over to my house and show me how to work it. Contact:

Tim Hughes, 277 Field St.,
Rochester, NY 14620-1953.

The only problem with January's cover story on scanning in Bermuda, is that scanner frequencies are off-limits in Bermuda, according to *Satellite Times'* columnist Todd Dokey, a frequent visitor to the island.

The Georgia Radio Reading Service reads portions of *Monitoring Times* for broadcast on radio and satellite services. Robert Rowlette, station manager at GRRS, has expressed his willingness to make these tapes available to sight-impaired and other interested hobbyists. For availability and cost, please call Robert at 912-233-2822.

Paul Rehn of Marion, IA, sent in this item from the *Cedar Rapids Gazette*:

Scanner listeners needed

"The *Gazette* is looking for a good set of ears. The newspaper is looking for people who monitor police and fire scanner traffic at night and who would be willing to alert the paper to developing news stories. If that sounds like something you might be interested in, please call."

It's nice to know someone still recognizes the contribution scanner listeners can make. Now if the local law enforcement agencies would just *catch on* ...

* * * * *

Open your magazine and, gentlemen and ladies, start your radios for yet another month of great monitoring times...

Rachel Baughn, Editor

Grove Introduces Expanded Technical Support Now Offering **Repair Services!**

You Can Expect Quality Service From Grove:

For the past fifteen years Grove has provided unexcelled sales and service. We've built our reputation on you, our customer. We listen to your needs and continually meet them. You've asked for a repair station with a reputation that you can trust. We heard! We are proud to introduce: The Grove Technical and Repair Support Division. Grove's newest service offers you:

- **Repair for receivers, scanners and amateur radio equipment only.**
- **Certified and licensed technicians.**
- **Equipment will be reconditioned to meet or exceed the manufacturer's specifications.**
- **Modifications to restore deleted frequencies are available for some models.**
- **Fast return of your repaired or modified equipment.**
- **All equipment serviced by Grove Enterprises is warranted for a period of 90 days from the return shipping date. The warranty is not transferable. Modifications to equipment may void original manufacturer's warranty.**
- **The Grove Assurance of Quality applies to all products that we sell and now service!**

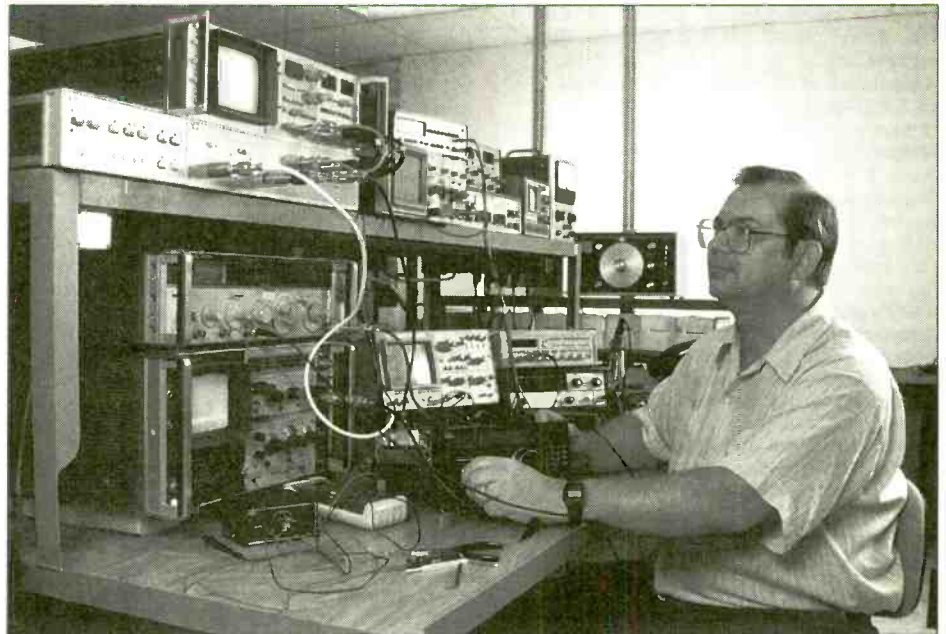

Friendly Grove technicians are only a phone call away.



Here's All You Need to Do:

1. Call the Grove Technical and Repair Support Line at 704-837-7081. (Please do not call the 800 number order line operators; they provide sales and product availability information only.)
2. Explain your problem to one of our trained technicians; it's possible the problem can be corrected on the phone at no charge!
3. If a repair is required, Grove will issue you a service order (SO) number and advise you of the return shipping charges.
4. Ship your equipment to Grove enclosing a payment to cover both the return shipping fee plus the \$39 diagnostic/repair fee. The SO# must be prominently displayed on the shipping carton. *Packages without SO#'s will be refused.*
5. If your equipment can be repaired for the \$39 minimum fee, your repaired equipment will be promptly returned. If additional labor (\$10 per quarter hour) or parts are required, you will be notified.

We accept trade-ins for credit only toward purchases of new equipment from the Grove catalog! Call today for a service order number.

Your New Source for High Quality Repairs!
Call 704-837-7081

Grove Enterprises, 300 S. Highway 64 W., Brasstown, NC 28902

All Ohio Scanner Club: Dave Marshall, 50 Villa Rd., Springfield, OH 45503-1036. U.S. northeast of the Mississippi; VHF/UHF/HF utilities. Net Mon 9:30pm 146.940. *American Scannergram*. \$18 U.S., \$21 Can/Mex, \$28 ww. \$3 sample. Annual summer meeting.

American SW Listener's Club: Stewart MacKenzie, WDX6AA, 16182 Ballad Lane, Huntington Beach, CA 92649, (714) 846-1685. Western US, Pacific, Asia. SWBC, utilities, longwave, clandestine. SWL. \$20 US, \$22 Can/Mex. \$1 sample (\$2 ww). Meets 1st Sats 10am address above.

Association of Clandestine Enthusiasts (A.C.E.): Kirk Baxter, P.O. Box 11201, Shawnee Mission, KS 66207. US, Europe and Middle East; Pirate and clandestine. *The A.C.E.* \$18 US, \$19 Can/Mex, \$25 ww.

Association of DX Reporters (ADXR): Reuben Dagold, 7008 Plymouth Rd., Baltimore, MD 21208. International; Utilities, ham band, QSLing, MW, LW, and SWBC. *DX Reporter*. \$19 US, \$29 Can/Mex, \$22ww. \$1 or 5 IRC's sample.

Association of Manitoba DX'ers (AMANDX): Shawn Axelrod, 30 Becontree Bay, Winnipeg, Manitoba, R2N 2X9 Canada, (204) 253-8644. Manitoba; LW, MW, SW, and VHF/UHF. Meets monthly. \$2.

Bay Area Scanner Enthusiasts: Bruce Ames, P.A.O., 105 Serra Way #363, Milpitas, CA 95035, (408)267-3244. Western U.S.; 25+

MHz. *Listening Post* (bi-monthly). Meets 2nd Mons. 7:30 Milpitas Police Admin Bldg. \$25 US, \$2 sample, or SASE for info.

Bayonne Emergency Radio Network (BERN): Ray Baron/Bob Frasca, P.O. Box 1203, Bayonne, NJ 07002-6203, 1-800-286-2876. Metro NJ, NY; Fire/disaster, pub safety.

Bearcat Radio Club: Larry Miller, Box 360, Wagontown, PA 19376, 1-800-423-1331. National. Scanning only. *National Scanning Report* (bi-monthly). \$17.50 or \$29.90, \$5 more Can. \$3 sample.

Boston Area DXers: Paul Graveline, 9 Stirling St., Andover, MA 01810-1408, (508)470-1971, 50 mile radius Boston; 3-30 MHz. Meets 3rd Fris 7:30pm, The Lexington Club, Rte 4/225 1/4 mi W of Rte 128.

British Columbia Shortwave Listening Club (BCDX): Box 500, 2245 Eton St., Vancouver, BC Canada V5L 1C9, (604) 255-8987 fax. Shortwave. *LOGJAM*. Meets 3rd Thurs. 7pm at 920 Davie St.

Canadian Int'l DX Club: Sheldon Harvey, 79 Kipps St., Greenfield Park., Quebec, Canada J4V 3B1, (514)462-1459. Canada nationwide/membership open to all; General coverage. *The Messenger*. \$26 Can, \$25 US, \$US28 or \$Can35 ww. \$2 sample. Meets 2nd Tues 7pm Montreal; several annual events.

Capitol Hill Monitors: Alan Henney, 6912 Prince Georges Ave, Takoma Park, MD 20912-5414, (301) 270-2531/5774 fax. DC, MD, No.VA, So.DE. Scanner bands. Frequency Forum BBS 703-207-

9622 (8-N-1) Net 1st & 3rd Mons 7:30pm 146.91. *Capitol Hill Monitor*. \$8. Meets irregularly.

Central Florida Listeners Group: David Grubbs N4EF, 956 Woodrose Court, Altamonte Springs, FL 32714-1261; (407) 296-2055 Andy Fountain. Central Florida; All bands. Net on 146.73 MHz Sun 8 pm. Meets 2nd Sats 12 noon. Conf#10 on Laser BBS (407)647-0031.

Central Indiana Shortwave Club: Steve Hammer, 2517 E. DePauw Road, Indianapolis, IN 46227-4404. Central Indiana; SW broadcasting, pirates, and the offbeat. *Shortwave Oddities*.

Central VA Radio Enthusiasts: Richard Rowland, POB 34832, Richmond, VA 23234-0832. Metro Richmond and vicinity. VHF/UHF. SASE. No newsletter, no dues. Meets quarterly in Richmond.

Chicago Area DX Club: Edward G. Stroh, 53 Arrowhead Dr., Thomton, IL 60476. 300 mile radius of Chicago; DXing all bands. *DX Chicago*. \$17, \$1 sample. Meets irregularly.

Chicago Area Radio Monitoring Association (CARMA): Ted & Kim Moran, 6219 N. Greenview, Chicago, IL 60660-1815. Chicago & midwest. Public safety & general coverage. SCUG/CARMA BBS (708)852-1292. *CARMA Newsletter*. Meetings (Sats) and newsletter bi-monthly on alternate months.

Colorado Shortwave Listeners Club: Rob Harrington NONNI, P.O. Box 370593, Denver, CO 80237-0593, 303-756-9455. Longwave, shortwave. *Colorado Shortwave Listener* (4x) 35 cents each. Meets 1st Sundays.

Communications Research Group: Scott Miller, 122, Greenbriar Drive, Sun Prairie, WI 53590-1706. Wisconsin area. Scanning.

DecalcoMania: Paul Richards, P.O. Box 126, Lincroft, NJ 07738, (908)591-2522. Worldwide AM, FM and collecting radio related items. *DecalcoMania*. \$10 US, \$11 Can/Mex, \$16 Eur, \$17.50 Asia/Pac.

Drake SPR4 Int'l Club: Bill Swiger, Route 1, Box 142A, Bridgeport, WV 26330. Worldwide; Drake SPR4 owners.

Fire Net: Tom Kravitz, Box 1307, Culver City, CA 90232, 310-838-1436, internet mpage@netcom.com. All of California; fire, EMS, tied in with nationwide notification net.

Global DX Club: David Williams, P.O. Box 1176, Pinson, AL 35126-1176; Internet: XYVD51A@Prodigy.Com. Worldwide; all bands. *Radio Waves* (bi-monthly). \$1 sample. Meets monthly.

Houston Area Scanners & Monitoring Club: Glen Dingley, 909 Michael, Alvin, TX 77511, (713) 388-1941. 75 mile radius of Houston, TX; scanning & SW. Paging network. *HASMC Newsletter*. Meets Jan & June.

Hudson Valley Monitors Association (HVMA): Patrick Libretti, P.O. Box 706, Highland, NY 12528. Mid-Hudson valley and surrounding counties; VHF/UHF, public safety. *The Hudson Valley Monitor*.

International 11 Meter Alliance: Allen Newton, Rt. 1 Box 187-A, Whitney, TX 76692, (817) 694-4047. Public safety, traffic handling, all bands, esp. 11 meters.

Int'l Radio Club of America (IRCA): Ralph Sanserino, P.O. Box 1831, Perris, CA 92572-1831. Worldwide; BCB/AM DX. *DX Monitor* (34 x) \$25 US, \$27 Can/Mex, \$28.50 ww. \$.29 or 2 IRCs sample.

Longwave Club of America: Bill Oliver, 45 Wildflower Rd., Levittown, PA 19057, (215) 945-0543. Worldwide; Longwave only. *The Lowdown*. \$18 US, \$19 Can/Mex, \$26 ww.

Listeners' Nets

You are invited to post your North American amateur radio net in this bi-monthly listing if its primary emphasis is devoted to the radio monitoring hobby (not amateur radio).

Capitol Hill Monitors

146.91 MHz 1st & 3rd Mon 7:30pm ET, DC, Md, N.Va, S.Del; Scanning and amateur radio Frequency Forum BBS 703-207-9622 [8-N-1] Net Mgr: N3RDC, John Korman Call Alan Henney 301-270-2531 or John Korman 301-299-5455 for info Newsletter \$8; 6912 Prince George's Ave, Takoma Park, MD 20912-5414

Central Florida Listeners Group

146.730 MHz, Sun 8pm ET, Central Florida; any radio communications outside amateur bands Net Mgr: N4EF

Telephone gateways announced; CFLG BBS conference on LASER BBS 407-647-0031 Call Mark Kuziv, KC4ZVK, 407-933-7163 for info

Larkfield's ARC SW-Scanner Net

147.210 MHz, Fri 8pm ET, Long Island, NYC, NJ, Conn; Shortwave BCers & utes, MW, amateur radio, scanning

Net Mgr: Hank Lukas, N2GCN Open to all amateurs on air; by letter for scanner listeners

Contact: P.O.Box 115, Plainview, NY 11803-0115

Montreal DX Listeners Net

146.910 MHz, Sun 8:15 pm ET, Montreal PQ area; MW SW, & Scanner

Net Mgr: Sheldon Harvey VE2SHW Telephone gateways announced

Monitoring the Long Island Sounds Net

146.805 Tues 8pm ET, Long Island, NY; Primarily scanning Net Mgr: WB2RVA, 2134 Decker Ave, North Merrick, NY 11566

Monix SW and Scanner Listeners Info Net

146.835 MHz, Thurs. 9:30 pm ET; Cincinnati/Tri-State Area; All band Net Mgr: Mark Meece, N8ICW, (513) 777-2909 (no collect calls)

Open to all amateurs; Telephone gateways to net mgr up to 1/2 hr before net; The Listening Post BBS (513) 474-3719

New York DX Association

146.880 Mon 9pm ET, NYC area; "DC to Light" Net Mgr: Charles Hargrove N2NOV, 723 Port Richmond Avenue, Staten Island, NY 10302-1736

Voice mail 1/2 hr before net: 212-978-3375; Compuserve 73167,312

Northeast SW Listeners and Scanners Net;

Rip Van Winkle Society 147.21 MHz (WB2UEB) Wed 8pm, Albany, NY, area.

Net Mgr: Ray Loeper N2RAD

Rocky Mountain Monitoring Net 147.225, 224.980 Denver; 145.460 Boulder; 145.160 Colorado Springs Sun 20:00;

communications monitoring Brian Gould, KB0MEP, Mt. News Net **Shortwave Listeners Net**, Association of North American Radio Clubs

7.240 MHz LSB, Sun 10am ET, Eastern US; Shortwave broadcasts and utilities

Net Mgr: KW3F, 238 Cricklewood Circle, Lansdale, PA 19446

Telephone gateways announced

Southern Wisconsin SW Listeners Net;

MARA 147.150 MHz, alt 146.760 MHz. Madison, WI, area

First Sun 8pm CT. Shortwave, scanning, dc to daylight, equipment notes and comments.

Net Mgrs: N9LTD, KA9SRU, N9EWO Contact: N9EWO, Dave Zantow, 1609 Ontario Drive, Janesville, WI 53545

SPECIAL EVENT CALENDAR

Date	Location	Club/Contact Person
Mar 4	Absecon, NJ	Shore Points ARC "Springfest '95/SPARC, P.O. Box 142, Absecon, NJ 08201. Location: Holy Spirit High School, Rte 9 approx 3/4 mi south of Rte 30. 9am. Talk-in 146.385/985. \$5 general admission.
Mar 4	Elk City, OK	West Central OK ARC / Rt 1 Box 66, Hammon, OK 73650,
Mar 4	Tuscaloosa, AL	Black Warrior Swap / WD4DAT, P.O. Box 032171, Tuscaloosa, AL 35403,
Mar 10-12	Lafayette, LA	Acadiana ARA /KE5FZ, Rt 2 Box 625, Sunset, LA 70584,
Mar 11	Scottsdale, AZ	FARE, ARCA / KD6XH, 8741 N. Hollybrook Ave, Tucson, AZ 85741,
Mar 11	Wichita, TX	Wichita Fils ARS / WB5LCN, 5100 Edgecliff, Wichita Falls, TX 76302.
Mar 11	Puyallup, WA	Mike & Key ARC / WA7UVJ, 637 2nd Ave, Kent, WA 98032,
Mar 11-12	Charlotte, NC	Roanoke Div / KA4EXP, 3213 Bridgemere Terr, Matthews, NC 28105,
Mar 12	Circleville, OH	Teays ARC / WB8PPH, 8951 SR 188, Circleville, OH 43113,
Mar 12	Conneaut, OH	Conneaut ARC / N8QBP, 5 Biscoff Ave, Conneaut, OH 44030,
Mar 12	York, PA	York, Hilltop, Penn-Mar, Keystone / N3JKY, 3291 Hoff Rd, RD 3, Spring Grove, PA 17362,
Mar 16-18	Kulpsville, PA	8th Annual Winter SWLFest / P.O. Box 591, Colmar, PA 18915. Location, Holiday Inn, Sumneytown Pike, Kulpsville. \$35 registration and meals. Ian McFarland, guest speaker.
Mar 17-19	Norfolk, NE	Nebraska State Conv / Jr WB0YWO, Box 113, Hoskins, NE 68740,
Mar 18	Marietta, GA	Kennehoochee ARC / K4JGK, 3564 Raymond Dr, Doraville, GA 30340.
Mar 18	Colby, KS	Trojan ARC / N0XNJ, 1872 County Rd 15, Colby, KS 67701,
Mar 18-19	Ft Walton Bch, FL	Playground ARC / W4RH, 323 Elliott Rd SE, Ft Walton Bch, FL 32548,
Mar 18-19	Midland, TX	Midland ARC / KC5BNT, P.O. Box 4401, Midland, TX 79704, (915)686-1841. Location: Midland Co. Exhibit Bldg, Bus 20 east, Sat 9am-5pm, Sun 8am-2:30pm.
Mar 19	Maumee, OH	Toledo Mobile / KB8KLK, 4901 Douglas St, Toledo, OH 43613,
Mar 19	Milton-Freewater, OR	Walla Walla Valley / WA5ZAY, P.O. Box 951, Walla Walla, WA 99362,
Mar 19	Sterling, IL	Sterling-Rockfalls ARS / KB9APW, 25873 Capp Rd, Sterling, IL 61081,
Mar 25	Texarkana, TX	Four States ARC / N5TC, 1700 Dominik, College Station, TX 77840,
Mar 25-26	Timonium, MD	Gtr Baltimore & MD State Conn / WB3DJU, P.O. Box 95, Timonium, MD 21094-0095, 410-HAM-FEST, 800-HAM FEST. Location: Timonium Fairgrounds, 8am-4pm both days, \$5 per day
Mar 26	Grayslake, IL	Libertyville & Mundelein ARS, N Shore RC / Francis Avellone W9GLO, 650 Green Bay Rd, Lake Bluff, IL 60044, 708-234-4124.
Mar 26	Kinston, NC	Down East Ham Assoc / KB4OHZ, 212 E. Capitola Ave, Kinston, NC 28501,
Mar 26	Madison, OH	Lake County ARA / N8LXS, 9310 Little Mt Rd, Kirtland Hills, OH 44060-7951,
Mar 26	Monroeville, PA	Two Rivers ARC / KC3ET, 2748 Glenny Ln., W Mifflin, PA 15122,
Mar 26	Charleston, WV	Charleston Hamfest / K8WXM, P.O. Box 916, St. Albans, WV 25177,
Mar 31-Apr 1	Little Rock, AR	Arkansas State Conv / Dale Temple W5RXU, 5200 Timber Creek, N Little Rock, AR 72116, 501-771-1111. Location: Little Rock Expo Center, I-30 Exit 126; Fri 1600-2100; Sat 0800-1700.

Monitoring Times is happy to run brief announcements of radio events open to our readers. Send our announcements at least 60 days before the event to: **Monitoring Times Special Events Calendar** P.O. Box 98, Brasstown, NC 28902-0098

DX Radio Tests

These special test broadcasts provide a unique opportunity to hear and identify the following stations. If you hear their broadcasts, please let the engineer know at the address provided. More information on DXing the broadcast band can be found in *DX Monitor*, the publication of the International Radio Club of America (IRCA, P.O. Box 1831, Perris, CA 92572-1831, USA) and *DX News*, the publication of the National Radio Club (NRC, P.O. Box 5711, Topeka, KS 66605-0711). For a sample of either publication, send one 32 cent stamp (\$1 US or 1 IRC overseas) to the addresses above. The following tests were arranged by J.D. Stephens for IRCA unless otherwise noted.

Saturday, Mar 4 - KFDF-1580, P.O. Box 573, Fort Smith, AR 72902, will conduct a test between 2-3:00 am EST. The test will include Morse code IDs, voice IDs, and possibly some "special music." KFDF will use a nondirectional antenna pattern, and the first 30 minutes of the test will be run at a power of 52 watts. The last 30 minutes will be at a power of 1,000 watts. Reception reports may be sent to Mr. Stuart Rowland (K15SX), Chief Engineer.

Monday, Mar 6 - WKBR-1250, P.O. Box 3822, Manchester, NH 03105, will conduct a DX test between 1-1:30 am EST. The test will include Morse code IDs, test tones, voice IDs, and "beautiful music." Reception reports may be sent to Mr. Peter George (N1GGP), Chief Engineer.

Monday, Mar 6 - KZIM-960, P.O. Box 1610, Cape Girardeau, MO 63702, will conduct a DX test between 2-2:30 am EST. The test will include Morse code IDs, voice IDs, and possibly some "special music." The first 15 minutes of the test will be

conducted on a 5 kW daytime pattern, and the last 15 minutes of the test will be conducted on a 5 kW nighttime pattern. Reception reports may be sent to Mr. Dave Obergöner, Director of Engineering.

Monday, Mar 13 - KWOC-930, Poplar Bluff, MO, will conduct a DX test between 2-2:30 am EST. The test will include Morse code IDs, voice IDs, and possibly some "special music." The first 15 minutes will be conducted on a 5 kW daytime pattern, and the last 15 minutes of the test will be conducted on a 5 kW nighttime pattern. Reception reports may be sent to Mr. Dave Obergöner, Director of Engineering, c/o KZIM-AM Radio (address above).

Monday, Mar 20 - KSIM-1400, Sikeston, MO, will conduct a DX test between 1-1:30 am EST. The test will include Morse code IDs, voice IDs, and possibly some "special music." Reception reports may be sent to Mr. Dave Obergöner, Director of Engineering, c/o KZIM-AM Radio (address above).

INDEX OF ADVERTISERS

Advanced Electronics Applications ..	3
Advanced RF Design	85
AIE Corporation	19
Alpha Delta	81
Amsoft	109
Antique Radio Classified	91
ARRL	79
Atlantic Ham Radio	103
Austin Antenna	99
Buckmaster Publishing	93
Cellular Security Group	29
Communications Electronics	11
Computer Aided Technologies	10, 67, 99
Dallas Remote Imaging	83
Datametrics	71
Delta Research	61
Drake	51
DWM Enterprises	29
DX Computing	63
Electronic Distributors	97
Electronic Equipment Bank	57
Gilfer Shortwave	61
Glenn Hauser	43
Grove Enterprises	8, 13, 27, 71, 115
ICOM America	Cover IV
Index Publishing	33
Jacques d'Avignon	57
Jade Products	25
Javation	107
KC4ZGL Ham Software	19
KIWA Electronics	103, 107
Klingenfuss	67
Lentini Communications	15
Marymac Industries	85
Microcraft	107
MilSpec Communications	101
Monitoring Times	103, 118
Motron Electronics	23, 111
National Scanning Report	37
OptoElectronics	Cover II, III
Orchid City Software	105
Palomar Engineering	18, 31, 89
Pioneer Data	25
Radio Accessories	69
Radiomap	69
Radioware Corp.	85
Ramsey Electronics	39
R.C. Distributing	87, 107
R.D.I. White Papers	103
RMA	87
Satellite Times	67
Signal Intelligence	71
Skyvision	87
Clem Small	53
Software Systems Consulting	61
Startek Int'l	75
Universal Radio	89, 99
U.S. Radio	105
U.S. Scanner Publications	5, 29
Viking International	109
Worldcom Technology	103, 107

STOCK EXCHANGE

Monitoring Times assumes no responsibility for misrepresented merchandise.

Ads for Stock Exchange must be received 45 days prior to publication date. All ads must be paid in advance to *Monitoring Times*.
Ad copy must be typed for legibility.

NON-COMMERCIAL SUBSCRIBER RATES:
\$.25 per word — *Subscribers only!*
All merchandise must be personal and radio-related.

COMMERCIAL RATES: \$1.00 per word.
Commercial line ads printed in bold type.

1-3/4" SQUARE DISPLAY AD: \$50 per issue. Send camera-ready copy or copy to be typeset. Photo-reduction \$5 additional charge. For more information on commercial ads, contact Beth Leinbach, 704-389-4007.

"TINY-TENNA!" See display ad page 29 this issue.

R-390-A SALES—SERVICE—PARTS.
Information SASE Miltronix, P.O. Box 3541, Toledo, OH 43608.

GE SUPERADIO III, custom designed with up to four noise-free SCA channels. Performance guaranteed. Credit Card orders accepted. (800) 944-0630.

ACOUSTIC GUITAR PICKUPS: quick-mount, low price, high quality, wholesale/retail, money-back guarantee--can also be used as a contact mic.. Sample \$20 S&H included. VISA/MC accepted. CLE, Box 1913, Sarasota, FL 34230-1913. Phone/FAX (813) 922-2633

Highest price paid for used scanners! (614) 544-5842 (03-95)

SCANNERS! Great prices! SASE Emkay Enterprises, Dept. MT, 87 Spindlewick Dr., Nashua, NH 03062.

EXPERT RADIO REPAIR! 14 years experience repairing amateur and short-wave equipment only. Formerly "locked" under contract, our services now available to you. Fast turnaround. \$30/hour. Worldcom (407) 466-4640.

THE ANARCHIST'S BBS is a resource for anarchists, investigators, researchers, computer hackers and phone phreaks. Categories include: Computer hacking, Investigation techniques, Telecommunications Technology and Surveillance. Call 214-289-8328 for free trial access

New YUPITERU MVT-7100 full coverage .5 to 1300 MHz hand held scanner plus extras. \$675 or best offer. Call (601) 924-3017.

ICOM-71A/E/D. Mint Condition. Computer interface EX-309 installed. Dust cover, box, manuals, shipping, etc. \$750. (305) 963-4585.

For Sale: Yaesu FRG100 \$450. Dressler ARA60 Active Antenna, \$150, will con-

sider trade for YAESU FRG9600, ICOM R7000 or PRO 2006. Call Eric (209) 835-9064.

Drake R-8 Communications Receiver. 0.1-30 MHz, just serviced by Drake. Excellent Condition. \$750. Call Dave (505) 835-3855.

For Sale: Sangean ATS-803, \$115 and Zenith Trans Oceanic, \$100. Both excellent. (904) 743-1808.

Uniden 8500 With 800 MHz converter. \$300. Will trade for PRO 2004, 5, 6 or Uniden 2500. (701) 746-8792.

FOR SALE: Bearcat 2500XLT, unblocked, outside antenna, mobile antenna, accessories. \$369. John (203) 254-9549.

Sony CRF-V21 Worldband Radio \$1495; ICOM 71A with FL-32 and all features \$525; Universal M1000 Computer Decoder Card \$150; MFJ 209 SWR analyzer \$65, AEA PK232MBX \$125. (914) 234-6753.

Grundig YB-400 with adaptor. Mint condition. \$175. (216) 545-5518.

For Sale: Sony 2010, shipping included. \$200. (515) 232-3362

Isn't It Time to Subscribe?

US Subscription

- 1 yr \$23.95
 2 yrs \$45.95
 3 yrs \$67.95

Canadian/Foreign

(US Funds/Surface Mail)

- 1 yr \$34.00
 2 yrs \$65.95
 3 yrs \$97.45

Methods of Payment

- Check/Money Order
 Mastercard
 Visa
 Discover Card

Monitoring Times



To place a credit card order call toll free 1-800-438-8155 or send subscription form to:

Grove Enterprises
P.O. Box 98
Brasstown, NC 28902

Name _____
Address _____
City _____ State _____ Country _____
Credit Card Number _____
Exp Date _____

POWERFUL
Field tested & proven by Pro's & hobbyists for two years!

COMPUTER INTERFACE for PRO-2004/5/6 & others

CE-232 Scanner/Computer 2-Way Interface
 ⇒ AutoPrograms all memory channels in minutes
 ⇒ AutoLogs end/or prints records of scanner hits
 ⇒ AutoRejects hits on birdies & undesired freqs
 ⇒ AutoLookup and display data per "hit"
 ⇒ Automated data collection & processing

Open architecture; 3rd party products; tech support & more!
 MSDOS 3.11up or Windows 3.11up; \$12-k RAM & 3Mb free HD space
 Kit of parts/PCB, disk, *delated* manual \$194.95, MC/VISA
 More info: FAX or BBS: (619) 578-9247 6pm-1pm, PST, weekdays
 Voice orders/info - same number, 1:30pm-5:30pm, PST, weekdays

COMMITronics Engineering
 PO Box 262478, San Diego, CA 92196

Scanner Cases
 Radio Shack PRO-39/43/44 Leather
 AOR AR1000 (all models) Leather
 Yupiteru MVT-7100 Leather and Vinyl
 All cases \$29.95. + \$2.00 S&H

Pocket BankPaks
 Pocket BankPaks are modular frequency organizers—custom-printed bank/channel forms for 23 of today's most popular scanners. Protected in their plastic holders. BankPaks slip right into your shirt pocket and go where you go. For most 100-, 200-, and 400-channel scanners.
 Priced from \$7.95 to \$15.95.
 Write for details.

Design EQ P.O. Box 1245MT
 Menlo Park, CA 94025 415-328-9181

PORTABLE SHORTWAVE RECEIVERS & ACCESSORIES

Dealer for Sangean and Panasonic shortwave receivers, Black Box MW & SW antenna's, G.E. Superadio III, and Select-A-Tenna for MW DXing.

***** Fall Specials *****
 Panasonic RF-B45 SW Receiver \$159.95
 G.E. Superadio III AM/FM Radio \$54.95
 Call or write today for our free catalog.
 818-780-2730

CHILTON PACIFIC LTD.
 5632 Van Nuys Blvd., #222
 Van Nuys, CA 91401 USA

Scanner Cases
 Radio Shack PRO-39/43/44 Leather
 AOR AR1000 (all models) Leather
 Yupiteru MVT-7100 Leather or Vinyl
 All cases \$29.95. + \$2.00 S&H

Pocket BankPaks
 Pocket BankPaks are modular frequency organizers—custom-printed bank/channel forms for over 20 of today's most popular scanners. Protected in their plastic holders. BankPaks slip right into your shirt pocket and go where you go. For most 100-, 200-, and 400-channel scanners.
 Priced from \$7.95 to \$15.95.
 Write for details.

Design EQ P.O. Box 1245MT
 Menlo Park, CA 94025 415-328-9181

RADIO
 C. CRANE COMPANY

Radio receivers and antennas of all kinds. Exemplary service.
 AM, FM, SW, Scanner, & Auto
 Custom cable and receiver modifications
 Many exclusive radio products

FREE CATALOG 558 • 10th Street
 Fortuna, CA 95540-2350
 (707) 725-9000 Fax (707) 725-9060

Orders: 800-522-(TUNE)8663

HUGE 100 PAGE CATALOG

- ▶ Shortwave Receivers
- ▶ Amateur Radio Gear
- ▶ Scanners
- ▶ RTTY & FAX Equipment
- ▶ Books & Accessories

Send \$1 to **Universal Radio**
 6830 Americana Pkwy. MT
 Reynoldsburg, OH 43068
 Tel. 800 431-3939

SCANNING WITH HIGH TECHNOLOGY

World Scanner Report

Published 10/yr for Pro's & casual hobbyists. Follows avant-garde technology of monitoring the radio frequency spectrum, DC-to-daylight; with consumer, pro & hobby electronics; do-it-yourself scanner/receiver projects & more. *SASE or 1 IRC for info.*
 \$15/half-yr, \$25/yr; \$45/two-yr, Canada +15%; other foreign +25% surface or +50% air. US Funds Only. MC/VISA ok
 FAX/BBS: (619) 478-9247 6pm-1pm PST - Voice Orders 1:30-5:30pm

The "World Scanner Report"
 PO Box 262478; San Diego, CA 92196

THE COMPLETE GUIDE TO MILITARY MONITORING

NEW BOOK covers all phases of Military Monitoring. Military Frequencies All Services, U.S. Military Bases, Military Black Projects, Major Air Force Installations, Monitoring Equipment and Systems, Navy/Coast Guard and more.

\$19.95 plus \$4 Priority Mail (\$23.95 total).
UNIVERSAL ELECTRONICS, INC.
 4555 Groves Road, Suite 12
 Columbus, OH 43232 (614) 866-4605

SATELLITE RADIO BOOK & GUIDE

NEW BOOK covers all Audio Services, SCPC, Subcarriers, FM², Facsimile, Press Services, Weather Services. Simple how-to-receive instructions. Satellite Radio Guide Included.
 \$16.95 plus \$3 Priority Mail (\$19.95 total).

UNIVERSAL ELECTRONICS, INC.
 4555 Groves Road, Suite 12
 Columbus, OH 43232 (614) 866-4605

SCANNER S/METERS

Analog S-Meter, completely assembled, wired, tested. AGC/Detector board, only 1-1/2" x 1/2". All scanners. You make two solder connections. Please specify Model No.

\$19.95 + \$3.00 S/H

CTP 517 Lower Terr. Huntington, WV 25705
 304-525-6372

PAN-COM INTERNATIONAL CATALOG

From Amplifiers to Zappers! Over 350 Kits, Plans & Books about Licensed/Unlicensed AM/FM/Cable broadcasting, Ham/CB/SW/lower/med/fer, surveillance, phone devices, software, MORE. Send \$ 1.00!

**PO Box 130-T
 Paradise CA 95967**

OptoScan456 & Icom Computer Control

Radio Manager for Windows Scan, Search, User defined channels, banks, delays, priorities., lockouts, & too much to mention here.

\$30 Shareware
 RM.ZIP on CompuServe's HamNet Interface Not Included - Inquires and orders (\$3 for unregistered version)
 TX Tax 7.75% To: Ben Saladin,
 660 W Oak, Hurst, TX 76053-5526

SCANNERS & SECRET FREQUENCIES

Bestselling new 320 page book covers scanning from A-to Z!
 "Useful, knowledgeable, and readable" (Popular Communications). "Wry, cynical and immensely entertaining" (Paladin Press). "An enormous collection of information: plenty of great reading" (Monitoring Times). "You can't miss" (American Survival Guide). "A high point of scanner publication" (RCMA).

Only \$19⁹⁵ plus \$3 s/h.
 Check/MO to Index, 3368 Governor Dr., Ste 273-T, San Diego, CA 92122.
 Credit Cards only 800-546-6707.

Join The Club!

Open to hobbyists worldwide, the **CANADIAN INTERNATIONAL DX CLUB** is an active promoter of the radio hobby through its monthly newsletter and local chapters.

The *Messenger* is packed with general coverage information including the broadcast band, shortwave, utilities, scanning, amateur radio and more. Send \$2 for a sample bulletin and membership information to:

CIDX
 79 Kipps St., Greenfield Park,
 Quebec, CANADA J4V 3B1

This space could be yours!

Contact our advertising manager, Beth Leinbach, at 704-389-4007

RFP I THERMO MUGS
 16-oz \$ 10 each, ppd



P.O. Box 20728 - M
 PORTLAND, OR 97220

YOU AIN'T HEARD NOTHIN'...YET!

Largest selection of scanner frequency guides (federal, military, police, aero, etc.); AM/FM/TV broadcast directories; HF "lite" directories; Books on espionage, covert ops., bugging, wiretapping, surveillance, clandestine radio, & more!

BIG FREE CATALOG!

CRB RESEARCH
 P.O. Box 56-MT
 Commack NY 11725

AR-8000 - THE POCKET SCANNER KILLER
 YOU WILL NEVER WANT ANOTHER POCKET SCANNER AFTER YOU GET YOUR AR-8000

FREQUENCY RANGE 100KHZ TO 1900MHZ (LESS CELLULAR)
 1000 MEMORY CHANNELS (20 BANKS OF 50 CHANNELS)
 ALPHANUMERIC DISPLAY
 TUNING STEPS ADJUSTABLE FROM 50HZ TO 999.95KHZ
 ALL MODE RECEPTION (FMN, FMW, AM, USB, LSB, CW)
 30 CHANNELS PER SECOND SEARCH AND SCAN
 COMPUTER CONTROL OPTION

INTRODUCTORY PRICE: \$589.00 (LIST \$799.00)
 (PRICE INCLUDES NI-CD BATTERIES AND CHARGER)

COMSEC ASSOCIATES, INC.
ORDER 24 HOURS (800) 990-0911
 WE ACCEPT VISA, MASTERCARD & AMERICAN EXPRESS



Take a look at the **Ontario DX Association**

DX Ontario magazine.
 80 pages! \$2.00 for sample

Call our BBS
 The Listening Post
 (905)841-6490

Ontario DX Association
 Box 161, Station A
 Willowdale, Ontario M2N 5S8
 Phone/Fax (905)853-3169
 CompuServe 73737,3453

Bits and Pieces

Get the facts straight: A recent article in the *Denver Post* was most misinformative. Writer Peter G. Chronis cautioned his readers, "...the new federal legislation that took effect Oct. 25...makes it unlawful to have and use a scanner that picks up (cordless) phone conversations. You could be fined if caught and convicted." Wrong.

Chronis goes on to compound the fiction by quoting another oracle of misinformation, Jarvis Seccombe of U.S. West, a cellular provider: "...the new act also makes it illegal to possess...scanners that can pick up the conversations." Wrong again. You can possess a radio that picks up *anything*—just don't listen in on telephone conversations.

Stop blaming the new hams: Hard to believe, but many old-time hams are still complaining that the no-code licensees will be the ruination of ham radio. Their short-term memories don't recall that it was the code-driven "incentive licensing" mistake promoted by these curmudgeons that caused the disintegration of ham radio; no-code has brought a resurgence of interest and fresh perspectives not seen in decades.

Interestingly enough, back in the early 1900s, when Morse was the dominant mode, a primary concern among government officials was the hams' abuse of privilege and their profanity. It's nothing new; the nuts are still with us. We don't need to impose a code test, we need to administer psychological evaluation.

FCC abandons enforcement: Congressional budget-cutting has taken its toll. The

Federal Communications Commission is phasing out of the enforcement business, ignoring volumes of interference complaints except in public safety situations. Is vigilantism an answer?

According to *L.A. Times* (May 27, 1992), Van Williams, who formerly thrilled youngsters in the 1960s as the Green Hornet, now operates a business repeater. Williams grew tired of hearing unlicensed abusers access his repeater; he lost customers who were disgusted with the incessant interference. When he asked the intruders to stop, they threatened to bomb Williams's home, business and repeater site. The Green Hornet had enough.

With a radio-equipped van, Williams used direction-finding equipment to locate the culprits who were then apprehended by police; their equipment was confiscated and they were convicted. Good ending to the story. Perhaps more civil or criminal action needs to be taken against abusers of the spectrum when the FCC won't help.

And finally, *a new, two-way radio service* has been proposed by Radio Shack's parent company, Tandy Corporation. The "Family Radio Service" would provide an effective UHF alternative to interference-plagued CB, taking its channels from the General Mobile Radio Service (GMRS), the members of which are understandably opposed to the move. At this writing the FCC has not yet rejected the proposal which was petitioned last July; while this does not mean that it will be accepted, it may indicate that it is being given active consideration. Stay tuned.



Another bright idea from **OPTOELECTRONICS**

But don't just take our word for it...

"I purchased the Scout... WHAT A UNIT! VERY IMPRESSED!!!"

Allen Wilde - Littleton, MA

"I take my Scout with me everywhere - it's very effective in mobile use, either in the car or on foot. I recommend a Scout over another scanner when adding to your collection... the most effective device so far from Opto for the Scannist."

Steve Dawkins - Pensacola, FL

"This is a breakthrough product in everyway... KUDOS!"

Robert Caron - Des Moines, IA

"The Scout is AWESOME-the folks at OPTO keep coming up with winners, and this is their best yet!"

Gordon West

Gordon West Radio School

"Scantastic"

Brad Schroeder - Omaha, NE



- 400 Frequency Memory with 250 Hit Counter
- Sleep Mode to prevent data loss when battery dies
- Reaction Tune - will tune a receiver with CI-V port in .01 seconds
- Beeper and Vibrator Signal indicator
- Digital Filter and Auto Capture
- CI-V Serial Data Port
- Software for uploading Frequencies to a PC included
- 16 Segment Signal Level Bargraph
- 10MHz to 2.8GHz Frequency Range
- 7 Hour Battery Operation
- Maximized Sensitivity for maximum antenna pick-up

SCOUT.....\$449.00

OPTIONS: Option 1: Mini DB32 Ant....\$29.00 Option 2: AC100 Rapid Charger....\$39.00 Option 3: Spectrum-CD ROM...\$39.00

Scout SPECTRUM-CD ROM



The SCOUT

ORDER LINE: 800-327-5912

TEL: (305) 771-2050

FAX: (305) 771-2052

5821 NE 14TH AVE, FORT LAUDERDALE, FL, 33334

VISA, MC, C.O.D., CASH OR MONEY ORDER-SHIPPING ADDT'L
ALL SPECIFICATIONS & PRICES ARE SUBJECT TO CHANGE
WITHOUT NOTICE OR OBLIGATION.

Scout Reaction-Tune



Tune Into a World of Excitement!

With ICOM's exclusive line of quality receivers!

► Listening is an exciting and interesting activity! ICOM is the leader in the industry offering you the most *complete* line of receivers to choose from. Whether you prefer to listen at home, on the road or even listen out in the field, ICOM's got the right receiver for you. From handhelds to mobiles to base stations, we bring you a world of intrigue, such as:

- Satellites
- Air-to-Ground
- CB
- Television
- Clandestine Stations
- Ship-to-Shore
- Business
- Worldwide Communications
- Public Safety
- Military
- Hams
- Int'l. Aeronautical

Rediscover the world around you with an ICOM quality receiver! Choose the ICOM that meets your listening needs and hear what you've been missing!

Choose the ICOM that matches your listening preferences:

IC-R9000 Base Station
(30 kHz - 1995.8 MHz)*

IC-R71A Base Station
(100 kHz - 30 MHz)

IC-R7100 Base Station
(25 MHz - 799 MHz, 900 MHz - 2000 MHz)*

IC-R100 Mobile
(50 kHz - 799 MHz, 900 MHz - 1300 MHz)*

IC-R1 Handheld
(2 MHz - 799 MHz, 900 MHz - 1300 MHz)*

* The 800-899 MHz band is available for government use only.

◀ 100 kHz 2000 MHz (2 GHz) ▶



IC-R9000

SP-7 Speaker (option)

RC-11 Remote Control (option)

SP-20 Speaker (option)

IC-R71A

IC-R7100

IC-R1

IC-R100

HP-4 Headphones (option)

SP-10 Speaker (option)

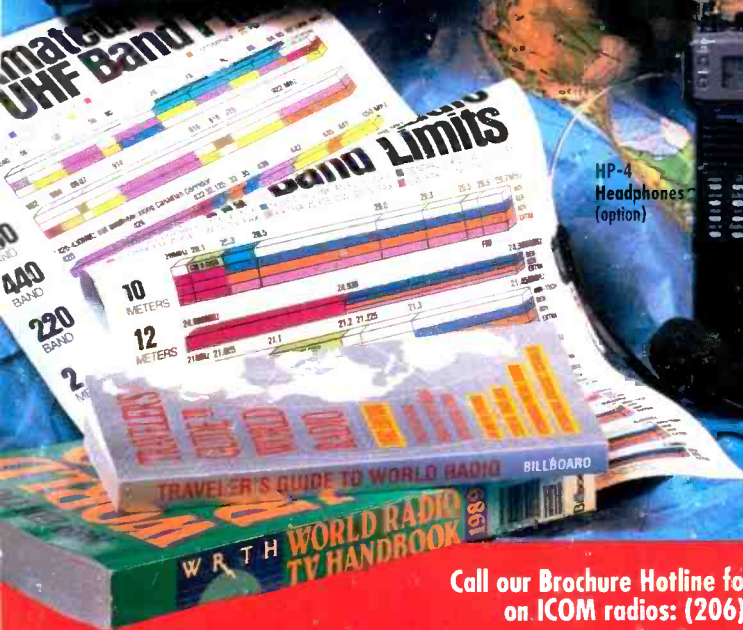

ICOM America, Inc. Corporate Headquarters
2380-116th Ave. N.E., Bellevue, WA 98004
Technical Support (206) 454-7819

© 1994 ICOM America, Inc. ICOM logo is a registered trademark of ICOM, Inc. All stated specifications are subject to change without notice or obligation. All ICOM radios significantly exceed FCC regulations limiting spurious emissions. ICYFAM994T

Call our Brochure Hotline for FREE literature on ICOM radios: (206) 450-6088

ICOM®