



# Monitoring Times

A Publication of  
Grove Enterprises, Inc.

**Plus:**  
New equipment  
reviews, projects, hints  
and tips.  
Get more out of your  
radio listening with  
the full-spectrum  
magazine

**BBC  
World  
Service:**  
BROADCASTING  
WITH A  
GLOBAL IMPACT



*A Monitoring Times  
Special Report*

**Monitoring  
the New  
Air Force!**





# OPTOELECTRONICS

BRINGING YOU INNOVATIVE PRODUCTS  
FOR 18 YEARS

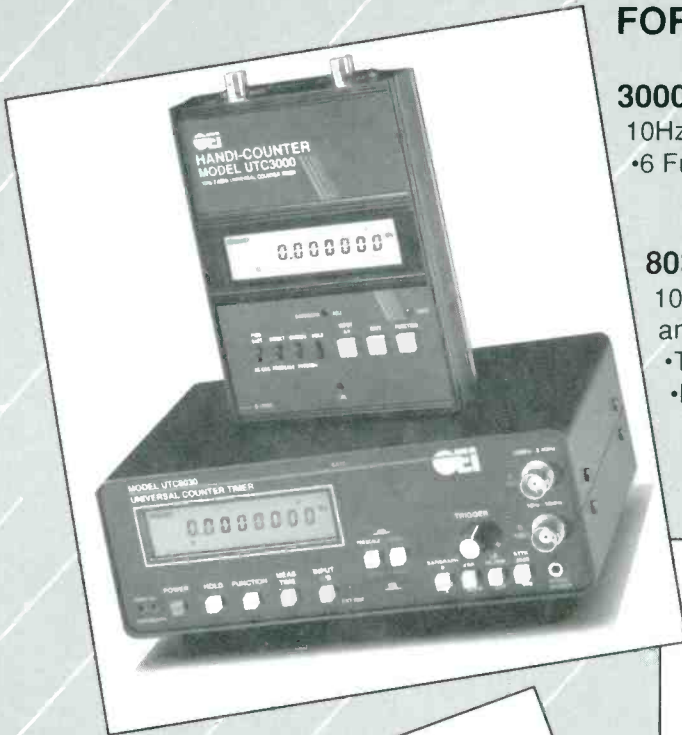

## 3000 – Our Best Handi-Counter®

10Hz - 3GHz Multifunction Counter, includes: •Bargraph  
•6 Functions •  $\pm 1$ PPM TCXO •NiCads & Charger  
**\$375.** (options: BLB30 \$75, TXCO30 \$100.)

## 8030 – Bench/Portable Multifunction Counter

10Hz - 3GHz Extremely High Sensitivity, High Resolution  
and Accuracy, includes: •Bargraph •  $\pm 1$ PPM TCXO  
•Two Inputs •Adjustable Trigger Level •Trigger Variable  
•Hold Button  
**\$579.** (options: BLB90 \$75,  
TCXO9  $\pm 1$ PPM TCXO \$135.)



## APS104

Our Active  
Preselector  
will  
unbelievably  
boost your  
counter's ability  
to detect  
frequencies up to  
10 times the  
distance. Tunable  
over 5 octaves.  
**\$995.**



## PC10 PC Based Multifunction Counter

Operates under Windows 3.1.  
("C" Library available)

•Instantly tunes a receiver •Data Logging  
•10 Digit •10Hz - 2.4GHz

**\$199.** (options: AP10H - Dual  
High Impedance Amplifier  
Head Unit \$199.)

Both PC10 & AP10H \$379.

**YOU  
CAN'T HIDE  
IT'S COMING  
IN THE FALL  
OF '92**

**Factory Direct Order Line  
1-800-327-5912**

(305) 771-2050 • FAX (305)771-2052  
30 Day Money Back Guarantee

5821 NE 44th Ave. • Ft. Lauderdale, FL 33334  
5% Shipping Handling, (Maximum \$10) U.S. & Canada.  
15% outside continental U.S.A. In Florida add 6% sales tax  
Visa and MasterCard accepted.



# Monitoring Times

## Monitoring the New Air Force

8

By Larry Van Horn

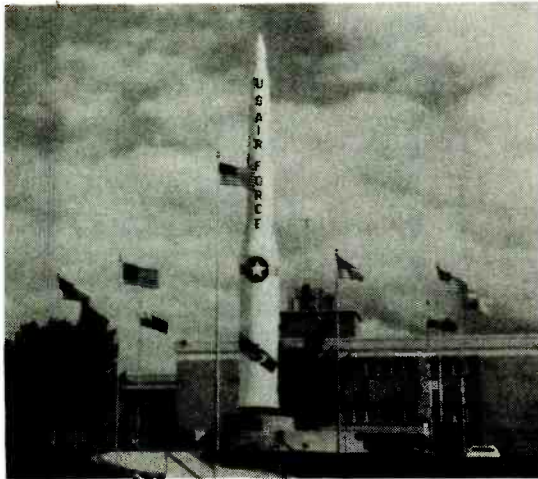

The end of the cold war has also meant an end to political and military institutions that have been part of our lives throughout most of this century. On June 1st, with a simple lowering of their flags, TAC, SAC and MAC ceased to exist.

The reorganization of the Air Force has naturally brought with it some confusion (within the Air Force as well as to the hobbyist), but the shake-up provides new challenges and excitement for the monitor. In this special report, Van Horn explains the new Global HF System and the division of responsibilities within the unified US Strategic Command.

## The Yardstick of Excellence: The BBC's World Service

By Jeff Chanowitz

No other broadcaster has attained the global recognition and respect achieved by the BBC's World Service in its 60 years of broadcasting. But even the venerable *Beeb* is being tested in these days of economic and political changes. *MT* looks at the BBC's past and its foreseeable future in a conversation with deputy director David Witherow.

14



## German Numbers Stations

By Nils Schiffhauer

Since unification, are German numbers stations gone but not forgotten? Hardly, says Schiffhauer, a German journalist who tracked down the transmitter site for one mysterious station.

24

**COVER PHOTO:** Chinese students in Beijing's Tiananmen Square bear a banner thanking the BBC for its broadcasts. Photo courtesy BBC.



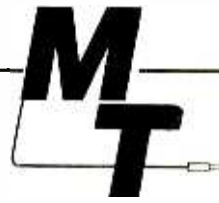

## On the Right Wavelength

18

By Jacques d'Avignon

Better men than *MT's* propagation forecaster have tried to explain to the layperson how ionospheric conditions affect radio waves. *MT* publishes monthly charts, so you don't have to understand it. But if you want to know how to use the charts more effectively, and why propagation may vary from their predictions, d'Avignon offers this introduction to propagation forecasting.

## So You Want to be an International Broadcaster

20

By Ken MacHarg

Have you ever dreamed of the adventure and excitement that must be the life of an international broadcaster? Do you wonder if you might have what it takes? Ken MacHarg of station HCJB, Quito, Ecuador, reveals some of the rigors and requirements encountered by the people behind the microphone.

## Emergency Call

26

By Laura Quarantiello

Do you drive to the scene of a nearby public safety emergency or not? — It's your call. Quarantiello outlines good scanner protocol.

## And More ... !

Are you a shortwave broadcast listener? A utility monitor? A bandscanner? Your listening preferences may determine whether the new Grundig Satellit 700 that "Magne Tests" is the radio for you. In "Scanner Equipment," Bob Grove checks out the Realistic®PRO-2026 Patrolman. Don't be fooled; it may look just like a Bearcat BC760XLT but it is specially manufactured for mobile operation.

Do your friends think of radio monitors as nerds who, when they're not boring friends with an account of their latest DX catch, are sitting for hours in a dim room with their radios? Show them "Federal File." Steve Douglass has found that radio monitoring, while maybe not lucrative, is anything but dull!

### DEPARTMENTS

Letters	3	QSL Corner	59
Communications	6	Shortwave Guide	60
Shortwave Broadcasting	28	Propagation Charts	88
Utility World	32	What's New	90
The Scanning Report	36	Scanner Equipment	94
The Beginner's Corner	40	Magne Tests...	96
Federal File	42	Computers & Radio	98
High Seas	44	Demaw's Workbench	100
Below 500 kHz	46	Experimenter's Workshop	102
American Bandscan	48	Antenna Topics	104
Satellite TV	50	Ask Bob	106
On the Ham Bands	52	Club Circuit	108
Outer Limits	54	Special Events Calendar	109
Reading RTTY	58	Stock Exchange	110

MONITORING TIMES (ISSN: 0889-5341) is published monthly by Grove Enterprises, Inc., Brasstown, NC, USA.

Address: P. O. Box 98, 140 Dog Branch Road, Brasstown, NC 28902-0098

Telephone: (704) 837-9200

FAX: (704) 837-2216 (24 hrs)

BBS: (704) 837-9200 (M-F 6:30PM-8AM; 24 Hrs on weekends)

Subscription Rates: \$19.95 in U.S. and \$28.50 US Funds elsewhere; Label indicates last issue of subscription

### STAFF

#### Publisher

Bob Grove, WA4PYQ

#### Editor

Rachel Baughn

#### Editorial Assistant

Beverly Berrong

#### Subscription Services

Chanel Hilliard

#### Advertising

Beth Leinbach (704)389-4007

#### Dealerships

Kelly Davis

#### Editorial Staff

Frequency Manager Greg Jordan

Frequency Monitors B. W. Battin

David Datko

Program Manager Kannon Shanmugam

Program Monitors John Carson

Jim Frimmel

Reading RTTY Jack Albert, WA9FVP

Beginner's Corner T. J. Arey, WB2GHA

Plane Talk Jean Baker

Computers and Radio John Catalano

Below 500 kHz Kevin Carey, WB2QMY

Experimenter's Wkshp Bill Cheek

DeMaw's Workbench Doug DeMaw, W1FB

Federal File Steve Douglass

Ham DX Tips Rob Gerardi, N9LAG

SW Broadcasting Glenn Hauser

High Seas James R. Hay

Scanning Report Bob Kay

On the Ham Bands Ike Kerschner, N3IK

Propagation Jacques d'Avignon

Magne Tests... Lawrence Magne

Communications Larry Miller

What's New? Larry Miller

Satellite TV Ken Reitz, KC4GQA

Antenna Topics W. Clem Small, KR6A

SW Broadcast Logs Gayle Van Horn

QSL Corner Gayle Van Horn

Utility World Larry Van Horn, N5FPW

Outer Limits George Zeller

American Bandscan Karl Zuk

Correspondence to columnists should be mailed c/o Monitoring Times. Any request for a personal reply should be accompanied by an SASE.

Second class postage paid at Brasstown, NC, and additional mailing offices.

POSTMASTER: Send address changes to Monitoring Times, Post Office Box 98, Brasstown, NC 28902-0098.

# LETTERS

The miserable propagation of this past summer must have accounted for many readers sitting down to their typewriters instead of the dials! I have before me a stack of interesting letters, and little space to cover them, so let's get right to it.

Richard Ashley of Salt Lake City, Utah, visited Hill Air Force Base near Ogden this past summer and snapped some photographs of an F117 Stealth, SR-71 Blackbird trainer, and an EC-135 Elint. Richard found the EC-135 to be one of the most interesting. "The aircraft served the Strategic Air Command at Ellsworth AFB in South Dakota as an airborne command post. This aircraft was on its final journey, to be decommissioned at Davis-Monthan AFB in Tucson, Arizona."

Of the large white radios, the upper is a Hewlett-Packard 3386B selective receiver and the lower unit is an HP 3336B synthesis generator. "The HP receiver seemed to be a very sensitive, broadband receiver, possibly able to receive from VLF to VHF. The 3336B synthesis generator worked in conjunction with the receiver, but I don't know how. I do know that most of this equipment was once classified, and obviously some equipment still is by its conspicuous absence."

"There were no radio operators with the crew, so I'd like to solicit the help of *MT* readers to identify the other equipment and its use." Thanks for the photos, Richard. Can anyone help him?

Richard pointed out that Hill AFB is home to the 488th Tactical Fighter wing, and maintenance and rebuilding facilities for a number of military aircraft, including C-130's. It is also the present home base for Southern Air, "the CIA's 'famous' air transport company."

Richard's visit was during an open house. However, Michael D. Kanner, a major in the US Army, writes to "caution your readers on two practices."

"Sullivan ('Planning a Scanning Vacation,' July issue) mentions taking some pictures inside cockpits during air shows. Before taking any pictures around military installations or equipment, ask permission. Security per-

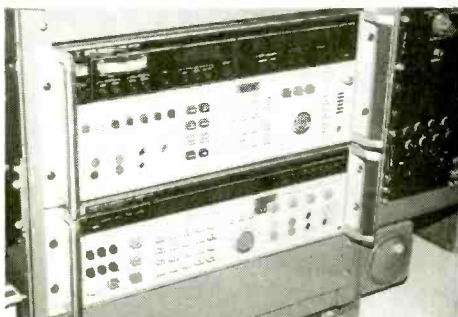

sonnel frown on people taking pictures of everything in sight. This can result in confiscation of film, camera and possible arrest.

"The other practice I would warn against is driving out to firing ranges (July 'Federal File'). Steve Douglass was lucky the pilots were able to identify him as an interested civilian. Not all are as lucky. Anyone who has worked around ranges has stories about civilian vehicles which have been mistaken for targets, sometimes with fatal results. Again, talking to the public affairs or range operations personnel is a good policy."

Major Kanner adds, "In Sullivan's article referring to Eglin Air Force Base, he left out that Eglin is also the home of the jungle phase of Ranger School. During this phase, Ranger candidates learn and practice the skills needed for patrols and raids such as used in Operation Just Cause. Monitoring the military FM frequencies you can hear patrols coordinating movements, resupply and fires. I hope these suggestions help your readers in their safe enjoyment of monitoring military transmissions."

## This is Not a Test

"It was a chilling reminder to read Randy Torno's hour by hour diary of the Los Angeles

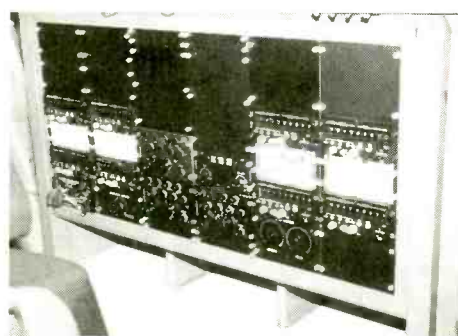
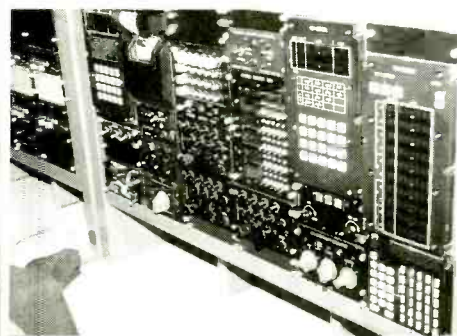

## SCORPIO

Model: 3386B (PORTABLE RADIO) Location: 3303 Jans  
 Date: 02-27-91 Price: \$11,975.00 End Prg: From 17,228.00  
 Model: 3336B Status: Approved: Comptrol (see) 0241  
 Remarks: 012008 1747101 - cargo: Approved: Comptrol (see) 0202  
 Date: 23- / - / 17,228.00 P/R / 012011 / 0202  
 [Date: / /] [Price: / /] [Terminal: / /] [Key: / /] [M/R: / /]  
 [Date: / /] [Price: / /] [Terminal: / /] [Key: / /] [M/R: / /]

[Menu] [Print] [Status] [F1] [F2] [Upload] [Download] [Home] [Exit] [Help] [Print]

Integrated Multi-Function Communications Software for IBM PC

### Simultaneous

- Radio Control / Scanning
- Log Database Management
- TU Digital Control/Disp

> LogScan, AutoLog and AutoTU functions > Interfaces with All Mode Terminal Units  
 > Mouse/Function Key control of Kenwood & Icom Receivers & RS232C Digital Terminal Units  
 > Search Log by any key including Remarks > Scan based on Log Search criteria  
 > Copy RTTY & other DIGITAL signals > AutoTU sets TU mode as needed during scan  
 > Log/Scan has real time UTC and FRO limit options > AutoLog builds database from 'this'

Optional Log Databases available for only \$19.95 each include:  
 English Language SW Broadcast - MidEast - Utility - Others

**\$89.95 (+ S&H)**

**ASHTEON**

Fax: (615) 397-0466 Compuserve # 72557,3560  
 PO Box 830 - Dandridge, TN 37725 - (615-397-0742)

**Monitoring Times welcomes your considered comments, questions and opinions on the world of radio. Address them to "Letters," P.O. Box 98, Brasstown, North Carolina 28902.**

**NATIONAL SCANNING REPORT**

HOT new scanning magazine. Everything from engaging features, helpful how-to-do's, reader exchange and lots of frequencies for the scanner listener, law enforcement and fire fighter enthusiast. Get six issues and a FREE county printout of police and emergency for \$17.50. (Specify county.) Send check, MO, MC/Visa to PO Box 291918, Kettering, OH 45429. Or call toll-free:

**1 800 423-1331**

Interested  
in  
Writing?

Send a self-addressed, stamped envelope for your copy of the *MT* Writer's Guidelines to:

**Writer's Guidelines**  
 Monitoring Times  
 P.O. Box 98  
 Brasstown, NC 28902-0098



riots," writes Steve Dichter of Hollywood, California. "Like Randy I was glued to my scanner radios for several days. However, no message on my scanner was as disturbing to me as the one I received on my AM radio.

"This message was a twenty second tone followed by the words, 'This is the Emergency Broadcasting System. This is not a test! Los Angeles County is under a state of siege and a curfew will be enforced at sundown.' After years of EBS test announcements, the real thing seemed very un-real."

## If You're Not a Business You've No Business on the Band

June's *MT* carried a review of the Realistic BTX-120 business band (151.625 MHz) walkie-talkie. While the review lauds Radio Shack for enclosing an FCC license application, Jeff Shinn of Boise, Idaho, points out that "you noticeably failed to mention that only legitimate business concerns are able to receive a license from the FCC, and that license, if on an itinerant frequency, is limited to certain geographic areas."

"Regardless of Motorola's, and now Radio Shack's new attention to the 'consumer' two-way market," continues Jeff, "the FCC has not loosened its requirements for licensure. Mom and Dad are not able to purchase a pair and use them when camping or when traveling across country in rental moving vans!"

Point well taken, Jeff; you are absolutely right.

## Age is No Excuse

Chris Bursche of Sault Ste. Marie, Ontario, enjoys listening to WA3NAN transmissions during shuttle missions; this is a ham retransmission of shuttle communications on 14.295 kHz. "Now, we all know that there are bad apples everywhere, and I sure heard some during my monitoring of the shuttle broadcasts," declares Chris. "I was astounded to hear someone say, 'I don't give a — about (it),' and then continue to splatter the frequency 1 kHz away. Others did the same only 1.5 kHz up or down from 14.295. I checked the band, and there were lots of other openings."

The day the shuttle was schedule to land, Chris encountered hams parked right on 14.295, saying "it was nice to finally get a cup of coffee here." WA3NAN continued its broadcasts and the hams finally moved.

"What I do not understand," remarks Chris, "is that the people had older, mature voices and should have known better. I never did hear a young voice. Is this what we are teaching the next generation? Yes, some of my friends want me to be an amateur, but I say no way; I am perfectly

happy being 'just' an SWL. P.S.: I am a young and fair-minded 76, and I don't believe I have special rights because of my age."

## Two for the Books

- Ted Daniel, an alumnus of American Forces Radio and Television Service (AFRTS), called our attention to the fiftieth anniversary of "this truly unique radio and television service." I wish there were space to do more than our short acknowledgement last month. However, Ted does recommend a book: "*Brass Button Broadcasters, A Lighthearted Look at 50 Years of Military Broadcasting*, a top notch book, was published by Turner Publishing Company, P.O. Box 3101, Paducah, KY 42002-3101. Telephone (502) 443-0121. *Brass Button Broadcasters* is the best thing ever done on AFRTS."

Adds Ted, "Every American who has worn a uniform and gone overseas during the last fifty years has been touched by AFRTS. Some of today's notables began their careers as AFRTS broadcasters: George Kennedy, Pat Sajack, Gary Collins, Ike Pappas, Alan Landsburg, and Adrian Cronauer (*Good Morning, Vietnam*), who now practices law in Washington, are among them."

- If the June "Radio Reflections" on Nicola Tesla caught your eye, Ashley Hardesty put ordering information for Tesla's book on the *MT* Bulletin Board. *My Inventions*, edited by Ben Johnston is \$7.95 plus \$1 shipping from Hart Brother Publishing, P.O. Box 205, Williston, VT 05495.

## Oops

- In the August issue, the article on receiving weather facsimile said that transmissions are sent on lower side band. However, Chuck Naylor of Massachusetts called to disagree; he says that all the transmissions he has received are on upper side band. He is correct; you should use USB, and tune just below the published frequency.

- Larry Price, W4RA, has this response to August's editorial comment, "I am PEEVED at people who can't spell PEEVE!" That's a double oops—Bob and I both know better than to be peaved!

- And, as if you still had doubts, here's additional proof that writers/editors are very human. Steve Forest of Cincinnati, Ohio, writes to express his disappointment at seeing the 1130 UTC entry for Radio Yugoslavia listed as "Radio Fascist" in the July issue.

Says Steve, "Now, I'm no great fan of what Serbia is doing to Croatia, Bosnia and the other Balkan states. I happen to agree with the UN sponsored sanctions. That, however, gives your magazine no right whatsoever to editorialize like it has done. Radio Yugoslavia continues to refer

to itself as 'Federal Radio,' not 'Fascist Radio.'"

"This listing has compromised *MT*'s well-earned reputation for fairness and accuracy. Many SWL's will tell you that they listen in the first place, in order that they can make political judgments for themselves, after having listened to both sides of the controversy."

The entry was made in anger, admits the embarrassed manager of the frequency section, after checking Radio Federal's signal shortly after a Bosnian breadline had been fired upon. But the impulsive entry was forgotten and not spotted until too late.

Thank you, Steve, for your complimentary opinion of the standards to which we aspire. Even though I believe there are occasions in which it is proper to editorialize, in the middle of a database is emphatically not one of them!

## On a Trivial Note

We've received several answers already to Peter Stawicki's questions last month questioning whose voice intones the time announcements for WWV. Ray Wilson of California and Lloyd Mathiesen of Luverne, Minnesota, both answered "Don Elliott of Atlanta." But that's all about to change.

Here's Lloyd's letter: "The voice that had been used for years, from 1967 until last August, was that of Don Elliott of Atlanta, Georgia. Jane Barbe was WWVH's voice. She was also from Atlanta, as indeed was the company that manufactured the old machine (AudioChron).

"I talked with Mr. Jim Maxton at WWV this morning who provided the following information: Nobody at the station knows the name of the voice used in their present digitalized form. It is known he is radio announcer in San Francisco. A female voice on a chip was tried at WWVH last August, but was unsuccessful due to technical problems. Both stations now have new chips with new voices and they are expected to begin using them shortly. The current WWV voice is lacking in high frequency components and the new chip has a new voice which corrects this problem."

Dale Neiberg of Laurel, Maryland, says, "I don't know who the announcer is on WWV, but if you're interested, the announcer on the US Naval Observatory audio clock (call 900-410-TIME or 202-653-1800) is George Fenneman. Yes, Groucho's old sidekick!"

Wow! And thanks! No question is too trivial for radio hobbyists as long as it involves good monitoring times!

See you in October, hopefully in Atlanta! Watch for an upcoming feature article on WWV which will have the name of the new announcer.

Rachel Baughn  
Editor

# Last Chance to Pre-register!

# The 1992 Monitoring Times Convention!

Omni Hotel CNN Center  
ATLANTA, GEORGIA



## October 2-4

Attend seminars by the leaders in  
radio monitoring:

Skip Arey	Fred Osterman
Jean Baker	Ken Reitz
John Fulford	Frank Terranella
Bob Grove	Larry Van Horn
Bob Kay	George Zeller
Larry Magne	

Covering such topics as:

- Radio Law
- Trunk Busting Basics
- Who's Who on the Spectrum
- Pirate DXing
- A Professional Monitoring Post
- Choosing an SW Receiver
- Surveillance
- Digital Communication Services
- Digital Communication Equipment
- TVRO: The State of the Art
- Setting up a Scanner Listening Post
- Monitoring Federal Communications
- When to Accessorize
- The International Broadcasters
- Receiving Antennas
- SW Domestic News Monitoring
- Aero Monitoring
- Scanner Experts Forum
- SW Experts Forum
- Beginner's Forums

Door Prizes  
will be awarded!



Grand Prize

JRC NRD-535D !



Great companies on exhibit:

- AIE Corp.
- All Ohio Scanner Club
- Austin Antenna
- Auto Security & Acces.
- Bearcat Radio Club
- Cellular Security Group
- Christian Science Monitor
- R.L. Drake
- DX Computing
- EWTN
- Grove Enterprises
- Ham Radio Business Council
- J&J Enterprises
- Japan Radio Company

- Lowe Electronics
- Official Scanner Guide
- Optoelectronics
- Passport to World Band Radio
- Radio Comm Monitoring Assn.
- Radio for Peace International
- Shortwave Paradise
- Somerset Electronics
- Universal Radio
- V-Communications
- Worldcom Technology

Exhibit entry only  
\$5 at the door!

### Plus these special events:

- Guest speaker Dick Tauber, CNN's director of satellites and circuits, at the Saturday evening banquet
- Free Tour of CNN Studios
- Hidden Transmitter Hunt
- Sunday Swap Meet

Registration booth will open at 12:00 PM on Friday,  
October 2nd; 8:00 AM on Saturday, October 3rd.

Monitoring Times Convention Registration  
P.O. Box 98  
Brassdown, NC 28902-0098  
(704) 837-9200

Enclosed is my \$40 registration fee

Enclosed is my \$21.95 banquet fee

Payment:

Check    Money Order    Credit Card

MC, VISA, Discover

Card # \_\_\_\_\_

Exp. Date \_\_\_\_\_

Signature: \_\_\_\_\_

Name: \_\_\_\_\_

Address: \_\_\_\_\_

City: \_\_\_\_\_ State: \_\_\_\_\_ Zip: \_\_\_\_\_

Daytime Phone #: \_\_\_\_\_



## SONY®

### I Looove Ham Radio

Michael McClanahan, KA5TDA, loved ham radio—too much, perhaps. Last month, an Oklahoma District Court judge sentenced McClanahan to 22 years in prison and fined him \$8,400.

Seems that KA5TDA was embezzling state funds for three years and using the money to buy parts for his ham radio operation. Total purchases falsely processed by the amateur radio operator were alleged to have topped \$22,000. Investigators stumbled onto the cache of ham gear at the Oklahoma Medical Center where McClanahan worked as a computer supervisor.

### Not the Picture of Harmony

Ham radio operators were duking it out in a Texas courtroom recently. Garland Moser, N5EWD, of Irving, Texas, was ordered to pay a \$10,000 damage judgment to David Pease, N5DA of Sunnyvale, Texas. Pease owns the North Texas Repeater Network, a group of linked repeaters on the 2 meter and 440 MHz ham bands.

The case goes back to 1987 when Pease filed a lawsuit against nine amateurs and the Texas VHF-FM Society. He charged the defendants with libel, slander, harassment, and conspiracy. The court dismissed the lawsuit and the remaining defendants eventually settled out of court. Moser, however, pressed forward with a countersuit but the court found for the plaintiff.

### Mad Cab Cops

It's a story you've heard before. In this case, Nevada Taxicab Authority Police have had to suffer through insults, belches and loud rock 'n roll music that is being broadcast over their own communications system. Despite repeated warnings from the authority's chief investigator, Ed Adkins, the rogue radio bandit continues to taunt cabbie cops.

Adkins worries that the interruptions in Taxicab Authority communications could put people's lives in danger. He says that the illegal transmissions are no laughing matter. In Nevada, they take their taxi cabs seriously and have 34 officers assigned to Las Vegas, many of whom are authorized to carry firearms and make arrests.

Adkins will probably have the final shot in the cat and mouse game with the pirate radio operator. He is buying a \$600 modification to the radios that will eliminate the bandit's access to the call mode on what is probably a lost or stolen Taxicab Authority Police radio.

### Sony: Artillery Against "Unauthorized Retailers"

It's a game of hardball with a twist. The giant Sony Corporation of America has released a list of "certain retailers in Florida who advertise and sometimes sell Sony Consumer Video, Audio, and HiFi products [and who] are not authorized Sony dealers."

Sony claims that these "certain unauthorized retailers" also alter or remove the serial number on the product and warns that "this action voids the limited warranty which Sony offers on its products." Why an unauthorized retailer would remove the serial number—perhaps to obscure the source of the product?—is not stated. Sony lists, by name, some 20 stores that it cites as unauthorized retailers, "[in the hope of] inform[ing] consumers of these facts."

### If It Scans — You Gotta Pay

A decision was finally handed down in the long-standing patent infringement suit by Uniden Corporation against AOR, Ltd. and Crum Development Corporation. In essence, according to U.S. District Court records filed in Indianapolis on April 30, 1992, the Court confirmed Uniden's patent rights to the scanning technology used in all of AOR's scanning receivers and dismissed AOR's anti-trust countersuit against Uniden.

We are not aware of any damages having been set at this time, nor of any out-of-court settlement, such as that reportedly agreed to by ICOM. The court has stated that the patents held by Uniden are "valid and enforceable." Will Uniden now go after other scanner manufacturers who are not paying royalties to them? Crum is appealing the case.

### More Radio Pioneers Die

#### Hallicrafters Founder Dead at 93

William J. Halligan, the man who brought countless hours of enjoyment into the homes of millions of people with his Hallicrafters radios, is dead at the age of 93. Halligan, ex-W9AC, got his first ham ticket as a teenager and later worked as a radio operator during World War I on the battleship *Illinois*.

Halligan led a varied life, working as a newspaper reporter after dropping out of West Point. Sometime thereafter, he left journalism to sell equipment for a radio supply company in Boston. In 1933, Halligan started Hallicrafters, supplying radios for hobbyists and manufacturing electronic equipment for home, industry, the military and aerospace.

Hallicrafters radios got their widest exposure during the 1950s and 1960s when his shortwave radios were sold through Sears and Roebuck and Montgomery Ward catalogs. Hallicrafters was acquired by Northrop Corp. in 1960. He continued on as president and chairman of the board of Hallicrafters until 1967.

#### Loudspeaker Inventor Dies

John Spence Timmons, the man credited with inventing the first loudspeaker, died recently at the age of 99. Timmons began his career in 1914 as product manager for the New York based Callophone Company, which manufactured communications products for the armed forces. There, he developed the throat-voice transmitter, which mounted on the strap of a pilot's helmet.

In 1921, just a year after commercial radio broadcasting got under way in Pittsburgh, Timmons invented his first radio loudspeaker. In 1928, his two companies, Timmons Radio Products and J.S. Timmons, Inc., merged with the Philadelphia Storage Battery Company, later known as Philco. He worked for Philco until he retired in 1956.

### Is This the Future?

The FCC is preparing to accept the first applications for licenses to broadcast in the new extension of the AM radio band by the end of this year. Currently, only broadcasters who are already licensed to transmit in the 540 to 1600 MHz band are eligible for licenses in the 1600 to 1700 kHz extension. Additional preference goes to stations who plan to broadcast in AM stereo.

Those who do win licenses will be allowed to simulcast for five years on both channels, using the same call letters. Power restrictions are 10 kW daytime and 1 kW nighttime. Prior to 1984, the new "extension band" was used by cordless telephones.

### FCC Goes High Tech

It's been a year since the 220-222 MHz band was allocated from amateur to narrow-band business radio. So far, no licenses have been issued and no equipment has been authorized to operate in the band. But that doesn't mean that the FCC isn't at work.

Some 60,000 applicants are hoping to win licenses in a lottery. No, the FCC won't be using capsules from a raffle drum or air-blown ping-pong balls to make the selection. For the first time, licenses will be awarded based on a random selection procedure by computer. That's life in the '90s.



# COMMUNICATIONS

## General Ham in Space

In the past, if you were planning to go into space and wanted to use your ham radio gear, you had to hold an Amateur Extra Class license. Now, thanks to an amateur-submitted petition, Section 97.207(a) has been revised. Any amateur radio licensee can now operate from outer space.

## BBC TV Lagging

Celebrations at the BBC World Service on its 60th anniversary have not put any cheer into the heart of its counterpart in TV. Ratings for the once-revered network are down—big time. Entering its 20th year, morale among the 23,500-member staff of BBC TV has plummeted and the government is issuing veiled threats that the institution once affectionately known as "Auntie" or "The Beeb," must justify the national licensing fee that provides its operating income. (Every British household with a TV is assessed a fee of 80 pounds [about \$145] annually.)

The top brass of the British Broadcasting Corporation recently retreated to Bath in an effort to map out the troubled TV network's future. The fact that the executives chose a luxurious country hotel that cost the taxpayers "tens of thousands of dollars," did not escape public scrutiny. Neither did the fact that, when they emerged three days later, nothing had been decided.

According to an article in the *Los Angeles Times*, the institution that was once the qualitative standard by which all other broadcasting networks were measured, finds itself "off course and without a compass." Complained senior correspondent Michael Buerk, a sometimes news anchor, "None of our program editors and senior managers have been broadcasters, which is like having nobody at the top of the Royal Air Force who can fly."

The BBC will attempt a mid-course correction this fall when they introduce a hugely expensive soap opera entitled "Eldorado." BBC publicists describe the show, as a heady brew of "sun, sand, sangria—and, of course, sex."

## Little Secrets

If the high and mighty at the Democratic National Convention wanted to keep a lid on their inside doings, they picked an interesting way to communicate. According to an article in the *New York Times*, party officials brought in more than 1,000 cellular phones. Noted reporter Anthony Ramirez, "This means that people with small inexpensive radio scanners

both inside and near...[Madison Square] Garden could lock onto those frequencies as easily as a motorist tunes into a station on a car radio.

"It is reported that in the Camp of Bill Clinton, some 20 top aides used cellular phones. On the other side of the political fence, Republicans completely banned cellular phones from the convention floor but downplayed the eavesdropping angle saying that "We're just [banning the cellular phones] because they might interfere with TV broadcast signals."

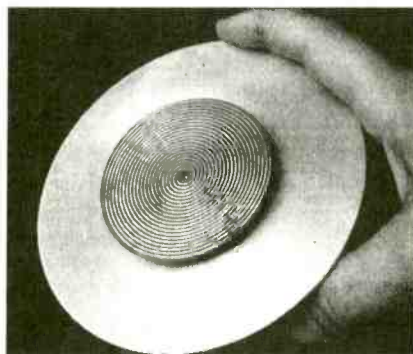

Wang-Tripp Corp.

*The new spiral-mode antenna can be pasted on any surface.*

## Antenna Pasties

From the *New York Times* "Tech Notes": Two Georgia Tech inventors have developed a small broad-band antenna that they say is less expensive and more versatile than existing antennas. The device is called a spiral mode microstrip antenna.

The Wang-Tripp Antenna, named for the two scientists who invented it—Victor K. Tripp and Johnson K. H. Wang—is only an inch thick and "can be molded to a surface and actually pasted on." Because of its broad band abilities, a single antenna could serve multiple purposes. In a car, for example, it could be used for the radio, the cellular phone and other communications equipment.

Thanks to these contributors who sent in news items: Pete Alanoni, Philadelphia, Pennsylvania; Marshall Coleman, Bremen, Florida; David Doan, Orlando, Florida; Loy Lee, Broadcasting from Somewhere in Kentucky; Ricardo Molinar, Ft. Lee, New Jersey; James Richardson, Littleton, Colorado; Bruce Tracy, Boulder City, Nevada. Special thanks to the *W5YI Report*. "Communications" is edited by Larry Miller.

# NOW YOU'RE TALKING!

## The Code-Free Ham License Is Here

Enjoy all Amateur Radio privileges above 30 MHz without having to pass a code test. All you have to do is pass a 55-question exam on basic radio and the FCC regulations. ARRL's new book, **Now You're Talking** makes understanding what is required on the test a snap! And there are exams given all over the country every weekend.



Just think how much fun you'll have communicating through repeaters, enjoy Sporadic E skip and worldwide communications on six meters when conditions are right. There's satellite communication and you can even talk to Astronauts and Cosmonauts in orbit. Enjoy friendly local communication both direct and through repeaters. Help with disaster drills and the real thing! Sound like fun? It is! Order your copy of **Now You're Talking** below: Enclosed is \$19 plus \$4 for shipping (a total of \$23) or charge \$23 to my  VISA  Mastercard  Discover  American Express

Signature \_\_\_\_\_

Acct. No. \_\_\_\_\_

Good from \_\_\_\_\_ Expires \_\_\_\_\_

Name \_\_\_\_\_

Address \_\_\_\_\_

\_\_\_\_\_

City \_\_\_\_\_ State \_\_\_\_\_ Zip \_\_\_\_\_

MT

**THE AMERICAN RADIO RELAY LEAGUE**  
225 MAIN STREET  
NEWINGTON, CT 06111



# Monitoring the New Air Force

## A Monitoring Times Exclusive Report

By Larry Van Horn

**One** by one, in solemn ceremonies, their flags were brought down. Each flag was cased, then replaced by one that was new. On this one single day, June 1, 1992, history somewhat quietly recorded the beginning of one era and the ending of another.

First Tactical Air Command (TAC) flags fluttered in a cool morning sea breeze at a ceremony at Langley Air Force Base (AFB) in Virginia. Then flags flapped and toppled in a stiff, midwest noon time wind at the Military Airlift Command (MAC) ceremony at Scott AFB, Illinois. Finally, in the late afternoon, flags hung still in a hangar at Offutt AFB, Nebraska, as the Strategic Air Command (SAC) flag was hauled down in a light misty rain.

Such was the day on which TAC, MAC and SAC ceased to exist, to be replaced with ACC, AMC and USSTRATCOM. As the old was eulogized and left behind, the new spread its wings and took over the job of protecting the United States from attack by aggressors.

What happened at each of these ceremonies on June 1, 1992, was "part of the largest-ever restructuring of the (U.S.) Air Force since it became a separate service in 1947," said Col. Russell Rinkin, vice commander of the new Air Force Air Mobility Command (AMC). The AMC is one of two major commands created on June 1; the other is ACC (Air Combat Command). When SAC stood down, it was replaced by United States Strategic Command (USSTRATCOM) which is a unified command under the Department of Defense (DOD).

And with the restructuring of the Air Force comes the reorganization of their communications networks and bases. The purpose of this article is to give our readers a first look at what we know with regard to the reorganization and its effect on traditional Air Force communications networks.

### Sort Through the Confusion...

First, to begin to understand what has happened to USAF communication systems we must understand what has happened to the Air Force command structure. A lot of confusion exists because people do not understand just what the Air Force did on June 1. Let's examine each command one by one.

#### United States Strategic Command (USSTRATCOM)

With the end of the Cold War, the world has entered an entirely new era, filled with fresh hope

for a truly global community of nations. While there is much to be hoped for, much still remains to be seen. Tens of thousands of nuclear weapons remain in the arsenals of former adversaries. The appetite for weapons of mass destruction appears to be growing. We could find ourselves threatened by a new set of countries that would not hesitate to use such weapons.

In the face of this prospect, we continue to retain a highly credible and survivable nuclear offensive force that can send a powerful deterrent message to any would-be aggressor. This is the mission of the United States Strategic Command—USSTRATCOM, for short.

In general, the control of all strategic arms of the United States is consolidated under this one command. This new unified command reports directly to the Secretary of Defense, and its leadership will rotate between an Air Force general and a Navy admiral.



Steve Douglass

#### KC-110 Tanker

As directed by the National Command Authority (NCA), USSTRATCOM performs a wide range of missions, from posturing bombers, missiles and submarines to deter attack, to preparing the nation's nuclear war plan. USSTRATCOM also conducts strategic reconnaissance around the globe, and maintains state-of-the-art command, control, communications and intelligence support networks that link these forces, which are ready to respond 24 hours a day, 365 days a year.

From its headquarters at Offutt AFB, USSTRATCOM exercises operational control of all strategic weapons systems through task force commanders within the Atlantic and Pacific fleets of the Navy, and Air Combat and Air Mobility Commands of the Air Force. Using this joint-service mix helps maintain a strategic deterrence using the most technologically advanced military systems. There are 2,900 Air Force and Navy personnel assigned to USSTRATCOM, all based at Offutt.

Strategic forces that support USSTRATCOM include Minuteman III and Peacekeeper land-based intercontinental ballistic missiles and Trident I and II missiles carried on fleet ballistic missile submarines. Airborne assets like the RC-135 and U-2 aircraft perform strategic reconnaissance missions, while EC-135 and E-6 aircraft maintain battlefield command, control and communications. B-1B and B-52 long range bombers can penetrate an enemy's most sophisticated defenses, threatening valued targets. KC-135 and KC-10 air refueling tankers increase the delivery range for many of these aircraft.

#### Air Combat Command (ACC)

Air Combat Command acts as the primary provider of air combat forces to the war fighting commands and as the proponent for ICBMs and fighter, bomber, reconnaissance, and command, control, communications and intelligence aircraft.

As a force provider, ACC organizes, trains, equips and maintains combat ready forces for rapid deployment and employment while ensuring that strategic air defense forces are ready to meet potential challenges from nuclear capable forces. These same services are also provided to theater air forces for the five geographic unified commands—US Atlantic Command, US European Command, US Pacific Command, US Central Command and US Southern Command—and air defense forces to the North American Aerospace Defense Command (NORAD). In short, ACC ensures air forces are prepared to *globally* implement national policy.

When mobilized, more than 87,000 members of the Air National Guard and Air Force Reserve are assigned to ACC. In total, ACC and these ACC-gained units consist of more than 3,600 aircraft and 900 ICBMs. These forces are supported by over 185,000 people (22,700 officers, 141,300 enlisted personnel and 21,300 civilians).

ACC's forces are organized under six numbered air forces and three major direct reporting units. The ACC commander is also commander of the US Air Forces Atlantic and the Air Force component commander of USSTRATCOM.

First Air Force, headquartered at Tyndall AFB, Florida, performs a daily operational mission as the Continental U.S. (CONUS) NORAD Region. The First Air Force commander, as the region commander, reports directly to CINCINORAD (Commander-in-Chief NORAD) for the air defense of the CONUS. First Air Force includes four air defense sectors responsible for



the air defense of their respective quadrants of the CONUS using aircraft on an around-the-clock alert. First Air Force plays a key role in the nation's war on drugs by working closely with the United States Coast Guard and the U.S. Customs Service to monitor and intercept illegal drug traffic.

Air Forces Iceland at Naval Air Station Keflavik, under the operational control of the commander-in-chief of U.S. Atlantic Command, provides a combat force for the air defense of Iceland and air surveillance data in support of the NORAD mission.

Second Air Force, with headquarters at Beale AFB, California, is responsible for control of strategic reconnaissance and battle management forces. These forces provide specialized support for theater commanders, USSTRATCOM and other U.S. agencies.

Eighth Air Force, operating from Barksdale AFB, Louisiana, is responsible for ACC forces based in the central U.S. More than 39,750 people and over 200 bomber and fighter aircraft are assigned to Eighth Air Force.

Ninth Air Force at Shaw AFB, South Carolina, has 12 wings performing fighter and bomber operations, training and air control. Ninth Air Force comprises 50,900 people and over 650 aircraft.

Ninth Air Force is also U.S. Central Air Forces (USCENTAF), the air force component of U.S. Central Command. Operation Desert Shield deployed the USCENTAF staff to the Southwest Asia theater, operationally controlling joint and multinational air forces. To prepare for this type of mission, USCENTAF active and reserve forces train regularly with Army, Navy and Marine Corps units in realistic joint training exercises.

Twelfth Air Force, located at Bergstrom AFB, Texas, operates combat-ready forces and equipment for air superiority, interdiction, reconnaissance and close air support. In addition, 12th Air Force is the air component of the U.S. Southern Command. More than 45,150 people and over 475 aircraft are assigned. The command's 10 wings perform fighter and bomber operations, training, reconnaissance, air control, and a wide range of electronic combat tasks.

Twentieth Air Force at Vandenberg AFB, California, is responsible for ACC's ICBM force and acts as missile component for USSTRATCOM. With seven wings, including six operational missile wings and one training and test wing, 20th Air Force has more than 18,000 people and over 900 ICBMs.

Hardware that makes up the Air Combat Command includes more than 2,000 aircraft. They include: A-10, AT-38, B-1B, B-52, C-21, C-27, C-130, E-3, E-4B, EC-130, EC-135, EF-111, F-4, F-4G, F-15, F-15E, F-16, F-111, F-117, KC-10, KC-135, OA-10, RC-135, RF-4C, U-2, and UH-1 aircraft.

### Air Mobility Command (AMC)

Airlift aircraft provide America with the capability to deploy air and air-mobile forces



Harry Baughn

### C-5 Transport Aircraft

anywhere in the world, and to sustain them in combat. Tankers provide the lifeline of global reach. Aerial refueling increases range, bomb load and loiter times, and since Air Force tankers can also refuel Navy, Marine and many allied aircraft, they leverage America's military capabilities on land, sea and in the air. In a nutshell, Air Mobility Command's primary mission is that of mobility for America's armed forces.

AMC was formed from elements of SAC and MAC. The AMC force consists of 179,000 personnel and 1,606 aircraft. AMC will be the provider of airlift, aerial refueling, aeromedical evacuation and combat rescue for all of the armed forces.

AMC aircraft use the callsign "Reach" followed by numbers. Two numbers only usually indicate a tanker aircraft. Aircraft bearing five numbers usually indicate airlift missions. In these early days, however, the MAC ##### callsigns have not disappeared. Sometimes old habits are hard to break and air crews continue to inadvertently use the old MAC call signs. Tankers that fly missions for ACC and USSTRATCOM have been noted using tactical callsigns.

Co-located at AMC headquarters at Scott AFB, Illinois, is the new Tanker/Airlift Control Center (TACC) callsign Hilda. This new agency centralizes command and control of airlift and air refueling assets. The TACC is responsible for scheduling and control of all tanker and airlift operations worldwide. All DOD tasking for airlift and air refueling support are channeled through this state-of-the-art hub of mobility control.

Three numbered air forces—15th Air Force at March AFB, CA; 21st Air Force at McGuire AFB, NJ (call sign Format); and 22nd Air Force at Travis AFB, CA (call sign Discard)—are assigned the resources of the AMC.

Some of the theater AMC Operations callsigns include:

Alaska ALCC	Denali
European ALCC	Phantom
Korean ALCC	Brickwall
Pacific ALCC	Tonight
So America ALCC	Furious

The AMC command hardware includes all C-5 and C-141 assets, including in-theater maintenance, aerial port, and command and control

## DIRECTORY OF NORTH AMERICAN MILITARY AVIATION COMMUNICATIONS (VHF/UHF)

20,000 Up-to-Date Listings in 4 Regional Editions  
\$14.95 plus \$3.50 First Class postage

HUNTERDON AERO PUBLISHERS  
P.O. Box 754, Flemington, NJ 08822 USA  
Credit Card Orders: 1-800-542-SCAN  
Send \$1 for catalog  
and receive \$2 off first order!

## Larry Van Horn's Monitoring the Strategic Air Command

Comprehensive. Authoritative. It's the ultimate "how to" book on monitoring the ultimate war machine. Includes shortwave and scanner frequencies. By America's acknowledged leader in utility monitoring. \$12.95 plus 1.50 book rate or 3.00 UPS from DX Radio Supply, Box 360, Wagontown, PA or use MC/VISA and call 215-273-7823.

## PC Software by W2XQ

WRTH Award-Winning *English Language Shortwave Broadcast Schedules*: by Country and by Transmission Start Time, \$27.50 & \$2.50 s/h. BBS annual subscription to update data files \$35/year.

Send SASE or download complete catalog from Pinelands RBBS 609-859-1910.

## TRS Consultants

PO Box 2275-MT  
Vincentown, NJ 08088-2275  
609-859-2447 | Fax 609-859-3226

FREE  
SAMPLE  
COPY!



## ANTIQUE RADIO CLASSIFIED

*Antique Radio's Largest-Circulation Monthly Magazine*

Articles - Classifieds - Ads for Parts & Services  
Also: Early TV, Ham Equip., Books, Telegraph, 40's & 50's Radios & more...

Free 20-word ad each month. Don't miss out!

1-Year: \$27 (\$40 by 1st Class)  
6-Month Trial - \$15. Foreign - Write.

A.R.C., P.O. Box 802-P7, Carlisle, MA 01741

**Table One****Air Mobility Command (AMC)**

Altus AFB, OK	Malstrom AFB, MT
Andrews AFB, MD	March AFB, CA
Charleston AFB, SC	McChord AFB, WA
Dover AFB, DE	McGuire AFB, NJ
Grissom AFB, IN	Norton AFB, CA
Hurlburt AFB, FL	Plattsburgh AFB, NY
Kirtland AFB, NM	Scott AFB, IL
Little Rock AFB, AR	Travis AFB, CA

**Air Combat Command (ACC)**

Barksdale AFB, LA	K.I. Sawyer AFB, MI
Beale AFB, CA	Langley AFB, VA
Bergstrom AFB, TX	Loring AFB, ME
Cannon AFB, NM	Luke AFB, AZ
Carswell AFB, TX	MacDill AFB, FL
Castle AFB, CA	McConnell AFB, KS
Davis-Monthan AFB, AZ	Minot AFB, ND
Dyess AFB, TX	Moody AFB, GA
Eaker AFB, AR	Mountain Home AFB, ID
Ellsworth AFB, SD	Myrtle Beach AFB, SC
England AFB, LA	Nellis AFB, NV
Fairchild AFB, WA	Offutt AFB, NE
F.E. Warren AFB, WY	Pope AFB, NC
George AFB, CA	Seymour-Johnson AFB, NC
Grand Forks AFB, ND	Shaw AFB, SC
Griffiss AFB, NY	Tyndall AFB, FL
Holloman AFB, NM	Whiteman AFB, MO
Homestead AFB, FL	Wurtsmith AFB, MI

**Table Two****Regional/Worldwide Communications Control Zones Frequency Listings***(Published)*

<b>Europe - Mediterranean</b>	
(Zones 11/12/14)	17975 15015 13201 11176 8993 8967 6738 4725
<b>Atlantic</b>	
(Zones 9/11/12)	17975 15015 13201 11176 8967 6738
<b>Caribbean - South America - Africa</b>	
(Zones 8/13)	15015 11176 6738
<b>Greenland - Arctic</b>	
(Zones 5/10)	17975 15015 13201 11176 8967 6738 4725
<b>Pacific</b>	
(Zones 2/3/4/5/6)	17975 15015 13201 11176 8993 8967 6738 4725
<b>Indian Ocean</b>	
(Zones 13/14)	17975 15015 11176 8993 6738 4725
<b>North America</b>	
(Zones 6/7/9)	17975 15015 13201 8993 8967 6738 4725

**Table Three****US Air Force Global HF System (GHFS) as of 1 June 1992***By station listing (Published)*

AFH3-Albrook AB, Panama (Zone 8)
15015 (1200-2400)/ 11176 (H24)/ 6738 (0001-1200)
AIE2-Andersen AFB, Guam (Zone 2)
13201 (2000-0900)/ 11176 (H24) 8967 (H24)/ 6738 (0900-2000)
AFA3-Andrews AFB, MD
17975 (1000-2400)/ 11176 (H24)/ 8967 (H24)/ 6738 (2400-1000)
AFD14-Ascension Aux AF (Zone 13)
15015 (0600-1800)/ 11176 (H24)/ 6738 (1800-0600)
AJE-Croughton AB, UK (Zone 11)
17975 (H24)/ 15015 (0500-2300)/ 13201 (H24)/ 11176 (H24)/ 6738 (H24)/ 4725 (2300-0500)
AKA5-Elmendorf AFB, AK (Zone 5)
17975 (H24)/ 15015 (Note 1)/ 13201 (Note 1)/ 11176 (H24)/ 8967 (H24)/ 6738 (Note 2)/ 4725 (Note 2)
AGA2-Hickam AFB, HI (Zone 4)
13201 (1600-0400)/ 11176 (H24)/ 8967 (H24)/ 6738 (0400-1600)
AJG9-Incirlık AB, Turkey (Zone 14)
17975 (H24)/ 15015 (0500-2000)/ 11176 (H24)/ 8993 (H24)/ 6738 (H24)/ 4725 (2000-0500)
CUW-Lajes Field, Azores (Zone 12)
15015 (H24)/8967 (H24)/6738 (H24)
AFL2-Loring AFB, ME (Zone 7/9)
15015 (0900-2400)/ 11176 (H24)/ 6738 (2400-0900)
AFE8-MacDill AFB, FL (Zone 7/9)
15015 (0900-2400)/ 11176 (H24)/ 8993 (H24)/ 6738 (2400-0900)
AFI2-McClellan AFB, CA (Zone 6/7)
17975 (H24)/ 15015 (1600-0400)/ 13201 (1600-0400)/ 11176 (H24)/ 8967 (H24)/ 6738 (0400-1600)/ 4725 (0400-1600)
AFS-Offutt AFB, NE
17975 (0800-2300)/ 11176 (H24)/ 8967 (H24)/ 6738 (2300-0800)
XPH-Thule AB, Greenland (Zone 10)
17975 (H24)/ 13201 (H24)/ 11176 (H24)/ 8967 (H24)/ 6738 (H24)
AIF2-Yokota AB, Japan (Zone 3)
17975 (H24)/ 15015 (2100-1000)/ 13201 (2100-1000)/ 8993 (H24)/ 8967 (H24)/ 6738 (1000-2100)/ 4725 (1000-2100)

**Notes:**

- 1 April - September 1800-0800, October - March 2000-0600
- 2 April - September 0800-1800, October - March 0600-2000

activities. AMC controls 932 airlift aircraft. These totals break out as follows: 115 C-5, 247 C-141, 18 C-9 and 132 OSA aircraft belong to AMC. Approximately two-thirds of the Air Force's KC-10s (38), two-thirds of its C-130s (420), and more than three-quarters of its KC-135s (506) are assigned to AMC. The remaining KC-10s, KC-135s and C-130s are assigned either to the Air Combat Command or to the theater commanders.

In addition, AMC has 130 rescue aircraft broken out as follows: 4 WC-135, 2 MC-130H, 27 HC-130, 10 HH-3, 43 HH-60, 15 HH-1, 21 UH-1N, 4 TH-53A and 4 MH-53J aircraft.

There are 116 military installations associated with AMC including 16 under their control (12 former MAC bases, four former SAC bases), 41 bases with an AMC presence (29 associated units and 12 overseas units) and 59 Air Reserve Components (38 Guard units, 21 Reserve units).

**The Big Picture**

So let's take a look at who owns your favorite Air Force base now. Table 1 is the latest list of bases versus ACC/AMC ownership. This should also help you update your frequency list for a particular base in regard to the mission they will now have to perform.

In the UHF military aircraft spectrum, AMC based aircraft will probably be found on old MAC CP frequencies. Also look on aerial refueling channels for AMC refueling aircraft. The callsign being used by the refueling aircraft will depend on who the refueling mission is for.

The ACC UHF frequency scheme will be slightly more complicated. It is not known as of this writing how a particular aircraft/base will decide on their frequency selection. It is my guess that we will see increased activity on the old Tactical Air Command Golden frequencies and

less on the old SAC UHF frequencies, except when that particular ACC aircraft is serving a USSTRATCOM function.

More information on these UHF frequencies may be found in the author's book on the Strategic Air Command available from several MT advertisers. Even though SAC is no longer, their frequencies and call signs remain in use on the air.

**High Frequency Changed Already!**

One of the most immediate changes we all noticed after 1 June 1992 was that the U.S. Air Force High Frequency (HF) networks were different. Frequencies have been shuffled, stations have revealed themselves (one for the very first time) using location callsigns, and traffic is scattered throughout the spectrum. As we did with the various commands, let's take this one system at a time.

**Global High Frequency System (GHFS)**

Air Force officials have told *Monitoring Times* that this new system incorporates the old Global Command and Control System (GCCS) and more. This might explain the addition of Offutt and Andrews AFB into the new system.

According to the Air Force, the GHFS is primarily used to support DOD aircraft and secondarily other US government aircraft with air-to-ground communications. Air Force Communications Command (AFCC) headquarters, in conjunction with headquarters for Air Combat Command, Air Space Command, Air Force Material Command, Air Mobility Command, Pacific Air Force, and US Air Force Europe, operate stations in this network throughout the

world. This HF system is used on a daily basis whether in peacetime, wartime or national emergency.

The system is dedicated to providing reliable, rapid, two-way communications between ground stations and aircraft regardless of their location. This system is capable of supporting command and control, special purpose and contingency air/ground/air communications. Neither GHFS nor individual stations are dedicated to any service, command or other activity, as they support all authorized users on a traffic-precedence basis.

GHFS Stations are tasked to provide Command, Control and Communications (C3) support to the President and other high ranking VIPs (through the Air Force Mystic Star network), Worldwide Airborne Command Post, Electronic Security Command, U.S. Air Force major command aircraft deployment/redeployments (Coronet Exercises), Foxtrot broadcast and emergency action messages, weather reconnaissance, rescue missions, disaster and contingency communications, all other mercy missions and service to any other authorized user.

To ensure as continuous and total high frequency coverage as possible, the frequency listing



# COMMUNICATIONS ELECTRONICS INC.

## Emergency Operations Center

has expanded to our new two acre facility and World Headquarters. Because of our growth, CEI is now your one stop source for emergency response equipment. When you have a command, control or communications need, essential emergency supplies can be rushed to you by CEI. As always, for over twenty three years, we're ready, willing and able to help. For 1992, we're introducing new products from Uniden, Shinwa, ICOM, Ranger Communications Inc., Grundig, Sangean, Magnavox and RELM.

### NEW! Shinwa SR001-B

List price \$799.95/CE price \$479.95/SPECIAL Continuous coverage from 25.000 through 999.995 Mhz. If you're looking for an excellent synthesized scanner designed for mobile surveillance use, the new Shinwa SR001 scanner offers features never before offered at such a low price. When you purchase this wide band scanner from CEI, you'll get a free infrared wireless remote control that allows you to control your scanner from over 20 feet away. Selectable frequency steps of 5.0/10.0/12.5/20.0/25.0/50.0 or 100.0 KHz. are available. Dual antenna inputs terminating in an "N-type" and "BNC" connectors are included. Other features include 200 memory channels grouped in 10 banks of 20 channels, easy to read multi color LCD display, lithium battery for memory back-up, 35 channel per second high speed scanning, priority, timer and even an alarm to alert you to transmissions on your choice of one special frequency. We even include a mobile mounting bracket. The SR001 can be used for base station use with the purchase of the ACS-B 12 volt DC power supply for only \$34.95 each. A great sounding external speaker #SPE-B is available for only \$24.95.

### SHINWA POCKET PAGERS

The fire department hazardous materials response teams and police department SWAT crews that need reliable radio alerting systems, stake their lives on Shinwa. We offer a two-tone pocket pager with monitor feature and even a voice storage option at an affordable price. To order, we need your paging frequency as well as tone reed frequencies. For other configurations or two-way radio information, please fax us your specifications to 313-663-8888 or phone 313-996-8888.

### ICOM ICR1-B

List price \$799.95/CE price \$529.95/SPECIAL Continuous coverage from 100 kHz through 1.300 GHz. The ICOM ICR1 keeps you in touch with the world when you're on the go. The palm-size ICR1 is equipped with AM, FM and wide-FM modes to fully answer your monitoring needs. With 100 memory channels and a dual frequency selection system, you get a top-class communications receiver. Not only can you program scan searches only for signals within a specified frequency range, it's also possible to write frequencies of received stations automatically into memory. In addition, unwanted frequencies can be skipped. Order ICB72-B battery rapid charger for \$99.95 and a BP84-B 1,000 ma. battery pack for \$74.95.

### ICOM ICR100-B

List price \$799.95/CE price \$579.95/SPECIAL Continuous coverage from 100 kHz through 1856 Mhz. Now you can bring a wider world of broadcasting, VHF air and marine bands, emergency services and many more communications into your vehicle. Icom's advanced ICR100 fully covers all the stations worth hearing with up to 100 memory channels and a multitude of features.

# SCANNERS/CB/RADAR UNIDEN

PRO310E-B Uniden 40 Ch. Portable/Mobile CB .....	\$72.95
PRO330E-B Uniden 40 Ch. Remote mount CB .....	\$99.95
GRANT-B Uniden 40 channel SSB CB mobile .....	\$152.95
WASHINGTON-B Uniden 40 Ch. SSB CB base .....	\$229.95
PC122-B Uniden 40 channel SSB CB mobile .....	\$113.95
PC66A-B Uniden 40 channel CB Mobile .....	\$78.95
PRO510XL-B Uniden 40 channel CB Mobile .....	\$39.95
PRO520XL-B Uniden 40 channel CB Mobile .....	\$54.95
PRO535E-B Uniden 40 channel CB Mobile .....	\$69.95
PRO538W-B Uniden 40 ch. weather CB Mobile .....	\$78.95
PRO810E-B Uniden 40 channel SSB CB Base .....	\$174.95

### UNIDEN RADAR DETECTORS

RD3000ZX-B Uniden 3 band suction mount radar ....	\$129.95
RD2400ZX-B Uniden 3 band radar detector .....	\$109.95
RD80-B Uniden 2 band radar detector .....	\$64.95
CARD-B 3 band credit card size radar detector .....	\$99.95
RD3XL-B Uniden 3 band radar detector .....	\$109.95
RD9XL-B Uniden "micro" size radar detector .....	\$69.95
RD27-B Uniden visor mount radar detector .....	\$39.95



19 PLUS-B Cobra CB radio .....	\$36.95
18RV-B Cobra CB radio .....	\$54.95
41PLUS-B Cobra CB radio .....	\$72.95
70LTD-B Cobra remote mount CB radio .....	\$99.95
19LTD-B Cobra Classic series CB radio .....	\$44.95
21LTD-B Cobra Classic series CB radio .....	\$54.95
25LTD-B Cobra Classic series CB radio .....	\$89.95
29LTD-B Cobra Classic series CB radio .....	\$109.95
146GTL-B Cobra AM/SSB CB radio .....	\$129.95
148GTL-B Cobra AM/SSB CB radio .....	\$149.95
90LTD-B Cobra Base station .....	\$89.95
142GTL-B Cobra AM/SSB Base station .....	\$199.95
2000GTL-B Cobra Deluxe AM/SSB Base station .....	\$379.95

### COBRA RADAR DETECTORS

RD3163-B Cobra 3 band radar detector .....	\$109.95
RD3175-B Cobra 3 band radar detector .....	\$129.95
RD3173-B Cobra 3 band radar detector .....	\$139.95
RD3183-B Cobra 3 band radar detector .....	\$139.95

### Bearcat 200XLT-B

List price \$509.95/CE price \$239.95/SPECIAL 12 Band, 200 Channel, Handheld, Search, Limit, Hold, Priority, Lockout Frequency range: 29-54, 118-174, 406-512, 806-956 Mhz. Excludes 823.9875-849.0125 and 868.9875-894.0125 Mhz. The Bearcat 200XLT sets a new standard for handheld scanners in performance and dependability. This full featured unit has 200 programmable channels with 10 scanning banks and 12 band coverage. If you want a very similar model without the 800 Mhz. band and 100 channels, order the BC100XLT-B for only \$179.95. Includes antenna, carrying case belt loop, ni-cad battery pack, AC adapter and earphone. Order your scanner from CEI today.

### Bearcat 800XLT-B

List price \$549.95/CE price \$239.95/SPECIAL 12-band, 40 Channel, Nothing excluded in the 800 Mhz. band. Bands: 29-54, 116-174, 406-512, 806-956 Mhz. If you do not need the 800 Mhz. band, order the Bearcat 210XLT-B for only \$178.95.

### Magnavox® Satellite Phone

CE price \$48,880.00/Special order - allow 45 days for delivery. When war broke out in Iraq, you heard all the action because CNN had a satellite telephone. When a disaster such as an earthquake or a hurricane strikes your community and communications are disrupted, you can depend on instant reliable communications, just like CNN did using your Magnavox MagnaPhone. Inmarsat communication satellites are in geostationary orbit along the equator. They beam two-way voice and data transmissions between your satellite phone and fixed earth stations. In most instances, telephone calls are dialed directly once you have selected the satellite serving your location. No matter where you are on the planet, the MagnaPhone automatically selects the Land Earth Station (LES) nearest the destination called. This makes placing a call as easy as using a standard telephone. Dual ID numbers permit a separate Inmarsat telephone number to be used to route calls to one of the external telephone ports which could be used for a fax machine or a computer data line. For telephone, telex, fax and data communications anywhere in the world, the new MX2020P MagnaPhone is the most compact Inmarsat-A, Class 1 terminal available today. Like a cellular phone, airtime will be billed to your account. The new MagnaPhone weighs just 47 lbs (21 kg), including the antenna. Add the optional ruggedized case (only \$950.00) and it can travel as airline baggage on commercial carriers. When you arrive at your destination, installation can be done in less than 5 minutes. For more information call our Emergency Operations Center at 313-996-8888.

RELM UC202-B 2 Watt transceiver on 154.57 MHz. ....	\$114.95
RELM RH256NB-B 25 Watt VHF transceiver .....	\$299.95
RC12950-B Ranger Comm. 25 Watt 10 Meter xcevr. ....	\$234.95
MR8100-B Uniden surveillance scanner . CALL FOR PRICE	
BC55XLT-B Bearcat 10 channel scanner .....	\$114.95
AD100-B Plug in wall charger for BC55XLT .....	14.95
PS001-B Cigarette lighter cable for BC55XLT .....	\$14.95
VC001-B Carrying case for BC55XLT .....	\$14.95
BC70XLT-B Bearcat 20 channel scanner .....	\$159.95
BP70-B Ni-Cad battery pack for BC70XLT scanner ..	\$39.95
BC142XL-B Bearcat 10 channel 10 band scanner .....	\$84.95
BC147XL-B Bearcat 16 channel 10 band scanner ..	\$94.95
BC172XL-B Bearcat 20 channel 11 band scanner ..	\$124.95
BC177XL-B Bearcat 16 channel 11 band scanner ..	\$129.95
BC590XLT-B Bearcat 100 channel 11 band scanner	\$194.95
BC760XLT-B Bearcat 100 channel 12 band scanner	\$254.95
BC002-B CTCSS tone board for BC590/760XLT .....	\$54.95
BC003-B Switch assembly for BC590/760XLT .....	\$22.95
BC855XLT-B Bearcat 50 channel 12 band scanner ..	\$199.95
BC560XLT-B Bearcat 16 channel 10 band scanner ..	\$94.95
BP205-B Ni-Cad battery pack for BC200/100XLT .....	\$39.95
TRAVELLER2-B Grundig shortwave receiver .....	\$84.95
COSMOPOLIT-B Grundig shortwave receiver .....	\$179.95
SATELLIT500-B Grundig shortwave receiver .....	\$499.95
SATELLIT650-B Grundig shortwave receiver .....	\$849.95
ATS800-B Sangean shortwave receiver .....	\$89.95
ATS803-B Sangean shortwave receiver .....	\$159.95
74102-B Midland emergency weather receiver .....	\$34.95
77116-B Midland CB with VHF weather & antenna ..	\$66.95
77118-B Midland CB mobile with VHF weather .....	\$62.95
77913-B Midland CB portable with VHF weather .....	\$79.95
76300-B Midland CB base station .....	\$92.95
NPD-B Uniden National Police Directory .....	\$19.95
FBE-B Frequency Directory for Eastern U.S.A. ....	\$14.95
FBW-B Frequency Directory for Western U.S.A. ....	\$14.95
RFD1-B MI, IL, IN, KY, OH, WI Frequency Directory ..	\$14.95
RFD2-B CT, ME, MA, NH, RI, VT Directory .....	\$14.95
RFD3-B DE, DC, MD, NJ, NY, PA, VA, WV Directory ..	\$14.95
RFD4 AL, AR, FL, GA, LA, MS, NC, PR, SC, TN, VI ..	\$14.95
RFD5 AK, ID, IA, MN, MT, NE, ND, OR, SD, WA, WY	\$14.95
RFD6 CA, NV, UT, AZ, HI, GU Frequency Directory ..	\$14.95
RFD7-B CO, KS, MO, NM, OK, TX Freq. Directory ..	\$14.95
PWB-B Passport to World Band Radio .....	\$16.95
ASD-B Airplane Scanner Directory .....	\$14.95
TSG-B "Top Secret" Registry of U.S. Govt. Freq. ....	\$16.95
TTC-B Tune in on Telephone Calls .....	\$14.95
CBH-B Big CB Handbook/AM/FM/Freeband .....	\$14.95
TIC-B Techniques for Intercepting Communications ..	\$14.95
EEC-B Embassy & Espionage Communications .....	\$14.95
SMHV1-B Scanner Modification Handbook/Volume 1	\$18.95
SMHV2-B Scanner Modification Handbook/Volume 2	\$18.95
LIN-B Latest Intelligence by James E. Tunnell .....	\$17.95
A60-B Magnet mount mobile scanner antenna .....	\$39.95
A70-B Base station scanner antenna .....	\$39.95
USAMM-B Mag mount VHF ant. w/ 12 cable .....	\$39.95
USAKB 3/4" hole mount VHF antenna w/ 12 cable ..	\$34.95

Add \$5.00 shipping for all accessories ordered at the same time. Add \$15.00 shipping per radio and \$6.00 per antenna.

### BUY WITH CONFIDENCE

Michigan residents please add 4% sales tax or supply your tax I.D. number. Written purchase orders are accepted from approved government agencies and most well rated firms at a 10% surcharge for net 10 billing. All sales are subject to availability, acceptance and verification. Prices, terms and specifications are subject to change without notice. All prices are in U.S. dollars. Out of stock items will be placed on backorder automatically or equivalent product substituted unless CEI is instructed differently. Shipments are F.O.B. CEI warehouse in Ann Arbor, Michigan. No COD's. Not responsible for typographical errors.

Mail orders to: Communications Electronics, Box 1045, Ann Arbor, Michigan 48106 U.S.A. Add \$15.00 per radio for U. P. S. ground shipping and handling in the continental U.S.A. For Canada, Puerto Rico, Hawaii, Alaska, or APO/ FPO delivery, shipping charges are two times continental U.S. rates. If you have a Discover, Visa, American Express or MasterCard, you may call and place a credit card order. 5% surcharge for billing to American Express. For credit card orders, call toll-free in the U.S. Dial 800- USA-SCAN. For information call 313-996-8888 FAX anytime, dial 313-663-8888. Order from Communications Electronics today. Scanner Distribution Center™ and CEI logos are trademarks of Communications Electronics Inc. Sale dates 11/1/91 through 4/30/92 AD #110291-B Copyright © 1991 Communications Electronics Inc.

## For more information call 1-313-996-8888

Communications Electronics Inc.  
Emergency Operations Center  
P.O. Box 1045, Ann Arbor, Michigan 48106-1045 U.S.A.  
For orders call 313-996-8888 or FAX 313-663-8888

**Table Four**

By Frequency Listing (Published)

4725	Croughton Elmendorf Incirlik McClellan Yokota
6738	Albrook Andersen Andrews Ascension Croughton Elmendorf Hickam Incirlik Lajes Loring MacDill McClellan Offutt Thule Yokota
8967	Andersen Andrews Elmendorf Hickam Lajes McClellan Offutt Thule Yolota
8993	Incirlik MacDill Yokota
11176	Albrook Andersen Andrews Ascension Croughton Elmendorf Hickam Incirlik Loring MacDill McClellan Offutt Thule
13201	Andersen Croughton Elmendorf Hickam McClellan Thule Yokota
15015	Albrook Ascension Croughton Elmendorf Incirlik Lajes Loring MacDill McClellan Yokota
17975	Andrews Croughton Elmendorf Incirlik McClellan Offutt Thule Yokota

in Table Two has been developed to support C3 requirements. It contains frequencies that are guarded by more than one GHFS station in a given geographical area. The objective is to increase the probability that an aircraft can contact a GHFS station regardless of the geographical location of the aircraft.

U.S. military departments, unified and specific commands, and the U.S. Air Force major commands require constant real-time command and control communications to effectively manage their aircraft. For GHFS purposes, the world is divided into 14 command and control zones (CCZs) with a GHFS station assigned command and control station (CCS) responsibilities for each zone. While each CCS is tasked with C3 responsibilities for their CCZ, any GHFS station will provide C3 to authorized users upon request. A complete list of each CCS, their zone(s) and primary published frequencies within the GHFS network appears in Table Three. Table Four is the same list, but in frequency order.

The GHFS station usually consists of a control site, receiver site and transmitter site. Ideally the transmitter and receiver sites are located 10 to 20 miles from the control site; however, the control site can be collocated with either. The GHFS station operating positions are normally linked through a Technical Control Facility to the transmitter and receiver sites by microwave and/or landlines.

The specific number and types of circuits terminating in the station are dependent on the particular mission(s) of the station. Circuits that normally terminate in the station are: Telephone circuits which provide direct or multiple access lines, including AUTOVON (now known as DSN or Defense Switching Network), to base and commercial switchboards for local and long distance traffic relay and phone patch; teletype circuits which are usually dedicated circuits direct from GHFS stations into common-user switching centers such as DSN; and subscriber hotlines which are usually dedicated direct lines to such agencies as command posts/command centers, base weather facilities and base operations.

**Table Five**

Possible (Unpublished) Discrete Frequencies by station

Albrook AB	3137 5710 6683 6730 7775 8967 8993 9020 11179 11126 11260 13201 15065 15675 18019 19500 20600 23325
Andrews AFB Andersen AB	Mystic Star channels (See Grove's <i>Shortwave Directory</i> ) 4721 4809 8101 8989 9057 9932.5 10430 11085 11170 11179 11407 11585 14435 14515 14560 15757.5 16435 18002 18594 20631
Ascension AB	6750 13244 19554.7 + Eastern Test Range Frequencies 10780 primary (See <i>Shortwave Directory</i> )
Croughton AB	3067 5203 5224 5703 5710 6728 6750 6757 7959 9011 11179 11207 13214 13247 15036 20631 23337
Elmendorf AFB Hickam AFB	3081 7938 8989 11480 13215 15018 17972 314 729 5908 7827 8964 8993 9057 9129 9932.5 10430 10452 11179 1140 / 3215 14435.0 14560 14772.0 17414 17440 17464 18002 18019 1814 8290 18475 18594 18997 19460 20108 20540 20631
Incirlik	313 972 10530 11112 13214 13215 13865 14735 15036 16272 19477.5 20631 20680 23227 23337
Lajes Field	3081 4746 5710 6750 6757 7567 8964 8989 10654 10662 11271 13215 13244 14882 15038 15576 15776 1797218227
Loring AFB MacDill AFB	307 688 8964 9014 9020 11179 11182 13214 13244 18002 20631 4449 4746 5432 5683 5688 5710 6740 6750 6757 6812 8893 8964 8989 9014 9018 9020 9234 9315 11055 11179 11228 11246 11288 13210 13244 13547 15038 15048 18019 20042 23407 23419
McClellan AFB	3067 4746 6730 6760 6780 7997 8050 8986 8989 8992 9017 9020 9320 10112 11035 11156 11239 11249 11413 13210 15031 15032 15048 17440 18002 18060 18290 20124 24274
Offutt AFB Thule AB Yokota AB	502 234 9315 11407 11607 13547 18594 20042 20420 23407 23419 5710 20631 23337 474 749 8101 9820 10695 11179 11236 11990 13215 15031 15038 17390 18002 18019 18594

Table Five is a unique list of discrete, non-published frequencies that each of the GHFS stations have been heard on in the past. While some of these frequencies are still in use, others may no longer be active. New ones may now pop up so monitors need to be on their toes. We appreciate reports of this kind and welcome your comments via our address in Brasstown.

### Giant Talk Still Around

Yep folks, the Air Force admits that Giant Talk, the HF failsafe system, is still with us. I think this is correct, but even it is not unchanged. For instance, 17975 and 4725 were SAC Giant Talk primary frequencies. These frequencies now are a part of the GHFS. In addition, 6761 no longer appears to be a primary night player as in years past. I still hear activity there but no EAM broadcasts.

Additionally, some of the GHFS frequencies now carry direct EAM broadcasts from Offutt and Andrews AFB on some, but not all, GHFS frequencies. These broadcasts are no doubt in support of USSTRATCOM mission aircraft. EAM broadcasts by GHFS stations on GHFS frequencies referring to the general AMC community appear to be associated with their general callsign "Mainsail." Contrary to early reports, Sky King and Sky Bird callsigns can still be heard in use on Giant Talk frequencies.

For more information and some of the frequencies of the Giant Talk network, see this month's "Utility World" column, the previously mentioned book on the Strategic Air Command and Grove's "Shortwave Directory."

### Callsigns?

When it comes to callsign identifications, I recommend Gayle Van Horn's new book, the *International Callsign Directory* published by Grove Enterprises. This directory of utility callsigns is a must for the military monitor. One whole section is devoted to tactical callsigns. Most of the information presented in this book on tactical callsigns is still valid (except for changing SAC/MAC/TAC to ACC/AMC/USSTRATCOM).

### Finally...

As always, I would appreciate any updates you might have, during this rapidly changing period in the history of the U.S. military. I would like to extend a personal invitation to each of you to attend a special forum at this year's MT convention in Atlanta on Monitoring the Military. I hope to bring to that forum, (Oct 4, 0900-1000) any late changes on the new Air Force communication systems discussed in this article.

As new flags continue to unfurl, signalling further changes in the military and its communications systems, I hope you'll follow the changes in the pages of *Monitoring Times*.

We are in for some very exciting times ahead and Air Force Chief of Staff, General Merrill A. "Tony" McPeak said it best at the TAC ceremony at Langley AFB:

*"Most of all I want to thank the men and women of SAC for their professionalism and their performance over the long years of the Cold War. The heritage you built goes with you into the Air Combat Command and Air Mobility Command and will be the Air Force forever."*



# AEA is the...

## Shortwave Solution

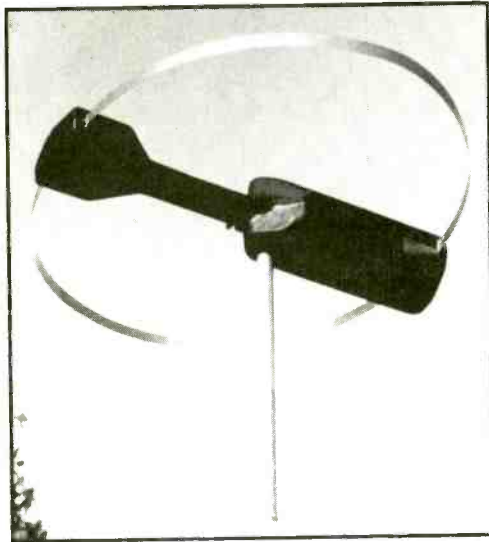

The IsoLoop 10-30 HF antenna is designed to work in limited space applications — apartments, condos, etc. Don't be deceived by its compact size (43" diameter) — it really works! Features include: Continuous coverage from 10 to 30 MHz; narrow bandwidth to suppress out-of-band signals; comes fully assembled (no mechanical joints); much more.

For complete information on these or any other AEA products, call the toll-free InfoLine at (800)432-8873.



**Advanced Electronic Applications, Inc.**

P.O. Box C2160 Lynnwood, WA 98036

Sales (206)774-5554

Upgrade Line (206)774-1722

FAX (206)775-2340

CompuServe I.D. 76702,1013

Hayes® Hayes Microcomputer Products.  
Hercules™ Hercules Computer Technology, Inc.  
Commodore 64 and 128® Commodore Business Machines. Macintosh® Apple Computer Inc. Epson® Seiko Epson Corp.



The PK-232MBX is a must for the digital Shortwave Listener. By far the most popular multi-mode controller ever, it can receive seven different types of data signals including Morse code, Baudot, ASCII, TDM (Time Division Multiplex), WEFAX, NAVTEX and Packet. It also features: The indispensable SIAM which automatically identifies many types of digital signals; superior software support for PC compatible, Macintosh and Commodore 64 and 128 computers.



AEA-FAX is simply the best way to demodulate multi-level grey scale fax images received by your general coverage receiver. All necessary hardware and software is included in the package which also features: On-screen tuning "scope"; Autolist feature for unattended image capture and save-to-disk; "Daisy-chain" external RS-232 input allows AEA-FAX to share a COM port with a PK-232MBX or other Hayes-compatible device; up to 16 grey levels (VGA); also supports EGA, CGA and Hercules formats; prints to HP LaserJet or Epson compatible printers.

# The Yardstick of Excellence:

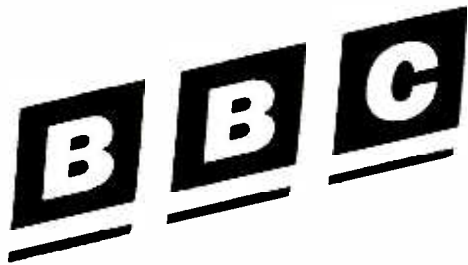

## The BBC's World Service

By Jeff Chanowitz

The chimes of Big Ben and the British tones of the announcer proclaiming "This is London" are indelible experiences connected with broadcasts of the BBC's World Service. With its superb entertainment and informational programs combined with comprehensive coverage of the late breaking news events throughout the globe, the BBC has become the yardstick of excellence by which all shortwave services are measured. Praised by former soviet president Mikhail Gorbachev, the American hostages in Lebanon, and bedouin in Somalia, the reputation of the BBC is at an all time high.

To probe the secret of the BBC's success, *MT* talked to David Witherow, Deputy Director of the World Service. With a Cambridge education and over a decade's experience in international broadcasting, Witherow is typical of the highly qualified personnel who make the World Service what it is today. Despite having less transmitter power and fewer languages than its leading competitors, the BBC's esteemed reputation draws an audience that is estimated to be at least 120 million, a figure that does not include such countries as China where research cannot be conducted.



David Witherow, Deputy Managing Director, World Service.

### 60 Years of Global Service

Based in Bush House in Central London, the external service originated in 1932 as the BBC's Empire Service, with its main mission being to communicate with Great Britain's colonial empire. Yet, it wasn't until 1937, when fascist Italy invaded Ethiopia, that the service started to add languages and set journalistic standards.

Instrumental in the development of the BBC was Lord Reith, the services's first director. He continually fought with Britain's Foreign Office to achieve for the BBC's external service the freedom from government control that was enjoyed by the domestic services at that time.

From World War II to the present, the BBC has expanded the number of languages broadcast and changed its name quite a few times. In 1938, the BBC's Empire Service became the Overseas Service. In 1958, the name was changed to the BBC External Service, and in 1988, John Tusa, then managing director, officially renamed the service stating, "Increasingly, the title of the BBC External Service has sat in a clumsy and uncomfortable way around our shoulders... As far as everyone else is concerned, we have always been the BBC World Service."

### The BBC in the Post Cold War Era

Today, with the ending of the Cold War, many shortwave critics have called for a reevaluation of the role of international broadcasting. Yet, Witherow discounts the effects of the ending of Communism stating, "Our role has never changed during or after the Cold War ... Our objective is to provide a credible news service backed up by good news analysis and a broad range of commentaries."

Yet, the breakup of the USSR is having an effect on the BBC. Witherow mentioned that the World Service is planning to add a Ukrainian and Uzbek service as a part of "increased coverage of the Eurasian region." He commented, "The World Service wants to continue to provide good, reliable news where it is most needed."

Despite the many changes taking place in the Eurasian region, the BBC has not ignored the listeners in the undeveloped nations. Witherow reaffirmed the BBC's intention to "continue to provide a good service to the Third World, which has a lot of need for good information."

Witherow emphasized the BBC's strong commitment to its broadcasts for the African continent, which includes increased programming in French, Hausa (spoken mainly in Nigeria) and Portuguese. For the Asian region, there will also be an expansion in its Chinese service "in the near future." Witherow added unequivocally, "All areas where there are strong BBC audiences in the Third World we will continue to serve."

### A Worldwide Audience

Judging by the large numbers of devoted listeners in numerous countries throughout the globe, the BBC continues to be successful in providing listeners with programming that fulfills their needs. In Somalia, where a brutal civil war has taken over one-hundred thousand lives, the BBC has responded by providing program-

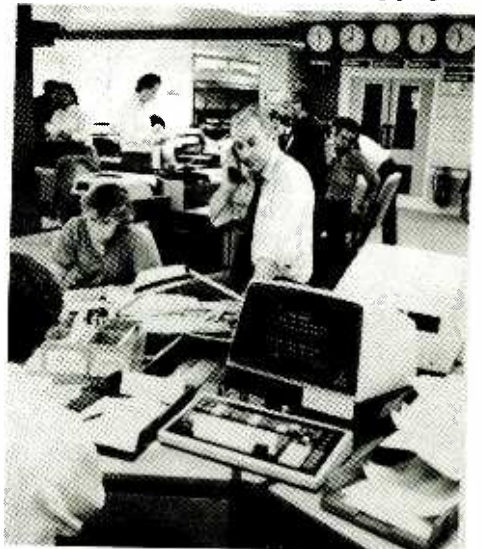

The Bush House newsroom where more than 200 daily news programs are prepared for broadcast in the BBC's World Service.





Ascension Island transmitter with dish.

ming that gives listeners vital information, which is heard by at least 41% of the population. So popular is the BBC's programming that a British anthropologist reported that while she was on a bus on route to Mogadishu, the Somali capital, the driver pulled off the road and turned off the engine so that all passengers could listen to the BBC.

One of the most popular programs on the Somali service is "Missing Persons," which is a program that puts listeners in touch with relatives who have gone abroad. On the program, desperate appeals from individuals are aired on a regular basis. Not uncommon are heart-rendering pleas such as this one: "Since my mother's house was destroyed, I do not know where she is. Tell my wife I'm alive... I do not know if my children have been killed."

The BBC's Vietnam service is also extremely popular. Many of the country's top communist leaders openly admit to listening and are proud of the English they have learned from the English lessons aired by the service. Ironically, ordinary people are arrested and put in jail for listening to the same broadcasts. Doung Dang, a college student who left Vietnam in 1988 for the United States and has been an avid DXer for many years, recalled the typical way of listening to the BBC was "to shut and lock the door to your room, turn out the light and listen to the BBC under the bed."

Judy Stowe, the Vietnam service's head, commented on the importance of shortwave service: "When Vietnamese have fled (as many have left in boats to Hong Kong) they've always clung to their radios."

In China, during the short-lived pro-democracy movement, students thought the BBC's service to be so important they publicly demonstrated their appreciation for the service by parading a banner in downtown Beijing stating, "Thank You BBC."

However, the importance of the BBC is exemplified best by one Russian listener who wrote a letter after the ill-fated Soviet coup stating, "I have listened to the BBC for the last 40 years, and I have been punished for that as have many other Soviet citizens during a certain period of our history, which is why it took me so long to write to you." He went on to state, "I am writing for the first and probably the last time to thank you for the moral support all these years."

Witherow described the letters from Russians, public statements of thanks from hostages coming out of Lebanon, and an unexpected en-

dorsement from Mikhail Gorbachev after the failed coup in 1991, as "testimonials that show how radio is truly the broadcast medium of the individual. It is a very human thing and it shows how important radio broadcasting is."

### The BBC's Diverse Programming

One of the main components of the BBC's success and popularity is its programming. Witherow commented, "One of our strengths is our news and current affairs programs." Perhaps the best example of this programming is "News Hour," an award winning program that consists of world news, headlines, in-depth reports, business updates and features. Contrary to its name, "News Hour" has now been augmented to three hours. Witherow commented that the reason for the program's expansion was to "have a one hour block for each potential time zone."

In addition to "Newshour," the BBC offers top-notch programming that is guaranteed to satisfy the most information-hungry listener. With the advantage of domestic service resources at its disposal, the BBC offers a variety of programs that range from in-depth business reports to features on sports, science, the environment and much more. The service even has a program about the BBC itself, which should be of special interest to shortwave enthusiasts. Called "Waveguide," the program allows SWLs to get more out of their BBC listening by presenting

historical, technical and program related information to listeners.

Despite its reputation for hard news, Witherow cautioned, "We don't want the tabloid service to neglect the cultural and high entertainment programs, where we have a high reputation." As an example, he added, "We will continue to be one of the few international services to do plays and high entertainment."

The BBC offers an impressive variety of music oriented programs that range from "Jazz for the Asking" to "Multi-Track," which highlights the British and Top-20 pop charts from around the world. The service also offers book reviews, quiz programs and dramas that were typical of the golden age of radio in the U.S.

Because so many programs are offered on the schedule, it is best to write for the program guide, *London Calling*. A yearly subscription is \$20 (U.S.). Write to: P.O. Box 76S, Bush House Strand, London, England, WC2B 4PH.

### The Gulf War Tests the BBC's Objectivity

One of the key tests of the BBC's goal of objective news coverage was the 1991 Gulf War. During the conflict, the BBC expanded its coverage to a 24-hour war status. Correspondents were placed on the scene of the conflict, at the United Nations and at other strategic points to provide full and comprehensive coverage of the

## SOMERSET ELECTRONICS Announces... THE MICRODEC™ 'SERIES'

Made in USA

**NOW IT'S YOUR CHOICE!** You select the Model and the features to meet your decoding and budget needs\*! Each choice is fully upgradeable to the top of the line! With our new VIP50 Interface you can choose an expanded display (32x16 characters on your television) and hard copy -- with or without a computer!

### FEATURES:

(Compact Size: 1.3Hx5.1Wx5.3D)

MORSE: DECODES CW WITH

Autospeed, software filter, speed display ★

RTTY (60,67,75, 100 WPM) (major shifts) ★

RTTY (bit inversion) ★

ASCII (110 & 300 BAUD) ★

ASCII (bit inversion) ★

AMTOR/SITOR Mode A-ARQ ★

AMTOR/SITOR Mode B-FEC ★

Smart display/Intensity control ★

On/Off with volume ★

Serial Interface ★

Code Oscillator ★

### AVAILABLE OPTIONS:

Display Colors: (Green standard--no charge) Red, or Yellow (your choice) . . . . . \$15.00

NICAD Batteries for portability . . . . . \$29.95 Model VIP50 Adaptor . . . . . \$189.95\*

\*MD300 price includes the VIP50 Interface Adaptor.

(TV Stations, phone companies, and public utilities are selecting MICRODEC™ for their operational and FCC requirements - FCC Docket 86-337.)

**Call us for special introductory prices and orders at 1-800-678-7388.**

**Fax orders: 1-407-773-8097 • Technical assistance: 1-407-773-8097**

**VISA • MASTERCARD • PERSONAL CHECKS • MONEY ORDERS**

**SOMERSET ELECTRONICS, INC. • 1290 Hwy. A1A, Satellite Bch., FL 32937**

Prices Plus Shipping/Handling  
**MD100 BASIC** List: **\$229.95**  
**MD200 PLUS** List: **\$329.95**  
**MD300 MAXIM** List: **\$429.95\***

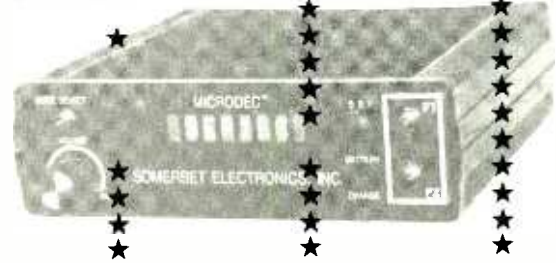



Jonathan Birchall with Egyptian troops in the Gulf.

war. As the fighting erupted, the BBC's audience doubled in size. Witherow commented, "They turned to the BBC to hear what was going on, if they did not hear it from the BBC first."

During the early part of the conflict, the BBC was jammed by Iraq. Then, realizing that they could get their message out more effectively by providing their view point to the BBC, Iraq ended any interference with the BBC's signal.

In its attempt to remain objective, the BBC got complaints from both sides of the conflict. On the Iraqi side, Jordan's government complained that the BBC provided news that was slanted in favor of the allied forces, while the army on the allied side complained that the BBC was not backing their forces.

Yet, the fairness of the service's coverage was indicated by its popularity among American troops. On the aircraft carrier *Saratoga*, Admiral J.D. Williams, the commander of the Sixth Fleet stated, "It (the BBC) was our primary news source during the war." Also, on the battleship *Wisconsin*, the BBC World Service was deemed to be so important that it was piped through the ship 24-hours a day. When the service made a comprehensive evaluation of its Gulf War coverage, "What came out time after time was how good the coverage was," said Witherow.

## BBC Monitoring

One of the ways the BBC evaluates its news coverage and that of its competition is through its one-hundred and fifty shortwave and satellite TV monitors, who listen and document radio and TV broadcasts of over 40 different countries. Called BBC Monitoring, the service records, transcribes and distributes information in publications such as *The Summary of World Broadcasts*, *Newsflashes*, and tailored packages that provide specific information on the movement of important commodities such as oil.

The World Service relies on BBC Monitoring as one of its sources for late breaking news developments and as a way to monitor other international broadcasters. Additionally, BBC Monitoring also has a network of world-wide

subscribers that range from news agencies (*Monitoring Times*, for one) to foreign embassies. With state of the art technology that would be a shortwave listener's dream, the multi-lingual monitors sit patiently in cubicals listening to broadcasts from its studios in Caversham, England.

The dedication of the BBC Monitoring Service's directors (which include Witherow) and staff who have been known to work around the clock during breaking world news stories is just one key element to the success of the service.

## Adapting to Competition

Despite its programming successes, the BBC continues to innovate in the face of increasing competition for listeners. Using a new strategy of program placement on local stations as a supplement to its shortwave broadcasts, the BBC has become aggressive in its drive to gain a larger audience. So far this strategy has been fairly successful. With the service's agreement for distribution to over 120 radio stations in the U.S. via the American Public Radio Network, the BBC is the most popular international broadcaster in the United States.

Additionally, the C-Span Audio Networks offer a whole channel of BBC programming on a 24-hour basis. Beth Glatt, who heads the C-Span Audio Networks, (see the Dec. 1990 issue of *MT* for details about the audio networks) stated, "Many subscribers commented on our listener surveys that one of the reasons they wanted the audio networks was to receive the BBC with a digital quality signal." This strategy has been equally successful in Europe. In Finland, where the service had only 50,000 listeners, the use of rebroadcasting via local radio stations increased its audience more than tenfold.

However, the new policy does not affect shortwave. Witherow commented, "We will continue to be on HF as a major means of communication; it is still the most direct means of program placement." He added, unequivocally, "We will continue to be on HF even in places where there is a movement toward FM listening."

The BBC's commitment to shortwave is exemplified by its network of 80 transmitter sites that includes facilities in Ramsham (2x100 and 8x500 kW HF transmitters), Wooferton (6x250 and 4x300 kW HF transmitters), and Daventry (4x100 and 6x300 HF transmitters) in the U.K. In addition, the BBC also uses a number of relay stations in Hong Kong (2x500 kW), Lesotho (2x100 kW), Cyprus (4x100 and 4x250 kW), Singapore (5x250 and 1x250 kW), Antigua (2x250kW) and in North America via transmitters in Sackville, Canada; Bethany, Ohio; Greenville, NC; and Delano, California. With its extensive global network of transmission facilities backed up by satellites, it should be no



Terry Waite with Barbara Myers (*Outlook*).

surprise that the BBC "came in the best" when Gorbachev was trying to listen to shortwave stations during the coup.

## The Future of International Broadcasting

As a part of the 50th anniversary of the VOA, the Smithsonian Institute in Washington, D.C., presented a forum on the future of international broadcasting. David Witherow, along with many other key players in shortwave broadcasting, took part in the discussion. Talking about the forum, Witherow commented, "We determined that there will be a need for international broadcasting in the future ... The question is how to supply that need and how to do that in the future with competition from TV and cable."

Witherow emphasized the factors associated with the future success of international broadcasters that were made evident during the discussion. One factor is "being available," which Witherow described as being in the right language at the right time. Also, "being attractive" is important. Witherow mentioned that attractive programs are "responsive to listener's needs." Moreover, for international broadcasters, "being accessible" is also a key and is defined as delivering international programs by the best means so that listeners will be able to receive them.

Most importantly, Witherow stated that broadcasters must "be aware," which he defined as "knowing your audience within each country." Witherow summed it up by saying, "Those who are successful in carrying out these factors will be the most successful international broadcasters in the future."

In the fast-changing world of shortwave broadcasting, where hundreds of services proliferate throughout the spectrum, only one service truly has global impact. While many broadcasters come and go, for shortwave listeners, it is comforting to know that one service has the tradition, foresight and reputation that is unique and indispensable in international broadcasting. For while there are many shortwave stations, there is only one BBC World Service.



# GALAXY ELECTRONICS

67 EBER AVE. BOX-1202

AKRON, OHIO-44309

216-376-2402

**NEW**

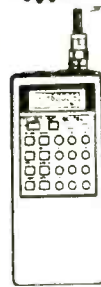

**AR-1000XLT**  
1000ch, covers  
500KHZ-1,300 MHZ, 10  
Search Banks, LCD  
Display, Priority, AC/DC, All  
Accessories

**\$395**

**CELLULAR  
MODS!!!**

**NEW**

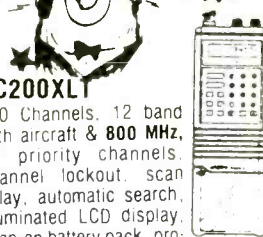

**BC200XL**  
200 Channels, 12 band  
with aircraft & 800 MHZ,  
10 priority channels,  
channel lockout, scan  
delay, automatic search,  
illuminated LCD display,  
snap-on battery pack, pro-  
grammable, track tuning  
direct channel access,  
with AC adapter, leather  
carry case & earphone

**249**

**AR-2500**

2016ch, 1-1,500 MHZ, LCD  
Display, AC/DC, Search, Priority,  
All Accessories

**\$439**

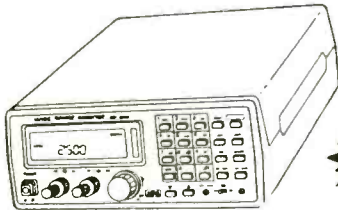

**NEW**



**279**

**BC760XLT** 100 channel 12 band  
base/mobile scanner with 800 MHZ band  
& Service Scan Weather, Priority,  
Lockout, Scan delay, Search, Program-  
mable, Track tuning, Direct ch. access

## SHORTWAVE RADIO

R-5000 100KHZ-30MHZ, 100 Memorys	889.00
R-2090 150KHZ-30MHZ, 10 Memorys	649.00
SONY-2010 150KHZ-30MHZ, + Air, Digital	349.00
ICOM R-72A 100KHZ-30MHZ, 99 Memorys	809.00
ICOM R-7100 - CALL - CALL - CALL - CALL	1689.00
NRD-535 90KHZ-30MH, 200 Memorys	975.00
DRAKE R8 100KHZ-30MHZ, 100 Memorys	685.00
FRG-8800 150KHZ-30MHZ, 12 Memorys	

## POLICE/FIRE SCANNERS

BC-200XLT, 200ch, 29-54, 118-174, 406-512, 806-952	259.00
BC-760XLT, 100ch, 29-54, 118-174, 406-512, 806-950	289.00
BC-855XLT, 50ch, 29-54, 108-174, 406-512, 806-956	209.00
AR-1000XLT, 500KHZ-1,300MHZ, 1000ch, Cellular	395.00
AR-2500, 1-1,500MHZ, 2016ch, Cellular, etc.	465.00
AR-3000A, 100KHZ-2036MHZ, 400ch, Cellular	959.00
ICR-1 100KHZ-1,300MHZ, 100ch, Cellular	529.00
ICR-100 100KHZ-1,856MHZ, 121ch, Cellular	599.00

**USED  
GEAR**

**Price Sheets \$1.00**

AIR/POLICE/800 MHZ

**BUY  
SELL  
TRADE**

**SAME DAY C.O.D. SHIPPING**  
**FREE SHIPPING & INSURANCE!!!**  
**WE TAKE TRADES!!!**

## Radioteletype Monitoring

**The Complete Guide**

Takes the mystery and guesswork out of tuning RTTY.  
How to tune in signals, read displays, test signals,  
code groups, traffic slugs, circuit identifiers and more.  
**\$9.95 + \$2 s/h (\$3 foreign)**

### The Essential RTTY Frequency List

1,000+ RTTY listings. Calls, location, service, speed/shift, time received, reference information.

**\$10.95 + \$2 s/h (\$3 foreign)**

### Limited Space Shortwave Antenna Solutions

All kinds of antenna options for those with little room for one. Plus valuable construction tips!

**\$10.95 + \$2 s/h (\$3 foreign)**

Order now from your radio book dealer or

**Tiare Publications**  
PO Box 493M, Lake Geneva WI 53147

Catalog \$1, free with order. Visa/MasterCard

## MAGNAVOX AE3405 COMPACT 12 BAND RECEIVER



An ultra compact receiver covering 10 shortwave bands (including tropical bands), AM and FM (FM stereo w/headphones). The AE3405's slim profile, light weight, and flush mounted controls make it an ideal travel radio.

- \* AM 530 - 1610 Khz
- \* FM 88 - 108 Mhz
- \* 10 SW Bands 11, 13, 16, 19, 22, 31, 41, 49, and 60 thru 120 meters
- \* Dual conversion circuitry
- \* Signal strength indicator
- \* FM Stereo indicator
- \* Hi-Low tone control
- \* Carrying case.
- \* Requires 2 AA cells
- \* Optional AC adapter
- \* 3 x 4.75 x .75 inches

**Only \$79.95 + \$5.00 S/H**  
(VISA / M-C / CHECK / MONEY ORDER)  
(California residents add Sales Tax)  
Order Line: 818-780-2730

**CHILTON PACIFIC LTD.**  
5632 Van Nuys Blvd., #222  
Van Nuys, California 91401

## SHOCKING MANUALS!!

Survival Electronics, Computers, Security, Weaponry, Rocketry, Phones, Energy, Financial, Medical, 100+ offers include Special Projects and Technical Research Services, and hardware. **Confidentiality Guaranteed!** Send \$4 for new Combined Catalog. By John Williams, former Senior Engineer (Lockheed), Professor of Computer Science (PMSU). As seen on CBS "60 Minutes" Since 1971.

**CELLULAR PHONE MANUAL:** Detailed manual on how cellular phones are re-programmed (ESNs and NAMS) and scanned. 30+ cellular phone mods described. Specific scanner mods. \$39.

**VOICE MAIL BOX HACKING:** Step-by-step descriptions of how 8 popular voice mail PBX systems are hacked. \$29.

**BEYOND VAN ECK PHREAKING:** Plans for surveillance systems some use to eavesdrop on TVs and computer monitors. \$29.

**SECRET & SURVIVAL RADIO:** Detailed manual describes the optimum freqs, equipment, mods and circuits for secret, survival and security situations. Includes small transmitters and receivers, ultrasonic, infrared and fiberoptic comms, improving and optimizing antennas. 70+ circuit diagrams. \$29.

**COMPUTER PHREAKING:** Detailed manual describes both computer viruses and how computers are penetrated. Includes 2 PC disks: [1] FLUSHOT+ protection system. [2] Disk loaded with hacker files. \$39.

Many more: **STEALTH TECHNOLOGY** (\$19), **PHONE COLOR BOXES** (\$29), **TV DECODERS & CONVERTERS** (\$14), **STOPPING POWER METERS** (\$19), **RADIOLOGS MANUAL** (\$29), **EM BRAINBLASTER** (\$29), **UNDER ATTACK** (\$29), **HIGH VOLTAGE DEVICES** (\$29), **DISK SERVICE MANUAL** (\$29), **ATM** (\$39). Include \$4 S/H. Educational purposes only.

### CONSUMERTRONICS

2011 CRESCENT, P.O. DRAWER 537, ALAMOGORDO, NM 88310  
**VOICE: (505) 434-0234, 434-1778 (8AM-9PM MST, Mon-Sat)**  
**FAX: 434-0234** (orders only 24-hours, 7 days/week. If you get answering machine press "F" than "1" any time).

### CUSTOMIZED PROPAGATION FORECASTING

FREQUENCIES, FIELD STRENGTH, BEST USABLE FREQUENCIES,  
SIGNAL/NOISE RATIO FOR ANY CIRCUIT WORLDWIDE

FOR MORE INFORMATION AND RATES WRITE:

JACQUES D'AVIGNON  
459 LEITCH DRIVE, CORNWALL, ONTARIO  
CANADA K6H 5P7

COMPUERVE: 70531,140

## The Time Has Come...

...to send for the latest copy of the free Consumer Information Catalog. It lists more than 200 free or low-cost government publications. Send your name and address to:

**Consumer Information Center  
Department TH  
Pueblo, Colorado 81009**

U.S. General Services Administration

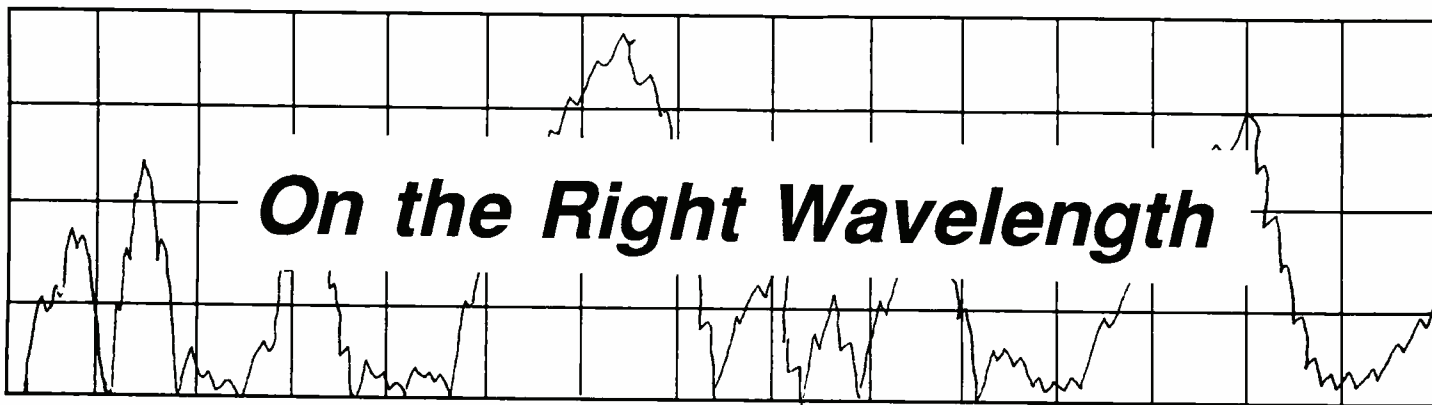

# On the Right Wavelength

## Taking the Mystery out of Propagation Forecasting

By Jacques d'Avignon  
Forecaster for Monitoring Times

**F**or many listeners, the propagation conditions and how they vary are still a mystery. Now you hear an interesting station and a few hours later you don't! What happened? You know from the schedule that the station is still transmitting! But it has disappeared...

This is caused by the vagaries of the propagation conditions on the path between your receiving site and the transmitter. Propagation is influenced by many factors such as: the time of day (not only at your receiving site but along the path and at the transmitting site), the season of the year, the state of restlessness of the sun, the land, sea or ice surface that reflects the waves on their travel to you. The sunspot or 10.7 cm radio flux of the sun and the season of the year are the factors that have the greatest influence on the height of the main ionized reflecting layers (E, F1 and F2) that allow us to receive transmissions from half way around the world.

The height of the E, F1 and F2 layers varies daily and hourly according to the season. This variation is directly related to the angle of the sun above the equator. The sun activities also influence these layers by increasing or decreasing the amount of ionization present. This is where the sunspot number comes into play.

The average sunspot number is a very cyclical phenomenon, and the cycle pattern is well defined. Since 1749, records of the sunspot numbers have been kept and it is possible to look back and review the pattern of the cycles. Thus it is possible to extrapolate what the monthly numbers for the next cycle should be. We also know that the average length of each solar cycle is 11 years—well, almost. Because of the length of these historical records, the quality of the extrapolation (forecasting the monthly sunspot number) is very good.

But...nature being what it is, there are always discrepancies between the actual and the forecasted sunspot numbers. The sunspot number used for forecasting propagation is not the actual "number," but an average number derived from the previous cycles as described above. The

numbers broadcasted hourly by WWV and WWVH are solar radio flux values measured at a frequency of 10.7 cm, not sunspot numbers. There is a well defined correlation between the sunspot number and the 10.7 cm flux, and anyone interested in this correlation can look it up any radio handbook.

As the height and the ionization density of the layers vary according to the sunspot number and the season of the year, the frequency that will be reflected (the purists use the word "refracted") also varies. If the frequency is too high, the signal will pass through the layers; if the frequency is too low, the signal will be absorbed by one or more of the layers. We now have just defined the Highest Possible Frequency (HPF) which will not be reflected, and the Lowest Usable Frequency (LUF) for a circuit, for a specific time of day and for a specific time of the year. Between these two extreme frequencies communications are possible, but with varying degrees of success.

The curves plotted on the propagation forecasting charts published monthly in *Monitoring*

*Times* are for the following frequencies: MUF, maximum usable frequency; OWF, optimum working frequency; and the LUF, lowest usable frequency.

The most interesting frequency for the short-wave listener is the OWF, the centre curve on the propagation charts. At that frequency, and within plus or minus 10% of the OWF, the chances of receiving a signal on a particular circuit, are better than 90%. As the frequency increases and reaches the MUF, the chances are now only between 50 and 90% of receiving a good signal.

Now we will look at the extreme forecasted frequencies that have been discussed previously. At the high end of the scale, the HPF, (this curve is not plotted on the charts published by *MT*) the chances have now diminished to less than 10%. At the low end of the scale, as the frequency decreases on a specific circuit and reaches the LUF, most of the signal is now absorbed and not reflected by the reflecting layers and the chances are minimal of receiving a detectable signal.

There are occasions, and the published *MT* graphs contain many examples, where the OWF, the MUF and LUF meet at some hour on the graph. This does not mean that no signal can be heard, but the chances are minimal. The signal would have to be very powerful to reach your receiving site. We all know that, today, many broadcasting and utility stations will use enough power to "punch" a signal under the worst conditions. I have heard some of these powerful signals being received with the antenna of a receiver actually grounded!

### A Less than Perfect World

Everything that I have described above would happen if all conditions were "ideal," and we all know that is a rare occasion. Let's review situations where the signal does not reach your receiving site or arrives very attenuated.

A transmitted signal could be attenuated by one or both of the following reasons: a) the

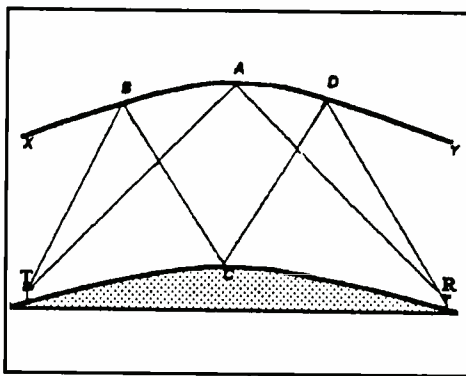

#### Notes:

- Diagram not to scale
- Curved surface X to Y is the reflecting layer
- A,B,C,D are the reflection points



transmitted signal is weak, and b) suffers from further attenuation. The first reason is quite understandable. Some utility stations do not have a very strong signal; their signals are not designed to be received at far stations. Those broadcasts which are designated "domestic" are also not intended to travel halfway 'round the world.

Next look at the second reason. It is the present theory that the signal along a circuit will bounce, sometimes more than once, between the ionosphere and the surface of the earth before arriving at your receiving site. The condition and texture of the earth surface where this signal bounces will also affect the propagation. The absorption of the signal at each bounce is determined by the reflecting surface: ice, water or land. When making a forecast of the signal strength, it is thus necessary to consider if the bounces are from the ocean, the earth or an ice covered region.

If the signal crosses one or the other auroral zones around the geomagnetic poles of the earth, there is a possibility that the signal can be severely degraded when the geomagnetic conditions are disturbed. Flutter, resembling very rapid fading would be heard on the signal. On the graphs published in *Monitoring Times*, a polar path is shown by the symbol (P) after the name of the transmitting site. This will help the shortwave listener understand why, if a signal is forecast to be of good quality on the circuit, it may be severely degraded by a very rapid fading.

At certain times, the signal may be reaching your receiving site by more than one path. Two different types of conditions can cause this situation and the effect on the received signal will be similar but noticeably different.

The first condition is caused by the same signal, on the same frequency, arriving at your receiver after having been reflected by two different layers or two different parts of the same layer. If you are listening to a broadcast transmission, the effect can be annoying—a slight delay in the signal's arrival time will produce a sound similar to an echo. But if you are listening to facsimile or radio teletype, the effect of this short delay can be devastating on the quality of your intercept. If you look at figure 1, it is obvious that the one hop path T-A-R is shorter than T-B-C-D-R. Thus there will be a time delay of varying length between the arrival of the two signals.

In weather FAX reception, for example, each "pixel" will have two or more components to it, each component being produced by the individual received signal. The clear and crisp lines on the original map will become very fuzzy and barely readable. In fact, it is possible to measure the delay between the arrival of the various signals from a fax chart received under these conditions.

In radioteletype (RTTY) reception, the signal can be so badly distorted as to make the

intercept impossible, even if the signal looks fairly good on the scope. The delay introduced by the receptions of the two or more signals will introduce a distortion in the final signal fed to the demodulator.

The second type of multipath reception is seldom encountered but can produce some startling sounds. This second type of multipath distortion is caused by the arrival of two signals each following a totally different path from the transmitter to your receiver. The first path is along the shortest great circle route from the transmitter to you and the second path goes around the globe before it reaches your receiver.

Admittedly, the second signal should be weaker and barely audible, but under certain conditions and on certain frequencies the signal will be heard quite clearly. The effect of this is for the listener to hear an echo in the received signal, this echo being very pronounced and clear. The delay time introduced by this multipath situation can be calculated using the speed of the

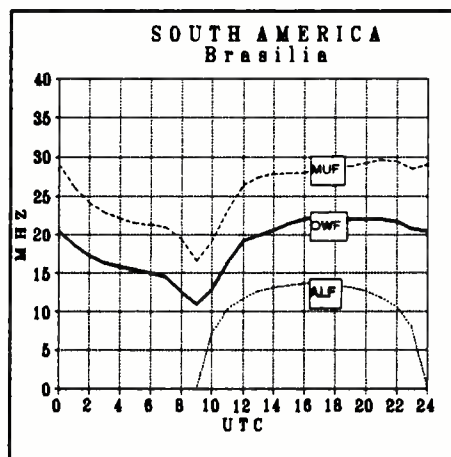

radio wave and the distance from the transmitting path around the world from the transmitter to your receiver. It is also necessary to add the additional path length introduced by the various bounces of the wavefront between the reflecting layer and the ground.

If these conditions are encountered by a utility listener, it is not possible to do much intercepting: change frequency or wait 'til tomorrow! The disgruntled listener could also put the coffee pot on and do some mathematics to calculate the length of the long path and the time delay introduced by this phenomenon in the received signal.

## A Word in Defense of the Forecaster

Many listeners complain that at certain times the conditions were "forecasted" to be good over a certain path and for a certain time period, but no signal was received. This situation is very frustrating and merits some explanations. The receiving conditions are forecasted for "normal" conditions of the sun and we all know that this is not the regular situation of the sun. The ionosphere can be disturbed by sudden solar flares and other sun related vagaries.

Solar flares and resulting magnetic storms are not easy to forecast and when they happen they cause major disruption in the HF communication circuits. As a matter of fact, magnetic storms can also produce major disruptions in the high voltage distribution system of your power company. The major power disruption that occurred in the northeastern electric grid of North America on March 9th, 1989, was caused by a significant magnetic storm. If you are interested in this occurrence, talk to your power company engineer. He will remember vividly the events of that particular night and the following days!

The shortwave listener should listen to the WWV or WWVH broadcasts giving the actual ionospheric and geomagnetic conditions and a forecast for the next 24 hours. The "a" index value broadcasted during the time slot allocated to this data is a good indication of the present conditions. The higher the value, the more disturbance you can expect to have on any circuits.

NOAA published a guide to their forecast format and it is an invaluable tool for the shortwave listener: *A Radio Frequency User's Guide To The Space Environment Services Centre Geophysical Alert Broadcasts*. This document has the catalog number: NOAA Technical Memorandum ERL SEL-80. It should be part of every listener's reference book collection. It gives clear definitions of the "a," "k" indices, and of the other various terms used during the broadcasts.

If the forecast transmitted by NOAA talks about geomagnetic storm and/or ionospheric disturbances, and gives an "a" index value in the 25 to 50 range or above, do not expect very good reception conditions. If you cannot hear WWV or WWVH, go back to your other hobby for a few days!

Finally, as a rule of thumb, if you have the choice of more than one frequency to receive a station, broadcast or utility, use the highest possible frequency: as close as possible to the OMF. This is where you have your best chance to intercept your signal. This will not insure that you will not be receiving the signal on more than one path, but chances are that the signal from the second path will be so attenuated it will not interfere with your intercept. Good listening!



## So... You Want to be an International Broadcaster

By Ken MacHarg

**As** you listen to a radio station, how often have you said to yourself "I wish I could work there." For many of us in the radio hobby, behind our DXing and QSL card collecting is the secret desire that some day we may be able to sit behind a control board or open up the back of a powerful transmitter and be involved professionally.

For most shortwave listeners (and mediumwave or FM DXers as well) that dream

will never come true. On the other hand, many shortwave professionals of today began as DXers and allowed their hobby to turn into a full time profession.

Just what is it like to work at a major international shortwave station? Is it one high after another, a chance for stardom and fame? Is it the opportunity to actually travel to distant exotic locations?

The answers to those questions are all elusive depending on the person, the station and the opportunities. For some, the work can be continually exhilarating, while for others it is a serious disappointment.

Fame may be a reward, but not what is expected. A Canadian newspaper once said that if Nolton Nash (who was Canada's "Dan Rather") walked down the main street of Montreal at noon he would instantly be recognized by 80% or more of the people. Yet, the article said if Ian McFarland (who was a personality on Radio Canada International) walked down the same street at the same time, he might be recognized by 5 or 10 friends. In spite of this difference, the article indicated that Ian McFarland had five times the audience on RCI that Mr. Nash had on CBC-TV. So fame perhaps might be relative.

### Do You Speak Shortwave?

There is continual excitement to being on an international radio station—and there is challenge. Shortwave broadcasting is as different from AM and FM as radio is from television. When dealing with an international audience, vocabulary, method of delivery, and assumptions as to their knowledge are all very different from producing programs for a domestic audience.

Many listeners to an English language service speak English as a second, third or fourth language. Many are just learning, so their vocabulary may be very limited. We all use slang words and expressions, most of which do not communicate across cultures. We assume a common knowledge of events, phrases, locations which others do not possess.

For example, having lived in Louisville, Kentucky, for 25 years before moving to HCJB, I assumed that everybody knew about the Kentucky Derby. Not so! I find that most people outside of the U.S. don't even know where Kentucky is, have never heard of the Derby and may not even know what a horse race is. At best they are familiar with Kentucky Fried Chicken!

In North American radio we are accustomed to a certain speed of delivery on our radio and television. In addition, we are very used to the frequent use of music beds under most commercials and other radio productions. But on shortwave, music beds and sound effects tend to mix with the spoken word creating chaos and cutting down on the ability of the listener to understand what is going on, especially if propagation is poor. Thus, music and sound must be kept to a minimum, and delivery must be slower to compensate for poor reception and minimal comprehension of English. The most frequent complaint that I get from listeners is that I speak too fast on the air.

Radio as we know it in North America is primarily a music medium. Yet—as you probably already know—music travels very poorly on shortwave. We have found that music is best utilized in the following order: Female vocalist, male vocalist, single instrument solo (flute, etc.), chorus, instrumental. So shortwave becomes a



Ken and Polly MacHarg, missionaries in Ecuador with HCJB World Radio.



spoken medium, and music must be selected carefully to be well heard.

Even voice styles need to be different. On many FM stations the ideal voice is soft, deep and smooth. But such a voice on shortwave will often become lost in the hash. What is more important is clear diction, correct pronunciation and perhaps a bit higher pitch to the voice. I have a friend in Louisville who has worked in radio. She has the most beautiful, sultry, almost sexy voice on the air of anyone I have ever heard. If I owned an FM or AM station in the U.S., I would hire her immediately. But on shortwave—well I'm afraid many listeners would have trouble understanding what she was saying.

## The Global Perspective

Obviously the nature and interests of the audience for an international station is very different from domestic radio. The global nature of shortwave means that not all listeners hold the same cultural concepts and understandings. Not all have a common background of politics, religion, social issues or entertainment. What is funny in Great Britain may not even bring a chuckle in Canada. What is assumed about politics in Australia may be very foreign to a listener in Iraq. So, as programs are prepared for an international audience, political and religious sensitivities must be considered, vocabulary carefully chosen (do you call them the Falkland Islands or the Malvinas?) and ideas clearly and carefully explained.

It is perhaps surprising to many that broadcasters at an international shortwave station probably spend less actual time in the studio than they would if they worked at almost any U.S. or Canadian station. Few stations have "shifts" (except perhaps for the news departments or continuity if that is done live), but programs are prepared perhaps only several times a week for multiple releases throughout the broadcast day. For example, HCJB's "Studio Nine" (a magazine program focusing on Latin American issues) is prepared once a day. That program is then broadcast seven times (three times to Europe including a shared release to the South Pacific) twice to the South Pacific, and three times to the Americas (believe me, it still adds up to seven times on the air!). Thus, for six hours of air time, there is actually only one or two hours of studio time.

Walking through the hallways of a station such as the VOA, the BBC World Service or HCJB is like being at the United Nations. In one studio you might find someone taping a program in Spanish while across the hall Japanese programs are being produced. Next door it is English while nearby one finds Quichua broadcasters. And still other people from various nationalities are encountered in programmers' meetings, at the post office or passing to and from the studios.

News coverage is very different from a local station newscast, and for one with a global con-

sciousness, much more exciting. While local stations always try to develop a local angle to every story (Boris Yeltsin decreed new economic measures today. Mr. Yeltsin once flew over our city on his way to an important international meeting!) shortwave stations must consciously avoid sounding too provincial. Indeed, the shortwave listener expects a much more global approach. Some stations specialize in reporting on news from their country or region, but always



*Dee Baklenko has been with HCJB just under 30 years. She produces the twice-weekly "Happiness Is" program.*

set those stories in a more international context.

At HCJB, we provide eight nine-minute English newscasts per day, plus two five-minute morning newscasts, one two-minute headline report in the morning, and a three-minute newscast each morning for our Spanish FM station. (Our evening English newscast to North America is also broadcast on our FM station). We try to divide each of these newscasts between world news and stories concerning Latin America. To develop these news bulletins, we utilize Reuters News Service in both English and Spanish which is fed directly into our newsroom computer. On days when we need more Latin American news, we also turn on our EFE (from Spain) news wire and consult one or both of Quito's morning newspapers. For each newscast, we update stories as changes warrant. We also regularly monitor broadcasts from CNN International, the BBC World Service and the Voice of America.

## The Life of a Broadcaster

If international broadcasters are in the studios only a few hours a week, what occupies their time otherwise?

First there is program preparation. Programs which are more than music and commercials with weather and traffic reports mixed in take much longer to prepare. Features must be researched, facts checked and double checked for accuracy, and scripts prepared. International radio produc-

# DELTA COMM™ DSS

## Digital Signal Strength Option For Your ICOM® R7000

DELTA COMM I-7000 and your MS-DOS computer gives you a custom interface integrated with optimized software that will not just control but will maximize the potential of your R7000.

- CYBERSCAN function allows scan file tracking control of systems employing frequency hopping techniques.
- Spectrum log at speeds in excess of 1300 channels/min. while automatically generating a histogram of activity.
- Birdie log during frequency search automatically characterizes your R7000, then locks out those frequencies.
- Automatic detection and storage of active frequencies during search and spectrum log operations.

DELTA COMM DSS (Digital Signal Strength) upgrade for the DELTA COMM I-7000 communication manager.

- Innovative interface design allows digitizing and storing the R7000 signal level information with 8-bit accuracy via your computer's game port.
- DSS allows user programmable upper and lower signal level detection limits during DELTA COMM I-7000's spectrum log function.
- Log signal strength information to printer or disk file while DELTA COMM I-7000 is scanning.

DELTA COMM I-7000 communication manager program includes all cabling, manual, UL listed power supply and Delta Research custom interface for \$299.00 + \$8.00 (U.S.) or \$25.00 (foreign) S&H. The DELTA COMM DSS interface upgrade comes complete with easy to follow NO SOLDER installation instructions, all cabling and 8-bit DSS A/D converter module for \$99.00 + \$8.00 (U.S.) or \$25.00 (foreign) S&H and is available as an upgrade option to registered I-7000 users.



# Delta Research

Box 13677 • Wauwatosa, WI 53213 • FAX/Phone (414) 353-4567





ers spend a great deal of time reading everything from the news wire to newspapers, magazines, books, press releases, etc. If they are working in a country where the language is different from the broadcast language, they must spend many hours translating features, articles, etc.

Due to the heavy flow of mail, many broadcasters spend hours in correspondence. While many stations send material as requested, we find that a number of letters require a personal response. Thus letter writing or at times talking on the phone with listeners who call in from around the world can consume a good deal of time.

What are some of the problems of international broadcasting? These include difficulty ascertaining the size and composition of the audience, working in the host country's language, the cost and often the difficulty of obtaining written material in your own language (an English language newspaper in Ecuador delivered on a daily basis costs almost \$600 per year), the irregular nature of telephone communication within the country or internationally.

## The Bottom Line

For those who dream of working at an international station, what is required? Language is one. Most international broadcasters want an announcer to work in their native tongue. But to live in another country you need some knowledge of the local language. So language ability may be required. Broadcast experience is important. These are not small 500 watt stations. They are major, powerful international voices which represent their cause carefully. The broadcaster must be professional and experienced.

The potential international radio star must remember that there are few jobs in the field. At HCJB there are only five full-time English language broadcasters (although we could use a few more). Many stations prefer to hire locally if people are available. Often a local military person, business man or student or expatriate spouse may find part or full-time employment at an international station.

Christian stations require that potential employees raise support from individuals or churches at home to underwrite their salaries. The Voice of America hires a good number of broadcasters. Their current needs can be ascertained by dialing 202-472-6909 for a recorded message.

Is working in international radio fun? Of course it is. It is nothing short of a thrill to sit at a control and know that you are broadcasting to listeners literally around the world. And it gives satisfaction to know that you can touch so many lives and perhaps add to international understanding and good will.

**M**



*A DXer himself, Rich McVicar provides information to the novice and experienced DXer each week on HCJB's DX Party Line.*



*HCJB's transmitter building at Pifo, Ecuador.*



*John Adams is a Canadian and the director of HCJB's English Language Service. He also hosts the "Musical Mailbag" program.*



# German Numbers Stations

## *Not Gone and Not Forgotten*

Story and photos by Nils Schiffhauer

*Shortwave listeners around the world have been a bit puzzled to hear those German numbers stations even after the unification of both Germanies. It has been widely thought that those monotonous broadcasts throughout the bands originated from the other side of the Iron Curtain. But that's only one part of the truth. German journalist Nils Schiffhauer (DK80K) tells you another one.*

**W**erner Stiller was sitting in front of his radio: "Exactly at 18.00 o'clock I heard

for the first time the Wessel anthem, named after the president of Bundes-Nachrichtendienst—BND, West Germany's CIA." At last the emotionless voice on the radio called up Stiller by his code ciphers: "I wrote down those 5er groups and deciphered them." To verify the reception, he sent a harmless looking picture postcard bearing his cover address.

### Spy vs. Spy

Stiller—who? Up to his flight from the German Democratic Republic in late 1979, Stiller had been the BND's top spy, situated in the very heart of its East German counterpart, the Ministerium fuer Staatsicherheit—MfS (the state security ministry) behind the Iron Curtain. The

turn of Werner Stiller was one of biggest successes of the otherwise invisible men at Pullach near Munich whose job it was to get some detailed information out of the GDR.

As with Stiller, hundreds of secret agents were guided by "Fuehrungsfunk." These radio transmissions, spread throughout the shortwave spectrum, sent information, orders and even birthday greetings by means of the coded number groups.

### Concertina: How these numbers work

"Fuehrungsfunk" is a quick and secure tool for transporting information. For reception all you need is an ordinary radio set with some shortwave bands. Stiller told that in the seventies Grundig's "Ocean Boy" was widely used for these purposes. But this wouldn't have worked for Werner Stiller since this radio would have created a sensation in one of the East-bloc countries. So one day he found in his letter-drop a modified receiver of GDR production. BND technicians had converted it for the reception of "Fuehrungsfunk."

To decipher these five-number groups, all secret agents used—and may use up to this day—code tables, folded zig-zag and looking like a mini-concertina. The densely printed tables of numbers were used to decode the five-figure groups, but even then not all information could be read "in the clear." The deciphered text still turned out as numbers. So "794" stood for "meeting as planned," "073" meant "place of work," and "956" denoted "West Germany," etc.

You might have wagered that after re-unification at least the German number stations would have left the air. But it's business as usual on the airwaves, and you can listen on many frequencies to German number stations as if nothing had happened on the political scene.

On a daily basis, a female computer voice transmits these groups in German with a military accent: "Fuennef-Zero-Dreien-Vier-Neuen"—5



*Entrance prohibited: The German number station in Husum is working behind barbed wires.*

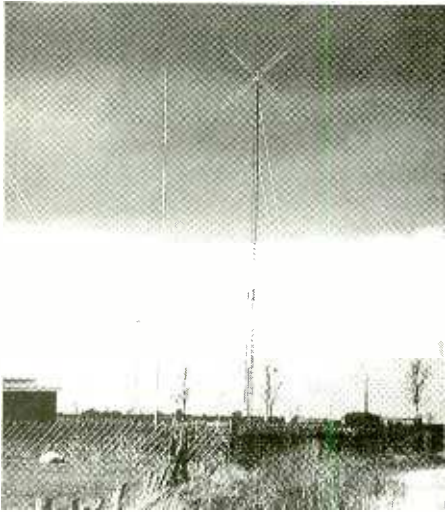

*The BFST station near Husum transmitted the VVV-marker of EC3Y on 9161 kHz.*

(Fuenf in everyday German), 0 (Null), 3 (Drei), 4 (Vier) and 9 (Neun). The transmitter power is usually around 20 kW, and rhombic antennas are the primary antennas used thanks to their excellent directivity and gain.

## BFST — The Secret Eavesdropper

In now-united Germany, all technical matters are covered by “Bundesstelle für Fernmeldestatistik—BFST” with their headquarters in Stockach, some seven miles northwest of Pullach where Bundes-Nachrichtendienst has its headquarters. BFST could be translated as “Federal Service for Telecommunications Statistics,” a harmless looking name for what turns out to be the telecommunications backbone of the German spy network—and more.

Branches of the BFST are spotted all over the country. You find them in cities, such as the one near Frankfurt’s main station, as well as in the countryside miles away from the electrical noise of bigger cities. I found one near Husum in Germany’s northernmost state, Schleswig-Holstein. Here I actually found two receiving and transmitting sites, the bigger one at Norderwungweg 21 in Husum’s north-east, the other one at a path without any street sign. On more detailed maps this one is named “Krumweg.”

The Krumweg site alone looks as though some ham radio operator’s dreams have come true. For communications with nearby countries you will see vertical folded dipoles with their typical high-angle radiation. A 2-element Quad as “Queen of Antennas” is mounted at considerable height for contacts with more remote countries. A horizontal broadband-dipole may be the prime choice for covering medium distances.

Astonishingly enough, the “Federal Service for Telecommunications Statistics” seems to make no use of telecommunications medium number

one, the ordinary telephone. So it was in vain that I looked them up in the local telephone directory.

Even Walter Genz, press officer of the responsible Post Office Divisional Administration couldn’t fully answer my question: “According to our law of telecommunications, this is a military facility.”

But if this were true, I would have noted proper warnings not to take any photographs or the like. Without this warning, the excited door-keeper at the “Norderwungweg” site should have had to return unsuccessfully into his glass booth. The facility is even enclosed behind barbed wire although it is situated in the middle of a small residential district.

I contacted Bundeswehr, the German Army, to get some more information on this BFST. They verified that it is indeed a civil facility. But BFST staff member Klaber wrote me that they also are doing some work for the German Army “and others.” Those “others” are Bundes-Nachrichtendienst (Germany’s Counter-intelligence Service working mostly outside Germany), Bundesverfassungsschutz (Germany’s Interior Secret Service) and Militaerischer Abschirmdienst, the Secret Service of the German Army.

For these clients, Klaber said, BFST “monitors the congestion of the allocated frequencies by statistical means in order to reduce interference.” If you were to believe the information given by BFST, they are responsible for research and merely arithmetical problems, namely: monitoring of the frequency spectrum in order to get data on its congestion, collecting statistical

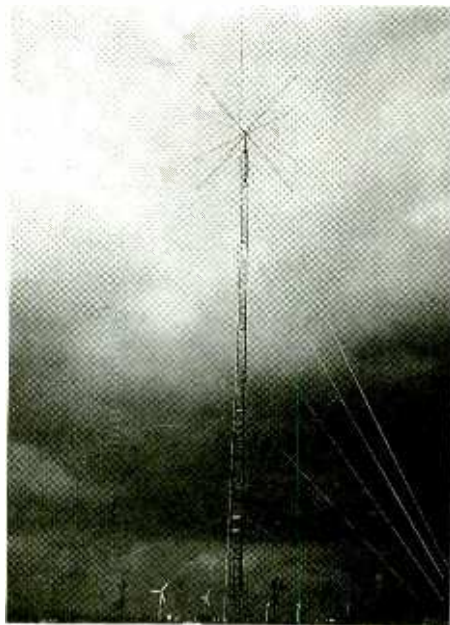

*This two-element quad antenna of a German number station would be a ham radio operator’s delight.*



*Eavesdropping at the pro’s: One pole of a large rhombic antenna.*

data on special frequency ranges, monitoring of transmitter signal strengths, and keeping the books on the interference of communications links.

But that’s not even one part of the whole story. Obviously BFST and their associated Secret Services are primarily interested in the contents of what is being transmitted, not in statistics. For example, just recently, Deutsche Bundespost (Germany’s postal and telecommunications authority) ordered several very expensive monitoring stations to provide information for keeping international treaties. It would be rather unusual to see even two public authorities doing exactly the same job!

## New Targets and Modern Methods

So which transmissions are gaining the interest of BFST? It couldn’t be all “open sources” like news agencies and shortwave broadcast stations. They are monitored for the German Government by a semi-secret station in Erdsdorf near Bonn, and by Deutsche Welle Monitoring near Cologne.

But there are more waves filling the air, and readers of *MT*’s Utility column know them very well: espionage, telephones, satellites, military communications, private conversations, and many more can be found in the electromagnetic spectrum. And their number is increasing: just think of cordless telephones and the growing market of mobile communication.

In Germany we are just introducing a mobile telephone net (such as GSM, with frequencies of around 900 MHz) with an estimated 4 million users by the year 2000. For this digital system there was discussed the introduction of a non-crackable system of encryption. This would have been an excellent way to guarantee the privacy of telecommunications as laid down in Germany’s Constitutional Law.

But Germany’s Secretary of telecommunications was “asked” by the Ministry of Interior



# Tone/Code Finder

Model TF-1 • Model TF-2 • Model TCF-3

The Tone/Code Finder is composed of a high speed display unit coupled to a scanning receiver. **ITS PURPOSE IS TO INSTANTLY FIND AND DISPLAY ALL CTCSS AND DIGITAL CODES, INCLUDING SPLIT CHANNEL AND INVERTING CODES.** On board memory retains all hit and time information which is then transferred to a printer or computer via a RS 232 port upon command. Time is stored in seconds and hits in units. In the event of power loss, the **FINDER** will maintain memory for up to three weeks. (Memory and real time clock optional) Signal processing is accomplished by an eight pole filter configured as a low pass with a cutoff of 234 Hz. The superior filter characteristics eliminates chopping and false reading.



## FEATURES:

- INSTAFIND
- Low Power Consumption
- Base or Mobile Capability
- Hit and Time Accumulator
- Micro Processor Control
- Low Cost
- CMOS LSI Technology
- 3 Year Warranty on Display Unit

## SPECIFICATIONS:

	TF-1	TF-2* or TCF-3*
Companion Receiver	BC560XLT	BC950/760XLT
Frequency Range	up to 512 MHz	up to 950 MHz
Size	5 1/2" x 6 7/8" x 3 1/2"	6 5/16" x 7 3/8" x 3 1/4"
Weight	2 lb. 12 oz.	3 lb. 4 oz.
Power Source	115 VAC or 12 VDC	115 VAC or 12 VDC

**\*Can be configured as a stand alone unit or coupled to other receivers.**



## MEASUREMENTS DIVISION AUTOMATED INDUSTRIAL ELECTRONICS CORP.

141 GRANITE ST. P.O. BOX 70 BATESBURG, S.C. 29006 1-800-397-9256 FAX (803)532-9258



responsible for at least two Secret Services in Germany to use an encryption of a lower stage. So the scanner user at home can't eavesdrop communications via this new D-net, but the professional eavesdropper at BFST can—and will, as we know the usual habits of Secret Services. By the way, the same goes for America's National Security Agency, NSA, which stopped a highly sophisticated encryption system developed by IBM for the very same reasons.

The ever growing market of mobile telecommunication is seen by the Secret Services with much joy. In Germany it is a somewhat intricate procedure to tap someone's telephone legally. But if communications shift more to the use of wireless means, "they" can monitor private and business talks and FAX without leaving any physical trace.

### The Automatic Listener

Automatic monitoring was demonstrated during the dissolving of MfS, the ex-GDR Counter-Intelligence Service. The MfS also had many monitoring posts along what was the German-German border. There they monitored nearly all wireless communications with an automated process. Only those interesting ones—automatically picked out by catchwords and/or phone numbers—were recorded for further evaluation. We were always told that East German technol-

ogy lagged about 10 years behind the west, so this gives a rough impression of the sophisticated tools on the West-German side!

Nowadays, these monitoring sites are added to the empire of government-run Deutsche Bundespost. It's kept secret what they are doing with them—but let's make a guess!

### The Source of EC3Y: Husum/Germany, not Madrid

Meantime, what's happening to the number stations? You noted it: they are active as ever. Even in the States (as *MT* reported several times) there was heard, for example, a station with the callsign EC3Y, which was assumed to transmit from somewhere in Spain.

Nope; you guessed wrong for the first time! The signal around 9.1 MHz originates from BFST at Krumweg station in Husum, North Germany! I verified that only a short ten meters away from the antenna after the signal overmodulated my car radio.

As an SWL, I am used to writing reports in order to get a QSL card. So I wrote what may be the very first reception report to a German number station—having the right address, and being 100% sure about the origin of the transmission. The answer came bittersweet but politely: they "on principle" will not verify reception reports; yours sincerely ...

Since I'm not "building castles in Spain," this answer was actually more than I expected. But speaking of Spain—isn't EC3Y a callsign to be used in Spain rather than in Germany?

After looking it up in "international treaties" it turned out that EC3Y was a callsign for a novice ham license in Madrid. That left me puzzled. I considered it as a clear case of illegal use of a callsign. And not only that, it was by a government authority supposedly looking after the fulfillment of these international treaties!

Since these days the Deutsche Bundespost is intensively controlling the (illegal) use of scanners, I asked them also to look after the violation of international laws under their own roof. Within one week I got a phone call from the PTT. It revealed that BFST used their callsign EC3Y for transmissions *towards* Spain, and would change the same day the PTT called me up to a legal one!

Immediately after hanging up, I jumped to my Yaesu FT-1000 to verify that. And they really did! Since the 20th of January, 1992, they no longer use EC3Y for their transmission on 9161 kHz. The new callsign is DEA47 which is in accordance with international laws.

Again I posted a reception report, and again they wrote me that they do not verify such reports "on principle." But I thought their changing the callsign one of my most beautiful QSLs—although only "on the air"!

# Emergency Call

## A Scanner Monitor's Guide to Decorum

By Laura Quarantiello

**Thursday night I confronted a decision** that every scanner owner who monitors Public Safety services must confront sooner or later in the course of listening — whether or not to drive to the scene of a nearby emergency call.

Police, Fire, and Emergency Medical agencies are some of the most highly monitored services among the scanning set. Given the fact that these agencies are regularly seen going about

their jobs on our own city streets day after day, sirens wailing, red and blue lights flashing, it's no wonder Public Safety monitoring has drawn many to the hobby.

The easy availability of a wide variety of VHF/UHF scanners on the market today make it easy to receive Public Safety frequencies and go "behind the scenes" of local agencies. Though many simply listen and have no interest in going any further, some feel the experience is not

complete without traveling to the scene and seeing things firsthand.

The law in many almost all areas of the United States makes it a clear misdemeanor to "sightsee" at the scene of an emergency. Local and state laws, though they vary from district to district, often provide for fines and/or arrests of individuals who interfere with emergency crews. A wise monitor checks applicable laws, either through library research or direct communication with the State's Attorney General's office. Make it a point to know the laws that affect you as a scanner monitor and by all means, obey them!

Scanner monitors can basically be divided into two distinct operating groups:

The "Police and Fire Buff" listens to local frequencies just waiting for that "big" call, will not think twice about driving a considerable distance to reach the scene and will frequently cruise around town following emergency crews in the hopes of seeing them in action. This person believes that he or she belongs alongside public safety officers, simply because he has access to the calls over a scanner radio. He will often cross police lines to speak with officers or firefighters, carrying the radio conspicuously.

The "Professional Public Safety Monitor" views the scanner as a tool through which he or she can learn the workings of emergency agencies, and has a more keen interest in hearing communications procedures during a call (What units are dispatched to which incidents? From what locations? How are the radio calls made? Are Mobile Data Terminals in use? What frequencies are used and in what order? What are the call signs? Unit numbers?). The Professional Monitor's interest remains with the radio, which is what communications are all about. Though they often carry handheld scanners along with them, they know and respect law enforcement and fire officials and remain clear of any potential or known emergency areas.

I have identified these two types based on personal experience and research. Though they are by no means the only types of scanner hobbyists that exist, they are the most common.

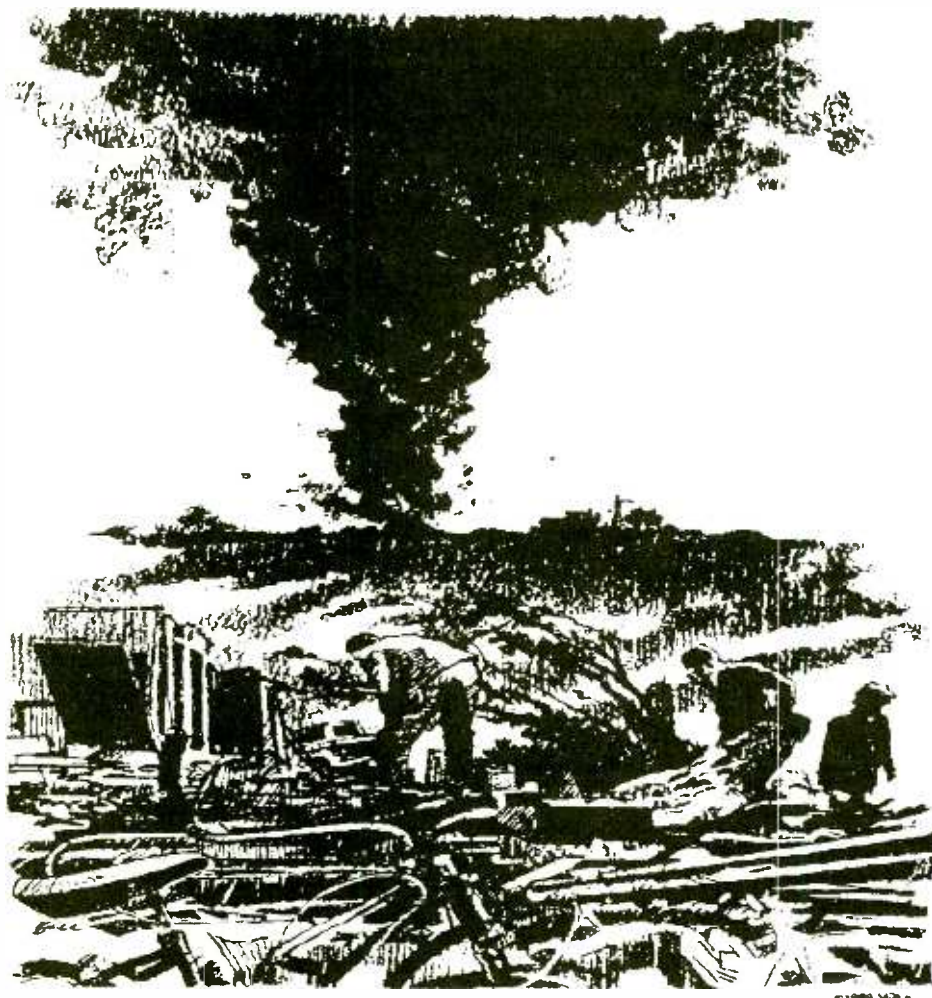



Occasionally there will be some crossover, such as when a serious incident occurs within view of the professional monitor's home and he walks out into his front yard to observe. This behavior is only normal — most of his neighbors are probably doing it, too. As long as he remains on his own private property, all is well and legal.

There is however, a line between being an interested onlooker and being an interfering "buff." Like so many other things in life, this is a fine line. Crowds routinely come "out of the woodwork" to observe activity at an emergency site and in 99% of cases this conduct is not frowned on by police and fire officials. It's the one instigator who shows up at all local scenes with a radio, getting in the way, trespassing at crime or accident sites, with no good reason to be there, that gives scanner hobbyists a bad name.

No matter which type of scanner monitor you are, there will come a time when you will find yourself contemplating going to an emergency call. Here are some basic questions to ask yourself before you do so:

- 1) Can I arrive at the call before emergency crews and assist in any way which might be beneficial?
- 2) Will showing up in the area contribute to unneeded traffic flow problems, or inhibit the movement of safety vehicles and authorized personnel?
- 3) What are the local laws relating to "sightseeing" at emergency scenes? Can I get arrested or fined?
- 4) Do I really need to be there? Won't I receive more information simply by staying home by the scanner?

If you do find yourself "on scene" at an emergency, there are some guidelines to follow, which will ensure that you and your scanner won't become victims or unwanted detritus:

- 1) If in a car, don't park on streets that might be used for main access to the scene by emergency personnel, as this might cause unwanted congestion and restrict avenues of approach. Keep your automobile well clear of any emergency areas.
- 2) If on foot, beware the movement of vehicles and remain at a distance, clear of potential danger areas which might result from explosions or gunfire.
- 3) *NEVER* cross yellow police/fire line tape or cone barriers. These obstructions are in place to limit public access and protect crime scenes.

- 4) Always heed the instructions of police officers and firefighters: if they ask you to move or leave the area, do so immediately.
- 5) If you have beneficial or important information about a crime or accident, or are a witness, make contact with a police officer at the scene to relay your information. Again, *DO NOT* cross barriers or enter crime scenes—wait by a patrol car or other emergency vehicle until an officer is free to speak with you.

As scanner monitors, out and about with radios in hand, we often hear "privileged" information over the airwaves relating to cases or incidents. The law makes it illegal to communicate anything we hear to a third party. It also makes it a punishable offense to divulge such communications to anyone known "to be a suspect in the commission of a crime with the intent to help the suspect escape arrest, trial, conviction or punishment." (Quoted from the California Penal Code section 636.5.)

Resist the urge to tell others around you at an emergency scene what you just heard over the scanner. Decorum warrants that you keep the volume low and the communications to yourself. If you don't, you just might be asked to leave by public safety officials.

You might have guessed by now that I didn't end up responding to that emergency call Thursday night. A scanner is only a license to listen and

doing anything more is abusing the privilege. I did what I usually do, stayed close to the radio monitoring the action, searching for new frequencies that might be in use. I didn't miss a thing ... honest.

As scanner monitors we have an inside edge about what transpires in life threatening public safety situations, we are held to a higher standard and therefore we should know better than to get in the way and become needless victims.

*M<sub>T</sub>*

## CELLULAR TELEPHONE MODIFICATION HANDBOOK

### *How are hackers making cellular phone calls for free?*



- Techniques for decoding & changing cellular phones' NAMS
- Where to buy programming devices
- The "roaming technique" scam!
- Instructions on how to change phone numbers on all models
- Cellular phone manufacturer's ESN codes
- Chip supplier's phone numbers



**Complete Manual only \$79.95**

M.O. or C.O.D. to **SPY Supply**

7 Colby Court Suite 215, Bedford, NH 03110 (617) 327-7272

*Sold for educational purposes only*

**Editor's Note:** The procedures detailed in this book are unlawful to perform. The text is intended for educational purposes only. Monitoring Times assumes no responsibility for any liability which may result from the implementation of its contents.

Has radio monitoring led you on an adventure? Take the time to write it down and submit it for publication. Send it to:

Editor  
Monitoring Times  
P.O. Box 98  
Brasstown, NC 28902-0098

# Shortwave Broadcasting

Glenn Hauser

Box 1684-MT

Enid, OK 73702

All times UTC; all freqs kHz

**AFGHANISTAN** Domestic service back on 7199 from 7202v, 0125 sign-on until 0300 fade-out, again 1400-1900 with severe QRM from Sudan 7200. Kabul also heard on 7085v from 1400 past 1530, very weak and poor modulation, Radio Yeyami Azade, run by guerrilla leader Hekmatiyar (Sarath Weerakoon and Victor Goonetilleke, Sri Lanka, Union of Asian DXers) It's Radio *Pyam-e-Azadi* (Message of Freedom) which has resumed after some weeks, heard at 1400 on 7090, and closing at 0930, but announcing 0145-0315 and 1400-1500; pro-Islamic revolution (BBC Monitoring)

**ANGOLA** VORGAN's approximate schedule: 0445-0835 on 9700, 7290, 6045; 1045-1435 on 11830, 7290; 1645-2345 on 7100, 4880; mostly in Portuguese, Umbundo and Kwayama, but at 2125-2150 in English, 2150-2215 in French (BBCM)

**ARGENTINA** I've discovered a pattern in the 26-MHz MW relays—subtract the MW frequency from 27169 to find the SW frequency, so it's as if the entire local dial is relayed in reverse order, some weak, some strong. Radio Libertad has also appeared on 26219 which is 27169 minus 950. Weak carriers from several others are being pursued. Could be accidental intermodulation or a wideband repeater (Alan Roberts, PQ, *World of Radio*) We heard a similar situation from Mexico City years ago (gh) Haven't heard the MW relays, but LPL, General Pacheco Radio was on 26160 USB at 1440, 1655, voice mirror and traffic paired with 25085 USB (Ed LaCrosse, CA, *W.O.R.*) R. Nacional revived 6060 in late July, heard at 0530 (Juan Carlos Codina©, Peru, *Play-DX*)

**ARMENIA** Radio Yerevan adds English at 2145-2200 on 11920, 9450; 2240-2300 on 17660, 12050, 11920 (BBCM)

**AUSTRALIA** On RA's *Communicator*, Shawn Pryor must have been a substitute; interchangeable host since has been Glenn Bartholomew, and one reporter last month was Joel Rubin, not Ribera! (gh) RA has been making propagation tests on 25750 at 0800-0900 beamed 3° east of north from Darwin (Mike Bird, Radio Nederland *Media Network*) RA was testing a dummy load on 21000 from Darwin, estimated radiation from feedline 35 watts, and heard by Robin Harwood in Tasmania off the back 3 Mm away (Jerome van der Linden, *SW Echo* via Kirk Baxter) Radio G'Day, pirate somewhere in Australasia on 11400 with 30 watts and a half-wave dipole, at 0600-0645, plans to return in late September or early October, and over Xmas, says Claude Crowe; address changed from PNG to: c/o Radio Waves, B.P. 130, Rueil 92504, France (Patrick McDonald, *SW Echo* via Baxter)

**AUSTRIA** ORF's fax number is 43-1-87878-3630 (Radio Austria)

**BOLIVIA** R. Galaxia on new 5178.45; L. V. del Tropico on 5111.33 at 0120 (Juan Carlos Codina©, Peru, via Monferini, RN *Radio-Enlace*)

**BOSNIA-HERCEGOVINA** Radio Yugoslavia wasn't finished yet; one transmitter back on air from Bijeljina in early July, including 0030 and 0130 on 11870 (Bill Westenhover, PQ; Diane Mauer, WI)

**BULGARIA** Radio Sofia mailbag program asks for IRCs now that postage rates have multiplied twelve times; new director does not favor continuing external service. Send letters of support to Radio Sofia, English Section, 4 Dragan Tsankov Blvd., Sofia, Bulgaria (Rich Burns, *SW Echo* via Baxter) All external broadcasts may be discontinued August 3, due to funding and new management (Rumen Pankov, Bulgaria, *ADXN*) Still going August 3....(gh) Announced that *Sofia Calling* 'DX program' is on these half-sesquihour broadcasts: Friday 1100, 1945; Saturday 0000; Monday 1100, 1730, 2145; Tuesday 0300 (John Norfolk, OK) Despite Western stations now relayed on FM in Sofia, 40 "bumblebee" jamming stations are still maintained (*Kontinent*, via *Austrian SW Panorama*)

**CANADA** New Zealand Radio DX League says 'proxy' QSLs such as RCI's issued by Canadian International DX club, are ineligible (Bob Padula, *ADXN*) How's that for gratitude?

**CHINA** CPBS First Program has a weekly English program, Sunday 0000-0030 on 17605, 15550, 15395, 15390, 12120, 11330, 9290, 7504, 6840, 6750, 6125, 5880. Daily English language lessons: Jiangxi PBS on 5020, 2445 at 1450-1500; Zhejiang PBS at 0030-0100, 1415-1445 on 4785, 2475; Fujian PBS First Program on 5040, 4975 at 0520-0550, 1330-1400, 2130-2200 (BBCM) But Fujian closes at 1230 on 5040; Zhejiang on 4785 until 1130. Xizang PBS, Lhasa on 5917 ex-5935 (Tsutomu Kito, Japan, *OzDX*)

**COSTA RICA** Radio For Peace International plans a fifth-anniversary *Fiesta on the Air*, Wednesday Sept. 16 (UTC Sept. 17) at 0000-0400, with a digital receiver and other prizes for callers to a U.S. 800 number or those writing two weeks in advance; also a new QSL card. At least James Latham and Joe Bernard will be at the *MT* Convention. Due to the news blockade in Haiti, RFPI started a Creole hour August 1, Saturday 2000, Sunday 0400 and 1200. *Vietnam Veterans Radio Network* urges positive response to RFPI so the program can continue. *VVRN*'s Jim Hale thinks it is on Thursday at 1330, Saturday at 2130, but RFPI tells us the schedule is Wednesday 2130, repeated Thursday 0530, 1330. But the first time we heard it was on a Saturday at 1030, which would be a repeat of Friday 1830, Saturday 0230. Second repeats of *World of Radio* are nominally Saturday 1200, Sunday 1000, Wednesday 1100; tune 7375, 13630-USB, 15030, 21465.

AWR planned to add 13750 toward the Caribbean, and 15460; but so far only Israel heard around 13750 (gh) Rumor has it from some fellows of the defunct Radio Impacto that Hector Requena got some new support (from CIA?) to run the station again, to beat the Castro regime (Raul Saavedra, Costa Rica) Correction to REE last month: 4, not 8 MHz band.

**CROATIA** Zagreb's 13-MHz-band frequency keeps shifting, lately on 13830 as early as 1800, as late as 0500 (John Ioannides, MA, *W.O.R.*) Announcements say they use two 100 kW and two 250 kW SW transmitters (Rumen Pankov, Bulgaria, *Australian DX News*)

**CUBA** RHC shifts at last to avoid interference: 11950 from 0000, 13710 from 0200. SSB on 13660 continues weekend tests; switch to wide filter for best audio (Arnie Coro, RHC *DXers Unlimited*) QSL guru Gerry Dexter says Coro's "QSLs on the air" don't count—must be tangible (Diane Mauer, WI) Now he offers QSLs by E-mail, a first? (gh) Relay exchanges with Russia terminated June 30 (BBCM) Manolo de la Rosa of Radio Moscow's DX program in Spanish announced he was moving back to Cuba (RN *Radio-Enlace*) One time to hear RHC's Spanish DX Program, *En Contacto*, is Sunday 1336-1351 on 11760; when we checked, no de la Rosa, just a boring discussion of Cuban radio and some calls to listeners (gh) de La Rosa delayed in Moscow trying to get plane ticket (*Radio-Enlace*)

(non) La Voz del CID on new 11940.4 at 1400, not // 9942v, weak with lots of Marti 11930 slop (Bolitho, Routenburg & Wolfish, Ont.)

**CZECHO** RCI schedule reveals at 0400 13715 is really for Mideast/East Africa, 15355 for Mideast/South Asia. See SLOVAKIA

**ECUADOR** Ondas Quevedenyas reactivated on 3324.6 after a sesquiyear at 0230, but terrible ute QRM, and from Guatemala almost as strong (Rich McVicar, Quito) Rich is going on furlough October-May, so Ken MacHarg and John Beck will cohost DX Partyline. Two live international phone-ins are planned, Sat. Sept. 12 at 0730, UTC Sunday Sept. 13 at 0230; after access code 011 in North America call 593-2-241-560. Also used weekly for *Open Line*, UTC Tuesdays 0130. (HCJB) New address in USA is 1065 Garden of the Gods Road or P.O. Box 39800, Colorado Springs, CO 80949 (Rob Harrington, *SW Echo* via Baxter)

Testing new SSB frequency 17535, as soon as WWCR left.

**GEORGIA** Georgian Radio, Tbilisi, in English at 0530-0600 on 12050, 11805, 2030-2100 and 2130-2200 on 11760.3;



unconfirmed at 0200-0300 and 1900-2100 on 9830; 1630-1700 on 12050 (BBCM)

**GOA** All India Radio about to start new site here with two 250 kW testing to Gulf and Mideast (Kanwarjit Sandhu, India, RNMN) Once a country, always a country (NASWA)

**HAITI** (non) see COSTA RICA; USA

**HUNGARY** Radio Budapest September topics on the 2100 broadcast, next UTC day at 0200, both one hour later from the 27th: 1 and 4, *Top Soldier in Civvies*. Wed. and Sat., *Music And... 2 & 5, The Pacifist Dog*; 9 & 12, *Countriyental*; 16 & 19, *The Crazy Spaniard*; 23 & 26, *Bob James D.J.*; 30 and Oct. 3, *The Pets*. Thur. and Sat.: 3 & 5, *History on a Plate—Hungarian delicacies*; 10 & 12 *Turning Points*—for different generations of Hungarians; 17 & 19, *North-South Waterway*; 24 & 26, *Media & Democracy* (via Carson, Wager)

**INDIA** AIR plans to beef up overseas service, with relays in friendly countries and more transmitters within India (PTI via BBCM) I've suggested they use Gabon now that Japan closes there earlier; or maybe Cuba now that their Russian deal is over (Jim Conrad, IA, W.O.R.) New AIR transmitter testing on 3345 at 0100-0300, 7200 at 0800-1200 with programming from Jaipur and Ajmer (Jose Jacob, RNMN) See also GOA. Some of AIR's Home News Services in English on SW: 0035-0040 on 15325, 11920, 7160; 0245-0300 on 15220, 15120, 11830; 0850-0910 at slow speed on 17850, 17795, 17705, 15250, 15165, 11970, 9610; 1530-1545 on 10330, 9950, 9715, 7412, 7290, 7160, 3945, 3925 (BBCM)

**INDONESIA** Among scads of Indos on DXpeditions in WA and BC: 5691.87, RPDT2 Berau, Tanjungredeb, Kalimantan, 1038 past 1357 (David M Clark with John Bryant, Orcas Island, *Fine Tuning*) 7173.1, RRI Serui, 1555-1612 (Tsutomu Kito, Japan, *ADXN*) Rarely reported

**IRAN** (non) *Sedaye Mojahed*, Voice of the Crusader, approximate times in Persian, frequencies vary and not all at once: 0130-0330 on 9650, 7070, 6220, 5630, 5600, 5225, 4700, 4670, 3780, 3557; 1630-1830 on 7070, 6720, 6510, 6220, 6110, 5740, 5590, 5245, 5080, 4700, 4470, 3790, 3557; also unconfirmed at 0900-1000 on six similars. Iran's Flag of Freedom Radio announced new schedule mid-July: 0330-0630 on 15640, 15565, 15100; 0645-0730 on 15620, 15100; 1400-1445 on 15620; 1630-1830 on 15620, 15100—all confirmed except 15100 (BBCM)

**IRAQ** Baghdad on 15240 did not last (Goonetilleke, UADX) At 1800-2000 including English added 13680 to 15210 (Tom Sundstrom, NJ, RNMN)

(non) V. of Rebellious Iraq, pro-Iranian-style Islamic revolution, back on 7097v instead of 8000-8100 range, 1730-1930, 0430-0630, 1230-1430 (BBCM)

**ISRAEL** Funding problem remains for external service, but decision put off till end of December. If you really want it to continue, better start writing letters all over again to new prime minister, foreign minister and minister of education and culture (*Calling All Listeners* on Israel Radio)

**ITALY** Radio Due last month belonged here, not under IRAQ

**KUWAIT** US State Dept. recommends scrapping VOA Israel relay project and putting it here instead (*Broadcast*, via Sennitt, *SW Echo* Baxter) Deal confirmed, 11 transmitters (Reuters via Alpert)

**LITHUANIA** Radio Vilnius complains that it gets less mail than before, often torn or opened although no longer routed via Moscow. At 2300-2330 on 11780, 13645, 15580 (BBCM) I hear 11780 with Brazil co-channel, nothing on 13645, splatter from 15585 on 15580 (Bob Thomas, CT) RV asks for reception reports by fax to 0122-660526 (BBCM) Khabarovsk out of order, leaving only 13645 and 11885 at 2300 (RV via BBCM)

**MOLDOVA** R. Moldova will soon start international service, English at 0130 on 11675, 11730; 1200 on 17800, 15430; 1830 on 15315, 13640 (R. Romania International via Allen Dean, WDXC)

**MOZAMBIQUE** RENAMO clandestine has external service on 10100 at 0500-0515, 1600 to 1615; domestic service on 7380 at 0515-0600 (BBM via RNMN)

**MYANMAR** (non) R. Norway International, whose heart is with Nobel laureate and political prisoner Aung San Suu Kyi, began carrying Radio Free Burma in mid-July, daily 1430-1455 on 17840, 80 degrees from Kvitsoy, planned expansion to an hour by mid-August (*NY Times* via Ricardo Molinar, Al Quaglieri, Kirk Baxter; BBCM, RNMN) Started in compatible SSB, then AM as co-channel BBC Antigua, changed antenna (RNMN) Jammed, moved to 17845, all in Burmese; correct name is Voice of Democratic Burma (T. Kondo and T. Yamashita, R. Japan)

**NETHERLANDS** "Media Network has never been a DX program" (Jonathan Marks, RNMN) And it's always been taboo to call its DX news "DX news" (gh) "Life is not always beer with sugar" (Tom Meijer, *Happy Station*) His program never changed in 20 years with letters, birthday calls and music which got boring. Needed to do more live remotes. New host Pete Myers can modernize the show (Larry Nebron, *SW Echo* via Baxter) New host for Spanish version is Jaime Baguena, who also continues with *Radio-Enlace* (gh)

**NEW ZEALAND** Kiwi Radio, pirate left 5850 for 5040, 250 watts, and never used 6060, 6220. Address is P.O. Box 1437, Hastings (Paul Ormandy, Oamaru, W.O.R.)

**PAKISTAN** R. Pakistan features at 0830 on 17900v, 21520; and at 1742 on 11570, 15550; Sat., *Great Muslims of History*. Sun., *See Pakistan*. Mon., *Our Cultural Heritage/Our Traditions*. Tue., *Pakistan Movement*. Wed., *Our Freedom Fighters*. Thu., *Facts about Pakistan*. Fri., *Extracts from Iqbal's Lectures*. All four frequencies beam 313° (*Pakistan Calling*, June, via Gigi Lytle)

**PALAU** V. of Hope on 11900 ex-11980 at 2200 (Bob Padula, Vic., *ADXN*) W92 season from Sept. 27 planned to keep 11980, 9830, but add 9785 with 50 instead of 100 kW at 2000-2400, all 310° (George Jacobs & Associates) 9785 also used by sister station KVOH elsewhere (gh) Transmitters for both are old HCJB units (Jim Heck, *DX Partyline*) Time available for Palauan shows (David Sharp, *DXSF*)

**PERU** 3901.31, Radio Hualchacca, Cerro de Pasco at 0045, 0138, 4278v, R. El Campesino ID after a year of very bad modulation, 0020, near Chota, later on 4349.9, 5271.82, R. Nor Oriental reactivated at 1404, 5419.07, R. Sonorama, Saposoa, reactivated at 0145, 6243.82, R. Calca reactivated after four years, until 1300, 6390.91, R. San Miguel, Ilave, back after six months at 0143, 6587v6585, R. Santa Fe, Urubamba, Cuzco, announcing 6315 at 1000-0100, sometimes going until 0200, 6628.48, L.V. de San Antonio, Bambamarca, reactivated around 0215 claiming 6627, previously heard on 2nd harmonic 13257; don't confuse with R. San Antonio on 5550v5605 (Juan Carlos Codina©, Peru, via *Play-DX* and *Radio-Enlace*) 6628.5, R.L.V. de San Antonio, nice signal at 0230-0320 (Hans Johnson, MD) also daily at 0130-0400v to 0430, romantic music until 0300, then Peruvian (Bolitho, Routenburg & Wolfish, Ont.) New on 5008 is R. Horizonte, Chachapoyas, had a beauty contest at 0117 (Kenneth Olofsson, Sweden, *SW Bulletin*)

**RUSSIA** Adventist World Radio Aug.-Sept. schedule shows English from Samara at 1600-1630 shifted from 15125 to 9775 (via Frank Orcutt, NY) *Aum Shinrikyo* is the way Japanese cult on Radio Moscow spells its name; gobbledygook claims to "teach the truth to make us gods, attain the holy heaven." BBCM lists 59 frequencies for this at 0430, best

### DX Listening Digest

— Much more info in the style of Hauser's column.

### Review of International Broadcasting

— SW programming, opinion, equipment, satellite monitoring.

Samples \$2.50 each (outside North America US\$3 or 7 IRCs)

10 issue subscriptions \$25 in USA, or both for \$47

Glenn Hauser, Box 1684-MT, Enid, OK 73702

here on 21505, 17675, 15550, 15210, audible on many more, but Moscow's separate west-coast service continues on 15425, 12050 (gh) Summer RMWS schedule does not show this, but lists programs for sale: Mon. 0130, Sat. 0330, 0930, 1430, 2030, 2330, Sun. 0430, 1130, 1730, 2130 (via Gigi Lytle, TX) R. Nadezhda (Hope), is new station for women, at 1900-2200 on 7280, 15340 (BBCM) and 1400-1700 on 9490, 11765, 11800, 15340, 17675 (R. Japan *Media Roundup*) R. 101 (*Sto Odin*) is heard in Moscow on 11990, 12020, sked unknown (Mick Ogrizek, *ADZN*) *Rukhi Meroc* is Tatar for Spiritual Heritage, Fridays 1500-1545 on 12075 from Moscow Islamic Centre, also announces 17890, 4055 (BBCM) *Shark* is definitely correct spelling of 5780 station in Ufa, but it means

99 **M A P R** 66

"east" in Turkic language; hopes to add some English, 1000-1900 with 15 kW (Anatskiy Sergey, director, via Bjoern Fransson, Sweden, *SWB*) R. Vostok, Khabarovsk, 0700-0830 except Sundays 0700-0800 on 4610, 7210 in five languages including English (Y. Kato, *RJMR*)

**RWANDA** R. Muhabura, Rwandan Patriotic Front clandestine, traced on 6400 at 0415-0515, 1000-1100, 1715-1815, later on 6340 instead; mostly in Kinyarwanda, some French and Swahili (BBCM) May be gone following a truce per BBC news (Mike Fern, *NASWA Journal*)

**ST. KITTS** R. Paradise has been sold to TBN, which took over KUSW (Ludo Maes, Belgium, *ADZN*) 825 MW, and harmonic 2475.

**SAO TOME & PRINCIPE** VOA will replace Liberia with relays here, four SW transmitters within two years, but first a 100 kW MW by next March which could cover many African capitals in daytime (Bill Whitacre, VOA, *RNMN*)

**SEYCHELLES** FEBA English at 1530 on new 11710 // 15330 (Ed LaCrosse, CA, *W.O.R.*)

**SIERRA LEONE** SLBS is among the exotic stations carrying UN Radio, English on 3316 Friday 2115-2130, Sunday 1900-1915 and 2115-2130 (June UN schedule via Bill Flynn, OR) QSL via UNR, S-850A, New York, NY 10017

**SLOVAKIA** Three of the five R. Czechoslovakia transmitters are here, two at Rimavska Sobota, and one at Velke Kostolany; uncertain what effect the split-up would have (Chuck Albertson)

**SOUTH AFRICA** Domestic SW sked until 5 Sept.: R. Suid-Afrika, 0300-0530 3320, 0440-0655 7285, 0650-1445 9665, 1440-1640 7285, 1645-2300 3320. R. Orion, 2300-0300 3320. R. Oranje, 0300-0540 3215, 0545-1615 9630, 1620-2200 3215. R. Five is no longer on SW (Kathy Otto, SABC via David Gasque, SC) Thought I heard a R. 5 ID; also did hear R. Oranje on 3345 at 0130-0200 (Gasque) Capital R. for sale by Transkei government, stopping subsidy, worth six megarand, to be privatized (*Austrian SW Panorama*)

**SHRI LANKA** TWR will start using 12.5 kW 49-meter band transmitter Sept. 27 at 1330-1500 (Dan Blocker, TWR, HCJB *DXPL*)

**SUDAN** R. Omdurman's new 100 kW on 7200 scheduled 0300-2200, mostly Arabic, but had English ID and request for reports to Box 572, at 0534 one day (BBCM) 7199.96, excellent nightly from 0246 (Terry Krueger, FL, *DXSF*) Don't confuse with Somalia also around 7200.

**TAHITI** After 21 years off frequency, RFO finally on 15170.0, at 0430 (Ernie Behr, *NASWA*)

**TANZANIA** 9685 irregularly still carries ANC R. Freedom but toned down and reduced to 1830-1900 Tue/Thu/Sat. Still has Pan-Africanist Congress of Azania programs at 0415-0430 M/W/F, 1815-1830 Tue/Thu/Sat, 1830-1900 M/W/F (BBCM)

**USA** On KRLD, 50 kW clear-channel 1080 from Dallas, David Coursey is late-night host of call-in *Texas USA*. Saturday nights include computer discussions, and SWL Coursey also wants to deal with shortwave. Listen for a SW special *Sat. Sept. 19* at midnight CT (actually UTC Sun. Sept. 20 at 0500) with guests including your columnist who has also appeared during this hour with shortwave segments. Toll-free number is 1-800-688-KRLD (gh)

KJES resumed broadcasting June 22 but at 1845 the antenna burned and had to shut down. Your report of July 7 was the first received (Rev. Richard M. Thomas, S.J., Our Lady's Youth Center, P.O. Box 1422, El Paso, TX 79948, replying to J.J. Hitt, Houston, TX, via *SW Echo* via George Thurman) First heard June 26, and some following days between 1800 and 1900 on 9510 (Ed LaCrosse, CA, *W.O.R.*) First heard during same hour July 1, ID is "KJES, broadcasting from The Lord's Ranch in New Mexico USA 88048 with approval of the FCC" (Bruce MacGibbon, OR, *SW Echo* via Thurman) Again July 13 with same type of call-and-repeat bible study as during previous activity a few years ago, including timely advice not to covet neighbor's female slaves. Reached KJES by phone whence Michael Reuter provided details: this transmission on 325° to western Canada; also in Spanish to Mexico at 2000-2100 on 9510; active Mon., Tue., Wed. and Fri. only, since next week's programs are taped on Thursdays when transmitter can't be on. Is a new 50-kW ELCOR transmitter imported from Costa Rica four months ago, log-periodic rotatable antenna. Planned to add 1400-1500 and 1500-1600 to same respective targets on 11715, but not yet heard at presstime; also planned 0700-0900 on 15385 to New Zealand, 0930-1030 on 9510 to Caribbean. Programming is "praying the scripture," by Fr. Rick and a 16-year-old girl; more music in Spanish version; frequencies were those immediately available; plans to get better ones later, and a 5 MHz for lower sunspots. Location is three miles east of Vado, NM, which is between Las Cruces and El Paso, alternate address Star Route 300, Mesquite, NM 88048. OLYC has youth program at La Cueva, food bank in Juarez, dormitory on ranch, where no ranching is currently done. Reports welcome, though QSL card not yet available (*W.O.R.*)

Mother Angelica's WEWN, from a small town 20 miles outside Birmingham, AL, plans to start testing in early October, regular by Xmas. Has 10 antenna towers, eight curtains, will use four 500 kW Continentals. Setting up remote automated monitoring sites including Vienna, and needs human volunteer monitors. Catholic, but not directly linked with Vatican Radio. 15 of 20 languages produced in Italy, rest in Birmingham; negotiating for transmitter time-share in Far East (Bob German, project manager at site, 1500 High Road, Vandiver, AL 35176, on *RNMN*) Frequencies registered for all four transmitters W-92 are: 5825, 7465, 7520, 7540, 9350, 9410, 9870, 9985, 11735, 11885, 11970, 13615, 13710, 17760, 17890, 18930, 21670, 21735 (George Jacobs & Associates) But first testing could be on others (*W.O.R.*) Rumors that Baptists and Methodists are thinking of doing same thing; and CNN/Turner possible for US SW station (German, *NASWA Journal*)

WWCR decided not to resume Radio Khalistan, in Punjabi, in deference to the Indian government which objects to it. Due to overseas interference on 17535, replaced with 13815 and also dropped 12160, so the Dr. Gene Scott Service is only on 5920 at 0200-1100, 13815 at 1100-0200. See last month for continuing *WORLD OF RADIO* times; on WNQM, 1300, Nashville, shifted to UTC Saturday 0525.

WSCV, Ch. 51, Telemundo in Miami heard with audio during newscast at 2200 interrupted by cuing on 26350 NBFM (Tim Hendel, *ibid.*) Correct spelling of RMI's Haitian clandestine is R. 16 DESANM, not DESARM as typoed last month.

**VENEZUELA** Ecos del Torbes active on 9640 at 1207, "*la emisora del pueblo*" (Rich McVicar, HCJB *DXPL*) R. Continental, 4940, has a DX program, "*America en Antena*" sometime between 0000 and 0400 UTC Mondays (Jose, Venezuela, via Barrera, RN *Radio-Enlace*)

**VIETNAM** (non) V. of Freedom is a new clandestine from Siberia on 15580, says a U.S. Vietnamese newspaper (*RNMN*) At 1400-1500 (BBCM) Weak in Hilversum; press release says first station concentrating on democracy and human rights there; HQ in Moscow, backed by refugees and U.S. financing (*RNMN*) Also 15425 (BBM via *RNMN*)

**ZAMBIA** External SW service is closed, but ZNBC Radio 1 operates: 0245-0605, 1500-2205 on 4910, 0605-1500 on 7220; Radio 2 at 0240-0605, 1530-2210 on 6165, 0605-1530 on 7235 (BBCM)

Until the next, 73 de Glenn!



# Broadcast Loggings

Thanks to our contributors — Have you sent in YOUR logs?

Send to **Gayle Van Horn**, c/o *Monitoring Times*.

English broadcast unless otherwise noted.

## 0000 UTC on 9580

CZECHOSLOVAKIA: Radio Prague. Political news and commentary. (Bob Fraser, Cohasset, MA) National news and commentary heard on 7345 kHz at 0358 UTC. (John Carson, Norman, OK)

## 0043 UTC on 17740

IRAQ: Radio Baghdad Int'l. National news from announcer duo, followed by commentary on Zionist entity occupying Arab lands. (Fraser, MA) Additional monitoring on 15210 kHz at 2130. National and world news to station ID and Arabic music. (Robert Tucker, Savannah, GA) (Carson, OK)

## 0100 UTC on 4509.2

PERU: El Puerto Radio. Spanish. Surprisingly fair signal quality for Peruvian huayno style music. ID at 0120. Peru's Radio Ondas del Mayo heard on 6803.3 kHz at 0115. Latin pops and rock. Station ID at 0117. (David A Gasque, Orangeburg, SC)

## 0113 UTC on 15105

MALTA: Deutsche Welle relay. "European Journal" on domestic problems of Chancellor Kohl's government. "Through German Eyes" feature interviewing *Der Spiegel* correspondent on retiring FM Hans Dietrich-Genscher. (Tucker, GA)

## 0119 UTC on 6754.6

PERU: Radio La Merced. Spanish. Announcer chat. Multiple IDs with sign-off by 0150. Radio Satellite heard on 6724.3 kHz with easy-listening music to IDs at 0215/0220. ID pronounced "Sah-ti-li-ti." Radio Cora noted on 4914.5 kHz at 0940. Huayno music and ID at the hour as simply "Cora." (Gasque, SC)

## 0139 UTC on 3300

GUATEMALA: Radio Cultural. Easy-listening vocals to ID. Moderate interference. (Maywoods DX Team, KY - Loy Lee, Wayne Gregory, Ed Shaw, Dr. Joel Roitman, Jim McClure, Charles Everman, Eric Petty) La Voz de Nahuala heard on 3360 kHz at 0200. Chat and bits of bumper music to ID at 0206. Radio Tezulutlan audible with marimba music and jingles at 1045-1050 on 4835.1. Signal strong but distorted. (Gasque, SC)

## 0140 UTC on 11955

OMAN: BBC relay. British folk tunes and "South Asia Survey" magazine show. Two items highlighted were Indian/Russian relations, and criticism of Indian army by Sri Lanka's president. (Tucker, GA)

## 0145 UTC on 4409.3

BOLIVIA: Radio Eco. Spanish. Tune-in with Spanish pop/rock tunes. "Eco" ID between songs and suffering through MARS traffic interferences. Radio Horizontes on 4509.3 kHz at 0915, and Radio Camargo on 3390.3 kHz. Poor copy from 0040-0100. Music bits and tentative ID at 0043, well-timed static crash preventing positive ID. (Gasque, SC) *I heard ya, David. ED*

## 0156 UTC on 11910

HUNGARY: Radio Budapest. Interval signal, sign-on ID, world news and political commentary. Monitored past 0205. (Carson, OK) "International Newsroom" and sports report audible on 9835 kHz at 0205 UTC. (James Heys, Omaha, NE) (Richard Jackson, Kansas City, MO)

## 0159 UTC on 9885

SWITZERLAND: Swiss Radio Int'l. Interval signal, sign-on ID into news on Swiss voters. "Sunday Supplement" program on a mountain solar power station. (Tucker, GA) "Switzerland in Focus" heard on 6165/13635 kHz at 0426. (Carson, OK) "Grapevine" show heard on 9810 at 2210 UTC. (Fraser, MA) (Wright, MS)

## 0325 UTC on 9877.5

DOMINICAN REPUBLIC: Radio Santiago. Spanish. Smooth Caribbean vocals. ID at 0329 UTC. (Jerry Witham, Keaau, HI) Station heard at 2340 on 9877 kHz. Latin vocals and clear "Santiago" ID. (Sam Wright, Biloxi, MS)

## 0327 UTC on 11765

TANZANIA: Radio Tanzania (Tentative). African highlife music amid excessive thunderstorm interferences. (Maywoods DX Team, KY) Tanzania heard on 5050 kHz at 0348. African music at tune-in to talk in presumed Swahili. Clear time tips at 0400 with Radio Tanzania ID and mentions of city Dar es Salaam. Fair quality and brief fading. (Brian Bagwell, St. Louis, MO)

## 0340 UTC on 4910

ZAMBIA: Radio One. Indigenous languages. Native African music program to station IDs. Local program updates to newscast at 0430 UTC. (Dave Frenz, Milwaukee, WI)

## 0345 UTC on 6230

MONACO: Trans World Radio. German. Religious music and sermon in progress at tune-in. (Wright, MS) Monaco logged on 9480 kHz at 0632. Interval signal, and sign-on at 0635 into "Wake Up" program. (Carson, OK)

## 0345 UTC on 17770

NEW ZEALAND: Radio New Zealand Int'l. Play-by-play sports coverage of rugby game between New South Wales vs. Wellington. (Tucker, GA) Additional monitoring at 1705 on 9675 kHz. (Witham, HI)

## 0349 UTC on 15170

TAHITI: Radio Tahiti. French/Tahitian. Exotic and intoxicating polynesian

island music! Announcer duo and promotionals. (Maywoods DX Team-KY)

## 0420 UTC on 4950.8

ANGOLA: Radio Nacional. Portuguese. African highlife music program to announcer ID and local news briefs. (Brian Schaft, Berea, OH) Additional monitoring on 11955 kHz at 0600. Station ID and news to pop tunes. Considerably weaker signal on parallel 9720.2 kHz. (ED)

## 0425 UTC on 5034

CENTRAL AFRICAN REPUBLIC: RTV-Centrafricaine. French/Indigenous. Fair signal with fading. African pops and highlife to program updates, and news briefs. Rooster sound effects during station ID. Abrupt sign-off at 0455. (Jackson, MO) RTV-Togolaise heard on 5047 kHz at 2215. French programming of Afro pops and "Radio Togo" ID. (Gasque, SC)

## 0449 UTC on 4770

NIGERIA: Radio Nigeria. Lively morning show with music by Prince. Station ID at 0500 to in-depth regional news. (Frenz, WI) Voice of Nigeria heard on 7255 kHz at 0530. (Maywoods DX Team, KY) (Tucker, GA) (Carson, OK) (Wright, MS) (Hilton, SC)

## 0459 UTC on 4800

LESOTHO: Radio Lesotho. Sesotho/English. Commercial to English national news. Station promo and talk in Sesotho. (Ken Loh, Santa Barbara, CA) Programming audible past 0510. (Maywoods DX Team, KY)

## 0500 UTC on 5010

CAMEROON: CRTV-Radio Garoua. National news in English at tune-in. ID breaks into African pops and chat. Good signal quality. (Alan D. Eagan, Myrtle Beach, SC) Parallel programming noted on CRTV-Yaounde with news and music on 4880 kHz at 0506. (Maywoods DX Team, KY)

## 0515 UTC on 4850

NIGER: La Voix Du Sahel. French. Ethnic African music with pop and reggae music thrown in. Station ID at 0532. (Gasque, SC)

## 0520 UTC on 15440

FINLAND: Radio Finland. English news to abrupt sign-off at 0529, weaker signal audible on 11755 kHz. (Bill Mandel, Calabasas, CA)

## 0532 UTC on 15240

AUSTRALIA: Radio Australia. Play-by-playsports coverage. (Maywoods DX Team, KY) Hour long broadcast at 0900. Station ID as "Thai Radio-Australia." English lessons, music, and frequent IDs. Regular Radio Australia programming at 1000. (Frenz, WI) (Carson, OK)

## 0535 UTC on 4915

GHANA: Radio One. Religious choral music. (Maywoods DX Team, KY) Station heard at 2240-2300 with IDs, world news, and music. (ED)

## 0905 UTC on 6210

CROATIA: Hrvatska Radio. Croatian. Enjoyable regional music with occasional chatter from male/female duo. Audible but weak signal on parallel 9830 kHz. (Witham, HI) Fair signal quality monitored on 9830/6210 kHz at 2330-0005. (Frank Hillton, Charleston, SC)

## 0920 UTC on 3315

PAPUA NEW GUINEA: Admiralty Islands-Radio Manus. Pidgin/English. Country and western tunes to station ID and national news. Station NBC heard on 4890 kHz at 0935. 70's era music to station ID and newscast. (Frenz, WI)

## 0941 UTC on 11915

BRAZIL: Radio Gaucha. Portuguese. DJ chatter to station ID at 0958. Brazilian music through the top of the hour. Brazil's Radio Intergracao heard on 4764.9 kHz at 1015. Program commercials, music and station ID. Radio Globo heard on 11805.2 kHz at 1103. DJ with newscast followed by music with IDs after each song. (Gasque, SC)

## 0949 UTC on 5025

SOLOMON ISLANDS: SIBC. Def Leppard music to station ID and sports commentary. Fair signal with moderate interferences. (Frenz, WI)

## 1140 UTC on 9830

PALAU: KHBN-Voice of Hope. Chinese/English. Lady announcer with programming news to 1145. English ID, QSL address P.O. Box 66, Koror, Republic of Palau 96940, Western Pacific. (Schaft, OH)

## 1210 UTC on 10058.9

VIETNAM: Voice of Vietnam. Unidentified Asian language in progress at tune-in. Parallel programming on 15009.2 kHz carrying similar programming. (Gasque, SC)

## 1720 UTC on 6185

CHINA: Huayi Broadcasting Co. Chinese. Piano recital of delightful light-classical. Brief announcements to station sign-off at 1800. (Witham, HI)

## 1800 UTC on 13620

KUWAIT: Radio Kuwait. Station ID and national anthem. Program "Kuwait the Land & People" on Kuwaiti culture and society. "Kuwait Homeland" on the Iraqi invasion and its impact on the national economy. (Tucker, GA) (Witham, HI) Excellent signal monitored past 1900. (Frenz, WI) (Wright, MS) (Hilton, SC)

## 2025 UTC on 9674.9

BRAZIL: Radio Cancao Nova. Portuguese. Fair signal quality with mostly talk from male/female duo to ID at 2031. Great afternoon for Brazilian logs including three others. Radio Anhanguera on 6080 kHz at 2320-2325. Radio Universo, 6060 kHz at 2325-2329. Radio Guarany heard on 6050 kHz from 2330-2335. (Gasque, SC)

# Utility World

Larry Van Horn  
c/o MT, P.O. Box 98  
Brasstown, NC 28902



## Anticipation

Well the big news this month in the Utility World is, "It's almost here." In just about 30 days, folks from all over the country will gather again at another *Monitoring Times* convention. This time it will be in Atlanta, Georgia. I'm excited about our move to "Hot Lanta" this year and I hope you are, too.

I really enjoy the forum talks and getting the chance to meet folks out there in the Utility World,

face to face. My forums have changed somewhat this year, and I hope that those attending will enjoy some of these new presentations.

For example, one of the talks I'm going to give this year is entitled, "How to set Up a Professional Monitoring Station."

Now this talk is more than just spending an hour telling you where and how to set up your equipment. I will go behind the scenes of some major stories and show how radio was used to follow those stories. I hope to let you in on some of the inside secrets and techniques on how the pros broke and followed these major news events. I will also talk about some advanced techniques you can use in the shack so that you can start covering major news stories on your own. It should be an interesting forum, one that has never been done before, so be sure to high-tail it to the meeting room since seating is limited.

Other forums that I will give this year are a Beginners Utility Talk and Who's Who in the Spectrum, as well as being on the panel for the scanner and shortwave experts forums.

I hope to find some time on Saturday for all the ute folks to meet informally in one of the rooms to exchange information like we did in Knoxville the first year. So bring your frequency list and watch for announcements!

## Two New Designators Found!

Someone recently added a new designator to my growing collection for the Air Force. Yes, folks, they are still using them. Unfortunately, that kind person did not sign his/her contribution so I can't give proper credit.

The new frequency with designator is 9806.0 (Whiskey 106). To our no-signer, thanks for the information.

This is as good a time as any to recap new frequencies we currently have for the Air Force HF systems. Keep in mind a few of these have changed:

### Whiskey #'s

5800 (101), 6757 (103), 7475 (104), 7831 (105), 9806 (106), 12070 (108), 13247 (109), 17972 (111), 18397 (112), 20124 (115), 20167 (116)

### Sierra #'s

3113 (302), 3295 (303), 4495 (304), 7330 (307), 9057 (309), 11220 (310), 11494 (311), 13211 (312), 15962 (315), 4725 (390), 6761 (391), 9027 (392), 11243 (393), 13241 (394), 17975 (395)

### Papa #'s

5700 (381), 5826 (382), 15044 (383)

### Xray #'s

6730 (903), 9017 (904), 11226 (905), 13217 (906), 17992 (908), 23265 (909)

I wonder where the new GHFS frequency primary channels discussed in this month's feature fit into this picture? Also, we have to consider the Mystic Star channels. I was surprised to see the F-989 designator for this system in this month's logging column. Interesting to say the least.

Over the last few years, Bill Battles and I have been collecting these designators. If you have any you would like to add, please send them to Utility World and updates will be run in this column as space warrants. As always any frequencies/designators regardless of service are always welcome as well as your list of frequencies.

## KKN Station Update

Our topic back in February, was on the so-called Department of State radio stations. Since that article, updates have poured in from our readers around the world. Long time reporter, Tom Redden, said he took my suggestion and loaded into his receiver memories all the frequencies in the boxed table and also some of the old frequencies. He worked these stations for several days between 0500-0600, 1600-1700, and 2000-2100 UTC. Here are some of the items Tom has discovered:

- The 12022.5 frequency of KKN50 appears to be dead. Their marker now says QSX on 11 MHz. After a small search 11455.5 appears to have replaced 12022.5.

- The 16458.0 frequency for KRH50 appears to have been replaced also. Since 16458.0 is in the restructured marine band they had to move the station to a new 16 MHz frequency. That new frequency is 16132.0 kHz.

- Tom says he has not heard KKN39 on the 13387.0 kHz frequency. He says he has heard the 4 and 17 MHz channels at the same time but the 13 MHz was missing. Well, it's time to try 13472.0 kHz, which appears to be the latest and greatest Miami frequency in use.

- He says that he has had problems hearing the Far East station KWA80. The only frequency he has heard activity on is 12210.0 kHz. Tom admits also having trouble contacting hams in Japan and other Far East countries except under grayline conditions near sunrise and sunset. He hasn't really tried hearing KWA80 during those times but plans to in the near future. The 12210.0 kHz frequency was heard at 2000 UTC about two hours before sunrise in Tokyo.

- Tom mentioned that all of the frequencies he monitored agreed with my table and he confirmed no activity on the old KKN44 frequencies.

By looking at the QSX markers throughout the day, one starts to get an idea of the target areas for these stations. Some of the stations change their QSX frequencies between day and night.

For example, the KWA78-Athens, Greece, CW marker shows it uses higher frequencies around 0600 UTC suggesting that they are targeting stations to their east—the Middle East, Turkey, Saudi Arabia, etc. During our daylight hours they QSX on the lower frequencies—again indicating targets to the East and not toward the United States where higher frequencies would more appropriate.

Tom uses the Miniprop computer program for his IBM compatible computer to calculate optimum frequency paths between any two places on the globe. One thing to keep in mind, however, is that no computerized



propagation program is perfect since many unpredictable factors influence propagation. Still, it is fascinating to use this computer aid in evaluating what is happening on the bands.

*Confidential Frequency List* compiler Geoff Halligey, a frequent visitor to these pages, has noted KRH50-London on a new frequency. During a recent 0900 transmission, KRH50 sent a number of coded messages to KRH48 (not heard). The frequency was 13545.0 kHz and Geoff notes that KRH48 has not been noted before.

Another DXer, I.M. Knotkiding in San Antonio, Texas, says he also has been using propagation techniques to try to figure out where KKN50 signals are headed. Based on that CW marker, they also appear to be heading east towards Africa and Europe during the morning hours.

He has also noted some very strange Morse code characters being hand sent on all the Department of State radio stations QRA CW markers from time to time. One example occurred recently around 0255 UTC. Here is what I.M.K. monitored:

QRA QRA QRA DE KWS78 KWS78 KWS78 QSX 3/4/7/10/14 K  
 QRA QRA QRA DE KWS78 KWS78 KWS78 QSX 3/4/.....7/10/14 K  
 QRA QRA QRA DE KWS78 KWS78 KWS78 QSX 3/4/7/.....0/14 K  
 QRA QRA QRA DE KWS78 KWS78 KWS78 QSX 3/4/7/.....0/14 K  
 QRA QRA QRA DE KWS78 KWS78 KWS78 QSX 3/4/7/...../10/14 K  
 QRA QRA QRA DE KWS78 KWS78 KWS78 QSX 3/4/7/10/15 K

KRH50 in London is not exempt from dropping or changing characters in its CW marker as the following shows:

0313 - 0356 QRA QRA QRA DE KRH50 KRH50 KRH50 QSX 5/7/11/13/16/20 ?  
 (repeated)  
 0356 QRA QRA QRA DE KRH50 KRH50 KRH50 SX 5/7/11/13/16/20 ? (repeated)  
 QRA QRA RA DE KRH50 KRH50 KRH50 QSX 5/7/11/13/16/20 ? (repeated)  
 QRA QRA QRA DE KRH50 KRH50 KRH50 QSX 5/7/11/13/1 ...../20 ?  
 (repeated)  
 QRA QRA QRA DE KRH50 KRH50 KRH50 QSX 5/7/11/13/16/20 ? (repeated)

One of the weirdest transmissions belongs to KKN50 located at Warrenton/Remington, VA. It goes as follows:

0635 QRA QRA QRA DE KKN50 KKN50 KKN50 QSX 6/10/11/15 K  
 (Heard on 6925.5/10637.0/11455.5/15970.5 kHz and repeated 11 times)  
 0700 (hand keyed) QRA QRA QRA DE KKN50 KNN50 KKN50 QSX 6/11 K  
 (All four frequencies silent)  
 0704 (hand keyed) QRA QRA QRA DE KNN50 KKN50 KNN50 QSX 11/15 K  
 (All four frequencies silent)  
 0707 (tape) QRA QRA QRA DE KKN50 KKN50 KKN50 QSX ...../11/15 K  
 QRA QRA QRA DE KKN50 KKN50 KKN50 QSX ...../10/11/15 K  
 QRA QRA QRA DE KKN50 KKN50 KKN50 QSX 6/10/11/15 K  
 (Repeated 10 times until IMK quit listening)

Very interesting information from all and I really appreciate all your input and continued support. Hopefully in the near future, additional information on the new Far East station KWA80 will surface. I wonder what Takashi Kuroda in Tokyo is hearing? Takashi!

### A Mystery Station Changes Calls

Speaking of Geoff Halligey, he has noted an interesting change in one of our more interesting mystery utility band stations. Our old friend EC3Y, who has sent his call sign as such for years now on the frequencies 8158.4, 9161.2 and 13582.0 has now changed his call sign to DEA47. That new station has the same break near the half-hour, sends a short message, then resumes its CW marker. The station closes down before 1700 UTC

weekdays and is off the air on Saturdays and Sundays. Thanks for that report Geoff; it is always a pleasure to hear from you. Our editor tells me she has the inside story on how this change came about; see the German Number Station feature in this issue.

### Inquiring Minds Want to Know

Bernard H. Shunk, WI8O, wants to find a source that lists information on some call signs he monitored recently.

Bernard says, "Where can I find a publication listing the CW coastal stations in the 6 MHz and 8 MHz bands? I have several pages of useless call signs that I have logged just because I like to listen to CW. As an example, between 8148 and 8512 kHz, I recently logged the following callsigns, all S-9 signals:

OVG XFL VCS FFL2 WJK CUL DAN FFL3 WOM OST KFI DAL  
 NMC FUF 4XO PPJ

I have no idea where they are located, what they are or who they are. It would be interesting to be able to supplement the propagation charts with a listing of worldwide beacons."

Well, Bernard, your request is not as tall an order as you might expect. You can check out any of the following books for the information you desire. Each has a small call sign directory to cross stations to frequencies and they are available from Grove Enterprises in Brasstown. They are the previously mentioned *Confidential Frequency List*, 8th Edition by Geoff Halligey and the *Klingenfuss Guide to Utilities 1992 Edition* by Joerg Klingenfuss.

Now if you want the ultimate in utility callsign books (this is no brag folks, just the facts) you have to get Gayle Van Horn's new *International Callsign Handbook*, 1st Edition. This book is a real winner and gives scanner buffs, utility listeners and low frequency beacon addicts great reference source to work from and well worth the \$24.95. It, too, is available right now from the friendly folks in Brasstown. Be sure to tell them the Old Chief sent ya.

One more source for these callsigns and their sources, Bernard, is the *Utility World* logging column. It is a great place to accumulate frequencies, callsigns, and station list. But just in case, here are the fills for the calls you listed above.

- CU Lisbon Radio, Portugal
- DAL/N Norddeich Radio, Germany
- FFL2/3 St. Lys Radio, France
- FUF French Naval Radio, Fort de France, Martinique
- KFI Dixon Radio, San Francisco, CA
- NMC US Coast Guard COMSTA, Point Reyes, CA
- OST Oostende Radio, Belgium
- OVG Frederikshavn Naval Radio, Denmark
- PPJ Junaco Radio, Brazil
- VCS Halifax Canadian Coast Guard radio, NS
- WJK Belcher Towing Service, Miami, Fl.
- WOM Pennsco Radio, Ft. Lauderdale, Fl.
- XFL Manzanlan Radio, Mexico
- 4XO Haifa Radio, Israel

Thanks to all who have made this month's column possible; your continued support is always appreciated and welcomed. Well, time to get a quick Hurricane and see what you folks have been hearing this month in the world of utility band monitoring. See all you folks next month in these pages and at the convention.

# Utility World

## Utility Loggings

### Abbreviations used in this column

APT	Automatic Picture Transmission	LSB	Lower Side Band
ARQ-E	Single channel ARQ	MAP	Maghreb Arabe Presse
ARQ-E3	Single channel ARQ ITA3 system	MARS	Military Affiliate Radio Sys
ARQ-M2	Multiplex ARQ transmission with 2 channels	Meteo/Metro	Meteorology
CANFORCE	Canadian Forces	MFA	Ministry of Foreign Affairs
CAP	Civil Air Patrol	NOAA	National Oceanic and Atmospheric Administration
CCG	Canadian Coast Guard	Ops	Operations
CGC	Coast Guard Cutter	Packet	A form of data comms between computers
COMSTA	Communications Station	PIAB	Presse- und Informationsamt der Bundesregierung
CQ	General Call	Pirep	Pilot Report
CW	Continuous Wave (Morse)	PTT	Post, Telegraph and Telephone Administration
EAM	Emergency Action Message	QRA	The name of my station is...
Fax	Facsimile	QRM	Interference
Fleetsatcom	Fleet Satellite Communications	QSX	I am listening to...
FF	French Forces	RAF	Royal Air Force
GHFS	Global High Frequency System	RTTY	Radioteletype
HF	High Frequency	RY	Using the letters RY, a common RTTY test tape.
HFRB	High Frequency Regional Broadcast	SAM	Special Air Mission
HRPT	High Resolution Picture Transmission	SITOR-A	Simplex printing over Radio, mode A
ID	Identification	SWED-ARQ	Adaptive Swedish diplomatic simplex ARQ
Intl	International	Unid	Unidentified
KCNA	Korean Central News Agency	USAF	United States Air Force
LDOC	Long Distance Operational Control	USB	Upper Side Band
Leasat	Leased Satellite	USS	United States Ship
		VFT	Voice Frequency Telegraphy

All frequencies in kilohertz (kHz), all times in UTC. All voice transmissions in English unless otherwise noted.

- 139.0 DCF39-DPA Frankfurt, Germany, with fax press photos at 1456. (RGA-UK)
- 438.0 CFH-CANFORCE Halifax, NS, with V CW marker at 0217. (Ted Hay-Watford, ON Canada)
- 2631.0 AXM31-Canberra Meteo, Australia, with fax weather maps at 1042. (Eddy Waters-Collingwood, South Australia)
- 2716.0 USS Nassau (LHA-4) calling San Diego Control, Seattle answered in USB saying San Diego Control not on the air. (Scott Burke-Tucson, AZ)
- 2815.0 IDR8-Rome Naval Radio with CW V marker at 0151. (Jack Dix-Yonkers, NY)
- 2854.0 JVD2-Unid station repeating callsign JVD2 in CW at 0153. (Dix-NY)
- 3167.0 'P' single letter HF CW (Probably Kaliningrad, Russia) at 0158. (Dix-NY)
- 3250.0 RXB70-Khabarovsk, Russia, with fax weather maps at 1033. (Waters-Australia)
- 3314.0 TPLY-Unid station calling K9F9 in CW at 0205. (Dix-NY)
- 3622.5 JMH-Tokyo, Japan with fax weather maps at 1044. (Waters-Australia)
- 3678.0 SXH32-Greek Naval Radio, Khandia, with CQ CW marker at 1727. (Allen Marshall-Crete, Greece)
- 3810.0 HD210A-Time station, Guayaquil, Ecuador, with Spanish ID at 0540. (Scott Billingsley-Camden, AR)
- 4408.0 WGK-St. Louis, MO, working WG9313-The Prosperity on the Mississippi River in USB at 0035. (Todd Koch-Bloomington, IL)
- 4414.0 US Navy L#L callsigns in exercise, said to stand by for a Yankee alert in USB at 0604. (Burke-AZ) *What makes you think it was an exercise, Scott?-Larry.*
- 4469.0 Tennessee CAP net with Blue Chip callsigns in use at 0203 in USB. (Russ Hill-MI)
- 4956.5 KKN39-Department of State Radio, Miami, FL, with CW QRA marker at 0032. (Hill-MI)
- 5320.0 CGC Point Arena working Coast Guard Group Mobile in USB at 1020. (Harry Riddell-Rochester, NY)
- 5696.0 Male operator with "Wrangler, Wrangler this is Hobo, Do not answer," with nothing heard before or after. Sounded like the beginning of an EAM with double tone beeps at 0825. Also have heard COMSTA Portsmouth try to broadcast weather and cut it off in mid-stream

- (probably after someone realized the goof) in USB at 2158. Also have heard Halifax military and COMSTA Boston with radio checks at 2155 then cleared. This frequency has had some weird activity on it in the past few months. What gives? (Fernandez-MA) *Good question Bill, I don't think this one is going SHARES but these days with all the changes, who knows for sure-Larry.*
- 5930.0 Spanish female 4-digit number station in AM at 0310. (Peter Stanwick-Norman, OK)
- 6224.0 Flashing X-ray working WZA7707 with radio check in USB at 0400. Juliett Charlie working WZA7707 in center of area 10, said weather supported ops. JC reported rendezvous time 0500 local, would contact 7707 on 2096.5 near rendezvous time. 7707 wanted to use 6218.5, but JC said he had to stay on maritime frequency. JC said he would be standing by on both nets. (Hill-MI)
- 6231.0 English female 5-digit number station in AM at 0334. (Hill-MI)
- 6440.0 Spanish female 5-digit number station in AM at 0645. (Fernandez-MA)
- 6464.0 YIS3-Sydney Radio with V CW marker at 1420. (Gordon Levine-Anaheim, CA)
- 6467.0 JCS-Choshi radio, Japan, with CQ CW marker at 1415. (Levine-CA)
- 6504.0 English female 3/2-digit number station in AM at 0140. (Hill-MI)
- 6642.0 FUM-French Navy Papeete, Tahiti, with V CW marker at 1407. (Levine-CA)
- 6667.0 Noted two fishing boats here chit-chatting in USB at 1232. (Hill-MI)
- 6676.0 Two males talking, probably fishing boats in USB at 0319. (Hill-MI)
- 6716.0 Air Force 1 working Andrews on F-989 in USB as primary at 0302. Also Air Force 2 at 0253. (Pihale-MN)
- 6738.0 Ardu Air 1 working MacDill Global 'GHFS' in USB at 1239. (Hill-MI)
- Doom 82 (B-52) working Loring Metro with Pirep for IR-144 in USB at 0440. (Pihale-MN)
- 6741.0 SXA24-Greek Naval Radio, Piraeus, with CQ CW marker at 1714. (Marshall-Crete)
- 6753.0 Trenton Military with weather broadcast at 0735 in USB. (Chris Hulse-Eugene, OR)
- 6756.0 Air Force 1 working Andrews on F-380 in USB then LSB and back again at 0255. (Pihale-MN)
- 6761.0 Poker 32 (KC-135 Ellsworth) and Chill 32 (B-52H Minot) calling Skybird in USB. Norse 21 & 24 requesting info on their tanker (Raid 25). Two B-1Bs and a KC-135 all out of Grand Forks AFB. Working their communications through Grand Slam Command Post in USB at 0337. (Pihale-MN)
- 6776.0 Scorpion Control working an unid station at 1400 in USB. (Frantz-GA) *Hummm, definitely not the FAA-Larry.*
- 6812.0 SAM 200 (VC-20) working Andrews with phone patch to SAM Command Post in USB at 1114. (Pihale-MN)
- 6817.0 Aircraft 565 working Andrews for phone patch traffic in USB at 0500. (Henry D. Spearman-Los Angeles, CA)
- 6835.0 Handbook (USS Forrester) working Seabreeze (FACSFAC Pensacola) in USB at 1655. *Forrester is my old ship, I'm surprised it is still afloat. (Frantz-GA) Don't be Bill, (I did my time on her too) she took the place of the Lady Lex in Pcola for the student pilots. You should hear a lot more from her on Hershey and Seabreeze frequencies-Larry.*
- 7315.0 Army MARS net (AARO callsigns) using LSB explaining CW procedures for the next day. (Ron Pratt-Oak Harbor, MI)
- 7625.0 HZN47-Jeddah Meteo, Saudi Arabia, with coded RTTY weather at 1759. (Marshall-Crete)
- 8140.2 IGJ44-Augusta Naval Radio, Italy, with CQ CW marker at 1628. (Marshall-Crete)
- 8335.0 English female 5-digit number station in AM at 0415. (Fernandez-MA)
- 8515.0 P2R-Rabaul Radio, Papua New Guinea, with CW marker followed by weather at 1001. (Dix-NY)
- 8573.0 CLA21-Havana Radio, Cuba, with CQ CW marker at 0553. (Todd Dokey-Lodi, CA)
- 8573.5 HSA2/4-Bangkok Radio, Thailand, with CQ CW marker and traffic list at 1151. (Dix-NY)
- 8580.5 DZO-Bulacan Radio Manila, Philippines, with CQ CW marker at 1009. (Dix-NY)
- 8582.5 KLB-Seattle Radio, WA, with CW traffic list at 0434. (Dokey-CA)
- 8616.0 HAR-Budapest Naval Radio, Hungary, with V CW marker at 1005. (Dix-NY)
- 8634.0 Unid time signals station here in USB at 0613. (Burke-AZ) *PPR-Rio Radio, Brazil-Larry.*
- 8686.0 CNP-Casablanca Radio, Morocco, with CQ CW marker at 1007, QRM from WNU53. (Dix-NY)
- 8776.0 Bravo 2 Echo in USB with an EAM broadcast. (Pihale-MN)
- 8876.0 Boulder Ops working Storm 4 (T-storms in Kansas) in USB at 0345. (Hay-ON) *Ted, probably aircraft working for the National Severe Storms Forecast Center in Kansas City. This frequency also has Keesler AFB, home of the hurricane hunters and the National Hurri-*



	<i>cane Forecast Center in Coral Gables. Interesting usage might have to start checking these during T-storm season-Larry.</i>	16132.0	KRH50-Department of State Radio London, England, with CQ QRA marker at 1914. (Dix-NY)
8993.0	Gunrunner Calling US Customs in Milwaukee through MacDill in USB at 2105. (Bob Pomeroy-Toledo, OH) MacDill Global heard with EAM at 1452 in USB. (Pihale-MN)	16324.9	RFTJ-FF Dakar, Senegal, with ARQ-E3 mode sending 'Controle de Voie' at 0931. (Robert Hall-Capetown, RSA)
9010.0	Halifax military, NS with EAM type broadcast in USB at 0502. (Pihale-MN)	16327.8	MFA, Cairo, Egypt, with SITOR-A transmission at 1745. (Hall-RSA)
9014.0	Raymond 7 working 641 and other aircraft in USB at 2000. (Riddell-NY)	17197.6	LOR-Argentine Naval Radio, Puerto Belgrano, with RTTY 5-letter groups at 1712. (Hall-RSA)
9015.0	Unid stations transmitting in Spanish using USB and scramblers at 0316. (Hay-ON)	17522.0	English female 3/2-digit number station in AM at 1833. (Gerald Brookman- Kenai, AK) <i>Welcome to the column Jerry.</i>
9043.0	SAM 403 working Andrews AFB (Mystic Star) in USB at 1315. (Frantz-GA)	17585.0	AOK-US Navy Rota, Spain, with fax chart at 1645. (Hall-RSA)
9114.0	HGG31-Hungarian News Agency (MTI), Budapest, with RTTY RY test tape at 1700. (Marshall-Crete)	17634.1	SUU-Cairo Meteo, Egypt, with RTTY weather at 1640. (Hall-RSA)
10125.0	CI02-Israeli Mossad number station in AM at 2050. (Fernandez-MA)	17995.0	CANFORCE 6481 working Trenton Military with a departure message in USB at 2001. Moved to 18012 and 11233 kHz. (Pihale-MN)
10258.0	NSS-US Navy Washington, DC, with a VFT carrying AP and UPI news items at 2323. (Mark Burkart-New Orleans, LA) <i>Mark, I believe this is from NAM out of Driver, VA. This is one of the composite fleet broadcast channels, like those carried in the 250 MHz range on the Fleetsatcom and Leasat military communications satellites-Larry.</i>	18018.0	RAF Akrotiri, Cyprus, with weather for airfields in USB at 1425. (RGA-UK)
10408.7	LN2A-Norwegian PTT with test transmission using SITOR-A and CW at 2117. (Robin Hood-UK)	18210.0	Unid station running phone patch singing happy birthday in USB at 2055. (Hay-ON) <i>Probably GIX63-Portishead Radio, England LDOC-Larry.</i>
10648.0	Israeli Mossad number station in AM with 5-letter groups. (Fernandez-MA)	18261.0	GFE24-Bracknell Meteo, England, with weather fax charts at 1400. (Hay-ON)
11176.0	Tribe 05 (B-1B from McConnell AFB) calling Offutt/Andrews Global then moved to 8967 where multiple EAMs were going on at 0406 in USB. Lazer 74 (B-52) calling Offutt and McClellan Global in USB at 1502. (Pihale-MN)	18532.0	Andrews working SAM 29000 and Listerine on this secondary frequency in USB at 2000. (Riddell-MI)
11226.0	WAR46 working an unid station in USB. (Frantz-GA) SAM 86202 (VC-20) working Andrews in USB at 1429. (Pihale-MN)	18972.0	DFZG-MFA Belgrade, Yugoslavia, with Serbo Croatian and English press items using 75 baud RTTY at 1630. (Marshall-Crete)
11243.0	Linotype working Humorous in USB at 2354, mention X-904/5. (Charles Kling-Outremont, PQ Canada) McClellan heard here standing by for traffic in USB at 0446. <i>(Most unusual log of the month goes to Norm for this interesting intercept-Larry) SAM 60202 working Mailplug (You get two guesses on who Mailplug was-Larry) in USB with a request. (Pihale-MN) Most interesting activity on these new "whatever we are going to call them"-Larry.</i>	19031.6	ACC60-US Army MARS Heidelberg working AE1USA and AA3USA using 300 baud packet at 1207. (Hall-RSA)
11288.0	Slingshot working unid station in USB at 2208. (Hay-ON) <i>US Customs ch-Larry.</i>	19091.7	Ministry of Foreign Affairs, Jakarta, Indonesia, with English and Indonesian news items at 1150 using RTTY. (Hall-RSA)
11455.5	KKN50-Department of State Radio. Warrenton/Remington, VA, with QRA CW marker and hand sent CW to KWR80 at 1544 - 1604. QSX was 18400. (Dix-NY) Noted at various times 2238 - 2301. (Jerry Johnson- Forsyth, MO)	19171.3	CNM85/X11-MAP Rabar, Morocco, with Asian news service with RTTY RY test tape, ID then English news items at 1226. (Hall-RSA)
12149.0	ABM4USA- US Army MARS Camp Coiner, S. Korea, using SITOR-A with messages to US at 1835. (Takashi Kuroda-Tokyo, Japan) <i>Welcome Takashi, hope you check in with us often-Larry.</i>	19365.1	Unid Air Force station sending fax weather charts at 1700. (Hay-ON) <i>USAF HFRB station in Homestead AFB, Florida-Larry.</i>
12664.5	FUO-French Naval Toulon, France, with CW marker at 1817. (Robin Hood-UK)	19860.4	MTO (ex-6YA) - Royal Naval Radio, London, with RTTY marker at 1610. (Hall-RSA) <i>Neat, Robert; I had heard that the call had changed, thanks-Larry.</i>
12700.0	XSQ4-Guangzhou Radio, PRC, with CQ CW marker at 1744. (Stanley Klemanowicz-Torrance, CA)	20022.4	DGU20H3-PIAB Bonn, Germany, with a RTTY test tape then into German news items at 1300. Klengenfuss has the callsign listed as DFU20H3 in his newest edition. On the test tape they definitely transmitted a 'G' instead of an 'F'. (Burkart-LA)
12874.0	VCS-CCG Halifax, NS with CW weather broadcast parallel to 16948.5. (Pihale-MN)	20348.5	9RE203-PTT Lubumbashi, Zaire, transmitting a correction to a previous telex; the corrected telex included many Delco Remy part numbers, and were mostly gaskets for a G.M. Detroit Diesel Allison. Using ARQ-M2 at 1411. (Burkart-LA)
12947.0	UFB-Odessa Radio, Ukraine, with V CW marker at 1002. (Dix-NY)	20385.0	RFFIA-French Naval Radio Le Bourget, Paris, France, with ARQ-E traffic (5-letter groups and Controle de Voie) to RFFX1 and RFFX at 1530. (Hall-RSA)
13113.0	VCS-Halifax CCG Radio, NS, sending ice report in USB at 2347. (Hay-ON)	20469.0	AXM37-Canberra Meteo, Australia, with coded weather plus HRPT and APT information for NOAA satellites using 50 baud RTTY then started a fax transmission at 0033. (Burkart-LA)
13201.0	McClellan AFB, CA, GHFS calling Pawn 22 with an all frequency request at 2313 in USB. (Burke-AZ)	20814.2	RFTJD-FF Libreville, Gabon, with ARQ-E3 idler at 1206. (Hall-RSA)
13205.0	SAM 682 working Andrews with a phone patch to Crown in USB at 1438. (Pihale-MN)	20987.3	SAM-Swedish Embassy, Stockholm, working SAM-91 in Lima, Peru using SWED-ARQ at 1411. (Burkart-LA) Heard same at 1458. (Hall-RSA)
13514.0	AAAGUSA-Fort Sam Houston, TX, Army MARS with CW at 0317. (P.Loo-Montreal, ON)	21967.0	Aircraft identified as PLOB calling an unid station. Operator had a very heavy accent in USB at 2251. (Hill-MI) <i>This is an LDOC channel for Deutsche Lufthansa airlines and they have a station in Frankfurt-Larry.</i>
13582.0	DEA47-Unid station sending a V CW marker at 1638. (Dix-NY) <i>Interesting Jack, this is our old friend EC3Y. See German Numbers feature-Larry.</i>	22356.0	EWAK-Soviet ship Polyarni Krug working Murmansk using RTTY at 1155. (Hall-RSA)
13816.0	CWH50-Unid station calling CWR93 in CW at 1604. Uruguay? (Dix-NY) <i>I think so Jack, probably a couple of their naval radio stations-Larry.</i>	22363.6	URWR-Soviet ship TR Aktarskij Liman working Kaliningrad Radio using RTTY at 1210. (Hall-RSA)
13975.0	Andrews working several L#L stations in USB at 1710, brief checks. (Frantz-GA) <i>Interesting intercept, this is a Naval Reserve channel, SHARES?-Larry.</i>	22395.1	UBHU-Soviet ship Efim Gorbenko working Novorossiysk Radio using RTTY at 1216. (Hall-RSA)
14245.0	COMSTA Miami working emergency WY22403 "Sea Harvest" with relays by WB4MDQ in USB at 0335. (Carl Parks-GA)	22420.0	XSQ-Guangzhou Radio, PRC, with SITOR-A idler tones and ID at 1126. (Hall-RSA)
14564.0	5BC68-Cyprus/Nicosia Radio with female in USB sending an English/Greek Voice marker at 1644. (Dix-NY)	22545.0	KKN39-Department of State Radio Miami, FL, with CW QRA at 1919 parallel to 13387 and 17413.5 MHz. (Dix-NY)
14641.0	EBA-Spanish Naval Radio, Madrid, with CQ CW marker at 1700. (Dix-NY)	22771.0	FFL91-St. Lys, France, with phone patch in USB at 1935. (E.Lish-Seminole, FL)
14856.0	ABM4USA- Army MARS Camp Coiner, S. Korea, using SITOR-A at 2205. (Kuroda-Japan)	22905.7	DMK-Ministry of Foreign Affairs, Bonn, Germany, working Santiago, Chile using ARQ-E at 1512. (Hall-RSA)
14875.0	RFLIGA-Kourou, French Guiana, with ARQ-E3 transmission at 0026. (Loo-ON)	22909.0	Unid station sending ARQ-E at 1224. (Kuroda-Japan) <i>Probably DMK above-Larry.</i>
15011.0	Antique Control working Hobart 26 in USB at 1612. (Riddell-MI)	23419.0	Unid stations with a phone patch between operator and credit card company regarding an unbilled charge for a rental car at 1625 in USB. (Burke-AZ) <i>Scott I show this one to be a MacDill discrete as well as a possible SAC/NORAD channel. Probably MacDill however, with their new GHFS band plan-Larry.</i>
15835.0	Swiss Radio Intl, Berne, with RTTY English news at 1740. (Kuroda-Japan)	24244.0	Telegrams in East European language (not Russian) using 68 baud RTTY, probably diplomatic at 1436. (RGA-UK)
16128.5	English female 5-digit number station in AM at 1730. (Burke-AZ)	25208.0	UFL-Vladivostok, Russia, with RTTY messages at 0701. (Waters-Australia)
		26101.5	OXZ-Lyngby Radio, Denmark, with a CW marker at 1833. (Hill-MI)

# The Scanning Report

**Bob Kay**

clo MT, P.O. Box 98  
Brasstown, NC 28902

## Inner Circle Scanning

On a map of your neighborhood, draw a circle around your home that represents a 50 mile radius. If you're using an indoor scanning antenna, use a 25 mile radius. Examine the circle and carefully note the various communities that have separate police departments. It should be possible for you to monitor every police department within the circle.

The concept is referred to as "Inner Circle Scanning." It allows you to target a specific area and to hear all of the scanning action that is contained in that area. It is especially exciting when the police from several different towns are in high speed pursuit. As the scanning action moves between towns, you'll be able to follow along and anticipate the frequencies that will become active.

You can also track summer thunderstorms, tornadoes and other weather phenomena. As the storm approaches or departs from your area, you can punch in the frequencies of the next town and listen to the weather related scanning action.

### Police

As mentioned, the diameter of your circle will probably enclose several different police departments. There is also a very good possibility that one or more of these police departments may be using unpublished or private frequencies. To find a secret frequency, search the range above and below a known frequency. For example: Suppose that 39.90 is an active police frequency. To find an unpublished frequency, search between 39.0 and 40.0 megahertz.

Police departments will also use frequencies that are assigned to maintenance crews. Highway maintenance and city government frequencies are prime targets. Check your local edition of *Police Call*, and scan those maintenance frequencies!

Depending upon where you live, your scanning circle may include an airport or major waterway. If so, refer to **Figures #1 and #2**. The two charts provide a few of the most popular sea and air frequencies that are in use nationwide.

### Have Business, Will Travel

The scanning action within your circle will also include a large number of active business frequencies. You can locate business communications by searching through the business bands in **Figure #3**. To

determine the frequency of a business that is operating near your home, direct your attention to the mobile rigs that are owned by the business.

To zero in on the radio frequency of a mobile unit, you'll need a frequency counter and a little patience. The easiest method is follow a mobile unit in your car, and wait for the driver to key the microphone. A more direct approach is simply to ask the driver to "key-up" so that you can "check" your frequency counter.

Don't have a frequency counter? You can limit the search area to a specific band by applying the following rules:

Band	Mobile Antenna Utilized
VHF Low Band	60-100" Whip or 35" whip with a 5" coil at the center.
VHF High Band	18" Whip or 40" whip with a 3" coil at the bottom. (Easily confused with the VHF Low Band antenna.)
UHF Band	6" Whip or 32" whip with 3" coil in the center.
800 MHz	3" Whip or 18" whip with coil (pig tail) in the center.

To visualize the different types of mobile antennas, refer to **Figure #4**. With a little practice, you'll be able to match the frequency band with the appropriate antenna within a few seconds.

As with most rules, there are exceptions. "Disguise" antennas are specifically made to prevent visual detection. These types of antennas are used primarily by law enforcement agencies, but they can also be found in local department stores. Radio Shack, for example, has a CB antenna that resembles a cellular antenna.

Inner circle scanning can be very challenging. Discovering new frequencies and the locations of transmitters can be one of the most intriguing aspects of our hobby. To find active frequencies, simply enter a high and low frequency range, and then sit back and listen. It's a good idea to limit your search range to a maximum of five megahertz. Search limits larger than five megahertz are too vast to search with any degree of accuracy.

Inner circle scanning is a unique way to monitor and follow the radio traffic in a specific area. Best of all, you can control the size of the monitored area. Scanner buffs living in or near a large city, may wish to concentrate their efforts by making the circle smaller. When all of the frequencies within the circle are located, the radius of the circle can be expanded and the search continued. It's an easy and fun way to add a new twist to the hobby of scanning. Give it a try and send your comments to the Scanning Report, P.O. Box 98, Brasstown, NC 28902.

156.425 Pleasure boats  
156.80 Distress  
157.10 Marine Broadcasts  
157.225/161.825 Marine Telephone calls.  
282.80 Search & Rescue

**Figure 1: Coast Guard**

122.850, 122.900, 122.925, 123.100 Pilot to pilot  
123.500 Flight schools  
123.400, 123.450 Common air show freqs  
129.30, 129.70, 130.25, 130.60 Request for repairs

**Figure 2: Aircraft**

33.0 To 46.0  
150.8 To 162.0  
461.0 To 465.0  
502.0 To 512.0  
851.0 To 853.0  
902.0 To 928.0

**Figure 3: Business Communications**

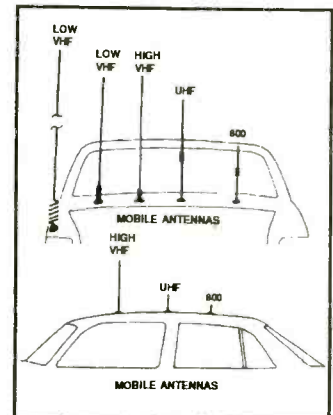

**Figure 4** Courtesy Police Call



## Treasure Hunt

Welcome to the start of a brand new Treasure Hunt. Beginning this month and continuing through October, you'll have a chance to win a top-of-the-line frequency counter from Optoelectronics. We have two models to be won: the 2600H and the 3000.



The 2600H features super sensitivity, 10 digit LCD display, 16 segment bargraph and a hold button that locks the detected frequency on display. You'll also get a nicad battery pack and AC charger adapter. With the 2600H, you'll be able to capture frequencies between 10.0 megahertz and 2.4 gigahertz.

The model 3000 is an advanced, handheld frequency counter that can capture frequencies between 10 Hertz and 2.4 gigahertz.

Both models are superbly crafted and professionally finished in black, extruded aluminum cases. The bargraph is a 16 segment display that reacts to signal strength. As the signal becomes stronger, the bargraph displays additional segments. Generally, if three segments are showing, there is a signal present that can be measured. With a little practice, the bargraph can be used to guide the user to the strongest point of the transmitted signal, where he or she has the best chance of catching a frequency.

After you catch the frequency, press the hold button and the 2600H and 3000 will "freeze" the display. In the past, you only had a few seconds to memorize the captured frequency. The hold button retains the frequency in the LCD until you decide to release it.

To win the 2600H or the 3000, answer the following clues:

1. What is the toll free phone number for Optoelectronics?
2. The frequency of a garage door opener can be captured with a frequency counter. True or False?
3. Provide the dates for the 1992 MT Convention.
4. The Uniden/Bearcat 800XLT must be modified to monitor between 870 and 890 megahertz. True or False?
5. In what year did Ronald Reagan restrict the release of federal frequency lists?

Send your answers to the Treasure Hunt, P.O. Box 98, Brasstown, NC 28902. Please observe the following rules: 1) FAX entries will not be accepted. 2) All entries must be mailed separately. 3) The use of post cards is encouraged.

## Frequency Exchange (all frequencies MHz)

During the month of September, we begin to anticipate the cool winds and colorful leaves that signal the beginning of fall. To prepare you for the seasonal change, let's visit **Vancouver Island, Canada**.

According to Robert Smith, the Royal Canadian Mounted Police use seven repeaters and seven simplex frequencies to cover the entire island. Here are the frequencies:

INPUT	OUTPUT	CHANNEL	DESCRIPTION
141.57	140.40	A	North Island Cities
141.57	140.37	B	Duncan/Campbell River
141.51	140.31	C	Cobble Hill/Nanaimo
Unknown	141.09	D	Nanaimo/Port Hardy
141.36	140.58	E	Extreme Northern Cities
141.72	140.79	F	Colwood/Alberni
141.48	140.28	G	Nanaimo

### Simplex Tactical Frequencies:

141.15	Channel 1	141.30	Channel 5
141.18	Channel 2	155.595	Channel 6

## GUIDE TO FACSIMILE STATIONS

12th edition • 416 pages • \$ 35 or DM 50

The recording of FAX stations on longwave and shortwave and the reception of meteorological satellites are fascinating fields of radio monitoring. Powerful equipment and inexpensive personal computer programs connect a radio receiver directly to a laser or ink-jet printer. Satellite pictures and weather charts can now be recorded automatically in top quality.

The new edition of our FAX GUIDE contains the usual up-to-date frequency lists and precise transmission schedules, including those of all US Air Force, US Coast Guard and US Navy stations worldwide. It informs you about new FAX converters and computer programs on the market. The most comprehensive international survey of the "products" of weather satellites and FAX stations from all over the world is included: 358 sample charts and pictures were recorded in 1991 and 1992! Here are that special charts for aeronautical and maritime navigation, the agriculture and the military, barographic soundings, climatological analyses, and long-term forecasts, which are available nowhere else.

### Additional chapters cover

- List of 310 frequencies monitored in 1991 and 1992. Call sign list.
- Exact schedules - to the minute! - of 90 FAX stations, and of meteorological satellites GMS (Japan), GOES (USA), and METEOSAT (Europe).
- Abbreviations. Addresses. Regulations. Technique. Test charts.

Further publications available are *Guide to Utility Stations* (10th edition), *Radioteletype Code Manual* (11th edition) and *Air and Meteo Code Manual* (12th edition). We have published our international radio books for 23 years. They are in daily use with equipment manufacturers, monitoring services, radio amateurs, shortwave listeners and telecommunication administrations worldwide. Please ask for our free catalogue, including recommendations from all over the world. All manuals are published in the handy 17 x 24 cm format, and of course written in English.

Do you want to get the **total information** immediately? For the special price of \$ 165 / DM 245 (you save \$ 32 / DM 40) you will receive all our manuals and supplements (altogether more than 1700 pages!) plus our **Cassette Tape Recording of Modulation Types**.

Our prices include airmail postage to anywhere in the world. Payment can be by \$ or DM check or cash (no credit cards please). Dealer inquiries welcome - discount rates and pro forma invoices on request. Please mail your order to ©

**Klingenfuss Publications**  
Hagenloer Str. 14  
D-7400 Tuebingen  
Germany  
Tel. 01149 7071 62830

141.21 Channel 3      155.70 Channel 7  
141.24 Channel 4

### Letter Designator

A	Rural Units	E	Special Units
B	General Duty	F	Foot Patrols (Special Events)
C	Traffic/Highway Patrol	G	Marine Units
D	Detectives	H	Helicopters

Robert reminds everyone that the above frequencies are used exclusively on Vancouver Island. The lower Mainland and interior areas use completely different frequencies.

The Hanford Nuclear Facility is located near the town of **College Place, Washington**. According to David Gervais, the facility uses the following frequencies:

162.10 164.375 164.750 164.325 (paging)

Traveling south, we'll plan a rest stop in the town of **Tracy, California**. Here is a list of frequencies that were submitted anonymously.

42.52	California Highway Patrol (CHP) Base
42.30	CHP Mobile
153.815	Tracy Fire
154.07	Tracy Fire
154.28	Tracy Fire
155.055	South Co. Dispatch
154.92	Tracy Police Department
155.505	Dept. of Corrections
155.31	Tracy PD Channel #1
155.79	Tracy PD Channel #2
155.895	Tracy City Works
167.875	Livermore Labs Security

- 167.925 Livermore Labs Data/Security
- 450.10 KCRA TV Channel 3 Link
- 450.125 KRBK TV Channel 31 Link
- 450.225 Air Traffic Reports
- 450.25 KTXL TV Channel 40 Link
- 450.3875 KXTV TV Channel 10 Link
- 465.10 San Joaquin Sheriff Helicopters
- 465.125 " "

Since we're already in California, let's visit **Norton Air Force Base**. Ralph Fellows lives in the vicinity and here are his favorite frequencies:

- |         |                        |         |                       |
|---------|------------------------|---------|-----------------------|
| 141.525 | Special Investigations | 413.00  | Medical               |
| 251.90  | Survival Training      | 413.10  | Terminal Services     |
| 282.80  | Search & Rescue        | 413.225 | Fire Tactical         |
| 407.350 | Taxi                   | 413.275 | Terminal Services     |
| 407.450 | Police                 | 413.50  | Logistics             |
| 408.00  | Police F-1             | 413.375 | Fire Dispatch         |
| 408.175 | Police F-2             | 457.575 | Burger King (on base) |

Ralph also wanted everyone to know that flight operations at Norton AFB are scheduled to cease in 1993. Anyone with further information is invited to contact the Frequency Exchange, P.O. Box 98, Brassstown, NC 28902.

As we pass through the heartland of America, pull out your scanner radio and punch in the frequencies for **Springfield, Illinois**.

- |         |                       |          |                     |
|---------|-----------------------|----------|---------------------|
| 39.25   | Sangamon Co Sheriff   | 156.35   | Springfield Police  |
| 39.50   | Sangamon Co Sheriff   | 158.95   | Sangamon Co Sheriff |
| 42.65   | Illinois State Police | 460.0375 | Springfield Police  |
| 154.935 | Illinois State Police | 460.125  | Springfield Police  |

The above frequencies were submitted by Tom Hamilton. If you want to remain behind, Tom has invited everyone to stay for dinner. For those of you who are continuing ahead, our next stop is **Raleigh, North Carolina**. A scanner buff with the nickname of "E.V." submitted the following.

- |          |                    |          |                    |
|----------|--------------------|----------|--------------------|
| 153.755  | Fairgrounds VFD    | 856.9875 | Cary City Trunking |
| 154.10   | Raleigh Fire       | 857.9875 | " "                |
| 154.15   | Garner Fire        | 858.9875 | " "                |
| 154.445  | Wake-Newhope Fire  | 859.9875 | " "                |
| 155.355  | Wake County EMS    | 860.9875 | " "                |
| 855.9875 | Cary City Trunking |          |                    |

The final stop on our trip is the home of Garrett Stevens. Garrett lives in **Muscle Shoals, Alabama**.

- 154.75 Alabama Beverage Control
- 155.505 Alabama Bureau of Investigation
- 173.025 Marshall Space Center (Rebroadcast Shuttle Comm.)
- 453.650 Emergency (Weather alert)

To invite the Frequency Exchange to your town, send a list of your favorite frequencies to the Frequency Exchange, P.O. Box 98, Brassstown, NC 28902.

## And the Winners Are

In case you've been wondering who to envy, here are the fortunate readers who have won Treasure Hunt prizes since the last report:

### Jul/Aug 1991 (Weather Station—Digital)

Matthew Lightner  
Claysburg, PA

### Sept/Oct 1991 (Intercoms—Midland)

Walter Detwiler  
Park Ridge, NJ

### Nov/Dec 1991 (ScanRecord—Capri Electronics)

Irvin M. Smith                      David Smith  
Levittown, PA                      Clarksville, IN

### Jan/Feb 1992 (Frequency Allocation Cards)

Everyone was a winner!

### Mar/Apr 1992 (Police Call—Hollins Radio Data)

F.L. Miller                      Henry Kelley  
Spring Valley, NY              Belen, NM

### May/June 1992 (Parsons Software)

Joseph Wirtz  
Boyce, LA

## Open Air Scanning

The use of scrambling techniques by law enforcement agencies is gaining in popularity. And many scanner buffs complain that it's nearly impossible to monitor "clear transmissions."

But one scanner buff proved that everyone slips up once in a while, and with a little technology and patience, you can capture some very interesting conversations.

It was late night in Philadelphia. Before going to bed, a scanner buff placed his radio on the frequency for the Federal Bureau of Alcohol, Tobacco and Firearms (ATF). Connected to his scanner was a voice activated tape player. On the following morning, the tape player had recorded several ATF agents talking in the clear. The agents were on a stakeout, and were using their radios to pass jokes and comments across the air.

The Special Agent in Charge said that the "Agents exercised poor judgement and could have jeopardized the investigation." The agents were "cautioned," but disciplinary action was not considered.

To monitor your local federal agencies, here are the frequency ranges to search:

- |                |                      |                           |
|----------------|----------------------|---------------------------|
| 29.90 to 30.55 | 40.01 to 41.99       | 225.00 to 400.00          |
| 32.01 to 32.99 | 46.61 to 46.99*      | 406.125 to 419.99375      |
| 34.01 to 34.99 | 49.61 to 49.99*      | *Shared w/cordless phones |
| 36.01 to 36.99 | 162.025 to 173.20    |                           |
| 38.27 to 38.99 | 173.4125 to 173.9875 |                           |

## Caution: Don't Get Fried

If you are powering a mobile rig from your battery as discussed last month, Robert Vallone of Racine, WI, advises that the hot wire from the battery **MUST** be fused at the battery to prevent a possible car fire if the line should short to ground. If it is not fused until the barrier strip as shown in Figure 2, Robert says, "you will have a very long unfused heating element in your car!"

## Next Month

See you in Atlanta, Georgia!

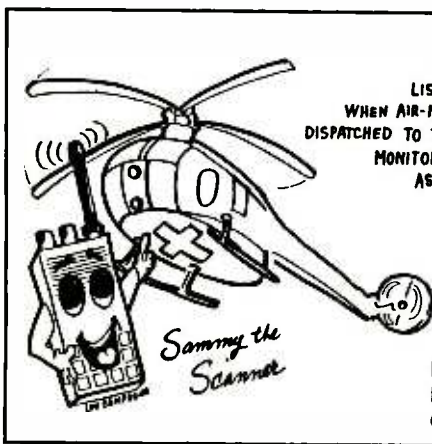

LISTEN AS THE DRAMA UNFOLDS  
WHEN AIR-MED EVACUATION UNITS ARE  
DISPATCHED TO THE ACCIDENT SCENE LIVE!  
MONITOR MEDICAL COMMUNICATIONS  
AS THEY ARE ENROUTE TO A  
NEARBY TRAUMA CENTER.

Northeast Scanning News  
P.O. Box 62  
Gibbstown, NJ 08027





"The Largest Dealer of Scanners in the World"

# SCANNER WORLD, USA

10 New Scotland Ave., Albany, NY 12208 • 518/436-9606

## SCANNER WORLD EXCLUSIVE UNIDEN BEARCAT BC205XLT

**\$239.99** (\$8.00 shipping)

Digital programmable 200 channel hand held scanner with raised button keyboard for easy programming of the following frequency ranges: 29-54 MHz, 118-174 MHz, 406-512 MHz, 806-956 MHz. \* Features include: Scan delay, memory backup, key pad lock, sidelit liquid crystal display, channel lockout, 10 twenty channel banks, direct channel access, automatic search, full one year factory warranty, 10 priority channels, Ni-Cad battery pack, AC adapter/charger, flexible rubber antenna carry case are all included. Size is 2-11/16" Wx1-3/8" Dx7-1/2" high. (Optional extended 2 yr. warranty \$29.99, 3 yr. extended warranty \$39.99.) (\* Excludes Cellular)

#CC-008 Heavy Duty Leather Carry Case \$27.99

## RADIO SCANNERS

BEARCAT BC55XLT	108.99	(7.00)
BEARCAT BC70XLT	144.99	(7.00)
BEARCAT BC100XLT	159.99	(7.00)
BEARCAT BC140	94.99	(7.00)
BEARCAT BC142XL	94.99	(7.00)
BEARCAT BC147XL	99.99	(7.00)
BEARCAT BC200XLT	279.99	(7.00)
BEARCAT BC205XLT	239.99	(8.00)
BEARCAT BC310A	85.99	(7.00)
BEARCAT BC330A	109.99	(7.00)
BEARCAT BC400XLT	99.99	(7.00)
BEARCAT BC560XLT	109.99	(7.00)
BEARCAT BC760XLT	269.99	(7.00)
BEARCAT BC800XLT	249.99	(8.00)
BEARCAT BC855XLT	186.99	(8.00)
BEARCAT BC950XLT	249.99	(7.00)
COBRA SR901	74.99	(6.00)

MIDLAND CB Radios	In Stock
COBRA CB Radios	In Stock
UNIDEN CB Radios	In Stock
Two-Way Radio Batteries	In Stock
Scanner Antennas	In Stock
Power Supplies	In Stock

RELM RH606B	414.99	(9.00)
RELM UC202 (2 or more)	129.99	(6.00)

## SCANNER ACCESSORIES

BCAD70	14.99	BP4	24.99
BCAD100	14.99	BP55	16.99
BCAD140	14.99	MA917	24.99
BCAD 580	16.99	MA518	14.99
BC003	7.99	ESP25	16.99
BC002	59.99	GRE8002	79.99
PS001	12.99	GRE-HH	54.99
UA502A	12.99	GRE9001	89.99
BP205/200	34.99	GRE 3001	62.99
BPT0	16.99	FBE	5.99
VCC01	12.99	FBW	5.99

★ ALL MERCHANDISE NEW, IN FACTORY SEALED CARTONS

## BOOKS

Covert Intelligence	8.95
Air Scan Directory	14.99
Betty Bearcat	5.99
Top Secret (7th)	15.99
Covert Techniques	9.95
Tomcat's Big CB	13.95
World Radio	18.99
Survival Directory	6.95
Rail Scan	7.95
Police Call	8.69
Scanner Modification	17.99

## RELM RH-256NB HIGH BAND TWO-WAY RADIO



**\$339.99**  
SPECIAL PACKAGE DEAL

(Plus \$9.00 Shipping Each)

16 channel digital readout two-way radio. Covers high band frequency range of 148-162 MHz without retuning. Perfect two-way radio for ambulance, police, fire, tow trucks, taxis, commercial companies who use this band. Features include CTCSS tones built-in, priority, 25 watts output, channel scanning, back lighted keyboard, message light, time out timer, scan delay, external speaker jack. Size is 2 1/4" Hx6 1/2" Wx10 1/4" D.

SPECIAL PACKAGE DEAL includes RH-256NB, mobile microphone, 1/4 wave body mount antenna, mobile mounting bracket and mobile power cord all for the low price of \$339.99

## UNIDEN BEARCAT BC-400XLT



**\$99.99**

(\$7.00 shipping)

Our best selling mobile scanner, 16 channel, AC/DC, programmable, digital, AC/DC cords, telescopic antenna, mobile mounting bracket, weather search, priority, 29.54 MHz, 136-174 MHz, 406-512 MHz, external speaker and antenna jack.



## BEARCAT BC-100XLT 100 Channel Digital Programmable Hand-Held Scanner

**\$159.99**

(\$7.00 shipping)

Our best price ever on a full featured complete package hand-held scanner. Manufactured by Uniden. Features include 11 bands of weather, aircraft, public service, trains, marine, plus more (29-54 MHz, 118-174 MHz, 406-512 MHz), 10 channel banks, 10 priority channels, lighted LCD display, earphone jack, channel lockout, AC/DC operation, scans 15 channels per second, track tuning. Special package deal includes following accessories: AC adapter/charger, rechargeable Ni-Cad battery pack, flexible rubber antenna, carry case.

## SANGEAN ATS-803A SHORT WAVE RECEIVER

**\$168.99**

(\$7.00 shipping)



AM/FM/LW and 12 shortwave bands plus FM stereo, BFO for SSB reception, clock radio. Includes AC adapter, telescopic antenna, stereo headphones, and shoulder strap.

## BEARCAT BC-147XLT 16 CHANNEL BASE SCANNER

**\$99.99**

(\$7.00 Shipping)

Programmable, digital, AC/DC operation. Frequency coverage 29-54 MHz, 136-174 MHz, 406-512 MHz. Weather button, priority, lockout button, squelch includes AC adapter, telescopic antenna.

## SPECIAL!! LOWEST PRICE EVER FOR A PROGRAMMABLE SCANNER



## SR-901

AVAILABLE ONLY FROM SCANNER WORLD

**ONLY! \$74.99** Each  
(\$6.00 Shipping Each)  
**\$69.99** (2 or more)

Features include: 10 programmable channels, one touch memory programming, external speaker jack, 29-54 MHz, 136-174 MHz, 400-512 MHz, squelch, lockout, full frequency digital readout, AC or DC operation, retains memory up to 3 days without power, scan button, includes AC adapter, telescopic antenna, and complete operating instructions. Size: 7 1/4" W x 2 1/4" H x 7 1/4" D. One year factory warranty. (Optional mobile cigarette lighter cord #901MPC \$4.99)

## UNIDEN BEARCAT BC 800XLT



DIGITAL BASE SCANNER

**\$249.99** (\$8.00 Shipping)

Receive police, fire, ambulance, cordless phones, marine, trains, weather, ham, stock cars, public service plus much more. Frequency coverage 29-54 MHz, 118-174 MHz, 406-512 MHz, 806-912 MHz (continuous), 40 channels, AC/DC operation, digital programmable, memory backup requires 2 AA batteries (not included), telescopic antenna included, AC power cord included, external speaker jack, external antenna jack. Dimensions: 9 1/4" D x 4 1/2" H x 12 1/2" W. Channel lockout, direct channel access, scan delay, priority, digital display, auto weather button, automatic search, track tuning.

## UNIDEN BEARCAT BC-950 XLT



**\$249.99** (\$7.00 shipping)

Digital Programmable 100 Channel Scanner

BC-950 XLT covers the following frequencies: 29-54 MHz, 118-174 MHz, 406-512 MHz, 806-954 MHz (excludes cellular). Features compact size of 6-5/16" Wx1-5/8" Hx7-3/8" D, scan delay, priority, memory backup, channel lockout, bank scanning, key lock, AC/DC power cords, telescopic antenna, mounting bracket supplied, one year factory warranty, search, direct channel access, track tuning, service search including preprogrammed frequencies by pushing a single button for police fire/emergency, aircraft, weather, and marine services plus exclusive optional features never available on any scanner before. First is an RF receive amplifier for boosting weak signals for only \$34.99 plus a CTCSS tone board is available for only \$59.99 to make this the number one scanner available in the USA. Optional cigarette lighter plug #950 MPC \$4.99.

## UNIDEN MR 8100



**\$289.99**  
SPECIAL SALE PRICE ONLY (\$10.00 Shipping Each)

100 channel digital programmable mobile scanner, turbo scan up to 100 channels per second, lockout, priority, built-in automatic 2 second delay, dimmer control, back lighted keyboard, track tuning, direct programming of frequencies from front keyboard plus you can also program MR 8100 from your IBM compatible PC computer with software and cables included with scanner from Scanner World. Frequency coverage: 29-54 MHz, 118-174 MHz, 406-174 MHz, 406-512 MHz, 806-956 MHz. Dimensions: 7.9" W x 5.8" H x 1.9" D. Earphone jack, BNC antenna jack, DC power cord, mobile mounting bracket, internal memory backup, bank scanning, 10 banks of 10 channels in any combination.

## MODEL: FB-911 ORIGINAL FIRE BOX PHONE

**\$54.99** (\$5.50 Shipping Each)



13 memory phone, 3 direct access emergency memories, auto redial, ringer on/off, top light flashes when telephone is ringing, tone/pulse switchable, desk/ wall mount, front door closes for authentic fire box appearance, FCC approved. Size: 16" Hx8 1/2" Wx7" D.

## GM-1A GLASS MOUNT SCANNER ANTENNA

—ONLY AVAILABLE FROM SCANNER WORLD—

Frequency coverage 25-1200 MHz —only 22 inches tall. NEW REVISED DESIGN — no holes to drill — no glue needed. Complete with 17 foot cable, Motorola connector, and mounting hardware. Swivels to vertical position — performance unaffected by moisture on the window. Made in USA.

**\$39.99**  
(\$4.00 Shipping Each)

## GLASS MOUNT ANTENNAS FOR TRANSCEIVERS

Includes mounting kit and cable. Low Band, High band and UHF band include PL259 connectors. 800 cellular band antenna includes TNC connector.

GM-27 27 MHz Low Band for CB	\$39.99 (\$4.00)
GM-155 144-174 MHz High Band	\$39.99 (\$4.00)
GM-450 450-470 MHz UHF Band	\$39.99 (\$4.00)
GM-800 Cellular Telephone Band	\$34.99 (\$4.00)

**ORDERING INFORMATION:** Call (518) 436-9606 to place orders or mail orders to Scanner World, USA, 10 New Scotland Ave., Albany, N.Y. 12208. Orders will be shipped within 24 hours by United Parcel Service if order is accompanied by MasterCard, Visa, cashier's check, money order, COD (COD shipped by United Parcel Service will be cash or money order only). (If a COD package is refused, customer will be billed for shipping and COD charges.) Mail orders with personal or business checks enclosed will be held 4 weeks for bank clearance. Prices, specifications, and terms subject to change without prior notice. If items are out of stock we will backorder and notify you of delivery date. All shipments are F.O.B. Scanner World's warehouse in Albany, N.Y. We are not responsible for typographical errors. All merchandise carries full manufacturer's warranty. Bid proposals and purchase orders accepted from government agencies only. Free full line catalog mailed 4 times per year. Merchandise delivered in New York State add 7% sales tax. No returns accepted after 7 days of merchandise receipt. \*Add (\$ per item, and \$3.50\* for all accessories ordered at same time. COD orders will be charged an additional \$4.95 per package. Full insurance is included in shipping charges. All orders are shipped by United Parcel Service to street address only. (No P.O. Box). Shipping charges are for continental USA only. All others ask for quote on shipping charge.

Scanner World, USA • 10 New Scotland Ave., Albany, NY 12208 • 518/436-9606

## Back to School — Back to Basics

A great person once said, "The unexamined life is not worth living." I suppose that I internalized this notion early on. Most of my life has been spent in pursuit of esoteric knowledge. I spent most of the Seventies cloistered in various colleges collecting degrees. Hey, can you think of a better way to avoid "Disco" music?

*This is going somewhere, right, Uncle Skip?*

Of course it is, my Captain! With every September comes a longing for those days when Old Uncle Skip packed for campus on a regular basis. Learning is in the air! As Autumn falls, I think it is time for me to put on my professional garb and call class to order. Gather 'round, beginners, 'tis time to review our listening skills for another year of radio monitoring fun. Open up your loose leaf binders and let's get started on...

**LISTENING 101 AS TAUGHT  
BY PROFESSOR UNCLE SKIP  
D.R.M. (Doctor of Radio  
Monitoring)**

This could be a very easy column to write. I could just write "listen, listen, listen, listen, listen, listen..." for a full two thousand words and I would be pretty much on target. What we will cover in this "class" is a bit of information on how to listen *smart*. After all, knowledge is power, Bunkey.

### Know Your Equipment

Old Uncle Skip is a prime proponent of the term, "When in doubt, read the manual." Pouring over the documentation that came in the box with your receiver gives you maximum access to all of your rig's abilities. Since modern receivers seem to have more buttons than an old maid's shoes, review of the receiver manual from time to time will refresh your memory on how to keep everything flying. Most manuals will also make suggestions concerning antennas and accessories that will further improve your listening.

Speaking of accessories, they often come with documentation, too. Bone up on these papers as well; you may discover certain quirks in accessory operation that must be dealt with to get things humming along in your listening post.

If you have been reading *MT* for any length of time, you have probably come across a few hardware tips from time to time that may apply

to your monitoring methods and madness. Professors Doug DeMaw, Bill Cheek and Ike Kerschner have enlightened us all from time to time. I usually read technical articles with a "highlighter" pen in hand. When I come across something worth trying out, I simply mark it off for future reference. Some folks prefer to make a clipping file. Any student of the sciences can tell you the value of maintaining a notebook.

Whatever method you may choose, if you don't take time to keep track of helpful hints, they won't be very helpful.

### Know What's Out There

This is so much more than simply being able to reel off a list of frequencies. Knowing the frequencies that various signals are broadcast on is not even half the battle. Sure, knowing where to listen for certain signals will get you an entry or two in your log book, but knowing how to listen for stuff that is unexpected will also give you unexpected rewards.

For starters, get to know the PROPAGATION CHARTS that are found each month in *MT*. Knowing which portions of the bands are "hot" will always point you to new listening opportunities. Scanner folks will also want to track weather patterns that can influence long distance listening opportunities on the VHF and UHF portions of the bands. Weather conditions that lead to a layer of cold air sandwiched between two layers of warm air can create extra long distance scanner DX.

Once you zero in on the bands that are going to bear the most fruit, tune around and get a notion of what is out there. Of course you will log all the stations you hear, but you will also want to keep track of all the other signals that frequent the band. This column has often reflected the notion that getting to know a few megahertz of the bands at a time is the key to long term listening skills. This applies equally to medium wave, scanner and all other forms of radio monitoring. Again, your logs and notes will serve to refresh your memory and turn you into a real DXpert.

As I said at the beginning of this tirade, there is no substitute for listening. A beginner with modest equipment who keeps his or her ear to the speaker is going to go a lot further than the "expert" with a multi-thousand dollar listening post who only twists the dials for an hour or two on weekends. Tenacity rules in radio monitoring, Compadre!

### Know Time

Since you are starting up a few notebooks, you might want to set aside a few pages to help you keep track of all this time stuff. As we know from both philosophy and science, time is an abstract concept. For various reasons far beyond the scope of this column, time is recorded in many different ways. Regardless of whether you are listening around the world or down the street, you will encounter Time Zones, Local Time, Coordinated Universal Time, Military Time, maybe even Gregorian and Julian calendars. Magazines such as our own *MT* regularly provide charts and hints to help monitors make sense out of time systems.

To give you a short course on common time problems: First get used to converting your local time into the 24-hour format. Midnight is ZERO hour (Just like in all those old war movies). 1:00 am through 12:00 noon remain the same as always. When you get to 1:00 pm you add twelve to each appointed hour. 1:00 pm becomes 13:00, 2:00 pm becomes 14:00 and so on until you reach midnight and zero hour again. Getting this notion down will allow you to follow local police, fire and emergency services that use the 24-hour format. It also prepares you for the quick and dirty system of learning Coordinated Universal Time (also known as UTC), the system used by most international broadcasters.

To find UTC, first convert your local time to 24-hour format. If you live in the Eastern Time zone add 5 hours to get the current UTC for your area. If your area is in daylight saving time subtract 1 hour from your answer (or just add 4 hours in the first place). Central Time folks will add 6 hours, Mountain Timers add 7 hours and Pacific dudes and dudettes will add 8 hours. Again don't forget to subtract 1 hour from your answer if you are currently in daylight saving time.

The other easy answer to keeping track of UTC time is to simply keep your subscription to *MT* current and follow the tops of the pages of THE SHORTWAVE GUIDE section of this magazine. We can't make it any easier than that folks!

### Know How to Manage Information

Even in this modern technological age, sometimes the "old ways" are the best ways. They are also the easiest and least expensive ways for beginners in the radio hobby. Old Uncle Skip's shack is populated with no less than three computers; however, it also includes a good old fashioned log book and card file. A traditional



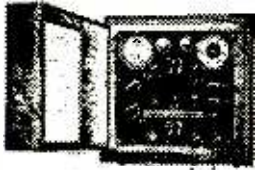

## September is the month for brushing up on your listening skills.

log book serves as a history of what I have heard over time. My file box serves as my frequency and station hit list. Sure, I have all this data entered into a computer system and I do use that system for ongoing trends and analysis. Still the traditional tools of the trade, log book and file box are often faster for basic record keeping while actually listening. Besides, have you ever heard the noises that digital computers can generate right in the middle of the bands we all enjoy monitoring?

While you can purchase commercially produced log books from many of the suppliers listed in the pages of *Monitoring Times*, you might find it fun to develop your own logging system. A plain old notebook will do. Just remember to keep track of all the basic data: (1) Date, (2) Time—UTC and Local, (3) Frequency, (4) Station, (5) Program data, (6) Signal quality data, (7) Verification (QSL) information.

Some people find it useful to keep track of other information such as local weather conditions or the propagation indexes that are given over WWV and WWVH. It's *your* log book. You can write what you want to!

The good old file box can serve as a master frequency catalog, not only of things you have heard but also things you are trying to hear. Let's say you've been trying to catch the Lower Slobovian relay of Radio Freedomia. You might make up a file card with all the days, times and frequencies this station may appear. If you're really hot on the trail you can make multiple cards that are cross-referenced by time and frequency. This way, when you sit down to DX, you know exactly what is the best place to go hunting for that rare catch.

Anyone who is getting involved in amateur radio will also want to start a card box of previous contacts and their areas of interest. This can help with "ragchewing" as you extend your circle of radio friends.

I know this may sound like a silly issue, but do yourself a favor and make sure you use good quality writing instruments when you are record keeping. If you take down information with a smudgy ballpoint pen or a felt tipped marker that

bleeds through onto the next page, over time, your data collection will be useless. 3" x 5" file cards are the most common, but do your eyes a favor and invest in the 5" x 7" size instead. And write **BIG!!!** You're not going to stay young forever.

## Know Yourself

Okay, Okay... So I probably took too many philosophy courses. So what if I knew who Joseph Campbell was ten years ago. This is more than just sage advice. This is the key to success in the radio hobby.

Try to judge honestly how much of your whole life you plan to devote to your radio hobby. Radio monitoring can be the spice of life, but I have found that, for most people, it makes a pretty poor meal three times a day. The basic guide lines are usually easy to see. If your listening habits are disturbing your work, your schooling, or your relationships with your friends and family, you are no longer a hobbyist, you are an addict.

Just like those melodramatic "crack" commercials on TV say, addictions are life destroying not life enhancing. Try to keep your perspective clear on this point because we all hope that your interest in monitoring will be lifelong. Heck, our advertisers are betting on it!

While you are working so hard to keep your perspective on your monitoring practices, you might as well take a crack at keeping your perspective on your monitoring goals and achievements. Even with super equipment, lots of practice and an advanced degree in the science of propagation, a good chunk of what happens is still pure luck. Don't be overly impressed with the successes of others. They were in the right place at the right time to hear some things. You will be in the right place at the right time for others.

In terms of total stations heard, the only thing most so-called experts have over you as a beginner is more time at the dials. You'll get there too, Bunkey. It just takes time. Relax, this is supposed to be fun, remember? Never forget that the only person you have to impress is yourself!

## Know Uncle Skip

Don't forget that a great place to celebrate your Beginnerdom is at the annual Monitoring Times Convention. We have set up no less than eight Beginner's Forums covering all aspects of the monitoring hobby. This is your big chance to ask all those questions you have about getting along in the radio world. Old Uncle Skip is going to be there with a whole crew of folks who want to help you enjoy the greatest hobby in the world. See you in Atlanta. Class dismissed!

# Why buy a TNC?

## PC HF FAX + PC SWL \$179.00

### SPECIAL COMBINATION OFFER

For a limited time, if you order PC HF FAX \$99 (see our other ad in this issue), you can add our new and improved PC SWL 3.0 for \$80.00 instead of our regular low price of \$99.00.

PC SWL contains the hardware, software, instructions and frequency lists needed to allow you to receive a vast variety of digital broadcasts transmitted over shortwave radio. All you need is any IBM PC or compatible computer and an SSB shortwave receiver. The product consists of:

- Demodulator
- Digital Signal Processing Software
- 200 Page Tutorial Reference Manual
- World wide Utility Frequency List
- Tutorial Audio Cassette with Samples

PC SWL automatically decodes Morse code, RTTY, AMTOR, SITOR, NAVTEX and ASCII

PC SWL lets you tune in on world press services meteorological broadcasts, ham radio operators, coastal shore stations, aviation telex and much more digital action on the shortwave bands. Why pay for another expensive box when a simple interface and your PC can do the job?

#### ADVANCED FEATURES:

- Tuning Oscilloscope
- Digital Waveform Presentations
- Auto Calibration and Code Recognition
- Continuously Tunable Filter Frequencies
- Variable Shift
- Adjustable CW Filter Sensitivity
- Unattended Capture and Printing
- Integrated Text Editor
- Integrated Log and Database
- Shell to DOS applications
- Seamless Integration with PC HF Facsimile

Call or write for our complete catalog of products. Visa & MasterCard welcome.

### Software Systems Consulting

615 S. LI Camino Real, San Clemente, CA 92672  
Tel: (714)498-5784 Fax: (714)498-0568

**ASA**

*"Service is the Reason For Our Success"*  
CALL OR WRITE FOR CATALOG  
DEALERS WELCOME

\$28.82

#### MODEL STG Full Range Through-The-Glass Scanner Kit

This Scan-Tenna Scanner Antenna System Features Full Frequency Coverage. Wide Band for Today's Needs. Easy To Install; No Holes to Drill; Mounting Thru-The-Glass Makes It Installer Friendly.

- Multi-Band Receiving Antenna; 30-1200 MHz Range
- 22" Collinear Whip
- 17' of RG58 Cable with Motorola Plug

150A  
"Scan Master"  
base station  
w/amplifier  
30-1200 MHz  
\$46.47

PATENT  
PENDING

+\$3.00 S&H (N.C. RES. 6% SALES TAX)  
CHECK IN ADVANCE OR C.O.D.

P.O. Box 30162 - Charlotte, NC 28230  
Phone 1-800-722-2681

**Tell them you saw it  
in Monitoring Times**

# Adventures in Monitoring

There are hobbies, and then there are HOBBIES! Many enjoy collecting baseball cards, (a fine pastime that can have some financial reward as well). Others like fishing. But, if you are reading this column, then you are probably as hooked on radio monitoring as I am. I can think of no other pastime available to the average citizen that can provide such excitement, intrigue and adventure.

*Adventure* you say? Sure, one can see the excitement in logging that rare military station or from monitoring the federal authorities watching one of "America's most wanted" on a stake out. But adventure from listening to radio?

Most people picture radio monitoring enthusiasts as a nerdy group of hobbyists, sitting alone listening to all kinds of unintelligible squealing and squawking. SWLs are thought of as incredible bores who tell long stories about how they logged a station in Diego Garcia. But as I told my wife (before I wed), being married to a military monitor would never be boring. Needless to say, it hasn't been and she sometimes prays for that restful moment.

Monitoring is never dull. There are times when there isn't much to monitor, but even those

times are rare. There is always something going on. If you are *into* monitoring like I am, (and from your letters I judge many of you are), I can promise you that life will never be dull. In all honesty, the innocuous hobby of radio monitoring can fill one's life with non-stop intrigue and adventure.

You want proof, you say? Here are just a few examples from my log book.

## Have Blue Has Crash

The year is 1980; an aircraft crashes on the Nellis AFB range. The pilot is killed and the aircraft is destroyed. From monitoring the communications involved in the rescue and recovery of the aircraft, it was easy for me to deduce that this wasn't the crash of a typical Air Force fighter. The press was kept out of the crash area and denied any information about what type of aircraft had crashed.

I couldn't believe my ears when two blabby Lockheed officials discussed the incident via unscrambled radio telephones, revealing that the aircraft was "special." This was my first encounter with the "black" Stealth world. However, it would be many years before I

discovered that the aircraft was one of the "Have Blue" prototypes of the F-117A stealth fighter.

catastrophes. Some monitors do not like the idea of reporting what they hear to the press, but in this instance nuclear weapons were involved and public safety was the issue. If I had a sinking Soviet sub, filled with nuclear explosives, off the coast of *my* home, I think I would like to know what was going on. I also believe the press is indeed the fourth branch of government and serves the important purpose of keeping the other three branches honest.

## The MT Connection

In 1989, while researching an article for *Monitoring Times* on the White Sands Missile Range, I was buzzed by an aircraft that to this day I still can't identify. Determined to do so, I began research into the fascinating world of stealth technology. I guess you can say I became a "stealth chaser," and during the course of my investigations, I have met quite a few fellow enthusiasts in the quest for answers. "Federal File" followers and stealth chasers have provided invaluable information on the subject, some of which directly led to the discovery of the super secret "Aurora Project" hypersonic aircraft and the still secret "TR-3A Black Manta" tactical reconnaissance aircraft.

## Stealth Chaser

Thanks go to all of you monitors and stealth aficionados out there. Because of you, *Monitoring Times* was able to break the story of the existence of the TR-3A Black Manta a full two months before the national news media did! Once the TR3A story broke I have had requests for information from all over the world and the pieces of the puzzle are still coming together, but that's the subject of a future column.

## Of Soviets and Submarines

In 1986, I monitored a Soviet submarine sinking off the coast of Bermuda. The Yankee Class SSBN was fatally damaged when the propellant in one its nuclear missiles exploded. The Soviet vessel sank, taking some of its crew with it. I monitored the story and broke the news to the national press. At first the Pentagon denied it, but after the Associated Press produced my audio tape of the incident, they had no choice but to confirm it.

Because of that incident, the national press never hesitates to ask me to monitor for them, especially during special events or

## Of Phones, Feds, and Fake Feds

Considerable political pressure was placed on the FBI to hunt down the culprit. Being the

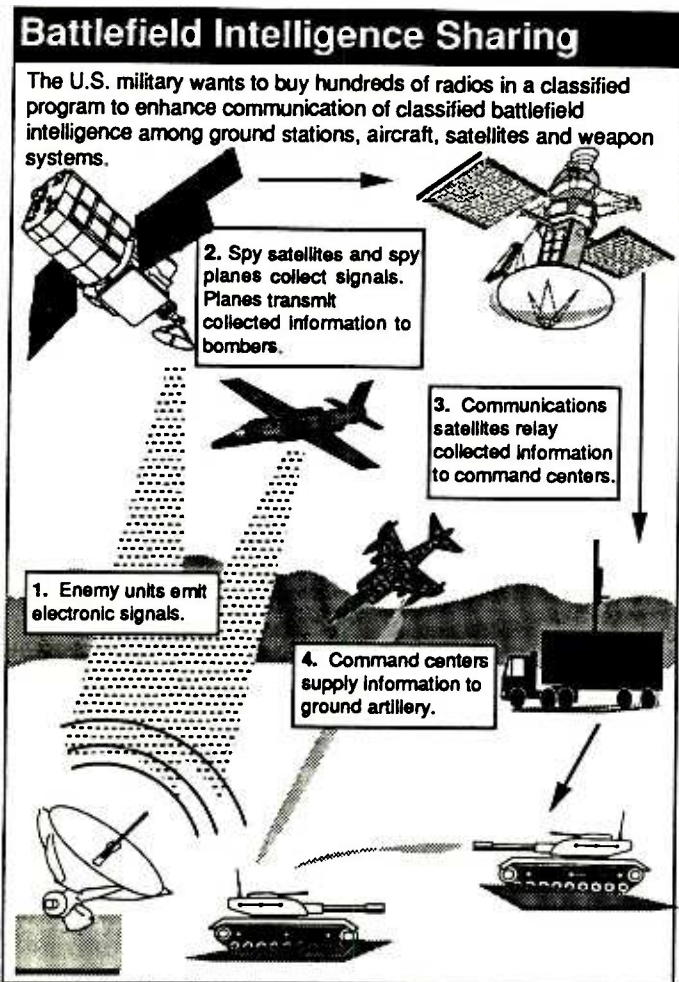



local "expert" on the subject, I was interviewed by the local media about the legal and moral issues behind cellular phone monitoring. Unfortunately, I had developed a reputation for "monitoring the unmonitorable" and I immediately became the prime suspect by an FBI that was scraping for clues.

I was interviewed by the authorities no less than three times, had my friends and family ("known associates") questioned and also placed under covert surveillance. I was also detained and interviewed by some bogus federal agents who were in reality probably detectives working for an interested third party. When the real cellular culprit was found I was exonerated. This all led to a *Monitoring Times* feature entitled "Sex Lies and Audio Tape."

### The Log Book Grows and Grows

In the last two years, I have been interviewed by the media more than I can count on both hands. One day, my neighbors came home to find a huge satellite dish mounted on an even bigger van parked on my front lawn, and people and cables ran into the house. Oddly, none of my neighbors ever asked me what was going on!

My views on monitoring have been published in no less than ten national and international magazines and newspapers. When the Gulf War broke, I had so many requests for military monitoring information that I had to put in another phone line.

What's next? Nobody knows what the future holds. Sometimes I can't help but wonder, though: do I seek all this adventure out or does it seek me?

One thing I have found, however, is that this type of adventure is typical of those deeply involved in radio monitoring. "The stories I could tell!" seems to be the standard quote from monitoring enthusiasts that I have had the pleasure to meet. If you have had a monitoring adventure you would like to share with others, send it in to the Federal File and let the story be told!

### Flying the MAINSAIL

Last month the Federal File reported that there were major changes in USAF communications on the HF bands. Now that ACC, AMC and STRATCOM are on the air, it seems apparent that the Air Force has gone back to a revamped version of an old network—the MAINSAIL communications system of the 70s and 80s.

It works this way: The USAF has divided the world into 14 operational zones. Military aircraft flying in a zone and needing assistance, can contact a ground station on the frequency allocated for that zone. For example: an aircraft flying in Zone 7 (continental U.S.) would contact Offutt AFB on 6.738 MHz or 11.176 MHz.

See Larry Van Horn's feature for details on the new plan, and send us your confirmations and changes.

### Air Force vs. Army

*Defense News* staff writer, Neal Munro, says that the U.S. Air Force's "Constant Source" program office and the U.S. Army's Commander's Tactical Terminal office are divided over the future of two classified intelligence-distribution radios. Both offices are pushing their own radio systems to link ground stations, aircraft and satellites for the transmission of classified battlefield intelligence.

The two systems are the Commander's Tactical Terminal Hybrid (CTT/H) and the Multimission Airborne Tactical Terminal (MATT). The Army is pushing for the use of the CTT/H system and the Air Force is promoting the MATT radios. Between 400 and 1000 radios are needed to share classified intelligence data, transmitted by ground stations, aircraft and satellites.

After the year 2000, similar radios are planned for use in the next generation of aircraft, including the USAF's F-22 ATF and the Army's RAH-66 Comanche helicopter gunship. The graphic on the facing page explains how the radio systems are designed to work.

### MAILBAG

• Larry Gold from El Paso, Texas, sent us a clipping that appeared in the *Alamogordo Daily News*.

According to the article, Holloman AFB (just southwest of Alamogordo) will soon become the new home to 12 German Air Force Tornado fighter aircraft and approximately 200 civilian personnel associated with the program. The plan, unveiled by the Pentagon and the German Ministry of Defense, will involve the movement of the German Air Force's Tornado fighter-bomber unit to Holloman from their current base in Germany. The move will bring a dozen Tornado aircraft, 60 German Air Force personnel and 140 civilian German contract workers to the base.

• Richard Kramer writes us from Reading, Pennsylvania, regarding some SATCOM signals he has intercepted. Richard says he has been listening in on some strange traffic on 266.950 NBFM.

What he heard sounded like a phone patch that was slightly off frequency. Tuning up 15 kHz, he came upon two men talking in a foreign language. After the conversation finished, there was the sound of digital dialing and a phone ringing, then the same men talked to a woman. Richard says he has encountered the same type of conversation on the same frequencies, on and off again, with the traffic occurring at all hours of the day and night.

Richard asks if any Federal File readers have any idea what this might be?

MT

## NEW ENHANCED DISCONE SCANNER ANTENNA

100%  
MADE  
IN USA

ONLY  
\$36<sup>95</sup>

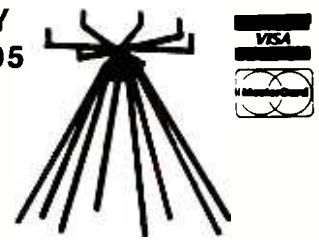

- 800 to 900 MHz enhancement.
- Transmit on 146, 220, and 440 amateur bands
- Compact, will fit in 36" x 36" space
- Receives all AM-FM & SSB frequencies.
- Gain improves with frequency increase.
- Mounts to any vertical mast 1" to 1 1/2".
- Aluminum mount & elements—
- 8 cone & 8 disk elements—same as other discones selling for nearly 3 times our price
- Accepts standard PL-259 connector.
- For type "N" connector add \$5.00.

Order Direct From

Lakeview Company, Inc.

3620-9A Whitehall Rd.

Anderson, SC 29624

800-226-6990 (Orders Only)

803-226-6990 (Tech. Questions)

Add \$4.00 per order for shipping/handling  
Catalog Available • Dealers Welcome

### Computer Control of Your Radio

JUST RELEASED VER. 4.5

with

SCANCAT



Computer Aided Software Control  
Never buy another program - SCANCAT runs ALL supported radios  
LOOK WHAT WE NOW SUPPORT!  
FLASH 1111 DRAKE R-4 & AOR-2600 FLASH 1111  
• KENWOOD FRG-9000, TS-440, TS-450, TS-960, TS-711  
• YAESU FRG-9000, 787GX  
• JAPAN RADIO NRD-825 and NRD-535  
• AOR-3000 WSP SPECTRUM DISPLAY ANALYSIS  
• MOST ICOMs including R-71, R-7000 & R-9000  
Icom & Yaesu FRG-9000 scan stop with inexpensive optional cable !!!

Once you use SCANCAT with your radio - You will never use your radio again without SCANCAT!

AOR-3000, NRD-835, ICOM, FRG-9600 FEATURES  
\* Automatic signal detection/scan stop \* Spectrum Analysis - Terrific graphics!  
\* Automatic logging to diskfiles. \* Save/Load radio's memories to disk

UNIVERSAL FEATURES  
\* Create Frequency Databases \* Scan by ANY increment - by any Delay.  
\* Scan between any frequencies \* Built in Communications program for TNC  
\* Up to 400 Frequencies per file. \* Share ANY radio's files with another radio  
SCANPORT

Now with version 4.5 we include SCANPORT, an ASCII text reader that imports almost ANY columnar frequency list to a running SCANCAT file. Now you can convert your existing databases and downloads off BBS's without having to retype everything again. The best part is it's free with your purchase!

FREE INFORMATION - or - Send for our fully operational Demo (\$5.00). We're so convinced you'll buy SCANCAT, that when you do, we'll refund the cost of the Demo and even pay the postage!

Requires IBM - MS/DOS Compatible - Minimum 1 Serial Port & One Floppy

**\$49.95** +\$5.00 P & H (Foreign add \$2.00)  
ICOM CABLE \$19.95 - YAESU FRG-9000 CABLE \$24.95  
Visa - Mastercard - Discover - AmExp or COD

FREE FILE - (Specify your choice) - CELLULAR or TOP200 UTILITIES  
J&J Enterprises - 4001 Parkway Dr. - Bossier City, LA 71112  
PHONE 318-631-3081 (10-5) or FAX 318-631-3082

## INTERCEPTS

### NEWSLETTER

**INSIDE INFORMATION FOR THE SERIOUS MILITARY MONITOR**

**DON'T MISS OUT!**

**12 Issues - 1 Year for \$18.00 and receive a custom print-out of frequencies of the USAF BASE OF YOUR CHOICE\* Add \$6.00 to Foreign Orders**

\*Please specify base with your subscription. Limited to Air Force Bases in the U.S.

**INTERCEPTS**  
Steve Douglas, 6303 Cornell  
Amarillo, TX 79109

Have a computer and a modem and need the latest inside military monitoring information?

**INTERCEPTS BBS** is where you'll find what you need 24 hrs. a day.

**For Only \$0.00 a year** (includes all BBS privileges & a 1-Year Subscription to INTERCEPTS NEWSLETTER)

Or send \$10.00 for complete details & a FREE sample.

## But What Does Mayday Mean?

### A Little Radio History

Summer is now drawing to a close and the fall routine is gearing up. Just as we relax during the summertime, we sometimes get lazy and take a lot of things for granted. Over the past few

months, we have discussed where the marine radio world is going, so perhaps this is a good time to stop and look at where some of our favorite monitoring came from.

On April 15, 1912, at 0220, a ship with the callsign MGY sent a distress call. This incident has fascinated the world ever since. The ship, as you know, was *RMS Titanic* and the Marconi operators, Jack Phillips and Harold Bride, while they have sunk to virtual obscurity, made an enormous contribution to maritime radio. The *Titanic* disaster was the first major shipping casualty to be made known by wireless distress call.

Interestingly enough, the *Titanic* used two separate distress signals. At the time there was no universal distress signal as there is now. Both CQD and SOS were being used depending on the wireless company operating the ship radio station; therefore, to maximize the chance of being understood the wireless operators used both signals.

On May 29, 1914, the *SS Empress of Ireland* sank after being struck by the *Storstad* on the Gulf of St. Lawrence. This was another major shipping disaster in which radio played a major part. The wireless operators aboard were able to summon assistance via the Marconi wireless station at Father Point, Quebec.

Interspersed between these was the Great Storm of 1913 on the Great Lakes. The remarkable feature of this storm was that while the casualties were very high, they did not occur among ships which were radio equipped.

These events contributed greatly to the confirmation of radio as an indispensable tool to preserving the mariner's safety. So much so that the Safety of Life at Sea Conventions from 1919 onward have included radio as a necessary part of safety equipment on board ocean going ships.

Ever since that time, distress frequencies have been set aside to guarantee the safety of ships and ensure that their distress calls would be heard. A world wide system of watch keeping has also been set up to further reduce shipping casualties.

### The Vocabulary of Distress

During the early days of maritime radio, it became evident that a standard vocabulary had to be developed. Since the diplomatic language of the day was French, many of the procedural terms were devised in that language.



Mayday, the term for distress, is developed from the French "m'aider" or "help me." In telegraphy, CQD was originally used to mean "all stations distress" but was later replaced by the more unmistakable SOS. There is no real evidence that SOS has any significant meaning apart from the fact that the characters...---... are not easily confused with any other signal.

The signal for an urgent situation, "Pan Pan," comes from the French "panne" meaning breakdown and is an apt term since it does not imply an emergency condition, but one which nonetheless requires rectification. In Morse, the "XXX" (-.- -.- -.-) signal used for a breakdown is not likely to be confused with anything else.

"Securite" is used to denote a safety call, and that is simply the French word for safety. Again, the equivalent Morse signal TTT (- - -) is not likely to be confused with anything else.

A somewhat curious procedural term is the use of "Say again" or "I say again" instead of "Repeat" or "I repeat." This is simply explained by the fact that "repeat" is a gunnery term telling the gun crew to fire again. Should the word repeat drift out from the radio at the wrong time, the results could be disastrous!

### A Frequency Standard

The now standard 500 kHz distress frequency for CW has been around for over 80 years. But in the early twenties, radiotelephony developed as a practical means of ship board communications. This brought in the new MF and HF frequency ranges in which 2182 became a standard distress frequency.

The military came up with single sideband which offered greater efficiency over AM. Less power was required and more channels could be squeezed into the same space. This was welcome news to the maritime world which was hungry for more frequency space.

Table 1

Chan	Ship	Shore	Allocation
5	156.250	156.250	Port Operations
6	156.350	156.350	Safety
7	156.350	156.350	Commercial
8	156.400	156.400	Commercial
9	156.450	156.450	Commercial and Non-Commercial
10	156.500	156.500	Commercial
11	156.550	156.550	Commercial
12	156.600	156.600	Port Operations
13	156.650	156.650	Navigational
14	156.700	156.700	Port Operations
15		156.750	EPIRB's
16	156.800	156.800	Distress, Safety and Calling
17	156.850	156.850	State Control
18	156.900	156.900	Commercial
19	156.950	156.950	Commercial
20	157.000	161.600	Port Operations
21	157.050	157.050	US Coast Guard Only
22	157.100	157.100	US Coast Guard Liaison
23	157.150	157.150	US Coast Guard Only
24	157.200	161.800	Public Correspondence
25	157.250	161.850	Public Correspondence
26	157.300	161.900	Public Correspondence
27	157.350	161.950	Public Correspondence
28	157.400	162.000	Public Correspondence
65	156.275	156.275	Port Operations
66	156.325	156.325	Port Operations
67	156.375	156.375	Commercial
68	156.425	156.425	Non-Commercial
69	156.475	156.475	Non-Commercial
70	156.525	156.525	Digital Data (GMDSS)
71	156.575	156.575	Non-Commercial
72	156.625	156.625	Non-Commercial
73	156.675	156.675	Port Operations
74	156.725	156.725	Port Operations
75	156.775	156.775	Not used-guard band for channel 16
76	156.825	156.825	Not used-guard band for channel 16
77	156.875	156.875	Port Operations
78	156.925	156.925	Non-Commercial
79	156.975	156.975	Commercial
80	157.025	157.025	Commercial
81	157.075	157.075	US Coast Guard Only
82		161.725	US Government Only
83	157.175	157.175	US Coast Guard Auxiliary
84	157.225	161.825	Public Correspondence
85	157.275	161.875	Public Correspondence
86	157.325	161.925	Public Correspondence
87	157.375	161.975	Public Correspondence
88	157.425	157.425	Commercial



# Popular Communications **SUMMER** Communications Guide

It's here, just in time for your summer vacation! LOADED with hundreds of festivals, rodeos, air shows, regattas, and outdoor concerts, this is THE book you need before you make any vacation plans.

INCLUDES many features, designed to—

- To help you understand mobile monitoring laws, in the United States AND Canada.
- To explain the ins, and outs of using your RADAR DETECTOR and how police radar works.
- To help you properly install your detector.
- To help you learn the ropes of using your CELLULAR PHONE while on the road.
- To let you hear all the SPORTS action wherever you are.
- To help you install your new antenna.

A state-by-state, province-by-province, territory-by-territory listing of commonly heard BROADCASTERS to help you get the latest news, music, and traffic information.

For amateur radio operators, there's also a list of the most common 2-meter repeater frequencies. Best of all, we've arranged everything in a quick, easy-to-find format—Just look up the state, province or territory and you'll find that page packed with information, frequencies, traffic information and much more!

AS AN ADDED BONUS, we've included a complete RADAR DETECTOR PRODUCT LISTING, portable communications, receivers, scanners, CB, and amateur transceivers. It's all completely updated with the latest specifications, prices, AND even includes addresses, and phone numbers of dealers and manufacturers!



ORDER YOUR COPY TODAY ...

YES, please send me \_\_\_\_\_ copies at \$4.95 each:  
(plus \$2.50 shipping & handling; \$3.50 foreign)

Name \_\_\_\_\_

Address \_\_\_\_\_

City \_\_\_\_\_ State \_\_\_\_\_ Zip \_\_\_\_\_

Check  Money Order  MasterCard  VISA  Amex

Card No. \_\_\_\_\_ Expires \_\_\_\_\_

Signature \_\_\_\_\_ (required on all charge orders)

Mail to: CQ Communications, Inc.  
76 North Broadway, Hicksville, NY 11801  
Phone: 516-681-2922/FAX: 516-681-2926

CQS

FM offered more opportunities. Its shorter range offered less interference and also meant less power consumption. The development of narrow band FM further meant that twice the number of channels could be squeezed into the same space.

Over the past 90 years, maritime radio has come a long way and technology promises to change things even more. SARSAT (Search and Rescue Satellite Aided Tracking System) and GMDSS (Global Maritime Distress and Safety System) rely heavily on satellites and the maritime world seems to be welcoming the innovations.

How well the new systems will work and what the future holds only time will tell. I, for one, will be most interested to see. The last 90 years have been interesting and fruitful, we can only hope that the next 90 years will be as good.

## Bringing History Up to Date

Finally, to refresh your memories, even if the shipping season is almost over in much of the country, Table 1 is the general band plan as

followed by the United States, with the appropriate uses.

In Table 1, Public Correspondence refers to the public telephone and messaging service provided by the marine operators and wireless telegraphy companies.

Channel 6 (156.300 MHz) is set aside for intership communications relating to safety and ship-to-shore, or for ship-to-shore coordination of Search and Rescue. Channel 9, starting in June 1992, is also designated as an alternate calling and working channel for pleasure craft. The United States Coast Guard has implemented it in the 1st District, and further implementation is expected next year once any problems have been worked out which the 1st District may find during the trial period.

Channel 13 (156.650 MHz) is used at facilities operated by the United States Army Corps of Engineers and is also required to be carried on commercial vessels for bridge-to-bridge communications between vessels.

Until next time, good listening.



MONITORING TIMES

www.americanradiohistory.com

## Attention Subscribers!



Be on the  
look-out  
for your  
renewal card!

You will receive only **ONE** renewal notice. The new postcard format will be sent via first class mail to ensure prompt and reliable delivery to you.

SEND IN YOUR RENEWAL PAYMENT AS SOON AS YOU RECEIVE YOUR RENEWAL CARD — THIS WILL BE THE **ONLY** RENEWAL NOTICE YOU RECEIVE!

Visa/Mastercard/Discover orders  
call 1-800-438-8155



September 1992

45

## A Homespun Longwave Loop

The first thoughts that usually come to mind when thinking of the longwaves, are of huge antennas reaching skyward, wires strung between mountains, gigantic tuning coils, and lots of raw RF power. While this may be true for some transmitting sites, the listening hobbyist can do quite well without such formalities.

Here is an easy-to-build loop antenna that will rival (and often beat) the receiving performance of many multi-acre arrays. This indoor directional antenna should be useful for the upcoming DX season to help you sort through competing stations and null out sources of man-made noise.

These junk box parts are needed to build the Loop:

- About 250 ft. of #26 - #30 gauge insulated or enamel wire (splicing is OK)
- A two-section tuning capacitor from an old broadcast set
- Five feet or so of coaxial cable (RG-58 or similar)
- A plug to fit the external antenna jack of your receiver
- Two wood slats; one 48" long and the other 42" long; 5/16" to 1/2" thick (furring strips work well)

### Plug in your soldering iron and read on!

- 1) Place a notch in each of the wood supports and fit the two pieces together to form the loop frame. Use a couple drops of glue to hold the joint together. Drill two small holes in the upright arm as shown in Figure 1.
- 2) Using a fine-toothed hacksaw, carefully saw 30 shallow slots, spaced about 3/16" apart, in each arm. Place one additional slot in the lower part of the upright arm to provide a starting point.
- 3) Wind the one-turn coupling loop in the middle slot of each arm. Pass the ends of the winding through the top hole previously drilled in the upright arm.
- 4) Wind the large loop in the remaining slots

starting from the outside and working toward the center. When you come to the one-turn winding installed in Step 3, simply cross over it to the next open slot. When you're finished, pass the ends of the winding through the lower hole in the upright arm.

- 5) Solder a jumper wire between the two stator terminals of the tuning capacitor. This combines both sections of the capacitor providing about 700 pf of total capacitance.
- 6) Mount the capacitor to the upright arm just below the loop as shown. This can be done with small screws or even a dab of silicone sealer. Solder one end of the large loop winding to the stator terminal of the capacitor. Attach the other end to the rotor connection (capacitor frame).
- 7) Connect one end of the single-turn loop to the center conductor of the coax feedline and connect the other end to the braided shield. Tape the connections to prevent shorting. Finally, install the antenna plug at the other end of the feedline.

This completes assembly of the loop. You can secure any loose wires to the upright arm with tape or plastic tie wraps. The antenna can be used in a hand-held fashion, or you could build a simple base plate to make it self-supporting.

### Initial Checkout

With the loop plugged into your receiver, tune to, let's say 375 kHz. Adjust the tuning capacitor for a peak in the background noise. This indicates the loop is tuned for resonance at that frequency. If you move more than 10 kHz or so, the capacitor should be re-peaked.

With the dimensions given here, the loop should be tunable from about 175 kHz to well inside the AM broadcast band. If you want coverage below 175 kHz, you can add a fixed "gimmick" capacitor across the variable capaci-

tor to extend its tuning range.

I use a 620 pf mica capacitor that allows my loop to be tuned down to 135 kHz. I leave one end of the mica capacitor connected to the frame of the tuning capacitor at all times. When I need lower frequency coverage, I connect the other end to the capacitor stator terminal with a small alligator clip. You could also install a small toggle switch to do the job.

Above all, feel free to experiment with this antenna. Nothing in the design is extremely critical, and a little deviation from the exact instructions won't hurt anything. Perhaps you'll even come up with some improvements of your own to make it more useful. If you build one, write in and tell me how it works for you! If there's enough interest, I may devote a column to a simple preamp for use with the loop. Let me know what you think.

### European DX—Well...Sort Of

Even with the best stateside antenna (loop or otherwise) you're not likely to hear too many beacons from Europe. Fortunately, one reader, Cor De Hoogh of the Netherlands has just the solution to this dilemma. He's offering to trade audio tapes of longwave bandscans with U.S. listeners. In this way, you can hear what the LF scene sounds like in Europe without any great pains. He's interested in anything below 500 kHz, not for serious DX purposes of course, but just for curiosity sake.

Anyone interested in trading tapes can write him at: Stationsstraat 12-B, 1211 EM Hilversum, The Netherlands.

And while your tape recorder is handy, you may want to take note of a new beacon on the air. Michael McFerrin of Fairhaven, MI, has announced the startup of his new experimental lower beacon "MJM" on 174.9 kHz. The beacon may also use the identifier "MJM - Michigan" and will be operating 24 hours a day. He's accepting reception reports by cassette recording. If the tape is correct, he will return it with a station QSL card. No return postage is necessary. The address is: Anchor Bay Broadcasting Corp., Beacon Verification, Box 230249, Fair Haven, MI 48023-0249.

Another beacon, this one outside the basement band, has taken to the air. It is part of a research project on radio propagation and may be of interest to beacon chasers. It is located in Wales, Alaska, and operates on 25.455 MHz 24 hours a day sending "R" in CW. At 100 watts output, you stand a good chance of hearing it when conditions are right.

Reception reports of the beacon would be appreciated and can be sent to: Dr. Robert Hunsucker, Geophysical Institute University of Alaska, Fairbanks, AK 80912-5000.

That's it for this month. See you in Atlanta!

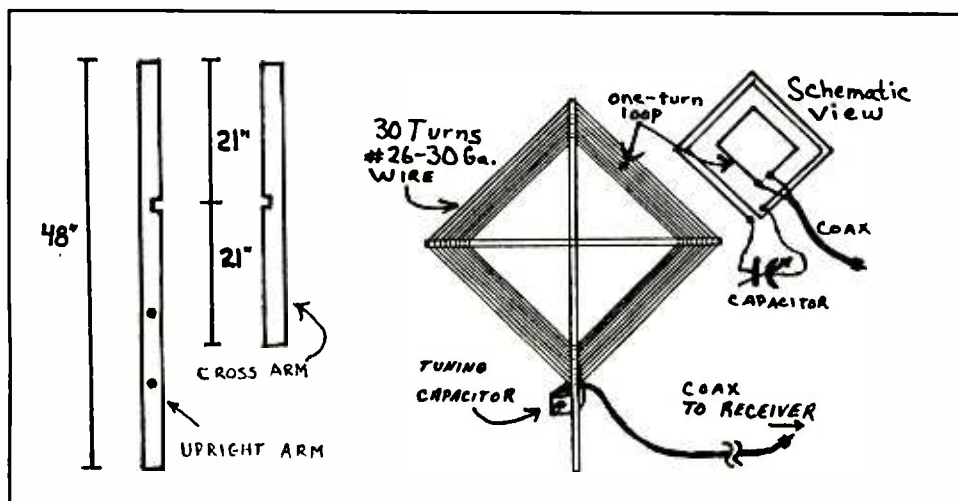

Figure 1: Loop Construction Detail





# INTERNATIONAL CALLSIGN HANDBOOK



After years of collecting and verifying tactical callsigns, Gayle Van Horn has finally published the most exhaustive list of tactical callsigns and their identifications ever assembled for shortwave and scanner listeners. Now you, the radio listener, can get this massive, 250 page directory!

You will now know what all those codes from the US Air Force, Navy, Army, Customs, Secret Service, Marine Corps, and foreign military actually are! Internationally registered callsigns and their users around the world are listed as well, with comprehensive entries from coastal maritime stations, embassies, merchant marine, aviation, NASA, US and foreign military, Interpol, MARS, and many more!

Order this extensive guide to utility callsigns from Grove today!

**Order BOK51 Today for ONLY \$24.95!\***



GROVE ENTERPRISES, INC.  
**1-800-438-8155**  
140 DOG BRANCH ROAD  
BRASSTOWN, NC 28902-0098



Books will ship on July 31, 1992  
Payment will not be processed until shipment.

\*Plus \$4 UPS Shipping

## Improve Your Scanning Coverage!

GRE America is proud to introduce a new family of products to enhance your scanning pleasure! First, GRE has designed the new **Super Converter 9001** for base model scanners. The 9001 converts 810 MHz - 950 MHz down to 410 MHz - 550 MHz. The 9001 is the perfect alternative to buying a new, expensive scanner covering the 800 MHz band. Next, GRE announces the new **Super Amplifier 3001** for base model scanners. The 3001 will increase gain by as much as 20 dB, and is engineered to help scanners with low sensitivity pull in weak signals. Both products use BNC connectors, (1) 9 volt battery and have an off/pass switch for returning to normal operation.



Super Converter 9001 & Super Amplifier 3001



Super Converter II



Super Amplifier

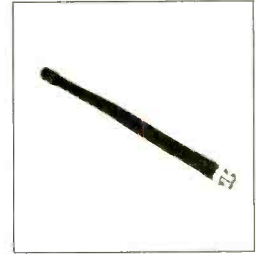

All-Band Antenna

*U.S. & International Distributorship inquiries welcome. Please call GRE for further information!*

### Let GRE Manufacture Your Radio Products!

GRE America, Inc. is a leading OEM developer and manufacturer of radio telecommunications products such as:

- Cordless Telephones
- CB & Marine Radios
- Spread Spectrum "engines"
- Remote Monitoring Systems

If you need a high quality, cost competitive, reliable manufacturer, GRE will provide you with a free production quotation.

For more information, please call GRE at (800) 233-5973. GRE is a subsidiary of General Research of Electronics, Inc.

**GRE** GRE America, Inc.

GRE America, Inc.  
425 Harbor Blvd., Belmont, California 94002  
(415) 591-1400 Outside California: (800) 233-5973

## Get Your Kicks on Sixty-Six Radio

Every day thousands of people drive across the Llano, the majestic high plains of New Mexico. A constant drone of traffic flows night and day between Tucumcari and Albuquerque down Interstate 40. Along the highway, Michael Esquibel has created an oasis serving passing motorists and all his neighbors, too. He owns and operates KSSR in Santa Rosa, New Mexico, the only radio station within sixty miles!

Santa Rosa has depended on the revenue of passersby for many years. It was formerly a resting place for everyone traveling along old Route 66. Interstate 40 has replaced this legendary road, but the city continues to serve all who stop and visit. The Route 66 Broadcasting Company is pivotal to Santa Rosa's economy.

"We try to draw people off Interstate 40. Part of our goal is to bring business into town. I have right-of-way signs that are on every artery leading into town that identify us as the official traveler's information station." The signs were purchased from the New Mexico Highway and Transportation Department as a subtle form of advertising. With enormous community support and Michael's perseverance, "KSSR Sixty Six Radio" has become an electronic Pied Piper for Santa Rosa.

Known as the City of Natural Lakes, Santa Rosa offers some of the best fishing, water sports, and hunting to be found. Its most famous body of water is the Blue Hole. Eighty feet deep, but only about 30 feet in diameter, it is filled with crystal clear artesian water which naturally stays at about 64 degrees. The Blue Hole is the only place in the Southwest where you can be certified as a deep sea scuba diver.

Mike often plugs the city on the air. "We try to lure people in to show them some hospitality, feed them, fill their tanks with gas, and give them a good night's rest. KSSR provides some pleasant music to listen to while they are here."

KSSR serves the people of Santa Rosa as well as the tourists who pass by. The station was formerly known as KSYX, but fell into heavy debt and a local bank seized it. Attempts were made to sell it, but there were no takers. The facility needed a lot of TLC.

"Basically, it's the same equipment that's been here for almost centuries!" jokes Michael. With some friendly persuasion, the silent station became an opportunity to expand the work he had already begun in his home town.

"I was running some drug programs in the community. I started an adolescent treatment center and I initiated some school-based programs. I'd try to help kids learn a little more about drug abuse and its harmful consequences."



*Michael Esquibel, General Mgr. of KSSR (1340AM), does a live remote at McDonalds in Santa Rosa.*

KSSR became a wonderful way to spread his anti-drug message. "The radio station helped me initiate a program where we could train young people who were having problems with drugs, bring them to Santa Rosa, and put them in a monitored setting and a structured environment. I thought radio would probably be one of the best ways to raise a kid's confidence and self-esteem."

Michael used his creativity to produce a format amiable to his entire community. "We call it multi-cultural radio. We think it's the first of its kind in the country." KSSR plays adult contemporary pop music every morning, three hours en Espanol at Noon, and country tunes from three until eight in the evening, when the station signs off.

"The whole town listens. We are very community oriented. We read birthdays and anniversaries once an hour along with a listing of what's happening around town. You'll hear the lunch menus for the schools and local football, basketball, and baseball games. We put a lot of local stuff on the air to get the locals to listen in." Hourly local newscasts are augmented with worldwide and national news from the Associated Press Wire Service. Weekends feature lots of youth-oriented programming including syndicated shows like "Casey's Top 40" and "American Dance Trax."

Audience response has never been better. Mike experimented with Unistar's A/C II format to program the station via satellite, but their sound proved too anonymous. "Getting off the bird was the best thing we could have done. The community said 'Boy, we like your station now! It was good before, and the music was OK, but it sure is nice to have local announcers and a local sound.' It makes a big difference."

There are still lots of dreams and lots of goals

to achieve in Michael's future. Enhancing community identity is important. "We're a Hispanic population, but we're not a real culturally strong population." Almost everyone has assimilated into the American culture and lifestyle. "If Santa Rosa is not mainstream America it's very close to it. Although the older population is still pretty entrenched in some of the older traditions and culture, most of the young kids no longer speak Spanish. We're right on I-40, so nobody has a strong accent."

"Cinco de Mayo (May 5, the Mexican Holiday) is really nothing in Santa Rosa. Maybe that's a media problem. Maybe that's something we haven't promoted as much as we could and really bring it forth. We have some Mexican nationals in the community, and they're pretty strong on it, but they don't really do anything. The Fourth of July is huge here compared to Cinco de Mayo."

Another dream is an FM sister station for KSSR. "It would be really nice if we could attract listeners on AM and FM, but I don't know where we would get the money for it." Michael worries about possible lightning damage to his tower and transmitter, or other maintenance costs that could threaten KSSR's survival. With a difficult economy, selling very inexpensive advertising to politicians in an election year could mean trouble, too. "Sometimes I feel like we're just holding on, but I'm really stubborn!" insists Mike.

So, if you find yourself rolling down I-40, tune to the one kilowatt sound of KSSR on 1340 kHz. Their hometown hospitality is just a pushbutton away! Michael will be calling you from that little building behind the auto repair shop on top of Sunshine Hill. Take a listen, and you may never want to say "Adios, amigo!"

### Bits 'N' Pieces

The summer E-skip season may be almost over, but a dedicated TV DXer's work is never done! Twice a year, the E Layer of the ionosphere becomes charged and turns into a natural reflector that bounces TV signals to your home from amazing distances much like the reception you hear on shortwave. You'll usually see stations between 500 and 1800 miles away during these brief periods of E-skip. It can be a fascinating and exciting hobby!

To aid the ionosphere chasers among us, "American Bandscan" has begun a joint project with The Worldwide TV-FM DX Association. Anyone who has watched rapidly fading and blurry E-skip television knows how quickly ID



**Be an American  
BandScan Reporter.**

See any stories about radio in the local paper? Send them to Monitoring Times, PO Box 98, Brasstown, NC 28902.

slides can fly by, and how easy they are to miss. We are currently preparing maps of the United States, one for each channel between two and six. Almost all E-skip openings appear on these five channels. Every station on channels 2 through 6 will be pinpointed on the map for the DXer's reference. We also want to reproduce each station's logo, but we need your help!

If you live in an area that has a channel 2,3,4,5, or 6, and you can find their logo in a TV Guide or newspaper, etc., please send it to American Bandscan for inclusion in our TV DX maps. Also let us know if the station uses a catch phrase like "Action Center 3." Remember you are the expert on your local stations! One person's local is someone else's DX of a lifetime! Send us a self-addressed stamped envelope along with your logos, and we'll send you a copy of the maps when they are ready for publication. The maps should be in your hands by the time E-skip returns during the middle of December. Thanks for all your help!

**Mailbag**

Fourth and fifth graders in Maynard, Concord, and Lexington, Massachusetts, stop their schoolwork every Friday morning for half an hour to listen to the radio. Their teachers don't get angry, they approve! MT Reader Malcolm Kaufman sent us a clipping from *The Boston Globe* describing a new program on Walden 1120, WADN in Concord, called Radio Vision. Students from nine surrounding schools call the program's host Jeff Loeb to talk to his guests and each other.

Radio Vision is not only very entertaining, it's educational too. Each show begins with a greeting between the two schools participating that week. Twenty-two kids in Concord yell "Hello, Maynard!" and they reply "Hello, Concord!" Then the students get to "Guess The Guest." Much like a game of twenty questions, both schools try to reveal the identity of Jeff's famous companion of the week. It's not easy! Featured guests have included Jim Maroney, a wheelchair marathoner, and a man who kayaked from Newfoundland to Boston. A question and answer period follows giving students ample opportunity to acquaint themselves with Jeff's guest. Time is also set aside for students to discuss topics on their minds.

Loeb developed the show with his combined love for radio and teaching. He taught in a local school for fourteen years, and has also worked as a media specialist and a free-lance composer. Radio Vision airs commercial free even though WADN is a commercial station. Jeff hopes to expand the range of the show by arranging simulcasts of his program throughout Massachusetts. Radio Vision airs Friday mornings on WADN 1120 AM at 9:30 am, and can be heard throughout the metropolitan Boston area.

**New Station Grants**

Here are some new stations that will be filling your dials this fall: Magalia, CA 88.3; Sebastopol, CA 93.7; Aspen, CO 107.1; Durango, CO 99.7; Telluride, CO 104.9; Fenwick Island, DE 92.1; Crystal River, FL 91.9; White City, FL 104.7; Hardinsburg, KY 104.3; Marquette, MI 91.5; McLain, MS 96.9; Asbury, MO 103.5; Sussex, NJ 88.5; Clovis, NM 102.3; Texico, NM 96.5; Conklin, NY 100.5; Durham, NC 90.7; Winston-Salem, NC 91.5; and Cookeville, TX 90.9. Courtesy of *The M Street Journal*.

**For Sale**

Want to go back to your little grass shack? Why not look at something much sturdier! You could be the new owner of "The Pacific Pipeline": a 50,000 watt non-directional AM powerhouse planted in beautiful Maui, Hawaii. Can't afford it? A limited partnership will be considered, too. Write to Richard Miller at KUAU, 33 Hui Drive, Lahaina, Hawaii 96761 to begin your life in paradise.

Waxing your skis and waiting for the first snow? Live right next to the slopes and operate a full-time kilowatt AM station in Colorado. This property has an excellent rapport with its community, and has been their news and sports leader for years. Appraised at \$365,000, the owners are asking \$315,000 with only \$75,000 down. Call Mr. Keith for details at 303-339-2383 today.

**International Bandscan**

Quite a birthday party was thrown for Auntie's 70th birthday last month! In August of 1922, the BBC began its first regularly scheduled broadcasts. To celebrate their longevity, a spectacular multi-media stage show and exhibition of broadcast memorabilia was staged at Broadcasting House in London. Old microphones, mixing consoles, studio equipment, and transmitting gear were on display along with a multitude of photographs depicting the Beeb's distinguished history.

The BBC's oldest transmission facility was put to rest in March. Transmissions have finally ended from Daventry after being on the air since 1925. It was the site of the first BBC regional service, the first nationwide long wave broadcasts, and many years of World Service shortwave transmissions. Britain's first experiments with television also used the Daventry towers in 1928. The transmitters and antenna farms will be retired, and Daventry will become a maintenance base for BBC operations. The BBC World Service broadcasts will be switched to Wooferton and Skelton.

Thanks to Ron Carruthers for the report, and until next month, happy trails!



**Sony ICF-2010  
Filter Mods**

- Improve wide and narrowband selectivity
- A must for AM and SSB reception
- Easy to install - Complete instructions are included

Kiwa's replacement filters allows maximum performance from the ICF 2010. The LFH-4S wideband filter is perfect for general listening while eliminating 5 kHz heterodyne interference. For narrow band, the new FM 3.5/S Filter Module is the perfect answer for serious DX'ing, reducing interference while boosting signal strength for those tough catches.

**Hear the difference - Maximize performance**

For more information please write or call

**Kiwa Electronics, 612 South 14th Ave.  
Yakima WA 98902 Tel: 509-453-KIWA  
or 1-800-398-1146**

**Satellite-TV** **FREE**  
100% Satisfaction Guarantee  
56 Page Catalog Buyer's Guide

Systems from \$479

- All Major Brands
- Complete Systems
- Accessories
- Huge Savings
- Easy Installation
- Complete Instruct.

Let Us Help You Select Your New Satellite TV Entertainment System

Over 40,000 Satisfied Customers

**1-800-334-6455**  
Int'l 218-730-5251 Fax 218-730-4870

**SKYVISION INC.®**  
1050 FRONTIER DRIVE  
FERGUS FALLS, MN 56537

**INSTALL OR UPDATE YOURSELF!**

**TOUCH-TONE DECODER/DISPLAY & ASCII CONVERTER BOARD**

Model TDD-8 decodes and displays all 16 DTMF digits and provides an ASCII serial output. Digits are displayed on eight LED's. 32 character memory can be scrolled. It will accept almost any audio source, such as a scanner, tape recorder, telephone answering machine, etc. Serial output can be connected to your computer. IBM compatible software included for displaying, storing and/or printing time, date and number for automatic logging.

**TDD-8 DTMF DECODER/DISPLAY/ASCII \$99**  
**CAB-1 AUDIO & COMPUTER CABLES \$20**  
**PS-12 110VAC TO 12VDC POWER PACK \$10**

add \$5 S/H - VISA/MC ACCEPTED

**MoTron Electronics TEL: 1-800-338-9058**  
**310 Garfield St.#4 (503)-687-2118**  
**Eugene, OR 97402 FAX: (503)-687-2492**

(Touch-Tone is a trademark of AT&T)

*R.S.V.P.*

MT columnists welcome your input and response to their columns. Please address your letter to the author  
c/o Monitoring Times  
P.O. Box 98  
Brasstown, NC 28902-0098

If you request a personal reply, always enclose a self-addressed stamped envelope (SASE).

# Picking Up Satellite Audio: The Universal SCPC-100

America's radio airwaves are filled with hundreds of narrowly targeted networks designed to fill the audio appetites of its special listeners. The concept is called "Niche Radio."

Many of these networks you've never even heard of: Transtar Radio, Automation Music, Coast-to-Coast Radio Network, Multimedia Broadcasting Network, just to name a few.

There are local news networks: Virginia News Network, Iowa Radio Network, Radio Pennsylvania Network, Kansas Information Network. Or special sports networks for every major professional sports team and many of the minor league teams. There are some familiar big voices: WBT, Charlotte; WHO, Des Moines; WCCO, Minneapolis-St. Paul; KOA, Denver and WGN, Chicago, for starters. There are the international standards: The Voice of America, Radio Canada and BBC. And the less standard: Ojibway Radio, Radio La Fiesta Mexicana, Radio Marti and the Cleveland Indians Radio Network.

All of these divergent networks have one thing in common: They get to their audiences via satellite. The method used to transmit these networks is known as SCPC (Single Channel Per Carrier). An SCPC signal is a very narrow transmission using relatively little equipment and operating totally independent of anything else that's happening on the satellite transponder.

## Satellite Basics

Satellite channel space is just like real estate: the closer you get to downtown the higher the rent. Therefore, audio subcarrier space on the so-called cable birds would carry a prohibitive cost to the niche broadcaster. As a result, virtually all of these networks appear in a small number of locations.

If you turned your satellite dish to Galaxy 2 and set the receiver to channel 3, you would see nothing on the screen. But, if you hooked your SCPC receiver to the dish and tuned through the channel, you would hear at least 50 of these niche broadcasters. Each network transmits its own narrowband signal and together you would put a hundred SCPC signals where one video and a few FM subcarrier signals would be. The best part is that each signal is independent and is unaffected by activities of the others. If you want to transmit stereo, you would transmit two separate carriers—one for the left channel and one for the right. To receive stereo, you would be required to have two SCPC receivers.



## The Universal SCPC-100

Until a few years ago, SCPC hobbyists had to tune the signals with a TV band radio or scrounge the hamfests for used commercial receivers. Both had limited capabilities and new commercial receivers cost thousands of dollars. Then came the introduction of a consumer grade SCPC receiver and few other scanning short-wave receivers which were capable of tuning the 950 to 1450 MHz range produced by most satellite TV downconverters.

Now a name already familiar to the hobby electronics world has come out with an SCPC receiver. It's called the SCPC-100 and it's made by Universal Electronics, Inc. of Columbus, Ohio.

The unit, looking high-tech with its black metal case, 1/2" high, red LED numbers and easy-to-read receiver status lights, will fit right in with today's satellite TV equipment. This "satellite audio receiver" is extremely easy to install and very easy to operate. It's clear that the designer's desire to keep this sophisticated piece of equipment "user friendly" has been met without sacrificing its technical capabilities.

## The Specs

Before getting any further into the performance of the product, here are the specifications for the SCPC-100:

Tuning Range:	950-1450 MHz
Tuning Steps:	8 kHz with variable speeds
Input Frequency:	950-1450 MHz
Input Impedance:	75 ohms coaxial cable
Audio Output:	1.5 watts, 3 to 8 ohms
Unit Power Required:	16 volts AC, 50-60 cycles 900 MA
Source Voltage:	110 AC 50-60 cycles power supply (included)
International Voltage:	16 volts AC, 50-60 cycles
Input Connector:	"F" type 75 ohms
Output Connector:	"F" type 75 ohms
Operating Environment:	60-90 degrees F
Tuning Display:	1/2" LED, 4 digits
Tuning Control:	Microprocessor controlled, non-volatile 50 channel memory bank, one-touch instant channel recall
Cabinet Size:	14" W x 2-1/2" H x 7-1/2" D
Weight:	5 lbs.

The SCPC-100 is made and assembled in the U.S.A.

## Installing the SCPC-100

The requirements for tuning SCPC signals are simple enough. You'll need a decent antenna (anything from 6.5 to 10 feet in diameter), the best low noise temperature LNB you can afford (something in the 40 degree range), any satellite receiver (this is used to power the LNB when tuning SCPC), and the SCPC-100. Please note that the older LNA 70 MHz downconverted satellite systems will not work with the SCPC-100.

The unit comes with a well written and clearly illustrated 15 page "Installation and Operation Manual" and a six page single spaced listing of "SCPC Services on the Satellites." Armed with this manual and listing, it literally takes only minutes from opening the box to listening to the world of SCPC.

## The Importance of Being Stable

Most electronic equipment is designed to operate best at a certain temperature. With satellite receiving equipment, this is even more important. This is why most satellite equipment manufacturers recommend leaving your TVRO system on all the time. (The only exceptions being when you are to be gone for extended periods of time or when thunderstorms are imminent. In the case of thunderstorms, turning off and unplugging and disconnecting all equipment is the only way to protect your system from damaging lightning strikes). This practice of leaving your equipment powered up applies as well to the SCPC-100.

Virtually every LNB exhibits some amount of temperature induced frequency drift. This drift goes unnoticed on the video channels but can create a problem when tuning the very narrowband services of SCPC. If it appears the SCPC receiver is drifting, it probably isn't; it's the LNB. The better the quality of the LNB the less drift will be exhibited. Thus, a top quality LNB which remains constantly powered up is critical for SCPC reception and for the SCPC-100 to function properly.

## SCPC-100 Innovations

The Universal SCPC-100 receiver has introduced several innovations to the world of



NOW!

## A QUALITY SATELLITE SCPC AUDIO RECEIVER

AT AN AFFORDABLE PRICE



### UNIVERSAL SCPC-100 AUDIO RECEIVER

#### SPECIFICATIONS

STABLE, MICROPROCESSOR CONTROLLED TUNING. • 50 CHANNEL MEMORY RECALL • COMPATIBLE WITH 950-1450 BLOCK SYSTEMS. • 3 MINUTE HOOK-UP. • LARGE L.E.D. TUNING SCALE. • RECEIVES C AND KU BAND SCPC. • DOES NOT DISABLE VIDEO WHEN IN USE.

#### SERVICES ON SCPC

HUNDREDS OF QUALITY SCPC CHANNELS ON SATELLITES - SPORTS - AP - UPI - RADIO NETS - HOME TOWN SPORTS & RADIO - RACING - TALK SHOWS - CLASSICAL, ROCK & JAZZ - RADIO STATIONS - FINANCIAL NEWS AND MORE.

PRICE \$439.<sup>00</sup> + S&H — TO ORDER CALL: 1 - 800 - 241-8171

### UNIVERSAL ELECTRONICS, INC.

4555 GROVES RD., SUITE 13, COLUMBUS, OH 43232  
(614) 866-4605 FAX (614) 866-1201

consumer grade SCPC receivers. First is the LED read-out relative logging scale. This four digit electronic display simplifies the function of tuning. A four digit number can be logged to correlate with any received signal. The big advantage here is that the number can be stored in a non-volatile memory bank. Thus the guess work of trying to return to the signal is eliminated. The 50 channel memory bank should be more than adequate for most listeners.

Another innovation is the two button tuning feature which tunes at a slow speed at first, but increases in tuning speed as the buttons are held. This allows one to tune rapidly through the transponder to get to the desired signals. Releasing the buttons returns you to the original tuning speed.

And last, but by no means least, there is a drift compensation feature which allows all stored memory channels to be shifted en masse up or down to compensate for any drift which may occur in your LNB.

### A Matter of Relativity

All SCPC receivers tune frequencies relative to the frequency stability of your LNB. Thus networks which appear at a certain logging frequency on one system may not be there when the receiver is disconnected and attached to a different system. This is why there is no standard listing of frequencies. The other reason for the lack of such a listing is that many of the broadcasters using SCPC delivery do so on very irregular schedules. Any detailed listing would be hopelessly out of date by the time it was committed to print.

An SCPC listener should create a log of what is heard when and where in order to keep track of the hundreds of transmissions. The information logged, however, would be pertinent only to the system on which it was logged. To aid in this effort, two logging sheets are provided with the SCPC-100. These should be used as original copies to be duplicated before entering actual loggings.

### The Downside

Into each product review a little rain must fall. The SCPC-100 has a very small audio amplifier which is used to drive a small external speaker (which the consumer provides). I would like to see a "line out" jack on the back of the unit so that it could be easily connected to a graphic equalizer and then to a stereo system with decent sized speakers. It is possible to hook this unit into your stereo as is, but a "line out" jack would be much more expedient.

Some consumers may be disappointed in their experience with SCPC reception, but the

SCPC-100 will not be to blame. Attempting very narrowband reception, such as SCPC, will put your current TVRO installation to a stringent test. Any shortcomings in the set-up of your satellite system will be magnified by trying to listen to SCPC. This, however, is not a cause for despair. It should be motivation to get out there at the dish site and peak the whole system up to par. Not only will you be getting better SCPC reception, but your video will improve dramatically.

### Final Notes

The SCPC-100 is available from Universal Electronics, Inc., 4555 Groves Road, Suite 13-MT, Columbus, OH 43232; phone 614-866-4605. The suggested retail price is \$450.

The only periodical which regularly publishes a list of SCPC services is the *The Satellite Channel Chart*. It is 32 pages, 8-1/2" x 11" format, and is published six times per year. A one year subscription is \$65. Requests for back-issue sample copies should be accompanied by a couple of dollars to help offset the postage and handling. In addition to the SCPC services, you'll also see every channel on every satellite, including all the FM subcarriers as well. Write Westsat Communications, P.O. Box 434-MT, Pleasanton, CA 94566 or call 510-846-7200.

### Transponder Notes

*Satellite Business News* reports that Digital Planet, a CD quality premium audio service located on Spacenet 1 channels 1 and 21, is to link up with satellite receiver manufacturer Echosphere to sell the service to the TVRO market. But in a concurrently running issue of *Multichannel News*, a cable trade journal, Digital Planet is said to be facing severe financial difficulty.

### Mailbag

• David Uribe of Brooklyn, NY, is looking for plans to build a 20 to 30 foot dish as he is going to South America and will not be able to afford to buy one. He would like a recommendation for construction plans.

David, depending on where in South America you are going, you may not be able to receive satellite signals which are beamed to North America. You may be too far out of the "footprint." In any case, building a 20 to 30 foot dish would likely cost many times more than purchasing a commercially built dish which would also do a better job. One company specializes in dishes for the Caribbean basin market and has a very nice 13.5 foot dish at a price that is very reasonable. Contact: Antenna Engineering Inc., David Johnson, President, 2220 Taylor Rd., Searcy, AR 72143.

• Glenn Cook, W7BNM, from Portland, OR, has some very good advice on purchasing RV satellite systems as discussed in the July *MT*. After experiencing a problem with a local RV satellite system dealer, he suggests prospective customers do some research regarding the company from which they intend to buy. These systems are not cheap and a good deal of your hard earned money and valuable time is at stake. Glenn urges you to call the Better Business Bureau, your State Department of Justice and your local Federal Trade Commission. Find out if your dealer has a reputation you should be aware of.

In fact, this advice applies when making any satellite system purchase. Unfortunately, this industry has not enjoyed the best image it might have, due to unscrupulous dealers.

MT

## The Simplicity of Simplex

What do the frequencies 52.525, 146.52, 223.50 and 446.0 MHz have in common? If you said they are the national calling frequencies on the four most popular VHF bands, you would be right. Amateurs use these frequencies when looking for a simplex contact, then normally switch to one of the other simplex frequencies. Simplex is communicating on one frequency; that is, both stations use the same input and output frequency.

It seems that a large portion of the new hams getting into the hobby do not really understand what this simplex thing is all about. Too often the new ham will load his VHF FM rig up with all of the popular repeater frequencies and get on and chat with the other users of the repeaters. There is nothing wrong with this to be sure; but there is a lot of fun to be had working simplex.

If you hear someone on the local repeater telling his friend to go to simplex, what is being said is: "Let's stop using the repeater because we can communicate directly without the machine." This is beneficial for several reasons. It eliminates wear and tear on the repeater, gives other users who may not be able to work simplex a chance to use the machine, and encourages others to follow the example.

A popular practice is to call someone on a repeater and request a simplex contact (not the national calling frequency). A station looking for a simplex contact using the calling frequency can call CQ if he wishes, but CQ is not normally used in this situation. Rather, the station will say, "N3IK listening on 52" (if he is on two meters) and then listen for a response. When contact is established both amateurs should move to another simplex frequency.

### DX

Many amateurs enjoy chasing DX on simplex. Often FM DXers employ good sized beam antennas and higher power than the average repeater user. My experience has been that 10 to 25 watts coupled to a decent beam antenna will allow communications up to 60 to 75 miles under normal conditions on 50, 146, 220 or 446 MHz. Often, contacts halfway around the world are waiting on six meters and QSOs of over a thousand miles are not uncommon on two or 220.

446 MHz does not normally propagate as well as the lower frequencies, but enough DX can be had to keep life interesting. Naturally, a good, high location is a plus. If your QTH is high and in the clear, contacts of 200 plus miles are routine (using a beam antenna).

"Rag chewing" is a very popular pastime on simplex. Many communities have simplex calling/monitoring frequencies which often become very active after dark. Round robin contacts of 10 to 20 stations are fairly common although the average number of stations taking part in a round

robin is five or six. Subjects discussed vary enough that even the most jaded HF op will pick up his ears and take note. This is a super way to meet new friends, and gain a wider range of interests.

### Gear

As mentioned earlier, 10 to 25 watts will let you have a lot of fun, and will allow you to work almost anything you can hear. Many stations use low power handi-talkies and work DX just fine. Of course higher power will get you noticed faster! The main objection to powers of over, say, a hundred watts is the interference you will cause to others. High power should be reserved for the true weak signal work such as moonbounce or meteor scatter on CW or SSB.

A good beam is essential for consistently good results on simplex; and of course a rotor to aim the beam. Use the best grade of feedline obtainable to feed your antenna (especially if lengths of more than 50 feet or so are involved). Commercial beams vary from simple two element to 18 or 20 element Yagis. Often two or more antennas will be stacked to increase gain and directivity. Homebrew beam antennas frequently take on different shapes. One popular and very good beam is called a Quagi and is described in detail in the ARRL's *Antenna Handbook* (available from most amateur equipment dealers).

A high gain monopole such as the Cushcraft Ringo Ranger is a good addition for working mobiles or during a roundtable. Such an antenna will allow monitoring 360 degrees for incoming signals, and when the proper direction is identified the beam can be correctly aimed at the DX station. Of course, since the gain of this type of antenna will be lower than that of a beam, you may not hear DX stations, but you *will* hear other stations calling them, which will alert you to the fact that they are there.

### Expeditions

One very enjoyable aspect of simplex DXing is going on mini DXpeditions. All you need do is find a good high spot and take your FM gear and a small beam. You will have a ball. With only one watt of power and a simple, four element, homebrew, fold-up beam, I have worked stations hundreds of miles away, and when conditions are good, it is easy to work up to 1200 miles or so. On top of it all you get to enjoy a day in the country. Pick a rare location and you will quickly become a popular person. (Grid locations are based on latitude and longitude and used for the VHF Century Club award; see the ARRL operating manual for full details).

### Getting involved

The easiest way to get involved in simplex operation is to connect your FM rig to a good outside antenna and monitor the national calling frequencies. If you have a scan mode or a scanner, program in all of the simplex frequencies to locate the active ones in your area. Often it is possible to break into an ongoing contact by simply saying "hello" or "may I join you?" Of course if a frequency is open, just announce yourself by saying your call and the listening freq you are tuned to, e.g., "N3IK listening 525," and wait for a reply.

The simplex frequencies are as follows.

6 Meters	2 Meters	1-1/4 Meters	3/4 Meters
52.490	146.52	223.42	223.78
52.510	146.535	223.44	223.80
52.525	146.55	223.46	223.82
	146.565	223.48	223.84
	146.56	223.50	223.86
	146.595	223.52	223.88
	147.42	223.54	223.90
	147.465	223.56	
	147.45	223.58	
	147.465	223.60	
	147.48	223.62	
	147.495	223.64	
	147.51	223.66	
	147.525	223.68	
	147.54	223.70	
	147.555	223.72	
	147.57	223.74	
	147.585	223.76	
			445 to 447

While these are the established frequencies, some localities may use other frequencies. This is perfectly okay as long as you do not interfere with a repeater input frequency. As a side note, please do not try to DX repeaters; it may sound like fun, but for the repeater users it is a pain in the neck! Too often trying to open one repeater at some distance will cause many machines to key up to no good use.

### State of the Art?

When was the last time you had a really satisfying QSO? You know what I mean—a QSO where you actually talked to each other. For most of us it has been far too long.

Wouldn't the personal satisfaction be as great if you won the award by getting to know the folks whose QSL is necessary to receive the certificate?

Ask the question, "why did I get into ham radio?" of yourself. Most of us did so in order to talk to people to get to know more about our planet and to gain technical knowledge about communications.

Yeah, I know you don't speak Russian or whatever, and sometimes the quickie QSO is the only way to go, but for a few bucks you can purchase a book that will let you communicate in a rudimentary way. One such book is the *Radio Amateur's Conversation Guide* containing a lot of phrases of value to hams. Translations from English to German, French, Italian, Span-



Bob Leonard's

## Ham DX Tips

Summer is over, the holiday season is still some time away and maybe you feel like nothing new and exciting will happen for a while. Well, you're wrong! It's a new DX season! Propagation is picking up; bands that were dead are now alive with new DX targets. Let's just take a look...

**AMERICAN SAMOA** Look for KH8/G4ZVJ operated by Andy Chadwick (3 Park Villas, Monkhouse, Cheadle, Stoke-on-Trent, ST10 1HZ, England) operating RTTY (check around 14085-14095 kHz) and SSB (check 14222 kHz at 0500 UTC) and the other DX nets starting on 2 September for seven days. Andy also hopes to make a trip to the other side of the island and operate 5W1JV from Western Samoa as well. **BANGLADESH** Fully accredited by the government for whom he works, look for S21A operating SSB at 1600 UTC on either 21335 or 21295 kHz on 15 meters. He may also appear on 14200-14210 kHz if 15 meter propagation is not too good. If you log this one, send your reports (with an SASE, please) to his QSL manager: W4FRU, John Parrott, P.O. Box 5127, Suffolk, VA 23435. **CONGO** TN1AT can be found every 1st and 3rd Saturday of the month on 2100 UTC on 14256 kHz SSB. Send QSL requests to his manager: F6FNU, Antoine Baldeck, B.P. 14, F-91291 Arpajon Cedex, France. **CROATIA** This former province of Yugoslavia was granted the prefix 9A by the International Telecommunications Union on June 3 and amateurs started using the prefix on 5 July. 9A2PM (whose QSL manager is: KA9WON, Benard H. Mortiz, 565 Larkdale Row, Wauconda, IL 60084) has been appearing daily on 14243 kHz SSB between 0200 and 0600 UTC. Listen to his callsign carefully, as another station 9A2MP has been heard operating on 20 meters SSB at the same time! **GEORGIA** If you need this country, try for UF6FJ who appears on 14200 kHz SSB Fridays at 2000 UTC. Send your reports to his QSL manager: Lars Peter Henneberg Jacobsen, Toften 18, DK-7323, Give, Denmark. **IRAQ/JORDAN** Yes, you can log an amateur from Iraq, and yes, you can obtain a QSL for the effort. Y10EB has been showing on 14251 kHz SSB daily at 0400 UTC and on RTTY on 21085 kHz at 1430 UTC daily. Often, his QSL manager, JY3ZH, (Zecan Hussein, Box 11020, Amman, Jordan) accompanies him on the 14251 kHz SSB operation. So, now you have a chance to log both countries and send reports to one address! **KAMPUCHEA** Working for a UN medical team here is G3NOM, who hopes to be active RTTY on 14085 kHz at 1200 UTC using the callsign of XV1NOM. He requests for QSL's be sent to G0CMM, A.R. Woodhouse, 24 Taylor Close, Hampton Hill, Greater London, TW12 1LE. **MIDWAY ISLAND** KH3AF (QSL to: Box 764, APO AP 96558) and KH3AE (Richard D. Giles, P.O. Box 976, APO AP 96558) will be using the former LORAN towers and antenna arrays (they are designed for low frequency operations) on 160 meters (check 1824 to 1840 kHz) every weekend now through December. They will transmit CW and some SSB at 0200, 0400 and 0500 UTC, listening for responses shortly thereafter each day. You can also find KH3AE weeknights on 142451 kHz SSB at 0300 UTC. **USA** If you're in the Chicago area on 12 September, you might want to check the annual W9 DXCC DX Convention to be held at the Glen Ellyn Holiday Inn. This annual DX event draws ham DXers from around the world, offering you a chance to see some of the people you may have heard. There will be discussions and presentations by participants in the recent South Sandwich and Clipperton DXpeditions, authorities on propagation and antennas and spot checking of QSLs for *CQ Magazine's* awards. The registration starts at 8 am CDT and the programs start at 9 am CDT. **VENEZUELA** YV500EA is a special station operated by the Association of Radio Amateurs of Venezuela (ARV) to celebrate the 500th anniversary of Columbus' discovery of the Americas. The station will be active on all HF amateur bands CW, SSB and RTTY 'til 12 October. The QSLing address is: ARV, P.O. Box 3636, Caracas, 1010-A, Venezuela.

Hope everyone has a good and safe Labor Day weekend, a good Rosh Hashanah and to our friends in Australia, a good and safe Father's Day.

ish, Portuguese, Russian and Japanese are included. The book is available from most ham dealers.

Naw, I'm not selling a book, I am only pointing out how useless it is to sit around waiting to work a guy on South Kawasaki Island for ten seconds just to say you worked him. I say, so what!

If for one would like to see contests limited to perhaps a dozen per year. Awards should be few and far between with maybe only WAC, WAS, and DXCC (limited to 100 countries, no honor roll). Maybe then we will get back to ham radio. See ya next month.

73, Ike, N3IK

## RF SIGNAL DISTRIBUTION

### Multiple signal monitoring in the .1 to 1000 MHz range

Increase your S/N before receivers using WI-COMM low noise (NF3dB) multicouplers  
RC06 with better linearity  
RC24 with better noise figure

Having (paging) interference problems while monitoring your scanner frequencies? Then consider WI-COMM super linear (IP55dBm) multicouplers  
CRC11 for 30 to 500 MHz  
CRC43 for 30 to 900 MHz

- 115/230VAC power supply
- 4-32 outputs to receivers
- Rx-Rx isolation 20 dB
- Fixed gain 3-12 dB
- 19" rack mounted enclosure
- BNC/TNC/N/SMA connectors



**WI-COMM ELECTRONICS INC.**  
P.O. Box 5174, Massena, NY 13662  
Ph. (315) 769-8334

### BOOST RECEPTION! Catch All the Action!

• **MINI-BOOSTER:** A powerful miniature ACTIVE ANTENNA amplifier module that fits INSIDE your radio's telescoping antenna will pick up SW signals like a 50 to 100 foot long wire antennal Will not harm AM, FM reception. Easy to install (no-soldering) into any Sangean ATS-803 or Realistic DX-440. EXCLUSIVE FEATURES: Can be bypassed using special power switch sequence, contains important interference-fighting BC HPF, operates from radio's batteries (very little battery drain). Assembled/tested: \$34.95

• **ACTION TAPE CONTROLLER:** Patches your scanner to your tape recorder, activating it only while your scanner is picking up some action! Plugs into recorder and scanner's speaker jack. Condense an entire night's scanning into minutes! Switchable "hang" time, no batteries or AC power needed. Comes assembled/ tested, in an attractive case w/all cables/plugs supplied: \$33.95

• **OTHER PRODUCTS:** FM WIRELESS SPEAKER RELAY BC FILTERNOTCH (fights broadcast interference), RECORD-OUT JACK UPGRADE for the DX-440, RECORDER PATCH CABLE for the ATS803A/DX440. To order, send check or MO, add \$4 shipping per order

CATALOG: To get our latest catalog, send a 29 cent stamp or call  
**Worldcom Technology P.O. Box 3364**  
Ft Pierce, FL 34948 (407) 466-4640

### QSL DESIGNS for SWL, CB, Ham

We produce a personalized, ready-to-print design on quality 60 lb. bond. Simply take it to your local printer for the quantity, color, and stock of your choice. A super value!

— send SASE for our free samples —

QSL Prints  
P.O. Box 112  
W. Henrietta, NY 14586



## Radio USA Busted, Yoder Fined \$17,500

As noted in the July "Communications" column, a June 8 FCC news release said that veteran pirate station **Radio USA** has received a Notice of Apparent Liability for "willful and repeated operation of an unlicensed broadcast station." A fine of \$17,500 was issued by the FCC on May 21 to Andrew R. Yoder of Chambersburg, Pennsylvania.

With the exception of **Radio New York International's** operations from a ship off Long Island in October 1988, the **Radio USA** shutdown was the biggest FCC pirate bust in decades. The \$17,500 fine is the largest sanction ever issued to a pirate in the United States.

Yoder has been extremely prominent in the DX hobby for many years. His excellent book, *Pirate Radio Stations: Tuning Into Underground Broadcasters*, is available from Universal Shortwave and many other *MT* advertisers. He edits a biweekly "Pirate Pages" newsletter, operates the Blue Ridge Summit maildrop, and writes a monthly "DX Clip Board" column in the *ACE* bulletin of the Association of Clandestine Radio Enthusiasts.

The FCC says that Mr. Blue Sky of **Radio USA** has transmitted punk rock music and comedy from various locations in Michigan, Ohio, Pennsylvania, New York, West Virginia, Virginia, and Tennessee. According to the FCC, the February 23 bust at Yoder's parents' home in Springs, Pennsylvania, came while the station was off the air.

Both Yoder and FCC Laurel, Maryland, Office Engineer-in-Charge Robert J. Douchis suprisingly went straight to the media with their respective sides of this story. *MT* reader Dwight Weidman sends in an article from the Hagerstown, Maryland, *Morning Herald* that quoted both Yoder and Douchis at length. Both men were quickly interviewed by WWCR's "Signals" DX program. Yoder printed both the FCC Notice of Apparent Liability and his written reply to the FCC in his July *ACE* column.

### Strange Circumstances

The circumstances of the **Radio USA** bust are unusual on both sides. \$7,500 of the fine was issued because Yoder refused entry to an FCC agent for a station inspection. But, Yoder holds no FCC radio license, the agent did not possess

a search warrant, and the "knock on the door" at 3:30 a.m. was certainly not during "normal business hours" when the FCC has authority to inspect licensed stations. This portion of the FCC fine seems clumsy at best.

Yoder claims that the FCC's evidence is flimsy and entirely circumstantial, and he denies the FCC allegations. Many suspect that the FCC's large fine is intentionally excessive, for purposes of intimidating a prominent pirate DXer.

On the other hand, between September 28, 1991, and February 23, 1992, when the FCC noted five **Radio USA** broadcasts, DX hobby bulletins document that the station actually was on at least 37 times during this five month period! On six of these days, **Radio USA** was on the air for more than two hours, topped by a 7-1/2 hour marathon schedule on January 26. Obviously the station was broadcasting excessively. It's puzzling, since Mr. Blue Sky is an experienced pirate who should have known better.

We will keep our eye on this major story, and we'll cover any significant future developments.

### Outrageous British Laws

Andy Cadier of Folkestone, Kent, in England sends in some disturbing news this month. European *MT* readers are certainly familiar with *Short Wave Magazine*, published by Practical Wireless. The British Government's Radiocommunications Agency (RA), a rough equivalent to the American FCC, has censored Andy's "Off the Record" column in the magazine. This column is similar to the "Outer Limits."

Fraser Murray of the Radio Investigation Service of RA says that in England, "it is an offence to publish the times or other details of any unauthorized broadcasts made by a pirate broadcaster." The RA threatens violators with "an unlimited fine and/or two years imprisonment." Thus, *Short Wave Magazine's* issues now have "heavily curtailed" pirate loggings coverage.

Fortunately, goofy and outrageous laws like this do not prevail in Brasstown. I was formerly under the impression that the United Kingdom was a free country, but I stand corrected.

### Omega Radio Busted

Although full details were not immediately available by the deadline for this column, *MT* has learned that Dick Tator of **Omega Radio** has received a Notice of Apparent Liability from the FCC. Dick was fined \$10,000. As we noted in August, station QSL's have been referring to a prior "visit" by FCC officials.

### Arkansas Pirates

David Sheley of Blytheville, Arkansas, forwards some interesting logs of local FM and AM pirates. He hears **X Radio** identifications from "northeast Arkansas" over a frequently active local FM pirate on 88.5 MHz. This station programs an eclectic mix of rock, country, cajun, brass band, and classical music. They also feature election results and community affairs shows.

David also notes a citizens band bootleg station on the very unusual AM frequency of 1300 kHz. With local candidate Bill Clinton on this year's Presidential ballot, **X Radio** could offer some interesting listening!

### Europirates

Peter Hills of **Radio Waves International** forwards the current schedule used by this European pirate. Look for them Saturdays at 2000-2300 and Sundays from 0200-1200, all times UTC. The station currently operates on 7473 and 11401 kHz, and they sometimes are reported by listeners in the Western Hemisphere. If you hear them, reports go to Boite Postale 130, 92504 Rueil, France.

Regular *MT* contributor Ed Rausch of Cedar Grove, New Jersey, bagged **DLR-106** on 6220.8 kHz at 0345. This operation normally relays an Irish FM station. Along with **Radio FAX** on 6205 kHz, it's a good one to check out as a Europirate propagation beacon.

### Illinois FM Pirates

**Black Liberation Radio** (107.1 MHz in Springfield, Illinois) and **Liberation Radio** (an FM pirate in Decatur, Illinois) are back in the news. Springfield Police Chief George Murphy has accused **Black Liberation Radio** of "fueling the fire" and "promoting unrest" during local



riots following the Rodney King police acquittal verdict in Los Angeles. In response, station operator Mbanna Kantako and spokesman Mike Townsend scheduled a "Black Counterattack Against Genocide" seminar at Sangamon State University in Springfield. Police officials claimed that the station was broadcasting positions of police officers during the riot. But, the station characterized the situation as a "rebellion" against the Rodney King verdict.

Meanwhile, Liberation Radio operator Napoleon Williams continues his legal battle against local police and the Illinois Department of Children and Family Services. We discussed his case in the June "Outer Limits." Napoleon solicits correspondence and assistance. If you're interested, you can write him at 756 Wise Street, Decatur, Illinois 62522.

## Strange Signals

- Nancy Ellen Walker of Gap, Pennsylvania, heard a "Mike India Whiskey Two" numbers station marker on 3890 kHz in the 80 meter ham band at 0500. Curiously, at 0600 the synthesized female voice changed suddenly to "Where are we, India, Briefcase, Two." The transmission came on March 23, and I wonder if any news in the Middle East that day might have been correlated?

- Al Underwood of Silver Springs, New York, reports numerous logs of the "foghorn" on 4625 kHz. But, at 0230 he also heard it loud and clear on a third harmonic frequency of 13875 kHz! Many have assumed that the foghorn's "braaapp" noise is an over the horizon radar system, but Al wonders why they would generate strong harmonics like this.

- Finally, Todd Dokey of Lodi, California, reports clear S9 Morse code signals from both KKN44 and KKN50 on 11474 kHz at 0115. These stations are licensed in Monrovia, Liberia, and Washington, DC, so Todd wonders how he could hear this two-way contact at 6:15 p.m. local time in California, with both stations punching through loudly. That's a good question, Todd. Many have speculated for years that these USA government stations may not always be located in Monrovia and Washington as advertised.

## Pirates Heard Lately

We are again buried in pirate loggings, despite a couple of high profile FCC busts and loud summer static levels. Seven different maildrop addresses are used by stations listed this month: P.O. Box 109, Blue Ridge Summit, PA 17214; P.O. Box 452, Wellsville, NY 14895; P.O. Box 69, Wolf Run, OH 43970; P.O. Box 146, Stoneham, MA 02180; P.O. Box 293, Mer-



J.R. "Bob" Dobbs of the Voice of Bob.

lin, Ontario N0P 1W0; P.O. Box 493, Boys Town, NE 68010; and P.O. Box 25302, Pittsburgh, PA 15242.

Ed Rausch and others forwarded a rumor heard on the "Signals" DX program that the Wolf Run address has closed. *MT* definitely confirms that this rumor is false, per direct information from the "droperator."

**Action Radio** 7415 at 0215. A. J. Michaels mixes rock oldies and novelty songs with parody ads from a transmitter off the western coast of Nebraska. New addr: Boys Town. (Alan Pavuk, North Huntingdon, PA)  
**CSIC**- 7413 at 0230. The Canadian Pirate Rambo, with his Psycho Chicken interval signal, has been pretty active lately with rock, comedy, mailbags, pirate commentary, and relays of other stations. Addr: Blue Ridge Summit. (Robert Confino, Douglassville, PA)  
**EBO Radio**- 7415 at 2130. This new station initially featured rock and test announcements from a country club in South Carolina. Addr: Wellsville. (George Zeller, Cleveland, OH)

**Jolly Roger International**- 7415 at 0500. Blackbeard the Pirate hosts a very well produced mix of rock and amusing comedy sketches. Addr: none, but reads reports on the ANARC computer BBS at (913) 345-1978. (Skip Harwood, Beale AFB, CA)

**Radio Anarchy**- 7419 at 0415. Recently has supplemented its punk rock anarchist format with flute music; not to be confused with the **Voice of Anarchy**. Addr: Blue Ridge Summit. (Harwood)

**Radio Boston**- 7413 at 0215. The QSL from this new rock oldies station features three bikini-clad women on a boat at the Boston Yacht Club! Addr: Stoneham. (Rausch)

**Saudi Sam**- 7415 at 0115. Originally associated with the 1991 Gulf War, the station has returned with rock music and comedy from the Persian Gulf. Bob's first pirate! Addr: Wolf Run. (Bob Dutcher, Brooklyn, NY)

**Secret Mountain Laboratory**- 7415 at 0100. SML's folk music and mellow male announcer have been favorites of pirate fans for over eight years now. Addr: Wellsville. (Pat Murphy, Chesapeake, VA)

**Voice of "Bob"**- 7415 at 0200. This veteran station, the voice of the Church of the Subgenius in Dallas, Texas, is a hilarious parody of fundamentalist preachers. The "Bob" on this station is not named Grove! Addr: Wellsville. (Murphy)

Isn't Your Radio Worth The Investment?

Protect It With

**THE PACK-IT**

FROM TRANSEL TECHNOLOGIES

**TRANSEL TECHNOLOGIES**

Protect your HT's, Cellular Phones, Pagers, and any other devices you carry that may be subject to damage.

The PACK-IT is made of 1/4" neoprene material which is safety belt sewn to the nylon protective backing. The PACK-IT doesn't fray like many other materials and is safe to wash whenever needed.

The strap and 2" beltloop is made from commercial grade webbing and is secured in the front with a Velcro hook and loop assembly.

The PACK-IT doesn't wear the radio like leather and protects the radio from the small falls which occurs in everyday usage. The neoprene material is a cushion material which not only covers the radio but also protects it. Various sizes available so call for the size to fit your need.

Made In The USA!

**\$15.95** + \$3.00 S&H

**1 (800) 829-8321**

Dealers Welcome

## The Pirate Radio Directory

by George Zeller

Profiles on 170+ Pirate Stations

\$9.95 + \$2 S/H

Tiare Publications

P.O. Box 493

Lake Geneva, WI 53147

**WARI**- 7415 at 2145. The announcer on Alternative Radio International says that his rock is the best music on shortwave. Addr: Wellsville. (Murphy)

**WEED**- 7415 at 0430. This one features rock music and pro-marijuana advocacy "from the Great Southwest." Addr: still none. (Harwood)

**WCYC**- 7415 at 2230. The World's Craziest Young Children usually mix rock music with pirate commentary. Addr: Blue Ridge Summit. (Rausch)

**WHIZ**- 7416 at 0030. A heavy metal rock station that normally uses upper sideband modulation. Addr: none. (Rausch)

**WKND**- 7415 at 0100. Many heard this one in June with instrumental music, but the male announcer did not sound like usual host Radio Animal. Addr: Pittsburgh. (Rausch)

**WNAR, New Age Radio**- 7415 at 0245. So far the only programming here has been a female announcer on a loop identification tape over new age music. Addr: none. (Rausch)

**WSRN**- 7415 at 0030. This new addition to the bands features rock, folk music, and novelty songs like Kinko the Clown from the Wisconsin Sick Radio Network. Addr: Merlin. (Murphy)

*MT*

**Closeout!**

# The 1991 Satellite TV Sourcebook

(includes '92 update)

was \$12.95, **NOW ONLY \$5.95!\***

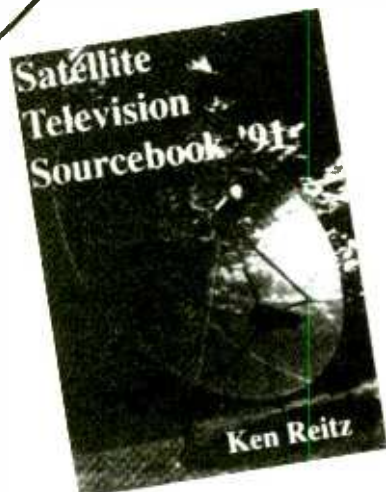

Whether you are a seasoned satellite veteran or a newcomer to the Clarke Belt, this ultimate reference to TV satellites will provide more diverse information than anything else on the market.

Lists of dealers, manufacturers and publishers, including addresses and phone numbers, for magazines, books and equipment. Detailed chapters on how satellite TV works, installing your system, lightning protection, tips for optimum reception.

C band, Ku band, weather, amateur, and even international satellites are covered. Approximately 500 transponders and their users identified.



**ORDER BOK19 NOW!**



**GROVE ENTERPRISES, INC.  
1-800-438-8155**

140 DOG BRANCH ROAD  
BRASSTOWN, NC 28902-0098

While Supplies Last!  
Closeout Price!

\* Plus \$4 UPS Shipping

**NEW BOOK!**

# Guide to the AR1000

If you think that your AR1000 manual was a bit thin, then here is your solution! Howard Bornstein has come to the rescue with this extensive look inside the AR1000. The guide is divided into an operations chapter; an applications chapter; an accessories chapter; and a detailed reference section which lists thoroughly the uses of every pushbutton and control on the scanner.

A handy, fold-out, quick-lookup chart is included at no extra charge to carry along just in case you forget what all the buttons are for. The Guide to the AR1000 also applies to the AR1000X, AR1000XC, AR1000XLT, AR2000, AR2800, and the Fairmate models HP100, HP200 and HP2000 as well. This guide is now available from Grove Enterprises for only \$14.95\*.

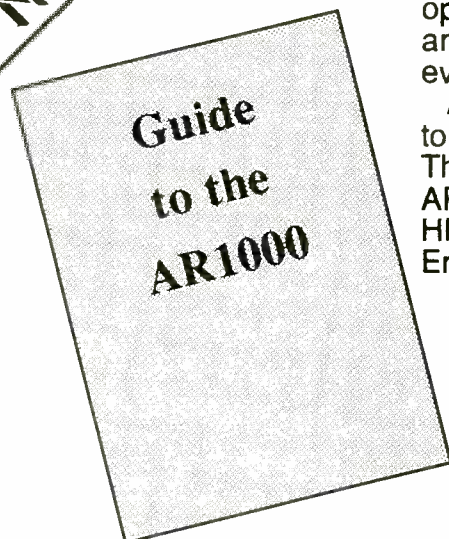

**ONLY \$14.95\* (Order BOK 61)**



**GROVE ENTERPRISES, INC.  
1-800-438-8155**

140 Dog Branch Road  
Brasstown, NC 28902-0098  
Hours: 8am-5pm, Monday-Friday

\* Plus \$4 UPS Shipping



**NEW BOOK!**

# ARRL Radio Frequency Interference Handbook

As more and more electronic devices come into play in today's society, more and more interference is generated by these devices. This new book from the ARRL thwarts both new and old radio interference problems. From tracing the source to shielding the receiver, this book has everything you need to know about solving the annoyance of interference.

Now available from Grove for only \$14.95\*. 235 pages, 8-1/2" x 11", perfect bound.

**RADIO FREQUENCY INTERFERENCE:**

How to Find It and Fix It



\* Plus \$4 UPS Shipping

**\$14.95\* (Order BOK 60)**



**GROVE ENTERPRISES, INC.**

**1-800-438-8155**

140 Dog Branch Road  
Brasstown, NC 28902-0098

**SEE MORSE, RTTY, FAX AND TOR  
LIKE YOU'VE NEVER  
SEEN THEM BEFORE!**



VGA, the top-of-the-line in personal computer graphics, now blazes into the amateur radio market in the all-new Universal M-8000. With stunning color, lightning character display and dazzling features, the M-8000 puts professional quality into your communications position. More than just a pretty picture, the M-8000 offers both old and new decoding modes including: RTTY, packet, ASCII, FDM, FEC-TOR, ARQ-TOR, Morse, WEFAX, and Piccolo. And because of its built in microprocessor, no PC is necessary.

Now with

**VGA**



**ONLY \$1298.95!\***

**GROVE ENTERPRISES, INC.**  
**1-800-438-8155**  
 140 Dog Branch Road  
 Brasstown, NC 28902-0098

\* Plus \$20 UPS Shipping

**ORDER: DEM6**

**Accessories:**

**KIT01 - 19" Rack Panel  
Mounting Kit - \$19.95**





Who doesn't like to save a few cents... especially when it comes to international mail! An Aerogramme could be your answer. Aerogrammes are single sheets that when folded and sealed create an all-in-one letter. Although they do restrict any enclosures, aerogrammes may be used for a briefer reception report to stations that do not require return postage. Aerogrammes are available through your local post office for forty-five cents in blue or white paper stock with preprinted postage on the face.

Postal cards are economical as well, provided you can condense your program details to postcard size. Don't forget that if your card is not printed by the United Postal Service, it should designate "postcard" on the face.

Why not stock up on Aerogrammes and airmail Postal Cards...and save yourself a few cents!



IRCS. Station address: Station Reception de la Marine, Pointe de Sables, 97200 Fort de France, Martinique. (Stanley Klemanowicz, Torrance, CA)

**AIRCRAFT TRAFFIC**

United Air Lines-Flight 862, Boeing 747, 5547 MHz. Verification letter returned and signed by R. Roedler-Senior Staff Representative. Received in eight days for an English utility report, and a stamped-self-addressed envelope. Airline address: c/o United Airlines-Flight Dispatch, P.O. Box 66100, Chicago, IL 60666. (Marilyn Mayer, San Francisco, CA)

**BOTSWANA**

Voice of America Relay, 7265 kHz. Full data Botswana Relay card, verified by Dan Ferguson. Received in 42/109 days for an English report and mint stamps (returned). Station address: Washington, DC 20547. (Mike Hardester, Jacksonville, NC) (Richard M.Earnhardt, Charlotte, NC)

**CYPRUS**

Nicosia Radio-5BA 42 RT, 8737.5 kHz. Full data letter with illegible signature. Received in 43 days for an English utility report and one IRC. Station address: Cyprus Telecommunications Authority, Head Office, Telecommunications St., P.O. Box 4929, Nicosia 142, Cyprus. (Nahl Martin, Austrian DX Club)

**IRAN**

VOIRI, Voice of the Islamic Republic of Iran, 9720 kHz. Partial data unsigned QSL card. 92' calendar, and magazine "Echo of Islam" included. Received in 80 days for an English report. Station address: P.O. Box 3333, Tehran, Iran. (Steve Hunter, Drexel Hill, PA)

**JAPAN**

Radio Tanpa, 6115 kHz. Full data color design card, unsigned. Received in 34 days for an English report, cassette program tape, and two IRCs. Station address: Nihon Shortwave Broadcasting Co., Ltd., 9-15 Akasaka 1-chome, Minato-ku, Tokyo 107 Japan. (David A. Gasque, Orangeburg, SC)

**LEBANON**

Wings of Hope, 11530 kHz. Full data world map card, verified by Mark Christian. Received in 40 days for an English report and one IRC. Station address: P.O. Box 3379, Limassol, Cyprus (QSL mailed from Israel). (Sam Wright, Biloxi, MS)

**MARTINIQUE**

FUF-16963 kHz. Partial data station card, unsigned. Received in 40 days for a French utility report and three

SEA CHALLENGER-ELEZ9, 156.65 MHz. (Cargo/Bulk Carrier). Full data prepared QSL card verified by Radio Officer. Received in 53 days for an English utility report and one U.S. dollar. Ship address: Sanko Marine Co., Ltd., Shin-Hibiyo Bldg. 3rd Floor, 3-6 Uchisawari-Cho Chiyoda-ku, Tokyo 100, Japan. (Holbrook, MD)

**SPAIN**

Ministerio de Obras Publicos y Transportes-ECA 7, 6918.5 kHz. Full data letter, verified by "Dieters". Station stickers and brochure included. Received in 22 days for an English utility report, and one IRC. Station address: c/o Madrid Meteo, Instituto Nacional de Meteorologia, Servicio de Universitaria, 28040 Madrid, Spain. (Martin, Austria)

**SRI LANKA**

SLBC, 9720 kHz. Full data color studio card, verified by Director-Audience Research. Received in 58 days for an English report. Station address: Colombo 7, Sri Lanka. (Cathy Turner, Yonkers, NY) (Gigi Lytle, Lubbock, TX)

**SWITZERLAND**

Swiss Radio Int'l, 12035/6135/6190/9885 kHz. Full data QSL card, without veri signer. Received in 26/42/59 days for an English report. Station address: CH-3000 Berne 15, Switzerland. (Mc Ferrin, MI) (Adams, NJ) (Klemanowicz, CA) (Wright, MS)

**TURKEY**

Voice of Turkey, 9445 kHz. Partial data Turkish Art card, without veri signer. Program schedule, station stickers, pennant, and tourist brochure included. Received in 22 days for an English report and mint stamps. Station address: P.O. Box 333, 06.443 Ankara, Turkey. (Doug Merkel, St. Louis, MO) (Adams, NJ)

**UNITED KINGDOM**

Radio FAX, 6205 kHz. Partial data QSL and personal note from Trevor Brook. Received in 122 days for an English report, and one U.S. dollar. Station address: Cranleigh, England, United Kingdom GU6 7BG. (Turner, NY)

**UNITED STATES**

KMI-Maritime Radio, 8743.7 kHz. Full data QSL card and personal note, verified by G. Sperling-Duty Suprv. Received in 20 days for an English utility report. Station address: KMI High Seas Radiotelephone Station, Pt. Reyes, CA 94956. (Mayer, CA)

KNLS-Alaska, 7355 kHz. Full data map QSL card verified by Beverly Jones. Received in 32 days for an English report and a stamped-self-addressed envelope. Station address: P.O. Box 473, Anchor Point, AK 99556. (Harold Frodage, Midland, MI) (Earnhardt, NC) (Dave Frenz, Milwaukee, WI)

OAS (Organization of American States), 11830 kHz. Partial data, unsigned QSL card. Received in 12 days for a Spanish report, mint stamps, and a souvenir postcard. Station address: 17th St. & Constitution Ave., N.W., Washington, DC 20006. (Stephen R. Hunter, Drexel Hill, PA) This station accepts English reports, too.

USCG Mars Station-NNNONCG, 14383.5 kHz. Full data station QSL with letter-fact sheet, verified by RM1 Matthew E. Skahill. Received in 17 days for an English report and a stamped-self-addressed envelope. Station address: 7323 Telegraph Rd. Alexandria, VA 22310-3999. (Hill, MI)

**NETHERLANDS ANTILLES**

Trans World Radio-Bonaire, 9535/11930 kHz. Full data QSL card, verified by Sally Rork. Station souvenirs, program schedule, and travel brochures included. Received in 35 days for an English report and two IRCs. Station address: Bonaire, Netherlands Antilles. (Hardester, NC) (Nicholas P. Adams, Port Murray, NJ) (Chris Hughes, Portland, OR) (Wright, MS) (Michael Mc Ferrin, Smith Creek, MI)

**NEW CALEDONIA**

FUJ-16958 kHz. Full data station letter, verified by M.J.R. Trans Jorand. Received in 64 days for a French utility report, and three IRCs. Station address: Boite Postal 38, Noumea, New Caledonia, French Polynesia. (Klemanowicz, CA)

**SHIP TRAFFIC**

CAPE LOBOS-KEBA, 8297 kHz. (Military Roll-On/Roll-Off). Full data prepared QSL card, verified by D.R. Pops-Radio Officer, and stamped with ship's seal. Received in 180 days for an English utility report and a stamped-self-addressed envelope. Ship address: U.S. Maritime Administration, 400 7th SW, NASSIF Bldg., Washington, DC 20590. (Russ Hill, Ferndale, MI)

MC KINNEY MAERSK-OUZW2, 156.65 MHz. (Container Vessel). Full data prepared QSL card verified by Radio Officer. Received in 23 days for an English utility report and one U.S. dollar. Ship address: DFDS/A/S, Sankt Anna Plads 30, DK-1295, Copenhagen, Denmark. (Hank Holbrook, Dunkirk, MD)

OLYMPIC MELODY-SZLK, 156.600 MHz. (Bulk Carrier). Full data prepared QSL card, verified by Ipsalantis Pavlos-Chief Radio Officer and stamped with ship's seal. Received in 300 days for an English utility report, and one IRC. Ship address: Springfield Shipping Co., 85 Atki Miaouli, Piraeus TK 18538, Greece. (Hill, MI)

POMEROL-KALC, 156.65 MHz. (Heavy Oil Carrier). Full data prepared QSL card verified by Radio Officer. Personal letter and ship photo included. Received in 47 days for an English utility report, and mint stamps. Ship address: Apex Oil Co., 8182 Maryland Ave, St. Louis, MO 63105 (Holbrook, MD)

M/S SAN NICOLAS-DGZP, 16.528 kHz (German Container). Full data prepared QSL card, verified by Pedrito Zurita-Radio Officer and stamped with ship's seal. Received in 30 days for an English utility report, two U.S. dollars, and a souvenir postcard. Station address: Claus Peter Offen KG, Gaensemarkt 24, W-2000 Hamburg 36, Germany. (Rick Albright, Merced, CA)

**How to Use the Shortwave Guide****1: Convert your time to UTC.**

Eastern and Pacific Times are already converted to Coordinated Universal Time (UTC) at the top of each page. The rule is: convert your local time to 24-hour format; add (during Daylight Time) 4, 5, 6, or 7 hours for Eastern, Central, Mountain, or Pacific Time, respectively.

Note that all dates, as well as times, are in UTC: for example, the BBC's "Ken Bruce Show" (0030 UTC Sunday) will be heard on Saturday evening (8:30 PM Eastern, 5:30 PM Pacific) in North America, not on Sunday.

**2: Choose a program or station you want to hear.**

Some selected programs appear on the lower half of the page for prime listening hours. If it's news you're interested in, check out the complete "Newline" listing, which begins on the next page.

Occasionally program listings will be followed by "See X 0000." This information indicates that the program is a re-run, and refers to a previous summary of the program's content. The letter stands for a day of the week, as indicated below, and the four digits represent a time in UTC.

S: Sunday  
M: Monday  
T: Tuesday  
W: Wednesday  
H: Thursday  
F: Friday  
A: Saturday

**3: Find the frequencies for the program or station you want to hear.**

Look at the page which corresponds to the time you will be listening. Comprehensive frequency information for English broadcasts can be

found at the top half of the page. All frequencies are in kHz..

The frequency listing uses the same day codes as the program listings; if a broadcast is not daily, those day codes will appear before the station name. Irregular broadcasts are indicated "tent" and programming which includes languages besides English are coded "v1" (various languages).

**4: Choose the most promising frequencies for the time, location, and conditions.**

Of course, every station can't be heard all the time. To help you find the right frequency, we've included information on the target area of each broadcast. Frequencies beamed toward your area will generally be easier to hear than those beamed elsewhere, even though the latter will often still be audible. Every frequency is followed by one of these target codes:

am: The Americas	me: Middle East
na: North America	as: Asia
ca: Central America	au: Australia
sa: South America	pa: Pacific
eu: Europe	va: various
af: Africa	do: domestic broadcast
me: Middle East	om: omnidirectional

Consult the propagation charts. To further help you find the right frequency, we've included propagation charts at the back of this section, which take into account conditions affecting the audibility of shortwave broadcasts. Simply pick out the region in which you live and find the chart for the region in which the station you want to hear is located. The chart indicates the optimum frequencies for a given time in UTC.

**Programs for Shortwave Listeners:** This section, published quarterly, lists programs with news and information about shortwave radio for listeners. (RR) denotes reruns of programs broadcast earlier in the week. For brevity, only programs at certain peak listening times are included.

**Sundays**

0018 Swiss Radio Int'l: Swiss Shortwave Merry-Go-Round  
0025 Spanish National Radio: DX Spot  
0039 HCJB: DX Party Line  
0106 Radio Czechoslovakia: DX Special  
0110 Voice of America (am, ca): Communications World  
0117 Deutsche Welle: World DX Meeting (monthly)  
0125 Spanish National Radio: DX Spot (RR)  
0140 Radio Havana Cuba: DX'ers Unlimited  
0200 Radio For Peace Int'l: World Of Radio  
0200 WRNO: World Of Radio  
0215 KSDA, Guam: DX Asiawaves  
0218 Swiss Radio Int'l: Swiss SW Merry-Go-Round (RR)  
0239 HCJB: DX Party Line (RR)  
0240 Radio Romania Int'l: DX Mailbag  
0240 Voice of Free China: Radio Corner  
0250 Radio Budapest: DX News  
0305 WWCR: World Of Radio  
0317 Deutsche Welle: World DX Meeting (monthly) (RR)  
0330 TWR, Bonaire: Bonaire Wavelengths  
0330 Voice of Turkey: DX Corner or Economic Panorama  
0340 Radio Havana Cuba: DX'ers Unlimited (RR)  
0406 Radio Czechoslovakia: DX Special (RR)  
0418 Swiss Radio Int'l: Swiss SW Merry-Go-Round (RR)  
0509 HCJB: DX Party Line (RR)  
0517 Deutsche Welle: World DX Meeting (monthly) (RR)  
0525 Spanish National Radio: DX Spot (RR)  
0635 Radio Korea: Shortwave Feedback  
1130 Radio Austria Int'l: Austrian Shortwave Panorama  
1135 Radio Korea: Shortwave Feedback (RR)  
1250 Radio Korea: Shortwave Feedback (RR)  
1330 Radio Austria Int'l: Austrian Shortwave Panorama (RR)  
1435 Radio Korea: Shortwave Feedback (RR)  
1440 FEBC Radio Int'l, Philippines: DX Report  
1530 Radio Austria Int'l: Austrian Shortwave Panorama (RR)  
1530 Radio Japan: Media Roundup  
1635 Radio Korea: Shortwave Feedback (RR)  
2300 Radio For Peace Int'l: World Of Radio (RR)  
2330 Radio Japan: Media Roundup (RR)

**Mondays**

0105 Radio Korea: Shortwave Feedback (RR)  
0110 Radio Tashkent: DX Program (monthly)  
0145 FEBC Radio Int'l, Philippines: DX Dial  
0330 Radio Austria Int'l: Austrian Shortwave Panorama (RR)  
0340 Voice of Free China: Radio Corner (RR)  
0430 Radio New Zealand Int'l: Mailbox (biweekly)  
0630 Radio Austria Int'l: Austrian Shortwave Panorama (RR)  
0637 BRT, Brussels: Radio World  
1307 BRT, Brussels: Radio World (RR)  
1320 Koi Israel: DX Corner  
1400 Voice of the Mediterranean: DX Program  
1435 All India Radio: DX'ers Corner (biweekly)  
1500 Radio For Peace Int'l: World Of Radio (RR)  
2320 Radio Vilnius: Feature For DX'ers

**Tuesdays**

0040 All India Radio: DX'ers Corner (biweekly) (RR)  
0600 Voice of the Mediterranean: DX Program (RR)  
1130 Radio Australia: Communicator  
1243 Radio Sweden: MediaScan (biweekly)  
1510 Polish Radio, Warsaw: DX Program  
1513 Radio Sweden: MediaScan (biweekly) (RR)  
1530 Radio Australia: Communicator (RR)

**Wednesdays**

0040 Radio Havana Cuba: DX'ers Unlimited (RR)  
0113 Radio Sweden: MediaScan (biweekly) (RR)  
0213 Radio Sweden: MediaScan (biweekly) (RR)  
0240 Radio Havana Cuba: DX'ers Unlimited (RR)  
0250 Radio Budapest: DX News (RR)  
0300 Radio For Peace Int'l: World Of Radio (RR)  
0415 BBC: Waveguide  
0440 Radio Havana Cuba: DX'ers Unlimited (RR)  
0640 Radio Havana Cuba: DX'ers Unlimited (RR)  
1100 Radio For Peace Int'l: World Of Radio (RR)  
1210 Polish Radio, Warsaw: DX Program (RR)

**Thursdays**

0014 Radio Czechoslovakia: DX Special (RR)  
0100 HCJB: Ham Radio Today  
0130 BBC: Waveguide (RR)

0150 Radio Netherlands: Media Network  
0215 RAE, Buenos Aires: DX Actuality  
0300 HCJB: Ham Radio Today (RR)  
0314 Radio Czechoslovakia: DX Special (RR)  
0340 Radio Sofia: Calling Amateurs And DX'ers  
0530 HCJB: Ham Radio Today (RR)  
1350 Radio Netherlands: Media Network (RR)  
1540 FEBC Radio Int'l, Philippines: DX Dial (RR)  
1550 Radio Netherlands: Media Network (RR)

**Fridays**

0050 Radio Netherlands: Media Network (RR)  
0250 Radio Netherlands: Media Network (RR)  
0350 Radio Netherlands: Media Network (RR)  
1140 Radio Sofia: Radio Sofia Calling  
1350 FEBC Radio Int'l, Philippines: DX Spot  
1511 Radio Portugal: DX Program (monthly)

**Saturdays**

0030 Radio Sofia: Radio Sofia Calling (RR)  
0120 FEBC Radio Int'l, Philippines: DX Report (RR)  
0241 Radio Portugal: DX Program (monthly) (RR)  
0250 Radio Budapest: DX World  
0340 Radio Sofia: Radio Sofia Calling (RR)  
0400 Radio For Peace Int'l: World Of Radio (RR)  
0618 Swiss Radio Int'l: Swiss Shortwave Merry-Go-Round (RR)  
0635 BRT, Brussels: Radio World (RR)  
1118 Swiss Radio Int'l: Swiss Shortwave Merry-Go-Round (RR)  
1130 TWR, Bonaire: Bonaire Wavelengths (RR)  
1200 Radio For Peace Int'l: World Of Radio (RR)  
1210 Voice of America: Communications World (RR)  
1305 BRT, Brussels: Radio World (RR)  
1318 Swiss Radio Int'l: Swiss Shortwave Merry-Go-Round (RR)  
1340 Radio Tashkent: DX Program (monthly) (RR)  
1510 Radio Romania Int'l: DX Mailbag (RR)  
1518 Swiss Radio Int'l: Swiss Shortwave Merry-Go-Round (RR)  
1615 KSDA, Guam: DX Asiawaves (RR)  
2330 KSDA, Guam: DX Asiawaves (RR)  
2335 BRT, Brussels: Radio World (RR)  
2350 Radio Nacional, Bogota: Colombia DX



**MT Monitoring Team**

P.O. Box 98, Brasstown, NC 28902-0098

**Greg Jordan**

Frequency Manager

North Carolina

Call 919-661-0095 7-11 pm

with updates

**Dave Datko**

California

**B.W. Battin**

New Mexico

**Jacques d'Avignon**

Propagation Forecasts

Ontario, Canada

**Kannon Shanmugam**

Program Manager

Kansas

**John Carson**

Oklahoma

**Jim Frimmel**

Texas

**October Deadline:  
August 28****newsline**

"Newsline" is your guide to news broadcasts on the air. • All broadcasts are world news reports unless followed by an asterisk, which means the broadcast is primarily national news. • All broadcasts are daily unless otherwise noted by the day codes.

**0000 UTC****(8:00 PM EDT, 5:00 PM PDT)**

BBC  
CBC, Northern Quebec  
Christian Science Monitor  
Croatian Radio, Zagreb [M-A]  
Radio Australia  
Radio Beijing  
Radio Czechoslovakia  
Radio Havana Cuba [T-S]  
Radio Luxembourg  
Radio Moscow  
Radio New Zealand Int'l  
Radio Sofia  
Radio Thailand  
Radio Ukraine Int'l  
SBC Radio 1, Singapore  
Spanish National Radio  
Swiss Radio Int'l  
Voice of America  
WWCR [T-A]

**0005**

Radio Pyongyang

**0010**

Radio Beijing\*

**0030**

All India Radio  
Christian Science Monitor (SE Asia) [M]  
Christian Science Monitor [T-F]  
HCJB

Radio Havana Cuba [T-S]

Radio Korea

Radio Netherlands

Radio New Zealand Int'l [M-F]

Radio Yugoslavia

Voice of America (Americas, East Asia) (Special English) [T-S]

Voice of America (East Asia) (Special English) [M]

**0045**

Radio Korea (News Service)

**0055**

WRNO [W, A]

**0100 UTC****(9:00 PM EDT, 6:00 PM PDT)**

BBC  
CBC, Northern Quebec [S-M]  
Christian Science Monitor  
Croatian Radio, Zagreb [S]  
Deutsche Welle

FEBC Radio Int'l, Philippines

Radio Australia

Radio Belize

Radio Canada Int'l [S-M]

Radio Czechoslovakia

Radio Havana Cuba [T-S]

Radio Japan

Radio Luxembourg

Radio Moscow

Radio New Zealand Int'l [M-A]

Radio Tashkent

Radio Thailand

Radiotelevisione Italiana

SBC Radio 1, Singapore

Spanish National Radio

Voice of America

Voice of Indonesia

WWCR [T-A]

**0115**

Radio Havana Cuba\* [T-S]

**0125**

Radio Korea [T-A]

**0130**

Christian Science Monitor (SE Asia) [M]

Christian Science Monitor [T-F]

Radio Austria Int'l

Radio Finland [T-A]

Radio Havana Cuba [T-S]

Radio Netherlands

Radio Yugoslavia

Voice of Greece [M-A]

**0155**

Voice of Indonesia

**0200 UTC****(10:00 PM EDT, 7:00 PM PDT)**

BBC

CBC, Northern Quebec [T-S]

Christian Science Monitor

Deutsche Welle

Radio Australia

Radio Budapest

Radio Canada Int'l [T-A]

Radio Havana Cuba [T-S]

Radio Moscow

Radio New Zealand Int'l [M-F]

Radio Romania Int'l

Radio RSA

Radio Thailand

RAE, Buenos Aires [T-A]

SBC Radio 1, Singapore

Swiss Radio Int'l

Voice of America

Voice of Free China

Voice of Myanmar

WWCR [T-A]

**0215**

Radio Cairo

Radio Nepal

**0230**

Christian Science Monitor

(Africa, Middle East) [M]

Christian Science Monitor [T-F]

HCJB

Radio Havana Cuba [T-S]

Radio Iraq Int'l

Radio Moscow

Radio Netherlands

Radio Pakistan (Special English)

Radio Portugal [T-A]

Radio Tirana

SLBC, Sri Lanka

**0250**

Radio Yerevan

**0300 UTC****(11:00 PM EDT, 8:00 PM PDT)**

BBC

CBC, Northern Quebec

Christian Science Monitor

Deutsche Welle

Radio Australia

Radio Bahrain

Radio Beijing

Radio Belize

Radio Czechoslovakia

Radio Havana Cuba [T-S]

Radio Japan

Radio Moscow

Radio New Zealand Int'l [T-F]

Radio RSA

Radio Sofia

Radio Thailand

SBC Radio 1, Singapore

Voice of America

Voice of Free China

Voice of Turkey

WRNO [F]

WWCR [T-A]

**0310**

Radio Beijing\*

**0315**

Radio Cairo

Radio Havana Cuba\* [T-S]

**0330**

BBC (Africa)\*

Christian Science Monitor

(Africa, Middle East) [M]

Christian Science Monitor [T-F]

Radio Austria Int'l [T-A]

Radio Bahrain

Radio Havana Cuba [T-S]

Radio Netherlands

Radio Tirana

UAE Radio, Dubai

**0340**

Voice of Greece [M-A]

**0355**

Radio Japan [M-F]

WYFR (Network) [T-A]

**0400 UTC****(12:00 AM EDT, 9:00 PM PDT)**

BBC

CBC, Northern Quebec [T-S]

Christian Science Monitor

Deutsche Welle

Kol Israel

Radio Australia

Radio Bahrain

Radio Beijing

Radio Canada Int'l

Radio Czechoslovakia

Radio Havana Cuba [T-S]

Radio Moscow

Radio New Zealand Int'l [W-F]

Radio Romania Int'l

Radio RSA

Radio Tanzania

Radio Thailand

SBC Radio 1, Singapore

Swiss Radio Int'l

Voice of America

**0405**

Radio Pyongyang

**0410**

Radio Beijing\*

**0425**

Radiotelevisione Italiana

**0430**

BBC (Africa)\* [M-A]

Christian Science Monitor

(Africa, Asia) [M]

Christian Science Monitor [T-F]

Radio Bahrain

Radio Botswana

Radio Havana Cuba [T-S]

Radio Moscow (World Service)

**0450**

Radio RSA

**0500 UTC****(1:00 AM EDT, 10:00 PM PDT)**

BBC ("Newshour")

CBC, Northern Quebec

Christian Science Monitor

Deutsche Welle

HCJB

Radio Australia

Radio Bahrain

Radio Japan

Radio Lesotho

Radio Moscow

Radio New Zealand Int'l [M-F]

Radio RSA

Radio Thailand

SBC Radio 1, Singapore

Spanish National Radio

Voice of America

WWCR

**0510**

Radio Botswana

**0515**

Radio Canada Int'l [M-F]

**0520**

Radio Finland [T-A]

**0530**

Christian Science Monitor

(Africa, Asia) [M]

Christian Science Monitor [T-F]

Radio Austria Int'l

Radio Moscow (World Service)

Radio Romania Int'l

Radio Thailand

RTM, Malaysia

UAE Radio, Dubai

Voice of Nigeria

**0545**

Voice of Nigeria\*

**0550**

Radio For Peace Int'l [T-A]

**0600 UTC****(2:00 AM EDT, 11:00 PM PDT)**

BBC

Christian Science Monitor

Deutsche Welle

## newsline

- GBC Radio, Accra\*  
Radio Australia  
Radio Bahrain  
Radio Havana Cuba [T-S]  
Radio Korea  
Radio Moscow  
Radio New Zealand Int'l  
Radio RSA  
SBC Radio 1, Singapore  
Swiss Radio Int'l  
Voice of America  
WWCR [M-A]  
**0603**  
Croatian Radio, Zagreb [M-A]  
**0605**  
Radio Pyongyang  
**0609**  
BBC\*  
**0610**  
Voice of Malaysia  
**0630**  
BBC (Africa)\*  
BRT, Brussels  
Christian Science Monitor [M-F]  
Radio Austria Int'l [T-A]  
Radio Havana Cuba [T-S]  
Radio Moscow (World Service)  
RTV Congolaise, Brazzaville [M-F]  
Voice of Nigeria  
**0640**  
Radio Czechoslovakia  
**0645**  
Radio Finland [T-A]  
Radio Romania Int'l  
Voice of Nigeria\*  
**0655**  
Radio Korea [M-F]
- 0700 UTC**  
**(3:00 AM EDT, 12:00 AM PDT)**  
BBC  
Christian Science Monitor  
GBC Radio, Accra  
MBC, Blantyre, Malawi [M-A]  
Radio Australia  
Radio Havana Cuba [T-S]  
Radio Japan  
Radio Moscow  
Radio New Zealand Int'l [M-F]  
SBC Radio 1, Singapore  
SLBS, Freetown, Sierra Leone  
Voice of Free China  
Voice of Myanmar  
**0703**  
Croatian Radio, Zagreb [S]  
**0705**  
Radio Pyongyang  
**0715**  
Radio Havana Cuba\* [T-S]  
**0730**  
BBC (Africa)\* [M-A]  
Christian Science Monitor [M-F]  
HCJB  
Radio Austria Int'l  
Radio Czechoslovakia  
Radio Ghana  
Radio Havana Cuba [T-S]  
Radio Moscow (World Service)  
Radio Netherlands  
**0745**  
Radio For Peace Int'l [T-A]  
**0755**  
Radio Japan [M-F]
- 0800 UTC**  
**(4:00 AM EDT, 1:00 AM PDT)**  
BBC  
Christian Science Monitor  
GBC Radio 1, Accra [S]  
GBC Radio 2, Accra  
MBC, Blantyre, Malawi [S]  
Radio Australia  
Radio Bahrain  
Radio Finland [T-A]  
Radio Korea  
Radio Moscow  
Radio New Zealand Int'l [S-F]  
Radio Pakistan  
SBC Radio 1, Singapore  
SLBS, Freetown, Sierra Leone  
Voice of Indonesia  
**0803**  
Croatian Radio, Zagreb [M-A]  
**0805**  
Radio Pyongyang  
**0810**  
Voice of Malaysia  
**0830**  
Christian Science Monitor [M-F]  
Radio Austria Int'l  
Radio Finland [T-A]  
Radio Netherlands  
**0840**  
Voice of Greece [M-A]  
**0855**  
Radio Korea [M-F]  
Voice of Indonesia
- 0900 UTC**  
**(5:00 AM EDT, 2:00 AM PDT)**  
BBC  
BRT, Brussels [M-A]  
Christian Science Monitor  
Deutsche Welle  
GBC Radio 1, Accra [M-F]  
GBC Radio 2, Accra  
MBC, Blantyre, Malawi [M-A]  
Radio Australia  
Radio Bahrain  
Radio Beijing  
Radio Japan  
Radio Moscow  
Radio New Zealand Int'l [S-M, W-H]  
SBC Radio 1, Singapore  
Swiss Radio Int'l  
Voice of Nigeria  
**0903**  
Croatian Radio, Zagreb [S]  
**0910**  
Radio Beijing\*  
**0915**  
Radio Korea (News Service)  
**0930**  
Christian Science Monitor [M-F]  
Deutsche Welle (Africa)\* [M-F]  
Radio Afghanistan  
Radio Moscow  
Radio Netherlands  
**0940**  
Radio Togo  
**0950**  
Radio Pacific Ocean [A]  
**0955**  
Radio Japan [M-F]
- 1000 UTC**  
**(6:00 AM EDT, 3:00 AM PDT)**  
All India Radio  
BBC  
Christian Science Monitor  
GBC Radio 2, Accra [A]  
HCJB  
Kol Israel  
MBC, Blantyre, Malawi [S]  
Radio Australia  
Radio Bahrain  
Radio Beijing  
Radio Moscow  
Radio New Zealand Int'l  
Radio RSA  
Radio Tanzania  
SBC Radio 1, Singapore  
Voice of America  
**1010**  
Radio Beijing\*  
**1030**  
Christian Science Monitor [M-F]  
MBC, Blantyre, Malawi [M-F]  
Radio Austria Int'l [M-F]  
Radio Korea  
Radio Moscow  
RTM, Malaysia  
UAE Radio, Dubai  
Voice of Nigeria  
**1040**  
Voice of Greece [M-A]  
**1055**  
All India Radio
- 1100 UTC**  
**(7:00 AM EDT, 4:00 AM PDT)**  
BBC  
CBC, Northern Quebec [A-S]  
Christian Science Monitor  
Deutsche Welle  
GBC Radio, Accra [A-S]  
MBC, Blantyre, Malawi [A-S]  
Radio Australia  
Radio Bahrain  
Radio Japan  
Radio Jordan  
Radio Korea  
Radio Moscow  
Radio New Zealand Int'l [S-F]  
Radio Pakistan  
Radio RSA  
Radio Sofia  
SBC Radio 1, Singapore  
Swiss Radio Int'l  
TWR, Bonaire [M-F]  
Voice of America  
WWCR [M-F]  
**1105**  
Radio Pakistan (Special English)  
Radio Pyongyang  
**1110**  
Radio Belize [T-A]  
Radio Botswana [M-F]  
**1115**  
Radio Korea (News Service)  
Radio Nepal  
**1125**  
Radio Belize [M]  
Radio Botswana [A-S]  
Radio Finland [T-F]  
**1130**  
BRT, Brussels [S]  
Christian Science Monitor [M-F]  
Deutsche Welle\* [M-F]  
Radio Austria Int'l [M-F]  
Radio Lesotho  
Radio Moscow  
Radio Yugoslavia  
RTM, Malaysia\*
- 1135**  
Radio Thailand  
**1150**  
Radio RSA  
**1155**  
Radio Japan [M-F]  
Radio Korea [M-F]
- 1200 UTC**  
**(8:00 AM EDT, 5:00 AM PDT)**  
BBC  
CBC, Northern Quebec [A-S]  
Christian Science Monitor  
MBC, Blantyre, Malawi [M-F]  
Polish Radio, Warsaw  
Radio Australia  
Radio Bahrain  
Radio Beijing  
Radio Canada Int'l [M-F]  
Radio Moscow  
Radio Nacional do Brasil [M-A]  
Radio New Zealand Int'l  
Radio Tashkent  
Radio Thailand  
RTM, Malaysia  
SBC Radio 1, Singapore  
SLBC, Sri Lanka  
Voice of America  
WWCR [M-F]  
**1203**  
Croatian Radio, Zagreb  
**1209**  
BBC\* [M-A]  
**1210**  
Radio Beijing\*  
**1215**  
HCJB [M-F]  
Radio Korea  
**1230**  
Christian Science Monitor [M-F]  
Radio Cairo  
Radio Finland [T-F]  
Radio France Int'l  
Radio Moscow  
SLBC, Sri Lanka  
TWR, Bonaire [A-S]  
Voice of Turkey  
**1235**  
Voice of Greece  
**1245**  
SLBC, Sri Lanka  
**1255**  
WYFR (Network) [M-F]  
**1257**  
HCJB [M-F]  
**1258**  
Africa Number One, Libreville
- 1300 UTC**  
**(9:00 AM EDT, 6:00 AM PDT)**  
BBC ("Newshour")  
BRT, Brussels [M-A]  
CBC, Northern Quebec  
Christian Science Monitor  
GBC Radio, Accra  
Kol Israel  
Radio Australia  
Radio Bahrain  
Radio Beijing  
Radio Belize  
Radio Canada Int'l [S]  
Radio Finland [A]  
Radio Jordan  
Radio Moscow  
Radio Romania Int'l
- Radio Tanzania [A-S]  
SBC Radio 1, Singapore  
Swiss Radio Int'l  
Voice of America  
**1305**  
Radio Pyongyang  
**1310**  
Radio Beijing\*  
Radio Korea [M-F]  
**1320**  
SLBC, Sri Lanka  
**1325**  
HCJB [M-F]  
**1328**  
Radio Cairo  
**1330**  
All India Radio  
Christian Science Monitor [M-F]  
FEBC Radio Int'l, Philippines  
Radio Austria Int'l [M-F]  
Radio Canada Int'l (Asia)  
Radio Finland [T-F]  
Radio Moscow  
Radio Netherlands  
Radio Tashkent  
RTM, Malaysia  
UAE Radio, Dubai  
Voice of America (Special English)  
**1346**  
All India Radio [A]  
**1350**  
Radio For Peace Int'l [T-A]
- 1400 UTC**  
**(10:00 AM EDT, 7:00 AM PDT)**  
BBC  
CBC, Northern Quebec [A-S]  
Christian Science Monitor  
GBC Radio, Accra  
MBC, Blantyre, Malawi [M-F]  
Radio Australia  
Radio Bahrain  
Radio Beijing  
Radio Belize [M-F]  
Radio Canada Int'l [S]  
Radio France Int'l  
Radio Japan  
Radio Korea  
Radio Moscow  
RTM, Malaysia\*  
SBC Radio 1, Singapore  
Voice of America  
WWCR [M-F]  
**1405**  
Radio Finland [T-A]  
**1410**  
Radio Beijing\*  
**1415**  
Radio Canada Int'l (Europe)  
Radio Korea (News Service)  
Radio Nepal  
**1425**  
HCJB [M-F]  
**1430**  
Christian Science Monitor [M-F]  
FEBC Radio Int'l, Philippines  
Radio Austria Int'l  
Radio Moscow  
Radio Netherlands  
Radio Romania Int'l  
Radio Tirana  
**1445**  
BBC (East Asia) (Special English) [M-F]  
Voice of Myanmar



# 100% PURE SCANNING ACTION!

National Scanning Report is America's fastest-growing scanning magazine. That's because every issue of National Scanning Report offers the latest in:



- \* Law Enforcement Communications
- \* Fire and Rescue
- \* Emergency Medical
- \* Listening Tips
- \* Frequency Lists
- \* New Products
- \* Aeronautical
- \* Railroad
- \* Federal
- \* Much More!



From first alarm to final clean up, National Scanning Report is crammed with up-to-date information written by and for the pros. National Scanning Report is your #1 guide to the scannerbands.™

Order your subscription today: \$17.50 gets you one year (six issues) plus a free custom frequency print-out for your county and more.

*National Scanning Report*™  
**1-800-423-1331**

OR SEND CHECK OR MONEY ORDER TO BOX 291918, KETTERING, OHIO 45429

1993 M-STREET **New**  
RADIO DIRECTORY

11,000+ station listing in US and Canada. Tons of info, cross-referenced. \$32.95 plus \$3.50 UPS or \$2.50 USPS.

Official Aeronautical **New**  
Frequency Directory **2nd**  
Edition

HF-VHF-UHF-800 Mhz  
All military and civilian aero freqs!  
\$24.95 plus \$3.50 UPS or \$2 USPS.

## Weather Radio



A complete guide. NOAA Weather Radio, VOLMET aviation weather, FAA, military, maritime weather

services. Where to tune and what you'll hear. 125 pp. \$14.95 plus 2.00 book rate or 3.50 UPS.

**SCANNER POCKET  
FREQUENCY  
GUIDE - \$2.00**

**DX RADIO SUPPLY**

P.O. BOX 360  
WAGONTOWN, PA 19376  
215-273-7823



## Austin Antenna

"The World Leader in Multiband Technology"

Manufacturers of multi-band Land Mobile, Microwave, and Scanner Antennas for Government Agency operations, Drug and Law Enforcement operations, Communications at the Kennedy Space Center and major networks such as NBC and ESPN.



*The Ultimate  
Omnidirectional  
Multiband Station Antenna*



*New Innovation brings  
New Dimensions for Portables!*

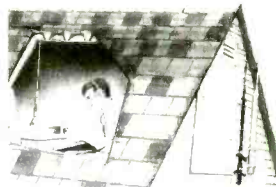
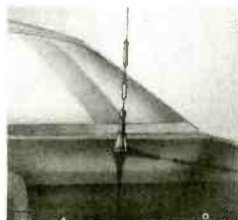

**Specira**

*Superb Performance!  
with Maximum Versatility for  
Mobile and Base Station*



Send \$1.00 for an Austin Scanner Antenna User's Guide [a regular \$3.95 value]

Austin Antenna 10 Main Street, Gonic, N.H. 03839 (603) 335-6339

## newslines

- 1455**  
All India Radio  
Radio Korea [M-F]
- 1500 UTC**  
(11:00 AM EDT, 8:00 AM PDT)  
BBC  
CBC, Northern Quebec [A-S]  
Christian Science Monitor  
Deutsche Welle  
GBC Radio 2, Accra  
Polish Radio, Warsaw  
Radio Australia  
Radio Bahrain  
Radio Beijing  
Radio Belize [M-A]  
Radio Canada Int'l [S]  
Radio Japan  
Radio Jordan  
Radio Moscow  
Radio Portugal [M-F]  
RTM, Malaysia  
SBC Radio 1, Singapore  
SLBC, Sri Lanka  
Swiss Radio Int'l  
Voice of America  
**1505**  
Radio Pyongyang  
**1510**  
Radio Beijing\*  
**1520**  
Radio Tallinn [M-F]  
**1530**  
Christian Science Monitor [M-F]  
Deutsche Welle\* [M-F]  
FEBA, Seychelles  
FEBC Radio Int'l, Philippines  
Radio Austria Int'l [M-F]  
Radio Moscow  
Radio Netherlands  
Voice of Greece [M-A]  
Voice of Nigeria  
**1540**  
Voice of Nigeria\*  
**1545**  
Radio For Peace Int'l [T-A]  
Radio Korea (News Service)
- 1600 UTC**  
(12:00 PM EDT, 9:00 AM PDT)  
BBC  
CBC, Northern Quebec [A]  
Christian Science Monitor  
Deutsche Welle  
GBC Radio 2, Accra  
MBC, Blantyre, Malawi  
Radio Australia  
Radio Bahrain  
Radio Beijing  
Radio Canada Int'l  
Radio France Int'l  
Radio Jordan  
Radio Korea  
Radio Lesotho  
Radio Moscow  
Radio Pakistan  
Radio RSA  
Radio Tanzania  
SBC Radio 1, Singapore  
Voice of America  
Yemen Radio  
**1609**  
BBC\*  
**1610**  
Radio Beijing\*  
Radio Botswana [M-F]
- 1615**  
Radio Pakistan (Special English)  
**1630**  
Christian Science Monitor [M-F]  
HCJB [M-F]  
Radio Canada Int'l  
Radio Moscow  
UAE Radio, Dubai  
Voice of America (Eu) (Spec Eng)  
WYFR (Network) [A]  
**1635**  
WYFR (Network) [M-F]  
**1655**  
Radio Korea [M-F]
- 1700 UTC**  
(1:00 PM EDT, 10:00 AM PDT)  
BBC  
CBC, Northern Quebec [A]  
Christian Science Monitor  
GBC Radio 2, Accra  
Kol Israel  
Polish Radio, Warsaw  
Radio Australia  
Radio Bahrain  
Radio Beijing  
Radio Belize [M-F]  
Radio Czechoslovakia  
Radio Japan  
Radio Moscow  
Radio New Zealand Int'l [S-F]  
Radio Pakistan  
Radio RSA  
SLBC, Sri Lanka  
Swiss Radio Int'l  
Voice of America  
**1705**  
Radio Pyongyang  
**1710**  
Radio Beijing\*  
**1715**  
Radio Korea (News Service)  
**1725**  
Radio Surinam Int'l [M-F]  
WYFR (Network) [A]  
**1730**  
Christian Science Monitor [M-F]  
Radio Moscow  
Radio Netherlands  
Radio Romania Int'l  
Radio Sofia  
**1740**  
BBC (Africa)\*  
**1750**  
Radio RSA
- 1800 UTC**  
(2:00 PM EDT, 11:00 AM PDT)  
All India Radio  
BBC  
BRT, Brussels  
CBC, Northern Quebec [M-H]  
Christian Science Monitor  
GBC Radio, Accra  
KVOH  
MBC, Blantyre, Malawi  
Radio Afghanistan  
Radio Australia  
Radio Bahrain  
Radio Belize [M-F]  
Radio Canada Int'l  
Radio Moscow  
Radio Nacional do Brasil [M-A]  
Radio New Zealand Int'l [S-F]  
Radio Portugal [M-F]  
Radio Tanzania
- Voice of America  
**1830**  
Christian Science Monitor [M-F]  
Radio Austria Int'l  
Radio Belize  
Radio Czechoslovakia  
Radio Finland [M-F]  
Radio Kuwait  
Radio Moscow  
Radio Netherlands  
Radio Yugoslavia  
Voice of America (Spec English)  
**1840**  
Voice of Greece  
**1845**  
Radio Cote d' Ivoire, Abidjan  
**1855**  
BBC (Africa)\* [M-F]  
Radio Finland  
WYFR (Network) [M-A]
- 1900 UTC**  
(3:00 PM EDT, 12:00 PM PDT)  
All India Radio  
BBC  
Christian Science Monitor [M-A]  
Deutsche Welle  
GBC Radio 2, Accra\*  
HCJB  
Kol Israel  
KVOH  
Radio Australia  
Radio Beijing  
Radio Canada Int'l  
Radio Iraq Int'l  
Radio Japan  
Radio Korea  
Radio Moscow  
Radio New Zealand Int'l [S-F]  
Radio Portugal [M-F]  
Radio Romania Int'l  
Radio Tanzania  
RAE, Buenos Aires [M-F]  
SLBS, Freetown, Sierra Leone  
Spanish National Radio  
Voice of America  
**1910**  
Radio Beijing\*  
Radio Botswana  
**1920**  
Voice of Greece  
**1930**  
Christian Science Monitor [M-F]  
Deutsche Welle\* [M-F]  
Polish Radio, Warsaw  
Radio Ghana  
Radio Moscow  
Radio Netherlands  
Voice of Nigeria  
**1935**  
Radiotelevisione Italiana  
**1945**  
Radio Sofia  
Radio Togo  
**1955**  
BBC (Africa)\* [M-F]  
Radio Korea [M-F]
- 2000 UTC**  
(4:00 PM EDT, 1:00 PM PDT)  
BBC  
CBC, Northern Quebec [S-F]  
Christian Science Monitor  
GBC Radio, Accra  
KVOH  
MBC, Blantyre, Malawi
- Radio Australia  
Radio Bahrain  
Radio Beijing  
Radio Belize [M-F]  
Radio Czechoslovakia  
Radio Havana Cuba [M-A]  
Radio Moscow  
Radio New Zealand Int'l [S-F]  
SLBS, Freetown, Sierra Leone  
Swiss Radio Int'l  
Voice of America  
Voice of Indonesia  
Voice of Nigeria  
Voice of Turkey  
**2005**  
Radio Pyongyang  
**2010**  
Radio Beijing\*  
**2025**  
Radio Havana Cuba\* [M-A]  
Radiotelevisione Italiana  
WYFR (Network) [M-F]  
**2030**  
Christian Science Monitor [M-F]  
Radio Havana Cuba [M-A]  
Radio Moscow  
WYFR (Network) [A]  
**2045**  
Radio Korea (News Service)  
**2055**  
Voice of Indonesia
- 2100 UTC**  
(5:00 PM EDT, 2:00 PM PDT)  
All India Radio  
BBC ("Newshour")  
BRT, Brussels  
CBC, Northern Quebec [S-F]  
Christian Science Monitor [M-A]  
Deutsche Welle  
GBC Radio 2, Accra\*  
KVOH  
MBC, Blantyre, Malawi  
Radio Australia  
Radio Bahrain  
Radio Beijing  
Radio Belize [M-F]  
Radio Budapest  
Radio Canada Int'l  
Radio Czechoslovakia  
Radio Japan  
Radio Moscow  
Radio New Zealand Int'l [S-F]  
Radio Romania Int'l  
Radio Ukraine Int'l  
Radio Yugoslavia  
SLBS, Freetown, Sierra Leone  
Spanish National Radio  
Voice of America  
**2103**  
Croatian Radio, Zagreb  
**2110**  
Radio Beijing\*  
**2130**  
Christian Science Monitor [M-F]  
Kol Israel  
Radio Austria Int'l  
Radio Cairo  
Radio Finland [M-F]  
Radio Moscow  
Radio Vilnius  
WYFR (Network) [M-F]  
**2145**  
Radio Korea  
Radio Sofia  
**2150**  
Radio For Peace Int'l [M-F]
- 2155**  
WYFR (Network) [M-A]
- 2200 UTC**  
(6:00 PM EDT, 3:00 PM PDT)  
All India Radio  
BBC  
CBC, Northern Quebec [M-F]  
Christian Science Monitor  
CIQX, Montreal [M-F]  
GBC Radio 2, Accra  
MBC, Blantyre, Malawi  
Radio Australia  
Radio Beijing  
Radio Canada Int'l  
Radio Havana Cuba [M-A]  
Radio Moscow  
Radio New Zealand Int'l  
Radio Tirana  
Radiotelevisione Italiana  
SBC Radio 1, Singapore  
SLBS, Freetown, Sierra Leone  
Swiss Radio Int'l  
Voice of America  
Voice of Free China  
Voice of Turkey  
**2209**  
BBC\*  
**2210**  
Radio Beijing\*  
**2225**  
Radio Havana Cuba\* [M-A]  
**2230**  
Christian Science Monitor [M-F]  
Radio Havana Cuba [M-A]  
Radio Moscow  
Voice of America (Special English)  
**2240**  
Radio Korea [M-F]  
**2245**  
GBC Radio, Accra  
Voice of Greece
- 2300 UTC**  
(7:00 PM EDT, 4:00 PM PDT)  
All India Radio  
BBC  
CBC, Northern Quebec [A]  
Christian Science Monitor [M-A]  
Radio Australia  
Radio Belize [M-F]  
Radio Canada Int'l  
Radio Japan  
Radio Luxembourg  
Radio Moscow  
Radio New Zealand Int'l  
Radio Vilnius  
RTM, Malaysia  
SBC Radio 1, Singapore  
Voice of America  
**2305**  
Radio Pyongyang  
**2320**  
Radio Thailand  
**2330**  
BRT, Brussels  
Christian Science Monitor [M-F]  
Radio Moscow  
Radio Nacional, Bogota [A]  
RTM, Malaysia\*  
**2345**  
Radio For Peace Int'l [M-F]  
SLBC, Sri Lanka [M]  
**2355**  
Radio Japan [M-F]  
WRNO [W, F]



# The Best Shortwave You Can Buy Comes From Drake



The Drake R8 Communications Receiver...simply the best shortwave clarity and fidelity you'll find, outperforming receivers costing much, much more.

Famous Drake technology gives you wide frequency coverage of all world bands and excellent dynamic range...in an uncluttered package with an ergonomic front panel, featuring keypad entry of functions.

For the best access to world events as they happen, buy yourself a Drake R8 shortwave receiver. Ask your dealer for more information, or contact a Drake sales office today at **1-800-568-3795 (1-800-LOVE-SWL)**.

**DRAKE**  
We Bring the World Closer

R. L. Drake Company, P.O. Box 3006, Miamisburg, OH 45343, USA Tel: 513-866-2421  
Drake Canada, 655 The Queensway #16, Peterborough, Ontario K9J 7M1, Canada  
Tel: 705-742-3122  
1-800-568-3795 (1-800-LOVE-SWL)

©1991 The R.L. Drake Co.

## DSP from JPS

Hear how Digital Signal Processing can improve your reception!

Use our new NF-60 to  
knock out ALL  
heterodynes and tune-ups.

Remove MULTIPLE heterodynes, (tones and whistles) and tune-ups with the new NF-60 automatic DSP audio Spectral Notch Filter. The unit connects between the receiver audio output and the speaker. Contains a built-in speaker amplifier. Knocks out TUNE-UPS, CW, or RTTY tones.



NF-60

Use our NIR-10 if you're  
troubled by more than just  
heterodynes.

Reduce white/pink noise, power line noise, ignition noise AND multiple heterodynes with the NIR-10. Unit includes variable BANDPASS filter mode and automatic NOTCH filter mode. Made possible by real time Digital Signal Processing (DSP) using a 40 MHz DSP chip.

**NF-60 Introductory Price: \$149.95.**

For 115VAC to 12VDC Adapter add \$12. Charge to MasterCard or Visa. Allow 1 week for personal checks. COD additional. We pay surface shipping in the Continental United States. NC residents add 6% sales tax.

**NIR-10: Still \$395.**



**JPS Communications, Inc.**  
P.O. Box 97757 Raleigh, NC 27624

TOLL FREE ORDER LINE **1-800-533-3819**

Technical Info 1-919-790-1048 FAX 1-919-790-1456

## 0000 UTC

## [8:00 PM EDT/5:00 PM PDT]

### FREQUENCIES

0000-0027	Czechoslovakia	7345na	9580na	11990na	
0000-0030	Australia	15170va	15320va	17630as	17750as
		17880as			
0000-0030	Canada, RCI Montreal	5960am	9755am	13670am	
0000-0030 a /var	Croatian Radio via WHRI	7315na	9495na		
0000-0030	Iran, Islamic Republic	9022am	15260am	15315am	
0000-0030 sm	Norway	15165am			
0000-0030	Swiss Radio Int'l	6135na	9650na	9885na	12035na
		17730na			
0000-0030	United Kingdom, BBC London	5965as	5975na	6005af	6175na
		6195as	7145as	7325na	9580as
		9590na	9915na	11750sa	11945as
		11955as	12095na	15070na	15260sa
		15360pa	17830as		
0000-0045	Bulgaria, Radio Sofia	11660na	11720na	15330na	
0000-0050	North Korea	11335na	13760na	15115na	
0000-0100	Australia, ABC Brisbane	4920do	9660do		
0000-0100	Australia, ABC Perth	9610do			
0000-0100	Canada, CFCX Montreal	6005do			
0000-0100	Canada, CFRX Toronto	6070do			
0000-0100	Canada, CFVP Calgary	6030do			
0000-0100	Canada, CHNX Halifax	6130do			
0000-0100	Canada, CKZU Vancouver	6160do			
0000-0100	China, Radio Beijing	9770na	11715na		
0000-0100	Cook Islands	11760pa			
0000-0100	Costa Rica, AWR	9725ca	11870ca		
0000-0100	Costa Rica, RFPi	7375na	13630na	15030na	
0000-0100	Cuba, RHC Havana	11970am			
0000-0100	Guam, KSDA Guam	15610as			
0000-0100	India, All India Radio	9910as	11715as	11745as	15110as
		15135as	15145as	17830as	
0000-0100 vl	Iraq, Radio Iraq Int'l	15150na	17740sa		
0000-0100	Luxembourg, RTL	15350va			
0000-0100	Malaysia, RTM Radio 4	7295do			
0000-0100	New Zealand, RNZI	17770pa			
0000-0100	Philippines, FEBC Manila	15450as			
0000-0100	Russia, Radio Moscow	11710va	11780va	11850va	12050va
		15290va	15405va	15410va	15425va

				15485va	15560va	17560va	17570va
				17860va	17890va	21690va	
0000-0100	Sierra Leone, SLBS	3316do					
0000-0100	Singapore, SBC1	5010do	5052do	11940do			
0000-0100	South Korea, Seoul	15575na					
0000-0100	Spanish National Radio	9530na					
0000-0100	Thailand	4830as	9655as	11905as			
0000-0100	Ukraine, Kiev	7195eu	7250eu	9640eu	10344eu		
		11520eu	15570na				
0000-0100	USA, CSMonitor Boston	7395na	9850af	13760na	17555as		
0000-0100 sa	USA, CSMonitor Boston	17865as					
0000-0100	USA, KTBN Salt Lake City	15590am					
0000-0100	USA, KVOH Los Angeles	17775am					
0000-0100	USA, VOA Washington	6130am	7405am	9455am	9775am		
		11580am	11695am	15120am	15205am		
0000-0100	USA, WHRI Noblesville	7315am	9495am				
0000-0100	USA, WINB Red Lion, Penn.	15145eu					
0000-0100	USA, WJCR Upton, Kentucky	7490na					
0000-0100	USA, WRNO New Orleans	7355am					
0000-0100	USA, WWCR Nashville	7435na	12160na				
0000-0100	USA, WYFR Okeechobee, FL	5985am					
0030-0100	Australia	15320va	15365pa	15420pa	17630as		
		17715pa	17750as	17795pa	17880as		
		21740pa	21775as				
0030-0100 sm	Canada, RCI Montreal	5960am	9755am				
0030-0100	Ecuador, HCJB Quito	9745am	15155am	21455am			
0030-0100	Netherlands	6020na	6165na	9860as	11655as		
		11835na	13700as				
0030-0100	Sri Lanka B'casting Corp.	6005as	9720as	15425as			
0030-0100	United Kingdom, BBC London	5965as	5975na	6005sa	6175na		
		7135as	7325na	9580as	9590na		
		9915na	11750sa	11955as	12095na		
		15260sa	15360pa				
0030-0100 WAR/var	Yugoslavia	11870am					
0045-0100	South Korea World News	7275as					

### SELECTED PROGRAMS

#### Sundays

- 0000 Radio Norway Int'l: Norway Today. A magazine program on issues and people affecting modern-day Norway.
- 0011 Radio Moscow: Newmarket. A look at commercial products and opportunities in Russia.
- 0030 BBC: The Ken Bruce Show. Ken Bruce plays pop music, past and present.
- 0031 Radio Moscow: Audio Book Club. The best of Russian classics and contemporary Russian literature.

#### Mondays

- 0000 Radio Norway Int'l: Norway Today. See S 0000.
- 0011 Radio Moscow: Music And Musicians. See S 1211.
- 0030 BBC: In Praise Of God. Christian religious services and meditations.

#### Tuesdays

- 0011 Radio Moscow: Focus On Asia And The Pacific. News and comments on events in the region.
- 0030 BBC: Panel Game. Literature is the subject of the quiz "Slightly Foxed" (1st, 8th, 15th, 22nd).
- 0031 Radio Moscow: Interview. See M 1631.
- 0039 Radio Moscow: Music. See S 0231.

#### Wednesdays

- 0011 Radio Moscow: Focus On Asia And The Pacific. See T 0011.
- 0030 BBC: Omnibus. Topical features on almost any topic, from



*Radio Beijing's Chi Wenjie is the voice behind "Travel Talk."*

Dracula to drugs.

- 0031 Radio Moscow: Interview. See M 1631.
- 0039 Radio Moscow: Music. See S 0231.

#### Thursdays

- 0011 Radio Moscow: Focus On Asia And The Pacific. See T 0011.
- 0030 BBC: Comedy/Drama (except 30th: Two Cheers For September). See W 1530.
- 0031 Radio Moscow: Interview. See M 1631.
- 0039 Radio Moscow: Music. See S 0231.

#### Fridays

- 0011 Radio Moscow: Focus On Asia And The Pacific. See T 0011.
- 0030 BBC: Music Feature. This month, "Modern Masterpiece" looks at great contemporary works of classical music.
- 0031 Radio Moscow: Interview. See M 1631.
- 0039 Radio Moscow: Music. See S 0231.

#### Saturdays

- 0011 Radio Moscow: Focus On Asia And The Pacific. See T 0011.
- 0030 BBC: From The Weeklies. A review of the British weekly press.
- 0031 Radio Moscow: Interview. See M 1631.
- 0039 Radio Moscow: Music. See S 0231.
- 0045 BBC: Recording Of The Week. See M 0615.



0100 UTC

[9:00 PM EDT/6:00 PM PDT]

## FREQUENCIES

0100-0115	India, All India Radio	9910as	11715as	11745as	15110as				
		15135as	15145as	17830as					
0100-0115 vl	Iraq, Radio Iraq Int'l	15150na	17740sa						
0100-0120	Italy, RAI, Rome	9575am	11800am						
0100-0125	Netherlands	6020na	6165na	9860as	11655as				
		11835na	13700as						
0100-0127	Czechoslovakia	5930na	7345na	9580na					
0100-0130 twhfa	Canada, RCI Montreal	5960am	9755am						
0100-0130	Laos, National Radio of	7116as							
0100-0130 sm	Norway	9615am							
0100-0130	Sweden	9685as	11730as						
0100-0130	Uzbekistan, R. Tashkent	5930as	5995as	7190as	7265as				
0100-0150	Germany, Deutsche Welle	6040na	6085na	6145na	9565na				
		9700ra	11810na	11865na	13610na				
		1377cna	15105na						
0100-0159 sm	Canada, RCI Montreal	9535am	9755am	11845am	11940am				
		13720am							
0100-0200	Australia	15240pa	15320va	15365pa	17630as				
		17715pa	17750as	17795pa	17880as				
		21740pa	21775as						
0100-0200	Australia, ABC Brisbane	4920do	9660do						
0100-0200	Australia, ABC Perth	9610do							
0100-0200	Canada, CFCX Montreal	6005do							
0100-0200	Canada, CFRX Toronto	6070do							
0100-0200	Canada, CFVP Calgary	6030do							
0100-0200	Canada, CHNX Halifax	6130do							
0100-0200	Canada, CKZU Vancouver	6160do							
0100-0200	Cook Islands	11760pa							
0100-0200	Costa Rica, RFPi	7375na	13630am						
0100-0200	Cuba, RHC Havana	11970am							
0100-0200	Ecuador, HCJB Quito	9745am	15155am	21455am					
0100-0200	Indonesia, Voice of	7125as	9675as	11752as	11785as				
0100-0200	Japan NHK	5960na	11840me	15195as	17810as				
		17835as	17845as						
0100-0200	Luxembourg, RTL	15350va							
0100-0200 smtwh	Malaysia, RTM Radio 4	7295do							
0100-0200	Namibia BC Corp, Windhoek	3290af							
0100-0200	New Zealand, RNZI	17770pa							
0100-0200	Philippines, FEBC Manila	15450as							
0100-0200	Russia, Radio Moscow	11710va	11780va	11850va	12050va				
		15290va	15405va	15410va	15425va				
		15485va	17560va	17560va	17570va				
		17655va	17860va	17890va	21690va				
0100-0200	Sierra Leone, SLBS	3316do							
0100-0200	Singapore, SBC1	5010do	5052do	11940do					
0100-0200	Spanish National Radio	9530na							
0100-0200	Sri Lanka B'casting Corp.	6005as	9720as	15425as					
0100-0200	Thailand	4830as	9655as	11905as					
0100-0200	United Kingdom, BBC London	5965as	5975na	6005sa	6175na				
		7135as	7325na	9580as	9590na				
		9915na	11750sa	11955as	12095na				
		15260sa	15280as	15360pa	17790va				
		21715as							
0100-0200	USA, CSMonitor Boston	7395na	9850af	13760na	17555as				
0100-0200 sa	USA, CSMonitor Boston	17865as							
0100-0200	USA, KTBN Salt Lake City	7510na							
0100-0200	USA, VOA Washington	5995am	6130am	7405am	9455am				
		9775am	11580am	15120am	15205am				
		7115as	7205as	9740as	11705as				
		15250as	17735as	21550as					
0100-0200	USA, WHRI Noblesville	7315am							
0100-0200	USA, WINB Red Lion, Penn.	15145na							
0100-0200	USA, WJCR Upton, Kentucky	7490na							
0100-0200	USA, WRNO New Orleans	7355na							
0100-0200	USA, WWCR Nashville	7435na	12160na						
0100-0200	USA, WYFR Okeechobee, FL	5985am	9505am	15440am					
0100-0200 WAR/var	Yugoslavia	11870na							
0130-0150 mtwhfa	Greece, Voice of	9395na	9420na	11645na					
0130-0155	Finland, YLE	11755na	15185na						
0130-0200	Austria, ORF Vienna	9875na	13730na						
0130-0200	Netherlands	9860as	11655as	13700as					
0130-0200	UAE Radio, Dubai	11795na	13695eu	15320eu	15435eu				
0145-0200	Vatican Radio	9650as	11935as						

## SELECTED PROGRAMS

## Sundays

- 0100 Radio For Peace Int'l: FIRE. Programming produced by women worldwide on women's issues.
- 0100 Radio Norway Int'l: Norway Today. See S 0000.
- 0101 BBC: Play Of The Week. This month's offerings: "The Wild Duck" (6th, 13th); "The Royal Hunt Of The Sun" (20th, starts at 0030 UTC); "French Without Tears" (27th).
- 0111 Radio Moscow: Moscow Mailbag. A question-and-answer show based on listener letters.
- 0124 Radio Moscow: Top Priority. A panel discussion on major events.
- 0131 Radio Moscow: Folk Box. A program for lovers of folk music.

## Mondays

- 0100 Radio For Peace Int'l: FIRE. See S 0100.
- 0100 Radio Norway Int'l: Norway Today. See S 0000.
- 0101 BBC: Feature/Drama. This month, hear "With Great Pleasure" (7th); "Hostages To Fortune" (14th); "Passport To Permanence" (21st); and our favorite haute cuisine, "The Sandwich" (28th).
- 0111 Radio Moscow: Moscow Mailbag. See S 0111.
- 0131 Radio Moscow: Audio Book Club. See S 0031.
- 0145 BBC: Feature. Step back in time to hear "Music From The Age Of Columbus" (7th, 14th, 21st), followed by the life story of violinist Giuseppe Tartini on "The Devil's Trill" (through November 2nd).

## Tuesdays

- 0100 Radio For Peace Int'l: FIRE. See S 0100.
- 0105 BBC: Outlook. See M 1405.
- 0111 Radio Moscow: Update. Comments on and in-depth analysis of the latest developments worldwide.
- 0130 BBC: Folk In Britain. Ian Anderson is the host, folk music is the fare.
- 0131 Radio Moscow: Folk Box. See S 0131.
- 0145 BBC: Health Matters. New medical developments and methods of keeping fit.

## Wednesdays

- 0100 Radio For Peace Int'l: FIRE. See S 0100.
- 0105 BBC: Outlook. See M 1405.
- 0111 Radio Moscow: Update. See T 0111.
- 0130 BBC: Talks. This month, hear more examinations of the world's "Great Newspapers."
- 0131 Radio Moscow: Music At Your Request. See M 1131.
- 0145 BBC: Country Style. David Allan profiles the country music scene on both sides of the pond.

## Thursdays

- 0100 Radio For Peace Int'l: FIRE. See S 0100.
- 0105 BBC: Outlook. See M 1405.
- 0111 Radio Moscow: Update. See T 0111.

- 0130 BBC: Waveguide. See W 0415.
- 0131 Radio Moscow: Jazz Show. See M 0331.
- 0140 BBC: Book Choice. See W 0425.
- 0145 BBC: The Farming World. Agricultural news and technological innovations for farmers.

## Fridays

- 0100 Radio For Peace Int'l: FIRE. See S 0100.
- 0105 BBC: Outlook. See M 1405.
- 0111 Radio Moscow: Update. See T 0111.
- 0130 BBC: Seven Seas. Malcolm Billings presents news about ships and the sea.
- 0131 Radio Moscow: Science And Engineering. See S 0511.
- 0145 BBC: Global Concerns. An update on environmental issues.

## Saturdays

- 0100 Radio For Peace Int'l: FIRE. See S 0100.
- 0105 BBC: Outlook. See M 1405.
- 0111 Radio Moscow: Update. See T 0111.
- 0130 BBC: Short Story (except 5th: Seeing Stars). See S 0430.
- 0131 Radio Moscow: Music. See S 0231.
- 0145 BBC: Jazz Now And Then. George Reid presents a weekly mix of new releases, old tracks, and interviews.

0200 UTC

[10:00 PM EDT/7:00 PM PDT]

## FREQUENCIES

0200-0225	Netherlands	9860as	11655as	13700as	0200-0300	Romania, R.Romania Int'l	5990am	6155am	9510am	9570am
0200-0230 mtwhfa	Kenya, Voice of	4935do					11830am	11940am		
0200-0230 sm	Norway	11930na			0200-0300	Russia, Radio Moscow	9470va	9530va	9685va	11710va
0200-0230	Philippines, FEBC Manila	15450as					11850va	12050va	15290va	15405va
0200-0230	Sri Lanka B'casting Corp.	6005as	9720as	15425as			15410va	15425va	15560va	17560va
0200-0230	Sweden	9695na	11705na				17570va	17635va	17685va	17730va
0200-0230	Swiss Radio Int'l	6135am	9650am	9885am	12035am		17850va	17860va	17890va	21690va
0200-0230	United Kingdom, BBC London	5975na	6005sa	6175na	6195eu	0200-0300	Sierra Leone, SLBS	3316do		
		7135as	7325na	9410eu	9580as	0200-0300	Singapore, SBC1	5010do	5052do	11940do
		9590na	9670me	9915na	11750sa	0200-0300	South Africa, Radio RSA	7270af		
		11955as	12095va	15260sa	15280as	0200-0300	Taiwan, V. of Free China,	5950na	9680na	9765pa
		15360pa	15380as	21715as				11860as	15345as	
0200-0230	USA, VOA Washington	5995am	7405am	9775am	11580am	0200-0300	Thailand	4830as	9655as	11905as
		15120am	15205am			0200-0300	USA, CSMonitor Boston	9350af	9455na	13760sa
0200-0250	Germany, Deutsche Welle	7285as	9615as	9690as	11945as	0200-0300 sa	USA, CSMonitor Boston	17555as	17865as	
		11965as	15235as	15560as		0200-0300	USA, KTBN Salt Lake City	7510am		
0200-0259 twhfa	Canada, RCI Montreal	9535sa	9755sa	11845sa	11940sa	0200-0300	USA, KVOH Los Angeles	17775am		
		13720sa				0200-0300	USA, VOA Washington	7205as	9740as	11705as
0200-0300 twhf	Argentina,RAE BuenosAires	11710am						15205am	17735as	21550as
0200-0300	Australia	15240pa	15320va	15365pa	17630as	0200-0300	USA, WHRI Noblesville	7315na		
		17715pa	17750pa	17795pa	17880as	0200-0300	USA, WINB Red Lion, Penn.	15145eu		
		21525as	21740pa	21775as		0200-0300	USA, WJCR Upton, Kentucky		7490na	
0200-0300	Australia, ABC Brisbane	4920do	9660do			0200-0300 vl	USA, WRNO New Orleans	7355am		
0200-0300	Australia, ABC Perth	6070do	9610do			0200-0300	USA, WWCR Nashville	5920na	7435am	
0200-0300	Canada, CFCX Montreal	6005do				0200-0300	USA, WYFR Okeechobee, FL	5985am	9505am	15440am
0200-0300	Canada, CFRX Toronto	6070do				0230-0245	Pakistan	9515as	15115as	17640as
0200-0300	Canada, CFVP Calgary	6030do				0230-0300	Albania, Radio Tirana	9580na	11825na	
0200-0300	Canada, CHNX Halifax	6130do				0230-0300 s	Kenya, Voice of	4935do		
0200-0300	Canada, CKZU Vancouver	6160do				0230-0300	Netherlands	9860as	11655as	13700as
0200-0300	Canada, RCI Montreal	6035eu	6125eu	7230eu	7260eu	0230-0300	Philippines, Manila	17760pa	17840pa	21580pa
		9650eu				0230-0300 twhfa	Portugal	9570am	9600am	9705am
0200-0300	Cook Islands	11760pa					Sri Lanka B'casting Corp.	9720as	15425as	
0200-0300	Costa Rica, RFPI	7375na	13630na			0230-0300	United Kingdom, BBC London	5975na	6005sa	6175na
0200-0300	Cuba, RHC Havana	11970na	13700na					7135me	7325na	9670me
0200-0300	Ecuador, HCJB Quito	9745am	15155am	21455am				11750sa	11955me	12095va
0200-0300	Egypt, Radio Cairo	9475na	9675na					15280as	15360pa	17790va
0200-0300 as	Guam, KSDA Guam	13720as				0245-0300	South Korea, Seoul	9640am	11805am	15575am
0200-0300	Hungary, Radio Budapest	6110na	9835na	11910na		0250-0300 varies	Armenia, Radio Yerevan	11675na	15580na	
0200-0300	Luxembourg, RTL	15350va				0250-0300	Vatican Radio	7305na	9605na	11620na
0200-0300 smtwh	Malaysia, RTM Radio 4	7295do				0255-0300	Bonaire, TWR Bonaire	11930am		
0200-0300	Namibia BC Corp, Windhoek	3290af								
0200-0300	New Zealand, RNZI	17770pa								

## SELECTED PROGRAMS

## Sundays

- 0200 Radio For Peace Int'l: World Of Radio. Glenn Hauser's communications program for shortwave radio listeners.
- 0200 Radio Norway Int'l: Norway Today. See S 0000.
- 0211 Radio Moscow: Moscow Mailbag. See S 0111.
- 0230 BBC: Feature. "The Invaders' Legacy" looks at Latin America 500 years after Columbus (through October 4th).
- 0230 Radio For Peace Int'l: RFPI Reports. Human rights, the environment, and other critical issues facing the world.
- 0231 Radio Moscow: Music. Music selected by Radio Moscow staff.

## Mondays

- 0200 Radio For Peace Int'l: Food For The Thoughtful. Current dietary trends and how they affect our health.
- 0200 Radio Norway Int'l: Norway Today. See S 0000.
- 0211 Radio Moscow: Culture And The Arts. See S 1611.
- 0230 BBC: Composer Of The Month. Profiles of famous composers.
- 0230 Radio For Peace Int'l: RFPI Reports. See S 0230.
- 0231 Radio Moscow: Russian By Radio. See S 0631.
- 0245 Radio For Peace Int'l: United Nations. Current events programming produced by UN Radio.

## Tuesdays

- 0200 Radio For Peace Int'l: The CFRU Series. Current affairs issues from a student-radio viewpoint.
- 0211 Radio Moscow: Newmarket. See S 0011.
- 0230 BBC: Quiz. See M 1215.
- 0230 Radio For Peace Int'l: RFPI Reports. See S 0230.
- 0231 Radio Moscow: Audio Book Club. See S 0031.
- 0245 Radio For Peace Int'l: United Nations. See M 0245.

## Wednesdays

- 0200 Radio For Peace Int'l: Amnesty Int'l Reports or The Other Americas Radio. Human rights reports, or issues affecting Central and South America.
- 0211 Radio Moscow: Science And Engineering. See S 0511.
- 0230 BBC: Development '92. Aid and development issues for developing nations.
- 0230 Radio For Peace Int'l: RFPI Reports. See S 0230.
- 0231 Radio Moscow: Russian By Radio. See S 0631.
- 0245 Radio For Peace Int'l: Along The Color Line. Manning Marable looks at issues relevant to the black community.

## Thursdays

- 0200 Radio For Peace Int'l: Second Opinion. A weekly conversation with Erwin Knoll, editor of The Progressive.

- 0211 Radio Moscow: Culture And The Arts. See S 1611.
- 0230 BBC: Sports International. Live play-by-play, interviews, features, and discussions from the sports world.
- 0230 Radio For Peace Int'l: RFPI Reports. See S 0230.
- 0231 Radio Moscow: Audio Book Club. See S 0031.
- 0245 Radio For Peace Int'l: UNESCO. See M 2330.

## Fridays

- 0200 Radio For Peace Int'l: Living Enrichment Center. See S 1500.
- 0211 Radio Moscow: Tonight. Program details not available at press time.
- 0230 BBC: Drama. See H 1130.
- 0230 Radio For Peace Int'l: RFPI Reports. See S 0230.
- 0231 Radio Moscow: Music. See S 0231.
- 0245 Radio For Peace Int'l: The Neumaier Report. Life experiences and opportunities from a spiritual perspective.

## Saturdays

- 0200 Radio For Peace Int'l: Common Ground. See W 2300.
- 0211 Radio Moscow: Outlook. See H 2331.
- 0230 BBC: People And Politics. The background to the British political scene.
- 0230 Radio For Peace Int'l: RFPI Reports. See M 0230.
- 0231 Radio Moscow: Science And Engineering. See S 0511.





0400 UTC

[12:00 PM EDT/9:00 PM PDT]

## FREQUENCIES

0400-0415	Israel, Kol Israel	11588am		
0400-0425	Netherlands	6165na	9590na	
0400-0427	Czechoslovakia	5930na	7345na	9540na
0400-0430	Bonaire, TWR Bonaire	9535am	11930am	
0400-0430	Bulgaria, Radio Sofia	9850eu	11720eu	15160eu
0400-0430	Canada, RCI Montreal	9650eu	11905eu	15275me 15445me
0400-0430 varies	Croatian Radio via WHRI	7315na	9495na	
0400-0430	Cuba, RHC Havana	11760am	11970na	13700am
0400-0430	Ecuador, HCJB Quito	9745am	15155am	21455am
0400-0430	Guatemala, Radio Cultural	3300do		
0400-0430 sm	Norway	9560na	11865na	
0400-0430	Romania, R.Romania Int'l	5990am	6155am	9510am 9570am
		11830am	11940am	
0400-0430	Sri Lanka B'casting Corp.	9720as	15425as	
0400-0430	Swiss Radio Int'l	6135am	9885am	12035am 13635me
0400-0430	Tanzania	5985af	9685af	11765af
0400-0430	Thailand	4830as	9655as	11905as
0400-0430	United Kingdom, BBC London	3255af	3955eu	5975na 6180eu
		6190af	6195eu	7105af 7230eu
		7325na	9410eu	9600af 9610af
		9915na	11760me	15070va 15280as
		15310as	15420af	15590eu 17885af
		6005af	6175am	11750va 11955me
		12095va	21715as	
0400-0450	Germany, Deutsche Welle	6130af	6145af	7150af 7225af
		9565af	9765af	11705af 11765af
		13610af	13770af	
0400-0450	North Korea	15180as	15230as	17765as
0400-0500	Australia	15240pa	15365pa	17630as 17715pa
		17750as	17795pa	21525as 21740pa
		21775as		
0400-0500	Australia, ABC Brisbane	4920do	9660do	
0400-0500	Australia, ABC Perth	9610do		
0400-0500	Canada, CFCX Montreal	6005do		
0400-0500	Canada, CFRX Toronto	6070do		
0400-0500	Canada, CFVP Calgary	6030do		
0400-0500	Canada, CHNX Halifax	6130do		
0400-0500	Canada, CKZU Vancouver	6160do		
0400-0500	China, Radio Beijing	11840na		
0400-0500	Cook Islands	11760pa		

0400-0500	Costa Rica, RFPI	7375na	13630na	
0400-0500	Kenya, Voice of	4935do		
0400-0500	Luxembourg, RTL	15350va		
0400-0500 smtwh	Malaysia, RTM Radio 4	7295do		
0400-0500 mtwhf	Namibia BC Corp, Windhoek	3270af	3290af	
0400-0500	New Zealand, RNZI	17770pa		
0400-0500	Russia, Radio Moscow	9470va	9685va	11675va 11850va
		11980va	12040va	12050va 13665va
		15210va	15320va	15405va 15425va
		15470va	15550va	17570va 17860va
		21690va	21775va	
0400-0500	Sierra Leone, SLBS	3316do		
0400-0500	Singapore, SBC1	5010do	5052do	11940do
0400-0500	South Africa, Radio RSA	5960af	9695af	
0400-0500 vl	South Africa, Radio Oranje	3215do		
0400-0500	USA, CSMonitor Boston	9455am	9840af	9870na 13760na
		17780as		
0400-0500 sa	USA, CSMonitor Boston	17555as		
0400-0500	USA, KTVN Salt Lake City	7510am		
0400-0500	USA, KVOH Los Angeles	9785am		
0400-0500	USA, VOA Washington	5995eu	6035me	6040me 6140me
		7170eu	7200eu	9575me 9715eu
		15115me	15205me	
0400-0500	USA, WHRI Noblesville	7315na	9495sa	
0400-0500	USA, WJCR Upton, Kentucky	7490na		
0400-0500 smtwhf	USA, WMLK Bethel, Penna.	9465eu		
0400-0500	USA, WRNO New Orleans	7395am		
0400-0500	USA, WWCR Nashville	5920na	7435na	
0400-0500	USA, WYFR Okeechobee, FL	5985am	9505am	
0415-0440	Italy, RAI, Rome	7275me	9575me	
0430-0500	Cuba, RHC Havana	11760na	11970na	
0430-0500	Nigeria	3326do	4770do	
0430-0500	Swaziland, TWR Swaziland	5055af	5965af	9655af 11750af
0430-0500	United Kingdom, BBC London	3255af	3955eu	5975na 6005af
		6180eu	6190af	6195eu 7230eu
		9410eu	9600af	11760me 12095va
		15070va	15280as	15310as 15400af
		15420af	15590eu	21470af 21715as
0430-0500	USA, VOA Washington	5995me	6040me	6140me 7170me
		7200me	7265me	9715me 11815me
0445-0500 t	Sri Lanka B'casting Svc	9720am	15425am	
0455-0600	Nigeria, Voice of	7255af		

## SELECTED PROGRAMS

## Sundays

- 0400 Radio For Peace Int'l: Peace Forum. Interviews and reports.  
 0400 Radio Norway Int'l: Norway Today. See S 0000.  
 0411 Radio Moscow (na): News And Views. See S 0311.  
 0411 Radio Moscow (World Service): Top Priority. See S 0124.  
 0415 BBC: Feature. This month, Rock 'n' roll is the fare in "Stuart Colman's Record Hop."  
 0430 BBC: Short Story. This month's selections: "There Are No Bones In Bullying Beel" (13th); "Just Another Day" (20th); "Dinner At Seven" (27th) (except 6th: Seeing Stars, a monthly look at astronomy).  
 0431 Radio Moscow (North America): Moscow Medley.  
 0431 Radio Moscow (World Service): Radio Oumu Shinri-Kyo. A Japanese evangelical program relayed by Radio Moscow.  
 0445 BBC: Talks. Martin Wainwright examines spectacular careers in "Missions Improbable" (6th, 13th); fanatics are the subject of "Singular Lives" (20th), followed by "Encounters With The Unknown" (through November 1st).

## Mondays

- 0400 Radio For Peace Int'l: Visions For A Better World. A look at organizations and people working to improve our world.  
 0400 Radio Norway Int'l: Norway Today. See S 0000.  
 0411 Radio Moscow (na): News And Views. See S 0311.  
 0411 R. Moscow (World Service): Transcription Service. See S 0631.  
 0415 BBC: Talks. Join Martin Redfern as he takes a "Journey To The Center Of The Universe" (through September 28th).  
 0430 BBC: Off The Shelf. Serialized readings from famous books.  
 0430 Radio For Peace Int'l: Sound Currents Of The Earth. Jim Bean presents new age, world, and electronic music.

- 0431 Radio Moscow (North America): Folk Box. See S 0131.  
 0431 R. Moscow (World Service): Radio Oumu Shinri-Kyo. S 0431.  
 0445 BBC: Andy Kershaw's World Of Music. Exotic world music

## Tuesdays

- 0400 Radio For Peace Int'l: Alternative Radio. Current political issues facing Latin America.  
 0411 Radio Moscow (na): News And Views. See S 0311.  
 0411 Radio Moscow (World Service): Update. See T 0111.  
 0415 BBC: Health Matters. See T 0145.  
 0430 BBC: Off The Shelf. See M 0430.  
 0431 Radio Moscow (North America): Music. See S 0231.  
 0431 R. Moscow (World Service): Radio Oumu Shinri-Kyo. S 0431.  
 0445 BBC: Talks. See M 2315.  
 0455 BBC: Talks. See M 2325.

## Wednesdays

- 0400 Radio For Peace Int'l: Seeing Beyond. A talk show on people working for positive planetary change.  
 0411 Radio Moscow (na): News And Views. See S 0311.  
 0411 Radio Moscow (World Service): Update. See T 0111.  
 0415 BBC: Waveguide. Tips on how to hear the BBC better.  
 0425 BBC: Book Choice. Review of a recently released book.  
 0430 BBC: Off The Shelf. See M 0430.  
 0431 Radio Moscow (North America): Music. See S 0231.  
 0431 R. Moscow (World Service): Radio Oumu Shinri-Kyo. S 0431.  
 0445 BBC: Country Style. See W 0145.

## Thursdays

- 0411 Radio Moscow (na): News And Views. See S 0311.

- 0411 Radio Moscow (World Service): Update. See T 0111.  
 0415 BBC: The Farming World. See H 0145.  
 0430 BBC: Off The Shelf. See M 0430.  
 0430 Radio For Peace Int'l: Voices Of Our World. See T 0330.  
 0431 Radio Moscow (North America): Music. See S 0231.  
 0431 R. Moscow (World Service): Radio Oumu Shinri-Kyo. S 0431.  
 0445 BBC: From Our Own Correspondent. See S 0330.

## Fridays

- 0400 Radio For Peace Int'l: UNESCO. See M 2330.  
 0411 Radio Moscow (na): News And Views. See S 0311.  
 0411 Radio Moscow (World Service): Update. See T 0111.  
 0415 BBC: Feature. See M 0145.  
 0430 BBC: Off The Shelf. See M 0430.  
 0430 Radio For Peace Int'l: WINGS. Women's issues.  
 0431 Radio Moscow (North America): Jazz Show. See M 0331.  
 0431 R. Moscow (World Service): Radio Oumu Shinri-Kyo. S 0431.  
 0445 BBC: Folk In Britain. See T 0130.

## Saturdays

- 0400 Radio For Peace Int'l: World Of Radio. See S 0200.  
 0411 Radio Moscow (na): News And Views. See S 0311.  
 0411 Radio Moscow (World Service): Update. See T 0111.  
 0415 BBC: Good Books (except 26th: A Month In The Country). See W 1445.  
 0430 BBC: Jazz Now And Then. See A 0145.  
 0430 Radio For Peace Int'l: RFPI's Mailbag. See S 0330.  
 0431 Radio Moscow (North America): Folk Box. See S 0131.  
 0431 R. Moscow (World Service): Radio Oumu Shinri-Kyo. S 0431.  
 0445 BBC: Worldbrief. See F 2315.



## 0500 UTC

## [1:00 AM EDT/10:00 PM PDT]

### FREQUENCIES

0500-0510	Lesotho, Maseru	4800do			
0500-0510 w	Malawi B'casting Corp.	3381do			
0500-0515 t	Sri Lanka B'casting Svc	9720am	15425am		
0500-0530	Cameroon CRTV Beau	3970do			
0500-0530	Swaziland, TWR Swaziland	5965af	9655af	11750af	
0500-0530	United Kingdom, BBC London	3255af	3955eu	6005af	6180as
		6190af	6195eu	7120eu	9410eu
		9600af	9640na	11760me	12095va
		15070as	15310as	15400af	15420af
		15590va	17885af	21470af	21715as
		5975na	15280as	15575as	
0500-0530	Vatican Radio	7250eu	11625af	15090af	17730af
0500-0550	Germany, Deutsche Welle	5960na	6130na	9515na	9670na
		11705na	11925na	13610na	13790na
0500-0600	Australia	15240pa	15365pa	17630as	17715pa
		17750as	17795pa	21525as	21740pa
		21775as			
0500-0600	Australia, ABC Brisbane	4920do	9660do		
0500-0600	Australia, ABC Perth	9610do			
0500-0600	Canada, CFCX Montreal	6005do			
0500-0600	Canada, CFRX Toronto	6070do			
0500-0500	Canada, CFVP Calgary	6030do			
0500-0600	Canada, CHNX Halifax	6130do			
0500-0500	Canada, CKZU Vancouver	6160do			
0500-0600	China, Radio Beijing	11840am			
0500-0600	Cook Islands	11760pa			
0500-0600	Costa Rica, RFPI	7375na	15030na		
0500-0600	Ecuador, HCJB Quito	11925am	21455am		
0500-0600 sa	Eq. Guinea, R. East Africa	9585af			
0500-0600 varies	Italy, IRRS Milan, Italy	7125eu			
0500-0600	Japan NHK	11870na	15195na	17765na	17810na
		17825na	17890na	21610na	
0500-0600	Kenya, Voice of	4935do			
0500-0600	Luxembourg, RTL	15350va			
0500-0600	Malaysia, RTM Radio 4	7295do			
0500-0600 mtwhf	Namibia BC Corp., Windhoek	3270af	3290af		
0500-0600	New Zealand, RNZI	17770pa			
0500-0600	Nigeria	3326do	4770do	4990do	7255af
0500-0600	Russia, Radio Moscow	12050va	13665va	15405va	15425va
		17605va			

0500-0600	Sierra Leone, SLBS	3316do			
0500-0600	Singapore, SBC1	5052do	11940do		
0500-0600	South Africa, Radio RSA	9695af			
0500-0600	Spanish National Radio	9530na			
0500-0600	Thailand	4830as	9655as	11905as	
0500-0600	USA, CSMonitor Boston	9455na	9840af	9870na	13760na
		17780as			
0500-0600 sa	USA, CSMonitor Boston	17555as			
0500-0600	USA, KTBN Salt Lake City	7510am			
0500-0600	USA, KVOH Los Angeles	9785am			
0500-0600	USA, VOA Washington	5995eu	6040me	6060eu	6140me
		6873eu	7170me	7200me	9670me
		9700eu	9715me	11815me	11825me
		15205me			
0500-0600	USA, WHRI Noblesville	7315na			
0500-0600	USA, WINB Red Lion, Penn.	15145eu			
0500-0600	USA, WJCR Upton, Kentucky		7490na		
0500-0600 mtwhfa	USA, WMLK Bethel, Penna.	9465eu			
0500-0600	USA, WWCR Nashville	5920na	7435na		
0500-0600	USA, WYFR Okeechobee, FL		5985am	9850eu	11915eu
		13695af			
0510-0515 w, vl	Botswana, Gaborone	5955af	7255af		
0510-0600 vl	South Africa, Radio Oranje	9630do			
0518-0559 mtwhf	Canada, RCI Montreal	6050eu	6150eu	7295eu	9750eu
		11775me	17840me		
0520-0530	Finland, YLE	6120va	9665va	11755va	15440va
0524-0600 f	Ghana, Radio 2, Accra	3366do			
0525-0600	Ghana, Radio 1, Accra	4915do			
0530-0600	Austria, ORF Vienna	6015na	6155eu	13730eu	21490me
0530-0600	Cameroon CRTV Yaounde	4850do			
0530-0600	Romania, R. Romania Int'l	15340af	15380af	17720af	17745af
		17790af	21665af		
0530-0600	Swaziland, TWR Swaziland	5965af	11750af		
0530-0600	UAE Radio, Dubai	15435as	17830as	21700as	
0530-0600	United Kingdom, BBC London	3255af	3955eu	5975na	6005af
		6180as	6190af	6195eu	7120eu
		9410eu	9600af	9640na	11760me
		12095va	15070as	15280as	15310as
		15400af	15420af	15575af	21470af
		21470af	21715as		
0545-0600	Cameroon CRTV Beau	3970do			

### SELECTED PROGRAMS

#### Sundays

- 0500 Radio For Peace Int'l: World Citizen's Hour. A wide variety of opinions, submitted by the citizens of the world.
- 0511 Radio Moscow (North America): Moscow Mailbag. See S 0111.
- 0511 Radio Moscow (World Service): Science And Engineering. Developments in Russian science and technology.
- 0531 Radio Moscow: Feature. See S 0331.

#### Mondays

- 0511 Radio Moscow (North America): Moscow Mailbag. See S 0111.
- 0511 Radio Moscow (World Service): News And Views. See S 0311.
- 0530 Radio For Peace Int'l: World Goodwill Forum. Goodwill organizations and their effects on the world.
- 0531 Radio Moscow (North America): Music. See S 0231.
- 0531 Radio Moscow (World Service): Africa As We See It. See S 1531.

#### Tuesdays

- 0500 Radio For Peace Int'l: United Nations. See M 0245
- 0511 Radio Moscow (North America): Update. See T 0111.
- 0511 Radio Moscow (World Service): Focus On Asia And The Pacific. See T 0011.
- 0515 Radio For Peace Int'l: RFPI Reports. See S 0230.

- 0530 Radio For Peace Int'l: Outlaw For Peace. Country music's Willie Nelson comes to shortwave.
- 0531 Radio Moscow (North America): Music. See S 0231.
- 0531 Radio Moscow (World Service): Africa s We See It. See S 1531.

#### Wednesdays

- 0500 Radio For Peace Int'l: UNESCO. See M 2330.
- 0511 Radio Moscow (North America): Update. See T 0111.
- 0511 Radio Moscow (World Service): Focus On Asia And The Pacific. See T 0011.
- 0515 Radio For Peace Int'l: RFPI Reports. See S 0230.
- 0530 Radio For Peace Int'l: Peace Forum. See S 0400.
- 0531 Radio Moscow (North America): Jazz Show. See M 0331.
- 0531 Radio Moscow (World Service): Africa As We See It. See S 1531.

#### Thursdays

- 0500 Radio For Peace Int'l: United Nations. See M 0245.
- 0511 Radio Moscow (North America): Update. See T 0111.
- 0511 Radio Moscow (World Service): Focus On Asia And The Pacific. See T 0011.
- 0515 Radio For Peace Int'l: RFPI Reports. See S 0230.
- 0530 Radio For Peace Int'l: Peace Forum. See S 0400.
- 0531 Radio Moscow (North America): Yours For The Asking. See M 2331.

- 0531 Radio Moscow (World Service): Africa As We See It. See S 1531.

#### Fridays

- 0500 Radio For Peace Int'l: Dialogue. See T 2330.
- 0511 Radio Moscow (North America): Update. See T 0111.
- 0511 Radio Moscow (World Service): Focus On Asia And The Pacific. See T 0011.
- 0515 Radio For Peace Int'l: RFPI Reports. See S 0230.
- 0530 Radio For Peace Int'l: Peace Forum. See S 0400.
- 0531 Radio Moscow (North America): Audio Book Club. See S 0031.
- 0531 Radio Moscow (World Service): Africa As We See It. See S 1531.

#### Saturdays

- 0500 Radio For Peace Int'l: United Nations. See M 0245.
- 0511 Radio Moscow (North America): Update. See T 0111.
- 0511 Radio Moscow (World Service): Focus On Asia And The Pacific. See T 0011.
- 0515 Radio For Peace Int'l: RFPI Reports. See S 0230.
- 0530 Radio For Peace Int'l: Outlaw For Peace. See T 0530.
- 0531 Radio Moscow (North America): Top Priority. See S 0124.
- 0531 Radio Moscow (World Service): Interview. See M 1631.
- 0539 Radio Moscow (World Service): Music. See S 0231.
- 0550 Radio Moscow (North America): Music. See S 0231.





## 0700 UTC

3:00 AM EDT/12:00 AM PDT

0700-0710	Cameroon CRTV Bafoussam	4000do				
0700-0710 w	Malawi B'casting Corp.	3381do	5995do			
0700-0715	Romania, R.Romania Int'l	11810au	11940au	15335au	17720au	
		17805au	21665au			
0700-0730	Australia	15170pa	15240pa	15320va	15365pa	
	17630as	17715pa	17750as	17795pa	21525as	21740pa
	21775as					
0700-0730	United Kingdom, BBC London	5975na	7150pa	9640va	11955as	
	15280as	15360pa	21715as	6180eu	6190af	6195eu
	7230eu	7325af	9410eu	9760eu	11760me	11940af
	12095eu	15070eu	15310as	15400af	15420af	15575as
	17640va	17790as	17885af	21470af	21660af	
0700-0750	North Korea	15350as	17765as			
0700-0800	Canada, CFCX Montreal	6005do				
0700-0800	Canada, CFRX Toronto	6070do				
0700-0800	Canada, CFVP Calgary	6030do				
0700-0800	Canada, CHNX Halifax	6130do				
0700-0800	Canada, CKZU Vancouver	6160do				
0700-0800	Cook Islands	11760pa				
0700-0800	Costa Rica, RFPI	7375na	15030na			
0700-0800 West NA	Cuba, RHC Havana	11760na				
0700-0800	Ecuador, HCJB Quito	11730eu	15270eu	21455eu		
0700-0800 sa	Eq. Guinea, R. East Africa	9585af				
0700-0800	Ghana B'casting Corp.	6130af				
0700-0800	Ghana, Radio 1, Accra	4915do				
0700-0800 f	Ghana, Radio 2, Accra	3366do				
0700-0800 varies	Italy, IRRS Milan, Italy	7125eu				
0700-0800	Japan NHK	15250me	17765eu	17810as	17860as	
		21525as				
0700-0800	Kenya, Voice of	4935do				
0700-0800	Lebanon, King of Hope	6280me				
0700-0800 tent	Liberia, ELBC Monrovia	7275do				
0700-0800	Luxembourg, RTL	15350va				
0700-0800 smtwha	Malaysia, RTM Radio 4	7295do				
0700-0800	Malaysia, Voice of	6175as	9750as	15295as		
0700-0800	Monaco/Monte Carlo, TWR	9480eu				
0700-0800	Monte Carlo, TWR	9480eu				
0700-0800	New Zealand, RNZI	17770pa				
0700-0800 smtwhf	New Zealand, ZXLA	3935do				
0700-0800	Nigeria	3326do	4990do			
0700-0800	Russia, Radio Moscow	4740va	4950va	4975va	5960va	
	7130va	7160va	7310va	9855va	11705va	11765va
	11880va	11975va	12010va	12055va	13705va	15280va
	15295va	15345va	15350va	15375va		
0700-0800	Sierra Leone, SLBS	3316do				
0700-0800	Singapore, SBC1	5010do	5052do	11940do		
0700-0800 vl	South Africa, Radio Oranje	9630do				
0700-0800	Swaziland, TWR Swaziland	7200af	11750af			
0700-0800	Taiwan, V. of Free China,	5950na				
0700-0800 sa	Thailand	4830as	9655as	11905as		
0700-0800	USA, CSMonitor Boston	9445na	9840eu	9870am	17555as	
		17780as				
0700-0800	USA, KTBN Salt Lake City	7510na				
0700-0800	USA, KVOH Los Angeles	9785na				
0700-0800	USA, WHRI Noblesville	7315eu				
0700-0800	USA, WJCR Upton, Kentucky		7490na			
0700-0800 smtwhf	USA, WMLK Bethel, Penna.	9465eu				
0700-0800	USA, WWCR Nashville	5920am	7435am			
0700-0800	USA, WYFR Okeechobee, FL	9850af	11915af	13695eu	15566na	
0703-0800 s	Croatian Radio, Zagreb	7240eu	9830eu	21480eu		
0705-0800 a	Cameroon CRTV Douala	4795do				
0730-0745 mtwhf	Icelandic National Radio	9265om				
0730-0745 mtwhfa	Vatican Radio	6245do	7250do	9645na	15210na	
0730-0800	Australia	11880pa	15170va	15240pa	15320va	
	15365pa	17630as	17715pa	17750as	17795pa	21525as
	21775as					
0730-0800	Czechoslovakia	17725pa	21705as			
0730-0800	Ecuador, HCJB Quito	9745au	11730eu	11925au	15270eu	
		21455va				
0730-0800	Netherlands	9630pa	11895pa			
0730-0800	United Kingdom, BBC London	6180eu	6190af	7325eu	9410eu	
	9600af	9760eu	11760me	11860af	11940af	12095va
	15070eu	15105af	15400af	15420af	15590af	17640va
	17830as	17885af	21470af	21880af	7150pa	9640va
	11955as	15280as	15310as	15360pa	17790as	21715as

## 0800 UTC

[4:00 AM EDT/1:00 AM PDT]

0800-0803 daily	Croatian Radio, Zagreb	7240eu	9830eu	21480eu		
0800-0810	Cameroon CRTV Bafoussam		4000do			
0800-0810 w	Malawi B'casting Corp.	3381do				
0800-0825	Finland, YLE	17800as	21550as			
0800-0825	Malaysia, Voice of	6175as	9750as	15295as		
0800-0825	Netherlands	9630pa	11895pa			
0800-0825	Swaziland, TWR Swaziland	7200af	11750af			
0800-0830	Australia	6080pa	15240pa	17630as	17715pa	
		17750as	21725as			
0800-0830	Ecuador, HCJB Quito	9745au	11730eu	11925au	21455va	
0800-0830	United Kingdom, BBC London	6180eu	6190af	7325eu	9410eu	
	9600af	9760eu	11760me	11860af	12095eu	15070eu
	15310as	15360pa	15400af	15420af	15590me	17790as
	17830as	17885af	21470af	21660af	7150pa	9640pa
	9660eu	11950af	11955as	15105af	15280as	17640va
	21715as					
0800-0835	Monaco, TWR Monaco	9480eu				
0800-0835	Monte Carlo, TWR	9480eu				
0800-0845	Pakistan	17902eu	21520eu			
0800-0850	North Korea	15180as	15230as			
0800-0900	Australia, ABC Brisbane	9660do				
0800-0900	Australia, ABC Perth	15425va				
0800-0900 a	Cameroon CRTV Douala	4795do				
0800-0900	Canada, CFCX Montreal	6005do				
0800-0900	Canada, CFRX Toronto	6070do				
0800-0900	Canada, CFVP Calgary	6030do				
0800-0900	Canada, CHNX Halifax	6130do				
0800-0900	Canada, CKZU Vancouver	6160do				
0800-0900	Cook Islands	11760pa				
0800-0900	Costa Rica, RFPI	7375na	15030na			
0800-0900 sa	Eq. Guinea, R. East Africa	9585af				
0800-0900	Ghana, Radio 1, Accra	4915do				
0800-0900 f	Ghana, Radio 2, Accra	3366do				
0800-0900 asmtwh	Guam, KTWR Guam	15200as				
0800-0900	Indonesia, Voice of	7125as	9675as	11752as	11785as	
0800-0900 varies	Italy, IRRS Milan, Italy	7125eu				
0800-0900	Kenya, Voice of	4935do				
0800-0900	Lebanon, King of Hope	6280me				
0800-0900	Luxembourg, RTL	15350va				
0800-0900 smtwha	Malaysia, RTM Radio 4	7295do				
0800-0900	New Zealand, RNZI	9700pa				
0800-0900 smtwhf	New Zealand, ZXLA	3935do				
0800-0900	Nigeria	3326do	4990do			
0800-0900	Nigeria, Voice of	7255af				
0800-0900	Papua New Guinea	4890do				
0800-0900	Russia, Radio Moscow	4740va	4975va	5960va		
	7130va	7160va	7310va	9535va	11705va	11765va
	11920va	11975va	12010va	12055va	13705va	15295va
	15345va	15350va	15420va	15435va		
0800-0900	Sierra Leone, SLBS	3316do	5052do	11940do		
0800-0900	Singapore, SBC1	5010do	5052do	11940do		
0800-0900 vl	South Africa, Radio Oranje	9630do				
0800-0900	South Korea, Seoul	7550eu	13670eu			
0800-0900	USA, CSMonitor Boston	9445am	11705eu	13615as	15665pa	
		17555as				
0800-0900	USA, KNLS Anchor Point	7365as				
0800-0900	USA, KTBN Salt Lake City	7510am				
0800-0900	USA, VOA Washington	11735eu	15160eu	15195me	21455me	
		21570me				
0800-0900	USA, WHRI Noblesville	7315eu	7355as			
0800-0900	USA, WJCR Upton, Kentucky		7490na			
0800-0900 smtwhf	USA, WMLK Bethel, Penna.	9465eu				
0800-0900	USA, WWCR Nashville	692am	5920na			
0803-0810 tent	Croatian Radio, Zagreb	7240eu	9830eu	21480eu		
0803-0900 s	Croatian Radio, Zagreb	7240eu	9830eu	21480eu		
0830-0845	Vatican Radio	6245eu	7250eu	9645eu	15210eu	
0830-0900	Australia	6080pa	9580pa	9710va	15240pa	
		17630as	17750as	21725as	21775as	
0830-0900	Austria, ORF Vienna	6155eu	13730eu	15450au	21490as	
0830-0900	Ecuador, HCJB Quito	9745au	11925au	15270eu	21455au	
0830-0900	Finland, YLE	15355as	17800as			
0830-0900	Italy, AWR Italy	7230eu				
0830-0900	Netherlands	9630pa	11895pa			
0830-0900	United Kingdom, BBC London	6180eu	6190af	7325eu	9410eu	
	9660eu	9760eu	11860af	11940af	11955as	12095eu
	15070va	15280as	15360pa	15400af	15420af	15590me
	17640va	17830as	21660af	21715as	17885af	
0835-0850 mtwhf	Monaco, TWR Monaco	9480eu				
0835-0850 smtwhf	Monte Carlo, TWR	9480eu				
0835-0850 mtwhf	Swaziland, TWR Swaziland	7200af	11750af			
0850-0900 s	Monaco, TWR Monaco	9480eu				
0850-0900 s	Monte Carlo, TWR	9480eu				

# shortwave guide

## 0900 UTC [5:00 AM EDT/2:00 AM PDT]

0900-0903 s	Croatian Radio, Zagreb	7240eu	9830eu	21480eu			
0900-0905	Ghana, Radio 1, Accra	4915do					
0900-0905 f	Ghana, Radio 2, Accra	3366do					
0900-0910	Malawi B'casting Corp.	5995do					
0900-0912 f	Guam, KTWG Guam	15200as					
0900-0915	Lebanon, Radio Voice of	6550me					
0900-0915 s	Monaco, TWR Monaco	9480eu					
0900-0915 s	Monte Carlo, TWR	9480eu					
0900-0925 mtwhf	Belgium, BRT Brussels	9905eu	13675eu				
0900-0925	Netherlands	9630pa	11895pa				
0900-0930	Costa Rica, RFPI	7375na	15030na				
0900-0930 asmtwf	Guam, KTWG Guam	15200as					
0900-0930 mtwhf	New Zealand, ZLXA	3935do					
0900-0930	Swiss Radio Int'l	9560as	13685as	17670as	21770as		
0900-0930	United Kingdom, BBC London	1170as	5975eu	6045eu	6180u		
	6190af	6195as	7325eu	9410eu	9660eu	9740as	
	9750eu	9760eu	11760me	11860af	11940af	12095eu	
	15070va	15400af	17640va	21660af	15190sa	15280as	
	15310as	15360as	15420af	15575me	15590me	17705eu	
	17790af	17830as	17885af	21470af	21660af	21715as	
0900-0950	Germany, Deutsche Welle	6160as	9565af	11915as	15410af		
0900-1000	Australia	17780as	17820as	21465as	21600af	21650as	21680as
				6080pa	9580pa	9710va	13605as
				15170as	21725as		
0900-1000	Australia, ABC Brisbane	9660pa					
0900-1000 s	Bhutan Broadcasting Svc	6035do					
0900-1000	Canada, CFCX Montreal	6005do					
0900-1000	Canada, CFRX Toronto	6070do					
0900-1000	Canada, CFVP Calgary	6030do					
0900-1000	Canada, CHNX Halifax	6130do					
0900-1000	Canada, CKZU Vancouver	6160do					
0900-1000	China, Radio Beijing	8450au	11755au	15440au	17710au		
0900-1000	Cook Islands	11760pa					
0900-1000	Ecuador, HCJB Quito	9745af	11925au	21455au			
0900-1000 sa	Eq. Guinea, R. East Africa	9585af					
0900-1000	Guam, KTWG Guam	11805as					
0900-1000 s	Italy, AWR via Portugal	9670eu					
0900-1000 varies	Italy, IRRS Milan, Italy	7125eu					
0900-1000	Japan NHK	15270au	17890au				
0900-1000	Japan NHK	11840as	21610as				
0900-1000	Kenya, Voice of	4935do					
0900-1000	Lebanon, King of Hope	6280me					
0900-1000	Luxembourg, RTL	15350va					
0900-1000	Malaysia, RTM Radio 4	7295do					
0900-1000	New Zealand, RNZI	9700pa					
0900-1000	Nigeria	3326do	4990do				
0900-1000	Nigeria, Voice of	7255af					
0900-1000	Papua New Guinea	4890do					
0900-1000	Philippines, FEBC Manila	9800as	11685as				
0900-1000	Russia, Radio Moscow	4740do	4940do	4975do	6000am		
	7130am	7245va	9535va	9780va	9855va	11705va	
	11765va	11920va	11975va	12055va	13705va	15175va	
	15280va	15295va	15345va	15545na			
0900-1000	Sierra Leone, SLBS	3316do					
0900-1000	Singapore, SBC1	5010do	5052do	11940do			
0900-1000 vi	South Africa, Radio Oranje	9630do					
0900-1000	Tanzania	5985af	9685af	11765af			
0900-1000	USA, CSMonitor Boston	9445am	11705eu	13615pa	15665pa		
		17555as					
0900-1000	USA, KTNB Salt Lake City	7510am					
0900-1000	USA, VOA Washington	11735eu	15160eu	15195me	21455me		
		21570eu					
0900-1000	USA, WJCR Upton, Kentucky		7490na				
0900-1000 smtwhf	USA, WMLK Bethel, Penna.	9465eu					
0900-1000	USA, WWCR Nashville	5920am	7435am				
0905-1000	Cameroon CRTV Yaounde	4850do					
0905-1000 sa	Ghana, Radio 1, Accra	4915do					
0905-1000 mtwhf	Ghana, Radio 2 School prg	7295do					
0905-1000 sa	Ghana, Radio 2, Accra,	3366do					
0910-0940 smwha	Mongolia, Ulaanbaatar	11850pa	12015pa				
0915-0930	South Korea World News	9570am	13670eu				
0930-1000	Afghanistan, Kabul	9635as					
0930-1000	Netherlands	9630pa	11895pa				
0930-1000	United Kingdom, BBC London	5975eu	6045eu	6180eu	6190af		
	6195as	9410eu	9660eu	9740as	9760eu		
	11750as	11760me	11940af	12095eu	15070va	15190sa	

	15400af	15420af	15575me	15590me	15190sa	17640va	
	17705eu						
0940-0950	Greece, Voice of		17525eu				
0950-0953 a	Russia, Vladivostok	4050do	4485do	5015do	5905do		
	6035do	6175pa	7175pa	7210pa	7260pa	7270pa	
	7345pa	9530pa	9600pa	9635pa	9825pa	9905pa	
	11815pa	15535pa	15595pa	17620pa	17695pa	17825pa	
	17850pa						

## 1000 UTC [6:00 AM EDT/3:00 AM PDT]

1000-1025	Netherlands	9630pa	11895pa				
1000-1030 tent	Afghanistan, Kabul	9635as					
1000-1030	Israel, Kol Israel	17545eu					
1000-1030	Tanzania	5985af	9685af	11765af			
1000-1030	United Kingdom, BBC London	5975eu	6045eu	6180eu	6190af		
	6195as	9410eu	9660eu	9740as	9750eu	9760eu	
	11750as	11760me	11940af	12095eu	15070va	15190sa	
	15310as	15400af	15420af	15575me	17640eu	17705eu	
	17790af	17885af	21470af	21660af	21715as		
1000-1030	Vietnam, Voice of		9840as	12020as	15010as		
1000-1100	Australia		6080pa	9580pa	9710va	11880pa	
			13605pa	21725as			
1000-1100	Cameroon CRTV Yaounde		4850do				
1000-1100	Canada, CFCX Montreal		6005do				
1000-1100	Canada, CFRX Toronto		6070do				
1000-1100	Canada, CFVP Calgary		6030do				
1000-1100	Canada, CHNX Halifax		6130do				
1000-1100	Canada, CKZU Vancouver		6160do				
1000-1100	China, Radio Beijing		8450as	11755au	15440au	17710au	
1000-1100	Cook Islands		11760pa				
1000-1100	Costa Rica, AWR		9725ca				
1000-1100	Costa Rica, RFPI		7375na	15030na			
1000-1100	Ecuador, HCJB Quito		9745au	11925au	21455au		
1000-1100 sa	Eq. Guinea, R. East Africa		9585af				
1000-1100 sa	Ghana, Radio 1, Accra		4915do				
1000-1100 mtwhf	Ghana, Radio 2 School Prg		7295do				
1000-1100 sa	Ghana, Radio 2, Accra		3366do				
1000-1100	India, All India Radio		15050as	17387as	17895as	21735as	
1000-1100 varies	Italy, IRRS Milan, Italy		7125eu				
1000-1100	Kenya, Voice of		4935do				
1000-1100	Luxembourg, RTL		15350va				
1000-1100	Malaysia, RTM Kuching		7160do				
1000-1100 mtwh	Malaysia, RTM Radio 4		7295do				
1000-1100	New Zealand, RNZI		9700pa				
1000-1100	Nigeria		4990do	7285do			
1000-1100	Nigeria, Voice of		7255af				
1000-1100	Philippines, FEBC Manila		9800as	11665as			
1000-1100	Russia, Radio Moscow		9455na	9495na	11840na	15485na	
1000-1100	Sierra Leone, SLBS		3316do				
1000-1100	Singapore, SBC1		5010do	5052do	11940do		
1000-1100	South Africa, Radio RSA		11900af				
1000-1100 vi	South Africa, Radio Oranje		9630do				
1000-1100	USA, CSMonitor Boston		9455am	9495na	13625as	17555as	
1000-1100 sa	USA, CSMonitor Boston		15665me				
1000-1100	USA, VOA Washington		5985as	11720au	15425au		
1000-1100	USA, WHRI Noblesville		7315na				
1000-1100	USA, WJCR Upton, Kentucky			7490na			
1000-1100	USA, WWCR Nashville		5920am	15690na			
1000-1100	USA, WYFR Okeechobee, FL			5950am			
1030-1040 mtwhf	Malawi B'casting Corp.		5995do				
1030-1100	Czechoslovakia		6055va	7345va	9505va	11990va	
1030-1100	Iran, Islamic Republic		9525as	11715af	11790as	11910as	
			11930me				
1030-1100	South Korea, Seoul		11715na				
1030-1100	Sri Lanka B'casting Corp.		11835as	15120as	17850as		
1030-1100 sa	Tanzania		5985af	9685af	11765af		
1030-1100	UAE Radio, Dubai		13675eu	15320eu	15435as	21605as	
1030-1100	United Kingdom, BBC London		5975eu	6045eu	6180eu	6190af	
	6195as	9410eu	9660eu	9740as	9750eu	9760eu	
	11750as	11760me	11940af	12095eu	15070va	15190sa	
	15310as	15400af	15420af	15575me	17640va	17705eu	
	17790af	17885af	21470af	21660af			
1040-1050	Greece, Voice of		15650as	17525as			
1055-1100	Bonaire, TWR Bonaire		11815am	15345am			



**NEW BOOK!**

# PROPAGATION PROGRAMS

## A REVIEW OF CURRENT FORECASTING SOFTWARE

by: JACQUES D'AVIGNON

### Introductory price of **ONLY \$9.95!\***

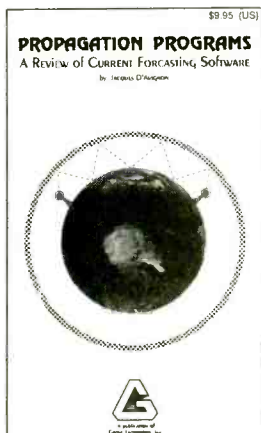

Bandaid? Miniprop? Ionsound? The number of shortwave radio propagation prediction programs on the market is bewildering. Which is best for you? This up-to-date review of the ten leading programs will help you make the right choice the first time!

Order BOK59 from Grove for only \$9.95 plus \$4 shipping and join the fast-growing world of computers in shortwave listening today.

GROVE ENTERPRISES, INC.  
**1-800-438-8155**  
140 DOG BRANCH ROAD  
BRASSTOWN, NC 28902-0098  
HOURS: 8AM-5PM, Monday-Friday, EDT

**ORDER BOK59 TODAY!**



\* Plus \$4 UPS Shipping

**GROVE BOOK!**

# The 1992 Guide To Shortwave Programs

by: Kannon Shanmugam

The 1992 Guide to Shortwave Programs contains all the up-to-date information you need for your shortwave listening. Its 133 pages present some 9000 programs from more than 60 worldwide broadcasters.

Twenty-four-hour programming is extensively cross-referenced by time and day of the week; a comprehensive frequency list increases your chances of success.

### **\$12.95\* (Order BOK 43)**

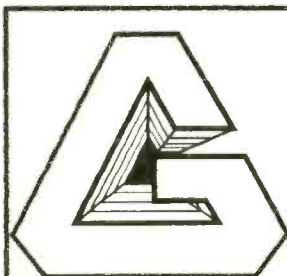
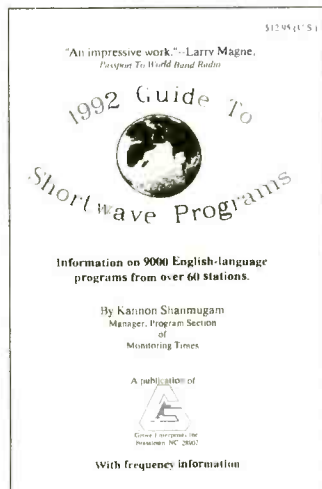

## GROVE ENTERPRISES, INC.

# 1-800-438-8155

140 Dog Branch Road  
Brasstown, NC 28902-0098

\* Plus \$4 UPS Shipping

1100 UTC

[7:00 AM EDT/4:00 AM PDT]

## FREQUENCIES

1100-1110 mtwhf	Ghana, Radio 2 School Prg	7295do			
1100-1110 sa	Malawi B'casting Corp.	5995do			
1100-1120	Pakistan	17902eu	21520eu		
1100-1130	Ecuador, HCJB Quito	9745au	11925au	15155au	21455au
1100-1130	Iran, Islamic Republic	9525af	11515af	11790as	11910as
		11930me			
1100-1130 irreg	Mozambique	9525af	11818af	11835af	
1100-1130	Sri Lanka B'casting Corp.	11835as	15120as	17850as	
1100-1130	Swiss Radio Int'l	13835as	15505as	17670as	21770as
1100-1130	United Kingdom, BBC London	5965na	6045eu	6180eu	6190af
		6195eu	9410eu	9515na	9660eu
		9740as	9750eu	9760eu	11750as
		11760me	11940af	12095eu	15070va
		15310as	15400af	15420af	15575me
		15220na	17640va	17705eu	17790af
		17885af	21470af	21660af	
1100-1130	Vietnam, Voice of	9840as	12020as	15010as	
1100-1150	Germany, Deutsche Welle	15410af	17765af	17800af	17860af
		21600af			
1100-1150	North Korea	6576na	9977na	11335na	
1100-1200	Australia	6020pa	6080pa	7240pa	9580pa
		9710va	11880pa	13605pa	21725as
1100-1200	Bonaire, TWR Bonaire	11815am	15345am		
1100-1200	Bulgaria, Radio Sofia	11630af			
1100-1200	Canada, CFCX Montreal	6005do			
1100-1200	Canada, CFRX Toronto	6070do			
1100-1200	Canada, CFVP Calgary	6030do			
1100-1200	Canada, CHNX Halifax	6130do			
1100-1200	Canada, CKZU Vancouver	6160do			
1100-1200	Cook Islands	11760pa			
1100-1200	Costa Rica, AWR	9725ca	11870ca		
1100-1200	Costa Rica, RFPI	7375na	15030na		
1100-1200	Czechoslovakia	6055va	7345va	9505va	11990va
1100-1200	Ghana, Radio 1, Accra	4915do			
1100-1200 sa	Ghana, Radio 2, Accra	3366do			
1100-1200 varies	Italy, IRRS Milan, Italy	7125eu			
1100-1200	Japan NHK	6120na	11815sa	11840na	
1100-1200	Luxembourg, RTL	15350va			
1100-1200	Malaysia, RTM Kuching	4950do	7160do		

1100-1200	Malaysia, RTM Radio 4	7295do			
1100-1200	New Zealand, RNZI	9700as			
1100-1200	Russia, Radio Moscow	9600na	11840na	12055na	15485na
		17830na			
1100-1200	Singapore, SBC1	5010do	5052do	11940do	
1100-1200	South Africa, Radio RSA	11900af			
1100-1200 vi	South Africa, Radio Oranje	9630do			
1100-1200	South Korea World News	15575af			
1100-1200	USA, CSMonitor Boston	9455am	9495na	13625as	17555as
1100-1200 sa	USA, CSMonitor Boston	15665me			
1100-1200	USA, KTBN Salt Lake City	7510na			
1100-1200	USA, VOA Washington	5985as	6110au	9760as	11720au
		15155au	15425as	21840as	
1100-1200	USA, WHRI Noblesville	7315na	9465na		
1100-1200	USA, WJCR Upton, Kentucky	7490na			
1100-1200	USA, WWCR Nashville	12160na	1569na		
1100-1200	USA, WYFR Okeechobee, FL	5950am	7355am		
1115-1130	South Korea World News	7275as	11740as		
1115-1145	Nepal, Kathmandu	3230as	5005as	7165as	
1120-1130	Vatican Radio	6245do	7250do	9645do	15210do
1125-1130 sa	Botswana, Gaborone	5955af	7255af		
1125-1150 mtwhf	Finland, YLE	15400na			
1130-1140	Lesotho, Masseru	4800do			
1130-1155 s	Belgium, BRT Brussels	17555va	21810na		
1130-1200	Austria, ORF Vienna	6155eu	11780as	13730va	15450as
1130-1200	Ecuador, HCJB Quito	11925am	15115am	17890am	21455am
1130-1200	Italy, AWR Italy	7230eu			
1130-1200	South Korea, Seoul	9650na			
1130-1200	Thailand	4830as	9655as	11905as	
1130-1200	United Kingdom, BBC London	5965na	6045eu	6180eu	6190af
		6195eu	9410eu	9515na	9660eu
		9740as	9750eu	9760eu	11750as
		11760me	11940af	12095eu	15070va
		15220na	15310as	15420af	15575me
		17640va	17705eu	17790af	17885af
		21470af			
1130-1200 WAR/var	Yugoslavia	17710as	17740am	21605pa	

## SELECTED PROGRAMS

## Sundays

- 1100 Radio For Peace Int'l: The Great Atlantic Radio Conspiracy. See S 0300.  
 1111 Radio Moscow: News And Views. See S 0311.  
 1130 BBC: The Ken Bruce Show. See S 0030.  
 1130 Radio For Peace Int'l: RFPI's Mailbag. See S 0330.  
 1131 Radio Moscow: Transcription Service. See S 0631.

## Mondays

- 1100 Radio For Peace Int'l: New Dimensions Radio. See M 0300.  
 1111 Radio Moscow: News And Views. See S 0311.  
 1130 BBC: Composer Of The Month. See M 0230.  
 1131 Radio Moscow: Music At Your Request. Music as requested by listeners.

## Tuesdays

- 1100 Radio For Peace Int'l: Steppin' Out Of Babylon. See T 0300.  
 1111 Radio Moscow: News And Views. See S 0311.  
 1130 BBC: Megamix. Music, sports, fashion, health, travel, news, and opinion for young people.  
 1130 Radio For Peace Int'l: Voices Of Our World. See T 0330.  
 1131 Radio Moscow: Folk Box. See S 0131.

## Wednesdays

- 1100 Radio For Peace Int'l: World Of Radio. See S 0200.



*The English staff at Radio Czechoslovakia in a recent photo. The station has undergone as many changes as the country, but some of these staff members are still a part of the team.*

- 1111 Radio Moscow: News And Views. See S 0311.  
 1130 BBC: Meridian. See W 0630.  
 1130 Radio For Peace Int'l: RFPI's Mailbag. See S 0330.  
 1131 Radio Moscow: Music. See S 0231.

## Thursdays

- 1100 Radio For Peace Int'l: Changemakers. See M 0630.  
 1111 Radio Moscow: News And Views. See S 0311.  
 1130 BBC: Drama. Follow the plight of Arcos the sorcerer in "The Heart Of Hark 'un" (through October 1st).  
 1130 Radio For Peace Int'l: New Dimensions Radio. See M 0300.  
 1131 Radio Moscow: Music. See S 0231.

## Fridays

- 1100 Radio For Peace Int'l: Alternative Radio. See T 0400.  
 1111 Radio Moscow: News And Views. See S 0311.  
 1130 BBC: Meridian. See W 0630.  
 1131 Radio Moscow: Yours For The Asking. See M 2331.

## Saturdays

- 1100 Radio For Peace Int'l: New Dimensions Radio. See M 0300.  
 1111 Radio Moscow: News And Views. See S 0311.  
 1130 BBC: Meridian. See W 0630.  
 1131 Radio Moscow: Music At Your Request. See M 1131.



1200UTC

[8:00 AM EDT/5:00 AM PDT]

FREQUENCIES

Table with columns for frequency, country/region, and time. Includes stations like New Zealand, RNZI; Luxembourg, RTL; Malaysia, RTM Radio 4; Nigeria, Voice of; USA, VOA Washington; Australia, ABC Brisbane; Canada, CFCX Montreal; and others.

SELECTED PROGRAMS

Sundays

1200 Radio For Peace Int'l: Peace Forum. See S 0400.
1200 Radio Norway Int'l: Norway Today. See S 0000.
1201 BBC: Play Of The Week. See S 0101.
1211 Radio Moscow: Music And Musicians. Music from world-famous performers and composers.

Mondays

1200 Radio For Peace Int'l: Visions For A Better World. See M 0400.
1211 Radio Moscow: Culture And The Arts. See S 1611.
1215 BBC: Quiz. Robert Robinson hosts the favorite general-knowledge game show "Brain Of Britain" (through October 4th).
1230 Radio For Peace Int'l: Sound Currents Of The Earth. See M 0430.
1231 Radio Moscow: Russian By Radio. See S 0631.
1245 BBC: Sports Roundup. See S 0315.

Tuesdays

1200 Radio For Peace Int'l: Alternative Radio. See T 0400.
1211 Radio Moscow: Focus On Asia And The Pacific. See T 0011.

1215 BBC: Multitrack 1: Top 20. See M 2330.
1231 Radio Moscow: Interview. See M 1631.
1239 Radio Moscow: Music. See S 0231.
1245 BBC: Sports Roundup. See S 0315.

Wednesdays

1200 Radio For Peace Int'l: Seeing Beyond. See W 0400.
1211 Radio Moscow: Focus On Asia And The Pacific. See T 0011.
1215 BBC: New Ideas. See 1615.
1231 Radio Moscow: Interview. See M 1631.
1235 BBC: Talks. See M 1635.
1239 Radio Moscow: Music. See S 0231.
1245 BBC: Sports Roundup. See S 0315.

Thursdays

1211 Radio Moscow: Focus On Asia And The Pacific. See T 0011.
1215 BBC: Multitrack 2. See W 2330.
1230 Radio For Peace Int'l: Voices Of Our World. See T 0330.
1231 Radio Moscow: Interview. See M 1631.
1239 Radio Moscow: Music. See S 0231.
1245 BBC: Sports Roundup. See S 0315.

Fridays

1200 Radio For Peace Int'l: UNESCO. See M 2330.
1211 Radio Moscow: Focus On Asia And The Pacific. See T 0011.
1215 BBC: Feature. Andy Kershaw looks at the mystique of motorcycles in "The Fatboy Means Business" (4th); "Farming After Communism" looks at agriculture in eastern Europe (11th, 18th, 25th).
1230 Radio For Peace Int'l: WINGS. See F 0430.
1231 Radio Moscow: Interview. See M 1631.
1239 Radio Moscow: Music. See S 0231.
1245 BBC: Sports Roundup. See S 0315.

Saturdays

1200 Radio For Peace Int'l: World Of Radio. See S 0200.
1200 Radio Norway Int'l: Norway Today. See S 0000.
1211 Radio Moscow: Focus On Asia And The Pacific. See T 0011.
1215 BBC: Multitrack 3. See F 2330.
1230 Radio For Peace Int'l: RFI's Mailbag. See S 0330.
1231 Radio Moscow: Interview. See M 1631.
1239 Radio Moscow: Music. See S 0231.
1245 BBC: Sports Roundup. See S 0315.

1300 UTC

[9:00 AM EDT/6:00 AM PDT]

## FREQUENCIES

1300-1315	South Korea, Seoul	9750na			
1300-1320	Brazil, Radiobras	15445am			
1300-1325	Belgium, BRT Brussels	17555va	21810na		
1300-1325	Kenya, Voice of	4935do			
1300-1325	Netherlands	9855eu			
1300-1330	Afghanistan, Kabul	9635as			
1300-1330	Bonaire, TWR Bonaire	11815am	15345am		
1300-1330 mtwhf	Cameroon CRTV Douala	4795do			
1300-1330	Egypt, Radio Cairo	17595as			
1300-1330 as	Finland, YLE	15400na	17880na		
1300-1330	Israel, Kol Israel	11587am	11605na	15590na	15640as
		15650as	17575eu	17590eu	
1300-1330 as	Norway	9590eu	15270af		
1300-1330	Swiss Radio Int'l	6165eu	7480as	9535eu	11690as
		12030eu	13635as	15505as	17670as
		21770as			
1300-1330	United Kingdom, BBC London	5965am	6180eu	6190af	6195ca
		9410eu	9515na	9660eu	9740as
		9750eu	9760eu	11750as	11760me
		11820as	11940af	12095eu	15070va
		15220na	15310as	15420af	15575me
		7180as	15220na	17640va	17705eu
		17790af	17840af	17885af	21470af
		21660af			
1300-1330	USA, VOA Washington	6110as	9760au	11715as	15155au
		15425au			
1300-1350	North Korea	9325eu	9345eu	9640as	13650as
		13650am	15230as	15230am	
1300-1400	Australia	5995pa	6080pa	7240pa	9580pa
		11800pa			
1300-1400	Australia, ABC Alice Sprg	2310do			
1300-1400	Australia, ABC Brisbane	4920do			
1300-1400	Australia, ABC Katherine	2485do			
1300-1400	Australia, ABC Perth	9610do			
1300-1400	Australia, ABC Tennant Cr	2325do			
1300-1400	Canada, CFCX Montreal	6005do			
1300-1400	Canada, CFRX Toronto	6070do			
1300-1400	Canada, CFVP Calgary	6030do			
1300-1400	Canada, CHNX Halifax	6130do			
1300-1400	Canada, CKZU Vancouver	6160do			
1300-1400 s	Canada, RCI Montreal	11955am	17820am		
1300-1400	China, Radio Beijing	9715as	11660va	11855na	
1300-1400	Cook Islands	11760pa			
1300-1400	Costa Rica, RFPI	13630na	15030na		
1300-1400	Ecuador, HCJB Quito	11925am	15115am	17890am	21455am
1300-1400 sa	Eq. Guinea, R. East Africa	9585af			
1300-1400	Ghana, Radio 1, Accra	4915do			
1300-1400	Ghana, Radio 2, Accra	7295do			
1300-1400	Luxembourg, RTL	15350va			
1300-1400	Malaysia, RTM Radio 4	7295do			
1300-1400	Nigeria	4990do	7285do		
1300-1400	Nigeria, Voice of	7255af			
1300-1400	Papua New Guinea	4890do			
1300-1400	Philippines, FEBC Manila	11995as			
1300-1400	Romania, R. Romania Int'l	11940eu	15365eu	17720eu	17850eu
1300-1400	Russia, AWR Russia	11855as			
1300-1400	Russia, Radio Moscow	7370va	9655na	9755na	11840na
		11870va	11985na	11995va	12050na
		12055na	15485na	17670na	17830na
1300-1400	Sierra Leone, SLBS	3316do	5980do		
1300-1400	Singapore, SBC1	5010do	5052do 1	1940do	
1300-1400 vl	South Africa, Radio Oranje	9630do			
1300-1400	Sri Lanka B'casting Corp.	6075as	9720as		
1300-1400 sa	Tanzania	5985af	9684af	11765af	
1300-1400	USA, CSMonitor Boston	9425au	9495am	13625as	13760na
1300-1400 as	USA, CSMonitor Boston	15665eu			
1300-1400	USA, KNLS Anchor Point	11580as			
1300-1400	USA, KTNB Salt Lake City	7510am			
1300-1400	USA, WHRI Noblesville	9465na	11790na		
1300-1400	USA, WJCR Upton, Kentucky		7490na		
1300-1400	USA, WWCR Nashville	12160na	15690		
1300-1400	USA, WYFR Okeechobee, FL		5950am	6015am	11550as
		11830am	13695na	17760am	
1315-1330	Lebanon, Radio Voice of	6549.5			
1320-1400	Jordan	9560eu			
1325-1400 mtwhf	Kenya, Voice of	4935do			
1330-1345	South Korea World News	7275as	11740as		
1330-1357	Canada, RCI Montreal	9535as	11795as		
1330-1400	Austria, ORF Vienna	11780as	15450as		
1330-1400	Cameroon CRTV Douala	4795do			
1330-1400	Finland, YLE	15400na	17880na		
1330-1400	India, All India Radio	9665as	11760as	15120as	
1330-1400 a	Indonesia, Radio Republik	3385do	6070do		
1330-1400	Laos, National Radio of	7116as			
1330-1400	Netherlands	17580pa	17605pa	21665pa	
1330-1400	UAE Radio, Dubai	13675eu	15320eu	15435as	21605as
1330-1400	United Kingdom, BBC London	5975eu	6045eu	6180eu	6190af
		6195ca	9410eu	9515na	9660eu
		9740as	9750eu	9760eu	11750as
		11820as	11940af	12095eu	15070va
		15220na	15310as	15420af	15575me
		7180as	17640va	17705eu	17790af
		17840af	17885af	21470af	21660af
1330-1400	USA, VOA Washington	6110as	9760as	15155au	15425au
1330-1400	Uzbekistan, R. Tashkent	5945as	9540as	15470as	17745as
1330-1400	Vietnam, Voice of	9840as	12020as	15010as	
1345-1400	Vatican Radio	11640au	15090au	17525au	21515au

## SELECTED PROGRAMS

## Sundays

- 1300 Radio For Peace Int'l: World Citizen's Hour. See S 0500.  
 1300 Radio Norway Int'l: Norway Today. See S 0000.  
 1311 Radio Moscow: Science And Engineering. See S 0511.  
 1331 Radio Moscow: Your Top Tune. See S 0331.

## Mondays

- 1311 Radio Moscow: Moscow Mailbag. See S 0111.  
 1330 Radio For Peace Int'l: World Goodwill Forum. See M 0530.  
 1331 Radio Moscow: Audio Book Club. See S 0031.

## Tuesdays

- 1300 Radio For Peace Int'l: United Nations. See M 0245.  
 1311 Radio Moscow: Moscow Mailbag. See S 0111.  
 1315 Radio For Peace Int'l: RFPI Reports. See S 0230.  
 1330 Radio For Peace Int'l: Outlaw For Peace. See T 0530.

- 1331 Radio Moscow: Music. See S 0231.

## Wednesdays

- 1300 Radio For Peace Int'l: UNESCO. See M 2330.  
 1311 Radio Moscow: Science And Engineering. See S 0511.  
 1315 Radio For Peace Int'l: RFPI Reports. See S 0230.  
 1330 Radio For Peace Int'l: Peace Forum. See S 0400.  
 1331 Radio Moscow: Russian By Radio. See S 0631.

## Thursdays

- 1300 Radio For Peace Int'l: United Nations. See M 0245.  
 1311 Radio Moscow: Culture And The Arts. See S 1611.  
 1315 Radio For Peace Int'l: RFPI Reports. See S 0230.  
 1330 Radio For Peace Int'l: Peace Forum. See S 0400.  
 1331 Radio Moscow: Audio Book Club. See S 0031.

## Fridays

- 1300 Radio For Peace Int'l: Dialogue. See T 2330.  
 1311 Radio Moscow: Moscow Mailbag. See S 0111.  
 1315 Radio For Peace Int'l: RFPI Reports. See S 0230.  
 1330 Radio For Peace Int'l: Peace Forum. See S 0400.  
 1331 Radio Moscow: Russian By Radio. See S 0631.

## Saturdays

- 1300 Radio For Peace Int'l: United Nations. See M 0245.  
 1300 Radio Norway Int'l: Norway Today. See S 0000.  
 1311 Radio Moscow: Newmarket. See S 0011.  
 1315 Radio For Peace Int'l: RFPI Reports. See S 0230.  
 1330 Radio For Peace Int'l: Outlaw For Peace. See T 0530.  
 1331 Radio Moscow: Audio Book Club. See S 0031.



1400 UTC

[10:00 AM EDT/7:00 AM PDT]

## FREQUENCIES

1400-1410	Malawi B'casting Corp.	3381do				1400-1500	Russia, Radio Moscow	7370va	9655na	9675na	9755na
1400-1415	Vatican Radio	15090au	17525au	21515au				11840na	11870va	11995na	12015va
1400-1425	Netherlands	17580pa	17605pa	21665pa				12030va	12050na	15435na	15485na
1400-1430	Cameroon CRTV Douala	4795do						15490va	15580va	17670na	17695va
1400-1430	Ecuador, HCJB Quito	11925am	15115am	17890am	21455am			17810va	21690na		
1400-1430	Malaysia, RTM Kuching	4950do				1400-1500	Sierra Leone, SLBS	3316do	5980do		
1400-1430	United Kingdom, BBC London	6190af	6195af	6195as	7180as	1400-1500	Singapore, SBC1	5010do	5052do	11940do	
		9410eu	9515na	9660eu	9740as	1400-1500 vl	South Africa, Radio Oranje	9630do			
		9750eu	9760eu	11750as	11820as	1400-1500	South Korea, Seoul	9570as			
		11940af	12095eu	15070eu	15220na	1400-1500	Sri Lanka B'casting Corp.	6075as	9720as		
		15310as	15575me	17640va	17705eu	1400-1500 sa	Tanzania	5985af	9684af	11765af	
		17790af	17840na	17880af	21470af	1400-1500	USA, CSMonitor Boston	9530as	13625as	13760am	15665eu
		21660af						17555am			
1400-1500	Australia	5995pa	6060pa	6080pa	7240pa	1400-1500 sa	USA, CSMonitor Boston	13710na			
		9540pa	9580pa	9770va	11800na	1400-1500	USA, KTBN Salt Lake City	7510na			
		15170va				1400-1500	USA, VOA Washington	6110as	9760as	15160au	15425au
1400-1500	Australia, VLW6 Wanneroo,	6140do				1400-1500	USA, WHRI Noblesville	9465na	15105na		
1400-1500	Cameroon CRTV Yaounde	4850do				1400-1500	USA, WJCR Upton, Kentucky	7490na			
1400-1500	Canada, CFCX Montreal	6005do				1400-1500	USA, WWCR Nashville	15690am	17535na		
1400-1500	Canada, CFRX Toronto	6070do				1400-1500	USA, WYFR Okeechobee, FL	6015am	11550as	11830am	17760am
1400-1500	Canada, CFVP Calgary	6030do				1405-1430	Finland, YLE	6120va	6155eu	9730af	11755eu
1400-1500	Canada, CHNX Halifax	6130do						11820va	15440me	17880eu	
1400-1500	Canada, CKZU Vancouver	6160do				1415-1425	Nepal, Kathmandu	3230do	5005do	7165do	
1400-1500 s	Canada, RCI Montreal	11955am	17820am			1415-1429	Canada, RCI Montreal	11935eu	15305eu	15315eu	15325eu
1400-1500	China, Radio Beijing	4200as	11815as	11855na	15165as			17795eu	17820eu	21545eu	
1400-1500	Cook Islands	11760pa				1415-1500	Bhutan Broadcasting Svc	5023do			
1400-1500	Costa Rica, RFPI	13630na	15030am			1430-1500	Albania, Radio Tirana	7155eu	9760eu		
1400-1500	France, RFI Paris	11910as	17650as	17695as		1430-1500 mtwhfa	Cameroon CRTV Douala	4795do			
1400-1500	Ghana, Radio 1, Accra	4915do				1430-1500	Ecuador, HCJB Quito	11925am	17890am	21455am	
1400-1500	Ghana, Radio 2, Accra	7295do				1430-1500	Myanmar, Voice of, Burma	5990do			
1400-1500	India, All India Radio	9665as	11760as	15120as		1430-1500	Netherlands	9890as	15150as	17605as	21665as
1400-1500 varies	Italy, IRRS Milan, Italy	7125eu				1430-1500	Romania, R. Romania Int'l	11775as	15335as	17720as	
1400-1500	Japan NHK	9505am	11865va			1430-1500	United Kingdom, BBC London	6180eu	6190af	6195as	9410eu
1400-1500	Jordan	9560eu						9515na	9740as	9750eu	9760eu
1400-1500 mtwhf	Kenya, Voice of	4935do						11750as	11820as	11940af	12095eu
1400-1500	Lebanon, King of Hope	6280me						15070va	15310as	15575me	17640va
1400-1500	Luxembourg, RTL	15350va						17705eu	17790af	17840va	17880af
1400-1500	Malaysia, RTM Radio 4	7295do						7180as	21470af	21660af	
1400-1500	Malta, V. of the Medit.	11925eu				1445-1500 smwha	Mongolia, Ulaanbaatar	7260as	13780as		
1400-1500	Nigeria	4990dc	7285do								
1400-1500	Nigeria, Voice of	7255af									
1400-1500	Philippines, FEBC Manila	11995as									

## SELECTED PROGRAMS

## Sundays

- 1400 Radio For Peace Int'l: From The Atom To The Universe. See S 0600.
- 1401 BBC: Feature. This month, phone-ins with rock and pop stars are the subject of "Pop On The Line" —just dial 011-44-71-379-7444!
- 1411 Radio Moscow: News And Views. See S 0311.
- 1430 BBC: Anything Goes. Bob Holness presents a variety of music and other recordings.
- 1430 Radio For Peace Int'l: Feature. See S 0630.
- 1431 Radio Moscow: Russian By Radio. See S 0631.

## Mondays

- 1405 BBC: Outlook. Conversation, controversy, and color from the UK and the world.
- 1411 Radio Moscow: News And Views. See S 0311.
- 1430 BBC: Off The Shelf. See M 0430.
- 1430 Radio For Peace Int'l: Changemakers. See M 0630.
- 1431 Radio Moscow: Folk Box. See S 0131.
- 1445 BBC: Talks. See S 0445.

## Tuesdays

- 1400 Radio For Peace Int'l: Peace Talks. See T 0600.

- 1405 BBC: Outlook. See M 1405.
- 1411 Radio Moscow: News And Views. See S 0311.
- 1430 BBC: Off The Shelf. See M 0430.
- 1430 Radio For Peace Int'l: New Dimensions Radio. See M 0300.
- 1431 Radio Moscow: Music. See S 0231.
- 1445 BBC: Feature. See M 0145.

## Wednesdays

- 1400 Radio For Peace Int'l: A Voice Of The Emerging World or Peace Forum. See W 0600.
- 1405 BBC: Outlook. See M 1405.
- 1411 Radio Moscow: News And Views. See S 0311.
- 1430 BBC: Off The Shelf. See M 0430.
- 1431 Radio Moscow: Jazz Show. See M 0331.
- 1445 BBC: Good Books. Recommendations of books to read (except 30th: A Month In The Country, Michael Hayes' wanderings of rural Britain).

## Thursdays

- 1400 Radio For Peace Int'l: Sound Currents Of The Earth. See M 0430.
- 1405 BBC: Outlook. See M 1405.
- 1411 Radio Moscow: News And Views. See S 0311.

- 1430 BBC: Off The Shelf. See M 0430.
- 1431 Radio Moscow: Yours For The Asking. See M 2331.
- 1445 BBC: Recording Of The Week. See M 0615.

## Fridays

- 1400 Radio For Peace Int'l: Food For The Thoughtful. See M 0200.
- 1405 BBC: Outlook. See M 1405.
- 1411 Radio Moscow: News And Views. See S 0311.
- 1430 BBC: Off The Shelf. See M 0430.
- 1430 Radio For Peace Int'l: The Practice of Peacemaking. See F 0630.
- 1431 Radio Moscow: Music At Your Request. See M 1131.
- 1445 BBC: Global Concerns. See F 0145.

## Saturdays

- 1400 Radio For Peace Int'l: The CFRU Series. See T 0200.
- 1401 BBC: Sportsworld. The latest soccer, cricket, tennis, golf, and more.
- 1411 Radio Moscow: News And Views. See S 0311.
- 1430 Radio For Peace Int'l: Second Opinion. See H 0200.
- 1431 Radio Moscow: Music. See S 0231.

1500 UTC

[11:00 AM EDT/8:00 AM PDT]

## FREQUENCIES

1500-1515 smwha	Mongolia, Ulaanbaatar	7260as	13780as						
1500-1525	Netherlands	9890as	15150as	17605as	21665as				
1500-1530 mtwhf	Portugal	21515me							
1500-1530	Romania, R.Romania Int'l	11775as	15335as	17720as					
1500-1530	Sweden	15270va	17870na	21500na					
1500-1530	Swiss Radio Int'l	13635as	15505as	17670as	21770as				
1500-1530 sa	Tanzania	5985af	9684af	11765af					
1500-1530	United Kingdom, BBC London	3915as	5975eu	6045eu	6180eu				
		6190af	6195eu	6195as	9410eu				
		9515na	9740na	9750eu	9760eu				
		11750as	11940af	12095eu	15070va				
		15310as	15400af	15420af	17840na				
			15260na	15575me	17640va	17705eu			
			17790af	17860af	17880af	21470af			
			21490af	21660af					
1500-1550	Germany, Deutsche Welle	9735af	11965af	13610af	17735af				
		17765af	21600af						
1500-1550	North Korea	9325eu	9640af	9977af	11705eu				
1500-1555	Polish Radio Warsaw	7285eu	9525eu	11840eu					
1500-1555	Seychelles, FEBA	9810as	11685af	15330as					
1500-1600	Australia	5995pa	6060pa	6080pa	7240pa				
		9540pa	9580pa	9770pa	11800pa				
		12000pa	13755pa	15170as	17565as				
1500-1600	Bangladesh	4880do							
1500-1600	Cameron CRTV Yaounde	4850do							
1500-1600	Canada, CFCX Montreal	6005do							
1500-1600	Canada, CFRX Toronto	6070do							
1500-1600	Canada, CFVP Calgary	6030do							
1500-1600	Canada, CHNX Halifax	6130do							
1500-1600	Canada, CKZU Vancouver	6160do							
1500-1600 s	Canada, RCI Montreal	11955am	17820am						
1500-1600	China, Radio Beijing	7405na	11815as	15165as					
1500-1600	Cook Islands	11760pa							
1500-1600	Costa Rica, RFPI	13630na	15030am						
1500-1600	Ecuador, HCJB Quito	11925am	17890am	21455am					
1500-1600	Ethiopia, Voice of	7165af							
1500-1600	Ghana, Radio 1, Accra	4915do							
1500-1600	Ghana, Radio 2, Accra	7295do							
1500-1600	Guam, KTWR Guam	11650as							
1500-1600	Japan NHK	11865am							
1500-1600	Jordan	9560eu							
1500-1600 mtwhf	Kenya, Voice of	4935do							
1500-1600	Luxembourg, RTL	15350va							
1500-1800	Malaysia, RTM Radio 4	7295do							
1500-1600	Malta, V. of the Medit.	11925eu							
1500-1600	Myanmar, Voice of, Burma	5990do							
1500-1600	Nigeria	4990do	7285do						
1500-1600	Nigeria, Voice of	7255af							
1500-1600	Philippines, FEBC Manila	11995as							
1500-1600	Russia, Radio Moscow	7370va	9655na	9755na	11665na				
		11840na	11995na	12015va	12030na				
		12050na	13645na	15405na	15485na				
		17670na							
1500-1600 twhfa	Seychelles, FEBA	9810as	15330as						
1500-1600	Sierra Leone, SLBS	3316do	5980do						
1500-1600	Singapore, SBC1	5010do	5052do	11940do					
1500-1600 vl	South Africa, Radio Oranje	9630do							
1500-1600	Sri Lanka B'casting Corp.	6075as	9720as						
1500-1600	USA, CSMonitor Boston	9530as	13625as	13760pa	15665eu				
		17555am							
1500-1600 sa	USA, CSMonitor Boston	13710na							
1500-1600	USA, KTBN Salt Lake City	15590na							
1500-1600	USA, VOA Washington	6110as	7125as	9645as	9760as				
		15395as							
1500-1600	USA, VOA Washington	9700eu	15205me						
1500-1600	USA, WHRI Noblesville	9465sa	15105na						
1500-1600	USA, WJCR Upton, Kentucky	7490na							
1500-1600 vl, irr	USA, WRNO New Orleans	15420na							
1500-1600	USA, WWCR Nashville	15690am	17535na						
1500-1600	USA, WYFR Okeechobee, FL	11705am	11830am						
1530-1540 mtwhfa	Greece, Voice of	15630na	15650na	17525na					
1530-1600	Austria, ORF Vienna	6155eu	11780as	13730eu	21490va				
1530-1600	Netherlands	9890as	15150as	17580as	17605as				
		21665as							
1530-1600	Sudan Nat'l B'casting Cor	9540do	9550do	11635do					
1530-1600	Switzerland, SRI	15430va							
1530-1600	Tanzania	5985af	9684af	11765af					
1530-1600	United Kingdom, BBC London	6190af	6195eu	6195as	7180as				
		9410eu	9740na	9750eu	11750as				
		11775na	12095eu	15070va	15260as				
		15310as	15400af	17640va	17705eu				
		17840na	17880af	21470af	21660af				
1545-1600	South Korea World News	7275va							
1545-1600	Vatican Radio	15090au	17865au						

## SELECTED PROGRAMS

## Sundays

- 1500 Radio For Peace Int'l: Living Enrichment Center. Life experiences and opportunities from a spiritual perspective.
- 1511 Radio Moscow: Top Priority. See S 0124.
- 1515 BBC: Concert Hall. Classical music from the world's great concert halls.
- 1530 Radio For Peace Int'l: The World In Review. News from the United Nations and worldwide from the week just past.
- 1531 Radio Moscow: Africa As We See It. News and features for the African continent.
- 1545 Radio For Peace Int'l: RFPI Reports. See S 0230.

## Mondays

- 1500 Radio For Peace Int'l: World Of Radio. See S 0200.
- 1511 Radio Moscow: Culture And The Arts. See S 1611.
- 1515 BBC: Feature/Drama. See M 0101.
- 1530 Radio For Peace Int'l: The World In Review. See S 1530.
- 1531 Radio Moscow: Africa As We See It. See S 1531.
- 1545 Radio For Peace Int'l: RFPI Reports. See S 0230.

## Tuesdays

- 1511 Radio Moscow: Focus On Asia And The Pacific. See T

0011.

- 1515 BBC: A Jolly Good Show. Dave Lee Travis presents listener rock music requests.
- 1530 Radio For Peace Int'l: UNESCO. See M 2330.
- 1531 Radio Moscow: Africa As We See It. See S 1531.
- 1545 Radio For Peace Int'l: RFPI Reports. See S 0230.

## Wednesdays

- 1511 Radio Moscow: Focus On Asia And The Pacific. See T 0011.
- 1515 BBC: Talks. See M 0415.
- 1530 BBC: Comedy/Drama. They're back! Arthur Dent, Ford Prefect, Zaphod Beeblebrox and the gang peruse "The Hitchhiker's Guide To The Galaxy" (except 30th: Two Cheers For September, a humorous look back at the month just past).
- 1530 Radio For Peace Int'l: Dialogue. See T 2330.
- 1531 Radio Moscow: Africa As We See It. See S 1531.
- 1545 Radio For Peace Int'l: RFPI Reports. See S 0230.

## Thursdays

- 1500 Radio For Peace Int'l: Common Ground. See W 2300.
- 1511 Radio Moscow: Focus On Asia And The Pacific. See T 0011.

- 1515 BBC: Music. See S 2315.
- 1530 Radio For Peace Int'l: Population Update or FAO. See W 2330.
- 1531 Radio Moscow: Africa As We See It. See S 1531.

## Fridays

- 1500 Radio For Peace Int'l: The Great Atlantic Radio Conspiracy. See S 0300.
- 1511 Radio Moscow: Focus On Asia And The Pacific. See T 0011.
- 1515 BBC: Music Review. See H 2315.
- 1530 Radio For Peace Int'l: United Nations. See M 0245.
- 1531 Radio Moscow: Africa As We See It. See S 1531.
- 1545 Radio For Peace Int'l: RFPI Reports. See S 0230.

## Saturdays

- 1500 Radio For Peace Int'l: WPU News. See F 1500.
- 1511 Radio Moscow: Focus On Asia And The Pacific. See T 0011.
- 1515 BBC: Sportsworld. See A 1401.
- 1530 Radio For Peace Int'l: RFPI Reports. See S 0230.
- 1531 Radio Moscow: Africa As We See It. See S 1531.



1600 UTC

[12:00 PM EDT/9:00 AM PDT]

## FREQUENCIES

1600-1605	Singapore, SBC1	5010do	5052do	11940do	1600-1700	Korea, Seoul	5975om	9870af				
1600-1610	Lesotho, Maseru	4800do			1600-1700	Luxembourg, RTL	15350va					
1600-1610	Malawi B'casting Corp.	3381do			1600-1700	Nigeria	4990do					
1600-1625	Netherlands	9890as	15150as	17580as	1600-1700	Nigeria, Voice of	7255af					
		21665as			1600-1700	Russia, Radio Moscow	9755na	9825na	11665na	11840na		
1600-1630	Canada, RCI Montreal	11935eu	15305eu	15325eu			11900va	11940va	11995na	12030na		
		21545eu					12050na	13645na	13665va	15375na		
1600-1630 as	Norway	15230af	17720as				15425na	15485na	17670na	17695na		
1600-1630	Pakistan	11570me	13665me	15060me	1600-1700	Saudi Arabia BC Svc	9705eu	9720eu				
		17555af	17725me		1600-1700	Sierra Leone, SLBS	3316do	5980do				
1600-1630	United Kingdom, BBC London	5975as	6190af	6195eu	1600-1700	South Africa, Radio RSA	9565af	11885af				
		9515na	9630af	9740me	1600-1700	Sri Lanka B'casting Corp.	6075as	9720as				
		11750as	11940af	12095eu	1600-1700	Swaziland, TWR Swaziland	9600af					
		15400af	17640va	17695eu	1600-1700	Tanzania	5985af	9684af	11765af			
		17840na	17860af	17880af	1600-1700	USA, CSMonitor Boston	11580as	13625as	17510na	21640af		
		7180as	15260na	15310as	1600-1700 sa	USA, CSMonitor Boston	13710na	17555am				
		21660af			1600-1700	USA, KTBN Salt Lake City	15590am					
1600-1630	USA, VOA Washington	9700eu	15205me		1600-1700	USA, VOA Washington	9575af	11920af	11995af	15225af		
1600-1630	Vietnam, Voice of	9840eu	12020eu	15010eu			15410af	15495af	15580af	17650af		
1600-1630	Yemen	5970as	7190as				17800af	21625af				
1600-1635	Guam, KTWR Guam	11650as			1600-1700	USA, WHRI Noblesville	9465am	15105am				
1600-1640 vl	South Africa, Radio Oranje	9630do			1600-1700	USA, WJCR Upton, Kentucky		7490na				
1600-1640	Vatican Radio	15090au	17865au		1600-1700 vl, irr	USA, WRNO New Orleans	15420na					
1600-1645	UAE Radio, Dubai	11795af	13675eu	15320eu	1600-1700	USA, WWCR Nashville	15690am	17535am				
1600-1650	Germany, Deutsche Welle	6170as	7225as	9875as	1600-1700	USA, WYFR Okeechobee, FL		11705na	11830am	15355am		
		15415as	15595as	17810as			17750na	21525eu	21615af			
1600-1700	Australia	5995pa	6060pa	6080pa	1610-1615 mtwhf	Botswana, Gaborone	5955af	7255af				
		9860pa	11910pa	12000pa	1620-1658 mtwhf	Morocco, Rabat	17595as					
		15170as	17565pa		1630-1657	Canada, RCI Montreal	7150as	9555as				
1600-1700	Canada, CFCX Montreal	6005do			1630-1700	Ecuador, HCJB Quito	15270me	17790me	21455me			
1600-1700	Canada, CFRX Toronto	6070do			1630-1700	Egypt, Radio Cairo	15255af					
1600-1700	Canada, CFVP Calgary	6030do			1630-1700 mtwhf	Portugal	21515me					
1600-1700	Canada, CHNX Halifax	6130do			1630-1700	United Kingdom, BBC London	5975as	6190af	6196eu	9410eu		
1600-1700	Canada, CKZU Vancouver	6160do					9515na	9630af	9740me	11750as		
1600-1700	China, Radio Beijing	4130do	8260af	11575af			11940af	12095eu	15070eu	15260na		
		15170af					15310as	15400af	15420af	17640va		
1600-1700	Cook Islands	11760pa					17695eu	17860af	17880af			
1600-1700	Costa Rica, RFPI	15030na					21470af	21660af				
1600-1700	France, RFI Paris	6175eu	11705af	12015af	1630-1700	USA, VOA Washington	6180eu	9700eu	9760me	11710me		
		17620af	17795af	17850af			15205me	15245me				
1600-1700	Ghana, Radio 1, Accra	4915do			1635-1700 s	Guam, KTWR Guam	11650as					
1600-1700	Ghana, Radio 2, Accra	7295do			1650-1700 smtwhf	New Zealand, RNZI	9670pa					
1600-1700	Guam, KSDA Guam	11980as										
1600-1700 mtwhf	Kenya, Voice of	4935do										

## SELECTED PROGRAMS

## Sundays

- 1600 Radio Norway Int'l: Norway Today. See S 0000.  
 1611 Radio Moscow: Culture And The Arts. A look at the varied arts and cultures of Russia.  
 1615 BBC: Feature. See S 0230.  
 1631 Radio Moscow: Audio Book Club. See S 0031.  
 1645 BBC: Letter From America. See S 0615.

## Mondays

- 1611 Radio Moscow: Science And Engineering. See S 0511.  
 1615 BBC: New Ideas. Innovative developments in technology and new products.  
 1631 Radio Moscow: Interview. Conversations with experts and newsmakers.  
 1635 BBC: Talks. "Writers In A Nutshell" provides Cliff Notes to the likes of Nadine Gordimer and E Forster (7th, 14th); head for jungle to hear "The Naturalist's Tale" (through October 26th).  
 1639 Radio Moscow: Music. See S 0231.

- 1645 BBC: The World Today. A look at a topical aspect of the international scene.

## Tuesdays

- 1611 Radio Moscow: Science And Engineering. See S 0511.  
 1615 BBC: Megamix. See T 1130.  
 1631 Radio Moscow: Interview. See M 1631.  
 1639 Radio Moscow: Music. See S 0231.  
 1645 BBC: The World Today. See M 1645.

## Wednesdays

- 1611 Radio Moscow: Culture And The Arts. See S 1611.  
 1615 BBC: Rock/Pop Music. See T 0630.  
 1631 Radio Moscow: Interview. See M 1631.  
 1639 Radio Moscow: Music. See S 0231.  
 1645 BBC: The World Today. See M 1645.

## Thursdays

- 1611 Radio Moscow: Moscow Mailbag. See S 0111.

- 1615 BBC: Network UK. Issues and events affecting people across the UK.

- 1631 Radio Moscow: Interview. See M 1631.  
 1639 Radio Moscow: Music. See S 0231.  
 1645 BBC: The World Today. See M 1645.

## Fridays

- 1611 Radio Moscow: Newmarket. See S 0011.  
 1615 BBC: Science In Action. The latest news about scientific innovations.  
 1631 Radio Moscow: Interview. See M 1631.  
 1639 Radio Moscow: Music. See S 0231.  
 1645 BBC: The World Today. See M 1645.

## Saturdays

- 1600 Radio Norway Int'l: Norway Today. See S 0000.  
 1611 Radio Moscow: Music And Musicians. See S 1211.  
 1615 BBC: Sportsworld. See A 1401.

## 1700 UTC

[1:00 PM EDT/10:00 AM PDT]

1700-1705	Ghana, Radio 2, Accra	7295do			
1700-1710	Cameroon CRTV Bafoussam	4000do			
1700-1715	Israel, Kol Israel	11587na	11675eu	15590af	15650va
1700-1728	Sierra Leone, SLBS	3316do	5980do		
1700-1730 mtwhf	Canada, RCI Montreal	5995eu	7235eu	13650eu	15325eu
		17820eu	21545eu		
1700-1730 as	Norway	9655eu			
1700-1730	Sri Lanka B'casting Corp.	6075as	9720as		
1700-1730	Swaziland, TWR Swaziland	3200af	9520af		
1700-1730	Swiss Radio Int'l	13635af	15430af	17635af	21770af
1700-1730	United Kingdom, BBC London	9515na	15260na	17895af	21470af
		21660af			
		3915as	5975as	6005af	6180eu
		6190af	6195eu	9410eu	9630af
		9740eu	11750as	11775na	12095eu
		15070eu	15310as	15400af	15420af
		17640va	17695eu	17860af	17880af
1700-1730	USA, VOA Washinton	3980eu	6040me	9575af	9700eu
		9760me	11920af	15205me	15410af
		15445af	15495af	15580af	17650af
		17800af	21625af		
1700-1750	North Korea	9325eu	9640af	9977af	11705eu
1700-1755	Polish Radio Warsaw	7270eu	9525eu		
1700-1800	Algeria, R. Algiers	17745na			
1700-1800	Australia	5995pa	6060pa	6080pa	9540pa
		9580pa	9860pa	11910pa	12000pa
		13755pa	15170as		
1700-1800	Canada, CFCX Montreal	6005do			
1700-1800	Canada, CFRX Toronto	6070do			
1700-1800	Canada, CFVP Calgary	6030do			
1700-1800	Canada, CHNX Halifax	6130do			
1700-1800	Canada, CKZU Vancouver	6160do			
1700-1800	China, Radio Beijing	4130af	8260af	9570af	11575af
		15345af			
1700-1800	Cook Islands	11760pa			
1700-1800	Costa Rica, RFPI	13630na	15030na		
1700-1800	Ecuador, HCJB Quito	15270me	17790me	21455me	
1700-1800	Egypt, Radio Cairo	15255af			
1700-1800 sa	Eq. Guinea, R. East Africa	7190af			
1700-1800	Ghana, Radio 1, Accra	4915do			
1700-1800	Guam, KSDA Guam	13720af			
1700-1800 varies	Italy, IRRS Milan, Italy	7125eu			
1700-1800	Japan NHK	7140as	11815na	11865na	15210me
		15345me			
1700-1800 mtwhf	Kenya, Voice of	4935do			
1700-1800	Luxembourg, RTL	15350va			
1700-1800 smtwhf	New Zealand, RNZI	9675pa			
1700-1800	Nigeria	3326do	4990do		
1700-1800	Nigeria, Voice of	7255af			
1700-1800	Pakistan	11570eu	15550eu		
1700-1800	Russia, Radio Moscow	11840na	11900va	11940va	11995na
		12030na	12050na	13645na	13665va
		15375na	15425na	15580na	17670na
		17695na	17710na		
1700-1800	Saudi Arabia BC Svc	9705eu	9720eu		
1700-1800	South Africa, Radio RSA	9565af	11885af		
1700-1800	Tanzania	5985af	9684af	11765af	
1700-1800	USA, CSMonitor Boston	11580as	13625as	17510na	21640af
1700-1800 sa	USA, CSMonitor Boston	13710na	17555am		
1700-1800	USA, KTNB Salt Lake City	15590am			
1700-1800	USA, VOA Washinton	6110as	7125as	9645as	15395as
1700-1800	USA, WHRI Noblesville	13760am	15105am		
1700-1800	USA, WJCR Upton, Kentucky	7490na			
1700-1800 smtwhf	USA, WMLK Bethel, Penna.	9465eu			
1700-1800 vl, irr	USA, WRNO New Orleans	15420na			
1700-1800	USA, WWCR Nashville	15690na	17535na		
1700-1800	USA, WYFR Okeechobee, FL	21500va			
1706-1800	Ghana, Radio 2, Accra	3366do			
1715-1730	Cameroon CRTV Beau	3970do			
1715-1730	South Korea World News	7550as	15575as		
1715-1730	Vatican Radio	6245eu	7250eu		
1715-1745	United Kingdom, BBC London	9560ca	21660ca		
1728-1800	Sierra Leone, SLBS	3316do			
1730-1745 a	Cameroon CRTV Douala	4795do			
1730-1800	Bulgaria, Radio Sofia	9700af	11720af	11765af	15330af
		17780af	17825af		
1730-1800 a	Latvia, Radio Riga	5935eu			
1730-1800	Netherlands	6020af	9605af	21515af	21590af
1730-1800	Romania, R. Romania Int'l	15340af	15365af	17745af	17805af
1730-1800	Swaziland, TWR Swaziland	3200af			

1730-1800	United Kingdom, BBC London	3255af	3915as	5975as	6005af
		6180eu	6190af	6195eu	9410eu
		9630af	9740me	11775na	12095eu
		15070eu	15260na	15310as	15400af
		15420af	17640va	17695eu	17860af
		17880af	21660af		
1730-1800	USA, VOA Washington	6040eu	9575af	9700eu	9760eu
		11920af	15205eu	15205me	15410af
		15495af	15580af	17650af	17800af
		21625af			
1730-1800	Vatican Radio	11625af	15090af	17730af	
1740-1800	Cameroon CRTV Yaounde	4850do			
1745-1800 mtwhfa	Cameroon CRTV Douala	4795do			
1745-1800	India, All India Radio	7412as	9950as	11620as	11860as
		11935as	15080as		
1745-1800 tent	Madagascar, RTV Madagascar	3232do	3286do	5005do	

## 1800 UTC

[2:00 PM EDT/11:00 AM PDT]

1800-1810	Malawi B'casting Corp.	3381do			
1800-1825	Belgium, BRT Brussels	9905eu	17750af		
1800-1825	Netherlands	6020af	9605af	21515af	21590af
1800-1830	Canada, RCI Montreal	13670af	15260af	17820af	
1800-1830	Congo, RTV Congolaise	3265af	4765af		
1800-1830	Czechoslovakia	5930eu	6055eu	7345eu	9605eu
1800-1830	Egypt, Radio Cairo	15255af			
1800-1830	United Kingdom, BBC London	3255af	3955eu	5975as	6180eu
		6190af	6195eu	7160me	7325af
		9410eu	9600af	9740me	11750as
		12095eu	15070eu	15310as	15400af
		17640va	17880af	21660af	
		21660af	21660af	21660af	
1800-1830	Vietnam, Voice of	9840eu			
1800-1840 w	Cameroon CRTV Bertoua	4750do			
1800-1845 mtwhfa	Cameroon CRTV Douala	4795do			
1800-1845	Swaziland, TWR Swaziland	3200af	9600af		
1800-1850 smtwhf	New Zealand, RNZI	9675pa			
1800-1900	Australia	5995pa	6060pa	6080pa	9505pa
		9580pa	9860pa	11910pa	12000pa
1800-1900	Brazil, Radiobras	15265eu			
1800-1900	Bulgaria, Radio Sofia	700af	11720af	11765af	15330af
		17780af	17825af		
1800-1900	Cameroon CRTV Yaounde	4850do			
1800-1900	Canada, CFCX Montreal	6005do			
1800-1900	Canada, CFRX Toronto	6070do			
1800-1900	Canada, CFVP Calgary	6030do			
1800-1900	Canada, CHNX Halifax	6130do			
1800-1900	Canada, CKZU Vancouver	6160do			
1800-1900	Cook Islands	11760pa			
1800-1900	Costa Rica, RFPI	13630am	15030am	21465na	
1800-1900 sa	Eq. Guinea, R. East Africa	7190af			
1800-1900	Ethiopia, Voice of	9662af			
1800-1900	Ghana, Radio 1, Accra	4915do			
1800-1900	Ghana, Radio 2, Accra	7295do			
1800-1900	Guam, KSDA Guam	13720as			
1800-1900	India, All India Radio	7412as	9950as	11620as	11860as
		11935as	15080as		
1800-1900 varies	Italy, IRRS Milan, Italy	7125eu			
1800-1900	Ivory Coast, Abidjan	11920af			
1800-1900 mtwhf	Kenya, Voice of	4935do			
1800-1900	Korea, Seoul	15575eu			
1800-1900	Kuwait, Radio Kuwait	13620na			
1800-1900	Luxembourg, RTL	15350va			
1800-1900 irreg	Mozambique	3265af	4855af	9618af	
1800-1900	Nigeria	3326do	4990do		
1800-1900	Russia, Radio Moscow	9795va	9855va	9860va	9875va
		9895va	11630va	11685va	11745va
		11840am	11995na	12030na	12050na
		15375va	15425na	15515na	15580va
		17565va	17655va	17695na	17710na
1800-1900	Saudi Arabia BC Svc	9705eu	9720eu		
1800-1900	Sierra Leone, SLBS	3316do			
1800-1900	Tanzania	5985af	9684af	11765af	
1800-1900	USA, CSMonitor Boston	9425pa	17510na	17725eu	21545af
1800-1900 sa	USA, CSMonitor Boston	17555am			
1800-1900	USA, KTNB Salt Lake City	15590am			
1800-1900	USA, VOA Washington	6040eu	9700eu	9760me	15205me
		6040eu	9575af	9700eu	9760me
		11920af	15205me	15410af	15445af
		15580af	17650af	17800af	21625af
1800-1900	USA, WHRI Noblesville	13760na	17835sa		



## 1800 UTC cont'd

1800-1900	USA, WINB Red Lion, Penn.	15295eu			
1800-1900	USA, WJCR Upton, Kentucky		7490na		
1800-1900	USA, WMLK Bethel, Penna.	9465eu			
1800-1900	USA, WWCR Nashville	15690na	17535na		
1800-1900	USA, WYFR Okeechobee, FL		21500va		
1815-1830	Lebanon, Radio Voice of	6550me			
1815-1900	Bangladesh	12030as	15255as		
1830-1900	Afghanistan, Kabul	9635am			
1830-1900	Austria, ORF Vienna	5945eu	6155eu	12010me	13730af
1830-1900 as	Canada, RCI Montreal	13670me	15260me	17820me	
1830-1900	Finland, YLE	6120eu	9730af	11755af	15440eu
1830-1900	Iran, Islamic Republic	9022af	15260eu		
1830-1900	Netherlands	6020af	9605af	21515af	21590af
1830-1900	Sri Lanka B'casting Corp.	9720eu	15120eu		
1830-1900	United Kingdom, BBC London	3255af	3955eu	6005af	6180eu
			6190af	6195eu	7325eu
			9600af	11750as	11955va
			15070eu	15400af	17880af
			6100eu	15140af	21660af
1830-1900 WAR/var	Yugoslavia				
1833-1900	Ivory Coast, Abidjan	11920af			
1840-1850 mtwhf	Greece, Voice of	15630af	17525af		
1845-1900	Ghana B'casting Corp.	6130af			
1845-1900	Guinea, RTV Conarky	4900af	7125af		
1845-1900 s	Mali, RTV Mali	4783do	4835do	5995do	7285do
1845-1900	Swaziland, TWR Swaziland	3200af			
1850-1900 smtwhf	New Zealand, RNZI	15120pa			

## 1900 UTC [3:00 PM EDT/12:00 PM PDT]

1900-1915	Tanzania	5985af	9684af	11765af	
1900-1920	Brazil, Radiobras	15265eu			
1900-1925	Netherlands	6020af	9605af	21515af	21590af
1900-1930 mtwhf	Canada, RCI Montreal	13670me	15260me	17820me	
1900-1930 as	Canada, RCI Montreal	5995eu	7235eu	13650eu	15325eu
		17875eu	21675eu		
1900-1930	Iran, Islamic Republic	9022af	15260eu		
1900-1930	Israel, Kol Israel	11587eu	11605sa	11675eu	15640eu
		17575eu	17630af		
1900-1930	Ivory Coast, Abidjan	11920af			
1900-1930	Japan NHK	9640am	11850af	11865va	
1900-1930 s	Lebanon, King of Hope	11530me			
1900-1930 as	Norway	17860va	21705va		
1900-1930	United Kingdom, BBC London	3255af	3955eu	6005af	6180eu
			6190af	6195eu	7160me
			9410eu	9600af	9630af
			12095eu	15070eu	15400af
			21660ef	17880af	
1900-1930	Vietnam, Voice of	9840eu	12020eu	15010eu	
1900-1945	Cameroon CRTV Yaounde	4850do			
1900-1950	Germany, Deutsche Welle	11785af	11810af	13780af	13790af
		15350af	15390af	17810af	
1900-2000	Argentina, RAE Buenos Aires	15345eu			
1900-2000	Australia	5995pa	6060pa	6080pa	7240pa
		9505pa	9580pa	9860pa	11720as
		11910pa	12000pa		
1900-2000	Canada, CFCX Montreal	6005do			
1900-2000	Canada, CFRX Toronto	6070do			
1900-2000	Canada, CFVP Calgary	6030do			
1900-2000	Canada, CHNX Halifax	6130do			
1900-2000	Canada, CKZU Vancouver	6160do			
1900-2000 mtwhf	Canada, RCI for UN Forces	5995eu	7235eu	13650eu	15325eu
		17875eu	21675eu		
1900-2000	China, Radio Beijing	9440af	11515af		
1900-2000	Cook Islands	11760pa			
1900-2000	Costa Rica, RFPI	1363am	15030am	21465na	
1900-2000	Ecuador, HCJB Quito	15270eu	17790eu	21455eu	
1900-2000 sa	Eq. Guinea, R. East Africa	7190af			
1900-2000	Ghana B'casting Corp.	6130af			
1900-2000	Ghana, Radio 1, Accra	4915do			
1900-2000	Ghana, Radio 2, Accra	7295do			
1900-2000	India, All India Radio	7412va	9950va	11620va	11860va
		11935va	15080va		
1900-2000 mtwhf	Kenya, Voice of	4935do			
1900-2000	Kuwait, Radio Kuwait	13620na			
1900-2000	Luxembourg, RTL	15350va			
1900-2000 s	Morocco, Rabat	11920as			
1900-2000 smtwhf	New Zealand, RNZI	15120pa			
1900-2000	Nigeria	3326do	4990do		

1900-2000	Nigeria, Voice of	7255af			
1900-2000	Romania, R. Romania Int'l	7145eu	9690eu	9750eu	11940eu
1900-2000	Russia, Radio Moscow	11840am	11900va	12050va	12055va
		12060va	12070na	13645na	13665va
		15180na	15375na	15405na	15415na
		15425na	15500na	15580na	17565va
		17605na	17655va	17695na	17795va
1900-2000	Saudi Arabia BC Svc	9705eu	9720eu		
1900-2000	Sierra Leone, SLBS	3316do			
1900-2000	Spanish National Radio	6130as	9675af	9685eu	9875eu
1900-2000	Sri Lanka B'casting Corp.	9720eu	15120eu		
1900-2000	Swaziland, TWR Swaziland	3200af	3240af		
1900-2000	USA, CSMonitor Boston	9425pa	17510na	17725eu	21545af
1900-2000 sa	USA, CSMonitor Boston	17555am			
1900-2000	USA, KTVN Salt Lake City	15590am			
1900-2000	USA, KVOH Los Angeles	17775sa			
1900-2000	USA, VOA Washington	6040eu	9525as	9575af	9700eu
		9760eu	11710eu	11870as	11920af
		15180au	15205eu	15410af	15445af
		15495af	15580af	17800af	
1900-2000	USA, WHRI Noblesville	13760na	17835na		
1900-2000	USA, WINB Red Lion, Penn.	15295eu			
1900-2000	USA, WJCR Upton, Kentucky		7490na		
1900-2000	USA, WMLK Bethel, Penna.	9465eu			
1900-2000	USA, WWCR Nashville	15690am	17535na		
1900-2000	USA, WYFR Okeechobee	15355eu	21615af		
1910-1915	Botswana, Gaborone	3356af			
1920-1930	Cameroon CRTV Beau	3970do			
1930-2000	Canada, RCI Montreal	6010eu	7230eu	13650eu	15325eu
		17875eu	21675eu		
1930-2000	Czechoslovakia	6055eu	7345eu		
1930-2000 la	Kazakhstan, R. Alma Ata	3955do	5035do	5260do	5960eu
		5970eu	7115eu	9505eu	9690eu
		11825eu	15215eu	15250eu	15270eu
		15285eu	15315eu	15360eu	15385eu
		17605eu	17730eu	17765eu	21490eu
1930-2000	Netherlands	17605af	21590af		
1930-2000	Polish Radio Warsaw	6095eu	6135eu	7145eu	7270eu
		9525eu			
1930-2000	Saipan, KFBS Saipan	9460af			
1930-2000	United Kingdom, BBC London	3255af	3955eu	6005af	6180eu
			6190af	6195eu	7160me
			9410eu	9600af	9630af
			12095eu	15070eu	15400af
			21660af	17880af	
1935-1945	Togo, RTV Togolaise	5047af			
1935-1955	Italy, RAI, Rome	7275eu	9710eu	11800eu	
1940-2000 smwha	Mongolia, Ulaanbaatar	11850eu	12015eu		
1945-2000	Bulgaria, Radio Sofia	11765as	17780as	17825as	
1945-2000	South Korea World News	6135as			
1950-2000	Sudan Nat'l B'casting Cor	9540do	9550do	11635do	
1950-2000	Vatican Radio	5885eu	7250eu		



## BBC replaces *London Calling* with new magazine

The BBC World Service has announced it will replace *London Calling*, its program magazine since 1939, with a new magazine, *BBC Worldwide*, reports Kannon Shanmugam.

The 100-page *Worldwide*, which will begin publication in November, will include feature articles, reports from BBC correspondents, and expanded information on BBC radio and television programs.

Not surprisingly, there's a rub to this apparent good news—subscription prices will double from 12 British pounds (\$20) to 24 pounds (\$40). To keep their subscriptions going, current *London Calling* readers will have to fork over an extra 6 pounds (\$10) for every year remaining on their subscription. Listeners in the Third World, who used to get *London Calling* for free, will have to start paying—a cost that will undoubtedly be out of the range of many readers there.

# shortwave guide

## 2000 UTC

[4:00 PM EDT/1:00 PM PDT]

2000-2010 mtwhf	Kenya, Voice of	4935do			
2000-2010 w	Malawi B'casting Corp.	3381do			
2000-2010 smwha	Mongolia, Ulaanbaatar	11850eu	12015eu		
2000-2015 mtwhfa	Greece, Voice of	7450eu	9395eu		
2000-2025	Polish Radio Warsaw	6095eu	6135eu	7145eu	7270eu
		9525eu			
2000-2030	Bulgaria, Radio Sofia	11765as	17780as	17825as	
2000-2030	Netherlands	17605af	21590af		
2000-2030	Nigeria, Voice of	7255af			
2000-2030 mtwhf	Portugal	11740eu			
2000-2030	Swiss Radio Int'l	9885eu	9885me	12035me	13635me
		15505me			
2000-2030	United Kingdom, BBC London	3255af	3955eu	5975eu	6005af
		6180eu	6190af	6195eu	7160me
		7180pa	7325eu	9410eu	9600as
		9630af	11750pa	12095eu	15070eu
		15260sa	15340pa	15400af	17880af
		21660af			
2000-2030	Vatican Radio	9645af	11625af	15090af	
2000-2050	North Korea	6576eu	9345eu	9640af	9977af
2000-2100	Australia	5995pa	6060pa	6080pa	7240pa
		9580pa	9860pa	11720as	11910pa
		1200pa			
2000-2100	Canada, CFCX Montreal	6005do			
2000-2100	Canada, CFRX Toronto	6070do			
2000-2100	Canada, CFVP Calgary	6030do			
2000-2100	Canada, CHNX Halifax	6130do			
2000-2100	Canada, CKZU Vancouver	6160do			
2000-2100	China, Radio Beijing	4130eu	9440af	9920eu	11500eu
		11715af	15170af		
2000-2100	Cook Islands	11760pa			
2000-2100	Costa Rica, RFPI	13630na	15030na	21465am	
2000-2100	Cuba, RHC Havana	15330eu	17705eu	17815me	
2000-2100 sa	Eq Guinea, R. East Africa	7190af			
2000-2100	Ghana, Radio 1, Accra	4915do			
2000-2100	Ghana, Radio 2, Accra	7295do			
2000-2100	India, All India Radio	11935af	15080af		
2000-2100	Indonesia, Voice of	7125as	9675as	11752as	11785as
2000-2100	Kuwait, Radio Kuwait	13620na			
2000-2100	Lebanon, King of Hope	6280me			
2000-2100	Luxembourg, RTL	15350va			
2000-2100 smtwhf	New Zealand, RNZI	15120pa			
2000-2100	Nigeria	3326do	4990do		
2000-2100	Russia, Radio Moscow	11675na	11840na	12050va	13665na
		15375na	15405na	15425na	15500va
		15560na	17655va	17695na	17795va
2000-2100	Saudi Arabia BC Svc	9705eu	9720eu		
2000-2100	Sierra Leone, SLBS	3316do			
2000-2100	Swaziland, TWR Swaziland	3200af	3240af		
2000-2100	USA, CSMonitor Boston	9455as	13625pa	15665eu	17510am
		17555sa			
2000-2100	USA, KTVN Salt Lake City	15590am			
2000-2100	USA, KVOH Los Angeles	17775sa			
2000-2100	USA, VOA Washington	6040eu	9700eu	9760eu	11710eu
		13710af	15160eu	15205eu	15410af
		15445af	15494af	15580af	17650af
		17800af	17895af	21485af	21625af
2000-2100	USA, WHRI Noblesville	13760af	17835va		
2000-2100	USA, WJCR Upton, Kentucky		7490na		
2000-2100	USA, WMLK Bethel, Penna.	9465eu			
2000-2100	USA, WRNO New Orleans	15420na			
2000-2100	USA, WWCR Nashville	15690na	17535na		
2000-2100	USA, WYFR Okeechobee, FL	7355eu	15566eu	15585eu	
		17750af	21525eu		
2005-2100	Syria, Radio Damascus	12085na	15095na		
2010-2100 sa	Kenya, Voice of	4935do			
2015-2030	Benin, Voice of the Rev.	4870af	5025af		
2025-2045	Italy, RAI, Rome	7235me	9575me	11800me	
2030-2035	Latvia, 1st Programme	5935do			
2030-2100	Egypt, Radio Cairo	15375af			
2030-2100 mh	Estonia, Tallinn	5925eu	9560eu		
2030-2100 varies	Georgian Radio, Tbilisi	11760eu			
2030-2100	Korea, Seoul	6480eu	7550af	15575eu	
2030-2100	Sweden	6065va	9655va	17730as	
2030-2100	United Kingdom, BBC London	3255af	3955eu	5975as	6005af
		6040	6180eu	6190af	6195eu
		7180pa	7325eu	9410eu	11750pa
		12095eu	15070eu	15260sa	15340pa
		15400af	15495	15580as	

2030-2100	Vietnam, Voice of	9840eu	12020eu	15010eu
2045-2100	South Korea World News	5975as		

## 2100 UTC

[5:00 PM EDT/2:00 PM PDT]

2100-2105	Syria, Radio Damascus	12085na	15095na		
2100-2110	Malawi B'casting Corp.	3381do			
2100-2110	Vatican Radio	5885eu	7250eu		
2100-2115	Swaziland, TWR Swaziland	3240af			
2100-2125	Belgium, BRT Brussels	5910eu	9905eu		
2100-2129	Canada, RCI Montreal	5995eu	7235eu	13650eu	
2100-2130	China, Radio Beijing	3985eu	11715af	15170af	
2100-2130	Czechoslovakia	5930eu	6055eu	7345eu	9605eu
2100-2130	Korea, Seoul	6480eu	7550af	15575eu	
2100-2130	Lebanon, King of Hope	6280me			
2100-2130 smtwhf	New Zealand, RNZI	15120pa			
2100-2130 as	Norway	17845na	21705va		
2100-2130 mtwhf	Portugal	15250af			
2100-2130	Sweden	6065va	9655va	17730as	
2100-2130	United Kingdom, BBC London	3255af	3955eu	5975as	6005af
		6180eu	6195as	7325eu	9410eu
		9590na	11750pa	12095eu	15070na
		15260sa	15340pa	15400af	
2100-2145 WAR/var	Yugoslavia	6100eu	11735na	11870na	
2100-2150	Germany, Deutsche Welle	9670eu	9765eu	11785eu	13780as
		15350as	15360as		
2100-2200	Australia	5995pa	6060pa	6080pa	11720pa
		11880pa	13705pa	15365as	
2100-2200	Canada, CFCX Montreal	6005do			
2100-2200	Canada, CFRX Toronto	6070do			
2100-2200	Canada, CFVP Calgary	6030do			
2100-2200	Canada, CHNX Halifax	6130do			
2100-2200	Canada, CKZU Vancouver	6160do			
2100-2200	Canada, RCI Montreal	15325af	17875af		
2100-2200	China, Radio Beijing	4130eu	8260eu	9920eu	11500eu
		15170eu			
2100-2200	Cook Islands	11760pa			
2100-2200	Costa Rica, RFPI	13630na	15030na	21465am	
2100-2200	Egypt, Radio Cairo	15375af			
2100-2200 sa	Eq Guinea, R. East Africa	7190af			
2100-2200	Ghana, Radio 1, Accra	4915do			
2100-2200	Ghana, Radio 2, Accra	7295do			
2100-2200	Hungary, Radio Budapest	6110eu	9835eu	11910eu	
2100-2200	India, All India Radio	7412eu	9910eu	9950eu	11620eu
		11715eu	15265eu		
2100-2200	Japan NHK	11815me	11840eu	15430eu	17810as
		17890as			
2100-2200	Luxembourg, RTL	15350va			
2100-2200	Nigeria	3326do	4990do		
2100-2200	Romania, R. Romania Int'l	5955eu	7145eu	9690eu	9750eu
		11940eu			
2100-2200	Russia, Radio Moscow	9685na	11780na	11840na	12040na
		12050na	12070na	13645na	13665na
		15355na	15375na	15405na	15425na
		15485na	15500na	15560na	17655va
		17710va	17735va	21690va	
2100-2200	Sierra Leone, SLBS	3316do			
2100-2200	Spanish National Radio	6130eu			
2100-2200	Sri Lanka B'casting Corp.	15120as			
2100-2200	Ukraine, Kiev	5960eu	7250eu	7340eu	9600eu
		9635eu	9865eu	15135na	15570eu
2100-2200	USA, CSMonitor Boston	9455as	13625pa	15665eu	17510na
		17555sa			
2100-2200	USA, KTVN Salt Lake City	15590am			
2100-2200	USA, KVOH Los Angeles	17775sa			
2100-2200	USA, VOA Washington	6040eu	9700eu	9760me	11710me
		11870pa	11960me	15185pa	15205me
		15410af	15495af	15580af	17650af
		17735pa	17800af	17895me	19261af
		21485af	21625af		
2100-2200	USA, WHRI Noblesville	13760am	17835na		
2100-2200	USA, WJCR Upton, Kentucky		7490na		
2100-2200	USA, WMLK Bethel, Penna.	9465eu			
2100-2200	USA, WRNO New Orleans	15420na			
2100-2200	USA, WWCR Nashville	15690am	17535am		
2100-2200	USA, WYFR Okeechobee, FL	7355eu	15566eu	17750af	21525eu
2103-2110 tent	Croatian Radio, Zagreb	7240eu	9830eu	21480eu	
2110-2200	Syria, Radio Damascus	12085na	15095na		
2115-2130 s	Indonesia, R. Republik	6070do			



## 2100 UTC cont'd

2115-2130 mtwhf	United Kingdom, BBC Carib.	15140ca	17715ca		
2115-2200	Egypt, Radio Cairo	9900eu			
2130-2145	Cameroon CRTV Beau	3970do			
2130-2155	Finland, YLE	6120af	11755as	15440eu	
2130-2200	Austria, ORF Vienna	5945eu	6155eu	9870af	
2130-2200	Canada, RCI Montreal	11880af	15150af	17820af	
2130-2200	Ecuador, HCJB Quito	15270eu	17790eu	21455eu	21480eu
2130-2200	Israel, Kol Israel	11585eu	11605eu	15100na	15590eu
		15640sa	17575eu		
2130-2200	Kazakhstan, R. Alma Ata	3955do	5035do	5260do	5960eu
		5970eu	7115eu	9505eu	9690eu
		11825eu	15215eu	15250eu	15270eu
		15285eu	15315eu	15360eu	15385eu
		17605eu	17730eu	17765eu	21490eu
2130-2200 smtwhf	Lebanon, King of Hope	6280me			
2130-2200	Lithuania, Radio Vilnius	9675eu	9710eu		
2130-2200	New Zealand, RNZI	17770pa			
2130-2200	United Kingdom, BBC Falk. I	13660sa			
2130-2200	United Kingdom, BBC London	3255af	3955eu	5975ca	6005af
		6180eu	6195as	7325eu	9410eu
		9590na	11750pa	12095eu	15070na
		15260sa	15340pa	15400af	
2145-2200	Bulgaria, Radio Sofia	11660na	11720am	15330eu	
2145-2200	Cameroon CRTV Yaounde	4850do			

2200-2300	United Kingdom, BBC London	5975na	6195as	7325am	9410eu
		9570pa	9590na	9915ca	11750sa
		11945as	11955as	12095na	15070na
		15260sa	15340as	15400af	17830as
2200-2300	USA, CS Monitor Boston	9465na	13625as	15405as	15665eu
		17555am			
2200-2300	USA, KTVB Salt Lake City	15590am			
2200-2300	USA, VOA Washington	7120as	9770as	11760as	15185au
		15290au	15305au	17735au	17820au
2200-2300	USA, WHRI Noblesville	13760na	17835sa		
2200-2300	USA, WJCR Upton, Kentucky	7490na			
2200-2300	USA, WRNO New Orleans	15420na			
2200-2300	USA, WWCR Nashville	12160na	15690na		
2200-2300	USA, WYFR Okeechobee, FL	17750eu	21525eu		
2230-2300 mtwhf	Congo, RTV Congolaise	4765do			
2230-2300	Sweden	6065eu			
2230-2300	USA, VOA Washington	9530eu	11905me	11960me	17885me
2240-2250 smtwhf	Greece, Voice of	11645a			
2245-2300	USA, WINB Red Lion, Penn.	15145eu			
2245-2300	Vatican Radio	9600au	11830au	15090au	

## 2200 UTC

[6:00 PM EDT/3:00 PM PDT]

2200-2210	Cameroon CRTV Bafoussam	4000do			
2200-2210	Syria, Radio Damascus	12085na	15095na		
2200-2215	Cameroon CRTV Yaounde	4850na			
2200-2215	Congo, RTV Congolaise	4765do	5985do		
2200-2225	Italy, RAI, Rome	9710as	11800as	15330as	
2200-2230	Albania, Radio Tirana	9760eu	11825eu		
2200-2230	Canada, RCI Montreal	5960na	9755na	11705as	11905na
		13670na			
2200-2230 2Russia	China, Radio Beijing	9740eu			
2200-2230	Czechoslovakia	5930eu	6055eu	7345eu	9605eu
2200-2230 a	Indonesia, Radio Republik	3385do	4805do		
2200-2230	Swiss Radio Int'l	9810sa	9885sa	12035sa	15570sa
2200-2230 s	USA, KGEI San Francisco	15280sa			
2200-2230	USA, VOA Washington	9530eu	11905me	11960me	15225me
		15445me	17885eu		
2200-2245	Egypt, Radio Cairo	9900eu			
2200-2245	USA, WINB Red Lion, Penn.	15185eu	15195eu		
2200-2300	Australia	11720pa	11880pa	13705as	15240pa
		15320pa	15365as	17795pa	
2200-2300	Bulgaria, Radio Sofia	11660am	11720am	15330eu	
2200-2300	Canada, CFCX Montreal	6005do			
2200-2300	Canada, CFRX Toronto	6070do			
2200-2300	Canada, CFVP Calgary	6030do			
2200-2300	Canada, CHNX Halifax	6130do			
2200-2300	Canada, CKZU Vancouver	6160do			
2200-2300	Cook Islands	11760pa			
2200-2300	Costa Rica, RFPI	13630ca	15030ca	21465am	
2200-2300	Cuba, RHC Havana	9620va	11930va		
2200-2300 sa	Eq. Guinea, R. East Africa	7190af			
2200-2300	Ghana, Radio 1, Accra	4915dc			
2200-2300	Ghana, Radio 2, Accra	7295dc			
2200-2300	India, All India Radio	7412eu	9910eu	9950eu	11620eu
		11715eu	15265eu		
2200-2300	Luxembourg, RTL	15350va			
2200-2300 smtwha	Malaysia, RTM Radio 4	7295do			
2200-2300	New Zealand, RNZI	17770pa			
2200-2300	Nigeria	3326do	4990do		
2200-2300	Russia, Radio Moscow	11710na	12050na	15355na	15405na
		15410na	15425na	15485na	17655va
		17720va	17735na	21690na	
2200-2300	Sierra Leone, SLBS	3316do			
2200-2300	Singapore, SBC1	5010do	5052do	11940do	
2200-2300	Taiwan, V. of Free China,	17750eu	21720eu		
2200-2300	Turkey, Voice of	9445na			
2200-2300	UAE Radio Abu Dhabi	13605na	15305na	17855na	

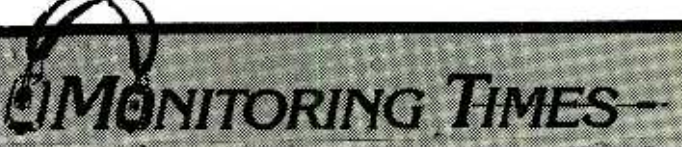

**MONITORING TIMES**

America's fastest growing monitoring hobby magazine! To subscribe just send the information below with your payment to *Monitoring Times*, P.O. Box 98, Brasstown, NC 28902.

**U.S. (mailed second class\*):**

1 Year \$19.95     2 Years \$38.00     3 Years \$56.00  
 (12 issues)                      (24 issues)                      (36 issues)

\* If you prefer first class mail in an envelope, add \$25.00 per year (i.e., one year = \$44.50)

*Payment received by the 10th of the month will receive next month's issue. Current or back issues, when available, can be purchased for \$4.50 each (includes 1st class mailing in U.S.)*

**Canada, Mexico and Overseas:**  
 (mailed in an envelope second class\*)

1 Year \$28.50     2 Years \$55.00     3 Years \$79.50  
 \* If you prefer air mail, please write for rates.

*All foreign subscriptions must be paid by Visa, Mastercard, International Bank or Postal Money Order in U.S. funds.*

NAME \_\_\_\_\_

ADDRESS \_\_\_\_\_

CITY \_\_\_\_\_ STATE \_\_\_\_\_ ZIP \_\_\_\_\_

Mastercard     Visa

Month    Year

## 2300 UTC

[7:00 PM EDT/4:00 PM PDT]

## FREQUENCIES

2300-2305	Ghana, Radio 1, Accra	4915do						17685na	17720va	17735na	17890na
2300-2305	Ghana, Radio 2, Accra	7295do						21690na			
2300-2315	Bulgaria, Radio Sofia	11660am	11720am	15330eu				2300-0000	Sierra Leone, SLBS	3316do	
2300-2330	Canada, RCI Montreal	11940sa	15235na					2300-0000	Singapore, SBC1	5010do	5052do 11940do
2300-2330	Lithuania, Radio Vilnius	9675na	9710na	11780na	13645na			2300-0000	South Africa, Radio Orion	4810af	
		15580na						2300-0000	Thailand	4830as	9655as 11905as
2300-2330 as	Norway	11795am						2300-0000	UAE Radio Abu Dhabi	9605na	11965na 13605na
2300-2330	United Kingdom, BBC London	5975na	6175na	6195as	7145as			2300-0000	USA, CSMonitor Boston	9465na	13625as 15405af 15665eu
		9410eu	9570pa	9590na	9915sa					17555af	
		11750sa	11945as	11955as	12095na			2300-0000	USA, KTBN Salt Lake City	15590na	
		15070na	15260sa	15340pa	15400af			2300-0000	USA, KVOH Los Angeles	9725am	
		17830af						2300-0000	USA, VOA Washington	7120as	9770as 11760au 15185au
2300-2350	North Korea	11700am	13650am							15290au	15305as 17735as 17820as
2300-2350	Turkey, Voice of	9445na								9530me	11905me 11960eu 17885me
2300-0000	Australia	11720pa	11880pa	15240pa	15320pa			2300-0000	USA, WHRI Noblesville	9495na	13760sa
		15365as	17795pa					2300-0000	USA, WINB Red Lion, Penn.	15145eu	
2300-0000	Canada, CFCX Montreal	6005do						2300-0000	USA, WJCR Upton, Kentucky	7490na	
2300-0000	Canada, CFRX Toronto	6070do						2300-0000	USA, WRNO New Orleans	7355na	
2300-0000	Canada, CFVP Calgary	6030do						2300-0000	USA, WWCR Nashville	12160na	15690na
2300-0000	Canada, CHNX Halifax	6130do						2315-0000 vl	Iraq, Radio Iraq Int'l	15150na	17740sa
2300-0000	Canada, CKZU Vancouver	6160do						2330-0000 as	Canada, RCI Montreal	11940sa	15235sa
2300-0000	Cook Islands	11760pa						2330-0000	Canada, RCI Montreal	9755am	11730am 13670am
2300-0000	Costa Rica, AWR	9725ca	11870ca					2330-0000 a	Colombia, R.Nacional	11822.5	17865am
2300-0000	Costa Rica, RFPI	13630na	15030na	21465am				2330-0000	Iran, Islamic Republic	9022am	15260am 15315am
2300-0000	Guam, KSDA Guam	15610as						2330-0000 m	Sri Lanka B'CASTING Svc	15425am	
2300-0000	India, All India Radio	9910as	11715as	11745as	15110as			2330-0000	United Kingdom, BBC London	5975na	6175na 6195as 7145as
		15145as	17830as							7325na	9570pa 9590na 9915sa
2300-0000	Japan NHK	11735eu	11815am	15195as	17810pa					11750sa	11945as 11955as 12095na
		17840va						2330-0000	Vietnam, Voice of	9840as	12020as 15010as
2300-0000	Luxembourg, RTL	15350va						2330-2355	Belgium, BRT Brussels	9930na	13655na
2300-0000 smtwha	Malaysia, RTM Radio 4	7295do						2335-2345 smtwhf	Greece, Voice of	7450eu	9425sa 11645sa
2300-0000	New Zealand, RNZI	17770pa									
2300-0000	Russia, Radio Moscow	11710na	12050na	15355na	15405na						
		15410na	15425na	15485na	17570na						

## SELECTED PROGRAMS

## Sundays

- 2300 Radio For Peace Int'l: World Of Radio. See S 0200.  
 2300 Radio Norway Int'l: Norway Today. See S 0000.  
 2305 BBC: World Business Review. The previous week's news and upcoming events.  
 2311 Radio Moscow: News And Views. See S 0311.  
 2315 BBC: Classics With Kay. No, not Tracey Ullman, but Brian Kay with his choice of classical music.  
 2330 Radio For Peace Int'l: The World In Review. See S 1530.  
 2331 Radio Moscow: Folk Box. See S 0131.  
 2345 Radio For Peace Int'l: RFPI Reports. See S 0230.

## Mondays

- 2300 Radio For Peace Int'l: New Dimensions Radio. See M 0300.  
 2305 BBC: World Business Report. The latest news from the markets worldwide.  
 2311 Radio Moscow: News And Views. See S 0311.  
 2315 BBC: Talks. Paddy Fenny meets personalities from Barbara Cartland to Prunella Scales in "Artists At Work" (through October 5th).  
 2330 BBC: Multitrack 1: Top 20. Tim Smith presents the smash singles on the UK pop music charts.  
 2330 Radio For Peace Int'l: UNESCO. A selection of programs presenting the cultural heritage of many nations.  
 2331 Radio Moscow: Yours For The Asking. Music as requested by listeners.  
 2345 Radio For Peace Int'l: RFPI Reports. See S 0230.

## Tuesdays

- 2305 BBC: World Business Report. See M 2305.  
 2311 Radio Moscow: News And Views. See S 0311.  
 2315 BBC: Concert Hall. See S 1515.  
 2330 Radio For Peace Int'l: Dialogue. News from the University for Peace in Costa Rica.  
 2331 Radio Moscow: Jazz Show. See M 0331.  
 2345 Radio For Peace Int'l: RFPI Reports. See S 0230.

## Wednesdays

- 2300 Radio For Peace Int'l: Common Ground. International relations and related political and social issues.  
 2305 BBC: World Business Report. See M 2305.  
 2311 Radio Moscow: News And Views. See S 0311.  
 2315 BBC: From Our Own Correspondent. See S 0330.  
 2330 BBC: Multitrack 2. Graham Bannerman presents new pop records, interviews, news, and contests.  
 2330 Radio For Peace Int'l: Population Update or FAO. Population-related issues or reports on food and agricultural production.  
 2331 Radio Moscow: Music. See S 0231.

## Thursdays

- 2300 Radio For Peace Int'l: The Great Atlantic Radio Conspiracy. See S 0300.  
 2305 BBC: World Business Report. See M 2305.  
 2311 Radio Moscow: News And Views. See S 0311.  
 2315 BBC: Music Review. News and views from the world of classical music.

- 2330 Radio For Peace Int'l: United Nations. See M 0245.  
 2331 Radio Moscow: Outlook. Details not available at press time.  
 2345 Radio For Peace Int'l: RFPI Reports. See S 0230.

## Fridays

- 2300 Radio For Peace Int'l: WPU News. Program details not available at press time.  
 2305 BBC: World Business Report. See M 2305.  
 2311 Radio Moscow: News And Views. See S 0311.  
 2315 BBC: Worldbrief. A roundup of the week's news headlines and developments.  
 2330 BBC: Multitrack 3. News and releases from the British alternative music scene.  
 2330 Radio For Peace Int'l: RFPI Reports. See S 0230.  
 2331 Radio Moscow: Science And Engineering. See S 0511.

## Saturdays

- 2300 Radio For Peace Int'l: Living Enrichment Center. See S 1500.  
 2300 Radio Norway Int'l: Norway Today. See S 0000.  
 2305 BBC: Words Of Faith. See S 0309.  
 2310 BBC: Book Choice. See W 0425.  
 2311 Radio Moscow: News And Views. See S 0311.  
 2315 BBC: A Jolly Good Show. See T 1515.  
 2330 Radio For Peace Int'l: The World In Review. See S 1530.  
 2331 Radio Moscow: Folk Box. See S 0131.  
 2345 Radio For Peace Int'l: RFPI Reports. See S 0230.



# GET THE LATEST ADVANCES IN ELECTRONICS

WITH A SUBSCRIPTION TO

# Radio- Electronics®



ENJOY THE WORLD OF ELECTRONICS EACH MONTH!

Now you can subscribe to the best electronics magazine. The only one that brings you articles on—electronics projects, technology, circuit design, communications, new products and much more.

Radio-Electronics looks to the future and shows you what new video, audio and computer products are on the horizon. What's more you'll find helpful, monthly departments such as Video News, Equipment Reports, Hardware Hacker, Audio Update, Drawing Board, Communications Corner. All designed to give you instruction, tips, and fun.



## Radio-Electronics gives you exciting articles like:

- ┌ ISDN: The Telephone Network of Tomorrow
- ┌ The Facts on FAX
- ┌ A Digital Phone Lock
- ┌ How To Design Switching Circuits

## PLUS: COMPUTER DIGEST! A New Kind of Magazine for Electronics Professionals.

- ┌ EIA-232 A real standard for serial interfacing?
- ┌ Build a synergy card for your PC
- ┌ '386 Power at a '286 price
- ┌ Build a biofeedback monitor
- ┌ More on Multiplexing

FOR FASTER SERVICE CALL TODAY  
1-800-999-7139

# DON'T DELAY SUBSCRIBE TODAY!

Radio-Electronics 7MT02

# Propagation conditions: Eastern United States

**How to use the propagation charts:** Propagation charts can be an invaluable aid to the DXer in determining which frequencies are likely to be open at a given time. To use the propagation charts, choose those for your location. Then look for the one most closely describing the geographic location of the station you want to hear.

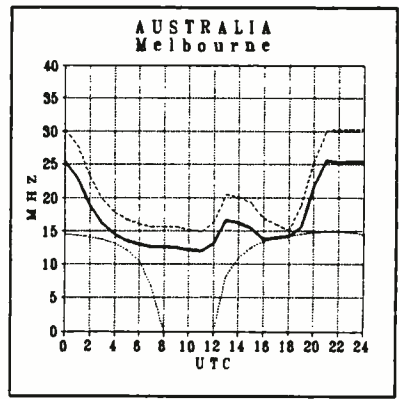
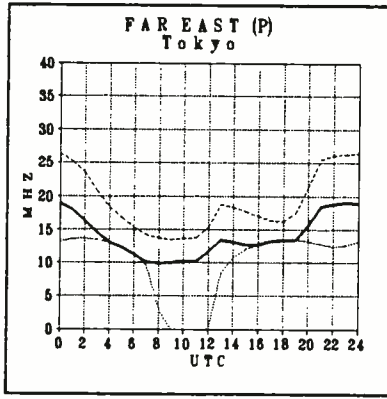
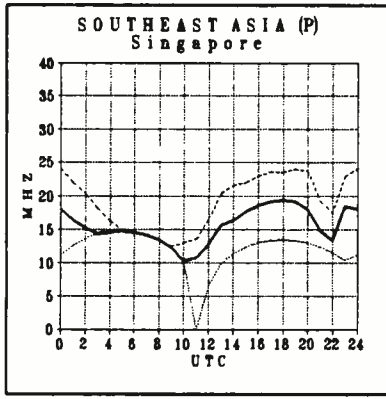
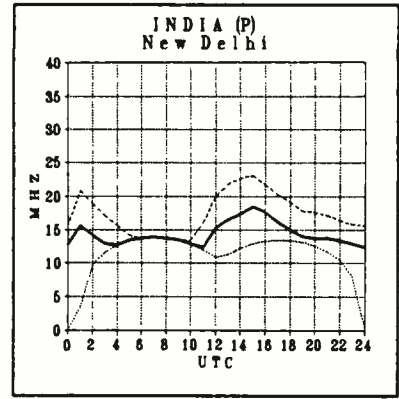
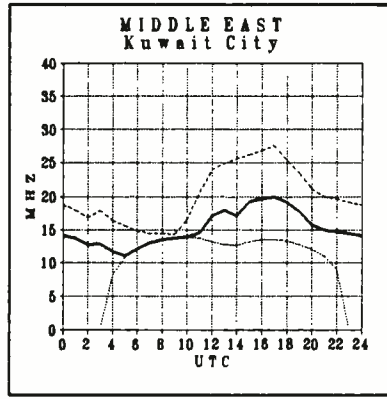
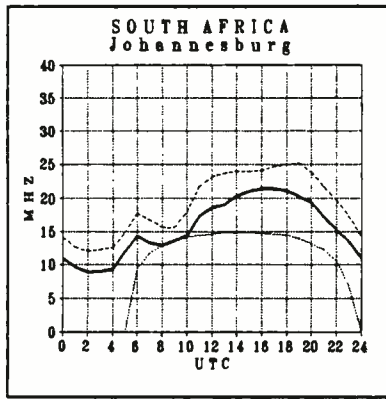
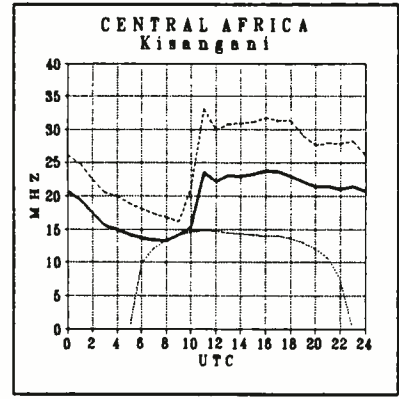
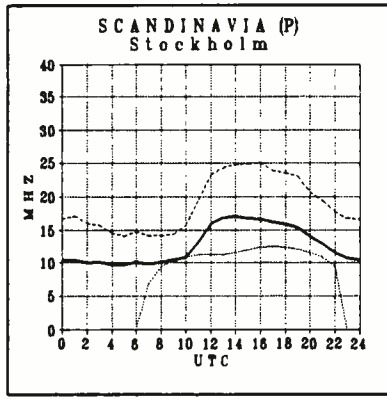
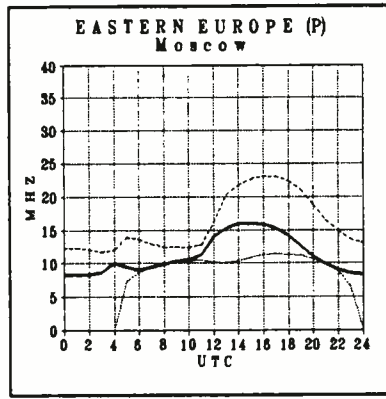
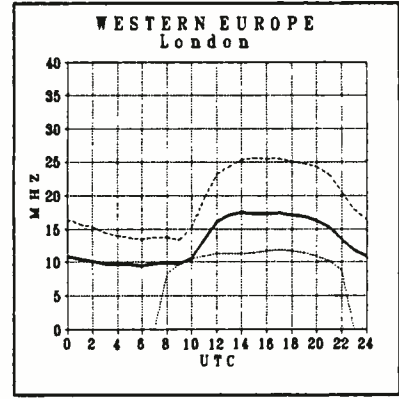
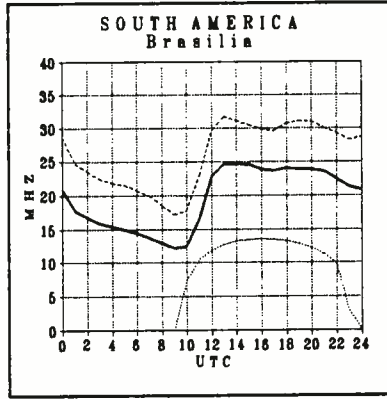
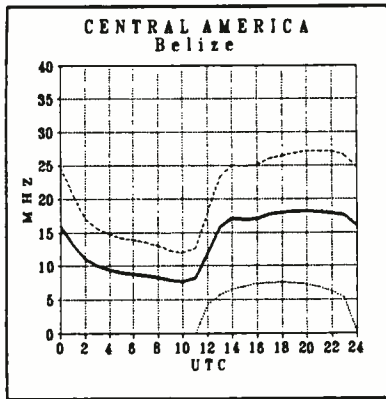



# Propagation Conditions: Western United States

Once you've located the correct charts, look along the horizontal axis of the graph for the time you are listening. The top line of the graph shows the maximum usable frequency (MUF), the heavy middle line is the frequency for best reception, or optimum working frequency (OWF), and finally, the bottom line is the lowest usable frequency (LUF). You will find the best reception along the heavy middle line. Circuits labeled (P) cross the polar auroral zone. Expect poor reception on these circuits during ionospheric disturbances.

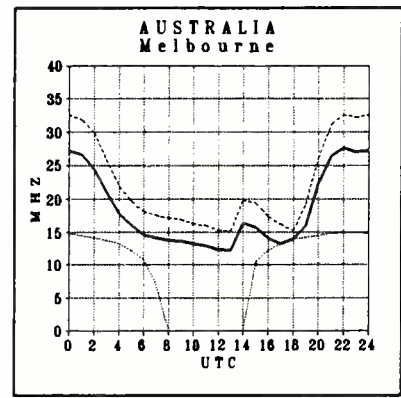
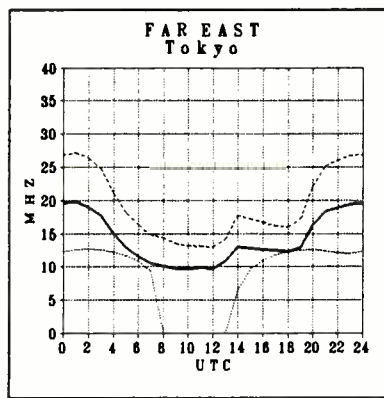
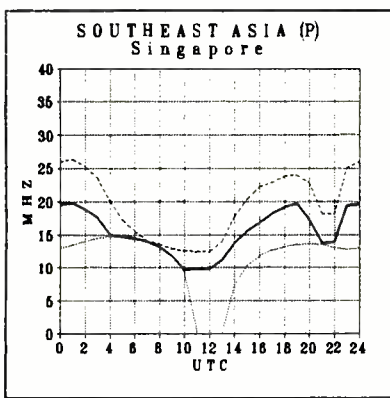
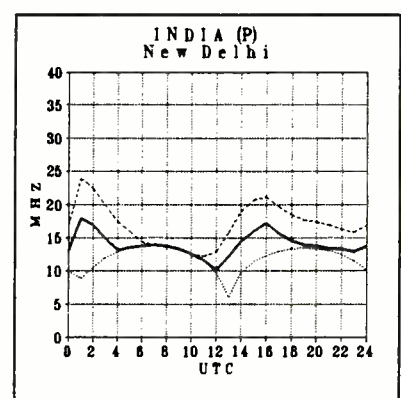
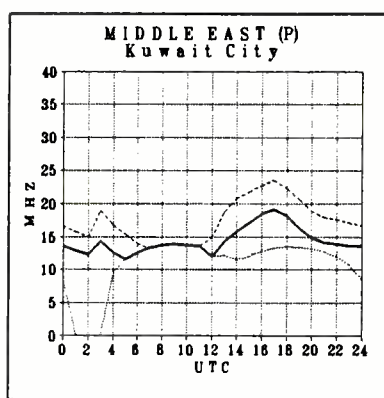
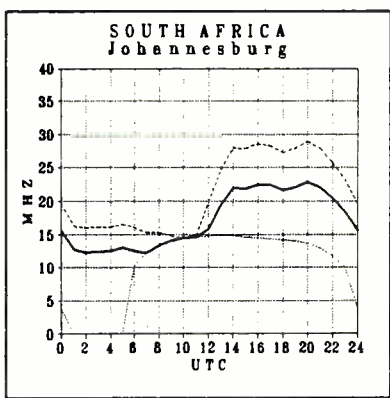
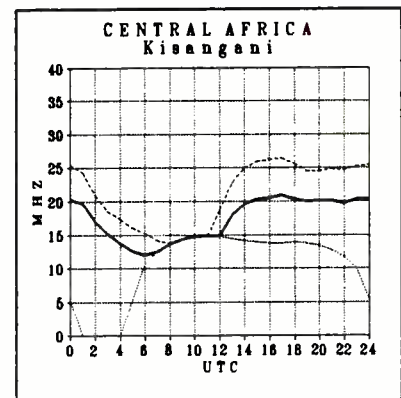
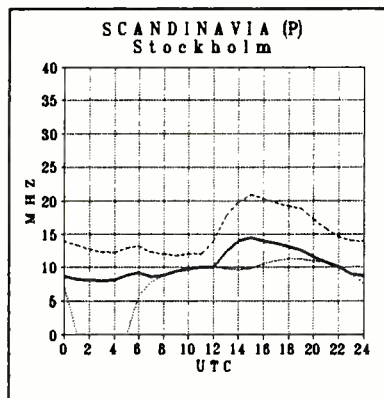
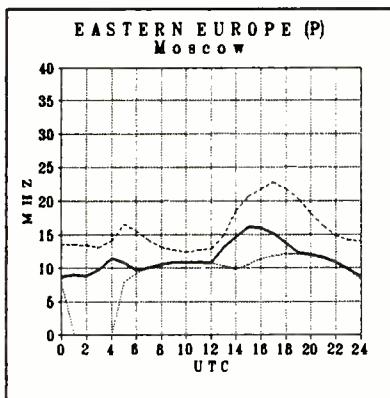
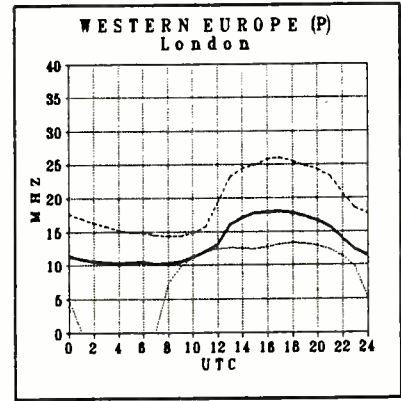
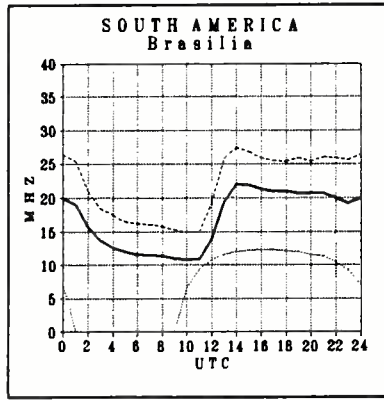
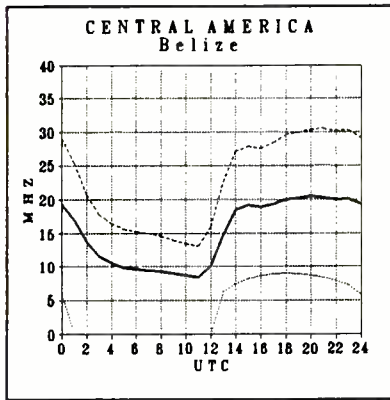

# what's new?

Larry Miller

## Serious 800 MHz Fun

If you're serious about your 800 MHz listening, Max System Antennas has some serious answers. For those who want to be able to sweep the horizon for distant 800 MHz signals, mount the powerful 800 MHz Loop Yagi antenna on a rotor. The powerful 11-element rear-mount antenna combines high gain performance with a reasonable price and comes complete—no soldering or assembly is required. Just attach a cable terminated in a Type-N connector.

The Max System 800 MHz Loop Yagi is available for just \$75.00 plus \$4.00 shipping from Cellular Security Group, 4 Gerring Road, Dept. MT, Gloucester, Massachusetts 01930.

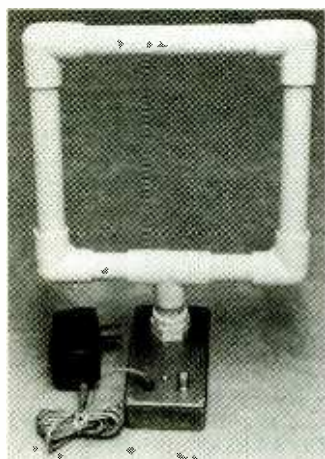

## Low Noise AM Loop

It's getting to be that time of year again—time for distant AM stations to start poking their signals through summer's blanket of static. One of the most effective ways to dig out those DX signals

is through the use of a loop antenna.

Although we haven't had any hands-on experience with one, Electron Processing is touting "greatly improved reception of AM broadcast band signals from an indoor antenna" with their BCL-1 loop antenna.

Using a compact 8" x 8" square unshielded loop, the BCL-1 reportedly has an internal 30 dB "signal intensifier." Interference can be reduced or eliminated through the directional characteristics of the loop.

Powered by 115VAC, the BCL-1 covers 530 through 2000 kHz. It comes with a jumper cable for connection to your receiver (specify model or end connector desired).

The BCL-1 is \$125 plus \$5.00 UPS. To order or to get more information, call 616-228-7020 or write P.O. Box 68-MT, Cedar, Michigan 49621.

## 8 Band Quarter Wave

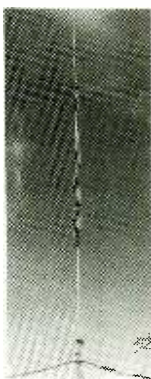

Cushcraft has announced "the next generation" of their eight band quarterwave vertical antenna. The 26 foot AP8A covers 10, 12, 15, 17, 20, 30, 40 and 80 meters and weighs only 9.5 pounds.

Constructed with double and triple-wall tubing, the AP8A provides uncompromising strength for high wind

survivability. Low-loss design and high efficiency traps add up to maximum output.

According to the manufacturer, assembly is quick, the

profile clean and operation superior.

As always, Cushcraft offers no sample antenna, only sketchy information, and, most puzzling, nothing on availability or pricing of their merchandise. If you are interested in more information, however, we suggest that telephone Cushcraft at 603-627-7877 or write them at P.O. Box 4680-MT, Manchester, New Hampshire 03108. Your local ham radio store might also be able to help you.



## New MOSFET Linear

The Japan Radio Co., Ltd. is now shipping their new JRL-2000F HF Linear Amplifier. This is the world's first MOSFET linear amplifier for the ham market.

The JRL-2000F features built-in automatic antenna tuner and four antenna output connectors. Any exciter can be used with the JRL-2000F, which senses the input RF and automatically tunes the amp to the operating frequency. The internal CPU stores band, tuner and antenna settings to one of 1,820 memory channels for fast recall.

Operation is in the 1.8, 3.5, 3.8, 7, 10, 14, 18, 21 and 24 MHz bands. Rated output power in SSB is 1kW PEP.

The JRL-2000F retails for \$4,899.00. For more information contact your favorite radio store or write JRC at 430 Park Avenue, Dept. MT, New York, New York 10022.

## PSE QSL!

*PSE QSL* is an expert's guide to amateur radio QSLing that author Bill Welsh says will "turn your mailbox into a QSL

magnet!" Included are tricks and techniques to help you confirm more of your contacts, get those rare ones and achieve the awards you're after at a faster pace. It's a true soup-to-nuts book that covers everything from the addressing of envelopes to "comic cards" to Russian mail.

*PSE QSL* is an excellent source of information for the ham that also contains gobs of good information applicable to the shortwave broadcast QSL chaser as well. To get your copy, send \$9.95 plus \$2.00 shipping and handling to Tiare Publications, P.O. Box 493-MT, Lake Geneva, Wisconsin 53147.

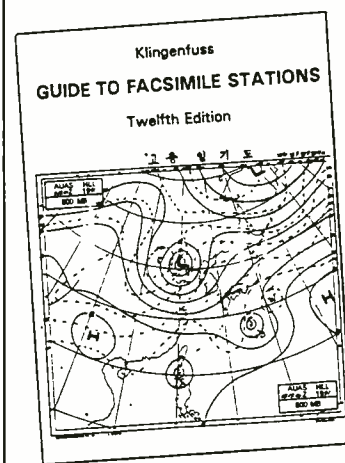

## Guide to Facsimile Stations

With the advent of powerful and inexpensive digital decoders like the MFJ-1278 and Universal M8000, more and more utilities monitoring enthusiasts have been discovering the world of radio fax.

Probably the most comprehensive and accurate is Klingenfuss' twelfth edition of the *Guide to Facsimile Station*. You'll find it packed with frequencies, callsigns, schedules, illustrations, tables and charts, and even product descriptions.

With almost no exception, all facsimile transmissions in the shortwave spectrum are weather charts—hand-drawn or computer-generated sketches of major weather systems affecting shipping interests on a global or regional basis.



But for those stalwart enthusiasts who enjoy watching these graphic images gradually evolve on a screen or printer, the *Guide* is the leading reference. Check with your favorite radio hobby book dealer for availability and price.



## Weather Satellites

Why settle for a facsimile station rebroadcast of a satellite picture?! As monitoring enthusiasts become increasingly comfortable with satellite technology, weather satellite reception and display has become quite popular.

No one has more of a following for his authoritative and easy-to-follow satellite articles than Dr. Ralph Taggard; his fourth edition of the *Weather Satellite Handbook* is filled with useful information, charts, photos and diagrams.

Concentrating on the 137 and 1691 MHz birds, Taggard's *Handbook* is a well organized and copious collection of technical construction details on antennas and rotators, tracking devices and programs, computer control, receivers, monitors and printers, converters and demodulators—both simple and sophisticated—for every experimenter's requirements.

The *Weather Satellite Handbook* is an ARRL publication, cover price \$20, available from the ARRL, 225-MT Main St., Newington, CT 06111, Grove Enterprises and other *MT* advertisers.

## Tuning in Shortwave TV

Not everything you hear on your radio is sound. Hundreds of amateur radio operators—including the space shuttle astronauts—are sending pictures via Slow Scan TV on HF, VHF and UHF. For those interested in tuning in the action, Software Systems Consulting is offering version 5.0 of their software package, PC SSTV.

PC SSTV is a complete system for IBM PCs with a VGA monitor. You can order yours by sending \$149.95 for the complete set or \$99.95 for an upgrade (if you're a current STV owner). Shipping is \$4.00. Call 714-498-5784 to order or for more information and be sure to mention *MT*. Software Systems Consulting is located at 615 S. El Camino Real, San Clemente, California 92672.



## Don't Bug Me

Do you ever wonder, in this electronic age, just how the professionals—and the not-so-professionals—tune in on their targets? Are you, or could you be, a victim of surveillance?

M.L. Shannon, in his book *Don't Bug Me*, takes a total overview of the spy game, explaining techniques, publishing ads from vendors and listing suppliers and publishers.

But there are ways to protect

## High Performance 800MHz

FREE CELLULAR FREQUENCY CHARTS!

### MAX 800 GROUND PLANE

- Absolutely the best reception . . . 10 times better!!!
- Astounding results outside using our RG6 cable
- Mount directly on base or hand-held scanner

Only \$19.95

Base scanner adapter - \$15.00  
Hand-held scanner adapter - \$12.00  
50 ft RG-6 cable assembly - \$35.00

Max Cellular Mag Mount - mobile 800 scanner antenna - \$29.95  
The Stinger - compact 800 MHz hand scanner antenna - \$7.95  
Loop Yagi - highly directional 13dB gain (3ft boom) - \$75.00

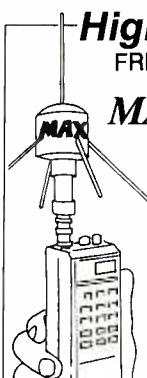

## Cordless and Baby Monitors

FREE CORDLESS FREQUENCY CHARTS!

### MAX 46-49 MHz DIPOLE

- The very best cordless phone and baby monitor antenna
- Hear conversations for miles around - don't miss anything!
- Install inside or outside
- Includes 50ft RG8X - BNC

Only \$49.95



## MAX System™ Antennas and Accessories

1-800-487-7539 ORDERS ONLY  
508-768-7486 FAX  
508-281-8892 INFO  
SASE for free Catalog

146/220/440/GMRS GP	25.95
Telescopic Whip	12.95
Telescopic GP	29.95
146/220 Mag Mount	29.95
146/440 Mag Mount	29.95
BNC Mag Mount	12.95
Custom Ground Plane	39.95
Telescopic Mag Mount	29.95

Send Payment To: Cellular Security Group  
4 Gerring Road  
Gloucester, MA 01930

CK-MO-MC-VISA Accepted (MA add 5%)  
US shipping and handling \$4.00

yourself, and Shannon describes these as well, everything from physical and electronics searches to building a spark gap blitzer which ruins radio and TV reception for blocks around you!

*Don't Bug Me* is not intended to be the ultimate tutorial on electronic surveillance; rather, it proposes to present a generalized look at the entire field, and this it does very well.

*Don't Bug Me* is available for \$19.95 plus \$2.90 shipping from Paladin Press (PO Box 1307, Boulder, CO 80306) and from Lysias Press (PO Box 19217, San Francisco, CA 94119).

## Army Oil

It is frequently necessary to apply a reliable cleaner/lubricant to an electrical contact to reduce noise from wear and dirt. Several spray applicators are available from a variety of sources, but one manufacturer claims his product is extraordinary.

"Army Oil," a trademark of the CFL Corporation, is a blend of petroleum distillates and cleaners. A list of successful applications provided by the manufacturer would seem to indicate that its usefulness is widespread through electrical and electronic equipment that has make/break and sliding contact surfaces.

The manufacturer cautions that to be effective, the contents must be well shaken before use to disperse the suspended contents uniformly, then applied sparingly.

Recommended applications include switches, potentiometers, slide wires, edge card connectors, model trains and slot car tracks, and other electrical contact surfaces.

Army Oil is \$8.95 for a one-ounce applicator bottle plus \$2 shipping from the CFL Corporation, PO Box 10142-MT, Austin TX 78766; phone 512-479-9393.



## Build Your Own Spectrum Analyzer

As anyone who attends the Dayton Hamvention will attest, one of the longest-running and best-attended booths is that of Science Workshop where Murray Barlowe demonstrates the latest version of his homemade spectrum analyzer.

Over the years Barlowe has refined his combination of TV tuners, ramp generators and audio detectors which compose this clever collage of components into a very useful spectrum analyzer semi-kit.

Articles have appeared in amateur magazines, both by Barlowe and other experimenters, offering enhancements and substitutions to make the project(s) even better. Now *Build Your Own Spectrum Analyzer* is available in book form.

If you would like to tackle a technical challenge and have a weekend to spare, the Poor Man's Spectrum Analyzer should titillate your fancy, and Barlowe's comprehensive book is a good place to begin. For your copy send \$24.95 to Science Workshop, Box 310-MT, Bethpage, NY 11714.

## BBC Books

Marking the 60th anniversary of the BBC last May, Broadside Books has produced *A World in Your Ear* by John Tusa, the Beeb's managing director the past

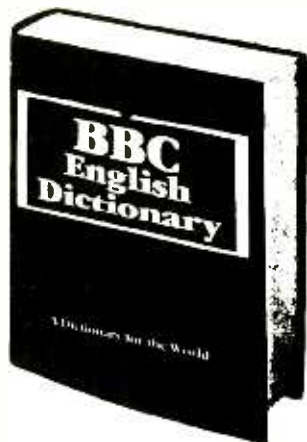

six years. *A World in Your Ear* is a collection of essays and speeches as well as extracts from his personal diary. Tusa reflects on the role of the BBC World Service in times of crisis and peace.

Says Euro DX, "Unlike any other observation on international broadcasting, *A World in Your Ear* offers the reader the fundamental reasons for the existence of stations such as the BBC." The book is £9.95.

*A Skyful of Freedom: 60 Years of the BBC World Service.* Written by former Bushman Andrew Walker, *Skyful* catalogues the growth and development of the BBC World Service during its 60 years of existence. From the Gulf War to Suez, the Second World War to the Falklands, the role of the World Service in time of war is well documented. *A Skyful of Freedom* is £15.95.

Finally, the BBC has gotten together with the renowned dictionary publisher Collins COBUILD (Collins Birmingham University Language Database) to produce the *BBC English Dictionary*. Based on the analysis of over 70 million words of BBC World Service output, the dictionary concentrates on English as spoken by the BBC. The 1408 page *BBC English Dictionary* is £29.45.

All three books can be obtained from the BBC World Service bookstore, Bush House, Strand, London WC2B 4PH or call 071 257 2573 with your Mastercard, Visa or American Express card.

## Propagation Programs

The number of propagation forecasting programs for the shortwave hobbyist and ham radio enthusiast is bewildering. Which program is best for your particular application?

While we have attempted to provide reviews in the pages of *MT*, nowhere—until now—has there been a comprehensive review of the leading programs. ASAPS, BANDAID, MAPPER, IONSOUND, WHATSON, MINIPROP, IONCAP, MICROPREDIC, DX4CAST and MINIFTZ4—they're all here!

*Propagation Programs—A Review of Forecasting Software* is now completed by Jacques d'Avignon, *MT*'s own propagation editor. This thorough, up-to-date and authoritative work makes the

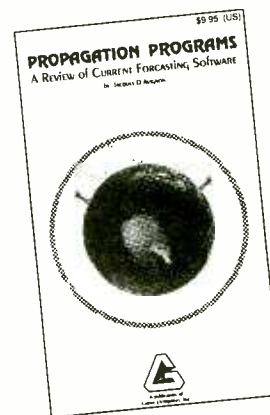

selection of a propagation program easy. With simple explanations of each program's capabilities, along with illustrations, d'Avignon has done all the work for you.

*Propagation Programs*, 47 pages, 7-1/2" x 4-1/2" is \$9.95 plus \$1.50 bookrate shipping from Grove Enterprises, P.O. Box 98-MT, Brasstown, NC 28902-0098.

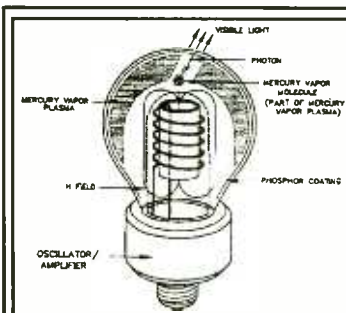

## "The Lamp of the Future" An Interference Nightmare?

So many readers have expressed concern over the forthcoming (1993) "E-Lamp" from Intersource (130 Kifer Court, Sunnyvale, CA 94086) that we

decided to contact that manufacturer for more information.

Similar to a non-filament fluorescent bulb, an electromagnetic field causes mercury vapor to release ultraviolet rays which strike a phosphor-coated glass, causing it to emit visible light of various colors.

A 25 watt, high efficiency E-Lamp has the same light output as a standard 100 watt incandescent. Although it may last twice as long as well, it costs 10-20 times as much.

But the phosphor-coated glass envelope may be changed when it dims (an incandescent lamp fails without warning), and the company claims that savings of several dollars per year in electricity and replacements will make the E-Lamp more cost-effective than present-day filament bulbs.

The controversy concerns the potential for radio frequency interference from the oscillator and amplifier in the base of the bulb which, in turn, causes the mercury vapor to emit ultraviolet rays. Interference, says Intersource, will be minimal, well below the FCC's Part 15 and 18 requirements.

According to the manufacturer, the oscillator is unmodulated and crystal-controlled on the internationally-allocated Industrial, Scientific and Medical (ISM) frequency 13.560 MHz. Tune in sometime and listen to similar equipment that has been operating there for decades.

But how about harmonics? The second and third harmonics (27.120 and 40.68 MHz) are also ISM allocations, but the fourth harmonic, 54.24 MHz, is on TV channel 2! That took some work, admitted an Intersource spokesman, but it was conquered. The bulb, apparently, is clean.



## Reviews



### Innova Power Pack

There has been a recent spate of portable battery power packs on the market, some good, some not so good. So how does the new Innova Power Pack measure up?

Measuring about 10 inches in height and weighing 6-1/2 pounds, the Innova has one fuse-protected, cigarette-lighter output jack which allows attachment of a 12 volt accessory to the internal 12 volt, 6.5 ampere-hour, maintenance-free, lead/acid battery.

The Innova has an integral carrying handle and comes with an attachable carrying strap. The overcharge-protected battery can be charged hundreds of times and a series of red, green and yellow LEDs signal its readiness status.

Any of a variety of low-power accessories—cellular phones, CB or ham radios, portable computers and TVs, lights (including camcorder spotlights) and even DC-powered tools, test and soldering equipment—can be attached.

The pack is recharged in 1-3 hours from a vehicular battery (integral cigarette lighter cord is hidden in the handle), or 8 to 10 hours from the AC wall charger (also included).

The Innova is U.S. made, but does not include the voltmeter, battery clip cables, cigarette lighter cord or 3/6/9/12 volt selection. These are standard with the \$79 Recoton "Smart Charge" power pack carried by Grove Enterprises. Power capacity of both units is the same.

Our sample unit was compact, lightweight, foolproof to use and convenient to carry. It would make a great camping, emergency, Field Day or work site power pack.

Available accessories include cellular telephone cradle, soldering iron, solar charger, lantern and emergency flashlight.

The Innova Power Pack can be found for around \$65 retail from a variety of nationwide dealers including Sears and Target stores. For more information, contact Innova Electronics, 17291-MT Mount Herrmann St., Fountain Valley, CA 92708 or phone 800-544-4150.

### Electronic Organizers — New Weapons in the DX Game

By Dan Phillips

As one who travels a lot, I am always looking for a better way of simplifying travel arrangements. Recently, I became convinced that if I had an electronic organizer my life would be easier. So, I began to make the rounds to determine cost. My first endeavors led me to Sharp Wizard and the Casio Boss. Both systems, with add-ons, could cost anywhere from \$100-\$300 dollars. While this seemed expensive in one sense, it also seemed to be necessary to meet the needs I had.

Then, one day while at Radio Shack, I found what was called a Data Organizer/Currency Converter on sale for \$19.95. The thought hit me, "This is so cheap I could fool around with this a while then buy the bigger organizer later."

When I asked the salesman how much memory it had, he said, "Twenty K." That didn't sound too bad considering some of the more expensive ones only held 32K of information. But then again, what would I do with a currency converter?

With some experimentation, I have successfully been able to do the following with the Radio Shack EC-324;

1. I placed my entire travel schedule for the next year in the organizer. This also includes an alarm which rings at the appointed time. This is especially neat when you want to watch a particular television program or listen to a shortwave station at a certain time. The alarm sounds to warn you of the event entered.
2. I included all frequently used addresses and phone numbers. During travel engagements, the name of the hotel, its address and phone number, are always helpful.
3. I also added all the shortwave stations, utility stations, and important scanning frequencies.

It is point three that I want to address for a moment. I don't know about you, but I find it very frustrating to be carrying my Sony 2002 with me and discover that I don't have any idea what frequency one of my favorite stations is on. Then I have to hunt up the latest *Monitoring Times* and leaf through it to get the frequency and time. And all too often, I have left the twisted issue lying beside my bed for a week until I begin to get dirty looks from my wife regarding to bedroom neatness.

Well, the EC-324 has solved my problems; As it is very small, only 2.5 by 4.125 by .25

inches, it fits anywhere unnoticed. And I discovered that shortwave stations can easily be entered and recalled very simply.

The trick is to use the address system in a different way. For instance, store the times (GMT) of shortwave stations in the address section and instead of using a telephone entry use the frequency of the station.

For example, I hit STORE and add 0200 Radio Moscow as the name of the address, then I hit STORE again and a note keys on the screen which says, "Enter Tel No." Instead of placing the phone number, I place 9530 space 9685 space 11850, etc. Those are the frequencies in kilohertz on which I can hear Radio Moscow at 0200 UTC. The other stations I listen to have also been added, of course, so at any particular time I hit the recall button, enter the time I desire to listen, hit recall again and the station and frequency appear on the screen.

Using this technique it is possible to enter any frequent DX station to the list. Entrance can be recalled by time, or by name of the station if you prefer. For example, in the previous entry I could have listed Moscow first, rather than 0200. This would mean I could list dozens of times and frequencies for Radio Moscow and they would jump on the screen anytime I recalled Radio Moscow.

### Search Ended

It's hard to believe, but this small organizer now has in it, football schedules, addresses, shortwave frequencies, engagements, important dates, a "to do" list, ICOM's toll free number, my visa number, tag number, *Monitoring Times*' 800 number, and personal goals. And to think, I still have over 13K of memory left!

I have discovered it does everything for me a more expensive organizer would do. Of course, the bad news is the sale is off and the price of the EC-324 is now \$29.95 again, but an even smaller Electronic Date Organizer Scheduler is now available from Radio Shack, the EC-331. Wow, wouldn't it be great to try one of those?

**Editor's Note:** The Bay Area Scanner Enthusiasts' club bulletin, "The Listening Post," suggested last year that such an organizer makes an excellent gift suggestion—"and your mate will never suspect that you are really asking for a radio communication accessory!"

It suggests using the Radio Shack EC-331 for a 100 channel scanner, the EC-324 or EC-329 for a 200-channel scanner. A 400 channel scanner might require the EC-330, EC-327, EC-340 or EC-339. An EC-32 or EC-333 will aid a 1000-channel scanner. They also point out that some of these organizers can interchange information with similar units or can load information using the RS232 port of your computer.

## Realistic® Pro-2026 Mobile Scanner

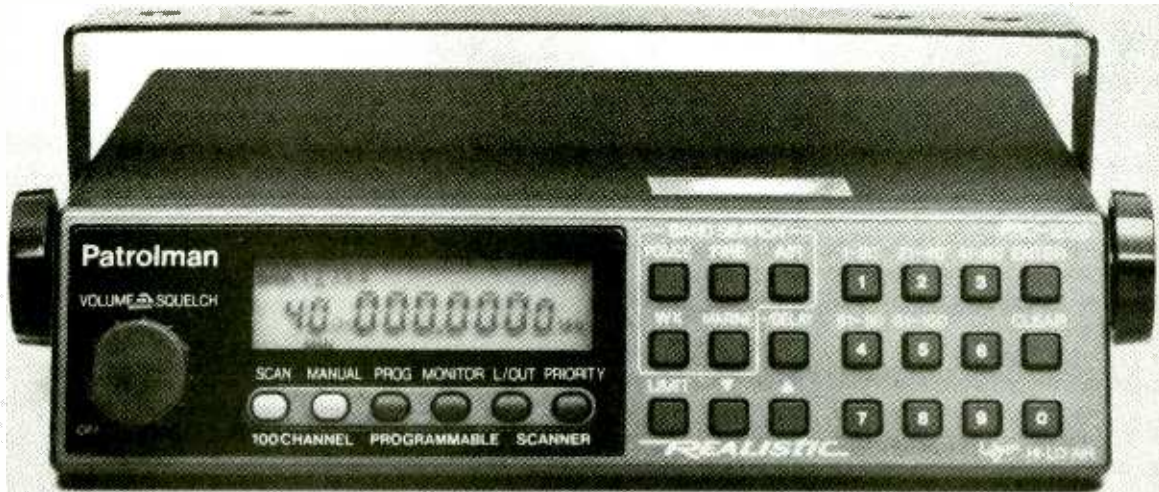

Yes, it does look like a Bearcat BC760XLT. No, it isn't a duplicate. There really are differences, especially in price. And a look inside the cabinet will convince the most skeptical critic that the PRO-2026 is a step away from the Bearcat, although it was made for Radio Shack by Uniden.

The 2026 is intended for mobile applications only, so it does not have a desk tilt bracket, AC adaptor, memory lock, external power jack or tape recorder jack, nor is there available an optional preamp or CTCSS decoder as with the Bearcat.

The keyboard layout looks familiar, but there are differences here as well. A program key must be pressed to allow new frequency entries. A monitor key allows temporary storage of a search-discovered frequency. Lockout and clear commands are on separate keys. Squelch rotation is in the opposite direction from the Bearcat.

Finding the decimal key was a chore; it is not on the numeral key cluster, nor is it mentioned anywhere in the manual. We finally found it after seeing a picture in the manual of the delay key (./DELAY).

A fixed-level keyboard "beep" loudly confirms keypresses and alerts "illegal" presses. On the 760 it is adjustable by the volume control.

The frequency coverage of the new 2026 is identical to that of the Bearcat with one exception: the aircraft range includes the 108-118 MHz airport VOR (radionavigational data) signals. The rest of the functions are identical to the Bearcat 760.

Up to 100 frequencies may be memorized in five banks of 20 channels each. Any channel may

be selected as a priority channel, allowing listeners to monitor a transmission on that channel whenever it becomes active regardless of the present search or scan routine operating. The priority function samples the designated channel every two seconds, resulting in a brief interruption of the other function.

Pre-recorded service search ("Band Search") frequencies allow the user to press one key to rapidly scan through his choice of police, fire, aircraft, weather or marine channels looking for action.

Individual channels in the memory may be locked out temporarily from the scan routine to avoid annoying traffic which is holding up the scan sequence. Any channel may select a delay function, allowing a two second wait for replies before the scan routine resumes.

### Specs

The published specifications are virtually identical to those of the popular Uniden BC760XLT. That isn't bad; after all the Bearcat is enjoying success in the consumer marketplace.

Frequency ranges are: 29-54, 108-174, 406-512 and 806-956 MHz (less cellular telephone). We don't know if cellular frequencies can be restored as in the Uniden product; the layout and the microprocessor chip are entirely different.

Scan speed is 14 channels per second and, in a side-by-side test, identical to that of the Bearcat. Search speed is slightly higher at 19 steps per second. Search increments are 5 kHz in the 29-54 and 137-174 MHz bands, and 12.5 kHz elsewhere.

Sensitivity is excellent. Unlike some Realistic® scanners like the PRO-2006 which have intentionally-reduced sensitivity to avoid strong-signal overload in metropolitan areas, the 2026 is capable of the same weak-signal reception as the comparable Bearcat. Specifications show an average FM sensitivity of 0.5-0.8 microvolts, perfectly satisfactory for mobile monitoring.

Selectivity, an important consideration for adjacent channel signal rejection, is 50 dB at 15 kHz from center frequency (the Bearcat claims 55 dB 25 kHz away). Again, very satisfactory for the majority of mobile monitoring requirements.

Although the competitive Bearcat claims audio output power of 3 watts into its 3 inch speaker, the 2026 claims only 1.1 watts, still enough to be heard in most noisy mobile environments.

12 VDC (13.6 VDC @ 0.5 A nominal) may be connected to the ignition switch so that the scanner is disabled when the vehicle is not in use, or directly to the battery line. Another wire goes to the battery line to preserve memory contents when the main power to the scanner is switched off.

The PRO-2026 measures 6-1/4" W x 1-1/2" H x 7-3/8" D and weighs 2 pounds, 3 ounces.

We were impressed with the performance of the new Realistic®PRO-2026. It is much cleaner internally than the competitive Bearcat, and the mobile monitoring enthusiast doesn't have to pay \$70 or more for features he doesn't need.

The PRO-2026 mobile scanner lists at \$199.95 from Radio Shack outlets nationwide.

**M**  
**T**

Realistic® is a registered trademark of the Tandy Corporation.



# ATTN: MOBILE SCANNER USERS

Introducing...

the

# Realistic® PRO-2026



Realistic® is a registered trademark of the Tandy Corporation

Everyone that has used a mobile radio knows how difficult some can be to program while driving. A touch of the button starts an instant search of hundreds of Police, fire, aircraft, marine or weather channels in your location.

Built for Realistic® by Uniden, the PRO-2026 looks like the Bearcat 760XLT, but is intended for mobile use only (includes mounting bracket and 12 VDC cable). The 2026 includes 100 memory channels in 5 banks. The audio is clearly heard from a 3" bottom-mounted speaker, even in the noisiest of mobile environments. With high sensitivity, sharp selectivity and a compact design, this new mobile radio races into vehicles with ease. The BNC connector attaches easily to mobile antennas like the Grove ANT-4.

The 2026 has frequency ranges from 29-54, 108-174, 406-512 and 806-956 MHz (less cellular telephone). The scan speed is a respectable 14 channels per second and search speed runs by at 19 channels per second. Search increments are 5 kHz in the 29-54 and 137-174 MHz bands and 12.5 kHz elsewhere.

The PRO-2026 is now available from Grove for only \$189.95\*! Call today and hit the open road with your new mobile powerhouse.

## Order SCN16 Today for only \$189.95!\*

Grove Enterprises, Inc.

1-800-438-8155

140 Dog Branch Road  
Brasstown, NC 28902-0098



\* Plus \$7.50 UPS shipping

### *Buy the Best in the Business - Buy Grove.*

## Grundig's New Top-of-the-line Satellit 700



For years, the name "Grundig" conjured up images of beefy world band radios with good sound and technology that was, well, a bit long in the tooth. With the Satellit 500, introduced in 1989, this began to change. The '500 was smaller—midsized—yet had worthy sound and a fair degree of advanced technology. It wasn't without fault, but it was quite able and succeeded nicely in the marketplace.

Now, the '500 is history—almost, as dealers sell out remaining stock—and so, too, is the larger Satellit 650. The '650 was classic Teutonic stuff: a fine performer, but large as a small suitcase and at least as weighty, with superb sound and some technology that would have been considered first class decades ago.

Apparently replacing both of these is the recently introduced Satellit 700, priced at \$699. Packaged in essentially the same cabinet as the '500, it is, in a nutshell, a nicely improved variation on that earlier model.

The '700 covers longwave, AM and shortwave from 150 kHz to 30 MHz, as well as FM from 87.5-108 MHz. AM, LSB, USB and synchronous sideband selectable modes are included, as well as FM mono and stereo. The '700 operates from four "D" cells or an outboard 110-127/220-240V AC power supply that is included with the radio. Charging for NiCad cells is built-in.

### Superior AM-Mode Audio Quality...

The '700's audio is not really equal to that of the '650. Yet, it is good enough that even weak shortwave and FM stations tend to be more readable and sound better on it than on the vast majority of other models. This is true both within the international bands and the static-ridden tropical bands. It's this sound quality that for some can make the '700 preferable to such alternatives as Sony's ICF-2010.

In the AM mode, our laboratory tests show overall distortion of 6% at 100 Hz, which is okay but hardly state of the art. Other measurements at 200, 400, 1000 and 2500 Hz produce excellent-to-superb results, which is partly why the set sounds so pleasant.

### ...but Distortion in Sideband Modes

So far, so good, but if you're listening in another mode, audio quality goes downhill. For example, overall distortion does not drop when synchronous selectable sideband is used, even though cutting distortion is one of its main

purposes. Rather, distortion rises to 15% at 100 and 200 Hz, and 8% at 400 Hz.

There's more. Conventional single-sideband reception shows a whopping 30% overall distortion at 100 Hz and 15% at 200 Hz!

Otherwise, the '700 generally fares well in the lab. Sensitivity, image rejection, blocking and phase noise measurements are all good, with first IF rejection being excellent. Dynamic range is only fair, sometimes even poor—not unusual for a portable.

The '700 has two bandwidths, plus continuous bass and treble controls. Its wide bandwidth is a tad broad, but both the narrow and wide bandwidths have excellent skirt selectivity.

### Mediocre Bandscanning Tuning...

In the AM mode, the receiver tunes only in 1 kHz steps, which causes it to chug annoyingly. 100 Hz increments are used for the sideband and synchronous modes, but the radio still chugs.

Worse, if you turn the dial faster, the entire tuning circuit mutes so you can't hear a single station as you dial by. This is assuredly not a bandscanner's receiver.



## ...but Excellent Direct Tuning

Fortunately, the keypad is almost the soul of simplicity. If you want 15070 kHz, just enter 1, 5, 0, 7, 0, then press the Frequency/M-band button. The rest of the '700 isn't always that straightforward. How complex this receiver can be is suggested by the 17 different error messages that can pop up.

Pre-stored from the factory are 120 frequencies for 22 stations. To access them, you have to enter a code, such as 0.5, then press the MEMORY/FILE button. This brings up a memory file with preset frequencies for, say, the BBC, with "BBC" appearing in the alphanumeric display. Pressing the MEMO-AF button accesses the various frequencies that appear in the BBC file. Press the MEMORY SCAN up/down button, and files for other stations appear. To supplement these, you can also create your own memory files.

## Synchronous Selectable Sideband

The '700's "sync" circuit operates similarly to that of the Sony ICF-2010, but it doesn't perform in the same league. When the '700's circuit is turned on, the station rumbles and no amount of fiddling cleans it up. Also, unwanted sideband rejection is just 16 dB, not the much better 24 dB found on Sony's '2010.

## Best Portable for Tuning Single Sideband

Yet, if you listen to utilities or hams, you'll find the '700's single-sideband tuning system virtually the best available in a portable. To interpolate between the receiver's 100 Hz tuning increments, there's a clarifier with a center detent to allow you to tune in exactly. It works well, indeed.

The Grundig Satellit 700 is a top-of-the-line portable with superior sound for shortwave listening, plus it has a number of advanced features—in all, a nice improvement over the Satellit 500. Despite that, it has shortcomings especially for bandscanning that make other models relatively more attractive.

## No Further News on Sony ICF-SW77

Some time back, Sony indicated it was contemplating certain improvements to the ICF-SW77. Thus far, we have received no word from Sony whether these or other improvements will be incorporated in later production units. Accordingly, the last report we had in *MT* on this model, as then revised, continues to be as current as we can make it.

*MT*

## Are You Ready for Fall

# DX SEASON?!



If so, you gotta stay tuned in to get the best tips and articles on your monitoring hobby.

### Moving?

Send us your address change in time to keep your *MT* coming!

### Subscription Current?

Check your mailing label! Your expiration date is shown to the right of your name. Renew early using the handy order form on page 85!

Stay tuned to Monitoring Times and be a Winner!



## LOOP ANTENNA



- Super medium wave reception.
- Low noise.
- Sharp directional nulls cut cochannel interference.
- High Q reduces adjacent channel interference.

Loop amplifier gives 20 db gain and sharp tuning to reduce interference. Plug-in loop Model BCB covers 550-1600 KHz AM broadcast band. It rotates and tilts to give optimum reception with minimum noise. Pulls in those stations that are otherwise unreadable because of noise and interference.

Model LA-1 Loop Amplifier \$99.95. Model BCB Loop \$89.95. Add \$4 shipping/handling in U.S. and Canada. California residents add sales tax.



Plug-in loops available from 10 KHz to 16 MHz. Send for free catalog that shows our complete line of antennas, amplifiers and filters.

## PALOMAR ENGINEERS

BOX 462222, ESCONDIDO, CA 92046

Phone: (619) 747-3343

FAX: (619) 747-3346

1-800-666-0908

NEW EQUIPMENT OFFERS & PRICES ONLY, PLEASE

### SHORTWAVE RADIOS

SONY - All Popular Models including the ICF2010 and the NEW SW77  
SANGEAN • ICOM • JRC • YAESU • GRUNDIG • and the NEW DRAKE R8

### SCANNING RADIOS

Featuring the NEW ICOM R1 Handheld and R100 Mobile/base • SHINWA  
SR001 • UNIDEN BEARCAT • AOR models including AR1000XC

Factory Authorized Dealer for: ALINCO • ICOM • JRC • STANDARD • YAESU  
DIAMOND • CUSHCRAFT, etc., Amateur Equipment  
Commercial 2-way from ICOM • MAXON • STANDARD • YAESU, etc.

FOR INFO AND TECH HELP CALL (203) 666-6227  
OUT-OF-STATE SALES CALL 1-800-666-0908  
CONN. SALES CALL (203) 667-9479

### LENTINI • COMMUNICATIONS • INC

21 Garfield Street Newington, CT 06111

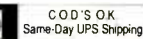

COD'S OK  
Same-Day UPS Shipping



PASSPORT'S "RDI White Paper" equipment reports contain virtually everything found during IBS' exhaustive tests of premium receivers and antennas. These reports are available in the U.S. from Universal Radio, EEB and DX Radio Supply; in Canada from PIF Books by Mail, Box 888, Hawkesbury, Ontario K6A 3E1; in the United Kingdom from Lowe Electronics Limited, Chesterfield Road, Matlock, Derbyshire DE4 5LE, England; in Australia and New Zealand from IBS Australia, P.O. Box 2145, Malaga WA 6062, Australia; and in Japan from IBS Japan, 5-31-6 Tamanawa, Kamakura 247. For a complete list of available reports, please send a self-addressed stamped envelope to RDI White Papers, Box 300M, Penn's Park PA 18943 USA.

## Witch Computer? How to Stay Away From Ghosts



With a very active used market, all types, models and manufacturers of PC clones can be found for very low prices. Can they be used with our hobby or are you wasting your money? In short, are they saints or evil spirits of a technological era gone by? How can you tell? Let's see if we can make some sense of this shrouded market.

In order to solve any problem the tools should be matched to the task. I am sure that to bang a nail into the wall we could use a 4-head, stereo VCR with full remote control. But why would you?! Well, this month's column is in answer to all the letters I've received asking how should a computer for our hobby be chosen.

The easy 1980's answer is get the biggest, the best and the latest. But today we are faced with the reality of the 1990's; financial resources and growth, both personal and national, are not limitless and must be used wisely. If you must have the latest to keep up with the "technocrat Joneses" regardless of your big charge card balance, then this month's column is not for you. Instead, stop reading this and get a second or third job; you'll need it at the rate new products are being released in this expand-or-die consumer electronics market.

Now for the rest of us, choosing a new or used PC clone begins with a realistic look at what our real use will be. Don't be confused with all a computer is *capable* of doing. Only then can we match the system's features to our exact requirements.

### Let's Get Started

First question: Choose one of the uses below for your system: A. Games machine; B. Business programs (word processing, spreadsheet, etc.); C. Equipment controller.

The first two choices are self-explanatory and outside the scope of this month's column. The third choice, which I hope most of you picked, encompasses our hobby: controlling a receiver, decoding digital signals and storing this data for later use. Actually, a very large population of PCs in industry are used as dedicated equipment controllers, so don't feel alone.

Now let's begin to define the exact system requirements relative to the maze of options

available. A good start is a list of the software we are going to use and a rough estimate of the percentage of time each will be used. Don't forget our goal is a basic cost effective system. Of course, if your primary software requires a specific, uncommon system element then that will set the pace. But for most communication software this will not usually be the case.

### Which System is For Me?

OK, what broad choice do we have in system options? Simply put, they are: 1. CPU - type and speed; 2. RAM - amount installed\max amount possible; 3. Video - type and resolution; 4. Hard disk - capacity and speed; and 5. Communication ports - type and number. It's not as bad as it sounds, so stay calm.

The CPU (central processing unit) is the heart of the machine. It resides on the large board in the computer, the "motherboard," into which the accessory printed circuit "cards" are plugged. Without going into technical detail this is the difference between the XT and AT models. The older XTs have 8080 or 8086 CPUs and the new ATs have 286, 386 and 486 CPUs.

Basically, the difference is how the CPU communicates with internal parts of the computer. The XT takes more time to perform an operation due to this fact. So even if the clock speed (the measure of how fast a computer can compute) of an XT is equal to an AT, the XT could be two times slower during some applications. Add to this the advances in maximum chip speeds incorporated into later AT CPUs, and the difference in speed between an XT and AT can be up to 100 times! So the big difference for our use between the XT and AT types is speed. The higher the clock speed, the better.

But wait! Higher speeds mean higher clock frequencies which are hard to keep inside the computer and out of our receivers. This, of course, is a function of mechanical design. Reject computers which don't have fully enclosed metal cases. It's okay if these are then covered with a plastic outer case for style. Due to the stricter FCC regulations on US manufacturers, the older PCs are usually much "quieter" in the radio signal spectrum.

Back to speed: how much is required in our hobby? For receiver control and digital signal decoding even the oldest XT running at 4.5 MHz is an unbelievable leap forward from paper and pencil. When I compare my Franklin XT to my 386 AT for these purposes, the XT shows a one to two second delay between keypress and screen action as compared to unnoticeable milliseconds for the AT. But if you want to minimize cost, the XT is perfectly acceptable. My Franklin was purchased at a hamfest for an obscenely low price and is a great controller and a good decoder.

The decoder programs I can use on the Franklin include all but the most complex. Operations such as FAX decoding are not possible due to the second system option, RAM. RAM, or Random Access Memory, is where the computer keeps instructions and some data while it is running a program. The more complex a program, the more RAM required.

Here is where you must be cautious. Some early XTs were made with only 512K of RAM and no possibility of expanding on the main circuit board. This will still be usable with over 60% of the communications software available today. But the standard amount of RAM today is 640K. So let the price you pay for an XT reflect if it is a 640K XT or a 512K. Check the software you have in mind to use. The oldie but cheapie might be just fine.

Before we leave speed, there is one radio application in which the delay times can become almost minutes longer with the slower XT machine; this is in manipulating large frequency, time and station database logs. When scanning through files containing hundreds of records this delay can become a very real problem. But even this can be minimized by breaking your listening files up into small files. For example, instead of having all your utility stations in one huge Utility File, break them up into Air Force, Navy, Diplo, etc. This pre-sort is helpful for any computer system but mandatory on an XT to minimize sort time delays.

### Video Choices

Next, let's look at the video display we will require. Again, for communication software this



is not a critical item. Basically there are three color standards of PC video: CGA, EGA and VGA, listed in the order of increasing picture viewing resolution or image quality. These are usually in color, but they can also be had in monochrome instead. Historically there have been many more video types, but today VGA or super VGA (SVGA) are the emerging standards.

In most cases, the software writers for our hobby have been very considerate and have written their programs for all types of displays; or at least EGA and VGA. The type of display you can use with your system is usually determined by the user/dealer removable printed circuit board installed in your PC. Therefore, you can usually upgrade the video type in most PC clones with the purchase of a video adapter "card" and corresponding monitor.

Talking about video, the monitor has to be an integrated part of your system. For example, if you have an CGA video adapter card it will only work with a CGA monitor. However, some recent VGA cards can emulate all three types via software which comes with the card.

When choosing a monitor the dot size should be matched to your application. Since the picture you see on any video monitor is made up of dots put together to form an image, the dot size determines how "grainy" your picture will look. If you are going to run a very detailed engineering drawing package, you would want the smallest dot size possible. Once again for communication applications this is not a major consideration. Remember, the finer the resolution of the screen (the smaller the dot), the higher the price. I use an old Hitachi CGA monitor on the Franklin with perfectly viewable results.

## Go For the Hard Drive

What is another major consideration for communications use? Hard drives: the amount of storage space and speed. Just think of the hard drive as a fast, large floppy drive. This is where you will store the communications programs that you will use and the frequencies and station logs.

This really is a case where larger is not only better, but a necessity. When XT's were first introduced 10 MEG of disk space was considered very large compared to the size required for the programs of the day. Today, programs have been developed to take advantage of the full power of the PC resulting in programs requiring 1 to 2 MEG of disk space. A receiver controller, digital decode, "total monitoring environment" with a number of database files can easily occupy 12 MEG of hard drive space. My frequently used programs and files come close to 50 MEG!

I would recommend a minimum of 40 MEG of hard drive space for our applications. Most hard drive controller cards, installed in the PC,

can control two hard drives. If this is the case, you could get two 20 MEG hard drives which would be cheaper than one 40 MEG. But be careful when purchasing a hard drive since there are three different types (RLL, IDE, SCSI) which must be matched to the controller card type that you have installed in your PC.

Finally, in order for the computer to be capable of "talking" to your receiver and decoder, a serial or RS-232 port is required. This is usually part of another card called a "communications card," having both serial and parallel ports. The parallel port is where most printers are connected. If you want to "talk" to both a receiver and decoder, such as a PK-232, a second serial port is required. On most communications cards not having two serial ports, the addition of two user/dealer installed integrated circuits and a connector will give you the second serial port.

A final word of caution. In the wild and woolly days of early PCs all sorts of custom made "almost" PC compatibles were made. Some of them had their add-on printed circuit cards permanently soldered in. These "dogs" should be avoided since the modifications and upgrades we have been discussing are not possible. Ask the question of the seller, "How many slots does the motherboard have?" If the answer is less than six, be careful. If the answer is less than four, don't buy it for more than the price of a calculator.

This approach is a good start in trying to decide which (not witch) used or new PC will be useful for our monitoring hobby. With the right choice your enjoyment of the hobby will be increased immensely and your pocketbook will not be haunted by bad end-of-the-month spirits! See you next month when we will once again put to work those great computer deals that you have wisely made.

# ENHANCED! \$49<sup>97</sup> ScanStar™ FOR IBM PC and compatibles

## Computer Assisted Radio Monitoring

### ENHANCEMENTS:

- \* Monitoring assistant keeps receiver adjusted properly as you tune it, logs freq, date, time & other info at your command - Ideal for HF!
- \* Remote programming of PRO-200x equipped with RW Systems add-in interface board
- \* Support for the Drake RB and Yaesu FRG-9600
- \* Support for NRD-535 upgrade (BWC-ROM F/G)

### STANDARD FEATURES:

- \* Combine up to 20 scan data sets or ranges into a single program and scan it all at once
- \* Specify percentage of time spent on each element of a scan program
- \* Full color spectrum analysis on NRD-535&AR3000
- \* Terminal window for TNC/RTTY/MODEM with log
- \* Concurrent operation of scan, edit, terminal window and spectrum analysis features
- \* Create and edit scanning databases
- \* Print reports and log information
- \* Professional quality user interface
- \* Easy to use and install

### SUPPORTS:

- \* NRD-535, NRD-525, RB, FRG-9600, MR-8100, R-7000, AR-3000, PRO-200x with RWSYS board
- \* Game or serial port scan step inputs
- \* Standard serial ports COM1-COM4, or multi-port cards (4/8 ports) at ANY ADDRESS!

### REQUIRES:

- \* IBM PC/CLONE 286 or better, hard disk, 640K
- \* EGA/VGA/MONO/HERC graphics card
- \* Serial port(s) for radio interface
- \* Level converter (if req'd by radio)

TO ORDER: Call 408-296-4224 VISA/MC/COD accepted  
FREE DEMO: Download demo version from the ScanStar 885 @ 408-258-6462

## COMMUNICATION AT ITS BEST

AR900 \$219; AR1000XC \$399;  
AR2500 \$439; AR3000A \$969

Lowest prices on AOR radios—GUARANTEED  
We also sell a variety of CBs, Scanners,  
Caller IDs and much more!  
For orders call: 1-800-33 TURBO  
Free Shipping

### TURBO ELECTRONICS

P.O. Box 8034  
Hicksville, NY 11802-8034

Questions welcome (516)938-1946

**MT**

"I am in my second year of subscribing to MT and will probably continue to read it as long as I listen to radio. My only regret is I didn't subscribe earlier!"

Scott Billingsley  
Camden, AR

Don't you have the same regret as Scott.



Subscribe to *Monitoring Times* today using the form on page 85!

DON'T MISS OUT ON THE OVERNIGHT ACTION !!  
CAN'T TAKE A SICK DAY FOR THE SHUTTLE LAUNCH ?!

Listen to it ALL when YOU want to with ...  
**MESSAGE CATCHER**

It lets your tape recorder monitor when YOU can't.  
Connects to your receiver's or scanner's speaker jack.  
Recorder turns on only when MessageCatcher "hears" activity

Includes: - MessageCatcher Unit  
- Power Supply, Cables & Plugs

.. All this and a good night's sleep for ..  
only \$19.95 (plus \$ 3.00 for s&h in USA)

To order, send check to: RADIO ACCESSORIES,  
10 Clark Hill Rd, E. Haddam, CT 06423 (203)526-9663

## Monitor VHF with a 5-Element Yagi

A vertically polarized Yagi beam antenna is easy to build and can provide solid reception of distant land-mobile services if you are too far from the signal source to enjoy good reception with whips and other no-gain antennas. I am referring here to the range of frequencies between 150 and 160 MHz that are used by such services as the police, fire departments and ambulances.

A 5-element Yagi antenna can provide up to 10 dB of gain (almost two S units) over a dipole or quarter-wave vertical. Also, a rotatable Yagi can discriminate against unwanted VHF signals that are off the sides or back of the antenna. This often aids reception of a specific land-mobile service in urban and other high-signal density areas. An ordinary TV antenna rotator is suitable for aiming the beam antenna in the favored direction.

### Anatomy of a Yagi Antenna

This type of antenna got its name from the Japanese inventors, Doctors Yagi and Uda. The antenna consists of a standard dipole as the driven element. Behind the dipole we add a reflector. It acts in a like manner to a mirror placed behind a light source, thereby concentrating the illumination in a forward direction. The reflector is approximately 5 percent longer than the resonant dipole used in the system. The dipole length is obtained from the standard formula:  $L(\text{feet}) = 468/f(\text{MHz})$ . Therefore, if we want to build a Yagi for, say, 155 MHz, the dipole length becomes 3.02 feet or 36-1/4 inches, tip to tip. The 5 percent longer reflector will be 38 inches long.

A Yagi can have numerous directors, depending upon the designer's choice for antenna gain. The greater the number of director elements the higher the antenna gain, up to a point of diminishing returns. It is not unusual to see VHF Yagis with as many as 20 elements.

Our antenna uses three directors. They are placed ahead of the dipole and the reflector. Each director is roughly 5 percent shorter than the dipole (also called the driven element). However, it is common practice to taper the director lengths lightly so that each director is a tad shorter than the preceding one. This provides greater antenna bandwidth (the useful frequency operating range) than when all of the directors are the same length. I like to cut each director 1 percent shorter than the preceding one. Therefore, the director that is the farthest from the dipole element is the shortest of the three.

The directors increase the antenna gain and concentrate the signal pattern in a forward direction. There is one major forward lobe of energy from this antenna, but there are two minor lobes as well. These occur adjacent to the major lobe. As you turn the antenna you will notice three peaks in signal strength if the Yagi is parallel to earth. The signal will be the loudest when the center of the main lobe is oriented toward the transmitting station. The approximate antenna pattern for a Yagi antenna with horizontal polarization is shown in Figure 1.

This pattern does not apply when we use the Yagi as a vertically polarized antenna because the minor lobes go toward the sky and toward ground. You should get just one major response as you aim the antenna at the source of the incoming signal. Vertical polarization is neces-

sary for proper reception of the VHF land-mobile services. Horizontal polarization is used for amateur CW and SSB communications in the 2-meter band, while vertical polarization is used for 2-meter FM communications.

### How to Build Your Yagi

A quick and easy Yagi may be constructed by using coat hangers for the elements. A long broom stick can serve as the boom for the antenna. Brazing rod also works nicely for the elements. I have used 3/8 inch OD aluminum tubing for my elements. They were attached to a wooden boom made from 2 x 2 inch lumber.

If you use coat hangers for the elements be sure to paint them to minimize rusting. Two coatings of Rustoleum paint should do the job. The wooden boom should be treated with exterior polyurethane varnish to keep it from deteriorating. The elements are held in place on the boom by soldering wires to them as shown in Figure 2. The dipole element is mounted on a plastic block as shown.

A gamma match maybe used to obtain a better impedance match between the driven element (no longer a dipole) and the 50-ohm feed line. This is illustrated in Figure 3. Unfortunately, one must apply RF power to the antenna in order to adjust a gamma match for an SWR or 1:1, and it's illegal to transmit a signal on unauthorized frequencies. You can, however, adjust the gamma match by setting it for maximum signal strength from a station of interest. An S meter is required for this tuning method. If you use the conventional dipole driven element you will have an SWR of roughly 2:1 and this won't cause a noticeable decline in received signal strength.

### The Spacing Between Elements

Various element spacings are used by designers. Some of the elements may be only 1/10th wavelength apart, where others are as far apart as 1/4 wavelength. The greater the element spacing the higher the feed point impedance. Forward gain and front-to-back ratio changes also with the element spacing.

I prefer 0.15 wavelength spacing between the driven element and the reflector. I use 1/4 wave spacing (0.25) between the driven element and the first director, and 1/4 wave spacing also between the remaining directors. The Figure 2 antenna is based on these dimensions. I have used 155 MHz as the design frequency in this example. It should work well for reception from 152 to 158 MHz.

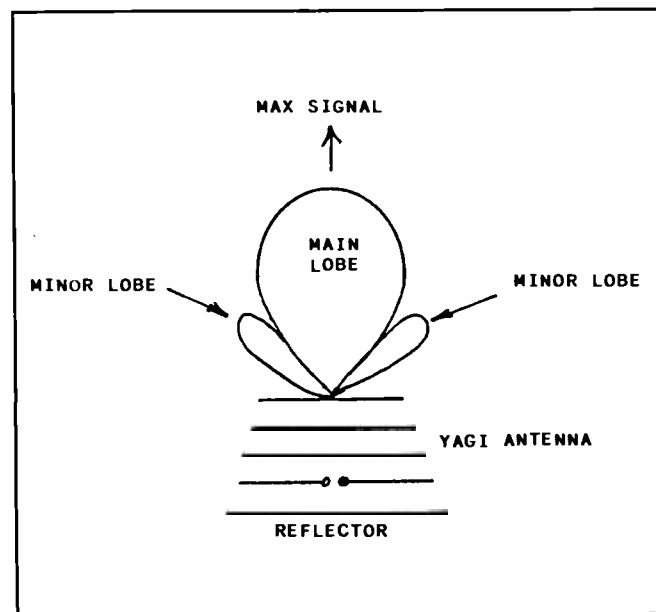

**Figure 1:** Example of a Yagi radiation pattern that shows the major lobe and two minor ones.



**Figure 2:** Mechanical details for a 5-element Yagi that is cut for 155 MHz. Coat hanger wire may be used for the elements and a broom stick can serve as the boom. The detail drawing below the Yagi shows how to affix the elements to the boom with wire and solder. The feed impedance is on the order of 25 ohms (see text) which results in an acceptable SWR for reception when feeding the antenna with 50-ohm coaxial line. Feed line should come away from the dipole element at 90 degrees and the mast should not be in the plane of the elements.

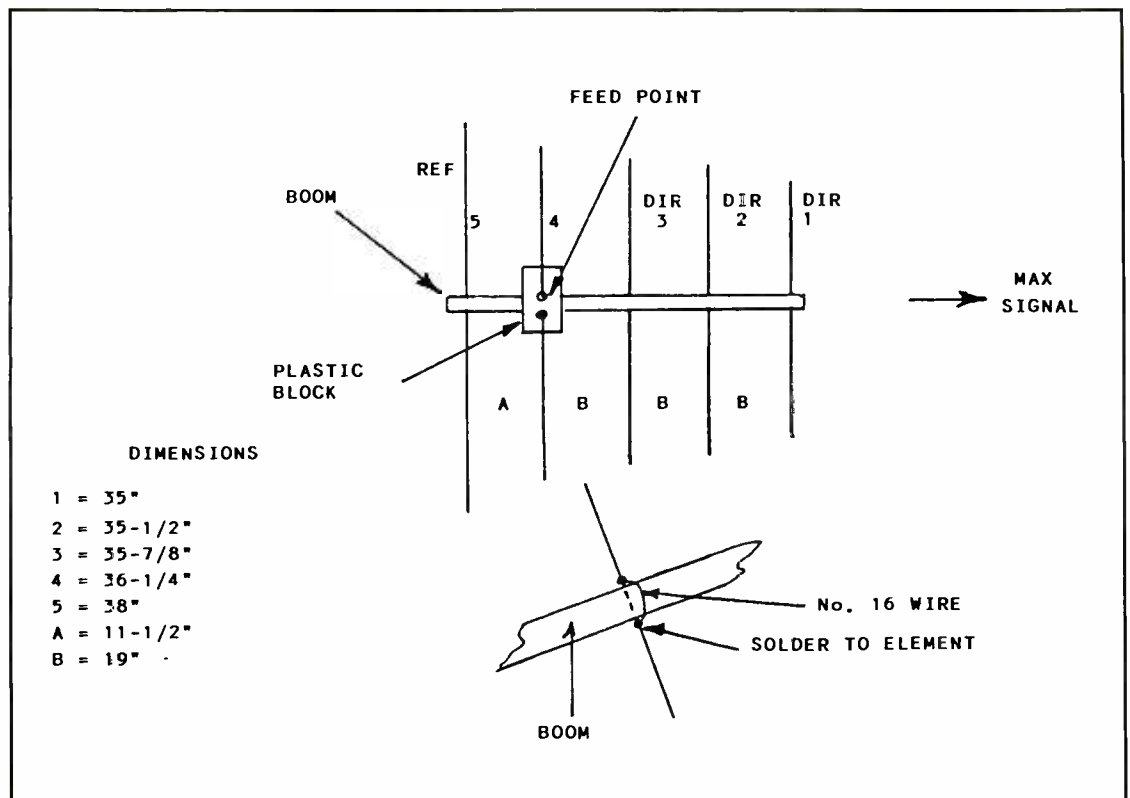

### Some Final Thoughts

Certainly, there are numerous other types of metal you can use for the antenna elements. Likewise for the wood in the antenna boom. A metal boom can be used if you wish. The centers of all of the elements, other than the dipole, are common to the boom if this is done. The dipole must be insulated from the boom. If you use a gamma match you may allow the driven element to also be common to the boom. This style of construction is known as "Plumber's Delight."

RG-8 or equivalent coax is best for feeding the antenna. But, if you can tolerate slightly more feed-line loss you can use RG-58 coax.

If you want a smaller antenna you can use only a director, dipole and a reflector. If this is done the antenna gain will drop to roughly 7.5dB. Your vertical Yagi should be mounted on an offset arm to prevent the mast from being in line with the elements.

*M<sub>T</sub>*

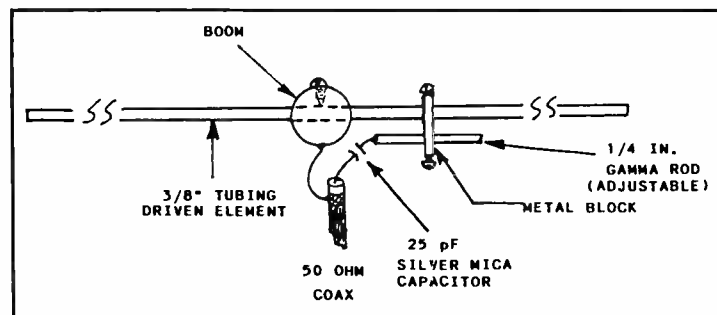

**Figure 3:** Details for a gamma matching section. The 1/4 inch OD gamma rod or tubing is 2 inches below the driven element. It is 8 inches long to allow for adjustment inside the metal shorting block. On-the-nose impedance matching will result when the fixed-value 25-pF capacitor is replaced by a 3-30 pF trimmer capacitor. This allows adjustment of the capacitor and the gamma rod.

## NEW COMMUNICATIONS GEAR

*Covering DC to Daylight at Discount Prices!*

AR1000XLT Scanner	\$ 399
AR2800 Scanner	\$ 399
Kenwood R-5000	\$ 879
AR-3000 Scanner	\$1050
Japan Radio NRD-535	CALL
ICOM R-71A HF Scanning Receiver	\$ 850
Collins R390A (Reconditioned/Calibrated)	CALL
Japan Radio NRD-525	\$1125
SONY ICF-2010	\$ 349
SONY ICF-7600	\$ 220
SONY Pro-80	\$ 370
RACAL RA-6790 (GM)/R-2174	CALL
Bearcat BC-760XLT - w/Cellular Restoration	\$ 285
Bearcat BC-200XLT - w/Cellular Restoration	\$ 275

**FREE DELIVERY**

WE OFFER REPAIR SERVICE \* MANUALS \* BROKERING  
 PROFESSIONAL MONITORING STATION  
 SEND \$2.00 FOR CATALOG CREDITED TO PURCHASE

**MIL-SPEC COMMUNICATIONS**  
 P.O. Box 461, Wakefield, R.I. 02880  
 Call Today (401) 783-7106

## Make a Miniature Mike

Now here's a dandy little tool for your tape recorder for those situations where the built-in microphone just doesn't quite pick up the sounds that you want. My LITTLE preamplified microphone will turn your deaf tape recorder, audio amplifier or other listening device into a set of "ears" so sensitive that it will pick up sounds from a pair of frolicking gnats at 50-feet!

Well, okay, I like to get carried away a little, but this Mini-Power-Mike will permit your tape recorder to CLEARLY detect the faintest whisper in a fair-sized room. You can also feed the output to an amplifier for even greater boost in pickup sensitivity. But keep in mind that it is unlawful to use any listening device for eavesdropping; only law enforcement officers—and then only with a court order—can conduct such surveillance.

Build your Mini-Power-Mike on a small piece of perf board, or as I did, point-to-point without a board! Use your imagination to create a housing for it. I used Radio Shack's 272-340 mini lamp holder, with the lamp holder guts removed, to hold everything including the electret

mike element and the gain adjust trimmer potentiometer. You might do better or worse with another design, but at least be creative: build it into a pen, cigarette lighter, or something else equally innocuous.

(I modeled one version after a very successful Viet Nam surveillance device that looked like an animal dropping. This variety can be rather conspicuously placed, if camouflage is not possible, because no one in his/her right mind is likely to monkey around with it!)

There's nothing very critical to the circuit, but use of tantalum capacitors and precision metal film resistors for R-1, R-2 & R-3 will minimize internally generated noise and help establish a super-low threshold of detection! Radio Shack has a good supply of tantalum capacitors, but you might have to go to an electronics supply house for the precision metal film resistors. Then again, you might find the needed values in Radio Shack's PMF resistor assortment package, 271-309. Good results can be obtained from the values specified in the Parts List, however.

### Mini-Power-Mike Parts List

Ckt Sym	Description	Radio Shack Catalog #
MIC	Electret mic element	270-090
R-1	Resistor, 1k, 1/4-watt	271-1321
R-2	Resistor, 10-k, 1/4-watt	271-1335
R-3	Resistor, 33-k, 1/4-watt	271-1341
R-4	Resistor, 4.7-k, 1/4-watt	271-1330
R-5	Resistor, 100 ohm, 1/4-watt	271-1311
C-1,2,3	Capacitors, tantalum, 10-uF	272-1436
C-4	Capacitor, tantalum, 2.2-uF	272-1435
VR-1	Trimmer potentiometer, 100-k	271-284
Q-1	Transistor, NPN, 2N2222A/sim	276-2009, -2016

The Mini-Power-Mike requires a DC supply of 2.5v-3.5v with 3v optimum. I designed the amplifier to be powered from the pair of AA batteries in a microcassette tape recorder, which satisfied the majority of my needs. You can also use a pair of silver oxide, mercury or other hearing-aid batteries to power the unit for a reasonable time; current drain is low at 1-ma or so. The Mini-Power-Mike can be concealed beneath layers of clothing, or other obstacles and still perform superbly.

It sports a voltage amplification factor of 47 or a power gain of 33-dB. This might be too much for some situations, so a GAIN control is included in the output circuit to adjust for exact needs. Polish off the Mini-Power-Mike with a flexible patch cable, preferably shielded mini-coax with a phone plug on the end to mate with the audio device of your choice.

Refer to Figure 1 for the schematic diagram and Figure 2 for a slightly enlarged reproduction of what the Mini-Power-Mike can be made to look like!

### Questions From the Readers

My desk is overflowing with questions, most of which I answer personally but I'll try to answer one or two of general interest.

• From Bob Camp, Michigan: "How can a computer be used to control or program a scanner that wasn't designed for that purpose?"

The keyboard switches of modern scanners apply 5-volt DC levels to certain pins on the scanner's microcontroller chip, depending on which key is pressed at the front panel. The microcontroller chip is factory programmed to go from there. So, it makes little difference, then, exactly where that 5-volt level comes from, be it the scanner's keyboard or a remote computer! It really is that simple! The scanner's microcontroller doesn't know the difference.

The Datametrics and RW Systems interfaces, as well as the new HB-232 Scanner/Computer Interface, use keyboard emulation to autoprogram the scanner's memory channels. Basically, the computer pushes all the right switches for us with accuracy and speed far greater than fingers!

Figure 1: Mini-Power Mike Schematic Diagram

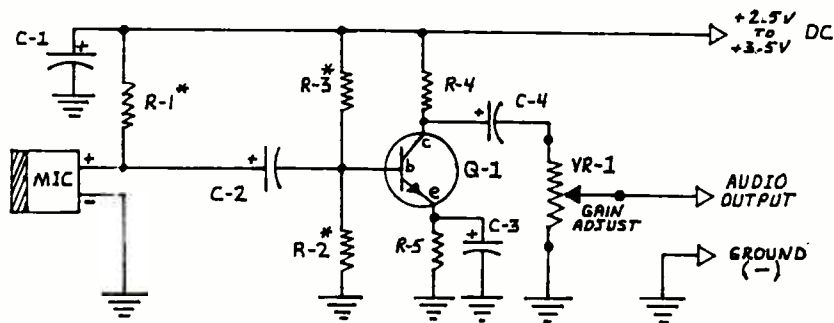

\* PMF RESISTORS BEST  
SEE TEXT

Figure 2: Mini-Power Mike Layout Hints

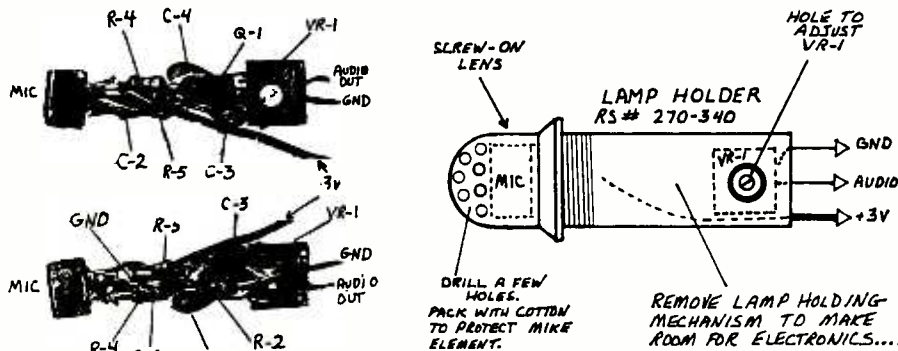

NOTE: R-1 NOT SHOWN IN DUE TO DIFFERENT MIKE ELEMENT USED. USE THIS EXAMPLE AS A GUIDE ONLY!



• From Larry Fenlow, Missouri: "Please tell us about electronic soldering tools and proper techniques."

Great request, Larry! I see a lot of emphasis nowadays on use of low heat solder pencils, but nothing could be worse for the casual hobbyist! Low heat, improperly applied, results in inferior, messy and eventually "cold" solder joints! Unless you're an expert, you're far better off with a fairly hot soldering pencil and I recommend something in the range of 35-60 watts with a slender, flat-blade "iron clad" tip, not copper!

Keep a sopping wet sponge nearby to wipe the hot tip on before making solder connections. A clean, hot tip is essential to success! Always use rosin core solder, never acid-core, when making electronic connections. Before each connection, wipe the tip on the wet sponge; apply a dab of solder to the tip and then momentarily heat the connection for, say one second, and then apply solder to the connection, NOT the tip of the soldering pencil!

When the solder flows into the connection, typically within another second, remove the solder first, leaving the tip in contact with the connection for another second and then remove the tip from the connection. The process requires about three seconds of contact with the connection and maybe two seconds for wiping the tip and pretinning it. Once you get into the groove, it's not difficult to do 8-12 solder joints per minute.

Cooled solder joints should be bright, shiny and smooth. The solder should look like it has cleanly and completely flowed into the joint. Grayish and/or "balled up" solder joints are likely to be defective and should be redone. Other tools and aids to good soldering include: desoldering braid or wick; a vacuum bulb or "solder sucker"; and a pick or two. By the way, dental plaque picks & scrapers are superb soldering & circuit tools. Ask your dentist if you can have one or two of his worn out ones!

My advice for good soldering is to be a little less cautious and a lot more attentive to results! I think heat and technique are a little overstressed. Modern electronic components are designed to withstand the heat of soldering, so exercise reasonable care, but pay attention to the results of your art. That's what counts!

## June Correction

Speaking of paying attention, Jim Venable of Newport News, VA, pointed out what should have been an obvious error in Figure 1C, page 102, in the June issue. Below is the corrected schematic with my apologies and my thanks to Jim.

M<sub>T</sub>

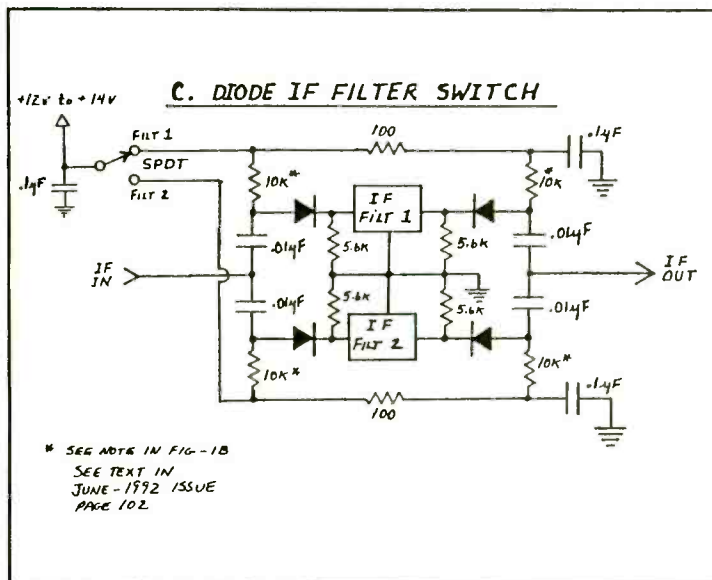

## UNIVERSAL RADIO HAS MOVED

Universal Radio has moved four miles to its new expanded location. We are now only 15 minutes from downtown Columbus and the Columbus airport. Visit our big operational show-room. We carry all lines of new and used shortwave and amateur equipment. Get a hands-on look at that new rig you have been thinking about!

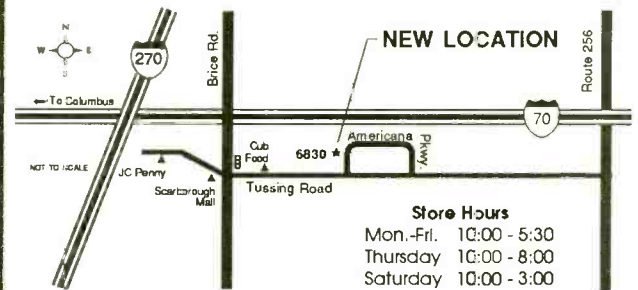

## HUGE COMMUNICATIONS CATALOG

The new Universal Radio 100 page communications catalog covers everything that is new for the amateur, shortwave listener and scanner enthusiast. Equipment, antennas, books and accessories are all shown with prices. This informative publication is available FREE by fourth class mail or for \$1 by first class mail.

**universal radio inc.**

**Universal Radio, Inc.**  
6830 Americana Pkwy.  
Reynoldsburg, Ohio 43068  
800 431-3939 Orders  
614 866-4267 Information  
614 866-2339 Facsimile

## PC HF FACSIMILE 6.0 \$99



## NOW EVEN BETTER!

Version 6.0 has just been released. It is the most comprehensive fax image reception system for the IBM PC and compatibles. It includes an FSK demodulator, advanced signal processing software, tutorial cassette, and complete 250 page reference manual. The software includes the following advanced features:

Menu Driven	CGA, HGA, EGA, VGA & Super VGA
Start/Stop Tone Recognition	Time Lapse Frame Looping
Unattended Operation	Slide Shows
Tuning Oscilloscope	Export to PCX & GIF Files
Resolution up to 1280x800x256 Levels	Programmable IOC & Line Rates
Programmable Colorization	Online Broadcast Database
Brightness and Contrast Control	Image Cropping
Pixel Photometry and Histograms	True Color Press Photos
Image Zoom, Scroll, Pan, Rotation	

## PC GOES/WEFAX \$250

PC GOES/WEFAX 3.0 is our finest fax imaging system. It is compatible with both HF and direct satellite broadcasts from GOES, METEOSAT, NOAA, SOVIET APT and C-Band services. It includes all of the above features plus a complete prediction system and advanced multispectral analysis software.  
Call or write for our catalog of products. Visa & MasterCard welcome.

**Software Systems Consulting**  
615 S. El Camino Real, San Clemente, CA 92672  
Tel. (714) 498-5784 Fax. (714) 498-0568

## Noise and Weak-Signal Reception

### *A Review of the Grove MiniTuner Plus*

What noise annoys an operator? The noise which competes with a weak radio-signal, that's what noise annoys most operators trying to pull a weak signal out of the snap, crackle, and pop of radio interference. For radio communication to be possible, the signal you want to hear can be detected reliably only when it is sufficiently above any noise present in your radio receiver's first stage.

The noise present at a receiver's first stage is composed of both external, or received noise (which comes in from the antenna) and internal noise (the noise generated within the receiver stage itself). At lower frequencies, the received noise is usually at a much higher level than the internal receiver-generated noise, and so, at lower frequencies received-noise level is the major limiting factor to weak-signal reception.

As frequency increases, received noise generally diminishes and internal noise becomes more of a consideration. The frequency at which internal noise starts to dominate the overall noise level in a receiver varies, but for the VHF band, and particularly for the UHF and microwave frequencies, the noise generated in the first stage of the receiver itself (internal noise) is usually the primary noise with which a signal must compete. Sometimes this is true also for the upper end of the HF band.

#### Using Receiving-Antenna Tuners

Any time we add selectivity to the front-end of a receiver which needs it, we help prevent intermodulation distortion (IMD), desensitization, and image reception. Because an antenna tuner adds some selectivity to a receiver's front end, it can help with these problems. But, we find that using an antenna tuner for maximizing output from the antenna to the receiver will improve weak-signal reception only in situations where external (received) noise is low.

This is because, when received noise is the dominant noise, maximizing the output from the antenna to the receiver increases received noise as much as it increases received weak-signals. Thus the overall signal-to-noise ratio is not improved by the increased output from the an-

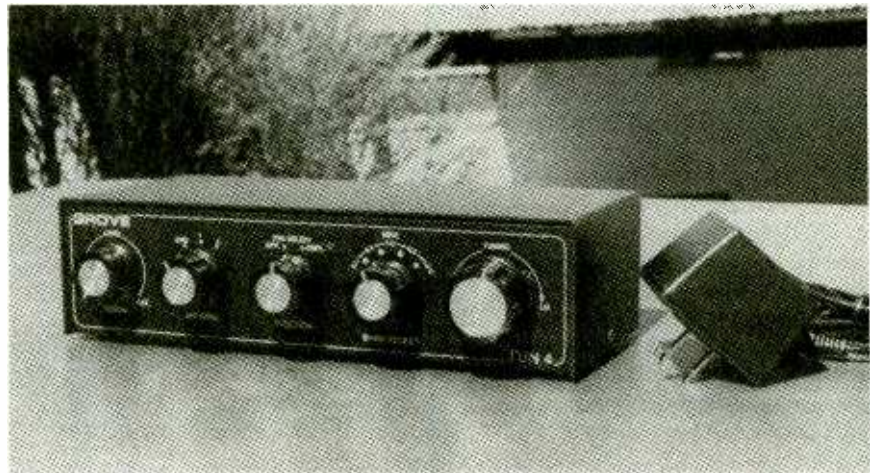

Figure 1: The Grove MiniTuner Plus antenna-tuner and preamplifier.

tenna, and reception is not improved. This explains why HF operators often report that using a receiving-antenna tuner between the receiving antenna's feedline and the receiver's input does little or nothing to improve weak-signal reception.

On the other hand, as the frequency utilized increases to VHF and higher, it becomes more likely that using an antenna tuner will improve weak-signal reception. This is because at these higher frequencies there is little or no received noise to ride in with the signal from the antenna. In such a situation, maximizing antenna output increases signal strength in relation to overall noise.

#### Using Receiving Preamplifiers

If a preamplifier generates less internal noise than the first stage of your receiver does, then connecting that preamplifier between the antenna and the antenna-input of your receiver effectively gives your receiver a lower-noise first stage. This means that received signals will compete with less internal noise.

Where received noise is relatively low, this receiver-preamplifier combination will lead to improved weak-signal detection. Thus a low-noise preamplifier is more likely to be of use for signals as frequency increases.

#### The Grove MiniTuner Plus

I recently tested a Grove Enterprises MiniTuner Plus, an antenna tuner combined with a low-noise preamplifier. The tuner was tested with a relatively state-of-the-art, top-of-the-line receiver which covers from 100 kHz to 30 MHz (the receiver portion of a Kenwood TS-930S), and a modest-quality general coverage (0.5 to 30 MHz) receiver: the Realistic®DX-100.

I listened across the full range of both receivers, checking out AM, CW, and SSB signals. The antenna tuner, used alone, did not improve weak-signal reception for either receiver. At this frequency range this is within normal expectation. On the other hand, the tuner peaked the signals as it should which indicates that it added selectivity to the receiver's input: a factor which will reduce IMD, desensitization, and image reception if you have a problem with these.

When the preamp was switched in, the results were sometimes quite dramatic. For both receivers it was possible to find signals which were inaudible without the preamp but perfectly readable with the preamp switched in. I expected this to be true for the DX-100 but I was surprised that it was true also for the Kenwood. The MiniTuner Plus obviously has a very good low-noise amplifier. These results indicate that the MiniTuner Plus is likely to improve your weak-signal reception, even if you have an excellent receiver.



**Grove's newest gadget**

# HTS-2 AUDIO BOOSTER AMPLIFIED SPEAKER



**Features Include:**

- 12 dB of Audio Gain
- 3.5" Oval Speaker
- Automatic Shut-Off
- Internal NiCad Charger
- External Power 5-15 VDC
- Tape Recorder Activator
- Auto Polarity Switch
- Input Level Adjustment
- Low Battery Drain
- Plugs into any scanner or shortwave receiver external speaker/earphone jack.

**Order SPK11 from Grove TODAY for ONLY:**

**\$29.95\***

\* Plus \$4.50 UPS Shipping

Accessories:  
ACC20: AC Wall Adaptor- \$9.95

**Grove Enterprises, Inc.**  
**1-800-438-8155**  
140 Dog Branch Road  
Brasstown, NC 28902-0098

## Computer Aided Scanning

*a new dimension in communications from Datametrics*



New Radio Shack PRO 2006 owners for the first time have access to the exciting world of Computer Aided Scanning with the highly acclaimed Datametrics Communications Manager system. Computer Aided Scanning is as significant as the digital scanner was five years ago and is changing the way people think about radio communications.

- The Datametrics Communications Manager provides computer control over the Radio Shack PRO2006 receiver.
- Powerful menu driven software includes full monitoring display, digital spectrum analyzer and system editor.
- Uses innovative Machine State Virtualizer technology (patent pending) hardware interface by Datametrics.
- Comprehensive manual includes step by step instructions, screen displays, and reference information.
- Extends receiver capabilities including autolog recording facilities, 1000 channel capacity per file, and much more.
- Simple 4 step installation - no soldering or modification to normal receiver operations.

### Datametrics, Inc

- Computer Aided Scanning system \$ 349
- PRO2006 receiver w/interface installed and CAS system \$ 749
- Manual and demo disk \$15
- Requires Radio Shack PRO 2006 receiver and IBM PC with 360K memory (640K for full channel capacity) and parallel (printer) port.

Send check or money order to Datametrics, Inc., 2575 South Bayshore Dr. Suite 8A, Coconut Grove, FL 33133. 30 day return privileges apply.

A plus for many operators considering this unit is that, due to its 20 dB of gain, it allows use of a relatively short indoor antenna with good results. Use of a longer antenna with this unit provides more signals, but if you can't put up a longer antenna, the MiniTuner Plus and a 20 ft indoor wire brings you a lot of excellent listening.

Another plus is the antenna-input attenuator. This can be used to reduce input from the antenna at times when excessively strong signals might otherwise cause overload problems.

The MiniTuner Plus is an attractively designed unit with black metal case and aluminum-on-black knobs. A red LED indicates when the preamp is switched on. Frequency coverage is very broad: 100 kHz to 30 MHz. When the MiniTuner is not in use, it may be switched out and bypassed entirely.

The MiniTuner has two outputs, allowing operation with two receivers simultaneously. The antenna switch gives a choice between two separate antenna inputs or, when the MiniTuner is not in use, grounding the antennas. Grounding the antennas helps prevent damage from lightning-induced surges coming in from the antennas. A gaseous-discharge type surge protector at the antenna input is also included.

The MiniTuner Plus which I received for review had an occasional problem with oscillation when first received. Opening the case and repositioning wires with my finger until the oscillation stopped removed the problem completely. After this simple procedure the unit provided smooth and stable operation.

The MiniTuner Plus is available from Grove Enterprises, 140 Dog Branch Road, P.O. Box 98, Brasstown, NC, 28902-0098. The price for the unit, with power supply, is \$99.95 plus \$5.00 UPS or \$7.50 US priority mail.

## Radio Riddles

### Last Month

Last month I said: "It seems obvious that the 'PL' of PL-259 stands for 'plug,' and the 'SO' of 'SO-239' is for socket. But what about the popular BNC and N-type connectors, and the C-type aircraft connectors? What do the letters stand for in these names?" Well, it seems that the BNC connector is the joint design of Mr. Neill and Mr. Councilman. The "BNC" then stands for: "Bayonet-Neill-Councilman." Bayonet, of course, refers to the way the connector goes in with a push-and-turn to engage the little studs ("bayonet pins") on the socket. Mr. Neill invented the low-loss "N" type connector, and the "C" type connector is the work of Mr. Councilman.

### This Month

We are often told that the center-feed impedance of a halfwave dipole is about 72 ohms. But it may surprise you to know that, in practical situations where the antenna isn't reasonably high off the ground, this antenna's impedance may be closer to 50 ohms than to 72 ohms! In fact, as the dipole's height above ground is changed, its feedpoint impedance can range from 20 ohms or lower to almost 100 ohms! Then why do people talk about this dipole having a 72-ohm impedance?

You'll find an answer to that, and much more, in your next issue of *Monitoring Times*. 'Til then, Peace, DX, and 73.

**MT**

Note: "Kenwood" and "Realistic" are registered trademarks of the Kenwood and Tandy Corporations respectively.

**Q.** *I purchased a pair of Radio Shack FM wireless intercoms. Can I hook up an external antenna to them to increase their range? (John Morris, Oak Harbor, WA)*

**A.** FM wireless intercoms are not really wireless; they generate a radio signal, usually in the 160-190 kHz range, which is sent into the power line which acts as a mutual antenna between the units.

If there is no telephone pole transformer between you and the corresponding party, you can talk up to a half mile on a set of these, but there usually is.

An effective antenna and ground system at these frequencies can be rather extensive, since a half-wave antenna is nearly a half mile in length! Of course you could wrap the length around a PVC pipe, but you would still need a good ground.

One hobby organization, the Longwave Club of America (45 Wildflower Rd., Levittown, PA 19057) deals extensively with experimental communications in these frequencies.

More important for safety, you would need to isolate the antenna line from the AC power cord by an appropriate 600 volt capacitor, then resonate the antenna with tunable components for efficiency.

Maybe you should just use the intercoms the way they were intended!

**Q.** *What is the optimum length and height for a wire antenna to monitor the 530-1600 kHz range medium-wave broadcast band? (Van Houten, New Smyrna Beach, FL)*

**A.** 1000 feet long and 500 feet high! Now you know why so many "random wire" antenna are used at the lower frequencies! It is also a good case for shorter vertical antennas with proper tuning since they can be mounted at ground level.

You might even try taking 100-200 feet of insulated wire and laying it on the ground as long and straight as practical. You will be amazed at how well such an antenna works below about 3 MHz.

**Q.** *Where is FM used in the shortwave bands? (Larry Thompson, Porthill, ID)*

**A.** Only above 25 MHz. Hams often use it between 29 and 29.7 MHz. Petroleum services, broadcast remotes and occasional land mobile services can be heard in FM mode between 25-

26 MHz and 29.7-30 MHz (especially foreign). Illegal CBers often use it above and below the legitimate 26.965-27.405 MHz range.

**Q.** *I have a Kenwood R5000; when I attach an antenna, I see an S3 noise level even without a signal present. What causes this? (James Ashe, Weymouth, MA)*

**A.** A receiver's signal strength meter will generally read S0 with no signal present. As soon as you attach an antenna, the cumulative signals from appliances, power lines and even the earth's atmospheric lightning and solar radiation all are detected at once, establishing a "noise floor" which causes the S meter to rise.

**Q.** *How does antenna polarization and directivity affect reception? (Peter Warncke, Vallejo, CA)*

**A.** Antenna polarization refers to the horizontal or vertical alignment of the driven element (to which the coax is connected) to the earth's surface. For optimum coupling efficiency, a receiving antenna should have the same polarization as a transmitting antenna.

The land mobile industry, due to the ease of mounting a vertical antenna on a vehicle, is universally vertically polarized. If you attempt to receive a vertically polarized signal with a horizontally polarized antenna, you may suffer as much as 30 dB (decibels) of signal loss.

In actual practice, however, especially over long distances, radio waves have a tendency to bend and scatter, mixing the polarization pattern. Large cities with signal-reflecting buildings and sharp-terrain mountain regions emphasize that effect.

Antenna directivity refers to the nature of most antennas to favor certain compass directions. An antenna a half wavelength long at a particular frequency, elevated at least a quarter wavelength above a reflective surface such as the earth, favors directions at right angles to the axis (length) of the wire.

Antenna directivity and gain are identical on receive and transmit. Don't worry about impedance matching for receiving antennas; you won't be able to tell the difference between a signal heard on a perfect 1:1 match or a terrible 20:1 match—the signal to noise ratio on shortwave will still sound the same.

Random wires are so named because they are unplanned for length, elevation and directivity. They are pot luck. If a random antenna is fed at the end by a wire, that wire is part of the antenna. Only coax or twinlead isolates the antenna from the feedline.

Even a random wire has a natural frequency of resonance—it has to be a half wavelength somewhere. For most applications a random wire at least 25 and up to 100 feet in length works well over the entire 2-30 MHz shortwave spectrum for receiving.

**Q.** *Are there any frequencies reported to have UFO activity on them? (Dan Hajema)*

**A.** Nope, not in many years, and there hasn't been any activity on those, either!

**Q.** *I have a terrible problem with overload from a local FM broadcaster on my Sangean ATS803A; is there anything I can do to eliminate it so that I can hear other FM stations? (Carl Olivetti, Bridgeport, CT)*

**A.** Maybe there is and maybe there isn't. First, plug an RCA phono plug into the external antenna jack and see if the interference goes away; this disconnects the whip and will let you know if the signal is penetrating the cabinet.

If the interference goes away, a filter connected in-line with an external FM antenna may do the trick. The trap will need to be tuned to the frequency of the interfering signal, and will have some attenuating effect on nearby frequencies as well.

See the June issue of *MT*, page 107, for instructions to make a simple wavetrap.

If the source of interference is in a different direction from the signal(s) you want to hear, try a directional FM beam antenna as well, with the undesired station off the side of the antenna for maximum rejection.

**Q.** *Which amateur bands use upper sideband, and which use lower sideband in the shortwave frequency range? (Clifford Legerton, Summerville, SC)*

**A.** Although hams can use upper or lower sideband interchangeably, by convention they use LSB only on the 160, 75 and 40 meter bands (1.8-2.0, 3.75-4.0 and 7.15-7.3 MHz).

**Q.** *I sometimes notice an echo effect on received shortwave broadcast signals. Is this due to multipath? (Jerry Brookman, Kenai, AK)*



**A.** It sure is. Since you are hearing the same signal, there will be no shift in frequency, thus no heterodyne (beat note) tone; but they might arrive out of phase, subjecting the signal to either enhancement or cancellation, depending upon the relative arrival times of the incoming waves.

If they are far enough out of sequence, you will hear one signal a sizable fraction of a second different from the other, resulting in the echo effect.

Years ago there were reports of long delay echoes (LDEs) occurring several seconds out of sequence. Since it takes only about 1/8 of a second for a radio wave to circumnavigate the globe, one can only speculate on where the signal had been before it was heard!

# CIA Case Files

**COMPANY BUSINESS**, a monthly newsletter dedicated to CIA activities, reviews and analyzes previously classified documents.

*Every Month, Articles on:*

CIA Weapons • Training • Surveillance • Technology  
Electronic Communications • Global Activities  
Current Situations

**COMPANY BUSINESS**  
One year subscription (12 issues)  
**ONLY \$25.00!**

Check or money order to:  
Company Business, Inc., 8038 W. Sample Road Suite 130  
Margate, Florida 33065  
(305) 755-5206



## Bob's Tips of the Month

*Note: It is unlawful to monitor mobile telephone conversations. The following procedure requires familiarity with microcircuit soldering and may violate your warranty. Monitoring Times assumes no liability resulting from its attempt.*

It was bound to happen. With tens of thousands of intrepid *MT* readers, someone would find out how to restore cellular telephone coverage on the new Realistic®PRO-43 handheld scanner and the PRO-2026 mobile scanner. Thanks to Gary Ross of Livermore, California, for the procedure on the PRO-43. The modification on the PRO-2026 was contributed by a long time Youngstown, OH, subscriber.

### Realistic®PRO-2026 Cellular Frequency Restoration

The new, low-cost Realistic®PRO-2026 is a hot seller, and with this modification it is an unequalled bargain.

The 2026 has cellular frequencies deleted at the factory, but restoration is the easiest we have ever seen—clip one marked wire! All you need is a Philips screwdriver and wire cutters.

- (1) Turn the scanner upside-down and remove the four side screws holding the bottom cover in place; pull the cover loose and set it back about two inches out of the way.
- (2) Locate the small circuit board at the lower right-hand corner and find jumper L201. Cut it and slightly separate the break.
- (3) Reassemble the radio which now has continuous 806-956 MHz coverage and 30 kHz search increments in the cellular band.

### Realistic®PRO-43 Cellular Frequency Restoration

**TOOLS NEEDED:** Fine point, low power soldering pencil; solder wick or a desoldering tool; pointed awl, hemostats or pointed tweezers; small Philips screwdriver; solder.

- (1) Remove the battery, antenna and back cover (held in place by four screws).
- (2) Remove the six screws holding the top circuit board in place. Carefully unsolder the two antenna connections from the board. Bend the antenna ground tab fully up from the board. Carefully lift the board, unplugging the black connector at its base, and lay the board out of the way on its bundle of colored wires.
- (3) Remove the two screws from the next board and lift it, carefully unplugging the white connector at the bottom of the board. Lift it up and lay it aside on its brown wire (which can be unplugged if necessary).
- (4) Unsolder and remove the metal shield from the final board, revealing the microprocessor; note the row of diodes labelled D1-D5 above it. Only diodes D1, D2 and D4 are present; assisted by a pointed tool, unsolder and remove D4, the lone diode. (This restores cellular frequencies which will be searched in 30 kHz steps.)
- (5) Resolder the removed diode carefully into position D3 to extend low band coverage to 88 MHz.
- (6) Reassemble the scanner, paying particular attention to the alignment of the plugs. Test the radio by entering any frequency between 870-890 MHz (cellular) and 51-88 MHz (low band).

Realistic® is a registered trademark of the Tandy Corporation.

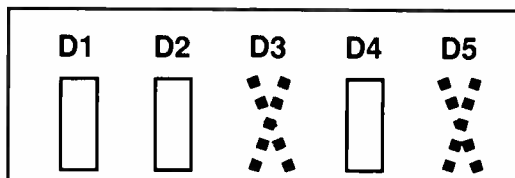

# Club Circuit

## Club Profiles

### Bearcat Radio Club

While the Bearcat Radio Club has Uniden as its sponsor, membership is open to all scanner hobbyists. It publishes the *National Scanning Report*—a bi-monthly scanning magazine for the U.S. and Canada—and provides frequency and technical information to its members.

*National Scanning Report* is edited by *MT*'s past editor, Larry Miller, and a sample is available for \$2 cash. You may call 1-800-423-1331 or write Box 360, Wagontown, PA 19376 for more information. Send an SASE for a list of local chapters to see if one meets in your area. Membership/subscription is \$17.50 per year.

### Boston Area DXers

The Boston Area DXers meet on the third Friday of each month to share their common interest in shortwave broadcasting. Whether you're a program listener, beginner, or seasoned DXer, you are invited to join in. Meetings are held at the GTE Labs in Waltham, MA; call or write Paul Graveline

(508-470-1971; 9 Stirling St., Andover, MA 01810) for directions and more information.

### Metro Radio System

The Metro Radio System uses a repeater whose signal covers a large part of Massachusetts, Rhode Island, New Hampshire, and Maine to advise members of Public Safety incidents. Many of MRS's 276 Active Members represent the TV, radio and newspaper media, or are members of area fire and police departments or emergency services. Control operators are on the air 95% of the time.

Associate Members do not use the radio system, but enjoy receiving the MRS newsletter and attend the dinner meetings, both of which occur four or five times per year. A flea market and the showing of a fire film also proved popular enough to become annual events.

For more information on the Metro Radio System, contact Julian Olansky at PO Box 26, Newton Highlands, MA 02161; 617-969-3000.

### Other news

- The European DX Council reports that the

1992 EDXC Club List is now available, providing details on each of its member and observer clubs. It is available for £1.00 or 3 IRC's worldwide from the European DX Council, P.O. Box 4, St. Ives, Huntingdon, PE17 4FE, England.

• WWCR will air shortwave club events if submitted at least two weeks in advance. Send the following information: club name, name of the event, any other sponsors involved, time and place of the event, and who to contact for more information (name and address) to: Adam Lock, "International Communique," 1300 WWCR Avenue, Nashville, TN 37218.

• Stephen Canney of ODXA is offering a course in shortwave listening through Centennial College, Warren Woods Campus, Scarborough, Canada. To register for the fall or winter course, call 416-698-8200.

## Club Listings A - L

Don't see your club listed this month or in last month's N-Z listing? Write or call the Brasstown office to request a form for the Club Circuit.

**All Ohio Scanner Club:** Dave Marshall, 50 Villa Rd., Springfield, OH 45503-1036. Ohio and surrounding states; VHF/UHF and some HF and amateur coverage. *American Scannergram*.

**American SW Listener's Club:** Stewart MacKenzie, WDX6AA, 16182 Ballard Lane, Huntington Beach, CA 92649, (714) 846-1685. Western US, Pacific, Asia, & Middle East; SWBC, utilities, longwave. SWL.

**Association of Clandestine Enthusiasts (A.C.E.):** Kirk Baxter, P.O. Box 11201 Shawnee Mission, KS 66207. US, Europe and Middle East; Pirate and clandestine. *The A.C.E.*

**Association of DX Reporters (ADXR):** Reuben Dagold, 7008 Plymouth Rd. Baltimore, MD 21208. International; Utilities, ham band, QSLing, MW, LW, and SWBC. *DX Reporter*.

**Association of Manitoba DX'ers (AMANDX):** Shawn Axelrod, 30 Beacontree Bay, Winnipeg,

Manitoba, R2N 2X9 Canada, (204) 253-8644. Manitoba; LW, MW, SW, and VHF/UHF.

**Bay Area Scanner Enthusiasts:** Herman Frisch, 4718 Meridian Ave. #265, San Jose, CA 95118. San Francisco Bay area; 30+ MHz. *Listening Post*.

**Bayonne Emergency Radio Network (BERN):** Ray Baron, P.O. Box 1203, Bayonne, NJ 07002, 201-662-2222. NE Jersey; Fire/disaster.

**Bearcat Radio Club:** Larry Miller, Box 360, Wagontown, PA 19376, 1-800-423-1331. US and Canada; Scanning only. *National Scanning Report*.

**Boston Area DXers:** Paul Graveline, 9 Stirling St., Andover, MA 01810, (508)470-1971, 50 mile radius Boston; SWBC.

**Canadian Int'l DX Club:** Sheldon Harvey, President, 79 Kipps St., Greenfield Pk., Quebec, Canada J4V 3B1, (514)462-1459. Canada nationwide/membership open to all; General coverage. *The Messenger*.

**Chicago Area DX Club:** Edward G. Stroh, 53 Arrowhead Dr., Thornton, IL 60476. 150 mile radius of Chicago; Dxing all bands. *DX Chicago*.

**Cincinnati Area Monitoring Exchange (MONIX):** John Vodenik, (513) 398-5968. SE Indiana, Kentucky, SW Ohio; SWBC, utility, military, satellites, scanning, BCB.

**Decalco Mania:** Paul Richards, P.O. Box 126, Lincroft, NJ 07738, (206) 356-3927(Phil). Collecting radio related items.

**Drake SPR4 Int'l Club:** Rick Sitz, 5210 14th St. W. #11, Bradenton, FL 34207. Worldwide; Drake SPR4 owners.

**DX Audio Service (NRC):** NRC Publications Center, P.O. Box 164, Mannsville, NY 13661-0164. Worldwide; AM/FM; DXAS Cassette 90-min monthly audio magazine. Sample \$3 to above address.

**DX Club of India:** Navin Patel, 809, M.G. Road, 1-Dutt Niwas, Mulund, Bombay-400 080, India. India; SW DXing.

**European DX Council:** Michael Murray, P.O. Box 4, St. Ives, Huntingdon, Cambs PE174FE, England. Europe.

**Ft. Wayne Radio Listeners Club:** Robert E. Hilton, 5809 Heatherview, Fort Wayne, IN 46818, (219)489-5821. Ft. Wayne area; All aspects of radio.

**Int'l Radio Club of America (IRCA):** Ralph Sanserino, 9705 Mary NW, Seattle, WA 98117. Worldwide; BCB/AMDX. *DX Monitor*.

**Longwave Club of America:** Bill Oliver, 45 Wildflower Rd., Levittown, PA 19057, (215)945-0543. Worldwide; Longwave only. *The Lowdown*.

## New Additions

**MONIX (Cincinnati/Dayton Area Monitoring Exchange):** Mark Meece, 79173rd St., West Chester, OH 45069-2212, (513)777-2909. Cincinnati/Dayton area; Full spectrum SW and scanning.



## SPECIAL EVENT CALENDAR

Date	Location	Club/Contact Person
Sept 4-6	Omaha, NE	National Radio Club DX Convention/Ernest J. Wesolowski 13312 Westwood Lane, Omaha, NE 68144, (402)330-7758.
Sept 6	Burlington, IA	Burlington Hamfest/Chuck Gysi, N2DUP, PO Box 974, Burlington, IA 52601-0974, (319) 752-3000. Location: Iowa National Guard Armory, Summer Street Road. 7:30 AM to 3:00 PM, \$4 admission. Talk-in on 146.790/146.520.
Sept 12-13	Melbourne, FL	Melbourne Hamfest/Gerry Wentz, KC4EHT, (407) 254-3095. Location: Melbourne Auditorium, talk-in on 146.85.
Sept 19-20	Peoria, IL	Peoria ARC Superfest/Merv Rennich, N9FXS PO Box 3508, Peoria, IL 61612-3508. Location: Exposition Gardens, Northmoor and University. Gates open at 6:00 AM, \$5 admission, talk-in on 146.76/16.
Sept 19-20	VA Beach, VA	VA Beach Hamfest/Lewis B. Steingold, W4BLO 3449 Dickens Drive, Va Beach, VA 23452, (804) 486-3800. Location: VA Beach Pavilion.
Sept 20	Mt. Clemens, MI	L'Anse Creuse ARC Swap Shop/Jerry & Donna Luh, KA8QBC & KA8QBD 732 Brookwood Lane, Rochester Hills, MI 48309, (517) 595-2309. Location: L'Anse Creuse HS; \$3 admission. Talk-in on 147.08/68 or 146.52.
Sept 26-27	Louisville, KY	Great Lakes Division Convention/Mike Doerhoefer, WB4AJZ PO Box 34233, Louisville, KY 40232.
Sept 27	New Pt Richey, FL	Pasco County Hamfest/Ralph, N4QIK, (813) 847-4043 Location: New Port Richey Rec Center, 6630 Van Buren. 9:00 AM to 5:00 PM, \$5 admission, talk-in on 145.35 or 147.15.
Sept 27	Yonkers, NY	Metro 70 cm Network/Otto Supliski, WB2SLQ 53 Hayward St., Yonkers, NY 10704.
Sept 27	Longmont, CO	BARCfest/CO Assoc of DXers* Location: Boulder County Fairgrounds
Oct 1	Houston, TX	SPECIAL OPERATION: KK5W 1500Z-2100Z to commemorate the 9th Annual Childrens Christmas Card Parade. Operation on 7292.9, 18129.9, 21392.9 and 28392.9. QSL and sase to KK5W, MD Anderson Hospital, Amateur Radio Volunteers, 1515 Holcombe Blvd., Houston, TX 77030-4095.
Oct 2-4	Atlanta, GA	1992 Monitoring Times Convention Location: Omni Hotel at CNN Center. \$40 registration, \$21.95 banquet. Walk-in for exhibits only for \$5. See ad on page 5 for more details.
Oct 3-4	Boxboro, MA	New England ARRL Convention/(617) 631-7388.
Oct 10	Columbus, IL	SPECIAL OPERATION: W9AWE, Western Illinois ARC celebrating Quincentenary of the European Discovery of America. 1400Z Oct 10 to 2400Z Oct 11 or general SSB and CW sub-bands, packet and 147.03 W9AWE repeater. QSL and sase to: WIARC, PO Box 3132, Quincy, IL 62305.
Oct 10	Baldwinsville, NY	RAGS Hamfest/(315)469-0590 Location: Tri-County Convention Center, 9 am-4 pm. Talk-in on 146.31/91 MHz.
Oct 11	Waukesha, WI	KMRA Swapfest/PO Box 411, Waukesha, WI 53187-0411. Location: Waukesha Co Exposition Center, Hwys J and FT.
Oct 17-18	Concord, CA	Pacific Div ARRL Convention/Lauren Styles, WA6CIE 1910 Sunshine Dr., Concord, CA 94520.
Oct 18	Golden, CO	RMRL Hamfest/David L. Avery, N0HEQ 6616 S. Lafayette St., Littleton, CO 80121-2545 Location: Jefferson Co Fairgrounds, West 6th and Indiana Avenues. \$2 admission, talk-in on 145.220.
Oct 18	Queens, NY	Hall of Science ARC Hamfest/Charles Becker, WA2JUJ, (516)694-3955 or Arnie Schiffman, WB2YXB, (718)343-0172. Location: NY Hall of Science parking lot, 47-01 111th Street. Opens at 9 am, admission by donation. Talk-in on 445.175 NB2A repeat 146.52 simplex.

\*SASE to Colorado Association of DXers, P.O. Box 22202, Denver, CO 80222-0202 for information.

Monitoring Times is happy to run brief announcements of radio events open to our readers. Send your announcements at least 60 days before the event to:

**Monitoring Times Special Event Calendar**  
P.O. Box 98  
Brasstown, NC 28902-0098

## INDEX OF ADVERTISERS

Advanced Electronics Applications	13
AIE Corporation	25
Antique Radio Classified	9
ARRL	7
Ashton ITC	3
Austin Antenna	63
Automotive Security & Accessories	41
Cellular Security Group	91
Chilton Pacific	17
Communications Electronics	11
Consumertronics	17
CQ Communications	45
Datametrics	105
Jacques d'Avignon	17
Delta Research	21
R.L. Drake Company	65
DX Radio Supply	9,63
Galaxy Electronics	17
GRE America	47
Grove Enterprises	47,56,57,75,95,105
Glenn Hauser	29
Hunterdon Aero Publishers	9
ICOM America	Cover IV
Intercepts Newsletter	43
J&J Enterprises	43
Japan Radio Company	Cover III
JPS Communications	65
KIWA	49
Klingenfuss	37
Lakeview	43
Lentini Communications	97
LJ Electronic Industries	55
MilSpec Communications	101
Monitoring Times	5,85
Motron Electronics	49
National Scanning Report	3
OptoElectronics	Cover II
Palomar Engineering	97
QSL Prints	53
Radio Accessories	99
Radio Electronics	87
RDI White Papers	97
Scanner World	39
Skyvision	49
Software Systems Consulting	41,103
Somerset Electronics	15
Spy Supply	27,107
Tiare Publications	17,55
TRS Consultants	9
Turbo Electronics	99
Universal Electronics	51
Universal Radio	103
V-Comm	99
WI-COMM	53
World Com Technology	53



*And tell them you  
read about it in  
Monitoring Times!*

# STOCK EXCHANGE

Ads for Stock Exchange must be received 45 days prior to the publication date. All ads must be paid in advance to *Monitoring Times*.

*Monitoring Times assumes no responsibility for misrepresented merchandise.*

**NON-COMMERCIAL SUBSCRIBER RATES:** \$.25 per word - *Subscribers only*. All merchandise must be personal and radio-related.

**COMMERCIAL RATES:** \$1.00 per word. Commercial line ads printed in bold type.

**1-3/4" SQUARE DISPLAY AD:** \$50 per issue. Send camera-ready copy or copy to be typeset. Photo-reduction \$5 additional charge. For more information on commercial ads contact Beth Leinbach, 704/389-4007.

**SURVEILLANCE, COUNTER SURVEILLANCE EQUIPMENT FOR SALE. WRITE SHERWOOD COMMUNICATIONS, BOX 535-G, SOUTHAMPTON, PA 18966 (215) 357-9065.**

**SUPER 800 MHz SCANNER DUCKIE ANTENNA \$19.95 (incl s&h), RG-6 QUAD-SHIELD COAX \$.28/ft + \$4 s&h (incl. F-conn inst) YAGI-UDA SUPER GAIN ANTENNAS FOR 400, 800, AND 900 MHz. MOBILE DIAGNOSTICS, P.O. Box 1226, Brick, NJ 08724-2925.**

**TONE-CALL TONE ALERTING SYSTEM for CB, Ham, Scanners. Radio stays silent until called. No modifications, inexpensive! Write: Rob Bellville, Box 892MT, Northboro, MA 01532.**

**NEW ICOMS: R1 \$449; R7100 \$1139; H16 \$515; U16 \$525; A21 \$479; M11 \$379; 100 feet 9913 with solder PL-259s \$99; MC/VISA/AMEX; XPM Inc. Communications (512) 693-4999.**

**ACE/AOR AR2500. 1-1500 MHz. Mint. \$300. (514) 739-9328.**

**KENWOOD R2000, new with original box and manual \$490. Including shipping UPS or trade for old model airplane cars ignition engines, (818) 913-4923, Willie Shuhaibar, 2423 Brenda, West Covina, CA 91792.**

**SHORTWAVE PARADISE BBS now has the new Fall schedules available. Call our computer line now at 1-305-524-1035. We are a FREE BBS computer system!**

**BC200XLT cellular restored, manual, excellent condition, \$185 +s/h or swap for BC800XLT in top condition. Bob Berg, Sr., 3539 Warringham, Waterford, MI 48329, (313) 623-6636.**

**PORTABLES: Mint SONY ICF-2010 with manual \$200. Very good PANASONIC RF-2900 5-band AM/FM/SW receiver with slow/fast tuning, digital readout, VFO, svc manual \$85. Dave (505) 835-1088.**

**FOR SALE: SONY 2010 excellent condition. Call Reginald (804) 627-4971.**

**LINIPLEX LOOP ANTENNA 50 kHz-30MHz. See ad page 83 Passport '91 for description, \$300. PALOMAR LOOP AMPLIFIER AND 5-15 MHZ LOOP, \$90. PC-SWL PROGRAM to decode CW/RTTY/FEC complete with electronics by SSC, \$50. Henry (919) 684-7590.**

**YAESU FT1012D TRANSCEIVER 10-160 meters \$300; YAESU FV 102 DM, external VFO \$125; UNIDENHR-2510 TRANSCEIVER \$200. ANTENNAS MALDOL 10 meter beam, 2 element \$75; 6 meter beam \$50; TELEX/HYGAIN 10 meter 3 element beam \$75; AEA AT-300 ANTENNA TUNER \$75. John (716) 693-5290 evenings.**

**ICOM R71A FM board and remote control installed. Mint, used 12 hours. Never modified. Includes manual and box \$700. (305) 974-3388 leave message.**

**KENWOOD R1000 shortwave \$200; AEA PK232 s/fax software \$200; both in excellent condition, all manuals and boxes. Christner, 306 Woodview, Cortland, OH 44410.**

**ICOM ICR7000 RECEIVER with remote. Like new less than 6 months old \$825. Will ship. Call Phillips (704) 982-6660.**

**UNIVERSAL M-7000 V3.03 (latest version) with FAX and clock options, rack ears, all manuals, like new \$700. INFOTECH M-92 terminal unit and INFOTECH 100 tri-mode converter \$100 pair. GALAXY R530 GENERAL COVERAGE RECEIVER with SC530 speaker and manuals \$175. (209) 226-5991 or (209) 431-9707.**

**SR-001 SHINWA with AC adaptor, 25-999 MHz, mint \$375. (602) 546-6940.**

**WANTED: Borrow or buy MT December 1991-UK distributor messed up subscription! MR8100 USERS: anyone done software improvements? Any UK users? Call UK (44) 81 878 6014 collect or leave number/best time to call back.**

**FOR SALE: INFOTECH M-6000 v.5 with new monitor, cables and manuals for \$780 nego-**

**table. Anthony (718) 256-5571 before 9:15 pm EST.**

**FOR SALE: YAESU FRG 7700 Communications receiver. 1.5 to 30 MHz, AM, USB, LSB, FM, CW. Excellent condition, \$250 plus shipping. (606) 734-6805 after 6 pm.**



**Do you have what these readers are looking for?**

## TAPE RECORDING OF

**RADIO SWEDEN BROADCAST:** The June 21, 1992, English broadcast of "In Touch with Stockholm" at 0200 to 0230 UTC (2200 to 2230 EDT) on 11705 or 9695 kHz, surprisingly featured a letter I wrote. Since I was not able to record it, I would like to obtain a copy of this program. Allan Frederickson, 1002 E. Tienken, Rochester Hills, MI 48306.

## OLD RADIO TUBES

**(DEAD OR ALIVE!):** Tubes needed for collection which will be mounted and given to radio oriented club when completed. Hugh M. Hawkins, P.O. Box 238, Port Gibson, MS 39150.

**YOU AIN'T HEARD NOTHIN...YET!**

Largest selection of scanner frequency guides (federal, military, police, aero, etc.); AM/FM/TV broadcast directories; HF "ute" directories; Books on espionage, covert ops., bugging, wiretapping, surveillance, clandestine radio, & more!  
**BIG FREE CATALOG!**

**CRB RESEARCH  
P.O. Box 56-MT  
Commack NY 11725**



# HUGE 100 PAGE CATALOG

- > Shortwave Receivers
- > Amateur Radio Gear
- > Scanners
- > RTTY & FAX Equipment
- > Books & Accessories

Send \$1 to **Universal Radio**  
 5830 Americana Pkwy. MT  
 Reynoldsburg, OH 43068  
 Tel. 614 866-4267

## Shortwave Database IBM or Compatible

Over 3,000 entries  
 Sort by frequency, station,  
 country, language, time.  
 Database can be updated.

\$20 ConUS \$25 Outside ConUS  
 Mention diskette size

**ORCHID CITY SOFTWARE**  
 P.O. Box 18402  
 West Palm Beach, FL 33416

## PRACTICE SAFE RADIO

You spent a fortune assembling the best station possible. Have the right antenna as high as possible, even added a preamplifier. But did you include a lightning arrester? If you did, do you know what level of protection it affords? Or how fast it acts? Most arrester manufacturers do not tell you that their arrester will allow HUNDREDS of volts to reach your receiver before any protection occurs. NCL is proud to offer an arrester that protects to SEVEN VOLTS and responds in only FOUR NANO-SECONDS! In fact, it is built so good that it comes with a TEN YEAR warranty. Please write for a full catalog of superior communication products including AM broadcast interference filters, parts and solar power systems.

**Northwest Communication Laboratories**  
 813 SW Highland, Suite C-310  
 Redmond, OR 97756  
 (503) 923-2540

## Radio for Peace International T-Shirts!

Blue, Green,  
 Yellow design on  
 White T-Shirt  
 \$5.00 each ppd.  
 specify size(s):  
 M, L, XL



**RADIO FOR PEACE INTERNATIONAL**  
 P.O. BOX 10869-C  
 EUGENE, OREGON 97440

## 801SCAN/801HF

**Computer Control Systems for ICOM**  
 801SCAN for VHF Scanning is available for the ICOM R7000 and R9000 receivers.  
 801HF for HF/shortwave listening is available for the ICOM R71, R72, R9000, IC735, and other transceivers.  
 Find out why advanced users prefer our software!  
 Programs run on IBM/PC compatibles. Available with required interface, or use your own. Demo disk \$5, please specify 801SCAN/801HF and receiver.  
 801SCAN program \$134.95 801HF program \$94.95  
 Interface \$60.00 Call or write for more information!

**Terzon Systems Inc.**  
 VISA and MasterCard accepted P. O. Box 835921  
 Richardson, TX 75083  
 (214) 234-8222

## PROGRAMMABLE TONE DECODERS

### FOR SELECTIVE LISTENING

CTCSS: Model TS-32P ... \$57.95      DTMF: Model DTD-1 ... 59.95  
 DCS: Model DCS-23 ... 59.95      2-TONE: Model SD-1000 ... 59.95

Call for free catalog of these and other tone signalling devices. **800-854-0547**



**COMMUNICATIONS SPECIALISTS, INC.**  
 426 West Taft Avenue • Orange, CA 92665-4296  
 Local (714) 998-3021 • FAX (714) 974-3420

RADIO NEW YORK INTERNATIONAL

Dedicated to global awareness of our environment and the promotion of world peace and understanding

Broadcasting Sundays  
 9:00 pm to 1:00 am EST  
 on 7535 kHz

**Radio New York International**  
 14 Prospect Dr., Yonkers, NY 10705  
 On-Air Phone 1-800-326-2957

## PAN-COM INTERNATIONAL CATALOG

From Amplifiers to Zappers!  
 Over 350 Kits, Plans & Books about Licensed/Unlicensed AM/FM/Cable broadcasting, Ham/CB/SW/lowfer/medfer, surveillance, phone devices, software, MORE. Send \$1.00!

PO Box 130-T  
 Paradise CA 95967

## COPY RTTY FOR \$29.95 FULLY ASSEMBLED INTERFACE

- RECEIVE TEXT SENT FROM AMATEUR, NEWS WIRE, SHIPS, FOREIGN EMBASSY, MILITARY, AND OTHER TRANSMITTERS
- CONNECTS YOUR IBM COMPATIBLE PC COMM PORT AND RECEIVER AUDIO OUT
- USERS MANUAL AND INDIVIDUAL TECHNICAL SUPPORT INCLUDED
- USE WITH DECODER PROGRAM (FREE COPY INCLUDED)

POST PAID  TRONCO P.O. BOX 304  CHECK OR M.O.  
 WINDSOR OHIO, 44099

## HIDDEN SIGNALS ON SATELLITE TV

There is more than TV on the satellites. You can receive press services, stock-financial services, SPCP, radio networks, sports radio nationwide, audio and music, data systems, telephone channels, commodity news, teletext, plus many others. **NEW Third Edition** shows you how to receive on your dish, 240 pages, hundreds of diagrams!

\$19.95 plus \$3 shipping - MC/VISA

**1 - 800 - 241 - 8171**

Free Catalog **Universal Electronics, Inc.**  
 4555 Groves Rd., Suite 13  
 Columbus, OH 43232

## HEAR ALL THERE IS TO HEAR WHERE YOU LIVE

25 MHz - 1500 MHz  
 Frequency Search Service

Send SASE to:  
**HEALD**  
 6886 Jefferson St.  
 North Branch, MI 48461

Also: Heald's Scan-Rail \$9.95  
 Heald's Scan-Air \$9.95

## SURVEILLANCE

COUNTERSURVEILLANCE Electronic Devices  
 Miniature Transmitter Kits. \$29.95 & up  
 Voice Changers, Vehicle Tracking, Touch Tone Decoders, Phone Scramblers, Phone Recording Systems, Bug & Phone Tap Detectors!

CALLER IDENTIFIER device - displays callers phone number before you answer with date & time of call...\$49.95 & up

FOR CATALOG SEND \$5 TO...  
 P.O. Box 337  
 Buffalo, NY 14226  
 (716) 691-3476

**E D E**

## PC Link your R5000!

Complete kit has ALL you need for: Keyboard Control, Loading and Saving frequency files, build scan files, log intercepts, color graphics, & more! Includes: interface chipset, level translator kit, & software! **Nothing else to buy! COMPARE !!**  
 Requires IBM- EGA/VGA- ~~HW~~ **Classic Kit \$119° Assembled \$159° S/H \$5°**  
 An SASE gets you our free catalog!

**JABOD ELECTRONICS**  
 R1 BOX 386, ALEXANDRIA, IN 46001

Mention this ad and get our "R5000 Modifications" booklet FREE! \$10 value! Offer good until 1-1-93

## SUPER SOUND DETECTOR HEAR THROUGH WALLS!



### ELECTRONIC STETHOSCOPE

Ultra-sensitive device picks up & amplifies sound through solid objects. Hear through glass, wood, plaster, brick or even 12" concrete. Use whenever audible sound is too faint for the unaided human ear. Picks up voices, machinery, running water, even mice or insects. Can be attached directly to a tape recorder. Includes headphones, sensor and battery. \$69.95 check/MO to:

**CLE, Box 1913**  
 Sarasota, FL 34230-1913  
 (813) 922-2633.  
 Visa/MC accepted.

## MONITOR CELLULAR DATA

The Digital Data Interpreter (DDI) will decode and display cellular data on your computer or an optional LCD display. You will see phone numbers, frequency changes and much more. The DDI will follow voice channel frequency changes and will automatically re-tune some radios.

Kits start at \$185 and assembled DDIs start at \$240. Write for an order form and details on the DDI and its options. Some radios require a part change and/or internal connection; others use the speaker jack. Ask for information on your radio.

**CCS**  
 P.O. Box 11191  
 Milwaukee, WI 53211

## The Guide to the AR1000

We publish the complete, 90-page guide to the operation and use of the AOR AR1000 and Fairmate HP 1000 family of scanners. Comes with 10 scan bank templates and a handy, 6-panel, folded Quick Reference Card.

Detailed sections on:  
 • Operations  
 • Applications  
 • Accessories  
 • Reference

"The ultimate owner's manual" — *Monitoring Times*, April 1992.

\$14.95 plus \$3.50 S&H (\$18.45) in U.S.  
 Design EQ  
 P.O. Box 1245  
 Menlo Park, CA 94025  
 415-328-9181

## QUICK-N-EASY SHORTWAVE LISTENING

Exciting new shortwave broadcast frequency guide! HIGH QUALITY laminated reference cards with SW frequencies. Full set is 4 cards: #1 for 0000-0559 UTC, #2 for 0600-1159, #3 for 1200-1759, #4 for 1800-2359. ORDER ONE OR ALL!

**CATALOG \$2** **JUST \$3.95 PER CARD FULL SET \$12.95**

**FB Enterprises**  
 15800 NW 31st Ct.  
 VANCOUVER, WA 98685  
 Phone/Fax: (206) 573-0910

## Dust Free Radio



Quality 10" brush will help keep your equipment free of dust. Soft bristles clean between knobs and buttons with ease. Works great on computers, too!

**\$2.95 each or 2/\$5 postage paid**  
 Check or money order to:  
**ASK Industries**  
 216 Banks Crossing, Suite 205  
 Fayetteville, GA 30214

## Frequency Microfiche by State

All FCC Licenses Statewide Shows freq-callsign-licensee and xmit location

**Latest 1992 issue**  
 A New World of Scanning

Send \$20 — Check OK  
 (Except NY-TX-CA \$30)

**G. Bellows, Box 1239**  
 Charleston, SC 29402

## Convention Fever

It's hard to believe that a year has gone by since some 400 of us stalwart monitoring enthusiasts met in Knoxville, but it has. And this year it looks as though even more will be in attendance with our special low rates at the luxurious Omni/CNN complex in Atlanta. If you haven't pre-registered, better do it now!

The lineup of guest speakers is impressive—experts in scanning and shortwave equipment, surveillance technology, antenna design, identifying signals, aeronautical monitoring, trunking and cellular systems, federal government and public safety communications, and dozens of other topics. Not just our own *MT* columnists, but other leading authorities as well.

Remember how CNN was the only network that was able to continue broadcasting during Desert Storm? Dick Tauber, our banquet speaker and CNN's director of satellites and circuits, promises to tell us how he did it.

Dozens of commercial dealers will be showing and selling the latest in receiving technology—shortwave broadcasting and utilities, VHF/UHF, satellites, digital modes, test equipment, antenna



systems, computers and software, book dealers and more — all at competitive prices.

Here in the heart of the southeast, VHF/UHF monitoring is incredible; don't forget your scanner! Even if you do, there will be plenty of receivers to go around; you won't spend a quiet weekend alone!

Ever been on a "fox hunt"? Looking for a hidden transmitter is a convention highlight for many conventioners, including last year's imaginative participant who dowsed the hotel with a forked willow stick! We suggest a scanner.

If you need additional information, read the final convention reminder in this issue or call us at 704-837-9200. I'm looking forward to seeing YOU this October 2-4th in Atlanta.

*Bob Grove*  
Publisher





# NRD-535D

*"Best Communications Receiver"*

World Radio TV Handbook 1992



*"Unsurpassed DX Performance"*

Passport to World Band Radio 1992

Setting the industry standard once again for shortwave receivers, the NRD-535D is the most advanced HF communications receiver ever designed for the serious DXer and shortwave listener. Its unparalleled performance in all modes makes it the ultimate receiver for diversified monitoring applications.

Designed for DXers by DXers! The NRD-535D (shown above with optional NVA-319 speaker) strikes the perfect balance between form and function with its professional-grade design and critically acclaimed ergonomics. The NRD-535D is the recipient of the prestigious World Radio TV Handbook Industry Award for "Best Communications Receiver."



*Japan Radio Co., Ltd.*

Japan Radio Company, Ltd., New York Branch Office - 430 Park Avenue (2nd Floor), New York, NY 10022, USA Tel: (212) 355-1180 / Fax: (212) 319-5227

Japan Radio Company, Ltd. - Akasaka Twin Tower (Main), 17-22, Akasaka 2-chome, Minato-ku, Tokyo 107, JAPAN Tel: (03) 3584-8836 / Fax: (03) 3584-8878

- Phase-locked ECSS system for selectable-sideband AM reception.
- Maximum IF bandwidth flexibility! The Variable Bandwidth Control (BWC) adjusts the wide and intermediate IF filter bandwidths from 5.5 to 2.0 kHz and 2.0 to 0.5 kHz—continuously.
- Stock fixed-width IF filters include a 5.5 kHz (wide), a 2.0 kHz (intermediate), and a 1.0 kHz (narrow). Optional JRC filters include 2.4 kHz, 300 Hz, and 500 Hz crystal type.
- All mode 100 kHz - 30 MHz coverage. Tuning accuracy to 1 Hz using JRC's advanced Direct Digital Synthesis (DDS) PLL system and a high-precision magnetic rotary encoder. The tuning is so smooth you will swear it's analog! An optional high-stability crystal oscillator kit is also available for  $\pm 0.5$  ppm stability.
- A superior front-end variable double tuning circuit is continuously controlled by the CPU to vary with the receive frequency automatically. The result: Outstanding 106 dB Dynamic Range and +20 dB Third-Order Intercept Point.
- Memory capacity of 200 channels, each storing frequency, mode, filter, AGC and ATT settings. Scan and sweep functions built in. All memory channels are tunable, making "MEM to VFO" switching unnecessary.
- A state-of-the-art RS-232C computer interface is built into every NRD-535D receiver.
- Fully modular design, featuring plug-in circuit boards and high-quality surface-mount components. No other manufacturer can offer such professional-quality design and construction at so affordable a price.

# Listen In With the Pros

**NEW**

Did you know ICOM receivers are used by local, state and federal government agencies? The professionals in these critical positions require the utmost in signal clarity, performance and reliability. ICOM's R7100 ultra high-tech receiver meets, and even exceeds, these stringent demands.

**Listen To Them All** ...on ICOM's R7100. Capture lowband, marine, aircraft, amateur, emergency — or relax with FM and television! Cover the entire 25 MHz to 2 GHz bands in 8 tuning steps: 100 Hz, 1-, 5-, 10-, 12.5-, 20-, 25- and 100-kHz, and 1 MHz.

**900 Memory Channels.** 9 bands of 100 channels each let you group and access all your favorite frequencies automatically.

**All Mode Scan.** Super fast scanning in Programmed Scan, Selected Memory and Window Scan — flexibility never before realized.

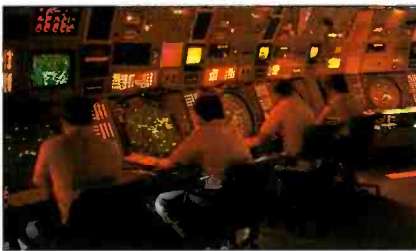

**Auto Memory Write Scan** automatically records busy frequencies for later monitoring.

**Loud and Clear With DDS.**

Direct Digital Synthesis means an extremely low carrier-to-noise ratio for the ultimate in receiver performance. Compare it and hear the difference!

**Dual Windows.** Scan in one window, tune in the other — like two receivers in one!

**The Most Important Feature.**

Designed and backed by ICOM. Our reputation for quality, reliability and service is unsurpassed in the communications industry. The pros don't settle for anything less. Neither should you.

*For more information, see your ICOM dealer or call our Brochure Hotline 1-800-999-9877.*

ICOM America, Inc., 2380-116th Ave. N.E.  
Bellevue, Washington 98004

**Customer Service Hotline (206) 454-7619**

All stated specifications are subject to change without notice or obligation. All ICOM radios significantly exceed FCC regulations limiting spurious emissions. R7100392



## IC-R1

Put the whole world in your pocket.  
Only 4" high!



**BUY ANY R7100,  
GET A TINY R1  
AT A TINY PRICE!**  
*Special limited time offer.  
See Icom Dealer for details.*

**ICOM**  
Simply the Best®