

WCSN

Monitoring Times

A Publication Of
Grove Enterprises

LISTENING to the WEATHER WATCHERS

**A Visit to the
Academy for
Air Traffic Control**

**On the Trail of
Air Force One**

Antenna Projects

And More!

**TransWorld Radio
TELLING THE WORLD OF
REDEMPTION**

**HOW TO
Wallpaper Your Shack**

*****3 DIGIT PRE *****
HERALD BROADCASTING INC 0992
P.O. BOX 109

COSTIGAN ME 04423



DON'T GAMBLE when you want the best

21 Reasons To Buy OPTOELECTRONICS' MODEL 3000

1. RANGE- 10Hz to 3GHz.
2. Hi-Speed ASIC (Application Specific Integrated Circuit) State-Of-The-Art.
3. 256 Times Faster than other hand held counters.
4. 10 Digit LCD. Readability even in Bright Sunlight.
5. 6 Functions - Frequency, Period, Ratio, Time Interval, Average and Prescale.
6. RF Signal Strength Bargraph - 16 Segment, Zero & Full Scale Adjust. Excellent for locating Hidden Transmitters.
7. Four extremely Fast Gate Times .01, .1, 1, 10 sec.
8. Dual High Impedance Amplifiers.
9. Maximized Sensitivity
10. Hold Switch - Locks in measurements FAST.
11. \pm 1PPM Accuracy
12. Direct Count - 1Hz resolution to 220MHz
13. Sensitivity <1mv 10MHz - 200MHz, <5mv - 2GHz.
14. Single Shot Time Interval 100ns, .1ns averaged.
15. Push-button Input, Gate & Function selection.
16. Extruded Aluminum Enclosure.
17. NiCad & Charger Included.
18. Low Battery Indicator.
19. 1 Year Parts & Labor Warranty
20. 30 day Money Back Guarantee.
21. OPTOELECTRONICS backs this with our 18 Years of Dependability & Service.

All this and more for the Low Price - \$375.

Also Available at Special Package Price:

For A Limited Time Only
Model 3000, Backlight/Beeper, Carry
Case & TA-100s Whip Antenna

All this for only \$449.

OPTIONS:

TCXO 30 \pm .2ppm TCXO	\$100.
BLB30 Back light & two step audible signal level indicator ..	\$ 75.
CC30 Carry Case	\$ 15.
TA100S Telescoping Whip Antenna	\$ 12.



OPTOELECTRONICS

Factory Direct Order Line

1-800-327-5912

(305)771-2050 • FAX(305) • 2052 5821 NE 14th Ave. • Ft. Lauderdale, FL 33334

5% Ship/Shandling (Max. \$10) U.S. & Canada. 15% outside continental U.S. Visa & Master Card Accepted.

YOU CAN'T LOSE!

**Call Grove Enterprises
1-800-438-8155
for special low price!**



Monitoring Times



Listening to the Weather Watchers

by P.J. Richardson

8

"The eyes and ears of the weather service" is what meteorologists call the net which springs into duty whenever severe weather threatens. The most modern radar equipment can't match these intrepid volunteers when it comes to saving lives. Watching for twisters or the conditions which spawn them, these "tornado watchers" can be heard reporting sightings or weather conditions, giving damage reports, or signalling shift changes to the net controller.

It Started in Tangier

by Charles Sorrell

14

Thirty-eight years ago, WTAN, the Voice of Tangier, began to broadcast on shortwave with a measly 2.5 kilowatts. But it was the beginning of what has become one of the world's most powerful religious broadcasting networks. Today, TransWorld Radio can be heard by 80% of the world's population. For founder Dr. Paul Freed, it has been an exciting adventure of faith.

TWR's Voice in the Caribbean

by Susan Peterson

18

The TransWorld Radio outlet heard best by North Americans radiates from Bonaire, a tiny island in the Netherlands Antilles. After relying on its broadcasts for news of the Soviet coup while she was out to sea, Susan Peterson determined to visit the powerful station. You'll enjoy this glimpse into broadcasting by a relative newcomer to the hobby.



OUR COVER PHOTO this month has had a lot of exposure since subscriber and photographer Johnny Autery first showed it to an expert on lightning. You may have seen it on the Today Show, the Weather Channel's calendar and elsewhere. It's an excellent reminder to ground your antennas and unplug your equipment whenever severe weather threatens!

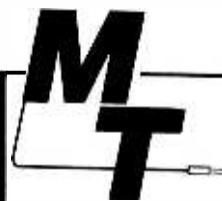

MONITORING TIMES (ISSN: 0889-5341) is published monthly by Grove Enterprises, Inc., Brasstown, NC, USA.

Address: P. O. Box 98, 140 Dog Branch Road, Brasstown, NC 28902-0098
Telephone: (704) 837-9200
FAX: (704) 837-2216 (24 hrs)
Subscription Rates: \$19.95 in U.S. and \$28.50 US Funds elsewhere; Label indicates last issue of subscription

STAFF

Publisher
 Bob Grove, WA4PYQ
Editor
 Rachel Baughn
Editorial Assistant
 Beverly Berrong
Subscription Services
 Chanel Hilliard
Advertising
 Beth Leinbach (704)389-4007
Dealerships
 Kelly Davis

Editorial Staff

Frequency Manager Greg Jordan
Frequency Monitors B. W. Battin
 David Datko
 Jack Hubby
 Tammy Wells
Program Manager Kannon Shanmugam
Program Monitors John Carson
 Jim Frimmei
Reading RTTY Jack Albert, WA9FVP
Beginner's Corner T. J. Arey, WB2GHA
Plane Talk Jean Baker
Computers and Radio John Catalano
Below 500 kHz Kevin Carey, WB2QMY
Experimenter's Wkshp Bill Cheek
DeMaw's Workbench Doug DeMaw, W1FB
Federal File Steve Douglass
Ham DX Tips Rob Gerardi, N9LAG
SW Broadcasting Glenn Hauser
High Seas James R. Hay
Scanning Report Bob Kay
On the Ham Bands Ike Kerschner
Propagation Jacques d'Avignon
Magne Test... Lawrence Magne
Communications Larry Miller
What's New? Larry Miller
Satellite TV Ken Reitz, KC4GQA
Outer Limits John Santosuosso
Antenna Topics W. Clem Small
SW Broadcast Logs Gayle Van Horn
QSL Corner Gayle Van Horn
Utility World Larry Van Horn, N5FPW
American Bandscan Karl Zuk

Correspondence to columnists should be mailed c/o Monitoring Times. Any request for a personal reply should be accompanied by an SASE.

Second class postage paid at Brasstown, NC, and additional mailing offices.

POSTMASTER: Send address changes to Monitoring Times, Post Office Box 98, Brasstown, NC 28902-0098.

How to Wallpaper Your Shack

by Lee Reynolds

22

It's a little-known fact that DXing contests and award hunting are not exclusively the domain of amateur radio operators. Short-wave listeners can get in on them, too, and the change might be just what you need! Here's how to embark on some new challenges.

Two April Fools

by Sal Emma

26

It was a chance for the ultimate reception! Heck, what could possibly go wrong?

A Change in Attitude

by Bruce Blair

27

My job as a reporter continually brought me into conflict with the fire and police departments ... until I bought the scanner.

And More...

Have you ever wondered what it takes to be an air traffic controller? Jean Baker visits the Air Traffic Control Academy in Oklahoma to find out what it takes and how the FAA finds out who's got it.

Hang on to this issue of the Federal File report in case you ever want to go hunting for presidential communications aboard Air Force One. Here's what you need to know in a nutshell.

If you're looking for equipment, Bob Grove checks out the new ICOM IC-R7100, and Larry Magne examines the Realistic DX-440's replacement, the DX-390. Or if the new models leave you cold, a growing craze is restoring antique radios. It's not that hard, says "The Beginner's Corner."

We're busting at the seams with good stuff this month, so why not get started?!

DEPARTMENTS

Letters	3	Shortwave Guide	60
Communications	6	Propagation Charts	88
Shortwave Broadcasting	28	What's New	90
Utility World	32	Scanner Equipment	94
The Scanning Report	36	Magne Tests...	96
The Beginner's Corner	40	DeMaw's Workbench	98
Federal File	42	Experimenter's Workshop	100
Plane Talk	44	Antenna Topics	102
Below 500 kHz	46	Computers & Radio	104
American Bandscan	48	Ask Bob	106
Satellite TV	50	Club Circuit	108
On the Ham Bands	52	Special Events Calendar	109
Outer Limits	54	DX Radio Tests	109
Reading RTTY	58	Stock Exchange	110
QSL Corner	59		

LETTERS

Bob Grove is secretly in the theater business, and these pictures are proof. After all, look at the HF vertical on the theater roof!

Actually, these two pictures were taken as an April Fool's joke by *MT's* RTTY columnist, Jack Albert. The top photo was taken in Pacific Grove, California, and the bottom one in Downers Grove, Illinois.



Monitoring Times welcomes Steve Douglass to the staff as a regular columnist, even though he has been a feature writer for several years. Over the past year, Steve has been the greatest contributor to the Federal File under the Rod Pearson by-line and we are pleased to give him this recognition.

In other changes, we bid a sad farewell to Dr. John Santosuosso, for six years the editor of the "Outer Limits" column. His work has been outstanding, and reader response to his column has added to its popularity. We wish John the very best, and hope he'll turn his flair for writing into an occasional feature article for *MT*.

I am sure you'll give the same enthusiastic support to the new columnist, George Zeller. Zeller, "Clandestine Profile" editor for the Association of Clandestine Radio Enthusiasts' publication *A*C*E*, is already a familiar name to most of you in the hobby, and we are honored to add him to the *MT* staff in May.

Serving the Visually Impaired Hobbyist

"Without the use of eyes, the world becomes very small and foreboding," says columnist Karl Zuk. Programs such as the InTouch Reading Service, the subject of this month's "American Bandscan," utilize radio as an audio link between the sightless and the world around them.

Monitoring Times, as a leading source of information on listening to radio, receives frequent inquiries from visually impaired hobbyists on how to obtain the magazine on tape. Unfortunately, we do not have the staff or the time to be able to produce such a tape each month ourselves, but if someone with experience has a proposal, we'd like to hear it.

Meantime, there are a few resources out there; the National Audio Service of the National Radio Club, for example, puts out a tape on a variety of highlights from AM/FM DX news columns. A sample cassette is \$3 to DXAS Cassette, NRC Publications Center, P.O. Box 164, Mannsville, NY 13661-0164.

We know of at least one reading service that includes *Monitoring Times* in the publications they read—the Georgia Radio

Reading Service out of Savannah. That is thanks to the initiative of station manager Robert Rowlette, who reports "a great deal of favorable response." This service is broadcast on the 67 kHz sub-carrier of the local PBS station.

We welcome your suggestions, offers of help, and information about other resources for the sight-impaired radio hobbyist. Those of you who have struggled with these barriers yourselves in order to pursue the monitoring hobby probably have learned a great deal that you could pass along to others. Where should we direct those who apply to *MT* for help and information?

Brain Teasers

Who was the first president to install a radio in the White House? This question was posed by E.H. Walters of Fayette City, PA. Any takers? Answer provided next month.

Walters also supplies the picture on page 4 of the FAA Tower at the 99th ARCOM, Oakdale, PA, an Army Reserve Base. Once, while doing telephone repair, Walters was admitted to the top floor.

"The building is about five stories high and is loaded with equipment, most of which I have never seen. Needless to say, I was escorted by someone at all times and they did not hesitate to ask why I was doing certain procedures. Talk about your James Bond!"

Even though it was apparently intended for another radio magazine, thanks for the submission, E.H. We always appreciate reader input.

While down with the flu, Cathy Turner of Yonkers, NY, watched a lot of old movies, and

AMIGA + ICOM SCAN....Version 2

The Ultimate Scanning Combination, now even better. !!!

Use the Amiga to control ICOM radios.....
 • May use one Amiga and one interface to control TWO Icom radios!
 • The ONLY scanner control system that directly generates SPEECH!
 • The Amiga can say the frequency, time and even the users comment!
 • The Amiga also directly controls the tape recorder, by channel!
 Imagine the possibilities, after an automated logging session a tape may be played back with hit activity (no dead time) and accompanying time and/or frequency information. All hit activity will be shown in high resolution graphics and may be saved to disk. Each individual channel (up to 1024 per file) may control.....
 Lockout (skip channel), Mode (AM / FM / SSB, etc), Say the frequency, Say the time, Say the users comment, (up to 80 characters long per channel), and / or record the hit on a tape recorder.

Scans over 2000 channels per minute on any Amiga. Global controls can also enable / disable the speech and record functions. User or auto scaled high resolution graphs display current activity and log. Extremely powerful scan delays. May scan by comment. Does NOT need Icoms speech board or Icoms CI-V interface, no radio modifications required. Fully mouse driven, menus, icons, built in editor etc. Range scan, Autoscan mode may generate scan files with date and time log. ASCII file format. Fully multitasking. Requires 1 MByte ram. WB2.0 compatible. Many more features.
 Includes custom hardware interface, SCAN software, example scan files, owners manual and U.S. shipping.

Specify Amiga version and radio model!
 Single Radio \$149 (VISA / M-C / check / money order)
 Multi-Radio \$199 Future Scanning Systems
 demo disk, example PO BOX 654
 scan files and manual Bartlesville OK 74005
 \$15 (refundable) 918-333-7474

Tone and Code Finder



Pricing
 Tone Only \$189.95
 Tone & Dig. \$299.95
 Tone w/Mem. \$239.95
 Tone & Digital
 w/Memory \$339.95

The Tone/Code Finder is composed of a high speed display unit mounted to a scanning receiver. Its purpose is to instantly find and display all CTCSS and DIGITAL codes, including split channel and inverted codes.

On board memory retains all hit and time information which is then transferred to a printer via a RS 232 port upon command. Time is stored in seconds and hits in units. In the event of power loss, the FINDER will maintain memory for up to three weeks.

Measurements Division
 AUTOMATED INDUSTRIAL ELECTRONICS CORP.
 141 GRANITE ST. P.O. BOX 70
 BATESBURG, S.C. 29006
 (803)532-9256 FAX(803)532-9258

THE SOUNDS OF NATURAL V.L.F. RADIO

We have compiled a 30 minute cassette tape containing recorded sounds of naturally occurring VLF radio emissions, much of it originating from lightning stroke radio impulse energy interacting with Earth's magnetosphere. Recorded sounds include many types of whistlers, ping-pong twees, lightning sferics, dawn chorus, and other natural emissions in the 0.1 to 10 KHz VLF frequency range. The recordings on the tape are good examples of what can be received with our hand-held Conversion Research Model WR-3 VLF "Natural Radio" receiver, available for \$48.00. The tape comes with an insert describing what is being presented in each recorded sample segment. (Brochure on the WR-3 included.) For the tape, send Check/M.O. to:

VLF TAPE: CONVERSION RESEARCH
\$8. ppd P.O. BOX 535
 (CA RES. ADD TAX) DESCANSO, CA 91916

NATIONAL SCANNING REPORT

HOT new scanning magazine. Everything from engaging features, helpful how-to-do's, reader exchange and lots of frequencies for the scanner listener, law enforcement and fire fighter enthusiast. Get six issues and a FREE county printout of police and emergency for \$17.50. (Specify county.) Send check, MO, MC/Visa to PO Box 291918, Kettering, OH 45429. Or call toll-free:

1 800 423-1331

LETTERS

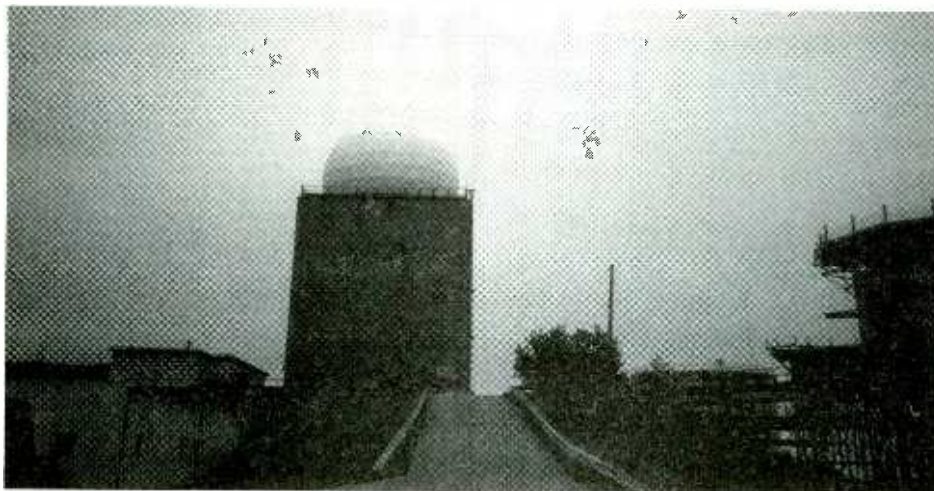

FAA Tower, 99th Arcom, Oakdale, Pennsylvania.

E.H. Walters

has come up with a brain teaser for you as well. One scene, in an oldie called "Dangerous Moonlight," had Polish flyers making plans during the Nazi bombardment, with an interval signal going on and on in the background.

"What other movies can you think of has radio playing an important part?" asks Cathy. "Some that I can think of are: 'High Treason' a spy drama involving hams, 'The Voice of Terror' a good old Sherlock-looks-for-a-Nazi-pirate, and 'Pump up the Volume' the teen pirate radio movie from a few years ago. I bet there are others."

I bet there are, too! There are those that feature talk show hosts or radio DJ's, such as "Play Misty for Me." As a kid, I always enjoyed edge-of-your-seat submarine combat, which invariably featured the difficulties of communications with the surface. What episodes come to your mind when you think of radio in the movies?

Todd Dokey of Lodi, CA, has a project that would produce some nice charts, even though we're not sure if their value is more than merely educational. You propagation experts could tell us the merit of the following exercise.

The idea, he says, is to take a map of the world (it'd be ideal to find one that centers on your location, but we know of no source for such). You mark on the map the longest paths of DX that you hear in one night's monitoring, with the callsign and SINPO next to the dot. SINPO stands for Signal strength, Interference, Noise, Propagation and Overall quality, using a scale of 1 to 5 (5 being best).

When you are done marking all your non-local stations, and finished with monitoring for the night, take a pencil and play "connect the dots" for a rough footprint of the propagation paths that were open.

"Of course," says Todd, "this would be really useful if done once each hour, using different colors of pencils on the same map."

Then you can take a compass and scribe a great circle path around your home base, connecting the extremities. This may hint at the size

and patterns of propagation for given conditions.

"I was thinking of making up a form that has a map on the top, followed by various conditions of weather and other factors to be filled in for that particular night of monitoring. Eventually, this might show a correlation between the weather patterns in your location and the skip chances to a particular region."

It sounds fun and very educational. On the other hand, wouldn't it be simpler just to use the propagation charts in *MT* for conditions from your location to another region of the world? Of course, you could use this method as a test of their accuracy. Before Jacques d'Avignon threatens to resign, I hasten to warn you, there is nothing so unpredictable as the propagation of radio signals!

Space Shuttle Comms

Michael Csontos of Lima, New York, felt somewhat intimidated by what he'd heard about direct monitoring of the Space Shuttle, so he never tried it. "However, during the last shuttle flight I happened across retransmissions on 3860 kHz by the Radio Amateur Club of the NASA Goddard Space Flight Center, WA3NAN" (P.O. Box 86, Greenbelt, MD 20768).

Michael says "3860 was clear and consistently strong here during the hours of the flight that I monitored."

Michael, for you and the many others who call our offices for shuttle frequencies, here is a compilation of those most commonly heard.

On unclassified missions, shuttle audio or other information will be broadcast by the following stations on or near the frequencies shown::

WA3NAN Goddard Space Flight Center,
Greenbelt, MD

3860 7185 14295 21395 28650 kHz and
147.45 MHz FM

W5RRR Johnson Space Center,
Clear Lake City, TX

3850 7227 14280 21350 28495 kHz and

146.64 MHz FM
W6VIO Jet Propulsion Lab,
Pasadena, CA
3840 21280 kHz, 224.04 MHz FM
W6FXN Los Angeles, CA
145.46 MHz FM

If an amateur radio operator is aboard the shuttle, check for his/her transmissions around 145.55 MHz. (The Atlantis flight scheduled for March 23 had four hams on board.) Other frequencies that have been heard recently are:

259.7 MHz	Shuttle primary, in orbit
5190 USB	Ascension Is AF tracking
5810 USB	"
9043 USB	"
10780 USB	"
13600 USB	"
20192 LSB	Astronaut voice phone patch
20198.3 LSB	"
6708 USB	SRB recovery vessels
19149.5	LSB

A news clipping sent in by Alfred Fossum of Fall River, MA, reported on the upgrading of NASA's oldest space shuttle, Columbia. Its capacity for food, waste storage, water, etc. has been increased to allow for flights of up to 16 days' duration. It is due for launch June 16th.

Alfred also asks how one can find out the dates of lift-off. Staying tuned to the above amateur frequencies may give you some clues.

However, there are other sources you can tap. Several NASA centers carry a recorded update on the following automated telephone systems:

Dryden (landing)	805-258-4464
Goddard	301-286-NEWS
Johnson (mission ops)	713-483-8600
Kennedy (prelaunch)	407-867-2525
Marshall	205-544-NEWS

NASA NEWS releases, and shuttle updates are available electronically via CompuServe at 1-800-848-8199; ask for representative 176. Also available via computer is the updated TV schedule for NASA Select: Call COMSTOR, 713-483-5817.

NASA Select carries programming in four-hour blocks starting at noon Eastern, except during real-time Shuttle missions. You can pick up NASA Select on C-band, Satcom F-2R, transponder 13 (72 deg. W. long; 3960 MHz; 6.8 MHz audio; Vert. polarization).

I hope this issue has challenged you to consider contesting, to build an antenna, to tune in new targets such as GWEN, the weather nets, or subcarrier services, or even to be a discriminating listener of religious broadcasters. Read and digest and try out what you find in these pages; then let us know about your good monitoring times!

Rachel Baughn,
Editor

IT'S BACK!



**OCTOBER 2,3,4
Omni Hotel at CNN Center**

Register before June 30, 1992 and save \$5.00 off registration fee & \$2.00 off banquet fee.

This year, join hundreds of shortwave and scanner enthusiasts and attend the most popular listeners' convention!

For only a \$35 registration fee, you can mingle with an impressive gathering of radio experts, hobbyists, manufacturers and exhibitors.

Your registration gives you entrance to all 40 seminars being presented Friday through Sunday and the exhibit hall. The exhibits alone feature over 50 displays from manufacturers and distributors of your favorite radio equipment and accessories, as well as international broadcaster displays.

AND, your registration includes a **FREE TOUR** of the Cable News Network (CNN), the leading news source that brings the emotion of war, the power of entire nations being built, and the joy of success home to millions of viewers around the nation.

PLUS, for only \$69 per night (regular price, \$185.00!), you can immerse yourself in the hobby for the entire weekend while enjoying the comforts of the prestigious Omni Hotel at CNN Center in the heart of Atlanta. But make your reservation early; space is limited!



**A journey into the future
with steps from the past.**

Be a part of the 1992 Monitoring Times Convention and save \$7.00 by signing up today! Return this registration along with your payment and you too can take a step into the future.

Tentative Schedule

Friday, October 2

12:00 to 5:00 PM
EXHIBITS OPEN AND
REGISTRATION BEGINS

7:00 to 9:15 PM
EVENING SEMINARS

Saturday, October 3

8:00 to 9:00 AM
REGISTRATION

9:00 to 12:30 PM
EXHIBITS OPEN AND
MORNING SEMINARS

12:30 to 3:00 PM
EXHIBITS OPEN AND
LUNCH BREAK

3:00 PM
EXHIBITS CLOSE

3:00 to 5:15 PM
AFTERNOON SEMINARS

7:00 to 9:00 PM
BANQUET

Sunday, October 4

9:00 to 12:30 PM
MORNING SEMINARS

CONVENTION CLOSSES AT 12:30 PM

Monitoring Times Convention Registration
P.O. Box 98
Braseltown, NC 28902-0098
(704) 837-9200

- Enclosed is my \$35.00 registration fee (\$5.00 savings)
- Enclosed is my \$19.95 banquet payment (\$2.00 savings)

Payment:

- Check Money Order Credit Card

Card # _____

Exp. Date _____

Signature _____

Name _____

Address _____

City _____

State _____

Zip _____

Daytime Phone # _____

You will receive a registration package within 10 days after receipt of payment.

Zzzzzt

Everything in Mary Lou Sinkule's house is normal with, perhaps, a few exceptions. When she's on the telephone, every 12 seconds she hears a "zzzzzt." It makes carrying on a conversation difficult but, if you pace yourself, both parties can make themselves understood.

In the kitchen, the radio also goes "zzzzzt" whether it's switched on or not. On closer examination, you might notice, too, that her stereo is in a metal cage and that her walls are covered by a metal-backed wallpaper.

The reason for all of this, says Ms. Sinkule, are the two snowballs outside her condominium. The "snowballs" are powerful radar domes operating at Patrick Air Force Base and every 12 seconds, the antennas sweep around, throwing a beam more than 200 miles across the Atlantic — and through the Pineada Ocean Club Condominiums.

Residents there are annoyed, not just by the "zzzzzt," but by what they say are unusually high incidence of Hodgkin's disease. The government, however, says that the radar is not causing the health problems although they do admit to the "zzzzzt."

Even though the radar puts out nearly 2,000 watts (a heavy duty microwave using 500 watts will thaw a frozen turkey in a few minutes), it is strongly disputed that it is affecting residents. "Our measurements clearly show that this radar is not posing a health hazard to people," said Gen. Jimmy Morrell, a commander at Patrick AFB.

And what about the "zzzzzt?" Residents recently received good news. The radar at Patrick AFB has been declared obsolete and will be replaced within two years.

Reach Out and Touch Fidel

It's a complicated story filled with the sort of intrigue and chess-like game-playing that often characterizes foreign policy. The Bush administration has given AT&T its permission to turn on a new undersea cable that provides phone service between the United States and Cuba.

State Department Margaret Tutwiler explained that the original undersea telephone cable that links Cuba with the United States wore out over four years ago. The cable was replaced within the year but was never turned on, forcing callers to the Caribbean nation to use a 1950s-era radio telephone link instead. Talks between Cuba and AT&T are now under way and, if successful, the cable will be turned on.

In the past, Cuba's share of the revenues from the telephone link were paid into an

account to which the Cuban government had no access. American officials concede that this is the first time that an American firm will be allowed to pay dollars directly to the Castro regime, but the State Department sees a side benefit to improved communications with the island. "[The improved telephone service] will permit greater communication between the Cuban-American community and their relatives on the island," says Tutwiler, and will act as an informal Voice of America.

Interactive TV Approved

In a 4-0 decision, the Federal Communications Commission has voted to set aside a special radio frequency for interactive over-the-air television services. The decision will soon make it possible for viewers to order pizzas, pay credit card bills or call up sports scores by pressing buttons on a pistol-shaped remote-control device, according to the *New York Times*.

The decision was received enthusiastically by television industry spokespeople. The decision was based on tests of a technology developed by TV Answer, Inc., of Reston, Virginia. In that system, viewers would have a small box on top of their TV that would relay signals from their handheld devices to a nearby base station. The base station would relay the signal via satellite to TVA's Virginia office.

Warner Amex Cable Communications pioneered a similar service, called Qube, on cable systems in the early 1980s but scrapped it by '84 for lack of interest.

"And Maryanne, the Skipper, too..."

Kim Brasher and her two children, ages 3 and 6, were watching a rerun of Gilligan's Island on Toledo, Ohio's WUPW-TV. The episode, they say, had an unusual twist. During a conversation between Mr. and Mrs. Thurston Howell III, the voices of the original actors were replaced with the sound track from a hard-core pornographic movie. "[Mrs. Howell] was very explicit, very detailed of what this man was doing to her," said Ms. Brasher. "It was gross. It was awful."

In the report from the *Toledo Blade*, WUPW marketing director Denis Katell said that the station received several complaints. "It's very difficult...to scrutinize every frame of video," he said.

Broadcasting Problem

According to *Radio World's* Barry Mishkind, the bad economy has encouraged thefts of broadcast station equipment. Says Mishkind, an

engineer, "There are few experiences worse than driving up to a deserted transmitter building and finding the door wide open. You've been robbed."

One Michigan FM station, says Mishkind, had its FM exciter stolen three times in six weeks. Another favorite target is the ground system at AM transmitter sites. "There's a lot of copper out there," says Mishkind. "Thieves have discovered it's easy to pull some of it out of the ground and haul it down to the scrap yard for a quick buck."

Sometimes the tower crews barely get the copper in before the thieves remove it. In Ypsilanti, a station's ground system was stolen on the day it was installed. The new ground system was a replacement for one stolen only days earlier.

The AIDS Bug

"60 Minutes" newsman Ed Bradley may face wiretap charges after microphones were found on AIDS activists at a protest that the CBS TV show was taping.

According to the *Atlanta Constitution News Brief*, Westboro, Massachusetts, police chief Harry Shepherd said the "bugs" were found on the protestors when they were arrested. He claimed that CBS had wired the activists with microphones to pick up sounds as it videotaped an "Act Up" rally. Chief Shepherd says that it is illegal in Massachusetts to record a conversation without both parties' knowledge. There was no comment from Bradley.

Cell Phones Stir Security Debate

A obscure committee of telecommunications experts have been meeting recently to decide what level of security will be built into new models of cellular telephones. People concerned with privacy are eager to incorporate more potent scrambling to prevent eavesdropping.

According to the *New York Times*, the telecommunications experts have been pressured not to adopt the maximum level of protection because of pressure from the super-secret National Security Agency (NSA). The NSA is the U.S. Defense Department agency in charge of electronic intelligence gathering around the world.

Part of the job of the NSA includes listening in on phone conversations in foreign countries and intercepting data sent by computers. Officials fear that the hard-to-crack security codes might be used overseas.

COMMUNICATIONS



ARRL directors and staff at dedication of "Silent Keys" monument.

Who's Afraid of a Scanner?

Speeches, press releases and general media posturing regarding the privacy of cordless phones is in high gear in California. Apparently, someone described as "a radio hobbyist" tape recorded a cordless phone conversation between Sacramento Kings owner Greg Lukenbill and another person, in which Lukenbill insulted potential business associate Fred Anderson. A friend of the radio hobbyist subsequently tried to sell the tape to Anderson for \$200,000.

Sacramento County District Attorney officials investigated but found that they did not have legal ground to prosecute. Assemblyman Lloyd Connelly, who represents Lukenbill's district, held up a copy of *Popular Communications* magazine to prove the prevalence of eavesdropping.

DA Steve White is suggesting legislation to close "loopholes" in state law regarding such telephones and Sheriff Glen Craig sent out a press release saying that "such...telephone conversations must remain private."

Craig has his own motives for supporting such anti-hobby legislation. He says that he was once shocked to hear a caller on a radio talk show say that he had monitored a conversation between two people at the capitol discussing rumors that he [Craig] might make a run for a state senate seat.

Caroline Kennedy on Cell Phones

According to the *Fresno Bee*, JFK's daughter Caroline Kennedy and her writing partner, Ellen Alderman, will get a \$400,000 advance

from Alfred Knopf for their second book. The book explores the right to privacy, including such topics as abortion and cellular phones.

Signed in Stone

The American Radio Relay League says that it has added the names of two ham radio operators to the stone monument at the ARRL headquarters in Connecticut. The two died while coordinating emergency communications during the Mt. St. Helens volcanic eruption almost 15 years ago. Four other hams are immortalized in stone, including Arthur "Pete" Vela of Texas who died during a fund raising event at a local school. "This monument serves as a perpetual reminder that Amateur Radio plays a vital public service function," says ARRL Executive Vice President Dave Sumner.

Shortwave Forum

Going to the 1992 Dayton Hamvention the last weekend in April? If so, be sure to catch the SWL Forum on Sunday 26th; *MT* publisher Bob Grove will be one of the panel members.

Credits and thanks to: Dave Alpert, New York, New York; Doug Chandler, West Sedona, Arizona (*The Arizona Republic*); Jaime Faucett, Dayton, Ohio; Ted Jones, Los Angeles, California (*National Scanning Report*); Albert E. Nichols, Clovis, California (Fresno Bee); Clem Small, Vermont (*Radio World*); Peter Smegly, Ontario, Indiana; Rudy Smith, Fair Oaks, California (*Sacramento Bee*); "JT," Securito, California (*New York Times*).

ICOM™ R7000 SWEEPING 1300 CHANNELS/MIN.

DELTA COMM™ I-7000 and your MS-DOS computer gives you a custom interface integrated with optimized software that will not just control but will maximize the potential of your R7000.

- Spectrum log at speeds in excess of 1300 channels/min while automatically generating a histogram of frequency activity.



- CYBERSCAN™ allows scan file tracking control of systems employing frequency hopping techniques.
- Birdie log during frequency search automatically characterizes your R7000, then locks out those frequencies during frequency search operation.
- Custom interface has electronics to allow software control (by channel number) of external tape recorder.

ICOM™ R71 RECEIVER COMMUNICATIONS MANAGER

DELTA COMM™ I-71 Version 4.0 offers read/write control of your R71 receiver's frequency, mode and memory channels. Additional program features include auto log frequency search, scanning, timer/clock event management, data base management, pull-down menu windows, split screen for your Terminal Node Controller (TNC) communication needs and the ability to control an antenna switching system or logging tape recorder.

- Data base management allows definition of frequency, call sign, time schedule, mode, target area, country, 140 character notes field, 69 character TNC command field, QSL status, control relay status and, in addition, displays user defined optimum settings of receiver front panel knob positions.
- Combined with your TNC, DELTACOMM™ I-71's user defined command codes program your TNC for reception and logging of PACKET, AMTOR, RTTY and Morse Code (fully unattended and automatically).

16-DIGIT TOUCH-TONE™ REPEATER PROGRAMMER

DELTA TONE™ 2.0 connects to your MS-DOS computer via the printer port. In its high speed mode, DTMF digits are sent to your repeater controller at a rate in excess of 500 per minute.

- DELTA TONE™ 2.0 accepts programming commands from a file created using your favorite word processor.
- Transformer coupled 600 ohm balanced output, adjustable to -10dbm, and software control of relay contacts makes interfacing an easy four (4) wire connection to your transceiver, handheld or repeater controller.

All DELTACOMM™ communication products include custom interface, UL listed power supply and components for cabling.

DELTA COMM™ I-7000 or I-71 \$299.00 each
(I-71 requires ICOM™ UX-14 converter)
DELTA TONE™ 2.0 including interface \$149.00

VISA, MC, AMEX and MO accepted. Contact us for discount pricing to registered DELTACOMM™ users.

DELTA RESEARCH

Box 13677 • Wauwatosa, WI 53213
FAX/Phone (414) 353-4567

The Eyes of NOAA:

Listening to the Weather Watchers

Story and photos by P.J. Richardson

For some, spring in the Midwest is hunting season, but their quarry cannot be killed, or even caught. These hunters try to prevent death by keeping the prey from catching the community unprepared. They stalk Mother Nature's bad boy, the wild and unpredictable tornado.

The National Weather Service (NWS), under the auspices of the U.S. Department of Commerce, National Oceanic and Atmospheric Administration (NOAA), casts its net every spring in the form of Skywarn. Their hunters are properly referred to as weather watchers, but in fact everyone calls them tornado spotters. They are trained by the NWS, then dispatched as needed by local government agencies. Many of them are police, fire and highway patrol personnel. But just as many are amateur radio operators who can be monitored on the two-meter ham band.



Meteorologist Larry Holien taking readings at National Weather Service Station, KCMO.

Despite all their sophisticated equipment, the NWS' first and best warning system is their spotters. Even the new Doppler radar technology cannot provide the accuracy given by a person in the field with a radio.

Complete and accurate reporting is the key to the efficiency of the system. Every spotter must pass a certification test at least every two years. This requires at least one long evening of films, slides and lectures, using material developed by the NWS. They are expected to know exactly what conditions favor tornado formation, as well as how to estimate wind speed and hail dimensions. For their own well being, they are also well versed in lightning safety and flash flood procedures.

As another part of the training, net controllers drill the spotters in radio protocol. Their reports are classified Emergency, Urgent, Inquiry and Damage in order of their importance. Any transmission declared "emergency" gets top priority. It is reserved for the sighting of a funnel cloud aloft or tornado on the ground. The spotter also provides direction and speed of travel.

Spotters also initiate traffic designated "urgent" to report the presence and rotation of a wall cloud, hail of 1/4-inch or larger, winds stronger than 30 mph, or rain falling at a rate of one inch per hour or more. A wall cloud can easily begin to rotate and become a funnel cloud, then a tornado.

"Inquiries" are initiated by the net controllers because NWS needs to know all the prevailing conditions. They may ask for speed and direction of straight line winds, gusting, lightning, flooding or other significant activity. They may also ask for damage estimates and reports of casualties.

Police, fire, and public works employees are weather watchers as part of their job. Amateur radio operators probably volunteer for this duty for the same reasons they rise at 5 am on weekends to provide communications services to parades and marathons. Spotting is more exciting, but also potentially dangerous. The hams, with the investment in their equipment and the donation of their time, provide a voluntary and invaluable service to their communities.



Meteorologist Larry Holien mans the "tornado desk" at the National Weather Service Office, MCI Airport, Kansas City, MO. Watches and warnings for 34 counties are issued from this desk.

Alan Pearson, former director of the National Severe Storms Forecast Center at Kansas City, Missouri, once said, "If Congress were to say, 'Pearson, here's \$10 million to improve weather forecasting,' I'd spend \$1 million for forecasting and \$9 million for communication."

Gearing Up For Action

The sprawling metropolis of Kansas City covers some 2,500 square miles in Missouri and Kansas, and is home to more than 2 million persons. That's a lot of area to cover and a lot of people to protect. Johnson County, Kansas, is on the southwesternmost edge of the metro area. Severe weather threatening Kansas City normally enters Johnson County first.

Johnson County's Emergency Preparedness Director, David Parrott, can field a vast network of spotters to guard that gateway. "I have a lot of respect for my spotters. They sacrifice their free time for training, drop what they're doing to go on watch, and sometimes lose sleep. They put up with a lot."

Things start rolling when the NWS issues a tornado watch, which means weather conditions encourage the formation of a tornado. Parrott's duty officer will open the radio net and call in at least two net controllers. When the controllers



Larry Holien seated at the National Weather Service Office, KCMO, workstation.

arrive, they take a radio roll call to determine who is listening and who is available for assignment. Since weather conditions generally deteriorate in the late afternoon, many spotters are still at work. Even so, the net controllers generally find them tuned in when the call goes out.

It is the responsibility of each volunteer spotter to be tuned in, packed up and ready to go. That means having freshly charged battery packs for the radio, antennas, flashlight, binoculars, rain coat, clipboard, pen, NWS handouts and spotter ID card. Sandwiches are also helpful.

If threatening conditions continue to develop, the net controllers will dispatch avail-

able ham radio spotters to fill the many gaps left by law enforcement field personnel. Upon arriving at the assigned location, the spotter then abandons his or her cherished call sign in favor of the grid coordinate of the station now occupied, for example, Alpha-1.

Each spotter location was chosen well in advance to fit several criteria. First, there must be at least two escape routes in case the spotter needs to vacate the position in a hurry. Policy dictates that spotters do not chase tornadoes, but they have been forced to flee on occasion. Second, spotter locations are usually situated on top of a hill to provide an unobstructed view, particularly toward the south and west. Third, the location needs to fit into a grid pattern providing some overlap and no uncovered territory over a wide area.

Once in place, the duty calls for a high state of alertness, coupled with unending patience. These sentries are silent. No chattering is allowed on the radio. They listen and watch, watch and listen. Any exchange must be brief and precise. If a spotter reports a wall cloud, funnel or tornado, the net controller will ask another spotter, looking from a different direction, to confirm that report.

A watch may last only 30 minutes. Many last for hours, since threatening weather tends to develop in waves. As spotters check out of the net to fulfill other obligations, additional spotters will usually check in. Positions are shifted and personnel rotated as necessary.

Sometimes, upon receiving a report of a funnel aloft—and always, in the case of a tornado on the ground—the NWS will issue a tornado warning, urging the public to take cover. At that point, the local emergency preparedness office sounds all alarms. Often it is the report of a

The advent of the NOAA weather watch system in the 1950's and its increasingly widespread use since then has helped reduce the number of tornado-related deaths. The reduction in deaths is also due in part to the efforts of the National Weather Service to educate the public on tornado safety measures. (The radical increase shown here in the number of tornadoes in recent years can be attributed to improved reporting procedures more than any drastic increase in tornadic activity.)

Decade	Tornadoes	Deaths
1930's	1,685	1,947
1940's	1,554	1,786
1950's	4,793	1,409
1960's	6,816	932
1970's	8,580	998
1980's	8,194	520

Why buy a TNC?

PC HF FAX + PC SWL \$179.00

SPECIAL COMBINATION OFFER

For a limited time, if you order PC HF FAX \$99 (see our other ad in this issue), you can add our new and improved PC SWL 3.0 for \$80.00 instead of our regular low price of \$99.00.

PC SWL contains the hardware, software, instructions and frequency lists needed to allow you to receive a vast variety of digital broadcasts transmitted over shortwave radio. All you need is any IBM PC or compatible computer and an SSB shortwave receiver. The product consists of

Demodulator

Digital Signal Processing Software
200 Page Tutorial Reference Manual
World wide Utility Frequency List
Tutorial Audio Cassette with Samples

PC SWL automatically decodes Morse code, RTTY, AMTOR, SITOR, NAVTEX and ASCII.

PC SWL lets you tune in on world press services meteorological broadcasts, ham radio operators, coastal shore stations, aviation telex and much more digital action on the shortwave bands. Why pay for another expensive box when a simple interface and your PC can do the job?

ADVANCED FEATURES:

Tuning Oscilloscope
Digital Waveform Presentations
Auto Calibration and Code Recognition
Continuously Tunable Filter Frequencies
Variable Shift
Adjustable CW Filter Sensitivity
Unattended Capture and Printing
Integrated Text Editor
Integrated Log and Database
Shell to DOS applications
Seamless Integration with PC HF Facsimile

Call or write for our complete catalog of products. Visa & MasterCard welcome.

Software Systems Consulting

615 S. El Camino Real, San Clemente, CA 92672
Tel: (714) 498-5784 Fax: (714) 498-0568

FREE
SAMPLE
COPY!

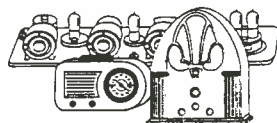



ANTIQUE RADIO CLASSIFIED

Antique Radio's Largest-Circulation
Monthly Magazine

Articles - Classifieds - Ads for Parts & Services
Also: Early TV, Ham Equip., Books,
Telegaph, 40's & 50's Radios & more...

Free 20-word ad each month. Don't miss out!

1-Year: \$27 (\$40 by 1st Class)  
6-Month Trial - \$15. Foreign - Write.

A.R.C., P.O. Box 802-P7, Carlisle, MA 01741

"BOOST RECEPTION! Catch All the Action!"

• **MINI-BOOSTER:** A powerful miniature ACTIVE ANTENNA amplifier module that fits INSIDE your radio! Your radio's telescoping antenna will pick up SW signals like a 50 to 100 foot longwire antenna! Will not harm AM, FM reception. Easy to install (no-soldering) into any Sangean AT-803 or Realistic DX-440. EXCLUSIVE FEATURES: Can be bypassed using special power switch sequence, contains important interference-fighting BC HPF, operates from radio's batteries (very little battery drain). Assembled/tested: \$34.95

• **ACTION TAPE CONTROLLER:** Patches your scanner to your tape recorder, activating it only while your scanner is picking up some action! Plugs into recorder and scanner's speaker jack. Condense an entire night's scanning into minutes! Switchable "hang" time, no batteries or AC power needed. Comes assembled/ tested, in an attractive case w/all cables/plugs supplied: \$33.95

• **OTHER PRODUCTS:** FM WIRELESS SPEAKER RELAY, BC FILTERNOTCH (fights broadcast interference), RECORD-OUT JACK UPGRADE for the DX-440, RECORDER PATCH CABLE for the AT-803/AT-804/440. To order, send check or MO, add \$4 shipping per order. CATALOG: To get our latest catalog, send a 29 cent stamp or call

Worldcom Technology P.O. Box 3364
Ft Pierce, FL 34948 (407) 466-4640

COMMUNICATIONS ELECTRONICS INC.

Emergency Operations Center has expanded to our new two acre facility and World Headquarters. Because of our growth, CEI is now your one stop source for emergency response equipment. When you have a command, control or communications need, essential emergency supplies can be rushed to you by CEI. As always, for over twenty three years, we're ready, willing and able to help. For 1992, we're introducing new products from Uniden, Shinwa, ICOM, Ranger Communications Inc., Grundig, Sangean, Magnavox and RELM.

NEW! Shinwa SR001-B

List price \$799.95/CE price \$479.95/SPECIAL
Continuous coverage from 25,000 through 999,995 MHz.
If you're looking for an excellent synthesized scanner designed for mobile surveillance use, the new Shinwa SR001 scanner offers features never before offered at such a low price. When you purchase this wide band scanner from CEI, you'll get a free infrared wireless remote control that allows you to control your scanner from over 20 feet away. Selectable frequency steps of 5.0/10.0/12.5/20.0/25.0/50.0 or 100.0 KHz. are available. Dual antenna inputs terminating in an "N-type" and "BNC" connectors are included. Other features include 200 memory channels grouped in 10 banks of 20 channels, easy to read multi color LCD display, lithium battery for memory back-up, 35 channel per second high speed scanning, priority, timer and even an alarm to alert you to transmissions on your choice of one special frequency. We even include a mobile mounting bracket. The SR001 can be used for base station use with the purchase of the ACS-B 12 volt DC power supply for only \$34.95 each. A great sounding external speaker #SPE-B is available for only \$24.95.

SHINWA POCKET PAGERS

The fire department hazardous materials response teams and police department SWAT crews that need reliable radio alerting systems, stake their lives on Shinwa. We offer a two-tone pocket pager with monitor feature and even a voice storage option at an affordable price. To order, we need your paging frequency as well as tone and frequencies. For other configurations or two-way radio information, please fax us your specifications to 313-663-8888 or phone 313-996-8888.

ICOM ICR1-B

List price \$799.95/CE price \$529.95/SPECIAL
Continuous coverage from 100 kHz through 1,300 Mhz.
The ICOM ICR1 keeps you in touch with the world when you're on the go. The palm-size ICR1 is equipped with AM, FM and wide-FM modes to fully answer your monitoring needs. With 100 memory channels and a dual frequency selection system, you get a top-class communications receiver. Not only can you program scan searches only for signals within a specified frequency range, it's also possible to write frequencies of received stations automatically into memory. In addition, unwanted frequencies can be skipped. Order ICBC72-B battery rapid charger for \$99.95 and a BP84-B 1,000 ma. battery pack for \$74.95.

ICOM ICR100-B

List price \$799.95/CE price \$579.95/SPECIAL
Continuous coverage from 100 kHz through 1856 Mhz.
Now you can bring a wider world of broadcasting, VHF air and marine bands, emergency services and many more communications into your vehicle. Icom's advanced ICR100 fully covers all the stations worth hearing with up to 100 memory channels and a multitude of features.

SCANNERS/CB/RADAR UNIDEN

PRO310E-B Uniden 40 Ch. Portable/Mobile CB	\$72.95
PRO330E-B Uniden 40 Ch. Remote mount CB	\$99.95
GRANT-B Uniden 40 channel SSB CB mobile	\$152.95
WASHINGTON-B Uniden 40 Ch. SSB CB base	\$229.95
PC122-B Uniden 40 channel SSB CB mobile	\$113.95
PC66A-B Uniden 40 channel CB Mobile	\$78.95
PRO510XL-B Uniden 40 channel CB Mobile	\$39.95
PRO520XL-B Uniden 40 channel CB Mobile	\$54.95
PRO535E-B Uniden 40 channel CB Mobile	\$69.95
PRO538W-B Uniden 40 ch. weather CB Mobile	\$78.95
PRO810E-B Uniden 40 channel SSB CB Base	\$174.95

UNIDEN RADAR DETECTORS

RD3000ZX-B Uniden 3 band suction mount radar	\$129.95
RD2400ZX-B Uniden 3 band radar detector	\$109.95
RD80-B Uniden 2 band radar detector	\$64.95
CARD-B 3 band credit card size radar detector	\$99.95
RD3XL-B Uniden 3 band radar detector	\$109.95
RD9XL-B Uniden "micro" size radar detector	\$69.95
RD27-B Uniden visor mount radar detector	\$39.95



19 PLUS-B Cobra CB radio	\$36.95
18RV-B Cobra CB radio	\$54.95
41PLUS-B Cobra CB radio	\$72.95
70LTD-B Cobra remote mount CB radio	\$99.95
19LTD-B Cobra Classic series CB radio	\$44.95
21LTD-B Cobra Classic series CB radio	\$54.95
25LTD-B Cobra Classic series CB radio	\$89.95
29LTD-B Cobra Classic series CB radio	\$109.95
146GTL-B Cobra AM/SSB CB radio	\$129.95
148GTL-B Cobra AM/SSB CB radio	\$149.95
90LTD-B Cobra Base station	\$89.95
142GTL-B Cobra AM/SSB Base station	\$199.95
2000GTL-B Cobra Deluxe AM/SSB Base station	\$379.95

COBRA RADAR DETECTORS

RD3163-B Cobra 3 band radar detector	\$109.95
RD3175-B Cobra 3 band radar detector	\$129.95
RD3173-B Cobra 3 band radar detector	\$139.95
RD3183-B Cobra 3 band radar detector	\$139.95

Bearcat 200XL-B

List price \$509.95/CE price \$239.95/SPECIAL
12 Band, 200 Channel, Handheld, Search, Limit, Hold, Priority, Lockout
Frequency range: 29-54, 118-174, 406-512, 806-956 MHz.
Excludes 823,9875-849,0125 and 868,9875-894,0125 MHz.
The Bearcat 200XL sets a new standard for handheld scanners in performance and dependability. This full featured unit has 200 programmable channels with 10 scanning banks and 12 band coverage. If you want a very similar model without the 800 MHz. band and 100 channels, order the BC100XL-B for only \$179.95. Includes antenna, carrying case belt loop, ni-cad battery pack, AC adapter and earphone. Order your scanner from CEI today.

Bearcat 800XL-B

List price \$549.95/CE price \$239.95/SPECIAL
12-band, 40 Channel, Nothing excluded in the 800 MHz. band.
Bands: 29-54, 116-174, 406-512, 806-956 Mhz.
If you do not need the 800 MHz. band, order the Bearcat 210XL-B for only \$178.95.

Magnavox® Satellite Phone

CE price \$48,880.00/Special order - allow 45 days for delivery. When war broke out in Iraq, you heard all the action because CNN had a satellite telephone. When a disaster such as an earthquake or a hurricane strikes your community and communications are disrupted, you can depend on instant reliable communications, just like CNN did using your Magnavox MagnaPhone. Inmarsat communication satellites are in geostationary orbit along the equator. They beam two-way voice and data transmissions between your satellite phone and fixed earth stations. In most instances, telephone calls are dialed directly once you have selected the satellite serving your location. No matter where you are on the planet, the MagnaPhone automatically selects the Land Earth Station (LES) nearest the destination called. This makes placing a call as easy as using a standard telephone. Dual ID numbers permit a separate Inmarsat telephone number to be used to route calls to one of the external telephone ports which could be used for a fax machine or a computer data line. For telephone, telex, fax and data communications anywhere in the world, the new MX2020P MagnaPhone is the most compact Inmarsat-A, Class 1 terminal available today. Like a cellular phone, airtime will be billed to your account. The new MagnaPhone weighs just 47 lbs (21 kg), including the antenna. Add the optional ruggedized case (only \$950.00) and it can travel as airline baggage on commercial carriers. When you arrive at your destination, installation can be done in less than 5 minutes. For more information call our Emergency Operations Center at 313-996-8888.

RELM UC202-B 2 Watt transceiver on 154.57 MHz. \$114.95	
RELM RH256NB-B 25 Watt VHF transceiver	\$299.95
RC12950-B Ranger Comm. 25 Watt 10 Meter xcvr. \$234.95	
MR8100-B Uniden surveillance scanner .CALL FOR PRICE	
BC55XL-B Bearcat 10 channel scanner	\$114.95
AD100-B Plug in wall charger for BC55XLT	14.95
PS001-B Cigarette lighter cable for BC55XLT	\$14.95
VC001-B Carrying case for BC55XLT	\$14.95
BC70XL-B Bearcat 20 channel scanner	\$159.95
BP70-B Ni-Cad battery pack for BC70XL scanner	\$39.95
BC142XL-B Bearcat 10 channel 10 band scanner	\$84.95
BC147XL-B Bearcat 16 channel 10 band scanner	\$94.95
BC172XL-B Bearcat 20 channel 11 band scanner	\$124.95
BC177XL-B Bearcat 16 channel 11 band scanner	\$129.95
BC590XL-B Bearcat 100 channel 11 band scanner	\$194.95
BC780XL-B Bearcat 100 channel 12 band scanner	\$254.95
BC002-B CTCSS tone board for BC590/780XLT	\$54.95
BC003-B Switch assembly for BC590/780XLT	\$22.95
BC855XL-B Bearcat 50 channel 12 band scanner	\$199.95
BC560XL-B Bearcat 16 channel 10 band scanner	\$94.95
BP205-B Ni-Cad battery pack for BC200/100XLT	\$39.95
TRAVELLER-2-B Grundig shortwave receiver	\$84.95
COSMOPOLIT-B Grundig shortwave receiver	\$179.95
SATELLIT500-B Grundig shortwave receiver	\$499.95
SATELLIT650-B Grundig shortwave receiver	\$849.95
ATS800-B Sangean shortwave receiver	\$89.95
ATS803-B Sangean shortwave receiver	\$159.95
74102-B Midland emergency weather receiver	\$34.95
77116-B Midland CB with VHF weather & antenna	\$66.95
77118-B Midland CB mobile with VHF weather	\$62.95
77913-B Midland CB portable with VHF weather	\$79.95
76300-B Midland CB base station	\$92.95
NPD-B Uniden National Police Directory	\$19.95
FBE-B Frequency Directory for Eastern U.S.A.	\$14.95
FBW-B Frequency Directory for Western U.S.A.	\$14.95
RFD1-B MI, IL, IN, KY, OH, WI Frequency Directory	\$14.95
RFD2-B CT, ME, MA, NH, RI, VT Directory	\$14.95
RFD3-B DE, DC, MD, NJ, NY, PA, VA, WV Directory	\$14.95
RFD4-B AL, AR, FL, GA, LA, MS, NC, PR, SC, TN, VI	\$14.95
RFD5 AK, ID, IA, MN, MT, NE, ND, OR, SD, WA, WY	\$14.95
RFD6 CA, NV, UT, AZ, HI, GU Frequency Directory	\$14.95
RFD7-B CO, KS, MO, NM, OK, TX Freq. Directory	\$14.95
PWB-B Passport to World Band Radio	\$16.95
ASD-B Airplane Scanner Directory	\$14.95
TSB-B "Top Secret" Registry of U.S. Govt. Freq.	\$14.95
TTT-B Tune in on Telephone Calls	\$14.95
CBH-B Big CB Handbook/AM/FM/Freeband	\$14.95
TIC-B Techniques for Intercepting Communications	\$14.95
ECC-B Embassy & Espionage Communications	\$14.95
SMHV1-B Scanner Modification Handbook/Volume 1	\$18.95
SMHV2-B Scanner Modification Handbook/Volume 2	\$18.95
LIN-B Latest Intelligence by James E. Tunnell	\$17.95
A60-B Magnet mount mobile scanner antenna	\$39.95
A70-B Base station scanner antenna	\$39.95
USAMM-B Mag mount VHF ant. w/ 12' cable	\$39.95
USA-K 3/4" hole mount VHF antenna w/ 12' cable	\$34.95

Add \$5.00 shipping for all accessories ordered at the same time. Add \$15.00 shipping per radio and \$6.00 per antenna.

BUY WITH CONFIDENCE

Michigan residents please add 4% sales tax or supply your tax I.D. number. Written purchase orders are accepted from approved government agencies and most well rated firms at a 10% surcharge for net 10 billing. All sales are subject to availability, acceptance and verification. Prices, terms and specifications are subject to change without notice. All prices are in U.S. dollars. Out of stock items will be placed on backorder automatically or equivalent product substituted unless CEI is instructed differently. Shipments are F.O.B. CEI warehouse in Ann Arbor, Michigan. No COD's. Not responsible for typographical errors.

Mail orders to: Communications Electronics, Box 1045, Ann Arbor, Michigan 48106 U.S.A. Add \$15.00 per radio for U. P.S. ground shipping and handling in the continental U.S.A. For Canada, Puerto Rico, Hawaii, Alaska, or APO/ FPO delivery, shipping charges are two times continental U.S. rates. If you have a Discover, Visa, American Express or MasterCard, you may call and place a credit card order. 5% surcharge for billing to American Express. For credit card orders, call toll-free in the U.S. Dial 800-USA-SCAN. For information call 313-996-8888 FAX anytime, dial 313-663-8888. Order from Communications Electronics today. Scanner Distribution Center™ and CEI logos are trademarks of Communications Electronics Inc. Sale dates 11/1/91 through 4/30/92 AD #110291-B Copyright © 1991 Communications Electronics Inc.

For more information call
1-313-996-8888

Communications Electronics Inc.
Emergency Operations Center
P.O. Box 1045, Ann Arbor, Michigan 48106-1045 U.S.A.
For orders call 313-996-8888 or FAX 313-663-8888

The technology is available to put a man on the moon, but still no technology exists to warn if a tornado will drop in for dinner. Conventional radar can indicate the heights of clouds and intensity of rainfall. In the case of a tornado, sometimes a telltale hook will appear on the radar screen. Sometimes.

A Doppler radar array will be installed in the Kansas City vicinity in October 1992. It will be one of the first to be used by the NWS. Will that make spotters obsolete? NWS Meteorologist-in-charge Randy McKee thinks not. "I foresee spotters being necessary from now on. I see an increased need for spotters. They will be more important than ever. This radar is very complicated equipment. Their presence allows us time to gain experience with it."

He explained that new Doppler technology can indicate a cloud's movement, for example, to the east. Unfortunately, it cannot tell if the cloud is one of those troublemakers headed toward the ground. When a suspicious echo appears on radar,

NWS tells spotters, through the radio net, where to look for trouble. Spotters, in turn, tell NWS precisely what is actually happening under those clouds.

Some things are best done the old fashioned way. That's why, after decades of Skywarn service, meteorologists still fondly refer to spotters as "the eyes and ears of the weather service."

How to Tune In

NOAA weather radio broadcasts on 162.40 to 162.55 MHz. Dedicated units that self-activate when a weather watch is issued are available from Radio Shack for around \$35. Spotters may be monitored on the two-meter amateur band and law enforcement channels.

Further frequency information can be obtained from your county emergency preparedness office and the nearest National Weather Service Office. Free copies of the "Spotter's Guide" are also available at those offices, or from NOAA, Rockville, Maryland 20852.

M
T

P.J. Richardson is a free-lance journalist and photographer based in Kansas City. She and her husband, WA0HHX, have been tornado spotters in Johnson County for five years. She used this background to write the fiction story, "Duty Calls," which appeared in the October, 1991 issue.

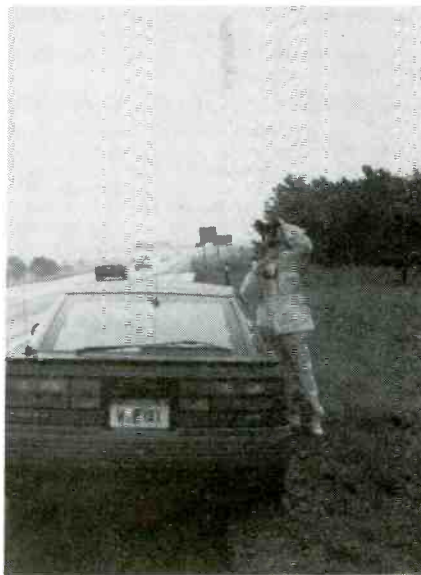
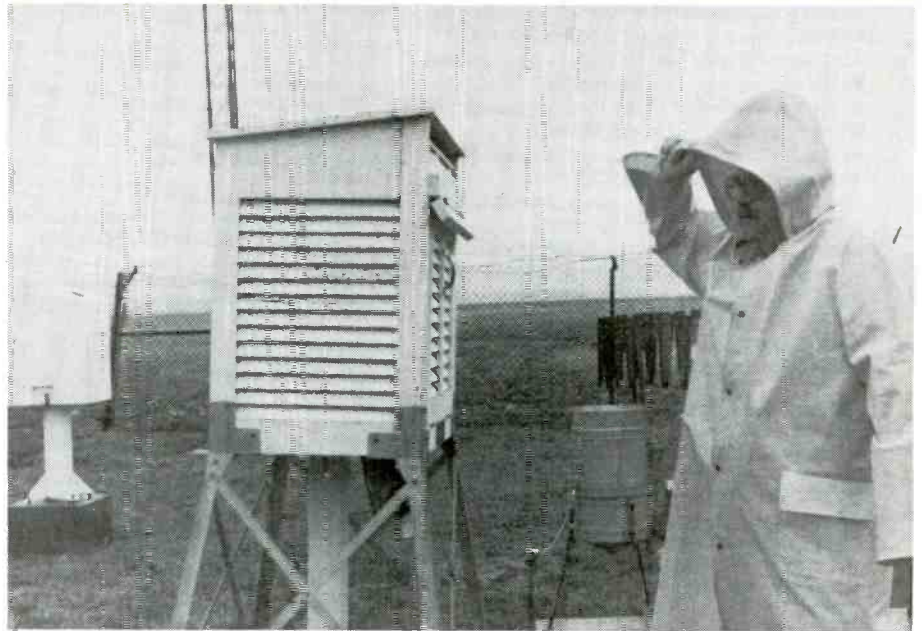
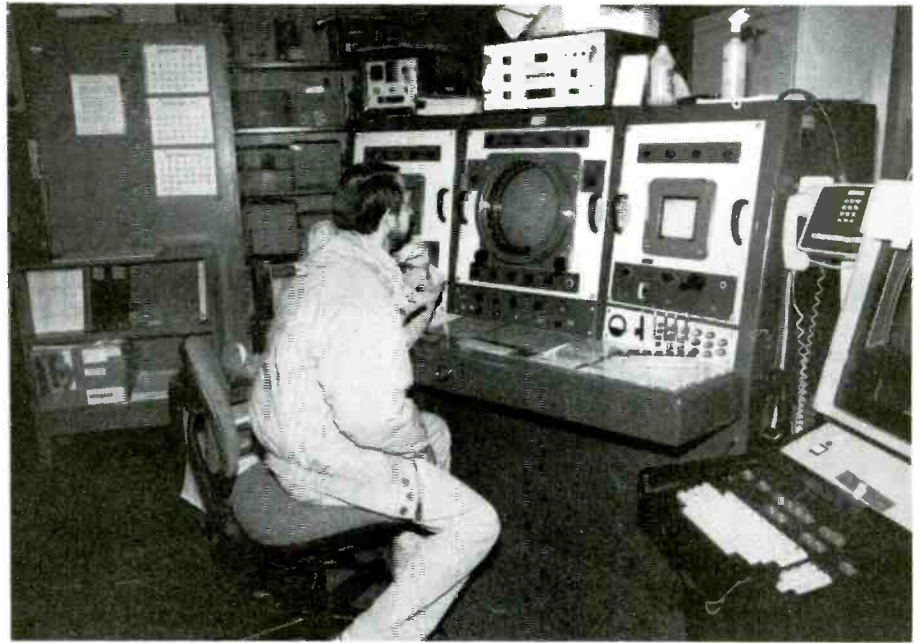

Photo captions:

Top: National Weather Service Office, KCMO, conventional radar monitor.

Center: Meteorologist Larry taking readings at National Weather Service Station, KCMO.

Left: Rod Richardson, WA0HHX, on volunteer spotter duty outside Kansas City, MO.

AEA is the...

Shortwave Solution

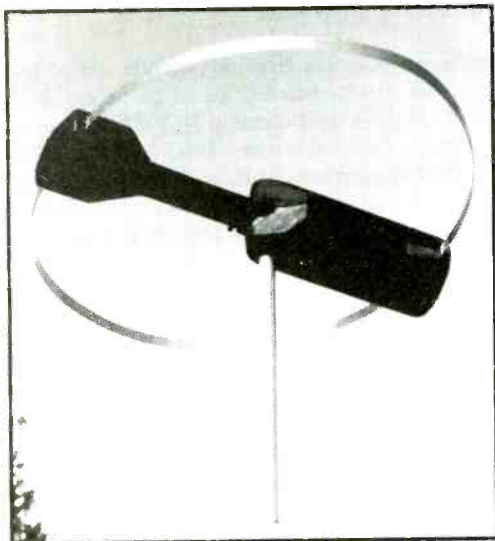

The IsoLoop 10-30 HF antenna is designed to work in limited space applications — apartments, condos, etc. Don't be deceived by its compact size (43" diameter) — it really works! Features include: Continuous coverage from 10 to 30 MHz; narrow bandwidth to suppress out-of-band signals; comes fully assembled (no mechanical joints); much more.

For complete information on these or any other AEA products, call the toll-free InfoLine at (800)432-8873.



Advanced Electronic Applications, Inc.

P.O. Box C2160 Lynnwood, WA 98036
Tech. Support/Sales (206)775-7373
Upgrade Line (206)774-1722
FAX (206)775-2340
CompuServe I.D. 76702,1013

Hayes® Hayes Microcomputer Products.
Hercules™ Hercules Computer Technology, Inc.
Commodore 64 and 128® Commodore
Business Machines. Macintosh® Apple
Computer Inc. Epson® Seiko Epson Corp.

**Come see us in Dayton
Booth 255-259**



The PK-232MBX is a must for the digital Shortwave Listener. By far the most popular multi-mode controller ever, it can receive seven different types of data signals including Morse code, Baudot, ASCII, TDM (Time Division Multiplex), WEFAX, NAVTEX and Packet. It also features: The indispensable SIAM which automatically identifies many types of digital signals; superior software support for PC compatible, Macintosh and Commodore 64 and 128 computers.



AEA-FAX is simply the best way to demodulate multi-level grey scale fax images received by your general coverage receiver. All necessary hardware and software is included in the package which also features: On-screen tuning "scope"; Autolist feature for unattended image capture and save-to-disk; "Daisy-chain" external RS-232 input allows AEA-FAX to share a COM port with a PK-232MBX or other Hayes-compatible device; up to 16 grey levels (VGA); also supports EGA, CGA and Hercules formats; prints to HP LaserJet or Epson compatible printers.

It Started in Tangier

By Charles Sorrell



Like the late Clarence W. Jones who founded HCJB, Dr. Paul Freed had long felt a call to get into missionary radio broadcasting—not in the service of an existing missionary radio group but with an organization of his own. Unfortunately he faced a problem common to most of us: he didn't have the money required to make his dream come true. So he started a company to build houses and house trailers. All the profits from the business went into a fund for the future radio project.

By 1952 Freed had enough money to get started. What would eventually become Trans World Radio was born with the name "International Evangelism." Freed's initial idea had been to broadcast to the Arab world, but other events swung the focus towards Spain instead.

At that time Tangiers, on the north coast of Morocco, was an open, international city so it looked like a good place from which to beam to Spain and so began what looked to be a long trek through the bureaucracy, seeking a broadcasting license. Then Freed met a man who had heard about Freed's plans. A man who just happened to already have a license to broadcast from Tangiers and was in the process of building the station. He offered to let Freed operate the station through a leasing arrangement. So Trans World Radio's first radio outlet was in operation—WTAN, the Voice of Tangier, went on the air on 22 February, 1954, via the facilities of "Radio International," overlooking the Straits of Gibraltar. The power was a measly 2.5 kilowatts.

It seemed as if TWR was off to a great start. Programs in Romanian and Serbo-Croat were soon added, as was a 10 kilowatt transmitter. But, this initial success was followed by a slump. The financial resources set aside to get going were soon exhausted. Freed's missionary parents, who had given up their plans for semi-retirement to go to Tangier and run the station were within days

of giving up the idea when an American church decided to take responsibility for their personal support.

As things improved on the financial scene a second 10 kW transmitter was added (1956), along with a more effective antenna system. By the end of its first five years, TWR had a staff of 26 people working in Tangiers.

Meantime, Dr. Freed had discovered Monte Carlo and began thinking about headquartering TWR there, perhaps even building a second station. International politics forced a decision. In 1959 Morocco got its independence from France and not only discontinued Tangiers' international status but announced plans to nationalize all of the broadcasters operating there. So the rather leisurely pace at which Monaco was being approached took on a real urgency because the Voice of Tangier had only nine months before nationalization would take effect.

A franchising agreement was worked out with Monaco under which Radio Monte Carlo would own the facility TWR was proposing to build and then lease it back to TWR. The new station would be housed in a huge stone building on top of Mt. Agel, 2,500 feet above Monte Carlo. Ironically, the building had been constructed by the Germans during WWII and was meant to

house a Nazi propaganda station but the war ended before it could get on the air.

On December 31, 1959, the Voice of Tangier aired its last broadcast and Trans World Radio's programs were nowhere to be heard on any shortwave or medium wave frequency.

In Monaco, activity was at a furious pace. Some 90 tons of antenna towers were hauled up the mountain. Twenty-one towers in all which would support giant curtain antennas aimed at the Mideast, Britain, Scandinavia, Spain and Eastern Europe. The Monte Carlo station would have a 100 kW transmitter, more than four times what had been available in Tangiers. But, still, that was one transmitter compared to three used before and that meant some programming had to be dropped.

TWR Monaco went on the air on 16 October, 1960. Today it beams to 46 target countries, using three shortwave transmitters—two 100 kW and one 500 kW—plus a 1.2 million watt medium wave unit. There's also a one million watt transmitter about 80 miles away, at Romoules, France, operating on 1467 kHz.

But there were many anxious times along the way as the group scrambled to raise the \$83,000 payments which had to be made to Radio Monte Carlo at specific intervals. On one occasion the last few thousand dollars arrived just within hours of the deadline. On another, Freed was in the bank director's office—a few thousand dollars short—when the banker took a phone call with the news that the necessary amount had arrived at the last second. One time there was no last minute phone call. But the banker checked the figures again, this time basing his calculations on new exchange rates and found the difference in TWR's favor was just enough to cover the missing amount!

The first year in Monte Carlo generated 18,000 letters and the organization began to grow in size and service. The studio in Tangier was

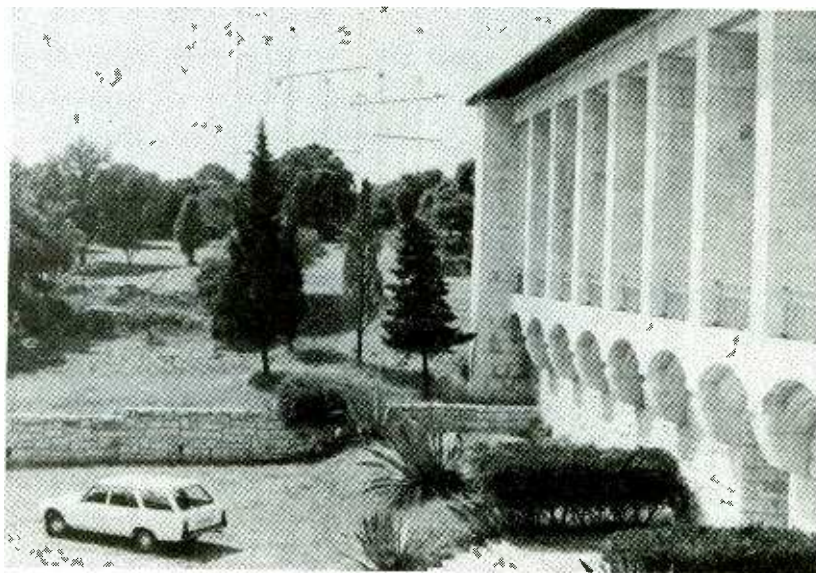

TWR Monaco is housed in a building originally planned as a Nazi propaganda station.

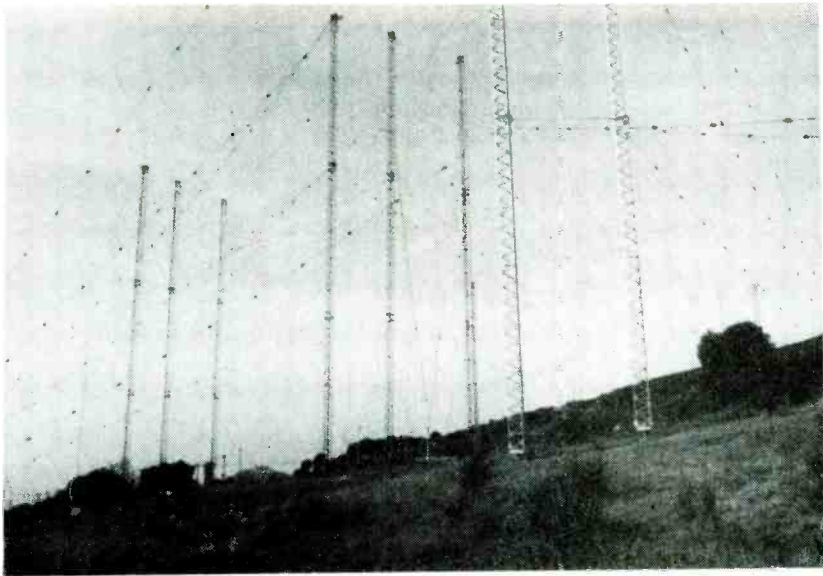

The Trans World Radio shortwave antenna system with high-gain directional beams to 13 target areas of Europe, North Africa, and the Middle East.

kept and provided programs in Spanish. A network of monitors was set up throughout Europe to provide daily signal reports. A recording studio was opened in Oslo, Norway. The Gospel Recording Society was created to produce programs for Israel and the Arab world. In 1966 TWR began making use of Radio Monte Carlo's medium wave transmitter during the hours it would otherwise have been off the air.

TWR Monaco's current shortwave frequencies are 6230, 7130, 7160, 7225, 7290, 7385, 9435, 9480, 9485, 9490, 9495, 9650, 9795, 11625, 11655 and 12020. The full schedule includes a large number of languages and is too extensive to include here. Listeners in North America who want to try for TWR Monte Carlo's English broadcasts should check between 0740-1015 UTC on 9480. The interval signal is a music box melody. The station can be reached at B.P. 349, 98007 Monte Carlo, Monaco.

By the early 1960s Freed was looking at maps again. He wanted to expand into the Western Hemisphere and felt that by placing a station in the Caribbean he could do that very effectively. Negotiations began with the government of Curacao in the Netherlands Antilles. An agreement to build a station there was actually signed. But then someone wondered about the close proximity of Curacao's international airport and the agreement was torn up. Airports and tall broadcast towers aren't a friendly combination.

So TWR ended up next door, on the salt flats of Bonaire. The government there not only welcomed TWR, it agreed to prepare the land, build the roads, provide the necessary landfill and even do the landscaping! On 1 October, 1964, TWR Bonaire signed on with a 500 kilowatt AM transmitter operating on 800 kHz, easily heard through most of the US during the nighttime hours. The next year a 300 kW shortwave transmitter came on. A few years ago, a 500 kW shortwave took the air from Bonaire. (See the companion article in this issue.)

Trans World Radio puts an excellent signal into North America from Bonaire and airs English programming on 11815 and 15345 from 1100-1330 and on 9535 and 11815 from 0300 to 0430. The interval signal is "Stand Up, Stand Up for Jesus." A program for SWLs, "Bonaire Wavelengths," is aired Sundays at 1130, hosted by Chuck Reswell. The station's address is simply: Trans World Radio, Bonaire, Netherlands Antilles.

On May 1, 1974, TWR Cyprus started broadcasting from a 600 kW medium wave transmitter, beaming to some 20 countries in the Mideast and northeast Africa. TWR's next move was to Africa, this time almost at the other end of the continent from where they began. A 50 kW medium wave, four 25 kW and one 100 kW shortwave transmitters went on the air from Mpangela Range, Swaziland, on November 1, 1974, to serve northeast and southern Africa.

The Swaziland station, while far from impossible to hear in North America, is still the most difficult of TWR's shortwave outlets. TWR Swazi operates in the 90 meter band (3200, 3240, 3365); on 4760, 4790 and 5055 in the 60 meter band, 5965 and 6025 in the 49 meter band. In the 41 meter band 7120 and 7200 are used. 31 meter band frequencies are 9515, 9520, 9595, 9640, 9650 and 9655. Other frequencies used are 11740, 11805, and 15280. Of all those, your best bet will usually be around 0300 or later on 3200 or 3240, running in Ndebele and Shona, respectively. The English broadcast on 5055 at 0430 sometimes comes through. Also try 0600 on 7200. The Swazi station uses the tune "We've a Story to Tell the Nations" played on hand bells as its interval signal. The station's address is: P.O. Box 64, Manzini, Swaziland.

Asia was the next target area. In May 1975, the FCC granted TWR granted permission to build a station on Guam and a 10 kilowatt station designed to serve a local audience was in opera-

NOW YOU'RE TALKING!

The Code-Free Ham License is Here

Enjoy all Amateur Radio privileges above 30 MHz without having to pass a code test. All you have to do is pass a 55-question exam on basic radio and the FCC regulations. ARRL's new book, **Now You're Talking** makes understanding what is required on the test a snap! And there are exams given all over the country every weekend.



Just think how much fun you'll have communicating through repeaters, enjoy Sporadic E skip and worldwide communications on six meters when conditions are right. There's satellite communication and you can even talk to Astronauts and Cosmonauts in orbit. Enjoy friendly local communication both direct and through repeaters. Help with disaster drills and the real thing! Sound like fun? It is! Order your copy of **Now You're Talking** below: Enclosed is \$19 plus \$4 for shipping (a total of \$23) or charge \$23 to my () VISA () Mastercard () Discover () American Express

Signature _____
 Acct. No. _____
 Good from _____ Expires _____
 Name _____
 Address _____

 City State Zip MT

THE AMERICAN RADIO RELAY LEAGUE
 225 MAIN STREET
 NEWINGTON, CT 06111

TRANS WORLD RADIO

Broadcasting the Gospel worldwide



Welcomed Partners, Branch, Cooperative Offices and Stations

Buenos Aires, Argentina	Biggleswade, England	Turin, Italy	Herrliberg, Switzerland
Balwyn, Australia	Hytvinkaa, Finland	Nairobi, Kenya	Kiev, USSR
Vienna, Austria	Beausoleil, France	Lilongwe, Malawi	Leningrad, USSR
Sao Paulo, Brazil	Wetzlar, Germany	Maputo, Mozambique	Moscow, USSR
London, Ontario, Canada	Baarn, Holland	Kristiansand, Norway	Miami, Florida, USA
Brattslava, Czechoslovakia	Hilversum, Holland	Asuncion, Paraguay	Montevideo, Uruguay
Brno, Czechoslovakia	Kowloon, Hong Kong	Warsaw, Poland	Maracay, Venezuela
Haderslev, Denmark	Eger, Hungary	Singapore	Harare, Zimbabwe
Santo Domingo, Dominican Republic	New Delhi, India	Madrid, Spain	

tion by August. On September 4, 1977, short-wave operations began from Guam, using a pair of 100 kW transmitters which have since been joined by two more. Programs from Guam reach audiences in China, Japan, Southeast Asia, the Eastern USSR as well as Australia. KTWR's main target area is China, though, and it airs programs in five Chinese dialects. Fifty-eight thousand letters have been received from listeners in China.

KTWR uses 9590, 9785, 9870, 11580, 11650, 11665, 11700, 11805, 11895, 12030, 15200, and 15485. Many in North America have noted the English broadcast which begins at 1458 on 11650. The interval signal is "We've a Story to Tell The Nations" played on an organ. KTWR can be addressed at P.O. Box CC, Agana, Guam, 96910. Include three IRCs for a reply.

Also providing coverage in Asia is a 400 kW medium wave transmitter at Puttalam, Sri Lanka, which beams to India and Bangladesh which went on the air in 1978, 100 miles of the coast of India. TWR's signal covers an area with a population of one billion. The organization is looking for ways to enlarge its capacity and therefore the amount of programming it can offer this audience and is looking for a way to use shortwave to achieve this. For a time, TWR was airing programs via the government's Sri Lanka Broadcasting Corporation but the government discontinued the arrangement.

Sprinkled in between all those milestones is a still growing list of other achievements. Intracare, established in 1982, is a training and research

center in Holland which works to help mission leadership, ministry staff and broadcasters in developing their outreach.

TWR has a cooperative arrangement with Radio Rural in Montevideo, Uruguay, whereby TWR has exclusive rights to all of the religious programming on the 50 kW medium wave station which includes Buenos Aires within its coverage area.

In June and September 1990, TWR opened the first evangelistic radio studios in the USSR—in St. Petersburg (Leningrad) and Moscow. In September 1990, TWR was granted two FM frequencies in Sao Paulo, Brazil.

Trans World Radio is represented in many other places, even though it has no transmitters there. There are branch offices, studio installations and "national partners" all over the world from Australia to Zimbabwe, Hungary to Hong Kong—over 30 in all and the list is growing. The organization has a staff of over 700 people, about half of them native Christians working in or broadcasting to their own countries. TWR's programs are estimated to reach 80% of the world's population.

The organization is currently working with HCJB, ELWA and FEBC, building eight new shortwave transmitters at HCJB's engineering facility in Elkhart, Indiana. World headquarters of Trans World Radio were moved from Chatham, New Jersey, to Cary, North Carolina, about two years ago. The headquarters facility houses any number of departments, including a six member public relations team, broadcaster relations, in-

ternational personnel, a library, art department, church relations, information systems and others.

All of the TWR stations are excellent verifiers. TWR Bonaire offers a series of QSLs, each year's group designed around one theme. In fact, the Bonaire station issues an award to DXers who submit proof of having heard and verified all TWR sites on shortwave, with special endorsements available for QSLing any of the medium wave stations or for those in the gray hair set who have QSLs from the original TWR station—WTAN. Send the QSLs (they'll be returned) or photocopies to Trans World Radio, Bonaire, Netherlands Antilles, and be sure to provide your name and address the way you want them to appear on the certificate. Include five IRCs.

1992 will mark 40 years since Dr. Freed first began to build Trans World Radio and 38 years since the first TWR broadcasts were heard over the Voice of Tangiers. What might have been a disaster for Trans World Radio in North Africa turned out to be a blessing as it spurred the development of one of the world's most powerful and widespread religious broadcasting organizations with access to nearly 6 million watts of transmitter power that enable TWR to be heard by 80% of the world's population. Don't make any bets that Trans World Radio plans to stop before that percentage reaches 100!

M_T

Editor's Footnote: The best use of the airwaves has always been as a vehicle for free speech; the publisher's editorial comments on page 112 are not directed toward those religious broadcasters who use that privilege responsibly and who seek to improve the quality of life of their listeners.

Take Advantage Of Our **NEW** Extended Warranty Plan . . . **Call Today!**

**SONY
ICFSW77**



From the genius of Sony, the world's most advanced portable Receiver. Factory programmed, 100 of the most popular SWL stations which you can reprogram yourself.

- .15-30MHz AM/CW/SSB
 - 76-108MHz FM (Stereo)
 - Station Name Tuning
 - 160 Memory Pre-set
 - Synchronous Detection
 - Wide-Narrow Filters
 - Multi Function Scan
 - Multi Function Clock/Alarm
 - 120VAC Adapter Incl.
 - 10.8x6.8x1.8 in. Wt. 52oz.
- List \$624.95 **EEB \$499.00 + sh.**

It's Time To Upgrade!

**SONY
ICF2010**

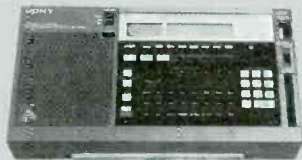

Big Receiver performance in a portable, take with you package. Thousands of satisfied users make the ICF2010 Sony's Biggest Seller!

- .15-30MHz AM/CW/SSB
 - 76-108MHz FM Band
 - 116-136MHz Air Band
 - Synchronous Detection
 - 32 Program Memories
 - Direct Keyboard Entry
 - Multi Scan Functions
 - Multi Clock Functions
 - 4.5 VDC (3D) & (2) AA not incl.
 - 120VAC Adapter Incl.
 - 6.25x11.3x2.2 Wt 48 oz.
- List \$429.95 **EEB \$349.95 + sh.**

A True Classic!

**SONY
ICFSW7600**



This is our number one selling mid-sized portable. Explorers and travelers will love the versatility of the ICF SW7600.

- .15-30MHz AM/CW/SSB
 - 76-108MHz FM Band
 - 10 Station Memory
 - Full SW Coverage .1-30MHz
 - Dual Conversion
 - AN61 Antenna Incl.
 - Clock, Timer, Alarm
 - AM/SSB/FM/FM Stereo
 - Direct Keyboard Entry
 - Power (4) AA Not Incl. AC adptr. incl.
 - 7 1/4 x 4 3/4 x 1 1/4 wt. 22 oz.
- List \$399.95 **EEB \$219.95 + sh.**

#1 Compact Portable!

**SONY
TCM38V**



Turns your scanner into a logging receiver. Let the TCM38V run unattended. Play back later. You won't miss any action.

- Logging cassette recorder
 - CH1 audio, ch 2, time date
 - Records date, time & play back to LCD readout
 - Ideal for scanner monitoring
 - VOR voice/audio auto start
 - Auto record level
 - Built in microphone or Ext.
 - Power (2) AA not incl.
 - Opt. AC adapter PA3N 13 \$9.95
 - 3 1/2 x 5 1/4 x 1 1/4 wt. 10 oz.
- List \$129.95 **EEB \$99.95 + sh.**

NEW Innovative Recorder!

**JRC
NRD535D**



The NRD515 then 525 now 535D. Each generation has introduced state-of-the-art features to satisfy the most discerning listener.

- 1-30MHz AM/CW/SSB/FM
 - New Exalted Carrier
 - New Selectable Sidband (ECSS)
 - Phase Lock Detection
 - Variable Bandwidth Control (BWC)
 - Tuning Steps 1Hz DDS (10Hz readout)
 - 100dB Dynamic Range
 - 200 station memory
 - RTTY Demod Option
 - 4 Filter Position 3 Supplied .1,2,6kHz
 - 13x5x11 in. Wt. 20lbs.
- List \$1995 **EEB \$1599 + sh.**

**ICOM
R71A**



Setting World Standards! Versatile, Reliable, Rugged. Our Top Selling Desktop Receiver!

- .1-30MHz AM/CW/SSB Opt. FM
 - Pass Band Tuning
 - 100dB Dynamic Range
 - Filters 6 & 2.4kHz Cpt. CW 500Hz
 - 120/240 VAC Opt. 12VDC
 - 32 Programmable memories
 - Dual VFO
 - Multi Scan Functions
 - IR. Remote Option
 - Computer Control Option
 - Many EEB Filters & other Options
 - 11.3x4.3x10.9 in. Wt. 16.5 lbs.
- List \$999 **EEB \$849.95 + sh.**

**DRAKE
R8**



Getting Rave Reviews From The Experts! EEB welcomes Drake back to the shortwave market. The R8 promises to be a big hit with the serious listeners.

- .1-30MHz AM/CW/SSB
 - VHF Opt. 35-55/108-174MHz
 - 100 Memory Channels
 - Synchronous Detection
 - 5 filters .5, 1.8, 2.3, 4, 6 kHz
 - All Mode AM, CW, SSB, RTTY, FM
 - Band Pass Tuning
 - RS232 Serial Interface
 - Dual Antenna Inputs
 - 13.2x13x5.25 in. Wt. 13lbs.
- EEB \$979.00 + sh.**

FREE in U.S.A.
NEW 1992 CATALOG



- All New expanded SWL
- New Amateur Section
- Enlarged Scanner Section
- New Specialty Section
- Expanded Book Section

This is our largest catalog ever! If you received our 1991 catalog your on our mailing list. Watch for your copy! If you never received an EEB catalog call-write or FAX (703-938-6911) today! Our Catalog is free in U.S. \$1.00 in Canada/Mexico. All others are \$3.00.



ELECTRONIC EQUIPMENT BANK
323 Mill Street N.E.
Vienna, VA. 22180

ORDERS: 800-368-3270
Local Tech: 703-938-3350
FAX: 703-938-6911

- Sorry, no COD's
- Free Catalog in U.S.
- Battery's not included
- Prices subject to change
- Prices do not include freight
- Returns subject to 20% restock fee

TWR's Voice in the Caribbean

By Susan Peterson



Tony Tangeman/TWR

Even in mid summer, darkness lingers at 0600 hours at 12 degrees north. Motivating myself to roll out of my cubby hole quarter berth aboard the sailing yacht *Sequin* was tough. But the faithful English language news broadcast of TWR-Bonaire helped get me going each morning.

My introduction to shortwave listening came about in this unlikely setting, thanks to the Russian coup of August 1991. Each morning our ship's company tuned in anxiously to VOA (which faded at sunrise) and TWR for the morning news. Intrigued by what I heard and by my host's description of TWR-Bonaire's studios, one of the western hemisphere's most powerful short wave and AM transmitters, I put it on my list of things to see while visiting Bonaire.

Even if you aren't looking for it, though, TWR is hard to miss. Just as it dominates the radio band at 800 kHz, it is one of the first things to appear on the horizon as you approach the tiny Caribbean island of Bonaire from seaward on a small boat. Its giant antenna farm of 500-foot steel towers on the island's south end appears, hair thin, in the distance, long before the low lying island is visible. Trans World Radio-Bonaire, devoted exclusively to the Biblical command "Go ye therefore and teach all nations," is one of the strongest of a half dozen TWR super stations broadcasting gospel throughout the world. Their signal is heard after sundown from the Yukon to Tierra del Fuego, with over two hundred fifty countries between tuning in.

Although there are many reasons for the phenomenal success of Dr. Paul Freed's missionary radio network, one major contributor to TWR's success is its impeccable integrity and high quality programming. Obviously, many people who listen to its Spanish, Portuguese, German, and English language broadcasts do so to seek the

Word of God. But plenty of other listeners tune in for hurricane information, original dramas, music, local talk shows on such things as what shortwave means to yachts, and for the station staff's meticulously researched and objective news broadcasts.

Station Frequency Coordinator Charles Reswell, a technical missionary on Bonaire for twenty five years, graciously gave me a tour of the studios, and explained to this novice listener, "More and more people in North America are turning to short wave radio as an alternative source of information."

He explained that Americans and Canadians are weary of having all their news carefully "filtered" and slanted by a handful of TV networks and corporate media giants before broadcast. People are now seeking other programming for an alternative view. And with the Russian turmoil of last summer giving a boost, sales of shortwave receivers in North America hit an all-time high.

Trans World Radio-Bonaire's outlook differs from that of the domestic networks, since it has a worldwide audience and is a missionary endeavor. Each announcer uses his mother tongue on air, and the station maintains extensive libraries on the countries and cultures to which it broadcasts. The station currently broadcasts on shortwave in English, German, Portuguese, and Spanish--its main target area being North, Central and South America.

But competing in a jungle of sound on the airwaves is not easy. Trans World Radio must match or surpass the super-power of secular stations since the radio waves today are filled with a multitude of voices. Power and flexibility in the use of frequencies to reach those listeners is a priority. As a past director of the Voice of America radio station once remarked, "The only

recourse is to have more power than competitors on the same frequency, and to be more flexible in the use of frequencies. This is jungle warfare. Victory (in radio) goes to the strong, the smart, and the quick."

Even as TWR with 3.2 million watts of its own diesel-generated power dominates the airwaves, it also occupies a prominent place in the landscape of the tiny Caribbean island from which it broadcasts. Paul Freed, founder of the Voice of Tangier, and later, a powerful gospel transmitter in Monte Carlo, wanted to reach South America's people. A chance meeting in Holland with a minister from the Netherlands Antilles led to the idea of a Gospel radio transmitted here.

Freed first visited Curacao and found it well suited to his needs. But later investigation showed there was a danger of interfering with the island's airport operations. The Antilles government suggested Bonaire, thirty miles away, as an alternative. This is a tiny, arid, unpretentious land of fossil coral, swept by ceaseless ocean trades and warmed by the intense sun of 12 degrees north. The economy here is geared to low-key tourism, salt production, and oil transshipment. Most people who visit do so because of their interest in nature. The island has a large park in its hilly north end that provides some of the best and most varied bird watching in the Caribbean. It is also ringed by extensive and pristine coral reefs that draw thousands of scuba diving tourists from Europe and North America.

Ironically, the chance offering of a transmitter site on Bonaire proved to be a superb choice for TWR because of the island's south end geography. This part of the island consists of a low-lying area dotted by thorny scrub, cactus, small trees and stretches of bare reddish earth. Just scant feet above sea level, dense mangrove



Tony Tangeman/TWR

thickets fringe its shoreline, and quiet sheltered lagoons offer food and habitat to one of the last breeding colonies of flamingos in the western hemisphere.

Here, too, Bonaireans pump sea water into diked-off salt pans where it evaporates. After about nine months of repeated cycles of flooding and evaporating, the sea salt residue is scraped up from the pan and pushed into huge glistening white piles. It is then sent abroad for industrial use and for de-icing roads in the US.

These salt pans and the nearby sea surface with their high conductivity, reflect radio waves upward, providing a huge boost to the power and range of the radio transmitter. Experts have said the decision to locate on Bonaire instead of on Curacao effectively doubled the planned station's power.

Construction began in 1963. Working conditions were difficult and the crews had to be almost completely self sufficient on the small remote island. During the building of the original 760 foot AM tower, workers had to contend with trade winds that at those heights swept by at fifty knots on more.

Bill Mial, the first TWR-Bonaire director, recalled, "Arc welding was a miserable task in the hot Bonaire sun with no shelter and wearing a mask with a glass window. We consumed eye drops, Solarcaine, and iced tea in prodigious amounts." Still the radio missionaries toiled on, and less than one year after ground-breaking, broadcasting began.

When the station began broadcasting, the response of listeners was immediate and over-



Tony Tangeman/TWR

TRANSEL TECHNOLOGIES

A DIVISION OF LJ ELECTRONIC INDUSTRIES
123 East South Street • Harveysburg, Ohio 45032
1 (800) 829-8321

MODEL # T270 **\$18.95**

SPECIFICATIONS

The T270 mobile dualband motorola (NMO) mount antennas are designed to provide years of satisfactory operation. They bring dual band operation to discriminating users of both amateur and commercial equipment. These antennas are designed to enhance the capabilities of portable equipment. The NMO mounting is a reliable method to ensure good continuity for many years to come. These antennas are supplied with a spring loaded positive pressure contact. VSWR at resonance is typically 1.5:1 or less. Power rating is 200 Watts P.E.P. Unity gain 140-170 Mhz; 2.5 db gain 440-470 Mhz; Weight is approx. 1lb.; Color: Black; Impedance: 50 ohms

\$23.95 MODEL # T270M
MODEL # T270MBN

SPECIFICATIONS

The T270M and T270MBN mobile dualband magnetic mount antenna kits are designed to provide years of satisfactory operation. They bring dual band operation to discriminating users of both amateur and commercial equipment. These antennas are designed to enhance the capabilities of portable equipment. The heavy duty magnet insures reliable operation at speeds up to 100 M.P.H. The base comes with a protective mylar to prevent damage to any mounting surface. These antennas are supplied with 12' of RG58A/U coax and a choice of connector T270-PL259 T270MBN-BNC.

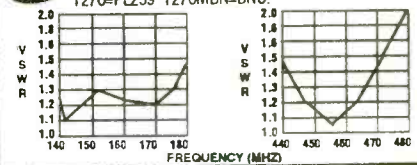

Computer Control of Your Radio

New Drake R-8
and AOR 2500!

with
SCANCAT



Computer Aided Software Control

Never buy another program - SCANCAT runs ALL supported radios

LOOK WHAT WE NOW SUPPORT!

- KENWOOD R-5000, TS-440, TS-950, TS-711
- YAESU FRG-9000, 7570/GXII, 7970
- JAPAN RADIO NRD-525 and NRD-535
- AOR-3000 with SPECTRUM DISPLAY/ANALYSIS
- MOST ICOMs including R-71, R-7000 & R-9000

icom signal detection / scan stop supported with inexpensive optional cable !!!

Once you use SCANCAT with your radio - You will never use your radio again without SCANCAT!

AOR-3000, NRD-525, ICOM FEATURES

- * Automatic signal detection/scan stop
- * Spectrum Analysis - Terrific graphics!
- * Automatic logging to diskfiles
- * Save/Load radio's memories to disk

UNIVERSAL FEATURES

- * Create Frequency Databases
- * Scan by ANY Increment - by any Delay.
- * Scan between any frequencies
- * Built In Communications program for TNC
- * Up to 400 Frequencies per file
- * Share ANY radio's files with another radio

FREE INFORMATION - or - Send for our fully operational Demo (\$5.00).

We're so convinced you'll buy SCANCAT, that when you do, we'll refund the cost of the Demo and even pay the postage!

IBM Compatible - Minimum 1 Serial Port & One Floppy (Game port required for Icom option)

\$ 49.95 PPD (Foreign add \$5.00) - ICOM CABLE **\$19.95**

Via - Mastercard - Discover - AmExp or COD

FREE FILE - (Specify your Choice) - CELESTAR or TOP200 UTILITIES
J&J Enterprises, 4001 Parkway Dr. - Bossier City, LA 71112
PHONE 318-631-3881 (10-5) or FAX 318-631-3082

DX Listening Digest

— Much more info in the style of Hauser's column.

Review of Int'l Broadcasting

— Shortwave programming, opinion, equipment, satellite monitoring.

Samples \$2.50 each

(outside North America US\$3 or 6 IRCs)

10 issue subscriptions \$25 in USA, or both for \$47

Glenn Hauser, Box 1684-MT, Enid, OK 73702

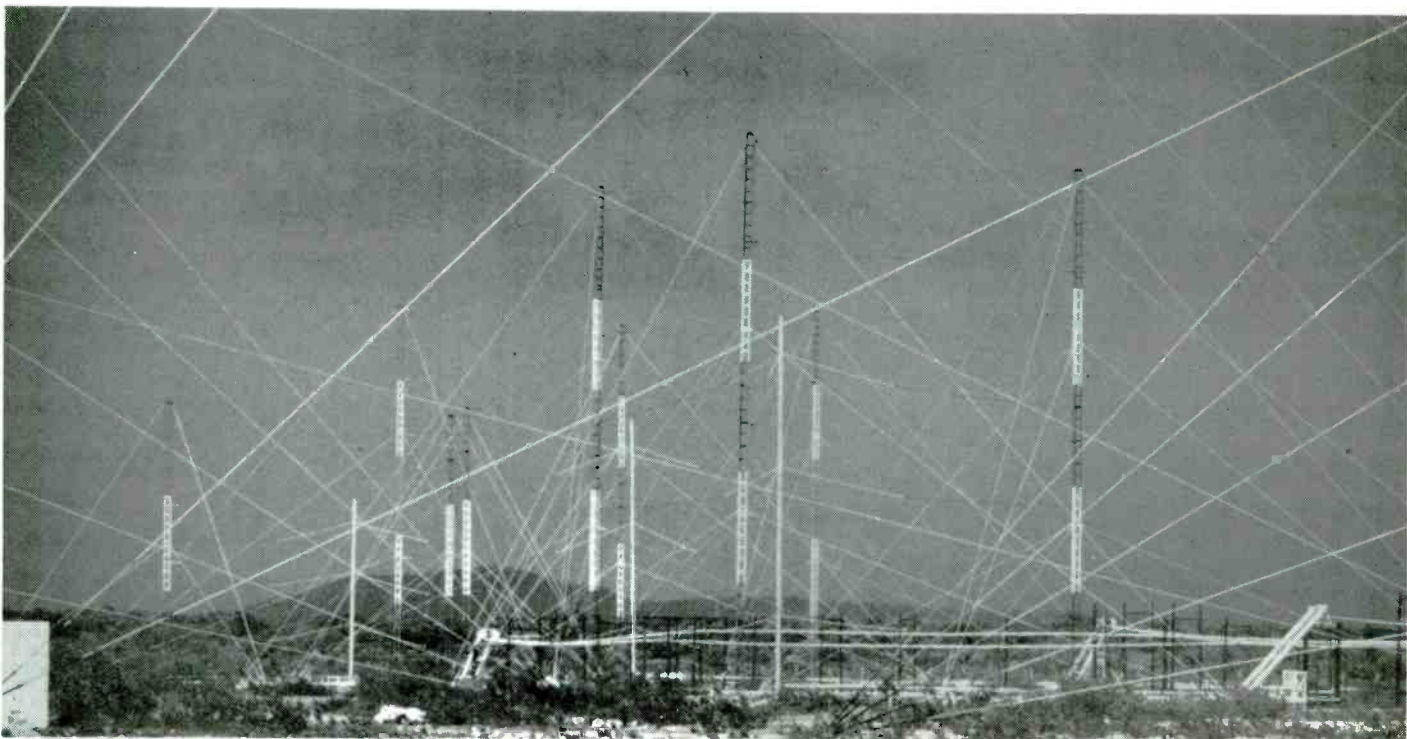

The TWR-Bonaire antenna field.

TWR

whelming. Thousands of letters, many of them moving testimonials to the hungry of isolated villagers and city dwellers alike for outside communication, poured in from 79 countries within the first two months of operation.

Since then, the station staff has grown and programming and power have expanded. Today, TWR broadcasts in four languages on several shortwave frequencies. North American listeners can pick them up on the 11815 and 15345 kHz bands in the morning (1055-1330) and on 9535 and on 11930 kHz in the evening (0255-0430). Those who live in the southern US can also receive TWR on the AM band at 800 kHz.

Broadcasts originate from a state of the art studio on the north side of down town Kralendijk, Bonaire's largest settlement and capital. The TWR studios are open for tours and provide a fascinating glimpse of the world of high tech gospel communications. Should you ever visit Bonaire, a stop here is well worth your time. And don't worry; You don't have to go to church!

The modern, windowless studio building is a sharp contrast to the generally informal wind swept ambiance of the island. There are four control rooms for original program production; offices; a large tape, record, and CD library; and several technical workrooms within the building. At the transmitter, power is supplied by two locomotive-sized diesels that power generators able to produce 3.2 million watts of power.

The station is equipped to broadcast using records, tapes, or compact disks. It receives and carefully screens dozens of tapes each week from the US and Canada for its English language broadcasts. All tapes are edited and any on-air appeals for funding are deleted.

The station's newsroom has a direct satellite link provided by the local cable TV company.

Wire service signals from outer space are "dumped" into a waiting computer which then organizes the data into paragraphs of copy. The news broadcaster then sits down at a terminal, pages through the day's news, blocks the paragraphs he wants, and then prints them out to read on the air. After a few days, unless saved, the computer program erases the news to make room for more information.

The station's music studio is a fascinating marriage of art and high tech. You enter it by means of massive steel double doors, much like the hefty portals of a nuclear power station control room. The doors also are separated by an airlock that, like the double sand-filled walls, helps sound proof the studio.

During a tour of the station "Chuck" Reswell remarked of the music studio's cave-like quiet, "After you are in here for awhile, you can hear the fluorescent lights. If you turn them off then pretty soon you hear a shush-shush. Now you are hearing the sound of your own heart!" If a jet aircraft flew directly overhead, its engines would not be audible inside the studio.

The room can be "tuned" to different instruments or sounds by opening and closing color-coded acoustic surfaces. The color coding indicates what frequency and type of sound that particular surface absorbs. A gleaming grand piano and a few chairs make up the balance of the room's furnishings, and the studio can accommodate a sizeable ensemble of several dozen players.

About fifty families on Bonaire keep TWR operating. Many are from the US and Canada and serve one- or two-year duty tours. But other workers come and stay on. Engineers, maintenance people, riggers, program producers, electronics experts and other highly skilled people

are drawn to Bonaire and make up a close knit Christian community here.

Perhaps nothing testifies more vividly to the power of radio than does the correspondence received at Bonaire. Freed, in his book *Trans World Radio, Towers to Eternity*, writes of a young man on the verge of suicide who turned on his radio to listen to a favorite program. Just a literal hair's breadth away on the band, the sound of singing came through, songs remembered from his childhood. He tuned them in and Freed wrote, "The message of the Gospel began to touch the heavy ache in his heart. Instead of taking his life, he gave it to the Lord Jesus Christ."

A listener in Belize wrote, "I enjoy the programs that have brought and bring a comfort to my soul." From Norway a student tuning in to Bonaire wrote "Through missionary radio, my eyes have seen our true God." And an English listener described the Caribbean signal as "colossal."

Each month letters continue to come in testifying to the comfort and pleasure that these broadcasts can bring. Bonaire will cheerfully acknowledge and confirm requests for verifications. The staff asks you to include date and time signal heard, frequency (within 50 kilohertz) proof of reception (at least 15 minutes of program content outlined) and signal strength (using SINPO code). Send to Trans World Radio, Bonaire, Netherlands Antilles.

And if you want to learn more about this non-profit and non-denominational missionary effort, write to either TWR, Bonaire, Netherlands Antilles, Caribbean, or to TWR, P.O. Box 700, Cary, North Carolina 27512.

MT



THE JAPAN RADIO CO. **NRD-535**

THE NEXT GENERATION IN HIGH-PERFORMANCE HF RECEIVERS

Once again JRC breaks new ground in shortwave receiver design. The new NRD-535 has all the features SWLs and amateurs have been waiting for. General coverage from 0.1 to 30 MHz in AM, USB, LSB, CW, RTTY, FAX and Narrow FM modes. Advanced ECSS operation for phase-lock AM reception. Variable bandwidth control (BWC). Tuning accuracy to 1 Hz possible with direct digital synthesis. 200 memory channels with scan and sweep operation. Triple Superheterodyne receiving

system. Superb sensitivity, selectivity and image rejection. Dual-width noise blanker eliminates impulse noise. Squelch, RF Gain, Attenuator, AGC and Tone controls. Optional RTTY demodulator available. 24 hour clock/timer. Easy to read vacuum fluorescent display with digital S-meter. AC and DC operation. Plus the most comprehensive computer interface found on any radio to date. Call or write today for a full color brochure, price list and dealer information.



Japan Radio Co., Ltd.

MAIN OFFICE: Akasaka Twin Tower (Main), Akasaka 2-chome, Minato-ku, Tokyo 107, JAPAN
Tel.: (03) 584-8836 Telex: 242-5420 JRCTOK J

IN U.S.A.: 430 Park Avenue (2nd Floor), New York, NY 10022
Tel.: (212) 355-1180 FAX: (212) 319-5227 Telex: 961114 JAPAN RADIO NYK

How to Wallpaper Your Shack

By Lee Reynolds

Does the decor of your shack bore you? Those utility QSLs just don't thrill you any more? Have you confirmed Radio Moscow on every last one of its relays? If you can answer "Yes" to any of these questions, perhaps it's time to try the new challenge of contesting and award hunting!

For many years, hams have been holding contests and giving awards within their fraternity. In fact, for some hams, contesting and award hunting has become an obsession that occupies much of their waking time, behavior and income.

A little known fact is that *the shortwave listener can also participate*. This can be a rewarding new field for the listener, providing new objectives, better understanding of propagation, handsome certificates to cover your walls, and a new lease on life for your hobby!

Awards and contests exist for radio just as with any other hobby or profession—a desire to compete with your fellows or just to prove to yourself that you can achieve a set goal or simply for the sheer fun of doing it. Contests and awards are usually sponsored and administered by

national radio societies or ham clubs and publications. These activities also have the effect of promoting ham activity worldwide and reminding people that radio is fun!

It's exciting as a listener to get the brightly colored QSL card from that country you needed to confirm—it's a great supplement to your BC/Utility hunting activities and the (often ornate) award certificates do look good hung on the wall above the listening post. (The QSL cards aren't bad either.)

Contests

Ham contests are usually held on a yearly basis—each one tends to occur at roughly the same time of year and usually lasts the better part of a weekend. Each is often targeted at promoting a specific kind of activity (RTTY, CW, SSB, etc.) or communication with a particular part of the world (such as the All Asian Single Side Band

Contest). The basic method of scoring is to amass the maximum number of points by working as many stations in as many different countries as possible. Additional points are awarded for stations in certain areas, whether the contact was with the next county or the next continent, etc.

It's a fun time and good practice at dragging weak signals out of a mass of heterodyne whistles and adjacent channel splatter. All you need to participate as a listener is a receiver, the contest rules and a log book for recording the stations that you hear.

Awards

Awards are a much more sedate affair and can be days, months or years in the achieving. They exist for similar reasons to contests but the target here is not to score the maximum number of points (as in contesting) but to meet the criteria demanded by the creators of the award. This may range from the simple (producing proof of having communicated with ham stations on all six continents) to the difficult (producing proof of having communicated with 30 countries in Oceania on each of the five major HF ham bands).

While a few are ham only, most are open to shortwave listeners as well. The requirements to participate as a listener are similar to those for contesting.

Verification

Once you've logged a needed station, you need to obtain a QSL card from him if you're award-hunting. This is because most award managers usually demand photocopies of QSLs, or a list of QSLs certified by either two hams or your national radio society.

The rules here are very much like Utility QSLing—be accurate in your report, be polite and *always* provide at least the minimum necessary number of IRCs for a reply. (Of course, an interesting and informative report doesn't hurt either!)

National QSL bureaus may also be used to send and receive reports and QSL cards. These bureaus are usually run by a national radio society for the benefit of its members and work as clearing houses for QSL cards—a ham will send

The Scandinavian Amateur Radio Teleprinter Group (S.A.R.T.G.)

takes pleasure in awarding this certificate of merit to

W1/G8LCK LEE REYNOLDS

in recognition of the achievement of gaining 2ND place
S.W.L.
SINGLE/MULTY operator, in THE WORLD
with a total score of 02640 points during the

21ST

S.A.R.T.G.
WORLD-WIDE RTTY
CONTEST

1991



Date 15 NOVEMBER 1991

E. O. Olin

SM4CMG
Contest & Awards Mgr.

S.A.R.T.G. President



QSLs like these can add up to an award.

a number of stamped, self-addressed envelopes for his national QSL bureau plus any outgoing QSL cards he may have for foreign contacts. The bureau will then forward his QSL cards to other bureaus and the foreign bureaus will forward incoming QSL cards to his. The bureau will then use the stamped, self-addressed envelopes to send the ham his incoming QSL cards from abroad.

This is by far the cheapest method of getting QSL cards, but the system is very slow because it uses surface mail for all transactions, and envelopes of incoming QSL cards are only sent to the recipient when they are filled with cards to the weight limit for which they are stamped. In the USA, check with the Amateur Radio Relay League (ARRL), 225 Main Street, Newington, CT 06111, concerning use of the national bureau by SWLs.

If you're participating in a contest rather than award hunting, things are much simpler. After the contest, sit down, reread the contest rules regarding logs and then carefully rewrite your rough contest logs clearly and legibly, making sure that they follow the contest's required format.

Check them for duplicates, errors or incorrect scoring. Try to make things as easy as possible for the contest manager.

If you have a computer, use it to check for duplicate station loggings and to print the contest entry log. A database program serves this purpose well or you can see if one of the QSL/Contest programs available on certain ham BBSes (bulletin board systems) are usable for your purposes. Two good examples of BBSes carrying interesting files are the K4NGG BBS at (703)680-5970 and the N8EMR BBS at (614)895-2553. Look for the following files to give you something for getting started.

DXCC.1ST
DXCC104.ZIP
LOGGER.ZIP
TOTALHAM.ARC

SSMAST.ARC
MACLOG.SIT
CONTEST.ARC
LOGGER12.ZIP.

Once you've done all this, send the log by registered airmail. This avoids the possibility of your precious entry going astray without your knowledge. Double check that you have kept a duplicate log for your own records.

Tips & tricks

Make sure that you can devote yourself to a contest for its full duration—the point here is that only first, second and third places get a certificate (for SWLs sometimes only first!) and you do want to be among the best, right?

If you don't already have them, get a good comfortable pair of headphones. It makes digging signals out of the noise easier and helps alleviate the spouse's desire to kill you after 12 solid hours of radio noise.

If you find a "big gun" station who can really attract the DX, try staying with him for a while. Listen to what he works—this can be a valuable source of additional loggings. Better still, if you have two receivers, leave one on him and tune the other around for additional contacts!

Try special mode listening—get HAC (Hear All Continents) on RTTY or SSTV (Slow Scan TV) for variety. Contest listening is a valuable source of loggings to pursue for other awards even if you're not entering the contest itself. If you find that you need that one Japanese station on 21 MHz to get that coveted award, try looking for it during the next major contest when ham activity is a couple of magnitudes higher.

Some societies that sponsor contests also issue awards. They will often accept a contest log in place of QSLs for an award. For example, you participate in the Scandinavian Amateur RTTY Group contest 1 and send in your log. This makes you a contender for the SWL awards in the contest. Additionally, if you heard the minimum

Bob's Bargain Bin

EQUIPMENT SPECIALS

3 Gaussmeters - \$125.95 - High AND low readings (NEW).

6 Seth Thomas 24 Hour Analog Clocks - \$25.95 - 13" Diameter (NEW).

2 Icom R1 - \$469.95 - 1 with no box, 1 has damaged manual and no dust plug.

2 Speco Amplified Speakers - \$44.95 - one with small scratch, other with damaged box.

2 Dual Digital 12/24 Hour Clocks - \$17.95 - have damaged packing boxes.

1 Bearcat 855XU - \$179.95 - Has damaged box.

Grove Enterprises, Inc.
1-800-438-8155

140 Dog Branch Road
Brasstown, NC 28902-0098



All Prices INCLUDE shipping!

COMMUNICATION AT ITS BEST

AR1000XC \$399; AR2500 \$469;
AR3000 \$969; ATS803A \$195

We now offer extended warranties
We also sell a variety of CBs, Radar Detectors, Caller IDs and much more!

For orders call: 1-800-33 TURBO

Free Shipping

TURBO ELECTRONICS

P.O. Box 8034

Hicksville, NY 11802-8034

Questions welcome (516)938-1946

SHOCKING MANUALS!!

Survival Electronics, Computers, Security, Weaponry, Rock-etry, Phones, Energy, Financial, Medical. 100+ offers include Special Projects and Technical Research Services, and hardware. Confidentiality Guaranteed! Send \$4 for new Combined Catalog. By John Williams, former Senior Engineer (Lockheed), Professor of Computer Science (NMSU). As seen on CBS '60 Minutes.' Since 1971.

SECRET & SURVIVAL RADIO: Comprehensive, detailed manual on the optimum freqs, equipment, modes and circuits for secret, survival and security situations. Includes small transmitters and receivers; ultrasonic, infrared and fiberoptic commo; improving and optimizing antennas. 70-circuit diagrams. \$29.

TV DECODERS & CONVERTERS: Detailed plans for several do-it-yourself better designed TV decoders, descramblers, converters and related devices (cable and satellite). Lists sources. Many tips. \$14.

CELLULAR PHONE MANUAL: Comprehensive, detailed manual on how cellular phone modes are re-programmed (ESNs and NAMs) and scanned. 30+ cellular phone modes described. Specific scanner mode. \$39.

Many more! **STEALTH TECHNOLOGY** (\$19), **PHONE COLOR BOXES** (\$29), **VOICE MAIL BOX HACKING** (\$29), **COMPUTER PHREAKING** (\$39), **BEYOND VAN ECK PHREAKING** (\$29), **STOPPING POWER METERS** (\$19), **RADIONICS MANUAL** (\$29), **EM BRAINBLASTER** (\$29), **HIGH VOLTAGE DEVICES** (\$29), **DISK SERVICE MANUAL** (\$29), **ATMs** (\$39).

SOLD FOR EDUCATIONAL PURPOSES ONLY. Include \$4 for ship/handl.

CONSUMERTRONICS

2011 CRESCENT DR., P.O. DRAWER 537
ALAMOGORDO, NM 88310 (505)-434-0234

number of required station types to qualify for the Worked Scandinavia RTTY Award, you can send a copy of the contest log to the award manager. He will accept this in lieu of QSL cards. This is an excellent way of gaining certain awards without the problem of having to obtain QSL cards.

Here are the details of a couple of the easier awards available to give you a chance to see if award hunting might be for you:

Heard All Continents (HAC)

- All modes
- All HF ham bands except 18 and 24 MHz
- Requires confirmed reception of one amateur station on each of the six continents—Africa, Asia, Europe, North America, Oceania and South America.
- Endorsements are available for SSTV, RTTY or FAX only, also for 1.8MHz, 3.5MHz or 50MHz only.
- Apply to: JARL Awards Section 1-14-2 Sugamo Toshima, Tokyo 170 Japan
- Enclose 10 IRCs for air mail return and a certified list of QSLs from either your national radio society or two hams.

European Award

- All modes
- All HF ham bands
- Requires confirmed reception of 15 different European DXCC (DX Century Club) countries as per DXCC listing.
- Valid prefixes are: C3, CT, CU, DL, EA, EA6, EI, F, G, GD, GI, GJ, GM, GU, GW,

HA, HB, HB0, HV, I, IS, JW, JX, LA, LX, LZ, OE, OH, OK, ON, OY, OZ, PA, SM, SP, SV, SV5, SV9, T7, TA, TF, TK, UA1, UA2, UA3, UB, UC, UO, UP, UQ, UR, Y2, YO, YU, ZA, ZB, 1A, 3A, 4U and 9H.

(A prefix refers to the letter/number combination denoting the ham station's country of origin)

- Various band and mode endorsements are available.
- Apply to: J. Lourens, PA0BN Keerweer 13 6862 CD Oosterbeek The Netherlands
- Enclose 7 IRCs and a certified list of QSLs from either your national radio society or two hams.

Reference Works

Essential for award hunting is a book titled *The KIBV DX Awards Directory*, by Ted Melinosky. This book contains over 250 pages of information on every kind of ham/SWL award imaginable! It is updated regularly and is the award hunter's major reference work. This is your shopping catalog—where you'll look for the awards that interest you and learn what is necessary to acquire them. It may be obtained from Ted Melinosky, P.O. Box 960, Keene, NH 03431-0960.

The Ham Callbooks—both North American and International listings. These provide names and addresses for the hams you log, QSL bureau addresses, international mail charges and other

useful information. These may be obtained from Radio Amateur Callbook Inc., 1695 Oak Street, P. O. Box 2013, Lakewood, NJ 08701.

The latest ARRL *DXCC Countries List*—this is published frequently and is an invaluable guide as to which ham prefixes or countries may be counted toward an award. Given the volatile state of Eastern Europe today, I'd suggest you buy this one as often as a new version is published. It's available from ARRL, 225 Main Street, Newington, CT 06111.

You will also need a source of contest dates and rule listings. Ham magazines (*QST*, *73*, *CQ* and *Worldradio*—often available at a good newsstand or ham store) carry this information, usually two or more months before the event. The definitive source of contest rules will be obtained by writing to the contest manager and requesting a copy of them. This may be advisable because ham radio has changed a lot in the last six or seven years and new modes and bands may or may not have been incorporated into a contest. Do not forget to include sufficient IRCs to pay for return postage.

Well, that's it—I've been award hunting and contesting for some twenty years on and off. I find it to be a fine way to entertain myself and to refresh my enthusiasm for the hobby when BC listening or utility chasing temporarily loses its charm for me. Give it a try and let us know how you do.

M

If you want to learn more about the SARTG contests, you can write to Bo Ohlsson SM4CMG, Skulsta 1258, S-71041, Fellingsbro, Sweden.

— THE SCANDINAVIAN AMATEUR RADIO TELEPRINTER GROUP —
(S. A. R. T. G.)

WSRY
Worked Scandinavia RTTY Award

THE CERTIFIED NAME
W I / S R L C L E R N I N G

HAS THIS DAY SUBMITTED SATISFACTORY EVIDENCE OF HAVING CONDUCTED
TWO-WAY RTTY COMMUNICATION WITH SCANDINAVIAN AMATEUR RADIO
STATIONS IN ACCORDANCE WITH THE RULES OF THE WSRY

EDR
SSA
NRRL
SRAL

affiliated

Karsten Tranberg
Karsten Tranberg OZ4FF
S. A. R. T. G. President

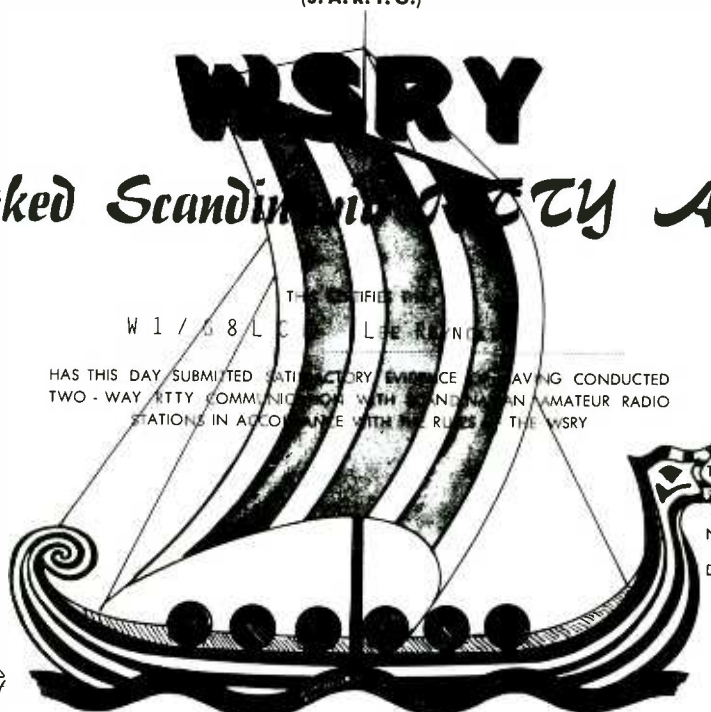

This certificate is issued in recognition
of this excellent achievement.

Number 193

Date 1991-12-31

Bo Ohlsson
Bo Ohlsson SM4CMG
Contest and Award Manager

It's BACK...

...and it's **BETTER!**

The Sony ICF-SW77



For those who have been looking for the next step up, it's here! The new (and improved) Sony ICF-SW77 has all of the features of the popular ICF-2010 (except air band), plus:

- * Front panel tuning dial
- * Separate bass and treble controls
- * 162 non-volatile memory channels
- * Stereo FM (headphones)
- * Station name display
- * 50 Hz fine tuning steps
- * Broadcasting time display
- * 24 hour/local time display
- * 5-event timer
- * Worldwide power supply

NOTE

The re-introduction of the SW77 has shown that Sony has corrected the problems that first occurred with the radio. This new version has improved sensitivity, a longer whip antenna and reduced noise.

Now available from Grove Enterprises for **ONLY**

\$465.95! *(plus \$7.50 shipping)*

Take a leap into the future of technology, the Sony ICF-SW77

Grove Enterprises, Inc.

1-800-438-8155

140 Dog Branch Road
Brasstown, NC 28902-0098

Two April Fools

by Sal Emma



Ever since we were old enough to talk, my good friend and fellow radio nerd Rich and I had discussed our pre-pubescent (and pre-girl-friend) fantasies about building the highest antenna our modest suburban neighborhood would ever have the chance to panic about.

One day, our scheme came to fruition.

The ANGRR/5, affectionately called the "Angry-Five" by its devout aficionados, was a U.S. Army design backpack receiver of Korean War vintage. It was one of our favorite radios because it ran on just about any voltage handy: 12 or 24 volt DC, 120 volt AC, B-plus and 1.5 filament—whatever. The thing probably ran on 400 cycles, too, for all I knew. Plus, it converted DC voltages with reed vibrators and transformers. When you turned it on it sounded like an electric razor.

The reason we loved it so was that we could unplug it from the house, throw it in the truck and take it out on field listening jaunts running from the truck battery.

One day, we were struck by what seemed like a terrific idea.

In a recent package of goodies received from Fair Radio Sales, Lima, Ohio, we had received 500 foot rolls of copper-clad nylon wire "Gibson Girl" emergency transmitter antennas, complete with reels.

We waited for a day when the wind was right.

Listening to NOAA weather at 3 am the night before, we planned the dawn's outing. To the park we would go, with the Angry-Five and the wire.

Dawn came; I slept.

At the crack of eleven, I mobilized.

I pulled on my bluejeans and sauntered over to Rich's house to see if he was awake. He was. Barely.

We hoisted the radio into the truck bed, threw in a few Cokes, called the dog and revved up the chilled engine in the cool spring air.

Our adventure had begun.

We arrived at the park at prime time. Children were running about, playing ball and tag. Young families barbecued. Moms and Dads relaxed in the cool spring sunshine as the smell of barbecued dogs and burgers filled the stiff breeze.

Everyone was happy to be out after a long winter of cabin-fever.

The stiff spring breeze was perfect.

We found a good spot, away from power lines, parked the truck and got out.

Immediately the dog diverted our well-laid plans. She spotted a Frisbee in mid-flight and intercepted it before either of us could divert her attention. She would not let anyone get near her, Frisbee tightly clenched in her teeth.

Rich and I and the Frisbee's bemused owners chased her down for what seemed like an hour and a half. Probably no more than ten minutes.

We finally tired her out, grabbed her, returned the drippy Frisbee to its rightful owners with chuckles, apologized, and got the dog on her leash.

We dragged the radio to the tailgate, connected the alligator clips to the truck battery and turned it on to get the tubes warm.

Found the copper roll and...the kite.

It was a big, powerful, rip-stop nylon bat-kite, deluxe model. Stable in flight and real strong in wind.

As soon as we got her spars and bridle together, she wanted to fly. It took the two of us to steady her as we got the copper hooked on, then let her loose.

Zzzzzz—the copper spooled off at break-neck speed as the kite soared high over our heads. In a matter of seconds, we neared the end of the spool and the kite looked like a matchbook in the sky.

The spring wind sang in the copper line. Humming a merry tune, changing pitch with the wind speed.

"Ready?" we asked each other.

"Let's do it."

I reached for the line, preparing to make the connection to the Angry's antenna terminal.

Before I actually touched it, a blue spark

leapt to my fingertips and knocked me on my Watusi.

I looked up at Rich from my new vantage point on the ground.

He looked back.

"What the —?"

I rose and studied the seemingly innocent copper line, still singing merrily away.

We were in the middle of practically nothing. The radio was running on 12 volts. The wire was connected to nothing except the kite. We were puzzled.

"You try it," I said to my comrade.

Rich steadied himself with one hand on the truck and carefully approached the wire.

BLAMMO. The wire bit again amid our howls of laughter.

We looked at each other and were suddenly enlightened.

Static. The wind whipping across the ungrounded wire was acting like a huge Van de Graff generator. Charging up like a bog capacitor in the sky. I gritted my teeth, grabbed the wire, and got a shock I felt all the way down to my toes. This time I held on.

I managed to get the wire hooked on and the antenna terminal tight without my hair standing on end.

We turned on the speaker, hoping to hear Ghana, Pyongyang, Caroline or some other exotic, low-power, elusive DX catch.

No such luck. With our 500-foot tall Leyden jar we were lucky to hear Moscow over the mammoth static crashes as the wire discharged through the radio.

We had succeeded in putting up an antenna higher than either of us had ever dreamed in our toy walkie-talkie days.

And all we could hear was static, as the befuddled bystanders peered over their newspapers and barbecues watching these two April fools before them.

A Change in Attitude

By Bruce Bair

It was just sheer frustration that prompted me to purchase a Radio Shack Model 2005. My job as area reporter for a daily paper in a rural area required me call 21 counties each morning, in an area of about 100 by 150 miles, gathering news of fires, accidents, and crime.

But though I had been making the calls for four years, I knew that I wasn't getting nearly all of the news. There is a natural animosity between police and reporters, animosity that takes years of work and trust to overcome. I frankly thought the sheriffs were deliberately hiding news from me, and sometimes I couldn't help but betray that resentment over the phone.

Finally, I got fed up, and spent nearly \$600 on the scanner, a discone antenna for my roof, and a magnetic mobile antenna for my car. If I couldn't get the information from them over the phone, I'd by God intercept it over the airwaves. The local Radio Shack provided a list of all the local frequencies, from police stations to school bus networks, and I became a bit of a fanatic, setting up a voice activated tape recorder next to the PRO 2005 so I could hear in the morning what went on at night.

I could never get the tape out jack to work properly. For some reason, it always activated the tape machine whether anything was coming over or not. My family didn't like to listen to the sometimes squawky reception over the internal loudspeaker, but at last I thought to place a pair of stereo earphones over the recorder microphone, and that worked just fine.

Because I live in a country home in a shallow river valley, my reception was limited to a radius of about 40 miles, unless conditions were excellent, but that radius included the closest and therefore most important counties on my beat, and thus I was satisfied with the reception. Besides, anything big that happened was relayed to every sheriff's office through the Highway Patrol network, so I found it didn't matter if I couldn't hear every county.

And I never was fanatic about performance. I used an old piece of RG 59U for the antenna run, which is about 100 feet too long, and runs through two splices. I estimate the tip of my antenna is

about 30 feet off the ground, which doesn't even come close to bringing the tip over the lip of the river valley.

The scanner paid off quickly. Hardly a day went by when I didn't find at least some little tidbit to report on, like a garage or barn fire, and sometimes, the scanner provided me with leads to major news, such as four-county chases, and once, a major downtown fire.

I wasn't worried about risking my relationship with the officials, because prior to purchasing the scanner, I figured I really didn't have any. At first I enjoyed asking sheriffs if anything had occurred the night before, being told that nothing had, and then asking, "what about that fire?"

But after listening to the scanner for a month or more, I began having more and more respect for the police, firemen, and ambulance attendants that I had routinely reported on for years. The scanner gave me a window into what their lives were really like, a window I hadn't had before.

Mostly, the police were out there working weary hours late at night, helping people. I don't know how many calls I heard where they went to assist stranded motorists, or made sure a young woman and her child who ran out of money on the interstate had a place to sleep for the night, and money to get on down the road, and often, I discovered, the money came from the cops' own pockets.

Late at night, the radio discipline would break down a bit, and the tired voices would joke a little to alleviate the boredom, and gradually, I began to assign faces to the voices. There was old Dusty, laconic and calm, and the county dispatchers, clucking like mother hens, checking the welfare of their officers, and I admit, nasty voices, too.

One of them conducted a six-months pogrom against this nemesis, a speeding green '76 Firebird, which he chased on Saturday nights down dirt back roads, unable to get close enough to make the arrest because of the dust. The driver knew all the tricks, and had a switch in his car which would turn off the tail lights, but not the headlights, perfect for nighttime games with the cops. I still listen to the scanner. It's still going on. And the cop's voice on the radio is getting bitter.

And it was surprising how often they were risking their lives, maybe talking some drunkard

with a high powered rifle who had barricaded himself inside his home into giving up. I never heard about those incidents before, because many of the rural sheriffs considered them humanitarian missions rather than opportunities to arrest someone. Once they got the person to unblock the door, they got him help, and there was never a record.

My whole attitude towards police shifted. When I asked them about something I heard had happened, I told them I had heard it on the scanner. Instead of being angry that I was spying on them, most were interested in what kind of scanner I had. Almost every policeman has one, and uses it to monitor channels not available on his two-way radio.

I began to realize the way into the hearts and confidence of the police was to become interested in things they were interested in. They would talk for hours about scanners, two-way radios, the virtues of semi-automatic pistols versus revolvers, and even what kind of foot wear was best for a cop. All of those topics worked into stories and one about a police department which was experimenting with patrolling with sports cars made the national wire.

In the morning, I would transfer my scanner from my home to my car and the mobile unit helped me track down where the action was. I was always careful to stay out of the way, and unlike many of the competing reporters, was conscientious about parking behind police lines, politely asking access, and walking to the site if given permission. I found if denied access, a pair of binoculars was often just as handy as being there. I could ask the questions later.

By being Johnny on the spot, the rank and file officers and firemen became used to me, and I found instead of being taciturn (except when engaged in a criminal investigation), they would be quite talkative. It is a long standing frustration with police and firemen, that often their stories aren't told accurately or aren't told at all. By being there and interviewing the rank and file, my stories were the best, and because I took the trouble to listen to the off-hours scanner chatter, I often had a good idea of the background, and could ask better questions.

As it turned out, the scanner made me not a spy, but a friend.



Shortwave Broadcasting

Glenn Hauser

Box 1376-MT

Mesilla Park, NM 88047

AFGHANISTAN (non?) A new Mojahedin station, Radio Payame Azadi (Message of Freedom) claims to broadcast from within the country, on 7100, at 0130-0300 and 1400-1500; then confirmed at 0200-0300 and 1400-1500, first halves in Pashto, second in Dari; later announced change for morning show to 0115-0315, and 7090 instead (BBC Monitoring)

Voice of Unity, first heard in 1980, missing since November 1991; transmitters thought to be in Egypt (BBCM)

ALASKA KNLS tentative English from March 29: 0800-0900 on 7365, 1300-1400 on 9660 (Bob Padula, *Australian DX News*)

ALBANIA Europe's premier split-frequency station, Radio Tirana: 6888.7 in German at 1700 (Harald Kuhl, Germany, *Play-DX*) 7182.0 replaced 7156.3 in Albanian at 2130-2200, parallel 9724.8 (Wolfgang Bueschel, Germany, *DSWCI SW News*) Tentative, seems home service at 2000-2200 on 7238.2v; three days earlier on 7242.8v (Ernie Behr, Ont.)

ANGOLA Voice of Black Cockerel site at Jamba has diesel-fuelled transmitters, four studios in metal cargo containers, two antenna towers. Bombed during war by Angolan air force MiG-23s, but ineffective from high altitude (*DXSF* via *Play-DX* via Gordon Bennett, *WDXC Contact*)

AUSTRIA Radio Austria International announced additional times for *SW Panorama*, Sunday 1030 and UTC Monday 0330, but at first the latter on 9870 continued with alternate program. Best at 1130, 1530 on 21490, 0630 on 6015 (*World of Radio*)

BOLIVIA Radio Capitan Victor Ustariz, La Voz del Tropico, at 2300 on 4435.13; ten days earlier at 0100-0200 it was on 4456.39, which had replaced 4435 (Juan Carlos Codina©, Peru, via Dario Monferini, *W.O.R.*)

Radio Frontera uses 4449.5 though authorized on 4855; Radio El Tropico on 3405, not 4775. Radio Batallon Colorados has been inactive on 6185 for some time, but plans to return (Takayuki Inoue Nozaki, *Relampago DX*, via *Radio Nuevo Mundo*)

BOTSWANA New VOA relay disappeared from 15445, but this must be the new one on 15495, 1600-2200 in English (Ernie Behr, William Westenhaver, Edwin Southwell) So the harmonic we heard would now be on 30990.

BOUGAINVILLE Radio Free Bougainville heard on 3880, not 3890, from 0845 'til buried by Asian hash at 1100 when started repeating tape giving schedule of 0750-1120; lots of IDs, music programs, addresses (David Norcross, Guam, *W.O.R.*) Fairly good here from 0900 until 1112, Pidgin and English with music at 1045-1100. Address is Humanitarian Aid Coordinator, P.O. Box 1203, Honiara, Solomon Islands (Arthur T. Cushen, New Zealand) 3880 barely audible from 0943 to anthem at 1102, US ham QRM earlier, RFB presumed, undermodulated (Walt Salmaniw, with a beverage on Vancouver Island, *W.O.R.*) Irregular since mid-February due to fuel shortage (N. Takahashi, Radio Japan *DX-Corner*) Radio Australia reported RFB is at Arawa (Diane Mauer, WI) And Sam Voron, the Australian ham who set it up, may be prosecuted.

CHINA Radio Guangdong is new regional English station, plans to add shortwave (Reuter via HCJB *DX Partyline*)

COLOMBIA Ecos del Atrato, 5020, reactivated at 0015-0030 (Giuseppe Zella, Italy, *Play-DX*) Caracol, 6075, had ID in French at 0628 (T. Sejimo, Japan, *RNM*) And in Russian on 6150 at 0227 (Roland Schulze, Germany, *Fine Tuning*) La Voz del Guainia, 3499.00, opened with anthem at 1015, gave ID as HJWC on 630, good but slightly muffled (Chuck Bolland, FL, *W.O.R.*)

Colombia-DX program on Radio Nacional, 11822.5 Saturday at 2330, in Spanish instead of English, contained no DX news (*W.O.R.*)

CONGO RNC, Brazzaville: 0400-0700 on 5986, 4765; 0700-1100 on 9610, 7105; 1100-1700 on 15190, 11710; 1700-2400 on 5986, 4765. Pointe Noire inactive on 4843 (BBCM)

COSTA RICA Radio for Peace International reactivated 13630 on USB; consolidated UN and other news, commentary programs into *RFPI Reports*, weekdays 1945-2000, 2130-2200, 2345-2400 plus repeats eight hours later. But a quarterly program shuffle occurs April 1; new times planned for *World of Radio* are Tuesday 1930, UTC Wednesday 0330, Friday 2000, Saturday 0400, 1900, Sunday 0300, 2300, Monday 0700—but we've requested they keep Saturday 1830, Sunday 0230 to avoid conflicts. Also check 21465, 15030, 7375.

Faro del Caribe announced it would be silent the first half of 1992 in order to move transmitter site to Heredia, later studios too; but it was still heard early in the year (Manual A. Rodriguez L., *The Radio News* via HCJB *DXPL*)

CROATIA Zagreb announced Americans could hear news at 2100 on 17272 (BBCM) No trace (gh) 7240 and 9830 came back with very strong signal from 2200 with Croatian and English news (Ernie Behr, Ont., *W.O.R.*) New on 4990 at 0520 along with 9830 (Dave Kernick, England, *BCXC Communication*) Sites of these frequencies are secret, making me wonder if really inside Croatia, though certainly in Europe, not WHRI (gh)

CUBA RHC will test on 25800 this spring when propagation is favorable (Arnie Coro, *DXers Unlimited*) *DXUL*'s first Saturday broadcast has moved to about 2035 on 17705 (Daryl Rocker, NY)

(non) La Voz del CID programs include Tito Hernandez imitating Castro on *Tia Tata Cuenta Cuentos*, daily at 1120 on 6305, 1720 and 0410 on 9942. Messages from Comandante Huber Matos, head of CID are Saturdays at 0200, 1100, Sundays 0100, 1100, 1700, Mondays 0200 (via *Radio Magazine*) Probably one UTC hour earlier shortly on DST.

ECUADOR During a prime west-coast half hour, 0430, there is no English on HCJB, but Japanese on some frequencies, German on others, and—Kikongo! until 0445 on 15115, 11730, with more at 0530-0545 on 15140 and 11960 (via BBCM) HCJB's Quito box number has been changed to 17-17-691, and don't forget the continent, South America (*DXPL*)

Power failures and then surges when it returned burned out some shortwave transmitters, such as Radio Cumanda, 3351, now back around 1100 or 0300; and Ecos del Oriente, missing for a while from 3270, stations we visited. Back on after long absences were Radio Antena Libre, 3240 at 0051; Radio Luz y Vida, 4851 at 0115, 1145; La Voz de Saquisilí, Radio Libertador on 4900. Stations recently missing: 3290, 4212, 5062. Regularly active: 3280, 3286, 3395, 4795, 4800, 4840, 4920, 4950, 4960, 5011, 5030, 5050, 5965, 6000. La Voz del Upano added a fourth frequency, 5020 heard at 1145, with four different programs (Rich McVicar, *DXPL*)

HCJB's Quechua frequency, 6079.93, put strong spurs around 6102 and 6057 at 0102, 0203 with evangelical program. Radio Continental, Macas, nominal 1320, heard on fourth harmonic 5276.95 varying to 5277.46, at 0028-0139 with canned ID, adstring (Juan Carlos Codina©, Peru via Monferini)

EL SALVADOR Radio Venceremos announced will now operate openly from San Salvador on 100.5 and 6.7 MHz at 0000, 0200, 1200 daily; heard on 6750 at 0053-0123, 0157-0320 (BBCM) One night



Shortwave Broadcasting

at 0313 on 6800; week later at 0002 on 6750 (Hans Johnson, MD, *W.O.R.*)
Radio Farabundo Marti wants to be legalized, but stay in Chalatenango.
Has softened its tone and content on FM 97.7, 92.5, 91.7 (BBCM)



FRANCE RFI's excuse for dropping the 0315 English broadcast was that Asian priorities left only one frequency for it, insufficient. That's nonsense, as one good frequency from French Guiana could and did cover all of North America. Plans to add more English eventually.

GEORGIA Georgian Radio First Program at 0300-1600 on 7125, 1600-2100 on 15240; and on 5040 throughout; Second Program at 0230-2300 on 4875 (BBCM) External English heard again at 0600 on 11803 (BBCM via Sweden Calling DXers)

HONDURAS Radio Luz y Vida, HRPC (Honduran Radio Proclaiming Christ), 3250, has added more English to increase international audience: *International Friendship Program* at 0330 UTC Sunday and Monday; *America Sings* weeknights at 0315-0345. Fax 504-57-03-94 (HCJB DXPL)

INDONESIA RRI Sorong, Irian Jaya, 4874.6, heard with English program for tourists, 1135-1150 Saturday, with Jinling interference at times (David M. Clark, Ont., *Fine Tuning*)

IRAN (non) Radio Azadi (Freedom) may have replaced Radio Iran, believed from Egypt, at 0230-0300, 1830-1930 on 15650, 9400 (BBCM) Seda'ye Mojahed believed to be station constantly changing frequencies in 0233-0423 period on three parallel transmitters: 4670-5070-6255, 4685-5060-6270, 4710-5075-6220, 4725-5070-6225, 4710-5070-6270 (Brian Alexander, PA, *W.O.R.*)

IRAQ Radio Iraq at 2315-0115 on 11830 and 15445, not 15455; often so distorted one can't tell English from Arabic, and timings vary widely (Bill Peek, NC, *W.O.R.*)

(non) Voice of Rebellious Iraq left 7097 for 6330 kHz at 1730, two-hour broadcasts also scheduled at 0430, 1230; may be one hour earlier in summer. Supports Islamic revolution (BBCM) Radio if Iraqi Republic, Voice of Iraqi People used 9985 at 1450-2320, then 9980 until 2107 switch to 9570, very irregular (Ernie Behr, Ont., *W.O.R.*) Around 2000 on 17965, 15611, 9985, which was covered by WCSN (Brian Alexander, PA, *W.O.R.*) Heard jammer behind WCSN 9985 at 2000 and 2200 (Bill Dvorak, WI) WCSN soon abandoned 9985.

ISRAEL Overseas broadcasting might join domestic in drastic March budget cuts (Radio Netherlands *Media Network*) But IBA kept promoting a March 29 time change for English, Sunday-Thursday 1300 instead of 1400, and again beamed to Australia. In his newspaper column, William Safire blames Secretary of State Baker for blocking construction of the VOA relay in Israel (via Will Martin, Kevin Klein)

ITALY Voice of Europe, 13666, testing daily except Sunday from 0800 past 1400 (Dario Monferini, Italy) Also heard 1400-1510 on 13666.05, very, very weak with continuous pop music, 1502 quick ID (Brian Alexander, PA)

JAPAN Radio Japan began March by dropping 9505 for 11865 at 1200-1930 (Daryl Rucker, NY) A week later, *DX Corner* changed hosts again, to Hiromi Ito (Bruce MacGibbon, OR) Show will get new name and regular contributions from Ian McFarland in April (Bill Westenhaver, SPEEDX) Expect usual DST shift on the Canada relay 5960 to UTC Mondays 0130.

KASHMIR (non?) Voice of Freedom of Kashmir has one-hour broadcasts in Urdu and Kashmiri at 0230, 1100, 1430, 1630 on 5000 and 6300; at 1630 also on 4085 ex-5900 (Mohammed--, Pakistan, NHK, *DX Corner*)

KIRIBATI Best fidelity on 14917.7 is *Country Western USA*, UTC Sundays 0630 (David Norcross, Guam, *W.O.R.*)

KURDISTAN (non?) Voice of Iraqi Kurdistan was on 6295 at 16723-1730, scheduled 1600-1730 also on 1615 kHz, 0430-0600 on 6295 and both times varying 5135-5155; in February replaced 6295 with 4175. Voice of the Kurdistan Revolution is new on 6716 at 0500-0700, 1400-1545, in Kurdish, Arabic, some Persian, maybe one hour earlier in summer (BBCM)



KUWAIT Radio Kuwait resumes shortwave service in Arabic, 500 kW at 0400-1305 on 6055, 1315-1745 on 11990, 1800-2300 on 15505, starting February 17 (Kuwaiti Embassy, Washington) Confirmed that day on 15505 at 2245-2310, to return at 0225; first time heard since Aug. 3, 1990 (Hans Johnson, MD) Transmitter hall blown away in the war, but antennas OK; hoped to resume English a week later (RNMN) but did not; previously was at 1800-2100.

LAOS (non) Russian relays of Vientiane in French at 1100-1130 are on 17860, 15190 (BBCM)

LATVIA WWCR may block Riga on 5935 all night, but earlier at 2130-2135 weekdays the domestic first program has news in English (BBCM)

LEBANON IBRA Radio, Niagara Falls, will cease broadcasting via Malta on April 1, instead in English via Voice of Hope, 11530, Sundays 1900-1930 (Peter Robinson, WDXC *Contact*)

LITHUANIA Radio Vilnius reported a sixfold increase in transmitting costs, so reception reports are more important than ever, at 0000-0030 on 7400, 17605, 17690 (Bill Peek, NC, *W.O.R.*) That's for Ukrainian and Russian relays; also 9750 in Lithuanian at 0200 (BBCM)

MOROCCO Rabat heard weekdays only in English at 1620-1658 on 17595 (Harry Riddell, NY) And Sundays only at 1900-2000 on 11920 with news and music (Brian Alexander, PA, *W.O.R.*) So don't take for Ivory Cote on same frequency daily at 1833-1930.

NETHERLANDS Spanish DX reports from your columnist are now scheduled on *Radio Enlace* the first Friday of the month, continued on the second; such as UTC Saturdays 0002 via Bonaire 15315.

NEW ZEALAND ZLXA, Print Disabled Radio, 3935, excellent at 0715 with *Unshackled*, 0729 ID, religious news, 0803 sign-off but carrier open past 0815. Should be a fairly easy catch (Walt Salmaniw with Nick Hall-Patch's beverage on Vancouver Island) Almost certainly heard at 0711-0801 week earlier on a Sunday (John Fisher, Ont., *FT*)

RNZI changed schedule March 15 with the end of DST: 1650-1845 on 9670, 1845-2130 on 15120, both daily except Saturday; 2130-0800 on 17770, 0800-1205 on 9700 both daily; occasionally for sports 1205-1645 on 9510. From May 3, 11735 replaces 15120 (Adrian Sainsbury, RNZI) Tested 7305, 9525, 9645, 9745, 15305; Saturdays 1700-2100 in January and February, will probably use 15305 from October (Arthur Cushen, NZ)

NICARAGUA Radio Miskut was the station trying 4560, 4590, 4870 in December, then on 5560 (Terry Krueger, FL, *Play-DX*) Planned to resume 4560 in March (R. Pavanello, *Play-DX*)

PALESTINE (non) Voice of Palestine, 15202, Arabic at 1740-1759 (Richard A. D'Angelo, PA) That would be via Algeria.

PERU Naylamp, Estacion Pucara on 4079.42 varying to 4080.42 at 0000, half an hour later on 4082.7, formerly around 4300, and announces 1150 AM. Radio Regional, 4299.85, in San Marcos, at 2321 when Pucara was also on frequency; previously two more Peruvians had used 4300, Radio El Puerto and Radio Moderna, but subsequently none were heard on 4300. Radio Uno, Huanuco, at 2330 on 4512.74, requiring FM slope detection as usual.

New station from mid-February on 5066.86 is Ondas del Sur-Oriente, Quillabamba, 0034 romantic music, 0101 lots of ads, very

Shortwave Broadcasting

professional, at 0200 sports remote. On 5120.87, unID perhaps Cuzco area with relay of Family Radio. 5699.75 to 5699.87, Radio San Ignacio at 2330 with a special program *Radio Maratona* jointly with Radio Ruder, 5269.60, but not in parallel. 6093.07, new station in Cuzco, Radio Universal, 2325-2358 sign-off, "la soberana del dial," no anthem at closing (Juan Carlos Codina©, via Dario Monferini, *Play-DX*)

PHILIPPINES FEBC has three DX programs: *DX Dial*, Mondays 0145 on 15450, Thursdays 1540 on 11995; *DX Report*, Saturdays 0120 on 15450, Sundays 1440 on 11995; *DX Spot*, for beginners, Fridays 1350 on 11995 (Alok Dasgupta, India, *Australian DX News*)

POLAND Dropping the 0630 broadcast will practically eliminate all listening possibilities of our listeners in North America or New Zealand. We're extremely sorry for that, but there's not much we can do about it (Polish Radio Warsaw via BBCM) English hours were then: 1300 on 6135, 7145, 9525, 11815; 1600 on 7285, 9525, 11840; 1800 on 7145, 9525; 2030 on 6095, 6135, 7145, 7270, 9525 (via Tom Kuca and Bill Peek)

ROMANIA Spain's Radio Exterior has reached agreement to use Former Radio Espanya Independiente transmitters here, once clandestine against Spain, for relays to eastern Europe. Had been closed for a sesquidecade, last on 7690, 10110, 12140, 14585, 15505 (BBCM)

RUSSIA Unlike last year, DST begins March 29, with Moscow UTC+4 (A. Osipov, *Play-DX*) Lots of frequency changes that day, and RMWS in Russian becomes Voice of Russia. RMWS in English becomes Radio Moscow International by June, when government funding must be replaced by independent sponsorship (RNMN) Relays in Moscow area via former shortwave jammers of Republic stations have been cut; only Azerbaijan, Belarus, Georgia, Kazakhstan, Lithuania, Ukraine and Uzbekistan remain (BBCM)

USB feeders with Radio Rossii instead of Mayak: 12175 at 1600-2000, 18195 at 1230-1600, 18870 at 1230-1700; still Mayak, 9180 at 1600-2300; RMWS in English on 10344 at 1530-2300, then Ukrainian services (Alan Roberts, PQ) Radio Kiev on that at 0100 (Bob Thomas, CT) And until 0500 (Walt Salmaniw, BC)

Via RMWS in Russian is a service called New Wave (*Novaya Volna*) promoting business with English announcements, Tuesdays, Wednesdays, Fridays and Sundays at 0700-0800, 1700-1800 (BBCM) Radio Galaxy was new commercial station in Moscow with business news in English, 2000-2300 on 9880 called "9.8 MHz." Supposed to be a local Moscow service on FM, but got a 700 kW SW transmitter by mistake-closed down, then came back with lower power (Vasily Strelnikov, RNMN) Polyus, private station in St. Petersburg is on 6045 around 0430-1400 (RMWS *DX Klub* via BBCM) Radio SNC, named for a rock promoter, is heard on 11735 at 1300-2000 for St. Petersburg. New independent station using former jamming site near Moscow is Radio Space, 20 kW on 11945 at 1500-1545 (Strelnikov, RNMN)

Radio Pamyat, right-wing station, moves to 12040 March 29 at 1530-1700; actively seeks reports (James Jordan & Clive Rooms, WDXC *Contact*) Has five QSL cards (A. Klepov, *DX Moscow* via *Play-DX*) AWR via 250 kW Novosibirsk uses nine languages, 9835 at 1700-2000, 2100-0100, 11855 at 0100-0800, 0900-1700, with English hours at 01, 07, 13, 19 (Radio Japan *DX Corner*)

SAIPAN KFBS has English at 1930-2000 on 9465 (Paul Blumstein, *SW Echo* via Kirk Baxter) Beware co-channel WMLK except Saturdays (gh) KFBS is on 9460 (Arthur Cushen, RNZI)

SEYCHELLES April sked for FEBA's two conflicting English services: to South Asia, 1500-1540 (Sunday to 1555, Saturday to 1615) on 11690; int'l program 1500-1600 Tuesday-Saturday on 9810, 15330

SOUTH AFRICA With Spain off 9630, Radio Oranje often good from 0510 to 0725 when Bonaire comes on; seems less Afrikaans,

more English than ever (Bill Peek, NC, *W.O.R.*)

SRI LANKA SLBC was to start North American service March 3, 2330-2400 on 15425 using 300 kW NHK Ekala transmitter; 0445-0515 using own lower powered 15425 and 9720, beamed 35° to western North America (Victor Goonetilleke, RNMN) Nice, but should get time on NHK via French Guiana! At 2330 nothing but Germany and Moscow were available on 15425.

SWITZERLAND SRI starts new look and new sound March 29, dropping some languages, starting each block with English at hourtop, still 0200 and 0400 to North America, others at 06, 09, 11, 13, 15, 17, 20, 22, 24. Second half of *Dateline* weekdays will have specific topics, e.g. Mondays science and tech, Wednesdays business and economics, Fridays culture and arts (Larry Nebron, *SW Echo* via Kirk Baxter) Saturdays will juxtapose *Grapevine* and *Merry-go-round* contact shows (The Two Bobs)

TAIWAN From March 29, WYFR via VOFC: English 1302-1502 on 11550; Hindi 1502-1602 on 11550; Mandarin 1102-1602 on 5275, 9280; 2100-2400 on 6300, 2100-2300 on 9280, 2100-2200 on 9955, 2200-2400 on 9465, 2300-2400 on 11550; Russian 1505-1705 on 9955. One change in VOFC English via WYFR, 2200-2300 on 17750, 21720 (WYFR)



UAE Abu Dhabi has neat letters program at 2300 Mondays, sometimes other days (Mrs. Leslie Edwards, PA) During Ramadan until April 4, English at 2200-2400 is on 13605 only, then joined by 9605, 11965 (UAE Radio via Edwards, *W.O.R.*)

UKOGBANI After 67 years, BBC Davenport site closes March 29. Hams in the Ariel Radio Group will commemorate it April 4-5, 11-12 as GB67XX using the old broadcast antennas on 80, 40, 30, 20, 17 and 15m (Giles Herbert via RFPI) RCI relays shift to Skelton (William Westenhaver) Radio Japan begins relay to Europe via Skelton July 1 (*Radio Japan News* via Daryl Rocker) BBC begins Ukrainian service March 29, half hour daily (Bob Padula, *ADXN*)

UKRAINE Since Feb. 1, about 20 transmitters formerly carrying Moscow services have been taken over for Kiev domestic and foreign programs, especially the Promin second program, found on 20 frequencies from 6020 to 21800 at 1030-1400, and on some frequencies between 0200 and 2300 (BBCM and Westenhaver) However, due to electricity costs rising 27 times, the Lvov site stopped domestic service and then closed entirely; it had been a major Radio Moscow outlet (BBCM) In Ukrainian, it's Lviv (Arto Mujunen, *DX-tra* via *SW Echo*, Baxter) see RUSSIA.

USA From DST on April 5, look for programs on WWCR and WRNO one UTC hour earlier. Aside from unexpected permanent time changes, *World of Radio* will then be on WWCR Friday 2130, UTC Sunday 0305, UTC Monday 0500, 2100; on WRNO UTC Sunday 0000 and 2030. WRNO-FM has been for sale; if and when sold, expect simulcasting to cease and SW programs to originate more reliably from transmitter site. WJCR, Upton, KY, planned to start using one 50 kW transmitter on 7490, mostly gospel music, and *Prayerline*.

Via WWCR, *Radio Khalistan*, Punjabi clandestine program moved to 2230 Mondays on 12160; *Voice of Kosovo*, in Albanian, Tuesday and Thursday 0730-0800 on 7435; *Young Albanian Exiles* has been Sundays 0700-0800. Inactive KJES is on The Lord's Ranch, three miles east of the I-10 Vado, NM exit, with a 19-element log periodic. VOA says the next language it will add is Kurdish (*W.O.R.*)

VIETNAM Hoang Lien Son divided into two new provinces, resulting in new station, Radio Yen Bai, 6463 at 1000-1030, 1130-1215 (Isao Ugusa, Radio Japan, *DX-Corner*)

Broadcast Loggings

Thanks to our contributors -- Have you sent in YOUR logs?

Send to **Gayle Van Horn, c/o Monitoring Times.**

English broadcast unless otherwise noted.

0000 UTC on 7345

CZECHOSLOVAKIA: Radio Prague International. Newscast to rock music and cultural-oriented news. Very good signal. (Andrew Lawrence, Perry, NY) Prague heard on 5930 kHz at 0300 UTC and 7345 kHz at 0400 UTC. (John Carson, Norman, OK)

0000 UTC on 7315

UNITED STATES: WHRI-Croatian Radio Zagreb. Intensive monitoring of WHRI's relay conducted over a four day period beginning at 0000 UTC. News reports on Croatia (Yugoslavia). Station IDs noted in English and Croatian at each hour, and program "News and Current Affairs." Filler music between the segments. Occasional broadcast delays due to technical difficulties, and sign-offs at 0009 and 0020 UTC on two days. (Stephen R. Hunter, Drexel Hill, PA) *Special thanks to Steve for his two pages of extensive loggings! - Ed.*

0010 UTC on 4799.8

GUATEMALA: Radio Buenas Nuevas. Spanish. Guatemalan music program, with frequent station IDs. (Dave Frenz, Milwaukee, WI) Guatemala City's Radio Caiman monitored on 9965 kHz at 1456 UTC. American pop/rock tunes and Spanish commentaries. Scott Billingsley, Camden, AR) Radio Cultural heard on 3300 kHz at 0252 UTC. (Carson, OK) (Frank Hillton, Charleston, SC)

0030 UTC on 15575

SOUTH KOREA: Radio Korea. News, Korean music, and commentary. Listener's letter box segment and interesting DX tips for shortwave. (Perry, NY) North Korea's Radio Pyongyang audible on 11700 kHz at 2307 UTC. (Robert E. Tucker, Savannah, GA) (Karen Campbell, Sacramento, CA)

0030 UTC on 17605

BELARUS: Radio Minsk. Russian. Interval signal and station ID, "Gorvit Minsk." Newscast at 0038 UTC, into Russian music and chat from announcers. (Carson, OK) Azerbaijan's Radio Baku heard in Russian on 4785 kHz at 0330 UTC. (Ernest Lawrence, Perry, NY)

0031 UTC on 9022

IRAN: VOIRI (Voice of the Islamic Republic of Iran) Station identification, Holy Koran readings and recitations. News on Israel and editorial on the Palestinians. (Tucker, GA) Similar editorials observed from Libya's Radio Jamahiriya on 15235 kHz at 1930 UTC. (Dave Frenze, Milwaukee, WI)

0045 UTC on 11710

ARGENTINA: Radiodifusion Argentina Al Exterior. Spanish. Argentine folk music to "RAE" ID. "Latitude South" program audible in English on 11710 kHz at 0148 UTC. Station also is identifying as "Radio Nacional" (Carson, OK)

0056 UTC on 4985

BRAZIL: Radio Central. Portuguese. Popular music of Brazil to evening comments. Signal strength fair, with interference from Venezuela's Ecos del Torbes on 4980 kHz. Local time check for Goiania and "canned" frequency schedule to station promotional. (Hillton, SC) Brazil's Radio Nacional da Amazonia noted at 0800 UTC on 11780/6180 kHz. (Patrick S. Barry, Mission Viejo, CA) (Carson, OK)

0105 UTC on 4980

VENEZUELA: Ecos del Torbes. Spanish. Local time check at tune-in into Latin pop vocals. Station ID, public service announcement and musical intros. Venezuela's Radio Rumbos also audible on 4970 kHz at 0110 UTC, with lively Latin salsas and "canned" Rumbos IDs. (Hillton, SC)

0130 UTC on 6145 UTC

GERMANY: Deutsche Welle. Peggy Graham with "Maibag" show into "German Why Not?" language program. (Carson, OK) (Jack R. Davis, Birmingham, AL) German service noted at 0334 UTC on 3995 UTC. (Tucker, GA) (Brian Dougherty, Harrisburg, PA)

0200 UTC on 9475

EGYPT: Radio Cairo. Opening IDs, comments, and Egyptian music. "The Holy Koran & its Meaning" feature on the fate of the unbelievers. Monitored to 0240 UTC. (Nicholas P. Adams, Newark, NJ) (Carson, OK) (Brian Bagwell, St. Louis, MO) (Hillton, SC) (Rose Carmine, Sidney, OH) (Davis, AL)

0225 UTC on 4919.9

ECUADOR: Radio Quito. Spanish. Romantic guitar ballads to 0229 UTC. Evening time check for Quito, local merchant commercial, and ID "Radio Quito, la voz de la capital." (Ed)

0230 UTC on 11821.5

COLOMBIA: Radio Dif. Nacional. Spanish. Colombian pop vocals to "Nacional" identification, monitored to 0315 UTC. Caracol Bogota audible on 6075 kHz at 0600-0630 UTC. (Barry, CA)

0235 UTC on 17640

PAKISTAN: Radio Pakistan. Slow-speed English news to 0245 UTC, and indigenous music. (Frenze, MI) Station also monitored on 21574.4 kHz at 0525 UTC. Interval signal, prayers, and sign-on with IDs, frequency quote in unidentified language. Continued prayers to music at 0538, leading into a radio drama. (Jerry Witham, Keauau, HI)

0330 UTC on 21480

RUSSIA: Radio Moscow. Traditional Russian folk tunes to 0400 station ID. (Barry, CA) Radio Moscow feeder in Russian at 0535 UTC on 8005 kHz (USB). (Witham, HI) Additional loggings taken at 2205 UTC on 6045/7115 kHz, and 2215 UTC on 7240 kHz. (Tammy Wells, Alfred, ME) 0048 UTC on 17665 kHz/ 0517 UTC on 9750 kHz/ 0700 UTC on 7240 kHz. (Carson, OK)

0405 UTC on 15170

TAHITI: RFO. Tahitian/French. Sunday religious service of hymns and devotional in Tahitian. French announcements at 0420 UTC. (Martin Winkler, Lindenhurst, IL)

0410 UTC on 4976

UGANDA: Radio Uganda. Announcer duo in English with world news and chat. Traditional African music with wonderful percussion. Severe fading, but clear station identification at 0429 UTC. (Lawrence, NY)

0430 UTC on 15420

SEYCHELLES: BBC Relay. African news on Nigeria. "Network Africa" dealt with South Africa's continuing political conflicts. (Tucker, GA) (Brian Schaff, Berea, OH)

0534 UTC on 7415.2

PIRATE: WSKY-Whiskey Radio. "WSKY Radio ... home of the Cowbell ... we are number 2." DJ also mentioned the Galaxy 4 uplink and, "this broadcast is brought to you by The House of Dog." Tarheel Road music tune to ID and Wellsville maildrop address for QSLs. Promotional for "Crappy Crab Restaurant" featuring seafood gruel. Station sign-off at 0618 UTC. (Carson, OK)

0630 UTC on 7270

POLAND: Radio Polonia. National political report to instrumental piano selections. Music from opera "Madam Butterfly," monitored to 0700 UTC. (Adams, NJ) Additional monitoring on 6135 kHz from 2245-2255 UTC sign-off. (John Miller, Thomasville, GA) (Davis, AL) (Schaff, OH)

0810 UTC on 9710

AUSTRALIA: Radio Australia. "Music of the World" show featuring music from the island paradise of Samoa. (Barry, CA) International news topics, sports update, and "Opinion From the Press" program at 1610 UTC on 13605 kHz. (Ron Pratt, Oak Harbor, WA) (David S. Walker, San Diego, CA) (Davis, AL) Wanneroo's service VLW6 heard on 6140 kHz at 1419 UTC. (Scott Billingsley, Camden, AR) (Carmine, OH) (Hillton, SC)

1000 UTC on 15050

INDIA: All India Radio. Newscast interrupted by transmitter problems. Return with report on South Africa's government at 1010 UTC. Parallel frequency 21735 kHz was not plagued by difficulties reported. (Witham, HI)

1200 UTC on 11940

SINGAPORE: SBC-Radio One. Pop music and interview with American actress from Rambo films. Weak signal for continued pops on parallel frequency 5052 kHz. (Witham, HI)

1350 UTC on 3940

CHINA: Hubei People's Broadcasting System. Chinese. Pleasing traditional Chinese music with chat and one station ID. Chinese/Japanese language lesson at 1400 UTC. (Witham, HI)

1610 UTC on 3000

NORTH KOREA: Voice for Youth Infantry Men. Korean. Drama or perhaps a film track featuring a highly emotional scene between male/female. Vocal music selection at 1624 UTC, and rousing band music continuing past the half-hour. Heard this station on parallel 3025 kHz with similar format but different material. (Witham, HI)

1720 UTC on 4866.5

INDONESIA: Irian Java. Radio Republik Indo-Wamena. Indonesian. American pop vocals to 1735 UTC. Low level modulation for announcements and music intros, until final fade-out at 1745 UTC. Sulawesi's RRI-Kendari heard on 4000.2 kHz at 1405 UTC (Witham, HI)

1920 UTC on 15600

ARABIA: Clandestine. Voice of the Iraqi Resistance. Arabic. Male announcer's chatter to pop tune at 1925 UTC. Station identification and news with teletype sound effects at 1930 UTC. News topics mainly covering Iraq. Holy Koran prayers and Arabic music at 1135 UTC. Station audible also on parallel 17960 kHz. (Witham, HI)

2052 UTC on 11530

LEBANON: Wings of Hope. Music tune "Danny Boy" in progress at tune-in. Additional American tunes to station ID and frequency quote at 2059 UTC. Taped religious programming with Mark Cambe on "Spiritual Warfare" to 2105 UTC. (Adams, NJ)

2053 UTC on 10000

JORDAN: Radio Jordan. Arabic. Tune-in with station heard over WWV. Arabic music to clear station ID and frequency quote at 2059 UTC. Station sign-off at 2100 UTC, resuming operation on 9560 kHz in Arabic. (Stephen J. Price, Conemaugh, PA)

2155 UTC on 17820

CANADA: Radio Canada International. "As it Happens" program (from CBC domestic feed), discussing the on-going problems of Russia. "Spectrum" program featuring editorials from Canadian newspapers. RCI's Canadian news from CBC feed, heard on 11945 kHz at 2200 UTC. RCI also audible on 7180 kHz at 2210 UTC. (Wells, ME) CBC Northern Service heard on 9635 kHz at 1311 UTC. (Camden, AR)

Utility World

Larry Van Horn
c/o MT, P.O. Box 98
Brasstown, NC 28902

It's Air Time!

No, I don't mean Springtime, spring cleaning, or promoting some new rap group's record. Now what is that crazy editor up to this time you say?

Well, to be exact, I thought I would devote some space to aeronautical monitoring this month. The aero and marine band profiles I run from time to time usually receive a very positive response. It gives us a chance to examine more closely what is on each aero or marine frequency in a given frequency range. So let's take a look at what can be heard in the 11 MHz aero frequency range from 11275 to 11400 kHz.

Freq	Service	User
11276	Regional/Domestic Air Routes	
11279	African Volmet	Algiers Kano
	Mid East Volmet	USSR Russian Network B
	North Atlantic-D	Bodo Cambridge Bay Iqaluit Reykjavik, Iceland
11282	Central East Pacific-1/2	Honolulu San Francisco
	Argentina Domestic	Espora NAB Comodoro Rivadavia Ezeiza Rio Gallegos San Carlos de Bariloche Santa Rosa
11285	Regional/Domestic Air Routes	
11288	Mid East LDOC	Jeddah (Saudi Airlines)
	North America Flight Test	Rockwell/Collins (Saudi Airlines LDOC) Voyager Aircraft Corp
	US Customs Service	Frequency Yankee Delta
	USAF GCCS Discrete	MacDill/McClellan AFB Discrete Channel
11291	South America 2	Canaries Cayenne Dakar Paramaribo Sal
	Africa 1	Dakar
11294	Regional/Domestic Air Routes	
11297	North Central Asia Volmet	USSR Russian Network A
11300	Africa-3	Addis Ababa Aden Asmara Benghazi Bujum Bura Cairo Dar es Salaam Djibouti Hargeisa Jeddah Khartoum Mogadishu Nairobi N'djamena Riyan Sana'a Seychelles Tripoli
11302	USAF Tactical channel	SAC EAM type broadcast noted here.
11303	Regional/Domestic Air Routes	
11305	South America LDOC	Maiquetia
11306	European LDOC	Portishead Radio - UK Flight Support
	South America LDOC	Lima, Peru (American Airlines)
	North America Flight Test	Rockwell/Collins Radio (Cedar Rapids & Richardson)
11309	North Atlantic-E	New York Santa Marie
11310	Illegal Fishing Net	One of the many spots in the aero bands where they show up to communicate
11312	Regional/Domestic Air Routes	
	Tactical Military Comms	Crossbow working Green Truck
11315	Caribbean Volmet	Not yet active
11318	North Central Asia Volmet	USSR Russian Network C
11319	SW Pacific Islands	Nauru Is Tarawa Kiribati
11321	Regional/Domestic Air Routes	
11324	North America LDOC	New York Radio (ARINC)
11327	South America LDOC	Rio de Janeiro (Varig)
	East Caribbean	Georgetown
	Northeast South America	Georgetown
11330	North Pacific	Honolulu Tokyo
11333	Russian Domestic	Yerevan
11336	North Atlantic-D	Gander
	Russian Domestic	Karbarovsk
11339	South Pacific	Rarotonga Nadi
11342	North America LDOC	New York San Francisco Honolulu (All ARINC) Atlanta (Delta) Tokyo (JAL) Sydney Skycoms
	Pacific LDOC	Stockholm Radio (SAS)
11345	European LDOC	Stockholm Radio (SAS)
	South America LDOC	Maiquetia (Caracus) Bogota (Avianca) Lima
11348	Africa LDOC	Mauritius Monrovia

	Middle East LDOC	Tehran
	North America LDOC	San Francisco (ARINC)
11351	European LDOC	Larnaca Paris Radio (Air France) Warsaw (LOT) Budapest (Malev) Belgrade Manila Nauru Beijing Karachi (Pakistan Intl Airlines) Rangoon Springbok Radio Johannesburg (South African Airlines) Luanda Algiers (Air Algerie)
	Pacific LDOC	Merida
	Asia LDOC	Bahrain "Falcon Control" (Gulfair)
11354	Africa LDOC	Central/Southeast Alaska Georgetown Asuncion Buenos Aires Cordoba Mendoza Salta Santa Cruz Aleutians Eastwick (NOVAIR)
	North America LDOC	Jakarta
	Middle East LDOC	Navigantes/Iltajai
11357	Alaska Domestic Routes	Georgetown
11360	Northwest South America	Ezeiza (+01,+15)
	Southwest South America	
11363	Alaska Domestic	
	European LDOC	
11366	Indonesian Domestic	
	Brazil Domestic	
11367	Northeast South America	
11369	South American Volmet	
11372	Regional/Domestic Air Routes	
11375	Middle East-3	Not yet active
11378	European Volmet	Not yet active
	South America LDOC	Quito, Lima (AeroPeru)
11380	Tactical US Military Comms	Various tactical call signs heard here
11381	Regional/Domestic Air Routes	
11384	Central West Pacific-2	Guam Honolulu Naha Tokyo Sofia (H+25,+55)
	European Volmet	
11387	South East Asia Volmet	Sydney (H+00,+30) Bangkok (H+10,+40) Karachi (H+15,+45) Singapore (H+20,+50) Bombay (H+25) Calcutta (H+05,+35) Barranquilla San Andres Paramaribo Piarco
	Eastern Caribbean	
11390	African LDOC	Brazzaville
11393	Pacific LDOC	Honiara Nadi
11396	West Caribbean	Guatemala Havana Merida New York Panama Piarco San Jose Tegucigalpa Bali Darwin Denpasar Jakarta Kuala Lumpur Manila Perth Singapore Sydney Ujung Pandang
	South East Asia-2/3	
11398	Hurricane Hunters	Hurricane Hunters to Miami Monitor

Most of the frequencies you will monitor in the 11 MHz band will be using the Upper Sideband (USB) mode of communication. You will find other modes here from time to time, however, so expect the unexpected. You will soon realize that English is the predominant language in use on aircraft frequencies. Two other languages you will hear, especially on this side of the globe, are French and Spanish.

And now for some explanation of the different aircraft communication services that you will encounter in the 11 MHz slice of the spectrum:

Domestic Communications

Regional/Domestic air routes are basically air traffic control frequencies for a region or country of the world. Usually when you listen to these frequencies the communications will be in the native language of the region or country.

Long Distance Routes

Long Distance Operational Control (LDOC) frequencies abound in the upper section of this aero band. There are certain frequencies set aside just for LDOC comms; however, be prepared to see them pop up almost anywhere. Not everyone obeys the rules of radio communication.

Basically, these frequencies are used by airlines to pass non air traffic control information, or what we aero buffs call "Company Traffic." You might hear about maintenance problems, gate changes, weather updates at the destination airport, etc. In fact, during aircraft hijackings these can be some very interesting frequencies to monitor, if you are parked on the appropriate company frequency.

LDOC ground stations are either run by the airline company, administered by ARINC (Aeronautical Radio, Inc., a US-based aero communications company), or government controlled.

Since the LDOC network is a cooperative effort, it will not be uncommon for one facility to handle LDOC traffic, not only for their own national airlines, but for other international airline companies as well.

Aviation Weather

Another station commonly heard will be the Volmet stations. Volmet is a French language abbreviation which loosely translates into Aviation Weather. Volmet broadcasts are regularly scheduled aviation weather forecasts, for selected city airports within a geographic proximity to the broadcast station. You will notice throughout the above frequency list, the start times for each Volmet station are listed as (H+XX). This means that weather broadcast starts at the given number of minutes past the top of each hour. They usually last about five minutes.

You will also see frequencies in the list for various regions throughout the world. These are frequencies that carry air traffic control communications to and from aircraft traveling through that region's air space. Since VHF/UHF communications are line of sight, HF is the only way to communicate with aircraft as they travel across ocean areas. In third world countries, HF is also the most economical way to communicate with transiting aircraft. I have included any ground stations that have been heard recently on the listed air traffic control frequencies.

Finally, you will notice some miscellaneous listings for military and other types of communications. As I have said before, not everybody follows the rules in the HF spectrum. Expect the unexpected and don't be surprised what might show up on a given frequency at any given time.

I hope you have enjoyed our list; if you would like to see more of this type of band scan, feel free to drop me a note via Brasstown. Your input is always welcomed.

Mailbag

• A couple of folks have suggested that I should change the format of the logging section to resemble the style used by some of the DX clubs. Basically, they propose something very structured and brief with an increased use of abbreviations in order to fit in more information per column.

I personally enjoy the free format style and I know that beginners do, too. So, although this column will continue to cater as much as possible to oldtimers and beginners alike, to substitute log descriptions in plain language text with a bunch of nonsensical abbreviations just to fit a few more on the page doesn't seem worth the trade-off. I support the KISS method, Keep It Simple Stupid—we've got enough abbreviations already.

• I get tons of mail regarding SAR (Search and Rescue) operations on the different Coast Guard SAR frequencies. I wish I could print more of them in the magazine, but space just will not permit the kind of detailed entries regarding SAR ops and conversations heard over the air and sent into Ute World headquarters.

Well, OK, I'll give you just one:

Jay Fowler in Monument Beach, MA, sent in some frequencies used during a SAR operation he heard recently. All HF entries are kHz and USB mode.

6714.0	Primary Multi service SAR channel
5681.4	Secondary SAR frequency (given by CG Rescue aircraft)

5696.0	1st Coast Guard District SAR Coordination (<i>most everybody else too-Larry</i>)
8984.0	1st Coast Guard District SAR Coordination (<i>ditto</i>)
156.3 MHz	SAR Primary frequency (FM voice)
157.0 MHz	SAR secondary frequency (FM voice)
282.8 MHz	SAR Primary UHF (AM voice)
303.0 MHz	SAR Secondary UHF (AM voice)
240.6 MHz	Coast Guard Marker Data Buoy at SAR scene.

• Since our column about the old Soviet military forces in October, Mark Chinsky has provided some interesting updates. He recently heard what may have been a long range Russian Navy broadcast on 6775 kHz in USB around 0000 UTC. This is the first time Mark has picked up such activity in the clear on this frequency which is 5 kHz above a Navy tactical CW channel (6770) and 3 kHz below another channel, 6778. Mark only heard traffic one night and he is not sure whether it was a naval RT circuit with a conference type call or a tactical network with an HF repeater in use. In any case, the communications were official and the main station appeared to use the call sign "CONTROL."

One other interesting note from Mark: he has an old logging regarding a Russian Strategic Force (Strategic Rocket Force) communications backup net on 10272 kHz using RTTY, FSK-CW and CW. Recent monitoring of that frequency seems to indicate the channel is still in use (very tentative). Might be an interesting frequency to watch in the future.

• Bill Battles checks in this month and ask the question, "Any idea what people pallets are?" Bill, I think you might find that these are seats for passengers. Most military and government folks who have transport type aircraft have the capability of reconfiguring the aircraft for people, cargo or both. The seats sit on pallets that are rolled into the aircraft just like the cargo is. It makes things easy when reconfiguring the aircraft for a different mission in a short period of time.

Bill says that Canforce (Canadian Forces) has started very intense flight plan notifications. This is probably as a result of the C-130 aircraft crash a while back at Alert Bay.

• While not totally HF, Ron Bruckman of the RMNM (Radio Monitors Newsletter of Maryland) asks about the tactical comms his members are hearing on the following frequencies (All frequencies in MHz using wide band FM): 305.55 382.35 397.05 336.80 366.0 390.0 291.0 355.4 246.95 345.5 322.75 326.0. Some of the callsigns are Stability, Scorecard, Bushpilot, Kiwi Bird, Redeemer, Skybound, Advantage, Sandwich, and Macaroni.

Ron, for the most part the frequencies you have indicated belong to the Alpha-Bravo or Autovon system. Ron Pearson ran this in his column a couple of years ago, but basically it is another communications system used for VIP military flights and SAC airborne command posts. If you want more information, check out my book on SAC available through DX Radio Supply.

At least one of the frequencies (249.50) appears to be a satellite channel. The rest I am not sure about and will have to research.

• Finally, as I start the fifth year of this column, I would like to take this opportunity to thank all of you for your support. You readers keep this column among the most popular in *Monitoring Times*. Nine years and several columns and features later, I can truthfully say, the most active readers frequent these pages.

I hope to continue to receive that support and look forward to each of your loggings, letters, and questions each month. I also would like to thank veteran utility listener Bob Grove for his unfailing support of utility listening and to Gayle, my wife, who continues to handle your mail each month. Without her help, correspondance would be next to impossible. Now it is time to start the next five years with your input.

It is time to go get a hurricane and see what you folks have been hearing in the world of the utility stations. This month we will be featuring some of Jack Dix' logs in the realigned marine bands and a couple of logs from Joerg Klingenfuss' DX-pedition to the Indian Ocean.

Utility Loggings

Abbreviations used in this column

AM	Amplitude Modulation	MV	Motor Vessel
CG	Coast Guard	NDB	Non Directional Beacon
Comms	Communications	QRM	Interference
COMSTA	Communications Station	PIAB	Presse- und Informationsamt der Bundesregierung
CQ	General call	RTTY	Radioteletype
CW	Continuous Wave, Morse code	SAR	Search and Rescue
DE	Means "from"	Selcal	Selective Calling
ETA	Estimated Time of Arrival	SITOR-A	ARQ-A data format
HF	High Frequency	Unid	Unidentified
ID	Identification	USAF	United State Air Force
kHz	Kilohertz	USB	Upper Side Band
LDOC	Long Distance Operational Control	USCGC	US Coast Guard Cutter
LSB	Lower Side Band	UTC	Universal Time
MHz	Megahertz	VWD	Vereingte Wirtschaftsdienste
MT	Motor Trawler		

All frequencies in kilohertz (kHz), all times in UTC. All voice transmissions in English unless otherwise noted.

- 123.7 DCF42-PIAB Bonn, Germany with SITOR-A marker plus news at 1345. (Ary Boender-Netherlands)
- 129.1 DCF45-VWD Frankfurt, Germany with RTTY financial news at 1355. (Boender-Neth)
- 147.3 DDH47-Deutsche Wetterdienst Hamburg with CW messages at 1330. (Boender-Neth)
- 344.0 PIX-Picture Rocks, PA, NDB with CW ID at 0157. (William Dickerman-Williamsport, PA)
- 366.0 YMW-Maiwaki, Quebec, Canada NDB with CW ID at 0759. (Dickerman-PA)
- 379.0 GKQ-Newark, NJ, NDB with CW ID at 0706. (Dickerman-PA)
- 414.0 BC-Baie Comeau, Quebec, NDB with CW ID at 0822. (Dickerman-PA)
- 2749.0 Yarmouth Canadian Coast Guard Radio with a marine weather broadcast for the Eastern Atlantic in USB at 0544. (Fernandez-MA)
- 2772.0 Unid station sending a CW marker consisting of SXGZ at 0550. Greek Navy? (Fernandez-MA) *I don't think so Bill, probably Radio Kiel in Germany trying to contact a Greek merchant ship-Larry.*
- 2815.4 OST-Oostende Radio, Belgium with SITOR-A idler tones and OST CW marker at 0556. (Fernandez-MA)
- 2872.0 Gander/Shanwick Aeradio working aircraft about flight data/positions in USB at 0601. (Fernandez-MA)
- 2982.0 Two unid stations working each other via scrambled comms. (Fernandez-MA)
- 3188.0 3BT2-Vacoas Meteo, Mauritius, with 75 baud RTTY, weather traffic to St. Denis at 1530. (Joerg Klingenfuss-Indian Ocean DX-pedition) *Thanks for the list Joerg, hope to run some more of these next month for all to enjoy-Larry.*
- 3330.0 CHU-Ottawa, Canada with time signals at 0246. (Dickerman-PA)
- 4028.0 Spanish female 5-digit number station at 0601 in AM. (Fernandez-MA)
- 4139.0 Port Louis Harbour Radio, Mauritius with English male doing weather reports in USB at 1630. (Klingenfuss-Indian Ocean DX-pedition)
- 4171.0 GYOQ-MV Abbey with SITOR-A messages a 2130. (Boender-Neth)
- 4179.0 UJUV-MV Professor Rybaltowski with RTTY messages at 2235. (Boender-Neth)
- 4346.0 WOM-AT&T High Seas, Ft. Lauderdale, FL, working cruise ship "Nordheim" in USB at 0259. (Tony D. Storz-Houston, TX)
- 4405.0 KMI-Pt. Reyes, CA, working Kirkpatrick in USB at 0334. (Storz-TX)
- 4414.0 Many unid stations, probably fisherman talking about the wind around 1115 in USB. (Ray McCarthy-Sag Harbor, NY)
- 4543.0 German female 3/2-digit number station in AM at 0612. (Fernandez-MA)
- 4654.0 Berne Radio, Switzerland, LDOC working several aircraft with weather request, flight data, position reports and selcal checks. All the aircraft were on the way to UK and Europe, over the Atlantic in USB at 0628. (Fernandez-MA)
- 4700.0 Canforce Halifax military working N4G aircraft regarding to shifting to another frequency, designated in coded form, for "a voice check" in USB at 0630. (Fernandez-MA)
- 4855.0 Cape Radio working Freedom Star in USB at 2310. (Fowler-MA)
- 5015.0 Papa November number station in AM at 0600 Wed UTC. (Thomas Mazanec-Maple Heights, OH) Same at 0642. (Fernandez-MA)
- 5230.0 MIW2-Israeli Mossad number station in AM at 0318. (Fernandez-MA)

- 5412.0 English female 5-digit number station in AM at 0500 Sun UTC. (Mazanec-OH)
- 5437.0 ART-Israeli Mossad number station in AM at 0332. (Fernandez-MA)
- 5575.7 Time station? Pips each second with one omitted at 30 second mark, double pips several times throughout each minute, and no ID at 00 minute mark. Sounds similar to the Russian time stations, but no ID at the hour mark. Heard between 0650-0710+. (Fernandez-MA) *Interesting Bill, right in the middle of the aero band. Anyone want to hazard a guess?-Larry.*
- 5680.0 Baker Lake Radio working Canforce 6477 at 0101 with clearance in USB. (Bill Battles-E. Kingston, NH)
- 5696.0 CAMSPAC San Francisco working CG 1704 in USB at 2202. (Gordon Levine-Anaheim, CA) Letter # Letter stations heard here operating with Slingshot. Constantly bumping heads with the Coast Guard COMSTAs around 2200 in USB. (L. Van Horn-New Orleans, LA)
- 5700.0 Pipeline calling Gonzo 04 Delta in USB at 0307. (Storz-TX)
- 5750.0 German female 3/2-digit number station heard in AM at 0325. (Fernandez-MA)
- 6266.0 H9AN-MV Panarea 1 with SITOR-A at 2005. (Boender-Netherlands)
- 6388.0 EBA-Madrid Naval radio with CQ CW marker at 0044. (Dix-NY)
- 6700.0 Belches, whistling, "I'm not getting any indication that anything is bad." Whistling, belches, "Well echo it sure sounds good to me." in USB at 0217. (John Robinson-Antioch, TN)
- 6714.0 Waterbug 110 (E2), USCGC Tamara and many others here working a SAR using USB. (Battles-NH)
- 6730.0 WAR-46 (Ft. Richie, MD) working Noon Tide with communications checks at 0301 in USB. (Battles-NH)
- 6761.0 Chili 42 working Warriors Den in USB at 0350. (Todd Dokey-Lodi, CA)
- 6787.0 Spanish female 5-digit number station in AM at 0600 Wed/Sun UTC. (Mazanec-OH)
- 6897.0 DOD Cape Radio, Cutter Dependable, USS Jack Williams, King-01, King-02, and Cape Osborne (that's DOD Cape) in USB on '68'. preparing for a shuttle mission during the evening hours. (Fowler-MA)
- 6934.0 English female 3/2-digit number station in AM at 0000 Sat UTC. (Mazanec-OH)
- 7537.0 Unid station sending the characters '261' repeatedly in CW at 2206. (Dix-NY)
- 7585.0 KTX23 (base) working mobile here from 1322-1400 with numerous checks plus test in tunnel in Minneapolis. Advised mobile to send a 9999 group call if he needs them. Mentioned channel 5 and 3 also but these are unknown at this time. (Battles-NH) *Bill, Probably a Transportation call, in Minneapolis-Larry.*
- 7847.0 Spanish female 5-digit number station in AM at 0400 Wed/Sun UTC. (Mazanec-OH)
- 7864.0 Spanish female 5-digit number station in AM at 0304 Sat UTC. (Mazanec-OH)
- 7887.0 Spanish female 5-digit number station in AM at 0307, 0611 and 0704 Sun UTC. (Mazanec-OH)
- 48188.0 Spanish female 5-digit number station in AM at 0800 Sun UTC. (Mazanec-OH)
- 8345.0 EKMN-MV Mekhanik Evgrafov sending SITOR-A messages at 1950. SQAZ-MV Uniwerk Jagiellonski calling Gdynia Radio using SITOR-A at 2140. (Boender-Neth)
- 8347.5 SQDE-MV Franciszek Zubrzycki with messages at 1953. FNBU-MV Port Baru with messages at 2028. CNFZ-MV Azial with messages to Casablanca at 2047. All ships used SITOR-A. (Boender-Neth)
- 8349.5 UQAF-MV 70-Letie Oktyabrya calling Tallin Radio at 1956 using SITOR-A. (Boender-Neth)
- 8351.0 UMTX-MV Sovietskaia Neft with Cyrillic SITOR-A messages at 2118. (Boender-Neth)
- 8356.0 UNJS-MT General Pliev with messages to BASF Ludwigshafen at 1948. LJPf3-MV Hebe with message to LHW shipping about new crew at 2020. UWYM-Khudozhnik Nesterov with message in Cyrillic. All ships this frequency using SITOR-A. (Boender-Neth)
- 8445.0 PKN-Balikpapan Radio, Indonesia with a CQ CW marker at 1112. PKC-Palembang Radio, Indonesia sending a CQ CW marker at 1142. QRM from WLO. (Dix-NY)
- 8455.0 9WH-Kota Kinabalu Radio, Malaysia with CQ CW marker at 1006. (Dix-NY)
- 8456.5 DEJA-MV Jork with a message to Sucanal Transit Ismailia with ETA to Port Said at 1940. EDEN-MV Villa de Mogor with message to Acacia Sanchez Mollinero Pontevedra at 1957. Both ships used SITOR-A. (Boender-Netherlands)
- 8457.0 PKG-Banjarmasin Radio, Indonesia with a CQ CW marker heard at 0016. (Dix-NY)
- 8470.0 XVG-Haiphong Radio, Vietnam with DE CW marker at 1103. QRM from MNM. (Dix-NY)
- 8472.0 TEC-Puntarenas (Ocean) Radio, Costa Rica with a CQ CW marker

at 2303. SUP-Port Said Radio, Egypt with a V/CQ CW marker at 2148. (Dix-NY)

8490.0 AQP-Karachi Naval Radio, Pakistan with V CW marker at 2003. (Dix-NY)

8522.0 9VWV20-Kuching Radio, Malaysia with a CQ CW marker followed by a traffic list at 1123. QRM from JOR. (Dix-NY)

8548.0 DZF-Manila Radio, Philippines with CW CQ marker at 1113. (Dix-NY)

8578.0 NRV/NWC-COMSTA Barrigada, Guam with V marker and weather that followed in CW. (Dix-NY)

8590.0 XVS-Ho Chi Minh City, Vietnam sending CQ CW marker at 1210. (Dix-NY)

8597.0 VIP03-Perth Radio, Australia with a V CW marker at 2102. (Dix-NY)

8619.0 VPS-Cape D'Aguilar Radio, Hong Kong with CQ CW marker at 1120. (Dix-NY)

8623.5 5BA-Nicosia Radio, Cyprus with CQ CW marker at 2147. (Dix-NY)

8646.0 VTP-Vishakhapatnam Naval Radio, India with V CW marker at 1235. QRM from FUJ. (Dix-NY)

8652.5 PZN-Paramaribo Radio, Surinam with CQ CW marker at 0019. (Dix-NY)

8666.0 FUG-French Naval La Regine Radio, France with V CW marker at 0937. (Dix-NY)

8686.0 PKF-Makassar Radio, Indonesia with CQ CW marker at 1203. (Dix-NY)

8690.0 UMV-Murmansk Radio, Russia with CQ CW marker at 1219. FJY4-Martin De Vives Radio sending a CQ CW marker at 1206. (Dix-NY)

8706.0 LYNX-Unid station with SITOP-A idler sending LYNX at 2128. (Dix-NY)

8764.0 Coast Guard COMSTA Honolulu with weather broadcast at 1759. COMSTA San Francisco with weather at 2243 in USB. (Chris Hulse-Eugene, OR)

8788.0 WLO-Mobile Radio, AL with USB weather report at 0605. (Levine-CA)

8791.0 WOM-Ft. Lauderdale, FL working the Susie Q-2 in USB at 0445. (Levine-CA)

8809.0 WOM-Ft. Lauderdale, FL working cruise ship Seaward with phone patch traffic using duplex USB at 0141. (Dodge-NY)

8879.0 Dynasty 092 (China Air, 747SP, ALEF) from Johannesburg to Taipei working Mauritius Radio at 1545 in USB. (Dan Fellows-Seattle, WA) *Welcome Dan, nice set of logs, hope you check in often-Larry.*

8942.0 MK741 (Air Mauritius, 747SP) from Hong Kong to Mauritius working Singapore Radio in USB at 1500. (Fellows-WA)

8972.0 Reporter (net control), Kilo Foxtrot Lima (on-site controller), Ghost 1 and Dust Off 24 in USB at 0243. Mentioned STAR (Strategic Tactical Air Rescue?), APU (not the aircraft kind) and I believe dust off might indicate some sort of spraying operation on drug crops. Location of mission was over Colombia. (Fred Dodge-Menands, NY) *Wow, Fred interesting log and all your assumptions are probably correct. I must plug this one in the radio, especially since this is the Navy Atlantic Safety of Flight channel, very unusual for this frequency. Spraying in Colombia, Hummmm!!!-Larry. Lots of scrambling and the usual letter # letter call signs noted at 2315 in USB. (L.Van Horn-LA)*

9032.0 Romeo working Architect in USB at 1821. (Tom Hites-FPO AE)

9090.0 English female number station in AM at 2105. (Bob Pettengill-Blanchard, OK)

10018.0 Aeroflot 550 (Tupolov 154), Moscow to Abu Dhabi, UAE working Bombay Radio at 1532 in USB. ETG50 (Ethiopian Air B-727, ET-AHM, EJDF) from Addis Ababa to Bombay working Karachi Radio in USB at 1500. (Fellows-WA)

10780.0 Cape Radio working MAC-71001, said monitor 27720 for shuttle comms in USB at 2315. (Fowler-MA)

11052.0 Air Force One working Andrews at 1555 in USB also Andrews working Rhetoric (EC-135). (Battles-NH)

11108.0 Papa November number station in AM at 0600. (Mazanec-OH)

11124.0 English female 3/2-digit number station in AM at 1700 Wed UTC. (Mazanec-OH)

11201.0 CG Rescue 1712 working CG San Juan, PR with SAR of MV Sinbad at 2259 in USB. (Battles-NH)

11300.0 LAA206 (Libyan Air 727) from Benghazi to Cairo working Tripoli Air at 1600 in USB. Sudan Air 225 (A-310) from Abu Dhabi to Khartoum calling Khartoum Radio in USB at 1612. GV-AEF (Seregaiese VIP 727) from Dakar to Jeddah working Cairo Radio at 0200 in USB. KYA102 (a 707) from London Gatwick to Nairobi working Khartoum Radio at 1508 in USB. Does anybody know what airline this is? (Fellows-WA) *My personal favorite air traffic control channel, Dan-Larry.*

11306.0 HZ-MS11, a DC-8 working Rockwell Radio and asking for Minneapolis weather around 1500 in USB. (Fellows-WA)

11607.0 English female 3/2-digit number station in AM at 1600 Tue/Wed UTC. (Mazanec-OH)

11634.0 Air Force One working Andrews in USB at 2045. Said go secondary. (Donald Wiemken-Sterling, IL) *Don you have found a USAF Mystic Star frequency where VIP aircraft operate. Secondary refers to another frequency being used to backup their primary frequency, the one you were listening on. There are several hundred of these frequencies throughout the HF radio spectrum-Larry.*

12564.5 RKTS-General Petrow with personal messages using RTTY at 0503. (Robinson-TN)

12682.5 PKF-Makassar Radio, Pakistan with a CQ CW marker at 1021. PNK-Jayapura Radio with a CQ CW marker at 0922. (Dix-NY)

12695.8 XSX-Keelung Radio, Taiwan with CQ CW marker at 1138. (Dix-NY)

12704.5 PKD-Surabaya Radio, Indonesia with CQ CW marker at 1128. QRM from WLO. (Dix-NY)

12709.2 9HD-Malta Radio with V CW marker heard at 1254. (Dix-NY)

12712.0 HLW3-Seoul Radio, South Korea with CQ CW marker at 2343. (Dix-NY)

12715.5 PKN-Balikpapan Radio, Indonesia with a CQ CW marker at 1216. (Dix-NY)

12727.0 HLJ-Seoul Radio, South Korea with CQ CW marker at 1136. (Dix-NY)

12800.0 HSA-Bangkok Radio, Thailand with CQ CW marker at 0926. (Dix-NY)

12808.5 VTG-Bombay Naval Radio with V CW marker at 2245. (Dix-NY)

12834.0 DZP-Manila (Novaliches) Radio with CQ CW marker at 1228. (Dix-NY)

12970.5 PKX-Jakarta Radio with CQ CW marker heard at 1154. PKB-Belawan Radio, Indonesia sending a CQ CW marker at 0036. (Dix-NY)

12982.2 DZM-Manila (Bulacan) Radio with CQ CW marker at 1147. (Dix-NY)

12916.0 HLF-Seoul Radio, South Korea with CQ CW marker at 1144. (Dix-NY)

12965.0 Spanish female 5-digit number station in AM at 2009 Tue UTC. (Mazanec-OH)

12970.5 PKX-Jakarta Radio, Indonesia with CW CQ marker at 1154. (Dix-NY)

13011.0 AQP-Karachi Naval Radio, Pakistan with V CW marker at 2253. (Dix-NY)

13065.0 6YI-Kingston Radio, Jamaica with CQ CW marker at 1236. (Dix-NY)

13208.5 STOL 73 working 'Stewart' enroute base at 1926 in USB. Will go UHF when closer. Pearl Control working Pearl 71 at 1533. (Battles-NH)

13210.0 SAM 60202 working MacDill on discrete frequency in USB at 1509. (Battles-NH)

13230.0 Honolulu Radio with weather for the Pacific in USB at 0531. (Dokey-CA)

13312.0 "Moody Operations" working 4541F at 1939 in USB with "There are no messages for the southern group". Also heard same base working X9C and referring to this frequency as channel 4. (Battles-NH)

13635.0 Single Letter HF Beacon 'S' heard during my local daylight hours here in Ohio sending 'S' CW ID. (Mazanec-OH)

14441.5 NNN0CUA-USS Alywin making general call in USB at 0145. Also caught the USS Brooke-NNN0CWK. (Robinson-TN)

14477.0 NNN0PKH working NNN0CSE-Elmer Montgomery (FF-1082) with phone patch traffic in USB at 0005. (Pettengill-OK)

14463.0 NNN0RWO working NNN0CNP-USS Bainbridge (CGN-25) and NNN0CVJ-USS L.Y. Spear (AS-35) with phone patch rotation in USB at 2357. (Pettengill-OK)

15000.0 WWV-Fort Collins, Co with time signals and ID at 0429 in AM. (Boender-Neth)

15021.0 Lufthansa 4245 working Stockholm at 1537 with phone patch in USB. (Battles-NH)

16178.0 Spanish female 5-digit number station in AM at 0000. (Robinson-TN)

16668.0 Y5KW-MV Meissem with message and location as Key West at 1218 using SITOP-A. (Boender-Netherlands)

16669.0 SWGK-MV Agia Dynamis calling Lyngby Radio at 1220 using SITOP-A. (Boender-Neth)

16870.5 DZJ-Manila (Bulacam) Radio, Philippines with a CQ CW marker at 1905. (Dix-NY)

16990.0 HLO-Seoul Radio, South Korea with CQ CW marker heard at 0038. (Dix-NY)

17052.0 XSX-Keelung Radio, Taiwan heard at 2333 with CW CQ marker, QRM JNA. (Dix-NY)

17084.0 VHI-Royal Aussie Naval Radio, Darwin with V marker in CW at 2304. (Dix-NY) 17130.0 HLW-Seoul Radio, South Korea with CQ CW marker at 2307. (Dix-NY)

18037.0 Spanish female 5-digit number station in AM at 2008. Sat UTC. (Mazanec-OH)

18880.0 Spanish female 5-digit number station at 1700 in AM, repeated 22222.0 logging information only one hour later. (Mazanec-OH)

20835.2 I need help on this one, tunes to ARQ-S4 on the M7000 but prints garbage on the printout, heard at various times. (Robert Hall-Capetown, South Africa) *Has anybody ID or copy this one-Larry?*

20890.0 Slingshot working Omaha 59 with intercept problem from South American government and forced to land at an air base at 2015. (Kenneth E. Wilkinson-Waco, TX)

22221.0 Spanish female 5-digit number station at 1600 in AM Sat & Sun UTC. (Mazanec-OH) Also at 1600. (Robinson-TN)

22395.0 HLW-Seoul Radio, South Korea with CQ CW marker at 2307. (Dix-NY)

22535.0 FUF-French Naval Radio-Fort de France, Martinique with V CW marker at 2125 using CW. (Pettengill-OK)

22539.0 KLB-Houston Radio, TX Limited Coastal Station calling CQ in CW. (Pettengill-OK)

22556.0 LSA-Boca Radio, Argentina with a V CW marker at 1857. (Dix-NY)

22589.0 VHI-Royal Australian Naval Radio, Darwin with V CW marker at 2319. (Dix-NY)

The Scanning Report

Bob Kay

*c/o MT, P.O. Box 98
Brasstown, NC 28902*

Phone Home on a Cordless

Listening to cordless phone conversations continues to be popular among scanner buffs. As most readers know, cordless phones can be monitored by searching between 46.60 and 47.00 megahertz. The exact frequencies are: 46.61, 46.63, 46.67, 46.71, 46.73, 46.77, 46.83, 46.87, 46.93, 46.97.

The Federal Communications Commission has also allowed cordless phones to operate between 902.00 and 928.00 megahertz. Since exact frequencies were not assigned, you'll need to place your scanner in the search mode. But don't expect it to be easy. As you search between 902 and 928 megahertz, you'll discover weird and bothersome signals from microwave ovens, hospital equipment, aircraft radio and ham radio. When you locate an active frequency, punch it into your scanner and then resume the search.

Modifying a cordless phone to transmit and receive from greater distances is another popular topic. It seems that everyone wants to extend the range of their cordless phone. Wouldn't it be great if you could use your cordless phone when you're several blocks from home? Or imagine the fun of using cordless phones at a vacation resort. To stay in touch with other family members, you simply rent a pair of cordless handsets. Give one handset to the kids, and slip the other in your pocket. Can't find the kids? No problem. Pull out your cordless and give them a call.

Within the next five years, evolving technology called Personal Communication Services (PCS) will do just that—extend the range of cordless phones. The idea behind PCS is to eliminate, or at least reduce, the number of street corner pay phones. To accomplish this task, the range and use of cordless telephones will be greatly expanded.

Small transmission stations—about the size of a file drawer—will be placed in buildings. In contrast to large cellular towers, a PCS transmission box will fit into a small utility room. The antenna can poke outside through an open window or small hole. Each box will have a transmission range of 300 to 400 feet.

Customers will carry handsets that will resemble scaled-down cordless phones. The per-minute cost of each call is expected to be less than half the cost of using a cellular phone. But unlike cellular phone users, PCS customers can only place calls, they can't receive them. Incoming calls will be directed to a beeper that can be attached to the handset.

Transferring calls from one station to another is not possible. And installation of the system into a wide coverage area will require numerous relay boxes. But despite the drawbacks, Eric Ensor, assistant VP of Bell South Enterprises, expects that PCS will become more popular than cellular phones, attracting tens of millions. His views are shared by every major telecommunications company across the country. An FCC spokesman said that the commission has received thousands of inquiries from companies trying to get a piece of the PCS business.

The system has already been tested in the Nation's Capitol, Athens, Georgia, and Orlando, Florida. The tests indicated that PCS customers were very receptive to the idea of extending the range of cordless phones. The tests also revealed some problems. Many customers complained about not being able to receive calls, but others actually liked the idea of screening incoming calls via their beepers. "Since I'll be paying for every minute of phone use, I'm glad that incoming calls are not possible," one user reported.



A new technology called PCS will extend the range of cordless phones in the next few years.

System engineers for PCS admit that there are differences of opinion that need to be resolved. But everyone agrees that the problems associated with the basic concept are not insurmountable. "The PCS system is here to stay," says Eric Ensor, assistant VP of Bell South Enterprises, "and we predict that it will get a big piece of the pie."

As of this writing, the FCC had not allocated a specific frequency range for PCS. There are rumors that the FCC is planning to reallocate a large swath of frequencies that are now used by railroads, electric utilities and public safety. If the rumor proves true, there's no way of predicting the frequency band that may be assigned to PCS. But don't get too anxious. The experts predict that it will take at least four years to perfect the system and present it to the public.

When the frequencies are assigned, I'll print them so that everyone can enjoy a "piece of the pie." Until then, keep your fingers crossed—your town could be selected as a PCS trial area.

Treasure Hunt

I've got two complete sets of *Police Call* to give away, but you can't win if you don't play. As you already know, *Police Call* is the largest selling frequency reference in the world. The complete twelve volume set contains frequencies for nearly every city in the nation. Here are the clues:

1. How many emergency vehicles are on the front cover of the '92 edition of *Police Call*?
2. How many antennas can you find on the front cover of the '92 edition of *Police Call*?
3. A ham license is required to use all of the features on the ICOM IC-2SRA. True or False?
4. With the "Super Converter II" from GRE, it would be possible to monitor the 800 megahertz band with an old PRO-30 scanner radio. True or False?

5. Refer to the December '91 edition of *MT* and provide the month and year that *Monitoring Times* was first published.

Can you become one of our lucky winners? Sure you can! The winners are selected by a random drawing. There are no gimmicks, and no hidden fees. But we do ask that you follow a few simple rules: 1) Fax entries will not be accepted. 2) All entries must be mailed separately. 3) The use of post cards is encouraged. Send your entries to the Treasure Hunt, P.O. Box 98, Brasstown, NC 28902. Good luck!

Frequency Exchange

Thinking about spring? Before the warm weather returns, let's take one more trip to the frozen territories of *Nova Scotia, Canada*.

<u>Halifax Police</u>	<u>Dartmouth Police</u>	<u>Metro Transit</u>
412.487	412.362	413.962
412.937	412.562	
413.612	412.812	
413.762	412.862	
414.162	413.187	

Government Services

143.565

The above frequencies were provided by Al Cycles. Are you ready to visit a warmer climate? Let's check in with John Moran. John frequently flies between *Phoenix, Arizona*, and *Anaheim, California*. Here are a few of the frequencies that John has monitored during his numerous trips.

154.515	Sea World Security, San Diego
453.625	City Parks, Phoenix
453.650	Life Guards, San Diego
460.750	Delta Airlines Operations, Phoenix
462.825	Airport Parking, Phoenix
464.325	American Express Security, Phoenix
464.375	Paradise Valley Mall, Phoenix
851.150	Hertz Rent a Car, Phoenix
852.0625	Airport Buses, Phoenix
852.3125	Youth Services, Los Angeles
856.3125	Marriott Sky Chief, Phoenix
857.3125	Marriott Sky Chief, Phoenix
857.8875	Delta Airlines Operations, Los Angeles
858.3125	Marriott Sky Chief, Phoenix
859.3125	Marriott Sky Chief, Phoenix

Anyone care to stop at the *Fairchild Air Force Base* in *Washington State*? The invitation came from Frank Lang, of Spokane, Washington. According to Frank, Stealth aircraft routinely fly at Fairchild. Here are the frequencies that Frank has programmed into his scanner radio.

148.545	Flight line Maintenance
163.275	Security
163.4875	Flight line Security
173.5125	Medical Net
235.100	Air Refuel Track 4B
275.800	Ground Control
289.600	Tower
362.600	Bomb Plot
372.200	Dispatcher

GUIDE TO UTILITY STATIONS 1992

10th edition • 534 pages • \$ 48 or DEM 70

7500 new coastal and fixed station frequencies!

Our bestseller covers the complete frequency range between 0 and 30 MHz. We are the very first to publish *all* new maritime frequencies worldwide in use since the gigantic global frequency transfer in July 1991 - *now* and not five years later! Latest military and political events such as the impacts of the Gulf War and of the recent and current revolutions in Eastern Europe are covered exclusively by our UTILITY GUIDE. Sophisticated operating methods and regular overseas monitoring missions (1991 for months in India, Malaysia, Mauritius, Reunion, Rodrigues, Surinam and Venezuela) complete this unique book.

The completely revised new edition includes a frequency list with 19136 frequencies, and a call sign list with 3514 call signs. Up-to-date schedules of FAX meteo stations and RTTY press services are listed both alphabetically and chronologically. Abbreviations, addresses, codes, definitions, explanations, frequency band plans, international regulations, modulation types, NAVTEX schedules, Q and Z codes, station classes, telex codes, etc. - this reference book lists everything. Thus, it is the ideal addition to the World Radio TV Handbook for the "special" stations on SWI!

Further publications available are *Guide to Facsimile Stations, Radio-teletype Code Manual* (11th ed.) and *Air and Meteo Code Manual* (new 12th ed.). We have published our international radio books for 23 years. They are in daily use with equipment manufacturers, monitoring services, radio amateurs, shortwave listeners and telecommunication administrations worldwide. Please ask for our free catalogue, including recommendations from all over the world. For recent *MT* book reviews see Jack Albert in 5/91 and Larry Van Hoorn in 9/91. All manuals are published in the handy 17 x 24 cm format, and of course written in English.

Do you want to get the *total information* immediately? For the special price of \$ 165 / DEM 245 (you save \$ 32 / DEM 40) you will receive all our manuals and supplements (altogether more than 1700 pages!) plus our *Cassette Tape Recording of Modulation Types*.

Our prices include airmail postage to everywhere in the world. Payment can be by \$ or DEM cheque or cash. Dealer inquiries welcome - discount rates on request. Please mail your order to ©

Klingenfuss Publications
Hagenloer Str. 14
D-7400 Tuebingen
Germany

Tel. 01149 7071 62830

375.200	Metro Weather
413.450	Crew Alerts

Our next invitation was sent in by Matt Gribas. Matt lives in *Grand Rapids, Michigan*.

42.48	Michigan State Police
42.58	"
42.74	"
47.70	Consumers Power Co.
47.78	Consumers Power Co.
151.085	Michigan Highway Dept.
151.13	Grand Rapids Streets & Sanitation
151.775	Amway Hotel Maintenance
152.45	Veterans Taxi
154.515	Amway Hotel Security
157.710	Veterans Taxi
464.00	Able Trash Service
464.10	Grand Rapids Public School Buses
464.375	Grand Rapids Public School Buses

Welcome to *Broken Arrow, Oklahoma*. John Owen, lives nearby, and he has provided a few local frequencies:

453.70	Broken Arrow Police
453.850	"
453.950	"
461.075	Woodland Hills Mall Security
462.925	Ambulance Dispatch

464.675 Woodland Hills Mall Security
 466.075 "
 469.675 "

Since I surprised everyone with a visit to the cold climate of Canada, I decided to end this month's Frequency Exchange by visiting **Sarasota, Florida**. As you feel the warm sand under your toes, you can thank Eric Owen, for sending us his invitation. Here are Eric's favorite frequencies.

<u>Sarasota Sheriff</u>	<u>Sarasota Police</u>	<u>Sarasota County</u>
154.770	460.075	154.10 Road Crews
154.875	460.125	158.835 School Buses
154.950	460.175	453.825 Building Inspectors
155.025		458.050 Vehicle Barn
155.175		

<u>Sarasota Mosquito Control</u>	<u>Florida Power & Light</u>
122.850 Helicopter	451.10 451.275
155.760 Repeater	451.375 451.525

Florida Rehabilitation Program
 45.160
 45.420

Inviting the Frequency Exchange to your home town is easy. Simply jot down a few of your favorite local frequencies and send them to the Frequency Exchange, P.O. Box 98, Brasstown, NC 28902. All requests for anonymity will be granted.

Photo Radar

If you're a regular reader of this column, you already know about Photo Radar. Police in several states are using hidden cameras that photograph a speeding vehicle's license plate. Several days later, a ticket is sent through the mail.

In Pasadena, California, the police mount a camera in the back of a Chevy Blazer. The rear window of the Blazer is lowered and the camera is pointed toward oncoming traffic. Further up the road, a temporary sign reads: "Smile, you just passed Photo Radar."

Thomas Hart lives near Pasadena, and he claims that he has personally witnessed the use of Photo Radar. But no one has yet to provide any proof of receiving a photo radar ticket. If you've been caught by photo radar, send me a copy of your ticket. I'd like to use it in the

MANY OF TODAY'S MOVIES ARE PRODUCED RIGHT ON LOCATION. BE SURE TO MONITOR THOSE MOTION PICTURE FREQUENCIES WHEN HOLLYWOOD COMES TO YOUR TOWN!

Sammy the Scanner
 LOW CAMPAGNA

Northeast Scanning News
 P.O. Box 62, Gibbstown, NJ 08027

column. If you request anonymity, I'll change your name and draw a moustache on the picture. Send your photo radar tickets to: Scanning Report, P.O. Box 98, Brasstown, NC 28902.

Scanner Buff Finds Plane Crash

When he first picked up the distress beacon on 121.500 megahertz, Lynn Caudle figured that it was a false alarm. "About 97 percent of these signals are false alarms, caused by dying batteries," he said. But after several hours of monitoring the signal on his scanner radio, Caudle got curious. It was after midnight when Caudle, armed with a flashlight and a signal direction finder, walked into the dark woods.

Approximately 45 minutes later, he found the site of the crash. It was a small, single engine plane. Investigators speculate that the crash may have resulted from the plane running out of fuel.

Scanner Buff Leads Police to Murder Suspect

A 74 year old woman who lived near Tacoma, Washington, was shot and killed by a man who broke into her home. Police reports said that the man fatally wounded the woman and fired shots at residents on the street. The attacker then fled on foot and disappeared. A short time later, a scanner buff, who had heard the attacker's description on his scanner radio, called the police to tell them that he had seen the suspect from his window. As you probably guessed, the police arrived and captured the villain.

Backyard Cellular Towers

As cellular phones become less expensive and more popular, there's a genuine need for additional transmission sites. No doubt you've already seen the high cellular towers featuring long whip antennas that point toward the sky and the ground.

Well, the folks in Cleveland, Ohio, want to regulate the location of the towers. But the cellular industry has filed suite, saying that the law is unconstitutional.

Why all the fuss? It's rather simple. The cellular folks are expanding into the rural areas, and they don't like being told where they can or can't place a cellular transmission tower.

If you're a suburbanite, you might want to discuss this topic at your next town meeting—before the cellular industry starts building in your neck of the woods. (News clipping from the *Ohio Plain Dealer*.)

The FCC and the EMRS

The Federal Communications Commission has proposed an "Emergency Medical Radio Service." In the current system, medical frequencies are shared by a variety of users, including rescue, disaster relief, safety patrols, animal safety and many others.

The FCC is concerned that the increase in the number of transmitters may actually overburden existing frequencies. By limiting eligibility into the new EMRS to life support operations, the FCC hopes to improve the quality and reliability of life support communications.

The exact date of implementation and frequency assignments were not known. Stay tuned for a future update.

Next Month

We'll give you another action packed issue. Check your seat belt and get ready for another non-stop adventure into the world of radio communications.



Scanner World, USA

"The Largest Dealer of Scanners in the World"

SCANNER WORLD, USA

10 New Scotland Ave., Albany, NY 12208 • 518/436-9606

SCANNER WORLD EXCLUSIVE UNIDEN BEARCAT BC205XLT

\$259.99 (\$7.00 shipping)

Digital programmable 200 channel hand held scanner with raised button keyboard for easy programming of the following frequency ranges: 29-54 MHz, 118-174 MHz, 406-512 MHz, 806-956 MHz. Features include: Scan delay, memory backup, key pad lock, sidelit liquid crystal display, channel lockout, 10 twenty channel banks, direct channel access, automatic search, full one year warranty, 10 priority channels, Ni-Cad battery pack, AC adapter/charger, flexible rubber antenna carry case are all included. Size is 2-11/16" Wx1-3/8" Dx7-1/2" high (Optional extended 2 yr. warranty \$299.99, 3yr. extended warranty \$399.99.) (*Excludes Cellular)

#CC-008 Heavy Duty Leather Carry Case \$27.99

RADIO SCANNERS

BEARCAT BC55XLT	108.99	(7.00)
BEARCAT BC70XLT	144.99	(7.00)
BEARCAT BC100XLT	159.99	(7.00)
BEARCAT BC140	94.99	(7.00)
BEARCAT BC142XL	94.99	(7.00)
BEARCAT BC147XL	99.99	(7.00)
BEARCAT BC172XL	139.99	(7.00)
BEARCAT BC177XL	139.99	(7.00)
BEARCAT BC200XLT	279.99	(7.00)
BEARCAT BC205XLT	259.99	(7.00)
BEARCAT BC210XLT	139.99	(8.00)
BEARCAT BC310A	85.99	(7.00)
BEARCAT BC330A	109.99	(7.00)
BEARCAT BC400XLT	99.99	(7.00)
BEARCAT BC560XLT	109.99	(7.00)
BEARCAT BC760XLT	269.99	(7.00)
BEARCAT BC800XLT	249.99	(8.00)
BEARCAT BC855XLT	186.99	(8.00)
BEARCAT BC950XLT	249.99	(7.00)
COBRA SR901	74.99	(6.00)

MIDLAND CB Radios	In Stock
COBRA CB Radios	In Stock
UNIDEN CB Radios	In Stock
Two-Way Radio Batteries	In Stock
Scanner Antennas	In Stock
Power Supplies	In Stock

RELM RH606B	414.99	(9.00)
RELM UC202 (2 or more)	129.99	(6.00)

SCANNER ACCESSORIES

BCAD70	14.99	BP4	24.99
BCAD100	14.99	BP55	16.99
BCAD140	14.99	MA917	24.99
BCAD 580	16.99	MA518	14.99
BC003	7.99	ESP25	16.99
BC002	59.99	GRE8002	79.99
PS001	12.99	GRE-HH	54.99
UA502A	12.99	GRE9001	89.99
BP205/200	34.99	GRE 3001	62.99
BP70	16.99	FBE	5.99
VC001	12.99	FBW	5.99

BOOKS

Covert Intelligence	8.95
Air Scan Directory	14.99
Betty Bearcat	4.00
Top Secret (7th)	15.99
Covert Techniques	9.95
Tomcat's Big CB	13.95
World Radio	18.99
Survival Directory	6.95
Rail Scan	7.95
Police Call	8.69
Scanner Modification	17.99

ORDERING INFORMATION: Call (518) 436-9606 to place orders or mail orders to Scanner World, USA, 10 New Scotland Ave., Albany, NY 12208. Orders will be shipped within 24 hours by United Parcel Service if order is accompanied by MasterCard, Visa, cashier's check, money order, COD (COD shipped by United Parcel Service will be cash or money order only). (If a COD package is refused, customer will be billed for shipping and COD charges.) Mail orders with personal or business checks enclosed will be held 4 weeks for bank clearance. Prices, specifications, and terms subject to change without prior notice. If items are out of stock we will backorder and notify you of delivery date. All shipments are F.O.B. Scanner World, warehouse in Albany, N.Y. We are not responsible for typographical errors. All merchandise carries full manufacturer's warranty. Bid proposals and purchase orders accepted from government agencies only. Free full line catalog mailed 4 times per year. Merchandise delivered in New York State add 7% sales tax. No returns accepted after 7 days of merchandise receipt. *Add (\$ per item, at \$3.50* for all accessories ordered at same time. COD orders will be charged an additional \$4.95 per package. Full insurance is included in shipping charges. All orders are shipped by United Parcel Service to street address only. (No P.O. Box). Shipping charges are for continental USA only. All others ask for quote on shipping charge.

Scanner World, USA® • 10 New Scotland Ave., Albany, NY 12208 • 518/436-9606

RELM RH-256NB HIGH BAND TWO-WAY RADIO



\$339.99

(Plus \$9.00 Shipping Each)

16 channel digital readout two-way radio. Covers high band frequency range of 148-162 MHz without retuning. Perfect two-way radio for ambulance, police, fire, tow trucks, taxis, commercial companies who use this band. Features include CTCSS tones built-in, priority, 25 watts output, channel scanning, back lighted keyboard, message light, time out timer, scan delay, external speaker jack. Size is 2 1/4" Hx6 1/2" Wx10 1/4" D.

SPECIAL PACKAGE DEAL includes RH-256NB mobile microphone, 1/4 wave body mount antenna, mobile mounting bracket and mobile power cord all for the low price of \$339.99

UNIDEN BEARCAT BC-400XLT



\$99.99

(\$7.00 shipping)

Our best selling mobile scanner. 16 channel AC/DC programmable, digital AC/DC cords, telescopic antenna, mobile mounting bracket, weather search, priority, 29-54 MHz, 136-174 MHz, 406-512 MHz, external speaker and antenna jack.

BEARCAT BC-100XLT



100 Channel Digital Programmable Hand-Held Scanner

\$159.99

(\$7.00 shipping)

Our best price ever on a full featured complete package hand held scanner. Manufactured by Uniden. Features include 11 bands of weather, aircraft, public service, trains, marine, plus more (29-54 MHz, 118-174 MHz, 406-512 MHz), 10 channel banks, 10 priority channels, lighted LCD display, earphone jack, channel lockout, AC/DC operation, scans 15 channels per second, track tuning. Special package deal includes following accessories: AC adapter/charger, rechargeable Ni-Cad battery pack, flexible rubber antenna, carry case.

SANGEAN ATS-803A

SHORT WAVE RECEIVER
\$168.99



AM/FM/LW and 12 shortwave bands plus FM stereo, BFO for SSB reception, clock radio includes AC adapter, telescopic antenna, stereo headphones, and shoulder strap.

BEARCAT BC-147XLT 16 CHANNEL BASE SCANNER

\$99.99

(\$7.00 Shipping)

Programmable, digital, AC/DC operation. Frequency coverage 29-54 MHz, 136-174 MHz, 406-512 MHz. Weather button, priority, lockout button, squelch. Includes AC adapter, telescopic antenna.

SPECIAL!! LOWEST PRICE EVER FOR A PROGRAMMABLE SCANNER



SR-901 AVAILABLE ONLY FROM SCANNER WORLD



ONLY! \$74.99 Each

(Plus \$6.00 Shipping Each)

\$69.99 (2 or more)

Features include: 10 programmable channels, one touch memory programming, external speaker jack, 29-54 MHz, 136-174 MHz, 406-512 MHz, squelch, lockout, full frequency digital readout, AC or DC operation, retains memory up to 3 days without power, scan button. Includes AC adapter, telescopic antenna, and complete operating instructions. Size 7 1/4" W x 2 1/4" H x 7 1/4" D. One year factory warranty. (Optional mobile cigarette lighter cord #901MPC \$4.99)

UNIDEN BEARCAT BC 800XLT



\$249.99 (\$8.00 Shipping)

Receive Cellular Phone Calls. Plus police, fire, ambulance, cordless phones, marine, trains, weather, ham, stock cars, public service plus much more. Frequency coverage: 29-54 MHz, 118-174 MHz, 406-512 MHz, 806-912 MHz (includes cellular), 40 channels, AC/DC operation, digital programmable, memory backup requires 2 AA batteries (not included), telescopic antenna included, AC power cord included, external speaker jack, external antenna jack. Dimensions: 9 1/4" D x 4 1/2" H x 12 1/2" W. Channel lockout, direct channel access, scan delay, priority, digital display, auto weather button, automatic search, track tuning.

UNIDEN BEARCAT BC-950 XLT



\$249.99 (\$7.00 shipping)

Digital Programmable 100 Channel Scanner

BC-950 XLT covers the following frequencies: 29-54 MHz, 118-174 MHz, 406-512 MHz, 806-954 MHz (excludes cellular). Features scan delay priority, memory backup, channel lockout, bank scanning, key lock, AC/DC power cords, telescopic antenna, mounting bracket supplied, one year factory warranty, search, direct channel access, track tuning, service search including preprogrammed frequencies by pushing a single button for police fire/emergency, aircraft, weather, and marine services plus exclusive optional features never available on any scanner before. First is an RF receive amplifier for boosting weak signals for only \$34.99 plus a CTCSS tone board is available for only \$59.99 to make this the number one scanner available in the USA. Optional cigarette lighter plug #950MPC \$4.99

UNIDEN MR 8100



SPECIAL SALE PRICE \$289.99 ONLY (\$10.00 Shipping Each)

100 channel digital programmable mobile scanner, turbo scan up to 100 channels per second, lockout, priority, built-in automatic 2 second delay, dimmer control, back lighted keyboard, track tuning, direct programming of frequencies from front keyboard plus you can also program MR 8100 from your IBM compatible PC computer with software and cables included with scanner from Scanner World. Frequency coverage: 29-54 MHz, 118-174 MHz, 406-512 MHz, 806-956 MHz. Dimensions: 7 9/16" W x 5 8/16" H x 1 9/16" Earphone jack, BNC antenna jack, DC power cord, mobile mounting bracket, internal memory backup, bank scanning; 10 banks of 10 channels in any combination.

★ ALL MERCHANDISE NEW, IN FACTORY SEALED CARTONS

BEARCAT BC210XLT \$139.99

(\$8.00 shipping each)



Scanning Radio Receiver

Digital programmable, 40 channels, 11 bands, including aircraft, AC/DC base, with raised letter keyboard for easy programming of the following frequency ranges: 29-54 MHz, 118-174 MHz, 406-512 MHz. Covering aircraft, police, fire, marine, trains, stock cars, weather, public service plus much more. Features include: digital display, no crystals required, priority, external speaker or headphone jack, scan delay, auto weather button, channel lockout, search, squelch, memory backup.

GM-1™ GLASS MOUNT SCANNER ANTENNA

—ONLY AVAILABLE FROM SCANNER WORLD—

Frequency coverage 25-1200 MHz — only 22 inches tall. NEW REVISED DESIGN — no holes to drill — no glue needed. Complete with 17 foot cable, Motorola connector and mounting hardware. Swivels to vertical position — performance unaffected by moisture on the window. Made in USA.



SPECIAL \$39.99 (\$4.00 Shipping Each)

Antique Radio Restoration

I get quite a few letters from you folks, and now that I can be reached via GENIE (mailbox T.AREY1), I am also receiving many questions over the phone lines. One frequent question is "What radios do you own, Uncle Skip?"

That is a very interesting question. Over the years I have had the pleasure of the company of many receivers. Just like courtship, some were summer flings, some hung around for awhile...a few overstayed their welcome. Some are gone but remain dear friends.

Talk about stretched analogies, Uncle Skip!

Relax Fearless Leader, I'm just trying to tell you that one radio has been with me from the start. It has sat on my desk since I got it for my sixth birthday. It's a six transistor Silvertone AM "shirt pocket" radio. It even has CONELRAD markings on the dial to remind me of the paranoia of the Cuban Missile crisis. The little bugger still works like a charm.

The point is that, now that this puppy is over thirty years old, it is dipping into the realm of antiquedom. Antique radio collection and restoration is a fast growing facet of the radio monitoring hobby, and it can be a great path for beginners. Radio is really not all that old; Quite a few of the early receivers are still out there in working order. As you move through into the era of mass produced receivers, more and more of this equipment can be found. Perhaps the most enticing aspect of antique radio collecting is that you can jump in with very little money and have a whole lot of fun.

That is the best excuse I know of to open the creaking door that leads to . . .

UNCLE SKIP'S GUIDE TO ANTIQUE RADIOS

Collecting radios is much like collecting stamps or comic books, you just need a bit more room. Most folks tend to be attracted to a particular group of old radios, the most common being those receivers produced for mass market from around 1929 through the Second World War. But post war, pre-integrated circuit receivers are also growing in value. I confess a weakness for five-tube plastic case radios from the 1950's.

Where Are All the Radios?

That is the easiest question I've been asked since I said "I DO"! Collectable radios are everywhere! A quick glance around Grandma's attic is likely to surface one or two boxes that will

Even shortwave receivers have become collectibles.



start you off. One of my prized Zenith console radios was found at someone's curb on trash day.

Periodically, my significant other drags me along to flea markets and swap meets as her designated beast of burden. On more than one occasion I was able to carry home a fine old receiver for myself as well. In previous columns I have talked about amateur radio flea markets. Lately, many collectable receivers, as well as parts to restore your treasures, can be found amongst the ham radio wares. Dates and times of hamfests can be found in the MT Special Events calendar, in many monthly radio hobby publications, or you can check with area hams.

The best tip I can give an antique radio recruit at this point is *start small and pay smaller!* Many great old radios will surface for less than \$50. Your first collectable rig will serve as the training event for your future as an antique radio maven.

Oh, by the way, once you have acquired your future museum piece, *do not under any circumstances plug it in or turn it on!!!* The deterioration that old radios are sometimes subjected to can lead to a room full of smoke and a stack of broken dreams. You will need to check out a few things before you can be sure it is okay to bring your receiver back to life. You have to remember that most radios ended up in the attic or out to the trash because they stopped working.

The plus is that the breakdown that sent the set packing is often a minor problem, frequently a weak or defective tube. What is nice about old tube type equipment is that everything inside these receivers is fairly big and easy to work with. Visual inspection and cleaning of old equipment comes first and, more often than not, will give you a notion of what problems lie ahead.

Hitting the Books

I'm sure you have heard the idea that veterinarians have to study harder than physicians

because there are so many different kinds of animals. Digging into the guts of old radios is a little like being a veterinarian. There are many different circuits. First you need to read up on some general restoration principles and then you will want to seek out schematics and diagrams pertinent to your specific equipment.

Don't be afraid, folks! Old-time radio innards is straight-forward stuff. Two books that have served Old Uncle Skip well through several restoration projects are: *How To Repair Old-Time Radios* by Clayton L. Hallmark, \$8.95, TAB Books, Blue Ridge Summit, PA 17214 and *Antique Radios Restoration and Price Guide* by David and Betty Johnson, \$10.95, Wallace-Homestead Book Company, 580 Water's Edge Road, Illinois 60148. You can also check with your public library for other titles or contact the advertisers in the pages of MT who specialize in radio related books.

Circuit diagrams can be a bit more tricky, but they are out there if you know where to look. The biggest source for schematics and manuals dating back all the way to the 1920's remains Howard W. Sams & Company, 2647 Waterfront Parkway East Drive, Indianapolis, IN 46214. If you supply them with a brand name, model and, if possible, chassis number, they can probably help you out. However, their photocopy rates for pre-1945 diagrams and manuals can be a bit steep. Olde Tyme Radio, 2445 Lyttonville road, Silver Spring, MD 20910 is an outfit more oriented toward the collector and his or her pocketbook.

If you live near a college with an electrical engineering program you may want to check out their library. Large technical libraries often have older Howard W. Sams materials in their stacks.

If It Ain't Broke Don't Fix It! But What If It Is?

Armed with all the book learning you have developed in the previous paragraph, you are

ready to poke and prod and figure out what went wrong all those years ago while Aunt Tilly was listening to "Our Miss Brooks."

First you will want to test all the tubes. Before you go pulling the tubes out, be sure you make note of all their numbers and locations. Since most Radio Shacks no longer have tube testing equipment, you will need to call around to older, established TV & radio repair shops in your area. You can also check with any amateur radio operators that you know are familiar with tube type equipment. It is possible to check out most tubes without a fancy tube testing machine but you will need to bone up on tube theory a bit to do it. As I said earlier, a stale tube is usually the culprit with these receivers.

Locating replacement tubes is really not that hard. Radio Shack stores across the country have a special order hotline for most common tubes. You may have to convince the salesperson that it exists. Tell him to turn to page 140 of their 1992 catalog. Again, older TV & radio repair shops often have good tube stocks. For rare tubes you will have to check out ham radio flea markets and specialized surplus and antique companies that often advertise in radio hobbyist magazines.

Another part that is often the cause of receiver demise is the capacitor. Many capacitors in older radios were made out of an oiled paper dielectric that fails with age. The only solution is to replace these components with modern plastic coated pieces. What most collectors do, for aesthetic reasons, is disassemble the paper capacitor and insert the modern replacement inside. This is easy to do because the modern capacitor is invariably smaller in size.

As you get more involved and begin to peruse the antique radio press, you will find outfits that specialize in all aspects of receiver restoration. Even such esoteric services as grill cloth matching and speaker rebuilding are out there to help bring Aunt Betsy's old Motorola back into the land of the living. A clearinghouse for information on supplies and services is the *Antique Radio Classified*, 9951 Sunrise Blvd. #R-9, Cleveland, OH 44133.

Isn't All This Learning Going to Take Time?

Well sure! But it is not that big of a problem. First of all, the learning curve isn't all that steep here. Track down a book or two on restoration and you can read as you go. Also, you have all the time in the world. Aunt Mildred's old Crosley has been waiting for sixty years to be reanimated. A few more months won't hurt a bit.

Old Uncle Skip "collected" radios for ten years before I ever got the time to actually start restoring anything. Saving these old beauties from the scrap heap is 80% of the battle. My first serious project took two years of free evenings to complete. So relax and have fun learning

about these fine old radios. Time is on your side, Bunkey!

Antique Shortwave Too!

Really great shortwave receivers began to appear after World War Two. But the fifties and sixties brought about some of the most famous equipment from companies such as National, Hammarlund, Hallicrafters and Collins. Finding and restoring one of these "Boat Anchors" is not only fun, but you can end up with a receiver that will allow you to pursue your radio monitoring hobby on a level that is often competitive with most modern equipment.

Shopping for this equipment will usually send you out, once again, to amateur radio flea markets. Price and value of collectable shortwave receivers can be a little tricky so you might want to arm yourself with some resources. The *Receivers and Scanners Pricing Guide* by Bob Grove (\$5.95 plus \$1.50 shipping from Grove Enterprises, P.O. Box 98, Brasstown NC 28902) and *Shortwave Receivers Past and Present*, by Fred Osterman (\$5.95 plus shipping from Universal Radio, 1280 Aida Dr., Reynoldsburg, Ohio 43068) will give you an idea of what reasonable prices might be for most older shortwave gear.

Any Clubs Out There???

You bet, Compadre! I even started one once. Back in the early eighties I formed the R-390 Users Group that initially specialized in restoring military surplus receivers. Over the years it evolved into *The Hollow State Newsletter* and addressed the needs of folks who collect all types of tube receivers. HSN is now published by Ralph Sanserino, 11300 Magnolia #43, Riverside, CA 92505. You can write him for current subscription rates (Don't forget the SASE).

Antique radio clubs can be found across the land. To find one near you contact the Antique Wireless Association, Main Street, Holcomb, NY 14469

Antique radio collecting is a hobby that will last a lifetime and then some. Your restored sixty year old receiver should be good for at least another sixty once you have brought it up to snuff.

This brings up another point. Take good care of your modern receivers. Maintain them with care and perform regular preventive maintenance on them and someday they too will be fine old collectibles. Just like my Silvertone six transistor. Someday I'll figure out why it plays better on the Oldies station.

MT

1-800-666-0908
NEW EQUIPMENT ORDERS & PRICES ONLY PLEASE

SHORTWAVE RADIOS

SONY - All Popular Models including the ICF2010 and the NEW SW77
SANGEAN - ICOM - JRC - YAESU - GRUNDIG - and the NEW DRAKE R8

SCANNING RADIOS

Featuring the NEW ICOM R1 Handheld and R100 Mobile/base • SHINWA SR001 • UNIDEN BEARCAT • AOR models including AR1000XC

Factory Authorized Dealer for: ALINCO - ICOM - JRC - STANDARD - YAESU
DIAMOND - CUSHCRAFT, etc., Amateur Equipment
Commercial 2-way from ICOM - MAXON - STANDARD - YAESU, etc.

FOR INFO AND TECH HELP CALL (203) 666-6227
OUT-OF-STATE SALES CALL 1-800-666-0908
CONN. SALES CALL (203) 667-9479

LENTINI • COMMUNICATIONS • INC

21 Garfield Street Newington, CT 06111

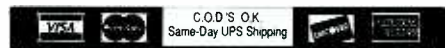

WR-3 WHISTLER RECEIVER

The WR-3 is a broadband, Very-Low-Frequency (VLF) "E-Field" receiver which receives naturally occurring VLF radio emissions in Earth's magnetosphere, much of it originating from lightning strokes. The unit receives emissions such as whistlers, twees, lightning sferics, dawn chorus, etc., in the 0.1 to 10 KHz VLF frequency range. The WR-3 comes with detachable 33-inch telescoping whip antenna and is powered by a 9 volt battery. Cast aluminum enclosure. Size: 4.5 X 2.5 X 1.2 in. Uses stereo "Walkman" type headphones (not included). 7 page listening guide to Earth's Naturally Occurring VLF Radio Emissions is included. A 30 min. tape of these sounds is available for \$8.00. Check/M.O. or write for info to:

MODEL WR-3 CONVERSION RESEARCH
\$48 ppd P.O. BOX 535
(CA RES. ADD TAX) DESCANSO, CA 91916

Tone and Code Finder



Pricing
Tone Only \$189.95
Tone & Dig. \$299.95
Tone w/Mem. \$239.95
Tone & Digital w/Memory \$339.95

The Tone/Code Finder is composed of a high speed display unit mounted to a scanning receiver. Its purpose is to instantly find and display all CTCSS and DIGITAL codes, including split channel and inverted codes.

On board memory retains all hit and time information which is then transferred to a printer via a RS 232 port upon command. Time is stored in seconds and hits in units. In the event of power loss, the FINDER will maintain memory for up to three weeks.

Measurements Division

AUTOMATED INDUSTRIAL ELECTRONICS CORP
141 GRANITE ST. P.O. BOX 70
BATESBURG, S.C. 29006
(803)532-9256 FAX(803)532-9258

INTERCEPTS

NEWSLETTER
INSIDE INFORMATION FOR THE SERIOUS MILITARY MONITOR

SUBSCRIBE NOW
12 Issues - 1 Year for \$18.00 and receive a custom printout of frequencies of the USAF BASE OF YOUR CHOICE* Add \$5.00 for Foreign Orders. *Please specify base with your subscription. Limited to Air Force Bases in the U.S.

ALSO
Have a computer and a modem and need the latest inside military monitoring information? INTERCEPTS BBS is where you'll find what you need 24 hrs. a day. For Only \$50.00 a year (includes all BBS privileges & a 1-Year Subscription to INTERCEPTS NEWSLETTER)

INTERCEPTS
Steve Douglass, 6303 Cornell
Amarillo, TX 79109

or send \$10 BASE for complete details & a FREE sample.

On the Trail With Air Force One

In February's *Monitoring Times* we featured an excellent article by Everett Slosman on monitoring the political action on the airwaves. When the candidates fly from primary to primary, the incumbent president hits the campaign trail, and the nation is focused on the exciting process of selecting its new leaders. This is one time the federal monitor has the unique chance of getting in some first-rate, high-ranking government radio intercepts.

Since Everett's article came out, the Federal File has been deluged with letters asking more about how to monitor the communications of the President and Vice President of the United States.

To beginning monitors, the fact that anyone can listen in on the President making radiotelephone calls from Air Force One sounds unbelievable. But as strange as it may seem, many of the Air Force One and Two's radiotelephone calls not only can be overheard but are in the clear. Personal calls to loved ones, calls to senators and congressmen, and discussions of campaign strategies have all been reported.

Exotic equipment is not needed and everything can be received on standard VHF/UHF scanners and shortwave receivers. All that is required is the right equipment covering the right frequency bands, the Federal File's frequency and callsign lists and a little patience. In this month's Fed File we will look a little closer at how you can monitor Air Force One and Air Force Two.

note that these are "split decimal" frequencies and many monitors will notice that their scanner will round off the number when entered, (for example 162.6875 MHz becomes 162.685 MHz). Don't worry; your scanner's selectivity will be wide enough to receive these communications.

When the President or Vice President is on the ground, you'll also find the bulk of Secret Service frequencies on VHF as well. Everything from motorcade communications to the agents protecting the Pres./Vice Pres. themselves can be heard. Check out the Secret Service listings in the February *MT* article.

Don't forget to scan the VHF low band as well. The White House Communications Agency (WHCA) has been heard using 32.23 MHz ("ABLE") WHCA vans. The Secret Service has been also been reported on 34.070, 37.180, and 46.75 (Secret Service helicopters); and on 46.70 MHz, 46.80, and 122.850, USMC helicopters escorting the President and Marine One can be heard.

PRESIDENTIAL BUZZWORDS AND CALLSIGNS

Callsign	Definition
ACROBAT	ANDREWS AFB
ANDY	ANDREWS AFB
BAMBOO	PRES. MOTORCADE
BIRDSEYE	DEPT. OF STATE
BUCKEYE	CAMP DAVID, MD.
BULLDOG	VIP PROTECTION CP
CACTUS	CAMP DAVID, MD.
CANDLESTICK	VIP PORTABLES
CEMENT MIXER	WH SITUATION ROOM
COACH HOUSE	DULLES AIRPORT D.C.
COBWEB	V.P. OFFICE, D.C.
CROWN	WHCA COM CTR
DOG POUND	PRESS AIRCRAFT
ELM	CAMP DAVID, MD.
FALCON	PRES. AIR COVER
FENCING MASTER	SEC OF TREASURY
FIREPLUG	SEC OF LABOR
FISTFIGHT	SEC OF HEW
FLYING FISH	SEC OF INTERIOR
HELPING HAND	THREAT
HORSEHIDE	AMBULANCE
HOTSHOT	WHCA DUTY OFFICER
MAGIC	HELO. COORDINATION
NIGHTHAWK	PRES. COPTER
PACEMAKER	V.P. STAFF
PAVILLION	V.P. OFFICE
POTUS	PRESIDENT
ROADRUNNER	WHCA COM. VAN
SAM & 5 DIGITS	VIP FLIGHT
SAM 01	FOREIGN VIP FLIGHT
SIGNATURE	PRES. COPTER
SKYMASTER	ANDREWS C.P.
SUNBURN	SEN. TED KENNEDY
THUNDER	REV. JESSE JACKSON
TIMBERWOLF	GEORGE BUSH
TRANQUILITY	BARBARA BUSH
WHEELS UP	AF-1/2 AIRBORNE
WHEELS DOWN	AF-1/2 LANDING
VENUS	SAM W.O. VIP

On the Scanner Bands

As touched on in Slosman's article, the bulk of presidential communications takes place on the scanner bands. Most Air Force One/Two radiotelephone calls can be heard in a rarely-scanned portion of the UHF band (407-410 MHz). Make sure the scanner you buy includes this small section of the UHF band. Most do, but some don't.

The frequencies to have programmed in your scanner at all time are 407.850 and 415.700. You must have both frequencies entered to receive both sides of the conversation. These frequencies are referred to as the "Echo/Foxtrot" pair. If you own a scanner capable of receiving the UHF military aviation band, be sure to check out following frequencies: (mode WBFM) 305.550, 361.600, and 397.050 (Alpha Bravo). You will also hear Air Force One talking to air traffic control towers and centers on UHF as well.

It is likewise a good idea to search the 260 to 396 MHz military satellite band in the wideband FM mode. You might just find some AF-1 satellite links there whenever AF-1/2 are in your area.

On VHF

Even those of you who do not own a receiver capable of monitoring the aforementioned portions of the UHF band are not out of luck. Another pair of AF-1&2 radiotelephone frequencies exists on VHF, right in the middle of the police bands.

Referred to as the "Yankee Zulu" pair, many telephone patches have been overheard on "Yankee" (162.6875 MHz uplink) and "Zulu" (171.2875 MHz downlink). Remember, you must have both frequencies keyed in to receive both sides of the telephone conversation. Also

The President on HF

If you own a good shortwave receiver, you're also in luck. For Presidential and VIP flights that take place outside the borders of the U.S. or out of the range of domestic communications sites, Air Force 1/2 and many diplomatic flights use Mystic Star. The same type of radiotelephone calls that can be overheard on VHF and UHF can be heard bouncing from around the globe on Mystic Star frequencies.

Reported as the most active of the Mystic Star frequencies are 6.756 MHz and 13.214 MHz. You will hear AF-1/2 in contact with "ANDY" (Andrews AFB, MA) providing radio checks, phone patches, etc. Andrews AFB is the controlling agency on Mystic Star. Note that all comms are in USB mode. See the accompanying table for Mystic Star frequencies.

Buzzwords

By now every Federal File reader knows that "Timberwolf" is the code name of President George Bush and "Supervisor" is the code name of Vice President Dan Quayle, but do you know who "Sunburn" and "Thunder" are? How about "Unicorn"? Listening in on Presidential communications can be confusing if you don't have a list of the latest buzzwords in use. The table on this page provides some of the callsigns and codewords not mentioned in Everett Slosman's article.

As the airwaves heat up with the communications of politicians hop-scotching around the airwaves, you'll be there behind the scenes on the campaign trail. Be sure and send in your loggings to the Federal File.

Mystic Star Network

Controlled by Andrews AFB, the U.S. Air Force provides worldwide HF SSB support for presidential and vice presidential flights via remote transmitters on global USAF installations utilizing telephone voice channels, primarily for use when the aircraft are out of UHF range.

(A)
4445 5152 5432 6993 769907873 7922 8029 8170
10202 11056 11466 11995 12106 12317 13752
14417 14863 15595 15733 16120 16320 17433
17480 18320 18390 19005 19050 19653 19668
20053 20400 22913 23687

(B)
4444 4487 5340 5398 6993 11413 11995 12029
12258 14670 14867 15687 16121 17496 18060
18320 18675 19513 19758 20124 20953 22723
23643 24274

(C)
4505 4865 4925 5078 5270 5395 5800 6812 7735
7907 7982 8045 8086 9320 9425 9885 10427 10590
10765 10780 11441 11615 12058 12105 12155
12270 13412 12385 14412 14715 14897 14957

(D)
3116 11229 13204 18023

(E)
6730 9017 11226 13217

(F)
6728 6731 9017 11220 11494 13211

(G)
7305 7469 8047 8162 9007 9991 11153 11466 11484
11995 12060 12106 12250 13565 14364 16011
16077 16320 16385 17460 17565 18100 18532
19008 20452 20650 22940 23243 24933 25433

(H)
4760 5340 5412 5437 5820 6993 8055 8162 8176
9270 9414 9958 10427 10586 11995 12090 12106
12240 12258 13440 15555 15672 15710 15742
16070 16100 16407 17480 17625 18095 18175
18478 18980 19180 19447 20165 20400 20972
21770 21843

(I)
6756 13440 13825 14412 14896 16246 17554 18331
20195 20340 20475 23035 25130

(J)
4455 4938 5026 5820 5937 6793 7497 7690 7827
8060 13247 13825 14448 15036 15041

(K)
4721 6756 6683 13247 13823 14576 14867 17457
17480 18320 18795 19160 20154 20400 23687

(L)
11056 16117

(M)
6927 6989 7466 7975 9475 9866 9921 10603 10881
11055 11498 1545 12170 12254 13457 13484 13585
14913 14957 15555 15680 15710 15760 16121
16320 16407 17386 17427 17480 18270 18490
19060 19373

(N)
8080 8162 9215 9320 10583 10720 10880 11055
11156 11448 11488 11627 12240 12324 13604
13710 13765 14572 14766 14829 14887 15664
15724 16080 16160 16186 17460 17480 17562
17679 17985 18146 18400 18629 18790 19047
19092 19270 19340 20150 20321 20425 20758
23397

(O)
19895 20016 20395 20665 23132 25227

(P)
5305 5760 5910 6790 7316 7660 7813 7930 7955
9188 10153 10357 10530 10550 11118 11667 12242
13455 13582 13760 13825 14902 15500 15776
15821 15908 16041 17480 17547 18218 18590
19237 19800 20313 20415 20535 20640

(Q)
4760 4982 5434 5820 6817 7997 8039 8050 9320
10112 11058 11156 24483

(R)
4982 5775 5822 7605 7765 7910 9043 11407 11634
11988 12107 12277 13878 14497 14896 16246
17554 18331 20195 20340 20475 23035 25130

(S)
9006 9180 1167 16041

(T)
6716 15018

Source: Shortwave Directory by Bob Grove

Mailbag

Speaking of Presidential monitoring, Bruce Frederick writes us from Burlington, MA, and says that the Federal File has solved a radio mystery for him. Bruce says, "I live near Hanscom Air Force Base, which has a Command Post (CP) frequency of 397.1 MHz. A few months ago I noted what appeared to be a wideband signal blanketing that frequency, but it didn't seem to be originating from Hanscom. At the time I wrote it off to a spurious image, because it sounded like a casual phone call, possibly originating from a defective airborne radiotelephone. In rereading your January and June columns from 1990 I noted that one of the Alpha Bravo frequencies is 397.05. That's what I was hearing."

Bruce goes on to say that Hanscom does nothing to prevent the transmissions from interfering with their C.P. channel. Even when AF-1 communications interfere severely with Hanscom's C.P. traffic, they continue to struggle and use the frequency.

According to Bruce, this happens frequently, for Hanscom is right underneath the flight path of AF-1 and other SAM flights as they shuttle between Andrews AFB and Pease AFB. Putting up with the interference is pretty strange especially considering Hanscom is home to the Air Force's Electronics System Division. Thanks for the info, Bruce.

Post Office Monitor

Ever wonder why that income tax refund is taking so long to arrive in your mail box? When Bob Wilcynski of Indian Orchard wonders, he just turns on his scanner. Apparently Bob monitors the U.S. Postal Service in nearby Hartford on 415.050 MHz. Bob says this seems to be their dispatch/working channel. Sometimes the communications are scrambled (DVP).

Bob, here are some of the frequencies allocated for the U.S. Postal Service nationwide, 169.000, 169.650, 169.800, 169.850, 170.175, 406.325, 406.375, 409.175, 409.275, 409.450, 410.200, 410.325, 413-600, 414.725, 414.750, 415.050, 416.225, 416.250, 418.100, 418.300, 418.575.

Thunderbirds And Blue Angels Schedules

Special thanks to Norm Pihale of Northfield, MN, for sending us the 1992 schedule for the Thunderbirds and Blue Angels flight demonstration teams. Here are the listings for April and May.

U.S. Air Force Thunderbirds

April 4 Seymore Johnson AFB, NC.
April 5 Pope AFB, NC.
April 11 Reswell, NM

AM/FM DXING



SUPERADIO II

HIGH PERFORMANCE - LONG RANGE AM/FM PORTABLE RADIO



- * **Long - Range Reception**
Air-gang tuning capacitor with tuned RF on AM and FM
976mm (38") swivel whip FM antenna
200mm (7 7/8") ferrite rod AM antenna
AM and FM external antenna terminals
- * **Station Selectivity and Separation**
Ceramic IF filter plus 3 IF Tuned Circuits on FM
4 IF Tuned Circuits on AM
AFC (Automatic Frequency Control) defeat switch for fine tuning adjacent FM stations
- * **Sound Quality**
Two-way Speaker System - 6 1/2" High - Sensitivity Woofer, 1 1/2" Piezo Tweeter, 700 mw RMS audio output. Separate Bass and Treble controls
- * **Other Features**
Two-way Power - AC or DC operation (6 "D" cells/batteries not included), 3.5mm Headphone jack, fold down carrying handle, One Year Limited Warranty, Dimensions: 12.5"W x 10.5"H x 4.5"D

Only \$54.95 + 6.50 Shipping/Handling
(CHECK / MONEY ORDER)
(California residents add Sales Tax)

CHILTON PACIFIC LTD.
5632 Van Nuys Blvd., #222
Van Nuys, California 91401

April 12 Altus AFB, OK
April 14/15 Muskogee, OK
April 18/19 Amarillo, Texas
April 25/26 NAS Norfolk, VA
May 2 Maxwell AFB, AL
May 3 Brunswick, GA
May 9 Shaw AFB, SC
May 10 Martinsburg ANGB, WV
May 16 Ft Smith ANGB, AR
May 17 Eaker AFB, AR
May 23 Kelly AFB, TX
May 24 Reese AFB, TX
May 27 USAF Academy, CO
May 30 Chanute AFB, IL
May 31 Scott AFB, IL

BLUE ANGELS

April 4-5 Wilmington, NC
April 11-12 MacDill AFB, FL
April 24-26 MCAS El Toro, CA
May 2-3 Redding, CA
May 9-10 Cape Girardeau, MO
May 16-17 Chattanooga, TN
May 22-23 Andrews AFB, MD
May 25 Naval Academy, MD
May 30-31 McConnell AFB, KS

Training for Control

Welcome aboard! In answer to the many questions from readers about how air traffic controllers are trained, we have a special feature this month. So fasten your seatbelts and we'll take off for the Air Traffic Controller's Academy in Oklahoma City to see what it takes to become a controller today.

Our hosts are Gwen Sawyer and David Mathews. Ms. Sawyer is the Supervisor of the Screen and Placement Section, which administers the initial qualification programs. She was a Controller at the Albuquerque (NM) Air Route Traffic Control Center and has been with the FAA for 18 years. David Mathews has 19 years experience as a Controller at the Atlanta ARTCC. At the Academy, he worked as an instructor in the Radar Training Facility and then as a manager creating and updating material for the field facilities and academy courses. David has since returned to the Atlanta ARTCC and resumed his career as an Air Traffic Controller.

What type of background does the average person have coming into the Academy, and what are the qualifications that are needed? David explained that 30% of the candidates today have aviation experience and 15 - 20% come to the Academy with military ATC training. Formerly, 50% of the applicants used to have experience in military air traffic control and about 70% had some type of aviation background. However, fully 45% of the prospective trainees today have college degrees and their backgrounds are quite diversified.

Requirements include three years of general work experience or four years of college, or any combination of education and experience equaling three years of general experience. Also, they must not be older than 30 years of age—except for those who intend to train for Flight Service Specialist. There is no age limitation in that specialization. Candidates must pass the Academy entrance exams with a minimum score of 75.1; a rating of 85% is preferable.

The tests explore the applicant's general aptitude in spatial relationships and abstract reasoning. There's also a specialized air traffic

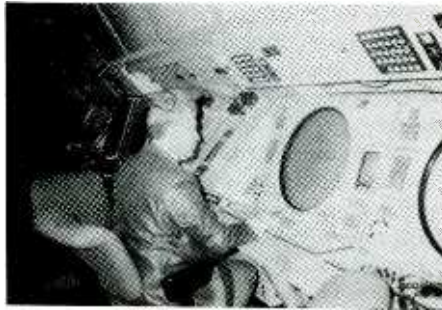

Close-up view of David Mathews working a simulation on radar scope in the radar lab for demonstration.

control aptitude exam. An individual can also score additional points for ATC background by performing well on a test for which prior experience is necessary to correctly answer the questions.

An Academy candidate also has to pass a very thorough physical exam. Just as in pilot training, certain medical qualifications must be met. In addition, there's extremely comprehensive psychological testing required to determine mental fitness for the job. Those fortunate to have to have met and passed all of the above are then hired as probationary employees.

Learning the Rudiments

When a prospective trainee enters the Academy, explains Gwen Sawyer, they are put through a Screen Program for nine weeks. The Screen is a job-simulator program which teaches the rules and procedures for air traffic control and then puts the candidates in a laboratory setting where they have to perform as controllers. Then, their potential is evaluated. The same testing is given for Tower/Tracon, Center Controllers and for Flight Service Specialists. While they're hired off the same register, once the job offer comes through they're separated into different training programs.

Approximately 50% of the Developmentals (trainees) will not make it to Full Performance Level Controllers; 40% of this loss occurs during the nine weeks of training. So while there is some fallout in later stages, the vast majority are screened out at the Academy and won't have to go through the trauma of washing out in the field.

The Screen program begins with four weeks of academics, in which rules, procedures and practices of ATC are learned. The main courses include Air Traffic Rules and Procedures, Aircraft Terminology and Characteristics, Aircraft Separation Criteria and Coordination Procedures, Phraseology and Communication, Board Management and Priority of Duties, and Flight Strip

Marking and Related Symbols.

The second half of the course is the laboratory where student controllers demonstrate the ability to do the job. They have to work practice problems such as the following: "Here are aircraft flight progress strips. In a few minutes, the clock will start and for the next 1/2 hour, you are the Controller. Do it!" The students are then required to resolve any separation problems and other conflicts between aircraft that are already in the air. In addition, they provide descent and approach clearance for those who want to land and clearance for those planes waiting to take off.

An Air Traffic Controller working in any facility has to learn his area—his chart. For that matter, even an experienced Controller who transfers to a new facility has to do the same thing. For use in the labs, one of the first things the students learn is a synthetic area called "Aero Center." All of the names on it are names of actual locations centered around Oklahoma City and the State of Oklahoma; all of the fixes, places, intersections, nav aids, are based on the actual ones. Although all the geography is real, a synthetic area is used, since the Academy trains people for the whole country.

One big final exam really measures the candidate's laboratory skills. It's a timed test where the controller has to analyze a situation, make a decision, and move on. This test is a good predictor as to whether a student will make it to Full Performance Level (FPL). When it comes right down to it, only the top of the cream of the crop make it from the Academy to the field, because all of the training after a Developmental passes the Screen program is all pass/fail training. The trainee has to succeed in each step up in the training, or that's it!

I asked, "At what point does a Developmental decide which option he or she wants (Enroute Center, Tower/Tracon, Flight Service Specialist), or is it chosen for them?"

Ms. Sawyer told us that up to this point the Developmental doesn't know which option, or even which geographical location they'll be given. The criteria for placing them is based on which region needs them and which positions need to be filled.

Another factor which determines placement is how well the student performs. The Level 1 and 2 Towers—even some of the Level 3s, where traffic is not too intense—offer those with lower scores a better chance of success than a very busy Center environment. Prior to this practice, those who had low final test scores had a 50-50 chance of making it at an Enroute Center. But by sending them to a low-activity Tower, they probably have an 80-90% chance of making it to FPL. Previously, too many potentially good people who would have performed well at a less busy



Gwen Sawyer, the Academy's Screen and Placement Section Supervisor.

facility were lost. "Consequently," said Ms. Sawyer, "we've found it's important to use the potential they demonstrated while they were here as a basis for what's most appropriate for them."

The Screen isn't designed to teach *everything* students need to know about air traffic control, just the basics that are necessary before they can go on into the options. Developmentals who are placed in the Tower/Tracon option stay at the Academy for another six weeks of additional training. Then they go out into the facilities, and, depending on the level and type of facility, they may come back to the Academy in 12-18 months for more training.

It takes about three years for an Enroute Center Controller to reach Full Performance Level; Tower/Tracon Controllers may reach FPL in a little less time, depending again on the size and complexity of the facility where he or she works.

Flight Service Specialists have a somewhat different program. Unlike the others, most of Developmentals in the FSS option have their facilities assigned to them when they first come to the Academy. Like their counterparts in the other options, they also have to undergo additional training on the job to learn their facility and area. However, the primary part of their actual classroom training takes place at the Academy.

Making it on the Job

A prospective Controller needs to have a unique spatial ability to be able to receive different stimuli at the same time, sort out and prioritize them and then get back to them in the right order for follow-up. However, no one in the world has been able to identify conclusively who has the ability to be an Air Traffic Controller and who does not.

Both Gwen Sawyer and David Mathews emphasized that while there are certain skills and abilities which cannot be taught, there are tests which can determine the potential for them. For instance, listening is one, and being able to prioritize is another. These are skills that a prospective Controller needs to have initially, then develop and fine-tune in the laboratory and on the job. Also, most controllers will tell you that self-confidence is very important to the job, and this is something else that can't be taught. As the controller grows in knowledge and confidence, it will show in the job performance. But, if a controller has 100% knowledge and lacks confidence, he won't make it.

Gwen added that an old phrase is frequently used in training, "Do something, anything, even if it's wrong!" Because as a controller, you have to be able to react—every controller has to do

that at one time or another, and there never has been a Controller that didn't make a mistake occasionally. But this is why it's said that you have to see and assess the situation coming up, have plan A, plan B—all the way down to Z! Because if you what you try first doesn't work, then you've got to be able to try something else.

"What about the stress factor? Many of *MT's* readers have wanted to know about this area of a controller's life."

Gwen told us that part of the screen and training process tries to identify those for whom this may be a stress-provoking job. Therefore, if someone's going to have a stress problem, usually it's going to be obvious during the training period.

David added that there's one thing that can never ever be replaced, however, and that's the on-the-job training Developmentals go through at the field facilities. An experienced controller stands behind the trainee and sees how the person reacts and applies procedures. But *most* importantly, they watch how the individual deals with working *real airplanes carrying live people, in real-time situations*. There's no way to simulate that. David mentioned that he'd seen students who have every skill, knowledge and ability imaginable. But when realization hits that those are real airplanes, not just symbols on a radar-scope, they sometimes resign.

Gwen agreed and remarked that Controllers who don't see their jobs as stressful are performing exactly the same duties as those who do. It's just a different perspective of the whole picture, confidence in their skills, and enjoyment of the challenge. To sum it up, the majority of controllers would tell you that if they didn't have confidence in what they do, even the big bucks wouldn't keep them there.

My final question to our hosts was if they had to do it all again, would they still have chosen Air Traffic Control? Gwen and David both agreed that without a doubt it would still have been their choice of careers!

I hope you've enjoyed our visit to the Academy, and we thank Gwen and David for their time and effort on our behalf.

New Frequencies

Two new frequencies have been added to ARINC's North Pacific family of frequencies: 17946 and 13339.

And speaking of ARINC, next time we'll look at an update on them—their VHF/HF radio services and frequencies. Also, we'll have some more airline company frequencies from different areas around the country. Keep sending them in, folks!

Until then, '73 and out.

MT

NEW ENHANCED DISCONE SCANNER ANTENNA

100%
MADE
IN USA

ONLY
\$36⁹⁵

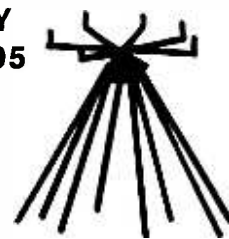

- 800 to 900 MHz enhancement.
- Transmit on 146, 220, and 440 amateur bands
- Compact, will fit in 36" x 36" space
- Receives all AM-FM & SSB frequencies.
- Gain improves with frequency increase.
- Mounts to any vertical mast 1" to 1½".
- Aluminum mount & elements.
- 8 cone & 8 disk elements—same as other discones selling for nearly 3 times our price
- Accepts standard PL-259 connector.
- For type "N" connector add \$5.00.

Order Direct From

Lakeview Company, Inc.

3620-9A Whitehall Rd.

Anderson, SC 29624

800-226-6990 (Orders Only)

803-226-6990 (Tech. Questions)

Add \$4.00 per order for shipping/handling
Catalog Available • Dealers Welcome

DIRECTORY OF MILITARY AVIATION COMMUNICATIONS (VHF/UHF)

EUROPE, NORTH AFRICA,
MIDDLE EAST

6,000 New Listings

\$19.95 plus overseas airmail

HUNTERDON AERO PUBLISHERS

P.O. Box 754, Flemington, NJ 08822 USA

Credit Card Orders: 1-800-542-SCAN

Send \$1 for catalog

and receive \$2 off first order!

Filter Modules



- Improve the selectivity of your receiver
- Various bandwidths are available specifically designed for the shortwave enthusiast: from 2.8 kHz to 6 kHz (-6 dB bandwidth)
- Special input and output amplifiers eliminate the need to match the filter to the receiver's circuitry
- Excellent shape factors and zero insertion loss
- Miniature shielded coax for all signal connections
- Self-adhesive velcro allows placement anywhere within the receiver's enclosure
- Easy to install - Complete instructions are included

Kiwa Electronics, 612 South 14th Ave.
Yakima WA 98902 Tel: 509-453-KIWA

Give GWEN a Try

Sooner or later, if you spend much time tuning below 175 kHz, you're going to hear them—those short, raspy bursts of energy that seem to come and go without notice. Called "buzz beacons" by some, these signals are actually part of the sophisticated Ground Wave Emergency Network (GWEN) run by the US Air Force. These stations send encrypted data packets (similar to those used by amateurs) for reception or retransmission by others in the network.

It is hoped that GWEN will never be needed. It exists solely to provide backup communications in the event normal modes fail, such as HF voice, RTTY or telephone. During nuclear hostilities, it's very possible that these modes would fail because of Electromagnetic Pulses (EMP) and ionospheric damage.

To deal with these problems, GWEN sites are EMP-hardened and, as the name implies, they do not rely on skywave propagation for communications. Using the ground-hugging characteristics of longwave, it is hoped that critical radio traffic could continue uninterrupted.

GWEN transmitters pump out a hefty 5000 watts and use impressive 300 foot tall "hot tower" antennas. This arrangement uses the tower structure itself as the radiating element (as is done with AM broadcast towers). An extensive array of burned ground radials around the base of the tower acts as a counterpoise. The result is a potent signal that can be heard for hundreds of miles around.

Look for GWEN signals between 150 and 175 kHz. You can't miss their broad, burst transmissions when the system is being tested.

Table I lists some of the GWEN sites believed to be active at this writing. The frequencies given are approximate, and subject to changes. Therefore, you should tune the entire 150-175 kHz range for the best hunting.

A Smaller, Simpler GWEN

Today's GWEN program is a small part of what was originally planned. Early schemes called for well over 300 stations—some in every state. Also, there were to be several rapid-deployment mobile stations in the network.

Deep budget cuts, a reduced Soviet threat, and a series of "not-in-my-backyard" protests, all led to a 1990 decision, to stop further GWEN construction. Today's scaled down system remains fairly active however, and only time will tell what the future holds for this rugged network.

In Response...

First-time contributor Tony Spiegel (OH) has been busy exploring the band with his Icom R71. He successfully logged several non-directional beacons from his area including CL (344 kHz) in Cleveland, Ohio, which had an aviation weather broadcast. Tony asks some good questions about NDBs. He would like to know what types of antennas are used and what the typical power levels are.

In the United States, most beacons operate at less than 50 watts (25 watts is the most common power). There are, however, some big exceptions to this rule. Here's just a few high power beacons that are readable over much of the northeast: TUK-194 kHz, Nantucket, MA (400OW); HL-298 kHz, Cape Henlopen, DE (500OW); ME-350 kHz, Chicago, IL (40OW) and GKQ-379 kHz, Newark, NJ (40OW). Also, as we saw last month, Canada sports many high power beacons that can be heard well into the United States.

Two types of antennas are commonly used for beacons; wire antennas and vertical top hats. Wire antennas of the longwire, flat top "T" and triangular style have been popular for many years. They're inexpensive, easy to install and extremely durable. Most NDBs that have been around for a few years will use one of these types.

Departing from tradition, the FAA is beginning to install vertical top hat antennas at many of its new and refurbished sites. This innovative design stands about 60 feet tall and needs no guylines for support (sounds like the dream lowfer antenna!). A series of capacity elements

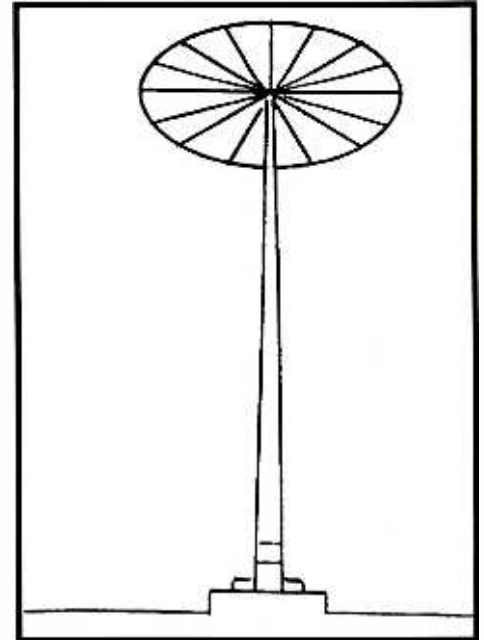

The new FAA Beacon Antenna

are arranged around the top of the antenna like spokes of a wheel. Expect to see more of these showing up in the future.

Last month I reported that Perry Crabill of Winchester, VA, exceeded the 600 mark in his quest for new beacons. I ran out of room last time, so I've included his latest loggings below along with an update that came in just before press time (see YFY-204 kHz below):

Beacon Loggings

FREQ.	CALL	LOCATION
201	RI	Riviera du Loup, PQ
204	YFY	Iqualuit, NWT*
257	ME	Maxton, NC
278	OZL	Ft. Bragg, NC
284	RQY	Elkins, WV
298	CL	Ft. Macon, NC
305	X	Passage Island LS, MI
388	NXX	Willow Grove NAS, PA
392	CF	Chesterfield, VA
408	LQK	Pickens, SC
410	XBR	Ozark, AL
515	PKV	Pt. Lavaca, TX

* About 200 miles south of the Arctic Circle

What are you hearing in the basement? What questions do you have? You can reach me by writing MT in care of this column. I'd also enjoy seeing your news, tech-tips, QSLs and other ideas for the column. 'Til next month, happy DXing.

Table 1.
Selected GWEN Stations

Approx. Freq.	GWEN Location
151	Spokane, WA
154	Mechanicsville, IA
157	Alligator Township, MS
158	Canton, OK
159	Gettysburg, PA
160	Omaha, NE (SAC)
163	Crownsville, MD
167	Bakersfield, CA
167	Clark, SD
169	Aurora, CO
169	Pembroke, GA
170	Pueblo, CO
173	Antioch, NC

DX Radio Supply

The Nation's Leading Source of Monitoring Information

24-Hour Service

P.O. Box 360, Wagontown, PA 19376
24-Hour Order Recorder: 215-273-7823



New Books!

Catalog
25 cents



Monitoring NASA Communications

From countdown to touchdown, you can monitor NASA on shortwave, scanner and satellites. New 100 page 8 1/2 x 11" book that includes the world's largest list of NASA frequencies. Shuttle missions are scheduled to launch almost every other month. Don't miss out on the action! 14.95 plus 1.50 book rate or 3.50 UPS.



The Compendium of American Railroad Radio Frequencies -- New 11th Edition

The most accurate and complete railroad frequency guide ever! Over 5,500 scannerband listings. Frequencies are arranged by railroad and include the state(s) in which it operates, use, more. Handy new format. \$14.95 plus 1.50 book rate or 3.00 UPS.

New--Ferrell's Confidential Frequency List

All HF and utility listeners will want this new edition. 500+ pages of info on voice, CW, RTTY, maritime, aero, military frequencies and more. Reverse listing of call signs to stations. Spiral binding this year. \$19.95 plus 2.00 book rate or 3.50 UPS.



All New Edition!

Federal Frequency Assignment Master File
350+ controversial pages of federal frequency info. Over 100 federal agencies, from the military to the CIA, FBI and Border Patrol. Not just for scanner listeners -- there's shortwave frequencies, too. \$24.95 plus 2.00 book rate or 3.50 UPS.



Police Call '92 -- NEW!

America's best-selling scanner directory in an all new, completely revised 29th edition! Specializes in police, fire, EMS, plus others. Frequencies arranged by location with cross-index by freq. Includes highly acclaimed "Listener's Guide Book," 10-Codes, more. Specify state. \$9.95 plus 1.50 book rate or 3.00 UPS.

Want to Hear More?

Great Scannerband Antenna



The Scantenna

If you're not satisfied with the performance of the whip antenna that came with your scanner, you may be ready to move up to an outdoor antenna. The Scantenna is a high-performance, full-frequency (25-1300 MHz), omnidirectional antenna offering superb reception of public safety, civilian and military aircraft, hams, cordless phones, maritime, even CB. Approximately 5'H. Includes mounting balun transformer and 50 ft. of coaxial cable. Just \$39.95 plus \$5.00 UPS.

Tune in on Telephone Calls

An in-depth examination of frequencies and techniques used to eavesdrop on cellular and other car phones, ship-to-shore calls, cordless phones, more. \$12.95 plus 1.50 book rate or 3.00 UPS.

The SAC Monitoring Handbook

Chuck Yarbrough of SPEEDX says, "I enthusiastically recommend this book to all utility listeners." The widely acclaimed guide to monitoring the secret world of the Strategic Air Command. Scanner and shortwave frequencies. 50+ page report by MT's "Utility World" columnist, Larry Van Horn. \$12.95 plus 1.50 book rate or 3.00 UPS.

It's Easy to Order from DX Radio Supply!

Send check, money order or credit card information (account # and expiry date) to Box 360, Wagontown, PA 19376. Or use Mastercard or Visa and call our 24-hour a day "Order Recorder" at 215-273-7823. PA res. add 6% sales tax.

SCORPIO

```
ID(Sta):GKY6 (PORTISHEAD RADIO) Location: England
Date:02-27-91 Begin Prg:03:17:35 End Prg: Freq:17.220.00
Mode:FSK Signal: Agw/Svc:Coastal (sea) QSL:
Remarks: SITOR traffic -<arg>-
Data: 23 / > / 17.220.00 FSK / signal() #2082
[Radio] [PSE] [CL8] Terminal Mode [CHG] [CLD] [S/F] [Q/OK]
[LogScan] Log of John Doe
```

```
CMD:AL
MODE NOW ALIST
.. THIS IS AN AUTO TELEX MESSAGE SYSTEM
TRAFFIC FOR THE FOLLOWING VESSELS:
USS FREDRICKS
HMS UINC...

GR #?
<arg FILE LOADED >
```

Integrated Multi-Function Communications Software for IBM PCs

Simultaneous

- Radio Control / Scanning
- Log Database Management
- TU Digital Control/Disp

- > LogScan, AutoLog and AutoTU functions > Interfaces with All Mode Terminal Units
- > Mouse/Function Key control of Kenwood & Icom Rcvrs & RS232 Digital Terminal Units
- > Search Log by any field including Remarks > Scan Receiver based on Log Search criteria
- > Copy RTTY & other DIGITAL signals > AutoTU sets TU mode as needed during scan
- > LogScan has real time UTC and FRQ. limit options > AutoLog builds database from "hits"
- > Run other programs (DOS) within Scorpio > Includes "Top 100" HF database & Manual

Optional Log Databases available for only \$19.95 each include:

English Language SW Broadcast - MidEast - Utility - Others

\$89.95 (+ S&H)

ash-ton

PO Box 830 - Dandridge, TN 37725 - (615-397-0742)
Fax: (615) 397-0466 Compuserve # 72557, 3560

SOPHISTICATED MONITORING

UNIVERSAL M-7000



If you are monitoring only voice shortwave stations, you are missing half the action! Thousands of shortwave stations transmit in non-voice modes such as Morse code, various forms of radioteletype and FAX. The Universal M-7000 will permit you to easily intercept and decode these transmissions. This is the most sophisticated surveillance decoder available. No computer is required. See the world of shortwave excitement you have been missing. \$1159.00 +shipping. UNIVERSAL M-900

For those desiring to copy the basic modes (Morse code, Baudot, Sitor A/B and FAX), we suggest the affordable M-900. From \$499.95

HUGE COMMUNICATIONS CATALOG

The new Universal Radio 100 page communications catalog covers everything that is new for the amateur, shortwave listener and scanner enthusiast. Equipment, antennas, books and accessories are all shown with prices. This informative publication is available FREE by fourth class mail or for \$1 by first class mail.



Universal Radio, Inc.
6830 Americana Pkwy.
Reynoldsburg, Ohio 43068
800 431-3939 Orders
614 866-4267 Information
614 866-2339 Facsimile

How To Keep In Touch

A radio can be a pair of eyes to the visually impaired. From a small studio complex in midtown Manhattan come the voices of hundreds of volunteers who are ready share the world of printed words with those who can't see. Twenty-four hours a day, seven days a week, The In-Touch Network serves as the radio newsstand for the visually handicapped. Over 400,000 listeners nationwide now enjoy "reading" as they listen to their radios via almost 200 nationwide affiliates.

Today, the vast amount of information available to the public has created an intimate global village, but without the use of eyes, the world becomes very small and foreboding. People who are visually impaired depend upon their ears as their link to everything that surrounds them. Listening to readings from a multitude of periodicals and newspapers brings them in touch with current events and information they need to know.

You don't have to be sightless to enjoy In Touch. Some listeners can see, but physical disabilities make turning pages difficult or impossible. Some fully functional people enjoy the service as well. In Touch Station Manager Carmen Mahiques receives compliments from quite a variety of listeners.

"I have calls from artists and painters that use us as a background, and they're reading as they work. We're reaching a lot of professionals that have retired."

When you listen to In Touch you'll hear almost everything you can buy at a newsstand being read aloud--over 100 newspapers and magazines each week, including publications written in Spanish. In Touch operates as a non-profit closed circuit system not for use by the general public. Every publication presented has generously donated the right to broadcast their work.

About 400 volunteer readers produce the programming you'll hear all day and night. Seventy percent of In Touch performers are broadcast or theatrical professionals from the metropolitan New York area. Their presentations range from informational to soothing to entertaining. All materials are read verbatim without commentary or interpretation. Carmen offers this advice to everyone who goes before their microphones: "You are not the listener's brain. You are the listener's eyes. Let them decide."

The In Touch programming schedule is designed to complement broadcasts made available through regular radio and television channels. General Manager Bruce Massis explains: "For years, radio reading services generally existed as if no other media were around.



Bruce Massis and Carmen Mahiques in the main control room of "In-Touch."

You can't really do that anymore because we're such an information-rich country. People are getting information thrown at them all the time, so we had to be careful. We channeled our programming when people wanted to hear it. They listen to CNN Headline News for 20 minutes and then tune us in for the full story."

To remain vital to its audience, In Touch periodically asks for suggestions and comments. Last year, over 500 people responded with an amazing variety of suggestions. Their requests and ideas were combined with the needs of all their nationwide affiliates to design a new programming schedule adopted this spring.

In Touch also produces and airs "Our World," a weekly half-hour program of news concerning the visually handicapped. Carmen describes the new show: "This program offers a world of specific information for our audience. For example: An organization offers a new program for blind veterans and we can alert our listeners and tell them where to write for more information. Or a university library announces a free music lending service and another offers a computer course."

"Our World" covers relevant and useful information on electronics, education, recreational programs, medical news, technology in various fields, mechanical aids and new programs and services available to blind and physically impaired persons. The nationwide radio reading service of Japan also airs "Our World" and has used the In Touch Network as a model for its operation.

Projects in the future will hopefully expand the scope of In Touch. In cooperation with a New York City based theater company, they plan to produce and broadcast a series of original dramatic readings. In Touch also hopes to start providing a descriptive audio service to augment the presentation of the ABC Television Sunday Movie of the Week. Those listening to the second audio program (SAP) channel on stereo televisions will hear someone describe the visual action of the movie mixed with the dialogue of the movie itself.

IN TOUCH

The Literacy Volunteers of America is also planning a new program with In Touch. People learning how to read will be given receivers to listen to In Touch programming. By looking at the publications being read, and hearing In Touch volunteers read the words they see before them, their reading skills should improve rapidly.

Getting In Touch

On the air since 1978, In Touch is the leading nationwide radio network for the visually impaired. Fifty-six affiliates air In Touch daily, broadcasting via subcarriers of regular broadcast FM radio stations. These SCA broadcasts require a special receiver to decode the In Touch signals. Another 7.8 million households receive In Touch via Superaudio, a Cable FM service based in Englewood, Colorado. Superaudio supplies a variety of FM radio programming to 32 cable TV systems that also provide FM radio service. You can also hear In Touch directly on satellite via Galaxy 3, transponder 11, 7.875 MHz subcarrier.

A local version of In Touch is transmitted to the New York metropolitan area via the 67 kHz subcarriers of WKCR 89.9 FM, New York, NY, and W232AL 94.3 FM, Pomona, NY, and on Manhattan Cable TV's FM service on 105.5 MHz. You can also call 212-769-6353 to hear another service of In Touch: a recording of each day's New York area television listings. The weekly In Touch broadcast schedule can be obtained on audio cassette.

Special radios receive the In-Touch Network are often provided free to those who are visually handicapped. Sighted individuals can buy radios to receive this service, as well. Similar services are broadcast in Australia, Canada, Japan, and New Zealand. Please send a self-addressed stamped envelope to American Bandscan, c/o MT, for information concerning availability of the service in your area, and sources of receivers.

The In Touch Network is a non-profit organization on a very limited budget. Public support is essential for their service to continue. Encourage your local FM broadcasters and cable TV operators to carry and promote In Touch. Your tax deductible contributions would be most welcome. Please write to: In Touch Networks, Inc., 15 West 65th Street, New York, NY 10023 or call 1-800-456-3166 for more information.

Bits 'N' Pieces

Many visually impaired people depend on radio for information and entertainment. Sometimes they are the showmakers themselves! Tune

in WMMM in Westport, Connecticut, on Saturday morning and groove to the sounds of one of America's great musicians: Jose Feliciano. Sightless since birth, Jose has enjoyed a remarkable career as a musician and songwriter, winning countless Grammy awards. Now he hosts a two hour radio show filled with all his favorite songs, many performed live.

Feliciano opens the door to the world of music for those who tune in. He loves to talk to listeners on the phone and field their questions and requests. A master of music trivia, he often reveals the inside story on memorable events in pop music history. "I'm not the kind of disk jockey who's going to give you the weather, but I can talk about certain things other people might not know about."

Feliciano never lets "the blind thing" get in his way. "I have tried to change the image of blind performers. I don't wear glasses, just like deaf people don't wear earmuffs. When I go to a restaurant and the waitress says to me 'Mr. Feliciano, would you like to see a menu?' I tell her 'Lady, I'd like to see anything!'"

WMMM now plays Jose's rendition of "The Star Spangled Banner" when it signs on and off the air. Many people still remember its debut before the fifth game of the 1968 World Series. Jose's show "Speaking of Music" can be heard every Saturday at 9:00 am on 1260 AM, WMMM, Westport, Connecticut.

Mailbag

Driving across America could lead to a career in broadcasting! Ask Meegan and Don Hildebrand. A couple of years ago they drove to Los Angeles and back to visit Meegan's relatives. Dependent on their car radio for entertainment during their journey, they heard very little programming they liked. The Hildebrands went to work and developed a new programming idea with their 80 year old friend, Arthur Jolley. Their "Super Seniors Network" now occupies four hours every Sunday morning on CKTB, St. Catharines, Ontario, a rock station serving the Toronto area.

Don is fairly comfortable in radio studios, having logged 42 years of experience in the broadcast industry. His co-host, Arthur Jolley, is a former builder who spent 10 years as a representative in the Ontario Legislature. Mrs. Hildebrand is a newcomer to the airwaves, although she learned to dance at three years old and travelled with a family vaudeville act as a child. There is no shortage of entertainment, conversational chatter and information here! Their goal is to eventually produce 40 hours of programming for seniors a week.

"Forty-seven percent of Canadians are older than 50, and 11 percent are over 65, but you'd never know it listening to the radio," Mr. Hildebrand said. The threesome combines great

music from the 1920s, '30s, 'and '40s with corny talk, jokes, brain teasers, and riddles to create amazing ratings during this usually lackluster time slot.

"Super Seniors Network" has become enormously popular, and CKTB has now added old-time radio broadcasts by Jack Benny, Red Skelton, and the famous "Amos 'n' Andy" series to their weekend schedule. "The Make-Believe Ballroom" continues the nostalgic sounds, featuring big bands and soloists throughout Sunday afternoon. Plans are underway to syndicate "Super Seniors Network" across Canada in the near future.

New Station Grants

The first allocations for the expanded AM band have been revealed. Here are the trendsetting stations with their original frequency and their new simulcast parallel higher up the band: WNDB Dayton Beach, FL 1150/1640; WLKF, Lakeland, FL 1430/1680; WAOK Atlanta, GA 1380/1670; WKCM, Hanesville, KY 1160/1640; KJLA Kansas City, MO 1190/1650; KHVN Fort Worth, TX 970/1660.

Don't forget these new FM outlets! Carmel, CA 95.5; Rancho Mirage, FL 99.5; Punta Rassa, FL 97.7; Broxton, GA 103.7; Chauncey, GA 101.3; Chateaugay, NY 94.7; Jamestown, NY 90.9; Morristown, NY 102.9; London, OH 106.3; Lubbock, TX 90.9; McCleary, WA 96.9; Nekoosa, WI 93.7. Courtesy of *The M Street Journal* and *Radio World*.

For Sale

You could be one of three! An AM station, with a constant positive cashflow, is available in a midwestern market of 100,000 people. Only two other outlets would be your competitors. Three nearby FM stations are available for purchase; combining this AM with an FM would make a tremendous combo for big profits. The current owners have other interests and wish to sell quickly. To make a deal, call David at 303-242-7800.

If you enjoy the American Southeast you might be a prospective buyer of this AM-FM combination being offered directly by its owner. It serves a top 100 market with a powerful Class C 3 FM license, along with a substantial AM signal. All assets, leases, and real estate are a part of this package deal, with some financing available. For details dial 804-977-0961.

Sunny Florida and a bright station could be the ingredients for a dream come true. Come to The Sunshine State's number one growth market and try a 50,000 watt powerhouse priced at only \$400,000 down. It's currently number two in the Arbitron ratings. Seller financing is available on an asking price of \$1,300,000. Find your sun-

glasses and call Tom Snowden or Dick Paul today! 919-355-0327.

International Bandscan

East and West Germany have reunited and many things have changed. Yet, thousands of young listeners want to make sure their favorite radio station stays the same!

DT-64 first hit the air as the voice of a Communist-sponsored youth congress in 1964. The East German government agreed to let the station continue to broadcast after the congress was over, responding to its instant success.

For 28 years, it has been the only place to hear rock 'n' roll from the free world in East Germany. With a budget of only \$100 a year to buy foreign made records, disk jockeys depended on cassette tapes, regularly smuggled across the border, to fill air time. In 1986, DT-64 was awarded a clear channel frequency to service all of East Germany in 1986. As public dissent grew, the station became the center of news and information concerning anti-establishment protests and movements. Citizens could air their views, uncensored, on a variety of call-in shows broadcast on DT-64.

Ironically, now that Germany has become reunited and free, DT-64 has been silenced forever. One article of the German unification treaty calls for the elimination of all established East German radio stations because they were seen as vehicles for Communist propaganda. DT-64 left the air in January of 1992. Outraged listeners have organized a campaign to save the station and petitioned the government with over 280,000 signatures. Current plans call for their clear channel frequency to be turned over to a state government radio network in June. Officials insist that the outlet will be replaced with a new station for young people that will allow free expression.

The staff of DT-64, and their loyal listeners, insist that is what they already are. "There are a lot of prejudices against us, mostly from people who have never heard our programming," said station director, Michael Schiewack. "They think we're too leftist, which is absolutely not true." Supporting DT-64 has become the largest protest movement in Germany since reunification.

Credits: Our warmest thanks to Carmen Mahiques and Bruce Massis at In-Touch Networks. Readers Keith Short, Frank Orcutt, W. Earle Doan, Ron Carruthers, Malcolm Kaufman, Richard Molinar and R.C. Watts provided additional material.

Also thanks to *Broadcasting Magazine*, *The British DX Club*, *The New York Times*, *The M Street Journal* and *The Associated Press*. Also thanks to Stacey, Goldie and Molly for inspiration and support. Enjoy the Spring and happy trails!

Digital Music Via Satellite

The progress of broadcasting over the last seventy years has developed a pattern with which we are all familiar: It is technologically driven. This desire to improve the technology of broadcasting has resulted in the achievement of near perfection in the transmission of sound.

FM stereo radio stations came into their own in the 1960's and with them came an appreciation for high fidelity. At last radios were capable of delivering "full spectrum" audio in a real stereo format. While the number of stations were limited and real Hi-Fi stereo radios were expensive, the idea of this new broadcasting capability was irresistible.

FM Progress

Prior to the age of satellites, the concept of stereo FM broadcasting was necessarily confined to over-the-air transmissions. The idea was as old as radio itself but the results were much more satisfactory. Gone was the crackling, fading, low fidelity signal of AM. FM had put the pleasure of listening to music on the radio back in the home.

The problem with such over-the-air transmissions, especially in the FM band, was the relatively small coverage area. In order to compete with the coverage of a similarly located AM signal, the FM transmission would have to have considerably more power. Even then the stereo effect would be lost beyond a certain distance. As usual, rural areas would not be well served, as our editor in Brasstown can testify.

But there was a further problem. Only the biggest markets would have more than a few such FM stations, meaning that only the basic formats such as Top 40, Country, and Easy Listening would be programmed. Those whose markets included colleges or universities might enjoy additional types of music, but often these stations were in the 10 to 100 watt category and intended to serve just the academic community.

The Cable Connection

With the advent of Community Antenna Television (CATV), local communities with no FM radio stations were able to listen to popular FM stations from a great distance. This was done at the CATV headend where highly amplified FM beam antennas were used to bring in these distant signals for the benefit of those on the system. By hooking a cable connection to a stereo receiver, these stations could be heard with great clarity.

By the end of the '70's, television stations such as WTBS, Atlanta, and WGN, Chicago, were beaming their signals around the country



Digital Audio Tuner manufactured by Scientific-Atlanta for Digital Music Express. Unit interfaces between satellite receiver and your stereo. Cost will be in the \$100-200 range with monthly subscriptions to all channels in the \$10 per month range.

to CATV systems, which by now were simply referred to as cable. It would not be long before additional audio services would be uplinked as well. FM broadcasting would never be the same.

It turned out that the video portion of a satellite transmission didn't use all of a given satellite transponder—that it was possible to "piggyback" additional signals on the carrier of the video. Earthbound FM signals retransmitted in this manner are called "subcarriers."

Ten years ago, WGN-TV was located on F3 channel 3 and had no fewer than eight separate FM audio subcarriers including Bonneville Easy Listening, Country Coast-to-Coast, Lifestyle, Moody Broadcasting Network, Rock America, Stardust Music, Starstation, and WFMT-FM (which still resides with the WGA carrier on its current location at G1, 3).

Radio Programming Via Satellite

Radio station owners have traditionally been notorious cheapskates. The FCC gives them a license to print money but they have always been reluctant to part with any of the proceeds. Anyone who has ever worked at a radio station will attest to this.

In the beginning, FM radio stations simply "simulcast" their AM signal on the FM band. What a great idea! Two radio stations for the price of one: one program, two revenue streams! After being in a coma for many years, the FCC finally required the FM master station to have a certain amount of its own programming. Gasp! You mean hire new staff?

Well, not if you install an automation system whereby all programming on the FM outlet is done via carefully programmed pre-recorded tapes. Of course, this type of equipment requires a lot of maintenance. Tape machines can grind to a halt on the air; all manner of problems can occur. Besides, after a few weeks, the programming is stale.

Taking its cue from the news networks which provided local stations with competent sounding newscasts, companies sprang up offering total music formats. That's what the above mentioned Rock America, Stardust, and Starstation were all about—delivering 24 hour a day programming to radio stations for a fee. All the station needs is someone to sit in the control room ready to call the station engineer if something goes wrong. It's an owner's dream come true.

TVRO Listener

Satellite TV enthusiasts have long been the happy recipients of this wide variety of programming. Even today there are over 100 such FM subcarriers which are beaming all manner of music, news, sports, and talk formats to anyone on the North American Continent with a satellite dish.

Every satellite receiver built today has the capability of tuning these Hi-Fi stereo signals. There are no special pieces of equipment necessary. But, there are a number of special audio services which are not so easily received.

Among these are SCPC (Single Channel Per Carrier) about which I have written in recent columns; FM Squared, which is a method of transmitting analog FM subcarrier signals on a channel which does not have a video carrier; FM Cubed, which is a proprietary digital transmission mixing audio and data, using time division multiplexing (TDM), and a number of other digital transmissions which use separate and incompatible decoders.

Digital Audio Services

With all the previously discussed analog audio services, there is one distinct disadvantage. The era of the digital compact disc has brought a new level of audio standard to the listeners at home. None of the standard broadcast music services can bring that "CD quality" sound to the TVRO, cable, or FM radio listening audience. A new transmission technique is called for if there is to be no degradation of audio quality from the studio to the home.

Seizing the technological opportunity, three companies were launched within months of each other in 1990 to fight for the most lucrative radio market since the FM band went commercial. Digital Cable Radio of Hatboro, Pennsylvania; Digital Music Express of New York, New York; and Digital Planet of Carson, California, have all staked their claims and are ready to change the way America listens to the radio.

Something in Common

If nothing else has been proven in the last fifteen years in the cable industry, this much is clear: it takes very deep pockets to survive. It also happens that with much money to be made the big players are already in the game.

Digital Cable Radio is backed by a partnership between General Instrument, Comcast Corp., Continental Cablevision, and Cox Communications. Cable box manufacturing giant Jerrold is making their tuner. Digital Planet is owned by an investment group which includes North American Phillips Corp. They will have Hitachi make their tuner. And Digital Music Express is headed by a man from the upper stratosphere of the music and cable industries. Their tuner is made by Scientific-Atlanta.

What They'll Offer

Programming on all three services is as diverse as America itself. Digital Music Express, for example, offers four separate jazz channels, three for classical music and one for each of the following: soul, blues, dance, reggae, rap, new age, world beat, show tunes, and contemporary Christian. There are no fewer than eight shades of rock. These services are truly a music lover's fantasy.

As far as price is concerned, all three are in the \$10-12 per month range. It's hard to get firm prices but it looks like the tuners will either be leased or sold outright to subscribers for somewhere between \$100 and \$200. Interestingly, only Digital Music Express (DMX) is actively courting the TVRO market in addition to their cable sales. It's conceivable that the others may do so by way of the various on-again off-again DBS ventures.

Of the three, only DMX will be not only commercial free but announcer free as well. The others will offer on-air "personalities" or as we used to say: disk jockeys. None of the services will offer news or weather announcements.

DMX offers 30 channels of separate formats with room to expand to 100 including simulcasts with video programming. Digital Planet plans 91 channels and claims a future capacity of 1300. They actually offer some twenty formats including retransmissions of existing radio stations. Digital Cable Radio offers 19 channels of various formats with additional simulcast capability. The one thing all three services eagerly anticipate is pay-per-listen.

Digital Cable Radio is located on Galaxy 3 channel 5, DMX is on F4, 19 and Digital Planet is on Spacenet 1 channel 1. For more information on these services write or call as follows: Digital Cable Radio, 2200 Byberry Road, Hatboro, PA 19040 (215-957-6290); Digital Music Express, Operating Headquarters, 342 Madison Avenue, Suite 505, New York, NY 10173-0002 (232-



Handheld infra-red remote control for DMX audio tuner. Listener can access 30 channels of CD quality stereo programming. Note LCD display which tells the listener which song is playing and who's performing it. There are no DJs on DMX.

983-3300); Digital Planet, 22010 South Wilmington Avenue, Carson, CA 90745 (213-513-1630).

Digital Future

Should all our local FM broadcasters give up? Will there be a local audience left in ten years? It's true that broadcast FM is getting a taste of its own medicine. In the early 60's AM was king, and, by the end of the decade, the tide had turned. Once again, technology has eclipsed an entire industry. But just as surely as AM has survived, so will FM. It will just be that much harder.

Nor will the inroads of digitally delivered CD quality music via satellite and cable be the end of it. It will, in fact, be just the start. One of the greatest values of broadcast FM is the mobile audience it delivers to advertisers during "drive time." Ten years from now that audience will belong to satellite delivered audio services such as the three discussed above.

Commuters will choose among dozens of audio formats including news and talk shows with call-in phone numbers accessible from their cellular phones. Travelers will enjoy their favorite channels from one end of the continent to the other.

Transmissions will be made via high powered satellites in the 2.3 GHz range with possibly several hundred watts. Reception will be possible with small antennas similar to those used now for cellular. As with the previous 70 years of broadcasting, it will be entrepreneurs chasing consumer dollars and listeners seeking a better sound that will drive this new technology. Dare we imagine what it will be like in twenty years?

M

MONITORING TIMES

LOOP ANTENNA

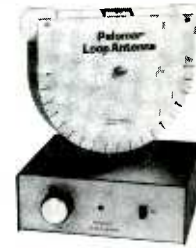

- Super medium wave reception.
- Low noise.
- Sharp directional nulls cut cochannel interference.
- High Q reduces adjacent channel interference.

Loop amplifier gives 20 db gain and sharp tuning to reduce interference. Plug-in loop Model BCB covers 550-1600 KHz AM broadcast band. It rotates and tilts to give optimum reception with minimum noise. Pulls in those stations that are otherwise unreadable because of noise and interference.

Model LA-1 Loop Amplifier \$99.95. Model BCB Loop \$89.95. Add \$4 shipping/handling in U.S. and Canada. California residents add sales tax.



Plug-in loops available from 10 KHz to 16 MHz. Send for free catalog that shows our complete line of antennas, amplifiers and filters.

PALOMAR ENGINEERS
 BOX 462222, ESCONDIDO, CA 92046
 Phone: (619) 747-3343
 FAX: (619) 747-3346

Satellite Television Sourcebook

by Ken Reitz

is available through the following:

EEB	800-368-3270
DX Radio Supply	215-273-7823
Grove Enterprises	800-438-8155
Shop at Home	800-366-4010
Universal Radio	800-431-3939
VHF Communications	800-752-8813
SNS Communications	908-806-7134

TUNE US IN!

Free Sample Issue! Free Advertising For Subscribers!

Subscribe now for only \$10 per year!

— Published Monthly —

The SWL Swapper is the only classified newsletter devoted to shortwave & scanner enthusiasts. Buy, sell or swap scanners, receivers, frequencies & more. Feature articles, frequencies, hints and tips.

To subscribe, call our order line anytime or send your check or m.o. to the address below. For your free sample copy, call or write today!

The SWL Swapper
 P.O. Box 1135
 Pepperell, MA 01463-1135
 Order Line: 508-433-8952

Sorry, no free samples outside U.S. and Canada

SATELLITE TV BUYING GUIDE

SATELLITE TV

NAME BRANDS AT 50% DISCOUNT
 This FREE 24 page Consumer Buying Guide tells all about Satellite TV and lists guaranteed lowest prices.

Salman, Inc.
 6310 N. University No. 3798 • Peoria, IL 61612
 1-800-472-8626

CALL FOR

April 1992

51

VHF Repeaters

The early days

Prior to the 1960's, VHF operation was not too popular due to restricted range, limited equipment availability, and expense. The average two meter ham could work 20 to 60 miles on AM from his home location, but from mobile operation, range was limited—5 to 10 miles and even then only if a horizontal mobile antenna was used.

A few hams were experimenting with FM because it provided noise free communication. The refurbished commercial units they used didn't catch on quickly for several reasons. First of all, power was supplied by either a vibrator or a dynamotor, both large and cumbersome to deal with. Secondly, the commercial gear was usually in several pieces and had to be cabled together and took up a lot of room in the family car.

As transistor power supplies were improved to the point where they were usable at VHF, commercial companies began to reduce size of the gear they manufactured.

Many older units were snapped up by hams on the surplus market at very low prices. Initially, hams used these units for local intercom systems. Since all of the gear was crystal-controlled, hams rarely had the capability of switching to more than two frequencies. Frequency hopping was not really required anyway since almost all operation was confined to 146.94 or 146.76 MHz.

Still, this FM operation was something hams had dreamed of for a long time. Now we could set the squelch and never know a receiver was turned on until someone pressed a mike button and talked.

Early Repeaters

A repeater is usually located at a good, high location, and is made up of a receiver and transmitter that receives on one frequency, sends the signal to the transmitter and re-transmits on a different frequency. The idea of repeaters was certainly not new; some AM repeaters had existed prior to WWII but since someone had to be present at all times they never became popular.

FM allowed remote monitoring. It was possible to put a repeater on a high location and control it from a distant point—in fact, even mobile control was possible! True, there were problems associated with this new idea but the problem was mainly one of acquiring equipment. Commercial interests had been using repeaters on FM for years, but the cost of these machines was quite high. Nor was it a simple

task to set up a repeater as we know it today. But the desire of being able to communicate over a wide local area was strong, and amateurs began building simple repeaters.

Many of these first repeaters consisted of a receiver site separated some distance from the transmitter site and connected either by wire or UHF radio. This was required to keep the transmitter from interfering with the receiver. Control was accomplished either by telephone connection to the repeater or tone control through a UHF link. ID was mainly by tape connected to timers. Some early repeaters did use duplexers (a device that allows a transmitter and receiver to use the same antenna) but building and tuning a duplexer was a difficult undertaking in the early days, so split sites were fairly common.

It was not at all uncommon to listen to a repeater for days on end without hearing any activity at all. Gear was still difficult to obtain and get working, but at last it was possible to communicate over distances of 100 miles or so on two meters from your car.

Still, there was not much acceptance of this new way of doing things until Wayne Green of *73 Magazine* began an information campaign to promote the effectiveness of FM. Many of us converted our first FM rig from an article in *73*.

Today, FM is a mainstay of amateur communications and repeaters are available to hams in most parts of the country. I suppose there are some areas of the U.S. where there is no repeater access, but then again, most likely there ain't no hams there, either!

Repeater Services

For the most part, repeaters are built and maintained by clubs to provide easy communications between members and to serve the community in general. The normal range of a repeater will be 40 to 75 miles. A few machines are linked to other repeaters to give even more coverage, but usually this type of service is in the West where distance between population centers is great. There is some interest in linking machines for special reasons, but it is not a daily occurrence.

The most popular activity on repeaters is general rag chewing and second is phone patching via "autopatch" (autopatch is a method of connecting the repeater to a telephone line so phone calls can be made via radio). Civil Defense, emergency and swap nets held on many repeaters are very well attended, too.

Repeater Etiquette

As with any endeavor, there are always problems. Some individuals feel compelled to argue and complain about how a repeater is run, some control operators will shut down a machine if one of their enemies tries to use it, and, of course, the jammer will always be with us. Fortunately these deranged types are few and far between; when they do pop up it does not take too long for the average repeater group to ferret them out and correct the difficulty. Perhaps the largest problem is with amateurs who use the machine to communicate only a few miles when simplex communication could be easily effected.

A problem of a different sort is the ham who puts up a large antenna and runs high power in an effort to communicate with as many repeaters as possible. Most of us understand the desire to communicate over long range, but one should remember that working a repeater several hundred miles away will usually open several other machines, even with a directional beam.

It is best to use only enough power and antenna gain to open your local repeater. If you can hear another repeater key up when you press the mike, reduce power or go to a smaller antenna—please! Use high power and high gain antennas only on the simplex frequencies to communicate with your long range friends.

The Radio Shack HTX-202

Speaking of going mobile, I recently acquired a Realistic two meter handi-talkie which came with a nicad battery pack and an alkaline battery holder. Measured output on my unit with the nicad pack was 2.2 watts into a 50 ohm load; the alkaline pack produced 3.8 watts into the same load.

In general, the HTX has adequate RF output. Plugged into the cigarette lighter in my car, it produced a whopping 7 watts of RF. Audio reports have all been excellent.

Receiver sensitivity is more than satisfactory with a 2 microvolt signal producing 20 dB of quieting. Spurious response attenuation, intermod attenuation and adjacent channel rejection all measure somewhat better than the figures stated in the manual. Overall the receiver of this little unit is outstanding!

I like the audio output. Plugged into the cigarette lighter, the receiver produces one watt of good clean audio which makes it a pleasure to use in mobile applications (especially if using the optional speaker mike).

Bob Lewis

Ham DX Tips

Greetings once again and I hope you are ready to try some new DX targets! See how many of the following you can add to your log book and QSL collection.

BURKINA FASO XT2BW can be located around 10109 kHz at 2200 UTC. Send reports to his QSL manager: WB2YQH, Robert E. Nadolny, 135 Wetherstone, West Seneca, NY 14224. **FALKLAND ISLANDS** Celebrating 1992 as "Heritage Year," hams here will add the suffix /92HY to their entire callsigns. There will be special activity by amateurs here on the important days of this year long celebration, so look for activity by many Falkland hams on: 13 July (which will be the 100th anniversary of "The Falkland Islands Volunteers") and 14 August (the 400th anniversary of the first sighting of the island group. Until then, check the DX net on 14256 kHz around 2300 UTC (this net meets daily) as Falkland stations often appear here. Also, VP8BFH can be logged by RTTY fans when he appears daily at 0030 UTC between 28080 to 28100 kHz. If you do, send your report to his QSL manager: WA3ZKZ, J. Crawford B. MacKean, 115 S. Spring Valley Road, Wilmington, DE 19807. **FRANZ JOSEPH LAND** This near arctic island, a part of the Russian Republic, counts as a separate DXCC country. You can add this one to your logs by checking the 21345 kHz SSB DX net at 1930 UTC for 4K2CC most days. RTTY fans can check 18080 kHz around 2030 UTC for 4K2CC. Send your QSL requests to the operation's home address: V.M. Dorokhov, Box 24, 127349 Moscow, Russian Republic, Europe. And here is a tip to help get your request answered: Avoid using callsigns or referring to amateur radio on your envelope. **SABAH** 9M6HF (whose QSL manager is: WE2K, Melvin D. Snitchler, RFD 2 Box 320-A, Binghamton, NY 13903) has been keeping CW fans happy by offering this rare one on 28010 to 28020 kHz daily at 0100 UTC. **MACO** An easy target for all HF licensed hams and SWL's is XX9AS who appears on 28380 kHz almost daily starting at 0000 UTC. XX9AS' QSL manager is N6LVY, A1C. Morelli, 2345 Cranston Dr., Escondido, CA 92025. **POLAND** This spring hams here will finally be given permission to operate on 6 meters, 50-52 MHz. **SOUTH KOREA** Offering this one to many a deserving DX'er has been HL1XP on 28485 kHz SSB at 0000 UTC most days. His address is: Seongtae Jeon, 58-1 Nonhyndong, Kangnamgu, Seoul, 135-010, South Korea. **SOUTH ORKNEY ISLANDS** While using the same prefix as the Falklands (VPS), hams here operate from what is considered to be a separate county. If you would like to log this one look for VP8CFM (reports go to QSL manager GM4KLO, Michael Mistofsky, 25 Broomcroft Rd., Newton Mearns, Glasgow, G77 5ER, Scotland) operating RTTY near 14085 kHz starting from 0145 to 0300 UTC. **TROMELIN ISLAND** This island in the Indian Ocean is one of the extremely rare countries in the ham world because it has no resident hams and it's not too often that an amateur travels here. Yet, this spring will see two hams operating. Look for FR5ZU/T (Yes, the "T" stands for Tromelin) from the time you read this until 10 April. He prefers the DX nets on 14256 kHz SSB (check around 2200 for announcements of his appearance) and 21335 kHz SSB around 1400 until 1900 UTC. FR5ZU/T is: Jack Quelli, 1 cte Meterogigue, F-97449 Lechaudron, Reunion Island, via France. During the entire month of May FR5AI/T (Yoland Hoarau, 4 eme km, St. Francois, F-97400, Reunion Island, via France) will be operating from here. Yoland prefers CW and plans to be on each band 10 to 20 meters around 5 kHz and 25 kHz up from the bottom of each band. **UGANDA** It has been some time since there has been an active amateur here, but 5X5WR/A has been on 21313 kHz SSB at 1900 UTC almost daily, and often on 28305 kHz SSB at 2030 UTC. The operator is Mario and he is operating from a location only 5 km from the capital of Kampala. The 5X5WR callsign has been assigned to DJ5RTW (Wilfried Ruppert, Reisenkopfweg 7, D8209, Schlossberg, Germany) to whom you send your reports for this one, but Mario has legal permission to use the callsign with "/A" on the end. And so we come to the end of our monthly around the world DX trip via ham radio! 73 de Rob.

There are a few problems, but only of a minor nature. I do not like the manual: it requires careful perusal in some areas, and the user has to flip back and forth to obtain information that should all be on one page. The control knobs are not arranged to my liking; the audio control is sandwiched between the squelch and tune control and is too close for ease of use—turning the set off requires a lot of effort. In addition, I often set the unit on low power when adjusting the

squelch—this and connecting the antenna are difficult to do, again due to the busy nature of the controls and connections on top of the unit.

The HTX 202 features 16 channels. There is a calling channel which is accessed by punching the CA button; three priority channels and 12 normal channels are programmable. Scanning by channels or in steps (user set steps) is also available. It is possible to program up to five

EXPAND SW MONITORING

Published
6 times
per year!

Our 22nd
Year!



Copies
available
at most
Retail Dealers

80 Pages!

There is only ONE Amateur Radio publication that delivers FULL COVERAGE on "ALL" specialty modes: FSTV SSTV WEFAX RTTY AMTOR PACKET OSCAR.

CURRENT technology allows you to MONITOR all-modes, even VIDEO & DATA communications! Our magazine educates you on what you need!

Annual subscriptions are just \$20 USA, \$25 Canada/Mexico or \$30 Foreign. Sample or current issue: \$3.75 ppd. MC/VISA accepted (5% added).

Call or Write Today!

SPEC-COM Journal

P.O. Box 1002,
Dubuque, IA 52004

(319) 557-8791
FAX: (319) 583-6462

autopatch sequences and tone squelch is available on all channels.

A timer built into the unit will shut the transmitter off and beep at you if you exceed the set time. Time out can be set for 30, 60, 120 seconds or off.

The HTX-202 also works great on packet; couple it to your laptop and tiny TNC when you travel to keep in touch with the world of ham radio.

For the price—\$259.95 at your local Radio Shack—this is one great buy. No, Radio Shack will not make you produce a ham ticket to buy one of these neat little rigs. Just be advised, there are stiff penalties for using an amateur rig if you don't have a ticket, and hams love to hunt down bootleggers!

North Dakota Award

The Theodore Roosevelt Amateur Radio Club is sponsoring a North Dakota Worked All Counties award. The award is available to SWL's for heard reports. Special activities are planned to activate all North Dakota counties. For full info and an application write to Steve Allar, 1701 6th Ave. NE, Beulah, ND 58523; please include a #10 envelope with postage.

Thanks for the mail concerning my column on simple antennas; there seems to be a lot of interest in this area, so a future article will go into more detail on simple, effective building projects. tnx es 73 de Ike, N3IK

MT

Let's Take Time Out to introduce our many new readers to what "The Outer Limits" column is all about. "Old timers" may also get some new insight into the kind of material we are always seeking. As the name implies, we explore those curiosities that don't really fit elsewhere. That gives us license to take a look at a tremendous variety of things.

A "staple in our diet" is of course the pirate stations. We do not seek to encourage or discourage unlicensed broadcasting, but simply to report what can be heard along these lines. American and Canadian pirates are sought out by a number of radio monitors.

Because of the tremendous DX challenge they offer and the historic impact they have sometimes had on government broadcasters, we make a special effort to include coverage of unlicensed stations in Europe and all of the former Soviet Union. Some of these can be classified as pirates, while others at times have enjoyed at least a temporarily legal status.

The "Outer Limits" seeks to report on clandestine stations. We will not get into the technical details of what is or is not a clandestine. Basically these are simply stations or programs provided by organizations seeking to overthrow an existing government.

We also examine the so-called "spy numbers" and related stations. Shortwave listeners have long concluded that most of these are probably the work of domestic and foreign intelligence operations. There is no real reason to doubt this theory, although these stations remain shortwave's biggest mystery.

The "Outer Limits" also wants to bring you news on all those other oddities that might otherwise "slip between the cracks." Strange noises, "water drips," "fog horns," or whatever

else you run across in your monitoring that makes you ask, "What in the world is that?" is "Outer Limits" material.

And, yes, there is much you may come across listening to legally, licensed government and private stations that belongs here. If it's out of the ordinary, "Outer Limits" readers might want to know about it. For example, I remember some years ago Radio Canada International broadcast live its attempt to place a telephone call to the notorious Ugandan dictator Idi Amin. Now if you hear someone trying to get through to Saddam Hussein, tell us about it!

In many ways our readers are the "Outer Limits" column. We welcome your loggings and other information on any of the above topics. We invite you to send as many loggings as you wish. However, we often have to do some editing, especially in the area of American pirates, so that everybody that participates gets to contribute.

Please do not send originals, but photocopies of QSLs are helpful. We think most readers will understand that we cannot use those that might be offensive to women or other groups in the population. This column is for the enjoyment of everybody. Newspaper clippings, magazine articles, and similar material are all useful. Thanks to the many who have contributed in the past.

Pressing personal reasons have required me to step down from writing this column after this issue, but the managing editor assures me that the philosophy of the column as I have just outlined will remain basically the same. Please give the new column editor the same support you have given me by sending your material to Outer Limits, c/o MT, Brasstown, NC 28902.

Now let's take a look at what you have been hearing:

Across the Bands

Minnesota's Alan Masyga is no stranger to this column, and Alan is reporting his usual success. **He-Man Radio** showed up at Alan's QTH on 7414.8 kHz at 2250. The exact same frequency also yielded Radio Free Northland at 1017 UTC. Alan's QSL collection continues to grow with contributions from the pirate CKLW, Radio USA, and Radio Free New England.

Greg Martin in Michigan is a first time contributor. Among his catches is the Europirate **Radio Gloria International**, which was relayed via a North American station at 2023 UTC. Gloria announced an address of 23 South Beechwood, Edinburgh, Scotland EH125 YR. At 0200 he also heard **Voice of Bono** via WSKY. Both Bono and **Voice of Stench** are relayed by this station. Don't forget to send us frequencies, as well as times, Greg! Grey's recent QSLs include WSKY, Radio USA, and the Canadian Radio Beaver.

Stephen Moore writes from Massachusetts to report QSLs from East Coast Beer Drinker and **The Fox**, which is relayed by ECBD.

Regular contributor Dwight Weidman of West Virginia found **Rastifarian Radio** on 7419.5 at 0505 with Reggae music and announcer Radio Animal. Dwight received a QSL from WSKY, which for a time was the most frequently logged of all pirates. One who did come across WSKY was Indiana's Rex Whetzel, who found it on 7415 at 0330.

Wisconsin's Glenn Waber and his wife seem to be logging everything in sight these days. Among his recent catches are CSIC on 7413 at 2353. **XERK** arrived on 7417 in LSB at 0222. **Omega Radio**, which appears to be religiously and philosophically oriented, came in on 7418 USB at 2255. **New Age Radio** made an appearance on 7415 at 0224. Among Glenn's more unusual catches was **Dr. R. F. and Otto** in USB on 7416 at 0240. QSLs include WJFK, WSKY, Secret Mountain Laboratory, and Jolly Roger International. New York's Mark Henning was also the recipient of a WSKY QSL.

Seldom does a month go by without some great loggings from Pat Murphy in Virginia. Pat found **Pirate Radio New England** on 7414 at 2356 and **WKND** on 7415 at 0615. One that hasn't been reported for awhile is **Voice of Elmer Fudd** in LSB on 7384 at 0709. **WRMR** made it in over a local TIS on 1620 at 2235. This station evidently likes to live dangerously, as it was giving out its home phone number and broadcasting for a lengthy period of time. QSL arrivals include Radio Audubon International and Jolly Roger International.

Thomas Gray found two Radio USA QSLs in his mailbox. First time reporter S. Davis of Indiana checks in with a **Jolly Roger International** log on 7415 at 0655. Another person new

the
VOICE
of
BONO

→ QSL ←

To: Glenn Waber

Time 0231 - 0252

date 23 November 1991

frequency 7414 kHz

Gary Daniels & Bono

100%
SUPERIOR
Audio
Radio

A BLEND OF PRIDE, CRAFTSMANSHIP AND TECHNOLOGY

Glenn Waber is now the proud owner of a Voice of Bono QSL.



Several "Outer Limits" readers are happy recipients of the Jolly Roger International QSL.

to pirate monitoring is Bob Ferguson of Pennsylvania. He was rewarded for his efforts with a couple of catches including **He-Man Radio** on 7415 USB at 2230.

Out in California, the "Shortwave Ape" found **Rastifarian Radio** on 7417.5 LSB at 0145. Another Californian, Skip Harwood, logged **KXKVI** on 7415 at 0030. **Voice of Anarchy** showed up on 7414 at 0800. In New Hampshire, Guy Chouinard took possession of a Radio USA QSL. Down in Texas Bill Hennessy heard **WSKY** on 7415 at 0345. Connecticut's Bob Thomas was awarded two Radio USA QSLs.

Back in the USSR?

Some fascinating radio news is coming out of what was until recently the Soviet Union. Bob Thomas has been in contact with a source in Belarus. The source says SWLs might find it advantageous to search 40 meters and other bands for "Soviet" pirates.

Young people in particular have heard recordings of American and Europirates. They find the idea intriguing and a useful way to report on the real conditions in their part of the world. There is a good chance some pirates will surface by mid-1992. Meanwhile some Soviet stations and former jammers are to be offered for foreign commercial use and as relays.

Bob offers several suggestions on where to hear government transmissions in English from a few of the former Soviet Republics. At 0000 UTC look for Radio Vilnius, Lithuania, on 7400 and 17090. Radio Kiev, Ukraine, might turn up at 0100 on 7400 and 17690. An interesting Russian station is Business Radio with 20 kW on 11850 from 2000 to 2200, 0500 to 0700, and 1300 to 1400. We do not know what languages this one uses. Bob also warns that former Soviet stations were supposed to move all transmissions one hour. Expect confusion in scheduling as a result.

The Shortwave Ape had a conversation with an exchange student from the Ukraine. He gave no frequencies or other details but did claim pirate activity was already very common in his area.

Clandestine Corner

In Florida, Mark Seiden heard Voice of Iranian Kurds at 0412 on 4065. Tom McKean of Indiana sent a copy of a recent *Wall Street Journal* article about the plight of the Kurds in northern Iraq. The article reports Kurdish claims that they were betrayed by allied radio during and after Desert Storm. With the destruction of most Iraqi government transmitters, the allies had a near monopoly on broadcasting. The Kurds were urged to rebel against Saddam Hussein, and then when they did, received no assistance against the Iraqi forces. The results were devastating.

MT

Bob's Bargain Bin

11 Digital Weather Stations (6 with software for computer, 5 with portable weather computer) -- either; \$248.95 -- Barometric pressure, Altitude, Wind speed and direction, inside and outside temperature, high and low temperature, windchill factor, 12/24 hour time, and with the optional rain collector, daily and accumulated rainfall.

Accessories for the Weather Station:

- 4 Rain Gauges -- \$49.95 -- comes with 40' of cable.
- 5 Portable Vinyl Carrying Cases -- \$9.95 -- Case for portable weather computer.
- 3 40' Extension Cable -- \$15.95 -- cable to connect the station and computer.
- 5 AC Adaptors -- \$10.95 -- AC adaptor to operate the portable weather computer.
- 5 Battery Packs -- \$8.95 -- 3 AAA NiCad batteries for the portable computer.
- 4 Desk Stands -- \$15.95 -- Stand to hold the portable computer. Stainless Steel.
- 4 Flush Mounting Plates -- \$12.95 -- Stainless steel plate for wall-mounting the computer.
- 4 Expanded Software -- \$99.95 -- To add to the software, allows graphic presentations.

Grove Enterprises, Inc.
1-800-438-8155

140 Dog Branch Road
Brasstown, NC 28902-0098

NEW COMMUNICATIONS GEAR

Covering DC to Daylight at Discount Prices!

AR1000XLT Scanner	\$ 399
AR2800 Scanner	\$ 399
Kenwood R-5000	\$ 879
AR-3000 Scanner	\$1050
Japan Radio NRD-535	CALL
ICOM R-71A HF Scanning Receiver	\$ 850
Collins R390A (Reconditioned/Calibrated)	CALL
Japan Radio NRD-525	\$1125
SONY ICF-2010	\$ 349
SONY ICF-7600	\$ 220
SONY Pro-80	\$ 370
RACAL RA-6790 (GM)/R-2174	CALL
Bearcat BC-760XLT - w/Cellular Restoration	\$ 285
Bearcat BC-200XLT - w/Cellular Restoration	\$ 275

FREE DELIVERY

WE OFFER REPAIR SERVICE * MANUALS * BROKERING
PROFESSIONAL MONITORING STATION
SEND \$2.00 FOR CATALOG CREDITED TO PURCHASE



MIL-SPEC COMMUNICATIONS

P.O. Box 461, Wakefield, R.I. 02880
Call Today (401) 783-7106



The *NEW*

ICOM IC-R7100

Frequency Range: 25-2000 Mhz
Tuning Steps: 100 Hz; 1/5/10/12.5/20/25/100 kHz; 1 MHz
Receiving Modes: AM, WAM, FM, WFM, NFM, USB, LSB
Memory: 900 Channels
Scan: 5/12 channels/second
Banks: 9
Clock: with 2 event timer
Computer interface: optional
Sensitivity: 0.35 uV NFM
Dimensions: 9-1/2"W x 3-3/4"H x 9-1/2"D
Power Requirements: 13.8VDC, 117/240VAC



The long-awaited follow-on to the successful R7000 has finally been released from ICOM. The new R7100 is smaller in size than the R7000, but boasts many new features.

The R7100 has a continuous frequency range, from 25-2000 MHz, without the 1000-1025 MHz gap that was in the R7000. It also has 900 memory channels held in 9 banks, a large, bright LCD display, the ability to use 120/240 VAC or 13.8 VDC (for mobile use). The R7100 also comes with a collection of plugs for the accessory jacks as well as spare fuses.

Grove's Price: \$1159.95*

Grove Enterprises, Inc



1-800-438-8155

140 Dog Branch Road
Brasstown, NC 28902-0098

* Plus \$15.00 Shipping

For more information, see the review on page 94!

We are constantly updating our catalog to bring you the best quality for the best prices. If you haven't received your new Grove Catalog/Buyers Guide yet, just give us a call at 1-800-438-8155 and we'll be happy to send you one!

It doesn't get any better than this!

The Icom R1 Pocket Scanner:

Now Only **\$479.95!** (plus \$6 Shipping)

Imagine, a shortwave and VHF/UHF scanner with continuous 100 kHz-1300 MHz (no gaps!) frequency coverage that fits in your shirt pocket! You select the mode -- AM, FM wide or narrow -- and install up to 100 of your favorite shortwave and scanner frequencies into memory. An edge-lit LCD shows frequency, memory channel, and other settings as well.

Less than 2" wide, the R1 scans, searches and autoloads, has knob tuning, a signal strength indicator, and even a 24-hour clock timer! This high-sensitivity scanner comes with a flex whip, rechargeable battery, AC wall charger/adaptor and belt clip.



ACCESSORIES:

ANT8	Range extending telescoping whip	\$16.95
ACC19	R1 Carrying case (no battery pack)	\$19.95
ACC30	BP-90 Replaceable AA battery case	\$16.95
ACC33	BP-90 Carrying case	\$19.95
ACC32	BP-84 Triple-life battery pack	\$75.95
ACC34	BP-84 Carrying case	\$19.95
ACC31	CP-12 Cigarette power cord	\$18.95
ACC48	BC-72A Desk charger	\$99.95

Grove Enterprises, Inc.

1-800-438-8155

140 Dog Branch Road
Brasstown, NC 28902-0098

Grove -- we bring you the best...for less.

For more information on the Icom R1, see the November, 1991 issue of Monitoring Times, page 98!

Hamcom Revisited

The response from the Hamcom offer in January's column was overwhelming. Many copies were mailed with only a few problems with bad disks and documentation.

A few readers had a problem with the HC.CFG file. If you don't know what that is, the .CFG file is a configuration file that sets up Hamcom when it's invoked (by typing HC then enter).

Hamcom has the ability to read the text in the file as long as it contains a valid command with the proper syntax. If the text is preceeded by a "#" it will be ignored. The "#" is very similar to the REM statement in Basic.

For example, Hamcom understands the following line.

```
define port com1 iobase 0 irq 0
```

It probably doesn't mean much to you, but it does to Hamcom! It tells it to ignore com1 by setting the iobase and irq to zero. If you have a mouse on com1, for example, it's a good idea to prevent Hamcom from accessing the port. If you look further down the page, you will see:

```
select port com2
```

This line tells Hamcom to use com2 as the data port. This is where you will connect the decoder circuit that's shown in the help documentation menu.

If your computer mouse is on com2 you will have to make a change in the configuration file. Simply load the ".CFG" file into a text editor such as Side Kick, Edlin or the DOS 5.0 editor; I use the Tandy Deskmate.

Change the "define port com1 iobase 0 irq 0" to "define port com2 iobase 0 irq 0" and change "select port com2" to "select port com1".

On some copies that I sent out there will be a line that looks like this:

```
#define port com4 iobase 0x2e8 irq5
```

Make sure that the "#" is in front of the line, which tells Hamcom to ignore it. You can also delete the line to avoid confusion. If you're bold and you have com ports 3 and 4 installed in your PC, you can define them in the .CFG file and select them in the Hamcom "PORT" pull down menu.

Using Hamcom with Another Decoder

Hamcom uses a technique known as zero crossing detection. The decoder circuit is nothing more than a high gain amplifier and the audio from the receiver is fed to its input. The high gain of the amplifier distorts the audio and shapes it into a square wave. The square wave is a signal that is processed easily by the computer and the FSK detection is handled in the software. The system works well if the copied RTTY is 599, but if it fades, the computer software gets lost and the text becomes unreadable.

One way to overcome this problem is to use a better filtering system. In the 60's and 70's FSK decoders were available in the 60's and 70's that did nothing but decode the FSK tones. They were normally used with the old mechanical machines such as the model 19 teleprinter. Remember the ST-4 demodulator that was shown in the *Amateur's Radio Handbook* for several years?

Later units, like the KAM Interface II or the AEA CP-1, were designed to interface to a Commodore or other computers. Software in the form of a game cartridge was used to decode the data from the demodulator and print it to the monitor screen.

If you have one of these boxes, don't toss it or sell at the next hamfest! It will work with Hamcom.

To use Hamcom with an external FSK demodulator you will need a modified version of the interface that is shown in the Hamcom help menu. I built one that uses a TLO-62 dual "op-amp" (you can use the TLO-82 Radio Shack # 276-1715). The schematic is shown in Figure 2.

The second section of the op-amp (U1-B) isn't much different from the original Hamcom circuit (except for the jumper at "X" which is needed when the external decoder is hooked up). When the audio input is disconnected and the

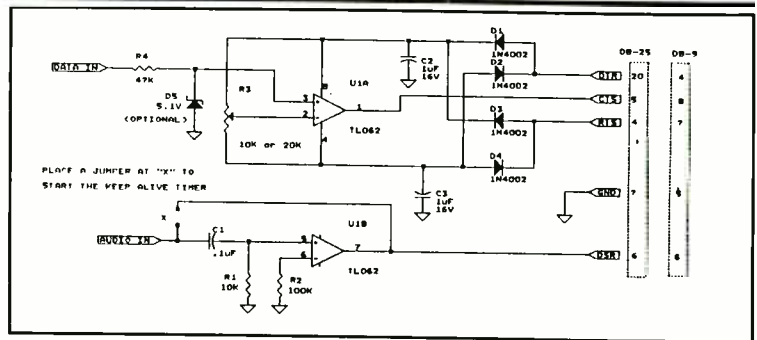

Figure 2

jumper is added, the op-amp oscillates, creating a "keep alive" timer. Without it Hamcom will lock up and you may have to reboot the computer.

Any audio source will keep Hamcom alive as long as the frequency of the source isn't too high. It should oscillate at 100 to 300 Hz if you're using an XT computer running at 4 MHz. This arrangement will render inoperative the tuning, the oscilloscope, and the spectrum modes. However, you can restore them simply by removing the jumper and connecting the audio input to the receiver.

The first section (U1-A) connects to the data output of your decoder. The 10 or 20 K ohm potentiometer (R3) is used to adjust the data threshold (+2 volts if a TTL level is used). The data from the demodulator should never be greater than plus or minus 8 volts. The ST-4 delivered about 160 volts to a teleprinter but I'm sure it can be modified to 5 volts. Check the level with a volt meter before you do any wiring. You don't want smoke to pour out of your computer! The schematic shows the connections for a DB-25 and a DB-9 connector.

Once you get the interface built and running, you'll have to change an option in the Hamcom menu. Use the mouse or hit ALTK to bring down the KEYING menu. Then select EXTERNAL DECODER. If everything is set up properly, you should be able to select the BAUDOT mode and see characters printed on the screen. If the text is unreadable, just click on the KEYING menu again and select REVERSE. You should see readable text if you're copying RTTY in the Ham bands and you have 45 baud selected.

When you select the tune mode the pointer on the barograph should be to the left and the data should scroll across the bottom of the screen. For some reason the tuning bar is operational only after you select the RTTY, ASCII or CW mode.

I ran Hamcom on 40 and 20 meters without any problems. The demodulator I used, of course, was the DSP (Digital Signal Processor) I have been helping to develop. All I needed was a cable that connected the DSP data output to the interface data input. Both connections were made at the rear of the computer. An audio cable was also used to connect my Kenwood TS-440 to the DSP's audio input. Connections were simple, and I didn't need an external demodulator to clutter up the shack.

```
K2LCK DE W5KSJ W5KSJ WELL ED WE WILL CHANGE
THE REPORT TO 30/9 30/9 THAT TIME HI HI

THE WX IS CLOUDY TEMP IS 50 DEGS HUMIDITY IS
35 PERCENT WINDS FROM THE SOUTH EAST AT 5
MPH BAROMETER IS 30.18 AND FALLING
RIG IS SWAN 100MXA RUNNING 50 WATTS TO A
TA33JR MOSLEY BEAM ON A 40 FT SPALDING
TOWER — SO HW NOW ED ???
K2LCK DE W5KSJ W5KSJ

K2LCK K2LCK DE W5KSJ W5KSJ
WELL GUESS IT WENT OUT ON US ED SO 73 FROM
THE OLD LAND OF ENCHANTMENT
K2LCK DE W5KSJ
0025GMT 5 FEB 92
SK SK SK

W5KSJ DE K2LCK ED IN ISLIP NY
LOVE THE REPORT, WISH I COULD TURN IT INTO
CASH HI HI HI...NAWN NAW NAW I GOT HUNG UP
AND COULDN'T GET THIS DARN THING OUT OF THE
LOGGING MODE. . SRI ABOUT THAT..... EVERY
ONCE IN A WHILE THIS THING GETS EVEN WITH
ME... GUESS I DONT FEED IT ENOUGH HI HI... YOUR
SIGNAL UP HERE IS STILL A BARN BURNER AL... BTU

W5KSJ DE K2LCK ED IN ISLIP NY
K2LCK K2LCK DE W5KSJ W5KSJ N
OK WILL CONTINUE A LITTLE HI HI WE ARE USING
THE COMMODORE VIC-20 WITH A MICROLOG AIR-1
INTERFACE WITH A PANASONIC 5 INCH TV FOR THE
MONITOR —
```

Figure 1: Here is some actual text copied on the 20 meter Amateur band using the logging feature of Hamcom. The frequency was 14.0887 using 45/170.

Lush tropical gardens, the snowcapped Andes mountains towering overhead, and in the distance ... a lone guitarist strums "Amor A Los Andes" from his mountain hut.

Ready for some escapism? HCJB—The Voice of the Andes broadcasting from Quito, Ecuador, may be your answer.

Some of the finest Ecuadorian music can be heard on HCJB, as well as cultural, current affairs, and spiritual programming.

Why not take a few minutes to write HCJB (Casilla 17-17-691, Quito, Ecuador), with your program details and comments or suggestions? HCJB offers a different QSL series each year, with six different cards in each series. These cards reflect the various themes of Ecuador or HCJB, and make a nice addition to your collection.

HCJB also has a listener's club, ANDEX International, which you are welcome to join. Don't forget to share your QSLs with *MT*!

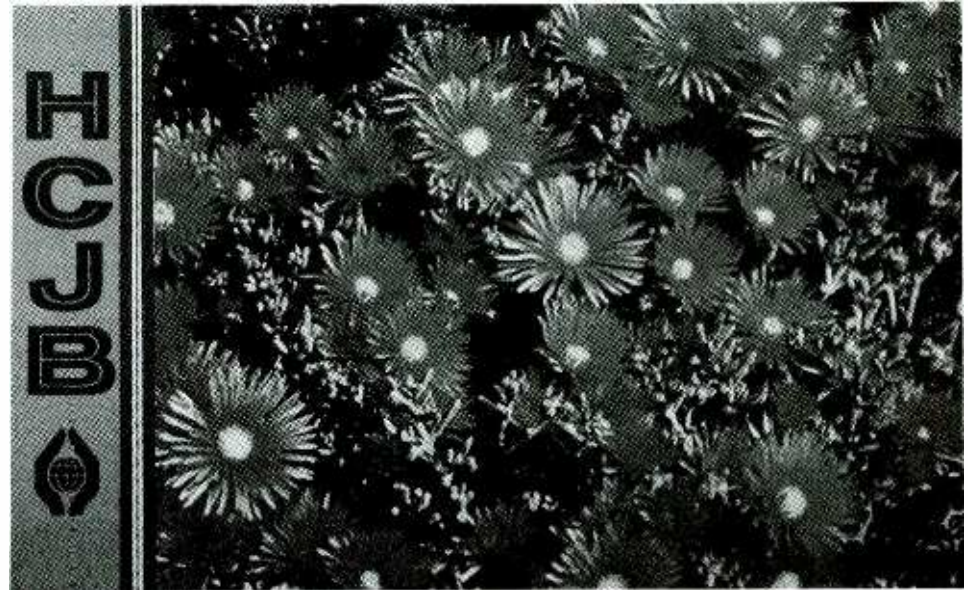

ARGENTINA

Radiodifusion Argentina Al Exterior, 11710 kHz. Full data station logo QSL card and personal letter, signed by Patricia Mendez (English Dept.) and Marsela G.R. Campos (Director). Program schedule and timetable/frequency chart included. Received in 93 days for an English report. Station address: C.C. 555, Correo Central, 1000 Buenos Aires, Republica Argentina. (Stephen R. Hunter, Drexel Hill, PA)

AUSTRIA

Radio Austria International, 9870/6015 kHz. Full data QSL letter with illegible veri signer. Station brochures and reception report forms included. Received in 18/29/32 days for an English report. Station address: A-1136 Wien, Wurzburggasse 30, Austria. (Michael J. McFerrin, Fair Haven, MI) (Nicholas P. Adams, Newark, NJ) (Paul Sullivan, Albany, NY) (Earl Bailey, Oakland, CA) (Jeff Leach, Omaha, NE)

CANADA

Halifax Coast Guard Radio, 13138.0 kHz USB. Personal letter, full data postcard QSL, and Coast Guard info sheet, verified by Robert N. Ward-Radio Operator. Received in 14 days for an English utility report, SWL station card, PFC, and one IRC. Station address: c/o Telecommunications Area Manager, Transport Canada, Ketch Harbor, Halifax, Nova Scotia BOJ 1X0, Canada. (Preston O. Sewell, Franklin, NJ)

St. John's Coast Guard Radio, 2182.0/2514.0 kHz USB. Full data form letter, signed by D.J. Ryan-Telecom Operations Manager. Received in 157 days for an English utility report, SWL station card, PFC, and one IRC. Station address: P.O. Box 1300, St. John's, Newfoundland, AIV, Canada. (Sewell, NJ)

ECUADOR

HCJB-The Voice of the Andes, 15155/15270/9745 kHz. Full data 60th Anniversary Card, verified by Director of Broadcasting. Program schedules and station brochures included. Received in 19/20/48 days for an English report and mint stamps. Station address: Casilla 17-01-00691, Quito, Ecuador. (McFerrin, MI) (Hunter, PA) (Adams, NJ) (Rose Carmine, Sidney, OH) (Jack R. Davis, Birmingham, AL) (Mike Schmitt, Livermore, CA) (Leach, NE) (Sullivan, NY) (Frank Hillton, Charleston, SC)

ITALY

RAI 11800/9575 kHz. No data QSL, with no veri-signer. Received in 6 months/327 days for an English report, and one IRC. Station address: Radiotelevisione

You, too, can receive an HCJB QSL card like Todd Dokey of Lodi, California.

c/o North American Service, Caselle Postale 320, Centro Corrispondenza, 00100 Roma, Italy. (McFerrin, MI) (Adams, NJ) (Carmine, OH)

JAMAICA

Radio c/Port Maria, 750-AM kHz. Partial data letter signed and confirmed by Gladstone Wilson-Director of Radio One/Radio Two. Received in 22 days for an English medium wave report and one US dollar. Station address: Jamaican Broadcasting Corp., 5 S. Odeon Ave, Kingston 10, Jamaica. (Dave Gasque, Orangeburg, SC)

MALTA

Voice of the Mediterranean, 9765 kHz. Full data QSL and map of Malta, without veri signer. Received in 34 days for an English report and one IRC. Station address: P.O. Box 143, Valletta, Malta. (Gasque, SC) (Sam Wright, Biloxi, MS)

NEW ZEALAND

Kiwi Radio-Free Radio for the South Pacific, 835-AM kHz/ 5850 kHz. Full data "Rock of the South Pacific" QSL cards for both frequencies, verified with an illegible signature for two English reports. Mediumwave card noted as, "first MW log from the USA." Station address: P.O. Box 1437, Hastings, New Zealand. (Gigi Lytle, Lubbock, TX) *Nice QSLs! -Ed.*

PORTUGAL

North Atlantic Treaty Organization-CTP 97, 16986 kHz, CW Traffic. Standard letter, signed by Joaquim M. Guerreiro- Communications Ops Supervisor. Letter stated the current security regulations on QSLs. Received in 15 days for an English utility report and one IRC. Station address: NATO, Headquarters of Commander in Chief Iberian Atlantic Area, Oeiras, Portugal, (or) NATO, U.S. Postal System, APO New York, NY 09678. (Nagl Martin, Austrian DX Club)

SOUTH AFRICA

Radio Orion and RSA, 3320 kHz. Partial data QSL and RSA schedule, without veri signer from H.F. Verwoerd Station. Radio Orion was not mentioned on the card either. Received in 21 days for an English report and one IRC. Station address: (for either station) 313, Auckland Park 2006, South Africa. (Gasque, SC) (Brian Bagwell, St. Louis, MO) (Wright, MS)

SHIP TRAFFIC

ZIEMIA GNIEZNIENSKA-SQMY, ZIEMIA OLSZTYNSKA-SQDR, 156.600 MHz. (Bulk Carriers) Full data prepared QSL cards, stamped with ship's seal, verified by Radio Officer for both cards. Received in 28/40 days for an English utility report, one IRC, a self-addressed envelope, and mint stamps. Ship address: c/o Polska Steamship Co. (Polska Zegluga Morska), Malo Polska 44, 70-515 Szczecin, Poland. (Russ Hill, Ferndale, MI)

TADEUSZ KOSCIUSZKO-SQLB, 156.65 MHz. (Container) Full data prepared QSL card verified. Received in 58 days for an English utility report, and one US dollar. Ship address: Francusko-Polskie Towarzystwo Zeglugowe, ul 10, Lutego 24, 81-364 Gdna, Poland. (Hank Holbrook, Dunkirk, MD)

MARINE RANGER-ELDT-6, 156.65 MHz. (Bulk Carrier). Full data prepared QSL card verified. Received in 28 days for an English utility report, and one US dollar. Ship address: Oldendorff, Egon-Funfhausen 1, Postfach 2135, D-2400 Lubeck 1, Germany. (Holbrook, MD)

UNITED STATES

WHLO-640 AM kHz, Akron, Ohio. No data unsigned personal note on schedule folder. Received in 16 days for a medium wave report, and a self addressed stamped envelope. Station address: 3535 S. Smith Rd., Akron, Oh. 44333. (Harold Frodge, Midland, MI)

WBAA-920 AM kHz, West Lafayette, Indiana. Full data station letter, verified by David Bunte-Sr. Staff Producer. Received in 7 days for a medium wave report and a self addressed stamped envelope. Station address: 1740 E.C. Elliot Hall of Music, Purdue University, Lafayette, IN 47907. (Frodge, MI)

WKYB-1000 AM kHz, Hemingway, S. Carolina. Full data station letter verified by Malcome (Mike) Holt, Owner & General Manager. Received in 7 days for a medium wave report, mint stamp, and an address label (used). Station address: Hyatt- Holt Communications Co., P.O. Box 1006, Hemingway, SC 29554. (Mike Hardester, Jacksonville, NC)

How to Use the Shortwave Guide**1: Convert your time to UTC.**

Eastern and Pacific Times are already converted to Coordinated Universal Time (UTC) at the top of each page. The rule is: convert your local time to 24-hour format; add (during Standard Time) 5,6,7, or 8 hours for Eastern, Central, Mountain, or Pacific Time, respectively.

Note that all dates, as well as times, are in UTC: for example, the BBC's "Ken Bruce Show" (0030 UTC Sunday) will be heard on Saturday evening (7:30 PM Eastern, 4:30 PM Pacific) in North America, not on Sunday.

2: Choose a program or station you want to hear.

Some selected programs appear on the lower half of the page for prime listening hours. If it's news you're interested in, check out the complete "Newline" listing, which begins on the next page.

Occasionally program listings will be followed by "See X 0000." This information indicates that the program is a re-run, and refers to a previous summary of the program's content. The letter stands for a day of the week, as indicated below, and the four digits represent a time in UTC.

S: Sunday	H: Thursday
M: Monday	F: Friday
T: Tuesday	A: Saturday
W: Wednesday	

3: Find the frequencies for the program or station you want to hear.

Look at the page which corresponds to the time you will be listening. Comprehensive frequency information for English broadcasts can be

found at the top half of the page. All frequencies are in kHz.

The frequency listing uses the same day codes as the program listings; if a broadcast is not daily, those day codes will appear before the station name. Irregular broadcasts are indicated "tent" and programming which includes languages besides English are coded "vl" (various languages).

4: Choose the most promising frequencies for the time, location, and conditions.

Of course, every station can't be heard all the time. To help you find the right frequency, we've included information on the target area of each broadcast. Frequencies beamed toward your area will generally be easier to hear than those beamed elsewhere, even though the latter will often still be audible. Every frequency is followed by one of these target codes:

am: The Americas	me: Middle East
na: North America	as: Asia
ca: Central America	au: Australia
sa: South America	pa: Pacific
eu: Europe	va: various
af: Africa	do: domestic broadcast
me: Middle East	om: omnidirectional

Consult the propagation charts. To help you further find the right frequency, we've included propagation charts at the back of this section, which take into account conditions affecting the audibility of shortwave broadcasts. Simply pick out the region in which you live and find the chart for the region in which the station you want to hear is located. The chart indicates the optimum frequencies for a given time in UTC.

From the Frequency Manager:

There were a lot of changes this past month. First there was the time change in Europe and elsewhere, and then there were the major changes caused by the breakup of the Soviet Union.

Moscow accounts for a lot of frequency usage. We have tried in this issue to bring you the most current information available, yet it is likely that Moscow made some alterations to their schedule after we went to press. So, please be sure to report to us what you hear.

Monitoring Central's phone number is 919-661-0095. Please, no calls between 11pm and 8am. The best time to reach me is after 7pm weekdays and on weekends. If you get my machine, I cannot return your call, so you may want to call again. We continue to improve the Guide and welcome your comments and suggestions.

Troubled Times for YLE

An article from Finland's weekly magazine, *Suomen Kuvalehti*, discussed the financial troubles of YLE, Finland's national radio/TV network. Reino Paasilinna, the network's new director, plans cuts in programming in the wake of the economic depression Finland is currently experiencing.

YLE, which gets its revenue from taxes on advertising, reported a decrease of 19 million dollars in revenue this past year. In the wake of this reduction, cuts are likely in both the domestic and the international services.

Maria Gerson of the Finnish embassy confirmed the magazine report, telling Jeff Chanowitz (who translated the article for *MT*), that her conversations with a high source at YLE indicated that cuts across the board would probably result in one hour less programming to North America this spring.

Suggestions? Something missing?

Let us know your corrections, additions, or suggestions of what you'd like to see in the Shortwave Guide. Programming information should be sent to Kannon Shanmugam, Programming Manager. Frequency information should be sent to Greg Jordan, Frequency Manager. Mail it to *MT*, P.O. Box 98, Brasstown, NC 28902-0098.

Our deadline for the May 1992 issue is April 1st.

MT Monitoring Team

P.O. Box 98, Brasstown, NC 28902-0098

Greg Jordan
Frequency Manager
P.O. Box 98
Brasstown, NC 28902

Jacques d'Avignon
Propagation Forecasts

Kannon Shanmugam
Program Manager
P.O. Box 98
Brasstown, NC 28902

Dave Datko
California

Jack Hubby
California

John Carson
Oklahoma

B. W. Battin
New Mexico

Tammy Wells
Maine

Jim Frimmel
Texas

newsline

"Newsline" is your guide to news broadcasts on the air. ■ All broadcasts are world news reports unless followed by an asterisk, which means the broadcast is primarily national news. ■ All broadcasts are daily unless otherwise noted by the day codes.

0000 UTC**(8:00 PM EDT, 5:00 PM PDT)**

BBC
CBC, Northern Quebec [A]
Christian Science Monitor
Radio Australia
Radio Beijing
Radio Canada Int'l
Radio Havana Cuba [T-S]
Radio Korea
Radio Luxembourg
Radio Moscow
Radio New Zealand Int'l [M-A]
Radio Prague Int'l
Radio Thailand
Radio Viinius
SBC Radio 1, Singapore
Spanish Foreign Radio
Voice of America
0005
Radio Pyongyang
0010
Radio Beijing*
0030
BRT, Brussels
Christian Science Monitor (Asia) [M]
Christian Science Monitor [T-F]
HCJB
Radio Havana Cuba [T-S]
Radio Netherlands [T-S]
Voice of America (Americas, East Asia) (Special English) [T-S]
Voice of America (East Asia) (Special English) [M]
0045
Radio Korea (News Service)
0055
WRNO [W, F]

0100 UTC**(9:00 PM EDT, 6:00 PM PDT)**

All India Radio
BBC
CBC, Northern Quebec

Christian Science Monitor
Deutsche Welle
FEBC Radio Int'l, Philippines
Radio Australia
Radio Belize
Radio Canada Int'l [S-M]
Radio Havana Cuba [T-S]
Radio Japan
Radio Kiev
Radio Luxembourg
Radio Moscow
Radio New Zealand Int'l [M-F]
Radio Prague Int'l
Radio Tashkent
Radio Thailand
Radiotelevisione Italiana
RAE, Buenos Aires [T-A]
SBC Radio 1, Singapore
Spanish Foreign Radio
Voice of America
Voice of Indonesia
WWCR (Program Two) [T-A]
WWCR [T-A]
0115
Radio Havana Cuba* [T-S]
0130
Christian Science Monitor (Asia) [M]
Christian Science Monitor [T-F]
Radio Austria Int'l
Radio Havana Cuba [T-S]
Radio Yugoslavia
Voice of Greece [M-A]
0155
Voice of Indonesia
WRNO [W, A]

0200 UTC**(10:00 PM EDT, 7:00 PM PDT)**

BBC
CBC, Northern Quebec [S-M]
Christian Science Monitor
Deutsche Welle
FEBC Radio Int'l, Philippines
Radio Australia

Radio Budapest
Radio Havana Cuba [T-S]
Radio Luxembourg
Radio Moscow
Radio Romania Int'l
Radio Thailand
SBC Radio 1, Singapore
Swiss Radio Int'l
Voice of America
Voice of Free China
Voice of Myanmar
WWCR [T-A]
0215
Radio Cairo
Radio Nepal
0230
Christian Science Monitor (Africa, Europe) [M]
Christian Science Monitor [T-F]
HCJB
Radio Havana Cuba [T-S]
Radio Moscow
Radio Pakistan (Special English)
Radio Portugal [T-A]
Radio Tirana, Albania
Radio Yugoslavia
0245
Radio Kiev
Radio Korea (News Service)

0300 UTC**(11:00 PM EDT, 8:00 PM PDT)**

BBC
CBC, Northern Quebec [T-S]
Christian Science Monitor
Deutsche Welle
Radio Australia
Radio Bahrain
Radio Beijing
Radio Havana Cuba [T-S]
Radio Japan
Radio Moscow
Radio New Zealand Int'l [M-F]

Radio Prague Int'l
Radio Thailand
SBC Radio 1, Singapore
TWR, Bonaire
Voice of America
Voice of Free China
WWCR [T-A]
0310
Radio Beijing*
0315
Radio Cairo
Radio Havana Cuba* [T-S]
0330
BBC (Africa)*
Christian Science Monitor (Africa, Europe) [M]
Christian Science Monitor [T-F]
Radio Austria Int'l
Radio Bahrain
Radio Havana Cuba [T-S]
Radio Netherlands [T-S]
Radio Tirana, Albania
UAE Radio, Dubai
0340
Voice of Greece [M-A]
0350
Radio Yerevan
Radiotelevisione Italiana
0355
Radio Japan [M-F]

0400 UTC**(12:00 AM EDT, 9:00 PM PDT)**

BBC
CBC, Northern Quebec
Christian Science Monitor
Deutsche Welle
Radio Australia
Radio Bahrain
Radio Beijing
Radio Canada Int'l
Radio Havana Cuba [T-S]
Radio Moscow
Radio New Zealand Int'l [M-F]

Radio Prague Int'l
Radio Romania Int'l
Radio RSA
Radio Sofia
Radio Tanzania
Radio Thailand
SBC Radio 1, Singapore
Swiss Radio Int'l
Voice of America
WRNO [F]
WWCR [T-A]
0405
Radio Pyongyang
0410
Radio Beijing*
0425
Radiotelevisione Italiana
0430
BBC (Africa)* [M-A]
Christian Science Monitor (Africa, Europe, NE Asia) [M]
Christian Science Monitor [T-F]
Radio Bahrain
Radio Botswana
Radio Havana Cuba [T-S]
0450
Radio RSA
0455
WYFR (Network) [T-A]

0500 UTC**(1:00 AM EDT, 10:00 PM PDT)**

BBC ("Newshour")
CBC, Northern Quebec [T-S]
Christian Science Monitor
Deutsche Welle
HCJB
Kol Israel
Radio Australia
Radio Bahrain
Radio Beijing
Radio Havana Cuba [T-S]
Radio Japan
Radio Lesotho

newsline

- Radio Moscow
Radio New Zealand Int'l
Radio Thailand
SBC Radio 1, Singapore
Spanish Foreign Radio
Voice of America
0510
Radio Beijing*
Radio Botswana
0515
Radio Havana Cuba* [T-S]
0530
Christian Science Monitor
(Africa, Europe, NE Asia) [M]
Christian Science Monitor [T-F]
Radio Austria Int'l
Radio Havana Cuba [T-S]
Radio Moscow (World Service)
Radio Romania Int'l
Radio Thailand
RTM, Malaysia
UAE Radio, Dubai
Voice of Nigeria
0550
Radio For Peace Int'l [T-A]
- 0600 UTC**
(2:00 AM EDT, 11:00 PM PDT)
BBC
CBC, Northern Quebec
Christian Science Monitor
Deutsche Welle
GBC Radio, Accra*
Radio Australia
Radio Bahrain
Radio Havana Cuba [T-S]
Radio Korea
Radio Moscow
SBC Radio 1, Singapore
Voice of America
WWCR
0605
Radio Pyongyang
0609
BBC*
0610
Voice of Malaysia
0615
Radio Canada Int'l [M-F]
Radio Korea (News Service)
0630
BBC (Africa)*
Christian Science Monitor [M-F]
Radio Austria Int'l [T-A]
Radio Havana Cuba [T-S]
Radio Moscow (World Service)
RTV Congolaise, Brazzaville [M-F]
Swiss Radio Int'l
Voice of Nigeria
0640
Radio Prague Int'l
0645
Radio Romania Int'l
- 0700 UTC**
(3:00 AM EDT, 12:00 AM PDT)
BBC
Christian Science Monitor
GBC Radio, Accra
MBC, Blantyre, Malawi [M-A]
Radio Australia
Radio Havana Cuba [T-S]
Radio Japan
Radio Moscow
Radio New Zealand Int'l [M, F-A]
SBC Radio 1, Singapore
SLBS, Freetown, Sierra Leone
Voice of Free China
Voice of Myanmar
WWCR [M-A]
0705
Radio Pyongyang
0715
Radio Havana Cuba* [T-S]
0730
BBC (Africa)* [M-A]
BRT, Brussels
Christian Science Monitor [M-F]
HCJB
Radio Ghana
Radio Havana Cuba [T-S]
Radio Moscow (World Service)
Radio Netherlands [M-A]
Radio Prague Int'l
Swiss Radio Int'l
0745
Radio For Peace Int'l [T-A]
0755
Radio Japan [M-F]
- 0800 UTC**
(4:00 AM EDT, 1:00 AM PDT)
BBC
Christian Science Monitor
GBC Radio 1, Accra [S]
GBC Radio 2, Accra
MBC, Blantyre, Malawi [S]
Radio Australia
Radio Bahrain
Radio Korea
Radio Moscow
Radio New Zealand Int'l [M, W-H]
Radio Pakistan
SBC Radio 1, Singapore
SLBS, Freetown, Sierra Leone
Voice of Indonesia
0805
Radio Pyongyang
0810
Voice of Malaysia
0830
Christian Science Monitor [M-F]
Radio Austria Int'l
Radio Moscow (World Service)
Radio Netherlands [M-A]
Swiss Radio Int'l
0840
Voice of Greece [M-A]
0855
Voice of Indonesia
- 0900 UTC**
(5:00 AM EDT, 2:00 AM PDT)
BBC
Christian Science Monitor
Deutsche Welle
GBC Radio 1, Accra [M-F]
GBC Radio 2, Accra
MBC, Blantyre, Malawi [M-A]
Radio Australia
Radio Bahrain
Radio Beijing
Radio Finland [M-F]
Radio Japan
Radio Moscow
Radio New Zealand Int'l
SBC Radio 1, Singapore
Voice of Nigeria
0910
- Radio Beijing*
0915
Radio Korea (News Service)
0930
Christian Science Monitor [M-F]
Deutsche Welle (Africa)* [M-F]
Radio Afghanistan
Radio Moscow
0950
Radio Finland [M-F]
Radio Tikhly Okean [S]
0955
Radio Japan [M-F]
- 1000 UTC**
(6:00 AM EDT, 3:00 AM PDT)
All India Radio
BBC
BRT, Brussels [M-A]
Christian Science Monitor
GBC Radio 2, Accra [A]
HCJB
MBC, Blantyre, Malawi [S]
Radio Australia
Radio Bahrain
Radio Beijing
Radio Moscow
Radio New Zealand Int'l [M]
Radio RSA
Radio Tanzania
SBC Radio 1, Singapore
Swiss Radio Int'l
Voice of America
1010
Radio Beijing*
1030
Christian Science Monitor [M-F]
MBC, Blantyre, Malawi [M-F]
Radio Korea
Radio Moscow
Radio Netherlands [M-A]
RTM, Malaysia
UAE Radio, Dubai
Voice of Nigeria
1040
Voice of Greece [M-A]
1055
All India Radio
- 1100 UTC**
(7:00 AM EDT, 4:00 AM PDT)
BBC
Christian Science Monitor
Deutsche Welle
GBC Radio, Accra [A-S]
Kol Israel
MBC, Blantyre, Malawi [A-S]
Radio Australia
Radio Bahrain
Radio Beijing
Radio Japan
Radio Korea
Radio Moscow
Radio New Zealand Int'l [T-W]
Radio Pakistan
Radio RSA
SBC Radio 1, Singapore
Swiss Radio Int'l
TWR, Bonaire [M-F]
Voice of America
1105
Radio Pakistan (Special English)
Radio Pyongyang
1110
Radio Beijing*
- Radio Belize [T-A]
Radio Botswana [M-F]
1115
Radio Korea (News Service)
Radio Nepal
1125
Radio Belize [M]
Radio Botswana [A-S]
1130
Christian Science Monitor [M-F]
Deutsche Welle* [M-F]
Radio Austria Int'l [M-F]
Radio Lesotho
Radio Moscow
Radio Netherlands [M-A]
RTM, Malaysia*
1135
Radio Thailand
1150
Radio RSA
1155
Radio Japan [M-F]
- 1200 UTC**
(8:00 AM EDT, 5:00 AM PDT)
BBC
CBC, Northern Quebec [A-S]
Christian Science Monitor
MBC, Blantyre, Malawi [M-F]
Radio Australia
Radio Bahrain
Radio Beijing
Radio Bras, Brasilia [M-A]
Radio Jordan
Radio Moscow
Radio New Zealand Int'l
Radio Romania Int'l
Radio Tashkent
Radio Thailand
RTM, Malaysia
SBC Radio 1, Singapore
Voice of America
WWCR [M-F]
1209
BBC* [M-A]
1210
Radio Beijing*
1215
HCJB [M-F]
Radio Korea
1230
BRT, Brussels [S]
Christian Science Monitor [M-F]
Radio Cairo
Radio France Int'l
Radio Moscow
TWR, Bonaire
1235
Voice of Greece
1257
HCJB [M-F]
- 1300 UTC**
(9:00 AM EDT, 6:00 AM PDT)
BBC ("Newshour")
CBC, Northern Quebec [A-S]
Christian Science Monitor
GBC Radio, Accra
Polish Radio, Warsaw
Radio Australia
Radio Bahrain
Radio Beijing
Radio Belize
Radio Canada Int'l [M-F]
Radio Moscow
- Radio Romania Int'l
Radio Tanzania [A-S]
SBC Radio 1, Singapore
Swiss Radio Int'l
Voice of America
WWCR [M-F]
1305
Radio Pyongyang
1310
Radio Beijing*
1325
HCJB [M-F]
1328
Radio Cairo
1330
All India Radio
Christian Science Monitor [M-F]
FEBC Radio Int'l, Philippines
Radio Austria Int'l [M-F]
Radio Canada Int'l
Radio Korea (News Service)
Radio Moscow
Radio Tashkent
RTM, Malaysia
Swiss Radio Int'l
UAE Radio, Dubai
Voice of America (Special English)
Voice of Turkey
1346
All India Radio [A]
1350
Radio For Peace Int'l [T-A]
1355
WYFR (Network) [M-F]
- 1400 UTC**
(10:00 AM EDT, 7:00 AM PDT)
BBC
BRT, Brussels [M-A]
CBC, Northern Quebec
Christian Science Monitor
GBC Radio, Accra
MBC, Blantyre, Malawi [M-F]
Radio Australia
Radio Bahrain
Radio Beijing
Radio Belize [M-F]
Radio Canada Int'l [S]
Radio France Int'l
Radio Japan
Radio Jordan
Radio Korea
Radio Moscow
RTM, Malaysia*
SBC Radio 1, Singapore
Voice of America
1410
Radio Beijing*
1415
Radio Nepal
1425
HCJB [M-F]
1430
Christian Science Monitor [M-F]
FEBC Radio Int'l, Philippines
Kol Israel
Radio Moscow
Radio Netherlands [M-A]
1445
BBC (East Asia) (Special English) [M-F]
Voice of Myanmar
1455
All India Radio

The Best Shortwave You Can Buy Comes From Drake



The Drake R8 Communications Receiver... simply the best shortwave clarity and fidelity you'll find, outperforming receivers costing much, much more.

Famous Drake technology gives you wide frequency coverage of all world bands and excellent dynamic range... in an uncluttered package with an ergonomic front panel, featuring keypad entry of functions.

For the best access to world events as they happen, buy yourself a Drake R8 shortwave receiver. Ask your dealer for more information, or contact a Drake sales office today at **1-800-568-3795 (1-800-LOVE-SWL)**.



R. L. Drake Company, P.O. Box 3006, Miamisburg, OH 45343, USA Tel: 513-866-2421
 Drake Canada, 655 The Queensway #16, Peterborough, Ontario K9J 7M1, Canada
 Tel: 705-742-3122
 1-800-568-3795 (1-800-LOVE-SWL)

©1991 The R.L. Drake Co.

1992 Popular Communications Communications Guide

The most up-to-date buyer's guide for communications equipment—from communications receivers and scanners, to CB radio and amateur transceivers is here!

Complete with articles by experts in the communications field, including Dexter, Kneitel, Helms, Gysi, Orr, Zeller, Margolis and many more, the 1992 Communications Guide is *the* book you've been waiting for—Here's what's inside:

An introduction to the fascinating world of communications monitoring with: illustrated articles on scanning, utility monitoring, antenna selection and construction, pirate radio, QSLing and much MORE!

AS AN ADDED BONUS, noted ham Fred Maia, W5Y1 tells just how easy it is to get your HAM LICENSE. In plain English, Maia explains ham radio and how YOU can become a licensed ham. In addition, a product listing with PHOTOS of amateur radio transceivers for use by Technician class licensed hams is included . . .

The Brand NEW 1992 Communications Guide includes the latest communications products on the market WITH detailed specifications and photos to make your buying decision easier. We've included shortwave receivers, scanners (BOTH base and handheld) and accessories to make your monitoring post complete.

IT'S ALL YOURS FOR JUST \$4.95 (please add \$2.50 shipping and handling; \$3.50 foreign).



YES, please send me _____ copies at \$4.95 each:

Name _____ Call _____

Address _____

City _____ State _____ Zip _____

Send only \$4.95 each (plus \$2.50 shipping & handling; \$3.50 foreign) Check Money Order

MasterCard VISA Amex Card No. _____ Expires _____

Signature _____ (required on all charge orders)

Mail to: CQ Communications, Inc., 76 North Broadway, Hicksville, NY 11801
Phone: 516-681-2922/FAX: 516-681-2926

newslines

Radio Finland [M-F]

1500 UTC**(11:00 AM EDT, 8:00 AM PDT)**

BBC
 CBC, Northern Quebec [A-S]
 Christian Science Monitor
 Deutsche Welle
 GBC Radio 2, Accra
 Radio Australia
 Radio Bahrain
 Radio Beijing
 Radio Belize [M-A]
 Radio Canada Int'l
 Radio Japan
 Radio Moscow
 Radio Portugal [M-F]
 Radio Romania Int'l
 Radio RSA
 RTM, Malaysia
 SBC Radio 1, Singapore
 Voice of America
 WWCR [M-F]

1505

Radio Finland
 Radio Pyongyang

1510

Radio Beijing*

1530

Christian Science Monitor [M-F]
 Deutsche Welle* [M-F]
 FEBA, Seychelles
 FEBC Radio Int'l, Philippines
 Radio Austria Int'l [M-F]
 Radio Moscow
 Radio Tirana, Albania
 Swiss Radio Int'l
 Voice of Greece [M-A]
 Voice of Nigeria
1545
 Radio For Peace Int'l [T-A]
 Radio Korea (News Service)

1600 UTC**(12:00 PM EDT, 9:00 AM PDT)**

BBC
 CBC, Northern Quebec [A-S]
 Christian Science Monitor
 Deutsche Welle
 GBC Radio 2, Accra
 MBC, Blantyre, Malawi
 Polish Radio, Warsaw
 Radio Australia
 Radio Bahrain
 Radio Beijing
 Radio Canada Int'l
 Radio France Int'l
 Radio Jordan
 Radio Korea
 Radio Lesotho
 Radio Moscow
 Radio Pakistan
 Radio RSA
 Radio Tanzania
 SBC Radio 1, Singapore
 Voice of America
 Yemen Radio
1609
 BBC*
1610
 Radio Beijing*
 Radio Botswana [M-F]
1615
 Radio Pakistan (Special English)
1630

Christian Science Monitor [M-F]

Radio Canada Int'l

Radio Moscow

Radio Netherlands [M-A]

UAE Radio, Dubai

Voice of America (except Africa) (Special English)

1700 UTC**(1:00 PM EDT, 10:00 AM PDT)**

BBC
 CBC, Northern Quebec [A]
 Christian Science Monitor
 GBC Radio 2, Accra
 Radio Australia
 Radio Bahrain
 Radio Beijing
 Radio Belize [M-F]
 Radio Canada Int'l
 Radio Japan
 Radio Jordan
 Radio Moscow
 Radio Pakistan
 Radio RSA
 Voice of America

1705

Radio Pyongyang

1710

Radio Beijing*

1715

Radio Korea (News Service)

1725

Radio Surinam Int'l [M-F]

1730

Christian Science Monitor [M-F]

Radio Moscow

Radio Romania Int'l

WYFR (Network) [A]

1735

WYFR (Network) [M-F]

1740

BBC (Africa)*

1750

Radio RSA

1800 UTC**(2:00 PM EDT, 11:00 AM PDT)**

All India Radio
 BBC
 CBC, Northern Quebec [A]
 Christian Science Monitor
 GBC Radio, Accra
 Kol Israel
 KVOH
 MBC, Blantyre, Malawi
 Polish Radio, Warsaw
 Radio Afghanistan
 Radio Australia
 Radio Bahrain
 Radio Belize [M-F]
 Radio Bras, Brasilia [M-A]
 Radio Canada Int'l
 Radio Korea
 Radio Moscow
 Radio New Zealand Int'l [S-F]
 Radio Prague Int'l
 Radio Tanzania
 RAE, Buenos Aires [M-F]
 Voice of America
1825
 WYFR (Network) [A]
1830
 Christian Science Monitor [M-F]
 Radio Austria Int'l
 Radio Belize

Radio Moscow

Radio Netherlands [M-A]

Radio Sofia

Radio Tirana, Albania

Swiss Radio Int'l

Voice of America (Special English)

1840

SLBC, Sri Lanka

Voice of Greece

1845

Radio Cote d'ivoire, Abidjan

1855

BBC (Africa)* [M-F]

1900 UTC**(3:00 PM EDT, 12:00 PM PDT)**

All India Radio
 BBC
 BRT, Brussels
 CBC, Northern Quebec [M-H]
 Christian Science Monitor [M-A]
 Deutsche Welle
 GBC Radio 2, Accra*
 HCJB
 KVOH
 Radio Australia
 Radio Beijing
 Radio Canada Int'l [M-F]
 Radio Havana Cuba [M-A]
 Radio Japan
 Radio Moscow
 Radio New Zealand Int'l [S-F]
 Radio Tanzania
 SLBS, Freetown, Sierra Leone
 Spanish Foreign Radio
 Voice of America
1910
 Radio Beijing*
 Radio Botswana
1920
 Voice of Greece
1930
 Christian Science Monitor [M-F]
 Deutsche Welle* [M-F]
 Radio Ghana
 Radio Havana Cuba [M-A]
 Radio Moscow
 Radio Prague Int'l
 Radio Romania Int'l
 Voice of Nigeria
1935
 Radiotelevisione Italiana
1945
 Radio Korea (News Service)

1955

BBC (Africa)* [M-F]

Radio Finland

WYFR (Network) [M-A]

2000 UTC**(4:00 PM EDT, 1:00 PM PDT)**

BBC
 Christian Science Monitor
 GBC Radio, Accra
 Kol Israel
 KVOH
 MBC, Blantyre, Malawi
 Radio Australia
 Radio Bahrain
 Radio Beijing
 Radio Belize [M-F]
 Radio Canada Int'l
 Radio Havana Cuba [M-A]

Radio Moscow

Radio New Zealand Int'l [S-F]

Radio Portugal [M-F]

SLBS, Freetown, Sierra Leone

Swiss Radio Int'l

Voice of America

Voice of Indonesia

Voice of Nigeria

2005

Radio Pyongyang

2010

Radio Beijing*

2025

Radio Havana Cuba* [M-A]

Radiotelevisione Italiana

2030

Christian Science Monitor [M-F]

Polish Radio, Warsaw

Radio Havana Cuba [M-A]

Radio Korea

Radio Moscow

Radio Netherlands [M-A]

2045

Radio Korea (News Service)

Radio Sofia

Voice of Indonesia

2100 UTC**(5:00 PM EDT, 2:00 PM PDT)**

All India Radio
 BBC ("Newshour")
 CBC, Northern Quebec [S-F]
 Christian Science Monitor [M-A]
 Deutsche Welle
 GBC Radio 2, Accra*
 KVOH
 MBC, Blantyre, Malawi
 Radio Australia
 Radio Bahrain
 Radio Beijing
 Radio Belize [M-F]
 Radio Budapest
 Radio Japan
 Radio Moscow
 Radio New Zealand Int'l [S-F]
 Radio Portugal [M-F]
 Radio Prague Int'l
 Radio Romania Int'l
 SLBS, Freetown, Sierra Leone
 Spanish Foreign Radio
 Swiss Radio Int'l
 Voice of America
 Voice of Turkey
 WWCR (Program Two) [M-F]

2110

Radio Beijing*

2125

WYFR (Network) [M-F]

2130

Christian Science Monitor [M-F]

Radio Austria Int'l

Radio Cairo

Radio Canada Int'l

Radio Moscow

WYFR (Network) [A]

2150

Radio For Peace Int'l [M-F]

2200 UTC**(6:00 PM EDT, 3:00 PM PDT)**

All India Radio
 BBC
 BRT, Brussels
 CBC, Northern Quebec [S-F]
 Christian Science Monitor

GBC Radio 2, Accra

MBC, Blantyre, Malawi

Radio Australia

Radio Beijing

Radio Canada Int'l

Radio Havana Cuba [M-A]

Radio Kiev

Radio Moscow

Radio New Zealand Int'l

Radio Prague Int'l

Radio Yugoslavia

Radiotelevisione Italiana

SBC Radio 1, Singapore

SLBS, Freetown, Sierra Leone

Voice of America

Voice of Free China

WWCR (Program Two) [M-F]

2208

Voice of America (Caribbean)* [M-F]

2209

BBC*

2210

Radio Beijing*

2225

Radio Havana Cuba* [M-A]

2230

Christian Science Monitor [M-F]

Kol Israel

Radio Havana Cuba [M-A]

Radio Moscow

Radio Tirana, Albania

Radio Vilnius

Swiss Radio Int'l

Voice of America (Special English)

WYFR (Network) [M-F]

2245

GBC Radio, Accra

Radio Sofia

Voice of Greece

2255

WYFR (Network) [M-A]

2300 UTC**(7:00 PM EDT, 4:00 PM PDT)**

BBC
 CBC, Northern Quebec [M-F]
 Christian Science Monitor [M-A]
 Radio Australia
 Radio Belize [M-F]
 Radio Canada Int'l
 Radio Japan
 Radio Moscow
 Radio New Zealand Int'l
 RTM, Malaysia
 SBC Radio 1, Singapore
 Voice of America
 Voice of Turkey
2305
 Radio Pyongyang
2315
 All India Radio
2320
 Radio Thailand
2330
 Christian Science Monitor [M-F]
 Radio Moscow
 Radio Nacional, Bogota [A]
 Radio New Zealand Int'l [A-H]
 RTM, Malaysia*
2345
 Radio For Peace Int'l [M-F]
2355
 Radio Japan [M-F]

Join the thousands
of others who've
enhanced their
enjoyment of radio
monitoring for over
ten years!



SUBSCRIBE NOW!

Several professional monitoring agencies, in fact, have subscriptions to **Monitoring Times**. That's because every month **Monitoring Times** offers the latest in:

- ▶ International Broadcasting
- ▶ Utility Monitoring
- ▶ Scanners
- ▶ Shortwave and Longwave
- ▶ Satellites
- ▶ Electronic Projects
- ▶ Listening Tips
- ▶ Frequency Lists
- ▶ Broadcasting Schedules
- ▶ News-breaking Articles
- ▶ Features
- ▶ Exclusive Interviews
- ▶ Insights from the Experts
- ▶ New Product Reviews & Tests

Jammed with up-to-date information and concisely written by the top writers in the field, **Monitoring Times** is considered indispensable reading by top government agencies.

From longwave to microwave, if *you* are interested in communications, **Monitoring Times** is your foremost guide to international broadcasters; new equipment and accessories; profiles of government, military, police and fire networks; home projects; and tips on monitoring everything from air-

to-ground and ship-to-shore to radioteletype, facsimile and space communications.

Order your subscription today by sending \$19.95 per year in the US; \$28.50 per year for foreign and Canada. For a sample issue, send \$3 (foreign, send 7 IRCs).

Please allow 4-6 weeks for delivery.

MONITORING TIMES

P.O. Box 98
Brasstown, N.C. 28902

Your authoritative source, every month.

- Yes, begin my subscription to Monitoring Times. I've enclosed a check.
- Send me a sample issue. Enclosed is a check for \$3.
- For MC/VISA orders, call 704-837-9200.

Name _____

Street _____

City _____

State _____

Zip _____

0000 UTC

[6:00 PM EDT/3:00 PM PDT]

FREQUENCIES

0000-0100	Australia	11720as	11880as	15160as	15240as	9905va	11985va	12025va	12045va
		15320as	15365as	17750as	17795as	12050va	15295va	15350va	15420va
		17880as	21740as			15425va	17610va	17655va	17665va
0000-0100	Australia, ABC Brisbane	4920do	9660do			17700va	17720va	17775va	17825va
0000-0100	Australia, ABC Perth	9610do				17890va	21480va	21690va	21790va
0000-0100	AWR Costa Rica	9725ca	11870ca			11335na	13760na	15115na	
0000-0100 tent, vl	Baghdad, Iraq Int'l	11830am	15140am			17770pa			
0000-0030	BBC London	5965as	5975na	6005af	6175na	15165am			
		6195as	7145as	7325na	9580as	0000-0100	N. Korea, Radio Pyongyang		
		9590na	9915na	11750sa	11945as	0000-0100	New Zealand, RNZI		
		11955as	12095na	15260sa	15360pa	0000-0030 sm	Norway		
		17830as				0000-0100	RCI Montreal	5960am	9755am
0000-0005	Canada, CBC	9625do				0000-0100	RFPI, Costa Rica	7375na	21465na
0000-0100	CFCX Montreal, Canada	6005do				0000-0100	SBC Radio 1, Singapore	5010do	5052do
0000-0100	CFRX Toronto, Canada	6070do				0000-0100	SLBS, Sierra Leone	3316do	11940do
0000-0100	CFVP Calgary, Canada	6030do				0000-0100	Spanish National Radio	9530na	
0000-0100	China, Radio Beijing	9770am	11715am			0000-0030	Swiss Radio Int'l	3985eu	6165eu
0000-0100	CHNX Halifax, Canada	6130do				0000-0100	Thailand	4830as	9655as
0000-0100	CKZU Vancouver Canada	6160do				0000-0100	Ukraine, Radio Kiev	4825eu	7240eu
0000-0100	Cook Islands	11760pa						10344va	17605am
0000-0100 s-f, vl	Croatian Radio via WHRI	7315na	9495na			0000-0100	VOA	6130ca	9455ca
0000-0100	CSMonitor World Svc, Bost	7395na	9850af	13760na	17555as			15120ca	15120am
0000-0100 sa	CSMonitor World Svc, Bost	17865as				0000-0100		7120as	9770as
0000-0100	Cuba, RHC, Havana	11950na				0000-0100		15290as	17735as
0000-0030	Czechoslovakia	7345na	9540na	11990na		0000-0100		7315am	9495am
0000-0100	FEBC Manila, Philippines	15450as				0000-0100		15145eu	
0000-0100	India, All India Radio	9910as	11715as	11745as	15110as	0000-0100		7355am	
		15135as	15145as	17830as		0000-0100		7435na	12160na
0000-0100 tent	Iraq, Radio Baghdad	11830va	15445va			0000-0100		5985am	
0000-0100	Korea, Radio Korea	15575na				0005-0100 a		9625do	
0000-0100	KSDA Guam	15610as				0030-0100		5965as	5975na
0000-0100	KTBN Salt Lake City	15590am						7135as	7325na
0000-0100	KVOH Los Angeles	17775am				0030-0100		9915na	11750sa
0000-0100	Luxembourg, RTL	15350va						15260sa	15360pa
0000-0100	Malaysia, RTM Radio 4	7295do				0030-0100		9745am	15155am
0000-0100	Moscow World Svc	4740do	4975do	6000am	6045am	0030-0100		9022am	9720am
		7110va	7115am	7135va	7150va	0030-0100		6020am	6165am
		7160va	7255va	7275va	7310am	0030-0100		6005as	9720as
		7390am	9625va	9665va	9715va	0030-0100		5995sa	7405sa
		9725va	9745va	9790va	9855va			9775sa	11580sa
						0030-0100		15120sa	15205sa
						0030-0100		VOIRI Teheran	9022na
						0030-0100		Yugoslavia, Radio Federal	9580am
						0040-0050 twhtas		Venezuela, Radio Nacional	9540om
						0045-0100		Korea World News	7275as

SELECTED PROGRAMS

Sundays

- 0015 Radio Korea: News Commentary. Opinion on developments in Korea and worldwide.
- 0020 Radio Korea: Sites and Sounds. A look at Korea's tourist attractions and industry.
- 0030 BBC: The Ken Bruce Show. Ken Bruce plays pop music, past and present.
- 0030 Radio Australia: Book Reading. Serialized readings from popular books.
- 0035 Radio Korea: From Us to You. Listener letters, questions, and comments, interspersed with Korean music.
- 0040 Radio Netherlands: Newslines. News analysis from correspondents worldwide.
- 0054 Radio Netherlands: Van Gogh's Ear. Barry O'Dwyer presents a magazine program.

Mondays

- 0015 Radio Korea: Echoes of Korean Music. See S 1115.
- 0030 BBC: In Praise Of God. Christian religious services and meditations.
- 0030 Radio Australia: Just Out. Rob Hoskin plays recent Australian music releases.
- 0030 Radio Netherlands: Happy Station. See S 1130.
- 0035 Radio Korea: Shortwave Feedback. See S 1135.

Tuesdays

- 0015 Radio Korea: News Commentary. See S 0015.

- 0020 Radio Korea: Seoul Calling. See M 1120.
- 0030 BBC: Panel Game. Who's Britain's top musical brain? Find out on "Ned Sherrin's Counterpoint" (through June 30th).
- 0030 Radio Australia: Music/Information. See S 0330.
- 0040 Radio Korea: Let's Learn Korean! See M 1140.
- 0040 Radio Netherlands: Newslines. See S 0040.
- 0045 Radio Korea: Sports Roundup. See M 1145.
- 0054 Radio Netherlands: The Research File. See M 1154.

Wednesdays

- 0015 Radio Korea: News Commentary. See S 0015.
- 0020 Radio Korea: Seoul Calling. See M 1120.
- 0030 BBC: Omnibus. Topical features on almost any topic, from Dracula to drugs.
- 0030 Radio Australia: Music/Information. See S 0330.
- 0040 Radio Korea: Let's Learn Korean! See M 1140.
- 0040 Radio Netherlands: Newslines. See S 0040.
- 0045 Radio Korea: Korean Cultural Variety. See T 1145.
- 0054 Radio Netherlands: Mirror Images. See T 1154.

Thursdays

- 0015 Radio Korea: News Commentary. See S 0015.
- 0020 Radio Korea: Seoul Calling. See M 1120.
- 0030 BBC: Comedy/Drama. See W 1530.
- 0030 Radio Australia: Music/Information. See S 0330.
- 0040 Radio Korea: Let's Learn Korean! See M 1140.
- 0040 Radio Netherlands: Newslines. See S 0040.

- 0045 Radio Korea: Pulse of Korea. See W 1145.
 - 0054 Radio Netherlands: Feature. See W 1154.
- Fridays**
- 0015 Radio Korea: News Commentary. See S 0015.
 - 0020 Radio Korea: Seoul Calling. See M 1120.
 - 0030 BBC: Music Feature. On the 200th anniversary of his birth, explore "Rossini And His World" (3rd/10th/17th) before embarking on a series of "Classic Recordings" (through June 19th).
 - 0030 Radio Australia: Music/Information. See S 0330.
 - 0040 Radio Korea: Let's Learn Korean! See M 1140.
 - 0040 Radio Netherlands: Newslines. See S 0040.
 - 0045 Radio Korea: Focus This Week. See H 1145.
 - 0054 Radio Netherlands: Media Network. See H 1154.
- Saturdays**
- 0015 Radio Korea: News Commentary. See S 0015.
 - 0020 Radio Korea: Let's Sing Together. See F 1120.
 - 0030 BBC: From The Weeklies. A review of the British weekly press.
 - 0030 Radio Australia: Word Of Mouth. See M 1445.
 - 0040 Radio Netherlands: Newslines. See S 0040.
 - 0045 BBC: Recording Of The Week. See M 0615.
 - 0045 Radio Korea: Listeners' Forum. See F 1145.
 - 0054 Radio Netherlands: Feature. See F 1154.

0100 UTC

[7:00 PM EDT/4:00 PM PDT]

FREQUENCIES

0100-0200	Argentina, RAE Buenos Aires	11710am			
0100-0200 twhfa	Argentina, RAE Buenos Aires	11710na			
0100-0200	Australia	11720as	11880as	15160as	15240as
		15320as	15365as	17630as	17750as
		17795as	21525as	21740as	21775as
0100-0200	Australia, ABC Brisbane	4920do	9660do		
0100-0200	Australia, ABC Perth	9610do			
0100-0115 tent, vl	Baghdad, Iraq Int'l	11830am	15455sa		
0100-0200	BBC London	5965as	5975na	6005sa	6175na
		7135as	7325na	9580as	9590na
		9915na	11750sa	11955as	12095na
		15260sa	15280as	15360pa	21715as
0100-0200 as	Canada, CBC	9625do			
0100-0200	CFMX Montreal, Canada	6005do			
0100-0200	CFRX Toronto, Canada	6070do			
0100-0200	CFVP Calgary, Canada	6030do			
0100-0200	CHNX Halifax, Canada	6130do			
0100-0200	CKZU Vancouver, Canada	6160do			
0100-0200	Cook Islands	11760pa			
0100-0200	Croatian Radio via WHRI	7315na	9495eu		
0100-0200	CSMonitor World Svc, Bost	7395na	9850af	13760na	17555as
0100-0200 sa	CSMonitor World Svc, Bost	17865as			
0100-0200	Cuba, RHC Havana	11950am			
0100-0127	Czechoslovakia	5930na	7345na	9540na	
0100-0150	Deutsche Welle, Germany	6040na	6055na	6085na	6145na
		9515na	9565na	9610na	9640na
		9770na	11865na		
0100-0200	FEBC Manila, Philippines	15450as			
0100-0200	HCJB Quito, Ecuador	9745am	15155am	21455am	
0100-0115	India, All India Radio	9910as	11715as	11745as	15110as
		15135as	15145as	17830as	
0100-0200	Indonesia, Voice of	7125as	9675as	11752as	11785as
0100-0130	Iran, Islamic Republic	9022am	9720am	15260am	
0100-0115 tent	Iraq, Radio Baghdad	11830va	15445va		
0100-0120	Italy, RAI, Rome	9575am	11800am		
0100-0200	Japan NHK	11840me	15195as	17810as	17835as
		17845as			
0100-0200	KTBN Salt Lake City	15590na			
0100-0130	Laos, National Radio of	7116as			
0100-0200	Luxembourg, RTL	15350va			
0100-0200 smtwh	Malaysia, RTM Radio 4	7295do			

0100-0200	Moscow World Svc	4740do	4940do	4975do	6000am
		6045am	7115am	7135va	7150va
		7160va	7240va	7255va	7275va
		7310am	7390va	9625va	9665va
		9715va	9725va	9745va	9765va
		9790va	9905va	11985va	12045va
		12050va	15265va	15295va	15350va
		15420va	15425va	17590va	17610va
		17655va	17665va	17700va	17720va
		17775va	17775va	17825va	17890va
0100-0200	Moscow World Svc	21480va	21690va	21790va	
0100-0200	Namibia BC Corp, Windhoek	3290af			
0100-0125	Netherlands	6020am	6165am	11835am	
0100-0200	New Zealand, RNZI	17770pa			
0100-0130 sm	Norway	9615am			
0100-0130 twhfa	RCI Montreal	5960am	9755am		
0100-0200 sm	RCI Montreal	9535am	11845am	11940am	13720am
0100-0200	RFPI, Costa Rica	7375na	15030am	21465am	
0100-0200	SBC Radio 1, Singapore	5010do	5052do	11940do	
0100-0200	SLBS, Sierra Leone	3316do			
0100-0200	Spanish National Radio	9530na			
0100-0200	Sri Lanka B'casting Corp.	6005as	9720as	15425as	
0100-0130	Sweden	9695na	9765as	9795as	
0100-0200	Thailand	4830as	9655as	11905as	
0100-0130	Uzbekistan, R. Tashkent	5930as	5995as	7190as	7265as
0100-0200	VOA	5995am	6130am	7405am	9455am
		9775am	11580am	15120am	15205am
		7205as	9740as	11705as	15250as
		17735as	21650as		
0100-0130	VOIRI Teheran	9022na	9755na	15260na	
0100-0200	WHRI Noblesville, Indiana	7315am	9495am		
0100-0200 mwf	WHRI Radio Free Croatia	7315na	9495na		
0100-0200	WINB Red Lion, Penn.	15145na			
0100-0200	WRNO New Orleans	7355na			
0100-0200	WWCR Nashville	5935na	7435na		
0100-0200	WYFR Okeechobee, FL	6065am	9505am	15440am	
0130-0200	Austria, ORF Vienna	9870sa	9875na	13730na	
0130-0150	Finland	9560na	11755na		
0130-0150 mtwhfa	Greece, Voice of	9395na	9420na	11645na	
0130-0200 mwf	Kazakhstan, R. Alma Ata	5915do	6135do		
0130-0200	UAE Radio, Dubai	11795na	13695eu	15320eu	15435eu
0130-0200	Yugoslavia, Radio Federal	9580na			
0145-0200	Vatican Radio	9650as	11935as		

SELECTED PROGRAMS

Sundays

- 0101 BBC: Play Of The Week. This month's Globe Theatre selections: Oscar nominee Ben Kingsley in "A Sense Of Things Moving Forward" (5th); "What Happened With St. George?" (12th); "Music And Silence" (19th, starting at 0030 UTC); "Faith" (26th).
- 0109 Deutsche Welle: Commentary. Opinion on current issues.
- 0117 Deutsche Welle: Feature. "Mailbag," "Nickelodeon" (listener requests for German music), or "Technical Tips For DX'ers."
- 0130 Radio Australia: At Your Request. Dick Paterson plays music requests.
- 0134 Deutsche Welle: German By Radio. An advanced German language course for English speakers.

Mondays

- 0101 BBC: Feature/Drama. This month's diverse crop: "Going To The Pictures" (6th); "A Hallelujah For Handel's Messiah" (13th); "An Oddly Complete Understanding" (20th); "My Dear Mr. Yeats" (27th).
- 0109 Deutsche Welle: Commentary. See S 0109.
- 0116 Deutsche Welle: Living in Germany. A weekly look at the social scene in Germany.
- 0130 Radio Australia: Music/Information. See S 0330.
- 0134 Deutsche Welle: Larry's Random Selection. Larry Wayne takes a look at Germany from the lighter side.
- 0145 BBC: Feature. After hearing the last of the "Mastersingers"

(6th), check out extraordinary true stories in "Truth To Tell" (through May 4th).

Tuesdays

- 0105 BBC: Outlook. See M 1405.
- 0109 Deutsche Welle: European Journal. See M 0209.
- 0130 BBC: Folk In Britain. Ian Anderson is the host, folk music is the fare.
- 0130 Radio Australia: Music/Information. See S 0330.
- 0134 Deutsche Welle: Transatlantic Diary. Cultural, science, and economic developments between the U.S. and Germany.
- 0145 BBC: Health Matters. New medical developments and methods of keeping fit.

Wednesdays

- 0105 BBC: Outlook. See M 1405.
- 0109 Deutsche Welle: European Journal. See M 0209.
- 0130 BBC: Talks. "It Made Our World" (1st) is followed by scary books in "Fear From The Book" (through May 13th).
- 0130 Radio Australia: Music/Information. See S 0330.
- 0134 Deutsche Welle: Transatlantic Diary. See T 0134.
- 0145 BBC: Country Style. David Allan profiles the country music scene on both sides of the pond.

Thursdays

- 0105 BBC: Outlook. See M 1405.

- 0109 Deutsche Welle: European Journal. See M 0209.
- 0130 BBC: Waveguide. See W 0415.
- 0130 Radio Australia: Music/Information. See S 0330.
- 0134 Deutsche Welle: Transatlantic Diary. See T 0134.
- 0140 BBC: Book Choice. See W 0425.
- 0145 BBC: The Farming World. Agricultural news and technological innovations for farmers.

Fridays

- 0105 BBC: Outlook. See M 1405.
- 0109 Deutsche Welle: European Journal. See M 0209.
- 0130 BBC: Seven Seas. Malcolm Billings presents news about ships and the sea.
- 0130 Radio Australia: Music/Information. See S 0330.
- 0134 Deutsche Welle: Transatlantic Diary. See T 0134.
- 0145 BBC: Global Concerns. An update on environmental issues.

Saturdays

- 0105 BBC: Outlook. See M 1405.
- 0109 Deutsche Welle: European Journal. See M 0209.
- 0130 BBC: Short Story (except 4th: Seeing Stars). See S 0430.
- 0130 Radio Australia: Music/Information. See S 0330.
- 0134 Deutsche Welle: Through German Eyes. See S 1513.
- 0145 BBC: Jazz Now And Then. George Reid presents a weekly mix of new releases, old tracks, and interviews.

0200 UTC

[8:00 PM EDT/5:00 PM PDT]

FREQUENCIES

0200-0300	Australia	11720as	11880as	15160as	15240as	0200-0300	Moscow World Svc	17775va	17825va	17890va	21480va
		15320as	15365as	17630as	17750as			21690va	21790va		
		17795as	21525as	21740as	21775as	0200-0300	Namibia BC Corp, Windhoek	3290af			
0200-0300	Australia, ABC Brisbane	4920do	9660do			0200-0300	New Zealand, RNZI	17770pa			
0200-0300	Australia, ABC Perth	200	6070do	9610do		0200-0230 sm	Norway	11930na			
0200-0230	BBC London	5975na	6005sa	6175na	6195eu	0200-0300 twhfa	RCI Montreal	9535sa	9755sa	11845sa	11940sa
		7135as	7325na	9580as	9590na			13720sa			
		9670me	9915na	11750sa	11955as	0200-0300	RFPI, Costa Rica	7375na	15030na	21465na	
		12095va	15260sa	15280as	15360pa	0200-0300	Romania, R.Romania Int'l	5990am	6155am	9510am	9570am
		15380as	21715as					11830am	11940am		
0200-0300	Canada, CBC	9625do				0200-0300	SBC Radio 1, Singapore	5010do	5052do	11940do	
0200-0300	CFRX Toronto, Canada	6070do				0200-0300	SLBS, Sierra Leone	3316do			
0200-0300	CFVP Calgary, Canada	6030do				0200-0230	Sri Lanka B'casting Corp.	6005as	9720as	15425as	
0200-0300	CHNX Halifax, Canada	6130do				0200-0230	Sweden	9695na	11705na		
0200-0300	CKZU Vancouver, Canada	6160do				0200-0230	Swiss Radio Int'l	6135am	9650am	9885am	12035am
0200-0300	Cook Islands	11760pa						117730am			
0200-0300	CSMonitor World Svc, Bost	9350me	9455na	13760am	17555	0200-0300	Taiwan, V. of Free China,	5950na	9680na	9765pa	11740ca
0200-0300 sa	CSMonitor World Svc, Bost	17555as	17865as					11860as	15345as		
0200-0300	Cuba, RHC Havana	11950na	13700na			0200-0300	Thailand	4830as	9655as	11905as	
0200-0250	Deutsche Welle, Germany	6035as	7285as	9615as	9690as	0200-0230	VOA	5995am	7405am	9775am	11580am
		11945as	15560as					15120am	15205am		
		9475na	9675na					7205as	9740as	11705as	15250as
0200-0300	Egypt, Radio Cairo	9475na	9675na					17735as	21550as		
0200-0230	FEBC Manila, Philippines	15450as				0200-0300	WHRI Noblesville, Indiana	7315na	9495sa		
0200-0300	HCJB Quito, Ecuador	9745am	15155am	21455am		0200-0300	WINB Red Lion, Penn.	15145eu			
0200-0300	Hungary, Radio Budapest	6110na	9835na	11910na		0200-0300	WRNO New Orleans	7355am			
0200-0230 mtwhfa	Kenya, Voice of	4935do				0200-0300	WWCR Nashville	5935na	7435am		
0200-0300 as	KSDA Guam	13720as				0200-0300	WYFR Okeechobee, FL	6085am	9505am	15440am	
0200-0300	KTBN Salt Lake City	7510am				0230-0300	Albania, Radio Tirana	9760na	11825na		
0200-0300	KVOH Los Angeles	17775am				0230-0300	BBC London	5975na	6005sa	6175na	6195eu
0200-0300	Luxembourg, RTL	15350va						7135me	7325na	9670me	9915na
0200-0300 smtwh	Malaysia, RTM Radio 4	7295do						11750sa	11955me	12095va	15260sa
0200-0300	Moscow World Svc	4740do	4940do	4975do	6045am			15280as	15360pa	21715as	
		7115am	7135va	7150am	7160va	0230-0300 s	Kenya, Voice of	4935do			
		7240va	7255va	7275va	7310am	0230-0245	Pakistan	9515as	15115as	17640as	21730as
		7350va	9625va	9665va	9715va	0230-0300 twhfa	Portugal	9570am	9600am	9705am	11840am
		9725va	9765va	9880va			Radio Pilipinas, Manila	17760pa	17840pa	21580pa	
		9905va	11920va	12010va	12035va	0230-0300	Sri Lanka B'casting Corp.	9720as	15425as		
		12045va	12050va	13670va	13745va	0240-0300	Zambia, Radio 2, Lusaka	6165do	7235do		
		15295va	15350va	15420va	15425va	0245-0300	Korea, Radio Korea	9640am	11805am	15575am	
		15470va	17590va	17610va	17655va	0250-3000	Vatican Radio	6095na	7305na	9605na	
		17665va	7690va	17700va	17720va	0255-0300	TWR Bonaire	11930am			

SELECTED PROGRAMS

Sundays

- 0209 Deutsche Welle: Commentary. See S 0109.
 0213 Deutsche Welle: Sports Report. The latest news from the world of sports.
 0219 Deutsche Welle: Mailbag Asia. Musical requests and answers to listener questions.
 0230 BBC: Feature. This month, check out "I Remember It Well" (5th); "Titanic: The Unsinkable Legend" (12th); "The Resurrection And The Life" (19th); and "The Inexorable Spread Of Rhe African Bee" (26th).
 0230 Radio Australia: Fine Music Australia. The best in Australian classical music.

Mondays

- 0209 Deutsche Welle: European Journal. A review of major events in Europe, with interviews and analyses.
 0230 BBC: Composer Of The Month. Profiles of famous composers. This month: Henry Purcell.
 0230 Radio Australia: Music/Information. See S 0330.
 0234 Deutsche Welle: Science and Technology. New scientific and technological developments.

Tuesdays

- 0209 Deutsche Welle: European Journal. See M 0209.
 0230 BBC: Quiz. See M 1215.
 0230 Radio Australia: Music/Information. See S 0330.
 0234 Deutsche Welle: Man and Environment. A program on all topics relating to the environment in industrial and developing countries.

Wednesdays

- 0209 Deutsche Welle: European Journal. See M 0209.
 0230 BBC: Development '92. Aid and development issues for developing nations.
 0230 Radio Australia: Book Reading. See S 0030.
 0234 Deutsche Welle: Insight. See T 1534.

Thursdays

- 0209 Deutsche Welle: European Journal. See M 0209.
 0230 BBC: Sports International. Live play-by-play, interviews, features, and discussions from the sports world.
 0230 Radio Australia: Music/Information. See S 0330.
 0234 Deutsche Welle: Living in Germany. See M 0116.

Fridays

- 0209 Deutsche Welle: European Journal. See M 0209.
 0230 BBC: Drama. See H 1130.
 0230 Radio Australia: Music/Information. See S 0330.
 0234 Deutsche Welle: Spotlight on Sport. See W 1534.

Saturdays

- 0209 Deutsche Welle: Commentary. See S 0109.
 0223 Deutsche Welle: Panorama. A review of the major news events of the week.
 0230 BBC: People And Politics. The background to the British political scene.
 0230 Radio Australia: This Australia. See S 0430.
 0234 Deutsche Welle: Economic Notebook. See F 1534.

SUBSCRIBERS!!
 See the important note
 regarding your
 subscription on page 85!

0300 UTC

[9:00 PM EDT/6:00 PM PDT]

FREQUENCIES

0300-0400	Australia	11720as	11880as	15160as	15240as	12010va	12035va	12050va	13670va	13745va
		15320as	15365as	17630as	17750as	15280va	15295va	15350va	15420va	15425va
		17795as	21525as	21740as	21775as	15470va	15520va	17590va	17605va	17610va
0300-0400	Australia, ABC Brisbane	4920do	9660do			17655va	17675va	17690va	17700va	17720va
0300-0400	Australia, ABC Perth	9610do				17775va	17825va	17890va	21690va	21790va
0300-0400	Bahrain Broadcasting Svc	6010me								
0300-0330	BBC London	3255af	5075	5975na	6005af					
		6005sa	6175na	6180eu	6190af	0300-0400	New Zealand, RNZI	17770pa		
		7135me	7325na	9410eu	9630af	0300-0330	Radio Pilipinas, Manila	17760pa	17840pa	21580pa
		9915na	11730af	11760me	11955me	0300-0400	RFPI, Costa Rica	7375na	15030na	21465na
		15070af	6005sa	6175na	7325na	0300-0400	SBC Radio 1, Singapore	5010do	5052do	11940do
		11750sa	15260sa	15310as		0300-0400	SLBS, Sierra Leone	3316do		
0300-0400	Bulgaria, Radio Sofia	9595af	11720na	11765af		0300-0400	South Africa, Radio RSA	3215af	11900af	
0300-0305	Canada, CBC	9625do				0300-0400	Sri Lanka B'casting Corp.	9720as	15425as	
0300-0400	CFCX Montreal, Canada	6005do				0300-0400	Taiwan, V. of Free China,	5950na	9680na	
0300-0400	CFRX Toronto, Canada	6070do				0300-0400	Tanzania	5985af	9685af	11765af
0300-0400	CFVP Calgary, Canada	6030do				0300-0400	Thailand	4830as	9655as	11905as
0300-0400	China, Radio Beijing	9770am	9690am	11715am		0300-0400	TIFC Costa Rica	5055ca		
0300-0400	CHNX Halifax, Canada	6130do				0300-0400	Turkey, Voice of	9445na		
0300-0400	CKZU Vancouver, Canada	6160do				0300-0400	TWR Bonaire	9535am	11930am	
0300-0400	Cook Islands	11760pa				0300-0400	Vatican Radio	6095na	7305na	9605na
0300-0400	CSMonitor World Svc, Bost	9350me	9455na	13760am		0300-0330	VOA	5965eu	11905me	15160me
0300-0400 sa	CSMonitor World Svc, Bost	17555as	17865as					17895me		
0300-0400	Cuba, RHC Havana	11950am	13700na					5135af	6035af	7265af
0300-0330	Czechoslovakia	5930na	7345na	9540na				9575af	11835af	11940
0300-0350	Deutsche Welle, Germany	6045na	6055na	6085na	6120na	0300-0400	WHRl Noblesville, Indiana	17715af	21600af	7405af
		9535na	9545na	9640na	9705na	0300-0400	WRNO New Orleans	7315na	9495sa	15115af
		9770na				0300-0400	WWCR Nashville	7355am		
0300-0330	Egypt, Radio Cairo	9475na	9675na			0300-0400	WYFR Okeechobee, FL	5935na	7435na	
0300-0400	Guatemala, Radio Cultural	3300do				0305-0400 as	Canada, CBC	6065am	9505am	
0300-0400	HCJB Quito, Ecuador	9745am	15155am	21455am		0330-0400	Albania, Radio Tirana	9625do		
0300-0400	Honduras, HRPC Luz y Vida	3250ca				0330-0400	Austria, ORF Vienna	9760na	11825na	
0300-0330	Japan NHK	15325am	17825am	21610am		0330-0400	BBC London	9870ca	13730am	
0300-0400	Kenya, Voice of	4935do						3255af	5975na	6005af
0300-0400	KTBN Salt Lake City	7510am						6180eu	6190af	6195eu
0300-0400	Luxembourg, RTL	15350va						9600af	9915na	11740af
0300-0400 smtwh	Malaysia, RTM Radio 4	7295do						11955me	12095eu	15280as
0300-0400	Moscow World Svc	4740do	4940do	4975do	6000am			15420af	17885af	21715as
		6045do	7135va	7150am	7160va	0330-0400	Japan NHK	5960na	11870na	17810na
		7270va	7310am	7350va	9450va	0330-0400	Netherlands	9590na	11720na	
		9715va	9725va	9750va	9765va	0330-0400	Sweden	9695sa	11705sa	
		9895va	9905va	11765va	11920va	0330-0400	UAE Radio, Dubai	11945na	13675na	15400na
						0340-0350 mtwhfa	Greece, Voice of	9395na	9420na	11645na
						0340-0350 twhtfas	Venezuela, Radio Nacional	9540om		
						0350-0400	Armenia, Radio Yerevan	7400na	15180na	17605na
									17690na	

Sundays

- 0309 BBC: Words Of Faith. Speakers from various faiths discuss scripture and their beliefs.
- 0309 Deutsche Welle: Commentary. See S 0109.
- 0313 Radio Australia: Back Page. Brendon Telfer looks at sports in the Asian/Pacific region.
- 0315 BBC: Sports Roundup. News from the world of sports.
- 0317 Deutsche Welle: Feature. See S 0117.
- 0330 BBC: From Our Own Correspondent. Reporters comment on the background to the news.
- 0330 Radio Australia: Music/Information. Overnight music, interspersed with news.
- 0334 Deutsche Welle: German By Radio. See S 0134.
- 0340 Radio Netherlands: Newsline. See S 0040.
- 0350 BBC: Write On... Listener letters, opinions, and questions.
- 0354 Radio Netherlands: Rembrandt Express. See S 0054.

Mondays

- 0309 BBC: Words Of Faith. See S 0309.
- 0309 Deutsche Welle: Commentary. See S 0109.
- 0313 Radio Australia: Sports Report. See S 1313.
- 0315 BBC: Sports Roundup. See S 0315.
- 0316 Deutsche Welle: Living in Germany. See M 0116.
- 0330 BBC: Anything Goes. See S 1430.
- 0330 Radio Australia: Music/Information. See S 0330.
- 0330 Radio Netherlands: Happy Station. See S 1130.
- 0334 Deutsche Welle: Larry's Random Selection. See M 0134.

Tuesdays

- 0309 BBC: Words Of Faith. See S 0309.

- 0309 Deutsche Welle: European Journal. See M 0209.
- 0313 Radio Australia: Sports Report. See S 1313.
- 0315 BBC: Sports Roundup. See S 0315.
- 0330 BBC: John Peel. Newly released albums and singles from the contemporary music scene.
- 0330 Radio Australia: Music/Information. See S 0330.
- 0334 Deutsche Welle: Transatlantic Diary. See T 0134.
- 0340 Radio Netherlands: Newsline. See S 0040.
- 0354 Radio Netherlands: The Research File. See M 1154.

Wednesdays

- 0309 BBC: Words Of Faith. See S 0309.
- 0309 Deutsche Welle: European Journal. See M 0209.
- 0313 Radio Australia: Sports Report. See S 1313.
- 0315 BBC: Sports Roundup. See S 0315.
- 0330 BBC: Discovery. An in-depth look at scientific research.
- 0330 Radio Australia: Music/Information. See S 0330.
- 0334 Deutsche Welle: Transatlantic Diary. See T 0134.
- 0340 Radio Netherlands: Newsline. See S 0040.
- 0354 Radio Netherlands: Mirror Images. See T 1154.

Thursdays

- 0309 BBC: Words Of Faith. See S 0309.
- 0309 Deutsche Welle: European Journal. See M 0209.
- 0313 Radio Australia: Sports Report. See S 1313.
- 0315 BBC: Sports Roundup. See S 0315.
- 0330 BBC: Assignment. A weekly examination of topical issues, from Batman to the Amazon.
- 0330 Radio Australia: Music/Information. See S 0330.

- 0334 Deutsche Welle: Transatlantic Diary. See T 0134.
- 0340 Radio Netherlands: Newsline. See S 0040.
- 0354 Radio Netherlands: Feature. See W 1154.

Fridays

- 0309 BBC: Words Of Faith. See S 0309.
- 0309 Deutsche Welle: European Journal. See M 0209.
- 0313 Radio Australia: Sports Report. See S 1313.
- 0315 BBC: Sports Roundup. See S 0315.
- 0330 BBC: Focus On Faith. Comment and discussion on major issues in various religions.
- 0330 Radio Australia: Music/Information. See S 0330.
- 0334 Deutsche Welle: Transatlantic Diary. See T 0134.
- 0334 Deutsche Welle: Transatlantic Diary. See T 0134.
- 0340 Radio Netherlands: Newsline. See S 0040.
- 0354 Radio Netherlands: Media Network. See H 1154.

Saturdays

- 0309 BBC: Words Of Faith. See S 0309.
- 0309 Deutsche Welle: European Journal. See M 0209.
- 0313 Radio Australia: Music/Information. See S 0330.
- 0315 BBC: Sports Roundup. See S 0315.
- 0330 BBC: The Vintage Chart Show. Paul Burnett with past Top 20 pop music hits. This month: 1968, 1975, 1988, and 1956.
- 0330 Radio Australia: Women In Politics. Women politicians.
- 0334 Deutsche Welle: Through German Eyes. See S 1513.
- 0340 Radio Netherlands: Newsline. See S 0040.
- 0354 Radio Netherlands: Feature. See F 1154.

0400 UTC

[10:00 PM EDT/7:00 PM PDT]

FREQUENCIES

0400-0500	Australia	11720as	11880as	15160as	15170as	0400-0500	Moscow World Svc - WC NAM	7270am	9505am	9895am
		15240as	15320as	15365as	17795as		9905am	12010am	12050am	15180am
		21525as	21740as	21775as			17720am			
0400-0500	Australia, ABC Brisbane	4920do	9660do			0400-0450	N. Korea, Radio Pyongyang	15180as	15230as	17765as
0400-0500	Australia, ABC Perth	9610do				0400-0500 mtwhf	Namibia BC Corp, Windhoek	3270af	3290af	
0400-0500	Bahrain Broadcasting Svc	6010me				0400-0425	Netherlands	9590am	11720am	
0400-0430	BBC London	3255af	3955eu	5975na	6180eu	0400-0500	New Zealand, RNZI	17770pa		
		6195eu	7105af	7230eu	7325na	0400-0430 sm	Norway	9560na	11865na	
		9610af	9915na	11760me	15070va	0400-0430	RCI Montreal	6150eu	9505eu	9670me
		15420af	15590eu	17885af	6005af	0400-0500	RFPI, Costa Rica	7375na	15030na	21465na
		11955me	12095va	21715as	6175am	0400-0430	Romania, R. Romania Int'l	5990am	6155am	9510am
0400-0500	Bulgaria, Radio Sofia	9595af	11720na	11765af				11830am	11940am	
0400-0500	Canada, CBC	9625do				0400-0500	SBC Radio 1, Singapore	5010do	5052do	11940do
0400-0500	CFCX Montreal, Canada	6005do				0400-0500	SLBS, Sierra Leone	3316do		
0400-0500	CFRX Toronto, Canada	6070do				0400-0500	South Africa, Radio RSA,	7270af	11900af	15230af
0400-0500	CFVP Calgary, Canada	6030do				0400-0430	Sri Lanka B'casting Corp.	9720as	15425as	
0400-0500	China, Radio Beijing	11695am				0400-0430	Swiss Radio Int'l	6135am	9885am	12035am
0400-0500	CHNX Halifax, Canada	6130do				0400-0430	Tanzania	5985af	9685af	11765af
0400-0500	CKZU Vancouver, Canada	6160do				0400-0430	Thailand	4830as	9655as	11905as
0400-0500	Cook Islands	11760pa				0400-0430	TWR Bonaire	9535am	11930am	
0400-0500 vl	Croatian Radio via WHRI	7315na	9495eu			0400-0430	VOA	5995eu	6040me	6140me
0400-0500	CSMonitor World Svc, Bost	9445am	9840af	13760na	17780as			7200eu	9715eu	6035af
0400-0500 sa	CSMonitor World Svc, Bost	17555as						9575af	11780af	11835af
0400-0430	Cuba, RHC Havana	6180am	11760am	11950na	13700am	0400-0500	WHRI Noblesville, Indiana	7315na	9495sa	
0400-0427	Czechoslovakia	5930na	7345na	9540na		0400-0500 mwf	WHRI Radio Free Croatia	7315na	9495na	
0400-0450	Deutsche Welle, Germany	6065af	6130af	7150af	7225af	0400-0500 smtwhf	WMLK Bethel, Penna.	9465eu		
		7275af	9565af	9665af	9765af	0400-0500 irreg	WRNO New Orleans	7355am		
		11765af	13770af			0400-0500	WWCR Nashville	5935na	7435na	
0400-0430	Guatemala, Radio Cultural	3300do				0400-0500	WYFR Okeechobee, FL	6065am	9505am	
0400-0430	HCJB Quito, Ecuador	9745am	15155am	21455am		0400-0500	Zambia, Radio 2, Lusaka	6165do	7235do	
0400-0500	Kenya, Voice of	4935do				0425-0440	Italy, RAI, Rome	5990me	7275me	
0400-0500	KTBN Salt Lake City	7510am				0430-0500	BBC London	3255af	3955eu	5975na
0400-0500	KVOH Los Angeles	9785am					6180eu	6190af	6195eu	7230eu
0400-0500	Luxembourg, RTL	15350va					11760me	12095va	15070va	15280as
0400-0500 smtwh	Malaysia, RTM Radio 4	7295do					15420af	15590eu	21470af	21715as
0400-0500	Moscow World Svc	4740do	4975do	6175va	7130va	0430-0500	Cuba, RHC Havana	6180na	11760na	11950na
		7135va	7150am	7160va	7240va	0430-0500	Nigeria	3326do	4770do	
		9450va	9535va	9625va	9750va	0430-0500	TWR Swaziland	5055af	5965af	9655af
		9880va	11765va	11975va	12035va	0430-0500	VOA	5995me	6040me	6140me
		13745va	15295va	15350va	15375va			7200me	7265me	9715me
		15470va	15520va	15520va	15530va			6035af	7405af	9575af
		17610va	17635va	17655va	17675va			17715af	21600af	
		17775va	17825va	17890va	21565va	0430-0500 s	Zambia, Radio Zambia Int'l	9505af	11880af	17895af
		21790va	21845va	21680va	21690va	0445-0500	Sri Lanka B'casting Svc	9720am	15425am	
						0455-0600	Nigeria, Voice of	7255af		

SELECTED PROGRAMS

Sundays

- 0409 Deutsche Welle: Commentary. See S 0109.
 0413 Deutsche Welle: Sports Report. See S 0213.
 0415 BBC: Feature. Take an alphabetical odyssey on "An A-Z Of Rock 'N' Pop" (through July 5th).
 0419 Deutsche Welle: International Talking Point. A round-table discussion on major trends and events.
 0430 BBC: Short Story. Half-hour dramatic selections, as written by listeners (except 5th: Seeing Stars, a monthly look at astronomy).
 0430 Radio Australia: This Australia. Documentaries about the land "down under."
 0434 Deutsche Welle: People and Places. Interviews, stories, and music beamed to Africa.
 0445 BBC: Talks. This month, hear women on "Sugar And Spice" (5th/12th) and men on "Men Facing Change" (through May 24th)!

Mondays

- 0409 Deutsche Welle: European Journal. See M 0209.
 0415 BBC: Feature. Religion is the rule this month, with "Lent Observed" (6th/13th) and "People From The Holy Land" (through May 18th).
 0430 BBC: Off The Shelf. This month's serialized readings: "The Wayfarer's Staff" (6th-10th);

"Conversations With An Angel" (13th-17th); and William Golding's "Lord Of The Flies" (through May 8th).
 0430 Radio Australia: Matters Of Faith. Dallas Adair examines the doctrines and beliefs of Asian/Pacific faiths.

- 0434 Deutsche Welle: Africa in the German Press. A look at what German papers and weeklies have to say about Africa.
 0445 BBC: And Y Kershaw's World Of Music. Exotic music from the world over.

Tuesdays

- 0409 Deutsche Welle: European Journal. See M 0209.
 0415 BBC: Health Matters. See T 0145.
 0430 BBC: Off The Shelf. See M 0430.
 0430 Radio Australia: World Of Country Music. A look at country music from all around the world.
 0434 Deutsche Welle: Africa Report. Reports and background to the news from correspondents.
 0445 BBC: Talks. See M 2315.

Wednesdays

- 0409 Deutsche Welle: European Journal. See M 0209.
 0415 BBC: Waveguide. Tips on how to hear the BBC better.
 0425 BBC: Book Choice. A short review of a recently released book.
 0430 BBC: Off The Shelf. See M 0430.
 0430 Radio Australia: Music Of Radio Australia. See S 1113.

- 0434 Deutsche Welle: Africa Report. See T 0434.
 0445 BBC: Country Style. See W 0145.

Thursdays

- 0409 Deutsche Welle: European Journal. See M 0209.
 0415 BBC: The Farming World. See H 0145.
 0430 BBC: Off The Shelf. See M 0430.
 0430 Radio Australia: Music Of Radio Australia. See S 1113.
 0434 Deutsche Welle: Africa Report. See T 0434.
 0445 BBC: From Our Own Correspondent. See S 0330.

Fridays

- 0409 Deutsche Welle: European Journal. See M 0209.
 0415 BBC: Feature. See M 0145.
 0430 BBC: Off The Shelf. See M 0430.
 0430 Radio Australia: Communicator. See S 1430.
 0434 Deutsche Welle: Africa Report. See T 0434.
 0445 BBC: Folk In Britain. See T 0130.

Saturdays

- 0409 Deutsche Welle: Commentary. See S 0109.
 0415 BBC: Good Books. See W 1445.
 0423 Deutsche Welle: Panorama. See A 0223.
 0430 BBC: Jazz Now And Then. See A 0145.
 0430 Radio Australia: Business Horizons. See T 1130.
 0434 Deutsche Welle: Man and Environment. See T 0234.
 0445 BBC: Worldbrief. See F 2315.

0500 UTC

[11:00 PM EDT/8:00 PM PDT]

FREQUENCIES

0500-0600	Australia	11720as	11880as	15160as	15240as							17635va	17655va	17665va	17675va
		15320as	15365as	17750as	17795as							17690va	17700va	17775va	17825va
		17880as	21525as	21740as	21775as							17890va	21680va	21690va	21790va
0500-0600	Australia, ABC Brisbane	4920do	9660do									21845va			
0500-0600	Australia, ABC Perth	9610do													
0500-0600	Bahrain Broadcasting Svc	6010me													
0500-0530	BBC London	3255af	3955eu	6005af	6180as										
		6190af	6195eu	7120eu	9410eu										
		9600af	9640na	11760me	12095va										
		15070as	15310as	15400af	15420af										
		15590va	17885af	21470af	21715as										
		5975na	15280as	15575as											
0500-0515	Bulgaria, Radio Sofia	9595af	11720na	11765af											
0500-0530	Cameroon CRTV Beau	3970do													
0500-0505	Canada, CBC	9625do													
0500-0600	CFCX Montreal, Canada	6005do													
0500-0600	CFRX Toronto, Canada	6070do													
0500-0600	CFVP Calgary, Canada	6030do													
0500-0600	China, Radio Beijing	11840am													
0500-0600	CHNX Halifax, Canada	6130do													
0500-0600	CKZU Vancouver, Canada	6160do													
0500-0600	Cook Islands	11760pa													
0500-0600	CSMonitor World Svc, Bost	9455na	9840af	13760na	17780as										
0500-0600 sa	CSMonitor World Svc, Bost	17555as													
0500-0550	Deutsche Welle, Germany	5960na	6045na	6120na	6130na										
		9535na	9670na	9690na											
0500-0600 sa	Eq. Guinea, R. East Africa	9585af													
0500-0530 tent	Georgian Radio, Tbilisi	11803va													
0500-0600	HCJB Quito, Ecuador	11925am	21455am												
0500-0600	Japan NHK	11870na	15195na	17765na	17810na										
		17825na	17890na	21610na											
0500-0600	Kenya, Voice of	4935do													
0500-0515	Kol Israel	11588am													
0500-0600	KTBN Salt Lake City	7510am													
0500-0600	KVOH Los Angeles	9785am													
0500-0510	Lesotho, Maseru	4800do													
0500-0600	Luxembourg, RTL	15350va													
0500-0510 w	Malawi B'casting Corp.	3381do													
0500-0600	Malaysia, RTM Radio 4	7295do													
0500-0600	Moscow World Svc	4740do	4975do	6175va	7130va										
		7135va	7150am	7160va	7240va										
		7310am	9450va	9530va	9535va										
		9750va	9765va	11765va	11880va										
		11975va	12035va	12055va	13670va										
		13745va	15280va	15295va	15350va										
		15375va	15400va	15420va	15465va										
		15470va	15520va	15530va	15545va										
		15550va	15595va	17590va	17610va										
0500-0600	Moscow World Svc - WC NAM														
		9795am	9825am	9895am	9905am										
		12010am	12050am	15180am	17720am										
0500-0600 mtwhf	Namibia BC Corp, Windhoek	3270af													
0500-0600	New Zealand, RNZI	17770pa													
0500-0600	Nigeria	3326do	4770do	4990do	7255af										
0500-0600	RFPI, Costa Rica	7375na	15030na	21465na											
0500-0600	SBC Radio 1, Singapore	5052do													
0500-0600	SLBS, Sierra Leone	3316do													
0500-0600	Spanish National Radio	9530na													
0500-0515	Sri Lanka B' Casting Svc	9720am	15425am												
0500-0600	Thailand	4830as	9655as	11905as											
0500-0530	TWR Swaziland	5965af	9655af	11750af											
0500-0530	Vatican Radio	9695af	11625af	15090af	17730af										
0500-0600	VOA	6035af	7405af	9575af	15115af										
		17715af	5995eu	6040me	6060eu										
		6140me	6873eu	7170me	7200me										
		9670me	9700eu	9715me	11815me										
		11825me	15205me												
0500-0600	WHRI Noblesville, Indiana	7315na	9495sa												
0500-0600	WINB Red Lion, Penn.	15145eu													
0500-0600 mtwhfa	WMLK Bethel, Pennsylvania	9465eu													
0500-0600	WWCR Nashville	5935na	7435na												
0500-0600	WYFR Okeechobee, FL	5985am	9850eu	11915eu	13695af										
0500-0600	Zambia, Radio 2, Lusaka	6165do	7235do												
0500-0600 s	Zambia, Radio Zambia Int'l	9505af	11880af	17895af											
0510-0515 w, vl	Botswana, Gaborone	5955af	7255af												
0510-0600 vl	South Africa, Radio Oranje	9630do													
0524-0600 f	Ghana, Radio 2, Accra	3366do													
0526-0600	Ghana, Radio 1, Accra	4915do													
0530-0600	Austria, ORF Vienna	6015na	6155eu	13730eu	21490me										
0530-0600	BBC London	3255af	3955eu	5975na	6005af										
		6180as	6190af	6195eu	7120eu										
		9410eu	9600af	9640na	11760me										
		12095va	15070as	15280as	15310as										
		15400af	15420af	15575af	21470af										
		21470af	21715as												
0530-0600	Cameroon CRTV Yaounde	4850do													
0530-0600	Romania, R. Romania Int'l	11840af	15380af	17720af	17745af										
		17790af	21665af												
0530-0600	TWR Swaziland	5965af	11750af												
0530-0600	UAE Radio, Dubai	15435as	17830as	21700as											
0545-0600	Cameroon CRTV Buea	3970do													

SELECTED PROGRAMS

Sundays

- 0509 Deutsche Welle: Commentary. See S 0109.
 0513 Radio Australia: Back Page. See S 0313.
 0517 Deutsche Welle: Feature. See S 0117.
 0530 Radio Australia: Interaction. Patti Orofino explores the experiences of multicultural Australia.
 0534 Deutsche Welle: German By Radio. See S 0134.

Mondays

- 0509 Deutsche Welle: Commentary. See S 0109.
 0513 Radio Australia: Music Of Radio Australia. See S 1113.
 0516 Deutsche Welle: Living in Germany. See M 0116.
 0530 Radio Australia: Music/Information. See S 0330.
 0534 Deutsche Welle: Larry's Random Selection. See M 0134.

Tuesdays

- 0509 Deutsche Welle: European Journal. See M 0209.
 0513 Radio Australia: Music Of Radio Australia. See S 1113.
 0530 Radio Australia: Points Of Law. See M 1530.
 0534 Deutsche Welle: Transatlantic Diary. See T 0134.

Wednesdays

- 0509 Deutsche Welle: European Journal. See M 0209.
 0513 Radio Australia: Music Of Radio Australia. See S 1113.
 0530 Radio Australia: Connections. See S 1530.
 0534 Deutsche Welle: Transatlantic Diary. See T 0134.

Thursdays

- 0509 Deutsche Welle: European Journal. See M 0209.
 0513 Radio Australia: Music Of Radio Australia. See S 1113.
 0530 Radio Australia: AgriNews. See T 1530.

- 0534 Deutsche Welle: Transatlantic Diary. See T 0134.

Fridays

- 0509 Deutsche Welle: European Journal. See M 0209.
 0513 Radio Australia: Music Of Radio Australia. See S 1113.
 0530 Radio Australia: Lane's Company. See T 1430.

Saturdays

- 0509 Deutsche Welle: European Journal. See M 0209.
 0513 Radio Australia: Music Of Radio Australia. See S 1113.
 0530 Radio Australia: Arts Roundabout. The arts in Australia, past and present.
 0534 Deutsche Welle: Through German Eyes. See S 1513.

0600 UTC

[12:00 AM EDT/9:00 PM PDT]

FREQUENCIES

0600-0700	Australia	11720as	11860as	15160as	15240as
		15320as	15365as	17750as	17795as
		17880as	21525as	21740as	21775as
0600-0700	Bahrain Broadcasting Svc	6010me			
0600-0630	BBC London	3955eu	6180eu	6190af	6195eu
		7230eu	9600af	11760me	11940af
	9410eu	9600af	11760me	11940af	11955as
	12095eu	15070va	15310as	15400af	15420af
	17790as	17830as	17885af	21470af	5975na
	9640va	15280as	15360pa	15575as	21715as
0600-0645 s	Cameroon CRTV Douala	4795do			
0600-0625	Cameroon CRTV Yaounde	4850do			
0600-0700	CFCX Montreal, Canada	6005do			
0600-0700	CFRX Toronto, Canada	6070do			
0600-0700	CFVP Calgary, Canada	6030do			
0600-0700	CHNX Halifax, Canada	6130do			
0600-0700	CKZU Vancouver, Canada	6160do			
0600-0700	Cook Islands	11760pa			
0600-0700	CSMonitor World Svc, Bost	9455na	9840eu	9870am	17555as
		17780as			
0600-0700	Cuba, RHC Havana	11760am			
0600-0650	Deutsche Welle, Germany	11765af	13610af	13790af	15185af
		15435af	17875af		
0600-0700 tent	ELBC Monrovia, Liberia	7275do			
0600-0700 sa	Eq.Guinea, R.East Africa	9585af			
0600-0700	Ghana, Radio 1, Accra	4915do			
0600-0700 f	Ghana, Radio 2, Accra	3366do			
0600-0700	HCJB Quito, Ecuador	11925am	21455am		
0600-0625	Kenya, Voice of	4935do			
0600-0700	King of Hope, Lebanon	6280me			
0600-0700	Korea, Radio Korea	7275om	11810na	15170na	
0600-0700	KTBN Salt Lake City	7510na			
0600-0700	KVOH Los Angeles	9785na			
0600-0630	Laos, National Radio of	7116as			
0600-0630 s	Latvia, Radio Riga	5935eu			
0600-0640 last a	Lithuania, RadioCentras	9710eu			
0600-0700	Luxembourg, RTL	15350va			
0600-0610 s	Malawi B'casting Corp.	3381do			
0600-0700 smtwha	Malaysia, RTM Radio 4	7295do			
0600-0700	Malaysia, Voice of	6175as	9750as	15295as	
0600-0700	Malta, V. of the Medit.	9765eu			
0600-0700	Moscow World Svc	4740do	4975do	6175va	7130va
		7135va	7150am	7160va	7310va
		9535va	9750va	9765va	9855va
		11880va	11975va	12035va	12055va
		15280va	15295va	15350va	15375va
		15465va	15470va	15520va	15530va
		15560va	15595va	17570va	17590va
		17635va	17655va	17665va	17680va
					17690va
					17700va
17775va					
21785va					
0600-0700	Moscow World Svc - WC NAM				
		7270am	7345am	9505am	7175am
		9825am	9905am	9905am	9795am
		15180as	15230as		
0600-0650	N.Korea, Radio Pyongyang	15180as			
0600-0700	New Zealand, RNZI	17770pa			
0600-0700	Nigeria	3326do	4990do	7255af	
0600-0700	RFPI, Costa Rica	7375na	15030na	21465na	
0600-0700	SBC Radio 1, Singapore	5010do	5052do	11940do	
0600-0700	SLBS, Sierra Leone	3316do			
0600-0700 vl	South Africa, Radio Oranje	9630do			
0600-0630	Swiss Radio Int'l	15430af	17565af	21770af	
0600-0700 sa	Thailand	4830as	9655as	11905as	
0600-0700	TWR Swaziland	5965af	7200af	11750af	
0600-0630	Vatican Radio	6245eu	7250eu		
0600-0700	VOA	6035af	6125af	7405af	9530af
		9575af	15115af	17715af	
		3980eu	5995eu	6040eu	6060me
		6110eu	6140eu	6873eu	7170me
		7325me	11805me	11815me	11825me
		11915me	15205me		
0600-0700	WHRI Noblesville, Indiana	7315eu	9495sa		
0600-0700 smtwhf	WMLK Bethel, Penna.	9465eu			
0600-0700	WWCR Nashville	5935na	7435na		
0600-0700	WYFR Okeechobee, FL	5985am	7355eu	9680eu	13695af
0600-0700	Zambia, Radio 2, Lusaka	6165do	7235do		
0600-0630 s	Zambia, Radio Zambia Int'l	9505af	11880af	17895af	
0600-0700 s	ZLXA New Zealand	3935do			
0603-0610	Croatian Radio, Zagreb	7240eu	9830eu		
0615-0630 s	Cameroon CRTV Bertoua	4750do			
0615-0630	Korea World News	7550eu	15575me		
0615-0700 mtwhf	RCI Montreal	6050eu	6150eu	7155eu	9740eu
		9760me	11905me		
0625-0700	Kenya, Voice of	4935do			
0630-0700	Austria, ORF Vienna	6015na			
0630-0700	BBC London	5975na	6180eu	6190af	6195eu
		7230eu	9410eu	9600af	9640pa
		11955as	12095eu	15070va	15310as
		15590va	17830as	17885af	21470af
		15360pa	17790as	21715as	15280as
0630-0655	BRT Brussels, Belgium	5910au	11695eu	13675eu	
0630-0645	Finland	6120eu	9560af	11755eu	
0630-0635 mtwhf	RTV Congolaise	7105do	9610do		
0630-0700	Vatican Radio	11625af	15090af	17730af	
0630-0700 smtwhf	ZLXA New Zealand	3935do			
0645-0700	Ghana B'casting Corp.	6130af			
0645-0700	Romania, R.Romania int'l	11840au	15335au	15380au	17720au
		17805au	21665au		

SELECTED PROGRAMS

Sundays

0609 Deutsche Welle: Commentary. See S 0109.
 0613 Deutsche Welle: Sports Report. See S 0213.
 0615 BBC: Letter From America. Alistair Cooke presents his unique reflections on the USA.
 0619 Deutsche Welle: International Talking Point. See S 0419.
 0630 BBC: Jazz For The Asking. Digby Fairweather plays listener requests.
 0630 Radio Australia: Fine Music Australia. See S 0230.
 0634 Deutsche Welle: People and Places. See S 0434.

Mondays

0609 Deutsche Welle: European Journal. See M 0209.
 0615 BBC: Recording Of The Week. A personal choice from the new classical music releases.
 0630 BBC: Feature. See S 1401.
 0630 Radio Australia: This Australia. See S 0430.
 0634 Deutsche Welle: Africa in the German Press. See M 0434.

Tuesdays

0609 Deutsche Welle: European Journal. See M 0209.

0615 BBC: The World Today. See M 1645.
 0630 BBC: Rock/Pop Music. After "Politics And Pop" (7th), hear "Guitar Legends In Seville" (through May 12th).
 0630 Radio Australia: Music Of Radio Australia. See S 1113.
 0634 Deutsche Welle: Africa Report. See T 0434.

Wednesdays

0609 Deutsche Welle: European Journal. See M 0209.
 0615 BBC: The World Today. See M 1645.
 0630 BBC: Meridian. Events in the world of the arts.
 0630 Radio Australia: Pacific Women. Conversations with Pacific women about their lives and concerns.
 0634 Deutsche Welle: Africa Report. See T 0434.

Thursdays

0609 Deutsche Welle: European Journal. See M 0209.
 0615 BBC: The World Today. See M 1645.
 0630 BBC: Sports International. See H 0230.

0630 Radio Australia: At Your Request. See S 0130.
 0634 Deutsche Welle: Africa Report. See T 0434.

Fridays

0609 Deutsche Welle: European Journal. See M 0209.
 0615 BBC: The World Today. See M 1645.
 0630 BBC: Meridian. See W 0630.
 0630 Radio Australia: Music Of Radio Australia. See S 1113.
 0634 Deutsche Welle: Africa Report. See T 0434.

Saturdays

0609 Deutsche Welle: Commentary. See S 0109.
 0615 BBC: The World Today. See M 1645.
 0623 Deutsche Welle: Panorama. See A 0223.
 0630 BBC: Meridian. See W 0630.
 0630 Radio Australia: Just Out. See M 0030.
 0634 Deutsche Welle: Man and Environment. See T 0234.

0700 UTC**1:00 AM EDT/10:00 PM PDT]**

0700-0800	Australia	11720as 21525as	11880as 21740as	15240as 21775as	15320as
0700-0710	Bafoussam, Cameroon	4000do			
0700-0800	Bahrain Broadcasting Svc	6010me			
0700-0730	BBC London	1780as	5975na	7150pa	9640va
	11955as	15280as	15360pa	21715as	6180eu
	6195eu	7230eu	7325af	9410eu	9760eu
	11940af	12095eu	15070eu	15310as	15400af
	15575as	17640va	17790as	17885af	21470af
0700-0800	CFCX Montreal, Canada	6005do			
0700-0800	CFRX Toronto, Canada	6070do			
0700-0800	CFVP Calgary, Canada	6030do			
0700-0800	CHNX Halifax, Canada	6130do			
0700-0800	CKZU Vancouver, Canada	6160do			
0700-0800	Cook Islands	11760pa			
0700-0800	CSMonitor World Svc, Bost	9445na 17780as	9840eu	9870am	17555as
0700-0800	Cuba, RHC Havana	11760am			
0700-0800 tent	ELBC Monrovia, Liberia	7275do			
0700-0800 sa	Eq.Guinea, R.East Africa	9585af			
0700-0800	Ghana B'casting Corp.	6130af			
0700-0800	Ghana, Radio 1, Accra	4915do			
0700-0800 f	Ghana, Radio 2, Accra	3366do			
0700-0730	HCJB Quito, Ecuador	9585eu	11730eu	21455eu	
0700-0800	Japan NHK	15250me	17765eu	17810as	17890as
	21525as				
0700-0800	Kenya, Voice of	4935do			
0700-0800	King of Hope, Lebanon	6280me			
0700-0800	KTBN Salt Lake City	7510na			
0700-0800	KVOH Los Angeles	9785na			
0700-0800	Luxembourg, RTL	15350va			
0700-0710 w	Malawi B'casting Corp.	3381do	5995do		
0700-0800 smtwha	Malaysia, RTM Radio 4	7295do			
0700-0800	Malaysia, Voice of	6175as	9750as	15295as	
0700-0800	Moscow World Svc	4740do	4950do	4975do	5960do
	7130do	7160do	7310am	9535va	9855va
	11765va	11880va	11975va	12010va	12055va
	15295va	15345va	15350va	15420va	15455va
	15465va	15470va	15500va	15520va	15530va
	15550va	15560va	17570va	17590va	17610va
	17635va	17655va	17665va	17700va	17710va
	17720va	17765va	17775va	17790va	17810va
	17890va	21680va	21690va	21725va	21785va
	21845va				
0700-0800	Moscow World Svc - WC Nam	7270am	7345am	9505am	9635am
		9795am	9825am	9905am	
0700-0750	N.Korea, Radio Pyongyang	15340as	17765as		
0700-0800	New Zealand, RNZI	17770pa			
0700-0800	Nigeria	3326do	4990do		
0700-0800	RFPI, Costa Rica	7375na	15030na	21465na	
0700-0715	Romania, R.Romania Int'l	11840au	15335au	15380au	17720au
		17805au	21665au		
0700-0800	SBC Radio 1, Singapore	5010do	5052do	11940do	
0700-0800	SLBS, Sierra Leone	3316do			
0700-0800 vl	South Africa, Radio Oranje	9630do			
0700-0800	Taiwan, V. of Free China,	5950na			
0700-0800 sa	Thailand	4830as	9655as	11905as	
0700-0800	TWR Monte Carlo	9480na			
0700-0800	TWR Swaziland	7200af	11750af		
0700-0800	WHRI Noblesville, Indiana	7315eu	9495sa		
0700-0800 smtwhf	WMLK Bethel, Penna.	9465eu			
0700-0800	WWCR Nashville	5935am	7435am		
0700-0800	WYFR Okeechobee, FL	9850af	11915af	13695eu	
0700-0800	Zambia, Radio 2, Lusaka	6165do	7235do		
0700-0800 smtwhf	ZXLA New Zealand	3935do			
0705-0800 a	Cameroon CRTV Douala	4795do			
0730-0800	BBC London	6180eu	6190af	7325eu	9410eu
	9600af	9760eu	11760me	11860af	11940af
	15070eu	15105af	15400af	15420af	15590af
	17830as	17885af	21470af	21660af	7150pa
	11955as	15280as	15310as	15360pa	17790as
0730-0800	Czechoslovakia	17725pa	21705as		
0730-0800	HCJB Quito, Ecuador	9585eu	9745au	11730eu	11925au
		21455va			
0730-0745 mtwhf	Icelandic National Radio	3295om	6100om	9265om	
0730-0800	Netherlands	9630au	11895au		
0730-0745 mtwhfa	Vatican Radio	6245do	7250do	9645na	15210na
0740-0800	TWR Monte Carlo	9480eu			

0800 UTC**[2:00 AM EDT/11:00 PM PDT]**

0800-0830	Australia	9580pa 17750as	15160as 21775as	15240as	17630as
0800-0900	Australia, ABC Brisbane	9660do			
0800-0900	Australia, ABC Perth	5425va			
0800-0810	Bafoussam, Cameroon	4000do			
0800-0900	Bahrain Broadcasting Svc	6010me			
0800-0830	Bangladesh, V. of Islam	15195as	17815as		
0800-0830	BBC London	6180eu	6190af	7325eu	9410eu
	9600af	9760eu	11760me	11860af	12095eu
	15310as	15360pa	15400af	15420af	15590me
	17830as	17885af	21470af	21660af	7150pa
	9660eu	11950af	11955as	15105af	15280as
	21715as				
0800-0900 a	Cameroon CRTV Douala	4795do			
0800-0900	CFCX Montreal, Canada	6005do			
0800-0900	CFRX Toronto, Canada	6070do			
0800-0900	CFVP Calgary, Canada	6030do			
0800-0900	CHNX Halifax, Canada	6130do			
0800-0900	CKZU Vancouver, Canada	6160na			
0800-0900	CKZU Vancouver, Canada	6160na			
0800-0900	Cook Islands	11760pa			
0800-0900	CSMonitor World Svc, Bost	9445am 17555as	11705eu	13615as	15665pa
0800-0900 sa	Eq.Guinea, R.East Africa	9585af			
0800-0850	Finland	15245as		17800pa	
0800-0900	Ghana, Radio 1, Accra	4915do			
0800-0900 f	Ghana, Radio 2, Accra	3366do			
0800-0830	HCJB Quito, Ecuador	9585eu	9745au	11730eu	11925au
		21455va			
0800-0900	Indonesia, Voice of	7125as	9675as	11752as	11785as
0800-0900 a	IRRS Milan, Italy	7125eu			
0800-0900	Kenya, Voice of	4935do			
0800-0900	King of Hope, Lebanon	6280me			
0800-0900	KNLS Anchor Point, Alaska	7365as			
0800-0900	Korea, Radio Korea	7550eu	13670eu		
0800-0900	KTBN Salt Lake City	7510am			
0800-0900 asmtwh	KTWR Guam	15200as			
0800-0900	Luxembourg, RTL	15350va			
0800-0810 w	Malawi B'casting Corp.	3381do			
0800-0900 smtwha	Malaysia, RTM Radio 4	7295do			
0800-0825	Malaysia, Voice of	6175as	9750as	15295as	
0800-0900	Moscow World Svc	4740do	4940do	4975do	5960do
	7130do	7160do	7310am	9535va	11705va
	11920va	11975va	12010va	12055va	13705va
	15345va	15350va	15420va	15435va	15455va
	15470va	15500va	15530va	15545va	15550va
	15605va	17570va	17580va	17605va	17610va
	17655va	17665va	17670va	17675va	17690va
	17710va	17720va	17765va	17775va	17790va
	17870va	17860va	21680va	21690va	21725va
	21790va	21845va			
0800-0850	N.Korea, Radio Pyongyang	15180as	15230as		
0800-0825	Netherlands	9630au	11895au		
0800-0900	New Zealand, RNZI	9700pa			
0800-0900	Nigeria	3326do	4990do		
0800-0900	Nigeria, Voice of	7255af			
0800-0845	Pakistan	17902eu	21520eu		
0800-0900	Papua New Guinea	4890do			
0800-0900	RFPI, Costa Rica	7375na	15030na	21465na	
0800-0900	SBC Radio 1, Singapore	5010do	5052do	11940do	
0800-0900	SLBS, Sierra Leone	3316do			
0800-0900 vl	South Africa, Radio Oranje	9630do			
0800-0900	TWR Monte Carlo	9480eu			
0800-0825	TWR Swaziland	7200af	11750af		
0800-0900	VOA	11735eu	15160eu	15195me	21455me
		21570me			
0800-0900	WHRI Noblesville, Indiana	7315eu	9495sa		
0800-0900 smtwhf	WMLK Bethel, Penna.	9465eu			
0800-0900	WWCR Nashville	5935na	7435am		
0800-0900	Zambia, Radio 2, Lusaka	6165do	7235do		
0800-0900 smtwhf	ZXLA New Zealand	3935do			
0803-0810	Croatian Radio, Zagreb	7240eu	9830eu		
0825-0855	Finland	15245as	17800au		
0830-0900	Austria, ORF Vienna	6155eu	13730eu	15450au	21490as
0830-0900	AWR Italy	7230eu			
0830-0900	BBC London	6180eu	6190eu	7325eu	9410eu
	9660eu	9760eu	11860af	11940af	11955as
	15070va	15280as	15360pa	15400af	15420af
	17640va	17830as	21660af	21715as	17885af
0830-0900	HCJB Quito, Ecuador	9745au	11925au	21455au	
0830-0900	Netherlands	11895pa	17575as	21485as	
0830-0845	Vatican Radio	6245eu	7250eu	9645eu	15210eu
0835-0850 mtwhf	TWR Swaziland	7200af	11750af		
0840-0850	Greece, Voice of	15650au	17525au		

0900 UTC [3:00 AM EDT/12:00 AM PDT]

Table listing radio frequencies for 0900 UTC. Columns include call letters, time, and frequency. Includes stations like Australia, Bahrain Broadcasting Svc, BBC London, and Deutsche Welle.

Table listing radio frequencies for 0930-0940 and 0950-0953 a. Includes stations like Netherlands, RTV Togo, and Vladivostok, R.S.Pac.Ocean.

1000UTC [4:00 AM EDT/1:00 AM PDT]

Table listing radio frequencies for 1000-1030 and 1030-1100. Includes stations like Afghanistan, Australia, Bahrain Broadcasting Svc, BBC London, and various international broadcasters.

Enter A World Of Excitement with a Subscription to Popular Electronics®

Get the latest electronic technology and information monthly!

Now you can subscribe to the magazine that plugs you into the exciting world of electronics. With every issue of Popular Electronics you'll find a wide variety of electronics projects you can build and enjoy.

Popular Electronics brings you informative new product and literature listings, feature articles on test equipment and tools—all designed to keep you tuned in to the latest developments in electronics. So if you love to build fascinating electronics, just fill out the subscription form below to subscribe to Popular Electronics... It's a power-house of fun for the electronics enthusiast.

EXCITING MONTHLY FEATURES LIKE:

- CONSTRUCTION**—Building projects from crystal sets to electronic roulette
- FEATURES**—Educational training on digital electronics, Ohm's Law, Antennas, Communications, Antique Radio, Simplified Theory
- HANDS-ON-REPORTS**—User test comments on new and unusual consumer products
- SPECIAL COLUMNS**—Think Tank, Circuit Circus, Computer Bits, DX Listening, Antique Radio, Amateur, Scanner Scene

PLUS: ALL OUR GREAT DEPARTMENTS!

You'll get 12 exciting and informative issues of Popular Electronics for only \$18.95. That's a savings of \$16.45 off the regular single copy price. Subscribe to Popular Electronics today! Just fill out the subscription order form below.

Protect Your Air Conditioner From Power Line Problems A-45724

Popular Electronics AUGUST 1991

DESIGN YOUR OWN ROBOT
Using nature as a model, researchers can create complex, behavior-based, mobile robots. Using the same principles, you can build your own simple yet fascinating demonstration robot

BUILD THE MAGIC-FILM SPEAKER
Learn about the properties of piezoelectric film, and how it can be used to create a most unusual speaker

ELECTRONIC LIMBS
New advances in electronics make modern artificial limbs work nearly as well as the real things

WIRE ANTENNAS FOR HAMS AND SWL's
Though these simple designs have been around since the dawn of radio, their low cost and easy construction make them practical today

Product Reviews
• Sony 8mm Camcorder
• Pioneer Laser Karaoke
• Heath Security System
• And Much More

Save 46% Off The Regular NEWSSTAND Rate
\$2.95 U.S. \$3.75 CANADA **3 NEW FunCircuits IN THIS ISSUE**

FOR FASTER SERVICE CALL TODAY
1-800-435-0715
(7:30AM-8:30PM)
EASTERN STANDARD TIME

Popular Electronics® SUBSCRIPTION ORDER FORM

P.O. Box 338, Mt. Morris IL. 61054

YES! I want to subscribe to Popular Electronics for 1 Full year (12 Issues) for only \$18.95. That's a savings of \$16.45 off the newsstand price.

Payment Enclosed Bill me later
Please charge my: Visa Mastercard

Acct. #

Signature Exp. Date

PLEASE PRINT BELOW:

NAME

ADDRESS

CITY STATE ZIP

Allow 6 to 8 weeks for delivery of first issue. U.S. Funds only.
In Canada add \$6.68 Postage (Includes G.S.T.). All Other Foreign add \$7.50 Postage.

1200UTC

[6:00 AM EDT/3:00 AM PDT]

FREQUENCIES

1200-1300	Australia	6020as	6080as	7240as	9580as					
		9710as	21720as							
1200-1300	Australia, ABC Brisbane	4920au								
1200-1300	Australia, ABC Perth	6140do	9610do							
1200-1300	AWR Costa Rica	9725ca	11870ca							
1200-1300	Bahrain Broadcasting Svc	6010me								
1200-1230	BBC London	6045eu	6180eu	6190af	6195eu					
		9410eu	9515na	9660eu	9740na					
		9750eu	9760eu	11750as	11760me					
		11940af	12095eu	15070eu	15220na					
		15310as	15420af	15575me	17640va					
		17705eu	17790af	17840af	17885af					
		21470af	21660af							
1200-1215	Cambodia, Voice of	9695as	11938as							
1200-1300 mtwhf	Cameroon CRTV Douala	4795do								
1200-1300	CFCX Montreal, Canada	6005do								
1200-1300	CFRX Toronto, Canada	6070do								
1200-1300	CFVP Calgary, Canada	6030do								
1200-1300	China, Radio Beijing	9530as	9665am	11600pa	11660as					
		15450pa								
1200-1300	China, Radio Beijing	9665am								
1200-1300	China, Radio Beijing	9715as	11600as	11660as						
1200-1300	CHNX Halifax, Canada	6130do								
1200-1300	CKZU Vancouver, Canada	6160do								
1200-1300	Cook Islands	11760pa								
1200-1300	CSMonitor World Svc, Bost	9425au	9495am	13625as	13760na					
1200-1300 as	CSMonitor World Svc, Bost	15665eu								
1200-1300 sa	Eq. Guinea, R. East Africa	9585af								
1200-1300	Ghana, Radio 1, Accra	4915do								
1200-1225 sa	Ghana, Radio 2, Accra	3366do								
1200-1300	HCJB Quito, Ecuador	11925am	15115am	17890am	21455om					
1200-1230	Iran, Islamic Republic	7215va	9525va	9685va	11790va					
		11930va								
1200-1300	Kenya, Voice of	4935do								
1200-1300	KTBN Salt Lake City	7510am								
1200-1300	Luxembourg, RTL	15350va								
1200-1210 w	Malawi B'casting Corp.	3381do	5995do							
1200-1300	Malaysia, RTM Radio 4	7295do								
1200-1300	Moscow World Svc	4810do	5940eu	5950eu	5960eu					
		7130va	7160va	7245va	7260va					
		7380va	9560va	9705va	9780va					
		9855va	9885va	9895va	11705va					
		11765va	12025va	13705va	15280va					
		15325va	15345va	15465va	15475va					
		15480va	15535va	17570va	17600va					
		17605va	17615va	17635va	17655va					
		17665va	17690va	17700va	17780va					
		17790va	17810va	17840va	17880va					
1200-1225	Netherlands	5955eu	9715eu	17575eu	21480eu					
		21520eu								
1200-1205	New Zealand, RNZI	9700as								
1200-1300	Nigeria	4990do	7285do							
1200-1300	Nigeria, Voice of	7255af								
1200-1230 as	Norway	17860as	21705as							
1200-1300	RFPI, Costa Rica	15030na	21465na							
1200-1230	Romania, R. Romania Int'l	15340as	15365as	17720as						
1200-1300	SBC Radio 1, Singapore	5010do	5052do	11940do						
1200-1300	SLBS, Sierra Leone	3316do	5980do							
1200-1230	Somalia, Radio Mogadishu,	6095af								
1200-1300 vl	South Africa, Radio Oranje	9630do								
1200-1300 sa	Tanzania	5985af	9684af	11765af						
1200-1230	Thailand	4830as	9655as	11905as						
1200-1300	TWR Bonaire	11815am	15345am							
1200-1230 smwha	Ulaanbaatar R., Mongolia	11850as	12015as							
1200-1230	Uzbekistan, R. Tashkent	5945as	9540as	15470as	17745as					
1200-1230	VOA	6110as	9760au	11715as	15155au					
		15425as								
1200-1230	VOIRI Teheran	7215me	9575as	9695me	11790as					
		11930as								
1200-1300	WHRI Noblesville, Indiana	7315am	9465am							
1200-1300	WWCR Nashville	5935am	15690am							
1200-1300	WYFR Okeechobee, FL	5950am	7355am	9705am	11830am					
		17760am								
1200-1230 s	Zambia, Radio Zambia Int'l	9505af	11880af	17895af						
1203-1210	Croatian Radio, Zagreb	7240eu	9830eu							
1215-1230	Cyprus, Radio Bayrak	6150va								
1215-1300	Egypt, Radio Cairo	17595as								
1215-1300	Korea, Seoul	9750am								
1226-1300	Ghana, Radio 2, Accra	7295do								
1230-1300	Bangladesh	15200as	15605as	15647as	17750as					
1230-1300	BBC London	6045eu	6180eu	6190af	6195ca					
		9410eu	9515na	9660eu	9740na					
		9750eu	9760eu	11760me	11940af					
		12095eu	12170as	15070eu	15220na					
		15310as	15420af	15575me	17640va					
		17705eu	17790af	17840af	17885af					
		21470af	21660af							
1230-1250 mtwhf	Finland	15400na	21550na							
1230-1300	RFI Radio France Int'l	9805eu	11670eu	15195eu	15425eu					
		21635na	21645na							
1230-1300	Sri Lanka B'casting Corp.	6075as	9720as							
1230-1300	Turkey, Voice of	9675as								
1230-1300	Vietnam, Voice of	9840as	12020as	15010as						
1230-1300	VOA	6110as	9760au	11715au	15155as					
		15425as								
1235-1245	Greece, Voice of	15565na	15650na	17515na						

SELECTED PROGRAMS

Sundays

- 1201 BBC: Play Of The Week. See S 0101.
 1227 Radio Australia: Tattslotto Results. And tonight's winning numbers are...
 1230 Radio Australia: Soundabout. Young, contemporary music from Australia and around the world.
 1230 Radio Korea: Echoes of Korean Music. See S 1115.
 1250 Radio Korea: Shortwave Feedback. See S 1135.

Mondays

- 1215 BBC: Quiz. Drama is the topic in "Break A Leg!" (6th/13th), and then test your knowledge in "The Litmus Test" (thru June 1st).
 1230 Radio Australia: Soundabout. See S 1230.
 1230 Radio Korea: News Commentary. See S 0015.
 1235 Radio Korea: Seoul Calling. See M 1120.
 1245 BBC: Sports Roundup. See S 0315.
 1255 Radio Korea: Let's Learn Korean! See M 1140.

Tuesdays

- 1215 BBC: Multitrack 1: Top 20. See M 2330.

- 1230 Radio Australia: Soundabout. See S 1230.
 1230 Radio Korea: News Commentary. See S 0015.
 1235 Radio Korea: Seoul Calling. See M 1120.
 1245 BBC: Sports Roundup. See S 0315.
 1255 Radio Korea: Let's Learn Korean! See M 1140.

Wednesdays

- 1215 BBC: New Ideas. See M 1615.
 1227 Radio Australia: Tattslotto Results. See S 1227.
 1230 Radio Australia: Soundabout. See S 1230.
 1230 Radio Korea: News Commentary. See S 0015.
 1235 BBC: Talks. See M 1635.
 1235 Radio Korea: Seoul Calling. See M 1120.
 1245 BBC: Sports Roundup. See S 0315.
 1255 Radio Korea: Let's Learn Korean! See M 1140.

Thursdays

- 1215 BBC: Multitrack 2. See W 2330.
 1230 Radio Australia: Soundabout. See S 1230.
 1230 Radio Korea: News Commentary. See S 0015.

- 1235 Radio Korea: Seoul Calling. See M 1120.
 1245 BBC: Sports Roundup. See S 0315.
 1255 Radio Korea: Let's Learn Korean! See M 1140.

Fridays

- 1215 BBC: Feature. After "To Believe Or Not To Believe" (3rd), examine issues of human equality in "First Among Equals" (10th/17th/24th).
 1230 Radio Australia: This Australia. See S 0430.
 1230 Radio Korea: News Commentary. See S 0015.
 1235 Radio Korea: Let's Sing Together. See F 1120.
 1245 BBC: Sports Roundup. See S 0315.

Saturdays

- 1215 BBC: Multitrack 3. See F 2330.
 1227 Radio Australia: Tattslotto Results. See S 1227.
 1230 Radio Australia: Women In Politics. See A 0330.
 1230 Radio Korea: News Commentary. See S 0015.
 1235 Radio Korea: Sites and Sounds. See S 0020.
 1245 BBC: Sports Roundup. See S 0315.
 1250 Radio Korea: From Us to You. See S 0035.

1400 UTC

[8:00 AM EDT/5:00 AM PDT]

FREQUENCIES

1400-1500	Australia	5995as	6080as	7240as	9580as	15520va	15535va	17605va	17610va	17655va	17665va
		9710as	9770as			17670va	17690va	17780va	17790va	17810va	17840va
		13755as				17860va	17870va	21615va			
1400-1500	Australia, VLW6 Wanneroo,	6140do				9735va	9755va	9760va	9795va	9855va	9895va
1400-1500	Bahrain Broadcasting Svc	6010me				11655va	11705va	11765va	11780va	11830va	11840am
1400-1430	BBC London	5975eu	6045eu	6180eu	6190af	12025va	12035va	13705va	15345va	15395va	15420va
	6195as	7180as	9410eu	9660eu	9740as	15450va	15465va				
	9760eu	11750as	11820as	11940af	12095eu	1400-1500		4990do	7285do		
	15310as	15575me	17640va	17705eu	17790af	1400-1500 s		Nigeria, Voice of	7255af		
	17880af	21470af	21660af			1400-1500		RCI Montreal	11955am		
1400-1430	Cameroon CRTV Douala	4795do				1400-1500		RFI Radio France Int'l	11910as	17650as	21770as
1400-1500	Cameroon CRTV Yaounde	4850do				1400-1500		RFP, Costa Rica	15030am	21465am	
1400-1500 as	Canada, CBC	9625do				1400-1500		SBC Radio 1, Singapore	5010do	5052do	11940do
1400-1500	CFCX Montreal, Canada	6005do				1400-1500		SLBS, Sierra Leone	3316do	5980do	
1400-1500	CFRX Toronto, Canada	6070do				1400-1500 vl		South Africa, Radio Orange	9630do		
1400-1500	CFVP Calgary, Canada	6030do				1400-1500		Sri Lanka B'casting Corp.	6075as	9720as	
1400-1500	China, Radio Beijing	7405as	11815na	11855as	15165as	1400-1410		Sudan, Radio Juba	9540do	9550do	
1400-1500	CHNX Halifax, Canada	6130do				1400-1500 sa		Tanzania	5985af	9684af	11765af
1400-1500	CKZU Vancouver, Canada	6160do				1400-1415		Vatican Radio	15090au	17525au	21515au
1400-1500	Cook Islands	11760pa				1400-1500		VOA	6110as	9760as	15160au
1400-1500	CSMonitor World Svc, Bost	9530as	13625as	15665eu	17555am	1400-1500		WHRI Noblesville, Indiana	6110as	7125as	9645as
1400-1500 sa	CSMonitor World Svc, Bost	13710na				1400-1500		WWCR Nashville	15395as	15205me	
1400-1500	FEBC Manila, Philippines	11995as				1400-1500		WYFR Okeechobee, FL	9465na	15105na	
1400-1500	Ghana, Radio 1, Accra	4915do				1400-1500		Finland	12160na	15690am	
1400-1500	Ghana, Radio 2, Accra	7295do				1405-1430			9705am	11550as	11830am
1400-1430	HCJB Quito, Ecuador	11925am	15115am	17890am	21455am				6120eu	9730af	11755eu
1400-1500	India, All India Radio	11760as	15120as			1415-1500		Bhutan Broadcasting Svc	21550eu		
1400-1500 a	IRRS Milan, Italy	7125eu				1415-1425		Nepal, Kathmandu	5023do		
1400-1500	Japan NHK	9505am				1430-1500		BBC London	3230do	5005do	7165do
1400-1500	Jordan	9560eu						6195as	5975eu	6045eu	180eu
1400-1500 mtwhf	Kenya, Voice of	4935do						11820as	9740as	9750eu	9760eu
1400-1500	King of Hope, Lebanon	6280me						17640va	11940af	12095eu	15070va
1400-1500	Korea, Seoul	9570as						17705eu	17790af	17880af	7180as
1400-1500	KTBN Salt Lake City	7510na						21660af			21470af
1400-1500	Luxembourg, RTL	15350va				1430-1500 mtwhfa		Cameroon CRTV Douala	4795do		
1400-1410	Malawi B'casting Corp.	3381do				1430-1500		HCJB Quito, Ecuador	11925am	17890am	21455am
1400-1430	Malaysia, RTM Kuching	4950do				1430-1500		Kol Israel	11587am	11605na	15640na
1400-1500	Malaysia, RTM Radio 4	7295do							17590eu		17575eu
1400-1500	Moscow World Svc	4740do	4810do	4975do	5905eu	1430-1500		Myanmar, Voice of Burma	5990do		
	5960eu	6055eu	7135va	7170va	7195va	1430-1500		Netherlands	5955eu	13770eu	15150eu
	7260va	7315va	7330va	7345va	7370va				17605eu		
	7420va	9675va	9705va	9725va	15480va	1440-1450 mtwhfa		Venezuela, Radio Nacional	9540om		
					15495va	1445-1500 smwha		Ulaanbaatar R., Mongolia	7260as	13780as	

SELECTED PROGRAMS

Sundays

- 1401 BBC: Feature. This month, something we've all been: "The Human Child" (through May 24th).
- 1415 Radio Korea: Echoes of Korean Music. See S 1115.
- 1430 BBC: Anything Goes. Bob Holness presents a variety of music and other recordings.
- 1430 Radio Australia: Communicator. The latest developments in the media and communications world.
- 1430 Radio Netherlands: Happy Station. See S 1130.
- 1435 Radio Korea: Shortwave Feedback. See S 1135.

Mondays

- 1405 BBC: Outlook. Conversation, controversy, and color from the UK and the world.
- 1415 Radio Korea: News Commentary. See S 0015.
- 1420 Radio Korea: Seoul Calling. See M 1120.
- 1425 Radio Australia: Stock Exchange Report. Financial news from Sydney and other exchanges.
- 1430 BBC: Off The Shelf. See M 0430.
- 1430 Radio Australia: Music Of Radio Australia. See S 1113.
- 1440 Radio Korea: Let's Learn Korean! See M 1140.
- 1440 Radio Netherlands: Newline. See S 0040.
- 1445 BBC: Talks. See S 0445.
- 1445 Radio Australia: Word Of Mouth. Oral histories of Australians.
- 1445 Radio Korea: Sports Roundup. See M 1145.
- 1454 Radio Netherlands: The Research File. See M 1154.

Tuesdays

- 1405 BBC: Outlook. See M 1405.
- 1415 Radio Korea: News Commentary. See S 0015.

- 1420 Radio Korea: Seoul Calling. See M 1120.
- 1425 Radio Australia: Stock Exchange Report. See M 1425.
- 1430 BBC: Off The Shelf. See M 0430.
- 1430 Radio Australia: Lane's Company. Terry Lane talks with people from all walks of life.
- 1440 Radio Korea: Let's Learn Korean! See M 1140.
- 1440 Radio Netherlands: Newline. See S 0040.
- 1445 BBC: Feature. See M 0145.
- 1445 Radio Korea: Korean Cultural Variety. See T 1145.
- 1454 Radio Netherlands: Mirror Images. See T 1154.

Wednesdays

- 1405 BBC: Outlook. See M 1405.
- 1415 Radio Korea: News Commentary. See S 0015.
- 1420 Radio Korea: Seoul Calling. See M 1120.
- 1425 Radio Australia: Stock Exchange Report. See M 1425.
- 1430 BBC: Off The Shelf. See M 0430.
- 1430 Radio Australia: Innovations. Desley Blanch reports on inventions and innovative practices.
- 1440 Radio Korea: Let's Learn Korean! See M 1140.
- 1440 Radio Netherlands: Newline. See S 0040.
- 1445 BBC: Good Books. Recommendations of books to read.
- 1445 Radio Korea: Pulse of Korea. See W 1145.
- 1454 Radio Netherlands: Feature. See W 1154.

Thursdays

- 1405 BBC: Outlook. See M 1405.
- 1415 Radio Korea: News Commentary. See S 0015.
- 1420 Radio Korea: Seoul Calling. See M 1120.
- 1425 Radio Australia: Stock Exchange Report. See M 1425.

- 1430 BBC: Off The Shelf. See M 0430.
- 1430 Radio Australia: Monitor. A look at the impact of science and technology on society.
- 1440 Radio Korea: Let's Learn Korean! See M 1140.
- 1440 Netherlands: Newline. See S 0040.
- 1445 BBC: Recording Of The Week. See M 0545.
- 1445 Radio Korea: Focus This Week. See H 1145.
- 1454 Radio Netherlands: Media Network. See H 1154.

Fridays

- 1405 BBC: Outlook. See M 1405.
- 1415 Radio Korea: News Commentary. See S 0015.
- 1420 Radio Korea: Let's Sing Together. See F 1120.
- 1425 Radio Australia: Stock Exchange Report. See M 1425.
- 1430 BBC: Off The Shelf. See M 0430.
- 1430 Radio Australia: Science File. See W 1130.
- 1440 Radio Netherlands: Newline. See S 0040.
- 1445 BBC: Global Concerns. See F 0145.
- 1445 Radio Korea: Listeners' Forum. See F 1145.
- 1454 Radio Netherlands: Feature. See F 1154.

Saturdays

- 1401 BBC: John Peel. See T 0330.
- 1415 Radio Korea: News Commentary. See S 0015.
- 1420 Radio Korea: Sites and Sounds. See S 0020.
- 1430 BBC: Sportsworld. Shortwave's "Wide World Of Sports," with the latest soccer, cricket, tennis, golf, and more.
- 1430 Radio Australia: Interaction. See S 0530.
- 1435 Radio Korea: From Us to You. See S 0035.
- 1440 Radio Netherlands: Asian. See A 1140.

1500 UTC

[9:00 AM EDT/6:00 AM PDT]

FREQUENCIES

1500-1600	Australia	5995as	6060as	6080as	7240as
		9580as	9860as	12000as	13755as
1500-1600	Bahrain Broadcasting Svc	6010me			
1500-1600	Bangladesh	4880do			
1500-1530	BBC London	3915as	5975eu	6045eu	6180eu
		6190af	6195eu	6195as	9410eu
		9515na	9740na	9750eu	9780eu
		11750as	11775na	11940af	12095eu
		15070va	15310as	15400af	15420af
		7180as	15260na	15575me	17640va
		17705eu	17790af	17840af	17860af
		17880af	21470af	21490af	21660af
1500-1600	Cameroon CRTV Yaounde	4850do			
1500-1600 as	Canada, CBC	9625do			
1500-1600	CFCX Montreal, Canada	6005do			
1500-1600	CFRX Toronto, Canada	6070do			
1500-1600	CFVP Calgary, Canada	6030do			
1500-1600	China, Radio Beijing	7405as	11815as	15165as	
1500-1600	CHNX Halifax, Canada	6130do			
1500-1600	CKZU Vancouver, Canada	6160do			
1500-1600	Cook Islands	11760pa			
1500-1600	CSMonitor World Svc, Bost	9530as	13625as	15665eu	17555am
1500-1600 sa	CSMonitor World Svc, Bost	13710na			
1500-1550	Deutsche Welle, Germany	9735af	11965af	13610af	17735af
		17765af	21660af		
1500-1600	Ethiopia, Voice of	7165af			
1500-1555	FEBA Seychelles	11685af			
1500-1600 twhfa	FEBA Seychelles	9810as	15330af		
1500-1600	FEBC Manila, Philippines	11995as			
1500-1600	Ghana, Radio 1, Accra	4915do			
1500-1600	Ghana, Radio 2, Accra	7295do			
1500-1600	HCJB Quito, Ecuador	11925am	17890am	21455am	
1500-1600 a	IRRS Milan, Italy	7125eu			
1500-1600	Japan NHK	9505am			
1500-1600	Jordan	9560eu			
1500-1600 mtwhf	Kenya, Voice of	4935do			
1500-1600	KTBN Salt Lake City	7510na			
1500-1600	KTWR Guam	11650as			
1500-1600	Luxembourg, RTL	15350va			
1500-1600	Malaysia, RTM Radio 4	7295do			
1500-1600	Moscow World Svc	11705va	11725va	11840am	12035va
		12065va	13705va	15395va	15420va
		15450va	15465va	15480va	15485va
		17605va	17610va	17655va	17670va
		17690va	17775va	17780va	17810va
		17870va	21615va	21785va	
		4740do	4940do	4975do	6055eu
		7135va	7170va	7220va	7260va

1500-1600	Myanmar, Voice of, Burma	5990do			
1500-1550	N.Korea, Radio Pyongyang	9325va	9640va	9977va	11705va
1500-1525	Netherlands	5955eu	13770eu	15150eu	17575ee
		17605eu			
1500-1600	Nigeria	4990do	7285do		
1500-1600	Nigeria, Voice of	7255af			
1500-1530 mtwhf	Portugal	21515me			
1500-1530	RCI Montreal	9555eu	11915eu	11935eu	13650eu
		15315eu	15325eu	17820eu	21545eu
1500-1600 s	RCI Montreal	11955am			
1500-1530 tent	RFI Radio France Int'l	17895af			
1500-1600	RFPI, Costa Rica	15030am	21465am		
1500-1530	Romania, R.Romania Int'l	11775as	11940as	15250as	15335as
		17720as	17745as		
1500-1600	SBC Radio 1, Singapore	5010do	5052do	11940do	
1500-1600	SLBS, Sierra Leone	3316do	5980do		
1500-1600	South Africa, Radio RSA,	7230af	11880af		
1500-1600 vl	South Africa, Radio Orange	9630do			
1500-1600	Sri Lanka B'casting Corp.	6075as	9720as		
1500-1530	Sudan, Nat'l Unity Radio	9535do			
1500-1530	Swiss Radio Int'l	7480as	11690as	13635as	15505as
		17830as	21695as		
1500-1530 sa	Tanzania	5985af	9684af	11765af	
1500-1515 smwha	Ulaanbaatar R., Mongolia	7260as	13780as		
1500-1600	VOA	9700eu	15205me		
1500-1600	VOA	6110as	7125as	9645as	9760as
		15395as			
1500-1600	WHRI Noblesville, Indiana	15105na	21840sa		
1500-1600	WWCR Nashville	12160na	15690am		
1500-1600	WYFR Okeechobee, FL	11830am	15215am	17760am	
1522-1535	Taiwan, Voice of	9910as			
1530-1600	Albania, Radio Tirana	9730af	11835af		
1530-1600	Austria, ORF Vienna	6155eu	11780as	13730eu	21490va
1530-1600	BBC London	6190af	6195eu	6195as	7180as
		9410eu	9740na	9750eu	11750as
		11775na	11940af	12095eu	15070va
		15280as	15310as	15400af	17640va
		17705eu	17880af	21470af	21660af
1530-1540 mtwhfa	Greece, Voice of	11645eu	15565na	17525na	
1530-1600	Sudan Nat'l B'casting Cor	9540do	9550do	11635do	
1530-1600	Sweden	17870na	21500na		
1530-1600	Tanzania	5985af	9684af	11765af	
1530-1600	Zambia, Radio Zambia Int'l	9505af	11880af	17895af	
1545-1600	Korea World News	7275va			
1545-1600	Vatican Radio	15090au	17865au		

SELECTED PROGRAMS

Sundays

- 1509 Deutsche Welle: Religion and Society. News and developments concerning the world's major religions.
- 1513 Deutsche Welle: Through German Eyes. German journalists provide a perspective on world events.
- 1513 Radio Australia: Music Of Radio Australia. See S 1113.
- 1515 BBC: Concert Hall. Classical music from the world's great concert halls.
- 1530 Radio Australia: Connections. Trevor Robertson presents education issues of the Asian/Pacific region.
- 1534 Deutsche Welle: Pop from Germany. A look at the German pop music scene.

Mondays

- 1509 Deutsche Welle: Newline Cologne. See M 1109.
- 1513 Radio Australia: Pacific Sunrise. Business and export development in the Pacific basin.
- 1515 BBC: Feature/Drama. See M 0101.
- 1530 Radio Australia: Points Of Law. Geraldine Coutts reports on law and society in Oceania.
- 1534 Deutsche Welle: Monday Special. An interview or report on an event or development with special relevance for Africa.

Tuesdays

- 1509 Deutsche Welle: Newline Cologne. See M 1109.
- 1513 Radio Australia: Music Of Radio Australia. See S 1113.
- 1515 BBC: A Jolly Good Show. Dave Lee Travis presents listener rock music requests.
- 1530 Radio Australia: AgrNews. News about agriculture of the Asian/Pacific region, with Denis Gibbons.
- 1534 Deutsche Welle: Insight. An in-depth feature, giving the background to political events and international developments.

Wednesdays

- 1509 Deutsche Welle: Newline Cologne. See M 1109.
- 1513 Radio Australia: Music Of Radio Australia. See S 1113.
- 1515 BBC: Talks. See M 2315.
- 1530 BBC: Comedy/Drama. "Frank Muir Goes Into..." more subjects for comedy and philosophy (through 22nd); those intrepid comedians return for "Two Cheers For April" (29th).
- 1530 Radio Australia: Matters Of Faith. See M 0430.
- 1534 Deutsche Welle: Living in Germany. See M 0116.

Thursdays

- 1509 Deutsche Welle: Newline Cologne. See M 1109.
- 1513 Radio Australia: Music Of Radio Australia. See S 1113.
- 1515 BBC: Music With Matthew. See S 2315.
- 1530 Radio Australia: Business Horizons. See T 1130.
- 1534 Deutsche Welle: Spotlight on Sport. Background stories and coverage of important sporting events.

Fridays

- 1509 Deutsche Welle: Newline Cologne. See M 1109.
- 1513 Radio Australia: Music Of Radio Australia. See S 1113.
- 1515 BBC: Music Review. See H 2315.
- 1534 Deutsche Welle: Economic Notebook. A look at the economic scene in Germany and around the world.

Saturdays

- 1509 Deutsche Welle: Africa Highlight. A weekly feature on an important topic concerning Africa.
- 1513 Deutsche Welle: Development Forum. Reports and interviews on projects and progress in Africa and Asia.
- 1513 Radio Australia: Music Of Radio Australia. See S 1113.
- 1515 BBC: Sportsworld. See A 1430.
- 1530 Radio Australia: One World. See S 1130.
- 1534 Deutsche Welle: Science and Technology. See M 0234.

1600 UTC

[10:00 AM EDT/7:00 AM PDT]

1600-1700	Australia 9860as 11910as	5995as 12000as	6060as 13605as	6080as 13755as	9580as	1600-1700 s	RCI Montreal RFI Radio France Int'l	11955am 6175eu 11705af 12015af 15530me
1600-1700	Bahrain Broadcasting Svc	6010me				1600-1700	RFPI, Costa Rica	17620af 17795af 17850af
1600-1630	BBC London	1540af	3915as	5975as	6190af	1600-1700	Saudi Arabia BC Svc	9705eu 9720eu
	6195eu 9410eu	9630af	9740me	9750eu	11750as	1600-1605	SBC Radio 1, Singapore	5010do 5052do 11940do
	11775na 11940af	12095eu	15070eu	15400af	17640va	1600-1700	SLBS, Sierra Leone	3316do 5980do
	17695eu 17705eu	17860af	17880af	7180as	15260na	1600-1700	Somali People, Voice of	6320do
	15310as 21470af	21660af				1600-1700	South Africa, Radio RSA,	15160af
1600-1700 a	Canada, CBC	9625do				1600-1640 vl	South Africa, Radio Oranje	9630do
1600-1700	CFCX Montreal, Canada	6005do				1600-1700	Sri Lanka B'casting Corp.	6075as 9720as
1600-1700	CFRX Toronto, Canada	6070do				1600-1700	Tanzania	5985af 9684af 11765af
1600-1700	CFVP Calgary, Canada	6030do				1600-1700	TWR Swaziland	9600af
1600-1700	China, Radio Beijing	11575af	15130af	15170af		1600-1615	UAE Radio, Dubai	11795af 13675eu 15320eu 21605eu
1600-1700	CHNX Halifax, Canada	6130do				1600-1615	Vatican Radio	15090au 17865au
1600-1700	CKZU Vancouver, Canada	6160do				1600-1630	Vietnam, Voice of	9840eu 12020eu 15010eu
1600-1700	Cook Islands	11760pa				1600-1630	VOA	9700eu 15205me
1600-1700	CSMonitor World Svc, Bost	11580as	13625as	21640af			9575af 11920af 15410af 15495af	
1600-1700 sa	CSMonitor World Svc, Bost	13710na	17555am				15580af 17800af 21625af	
1600-1650	Deutsche Welle, Germany	6170as	7225as	9615as	9875as		6110as 7125as 9645as 9760as	
		11785as	15105as	15415as	15595as			
1600-1700	Ghana, Radio 1, Accra	4915do				1600-1700	WHRI Noblesville, Indiana	15105am 17830am 17830am 21840am
1600-1700	Ghana, Radio 2, Accra	7295do				1600-1700	WWCR Nashville	15690am 17525am
1600-1630 a	IRRS Milan, Italy	7125eu				1600-1700	WYFR Okeechobee, FL	11830am 15215am 15355am 17760am
1600-1700 mtwhf	Kenya, Voice of	4935do					21525eu 21615af	
1600-1700	Korea, Seoul	5975om	9870af			1600-1630	Yemen	5970as 7190as
1600-1700	KSDA Guam	11980as				1600-1700	Zambia, Radio Zambia Int'l	9505af 11880af 17895af
1600-1700	KTBN Salt Lake City	15590am				1610-1615 mtwhf	Botswana, Gaborone	5955af 7255af
1600-1635	KTWR Guam	11650as				1620-1658 mtwhf	Morocco, Rabat	17595as
1600-1610	Lesotho, Maseru	4800do					BBC London	3915as 5975as 6190af 6196eu
1600-1700	Luxembourg, RTL	15350va					9410eu 9630af 9740me 11750as 11775na 11940af	
1600-1610	Malawi B'casting Corp.	3381do					12095eu 15070eu 15260na 15310as 15400af 15420af	
1600-1700	Moscow World Svc	6055eu	6175va	7135va	7170va		17640va 17695eu 17860af 17880af 21470af 21660af	
	7260va 7280va	7330va	7345va	7370va	7380va	1630-1700	Egypt, Radio Cairo	15255af
	7420va 9575va	9685va	9720va	9730va	9755va	1630-1700	HCJB Quito, Ecuador	15270me 17790me 21455me
	9760va 9795va	9830va	9895va	11730va	11840am	1630-1700 mtwhfa	Netherlands	6020af 15570af
	12030va 13670va	15450va	15485va	17670va		1630-1657	RCI Montreal	7150as 9555as
1600-1700	Nigeria	4990do				1630-1700	RTV Rwandiasse	3330 6055
1600-1700	Nigeria, Voice of	7255af				1630-1700	VOA	6180eu 9700eu 9760me 11710me
1600-1630 as	Norway	15230af	17720as				15205me 15245me	
1600-1630	Pakistan	11570me	13665me	15060me	15550af	1635-1700 s	KTWR Guam	11650as
		17555af	17725me			1650-1700 smtwhf	New Zealand, RNZI	9670pa
1600-1655	Polish Radio Warsaw	7285eu		11840eu				

Sundays

- 1609 Deutsche Welle: Arts on the Air. See S 1109.
- 1615 BBC: Feature. See S 0230.
- 1615 Radio Korea: Echoes of Korean Music. See S 1115.
- 1630 Radio Australia: Music Of Radio Australia. See S 1113.
- 1634 Deutsche Welle: German by Radio. See S 0134.
- 1635 Radio Korea: Shortwave Feedback. See S 1135.
- 1645 BBC: Letter From America. See S 0615.
- 1645 Radio Australia: Sports Report. See S 1313.

Mondays

- 1609 Deutsche Welle: Newline Cologne. See M 1109.
- 1615 BBC: New Ideas. Innovative developments in technology and new products.
- 1615 Radio Korea: News Commentary. See S 0015.
- 1620 Radio Korea: Seoul Calling. See M 1120.
- 1630 Radio Australia: Music Of Radio Australia. See S 1113.
- 1634 Deutsche Welle: Asia-Pacific Report. Correspondents' reports, interviews, and background news from the Asia-Pacific region.
- 1635 BBC: Talks. The last of "Trees" (6th) is followed by "What ever Happened To..." (through May 25th).
- 1640 Radio Korea: Let's Learn Korean! See M 1140.
- 1640 Radio Netherlands: Newline. See S 0040.
- 1645 BBC: The World Today. A look at a topical aspect of the international scene.
- 1645 Radio Australia: Sports Report. See S 1313.
- 1645 Radio Korea: Sports Roundup. See M 1145.
- 1654 Radio Netherlands: The Research File. See M 1154.

Tuesdays

- 1609 Deutsche Welle: Newline Cologne. See M 1109.
- 1615 BBC: Megamix. See T 1130.
- 1615 Radio Korea: News Commentary. See S 0015.

- 1620 Radio Korea: Seoul Calling. See M 1120.
- 1630 Radio Australia: Music Of Radio Australia. See S 1113.
- 1634 Deutsche Welle: Asia-Pacific Report. See M 1634.
- 1640 Radio Korea: Let's Learn Korean! See M 1140.
- 1640 Radio Netherlands: Newline. See S 0040.
- 1645 BBC: The World Today. See M 1645.
- 1645 Radio Australia: Sports Report. See S 1313.
- 1645 Radio Korea: Korean Cultural Variety. See T 1145.
- 1654 Radio Netherlands: Mirror Images. See T 1154.

Wednesdays

- 1609 Deutsche Welle: Newline Cologne. See M 1109.
- 1615 BBC: Rock/Pop Music. See T 0630.
- 1615 Radio Korea: News Commentary. See S 0015.
- 1620 Radio Korea: Seoul Calling. See M 1120.
- 1630 Radio Australia: Music Of Radio Australia. See S 1113.
- 1634 Deutsche Welle: Asia-Pacific Report. See M 1634.
- 1640 Radio Korea: Let's Learn Korean! See M 1140.
- 1640 Radio Netherlands: Newline. See S 0040.
- 1645 BBC: The World Today. See M 1645.
- 1645 Radio Australia: Sports Report. See S 1313.
- 1645 Radio Korea: Pulse of Korea. See W 1145.
- 1654 Radio Netherlands: Feature. See W 1154.

Thursdays

- 1609 Deutsche Welle: Newline Cologne. See M 1109.
- 1615 BBC: Network UK. Issues and events affecting people across the UK.
- 1615 Radio Korea: News Commentary. See S 0015.
- 1620 Radio Korea: Seoul Calling. See M 1120.
- 1630 Radio Australia: Music Of Radio Australia. See S 1113.
- 1634 Deutsche Welle: Asia-Pacific Report. See M 1634.
- 1640 Radio Korea: Let's Learn Korean! See M 1140.

- 1640 Radio Netherlands: Newline. See S 0040.
- 1645 BBC: The World Today. See M 1645.
- 1645 Radio Australia: Sports Report. See S 1313.
- 1645 Radio Korea: Focus This Week. See H 1145.
- 1654 Radio Netherlands: Media Network. See H 1154.

Fridays

- 1609 Deutsche Welle: Newline Cologne. See M 1109.
- 1615 BBC: Science In Action. The latest news about scientific innovations.
- 1615 Radio Korea: News Commentary. See S 0015.
- 1620 Radio Korea: Let's Sing Together. See F 1120.
- 1630 Radio Australia: Music Of Radio Australia. See S 1113.
- 1634 Deutsche Welle: Asia-Pacific Report. See M 1634.
- 1640 Radio Netherlands: Newline. See S 0040.
- 1645 BBC: The World Today. See M 1645.
- 1645 Radio Australia: Sports Report. See S 1313.
- 1645 Radio Korea: Listeners' Forum. See F 1145.
- 1654 Radio Netherlands: Feature. See F 1154.

Saturdays

- 1609 Deutsche Welle: International Talking Point. See S 0419.
- 1615 BBC: Sportsworld. See A 1430.
- 1615 Radio Korea: News Commentary. See S 0015.
- 1620 Radio Korea: Sites and Sounds. See S 0020.
- 1623 Deutsche Welle: Development Forum. See A 1513.
- 1630 Radio Australia: Music Of Radio Australia. See S 1113.
- 1634 Deutsche Welle: Religion and Society. See S 1509.
- 1635 Radio Korea: From Us to You. See S 0035.
- 1640 Radio Netherlands: Newline. See S 0040.
- 1645 Radio Australia: Sports Report. See S 1313.
- 1654 Radio Netherlands: Airtime Africa. Music, discussion with studio guests, and analysis of the issues that concern both Europe and Africa.

1700 UTC [11:00 PM EDT/8:00 AM PDT]

1700-1800	Algeria, R. Algiers	17745na			
1700-1800	Australia	5995as 6060as 6080as 9580as			
		9860as 11910as 12000as 13605as			
		13755as			
1700-1710	Bafoussam, Cameroon	4000do			
1700-1800	Bahrain Broadcasting Svc	6010me			
1700-1730	BBC London	3255af 7160me 15260na 21470af			
		21660af			
		3915as 5975as 6005af 6180eu			
		6190af 6195eu 9410eu 9630af			
		9740eu 11750as 11775na 12095eu			
		15070eu 15310as 15400af 15420af			
		17640va 17695eu 17860af 17880af			
1700-1800 a	Canada, CBC	9625do			
1700-1800	CFCX Montreal, Canada	6005do			
1700-1800	CFRX Toronto, Canada	6070do			
1700-1800	CFVP Calgary, Canada	6030do			
1700-1800	China, Radio Beijing	7405af 9570af 11575af			
1700-1800	CHNX Halifax, Canada	6130do			
1700-1800	CKZU Vancouver, Canada	6160do			
1700-1800	Cook Islands	11760pa			
1700-1800	CSMonitor World Svc, Bost	11580as 13625as 21640af			
1700-1800 sa	CSMonitor World Svc, Bost	13710na 17555am			
1700-1800	Egypt, Radio Cairo	15255af			
1700-1800	Eq. Guinea, R. East Africa	7190af			
1700-1800	Ghana, Radio 1, Accra	4915do			
1700-1705	Ghana, Radio 2, Accra	7295do			
1700-1800	HCJB Quito, Ecuador	15270me 17790me 21455me			
1700-1800	Japan NHK	7140as 9505am 11815na 15345me			
1700-1800 mtwhf	Kenya, Voice of	4935do			
1700-1800	KSDA Guam	13720as			
1700-1800	KTBN Salt Lake City	15590am			
1700-1800	Luxembourg, RTL	15350va			
1700-1800	Moscow World Svc	7170eu 7260eu 7330eu 7345eu			
		7370eu 7420eu 9530va 9540va			
		9575va 9685va 9720va 9755va			
		9765va 9790va 9795va 9830va			
		9860va 9895va 11630va 11840va			
		13670va			
1700-1750	N. Korea, Radio Pyongyang	9325va 9640va 9977va 11705va			
1700-1725	Netherlands	6020af 15570af			
1700-1800 smtwhf	New Zealand, RNZI	9670pa			
1700-1800	Nigeria	3326do 4990do			
1700-1800	Nigeria, Voice of	7255af			
1700-1730 as	Norway	9655eu			
1700-1800	Pakistan	11570eu 15550eu			
1700-1730	RCI Montreal	5995eu 7235eu 13650eu 15325eu			
		17820eu 21545eu			
1700-1800	RFPI, Costa Rica	15030na 21465na			
1700-1800	Saudi Arabia BC Svc	9705eu 9720eu			
1700-1728	SLBS, Sierra Leone	3316do 5980do			
1700-1800	South Africa, Radio RSA,	15160af			
1700-1730	Sri Lanka B'casting Corp.	6075as 9720as			
1700-1730	Swiss Radio Int'l	13685af 15430af 17830af 21630af			
1700-1800	Tanzania	5985af 9684af 11765af			
1700-1730	TWR Swaziland	3200af 9520af			
1700-1730	VOA	3980eu 6040me 9575af 9700eu			
		9760me 11920af 15205me 15410af			
		15445af 15495af 15580af 17800af			
		21625af			
		6110as 7125as 9645as 15395as			
1700-1800	WHRI Noblesville, Indiana	13760 15105			
1700-1800 smtwhf	WMLK Bethel, Penna.	9465eu			
1700-1800	WWCR Nashville	15690 17525			
1700-1800	WYFR Okeechobee, FL	21500va			
1700-1800	Zambia, Radio Zambia Int'l	9505af 11880af 17895af			
1706-1800	Ghana, Radio 2, Accra	3366do			
1715-1745	BBC London	9560ca 21660ca			
1715-1730	Cameroon CRTV Buea	3970do			
1715-1730	Korea World News				
1715-1730	Vatican Radio	6245eu 7250eu			
1728-1800	SLBS, Sierra Leone	3316do			
1730-1800	BBC London	3255af 3915as 5975as 6005af			
		6180eu 6190af 6195eu 9410eu			
		9630af 9740me 11775na 12095eu			

1730-1800	Bulgaria, Radio Sofia	15070eu 15260na 15310as 15400af			
		15420af 17640va 17695eu 17860af			
		17880af 21660af			
		6035eu 9560eu 9700af 11680eu			
		11720af 11735af			
1730-1745 a	Cameroon CRTV Douala	4795do			
1730-1745	Cyprus, Radio Bayrak	6150va			
1730-1800 a	Latvia, Radio Riga	5935eu			
1730-1800	Romania, R. Romania Int'l	11790af 15340af 15365af 17720af			
1730-1800	TWR Swaziland	3200af			
1730-1800	Vatican Radio	11625af 15090af 17730af			
1730-1800	VOA	9575af 11920af 15410af 15580af			
		17800af 21625af			
		6040eu 9700eu 9760eu 11920af			
		15205eu 15410af 15495af 15580af			
		17800af 19261af 2125af			
1740-1800	Cameroon CRTV Yaounde	4850do			
1745-1800 mtwhfa	Cameroon CRTV Douala	4795do			
1745-1800 tent	RTV Madagascar	3232do 3286do 5005do			

1800 UTC [12:00 AM EDT/9:00 AM PDT]

1800-1900	Abidjan, R. Ivory Coast	11920af			
1800-1900	Australia	5995as 6060as 6080as 9580as			
		9860as 11910as 12000as 13605as			
		13755as			
1800-1900 tent, vl	Baghdad, Iraq Int'l	11740eu			
1800-1900	Bahrain Broadcasting Svc	6010me			
1800-1830	BBC London	3255af 3955eu 5975as 6180eu			
		6190af 6195eu 7160me 7325af			
		9410eu 9600af 9740me 11750as			
		12095eu 15070eu 15410as 15400af			
		17640eu 17880af 21660af			
1800-1900	Brazil, Radiobras, Brasilia	15265eu			
1800-1825	BRT Brussels, Belgium	5910eu 9905eu 15515af			
1800-1900	Bulgaria, Radio Sofia	6035eu 9560eu 9700af 11680eu			
		11720af 11735af			
1800-1840 w	Cameroon CRTV Bertoua	4750do			
1800-1845 mtwhfa	Cameroon CRTV Douala	4795do			
1800-1900	Cameroon CRTV Yaounde	4850do			
1800-1805 mtwh	Canada, CBC	9625do			
1800-1900	CFCX Montreal, Canada	6005do			
1800-1900	CFRX Toronto, Canada	6070do			
1800-1900	CFVP Calgary, Canada	6030do			
1800-1900	CHNX Halifax, Canada	6130do			
1800-1900	CKZU Vancouver, Canada	6160do			
1800-1900	Cook Islands	11760pa			
1800-1900	CSMonitor World Svc, Bost	9425pa 17510na 17725eu 21545af			
1800-1900 sa	CSMonitor World Svc, Bost	17555am			
1800-1830	Czechoslovakia	5930eu 6055eu 7345eu 9605eu			
1800-1830	Egypt, Radio Cairo	15255af			
1800-1900	Eq. Guinea, R. East Africa	7190af			
1800-1900	Ethiopia, Voice of	9662af			
1800-1900	Ghana, Radio 1, Accra	4915do			
1800-1900	Ghana, Radio 2, Accra	7295do			
1800-1900	India, All India Radio	9950as 11860as 11935as 15080as			
1800-1900 mtwhf	Kenya, Voice of	4935do			
1800-1815	Kol Israel	11587na 11675eu 15590af 15640va			
		17575sa			
1800-1900	Korea, Seoul	15575eu			
1800-1900	KSDA Guam	13720as			
1800-1900	KTBN Salt Lake City	15590			
1800-1900	Luxembourg, RTL	15350va			
1800-1810	Malawi B'casting Corp.	3381do			
1800-1900	Moscow World Svc	7260eu 7330eu 9540eu 9630va			
		9685va 9725va 9755va 9765va			
		9780va 9795va 9855va 9860va			
		9875va 9895va 11630va 11685va			
		11745va 11840am 12050va 12055va			
		3265af 4855af 9618af			
1800-1900	Mozambique	9670pa			
1800-1845 smtwhf	New Zealand, RNZI	9670pa			
1800-1900	Nigeria	3326do 4990do			
1800-1855	Polish Radio Warsaw	7145eu 9525eu			
1800-1830 mtwhf	RCI Montreal	13670af 15260af 17820af			
1800-1900 as	RCI Montreal	13670me 15260me 17820me			

1800 UTC cont'd.

1800-1900	RFPI, Costa Rica	13630am	15030am	21465am			
1800-1830	RTV Congolaise	3265af	4765af				
1800-1900	Saudi Arabia BC Svc	9705eu	9720eu				
1800-1900	SLBS, Sierra Leone	3316do					
1800-1900	Tanzania	5985af	9684af	11765af			
1800-1845	TWR Swaziland	3200af	9600af				
1800-1830	Vietnam, Voice of	9840eu	12020eu	15010eu			
1800-1900	VOA	6040eu	9575af	9700eu	9760me		
		11920af	15205me	15410af	15445		
		15580af	17800af	21625af			
		6040eu	9700eu	9760me	15205me		
1800-1900	WHRI Noblesville, Indiana	13760na	17830sa				
1800-1900	WINB Red Lion Pennsylvan.	15295eu					
1800-1900	WMLK Bethel, Penna.	9465eu					
1800-1900	WWCR Nashville	15690na	17525na				
1800-1900	WYFR Okeechobee, FL	21500va					
1800-1900	Zambia, Radio Zambia Int'l	9505af	11880af	17895af			
1815-1900	Bangladesh	12030as	15255as				
1815-1830	Lebanon, Radio Voice of	6550me					
1830-1900	Afghanistan	9635am					
1830-1900	Albania, Radio Tirana	7120eu	9480eu				
1830-1900	Austria, ORF Vienna	5945eu	6155eu	12010me	13730af		
1830-1900	BBC London	3255af	3955eu	6005af	6180eu		
		6190af	6195eu	7325eu	9410eu		
		9600af	11750as	12095eu	15070eu		
		15400af	17880af	21660af			
1830-1900	Finland	6120eu	9730af	11755af			
1830-1900	Netherlands	6020af	15570af	17605af	21685af		
1830-1900	Sri Lanka B'casting Corp.	9720eu	15120eu				
1830-1900	Yugoslavia, Radio Federal	6100eu	15140af				
1833-1900	Ivory Coast, Abidjan	11920af					
1840-1850 mtwhfa	Greece, Voice of	11645af	12105af	15650af			
1840-1850 mtwhfa	Venezuela, Radio Nacional	9540om					
1845-1900	Ghana B'casting Corp.	6130af					
1845-1900 smtwhf	New Zealand, RNZI	15120pa					
1845-1900	RTV Guinea, Conakry	4900af	7125af				
1845-1900 s	RTV Mali	4783do	4835do	5995do	7285do		
1845-1900	TWR Swaziland	3200af					

1900-1930	Japan NHK	9505am	9640am	9645au	11850af		
1900-2000 mtwhf	Kenya, Voice of	4935do					
1900-2000	KTBN Salt Lake City	15590am					
1900-1930 s	Lebanon, Voice of Hope	11530me					
1900-2000	Luxembourg, RTL	15350va					
1900-2000 s	Morocco, Rabat	11920as					
1900-2000	Moscow World Svc	7170eu	7330eu	9540va	9685va		
		9710va	9720va	9725va	9765va		
		9795va	9855va	9860va	9875va		
		9895va	11630va	11685va	11840am		
		12050va	12055va	12060va	15425va		
1900-1925	Netherlands	6020af	15570af	17605af	21685af		
1900-2000 smtwhf	New Zealand, RNZI	15120pa					
1900-2000	Nigeria	3326do	4990do				
1900-2000	Nigeria, Voice of	7255af					
1900-1930 a,s	Norway	17860va	21705va				
1900-1930 mtwhf	RCI Montreal	13670me	15260me	17820me			
1900-2000	RFPI, Costa Rica	13630am	15030am	21465am			
1900-2000	Saudi Arabia BC Svc	9705eu	9720eu				
1900-2000	SLBS, Sierra Leone	3316do					
1900-2000	Spanish National Radio	6130as	9675eu	9685af	9875eu		
1900-2000	Sri Lanka B'casting Corp.	9720eu	15120eu				
1900-1915	Tanzania	5985af	9684af	11765af			
1900-2000	TWR Swaziland	3200af	3240af				
1900-1930	Vietnam, Voice of	9840eu	12020eu	15010eu			
1900-2000	VOA	6040eu	9525as	9575af	9700eu		
		9760eu	11710eu	11870as	11920af		
		15180au	15205eu	15410af	15445af		
		15495af	15580af	17800af	19261af		
1900-2000	WHRI Noblesville, Indiana	13760	17830				
1900-2000	WINB Red Lion Pennsylvan.	15295eu					
1900-2000	WMLK Bethel, Penna.	9465eu					
1900-2000	WWCR Nashville	15690am	17525am				
1900-2000	WYFR Okeechobee, FL	15355eu	21615af				
1900-2000	Zambia, Radio Zambia Int'l	9505af	11880af	17895af			
1910-1915	Botswana, Gaborone	3356af					
1920-1930	Cameroon CRTV Buea	3970do					
1930-2000	BBC London	3255af	3955eu	6005af	6180eu		
		6190af	6195eu	7160me	7325eu		
		9410eu	9600af	9630af	11750pa		
		12095eu	15070eu	15400af	17880af		
		21660af					
1930-1940 irr	Burkina Faso	4815af	7230af				
1930-2000	Czechoslovakia	6055eu	7345eu				
1930-2000	Iran, Islamic Republic	6030eu	9022eu	15260eu			
1930-2000	KFBS Saipan	9460af					
1930-2000	Romania, R.Romania Int'l	5990eu	6105eu	7145eu	7195eu		
		9690eu					
1930-2000	Sweden	6065eu	9655eu	15270eu			
1930-2000	VOIRI Teheran	6140eu	9022eu				
1935-1955	Italy, RAI, Rome	7275eu	9710eu	11800eu			
1935-1945	RTV Togo	5047af					
1940-2000 smwha	Ulaanbaatar R., Mongolia	11850eu	12015eu				
1945-2000	Bulgaria, Radio Sofia	9560eu	11680af	11735af			
1945-2000	Korea World News	6135as					
1950-2000	Sudan Nat'l B'casting Cor	9540do	9550do	11635do			

1900 UTC

[1:00 PM EDT/10:00 AM PDT]

1900-2000	Argentina, RAE Buenos Aires	15345eu					
1900-2000	Australia	5995as	6060as	7240as	9580as		
		9860as	11910as	12000as	13605as		
		13755as					
1900-2000	Bahrain Broadcasting Svc	6010me					
1900-1930	BBC London	3255af	3955eu	6005af	6180eu		
		6190af	6195eu	7160me	7325eu		
		9410eu	9600af	9630af	11750pa		
		12095eu	15070eu	15400af	17880af		
		21660af					
1900-1945	Cameroon CRTV Yaounde	4850do					
1900-2000	CFCX Montreal, Canada	6005do					
1900-2000	CFRX Toronto, Canada	6070do					
1900-2000	CFVP Calgary, Canada	6030do					
1900-2000	China, Radio Beijing	6955af	9440af				
1900-2000	CHNX Halifax, Canada	6130do					
1900-2000	CKZU Vancouver, Canada	6160do					
1900-2000	Cook Islands	11760pa					
1900-2000	CSMonitor World Svc, Bost	9425pa	17510na	17725eu	21545af		
1900-2000 sa	CSMonitor World Svc, Bost	17555am					
1900-1950	Deutsche Welle, Germany	9765af	11765af	11785af	11905af		
		13790af	15350af	17810af			
1900-2000	Eq. Guinea, R. East Africa	7190af					
1900-2000	Ghana B'casting Corp.	6130af					
1900-2000	Ghana, Radio 1, Accra	4915do					
1900-2000	Ghana, Radio 2, Accra	7295do					
1900-1915 mtwhfa	Greece, Voice of	7450eu	9395eu				
1900-2000	HCJB Quito, Ecuador	15270eu	17790eu	21455eu			
1900-2000	India, All India Radio	7412va	9950va	11620va	11860va		
		11935va	15080va				
1900-1930	Ivory Coast, Abidjan	11920af					



Karl H. Teumer of Chicago, Illinois, meets with some of the Radio Beijing staff.

2000 UTC

[2:00 PM EDT/11:00 AM PDT]

2000-2100	Australia	5995as 9580as 13605as	6060as 9860as 13755as	6080as 11910as	7240as 12000as
2000-2100	Bahrain Broadcasting Svc	6010me			
2000-2030	BBC London	3255af 6180eu 7180pa 9630af 15260sa 21660af	3955eu 6190af 7325eu 11750pa 15340pa	5975eu 6195eu 9410eu 12095eu 15400af	6005af 7160me 9600as 15070eu 17880af
2000-2030	Bulgaria, Radio Sofia	9560eu	11680af	11735af	
2000-2005 smtwhf	Canada, CBC	9625do			
2000-2100	CFCX Montreal, Canada	6005do			
2000-2100	CFRX Toronto, Canada	6070do			
2000-2100	CFVP Calgary, Canada	6030do			
2000-2100	China, Radio Beijing	9440af 15170af	9920eu	11500eu	11715af
2000-2100	CHNX Halifax, Canada	6130do			
2000-2100	CKZU Vancouver, Canada	6160do			
2000-2100	Cook Islands	11760pa			
2000-2010 tent	Croatia, Zagreb	17272na			
2000-2100	CSMonitor World Svc, Bost	9455as 17555sa	13625pa	15665eu	17510am
2000-2100	Cuba, RHC Havana	9760eu	17705eu		
2000-2100	Eq. Guinea, R. East Africa	7190af			
2000-2100	Ghana, Radio 1, Accra	4915do			
2000-2100	Ghana, Radio 2, Accra	7295do			
2000-2100	India, All India Radio	11935af	15080af		
2000-2100	Indonesia, Voice of	7125as	9675as	11752as	11785as
2000-2030	Iran, Islamic Republic	6030eu	9022eu	15260eu	
2000-2010 mtwhf	Kenya, Voice of	4935do			
2000-2100 tes	KFBS Saipan	9475af			
2000-2100	King of Hope, Lebanon	6280me			
2000-2030	Kol Israel	7465am 11675eu	9435am 17575af	11587am	11605am
2000-2100	KTBN Salt Lake City	15590am			
2000-2100	Luxembourg, RTL	15350va			
2000-2010 w	Malawi B'casting Corp.	3381do			
2000-2100	Moscow World Svc	5950eu 7240va 7390va 9725va 9860va 11840am 13670va 15140eu	5960eu 7255va 9450va 9765va 9865va 12050va 15425va 15205eu	6175eu 7330va 9710va 9795va 9895va 12055va 21480va 7145eu	7170va 7340va 9720va 9855va 11685va 12060va 21465am 7195eu
2000-2050	N. Korea, Radio Pyongyang	6576me 9977af	9325	9345eu	9640eu
2000-2100 smtwhf	New Zealand, RNZI	15120pa			
2000-2100	Nigeria	3326do	4990do		
2000-2030	Nigeria, Voice of	7255af			
2000-2030 mtwhf	Portugal	11740eu			
2000-2030	RCI Montreal	5995eu 15140eu	7235eu 15325eu	11945eu 17875eu	13650eu
2000-2100	RFPI, Costa Rica	13630na	15030na	21465am	
2000-2030	Romania, R. Romania Int'l	5990eu 9690eu	6105eu	7145eu	7195eu
2000-2100	Saudi Arabia BC Svc	9705eu	9720eu		
2000-2100 mtwhf	Senegal (multilingual)	7210do			
2000-2100	SLBS, Sierra Leone	3316do			
2000-2030	Sweden	6065eu	9655eu	15270	
2000-2030	Swiss Radio Int'l	9885eu			
2000-2100	Turkey, Voice of	9445eu			
2000-2100	TWR Swaziland	3200af	3240af		
2000-2010 smwha	Ulaanbaatar R., Mongolia	11850eu	12015eu		
2000-2030	Vatican Radio	11625af	15090af	17730af	
2000-2100	VOA	6040eu 15160eu 15494af 21485af	9700eu 15205eu 15580af 21625af	9760af 15410af 17800af	11710eu 15445af 19261af
2000-2100	WHRI Noblesville, Indiana	13760af	17830sa		
2000-2100	WMLK Bethel, Penna.	9465eu			
2000-2100	WWCR Nashville	15690	17525		
2000-2100	WYFR Okeechobee, FL	7355eu 21525eu	9590	15566eu	17750af
2000-2100 s	Zambia, Radio Zambia Int'l	9505af	11880af	17895af	
2005-2100 s	Canada, CBC	9625do			
2005-2100	Syria, Radio Damascus	12085na	15095na		
2010-2100 sa	Kenya, Voice of	4935do			
2015-2030	Benin, Voice of the Rev.	4870af	5025af		
2025-2045	Italy, Rai, Rome	7235me	9575me	11800me	

2030-2100	BBC London	3255af 6040 7180pa 12095eu 15400af 21485	3955eu 6180eu 7325eu 15070eu 15495	5975ca 6190af 9410eu 15260sa 15580as	6005af 6195eu 11750pa 15340pa 17800pa
2030-2100	Egypt, Radio Cairo	15375af			
2030-2100 mh	Estonia, Tallinn	5925eu	9560eu		
2030-2100	IRRS Milan, Italy	7125eu			
2030-2100	Korea, Seoul	6480eu	7550af	15575eu	
2030-2035	Latvia, 1st Programme	5935do			
2030-2100	Netherlands	7285	9895af	11660af	13700af
2030-2100	Polish Radio Warsaw	6095eu 9525eu	6135eu	7145eu	7270eu
2030-2100	RCI Montreal	6010eu 13650eu 17875as	7230eu 15140eu	9650eu 15325as	11945eu 17820
2030-2100	Vietnam, Voice of	9840eu	12020eu	15010eu	
2045-2100	Korea World News	5975as			
2050-2100	Vatican Radio	5885eu	7250eu		

2100 UTC

[3:00 PM EDT/12:00 PM PDT]

2100-2200	Angola, R. Nacional	3355af	9535af		
2100-2200	Australia	5995as 11880as	6060as 13705as	6080as	11720as
2100-2106	Bahrain Broadcasting Svc	6010me			
2100-2130	BBC London	3255af 6180eu 9590na 15260sa	3955eu 6195as 11750pa 15340pa	5975ca 7325eu 12095eu 15400af	6005af 9410eu 15070na
2100-2125	BRT Brussels, Belgium	5910eu	9905eu	15515af	
2100-2105 smtwhf	Canada, CBC	9625do			
2100-2200	CFCX Montreal, Canada	6005do			
2100-2200	CFRX Toronto, Canada	6070do			
2100-2200	CFVP Calgary, Canada	6030do			
2100-2130	China, Radio Beijing	11715af	15170af		
2100-2200	China, Radio Beijing	9920eu	11500eu		
2100-2200	CHNX Halifax, Canada	6130do			
2100-2200	CKZU Vancouver, Canada	6160do			
2100-2200	Cook Islands	11760pa			
2100-2200	CSMonitor World Svc, Bost	9455as 17555sa	13625pa	15665eu	17510na
2100-2130	Czechoslovakia	5930eu	6055eu	7345eu	9605eu
2100-2150	Deutsche Welle, Germany	6185eu	9670eu	9765eu	11785eu
2100-2200	Egypt, Radio Cairo	15375af			
2100-2200	Eq. Guinea, R. East Africa	7190af			
2100-2200	Ghana, Radio 1, Accra	4915do			
2100-2200	Ghana, Radio 2, Accra	7295do			
2100-2200	Hungary, Radio Budapest	6110eu	9835eu	11910eu	
2100-2200	India, All India Radio	7412eu 11715eu	9910eu 15265eu	9950eu	11620eu
2100-2200	IRRS Milan, Italy	7125eu			
2100-2200	Japan NHK	11815me 17890as	11840eu	15430eu	17810as
2100-2130	King of Hope, Lebanon	6280me			
2100-2130	Korea, Seoul	6480eu	7550af	15575eu	
2100-2200	KTBN Salt Lake City	15590			
2100-2200	Luxembourg, RTL	15350va			
2100-2110	Malawi B'casting Corp.	3381do			
2100-2200	Moscow World Svc	5950eu 6175eu 7185va 7330va 9725va 9855va 9860va 9890va 15425va 17700va	5960eu 7115am 7240va 7340va 9755va 9765va 9860va 12050va 17605va 17720va	6045am 7150am 7255va 9520va 9720va 9790va 9870va 12055va 17655va 21480va	6055eu 7170va 7295va 9720va 9790va 9870va 15130va 17665va
2100-2125	Netherlands	7285	9860af	9895af	11660af
2100-2130 smtwhf	New Zealand, RNZI	15120pa			
2100-2200	Nigeria	3326do	4990do		
2100-2130 as	Norway	17735va	21705va		
2100-2130 as	Norway	9590eu			
2100-2125	Polish Radio Warsaw	6095eu 9525eu	6135eu	7145eu	7270eu
2100-2130 mtwhf	Portugal	15250af			
2100-2200	RFPI, Costa Rica	13630na	15030na	21465am	
2100-2130	Romania, R. Romania Int'l	5990eu	6105eu	7145eu	7195eu
2100-2200	SLBS, Sierra Leone	3316do			

2100 UTC cont'd.

2100-2200	Spanish National Radio	9875eu			
2100-2200	Sri Lanka B'casting Corp.	15120as			
2100-2105	Syria, Radio Damascus	12085na	15095na		
2100-2115	TWR Swaziland	3240af			
2100-2110	Vatican Radio	5935eu	7250eu		
2100-2110	Vatican Radio	5885eu	7250eu		
2100-2200	VOA	6040eu	9700eu	9760me	11710me
		11870pa	11960me	15185pa	15205me
		15410af	15495af	15580af	17735pa
		17800af	17895me	19261af	21485af
		21625af			
2100-2200	WHRI Noblesville, Indiana	13760	17830		
2100-2200	WMLK Bethel, Penna.	9465eu			
2100-2200	WWCR Nashville	15690	17525am		
2100-2200	WYFR Okeechobee, FL	7355eu	15566eu	17750af	21525eu
2100-2145	Yugoslavia, Radio Federal	6100eu	9505eu		
2100-2200	Zambia, Radio Zambia Int'l	9505af	11880af	17895af	
2103-2110	Croatian Radio, Zagreb	7240eu	9830eu		
2105-2200 s	Canada, CBC	9625do			
2110-2200	Syria, Radio Damascus	12085na	15095na		
2115-2130 mtwhf	BBC London Caribbean Rpt.	15390ca	17715ca		
2115-2200	Egypt, Radio Cairo	9900eu			
2115-2130 s	Indonesia, R. Republik	6070do			
2130-2200	Austria, ORF Vienna	5945eu	6155eu	9870af	
2130-2200	BBC London	3255af	3955eu	5975ca	6005af
		6180eu	6195as	7325eu	9410eu
		9590na	11750pa	12095eu	15070na
		15260sa	15340pa	15400af	
2130-2200	BBC London Falkland Is Sv	13660sa			
2130-2145	Cameroon CRTV Buea	3970do			
2130-2200	Finland	6120af	9730eu	11755as	
2130-2200	HCJB Quito, Ecuador	15270eu	17790eu	21455eu	
2130-2200 smtwhf	King of Hope, Lebanon	6280me			
2130-2200	Lithuania, Radio Vilnius,	9675eu	9710eu		
2130-2200	New Zealand, RNZI	17770pa			
2130-2200	RCI Montreal	11880af	15150af	17820af	
2130-2200	Sweden	6065eu			
2140-2150 mtwhfa	Venezuela, Radio Nacional	9540am			
2145-2200	Bulgaria, Radio Sofia	9595am	9700na	11660eu	11680na
		11720eu	11950na		
2145-2200	Cameroon CRTV Yaounde	4850do			

2200 UTC [4:00 PM EDT/1:00 PM PDT]

2200-2300	Australia	11720as	11880as	13705as	15160as
		15320as	15365as	17795as	
2200-2210	Bafoussam, Cameroon	4000do			
2200-2300 tent, vl	Baghdad, Iraq Int'l	11740eu	11880		
2200-2300	BBC London	5975na	6195as	7325am	9410eu
		9570pa	9590na	9915ca	11750sa
		11945as	11955as	12095na	15070na
		15260sa	15340as	15400af	17830as
2200-2300	Bulgaria, Radio Sofia	9595am	9700am	11660eu	11680na
		11720eu	11950na		
2200-2215	Cameroon CRTV Yaounde	4850na			
2200-2300 mtwhfa	Canada, CBC	9625do			
2200-2300	CFMX Montreal, Canada	6005do			
2200-2300	CFRX Toronto, Canada	6070do			
2200-2300	CFVP Calgary, Canada	6030do			
2200-2230	China, Radio Beijing	3985eu			
2200-2300	China, Radio Beijing	7170eu	9880eu		
2200-2300	CHNX Halifax, Canada	6130do			
2200-2300	CKZU Vancouver, Canada	6160do			
2200-2300	Cook Islands	11760pa			
2200-2300	CSMonitor World Svc, Bost	9465na	13625as	15405as	15665eu
		17555am			
2200-2300	Cuba, RHC Havana	7215va	9620va		
2200-2230	Czechoslovakia	5930eu	6055eu	7345eu	9605eu
2200-2245	Egypt, Radio Cairo	9900eu			
2200-2300 sa	Eq Guinea, R. East Africa	7190af			
2200-2300	Ghana, Radio 1, Accra	4915do			
2200-2300	Ghana, Radio 2, Accra	7295do			
2200-2300	India, All India Radio	7412eu	9910eu	9950eu	11620eu
		11715eu	15265eu		
2200-2230 a	Indonesia, Radio Republik	3385do	4805do		
2200-2225	Italy, RAI, Rome	5990as	9710as	11800as	
2200-2230 s	KGEL San Francisco	15280sa	17750		
2200-2300	KTBN Salt Lake City	15590			
2200-2300	Luxembourg, RTL	15350va			
2200-2300 smtwha	Malaysia, RTM Radio 4	7295do			

2200-2300	Moscow World Svc	6045am	7115am	7135va	7150am
		7185va	7240va	7255va	7295va
		7330va	9520va	9530va	9725va
		9765va	9790va	9860va	9870va
		12045va	12050va	12055va	15130va
		15150va	15425va	17655va	17665va
		17700va	17720va	17890va	21480va
		21690va	21790va		
2200-2300	New Zealand, RNZI	17770pa			
2200-2300	Nigeria	3326do	4990do		
2200-2300	RCI Montreal	5995eu	6162eu	7180eu	9760eu
		11705eu	11945eu	13650eu	15325eu
2200-2300	RFPI, Costa Rica	13630ca	15030ca	21465am	
2200-2218	RTV Congolaise	4765do	5985do		
2200-2300	SBC Radio 1, Singapore	5010do	5052do	11940do	
2200-2300	SLBS, Sierra Leone	3316do			
2200-2230	Sweden	6065eu			
2200-2230	Swiss Radio Int'l, Berne	9885eu			
2200-2210	Syria, Radio Damascus	12085na	15095na		
2200-2300	Taiwan, V. of Free China,	17750eu	21720eu		
2200-2300	Turkey, Voice of	7185eu	9445na	11895me	
2200-2300	UAE Radio Abu Dhabi	7215na	9605na	11965na	
2200-2230	VOA	9530eu	11905me	11960me	15225me
		15445me	17885eu		
		7120as	9770as	11760as	15185au
		15290au	15305au	17735au	17820au
2200-2300	WHRI Noblesville, Indiana	13760na	17830sa		
2200-2245	WINB Red Lion, Penna.	15185	15195		
2200-2300	WRNO New Orleans	15420na			
2200-2300	WWCR Nashville	12160na	15690na		
2200-2300	WYFR Okeechobee, FL	17750eu	21525eu		
2200-2215	Zambia, Radio Zambia Int'l	9505af	11880af	17895af	
2230-2300	Albania, Radio Tirana	7215eu	9725eu		
2230-2300	Kazakhstan, R. Alma Ata	3955as	4395as	5035as	5260as
		5945as	5960as	5970as	5985as
		6060as	6075as	6125as	6130as
		7115as	7235as	7240as	7280as
		7320as	9505as	9550as	9705as
2230-2300	Kazakhstan, R. Alma Ata	11825as	11920as	15215as	15270as
		15315as	15385as	17605as	17715as
2230-2300	Kol Israel	17730as	21490as		
		7465am	9435am	11585am	11605am
		11675sa	17575eu		
2230-2300 mtwhf	RTV Congolaise	4765do			
2230-2300	VOA	9530eu	11905me	11960me	17885me
2240-2250 smtwhf	Greece, Voice of	11645au			
2245-2300	Vatican Radio	9600au	9845au	11830au	
2245-2300	WINB Red Lion Pennsylvan.	15145eu			

Attention Subscribers!

Be on the
look-out



for your
renewal
card

You will receive only **ONE** renewal notice. The new postcard format will be sent via first class mail to ensure prompt and reliable delivery to you.

SEND IN YOUR RENEWAL PAYMENT AS SOON AS YOU RECEIVE YOUR RENEWAL CARD — THIS WILL BE THE **ONLY** RENEWAL NOTICE SENT TO YOU!

Visa/ Mastercard orders call 1-800-438-8155

2300 UTC

[5:00 PM EDT/2:00 PM PDT]

FREQUENCIES

2300-0000	Australia	11720as	11880as	15160as	15320as	2300-0000	Moscow World Svc	15130va	15350va	15420va	15425va
		15365as	17795as					17610va	17655va	17665va	17700va
2300-0000	AWR Costa Rica	9725ca	11870ca					17720va	17775va	17890va	21480va
2300-2330	BBC London	5975na	6175na	6195as	7145as			21690va	21790va		
		9410eu	9570pa	9590na	9915sa	2300-2350	N.Korea, Radio Pyongyang	11700na	13650na		
		11750sa	11945as	11955as	12095na	2300-2400	New Zealand, RNZI	11770pa			
		15070na	15260sa	15340pa	15400af	2300-2330 as	Norway	11795am			
2300-0000	Bulgaria, Radio Sofia	9595am	9700am	11660eu	11680na	2300-0000 as	RCI Montreal	9535sa	11940sa		
		11720eu	11950na			2300-2330	RCI Montreal	9535sa	9755na	11730na	11940sa
2300-0000	CFCX Montreal, Canada	6005do				2300-0000	RFPI, Costa Rica	13630na	15030na	21465am	
2300-0000	CFRX Toronto, Canada	6070do				2300-0000	SBC Radio 1, Singapore	5010do	5052do	11940do	
2300-0000	CFVP Calgary, Canada	6030do				2300-0000	SLBS, Sierra Leone	3316do			
2300-0000	CHNX Halifax, Canada	6130do				2300-0000	South Africa, Radio Orion	4810af			
2300-0000	CKZU Vancouver, Canada	6160do				2300-0000	Thailand	4830as	9655as	11905as	
2300-2400	Cook Islands	11760pa				2300-0000	UAE Radio Abu Dhabi	7215na	9605na	11965na	
2300-0000	CSMonitor World Svc, Bost	9465na	13625as	15405af	15665eu	2300-2200	Ukraine, Radio Kiev	5960eu	6020eu	7380eu	9785eu
		17555af				2300-0000	VOA	7120as	9770as	11760au	15185au
								15290au	15305as	17735as	17820as
2300-2305	Ghana, Radio 1, Accra	4915do						9530me	11905me	11960eu	17885me
2300-2305	Ghana, Radio 2, Accra	7295do				2300-0000	WHRI Noblesville, Indiana	9495na	13760sa		
2300-2400	India, All India Radio	9910as	11715as	11745as	15110as	2300-0000	WINB Red Lion, Penna.	15145			
		15145as	17830as			2300-0000	WRNO New Orleans	7355na			
		17810pa	11815am	15195as	15430am	2300-0000	WWCR Nashville	12160na	15690		
2300-0000	Japan NHK	11735eu				2315-0000 tent, vl	Baghdad, Iraq Int'l	11830am	15455sa		
		17810pa				2315-0000 tent	Iraq, Radio Baghdad	11830va	15445va		
2300-0000	KSDA Guam	15610as				2330-0000	BBC London	5975na	6175na	6195as	7145as
2300-0000	KTBN Salt Lake City	15590na						7325na	9570pa	9590na	9915sa
2300-2330	Lithuania, Radio Vilnius,	7400na	9870am	15180na	17605na			11750sa	11945as	11955as	12095na
		17690na						15070na	15260sa	17830as	
2300-2400	Luxembourg, RTL	15350va				2330-2155	BRT Brussels, Belgium	9930na	13710na		
2300-0000 smtwha	Malaysia, RTM Radio 4	7295do				2330-0000 a	Colombia, R.Nacional	11822.5	17865am		
2300-0000	Moscow World Svc	6000am	6045am	7110va	7115am	2330-2400	Sri Lanka B' Casting Svc	15425am			
		7135va	7150am	7255va	7295va	2330-0000	Sweden	9695ca	11705ca		
		7330va	7390va	9625va	9715va	2330-0000	Vietnam, Voice of	9840as	12020as	15010as	
		9725va	9790va	9810va	9870va	2335-2345 smtwhf	Greece, Voice of	9425sa	11645sa	12105sa	
		9905va	12045va	12050va	12055va						

SELECTED PROGRAMS

Sundays

- 2305 BBC: World Business Review. The previous week's news and upcoming events.
- 2313 Radio Australia: Sports Report. See S 1313.
- 2315 BBC: Music With Matthew. Brian Matthew with classical music selections.
- 2330 Radio Australia: Business Report. A look at the day's business developments.

Mondays

- 2305 BBC: World Business Report. The latest news from the markets worldwide.
- 2313 Radio Australia: Sports Report. See S 1313.
- 2315 BBC: Talks. John Turtle's "The Learning World" examines education (through June 29th).
- 2330 BBC: Multitrack 1: Top 20. Tim Smith presents the smash singles on the UK pop music charts.
- 2330 Radio Australia: Business Report. See S 2330.

Tuesdays

- 2305 BBC: World Business Report. See M 2305.
- 2313 Radio Australia: Sports Report. See S 1313.
- 2315 BBC: Concert Hall. See S 1515.
- 2330 Radio Australia: Business Report. See S 2330.

Wednesdays

- 2305 BBC: World Business Report. See M 2305.
- 2313 Radio Australia: Sports Report. See S 1313.

- 2315 BBC: From Our Own Correspondent. See S 0330.
- 2330 BBC: Multitrack 2. Graham Bannerman presents new pop records, interviews, news, and contests.
- 2330 Radio Australia: Business Report. See S 2330.

Thursdays

- 2305 BBC: World Business Report. See M 2305.
- 2313 Radio Australia: Sports Report. See S 1313.
- 2315 BBC: Music Review. News and views from the world of classical music.
- 2330 Radio Australia: Business Report. See S 2330.

Fridays

- 2305 BBC: World Business Report. See M 2305.
- 2313 Radio Australia: Music/Information. See S 0330.
- 2315 BBC: Worldbrief. A roundup of the week's news headlines and developments.
- 2330 BBC: Multitrack 3. News and releases from the British alternative music scene.

Saturdays

- 2305 BBC: Words Of Faith. See S 0309.
- 2310 BBC: Book Choice. See H 0140.
- 2313 Radio Australia: Back Page. See S 0313.
- 2315 BBC: A Jolly Good Show. See T 1515.
- 2330 Radio Australia: At Your Request. See S 0130.

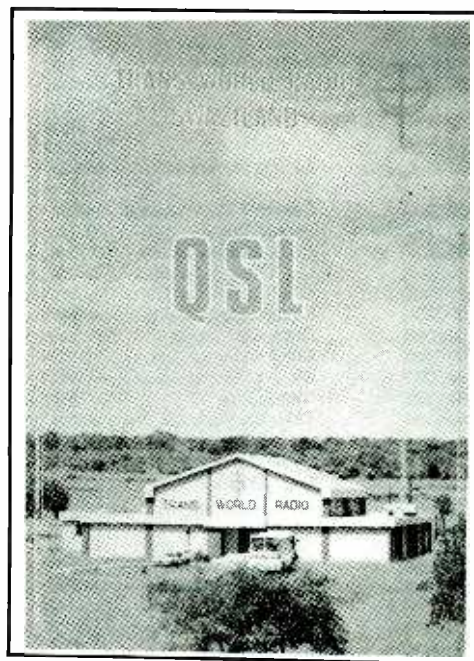

John Carson, Norman, OK, has this TWR QSL in his collection.

Tone/Code Finder/User

Now you can have programmable tone/digital squelch on the popular Radio Shack Pro 2004, 5, 6 receivers. The TCF-4 is also available with 760/950 series receivers.

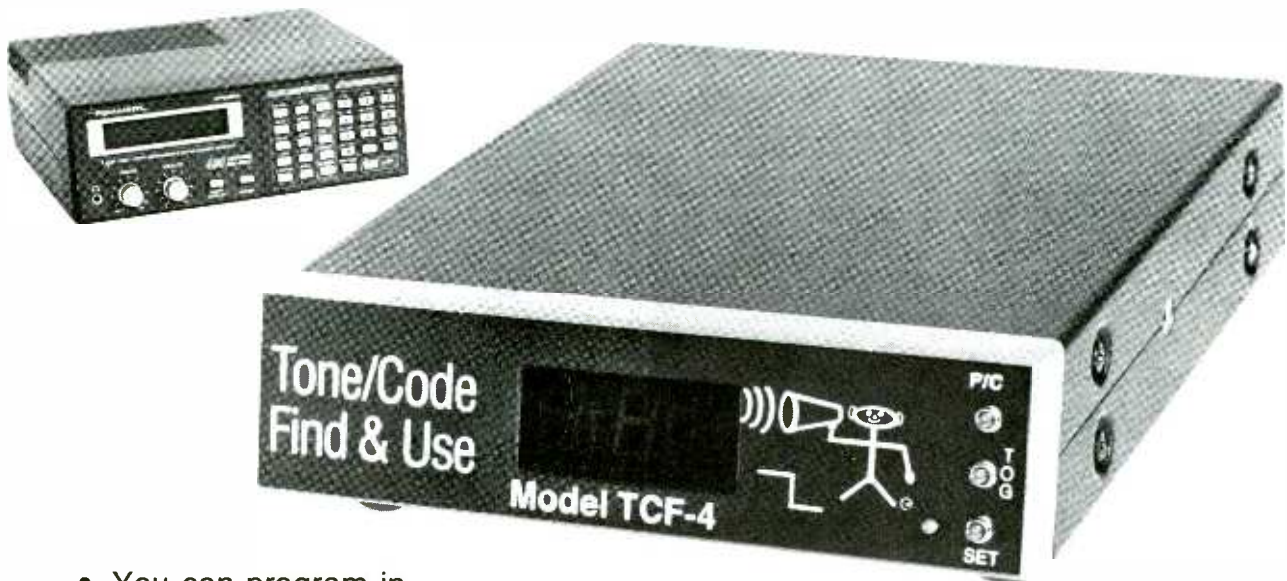

- You can program in up to ten tones or digital codes in any combination on any or all channels.
- Carrier squelch can be put on any channel.
- Connections between Finder/User and Receiver are very simple. A modular telephone jack (RJ 45) is on each unit with a short cable between them.
- The Finder/User is ruggedly built and can be run on 12V DC for mobile applications. A wall adapter is supplied for 110V applications.
- Internal memory back-up battery retains your program for a thousand hours in the event of power loss.
- Front panel programming for ease of operation.
- Three year warranty on the Finder/User.
- Price \$329.95 + \$30.00 installation. VISA or MasterCard accepted.

FOR MORE INFORMATION CONTACT:



MEASUREMENTS DIVISION
AUTOMATED INDUSTRIAL ELECTRONICS CORP.

141 GRANITE ST. P.O. BOX 70 BATESBURG, S.C. 29006 (803)532-9256 FAX(803)532-9258



Propagation conditions: Eastern United States

How to use the propagation charts: Propagation charts can be an invaluable aid to the DXer in determining which frequencies are likely to be open at a given time. To use the propagation charts, choose those for your location. Then look for the one most closely describing the geographic location of the station you want to hear.

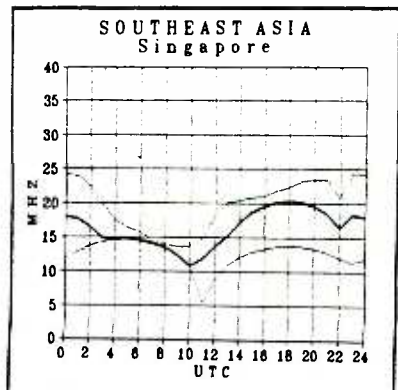
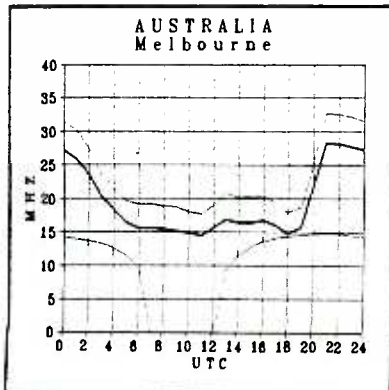
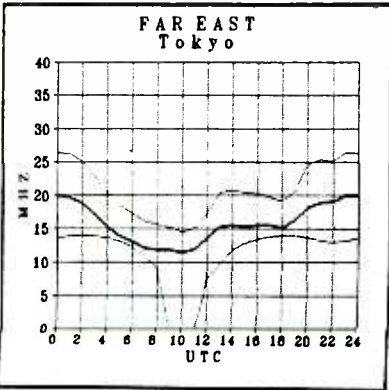
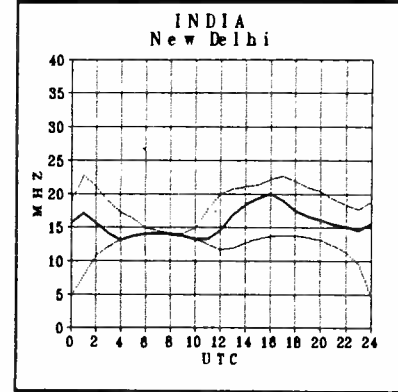
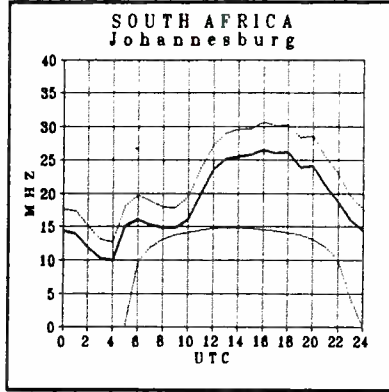
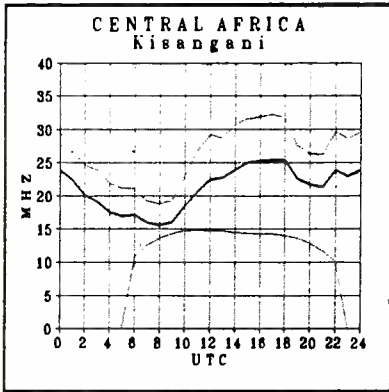
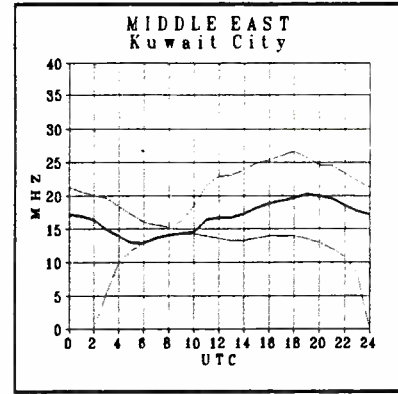
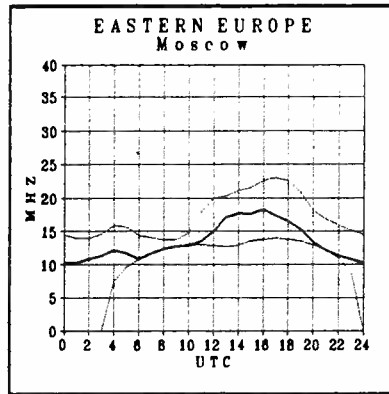
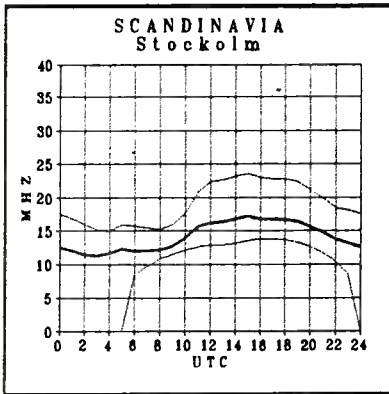
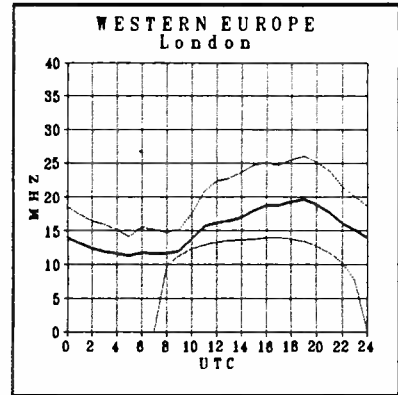
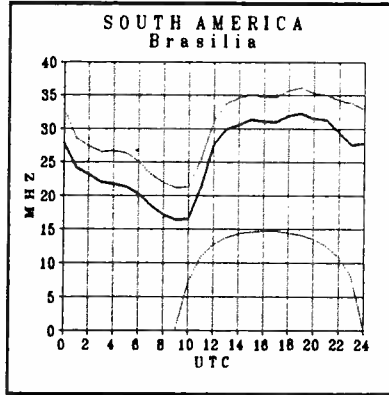
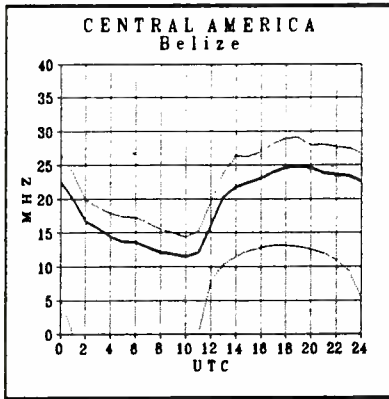

Propagation Conditions: Western United States

Once you've located the correct charts, look along the horizontal axis of the graph for the time you are listening. The top line of the graph shows the highest, or maximum usable frequency (MUF), the heavy middle line is the frequency for best reception, or optimum working frequency (OWF), and finally, the bottom line is the lowest usable frequency (LUF). The strongest signal will be found along the heavy middle line.

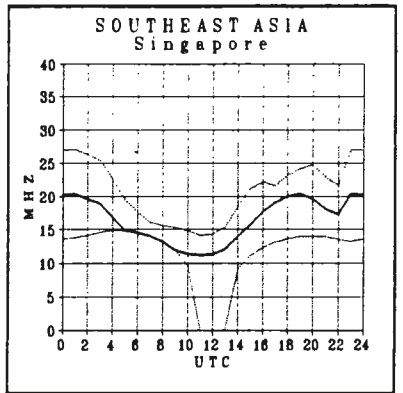
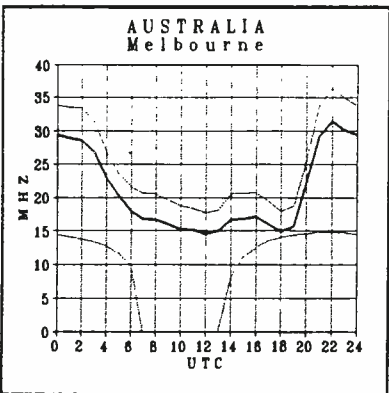
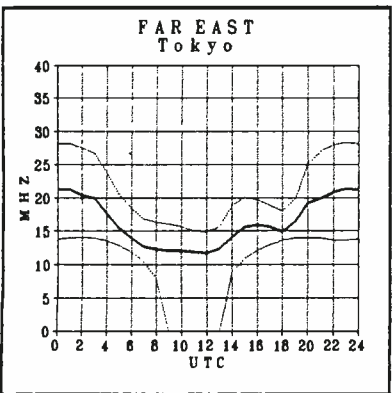
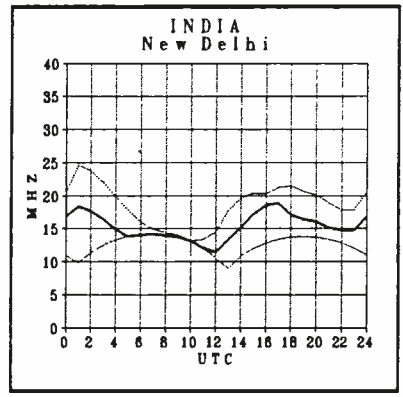
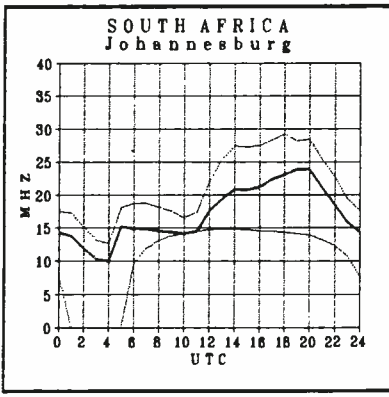
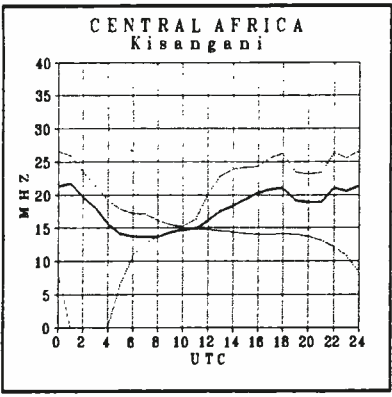
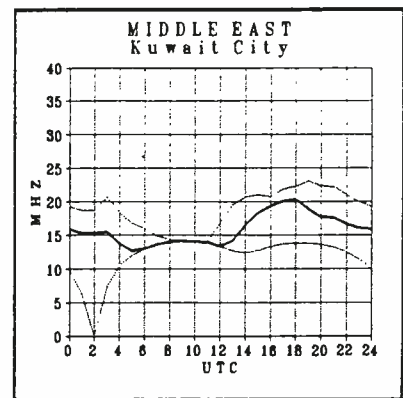
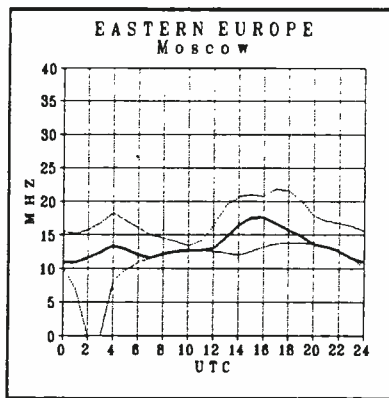
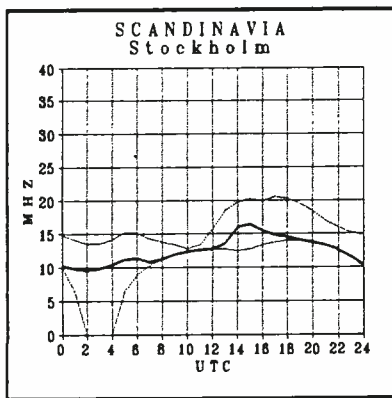
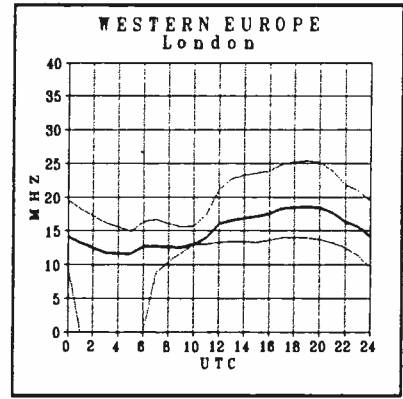
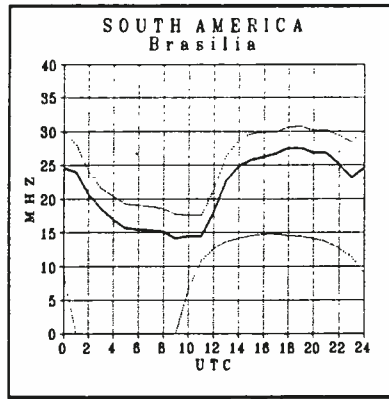
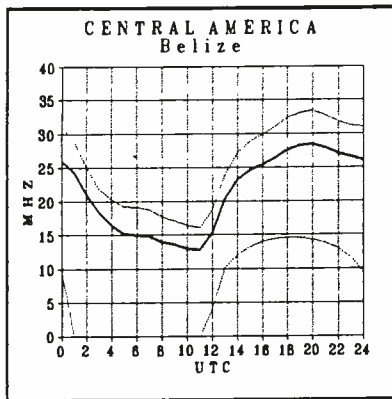

what's new?

Larry Miller

Sharpen Up

If you'd like to sharpen up your Sony ICF-2010/2001D receiver, Kiwa Electronics has just the thing. Kiwa has redesigned their 455 kHz filter module to specifically replace the Narrowband IF filter in the '2010/2001D.

The new filter module is called the FM 3.5/S and is designed to provide superior narrowband AM and SSB performance. It provides selectivity (-6 dB bandwidth) of 3.5 kHz (compared to the original 4.2 kHz) for improved interference protection. Complete step-by-step installation instructions are included.

For more information, contact Kiwa at 612 South 14th Avenue, Yakima, Washington 98902 or call 509-453-KIWA. Tell Craig Siegenthaler that *MT* sent you.



The 900 MHz Phones... Are Coming

You've heard rumors about them. Perhaps you've even seen them advertised for sale in catalogs. Three manufacturers now have official FCC approval to make these devices — Panasonic, VTECH and Code-A-

Phone. VTECH's Tropez 900DX was reportedly in stores at the end of 1991 at a suggested retail price of \$299.00. Panasonic's \$499.95 KX-T9000 900 MHz cordless phone was released last month and Code-A-Phone's \$400.00 Epic90000 will be available this summer.

Code-A-Phone appears to have fallen head-over-heels in love with the 900 MHz phones, so much so that according to President Jim Bazet, the company already has a second-generation model in the works. But Code-A-Phone is not alone. Bill Kopp, vice president and general manager of Panasonic's Home Office Group, touts the 900 MHz phones as "a real breakthrough [that has] significantly better reception, greater range and better security."



Cordless Security

If better security is all you're looking for, though, why go to 900 MHz? In the latest Hammacher Schlemmer catalog, we spied a cordless Phone-Mate telephone which provides privacy for only \$200. Its patented Secure Call circuitry scrambles the signals between the hand-set and the base—the only place they can be intercepted by

radio. It also scans ten available channels for the best reception in your environment. Call 1-800-543-3366 for more information.

Turn those Beams

Philips ECG has introduced a heavy-duty antenna rotor that the company says will turn and accurately position even the largest scanner, shortwave, TV or FM antenna. The U-105 Rotator's precision-cut, hardened steel drive train and high torque "can easily handle the largest...array."

Also featured by the unit are a durable, one-piece cast aluminum housing, large bearing surfaces, reinforced mast support for lateral loads, and a ball bearing for thrust (vertical load). A water-tight seal and fully lubricated drive train further equip the U-105 for operation in high winds and the harshest weather extremes.

The U-105 comes with an automatic, synchronized control unit and three-conductor cable for control-to-drive unit connection.

Philips does not say how much the U-105 will set you back but they do offer to put you in touch with a local dealer if you'll just call their toll-free number, 1-800-526-9354.

Maritime Frequency Directory

The *Maritime Frequency Directory* by Robert Gad is a brand new offering from Official Scanner Guide, and is the first exhaustive maritime radio directory to integrate HF listings for the shortwave enthusiast with VHF/UHF material for the scanner hobbyist.

Covering the contiguous United States, Gad's work is alphabetized

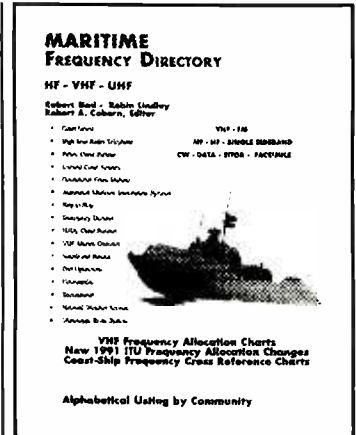

by state, city, and licensee. Service type is included along with frequency, call sign, channel number and use.

An introductory section provides a glossary of terminology as well as tables of frequency assignments (extensively changed as of July, 1991).

To order the *Maritime Frequency Directory*, send \$24.95 plus \$3.05 shipping to Official Scanner Guide, P.O. Box 712-MT, Londonderry, NH 03053.

New Monitoring Experience

If monitoring your local police has gotten a little dull, why not specialize in tuning in arrows? We're talking about hunting arrows.

The ETS Corporation has introduced the Beacon Arrow Tracking System. The system utilizes a tiny transmitter and lithium battery that screws onto the arrow shaft just behind the head. You leave the connection loose until you're ready to hunt then tighten it up to make the connection. A handheld receiver then allows the hunter to find lost arrows and wounded animals.

In fact, that's one of the benefits of the Beacon Arrow Tracking System. If you do hit an animal and the

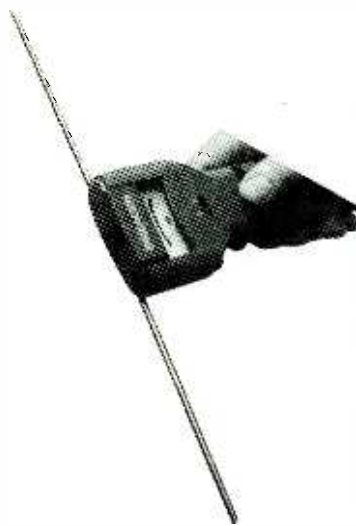

shaft breaks off as the wounded creature runs through the dense underbrush, the arrowhead and transmitter stay imbedded in its flesh, acting as a "beacon" that you can follow until it dies or you do.

The lithium battery keeps the transmitter going for 40 hours and depending on terrain, it can be tracked for 300 yards. The module adds just 70 grains to the arrow's total weight. For more information on the Beacon Arrow Tracking System, write the ETS Corporation at Box 839, Dundee, Illinois 60118 or call 708-426-2215.

Scanning Software

DataFile's new ProScan, Version 1.0, is an easy-to-use yet powerful piece of software that will make the job of tracking frequencies a lot less taxing. With ProScan you can track up to 9,999 records. ProScan features an onscreen listing of records. Each contains a bank number, channel/record number, frequency number, name, location, class, type and call sign. These records can be listed in order by channel, frequency, name, location or class. Changing orders is as easy as pressing the left or right arrow keys.

ProScan can also seek individual records by channel number, frequency number or name. "Intelligent Seek" provides for closest match when an exact match is not found. And not only does ProScan print reports by channel, frequency, name, location or class, it prints selected groups as well.

ProScan requires an IBM or compatible computer, MS/PC-DOS version 2.0 or higher, 640k RAM, hard disk and can be used with IBM/Epson or compatible printers. ProScan is available for just \$39.95, making it one of the more affordable pieces of software on the market. A demonstration version is available for \$7.50, applicable to purchase price.

To order your copy, send check or money order to DataFile Inc., P.O. Box 20111-MT, St. Louis, Missouri 63123. Please specify 5-1/4 or 3-1/2 inch disks. Be sure to say that you read about it in *MT*.

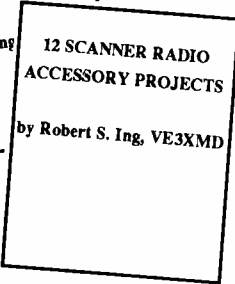
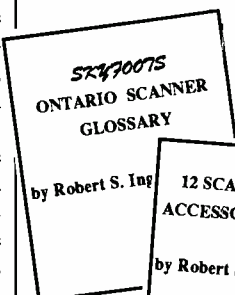

Canadian Scanning, Eh?

Ontario's Phillip Boucher has released two new booklets, "perfect companions to our company's *Toronto Scanner Directory*. Both books are written by Robert Ing.

Book number one is called *12 Scanner Radio Accessory Projects* and is designed for the "roll your own" hobbyist. *Skyfoot's Ontario Scanner Glossary* is "an extensive guide to terms used both on and off the air in the scanner hobby."

12 Scanner Radio Accessory Projects is \$6.95 plus \$1.00 postage and handling; *Skyfoot's Ontario Scanner Glossary* is \$4.95 plus \$1.00 postage. For more information or to order, write P.O. Box 37-MT, Str. N. 2930 Lakeshore Blvd, W. Etobicoke, Ontario, Canada M8V 3S4.

High Performance 800MHz FREE CELLULAR FREQUENCY CHARTS!

MAX 800 GROUND PLANE

- Absolutely the best reception . . . 10 times better!!!
- Astounding results outside using our RG6 cable
- Mount directly on base or hand-held scanner

Only \$19.95

Base scanner adapter - \$15.00
Hand-held scanner adapter - \$12.00
50 ft RG-6 cable assembly - \$35.00

Max Cellular Mag Mount - mobile 800 scanner antenna - \$29.95
The Stinger - compact 800 MHz hand scanner antenna - \$7.95
Loop Yagi - highly directional 13dB gain (3ft boom) - \$75.00

Cordless and Baby Monitors FREE CORDLESS FREQUENCY CHARTS!

MAX 46-49 MHz DIPOLE

- The very best cordless phone and baby monitor antenna
- Hear conversations for miles around - don't miss anything!
- Install inside or outside
- Includes 50ft RG8X - BNC

Only \$49.95

MAX System™ Antennas and Accessories

146/220/440/GMRS GP	25.95
Telescopic Whip	12.95
Telescopic GP	29.95
146/220 Mag Mount	29.95
146/440 Mag Mount	29.95
BNC Mag Mount	12.95
Custom Ground Plane	39.95
Telescopic Mag Mount	29.95

1-800-487-7539 **ORDERS ONLY**
508-768-7486 **FAX**
508-281-8892 **INFO**
SASE for free Catalog

Send Payment To: Cellular Security Group
4 Gerring Road
Gloucester, MA 01930

CK-MO-MC-VISA Accepted (MA add 5%)
US shipping and handling \$4.00

The Guide to the AR1000

If you own an AOR AR1000 wide-range hand held scanner, you know that it's a powerful radio but, like other AOR scanners, documentation is skimpy. *The Guide to the AR1000*, which covers all models of the AR1000 and Fairmate HP100/200 scanners, is written for both beginner and veteran.

The number of topics covered by author Howard Bornstein will open the eyes of anyone who owns one of these scanners. Because the publication is produced independent from ACE or AOR, it discusses both the good and bad points of the radio and finds ways to get you past the AR1000's famous "idiosyncrasies."

The 90 page *Guide to the AR1000* comes with ten blank bank templates that you can use to record the contents of all 1,000 scan channels. In addition, the *Guide* comes with a handy, six panel, Quick-Ref-

erence Card that contains a concise descriptions of all the major operations of the AR1000.

Frankly, the bottom line is this: this is the ultimate owner's manual. Too bad there aren't ones for other scanners, especially AOR models. *The Guide to the AR1000* is available for \$14.95 plus \$3.50 shipping from Design EQ, P.O. Box 1245-MT, Menlo Park, CA 94025.

California Radio Map

If you're one of those people who has to know everything about a specific transmitter site or if you're someone who likes to pile the kids in the car and check out a mountaintop repeater, *Radio Sites of Central and Southern California* is for you.

This handy book presents a ready source for accurate and current data detailing nearly 400 individual two-way radio sites, site management and ownership, site

Radio Sites of Central and Southern California

including portions of western Arizona and southern Nevada

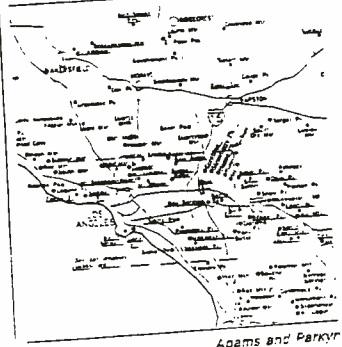

coverage and frequency coordination organizations. The amount of information is intense. There are even directions to the sites—"Take Palm Street up to the side of the mountain. Palm turns into a gravel road at 0.5 miles. The site is surrounded by a chain link fence..."

Radio Sites of Central and Southern California is \$20.00 and can be obtained by mentioning *MT* when you write to Arroyo Borracho Press, P.O. Box 91468, Pasadena, California 91109-1468.

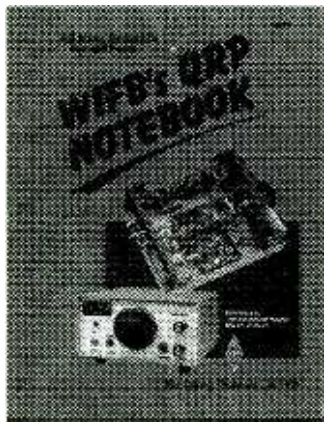

Low Power Communications

"QRP" is the abbreviated expression for low power, having survived the days of Morse, and now generically applied to low-powered transmitters. Two of the hobby's leading experts on the subject have introduced books to get you into the hobby, too.

MT readers and long-time hams know the name Doug DeMaw, author of *WIFB's QRP Notebook*, for his simple, yet authoritative technical articles on all aspects of radio communications.

DeMaw's 180-page notebook contains chapters on layout, parts sources, receiver design and circuits, transmitter design and circuits, even technical tips for building and operating.

This nice guide for the home experimenter can be ordered for \$10 plus \$3 shipping from the American Radio Relay League, 225-MT Main St., Newington, CT 06111.

Former *MT* "Experimenter's Workshop" columnist Rich Arland has also addressed the subject in his *Low Power Communications, Volume 1*. Arland takes you through a complete QRP workout with sections on QRP history, the QRP "mindset," getting started, antennas, propagation, basic QRP operating, contesting, miliwatting, digital QRP, solar power, computers, getting organized, QRP products and organizations.

Low Power Communications is a 95 page book that will cost you \$14.95 plus \$2.00 S&H from Tiare Publications, P.O. Box 493MT, Lake Geneva, Wisconsin 53147.

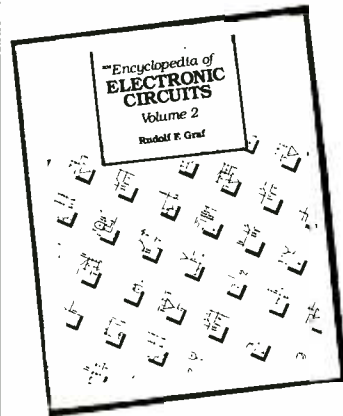

Cooking With Electricity

Looking for a good electronic circuit cookbook? This is it. *The Encyclopedia of Electronic Circuits, Volume 2*, contains over 1000 simple schematics for virtually any elec-

tronic device you can think of: flashers, converters, detectors, amplifiers, theremins, motor speed controls, battery chargers, exhaust emission analyzers, oscillators, sound generators, mixers, lasers....

Author Rudolf F. Graf assumes some electronic knowledge of the reader. No extensive notes or parts sources are provided, just schematics, but lots of them!

The Encyclopedia of Electronic Circuits is \$29.95 from TAB Books, Blue Ridge Summit, Dept. MT, PA 17294-0850.

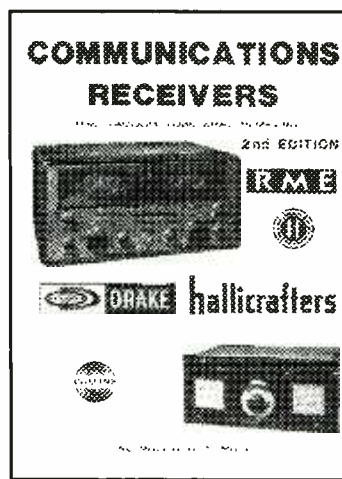

Tubular Memories

We live in a hi-tech era, exposed daily to the intimidation of an electronic environment with new devices being produced at a fever pitch. Many of us yearn for simpler times, providing a ready market for nostalgic reminders of yesteryear.

Raymond S. Moore's second edition of *Communications Receivers: The Vacuum Tube Era* is expanded over the original and, according to the author himself, will be the last edition. Collectors and radio nostalgia buffs had better get one while they are still available.

The book is printed entirely on glossy paper, producing contrasty photos and sharp descriptive text, alphabetically listed from Allied through Tobe.

They're all here—Hammarlund, National, Hallicrafters, Heath,

Drake, RCA, Meissner, Pilot, Grebe, Collins, Multi-Elmac, Howard, McMurdo Silver, Gonset and many more. A delight to thumb through and remember.

Send \$19.95 plus \$3 shipping to get your copy of *Communications Receivers: The Vacuum Tube Era, 1932-1981*, from ER Bookstore, Box 57-MT, Hesperus, CO 81326.

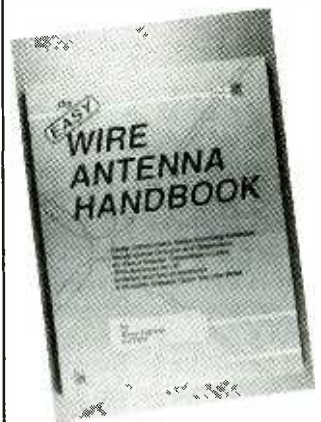

Easy Wire Antennas

No doubt about it. After questions about amateur transceivers subside, a barrage of antenna questions ensues. And justifiably so; the antenna is the most important piece of equipment you can own next to the radio.

Author Dave Ingram is well known for his antenna expertise. His newest work, *The Easy Wire Antenna Handbook*, is a quality-printed, excellently-illustrated how-to book, covering all aspects of HF transmitting antennas (which are good for receiving as well) and tuners.

Windoms, zepps, deltas, slopers, inverted vees, dipoles, wire beams, rhombics—they're all here and more. Even inconspicuous "hidden" antennas for apartment dwellers.

Easy Wire Antenna Handbook is available for \$9.95 plus \$3 shipping from Universal Electronics, 4555 Groves Rd., Suite 13-MT, Columbus, OH 43232.

Review

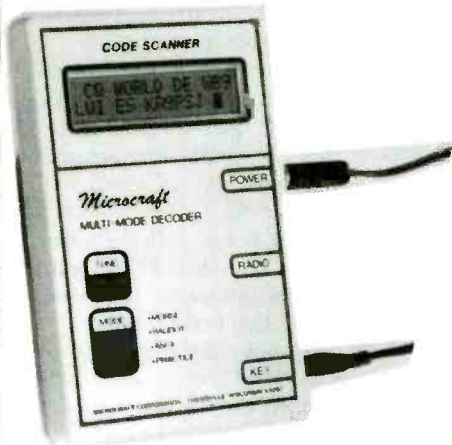

Microcraft Multimode Decoder

Professionally packaged and compact, the simplest decoder/display to hit the market is Microcraft's Code Scanner (model CSCAN), selling for \$189 plus \$6 shipping and handling.

Measuring 3-1/2" wide and 5-3/4" tall, the Code Scanner hooks to either the record output, earphone or external speaker jack of the host shortwave receiver and allows automatic display of up to 32 characters on a two-line LCD.

You'll know when the receiver is properly tuned to the decoder's sharp filters--an LED will blink with the audio.

Automatic speed tracking in Morse (3-70 words per minute), RTTY (60, 67 and 100 wpm) and ASCII are all selectable by a single pushbutton.

A built-in speaker allows continued signal monitoring when the instrument is plugged into the host receiver, thus disabling that radio's internal speaker. An internal code practice oscillator—with readout—is enabled when a hand key is plugged into the accessory jack.

And, if you are just learning the Morse code, a special practice mode is included.

The unit is powered either by external 12 VDC or the provided AC wall adaptor.

For additional information, contact the Microcraft Corporation, P.O. Box 513-MT, Thiensville, WI 53092, or call 414-241-8144.

World's Smallest Recorder

This is an Amazing little recorder. Small enough to fit in a pack of cigarettes, packed full of features. Comes with recorder, docking port w/speaker, earphones, padded case, AC adapter and more. This very high quality recorder is use by the hundreds in federal agencies. Built by Panasonic to the highest standards.



Only \$299.95
Free shipping

Forbidden Technologies

The Spook Book deals head on with Electronic Surveillance, Countermeasures, Lock Picking, Rearming Hand Grenades, Amateur Rocket Weapons and much more. Favorably reviewed. 258 pages, 8.5x11, soft bound..... \$34.95 postage paid

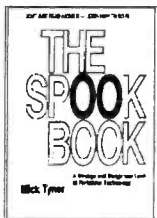

Surveillance Audio Amplifiers

SAA is a Surveillance Specialist cookbook. Covering any and all subjects concerning Audio Surveillance with no exceptions. From wiretapping to audio filtering, this is a must have publication. 277 pages, 8.5x11, soft bound..... \$34.95 postage paid



Now Hear This!

Electronic Eavesdropping Equipment Design

Full of detailed professional quality schematics and plans for all types of Electronic Surveillance Equipment. Excellent book! 110 pages, 8.5x11, soft.....\$34.95 postage paid



Computer Bulletin Board

Largest computer BBS in NC!

Nets: FidoNet 1:379/16 WWIVnet 1@7418
Online Capacity: 4300 megs
Software: Wildcat! 3.0 (beta test site)
Supporting 1200-14400 baud, v.32/HST/MNP
Regional support BBS for NCSA in Wash., DC
Over 62,000 files and 260+ message areas
Hundreds of monitoring and ham radio files



- * Disk swapping available
- * Inhouse color scanning service
- * Over 350 megs of adult graphics
- * Too many features to list!

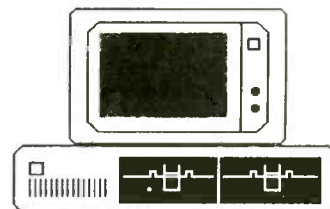

24 hours a day, 7 days a week
704-545-7076 or 1205

Advanced Electronic Technologies

Suite 173, 5800-A North Sharon Amity Rd., Charlotte, NC 28215

Order Toll Free 1-800-543-5207 Info/Tech (704)545-2681

FAX (704)545-9061 Computer BBS (704)545-7076

"Dx Multi Scan"™ Series

BASE and MOBILE

scanner antennas from WINTENNA

All less than \$40.00 ea.

Scan 50 Scan Master™ Multi Wave™ 30-1200 MHz
Our Best Base Station Scanner Antenna. Gain: Up to 7 dbi Multi Wave™ resonant point for all scanner bands. Highest gain and performance on Lo-HI VHF/UHF Police, Fire, Amateur, Telephone, and Cellular phone bands.
Scan 50A Same as Scan 50, with built-in amplifier.



ASA

AUTOMOTIVE SECURITY & ACCESSORIES
"Service is the Reason For Our Success"

Tel: (704) 358-4815 P.O. Box 30162
Watts: 1 800 732 2681 Charlotte, NC 28230

DON'T MISS OUT ON THE OVERNIGHT ACTION !!
CAN'T TAKE A SICK DAY FOR THE SHUTTLE LAUNCH ?!

Listen to it ALL when YOU want to with ... MESSAGE CATCHER

It lets your tape recorder monitor when YOU can't
Connects to your receiver's or scanner's speaker jack.
Recorder turns on only when MessageCatcher "hears" activity
Includes: - MessageCatcher Unit
- Power Supply, Cables & Plugs

.. All this and a good night's sleep for ..
only \$19.95 (plus \$3.85 for s&h in USA)

To order, send check to: RADIO ACCESSORIES,
Box 168, Melvin Village, NH 03850 (603) 544-2110

Larry Van Horn's Monitoring the Strategic Air Command

Comprehensive. Authoritative. It's the ultimate "how to" book on monitoring the ultimate war machine. Includes shortwave and scanner frequencies. By America's acknowledged leader in utility monitoring. \$12.95 plus 1.50 book rate or 3.00 UPS from DX Radio Supply, Box 360, Wagontown, PA or use MC/VISA and call 215-273-7823.

ICOM R7100 VHF/UHF Receiver

The long-awaited follow-on to the successful R7000 has finally been released from ICOM. It is not a replacement, however; the venerable 7000 is scheduled to remain in production. Many government agencies utilize it in large numbers.

The R7100 is smaller (9-1/2"W x 3-3/4"H x 9-1/2"D), lighter (13 lbs) and more cosmetically "consumer" than its predecessor. A hinged wire bail can be used to tilt the receiver upward.

Like the 7000, an N connector is provided on the rear apron of the 7100 for the antenna, and a 10.7 MHz output is available for a video or spectrum display unit.

Its frequency coverage is 25-2000 MHz without the 1000-1025 MHz gap of the 7000. It also scans conventionally, resuming its scan 2 seconds after signal dropout. Other scan configurations may be selected as well.

All modes are front-panel selectable (USB and LSB had to be selected from the rear panel on the R7000). Modes are AM, AM wide, FM, FM narrow, FM wide, USB and LSB. An audible "beep," volume-control adjustable, confirms any key press.

Triple conversion (778.7 MHz for 25-512 MHz, 266.7 MHz for 512-1025 MHz; and 10.7 MHz and 455 kHz for final IF) is available on all modes except WFM (no 455 kHz). Automatic frequency control (AFC) prevents frequency drift on FM. A noise limiter reduces AM/SSB pulse interference.

The display is an LCD rather than the 7000's vacuum fluorescent, and the S meter is smaller. Frequency readout is to 100 Hz with selectable tuning increments of 100 Hz and 1, 5, 10, 12.5, 20, 25 and 100 kHz. A 1 MHz step button is also included.

Nine hundred memory locations (9 banks of 100 channels each) store frequency, mode and step search; the tuning dial may be used to change any memory frequency chosen. Unwanted memory channels may be locked out with the "Skip" key. Scanning speed is selectable as 5 or 12 channels per second.

A 24-hour clock/timer allows two separate on/off times for programmed recording of any two memory channels. A dual-function (carrier and voice activated) squelch control mutes audio whenever a signal is not present.

Ten separate frequency ranges can be searched ("Programmed Scan") in any combination, and up to 100 memory locations may be autoloading ("Auto Memory Write Scan") when a signal is detected. A priority function ("Window Scan"), watching certain guard channels for activity while listening to other frequencies, is also available.

A lock key prevents accidental rotation of the main tuning knob from changing frequency,



but does not deactivate any other control. An attenuator key may be pressed to prevent strong signal overload in dense RF environments.

Power requirements may be chosen from 120/240 VAC or 13.8 VDC with the included mobile cord. A collection of plugs for the accessory jacks as well as spare fuses are also provided.

A Closer Look

Switched on, the receiver sports a bright, backlit LCD and an illuminated S-meter. Three dots on the LCD are intended as an aid in tuning AM and FM signals more accurately. In fact, the center dot remains activated +/- 4 kHz of center frequency on AM and NFM, and +/- 25 kHz on WFM. It doesn't work on very weak signals.

Sensitivity, specified as 0.2 uV SSB, 1.6 uV AM and 0.35 uV NFM for 10-12 dB quieting, is excellent, superior to the R7000 on UHF (above 200 MHz).

Selectivity specs are vague, stated as "more than" 2.4 kHz SSB, 6 kHz AM/NFM, 15 kHz FM/WAM and 150 kHz WFM. No shape factor or ultimate attenuation for the filters is given, although spurious rejection is stated as "more than 50 dB."

The wide FM filter is much too wide, allowing moderate-strength FM broadcasters to be heard at least 250 kHz off their assigned frequencies. Then the center-tuning indicator malfunctions, displaying a correct tuning icon when the receiver is actually midway between two occupied channels where both signals are heard simultaneously.

The other (narrower) FM and AM filters seem adequate for utilities monitoring since VHF and UHF assignments are regularly spaced, not tightly clustered as they are in the interference-plagued HF (shortwave) spectrum.

Audio output is given as more than 2 watts (1 watt on NFM) at 10% total harmonic distortion (THD) into an 8 ohm load. The small internal speaker provides clear, room-filling audio at high volume settings.

There are only three knobs but 42 pushbuttons (14 of which are dual function), typical of Japanese designs which offer a myriad questionable-use features which render many

functions impossible to understand without thoroughly reading the manual.

The pushbuttons are small. The numeric keypad buttons are only 1/8" high and nearly flush with the front panel, awkward for large fingers or long fingernails. Key bounce occasionally made double entries which had to be cleared and re-entered.

The tuning dial has a finger indent and rotates smoothly, but our new test unit had a wobbly tuning shaft that couldn't be corrected by tightening the friction brake tension.

Under very quiet conditions the squelch relay could be heard mechanically switching inside the cabinet; slightly distracting at first, users should have no problem adjusting to it once they recognize that it's not a defect.

There were very few "birdies" (internally-generated spurious signals). They can be verified by pressing the attenuator key; if the signal level is not substantially reduced, it is a spur.

We found single-sideband reception (SSB) quite acceptable, although slightly unstable when compared to an HF general coverage communications receiver. While 100 Hz tuning steps are really too coarse for totally-natural-sounding sideband reception, voices will be completely intelligible.

As with the R7000, squelch settings on the R7100 will vary depending upon mode. This means that scanning through a combination of modes may mean some misses on extremely weak signals.

Scan delay was erratic in the most popular mode, two second delay. If the signal dropped out but returned again, even if a reply came on from the responding unit, scanning would resume one second later—even though the station was still talking.

The Bottom Line

The R7100 costs more than the R7000, so prospective customers will need to assess their relative features and faults. Certainly the 7100's no-gap frequency coverage, more conventional scanning, faster scan rate, higher UHF sensitivity, clock/timer, smaller profile, AC/DC power supply and 900 memory channels weigh heavily in its favor.

But it has its drawbacks, too, such as its consumerized quality, erratic scan delay, and unfamiliar keyboard routines.

But the good points outweigh the bad, and the prospective buyer, after considering the advantages and the disadvantages, should still be impressed with this new entry from ICOM.

Improve Your Scanning Coverage!

GRE America is proud to introduce a new family of products to enhance your scanning pleasure! First, GRE has designed the new **Super Converter 9001** for base model scanners. The 9001 converts 810 MHz - 950 MHz down to 410 MHz - 550 MHz. The 9001 is the perfect alternative to buying a new, expensive scanner covering the 800 MHz band. Next, GRE announces the new **Super Amplifier 3001** for base model scanners. The 3001 will increase gain by as much as 20 dB, and is engineered to help scanners with low sensitivity pull in weak signals. Both products use BNC connectors, (1) 9 volt battery and have an off/pass switch for returning to normal operation.



Super Converter 9001 & Super Amplifier 3001



Super Converter II



Super Amplifier



All-Band Antenna

U.S. & International Distributorship inquiries welcome. Please call GRE for further information!

Let GRE Manufacture Your Radio Products!

GRE America, Inc. is a leading OEM developer and manufacturer of radio telecommunications products such as:

- Cordless Telephones
- CB & Marine Radios
- Spread Spectrum "engines"
- Remote Monitoring Systems

If you need a high quality, cost competitive, reliable manufacturer, GRE will provide you with a free production quotation.

For more information, please call GRE at (800) 233-5973. GRE is a subsidiary of General Research of Electronics, Inc.

GRE GRE America, Inc.

GRE America, Inc.
425 Harbor Blvd., Belmont, California 94002
(415) 591-1400 Outside California: (800) 233-5973

Want to increase your code speed quickly and easily, and enjoy doing it?

Who says Morse Code has to be hard?

Thousands of radio enthusiasts have discovered just how easy and fun learning and improving their Morse Code skills can be. **MorseMan Plus**, the premier Morse Code trainer for the IBM-PC computer, has helped many radio enthusiasts realize their dream of obtaining an amateur radio license and upgrading. Just look at what your friends, and the experts say:

"A slick commercial program that clearly ranks among the top Morse trainer programs" - Karl Thurber, W8FX, CQ Magazine
"sickest program to come along in a long time - I highly recommend it to those who want to learn Morse properly" - Ike Karschner, N3IK, Monitoring Times
"One of the top Morse trainers available", Gordon West, WB6NOA

If you are just a beginner, then **MorseMan Plus** will teach you the code, at your own pace and speed, and is even **Farnsworth** selectable. After you know the code, **MorseMan Plus** lets you progress rapidly by allowing you to choose from a variety of training methods that are geared toward helping you gain proficiency in the fastest possible time. You can choose from copying random characters, true random words (from a 50,000 word database), listening to computer simulated QSO's (over 3 trillion different ones possible), realistic random call signs (in pileup fashion) - you can even taking a simulated FCC/VEC code exam. You can also create and send ASCII text files as well as practice only the characters that you desire. **MorseMan Plus** will even record everything it generates to a file for later use.

So, if you want to get ahead in your Morse Code training, without the headaches, then get **MorseMan Plus**. For only \$24.95 (plus \$4.00 s/h, \$9.00 overseas) you can have the best training program available. Call 1-800-525-7235 anytime, 24 hours a day (or fax 205-757-8664) to order with Visa or Mastercard, or send Check/MC to the address listed below.

(MorseMan Plus requires an IBM-PC or compatible with at least 512k RAM and DOS 3.0 or later. Please specify disk size when ordering)



renaissance software & development

killen plaza - box 640
killen - alabama 35645

(205)757-5928 - fax (205)757-8664

Computer Aided Scanning

a new dimension in communications from Datametrics



Now Radio Shack PRO 2006 owners for the first time have access to the exciting world of Computer Aided Scanning with the highly acclaimed Datametrics Communications Manager system. Computer Aided Scanning is as significant as the digital scanner was five years ago and is changing the way people think about radio communications.

- The Datametrics Communications Manager provides computer control over the Radio Shack PRO2006 receiver

- Comprehensive manual includes step-by-step instructions, screen displays, and reference information.

- Powerful menu driven software includes full monitoring display, digital spectrum analyzer and system editor.

- Extends receiver capabilities including autolog recording facilities, 1000 channel capacity per file, and much more.

- Uses Innovative Machine State Virtualizer technology (patent pending) hardware interface by Datametrics.

- Simple 4 step installation - no soldering or modification to normal receiver operations.

Datametrics, Inc

- Computer Aided Scanning system \$ 349
- PRO2006 receiver w/interface installed and CAS system \$ 749
- Manual and demo disk \$15

Requires Radio Shack PRO 2006 receiver and IBM PC with 360K memory (640K for full channel capacity) and parallel printer port.

Send check or money order to Datametrics, Inc., 2575 South Bayshore Dr, Suite 8A, Coconut Grove, FL 33133. 30 day return privileges apply.

- Radio Shack's New DX-390 Portable
- Sony ICF-SW77 May Have Reduced Chugging
- Sony ICF-2010 Remains for 1992
- Japan Radio NRD-535D's Variable Bandwidth

DX-390 Replaces Venerable DX-440

A number of bargain hunting *MT* readers who were on their toes managed to snare Realistic DX-440 portables, normally \$199.95, on the cheap during a recent sale at Radio Shack stores. Here and there some remain, but as we go to press Radio Shack tells us that once those are gone, so is the '440—forever. It marks the end of an era in which one of the best bargains in world band radio was available at nearly any mall or shopping center in North America.

Its replacement, the \$239.95 Realistic DX-390, is expected to appear on dealer shelves by late March. The '390 falls into the large-midsize category, being similar in size and appearance to the Grundig Satellit 500 and weighing 4.5 pounds with its full complement of seven batteries: four beefy "D" (not "C" as in the Radio Shack catalog) and three small "AA." The radio also operates from 120V AC via an optional outboard transformer.

All this size and weight makes the '390 at least as unwieldy as the '440 for taking on airplane trips. Yet, it's nigh ideal for use around the house, backyard or on car trips—which is, after all, where nearly all shortwave listening takes place.

The Realistic DX-390, also sold as the similar Sangean ATS-818, tunes the usual FM band in stereo (via earphones only, although they aren't supplied), plus longwave, AM and the entire shortwave spectrum through 29999 kHz. Tuning increments are 1 kHz, and the large LCD's frequency counter reads out to that same degree of resolution. Tuning is by knob (in 1 or 5 kHz increments on shortwave), keypad, up/down slewing (in 5 kHz increments on shortwave) and rudimentary but effective scanning.



Bandscan Tuning Compromised by Muting

The curse of the '390's tuning knob performance is the extreme muting used to camouflage synthesizer chugging. True, this muting makes chugging all but imperceptible. But if you turn the tuning knob at much more than a snail's pace, the muting overwhelms, making stations inaudible. It's a bandscanner's nightmare—how can you know when to stop tuning if you can't hear anything? Hopefully this recent oddity in Sangean receiver design, apparently brought about by earlier complaints about chugging in the DX-440 and ATS-803A, will be revised.

Of course, if you know the frequency you wish to select you need a keypad, not a tuning knob. Alas, the '390's keypad is not in the conventional telephone-pad format, nor is it

backlit. However, it has good "feel"—pretty much equal to that of the \$1,000 Drake R8. Additionally, 45 presets are included, of which 18 work on shortwave. Those are activated via the keypad, not via separate buttons as on, say, the Sony ICF-2010, which requires a mere single push of a button to bring up a desired station.

Single sideband is demodulated using a BFO switch wedded to a variable-pitch potentiometer, as there are no separate LSB or USB switch settings. Although the '390 is fairly stable, the potentiometer tunes so broadly that it requires the fingers of a surgeon to adjust properly. Ergonomics aside, the end result is pretty good, especially when the "narrow" bandwidth is used.

Signal strength is displayed by a five-level indicator on the LCD, which is backlit. That same indicator automatically transforms into a six-second battery-strength readout when the radio is switched off. Additionally, there's a

power lock switch, useful for travels to keep the main batteries from running down accidentally. Tone is adjusted by a lone control, a step backwards from the separate bass and treble controls found on the '440-- which, by the way, continues to be sold as the Sangean ATS-803A. Says a Sangean spokesperson, "Why should we give up on a winner?"

Other features include dual bandwidths, an RF gain control, sleep off and a 24-hour clock/timer with two time zones. Thankfully, UTC is displayed at all times, regardless of whether the radio is on or off. The day of the week is not displayed, however.

Performance Characteristic of Price Class

The '390 is a typical performer for its price class. Sensitivity, an important variable in the central and western zones of North America, is good, but not outstanding. Audio quality is quite pleasant, the single tone control notwithstanding, although it sounds somewhat hissy.

Selectivity in the wide position is a bit broader than it should be for shortwave, but it's still adequate for receiving a good many signals without undue interference. The narrow position fares much better—it's excellent for when adjacent-channel interference rears its head.

Bottom Line: Minor Evolution from DX-440

In all, although the DX-390 is the replacement for the established DX-440, the differences are neither significant nor necessarily all positive. Yet, there's no question that the '390 will be a popular set for the same reasons as was the '440.

Sony ICF-SW77 May Have Further Improvements

At the other extreme of the chugging scale to the DX-390 is Sony's ICF-SW77, which when tuned sounds more like a Nintendo gatling gun than a radio. Further to last month's report on the forthcoming revised version of this portable, Sony Engineering advises us that they will try to improve on the chugging problem before the revised version comes on the market.

That means another delay, albeit for good cause. We had hoped to report on the '77 soon, but until the final revised version becomes available we can't begin to test it, much less report on it.

Sony ICF-2010 Not Discontinued

More good news from Sony is that they expect to keep the justifiably popular ICF-2010 in the Sony world band line at least throughout most of 1992. Given that the similarly priced new ICF-SW55 lacks synchronous detection and that the sync-equipped ICF-SW77, when it resurfaces, is to be relatively costly and require a computer-oriented mentality to operate, the retention of the '2010—top rated in the 1992 *Passport to World Band Radio*—is cause for celebration, indeed!

Japan Radio NRD-535D Now Has Variable Bandwidth

As reported last month, the RDI White Paper on the Japan Radio NRD-535 is to be made available in March. Very late in March, really, as we expect to obtain the matching speaker no earlier than sometime during the first week or so in March. One of the highlights of the RDI tests is of the variable-bandwidth system found only in the revised "D" version.

In a nutshell, the concept works and is a real plus. However, this welcome flexibility comes at the expense of considerable flyback near -55 dB, which in a "yes it does, no it doesn't" way degrades skirt and ultimate selectivity. Bottom line is that many shortwave operators will like the overall result, but few mediumwave (AM/BCB) DXers will.

JRC's New York office indicates that the variable-bandwidth feature will be made available for retrofit for under \$200 to those with '535's manufactured earlier. Sound unfair? Not really, as the street price of the '535D is expected to rise when the revised version appears on dealer shelves, likely by April. *Pas de déjeuner gratuit!*

Well, maybe a free *petit déjeuner*. JRC, to its credit, will replace old ROMs with new ones having superior computer interface capability, if computer interfaces are your special thing. But JRC has a "green" policy of recycling old ROMs, so to get your freebie you first have to return the old one.

If this seems Mickey Mouse, keep in mind that much of the depletion of the earth's ozone layer comes from the manufacture of electronic circuitry.



PRO-2006 Hyperscan Base & Mobile Scanner

\$359 Reg. \$399

UPS Shipping Included



Pioneer Data, Inc.

1515 N. Pacific Hiway
Woodburn, OR 97071

(503) 982-5115

A Radio Shack® Dealer

TOUCH-TONE DECODER/DISPLAY & ASCII CONVERTER BOARD

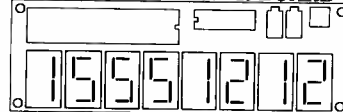

Model TDD-8 decodes and displays all 16 DTMF digits and provides an ASCII serial output. Digits are displayed on eight LED's. 32 character memory can be scrolled. It will accept almost any audio source, such as a scanner, tape recorder, telephone answering machine, etc. Serial output can be connected to your computer. IBM compatible software included for displaying, storing and/or printing time, date and number for automatic logging.

TDD-8 DTMF DECODER/DISPLAY/ASCII \$99
CAB-1 AUDIO & COMPUTER CABLES \$20
PS-12 110VAC TO 12VDC POWER PACK \$10
add \$5 S/H - VISA/MC ACCEPTED

MoTron Electronics TEL: 1-800-338-9058
310 Garfield St.#4 (503)-687-2118
Eugene, OR 97402 FAX: (503)-687-2482

(Touch-Tone is a trademark of AT&T)

PASSPORT'S "RDI White Paper" equipment reports contain virtually everything found during IBS' exhaustive tests of premium receivers and antennas. These reports are available in the U.S. from Universal Shortwave, EEB and DX Radio Supply; in Canada from PIF Books by Mail, Box 888, Hawkesbury, Ontario K6A 3E1; in the United Kingdom from Lowe Electronics Limited, Chesterfield Road, Matlock, Derbyshire DE4 5LE, England; and in Japan from IBS-Japan, 5-31-6 Tamanawa, Kamakura 247. For a complete list, please send a self-addressed stamped envelope to RDI White Papers, Box 300M, Penn's Park PA 18943 USA.

Tell them you saw it
in Monitoring Times!

Build an Active Antenna

You have heard many times the term "active antenna." Perhaps you have wondered "exactly what is this antenna and how might it be used?"

Let's start by defining the word "active." This does not suggest physical activity on the part of an electronic device. Rather, it tells us that the circuit is active in terms of voltage and current. A passive device, on the other hand, is a circuit that requires no operating voltage. It will exhibit some power loss as a signal is passed through it. Examples of passive devices are diode mixers, filters that use inductance and capacitance (LC filters) and all manner of wire antennas, etc.

An active mixer, on the other hand, uses a transistor or an IC, and operating voltage is applied to it. The mixer draws current and can cause a signal increase from the input to the output terminals. This is known as "conversion gain." Active antennas contain RF amplifiers that require an operating voltage. Some active circuits may be designed to provide gain, while others may have unity gain (1) or a negative gain

(signal loss). The nature of the active circuit depends upon its particular application.

Filters may be made active or passive. An active filter is often used to increase receiver selectivity at audio frequencies. This type of filter has no coils or inductors. Instead, it uses resistors, capacitors and ICs. An active filter may be designed for unity gain, or it may have a gain of 2 or 3, typically.

Active Antennas

What is an active antenna and why might we wish to build one? Active antennas are physically short, and they cover a wide spectrum of frequency. For example, an active antenna may perform uniformly from, say, 550 kHz to 50 MHz if it is designed well. This means that no antenna tuning or matching circuits are needed.

This type of antenna would be quite lossy if it did not include an RF amplifier section. In other words, if you connected a 6-foot whip

antenna to your SW receiver and measured a 6.7-MHz signal at S3, that same signal might register 10 dB over S9 on your S meter if you switched to a full size dipole that was cut for 6.7 MHz. However, if we add an RF amplifier to the 6-foot whip before the signal is routed to the receiver, the S meter will indicate a similar reading to that when the dipole is used.

Why Use an Active Antenna?

Active antennas provide an alternative to no antenna at all if you are an apartment dweller or live in an urban area where external antennas are prohibited. These small active antennas are desirable for those who conduct business travel and find it necessary to stay in hotels or motels while on the road. The SWL need not be without an antenna if he is willing to build an active one.

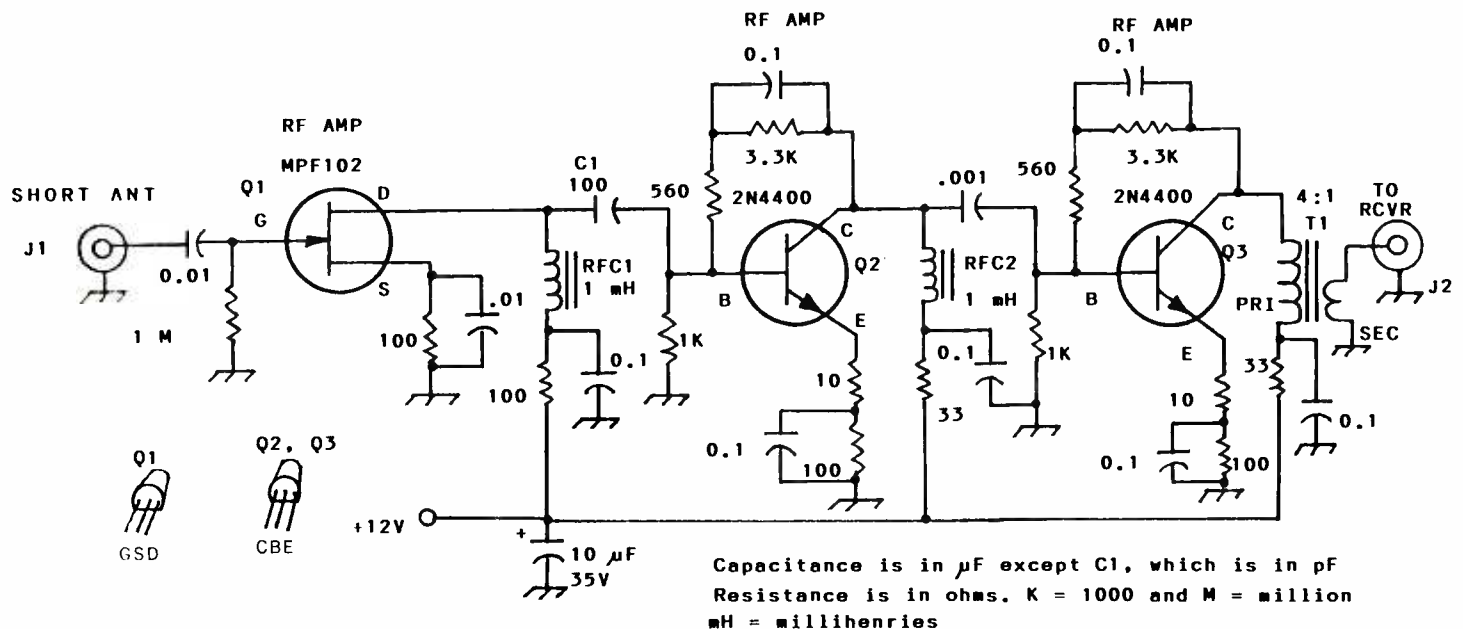

Figure 1: Schematic diagram of the active antenna amplifier. Capacitors without polarity marked are disc ceramic, 50 volts or greater. Resistors are 1/4 watt carbon composition or carbon film. RFC 1 and RFC 2 are miniature iron-core RF chokes (see text). J1 and J2 are jacks of the builder's choice. T1 has 12 turns of no. 26 enam. wire (primary winding) on an Amidon Assoc. or FairRite FT-50-43 ferrite toroid core (850 mu). The secondary winding has six turns of no. 26 enam. wire wound uniformly over the primary winding. Overall amplifier gain is approx. 30 dB.

A Simple but Practical Active Antenna

Figure 1 contains a schematic diagram for an active antenna. The parts are inexpensive and easy to obtain. You can tack this circuit together in an evening. It may be constructed on a piece of perf board or a breadboard of your choice. The leads should be kept as short as practicable in order to ensure wide frequency coverage and the prevention of unwanted self-oscillations.

Q1 is a junction field-effect transistor (JFET). It has an input impedance of 1 megohm when wired as shown. This is an ideal situation when we attach a short antenna at J1. You may use a long telescoping whip antenna, or a short hank of wire may be used. Any length from 6 to 10 feet is okay. Longer pieces of wire may be desirable for reception below 20 MHz. Don't be afraid to experiment.

Q2 further amplifies the incoming signal (10 dB) and Q3 performs the same function, adding another 10 dB of gain. The gain of Q2 and Q3 may be as great as 15 dB per stage, depending upon the beta of the particular transistor plugged into the circuit. Q2 and Q3 operate as linear broadband amplifiers that use shunt and degenerative feedback. These two stages can be replaced by a single CA3028A or MC1350P IC, should you wish to do your own thing.

The output of Q3 is approximately 200 ohms. A 4:1 broadband step-down transformer (T1) converts the 200-ohm output to 50 ohms. This makes it suitable for use with most short-wave and amateur receivers.

Although the circuit calls for a 12-V power supply, it will work well at 9V, should you wish to use a battery. Total current drain is on the order of 13 mA at 12 V, and it drops to 8 mA when the supply voltage is lowered to 9.

This circuit works well from 1.6 to 35 MHz. Operation at lower frequencies may be had by changing RCF1 and RFC2 to 10-mH units.

Using the Active Antenna

Connect a short antenna at J1. Vertical polarization will result if the wire or whip is vertical. Moving the antenna to a horizontal position will favor horizontally polarized signals. Be sure to experiment with the orientation of the antenna when monitoring different bands.

In an ideal situation the active antenna and its electronics would be located out of doors (on a balcony, deck or whatever). This will keep it away from electrical house wiring and steel frameworks if you live in an apartment. These man-made objects not only absorb signals but they may radiate noise. You may use RG-58 coaxial cable between the active antenna (T1) and your receiver. Any convenient length is suitable.

High Tech Satellite Imagery!

Featured in
April and May
1990 issues of
QST magazine

City _____ Price Total _____
 _____ \$255
 _____ \$495
 _____ \$125

6404 Lakeside Court
 Telephone 1-813-947-4545

OFS WeatherFAX

Achieve professional results—often surpassing the capabilities of local TV weather reporting. Plug it into your receiver earphone jack and decode all APT mode- GOES & Polar satellite as well as HF Marine fax. Capture, enhance, print gray scale weather facsimile using your PC. Latest technology for optimal noise rejection, self-test mode, advanced menu-driven software and help windows assure easy operation.

LOOK AT THESE FEATURES!

- All modes: GOES-WEFAX, GOES-TAP, NOAA, Meteosat, Meteosat, HF-WEFAX, HF-Marine/C-Band wire photos
- Full satellite pass at full resolution
- 1280x1024 with 256 colors and below
- Temperature calibration & contour maps
- Latitude/longitude grids and "you are here" function
- Unattended operation & 24-hour schedule/timer
- Standard TIFF and GIF file formats
- User-defined palettes, interpolation, zoom, scroll, rotate, reverse, histograms, brightness, contrast, negative, linear/logarithmic enhancement curves.
- Integrated GOES-TAP and WEFAX animation option
- Print gray-scale on laser and dot matrix printers

Half-size card plugs into your PC

Complete kit/software \$255
 Assembled card/software \$495
 Animation software for GOES/TAP/WEFAX \$125
 Foreign orders - add \$14 shipping
 Total _____

Name _____
 Address _____
 Phone _____

GROVE COMPUTER BULLETIN BOARD

1-704-837-7081

M-F 5:00 PM thru 8:00 AM

On Line 24 Hours

on weekends

If you live near a powerful commercial broadcast station, a CBER with illegal power or an amateur radio station, you may find that the active antenna will overload and cause spurious signals across the tuning range of your receiver. This is a price that must be paid when a broadband circuit is used. Tuned circuits create needed selectivity for eliminating interference from nearby stations with strong signals. Active antennas do not contain tuned circuits.

Build the circuit in a metal box so that it is shielded. You should route the circuit ground to the metal box and ground the box to a cold water pipe or an earth ground. This is not an essential action on your part, but it will help to improve the active antenna's overall performance.

You may substitute 2N4416 FETs for the MPF102 shown at Q1 of Figure 1. Similarly, you may use 2N4400, 2N4401 or 2N5179 transistors at Q2 and Q3. The 1-mH RF chokes are available from Oak Hills Electronics in Big Rapids, MI 49307 or from Mouser Electronics in TX. The core for T1 is available from Amidon Assoc., Inc., 2216 E. Gladwick St., Dominguez Hills, CA 90220. Catalogs are available from all three companies.

NEW RELEASE: VERSION 2.0 **\$49⁹⁷**

ScanStar™

FOR IBM PC and compatibles

Computer Assisted Radio Monitoring

New In Version 2.0:

- Computer controlled program, scan, search and spectrum analysis with data logging
- Terminal window for TNC/RTTY/modem
- Search, store and scan at the same time
- Edit databases while scan & terminal window operate in background

STANDARD FEATURES:

- Create and edit scanning databases
- Print reports and log information
- Professional quality user interface
- Easy to use and install

SUPPORTS:

- Remote control/programming on NRD-525, NRD-535, AR-3000, MR-8100, R-7000
- Over 25 other radio models
- Standard serial ports COM1-COM4, or multi-part cards (4/8 ports) at any address
- Hook up as many radios as you have ports

REQUIRES:

- IBM PC or 100% compatible, hard disk, 640K
- EGA/VGA/MONO/HERC graphics card
- Serial port(s) for radio interface
- Level converter (if req'd by radio)

To order, call: VISA-MC-COD
1-408-296-4224

For more info or demo copy, call our
 BBS at: (2400/1200/300/N/8/1)
1-408-258-6462

Itching to Write?

Any hobbyist with some enthusiasm and experience, has something to share. Write the Editor, P.O. Box 98, Brasstown, NC 28902.

M
T

Correcting the Shortcomings of the ICOM R-1?

I have completed an interim technical evaluation of the ICOM R-1 DC-to-Daylight pocket scanner/receiver; a tremendous whallop of dynamite in a small package! The focus of my investigation was on its much-talked-about weaknesses & deficiencies, not on its strengths and good points, which are numerous and well documented elsewhere. My analysis confirms two major deficiencies of the R-1 and points the way to a possible solution of one.

The R-1 is susceptible to two forms of pseudo interference—and by that, I mean *internally* created interference, not the external kind: (1) front end overload from nearby or very strong signals, and (2) adjacent channel interference, mostly on the crowded LF-MF-HF AM bands where selectivity is vital.

Poor selectivity in this unit is caused by the 15 kHz-wide 455 kHz IF filter on the R-1's DET-A board, which is active in both the AM and NFM modes. The 15 kHz filter (FL-1) is more or

less adequate for VHF & UHF NFM operation but much too wide for the LF-MF-HF AM shortwave bands where signals can be separated by as little as 3 kHz. Imagine then, receiving up to five different signals on one frequency. No thank you!

Another puzzing factor at play here is that the R-1 can receive adjacent channel interference from signals well outside its IF passband, up to 200 kHz or so from the actual frequency. This could be caused by "dirty" VCO & mixer products or by spurious responses within a defective or inferior IF filter.

A retrofit remedy for the strong signal overload problem is not likely to be forthcoming in the near future, if ever, because the receiver's front end is not designed for Automatic Gain Control. AGC is a vital requirement to minimize or eliminate overload. It is generally not feasible to retrofit AGC into receivers which were not designed for it. Overload can be controlled to an

extent by the user, however, either with a less efficient antenna or by an attenuator placed between the antenna and the BNC connector on the receiver. By and large, the ICOM R-1 was designed for use with the supplied rubber duckie antenna, which minimizes strong signal overload to some extent.

So what about a remedy for the R-1's inferior Adjacent Channel Rejection? A company in England, RayCom, has developed a retrofit mod, apparently to replace FL-1 on the DET-A board with a narrower, much sharper IF filter. Given conflicting reports from those who sent their R-1's over the pond for this service, I am not sure that this specific mod is a panacea.

The problem as I see it, is two-fold: first there is the matter of space or available "real estate" in the R-1...almost none! All decent IF filters of which I am aware are larger than the R-1's stock FL-1, and therefore we'll not find a ready residence to replace FL-1. But even if one is found—and RayCom apparently knows of one—a serious problem might still remain!

A useful IF filter for LF-MF-HF AM operation (with say, a 6 kHz bandwidth) will be too narrow for some NFM signals, especially at 800 MHz and up where FM deviation (modulation) can be rather wide and where transmitter frequency tolerances can place a signal outside the bandpass of a sharp IF filter! Such an IF filter will clip NFM signals which are FM-deviated more than 3 kHz as can be the case on 800 MHz & up.

Therefore, the ideal remedy for poor Adjacent Channel Rejection is a narrow IF filter that is auto-switched INTO the circuit whenever the AM mode is selected and OUT for NFM. But how? Space limitations and the uncertainty of a suitable miniature IF filter make this solution difficult.

There is also the matter of invading and hacking the R-1. After a detailed scrutiny of its compressed design and lack of working room, I can only conclude that there is a good chance for grievous mechanical or electrical error associated with exploratory invasive efforts. It is ill-advised for the novice hacker to probe the workings of the R-1 at this stage.

A Challenge to Professionals

Ordinarily, my columns are designed for the average or casual hobbyist. However, there is a pressing need for a solution to the R-1's poor Adjacent Channel Rejection, so this month's project is aimed at the experienced experimenters who are better prepared to develop or refine an

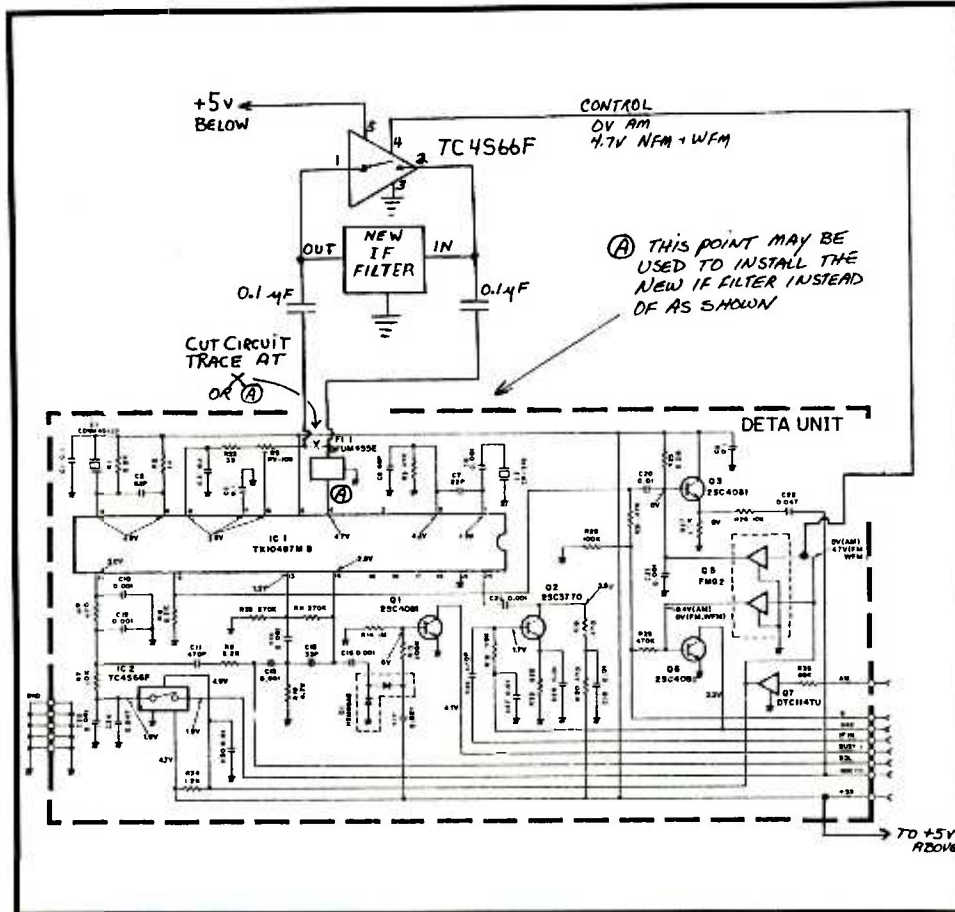

Figure 1: R-1 Selectivity Improvement

ideal remedy. If and when it is found, I will share it with you in layman's terms here.

Following is a strategy designed for you professionals to explore:

A service manual for the R-1 is vital before going farther than removing the outer case. See the sidebar for the source. One potentially viable approach is to intercept a signal path in series with FL-1 on the DET-A board, either into or out of the FL-1 filter (doesn't matter which). Cut a suitable point on this circuit trace and insert a narrow, sharper 455-kHz IF filter in the cut so that it is in series with FL-1 (see Figure 1).

The new filter should be automatically switched IN or OUT, depending on which mode, AM or NFM, is selected. This can be accomplished by connecting the IN & OUT terminals of the new IF filter to the IN & OUT pins of a tiny CMOS bilateral IC switch such as a TC4S66F with the control pin of the switch connected to the Collector of Q-7 or either of the dual bases of Q-5 on the DET-A board. This is a +5v control signal for the NFM/WFM modes (0v for AM) which will enable the CMOS switch to bypass the new filter in the NFM/WFM modes, and to be inactive or open in the AM mode. Be sure to keep the leads of the new IF filter and the CMOS bilateral switch as short as possible to minimize stray coupling and other problems.

Some refinement to this approach may be necessary for best results, but it sure seems the way to go at the moment for the serious researcher. The problem here is that I have not yet identified or located a suitable miniature IF filter that can easily reside inside the cramped quarters of the R-1. The filters that I've seen available from Murata-Erie and other suppliers are too large.

For those who don't grasp this possible technique, imagine a simple SPST switch connected to the IN & OUT terminals of the new filter. When the switch is closed, the filter is effectively shorted out, thereby routing any signal around the new filter. When the switch is open, signals must pass through the filter. The required Mode Control Signal is handily available at the collector of Q-7 or either base of Q-5 on the DET-A board, which can be used to automatically activate/deactivate the CMOS bilateral switch; i.e., OUT for AM, and IN for NFM & WFM.

NOTE: A conventional 74HC4066 chip could work except that it is rather large for the R-1, so a suitable alternative is the tiny TC4S66F (used as IC-10 in the Realistic PRO-2006 and as IC-2 on DET-A of the R-1). The TC4S66F is a single section surface-mount CMOS bilateral switch and is available as a spare part from the sources listed in the sidebar.

In closing and summary, simple replacement of FL-1 in the R-1 to improve Adjacent Channel Rejection in the LF-MF-HF AM bands can degrade the performance of the NFM mode in the VHF-UHF bands. The ideal approach will leave FL-1 intact and permit a higher performance filter to be switched in only for the crowded AM bands. Depending on your interest, the tradeoff of one serious problem for another is not a good way to go.

More research and analysis is required before a solution can be highly recommended to the R-1 community. If it is determined that FL-1 is inferior or defective, then a quality 15 kHz-wide 455 kHz IF filter may be mandated for minimal interference for NFM and AM modes.

Thank you for your indulgence this month. As I see it, the importance of the R-1 to the hobby radio community is so significant that I hope to hear from anyone who has experimented with mods and solutions to this fine receiver's deficiencies. The search goes on..... 73/bc

SOURCES:

Parts for TC4S66F & ICOM Service Manuals

ICOM AMERICA, INC
2112 - 116th NE
BELLVIEW, WA 98004
206-454-7619 & 800-999-9877

ICOM CANADA, INC..
3071 - #5 ROAD, Unit 9
RICHMOND, BC CANADA
V6X 2T4

Another parts source for TC4S66F

TANDY NATIONAL PARTS

MT

PC HF FACSIMILE 6.0 \$99

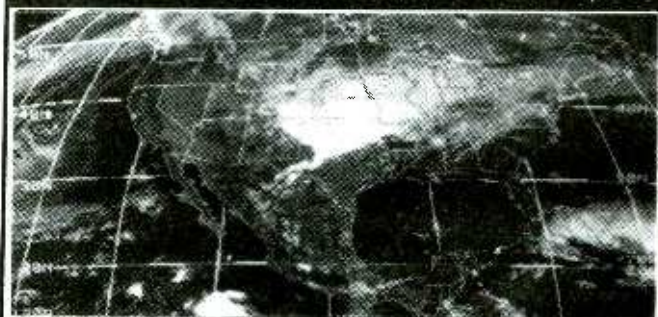

NOW EVEN BETTER!

Version 6.0 has just been released. It is the most comprehensive fax image reception system for the IBM PC and compatibles. It includes an FSK demodulator, advanced signal processing software, tutorial cassette, and complete 250 page reference manual. The software includes the following advanced features:

Menu Driven
Start/Stop Tone Recognition
Unattended Operation
Tuning Oscilloscope
Resolution up to 1280x800x256 Levels
Programmable Colorization
Brightness and Contrast Control
Pixel Photometry and Histograms
Image Zoom, Scroll, Pan, Rotation

CGA,HGA,EGA,VGA & Super VGA
Time Lapse Frame Looping
Slide Shows
Export to PCX & GIF Files
Grayscale on all Popular Printers
Programmable IOC & Line Rates
Online Broadcast Database
Image Cropping
True Color Press Photos

PC GOES/WEFAX \$250

PC GOES/WEFAX 3.0 is our finest fax imaging system. It is compatible with both HF and direct satellite broadcasts from GOES, METEOSAT NOAA, SOVIET APT and C-Band services. It includes all of the above features plus a complete prediction system and advanced multispectral analysis software.
Call or write for our catalog of products. Visa & MasterCard welcome.

Software Systems Consulting

615 S. El Camino Real, San Clemente, CA 92672
Tel. (714) 498-5784 Fax. (714) 498-0568

900 E. NORTHSIDE DR
FT. WORTH, TX 76106
800-442-2425 & 817-870-5600

Possible Source of R-1 Upgrade:

RAYCOM; INTERNATIONAL HOUSE
963 WOLVER HAMPTON RD. OLDBURY,
WEST MIDLANDS ENGLAND B69 4RJ
011-44-021-544-6767

455 kHz IF Filter Sources

COLLINS/DIV OF ROCKWELL
2990 AIRWAY AVE.
COSTA MESA, CA 92626
714-641-5311

MILLER, J. W. INC..
PO BOX 5825
COMPTON, CA 90224
213-537-5200

DRAKE, R. L., COMPANY
PO BOX 3006
MIAMISBURG, OH 45342

MURATA-ERIE NA LTD.
1148 FRANKLIN RD. SE
MARIETTA, GA 30067
404-436-1300

FOX-TANGO CORP.
PO BOX 15944
WEST PALM BEACH, FL 33406
305-683-9587

PIEZO TECHNOLOGY, INC.
PO BOX 7859
ORLANDO, FL 32854
305-298-2000

KIWA ELECTRONICS
612 SOUTH 14th AVE
YAKIMA, WA 98902
509-453-KIWA

SHERWOODENG., INC.
1268 S. OGDEN ST.
DENVER, CO 80210
303-722-2257

When contacting these companies, please reference *Monitoring Times* and this column as your source.

A Convertible Mutliwhip-Multiflex-Multifloppy for Your Handheld

Most handheld scanners or transceivers come with a rubber-ducky type whip antenna as a standard accessory. But there comes a time for most of us when we wonder if replacing that short antenna with something longer might not lead to more effective communications. The answer is often "yes," and this month we cover an approach which lets you lengthen that antenna in several ways while building your own "pocket-sized antenna farm" in the process!

What's a Convertible Antenna?

The "multiwhip-multiflex-multifloppy" antenna—or "MX3"—which we feature this month consists of a base connector and as many interchangeable antenna elements as you care to build for it. Each element, only one of which is plugged into the base at any one time, can be either a telescoping whip, fixed-length flexible whip, or fixed-length floppy wire element. Changing elements takes about three seconds, and the elements can be tailor-made to whatever band you choose.

Why Do I Want an MX3?

First, you can make antennas which are cut to a specific length to maximize response on your favorite bands. This is particularly useful if you are transmitting as well as receiving with your handheld. And, if you are using a rubber duck now, you can expect improved weak-signal work by using longer elements with the MX3.

Second, we all know of the problem which telescoping whips have with rough usage, such as when you are working, camping, or hiking. Both the flexible and the floppy elements work great in such situations and let you save the telescoping whip for less stressful use.

Lastly, with the MX3 antenna you can have a whole miniature antenna farm for something like ten dollars!

What You'll Need to Make an MX3

A. Most handhelds utilize a BNC antenna connector. For these you will need one Motorola-female-to-male-BNC type RF adapter (Radio Shack part number 278-117). If you want to use the MX3 on a radio which already has a Motorola-type antenna connector, you do not need the RF adapter.

B. There are several styles and lengths of telescoping replacement antenna elements available which can be adapted for use with the MX3. I used a Radio Shack part number 270-1413 for the prototype described below. Be sure that the bottom end of the elements you choose will fit inside the RF adapter with space left for the shrink tubing insulation described below.

The shrink insulation is very thin-walled and a space about the thickness of a playing card will usually be enough. If the element is so small that it leaves a large gap, you can usually build up the thickness of the antenna element to fit snugly into the adapter by adding more shrink tubing.

C. For each antenna element that you make, you will need one Motorola-type male plug. This kind of plug is almost universally used on auto radio receiver antenna cables. Radio Shack part number 274-711 includes two of these plugs.

D. You'll need some 1/2-inch, heat-shrink insulation tubing and/or plastic electrical tape. The tubing makes a stronger, more durable and neater job.

E. You'll also need some stranded, insulated wire for the floppy elements. Any wire with plastic-type insulation should be OK. For semi-floppy elements you can use the center conductor and inside insulation of a piece of coaxial cable: either of the common sizes, large or small, will work. Just remove the outside insulating-jacket and the braided shield of the coax and leave the inner insulation on the inner conductor.

For short elements, this wire is semi-floppy-semi-rigid and will stand in a somewhat upright position. For some applications this is good, but where you need a more floppy wire, use a stranded, insulated wire.

F. For the flexible antenna elements you will need some 12-gauge insulated copper wire, such as that used by electricians to wire houses. For lengths of up to two feet or more this wire can be shaped to hold itself as a straight element which is easily bent and easily re-straightened.

Making the Antenna Elements

To make a floppy or flexible element cut the wire to length by the formula:

$$\text{Length (in feet)} = 234 / \text{Frequency (in MHz)}$$

For example, for 234 MHz, length would be $234/234 = 1$ ft.

Remove about 5/8-inch of insulation from one end of the element. Build up the thickness of the element just past this end with tape or heat shrink so that it will fit snugly inside the length of the Motorola-type plug. Solder the end into the plug tip. When the wire is soldered, slip some shrink tubing over the wire and part-way onto the rear of the plug. Shrink it to cover 1/2-inch of the end of the plug and an inch or so of the wire. The element is then ready to use.

To make the whip element, remove and discard the small stub which is hinged to the bottom of the whip. Do this by taking out the screw which holds the stub to the telescoping section. Tin the bottom flange of the stub so that it will take solder and will hold the wire which is added in a later step. Loop solid copper hookup

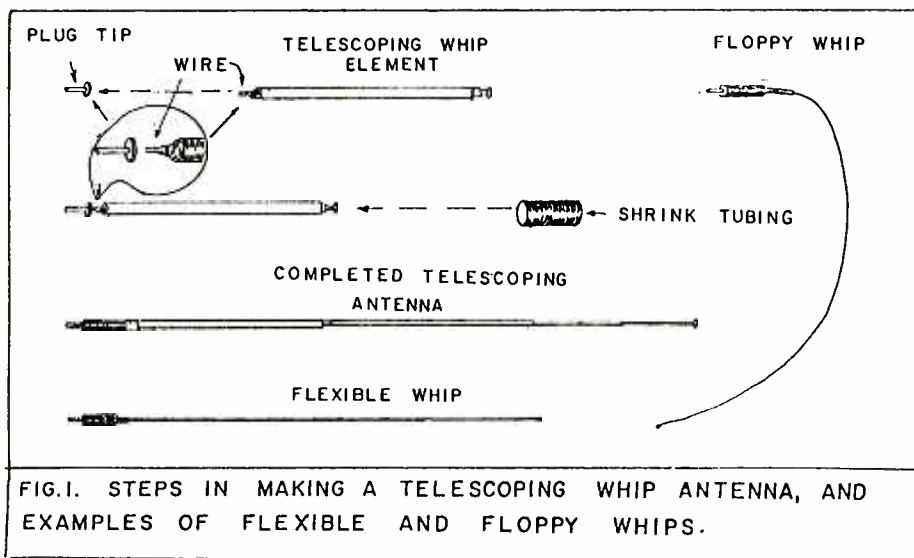

FIG.1. STEPS IN MAKING A TELESCOPING WHIP ANTENNA, AND EXAMPLES OF FLEXIBLE AND FLOppy WHIPS.

wire, about 18 gauge or so, twice through the hole in the bottom of the telescoping section and solder it in position as shown in figure #1.

Take a Motorola-type plug and open it up by using pliers to bend the metal strips out to the sides. If you bend the side strips all the way out, the pin with its insulating disk still attached should come out without much trouble. Carefully remove the pin from the plug body, leaving the insulating disk on the pin intact. Discard the plug body. Solder this pin to the wire from the antenna element as shown in figure #1.

Cut a 2-1/4 inch length of shrink tubing and slip it over the antenna element so that a scant 1/4-inch protrudes past the insulating disk on the Motorola-type pin. Shrink the tubing, then try the element for fit in the adapter. If the fit is not yet snug, add another piece of tubing, shrink it, and check the fit again. Add more tubing until the fit is snug.

The element is now ready to use. Using the whip at its maximum length is often best for receiving. For transmitting, use the formula given above to determine the best length to set your whip.

RADIO RIDDLES

Last Month

I asked you to guess how small was the smallest antenna we found in a "largest-smallest antenna" contest which we ran in *Monitoring Times* about five years ago. Well, there were several really small ones, including one in a "James Bond cocktail" which had a transmitter hidden inside an olive in a martini, with a fake toothpick as an antenna!

But the smallest seemed to be a tiny .25-inch diameter metal ring around a "pill" transmitter which can be swallowed by political figures if they are kidnapped. It allows tracking their whereabouts by radio from three to five miles away! I thought that was getting pretty small, but recently scientists at the National Institute of Standards and Technology have developed a spiral antenna the size of a grain of sand! We'll have more on that another time.

This Month

You guessed it—next month's riddle asks you, "How large was the largest antenna that we found in our largest-smallest contest?"

We'll have the answer to that, and much more, in your next issue of *Monitoring Times*. 'Til then, Peace, DX, and 73.

MT

GALAXY ELECTRONICS

67 EBER AVE. BOX-1202

AKRON, OHIO-44309

216-376-2402

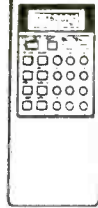

AR-1000XLT
1000ch, covers
500KHZ-1,300 MHZ, 10
Search Banks, LCD
Display, Priority, AC/DC, All
Accessories
\$395

**CELLULAR
MODS!!!**



BC200XLT
200 Channels, 12 band
with aircraft & 800 MHZ,
10 priority channels,
channel lockout, scan
delay, automatic search,
illuminated LCD display,
snap-on battery pack, pro-
grammable, track tuning,
direct channel access.
with AC adapter, leather
carry case & earphone
249

AR-2500
2016ch, 1-1,500 MHZ, LCD
Display, AC/DC, Search, Priority,
All Accessories
\$465

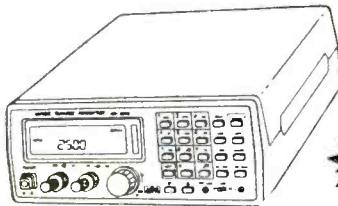

BC760XLT 100 channel 12 band
base/mobile scanner with 800 MHZ band
& Service Scan Weather, Priority,
Lockout, Scan delay, Search, Program-
mable, Track tuning, Direct ch access
279

SHORTWAVE RADIO

R-5000 100KHZ-30MHZ, 100 Memorys	889.00
R-2000 150KHZ-30MHZ, 10 Memorys	649.00
SONY-2010 150KHZ-30MHZ, + Air, Digital	349.00
ICOM R-72A 100KHZ-30MHZ, 99 Memorys	809.00
ICOM R-7100 - CALL - CALL - CALL - CALL	
NRD-535 90KHZ-30MH, 200 Memorys	1589.00
DRAKE R8 100KHZ-30MHZ, 100 Memorys	975.00
FRG-8800 150KHZ-30MHZ, 12 Memorys	689.00

POLICE/FIRE SCANNERS

BC-200XLT, 200ch, 29-54, 118-174, 406-512, 806-952	259.00
BC-760XLT, 100ch, 29-54, 118-174, 406-512, 806-950	289.00
BC-855XLT, 50ch, 29-54, 108-174, 406-512, 806-956	209.00
AR-1000XLT, 500KHZ-1,300MHZ, 1000ch, Cellular	395.00
AR-2500, 1-1,500MHZ, 2016ch, Cellular, etc.	465.00
AR-3000A, 100KHZ-2036MHZ, 400ch, Cellular	959.00
ICR-1, 100KHZ-1,300MHZ, 100ch, Cellular	529.00
ICR-100, 100KHZ-1,856MHZ, 121ch, Cellular	599.00

**USED
GEAR**

Price Sheets \$1.00

AIR/POLICE/800 MHZ

**BUY
SELL
TRADE**

**SAME DAY C.O.D. SHIPPING
FREE SHIPPING & INSURANCE!!!
WE TAKE TRADES!!!**

New Sony ICF-2010 Filter Module

- Improve the ICF 2010's narrowband selectivity
- A must for SSB and narrowband AM reception
- Easy to install - Complete instructions are included

Kiwa's new FM 3.5/S Filter Module allows maximum performance from the ICF 2010. The 3.5kHz bandwidth cuts out the interference for cleaner more listenable reception.

Kiwa also offers a wideband replacement filter that has earned rave reviews.

Hear the difference - Maximize performance

For more information please write or call:

Kiwa Electronics, 612 South 14th Ave.
Yakima WA 98902 Tel: 509-453-KIWA

"DISGUISE" AC WALL OUTLET



NEW! \$99.00
ppd.

FM TRANSMITTER KIT

Looks and functions like a common outlet; uses power line for power and antenna (no batteries needed ever!)
SURVEILLANCE CATALOG\$5.00

CALL IDENTIFIER displays callers phone number, stores phone number with date & time of call...\$59.95ppd.

P.O. Box 337, Buffalo, NY 14226 (716) 691-3476

MOVING?

Send notification of your new address as soon as you know it so you won't lose a single issue — or have your 2nd class mail forwarded.

The Facts About the Fax

A Review of Software Systems Consulting's PC HF Facsimile 6.0

After a few columns devoted to receiver control and frequency management, this month we will look at another powerful use of the personal computer in radio listening: in this case viewing FAX decoding.

Fax is short for facsimile: a replica of an original. The first fax machines were rotating drums of electro-sensitive paper over which a stylus was dragged. When a contrast pulse was received it was converted to a voltage which left a dark mark on the paper. Pretty crude by today's standards, it was a marvel of technology which helped DC-3 pilots and oceanliner captains bring their passengers safely into port for many years. Although the advent of computers has seen new ways of transmitting data, the old terminology has stuck. This month we look at a fax decoding program for the IBM PC.

You'll want to remember the name Software Systems Consulting (SSC). When SSC's PC HF Facsimile version 6.0 arrived, it was packaged in a top notch manner: specialty box with custom foam insert to hold the small demodulator and an audio cassette, plus three computer program disks neatly held down by a 250-page manual. My first impressions were that I hoped the program performed half as good as the effort put into the packaging, and secondly, that if it took 250 pages to run the thing, then we had a problem.

Well I can tell you that it does not take 250 pages. In fact, to set up the program on my hard disk, connect the interface and begin receiving my first fax took about twenty minutes and fifteen pages. The actual first image is shown in figure 1. This was from NAM, Norfolk, VA on 8.080 MHz. Not bad for a first try without reading all of the features that the SSC program can perform.

Compared to other listening specialty books on the market today, the 250-page book included with the program is more than a \$20 value in its wide coverage of fax related topics. It is very well written and gives the reader all the details he/she needs to become a very competent fax listener.

The topics are not limited to the SSC PC HF Facsimile program (thoroughly covered in easy to understand language). Construction details of simple antennas and receiving set-ups are also given. Even a brief discussion on keeping computer noise to a minimum is included. A primer on meteorology, how to read the charts you will no doubt be receiving, what each chart symbol means and how it can affect the weather is part of the manual. Then comes even more valuable frequency/fax station listings and information.

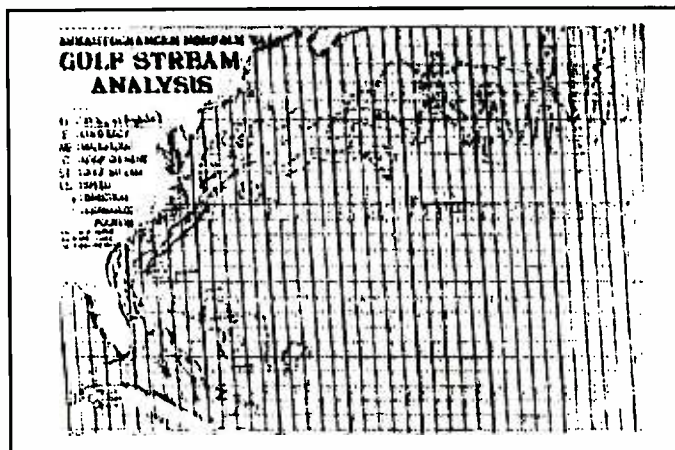

Figure 1: Satellite map of U.S. from SW station NAM. First try!

About 50% of those 250 pages are what you and I would pay tens of dollars for alone.

So much for the big manual. Now how about the program?

Beginners Luck?

The equipment required is: a stable short-wave receiver, a PC with a minimum of 640K of RAM and either a 5-1/4 or 3-1/2 inch floppy disk drive—the program is available on either size. Although the program can operate with almost any type of monitor, to use the image options to their fullest, an EGA, or better yet, a VGA monitor is required.

One end of the SSC demodulator/interface is plugged into one of the serial ports of the computer and the miniature phone plug coming from the demodulator is connected to the receiver's audio: either the earphone or record output. The demodulator does not require additional power since it takes it from the serial port.

PC HF Facsimile is controlled from a simple menu which is broken into four sections: Capture Options, Display Options, File Options and Control Options. You select the command by pressing the first letter of the desired function. For example, to begin receiving an image you push the "C" key corresponding to the "Capture image" command displayed in the Capture Options section of the menu screen. When your chart is complete it can be saved to disk for future use or printed on your printer.

Ready for the next fax? Press the "S" key and the program senses the start pulses sent by the station and only begins its scan when these are received.

The "Autostart" option allows you to capture scheduled charts by time and date even when you

cannot be present to start, store and start again the capture of images. In this way the SSC program emulates a VCR with up to nine different times and dates stored for operatorless chart reception and recording to disk.

The first time you run SSC's program you set it up by pressing "H" for hardware configuration. Although you can fine tune the program to get newspaper quality prints, to get off the ground all you need to input is the type of display screen you are using and the communications port where you have the demodulator connected to your computer. All instructions are clearly annotated on the screen at each operator input point. The "Esc" key always brings you back through your steps to the command menu.

The features that this program puts at the listener's disposal seem almost limitless. However, it can also function in a simple, almost two-keystroke mode for the beginner or lazy ones among us. The advanced features include a tuning scope option which gives the listener a graphical representation of how to fine tune the signal—simple yet elegant. The method—seen in sophisticated photographic and microscopy equipment—allows you to tune the receiver until the signal is centered between two horizontal lines; reception of a picture is almost assured.

The SSC software does not stop with image capture. The image processing features can take an extremely poor image and make it readable. Image alignment, rotation, brightness, color, contrast and much, much more is included in the SSC's program. Successive multiple images can be arranged in sequence and give you a moving show on the weather pattern over the past day. Move over, WNBC's weather guy!

Areas of interest (your mother-in-law's state perhaps) can be zoomed in and magnified. I have tried all these features, and many others described in the book, without a sign of a programming bug—only the creativity bug, which had the land mass purple with yellow clouds and strikingly artistic grey lettering.

A very useful feature "hidden" in the "Image Capture Scheduler" menu is the "Online Broadcast Schedules" which allows the listener to search the very complete database of fax stations worldwide. This can be performed by either station call, location, time of transmission, broadcast type or frequencies. If one of these, such as "call," is inputted by the listener, the SSC program will display the corresponding information.

For example, by typing NAM in the call box and pressing the "S" key (for search) the screen responds with: Location- Norfolk VA. USA,

Time- 1600, Broadcast- NFAV SCHEDULE, and Frequencies- 3.357/8.080/10.865/16.410/20.015.

Could There Be More?

Two suggestions for future revisions come to mind. The first are HELP screens for each menu showing all commands and the corresponding keystrokes. This would keep page flipping to a minimum. The second is much more ambitious but becomes obvious after a few hours of fax capturing: the size of the saved faxes. Even in the compressed mode, each saved fax takes over 120K of disk space. That's less than three on a 360K disk. Even a hard disk gets full very quickly after a few days of fax monitoring. So that most of the charts received can be saved, more efficient compression methods of the file to less than 25K should be developed.

Far from just fancy packaging, PC HF Facsimile version 6.0 from Software Systems Consultant is an excellent fax program. When used with SSC's demodulator, it gives the beginner fax listener/watcher all the information he or she will need. At the same time it provides an experienced user a complete package as well. SSC has produced a winning product that could serve both as a model and as a quality standard for radio related software/hardware developers. Helpful touches such as the included audio cassette which introduces listeners to the various sounds of correctly tuned maps and charts are built into all aspects of the program.

PC HF Facsimile 6.0 on floppy disk, with demodulator, audio cassette "Tuning HF Facsimile," and an excellent manual is available for \$99 from Software Systems Consultants, 615 S. El Camino Real, San Clemente, CA 92672. Telephone number (714) 498-0568 and of course (714) 498-0568 for their FAX.

Reader's Feedback

I'd like to thank all of you who have written in with good wishes, ideas and questions about using computers and radios. Please keep them coming and I will use them to determine what topics and reviews we cover in the future.

One common question which is emerging is, "Are there programs for computers other than IBM PC clones?" Well, as the owner of many other computers, including Europe's popular Atari ST1040, I know your frustration.

Let's hear from software manufacturers who support other than PCs. If we get enough response I'll do a column for alternative hackers! Meantime if you enclose an SASE with your questions I will attempt to answer them.

To end this month I can't resist borrowing a line from Jack Webb, or more recently Dan Akroyd, "Just the fax ma'am, just the fax."

M

SOMERSET ELECTRONICS

Made in USA

Announces... THE MICRODEC™ 'SERIES'

NOW IT'S YOUR CHOICE! You select the Model and the features to meet your decoding and budget needs*! Each choice is fully upgradeable to the top of the line! With our new VIP50 Interface you can choose an expanded display (32x16 characters on your television) and hard copy - with or without a computer!

FEATURES:

(Compact Size: 1.3Hx5.1Wx5.3D)

MORSE: DECODES CW WITH

Autospeed, software filter, speed display ★

RTTY (60,67,75, 100 WPM) (major shifts) ★

RTTY (bit inversion) ★

ASCII (110 & 300 BAUD) ★

ASCII (bit inversion) ★

AMTOR/SITOR Mode A-ARQ ★

AMTOR/SITOR Mode B-FEC ★

Smart display/Intensity control ★

On/Off with volume ★

Serial Interface ★

Code Oscillator ★

AVAILABLE OPTIONS:

Display Colors: (Green standard--no charge) Red, or Yellow (your choice) \$15.00

NICAD Batteries for portability \$29.95 Model VIP50 Adaptor \$189.95*

*MD300 price includes the VIP50 Interface Adaptor.

(TV Stations, phone companies, and public utilities are selecting MICRODEC™ for their operational and FCC requirements - FCC Docket 86-337.)

Call us for special introductory prices and orders at 1-800-678-7388.

Fax orders: 1-407-773-8097 • Technical assistance: 1-407-773-8097

VISA • MASTERCARD • PERSONAL CHECKS • MONEY ORDERS

SOMERSET ELECTRONICS, INC. • 1290 Hwy. A1A, Satellite Bch., FL 32937

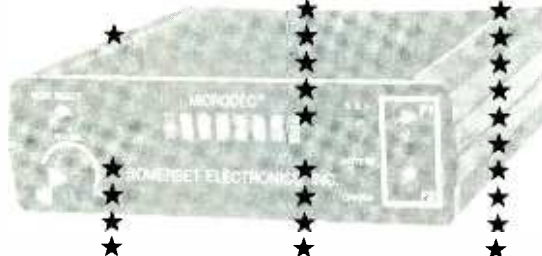

Radioteletype Monitoring

The Complete Guide

Takes the mystery and guesswork out of tuning RTTY. How to tune in signals, read displays, test signals, code groups, traffic slugs, circuit identifiers and more. \$9.95 + \$2 s/h (\$3 foreign)

The Essential RTTY Frequency List

1,000+ RTTY listings. Calls, location, service, speed/shift, time received, reference information.

\$10.95 + \$2 s/h (\$3 foreign)

Limited Space

Shortwave Antenna Solutions

All kinds of antenna options for those with little room for one. Plus valuable construction tips!

\$10.95 + \$2 s/h (\$3 foreign)

Order now from your radio book dealer or

Tiare Publications

PO Box 493M, Lake Geneva WI 53147

Catalog \$1, free with order. Visa/MasterCard

MOVING?

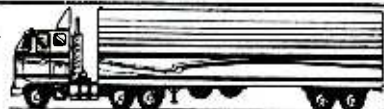

Let us know four to six weeks before you move and we will make sure your MT arrives on schedule. Just remove the mailing label and affix below. Then complete your new address (or any other corrections) in the space provided.

My new address:

Monitoring

Times

P.O. Box 98

Brasstown

NC 28902

AFFIX OLD LABEL HERE

Q. *I have the FCC frequency allocation chart, but am unable to find any government or military listings. Where are they available? (Daniel Myers, Abington, PA)*

A. They aren't. In 1982, Ronald Reagan issued a presidential proclamation prohibiting the release of these federal frequencies which had previously been available for decades, classifying them "Confidential."

While the FCC licenses civilian applicants, the Interdepartment Radio Advisory Committee (IRAC) of the Department of Commerce manages federal and military frequency assignments.

From time to time, private directories are published which contain collections from various sources which may include official sources and off-air listening. Several of these directories are available from leading *MT* advertisers.

Q. *I have a Sony 2010; how do I know whether to tune single sideband in USB or LSB? (Don Roth, Shelton, CT)*

A. Almost all voice communications in the shortwave spectrum are upper sideband (USB). The singular exceptions to this are ham transmissions in the 160, 75 and 40 meter bands, and some diplomatic ("Mystic Star" network) Air Force air-to-ground transmissions.

Q. *My scanner does not receive the 800 MHz band. Is there any easy way to convert it to receive these frequencies? ("Left Out", San Francisco, CA)*

A. Sure. The GRE "Super Converter" is an effective and powerful 800 MHz converter that works with all scanners. It is available for under \$90 from Grove Enterprises and several other *MT* advertisers.

There is no way to "restore" 800 MHz reception to a scanner that is not equipped from the factory to receive that frequency band. Only those scanners that already have 800 MHz circuitry in them, but have cellular frequencies factory-censored, can be "restored."

Q. *Is there a dust cover available for the Sony ICF2010? (R. Maldonado, Tucson, AZ)*

A. Not that we know of. Universal Shortwave (1280 Aida Drive, Reynoldsburg, OH 43068; phone 800-431-3939) has a black canvas carry-

ing bag for the 2010, Sangean AT803A and Grundig 600 (\$29.95) and a series of clear vinyl dust covers for desktop radios (\$8.95), but not for the 2010.

Q. *Is it possible to modify a BC200XLT scanner to receive the 225-400 MHz military aircraft band? (Daniel Myers, Abington, PA)*

A. No.

Q. *Where can I find a detailed chart of frequency allocations that would help in searching out scanner frequencies?*

A. There are no comprehensive lists available. Grove Enterprises will publish such an exhaustive list if there are enough requests for it.

Q. *Can decoders for CW, RTTY and ASCII be used with VHF/UHF scanners? (David Christy, Lake Wales, FL)*

A. No. They have a very-sharply-tuned input filter which requires precise audio tone(s); this is why they are used with shortwave receivers equipped with either a BFO or product detector which can be fine tuned.

Scanners have no such provision; you are stuck with whatever tone may be present on the signal, and the likelihood of it being just the one you want is vanishingly small.

Q. *There are many desktop receivers with a variety of audio quality. How do I know which one sounds best? (Robert Sabato, Bloomfield, NJ)*

A. You don't. Sound quality is often a matter of taste, and there are so many bad-sounding transmitters to be heard in the shortwave spectrum that it's difficult to tell when it's the receiver's problem.

But that's still no excuse for poor design. Early models of some of the most expensive receivers being sold were absolutely awful; for the most part they have been cleaned up and generally have an acceptable sound.

Q. *Why do recorded NOAA weather warnings get broadcast on*

TV before they can be heard on the National Weather Service 162 MHz frequencies? (Curious in Oklahoma)

A. I called NOAA to find out, and they didn't know either! I suspect that it is a local decision based on the fact that at any moment more residents in the affected area would be tuned into the boob tube than monitoring their scanners.

Q. *I am occasionally assigned overseas where I enjoy monitoring spy numbers broadcasts and other utilities communications. Have you heard of any problems encountered by US citizens abroad who are listening to shortwave? (Melvin Pratt, APO)*

A. We've never heard of such problems among US citizens, but plenty of problems are incurred by citizens of foreign countries who monitor such communications in their own countries.

There is no rule of thumb since every country looks differently on radio monitoring; however, I don't think I would be inclined to discuss freely my inquisitive listening habits with the general populace if I were you.

Q. *What type of code is used for mobile data terminals common in police vehicles? (David Christy, Lake Wales, FL)*

A. Apparently a non-standard ASCII packet format, probably 4800-9600 baud. We have never heard of a successful intercept by a hobbyist.

Q. *If a person had a highly-selective AM radio with an indoor antenna, could he hear frequencies like 695, 705 or 801 kHz? (Bob Broch)*

A. Sure, if there were no station operating on frequencies within 5-10kHz of those. AM broadcasters are separated by 10 kHz in this country because their sidebands extend several kilohertz either side of center frequency.

If you had an AM receiver with a sharp 1 kHz IF filter installed, you would still hear adjacent channel interference if you tuned that close to the offender because his sidebands are really present on your target frequency, and audio quality would be atrocious.

Bob's Tips of the Month

How Far Can Your Scanner Antenna "See?"

On perfectly flat land, a person can see about 7 miles to the horizon; with elevation, or with a tall distant object, their visual separation is greater.

To calculate the approximate distance in miles an antenna can "see," simply double the height of the antenna in feet and take its square root. For example, a 50 foot antenna would be seen for 10 miles (the square root of double the antenna's height).

If the other end of the circuit also has an elevated antenna, do the same calculation for it and add the sums. In the example above, two identical 50-foot antennas could "see" each other for 20 miles.

Factors which increase radio range include transmit power, receiver sensitivity, atmospheric refraction (bending) and absorption, physical obstructions to the signal, antenna gain, transmission line losses (efficiency) and interference.

In coastal areas where temperature inversions are common (temperature increases, rather than decreases, with height above sea level), a phenomenon called "ducting" traps signals and may carry them hundreds of times the normal radio horizon.

Preventing Self-Oscillation in the Grove TUN-4 Minituner Plus

Grove's TUN-4 amplified preselector is a popular shortwave signal booster, but on rare occasions its amplifier may exhibit self-oscillation, characterized by a loud buzzing sound on certain settings of the fine tuning dial.

The fix is simple. Remove the two side cabinet screws and lift off the lid. Note the black or brown wire which runs from the rear RECEIVER 1 connector to the front (center) switch. pull the wire gently toward the middle of the cabinet so that it runs alongside the lead from the rear power jack. That's it!

High-gain amplifiers have a tendency to oscillate on their own if input and output leads are close together; in some runs of the TUN-4, the leads were not pulled far enough apart. I wish all fixes were this easy!

FREE ^{500 Dollars} Satellite TV

Catalog/Buyers Guide

(Ask for "Domestic(56 page) or International(16 page) version)

- Complete Systems
- Upgrades
- 2ft to 24ft Dishes
- Parts
- Accessories
- Major Brands
- Factory Fresh
- USA Warranty
- Fast Delivery



WORLD SATELLITE TV AND SCRAMBLING METHODS

"The Technicians' Handbook"
This thorough text is a must-buy for technicians, satellite professionals and curious do-it-yourselfers. The design, operation and repair of satellite antennas, feeds, LNBS, receivers and modulators are examined in detail. An in-depth study of scrambling methods and broadcast formats including the VideoCipher II, Oak Orion, FilanNet, Sky Channel, EuroCypher, D2 MAC, BSB and Teleclub Payview III. Circuit and block diagrams of all components are presented and clearly examined throughout the handbook. This information is a prelude to the chapters on troubleshooting and setting up a test bench. This expert guidance on testing, servicing and tuning is complimented by a wealth of detailed illustrations.

340 pages, 8 1/2 x 10 3/8 over 200 photos, diagrams, wiring schematics and 16 tables / appendices / index
S&H \$5 (U.S.) \$39.95



THE SKYVISION DO-IT-YOURSELF INSTALLATION VIDEO

"Now You Can Watch It Being Done"
Installing or "Tuning up" your satellite system made simple.
VHS or Beta... S&H \$3 (U.S.) \$33.95



ORBITRON Mesh Dishes

"Quality Demonstrated by Performance"

7ft	dish & polar tracking mount	\$235
8.5ft		295
10ft		345
10ft H D		435
12ft		625



ACTUATORS

18"	Superjack II	S&H \$14	\$89
24"	Superjack XL	ball	15
139			
24"	Venture acme	15	129
51"	JGS acme	22	219



Bulz-I-Tuning Meter
Now with audio alert



Pico dish Tuning Meter

TUNE YOUR DISH TO ITS' MAXIMUM!

A must for the serious dealer or satellite system owner. Saves time, frustration and money. Use when installing a new system, moving your dish, re-alignment of a dish that has been moved by wind, frost heaves etc., gets you right on the satellite belt for the best possible pictures!

Pico meter S&H \$6 Catalog price \$89.95

Sale Price \$79.95

Bulz-I-IV meter S&H \$6 Catalog Price \$140.95

Sale Price \$139.95

DRAKE

1524



NEW "TOP OF THE LINE"

Introducing the Drake 1524 IRD
(Integrated receiver decoder)

The new Drake 1524 is at present the ultimate in engineering achievement for IRDs. Picture quality is nothing less than fantastic. Most of the time as we review new product models, we find some new and exciting bells and whistles. They come with the Drake 1524 also, but this model goes beyond the usual. It has the best dang picture quality that we've ever seen.

Hooked up to a new 60" Hitachi rear projection TV you can see the difference. With other top-of-the-line IRDs we see a lot of magnification of video noise. Not so with the Drake 1524... It gives us sparkle free pictures on all but the weakest of transponders.

Use it with smaller satellite dishes and the 1524 continues to shine. It's low threshold (less than 7dB C/N) provides performance on a 7 foot dish that we used to see on a 10 footer.

We've seen them all (all major brands) and have them in stock. Right now the Drake 1524 leads the pack and best of all it's made in the U.S.A. If you're considering a new system or upgrading your present system... The top-of-the-line Drake 1524 IRD would be the intelligent choice. Your satisfaction is guaranteed!



REDUCED!

LNBS LOW TEMP

"Herm Technology"
"Commercial Grade"

45"	LNBS C-band 4GHz	S&H \$6	\$95
40"	LNBS		95
30"	LNBS		139
25"	LNBS		195
	1.3dbLNBS Ku	12GHz	S&H \$6
	1.2dbLNBS		119
	1.1dbLNBS		129
	1.0dbLNBS		139
	0.9dbLNBS		149
	0.8dbLNBS		219

100% SATISFACTION GUARANTEE

Send in coupon or call toll free

All Major Credit Cards Accepted

Skyvision Inc.

1050 Frontier Drive, Fergus Falls, MN 56537 - Toll Free 800-334-6455

Mail in coupon or call Toll FREE today for the SKYVISION Satellite TV Product Catalog

Delivered free to your mail box in U.S. and its possessions

• International requests add \$8.00 to cover shipping and handling

Send Skyvision Satellite TV Products Catalog

Name _____ Phone (____) _____

Address _____

City _____ State _____ Zip _____



Install A System, Upgrade & Repair Yourself And Save \$\$\$

Call Toll Free 800-334-6455 International 1-218-739-5231 Fax 218-739-4879

Japan Radio Co. NRD-535D receiver - save \$ - call. Skywaves WAS-50 antenna - .1-30 MHz - no traps - 50' needed to install - \$79.95 + \$5 s/h. IBM PC s/w for JRC and Kenwood revrs; English Lang SW Broadcast Schedules \$27.50 + \$2.50 s/h & BBS subscription \$35/yr. Send SASE or download catalog from the Pinelands RBBS 609-859-1910.

TRS Consultants

PO Box 2275-MT

Vincentown, NJ 08088-2275

609-859-2447 | Fax 609-859-3226

QSL DESIGNS for SWL, CB, Ham

We produce a personalized, ready-to-print design on quality 60 lb. bond. Simply take it to your local printer for the quantity, color, and stock of your choice. A super value!

— send SASE for our free samples —

QSL Prints

P.O. Box 112

W. Henrietta, NY 14586

Club Circuit

This month, clubs from "N" to "Z" are listed, along with new listings. Next month, we'll pick up the rest of the alphabet. This way your club will appear once every two months—until we grow some more!

If your club is not listed in Club Circuit, write or call to request a form.

Club Profiles:

Ontario DX Association (ODXA)

This club for shortwave listeners, DX enthusiasts and scanner owners was organized in late 1974 by several Ontario shortwave listeners. They identified a need for a club which would concentrate on organizing local radio listeners, hold meetings and publish a regular bulletin which would contain listening tips from and for local listeners.

Today's *DX Ontario* bulletin has grown from a few pages to eighty, and has been praised as one of the foremost DX publications in the world. Regular columns, written by volunteers, cover mediumwave, FM, TV, scanners and shortwave broadcasting, as well as utility DXing.

Being a regional club, some things are done differently in the ODXA. Although any-

one anywhere in the world may join the ODXA, the loggings found in the bulletin are only from Ontario members. Non-Ontarians are welcome to contribute other types of articles, but the listening tips are designed to aid the Ontario member. Likewise, hobby events and advertisements in the Ontario area are given prominence.

Meetings for ODXA members are encouraged and regular meetings take place in Toronto, London, Ottawa, Kitchener-Waterloo, Sudbury, Gravenhurst and other locations. Advance details of the program activities are always printed in *DX Ontario*. The 1992 ODXA Convention is being held April 25th at the Valhalla Inn in Etobicoke.

Several DXpeditions are held each year, with dozens of members spending a weekend at a camp trying out different receivers and antennas, looking for new and exciting catches. May 29-31 is the date for the next DX camp, to be held at the Mansfield Outdoor Centre in Mansfield, Ontario.

For those interested in learning more about the ODXA, a sample magazine and complete information is available for \$2 from the Ontario DX Association, P.O. Box 161, Station A, Willowdale, Ontario M2N 5S8. Membership fees are \$28.75 per year (plus GST). Direct telephone inquiries to 416-853-3169. The DX-Change is a message service offering hobby and club infor-

mation via the telephone at 416-299-ODXA.

Southern California Area DXers (SCADS)

SCADS is a regional club whose membership is drawn from the Santa Barbara to San Diego area. It offers one-to-one help with your AM (longwave), FM, TV, scanner and world band (shortwave) reception problems.

Working demonstrations of radio receivers, plus station frequency and program information up-dates, and other hobby-related information are given out at the monthly get-togethers.

Regular club meetings are held on the third Saturday afternoon of each month from 1:30 to 4 pm at the Huntington National Bank Community Room, 9025 East Artesia Blvd., Bellflower, CA. Guests are always welcome. The 1992 schedule is as follows: April 18, May 16, June 20, July 18, August 15, September 19, October 17, November 21, December 19.

To request a membership form or for more information, send a self-addressed, stamped #10 envelope to SCADS, Don R. Schmidt, Pres., 3809 Rose Avenue, Long Beach, CA 90807-4334; (310) 424-4634.

Club Name: National Radio Club Contact: Paul Swearingen, Publisher Club Address: P.O. Box 5711 Topeka, KS 66605-0711 Region: Worldwide Interests: AM/FM Publications: DX News 30 times yearly Sample for a 29 cent stamp	Region: Predominantly Providence of Ontario Interests: SWBC, utility, MW, FM-TV, scanning, technical, propagation Publication: DX Ontario	Interests: All bands Publications: Annual meeting calendar for an SASE	New Additions: Club Name: DX Audio Service (NRC) Contact: NRC Publications Center Club Address: P.O. Box 164 Mansville, NY 13661-0164 Region: Worldwide Interests: AM/FM Publication: DXAS Cassette 90-min monthly Audio magazine. Sample \$3 to above address
Club Name: North American SW Assoc. Contact: Bob Brown, Executive Dir. Club Address: 45 Wildflower Lane Levittown, PA 19057 Region: Worldwide Interests: Shortwave broadcast only Publication: The Journal	Club Name: Pacific NW/BC DX Club Contact: Phil Bytheway Club Address: 9705 Mary NW Seattle, WA 98117 (206) 356-3927 Region: WA, OR, ID, BC Interests: DXing all bands	Club Name: Southern California Area DXers (S.C.A.D.S.) Contact: Don R. Schmidt Club Address: 3809 Rose Avenue Long Beach, CA 90807-4334 Phone: (310) 424-4634 Region: California area Interests: AM, FM, TV, scanner and shortwave broadcasting	Club Name: Ft. Wayne Radio Club Contact: Robert E. Hilton Club Address: 5809 Heatherview Fort Wayne, IN 46818 Phone: (219) 489-5821 Region: Ft. Wayne area Interests: All aspects of radio
Club Name: Northeast Ohio SWL/DXers Contact: Mike Fanderys Club Address: 5618 Velma Ave. Parma, OH 44129 Phone: (216) 661-2443 Region: NE Ohio Interests: SWBC and utilities	Club Name: Pakistan SW Listeners Club Contact: Mrs. Fatima Naseem Club Address: Sultanpura, Sheikhupura 39350 Pakistan Region: Pakistan Interests: SWBC	Club Name: SPEEDX (Society to Preserve the Engrossing Enjoyment of DXing) Contact: Bob Thunberg, Business Mgr. Club Address: P.O. Box 196 DuBois, PA 15801-0196 Region: Worldwide Interests: SWBC, utilities Publication: SPEEDX-monthly newsletter	Club Name: Longwave Club of America Contact: Bill Oliver Club Address: 45 Wildflower Rd. Levittown, PA 19057 Phone: (215) 945-0543 Region: Worldwide Interests: Longwave only Publication: The Lowdown
Club Name: Northeast Scanner Club Contact: Les Mattson Club Address: P.O. Box 62 Gibbstown, NJ 08027 Phone: (609) 423-1603 evenings Region: Maine thru Virginia Interests: UHF, VHF, public safety, aircraft, military Publication: Northeast Scanning News (NESN)	Club Name: Radio Monitors of Maryland Contact: Ron Bruckman Club Address: P.O. Box 394 Hampstead, MD 21074 Maryland Interests: VHF/UHF/HF utilities Publication: Radio Monitors Newsletter of MD	Club Name: Susquehanna Cty Scanner Club Contact: Alan D. Grick Club Address: P.O. Box 23, Prospect St. Montrose, PA 18801 Region: PA area Interests: Scanning all bands	Club Name: Puna DX Club Contact: Jerry Witham Club Address: P.O. Box 596 Keaau, HI 96749 Region: Puna, HI Interests: SW and MW
Club Name: Ontario DX Association Contact: Harold Sellers, General Mgr. Club Address: P.O. Box 161, Station A Willowdale, Ontario M2N 5S8 Canada Phone: (416) 853-3169 voice & fax (416) 299-6392 DX-Change information svce.	Club Name: Regional Communications Network (RCN) Contact: Bill Morris, Public Info. Officer Club Address: Box 83-M Carlstadt, NJ 07072-0083 Region: 50 mie radius of NY City Interests: HF, VHF, UHF, 800 MHz, utilities, and broadcast	Club Name: Toledo Area Radio Enthusiasts Contact: Ernie Dellinger, N8PFA Club Address: 6629 Sue Lane Maumee, OH 43537 Phone: (419) 865-4284 Region: NW Ohio and SE Michigan Interests: Shortwave, scanning, amateur	Club Name: RCMA (Radio Communications Monitoring Assn.) Contact: Carol Ruth, Gen'l Mgr. Club Address: P.O. Box 542 Silverado, CA 92676 Region: North America, Europe, Australia Interests: All modes above 30 MHz Publication: RCMA Journal
Club Name: Rocky Mountain Radio Listeners Contact: Wayne Heinen Club Address: 4131 S. Andes Way Aurora, CO 80013-3831 Region: Colorado Front Range			

SPECIAL EVENT CALENDAR

Date	Location	Club/Contact Person
April 4-5	Spokane, WA	Spokane Radio Amateurs, Inc./Warren Kelsey, N7KYH S1405 Crestine, Spokane, WA 99203
April 4-5	N. Little Rock, AR	Delta Division Convention/Elisha Dixon, N5QCH 1723 N. Augusta, N. Little Rock, AR 72114
April 5	Longmont, CO	COADX Hamfest P.O. Box 22202, Denver, CO 80222 Location: Boulder County Fairgrounds, 8AM to 2PM
April 5	Madison, WI	Madison Swapfest & Computer Show/MARA P.O. Box 8890, Madison, WI 53708-8890, (608)249-7579. Location: Dane County Expo Center Forum Bldg, \$5 admission at door.
April 10-12	Visalia, CA	International DX Convention/Rick Samoian 5302 Cedarlawn Dr., Placentia, CA 92670
April 12	Rockford, IL	Rockford ARA/Clayton DeWitt, N9HUB 1137 Roxbury Rd., Rockford, IL 61107
April 18	Bowling Green, KY	KY Colonel's Amateur Radio Club P.O. Box 9781, Bowling Green, KY 42102, (502)777-3681. Location: National Guard Armory, Morgantown Road, \$4 admission.
April 24-26	Dayton, OH	Dayton Hamvention/Bill Schmid, WD8LOI PO Box 964, Dayton, OH 45401
April 25	Etobicoke, CN	ODXA '92 Convention/Harold Sellers P.O. Box 161, Station A, Willowdale, Ontario, M2N 5S8, Canada Location: Valhalla Inn, Etobicoke, Hwy 427 and Burnhamthorpe Rd. 8AM to 4PM; registration \$12 at the door
May 1-3	Fresno, CA	San Joaquin Valley ARRL Section Convention/Lee Rhoj, WA6YAB 4817 N. Crystal, Fresno, CA 93705.
May 2	Cedarburg, WI	Cedarburg Swapfest/Ozaukee Radio Club 11448 Laguna Dr., Mequon, WI 53092, (414)242-4995. Location: Circle-B Recreation Center, Hwy 60 and Cty I.
May 2-3	Abilene, TX	ARRL West Texas Convention/Peg Richard, KA4UPA 1442 Lakeside Dr., Abilene, TX 79602
May 2-3	Baton Rouge, LA	Baton Rouge ARC Hamfest/Herb Ramey, KB5AQ 4079 Florida Blvd, Baton Rouge, LA 70806, (504)346-000 or 654-6087. Location: Baton Rouge Hilton
May 3	Yonkers, NY	Metro 70cm Network/Otto Supliski 53 Hayward St., Yonkers, NY 10704.
May 16-17	Birmingham, AL	BirmingHamfest '92-ARRL SE Convention P.O. Box 94775, Birmingham, AL 35220, (205) 979-7039 Location: Birmingham-Jefferson Civic Center; \$5 admission, talk-in on 146.880 MHz.
May 16-17	Henrietta, NY	Rochester Hamfest-NY ARRL Convention 300 White Spruce Blvd., Rochester, NY 14623 Location: Monroe County Fairgrounds, corner of East Henrietta Rd. and Calkins Rd.
May 17	Queens, NY	Hall of Science ARC Hamfest/Charles Becker, WA2JUJ, (516)694-3955 or Arnie Schiffman, WB2YXB, (718)343-0172. Location: 47-01 111th St., Queens, NY. Opens 9AM, \$5 admission, talk-in on 455.175 NB2A repeat.
May 17	Peotone, IL	Kankakee Area Radio Society/Frank DalCanton, KA9PWW 117 Kristina Dr., Bourbonnais, IL 60914.
May 22-23	So Sioux City, NE	Midwest Division ARRL Convention/R.W. Pitner, W0FZO 2931 Pierce St., Sioux City, IA 51104.
May 29-31	Kansas City, MO	PHD ARC/Chuck Miller, WA0KUH P.O. Box 11, Liberty, MO 64068

INDEX OF ADVERTISERS

Advanced Electronics Applications	13
Advanced Electronic Technologies	93
AIE Corporation	3, 41, 87
Antique Radio Classified	9
ARRL	15
Ashton ITC	47
Automotive Security & Accessories	93
Cellular Security Group	91
Chilton Pacific	43
Communications Electronics	11
Consumertronics	23
Conversion Research	3, 41
CQ Communications	63
Datametrics	95
Delta Research	7
R.L. Drake Company	63
DX Radio Supply	47, 93
Electronic Equipment Bank (EEB)	17
EDE	103
Future Scanning Systems	3
Galaxy Electronics	103
GRE America	95
Grove Enterprises	23, 25, 55, 56, 57
Glenn Hauser	19
Hunterdon Aero Publishers	45
ICOM America	Cover IV
Intercepts Newsletter	41
J&J Enterprises	19
Japan Radio Company	21
KIWA	45, 103
Klingenfuss	37
Lakeview	45
Lentini Communications	41
LJ Electronic Industries	19
MilSpec Communications	55
Monitoring Times	5, 65, 95
Motron Electronics	97
National Scanning Report	3
OFS Weatherfax	99
OptoElectronics	Cover II, III
Palomar Engineering	51
Pioneer Data	97
Popular Electronics	75
QSL Prints	107
Radio Accessories	93
RDI White Papers	97
Satellite TV Sourcebook	51
Satman	51
Scanner World	39
Skyvision	107
Software Systems Consulting	9, 101
Somerset Electronics	105
Spec-Com	53
SWL Swapper	51
Tiare Publications	105
TRS Consultants	107
Turbo Electronics	23
Universal Radio	47
V-Comm	99
World Com Technology	9

DX Radio Test

The following is a "special event" set-up as a mediumwave DX opportunity for listeners. The listing was arranged by the Courtesy Program Committee of the National Radio Club. For more information on the NRC and BCB DXing, send \$1 to the NRC Membership Center, P.O. Box 118, Poquonock, CT 06064-0118.

WCKB-780, P.O. Box 789, Dunn, NC 28935, will conduct a DX test from 0530 to 0600 EST on Tuesday morning, April 7, 1992. This test will consist of test tones and ID's. This test is an extension of their normal first Tuesday frequency check.

*Tell them you read
about it in
Monitoring Times!*



STOCK EXCHANGE

Ads for Stock Exchange must be received 45 days prior to the publication date. All ads must be paid in advance to *Monitoring Times*.

Monitoring Times assumes no responsibility for misrepresented merchandise.

NON-COMMERCIAL SUBSCRIBER RATES: \$.25 per word - *Subscribers only*. All merchandise must be personal and radio-related.

COMMERCIAL RATES: \$1.00 per word. Commercial line ads printed in bold type.

1-3/4" SQUARE DISPLAY AD: \$50 per issue. Send camera-ready copy or copy to be typeset. Photo-reduction \$5 additional charge. For more information on commercial ads contact Beth Leinbach, 704/389-4007.

SURVEILLANCE, COUNTER SURVEILLANCE EQUIPMENT FOR SALE. WRITE SHERWOOD COMMUNICATIONS, BOX 535-G, SOUTHAMPTON, PA 18966 (215) 357-9065.

800 MHz (INCLUDING CELLULAR) SUPER SCANNER DUCKIE ANTENNA Hear stations that couldn't be heard before. Full year warr. \$19.95 (incl. s&h), **MOBILE DIAGNOSTICS, P.O. Box 1226, Brick, NJ 08724-2925.**

World maps showing predicted HF propagation from your Amateur, SWL, or SW broadcast station to entire globe. World-Vu® Box 946, Portsmouth, RI 02871.

FAX THIS! Our scanner and shortwave catalog prints out on your fax machine! "Poll" us 24 hours a day at (212)989-6158. Or call our voice line at (212)989-5773. Firecom, P.O. Box 61-MT, New York, NY 10011.

PRESS RTTY AND FACSIMILE LIST \$2 plus SASE to: Press, 6713 Bellaire Dr., New Orleans, LA 70124

FOR SALE: NRD 525, mint, new 9/89. 4.0, 2.3, 1.8, 1.0 filters, NVA-88 speaker. \$1600 value for \$900. Contact Mark at (305)371-6421 weekdays or Box 112007, Miami, FL 33111-2007.

UNIDEN PROFESSIONAL SCANNER MR8100, 100 ch. VHF/UHF full 800 MHz. \$260. VHF-PORTABLE YAESU FTH-2008, mini 5 watt, high band, 15 channels, 2-batt, charger, program in box \$350. (907) 248-4456 Alaska time.

WANT TO HEAR MORE OF NEW YORK CITY AND LONG ISLAND? Get a copy of "Monitoring the Long Island Sounds" and hear

all that there is to hear in the NYC-LI area. It's a six-page monthly newsletter, free to you, simply for an SASE each month. Frequencies, scanning tips, and much more. For a sample issue, send an SASE to MLIS, 2134 Decker Ave., North Merrick, NY 11566.

PRO-2004, complete 800, 400 channel, original box and manuals, \$285. GROVE POWER ANT III, preamp, \$40. MONITORING TIMES, first six years, complete Jan. '82 thru Dec. '87, \$50. (703) 483-1468.

UNIDEN HR-2510, brand new, box and manuals, \$200 (plus shipping); RCI 2950, brand new, box and manuals, \$200 (plus shipping). John (716) 693-5290 evenings.

FOR SALE: ICOM R71A, PBT, FL44A filter, all manuals and cover, \$675. (908) 390-0977.

REALISTIC PRO-2006, mint, box, manuals \$300; CHANNEL MASTER 5094A MONITENNA SCANNER ANTENNA \$30. Jim (606) 441-9684.

DRESSLER VHF/UHF ACTIVE ANTENNA ARA-900. New from Gilfer Shortwave \$189.95. Yours for \$129.95 includes UPS shipping. Darrel Charest, 3420 Trenary Lane, Colorado Springs, CO 80918. Call (719) 528-1322.

WANTED: Tube type citizen's band radio base stations. Must be clean, complete and in good working order. Louis Femine, 440 Inglewood Circle, Las Vegas, NV 89123.

SONY ICF-2010, new with warranty, \$325. (619) 789-3674.

FOR SALE: SONY WA8800, AM/SW/FM, stereo cassette, miniature device. Not available in USA. Original \$425, mint \$175. Harrison (513) 977-3153 days 10-2pm or SASE, 4575 Walton Creek, Cincinnati, OH 45243.

WANTED: REGENCY TS-2, \$4030, Polaris xcvr; UNIDEN MC615 OR MC690; ALLIED/LAFAYETTE catalogs 1966-1970, (912) 226-6786.

REALISTIC DX-440 hardly used \$100; DRAKE FS-4 \$250. Ken (708) 653-4046 early am/late pm.

PRO-2004/5/6 and PRO-34 for sale. Two 2004's with 400 ch, cellular and scan speed mods, \$225/ea. The 2005 has cellular and a Key Research search and hold module, \$275. The 34 has cellular, \$200. Also, two stock 2006's, one with 5-yr TSP, \$275 & \$300. Manuals and box available for all. May consider some trades, R71, R7000, ICR-1, etc. Call Harry (703) 680-6345. Please leave message if not at home.

GROVE MINITUNER \$50, SOMERSET MICRODEC MD100 BASIC \$150. Hugh (513) 876-3115.

WANTED: ICOM R-7000 AND ICOM R-71A. Willing to pay \$600 and \$500 respectively. Call (714) 763-0604, Steve.

FOR SALE: UNIDEN HR 2510, 10-meter transceiver, new in box, \$180. I pay shipping. Frank (707) 539-3171.

FOR SALE: KENWOOD R-5000 with computer control and filter options, \$675. AEA PK232MBX with latest software, \$250. REALISTIC PRO-2004 scanner \$225. All items in excellent condition and include shipping. (606) 365-9042.

FOR SALE: Pink, like new, JRC RECEIVER NRD-525, with speaker, \$775 plus UPS. Jose A. Fernandez, P.O. Box 3047, Bayamon, PR 00960, (809) 798-7281.

FOR SALE: UNIVERSAL M-7000 V5 \$750; INFOTECH M200F \$100 OBO; M-600 \$225 OBO. Todd, KM4IC (919) 851-8586.

FOR SALE: SYNCHRONOUS DETECTOR for 455 kHz IF receivers. Dramatically improves AM: Reduces fading distortion, selectable sideband cuts interference. Kit: \$139. Built/tested: \$199. Info: \$3. Steve Johnston, P.O. Box 3420, York, PA 17402-0420.

HOOKED ON CODE

Phillip Kawa, a musician and ham radio operator, has succeeded in creating a logical, inspired tape which combines two forms of art — Morse code and rhythmic music. The result is an innovative avant garde cassette tape that gives listeners a new way to learn the basic Morse code alphabet.

Order **The Rhythm of the Code** today for only \$5.95 plus \$2 shipping/handling (check or money order) from

KAWA Records
P.O. Box 319, Dept. MT
Weymouth, MA 02188
Send an SASE for free information!

PAN-COM INTERNATIONAL CATALOG

From Amplifiers to Zappers! Over 350 Kits, Plans & Books about Licensed/Unlicensed AM/FM/Cable broadcasting, Ham/CB/SW/lower/med/fer, surveillance, phone devices, software, MORE. Send \$1.00!

**PO Box 130-T
Paradise CA 95967**

Radio for Peace International T-Shirts!

Blue, Green, Yellow design on White T-Shirt
\$15.00 each ppd. specify size(s):
M, L, XL



**RADIO FOR PEACE INTERNATIONAL
P.O. BOX 10869-C
EUGENE, OREGON 97440**

BROADCAST BAND INTERFERENCE?

Plagued with interference from high powered AM broadcast stations? Block it before it gets to your receiver with a precision filter from NCL. Two models provide 40+ dB rejection of broadcast band energies below and above the AM broadcast band. A variety of options allow flexibility in connection and mounting. All filters include weather proofing for outside applications. Call or write for free tech sheets on quality communication products from NCL. Designed by monitors for monitors. Models starting at \$49.95.

NORTHWEST COMMUNICATIONS LABORATORIES
813 SW Highland, Suite C-310
Redmond, OR 97756
(503) 923-2540

HIDDEN SIGNALS ON SATELLITE TV

There is more than TV on the satellites. You can receive press services, stock-financial services, SCPC, radio networks, sports radio nationwide, audio and music, data systems, telephone channels, commodity news, teletext, plus many others. **NEW Third Edition** shows you how to receive on your dish, 240 pages, hundreds of diagrams!

\$19.95 plus \$3 shipping - MC/VISA

1 - 800 - 241 - 8171

Free Catalog

Universal Electronics, Inc.
4555 Groves Rd., Suite 13
Columbus, OH 43232

Federal Frequency Database

The complete, unabridged listing of military and federal government allocations, showing frequency, location, agency, mode, and other data for the 0-3 MHz region. This information is from the last release of the IRAC database—the government's definitive interagency frequency file, before it was classified in 1982.

Available for IBM-PC compatible and Macintosh (specify format) to work the PC-File or other popular database programs. \$24.95 plus \$1.95 s&h

Printed listings available—write or call for details. Also available Low Frequency beacon database, derived from aviation and naval sources, on disk for your computer—\$19.95 plus \$1.95 s&h

Ludus Associates
73B Granite Ave.
Greenville, NH 03048
(603) 878-4077

CODE SCANNER
Copies Coded Radio Signals



Morse, RTTY, ASCII Codes
32 Character LCD Display
Compact Size 3.5 x 5.75
Easy Hookup to Radio

FREE Brochure . Order Factory Direct.

Model CSCAN.....\$189.00 + \$6 S&H

MICROCRAFT CORPORATION
P.O. Box 513, Thiensville, WI 53092
Telephone (414) 241-8144

HEAR ALL THERE IS TO HEAR WHERE YOU LIVE

25 MHz - 1500 MHz
Frequency Search Service

Send SASE to:

HEALD
6886 Jefferson St.
North Branch, MI 48461

Also: Heald's Scan-Rail \$9.95
Heald's Scan-Air \$9.95

RADIO NEW YORK INTERNATIONAL



Dedicated to global awareness of our environment and the promotion of world peace and understanding

Broadcasting Sundays
9:00 pm to 1:00 am EST
on 7535 kHz

Radio New York International
14 Prospect Dr., Yonkers, NY 10705
On-Air Phone 1-800-326-2957

HUGE 100 PAGE CATALOG

- ▶ Shortwave Receivers
- ▶ Amateur Radio Gear
- ▶ Scanners
- ▶ RTTY & FAX Equipment
- ▶ Books & Accessories

Send \$1 to

Universal Radio
6830 Americana Pkwy. MT
Reynoldsburg, OH 43068
Tel. 614 866-4267

PROSCAN
by DataFile Inc.

FOR THE SCANNER ENTHUSIAST!
Powerful EZ to use, frequency manager

Track up to 9,999 entries by bank, channel, name, location or class
Seek by channel, frequency, name
Notepad w/ auto time/date stamp

\$39.95
\$78 Demo Version
Applicable to purchase

Requires MS/PC-DOS, 640K, hard disk

Send Check or M.O. to
DataFile Inc.
PO Box 20111
St. Louis, MO 63123

YOU AIN'T HEARD NOTHIN...YET!

Largest selection of scanner frequency guides (federal, military, police, aero, etc.); AM/FM/TV broadcast directories; HF "ute" directories; Books on espionage, covert ops., bugging, wiretapping, surveillance, clandestine radio, & more!

BIG FREE CATALOG!

CRB RESEARCH
P.O. Box 56-MT
Commack NY 11725

801SCAN/801HF

Computer Control Systems for ICOM

801SCAN for VHF Scanning is available for the ICOM R7000 and R9000 receivers.

801HF for HF/shortwave listening is available for the ICOM R71, R72, R9000, IC735, and other transceivers.

Programs run on IBM/PC compatibles. Available with required interface, or use your own. Demo disk \$5, please specify 801SCAN/801HF and receiver. Call or write for current prices or other information.

Terzon Systems Inc.
VISA and MasterCard accepted
P. O. Box 835021
Richardson, TX 75083
(214) 234-8222 mailbox 801

PRO-2004/5/6
Search and Store Modules

- Automatically find unknown frequencies. Internal no-holes installation, keyboard control, retain all present functions.
- Dual-mode Power Model PS-90 stores in the main memory channels with a DIP switch adjustable limit to 255 channels or only in the ten monitor ch. - \$44.95
- Model SS-45, Ten monitor ch. - \$24.95

Wired/TESTED/Postpaid (US & Canada)
US checks or MO in US, NO add tax
For full Info/specs send SASE

KEY RESEARCH
POB 846M, CARY, NC 27512-0846

HAND-HELD SCANNERS!

MetroWest is your source for:

- Bearcat Hand-Helds
- Double-Life Battery Packs
- Drop-In Chargers
- Specialty Antennas
- Books and more



Send for our free catalog

MetroWest, Inc.
822 N. Sprung
LaGrange Park, IL 60525
(708) 354-2125
(800) 657-1475

THE BEST OF HAWAIIAN MW/BCB DX

We have compiled a 60 minute cassette tape of AM (MW) Broadcast Band DX as heard on the islands of Kauai, Oahu, and especially the Big Island of Hawaii, between 1986 and 1991. The recordings were made by a DXer using long-wire and "Beverage" antennas with various communication receivers at several remote locations on each Hawaiian Island. Saudi Arabia, India, the Pacific Islands (such as Samoa, Fiji, Tahiti), Japan, Alaska, lots of North Americans (including Midwestern and Eastern stations), Australia, New Zealand, and so forth make fascinating examples of what MW DX is like in our 50th State. You are likely to be inspired to bring your receiver and a roll of wire with you on your next vacation! Comes with insert.

HI-DX TAPE
\$11. ppd
(CARES, ADDTAX)

CONVERSION RESEARCH
P.O. BOX 535
DESCANSO, CA 91916

ATTENTION ADVERTISERS

Our large readership base allows our advertisers to spread the word about their product or service.

These spaces are available — and could be yours — in the next issue of Monitoring Times.

Contact our Advertising Manager
Beth Leinbach
704-389-4007

Religious Broadcasters in Perspective

While I firmly believe in freedom of speech, I must admit that religious broadcasters are not among my listening priorities. A chain letter I just received asking me to write to the FCC in support of those broadcasters really irked me (I'll discuss the letter shortly).

At any time of the day or night, on AM, FM, TV and shortwave, itinerant preachers drone on and on. Listening for as long as I can endure (usually about 60 seconds), I wonder who listens to these rapturous rantings—insomniacs?

Let me reassure my readers that I find some religious programs inspirational and informative. My heart goes out to missionaries who truly sacrifice, giving comfort to the less fortunate, bringing hope to the downtrodden and kinship to shut-ins.

But mechanical-sounding ministers who incessantly plea for contributions from their faithful flock—often the poor and uneducated who can't afford the fleecing—I can do without.

But it must work. Some of the strongest signals are from religious stations, and signals like this take money—a lot of money. Listeners must be generously supporting prophets for profits.

And now about that letter. What may be the oldest pyramid letter in history—now at 17 years and with no return address to identify its fabricator—is still being circulated by misinformed supporters of religious broadcasting.

The contrived letter urges its readers to write to the FCC protesting atheist Madalyn Murray O'Hair's alleged attempt to have religious broadcasting banned from the airwaves. That's the fabrication. Here's what really happened.

In 1975, Jeremy D. Lanaman and Lorenzo W. Milam (O'Hair had nothing to do with it) asked the FCC to keep new religious broadcasters off educational FM and TV channels; there was no request to ban religious broadcasting. Their petition was denied; religious stations continued to multiply.

In spite of the issue being long-dead, the FCC still receives letters—now past 20 million—from misguided individuals who accept the hoax without bothering to check the facts, much less figuring out who is perpetuating the myth.

The broadcasting spectrum is a rainbow of colorful programming. There are messages from humanitarians and pitches by opportunists; can you tell the difference?

Bob Grove
Publisher



OPTOELECTRONICS

"Here at Radio School classes held throughout the country, the only counters that we will use are Optoelectronics' Handi-Counters."

Gordon West
Gordon West
President
Radio School,
Inc.



Made in the USA

Our Name says quality, service and dependability – Our customers agree!

"The best part of the Optoelectronics LCD counters are their extreme sensitivity, their brilliant LCD readout that can be seen even in bright sunlight and the rugged construction allowing them to get banged around, but still continue to operate smack dab on frequency... Yours is the only counter which reliably gives us (at Radio School) an instant frequency readout with its rock-steady LCD digits featuring incredible 1Hz resolution."

Gordon West

Optoelectronics has satisfied its customers for over 18 years – See for yourself what countless others have already discovered!

*** Call Grove Enterprises
1-800-438-8155
for special low price!**

**FACTORY DIRECT ORDER LINE
1-800-327-5912
(305)771-2050 • FAX(305)771-2052**

5821 NE 14th Avenue • Fort Lauderdale, FL 33334
5% Shipping Handling, (Maximum \$10) U.S. & Canada. 15% outside continental U.S.A. In Florida add 6% sales tax.
Visa and MasterCard accepted.



"I was encouraged by one of my readers words of wisdom, and bought the Model 2300.

Your service was superb! After testing this unit I personally feel that all serious radio enthusiasts should own an Optoelectronics Frequency Finder"

Ron Bruckman
Radio Monitors Newsletter
Of Maryland

Model	8030	3000*	2600H	2810	2600HA	2210A	2300*
Function	Freq. Period Ratio, Interval	Freq. Period Ratio, Interval	Frequency	Frequency	Frequency	Frequency	Frequency
Range	10Hz-3.0GHz	10Hz-3.0GHz	1MHz-3.0GHz	10Hz-3.0GHz	1MHz-3.0GHz	10Hz-2.4GHz	1MHz-2.4GHz
Display	10 Digit LCD w/Function Annunciators	10 Digit LCD w/Function Annunciators	0 Digit LCD	10 Digit LCD	10 Digit LCD	8 Digit LED	8 Digit LED
RF Signal Strength Indicator	16 Segment Adjustable Bargraph	16 Segment Adjustable Bargraph	16 Segment Adjustable Bargraph
Hold Switch	Yes	Yes	Yes	Yes	Yes	No	Yes
Price	\$579.	\$375.	\$325.	\$259.	\$225.	\$179.	*\$99.

Sensitivity: <1 to <10mV typical. Time Base: ±1 ppm; ±2ppm and \$100...CD Models only. Nicads & AC charger/adaptor included except for 2300. *For 2300, available with Nicad inside & AC charger/adaptor, complete package \$128. A full line of Antennas, Probes & Carry case are sold separately. (One year parts & labor warranty.)

TAKE THE WORLD ON THE ROAD

WORLDWIDE RECEIVERS FROM ICOM

IC-R1 HANDHELD RECEIVER

The smallest wideband handheld available today, the IC-R1 continuously covers 100kHz-1300MHz with AM, FM and wide-band FM modes. This tiny receiver goes anywhere you go, measuring just 1.9"W x 4.0"H x 1.4"D.

Easy operation is a snap with the IC-R1's Dual Frequency Selection (direct keyboard and rotary tuning), 100 memories and a 24-hour clock complete the world's smallest full-featured handheld receiver.

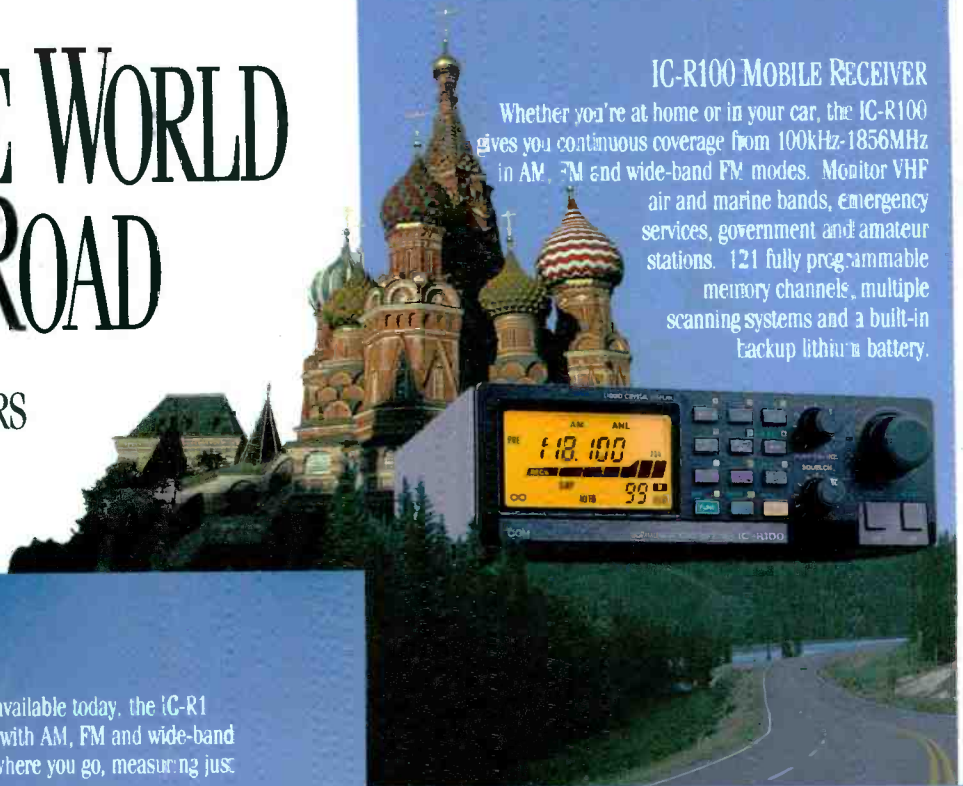

IC-R100 MOBILE RECEIVER

Whether you're at home or in your car, the IC-R100 gives you continuous coverage from 100kHz-1856MHz in AM, FM and wide-band FM modes. Monitor VHF air and marine bands, emergency services, government and amateur stations. 121 fully programmable memory channels, multiple scanning systems and a built-in backup lithium battery.

IC-R72 BASE RECEIVER

The IC-R72 continuously receives 100kHz-30MHz in SSB, AM and CW modes with exceptionally high sensitivity. An optional UI-8 provides FM reception. The IC-R72 incorporates a noise blanker, five scanning systems, internal backup battery and built-in clock with Icom's DDS System. The IC-R72 boasts a 100dB wide dynamic range while an easy to access keyboard provides convenient programming versatility... superb for shortwave listeners!



See our complete line of quality receivers at your local authorized Icom dealer.

For full details call the Icom Brochure Hotline at 1-800-999-9877.

CORPORATE HEADQUARTERS:
ICOM America, Inc., 2380-116th Ave. N.E.
Bellevue, WA 98004
CUSTOMER SERVICE HOTLINE
(206) 454-7619
CUSTOMER SERVICE CENTERS:
18102 Sloopark South, Suite 52-B
Irvine, CA 92714
1777 Phoenix Parkway, Suite 201
Atlanta, GA 30349
3071 - #5 Road, Unit 9
Richmond, B.C. V6M 2T4 Canada
2380-116th Ave. N.E., Bellevue, WA 98004
All stated specifications are subject to change without notice or obligation. All ICOM radios significantly exceed FCC regulations limiting spurious emissions. R19-91

