

ICD 08559

MODERN ELECTRONICS™

MAY 1987 \$1.95
CANADA \$2.50

THE MAGAZINE FOR ELECTRONICS & COMPUTER ENTHUSIASTS

- **Apple "Open-Architecture" Macintosh Computers**
- **Delta Modulation—The Forgotten A/D Converter**
- **8-Pattern Generator For Digital Troubleshooting**



NEC's New "MultiSpeed" Laptop Computer (p.82)

Construction Plans:

- **Fast EPROM Eraser**
- **Electronic Fan Controller**
- **Compact Car Air Conditioning**
- **Speed Upgrade for XT & Clone Computers**

Full Product Reviews:

- **Hercules & Paradise Graphics Cards**
- **A Solid-State Spelling Checker**

SEP87 ME 001HP 00054376 05
MR DUNN
42 N MAIN ST
CASTLETON-ON-HUDSON NY 12033 *

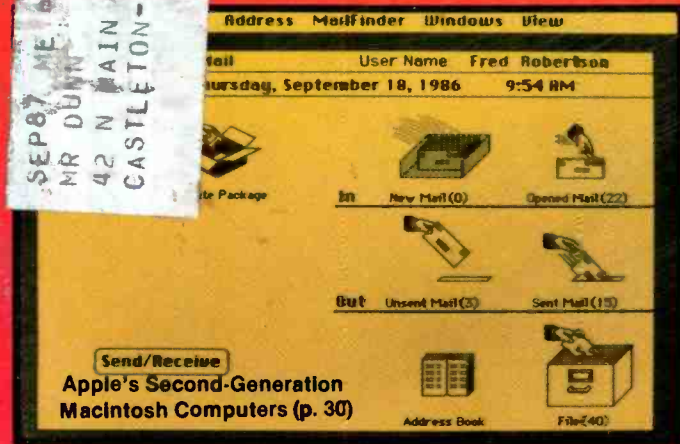

Send/Receive
Apple's Second-Generation Macintosh Computers (p. 30)

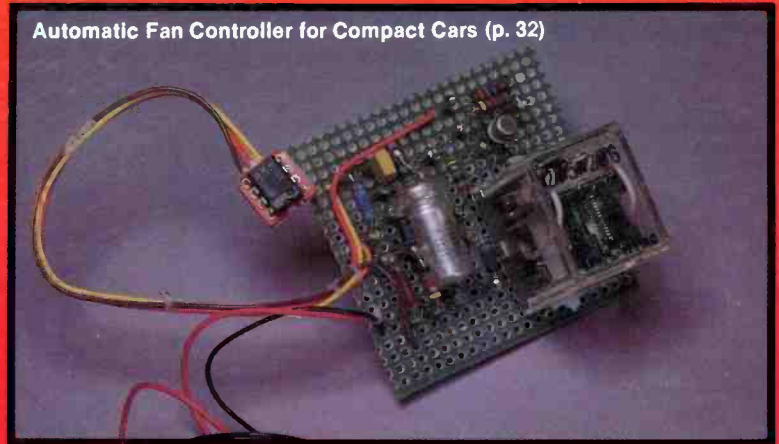

Automatic Fan Controller for Compact Cars (p. 32)

Bulk Rate
Permit No. 79
U.S. Postage Paid
Gordonsville, VA 22942

Also: Using Op Amps to Generate Signals ● Forrest Mims' Unconventional Miniature Circuits ● Eric Grevstad Looks at NEC's MultiSpeed Laptop Computer ● Don Lancaster on Remote Power Control, Laser Die Cutting and Short Time Delays ● Electronic & Computer News ... and more.

Bad News For Escort

3RD IN A SERIES

Dear Customer, *From Drew Kaplan*

Escort has ignored DAK's second, one-on-one Maxon versus Escort radar challenge. And frankly, I'm fighting mad. I suppose they have a right to ignore me. But after referring to my challenge as only an "advertising gambit" and calling Maxon's radar detector an off-shore, primitive, and bottom-end unit, I'd think they'd be glad to wipe us out in a head to head duel to the death. But, I'm really mad for two other reasons and I think that you may be as fascinated by them as I am.

Mad Reason 1. Road and Track Magazine held an independent general radar detector test in their September 86 issue.

As far as I can see, Maxon beat Passport in Uninterrupted Alert, and Passport beat Maxon in Initial alert. Now to be fair, neither of us seem to have beaten the other by even 2 seconds at 55 miles per hour. So, we didn't win or lose by much.

And, Maxon's \$99⁹⁰ detector was tested against the \$295 Passport, not the \$245 Escort we challenged. What's interesting is that Road and Track had nice things to say about Passport and even about Escort, which **wasn't even included** in the tests any more.

Now, if you've been following DAK's challenge, you know we've only been challenging Escort. If you've read Road and Track's tests, you'll be amazed when you read Boardroom Reports, which I've reprinted for you to the right. What's really interesting is that **it's the exact same person** in both publications.

Actually, Maxon did extremely well. Road and Track only used 'over hill' and 'around curve' tests because on straight-aways the differences weren't worth describing. (Imagine that!)

It's just as I've said in my challenge. I don't think there's much difference between Maxon's and Cincinnati's Radar detectors when it comes to sensing radar.

THE CHALLENGE GROWS

In view of the opinions stated in the article in Boardroom Reports about the \$245 Escort, DAK hereby adds the \$295 Passport to our challenge.

Mad Reason 2. Did you ever hear about the cure for dandruff that was developed in the middle-ages? It was the guillotine. And frankly, I think you should be aware of Cincinnati Micro-

wave's advertising cure for the Rashid VRSS Collision Avoidance System.

The Rashid VRSS system, as described in Popular Science magazine, January 1986, sends out a radar signal on the K band ahead of your car. The good part is that it can help you avoid running into things higher than your front bumper. The bad news is that since it operates on K band, it sets off radar detectors.

Well, hats off to Cincinnati Microwave. I've tested the Passport against the Rashid unit and, as usual, they have done a splendid job. While every other detector I tested, including Maxon's, was driven crazy, theirs didn't utter a peep.

But then, my Maxon hasn't uttered any peeps lately either and let me tell you why. I was on my way to the Far East to visit Maxon, so I asked Tom, a manager at DAK, to purchase and test the Rashid.

Well, did I ever hear from him. First the unit cost \$558 plus about \$100 to install. Then buying it and finding someone to install it took almost a month.

But the real reason he was unhappy was that the recommended method of installation involved **cutting a 6 1/2" hole** in the front grill of his neat new car.

Well, much to my wife's chagrin, it's now installed in her station wagon.

After installation, it has to be set by an installer. He drives between 15 and 30 miles per hour toward a solid object. When the installer **thinks** he's reached a safe stopping distance, he adjusts the warning alarms to sound. Then in the future, when a similar distance is reached, lights will flash and an alarm will sound.

Of course, if you accelerate too quickly into a lane behind another car the same alarms can go off.

And, I haven't figured out what to do if

there's a dog in the road, dirt on the radar sensor, or how to compensate for the different stopping distances encountered on dry, wet, icy or snowy roads.

MOST IMPORTANT PART

Speaking of advertising gambits, in **virtually every magazine I pick up**, I've been seeing Cincinnati's Bad News for Radar Detector ads spelling out the obsolescence of all other detectors.

If it's such an important feature that distinguishes them from us, there had better be some of these devices on the road, or Cincinnati Microwave's credibility may just be on the road as well.

I will add \$10,000 to my Escort/Passport challenge if Cincinnati Microwave can prove that there are even 1000 Rashid units on the road **anywhere** in the U.S. Oh heck, I'll add \$5000 if they can even find 500. **(And, look at this.)**

NOTE: There are several other potential collision avoidance systems on the drawing boards and each may have a **DIFFERENT FINGERPRINT.**

So, if you're a current Escort or Passport owner, I suggest that you find out how many Rashid units there are and what Cincinnati Microwave will do about the 'other' units **before** you pay \$\$\$ to have your current detector upgraded.

Besides, with over 3,000,000 square miles in the U.S., even 1,000 units would work out to less than one unit for every 3,000 square miles.

If a major car company successfully sells a collision avoidance system, then Maxon will be ready. But, the car companies currently can't even get consumers to pay \$200 for air bags. So, you decide. Is it significant, or an advertising gambit?

Below is the **NEW** version of the challenge. Escort, a reply please!

A \$20,000 Challenge To Escort

Let's cut through the Radar Detector Glut. We challenge Escort & Passport to a one on one Distance and Falsing 'duel to the death' on the highway of their choice. If they win, the \$20,000 check pictured below is theirs.

By Drew Kaplan

We've put up our \$20,000. We challenge Escort to take on Maxon's new Dual Superheterodyne RD-1 \$99⁹⁰ radar detector on the road of their choice in a one on one conflict.

Even Escort says that everyone compares themselves to Escort, and they're right. They were the first in 1978 to use superheterodyne circuits and they've got a virtual stranglehold on the magazine test reports.

But, the real question today is: 1) How many feet of sensing difference, if any, is there between this top of the line Maxon Detector and Escort's or Passport's? And 2) Which unit is more accurate at interpreting real radar versus false signals?

So Escort, you pick the road (continental U.S. please). You pick the equipment to create the false signals. (Don't forget our \$10,000 Rashid challenge). And finally, you pick the radar gun.

Maxon and DAK will come to your
...Next Page Please



...Challenge Continued highway with engineers and equipment to verify the results.

And oh yes, we'll have the \$20,000 check (pictured) to hand over if you beat us by more than 10 feet in either X or K band detection with the Escort, or by 2 seconds at 55mph with the Passport.

BOB SAYS MAXON IS BETTER

Here's how it started. Maxon is a mammoth electronics prime manufacturer. They actually make all types of sophisticated electronic products for some of the biggest U.S. Electronics Companies. (No, they don't make Escort's).

Bob Thetford, the president of Maxon Systems Inc., and a friend of mine, was explaining their new RD-1 anti-falsing Dual Superheterodyne Radar detector to me. I said "You know Bob, I think Escort really has the market locked up." He said, "Our new design can beat theirs".

So, since I've never been one to be in second place, I said, "Would you bet \$20,000 that you can beat Escort?" And, as they say, the rest is history.

By the way, Bob is about 6'9" tall, so if we can't beat Escort, we can sure scare the you know what out of them. But, Bob and his engineers are deadly serious about this 'duel'. And you can bet that our \$20,000 is serious.

We ask only the following. 1) The public be invited to watch. 2) Maxon's Engineers as well as Escort's check the radar gun and monitor the test and the results.

3) The same car be used in both tests. 4) We'd like an answer from Escort no later than July 31, 1987 and 60 days notice of the time and place of the conflict. 5) If Escort can prove that there are 1,000, or even 500 Rashid units in operation, we will present them with the appropriate \$10,000 or \$5,000 check at the beginning of the conflict. And, 6) We'd like them to come with a \$20,000 check made out to DAK if we win.

HOW'S THIS FOR FAIR

Cincinnati Microwave will be deemed the winner and given the check if either

Escort beats Maxon by 10 feet in both uninterrupted and initial alerts, OR if Passport beats Maxon by 2 seconds at 55mph in both uninterrupted and initial alerts. So, DAK wins only if we beat both Escort and Passport.

A tie will exist only if both the \$295 Passport and \$245 Escort fail to beat Maxon's \$99⁹⁰ Dual Superheterodyne RD-1 Radar Detector.

SO, WHAT'S DUAL SUPERHETERODYNE?

Ok, so far we've set up the conflict. Now let me tell you about the new dual superheterodyne technology that lets Maxon leap ahead of the pack.

It's a technology that tests each suspected radar signal 4 separate times before it notifies you, and yet it explodes into action in just 1/4 of one second.

Just imagine the sophistication of a device that can test a signal 4 times in less than 1/4 of one second. Maxon's technology is mind boggling.

But, using it isn't. This long range detector has all the bells and whistles. It has separate audible sounds for X and K radar signals because you've only got about 1/3 the time to react with K band.

There's a 10 step LED Bar Graph Meter to accurately show the radar signal's strength. And, you won't have to look at a needle in a meter. You can see the Bar Graph Meter with your peripheral vision and keep your eyes on the road and put your foot on the brake.



So, just turn on the Power/Volume knob, clip it to your visor or put it on your dash. Then plug in its cigarette lighter cord and you're protected.

And you'll have a very high level of protection. Maxon's Dual Conversion Scanning Superheterodyne circuitry combined with its ridge guide wideband horn internal antenna, really ferrets out radar signals.

By the way, Escort, we'll be happy to have our test around a bend in the road or over a hill. Maxon's detector really picks up 'ambush type' radar signals.

And the key word is 'radar', not trash signals. The 4 test check system that operates in 1/4 second gives you extremely high protection from signals from other detectors, intrusion systems and garage door openers.

So, when the lights and X or K band sounds explode into action, take care, there's very likely police radar nearby. You'll have full volume control, and a City/Highway button reduces the less important X band reception in the city.

Maxon's long range detector comes complete with a visor clip, hook and loop dash board mounting, and the power cord cigarette adaptor.

It's much smaller than Escort at just 3 1/2" Wide, 4 3/4" deep and 1 1/2" high. But, it is larger than Passport. It's backed by Maxon's standard limited warranty.

Note from Drew: 1) Use of radar detectors is illegal in some states.

2) Speeding is dangerous. Use this detector to help keep you safe when you forget, not to get away with speeding.

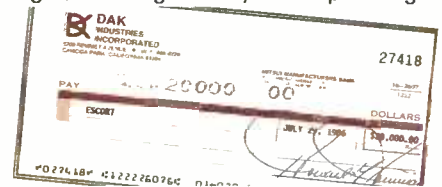

CHECK OUT RADAR YOURSELF RISK FREE

Put this detector on your visor. When it sounds, look around for the police. There's a good chance you'll be saving money in fines and higher insurance rates. And, if you slow down, you may even save lives.

If you aren't 100% satisfied, simply return it in its original box within 30 days for a courteous refund.

To get your Maxon, Dual Superheterodyne, Anti-Falsing Radar Detector risk free with your credit card, call toll free or send your check for just \$99⁹⁰ (\$4 P&H). Order No. 4407. CA res add tax.

Special Note: Now that we're challenging Passport, we've added an optional suction cup windshield mount and extra coiled power cord. (Sorry we can't afford to throw them in for free.) They're just \$5⁹⁰ (\$1 P&H) Or. No. 4800.

OK Escort, it's up to you. We've got \$20,000 that says you can't beat Maxon on the road. Your answer, please?

Escort and Passport are registered trademarks of Cincinnati Microwave. Rashid VRSS, and Rashid Radar Safety Brake are registered trademarks of Vehicle Radar Safety Systems, Inc.

DAK INDUSTRIES INC.
 Call Toll Free For Credit Card Orders Only
 24 Hours A Day 7 Days A Week
ME64 1-800-325-0800
 For Toll Free Information, Call 8AM-5PM Monday-Friday PST
Technical Information. . . . 1-800-272-3200
Any Other Inquiries. 1-800-423-2866
 8200 Remmet Ave., Canoga Park, CA 91304

John Tomerlin Road & Truck Radar detectors

Today's best radar detectors aren't much bigger than a pack of cigarettes and have eight times the range of existing new circuitry.

What to look for:

- X-band and K-band sensitivity. Both are used in the newer anti-radar units.
- Different alert sounds for the different types of radar. X-band radar is used in the newer anti-radar units where police locate themselves out of sight.
- Loud warning buzzer sounds from as far as three miles away. The driver can gradually slow down as the intensity of the alarm increases.
- X-band is also used in an anti-burglar alarm which makes it much more likely to generate false alarms.
- Pulse-alarm filtering. Most newer models have specialized circuits that filter out many false alarms. Since many detectors don't have good filtering capability, anytime there's almost impossible to determine whether the near-on-sent buzzer means that speed radar is being used.
- A proximity indicator. Good detectors change the warning sound as the detector gets closer.
- Easy mounting method. Good detectors have become almost as popular with thieves as car stereo. It helps it to be on the dash for the owner to remove whenever he leaves the car.
- Bright visual display. Radar detectors have light-emitting diodes (LED) that glow brightly during daylight. Constant scale are less useful—and the can be dangerous because the driver has to focus on the meter to see exactly where the needle is.

The best at any price: Cincinnati Microwave's Passport. The price a step \$295 for this 6 1/2" once with that measures 7" high x 4 1/2" deep.

Features: Dual-tone alarm auto-matic-brightness adjustment of the LED prox-only meter, a very sophisticated false alarm filter, and the can be dangerous during the driver has to focus on the buzzer that allows the driver to turn the meter on automatically for the next encounter. **Escort** is still sold (for Passport. The only mistake is still sold (for \$245). It was once the best available but is as technologically sophisticated as directly from the factory, there's no price discounting.

Good protection for half the price: The Cobra Topkicker offers many of the same features as the Passport for a suggested retail price of \$230. Major drawback: In bright sunlight it's difficult to tell if the LED lights are on. Other worth considering: B.L.L. Tonics Limited's Micro Eye XKR Lt. \$299.95 and Whisler Spectrum 2, \$140.

Reprinted with permission of Boardroom Reports, 330 West 42nd Street, New York, NY 10036.



30

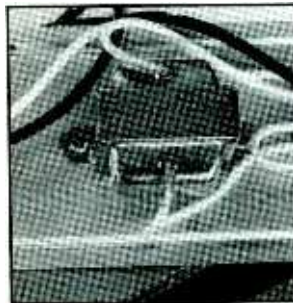

40

e men, wheelbarrow, and
ing herd of cattle
en appearance of Mariette

PHONE	
on	1-603-555-5272
	1-516-681-2922
	1-555-9920
	555-0186
	1-203-524-8123
e	555-2907
	1-213-555-0392
	555-6691

82



52

FEATURES

- 20 Delta Modulation: The Forgotten A/D Converter**
A close examination of this bandwidth-compression circuit. *By Rodney A. Kreuter*
- 26 Using Op Amps to Generate Signals**
Low-cost way to obtain sine, square, triangle and sawtooth waveforms. *By C.R. Fischer*
- 30 2nd Generation Macintosh Computers**
Apple's new, expandable Macintosh computers add power and flexibility. *By Alexander W. Burawa*
- 32 Automatic Fan Control for Small Cars**
Runs your car's air conditioner and engine more efficiently in the summer. *By Anthony J. Caristi*
- 40 EPROM Eraser**
Build a UV EPROM eraser for a fraction of the cost of a commercial model. *By Ralph Tenny*
- 52 Build the Pattern-8 Generator**
Lets you program up to eight patterns for quick, accurate digital troubleshooting. *By Desi Stelling*
- 66 The "PC Express"**
Upgrading a 4.77-MHz IBM PC, XT or clone computer to a blazing 8 MHz. *By Crady M. VanPawlak*

PRODUCT EVALUATIONS

- 16 New Graphics Cards** *By Joe Desposito*
 1. The Hercules Miracle Adapter: Graphic Card Plus
 2. Paradise's Hi-Res Graphics Card: Provides Historical Tour of PC Video Displays

COLUMNS

- 70 Electronics Notebook**
Unconventional Miniature Circuits. *By Forrest M. Mims III*
- 78 Hardware Hacker**
Author answers readers' questions. *By Don Lancaster*
- 82 PC Papers**
Best Yet: NEC's MultiSpeed. *By Eric Grevstad*
- 86 Software Focus**
PC Type Right: A Solid-State Spelling Checker. *By Art Salsberg*

DEPARTMENTS

- 4 Editorial**
A is For Analog. *By Art Salsberg*
- 4 Letters**
- 6 Modern Electronics News**
- 8 New Products**
- 88 Books & Literature**
- 96 Advertisers Index**

EDITORIAL STAFF

- Art Salsberg**
Editor-in-Chief
- Alexander W. Burawa**
Managing Editor
- Dorothy Kehrwieler**
Production Manager
- Elizabeth Ryan**
Art Director
- Barbara Scully**
Artist
- Pat Le Blanc**
Florence Martin
Phototypographers
- Hal Keith**
Illustrator
- Bruce Morgan**
Photographer
- Joseph Desposito, Leonard Feldman,**
Eric Grevstad, Don Lancaster,
Forrest Mims III
Contributing Editors

BUSINESS STAFF

- Richard A. Ross**
Publisher
- Art Salsberg**
Associate Publisher
- Dorothy Kehrwieler**
General Manager
- Frank V. Fuzia**
Controller
- Arlene Caggiano**
Accounting
- Catherine Ross**
Circulation Director
- SALES OFFICES**
- Modern Electronics**
76 North Broadway
Hicksville, NY 11801
(516) 681-2922
- Eastern Advertising Representative
Herb Pressman
Sales Assistant
Cheryl Chomicki
76 North Broadway
Hicksville, NY 11801
(516) 681-2922
- Midwest & West Advertising Representative
Market/Media Associates
1150 Wilmette Ave.
Wilmette, IL 60091
(312) 251-2541
Ted Rickard
Greg Morin
Kevin Sullivan
- Offices: 76 North Broadway, Hicksville, NY 11801. Telephone: (516) 681-2922. Modern Electronics (ISSN 0748-9889) is published monthly by Modern Electronics, Inc. Application to mail at second class rates pending at Hicksville, NY and other points. Subscription prices (payable in US Dollars only): Domestic—one year \$17.97, two years \$33.00, three years \$48.00; Canada/Mexico—one year \$20.00, two years \$37.00, three years \$54.00; Foreign—one year \$22.00, two years \$41.00, three years \$60.00. Foreign Air Mail—one year \$75.00, two years \$147.00, three years \$219.00.
- Entire contents copyright 1987 by Modern Electronics, Inc. Modern Electronics or Modern Electronics, Inc. assumes no responsibility for unsolicited manuscripts. Allow six weeks for delivery of first issue and for change of address. Printed in the United States of America. Postmaster: Please send change of address notice to Modern Electronics, Inc., 76 North Broadway, Hicksville, NY 11801.

2 SIMPLE SOLUTIONS TO 235,000 PROBLEMS.

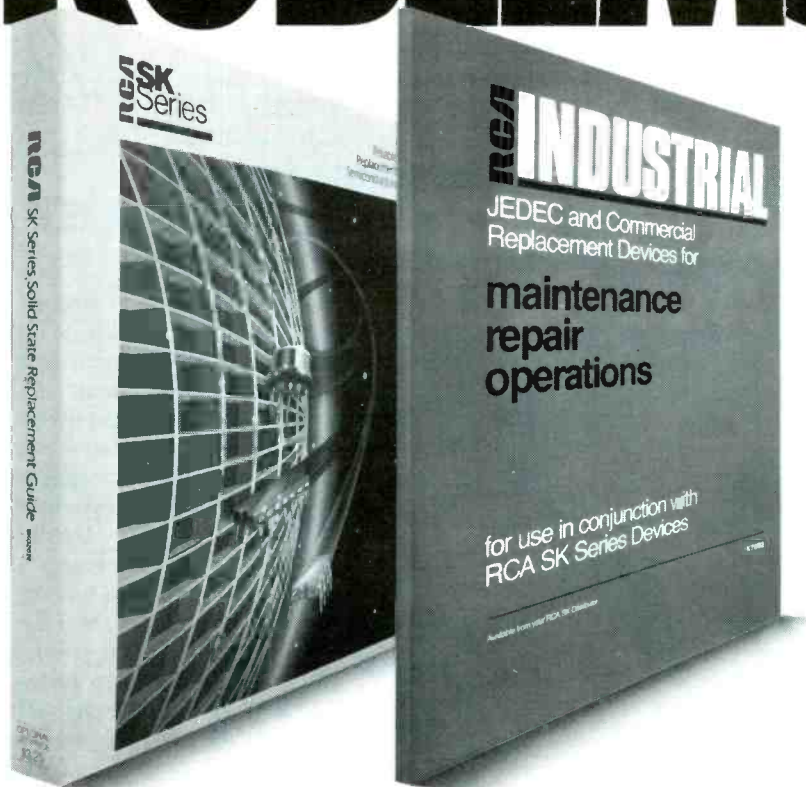

RCA's SK Series Replacement Guide (SKG202E) is your one source for over 214,000 solid state replacements using 2,900 SK and KH types. Integrated circuits, thyristors, rectifiers, transistors, microprocessors — RCA has them all.

Likewise, RCA's Industrial MRO Guide (1K7862) lists over 4,000 devices that replace more than 21,000 JEDEC* and Commercial types. The Guide also includes Power MOS/FETs, QMOS Integrated Circuits, a combined index/cross reference, and a section on high-reliability devices.

Together, these RCA Guides provide fast, easy answers for 235,000 solid state replacement problems.

For copies, see your local RCA distributor. Or write: Sales Promotion Services, RCA Distributor and Special Products Division, 2000 Clements Bridge Rd., Deptford, NJ 08096-2088.

*Joint Electron Device Engineering Council

RCA SK Replacement
Solid State

A Is For Analog

For more than a decade, "digital" has been the buzzword in electronics. Yet, the real world isn't that simple. It doesn't consist of near 1's and 0's or on and off sequences. So analog devices and the circuits in which they operate are obviously still with us.

Sure we can replace a horde of analog functions with nice, neat digital sampling methods. There are many times, though, when analog approaches are better than discrete signal methods. For example, at very high frequencies, digital devices are often not fast enough to take satisfactory samplings of the signals. Readouts from digital meters can't even be read if the signal wavers too quickly, and so on.

Solid-state devices used for digital purposes use the device's active region as a "street" to cross on the way to cut-off or saturation, while analog devices work virtually fully in the "street" itself. The analog thoroughfare is a well-traveled road, with concepts implemented in radio broadcasts and TV video broadcasts,

as an example, as well as in a variety of continuous processes that are captured by appropriate sensors such as temperature probes, strain gauges, flow meters, and so on. To work with digital equipment, an analog-to-digital converter is needed, naturally.

Not even computers are *all* based on digital premises. Remember, the first computers were analog types, and there are still a few around for certain specialized work. So as nice and relatively simple as digital electronics is, you still must understand analog principles because it's not a completely digital world yet. Even comparators are really analog devices. When used in a digital manner, it's still a comparison of analog signal levels. Too, analog and digital circuits live together in increasing numbers. There are a growing number of front ends that are analog, for example.

A key electronic IC in building analog circuit blocks, the operational amplifier, is one among many linear devices that

you'll be continually using. High power MOSFETs, smart power chips, and feedback amplifiers are some others.

Yes, digital devices are introduced at a fast and furious pace. One of the reasons for the seemingly lethargic advancements made with linear devices is that so many applications do not require high volume production and, therefore, economics defies large-scale integration processes. They're sort of tacked onto other devices, often digital ones, for particular applications.

The foregoing promises to change as design of analog application-specific ICs (ASIC) become more efficient through standard-cell libraries that form familiar building blocks. Ironically, this analog IC formulation method is made possible by using digital computer-aided-design machines and software.

Art Salsberg

LETTERS

• It looks like whoever edited my "Full-Range Speaker System" (Jan. 1987) must have actually built at least one system, judging from the nice construction details that were added. That was a nice touch for the more timid builders. In reading the rest of the article, I noted one error in editing.

Under "Technical Details," the reference to "It's designed to be mounted in a 0.8-cubic-foot enclosure" is not correct. The 0.8-cu.-ft. specification is technically referred to as V_{as} , which is defined as an enclosed volume of air that has the same stiffness as that of the driver's cone suspension. This is not the same thing. The 0.43-cu.-ft. cabinet stuffed with fiberglass is the finished volume, effectively, seen by the driver, with the effects of the fiberglass and empty air volume taken cumulatively and not the 0.83 cu. ft. specified.

William R. Hoffman

• Build your own surface-mount devices and a PC clock speedup? I'm really impressed—never let it be said the *Modern*

LOW COST PROBES FOR ALL SCOPES



TPI offers equivalents to all makes of probes including modulators, at savings up to fifty percent. TPI probes compensate to all scopes. Slender, flexible cables are easier to handle yet more durable because of their unique center conductor. Performance is guaranteed.

FOR FAST RESPONSE CALL
800-368-5719
In Calif. 800-643-8382

\$43

MODEL SP-100
SWITCHABLE X1-X10
100 MHz

TPI

TEST PROBES, INC.

Your Probe Specialists
COLINE U.S. SALES & STOCKING SOURCE

P.O. Box 2113, LA JOLLA, CALIFORNIA 92038 (619) 459-4197

CIRCLE 29 ON FREE INFORMATION CARD

Electronics isn't up-to-date and innovative. Against that, at the risk of sounding like a whiner, I'm not keen on the "Press < N > or < Enter >" style that showed up in February. I know *PC World* does it, but I think it's more ugly than it's worth. Computer-column readers are familiar enough and used to reading a simple "Press Enter or the F3 key." Just sounding off as your fussiest and crankiest columnist.

Eric Grevstad

Better Late Than Never

On occasion, authors send us article enhancement material that arrives too late to include in their published articles.

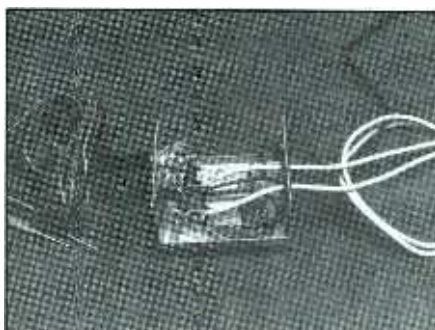
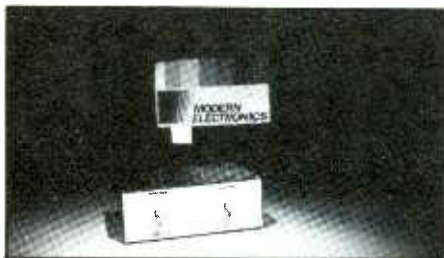

Two such case are represented in the photos here. In the first photo is shown the "Audio/Video Distribution Amplifier" that appeared in the March 1987 issue. The upper of the two remaining photos is an interior view of the "In-Circuit Component Tester" that was featured in the April 1987 issue, while the lower photo shows the Component Tester connected to an oscilloscope while it is being used in a typical troubleshooting setup.—Ed.

Parts Identification

• As a new reader of *Modern Electronics*, let me compliment you for taking over the niche left vacant when *Popular Electronics* abandoned those of us with a hobby interest. However, I am infuriated when a project calls for parts that are not identified or are so exotic that they're virtually unobtainable. A case in point is the "Digital 100-Watt Audio Amplifier" featured in the December 1986 issue. No manufacturer or part numbers were giv-

(Continued on page 96)

SHORTWAVE RADIO HEADQUARTERS



The Nations LEADING shortwave equipment dealer invites you to share the world of music, news & views of far off lands!

NEW 1987 CATALOG

Send \$1.00 for your copy. Refundable with 1st order.

Radios, Antennas, Scanners, Accessories, Books, New products; all items of interest to the shortwave listener.

ORDER TOLL FREE: 800-368-3270



ELECTRONIC EQUIPMENT BANK



516 MILL STREET
VIENNA, VIRGINIA 22180

Technical and VA orders:(703) 938-3350

CIRCLE 27 ON FREE INFORMATION CARD

CALL FOR FREE CATALOG

TEXT TO SPEECH BOARD!

PC/XT COMPATIBLE. MAKE YOUR COMPUTER TALK!
A VERY POWERFUL AND AMAZING SPEECH CARD. USES THE NEW GENERAL INSTRUMENTS SPO256-AL2 SPEECH CHIP AND THE CTS256A-AL2 TEXT TO SPEECH CONVERTER.

THIS BOARD USES ONE SLOT ON THE MOTHERBOARD AND REQUIRES A COM SERIAL PORT. BOARD MAY ALSO BE USED IN A STAND ALONE ENVIRONMENT WITH ALMOST ANY COMPUTER THAT HAS A RS232 SERIAL PORT. FEATURES ON BOARD AUDIO AMP OR MAY BE USED WITH EXTERNAL AMPS. DEMONSTRATION SOFTWARE AND A LIBRARY BUILDING PROGRAM ARE INCLUDED ON A 5 1/4 INCH PC/XT DISKETTE. FULL DOCUMENTATION AND SCHEMATICS ARE ALSO INCLUDED.

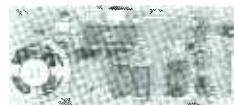

\$89.95
ASSEMBLED & TESTED

NEW!

CANON 80 COLUMN PRINTER - \$39.95

ORIGINALLY MANUFACTURED FOR THE PC JR. BUT WITH OPTIONAL CONNECTOR WILL WORK WITH PC, XT, OR AT. REQUIRES SERIAL I/O. THIS THERMAL PRINTER IS QUIET AND USES EASY TO GET 8 1/2 IN. ROLLS OF PAPER. 50 C.P.S., UPPER AND LOWER CASE, PLUS GRAPHICS. ORIGINAL LIST PRICE \$199.00. ADD \$3.00 FOR PC/XT CONNECTOR. ADD \$5.00 UPS.

PC/XT EPROM PROGRAMMER

\$199

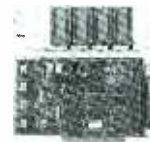

NEW!

* LATEST DESIGN * PROGRAMS UP TO 4 DEVICES AT ONE TIME * FEATURES EASY TO USE MENU DRIVEN SOFTWARE THAT RUNS UNDER PC OR MS-DOS. * USES AN INTELLIGENT PROGRAMMING ALGORITHM FOR SUPER FAST (8X) EPROM BURNING. * THIS PLUG-IN BOARD ATTACHES TO AN EXTERNAL MINI CHASSIS CONTAINING 4 TEXTOL ZIF SOCKETS. * NO PERSONALITY MODULES REQUIRED * AUTOMATIC VPP SELECTION: 12.5V, 21V, OR 25V. * EPROM DATA CAN ALSO BE LOADED FROM OR SAVED TO A DISKETTE. * PROGRAMMING SOFTWARE SUPPORTS: 2716, 2732, 2732A, 2764, 2764A, 27128, 27128A, 27256, 27256A, 27512, AND 27512A. * ASSEMBLED AND TESTED, BURNED. IN WITH MANUAL. \$199 WITH SOFTWARE.

Digital Research Computers

(OF TEXAS)

P. O. BOX 381450B • DUNCANVILLE, TX 75138 • (214) 225-2309

TERMS: Add \$3.00 postage. We pay balance. Orders under \$15 add 75¢ handling. No C.O.D. We accept Visa and MasterCard. Texas Res. add 6-1/4% Tax. Foreign orders (except Canada) add 20% P & H. Orders over \$50 add 85¢ for insurance.

CIRCLE 38 ON FREE INFORMATION CARD

ALL SALES SUBJECT TO THE TERMS OF OUR 90 DAY LIMITED WARRANTY. FREE COPY UPON REQUEST.

4-MEGS ON A CHIP. IBM has developed one-million-bit computer memory chips that occupy a silicon area only 35% larger than its one-mega-bit chip. It accesses a data bit in only 65 nanoseconds compared to IBM's most advanced one-megabit chip. All of the dynamic RAM's 4,194,304 storage cells can therefore be "read" in less than a quarter of a second. That's the equivalent of about 400 pages of double-spaced typewritten text! There are power savings, too, as the chip operates on a single 3.3 volt power supply compared to the usual 5-volt supply.

BACK-STEPPING CALCULATOR. Technico, (New York, NY) has announced the first non-printing calculator that allows a user to go back and check each entry by pressing a key. Up to 32 "instant replays" can be observed on its Model PL-941 portable's large LCD readout. The compact (4½" L x 4 3/4" W x 1" D) eight-digit calculator is retail priced at only \$12.95.

AMNESTY OFFERED ON ILLEGAL DESCRAMBLERS. General Instrument's VideoCipher Division offered a one-time, four-week amnesty program to home satellite TV viewers who have been illegally decoding scrambled pay TV broadcasts. This allows consumers to return tampered, illegal decoders to VideoCipher for a free retrofit to legal status, no questions asked. The offer expired March 15, 1987. (Why not four months so word can get out?)

THE ARRL OPPOSES 220-MHZ PROPOSAL. The American Radio Relay League plans strong opposition to an FCC proposal to reallocate 2 MHz of the 220-225 MHz Amateur Radio band to the land mobile service. Packet radio networks for amateur radio operators would be completely disrupted if the change is made, says the ARRL.

SIR CLIVE IS BACK. Britain's Sir Clive Sinclair, who sold Sinclair Research's computer business to Amstrad, formed a new company that has introduced a \$300 laptop (in Great Britain) as its first product. Who says you can't come back?

FIBER OPTIC ELECTRONIC DOOR LOCK. Yale Security Group has introduced a new electronic door lock system with a fiber optic link developed by AMP Incorporated that's used during the lock's programming. The system uses a plastic card key that's personalized for a guest when he checks in through a unique set of computer-punched holes. When the card key is first inserted into the door lock, it programs the lock to respond only to the personalized code. The non-conductive fiber optic connection is said to be virtually tamper-proof because it doesn't require any electrical voltage.

UNI WHO? That's Unisys! Stands for "united information systems." It's the name chosen for the company that emerged from the merging of two venerable computer corporations: Burroughs and Sperry. It was chosen from among 31,000 suggested names submitted by Burroughs and Sperry employees, would you believe.

Which Way To YOUR Future?

Are you at a crossroads in your career? Have you really thought about it? Are you *planning* for your future, or perhaps refusing to face the subject? Which way will you go — down the same old road? Or are you ready for something else?

In electronics you can't stand still. If you are not moving ahead, then you're falling behind. At the crossroads of your career, various choices are available — and, yes, *decisions* have to be made.

Which road will you take — one that doesn't go where you want to be, or one that leads to hard work *but also* to the better life? Ah, decisions, decisions!

Career decisions are so important that you need all the *input* you can get before locking-in on one of them. Grantham College of Engineering offers you *one* source of input which may help you in making that decision. It's our free catalog.

Ask for our free catalog and you may be surprised to learn how it is easily possible to earn a B.S. degree in electronics without attending traditional classes. Since you are already in electronics (you are, aren't you?), you can complete your B.S. degree work with Grantham while studying at home or at any convenient place.

But don't expect to earn that degree without hard work. Any degree that's worth your effort can't be had without giving effort to the task. And of course it is what you learn in the process, as much as the degree itself, that makes you stand out above the crowd — that places you in an enviable position, prestige-wise and financially.

Grantham College of Engineering
10570 Humbolt Street
Los Alamitos, California, 90720

**This booklet
FREE!**

This free booklet explains the Grantham B.S. Degree Program, offered by independent study to those who work in electronics.

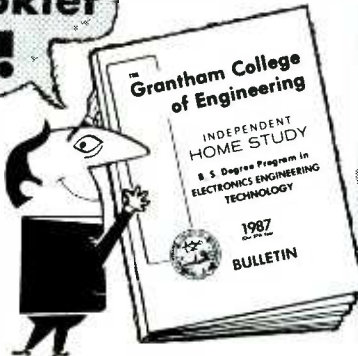

for **FREE**
Booklet
CLIP
COUPON
and mail in
envelope or
paste on
postal
card.

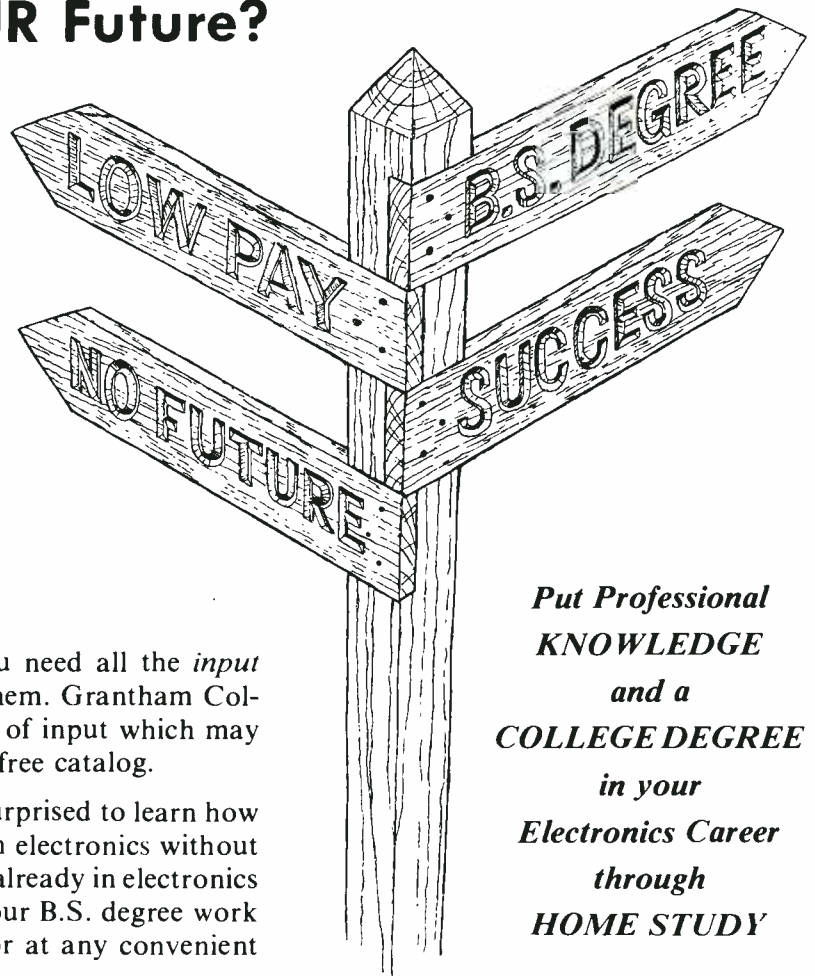

**Put Professional
KNOWLEDGE
and a
COLLEGE DEGREE
in your
Electronics Career
through
HOME STUDY**

Grantham offers this program, complete but without laboratory, to electronics technicians whose objectives are to upgrade their level of technical employment.

Recognition and Quality Assurance

Grantham College of Engineering is accredited by the Accrediting Commission of the National Home Study Council, as a degree-granting institution.

All lessons and other study materials, as well as communications between the college and students, are in the English language. However, we have students in many foreign countries; about 80% of our students live in the United States of America.

Grantham College of Engineering M-5-87

10570 Humbolt Street, Los Alamitos, CA 90720

Please mail me your free catalog which explains your B.S. Degree independent-study program.

Name _____ Age _____

Address _____

City _____ State _____ Zip _____

For more information on products described, please circle the appropriate number on the Free Information Card bound into this issue or write to the manufacturer.

Portable CD Player

Panasonic's new Model SL-NP10 portable CD player is small enough (4.96" x 4.96" x 0.87") to fit in the palm of a hand. It has a compact fine-focus, single-beam laser pickup that features a combined collimator focus lens system. A friction-free, four-wire suspension system supports the focus lens, and a spring-loaded guide rail carries the transverse mechanism. The tracking-error detection system combines the fingerprint resistance of one-beam systems with the scratch resistance of three-beam systems.



A high-resolution digital filter uses oversampling to shift the digital noise far above the audio spectrum, where it is cleaned up with a 96th-order FIR double oversampling filter. The player features 18-step random-access programmability that uses a skip key to select tracks and a memory key to specify the input. Any portion or all of the disk can be played again with the touch of a repeat key. An LCD window displays total tracks in play, total playing time, track number in play, elapsed playing time, remaining playing time, battery condition, repeat and memory recall. There is a high-cut filter switch for headphone listening. The player is powered by a rechargeable battery pack, which is included. \$299.95.

CIRCLE 46 ON FREE INFORMATION CARD

Automatic Telephone Dialer

Automatic dialing through a telephone's mouthpiece and confidential data functions highlight a new electronic phonebook from Sharp. Triggered by the touch of a button, the Model EL-6250 pocket "Dial Master" automatically dials any number in its 200-number (4K RAM) memory. The battery-powered "calculator" also offers such standard arithmetic functions as addition, subtraction, multiplication, division and percent, plus a 10-digit numeric memory.

Dial Master also serves as an electronic data bank and memo pad. Addresses, company names, appointments, shopping lists and notes can be stored in the unit's memory. These can be instantly retrieved through the EL-6250's quick-search



feature via a key letter, number or word, or by category. Other highlights include a secret store code for protecting confidential data, large, easy-to-read two-line by 12-character dot-matrix LCD display and pocket wallet. \$89.95.

CIRCLE 47 ON FREE INFORMATION CARD

Loran Navigator/Plotter

Apelco's (Tampa, FL) DXL 6600 Loran-SEE Navigator/Plotter combines a 100-waypoint Loran-C receiver with a new kind of graphic LCD plotter that displays the outline of the coast, landmarks and navigational aids. It zooms in for a 5-nm scale and out to give a choice of 10-, 20-, 50- or 100-nm chart scales. Tracking speeds automatically adjust to scale and are manually selected. Your boat appears on-screen as a blinking symbol. A cursor lets you place markers to designate up to five waypoints, event marks or other chart marks. A dotted trail indicates where you have been. You can also draw a course for route planning. All controls are touch keys.

Numeric readouts of navigational data are superimposed on the LCD chart. At the top of the screen is a constant readout of present position and other data. A second selectable display at the bottom of the screen shows bearing and distance to next waypoint or other chart marks.

Features include: automatic selec-



tion of best master and secondary loran stations; compensation for true or magnetic variations; six noise-eliminating notch filters; Lat/Lon or TD position coordinates; distance and bearing to waypoint; steering guidance; speed, course over ground and time-to-go; cross-track error alarm; anchor watch; waypoint "arrive" warnings; standard clock, stopwatch and timer; and outputs for interface with autopilot or other instruments. \$1,395.

CIRCLE 48 ON FREE INFORMATION CARD

Hard-Disk Cards

Concepts in Computer Technology (Lakewood, NJ) has a line of four Concept Card™ hard-disk cards for

Two 65-ms access-time models are offered. These are the 21M-byte capacity Model CC-T20 (\$599) and 32M capacity Model CC-T30 (\$699).



IBM PC and compatible computers, offering capacities ranging from 21M to 63M bytes. All four models utilize VLSI chip technology and incorporate anti-stick design. They are supplied fully formatted for DOS 3.1. Each takes up 1 or 1½ slots, depending on the computer in which it is installed.

Plug-in-and-go installation is said to be so simple that even a novice with no prior hardware experience can be computing in less than 30 minutes. The cards are preconfigured, and all software required for their use is in an on-board ROM.

There are also two faster 39-ms access-time models, which include the 42M capacity Model CC-T40 (\$1,499) and 63M capacity Model CC-T60 (\$1,699).

CCT also offers special software as an option to overcome DOS's 30M-byte ceiling. This software also permits an exiting hard-disk drive to be used with a Concept Card. Default designations for the drives are "C" and "D," or both drives can be addressed as a single volume, provided the Concept Card is used as the host controller for both drives.

CIRCLE 49 ON FREE INFORMATION CARD

Digital Storage Oscilloscope

BBC-Metrawatt/Goerz's Model SE 571 Digitalscope integrates a number of functions that previously required additional equipment, all housed in a single portable and easy-to-use instrument. Built in is an integrated hardcopy printer that documents on strips of paper measured signals, complete with waveshape, amplitude, time and cursor measurements. Complete autoranging permits almost any signal to be displayed at a touch of a button, eliminating the typical trial-and-error method of setting input sensitivity and timebase.

An integrated "Softdisk" remembers up to 10 complete oscilloscope setups and 20 reference waveforms.



The 8-bit logic input allows users to analyze digital signals, including conversion to octal, hexadecimal and ASCII. The scope can even compare analog and digital signals in real time, triggering on either one.

CIRCLE 50 ON FREE INFORMATION CARD

The one-of-a-kind gift for 1987

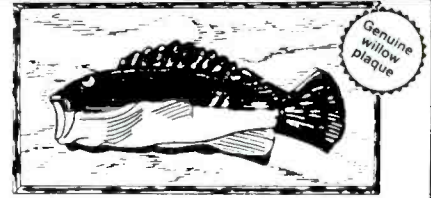

"IT'S ALIVE ON YOUR WALL"

The Electronic Trophy Fish -- astounding reaction!

Taxidermist designed large mouth bass expertly mounted on a genuine willow hardwood trophy plaque

When turned on, internal sonic microphone causes the fish to squirm as if freshly caught when it hears a voice, whistle, or handclap

No wires. The entire system is self-contained. Quality engineering with electronic train contact timer. Enjoy years of use.

SUGG. RETAIL **\$39⁹⁵** SAMPLE \$29 plus \$3.00 shipping/handling
Dozen & up \$20.50 ea. F.O.B.

AM/FM Restroom Radio with Telephone

Telephone: • FCC approved
• Direct phone conversation
• Electronic tone ringer
• Last number redialing
• Easy to install

Radio: • Operates on 2 C cell batteries • AM or FM programming

SUGG. RETAIL **\$39⁹⁹** SAMPLE \$26.50 plus \$2.00 shipping & handling
Dozen \$17.85 each
50 & up \$15.71 FOB

Remote Control DESCRAMBLERS-CONVERTERS

All Makes - Low Prices - \$29.95 & Up

• Jerrold • Zenith
• Pioneer • RCA
• Mini-mode • Many more

CABLE HOTLINE 1-402-330-5052

*For use only with cable company & federal regulations.

BEST BUY

COMPLETE Ready to run

I.B.M. Compatible XT High Performance Turbo System

- 256K memory expandable to 640K on mother board
- Heavy duty power supply—150 W (industry standard 135)
- Phoenix Bus as used by Tandy, AT&T, and ITT to insure compatibility
- 360K Floppy disc drive
- 4.77 8 Meg Turbo clock speed allows superfast processing (nearly double that of IBM P.C.)
- High resolution monochrome monitor (amber or green) • Built-in printer port

\$799 plus shipping & local sales tax
COMPLETE

LIGHTER WATCH

Beware of cheap imitations that fall apart

RETAIL **\$19.95**

SAMPLE \$9.99 plus \$3.00 shipping handling
12 & up \$7.50 ea. F.O.B.

- LCD 5 function watch
- refillable gas butane
- adjustable flame
- manufacturer's warranty

NEW! CALCU-LITE

Full-function pocket size calculator. Refillable butane lighter. Gift packaged.

Sample \$10.00 plus \$3.00 shipping and handling. One dozen & up \$7.45 each F.O.B.

Retail \$19.95

BREATH ANALYZER

- Police Calibrated
- Concentration Meter
- Instant Reading
- Carry Case Included
- Warning Light
- Laboratory Tested
- Full Warranty
- Field Tested

Retail **\$89.95**
Sample \$50.00 plus \$3.00 freight.
Dozen & up \$39.99 each F.O.B.

Order Now 1-402-330-5052

or send check or money order to: **T.F.C. WHOLESALE**
3208 S. 121st St. #700
Omaha, NE 68144

NEW PRODUCTS...

Class-A Power Amplifier

Hallmarked in the new Perreux Model PMF-1050 stereo power amplifier are class-A operation and individually calibrated and matched

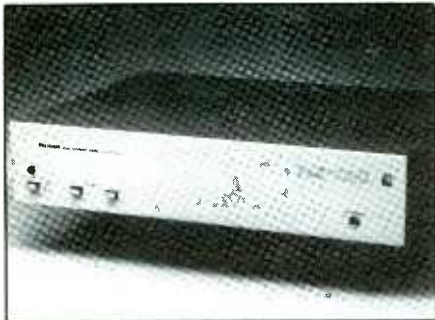

components. The new amplifier operates pure class A at up to 10 watts rms per channel into 8 ohms and class A/B beyond 10 watts up to 100 watts rms. It is claimed that it can produce up to 250 peak watts per channel before audibly distorting.

There are only three controls on the front panel: power on/off and separate speakers A and B selector

CIRCLE 51 ON FREE INFORMATION CARD

switches. Also on the front panel is a stereo headphones jack that automatically cuts the power to the speakers whenever phones are plugged into it.

Technical specifications: output power is 100 watts per channel into 8 ohms, 20 Hz to 20 kHz, at 0.03% or less THD from 0.25 watt to rated output; dynamic headroom is 2 dB or greater with music; bandwidth is +2 degrees at 20 Hz to -2 degrees at 20 kHz; frequency response is greater than 500 kHz at 1 watt; power bandwidth is 1 dB, 10 Hz to 3 MHz, at 1 watt; channel separation is greater than 60 dB from 20 Hz to 20 kHz; risetime is less than 1 microsecond; hum and noise are 100 dB (unweighted) below rated output from 20 Hz to 20 kHz; damping factor is greater than 500 from 10 Hz to 20 kHz; input sensitivity is 1.5 volts rms across 47k ohms for rated output at 1 kHz; 17"W x 13.5"D x 4"H measurements; and weight is 27 lbs. \$1,050.

8-mm Camcorder

Kyocera's 3-lb. 3-oz. Finemovie 8, Model KD-2010U, 8-mm camcorder offers all the record/play functions of larger models. Among its key features are autofocus, a 6:1 power-zoom lens with macro position and in-camera playback. Its solid-state image sensor has a resolution of 640 x 490 picture elements, and horizontal resolution is rated at 350 lines. The lens has an f/1.2 aperture.

Composition and framing are done with a 2/3" black-and-white electronic viewfinder with LED information displays. Focusing can be infrared autofocus continuously, on demand or manually. Auto white balance can be continuous or on demand. Auto iris has a manual override for backlight compensation.

Feather-touch controls are provided for fast forward, rewind, play, record and pause. The transport section features picture search, LCD counting of tape time, and recording



and playback at SP speed. A playback-only function at the LP speed makes the KD-2010U compatible with other machines.

Power for 1 hour is via a supplied rechargeable battery. (An optional 2-hour battery is available.) Supplied are an r-f converter for playback on a TV receiver; direct-line audio and video outputs for driving a TV receiver/monitor; and direct-line audio and video inputs for taping off the air through a TV receiver/monitor. \$1,795.

CIRCLE 52 ON FREE INFORMATION CARD

Coaxial Adapter Kit

Test Probes, Inc.'s (LaJolla, CA) Model TPI 4030 universal coaxial adapter kit, claimed to be the most complete of its kind, provides 72 possible combinations of BNC, TNC, SMA, N, uhf and mini-uhf connectors. It includes two each male and

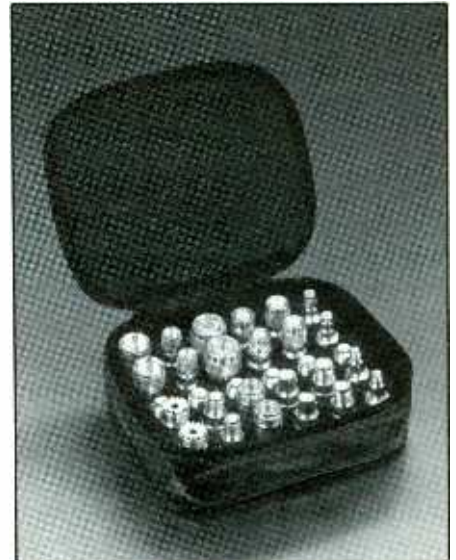

female of each type of connector, as well as six universal interfaces. Any desired adapter is created by simply screwing the appropriate connectors to each end of the interface. The connectors are silver plated and have gold contacts. \$150.

CIRCLE 53 ON FREE INFORMATION CARD

Theft-Proof Car Stereo

Denon's Model DCR-5520 in-dash car radio slides out of the dashboard to put to rest the fears of drivers who are concerned about the security of their car stereo equipment. It features a frequency-synthesized AM/FM tuner, auto-reverse cassette deck, preamplifier/power amplifier and antitheft "slip case"—in a DIN E-size chassis.

Featured in the cassette deck is Denon's Optimum Reception System (D.O.R.S.) that automatically adjusts muting, sets the high-cut filter and continuously varies separator.

(Continued on page 50)

Train for the Fastest Growing Job Skill in America

Only NRI teaches you to service all computers as you build your own fully IBM compatible microcomputer

With computers firmly established in offices—and more and more new applications being developed for every facet of business—the demand for trained computer service technicians surges forward. The Department of Labor estimates that computer service jobs will actually *double* in the next ten years—a faster growth rate than for any other occupation.

Total systems training

No computer stands alone... it's part of a total system. And if you want to learn to service and repair computers, you have to understand computer

systems. Only NRI includes a powerful computer system as part of your training, centered around the new, fully IBM PC compatible Sanyo 880 Series computer.

As part of your training, you'll build this highly-rated, 16-bit IBM compatible computer system. You'll assemble Sanyo's "intelligent" keyboard, install the power supply and disk drive, and interface the high-resolution monitor. The 880 Computer has two operating speeds: standard IBM speed of 4.77 MHz and a remarkable turbo speed of 8 MHz. It's confidence-building,

real-world experience that includes training in programming, circuit design and peripheral maintenance.

***No experience necessary—
NRI builds it in***

Even if you've never had any previous training in electronics, you can succeed with NRI training. You'll start with the basics, then rapidly build on them to master such concepts as digital logic, microprocessor design, and computer memory. You'll build and test advanced electronic circuits using the exclusive NRI Discovery Lab®, professional digital multimeter,

Learn Computer Servicing Skills with NRI's "Hands-On" Training . . .



Using NRI's unique Action Audio Cassette, you are talked through the operation and practical application of your hand-held digital multimeter—the basic, indispensable tool for the computer specialist.



You'll set up and perform electronics experiments and demonstrations using your NRI Discovery Lab. You'll even interface the lab with your computer to "see" keyboard-generated data.



After you build this digital logic probe, you'll explore the operation of the Sanyo detached "intelligent" keyboard and its dedicated microprocessor.

NEW!

Train with the newest Sanyo 880 Series Computer—it's fully IBM-compatible and runs almost twice as fast as the IBM PC!

Your NRI total systems training includes all of this: NRI Discovery Lab™ to design and modify circuits • Four-function digital multimeter with walk-you-through instruction on audio tape • Digital logic probe for visual examination of computer circuits • Sanyo 880 Series Computer with "intelligent" keyboard and 360K double-density, double-sided disk drive • High resolution monochrome monitor • 8K ROM, 256K RAM • Bundled software including GW BASIC, MS DOS, WordStar, CalcStar • Reference manuals, schematics, and bite-sized lessons.

and logic probe. Like your computer, they're all yours to keep as part of your training. You even get some of the most popular software, including WordStar, CalcStar, GW Basic and MS DOS.

Send for 100-page free catalog

Send the post-paid reply card today for NRI's 100-page,

full-color catalog, with all the facts about at-home computer training. Read detailed descriptions of each lesson, each experiment you perform. See each piece of hands-on equipment you'll work with and keep. And check out NRI training in other high-tech fields such as Robotics, Data Communications, TV/Audio/Video Servicing, and more.

If the card has been used, write to NRI Schools, 3939 Wisconsin Ave., N.W., Washington, D.C. 20016.

NRI SCHOOLS

McGraw-Hill Continuing Education Center
3939 Wisconsin Avenue, NW
Washington, DC 20016



We'll Give You Tomorrow.

IBM is a Registered Trademark of International Business Machine Corporation.

as You Build Your Own Sanyo 880 Computer System.

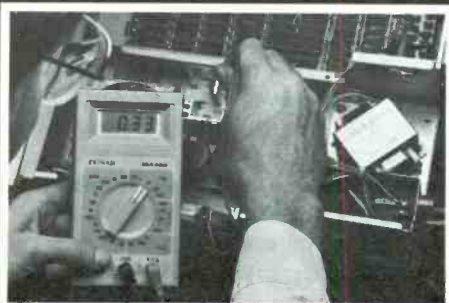

The power supply is assembled in the main unit of the computer. You check out keyboard connections and circuits with the digital multimeter included for training and field use.

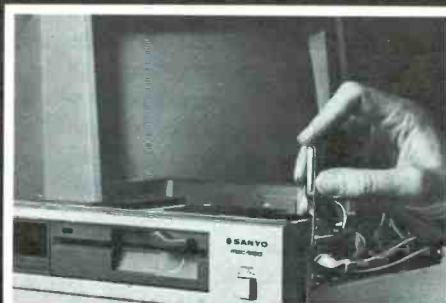

Next, you install the disk drive. You learn disk drive operation and adjustment, make a copy of MS-DOS operating disk and begin your exploration of the 8088 CPU.



Using the monitor, you focus on machine language programming, an indispensable troubleshooting tool for the technician. You continue by learning BASIC language programming.

Computers

New PC Graphics Cards

1. The Hercules Miracle Adapter: Graphics Card Plus

Anyone who has ever purchased an IBM PC with a monochrome card has traded off graphics capability for superior text character form and resolution. Back in 1982, a company named Hercules capitalized on this deficiency by introducing the Hercules Graphics Card, a monochrome card that could also display graphics. The card, which sold for \$499, was especially useful to Lotus 1-2-3 users since it let them view graphs of their spreadsheet data on-screen rather than forcing them to rely on a printer.

The Hercules Graphics Card was wildly successful—the company sold more than 500,000 of them. Due to its popularity, the board established a *de facto* standard, which is supported by most popular software. (For example, Lotus 1-2-3 includes a Hercules screen driver.) Recently, however, a flood of Taiwanese boards that emulate the Hercules Graphics Card have come to market selling for around \$100.

Hercules has responded to this challenge in a dramatic way. Its latest product, the Hercules Graphics Card Plus not only emulates the original Graphics Card completely, but introduces RamFont, which Hercules hopes will establish a new standard for IBM PC monochrome adapters. RamFont lets users display a wide variety of customized text fonts, symbols, and foreign alphabets, as well as readily mix text and graphics on the same screen. RamFont can display up to 24 complete character fonts of varying widths and heights. And most importantly, all these fonts can be displayed at monochrome speed. The suggested retail price of the new card is only \$299.

Understanding RamFont

Before we explain RamFont, let's review normal text and graphics modes on the IBM PC. Text mode displays 256 characters and symbols predefined in a ROM chip called the character generator. Each character can be displayed with such at-

tributes as underline, reverse video, blank, blink, and high intensity.

A text screen is divided into 80 columns and 25 rows, or 2,000 cells. Each cell can contain one of the 256 characters. A character is specified by an 8-bit character code and 8-bit attribute code. Text mode is best for processing text due to its speed and simplicity.

Graphics mode has an edge over text mode since it allows greater flexibility in defining character fonts. However, the penalty is slow speed and complexity. In graphics mode, the software must manipulate individual pixels. This lets you display any graphics image on the screen, but a programmer must draw each dot, unaided by the character generator.

Consider, for example, the letter T. In text mode, it requires only that 0054 H (the ASCII code for T and the attribute

code for normal) be stored in the video buffer. With this code, a capital T is drawn on a 9×14 matrix of pixels in the appropriate cell location.

In graphics mode, each pixel of the 9×14 matrix must be individually specified. That is, to display a T, 9 times 24 or 216 bits of information are needed, versus 16 bits in text mode. Programmers working in graphics mode must also initialize the board's 6845 CRT controller, which is addressed through an index and data register. The advantage is that graphics mode is not confined to a single text font style, but can display virtually any graphics image.

RamFont mode on the Hercules Graphics Card Plus combines the speed and ease-of-use of text mode with much of the versatility of graphics mode. It does this by allowing the programmer to de-

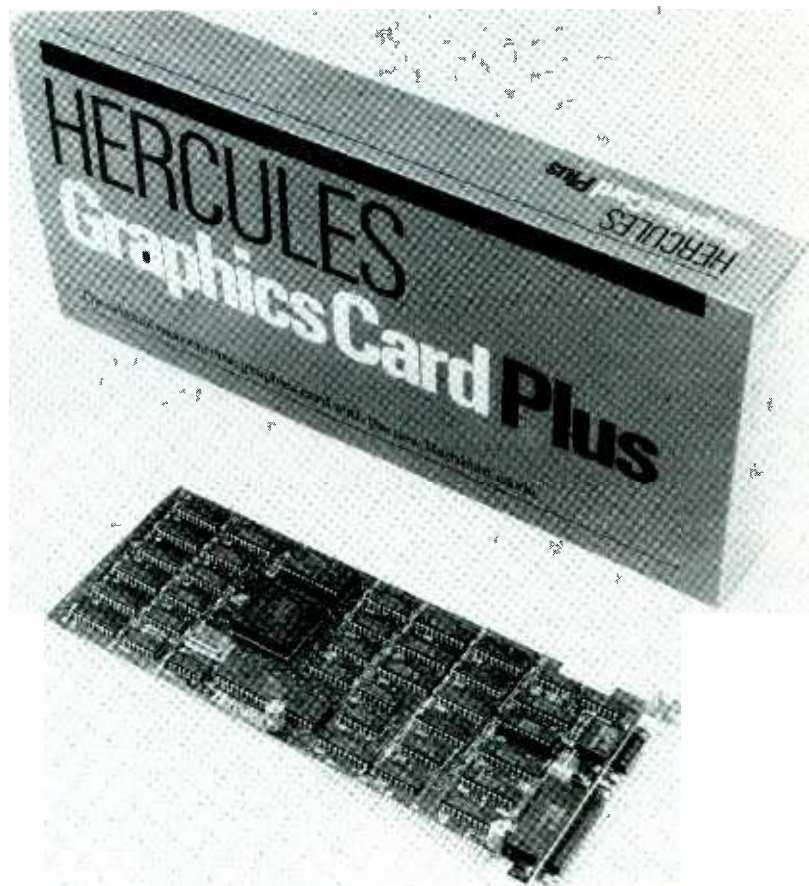

fine up to 3072 characters, and display them as easily as if they were being produced by a character generator.

RamFont, in effect, provides a bit map for creating images. But instead of forcing the software to address each pixel individually, as is done in graphics mode, RamFont divides the display screen into cells, each accessible with a 12-bit character code and a 4-bit attribute code.

This coding scheme is the key to RamFont's implementation. A 12-bit character code lets you address 3K characters, rather than the 256 characters addressable with text mode's 8-bit character code. With 3K characters you have the equivalent of 12 full 256 character fonts, allowing several fonts to be displayed at once. Characters can be strung together to create larger ones; for example, two 8 × 16 cells will create 16 × 16 cells, and for 8 × 12 cells will create 16 × 24 cells.

Description, Installation, Use

The Hercules Graphics Card Plus is a 10"-long board that contains a proprietary VLSI chip, the Hercules V112, a 6845 video controller, and 64K of video RAM. On the edge of the board are DB-9 and DB-25 female connectors for TTL video and a parallel port, respectively. On the board itself is a 6-pin light pen connector. There are no switches, so if you want to disable the parallel port, you must remove a chip from the board.

Installing the Graphics Card Plus is as simple as installing any other type of monochrome card. You simply insert the card into any expansion slot and set DIP switches on the IBM PC or XT system board or run the setup program on an AT. (Since the card is 10" long, it cannot be used in a short slot.)

As with most monochrome/graphics cards, the Graphics Card Plus provides a resolution of 720 by 348 pixels in either text or graphics modes. Upon bootup, the card comes up in its Diag configuration, which allows you to run text-mode software. The Full configuration is the normal operating configuration and is

required by software programs such as Lotus 1-2-3 (V. 1A). A Half configuration allows other graphics cards to coexist in the system with the Hercules card. All these configurations are enabled through software supplied with the Graphics Card Plus.

Programs included with the Hercules card let you take advantage of some of the features of the card with traditional applications software such as 1-2-3, Framework, or any other program that runs in monochrome text mode. For example, if you want to change fonts on the screen, you may do so with the RamFont program. There are 27 fonts included on the disk, any of which can be invoked simply by typing:

Ramfont Fontname.fnt

at the system prompt. Thus, you can have a 1-2-3 spreadsheet that uses medieval characters. However, these characters cannot be printed out.

Whenever you use the RamFont program, you are using what is called the 4K RamFont mode. In this mode, you essentially replace IBM's standard 256-character set with a different set. There is another mode, however, called 48K RamFont mode. This is the mode that is radically different than anything that has ever been done before on an IBM PC. There is no current applications software that will take advantage of this mode, but Hercules provides a demo program that shows off the capabilities of the Graphics Card Plus. The program is called Chess.

When you run Chess, a chess board appears on the screen. Normally, the only way to draw a chessboard on the screen would be through bit-mapped graphics. However, the chessboard is actually made up of "text"-type characters. When you select "Play a game" from the menu, the chess pieces move so fast that you would think you had an 80386 processor in the PC manipulating a bit-mapped graphics screen.

This pseudo graphics mode can let you display fonts in any size (like the Macintosh is famous for doing). However, unlike the Macintosh, scrolling is lightning

fast, again because individual bits do not have to be manipulated by the processor.

A program called FontMan lets you create your own RamFont characters. This program was designed by Hercules as an aid to software developers. Characters are created with FontMan by moving a cursor around an 8 by 16-dot matrix with cursor keys, and selecting and deselecting pixels with function keys.

Several utilities are included with the Graphics Card Plus. SAVE is a program that blanks the screen after five minutes of no keyboard activity. Another program, HPRINT, lets you print graphics with an IBM graphics printer or Epson FX, RX or MX (with Graftrax) dot-matrix printers. HPRINT produces a printout that compensates for the differing aspect ratios of the screen and printed page. Note that HPRINT is basically for graphics and does not print an accurate representation of the screen in RamFont mode. Another utility, HBASIC, lets you run BASICA, with all its graphics commands, on the Hercules graphics Card Plus in an IBM computer.

One other disk that Hercules provides is a driver diskette that includes drivers for 1-2-3 (V. 2.0), Symphony, Framework II and Microsoft Word. These drivers let you display up to 90 columns on the screen, and depending on the program, you can display up to 43 rows. In 1-2-3, you can display graphs in a window on the worksheet screen. The driver for Microsoft Word (V. 3.0) supports all of Word's character fonts. With this driver, you can speed up Word without losing the ability to display multiple fonts on the screen (and print them out). One drawback, however, is that the Graphics Card Plus does not support the mouse.

A program that may make the best use of the Graphics Card Plus is a new product from Lotus called Manuscript. However, Manuscript was not available to us at the time of this review.

We used the drivers to bring up a 43 line by 90 display in Framework II. Normally, extended displays like these are done in graphics mode. However, the

PRODUCT EVALUATIONS *continued...*

Hercules Miracle Adapter

Graphics Card Plus drivers use the Ram-Font feature, making scrolling very fast.

Conclusions

There are many questions that come to mind when evaluating a piece of hardware like the Hercules Graphics Card Plus. This is a revolutionary new product and thus does not have much software support for its advanced features. For example, the card is capable of running graphics-like programs at the speed of text mode, but there are no programs to run. You could also use a Graphics Card Plus font with your current word processor, yet not be able to print it out.

The biggest question that comes to mind about the Graphics Card Plus is this: Is it too late for an innovative product like this? Other types of graphics cards with state-of-the-art graphics processors and coprocessors, such as the Texas Instruments 34010 and Intel 82786, are just about to come to market. These cards are expected to work with current applications software and to speed up bit-mapped graphics significantly on the IBM PC—in color, too.

Another question is: If software vendors do decide to support the Graphics Card Plus, how long will it take them to exploit its full capabilities so that, for instance, you could have a word processor display text in various fonts and sizes on

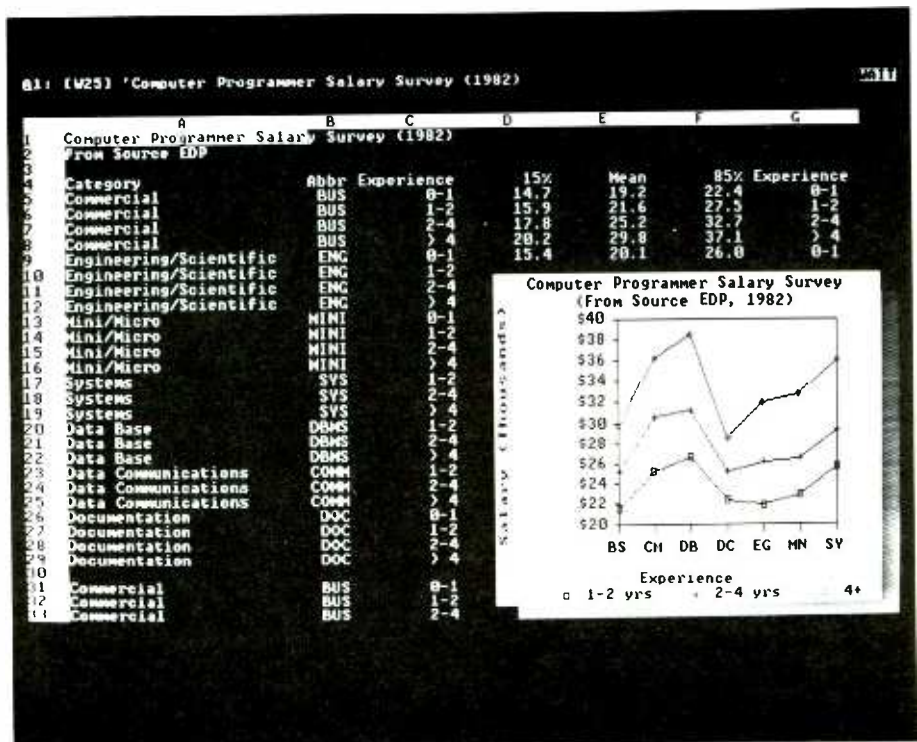

Graphic Card Plus allows text and graphics to be mixed on same screen.

the screen, along with graphics, and have the screen printed out on a laser printer?

To conclude, I think that the Hercules Graphics Card Plus is a superior new product. At just \$299, it offers so much capability that it could give the original

IBM PC a second life (albeit in monochrome). However, the product is limited right now since there aren't any software products that fully exploit its rich capabilities.

—Joe Desposito

CIRCLE 8 ON FREE INFORMATION CARD

Computers

2. Paradise's Hi-Res Graphics Card: Provides Historical Tour of PC Video Displays

The features of the Hi-Res Graphics card from Paradise Systems, Inc. read like a history of display technology for the IBM PC family of personal computers.

The Hi-Res card can emulate the original monochrome mode of the PC, right down to the included parallel port, and also the improvement upon that mode—

Hercules monochrome graphics. This historical treatment doesn't end with monochrome, though. There is some color to the story, too.

The Hi-Res board can emulate the original IBM color mode, CGA (color graphics adapter), and also one of the improvements upon that—the Plantronics color mode. However, in the same way that many history texts do not cover current events, the Hi-Res board does not include the current IBM graphics standard, EGA (enhanced graphics adapter). A more expensive Paradise board, the AutoSwitch EGA, covers this most recent development. At \$299, the suggested sales price of the Hi-Res board is about \$150 less than the AutoSwitch EGA.

Just like a history book condenses events of our time, the Hi-Res card condenses what were once four separate full-size boards into a board small enough to fit in a short slot of an IBM PC/XT. Among other things, the board includes the standard 6845 video controller, and two custom VLSI chips from Paradise. A slide switch on the board lets you select monochrome or color, and a 2-position DIP switch lets you configure the parallel port as LPT1, 2, 3 or disabled. A row of six pins at the top of the card is for a light pen, and a row of four pins adjacent to it is for use with a composite monitor. The usual DB-9 and DB-25 connectors on the edge of the board are for TTL or RGB monitors and parallel port, respectively.

Installing the board is routine; all that needs to be set are the switches. These are situated at the top end of the board for easy access. (As with any video adapter, if you expect it to work properly, you must set switches on the IBM PC or PC/XT or run the Setup program on the PC/AT. These procedures are documented in the well-written and illustrated Hi-Res Graphics card manual.)

In IBM monochrome mode, the Hi-Res card has a text resolution of 720 by 350, and a character matrix of 9 by 14 pixels. This gives you 25 lines by 80 columns. Hercules graphics mode gives you, additionally, dot-addressable graphics at the same resolution.

In the IBM color graphics mode, the Hi-Res board gives you text resolutions of 320 by 200 or 640 by 200 with an 8 by 8

pixel character matrix. This allows for 25 lines by 40 or 80 columns, respectively. In the lower resolution, four colors are available; in the higher, only two. In the Plantronics color graphics modes, 16 colors can be displayed at the low 320 by 200 resolution and four colors at 640 by 200.

A Hi-Res Workout

We tried the board in all of its modes, with monochrome and RGB color monitors, and it worked perfectly. The character set emulated IBM's just fine. Among other software, we used Lotus 1-2-3 (V. 1A) to test Hercules mode, and Lotus Symphony to test Plantronics mode. A utilities disk included with the card has a program called Hires.com that must be run before 1-2-3 can take advantage of Hercules mode (you type Hires Full at the A prompt), which makes it possible to use 1-2-3's graphics.

This is necessary because when you first turn on your computer, the Hi-Res card is in the IBM monochrome mode. Some software packages, such as Lotus 1-2-3 (V. 2.0), recognize the Hercules mode automatically, but 1-2-3 (V. 1A) doesn't. Naturally, if you use 1-2-3 (V. 1A) often, Hires.com should be added to your boot disk or root directory and Hires Full added to your autoexec.bat file so that it's loaded automatically.

Other utilities worth mentioning are Hires Save and Hires Print. The former blanks the monochrome screen after a certain amount of time has elapsed during which a key has not been pressed. The latter lets you print graphics that's on your monochrome display to an IBM graphics printer or graphics-equipped Epson dot-matrix printer, much as a full screen of text can be dumped. Again, all you need do to use these utilities is to type them in at the system prompt.

We tried hooking two monitors up at the same time using the Hi Res card for monochrome and an IBM CGA for color graphics. The manual cautions that in this configuration you cannot use the

Hires Full command to enable Hercules mode. Instead you must use Hires Half. This command enables page 0 graphics, but not page 1 as in full Hercules mode. We found that we could run 1-2-3 normally in monochrome, but could not produce graphs on the screen with the board configured for Hi-Res Half. The reason you cannot configure the board for Hi-Res Full is basically due to the fact that the full Hercules mode uses the same area of video memory as the CGA mode and they cannot coexist in memory at the same time.

Conclusions

One question that needs to be asked about the Hi Res card is: Who is it for? It seems that there are a few audiences it should interest. There are the first-time buyers who want a monochrome/color board from a reliable manufacturer, but can afford neither the extra \$150 for EGA compatibility, nor the additional cost for an EGA monitor. Then there are those who use an IBM monochrome system but never upgraded from the original monochrome adapter. The Hi Res card would give them graphics capability and a fairly low-cost way to gain a color display. Another group might be those who have CGA capability and now want better resolution at a minimum cost, but do not have a slot available for a second video adapter.

We found the performance of the Paradise Hi-Res Graphics card to be excellent. The board does nothing new, but what it does do, it does well. Like the good history text that retells the past succinctly and accurately, the Hi-Res Graphics card brings the most popular video displays of the past five years together on a short-size card, and all modes run without a hitch. The crucial question for the buyer of this board is not related to its quality, but to whether he is interested in the lower-cost past or the more dear present and future?

—Joe Desposito

CIRCLE 77 ON FREE INFORMATION CARD

Delta Modulation: The Forgotten A/D Converter

A close examination of this often-overlooked bandwidth-compression circuit for use in telephone, cable-TV and digital data-recording

By Rodney A. Kreuter

Data acquisition is currently big business. It seems like everyone who has an analog signal wants to digitize it, and everyone who has an 8-bit digital signal wants to convert it into analog form.

Many techniques can be used to convert an analog signal into digital form. Among them are single- and dual-slope integration, successive approximation, voltage-to-frequency (v/f) conversion, flash modulation and, last but not least, delta modulation. (According to the *Datel-Intersil Data Acquisition and*

Conversion Handbook, 70 to 80 percent of all analog-to-digital, or A/D for short, converters now in use employ the successive-approximation method.) While each method has its unique advantages and disadvantages, it seems that the world has forgotten *delta modulation*. This is unfortunate because delta modulation offers benefits not obtainable with the other methods popularly used.

Lest you believe that delta modulation is a panacea, let us first state its disadvantages. Delta modulation doesn't have the great bandwidth capabilities characteristic of flash conversion, nor does it have the great accuracy of the dual-slope method.

What it does offer, however, is good performance at a low price, with the bonus of bandwidth compression and a serial digital output—all without a voltage reference.

If your data transmission system has more bandwidth than you know what to do with, you can count yourself lucky; you probably aren't interested in bandwidth compression. But if you're into telephone systems or cable TV or digital data recording, you have (or should have) a very high interest in bandwidth compression and the economical way it can be obtained by using delta modulation. With this in mind, let's examine delta modulation methods with an eye to-

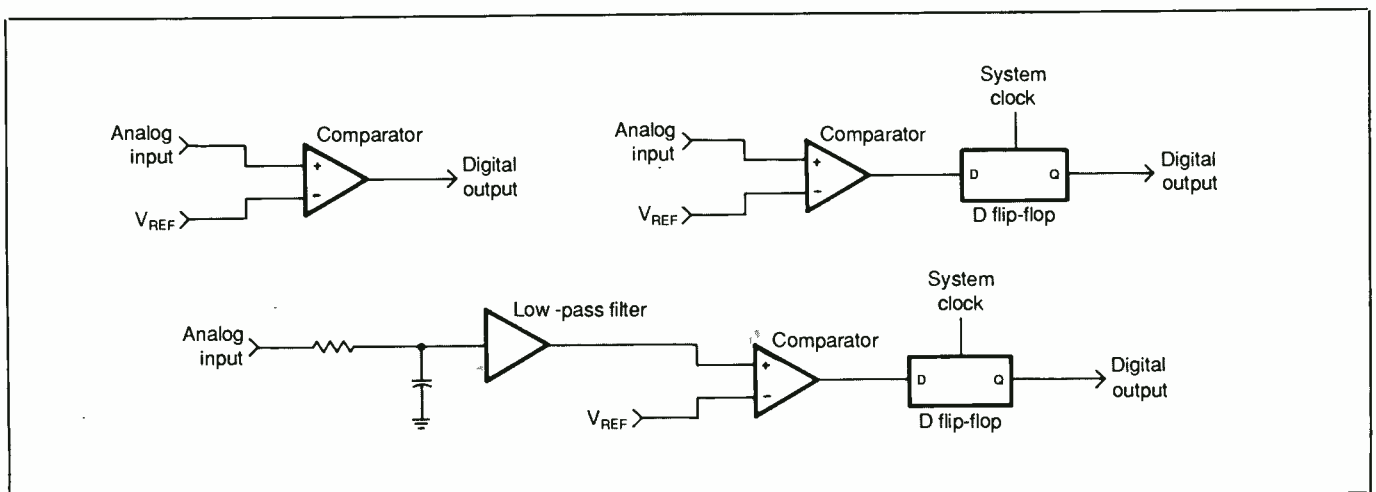

Fig. 1. Comparator (A) is simplest of A/D converters. Adding a D flip-flop (B) synchronizes converter's digital

output with rest of system. Low-pass filter (C) eliminates state-change problems that can occur between clock pulses.

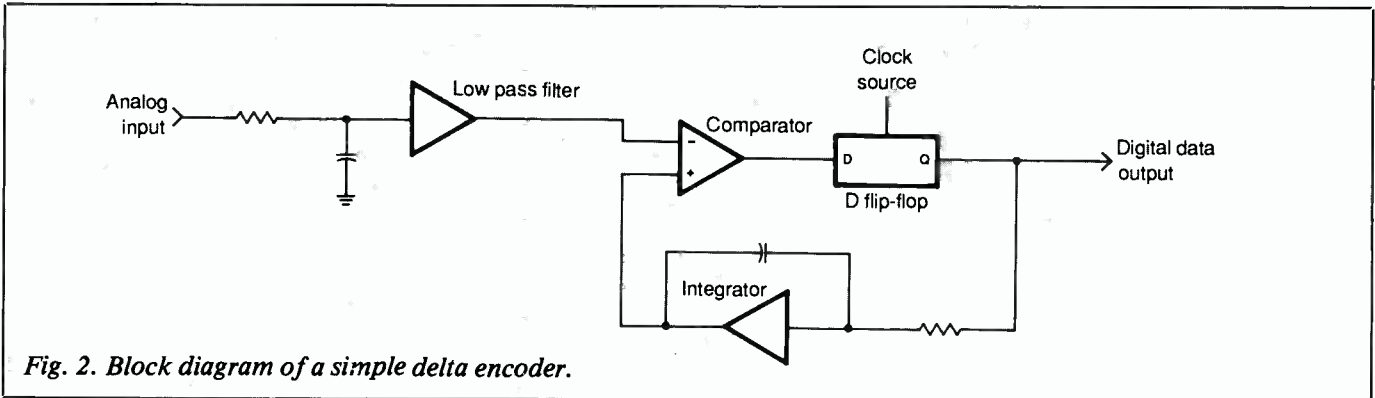

Fig. 2. Block diagram of a simple delta encoder.

ward implementing it in your electronic circuits and systems.

Theory of Operation

To understand the theory behind delta modulation, let's first look at the simplest A/D converter—the comparator shown in Fig. 1(A). In this circuit, if the input potential to the comparator's noninverting (+) input is greater than the reference voltage (V_{ref}) at its inverting (-) input, the output will be a logic 1. Conversely, if the + input voltage is less than V_{ref} , the output will be a logic 0. This 1-bit A/D converter may not be very fancy, but it finds many uses in electronics where only simple 1/0 results are needed.

If the comparator's response is fast enough, the output can change from a 0 to a 1, or vice-versa, as fast as the analog signal can change. This can cause problems in most digital systems. In order to synchronize the digital output of the comparator with the system, a D flip-flop, shown at the output of the comparator in Fig. 1(B), is added to the basic circuit. However, the problem of a fast comparator and a fast analog signal can still cause the comparator to change states between clock pulses in a digital system. To remedy this, an analog low-pass filter is placed in front of the comparator, as shown in Fig. 1(C), so that the problem of

changing states between clock pulses is eliminated.

Delta modulation uses the 1-bit A/D principle just described but with the slight twist that the reference voltage isn't fixed. Instead, V_{ref} is the integrated output from the flip-flop.

The integrator outputs a voltage that is based on the "average" of the last few samples. The next sample will be a 1 if the analog input voltage is greater than this average. In essence, then, the output will be a 1 if the analog input is rising or a 0 if the input is falling. Therefore, the comparator is always looking at the *difference* (or "delta," which is taken from the Greek letter Δ) of the average of the last two samples and the current analog input. As a bonus, no UARTs or shift registers are needed to convert the digital data into a serial-format output—it's already a serial data stream!

A block diagram of a delta encoder is shown in Fig. 2. Notice the feed-

back loop from the output to the integrator. By integrating the digital data stream, past history is obtained for the comparator. This results in a lower bandwidth for a given signal-to-noise ratio (S/N) and frequency response.

Decoding at the receiving end couldn't be simpler. You simply integrate the digital data stream (the output from the integrator will look exactly like the output from the integrator in the encoder) and low-pass filter the signal to remove the clock edges. A block diagram of the decoder is shown in Fig. 3.

The simple delta modulator/demodulator is built around a fixed-slope integrator. Think of it as a low-pass filter with a fixed-slew-rate operational amplifier that has a fairly slow response. This is okay for signals with a low dynamic range of less than 20 dB. However, for signals with a greater dynamic range, music for example, the fixed-slope integrator can't keep up with the rapidly

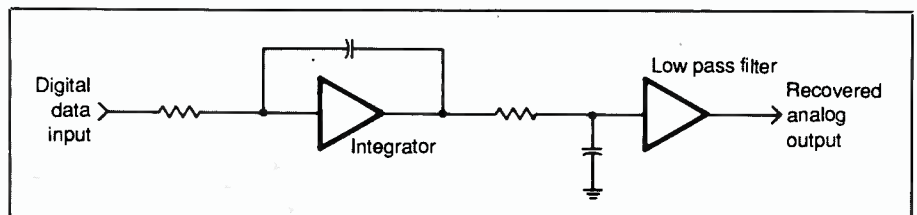

Fig. 3. Block diagram of a simple delta decoder.

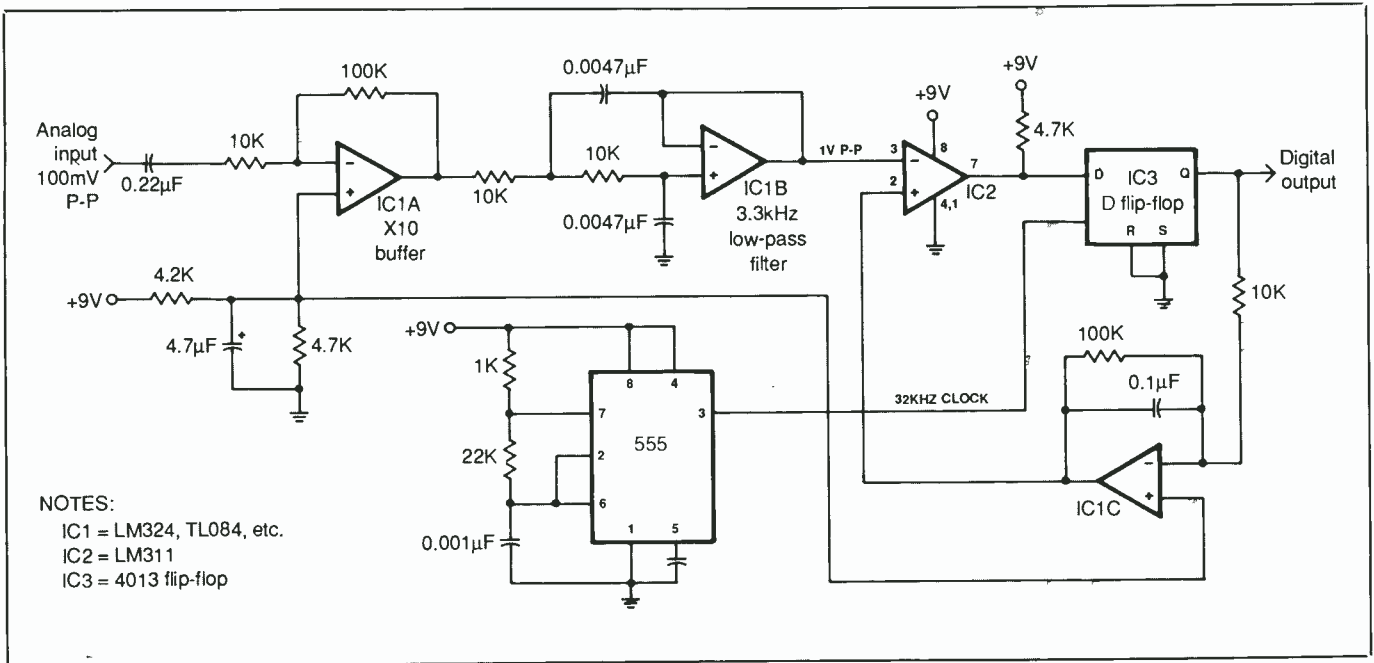

Fig. 4. A practical delta modulator.

changing input waveform. A higher clock frequency helps by making each change smaller, but at the expense of increased bandwidth.

Two manufacturers—Motorola and Harris—offer a solution to the fixed-slope problem. This is the continuously variable slope delta (CVSD) integrator. Unlike the simple delta integrator, the CVSD integrator slope is variable. In practice, this means that a rapidly changing input signal will cause the integrator

to slew faster. Performance specifications include a 30-dB S/N and 50-dB dynamic range. ICs that contain all the circuitry (except passive devices and clock generator) to implement a CVSD modulator/demodulator include the MC3517 and MC3518 from Motorola and HC5535 (demodulator only) and HC55564 from Harris.

In addition to a voice or music data link, CVSDs lend themselves to other applications as well:

Secure Communications. Since the output of the delta modulator is a serial data stream, it can be encoded with a pseudo-random noise source to provide data security.

Music Delay Line. Here a simple shift register can be used to delay the data stream. Taps on the shift register can provide echo, reverberation and other special effects. However, to obtain a meaningful delay, the shift register must have a fairly high bit count, perhaps 10K bits or more.

(Continued on page 89)

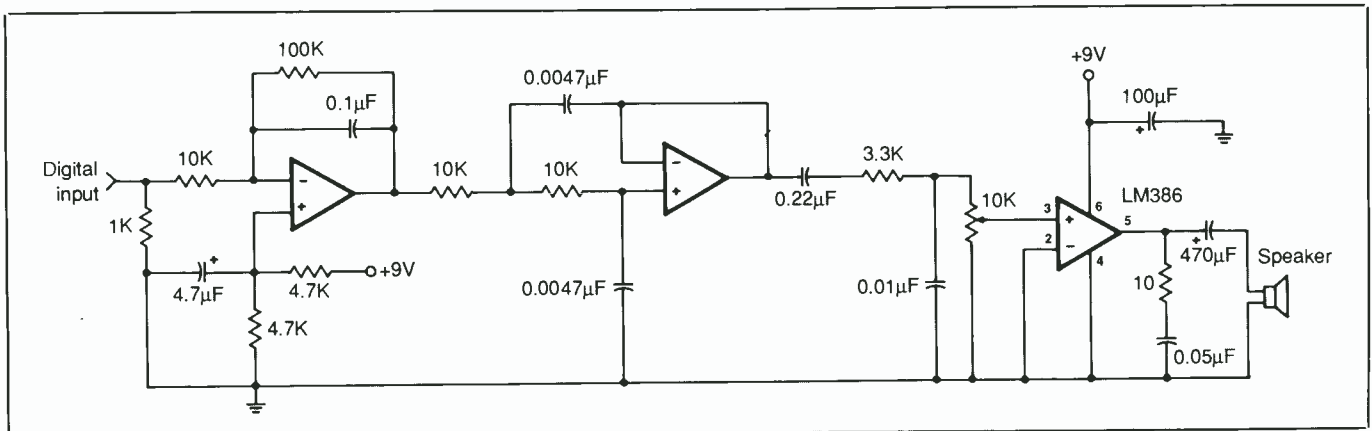

Fig. 5. A practical delta demodulator.

Introducing...

The AR 2002

The Professional Monitor Receiver



Now! In America

For the first time, the AR2002 is available in the U.S.A.! Acclaimed worldwide for its full spectrum coverage, its superior sensitivity, excellent selectivity and convenient, compact design; it has all the features a sophisticated and discerning public service band radio user desires. Experts in Europe, and around the world report excellent performance in independent lab tests. For example: sensitivity across all bands will typically exceed .3 microvolts in NFM. And now the AR2002 is available to you exclusively through this offer.

Performance Above and Beyond

You'll hear signals from 25 through 550 MHz, plus 800 MHz through 1.3 GHz. In any mode: narrow band FM, wide band FM, or AM. Search through entire bands, or enter selected frequencies into any of 20 memory channels. The sidelighted LCD gives full information on status and programming. Profession quality hinged keys and a digitized front

panel control knob make tuning easier than ever before. There's even a real time clock with backup, a signal strength meter and a front panel head phone jack. Plus, programmable search increments, a laboratory quality BNC antenna connector with switchable attenuator, full memory backup, and power cords for AC or DC operation. A professional quality swivel mount telescoping antenna is also supplied.

...And More!

Every AR2002 has a special connector on the rear panel. It interfaces to our custom RC-pack. A little device that makes the AR2002 controllable by ANY computer with an RS-232C port. The possibilities that result from this option are nearly limitless. In effect, virtually your only monitoring constraint will be your imagination.

Yet Convenient to Own

The AR2002 is available exclusively through us — so call us direct, TOLL FREE. We'll be happy to answer any questions you may have. And if you

CIRCLE 17 ON FREE INFORMATION CARD

respond like thousands of other monitor users the world over, we'll be shipping you an AR2002 within 48 hours by surface UPS for only \$455. Plus we pay all freight and handling charges. Remember to ask about our custom test and triple extended buyer protection warranty plans, and our express shipping option. If you're not satisfied within 25 days, return your AR2002. We'll refund your purchase and return shipping costs. There are no catches, no hidden charges.

The AR 2002

The Professional Monitor Receiver



10707 East 106th Street, Indianapolis, IN 46256

Call Toll Free **800-445-7717**

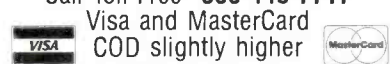

Visa and MasterCard
COD slightly higher

In IN 317-842-7115 Collect

Warehouse: 22511 Aspari Street, Lake Forest, CA 92630

(7 $\frac{1}{8}$ " D × 5 $\frac{1}{16}$ " W × 3 $\frac{1}{8}$ " H Wt. 2 lbs., 10 oz.)

Using Op Amps to Generate Signals

A low-cost way to obtain the sine, square, triangle and sawtooth waves called for in many modern analog and digital circuits

By C.R. Fischer

One or more periodic waveforms are frequently used in many types of electronic circuits to produce a specific function. The circuit can be anything from a simple oscillator for a toy electronic organ to a sophisticated crystal-controlled oscillator to regulate the timing of a microprocessor. Though a variety of specialized integrated circuits are available to fill these needs, the common operational amplifier can in many cases be used to perform the same task. A garden variety op amp is usually cheaper and easier to find, too. Consider also that if the circuit being designed already has several amplifiers elsewhere in it, a dual or quad op amp IC package could be drafted to perform all of the work with a single chip!

Op amps can be used to create special waveforms that would be difficult or too costly to generate by other means. For example, to generate a triangle wave with a digitally based circuit would require a clock oscillator, a counter, RAM or ROM containing the waveform parameters, a digital-to-analog (D/A) converter and a smoothing filter for the D/A output. Of course, a digital waveform generator has capabilities that go far beyond what's possible with

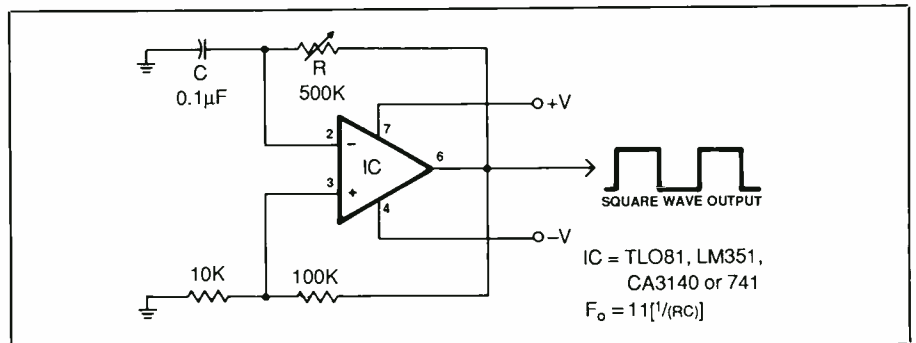

Fig. 1. Simple, low-cost multivibrator.

the common function generator, but there's also a large difference in price and complexity. And unless you absolutely need the complexity of such a waveform-generating system, using a complex digital waveform generator can be unjustifiably costly.

In this article, we discuss a series of circuits built around op amps to demonstrate how versatile a device it is to use for signal generating purposes. These circuits have all been "proofed" at a workbench and, thus, can be used as needed. But the main objective of this article is to stimulate you to do creative thinking of your own when it comes time to design and build signal-generating circuits. You can certainly build these circuits without knowing op-amp theory, but you can go much further in designing your own circuits by taking a short course in op-amp design. An excellent primer for

this is "Using Op Amps" by Robert A. Witte presented in the October 1985 issue of *Modern Electronics*.

Simple Multivibrator

A very inexpensive and versatile multivibrator built around an op amp is shown in Fig. 1. This circuit can be powered by just about any 6-to-18-volt source that has positive and negative buses referenced to ground. In this circuit, R and C set the output frequency, while the two resistors at the noninverting (+) input to the op amp set the switching thresholds for the circuit. The value of R can range from a couple of thousand ohms to several megohms, with the output frequency ranging from less than one cycle per minute to several kilohertz.

Operation of the Fig. 1 circuit is as follows. Assume that the inverting (-) input of the amplifier is at

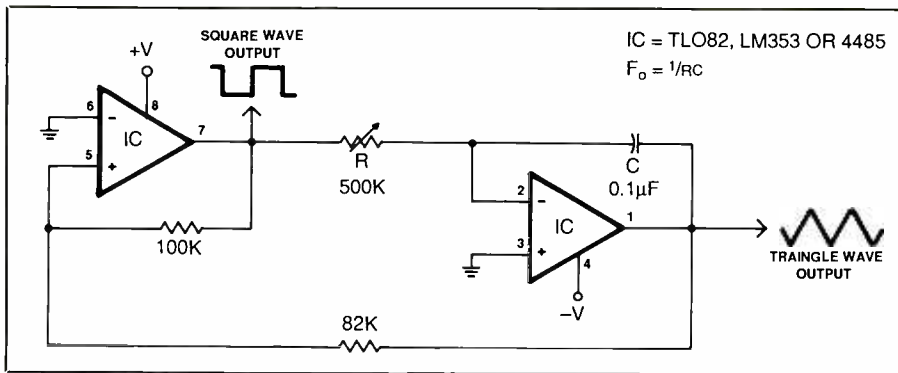

Fig. 2. An oscillator that generates square and triangle waves.

ground potential and the output is at $V+$. The capacitor begins charging in the positive direction until the voltage at the $+$ input of the op amp is reached. At this time, the output will switch toward $V-$. The capacitor will then discharge toward the negative supply voltage until the negative threshold point is reached, at which time the cycle repeats. The output of the IC continues this positive/negative charging action for as long as power is applied.

Multivibrators provide a fairly symmetrical square-wave output, as well as a crude semi-triangle waveform at the inverting input. The triangle waveform is distorted and is, therefore, not suitable for critical applications.

The multivibrator in Fig. 1 has a frequency range from about 40 Hz to about 2.5 kHz with the 500k potentiometer and 0.1-microfarad capacitor specified for R and C in the feedback circuit to the $-$ input.

A single-polarity power-supply version of the multivibrator circuit can be had by adding a second 10k resistor between the $+$ input of the op amp and the positive supply rail. This resistor biases the $+$ input at about 0.5V+, making it possible to use this circuit in applications where a split power supply isn't available.

Triangle/Square Wave Oscillator

A slightly more elaborate circuit than the one shown in Fig. 1 generates a much cleaner triangle wave. A second amplifier is required to accomplish this, as shown in Fig. 2. This triangle/square-wave oscillator has many uses, such as operation as a sweep generator for AM and FM. In many effects boxes used by rock musicians, this circuit is used to modulate a signal to produce such effects as phasing, flanging and chorusing.

A TL082 op amp is a good choice for the triangle/square-wave oscilla-

tor circuit. Thanks to its very-high-impedance FET inputs, the TL082 can use large-value resistors as timing components. If you have to generate very-low frequencies, a large value of resistance and small value of capacitance in the frequency-determining network makes building this circuit easier and more economical than using a large value of capacitance and small value of resistance. In addition, the TL082 has a high slew rate that permits the op amp to be used at higher frequencies with a minimum of distortion.

Using the same timing-component values as in Fig. 1, the Fig. 2 circuit can deliver a respectable range of 1,500:1 (15 kHz to 10 Hz).

A variation of the triangle wave, known as the sawtooth or ramp wave, is needed in certain applications. For example, a ramp wave is frequently used as a sweep generator and in electronic music for its high overtone content.

To change a triangle waveform into a sawtooth waveform, you simply add a pair of diodes to the circuit, as shown in Fig. 3. These diodes force the timing resistor to be in the circuit on only the positive-going portion of the cycle. When C discharges, reset time is almost instantaneous. Keep in mind, though, that the diodes affect the output frequency because they put the timing resistor into the circuit for only part of the time.

A square wave is reshaped in a similar way. An asymmetrical square wave, known as a pulse, is used in many types of analog and digital circuits and systems. What's even better is a pulse that has a variable duty cycle (the ratio of on to off time) that can be determined by a control voltage. This type of pulse is put to good use in switching power supplies and for sending analog signals by infrared or radio methods. The signal to be sent is used to modulate the width of the pulse. The pulse train is then used as a carrier. At the

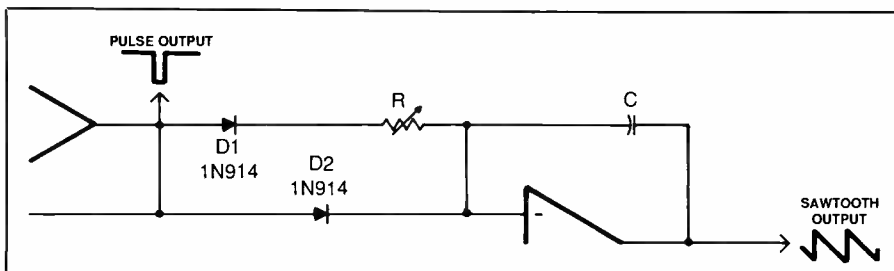

Fig. 3. Modifications show how square/triangle-wave oscillator can be used to output sawtooth waveform.

receiving end, the carrier is removed with a low-pass filter to recover the original signal.

A very simple way to obtain a variable-width pulse signal is illustrated in Fig. 4. If the potential applied to the + input of the op amp is greater in amplitude than the potential at the - input, the comparator output from the op amp will be positive, and vice-versa.

If the triangle waveform is fed into one input and the control voltage is fed to the other input, the comparator's output will change polarity whenever the triangle wave crosses the threshold set by the control voltage. With the control voltage set halfway between the V+ and V- supplies, the output will be a square wave. By changing the setting of the PULSE WIDTH control, duty cycles from 0 to 100% can be obtained.

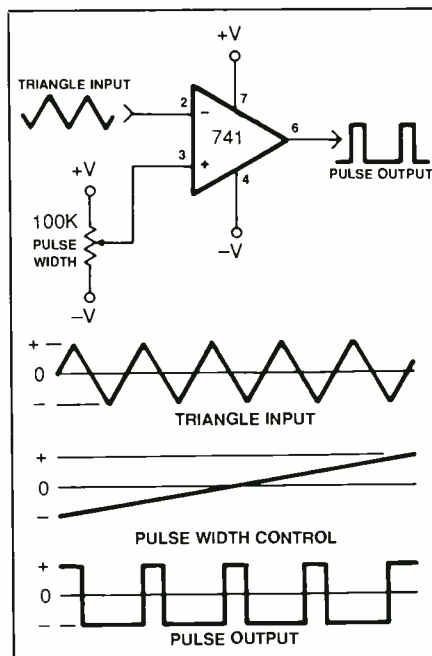

Fig. 4. A third operational amplifier gives square/triangle-wave oscillator independent variable-pulse output.

for the circuit to generate sine waves with minimum distortion.

When operating the Wien-bridge oscillator circuit, you first set the trimpot to maximum resistance before applying power. If the circuit fails to oscillate within a few seconds of being powered, you slowly decrease the trimmer's resistance until a sine-wave output appears.

While the trimmer potentiometer can be "tweaked" so that the circuit's distortion is very low, the amplifier may have insufficient gain to start or maintain oscillation. If a cleaner waveform is required, it's best to set the trimmer for stable oscillation with a slight amount of clipping and to follow the output with an appropriate low-pass filter.

A variable-frequency Wien-bridge oscillator with a few extras thrown in is shown in Fig. 6. Here, the zener diodes keep the amplitude of the sine wave constant and eliminate the need for the trimpot. By changing the value of the 10k resistor between the + input of the op amp and the trimpot that goes to ground, the amplitude of the output can be adjusted to a desired level. A lower resistance raises the amplitude of the output signal, while a larger resistance attenuates it.

In the Wien-bridge oscillator circuits shown in Figs. 5 and 6, the frequency-determining components

Sine-Wave Oscillators

A sine wave, fundamentally the simplest of waveforms, resembles the triangle wave, except that it has a curved appearance and there are no sharp points on it. Because it lacks any "edges," a perfect sine wave resonates at a single frequency and has no overtones. Don't expect to be able to generate perfect sine waves. However, it's easy to put together a reasonably clean sine-wave generator without too much trouble.

Dating all the way back to the early days of vacuum tubes, the oldest design for a sine-wave generator is the Wien-bridge oscillator shown in Fig. 5. The easy-to-build circuit oscillates at a single frequency with a slight amount of distortion byproducts. Note that two RC networks are involved in determining the output frequency. Both RC pairs must be matched to within 1 percent or better

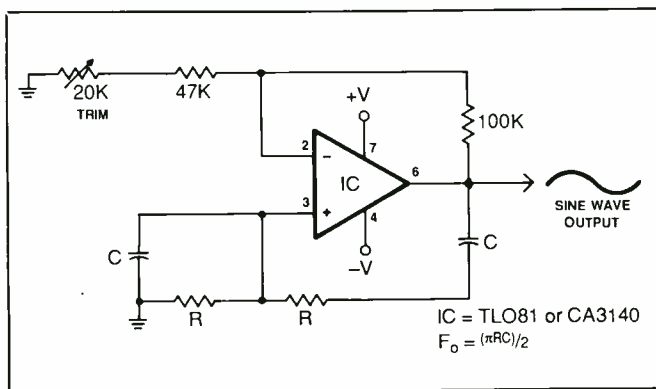

Fig. 5. Simple Wien-bridge oscillator gives relatively pure sine-wave output.

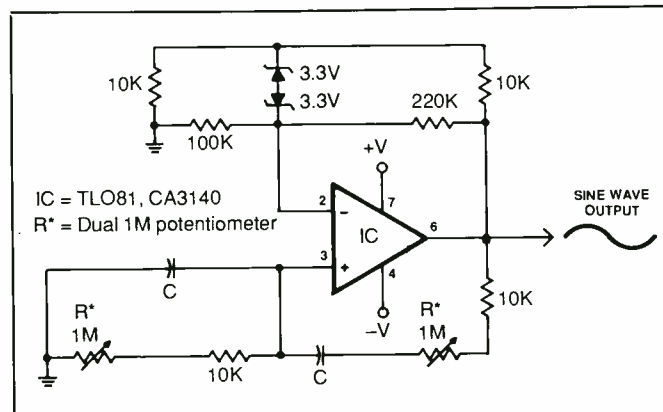

Fig. 6. Variable-frequency sine-wave oscillator.

(Continued on page 96)

Spectacular Introductory Offer...

Take Any **3** COMPACT DISCS Just **\$1.00** plus shipping & handling with Club membership

SAVE 50% ON CDs... Instantly!
See details below.

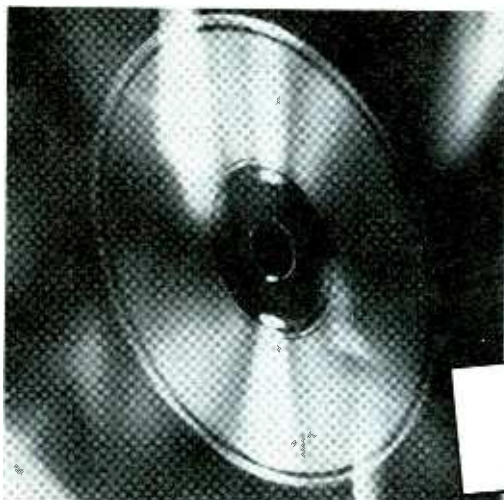

115146

Steve Winwood: *Back In The High Life* Higher Love, more. Island 153271

Peter Gabriel: *So* • Sledgehammer, In Your Eyes, Red Rain, etc. Geffen 114764

Vivaldi, *The Four Seasons* • Pinnock/English Concert. Archiv DIGITAL 115356

Linda Ronstadt: *For Sentimental Reasons*, My Funny Valentine, etc. Asylum 154382

Bach, *Organ Works* • Daniel Chorzempa plays Toccata & Fugue in D Minor, more. Philips DIGITAL 115193

Dire Straits: *Brothers In Arms* • Money For Nothing, etc. Warner Bros. 114734

Rimsky-Korsakov, *Scheherazade* • Vienna Phil./Previn. Philips DIGITAL 115415

ZZ Top: *Afterburner* • Stages, Sleeping Bag, Velcro Fly, more. Warner Bros. 164042

Bob James & David Sanborn: *Double Vision* • #1 jazz album! Warner Bros. 123682

Alabama: *Greatest Hits* • She And I, Why Lady Why, Feels So Right, etc. RCA 120247

Mozart, *Requiem* • Schreier leads the Leipzig Radio Choir & Dresden State Orchestra. Philips DIGITAL 115039

John Cougar Mellencamp: *Scarecrow* Lonely Ol' Night, Small Town, Rain On The Scarecrow, more. Riva 144512

Pavarotti: *Mamma* • Title song, Vieni sul mar, more. Arranged & conducted by Henry Mancini. London DIGITAL 115310



143811

Kitaro: *Tenku* • Japanese New Age master returns with all-new magic! Geffen DIGITAL 104859

Robert Palmer: *Riptide* • Addicted To Love, I Didn't Mean To Turn You On, etc. Island DIGITAL 133507

Canadian Brass: *High, Bright, Light & Clear* • Masterpiece Theatre theme, Air On A G String, more. RCA DIGITAL 144529

Prince And The Revolution: *Parade* • Kiss, Mountains, Girls & Boys, others. Warner/Paisley Park 140234

Richard Stoltzman: *Begin Sweet World* Amazing Grace, Air, Pie Jesu, others. RCA DIGITAL 150414

Daryl Hall: *Three Hearts In The Happy Ending Machine* • Dreamtime, Foolish Pride, Someone Like You, For You, etc. RCA 123691



154203



125074



154381



113333



173392



173824



115527

Heart • What About Love?, These Eyes, Dreams, If Looks Could Kill, Nothin' At All, Never, etc. Capitol 144276

Mozart, *Symphonies Nos. 40 & 41 (Jupiter)* Chicago Symphony Orchestra led by James Levine. RCA DIGITAL 104810

Bizet, *Carmen (Film Highlights)* • Julia Migenes-Johnson, Plácido Domingo; Lorin Maazel conducts. Erato DIGITAL 154105

The Judds: *Rockin' With The Rhythm* Have Mercy, Grandpa (Tell Me 'Bout The Good Old Days), others. RCA 154265

Kenny Rogers: *They Don't Make Them Like They Used To* • Title song, Hold On To Love, After All This Time, more. RCA 151174

The Police: *Every Breath You Take—The Singles* • Their 12 greatest hits! A&M 173924

Van Halen: *5150* • Why Can't This Be Love, Dreams, etc. Warner Bros. 170220



134541

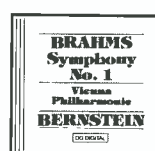

125224



115306



154570

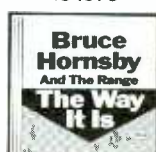

163918

Elvis Presley: *Return Of The Rocker* • King Of The Whole Wide World, Return To Sender, Stuck On You, etc. RCA 164071

Horowitz In London • Schumann, Kinder-scenen; more by Chopin & Scriabin. RCA DIGITAL 162507

Phil Collins: *No Jacket Required* • One More Night, Susstadio, Don't Lose My Number, etc. Atlantic 120771

Toscanini: *Beethoven, Symphonies Nos. 1 & 3 (Eroica)* • RCA 154201

INSTANT HALF-PRICE BONUS PLAN

Unlike other clubs, you're eligible for half-price bonus savings immediately! With the very first purchase you make at regular Club prices, we'll send you a certificate you can redeem for a CD at 50% savings! A shipping & handling charge is added to each shipment.



—YOUR SAVINGS START HERE—

Mail to: Compact Disc Club
P.O. Box 91412 • Indianapolis, IN 46291

YES, please accept my membership in the Compact Disc Club and send me the three CDs I've indicated below for only \$1, under the terms outlined in this ad. I need buy as few as two more CDs at regular Club prices during the next two years...without obligation to buy anything further! (Shipping & handling added to each shipment.)

RUSH ME THESE 3 SELECTIONS (Indicate By Number):

D D D

I am most interested in the following type of music—but am always free to choose from both categories (check one only) } 1 CLASSICAL } 2 POP/SOFT ROCK

MR. MRS. MISS First Name Initial Last Name (PLEASE PRINT)

Address _____

City _____ State _____ Zip _____

Telephone () _____ Area Code _____

Limited to new members; continental U.S.A. only; one membership per family. We reserve the right to request additional information or reject any application(s). Local taxes, if any, will be added.

WET33 BJ

THE ULTIMATE IN SOUND AND SAVINGS!

Yes, take any 3 CDs for only \$1 plus shipping/handling. You need buy just two more selections at regular Club prices (usually \$14.98–\$15.98) in the next two years.

HOW THE CLUB OPERATES

You select from hundreds of exciting Compact Discs described in the Club's magazine mailed to you 19 times a year. Each issue highlights a Featured Selection in your preferred musical division plus alternate selections. If you'd like the Featured Selection, do nothing. It will be sent to you automatically. If you'd prefer an alternate selection, or none at all, just return the card enclosed with each issue of your magazine by the date specified on the card. You will have at least 10 days to decide, or you may return your Featured Selection at our expense. Cancel your membership at any time after completing your membership agreement, simply by writing to us.

FREE 10-DAY TRIAL!

Listen to your 3 introductory selections for a full 10 days. If not satisfied, return them with no further obligation. You send no money now, so complete the coupon and mail it today.

CD 650

CD Club, 6550 E. 30th St. Indianapolis, IN 46219-1194

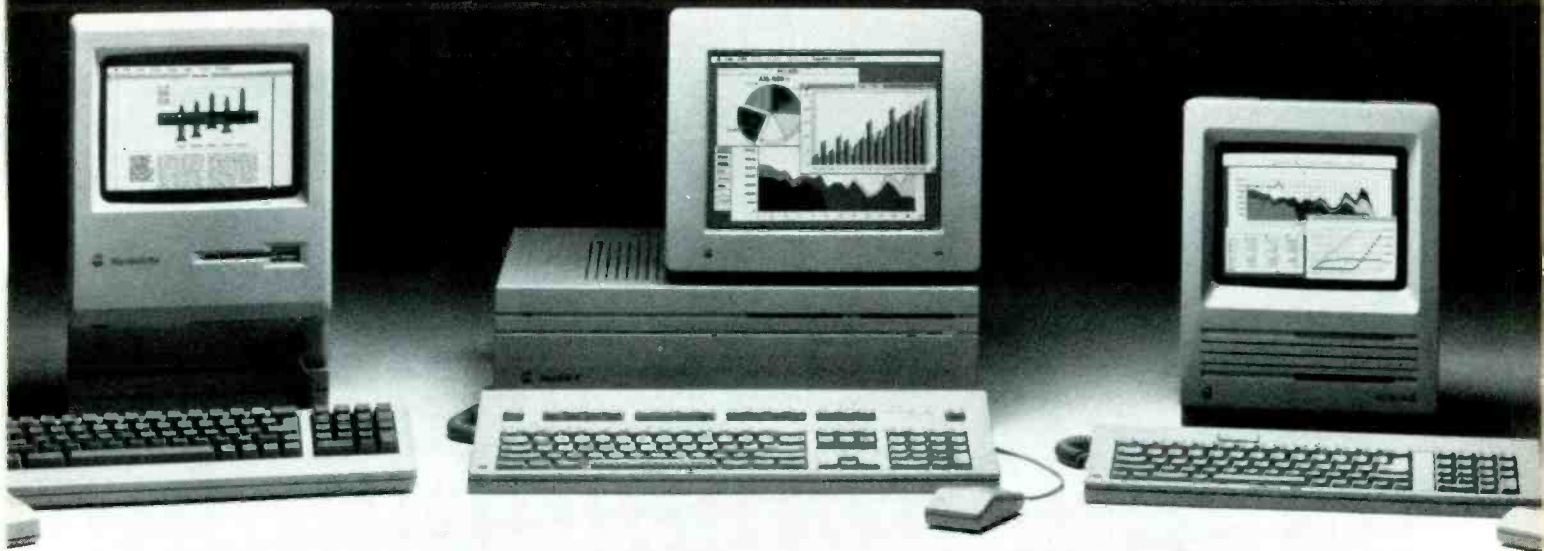

Macintosh is a family of personal computers consisting of the high-performance, open-architecture Macintosh II (center), expandable Macintosh SE (left), entry-level Macintosh Plus (right) and Macintosh 512KE (not shown).

2nd Generation Macintosh Computers

Apple Computer's new, expandable Macintosh computers add power and flexibility to its family

By Alexander W. Burawa

Macintosh computers, the 512KE and Plus models, are highly popular. Nevertheless, they haven't been able to compete successfully against IBM and compatible machines in the business world. With the introduction of two new, powerful and flexible computers—the Models Macintosh SE and Macintosh II—Apple Computer hopes to change this.

Its smaller Macintosh SE (System Expansion), which retains the same

size as earlier models, is really a super Macintosh Plus that has a single expansion slot for adding cards internally and externally (through an Accessory Access Port). It comes with two internal disk drives instead of only one, and one of these drives can be a 20-Mb hard disk. Moreover, 1 megabyte of RAM (expandable to 4 Mb) is standard. Using the same 8-MHz 68000 CPU, overall performance is improved through VLSI technology. This reportedly increases processing speed 15 to 20 percent and transfers information from hard

disks up to twice as fast as a Macintosh Plus does. A fan is included to dissipate heat.

The SE-Bus expansion facility, combined with a bevy of third-party hardware and software, makes it possible for the SE model to employ MS-DOS cards for IBM PC compatibility, external video cards and monitors to obtain color displays, and a host of other options. Apple itself advises it's introducing MS-DOS file transfer software and a 5.25" MS-DOS floppy disk drive and controller card.

The Macintosh SE lists for \$2,898 with dual floppy drives and \$3,698 for the hard disk/floppy drive model.

Top-of-line model Macintosh II is a truly new design intended for advanced applications in business, desktop publishing and engineering environments. It is considerably larger than the other models, as well as being much more powerful and flexible. Its price reflects this capability, too, with a configuration of one 800 Kb floppy-disk drive and one 40-Mb internal hard-disk drive, 1 Mb of RAM, a 12" monochrome monitor and video card listing for \$6,396. Substituting a color monitor raises the price of the system to \$6,996. Here are fuller details.

Technical Details

Based on the 32-bit Motorola 68020 microprocessor operating at 16 MHz, the Macintosh II includes a 68881 floating-point arithmetic chip that is said to perform mathematical operations at up to 200 times faster than the 68020. With this combination, Macintosh II can process at a speed of 2-million instructions per second (2 MIPS) and transfer data at rates greater than 1 megabyte per second over its Small Computer Systems Interface (SCSI).

Supplied standard with 1 megabyte of on-board user RAM, the Macintosh II is expandable to 8 megabytes on the logic board and to a whopping 1.5 gigabytes with optional plug-in RAM cards.

I/O capabilities include the Macintosh Plus-compatible ports for an SCSI connection, two RS-422 serial ports, an external SCSI disk-drive interface and a sound port with four-voice stereo capability. Like other Macintosh computers, the Macintosh II has the AppleTalk network built in.

Six expansion-bus slots in the computer use the processor-independent, high-performance NuBus protocols that support 8-, 16- and



Mac's SE bus and Accessory Port permit use of large-screen monitor.

32-bit data paths. This bus permits fast transfer of large quantities of data between plug-in cards and the logic board. Because the bus features fair arbitration and geographical addressing, plug-in cards can "identify" themselves to the system, regardless of the slots into which they are plugged. This eliminates the need to set DIP switches and to plug specific cards into dedicated slots.

Video interfacing is provided by Macintosh II video card that plugs into the bus. It can drive either a monochrome or an RGB color monitor. In its standard configuration, the video card can simultaneously generate 16 colors or shades of gray from a standard palette of more than 16-million colors. Adding the Macintosh II Video Card Expansion Kit allows the card to generate up to 256 colors or shades of gray from the same palette.

At this writing, two video display monitors are available for the Macintosh II—a 12-inch high-resolution monochrome model and a 13-inch high-resolution RGB color model.

Both feature 640 × 480-pixel resolution and both utilize an analog input format that lets the monochrome monitor display millions of gray values and the color monitor to display millions of colors or gray values.

The monochrome monitor is capable of displaying the full width and more than half the length of a page and is suitable for such applications as word processing, spreadsheeting and displaying business graphics. The RGB monitor combines this full-width viewing area with the capability of displaying high-resolution text and graphics in both color and monochrome. (A tilt/swivel stand is available optionally for both monitors.)

Users who wish to configure the Macintosh II for multiple-monitor capability can do so simply by plugging into the computer's expansion bus as many video cards as are needed. Various monitors and video cards are also available from third party manufacturers.

(Continued on page 90)

An Automatic Fan Control For Compact Cars

Lets you run your car's air conditioner and engine more efficiently during the hot summer months

By Anthony J. Caristi

If you drive a compact car that has front-wheel drive and air conditioning, especially an imported model, the hot summer months can present real operating problems due to design inadequacies that will be addressed later. The upshot is that the air-conditioning system operates at less than peak efficiency and the engine labors because of excessive compressor-head pressure. This increases wear and tear on your car and cuts drastically into your fuel economy.

The simple Automatic Fan Control system to be described can correct the problem, as you shall see.

Background

When automobile manufacturers designed front-wheel drive cars, they put the engines into their smaller models "sideways" to provide a better configuration between the engine's crankshaft and the driven front wheels. As a result, the old-fashioned mechanically driven radiator fan became a thing of the past, replaced by a fan driven by a thermostatically controlled electric motor. This motor is operated intermittently in accordance with the engine's cooling requirements. It doesn't take into account the needs of air conditioning in those cars with this option.

Automotive air conditioners are relatively large-capacity units. Their typical cooling range is rated at between 12,000 and 24,000 BTU,

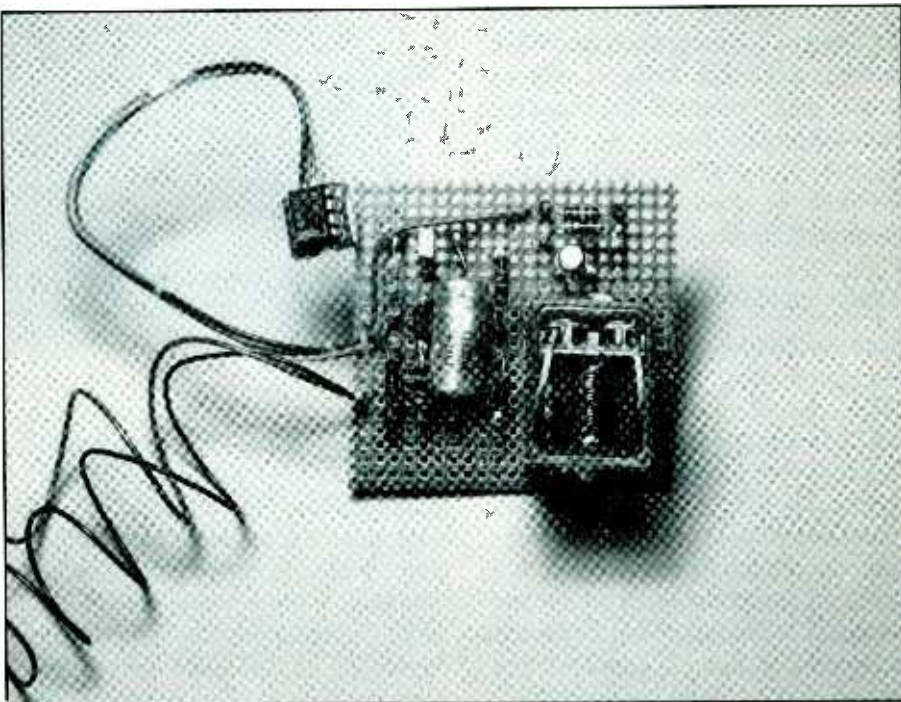

which is 2 tons of cooling power! These air conditioners remove heat from the passenger compartment and deliver it to the condenser, which usually sits in front of the radiator in the engine department.

Dissipating between 12,000 and 24,000 BTU of heat from the condenser with the electric-motor-driven fan is no small task. Unfortunately, the thermostatic fan controls in many cars are designed to respond to radiator temperature. Its response to the needs of the air-conditioning system is either nonexistent or sluggish at best.

In any car air-conditioning system, the most important temperature to monitor is that of the liquid

freon line (radiator temperature sensing is a poor substitute). As a result, the compressor will operate at very high head pressures, especially in stop-and-go traffic. Under these conditions, the cooling effect inside the passenger compartment is reduced and the engine must work harder to maintain the excessive compressor head pressure. You get less cooling, your car uses more fuel, and less horsepower is available to drive the car's wheels.

Our Automatic Fan Control system is designed to monitor and respond to the operating temperature and pressure of the air-conditioning system to ensure adequate cooling of the condenser. When installed, the

An absolutely no-risk guarantee.

Select 5 Books for only \$3⁹⁵ and get a Free Gift!

Values to \$128.75

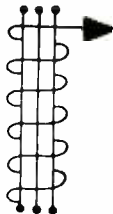
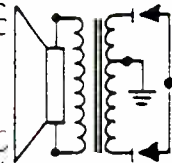

2724 \$24.95

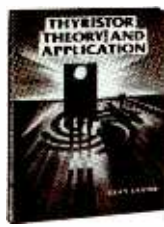

2665 \$17.95



1625 \$24.95



2707 \$24.95



2790 \$17.95

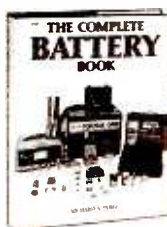

1757 \$24.95

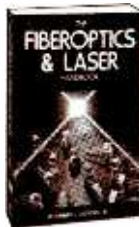

1671P \$16.95

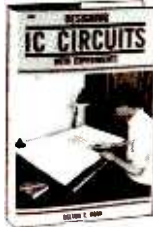

1925 \$24.95

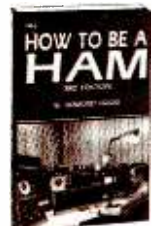

2653P \$12.95

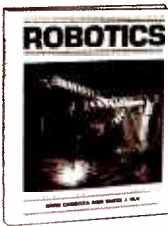

1858 \$16.95



1992 \$14.95



1957 \$21.95



1586 \$17.95



1909P \$14.95

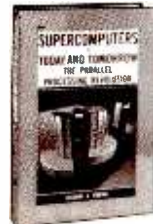

2622 \$21.95

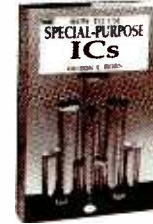

2625 \$23.95

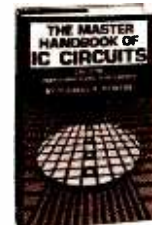

1370 \$26.95

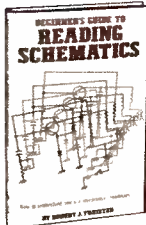

1536 \$14.95



TROUBLESHOOTING & REPAIR

1503P. Maintaining and Repairing Videocassette Recorders Paper \$15.95

1897P. Beginner's Guide To TV Repair—3rd Ed. Paper \$12.95

1250P. Digital Electronics Trouble-shooting Paper \$14.95



PROJECTS

1599P. GIANT Book of Easy-to-Build Electronic Projects Paper \$16.95

1996P. The 555 IC Project Book Paper \$11.95

2604. 101 Sound, Light and Power IC Projects \$24.95

1277P. How To Design/Build Remote Control Devices Paper \$15.95

1793. A Beginner's Guide to Making Electronic Gadgets—2nd Ed. \$14.95



AUDIO/VIDEO

1474P. Video Electronics Technology Paper \$12.95

781P. Handbook of Multichannel Recording Paper \$12.95

1964P. Designing, Building and Testing Your Own Speaker System . . . with Projects—2nd Ed. Paper \$10.95

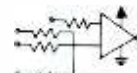

COMMUNICATIONS

1255P. The Complete Shortwave Listener's Handbook—2nd Ed. Paper \$13.95

1632P. Satellite Communications Paper \$12.95

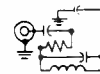

BASIC ELECTRONICS

728P. Basic Digital Electronics: Understanding Number Systems, Boolean Algebra & Logic Circuits Paper \$10.95

1133P. The Active Filter Handbook Paper \$14.95

1199P. The Master IC Cookbook Paper \$16.95

1420. The Handbook of Electronic Safety Procedures \$17.95

1593P. Understanding Digital Electronics Paper \$8.95

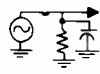

COMPUTER PROGRAMMING

1970. True BASIC® —A Complete Manual \$22.95

1085P. 24 Tested, Ready-To-Run Game Programs in BASIC Paper \$10.25

(Publisher's Prices Shown)

FREE when you join



Handy, Pocket-Sized Resistor/Inductor Color Code Calculator

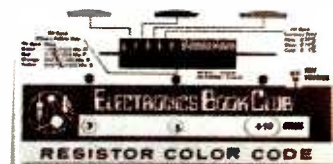

ELECTRONICS BOOK CLUB

P.O. Box 10, Blue Ridge Summit, PA 17214

Please accept my membership in the Electronics Book Club and send the 5 volumes circled below, plus my Free Resistor and Inductor Color Code Calculator (No. 502E) billing me only \$3.95 plus shipping and handling charges. If not satisfied, I may return the books within ten days without obligation and have my membership cancelled. I agree to purchase 3 or more books at regular Club prices (plus shipping/handling) during the next 12 months, and may resign any time thereafter. Order subject to acceptance by Electronics Book Club.

728P 781P 1085P 1133P 1199P 1250P 1255P 1277P 1370 1420 1443 1474P 1503P 1536 1586 1593P 1599P 1625 1632P 1665P 1671P 1683 1693 1699P 1734 1757 1793 1858 1887 1897P 1905P 1909P 1925 1957 1964P 1970 1977P 1984P 1990 1992 1996P 1999 2604 2609 2622 2625 2635 2653P 2665 2675 2707 2724 2790 2838

Name _____
 Address _____
 City _____
 State/Zip _____ Phone _____

Foreign applicants will receive special ordering instructions. Canada must remit in U.S. Currency.

MDNE-587

NO-RISK GUARANTEE

If dissatisfied in any way, return your books within 10 days without obligation

See other side for more exciting selections!

Build Your Electronics Skills . . . Join Now!

Take 5 Books for Only \$3.95

The Electronics Book Club puts you in the mainstream of today's electronics practice:

- Access to the latest state of the art developments in lasers, microcomputers, holography, robotics, test instrumentation, and more!
- Step-by-step how-to's for building your own electronic games, gadgets, home control devices, solar energy units, and more!
- Expert guidance in every phase of electronics practice!
- Time- and money-saving tips on choosing, installing, maintaining all kinds of electronic equipment!
- Practical advice on how to turn your electronics knowledge into a *profitable full- or part-time career!*
- No other electronic information source offers you so much at such low cost . . . Save now, keep on saving month after month!
- Your only obligation is to purchase 3 or more books at regular club prices (plus shipping-handling) during the next 12 months. You may resign any time thereafter . . . or continue to enjoy the savings and convenience available only through the Electronics Book Club!

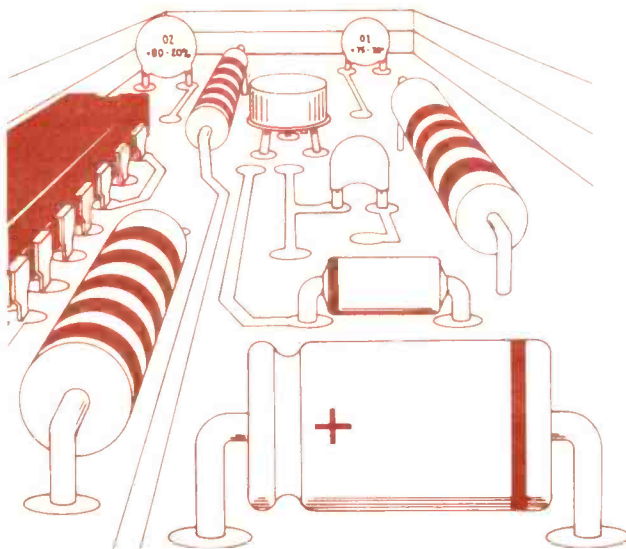

2609 \$26.95

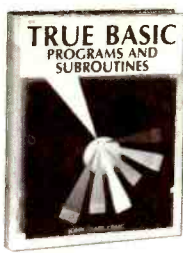

1990 \$24.95

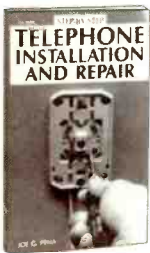

1984P \$9.95

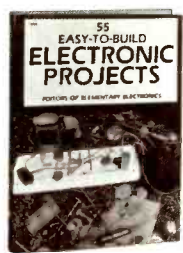

1999 \$21.95

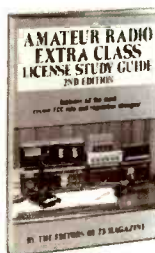

1443 \$17.95



1693 \$21.95



2675 \$22.95

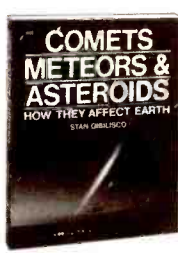

1905P \$14.95

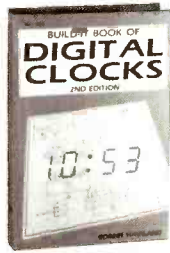

1683 \$21.95



2635 \$19.95

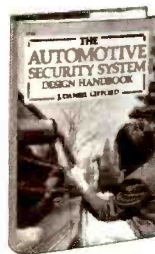

1734 \$18.95

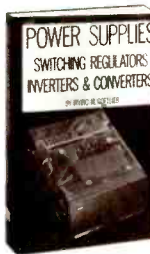

1665P \$17.95



1887 \$22.95

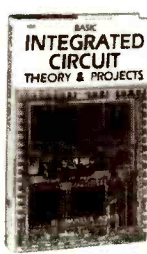

1699P \$11.95

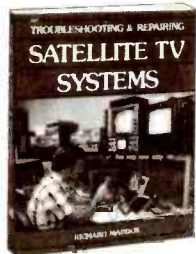

1977P \$18.95

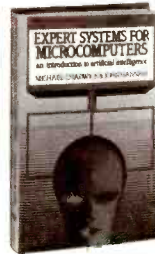

2838 \$19.95

No other book source offers so much for such *low cost!*



NO POSTAGE
NECESSARY
IF MAILED
IN THE
UNITED STATES

BUSINESS REPLY MAIL

FIRST CLASS PERMIT NO. 9 BLUE RIDGE SUMMIT, PA 17214

POSTAGE WILL BE PAID BY ADDRESSEE

Electronics Book Club

P.O. Box 10
Blue Ridge Summit, PA 17214



7 very good reasons to join Electronics Book Club

- **Big Savings.** Members save up to 75% off publisher's list prices.
- **Ironclad No-Risk Guarantee.** All books returnable within 10 days without obligation.
- **Club News Bulletins.** All about current selections—mains, alternates, extras—plus bonus offers. Comes 14 times a year with hundreds of up-to-the-minute titles you can pick from.
- **"Automatic Order."** Do nothing, and the Main selection will be shipped automatically! But . . . if you want an Alternate selection—or no books at all—we'll follow the instructions you give on the reply form with every News Bulletin.
- **Bonus Books.** Immediately get Dividend Certificates with every book purchased and qualify for big discounts of 60% to 80%.
- **Bonus Specials.** Take advantage of sales, special events, and added-value promotions.
- **Exceptional Quality.** All books are first-rate publisher's editions selected by our Editorial Board, filled with useful, up-to-the-minute information.

If card is missing, use this address to join:
Electronics Book Club, Dept MDNE-587
P.O. Box 10
Blue Ridge Summit, PA 17214



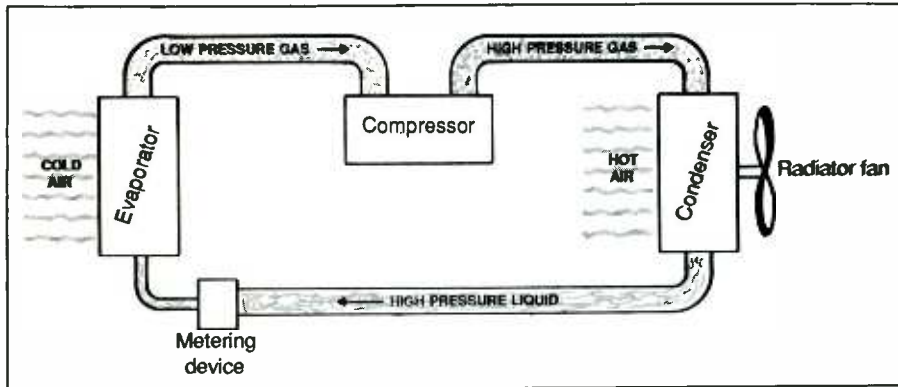

Fig. 1. Simplified diagram of an automotive air-conditioning system.

project will make your air-conditioning system more efficient by reducing the compressor's head pressure. As a result, your engine won't have to labor, and there will be less wear and tear on your car's systems.

About the Circuit

A simplified diagram of a typical automotive air-conditioning system is shown in Fig. 1. The compressor pumps freon gas from the low-pressure to the high-pressure side, raising its temperature. The high-temperature, high-pressure freon gas is then passed through the condenser, where it loses heat and is converted into a liquid. The liquid freon is then metered into the low-pressure evaporator, where it absorbs heat from the passenger compartment's air and boils at a temperature of about 32 degrees F (0 degree C).

If the car's radiator fan is operating, all is well. However, if the radiator fan is off because radiator temperature is not high enough to trip its sensor, the high-pressure freon isn't cooled sufficiently and, thus, quickly becomes too hot. Head pressure builds up as freon temperature increases.

As shown in the all-electronic circuit in Fig. 2 and the alternate relay circuit in Fig. 3, the sensor of the Automatic Fan Control system is integrated circuit *IC1*, which clamps to the liquid freon line at any point between the condenser and evaporator.

Since the IC is in intimate contact with the liquid freon line, it can accurately sense its temperature and, thus, pressure. The circuit turns on the fan motor when the temperature of the freon line exceeds 117 degrees F (47 degrees C). This ensures that fan operation begins before compressor head pressure builds to unacceptable levels.

Integrated circuit *IC1* has been specifically designed as a temperature measurement and/or control system. It includes a temperature sensor, stable voltage reference of 6.85 volts and an operational amplifier. The temperature sensor provides a voltage that is a function of temperature and has a linear output of 10 millivolts per degree C (referred to pin 4 of the chip). Actual output voltage of the sensor is equal to $(0.01 \times \text{degrees C}) + 2.63$. The voltage is applied to the noninverting (+) input of the op amp.

By connecting the *IC1* op amp in a comparator configuration, the pin 2 output will switch as the chip's temperature traverses the set-point voltage fed to the inverting (-) input at pin 3. The divider action of *R1* and *R2* provides an accurate, stable 3.2-volt set-point potential between pins 3 and 4 of the IC to set the switch-over temperature at 47 degrees C.

When sensor potential exceeds 3.2 volts as the temperature of *IC1* rises, the output of the comparator drives *R4* to ground potential. This for-

ward biases *Q1* and sends *Q2* in Fig. 2 into conduction or energizes relay *K1* in Fig. 3. This turns on the car's radiator fan motor. A small amount of hysteresis is provided by *R5* to assure that *IC1* cools to 1 or 2 degrees below 47 degrees C before the fan motor turns off.

Construction

Most of the circuitry that makes up the Automatic Fan Control system can be mounted on a small printed-circuit board that measures less than 2-inches square. If you wish to fabricate your own pc board, you can use the actual-size etching-and-drilling guide shown in Fig. 4.

Once you have your pc board ready for wiring, install the components on it as shown in the wiring diagram shown at the right in Fig. 4. Be sure to mount the diodes, electrolytic capacitor and transistor in the orientations shown; otherwise, the circuit won't work.

You *must* use temperature-stable resistors for *R1* and *R2* to set the temperature switch-over point. If you use carbon-composition resistors instead, the circuit will drift as the temperature inside the engine well changes and value changes occur as the resistors age.

To achieve optimum temperature sensing, the project is designed so that *IC1* connects to the rest of the circuit by means of a four-conductor cable. This permits the IC to be placed in intimate contact with the liquid freon line with the circuit board located somewhere nearby.

Use a socket for *IC1* and, if possible, connect four different-color stranded wires to pins 1 through 4 (pins 5 through 8 aren't used in this project). After soldering the wires to the socket pins, coat the connections with epoxy cement or silicone adhesive to insulate them and provide a strain relief for the wires. Make sure you don't get any cement or adhesive in the socket's receptacles.

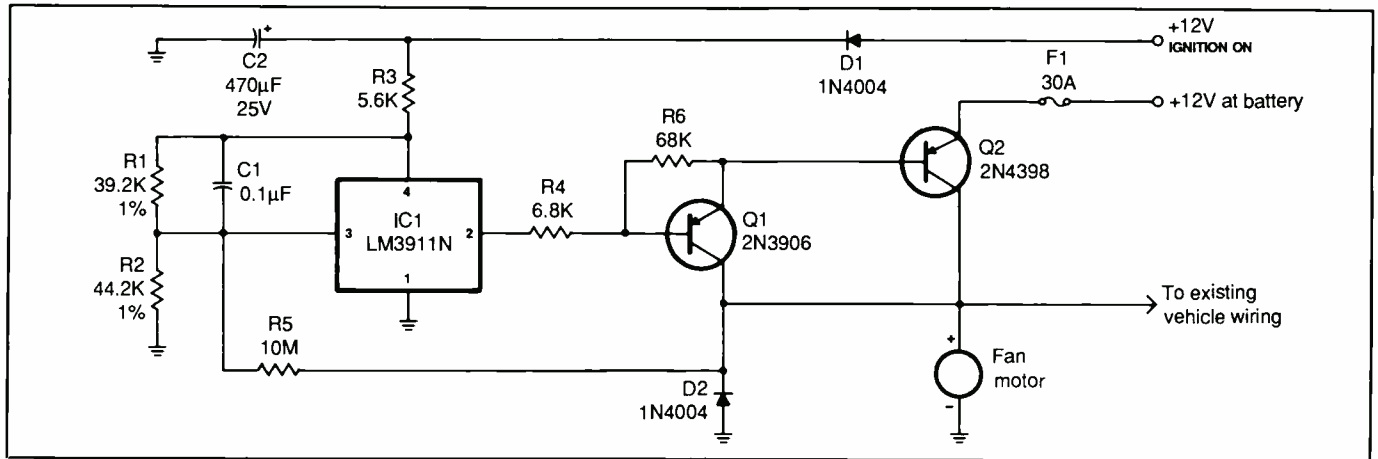

Fig. 2. An all-electronic control system using a power-Darlington "switch."

PARTS LIST

Semiconductors

D1, D2—1N4004 or equivalent 400-PIV silicon diode
 IC1—LM3911N temperature controller
 Q1—2N3906 or similar pnp silicon transistor
 Q2—2N4398 or equivalent 30-ampere pnp silicon transistor (Fig. 2 only; see text)

Capacitors (25 WV or more)

C1—0.1-µF ceramic
 C2—470-µF electrolytic

Resistors (1/4-watt, 10% tolerance)

R3—5,600 ohms
 R4—6,800 ohms
 R5—10 megohms
 R6—68,000 ohms
 R1—39.2k, 1% tolerance metal-film (type RN55C3922F)
 R2—44.2k, 1% tolerance metal-film (type RN55C4422F)

Miscellaneous

F1—30-ampere automotive-type fuse
 K1—12-volt dc relay with 10-ampere contacts (Radio Shack Cat. No. 275-218 or similar—Fig. 3 only; see text)
 Printed-circuit board; socket for IC1; in-line automotive fuse holder; heat sink and insulator for Q2 (Fig. 2 only; see text); 14-gauge or larger stranded wire; epoxy cement or silicone adhesive; Mylar tape (see text); stranded 22-gauge hookup wire; solder; etc.

Note: The following items are available from A. Caristi, 69 White Pond Rd., Waldwick, NJ 07463: ready-to-wire pc board for \$5.75; 39.2k and 44.2k metal-film resistors for \$1.25 per pair; 2N4398 pnp transistor for \$9.99; and LM3911N for \$5.25. Add \$1.00 P&H; New Jersey residents, please add state sales tax.

If you decide to use the Fig. 2 power-Darlington circuit, you *must* mount Q2 on a heat sink to keep it cool. This is necessary because the fan motor draws as much as 15 amperes of current, which would quickly burn out the transistor if it isn't adequately heat-sinked. When you mount Q2, be sure to properly isolate its case from any metal part of the heat sink or the car. Use a mica insulator and heat-transfer compound.

Before proceeding to installation, you should check the set-point voltage across R1 with an accurate dc voltmeter. You can use a dc power supply or the car's battery as a source of power for the project to perform this test. At this point, you don't need Q2 (Fig. 2) or K1 (Fig. 3) wired into the circuit.

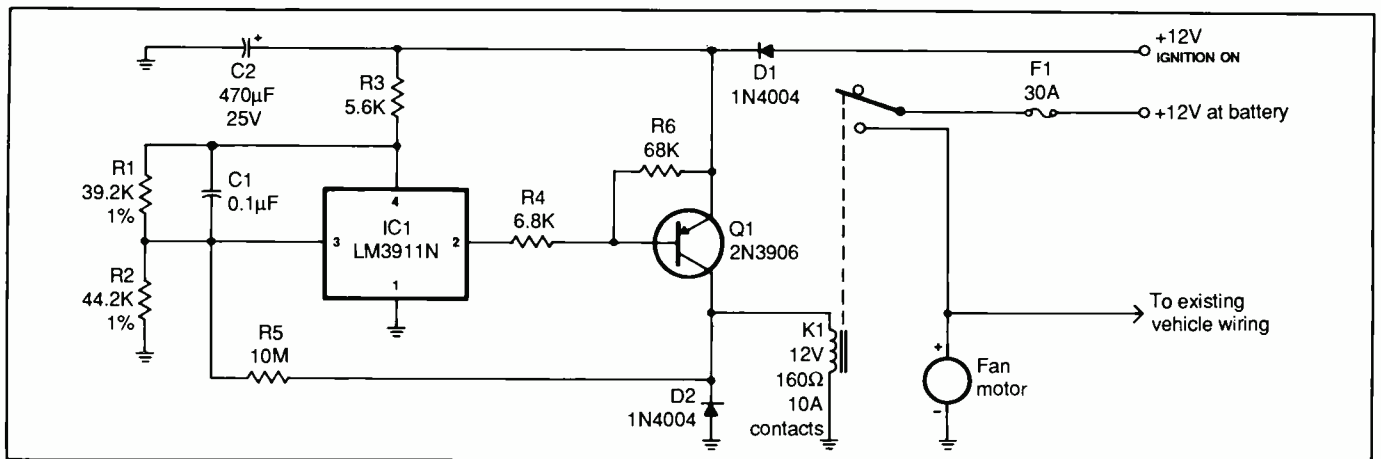

Fig. 3. Automatic Fan Control system using a relay "switch."

With *IC1* plugged into the socket and 12 volts dc applied to the circuit as in Fig. 2 or 3, the potential measured across *R1* should be 3.2 volts. Since there's a variation in ICs, you may have to shunt *R1* or *R2* with a higher-value (470,000-ohm or 1-megohm) resistor until you obtain a reading of 3.2 volts. This shunt can be an ordinary carbon-composition resistor. However, do *not* use a potentiometer.

When you're satisfied that the set-point voltage is correct, check circuit operation before installing the Automatic Fan Control system in your car. To be able to do this, connect your dc voltmeter across *D2*. With the IC at ambient temperature, you should obtain a reading of 0 volt. Now, using a hair blow dryer or a soldering iron (don't touch the case of the IC with the latter!)—*not* an open flame—slowly heat *IC1* while observing the meter. You should note a meter reading that swings to about 11 volts as chip temperature passes the set-point voltage. Removing the heat source from the vicinity of and allowing *IC1* to cool should cause the meter reading to switch back to 0 volt as the chip cools to less than 47 degrees C.

When you obtain the proper responses from the circuit, the project is ready to be installed in your car.

Installation

Decide now which version of the project you wish to install in your car. The preferred version is the all-electronic system shown in Fig. 2, which should provide service for the life of your car with no further attention from you. If you decide to use the relay version illustrated in Fig. 3, keep in mind that the relay chosen must be a heavy-duty type with contacts rated at 10 amperes or more. This is necessary because the fan motor draws a very high in-rush current when power is first applied to start the fan motor.

Regardless of which circuit you

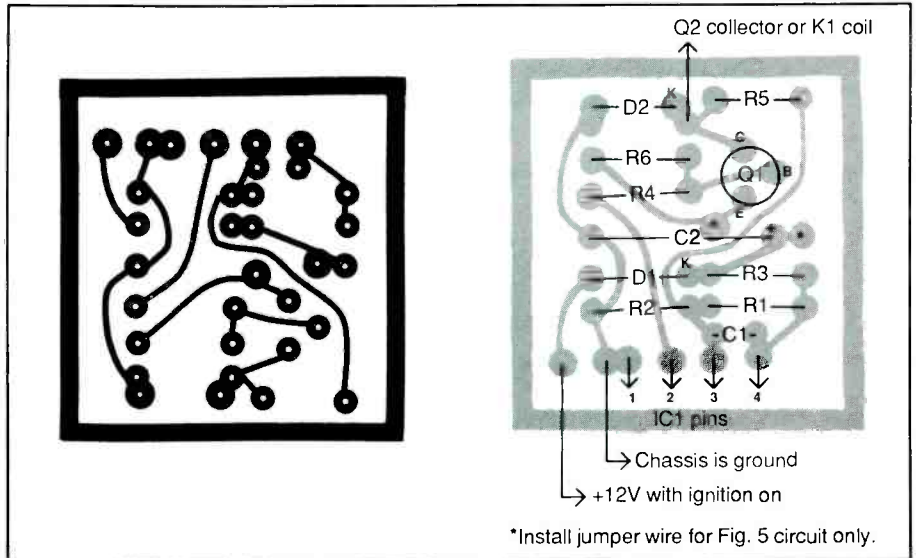

Fig. 4. Actual-size pc guide (left) and wiring diagram (right).

choose, use 14-gauge or larger wire from the +12-volt side of your car's battery to the *Q2*'s emitter (Fig. 2) or *K1*'s contacts (Fig. 3) and to the positive side of the fan motor. Also, be sure to include a 30-ampere in-line fuse and holder in this circuit, as indicated in the schematics. (You can obtain in-line fuse holders from any automotive supply store.) There's no need to install a wire between the chassis ground and the negative side of the fan motor, which is already grounded to the car's chassis.

Connect a stranded hookup wire from circuit ground on the circuit-board assembly to some convenient point on the car's chassis. Since very little current is drawn by the circuit-board assembly, power for this portion of the project can be tapped from any line in your car that's at +12 volts when the ignition is on and is at 0 volt when the ignition is off. Use a dc voltmeter to locate an appropriate line. You can use ordinary stranded hookup wire to make this connection.

To determine where to mount the sensor IC, locate the liquid freon line that runs between the condenser and evaporator. This will be the smaller-diameter of the two lines entering the condenser. If you have any doubts,

operate the air-conditioning system and note which of the two becomes the cooler. The cooler of the two is the liquid freon line.

Mount the sensor to a metal portion of the liquid freon line. To avoid creating a short circuit, place a very thin piece of Mylar tape across the top of the IC. Make this tape long enough so that it can wrap down the sides of the IC over the pins. Then place the IC with its top in intimate contact with the liquid freon line and secure it in place with a couple of layers of tape. Then to provide total isolation from external heat in the engine compartment, wrap the pipe and IC with insulating material. The best type to use here is the self-stick plastic insulation sold in hardware stores as pipe insulation.

When installation is complete, check out the Automatic Fan Control system as follows. Wait until your car's engine is "cold." Then start the engine, turn on the air conditioner, and set it for maximum cooling. With the radiator fan not running, the liquid freon line will heat up before the engine does. When this line becomes warm to the touch, the fan should turn on. That's all there is to it!

ME

TAKE ANY ONE OF THESE HANDBOOKS — when you join the ELECTRONICS AND

- your one source for engineering books from over 100 different publishers
- the latest and best information in your field
- discounts of up to 40% off publishers' list prices

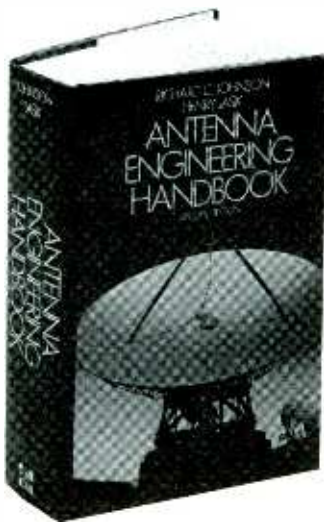

322/910

Publisher's Price \$110.00

ANTENNA ENGINEERING HANDBOOK, Second Edition

Edited by R. C. Johnson and H. Jasik

- 1,408 pages, 946 illustrations
- covers all types of antennas currently in use with a separate chapter devoted to each
- provides detailed data on physical fundamentals, operating principles, design techniques, and performance data
- up-to-the-minute information on antenna applications
- a must for those involved in any phase of antenna engineering

Publisher's Price \$64.50

STANDARD HANDBOOK OF ENGINEERING CALCULATIONS, Second Edition

By T. G. Hicks

- 1,468 pages, 793 illustrations, 499 tables
- puts more than 1,100 specific calculation procedures at your fingertips
- every calculation procedure gives the exact, numbered steps to follow for a quick, accurate solution
- virtually all procedures can be easily programmed on your PC or calculator
- uses USCS and SI units in all calculation procedures



287/35X

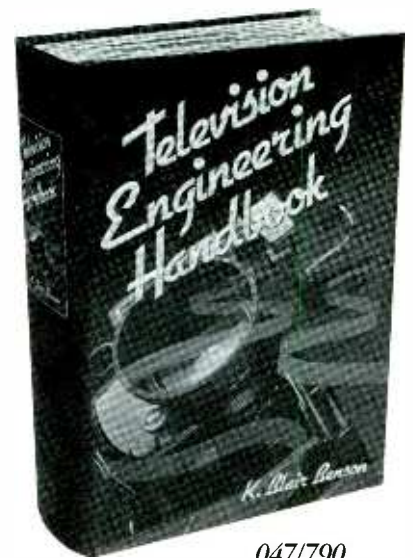

047/790

Publisher's Price \$89.50

TELEVISION ENGINEERING HANDBOOK

Edited by K. B. Benson

- 1,478 pages, 1,091 illustrations
- packed with all the technical information today's engineer needs to design, operate, and maintain every type of television equipment
- extensive coverage of receivers, broadcast equipment, video tape recording, video disc recording, and the latest technological advances
- provides television system and industry standards for the U.S. and other countries
- the most comprehensive book on the subject of television engineering

FOR ONLY \$14.95 – VALUES UP TO \$110.00 CONTROL ENGINEERS' BOOK CLUB®

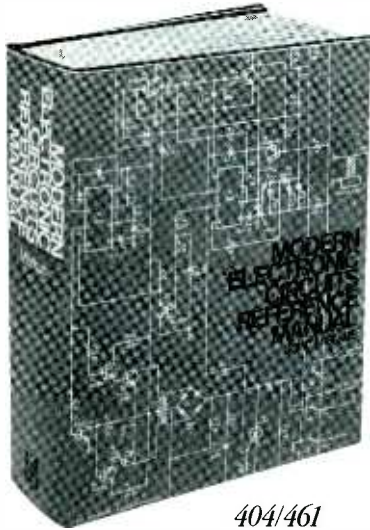

404/461

Publisher's Price \$82.50

MODERN ELECTRONIC CIRCUITS REFERENCE MANUAL

By J. T. Markus

- 1,264 pages, 3,666 circuit diagrams
- a handy, desktop reference with 103 chapters organized by "family" grouping
- filled with predesigned and use-tested circuits to save you production time and money
- includes concise summaries of all the recent applications notes, journal articles, and reports on each circuit, efficiently organized and indexed for the practicing engineer



4 reasons to join today!

1. Best and newest books from ALL publishers! Books are selected from a wide range of publishers by expert editors and consultants to give you continuing access to the best and latest books in your field.

2. Big savings! Build your library and save money, too! Savings range up to 40% off publishers' list prices.

3. Bonus books! You will immediately begin to participate in our Bonus Book Plan that allows you savings up to 70% off the publishers' prices of many professional and general interest books!

4. Convenience! 14-16 times a year (about once every 3-4 weeks) you receive the Club Bulletin FREE. It fully describes the Main Selection and alternate selections. A dated Reply Card is included. If you want the Main Selection, you simply do nothing — it will be shipped automatically. If you want an alternate selection — or no book at all — you simply indicate it on the Reply Card and return it by the date specified. You will have at least 10 days to decide. If, because of late delivery of the Bulletin you receive a Main Selection you do not want, you may return it for credit at the Club's expense.

As a Club member you agree only to the purchase of three additional books during your first year of membership. Membership may be discontinued by either you or the Club at any time after you have purchased the three additional books.

Publisher's Price \$89.00

ELECTRONICS ENGINEERS' HANDBOOK, Second Edition

By D. G. Fink and D. Christiansen

- 2,272 pages, 2,189 illustrations
- unrivaled for its completeness, authority, reliability and timeliness
- 80% new or extensively revised
- prepared by a staff of 173 expert contributors
- brings you more than 2,000 formulas and equations
- has over 2,500 bibliographic entries



209/812

FOR FASTER SERVICE IN ENROLLING CALL TOLL FREE 1-800-2-MCGRAW

McGraw-Hill Book Clubs

Electronics and Control Engineers' Book Club®

11 West 19th Street

4th floor

New York, NY 10011

Please enroll me as a member of the Electronics and Control Engineers' Book Club® and send me the book I have chosen for only \$14.95, plus local tax, postage, and handling. I agree to purchase a minimum of three additional books during my first year as outlined under the Club plan described in this ad. Membership in the club is cancellable by me or McGraw-Hill any time after the three book purchase requirement has been fulfilled. A shipping and handling charge is added to all shipments.

I wish to order the following book:

- ANTENNA ENGINEERING HANDBOOK (322/910)
- MODERN ELECTRONIC CIRCUITS REFERENCE MANUAL (404/461)
- ELECTRONICS ENGINEERS' HANDBOOK (209/812)
- TELEVISION ENGINEERING HANDBOOK (047/790)
- STANDARD HANDBOOK OF ENGINEERING CALCULATIONS (287/35X)

Signature _____

Name _____

Address/Apt. # _____

City/State/Zip _____

This order subject to acceptance by McGraw-Hill. Offer good only to new members. Foreign member acceptance subject to special conditions. This offer expires July 1, 1987.

E33879

EPROM Eraser

Here's how to build an ultraviolet EPROM eraser for a fraction of what it would cost you to buy a commercial eraser

By Ralph Tenny

Every experimenter who programs his own EPROMs needs an EPROM eraser. But even the smallest commercial ones are quite costly. In this article, we'll show you how to build a low-cost EPROM eraser that serves as an effective companion to any EPROM programmer. [An excellent example of a sophisticated low-cost build-it-yourself Stand-Alone EPROM Programmer appeared in the February and March 1987 issues of *Modern Electronics*.—Editor.]

Two elements account for most of the cost of the typical EPROM eraser. These are an ultraviolet (UV) fluorescent tube that provides the needed erasing radiation and the ballast that starts the tube. What circuitry remains consists of a switch and some wire. The housing for commercial erasers is usually made out of aluminum or steel. A do-it-yourself eraser can be built from a variety of materials in a number of ways, depending on your needs and/or desires. How you build the enclosure rests with how fancy you want to get, the amount of money and time you want to invest in the project, your mechanical skills, and the tools you have on hand.

In this article, we present details for building a low-cost EPROM Eraser into an enclosure made up of corrugated cardboard pieces that you glue together. This method of construction will suit the needs of the computer experimenter who has only

occasional need of an EPROM eraser. If you anticipate heavy-duty usage, or you prefer to build a more professional-looking project, feel free to substitute such other materials as plywood, Masonite and even sheet metal. The only stipulation is that whatever material you choose, you must make sure the enclosure is light-tight to assure operator safety.

Cost of building the EPROM eraser to be described is only about \$25 if you use corrugated cardboard (which can be salvaged from a shipping carton as was done for the prototype shown in the photos in this article) for the enclosure. If you build the enclosure out of lumber, plywood, Ma-

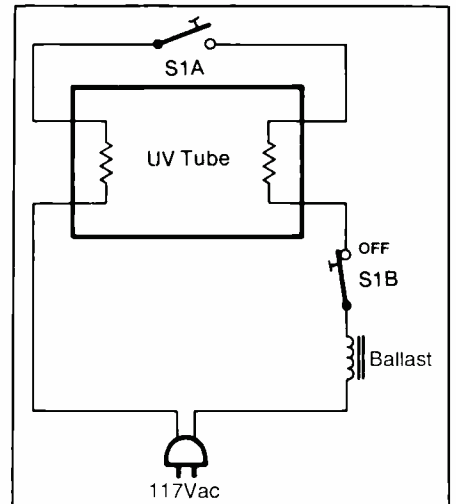

Fig. 1. Schematic diagram of EPROM Eraser circuit.

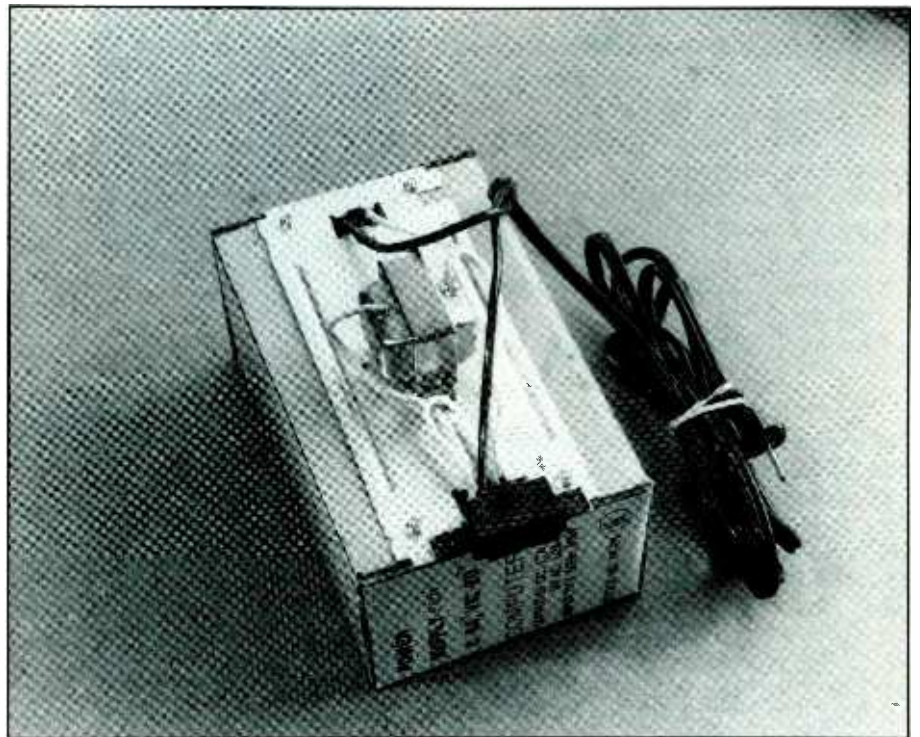

Fig. 2. Eraser built into a corrugated-cardboard enclosure.

sonite or metal, plan on adding \$10 to \$20 or so to this figure.

Cardboard Enclosure

Shown in Fig. 1 is the schematic diagram of a typical EPROM eraser built around a miniature short-wave ultraviolet fluorescent tube. Using this circuit, you can build a UV eraser that will reset all memory cells in an EPROM to all 1s in short order to ready them for new programming. The procedure is effective and costs very little to perform in terms of hardware.

Let's briefly look at the eraser at various stages of assembly to get an idea of how to build the project. Figure 2 shows the simple construction used for housing the EPROM eraser in a box made of corrugated cardboard held together with white glue. Note that the EPROM eraser described here has the ballast, switch and wiring exposed on the top of the box. If you build the circuitry into a commercial-style sheet-metal or wood box, you can enclose everything except the switch rocker from view. The cardboard enclosure shown in the photos in this article is adequate if you have only occasional need of the EPROM eraser. If you anticipate heavy eraser usage, you're urged to build the enclosure out of wood or metal.

In Fig. 2, you see the cardboard box, a metal plate, the wiring and an ac-line power cord. Figure 3 shows a different view. Here you see the plate and the top of the box. Note the protruding bolts that are used to mount the UV fluorescent tube fixture. Building the eraser in this manner permits the tube to be replaced should this become necessary. The slot in the top of the box allows the tube to protrude into the area of the box in which erasing takes place when the project is operated.

On one end of the metal plate is the spring-loaded rocker switch that is

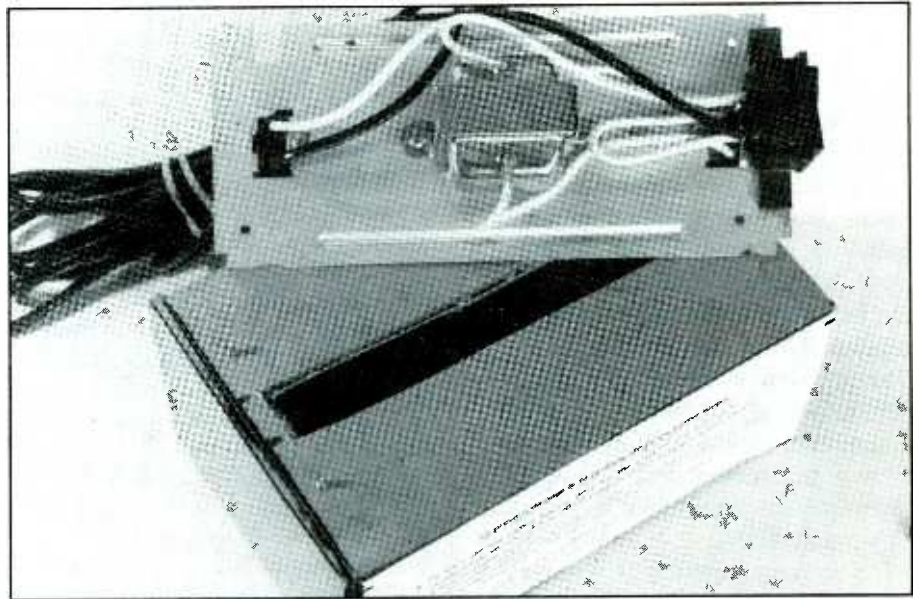

Fig. 3. Details of enclosure, electrical circuit and mounting screw ends. The long rectangular slot in the top of the box is for the UV tube.

used to start the UV tube. In the middle of the plate is the starter ballast, which looks like an ordinary low-voltage power transformer. Also shown are the wires that electrically tie together the UV tube, rocker switch and ballast.

Moving on to the bottom view of the plate shown in Fig. 4, you can see the miniature UV tube mounted in its sockets. At this stage of assembly, construction of the eraser is far from complete. The tube is shown installed in its socket only to illustrate

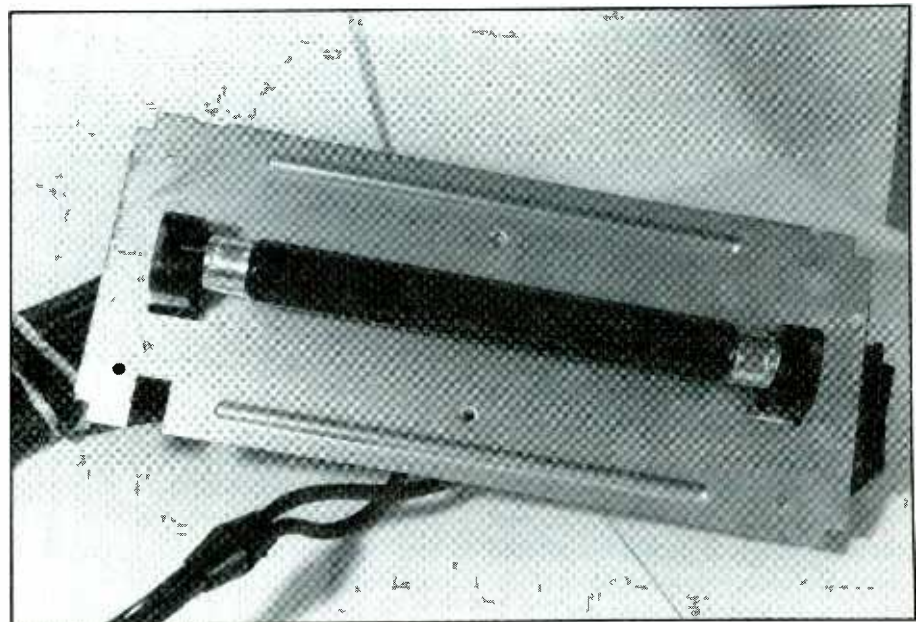

Fig. 4. This view shows UV tube mounted in its sockets.

what the assembly looks like. You would not install the tube until you're nearing final assembly. Always keep the tube in its container until you're ready to install it.

Figure 5 shows the eraser partially open. Note the conductive foam glued to the bed of the EPROM shelf. This foam holds the EPROM in place close to the source of UV radiation during the erasing process. The top view of the drawer with an EPROM plugged into the conductive foam is shown in Fig. 6. The bottom view of the drawer, shown in Fig. 7, illustrates the simplicity of the drawer's construction.

As you can see in Fig. 7, the drawer consists of a shallow rectangular box to which the front panel is glued. Since what you really need for the eraser is a platform, the box is inverted before being glued to the front panel so that there is a flat bed on which you glue the conductive foam.

Finally, Fig. 8 shows the inside of the fully assembled eraser with the EPROM drawer removed. At this stage of construction, you mount the plate on which are the tube sockets, ballast, rocker switch and wiring on the top of the box so that the tube extends fully through a rectangular slot into the cavity of the enclosure.

Construction

Construction begins with the hardware. You mount the UV tube sockets, ballast and rocker switch on the metal plate and wire the circuit according to Fig. 1. The hardware items in the prototype were purchased from Lolir Lectronics, but you can obtain them from the source given in the Note at the end of the Bill of Materials.

The corrugated-cardboard enclosure used for the prototype and shown in Figs. 2 through 8 started out as the shipping carton for a Commodore computer power supply. It was chosen for the eraser's enclosure

What You Should Know About EPROMs

Before setting out to erase any EPROM, you should know the electrical characteristics and something about the physical makeup of this memory device. Like any other solid-state memory device, the EPROM is made up of a series of memory "cells" that store data as logic 1s and 0s. Unlike RAMs, however, the EPROM maintains whatever is stored in it for 10 years or more. It doesn't permit writing to it except under programming conditions that are not normally available in the circuit in which the EPROM is designed to operate as a memory device. A RAM, being a temporary memory device, on the other hand, can be written to and erased under the normal conditions in its read/write circuitry. To be able to write new data into it, an EPROM must be removed from the circuit in which it normally operates for erasing and reprogramming with external equipment.

Each memory cell in an EPROM is a metal-oxide silicon (MOS) transistor that has two gates. One gate stores the bit in memory, while the other reads it from memory. The storage gate, buried in an insulating material, has no external connection to it. It operates on a "stored-charge" principle. That is, if the gate is charged, a logic 0 is stored in it, while removing the charge results in the cell storing a logic 1.

By generating an electric field across the gate, the storage gate is charged. This causes electrons to collect on the gate and charges it so that the transistor is turned on and stores a logic 0. If done correctly, the programmed charge will remain 10 years or so. If you wish to reprogram the EPROM before this time, the charge on each buried gate can be

forced to leak off. This is done by subjecting the EPROM to a special wavelength of ultraviolet radiation.

Erasure of an EPROM is a radical operation. There are no half measures. Whenever you erase an EPROM, *all* data stored in it is wiped out. You can't save a portion of the data as you can by overwriting selected portions of RAM with new data.

EPROMs have built into the tops of their cases quartz windows in line with the surface of the chip for erasing purposes. During erasure, the UV energy temporarily changes the insulator's characteristics so that the stored charge is allowed to leak off. When the charge is all gone, the memory cells will be turned off and, thus, have a logic 1 stored in them. If you were to reinstall an erased EPROM in the circuit from which it was removed and attempted to read its contents, you would obtain a display of all 1s in binary or all Fs in hexadecimal.

An EPROM can be accidentally erased in about three days if it's left out in direct sunlight or in about a week if it's left under a continuously-on bright fluorescent lamp. So it's important to cover the quartz window of any programmed EPROM with some easily removable opaque material. You can cover the window with plastic electrical tape or a floppy-disk write-protect tab.

An EPROM eraser uses a high level of UV radiation to do its job quickly and efficiently. *This radiation is dangerous to the human eye. If viewed directly, the UV radiation can cause severe burns and even blindness. Therefore, never operate a UV lamp in an enclosure unless it fully seals in the UV radiation!*

solely on the basis that it was the correct size for the project's hardware. If you don't have such a carton, you can use any other corrugated box that can be modified by cutting and gluing to accommodate the hardware. Use the hardware mounted on

the metal plate to determine the size of the enclosure needed.

Start construction by gluing all box flaps, lid and end pieces together with liquid white glue to produce a sturdy box, as shown in Fig. 8. Save fabrication of the EPROM drawer

EXPAND YOUR CAREER HORIZONS...



The CIE Microprocessor Trainer helps you to learn how circuits with microprocessors function in computers.

START WITH CIE.

Microprocessor Technology. Satellite Communications. Robotics. Wherever you want to go in electronics... start first with CIE.

Why CIE? Because we're the leader in teaching electronics through independent study. Consider this. We teach over 25,000 students from all over the United States and in over 70 foreign countries. And we've been doing it for over 50 years, helping thousands of men and women get started in electronics careers.

We offer flexible training to meet your needs. You can start at the beginner level or, if you already know something about electronics, you may want to start at a higher level. But wherever you start, you can go as far as you like. You can even earn your Associate in Applied Science Degree in Electronics.

Let us get you started today. Just call toll-free 1-800-321-2155 (in Ohio, 1-800-362-2105) or mail in

CIRCLE NO. 171 ON FREE INFORMATION CARD

the handy reply coupon or card below to:
Cleveland Institute of Electronics,
1776 East 17th Street, Cleveland, Ohio 44114.

CIE

World Headquarters

Cleveland Institute of Electronics, Inc.
1776 East 17th Street • Cleveland, Ohio 44114

Please send your independent study catalog.
For your convenience, CIE will try to have a representative contact you — there is no obligation.

Print Name _____

Address _____ Apt. _____

City _____ State _____ Zip _____

Age _____ Area Code/Phone No. _____

Check box for G.I. Bill bulletin on Educational Benefits

Veteran Active Duty **MAIL TODAY!**

Just call toll-free 1-800-321-2155 (in Ohio, 1-800-362-2105)

AMO-80

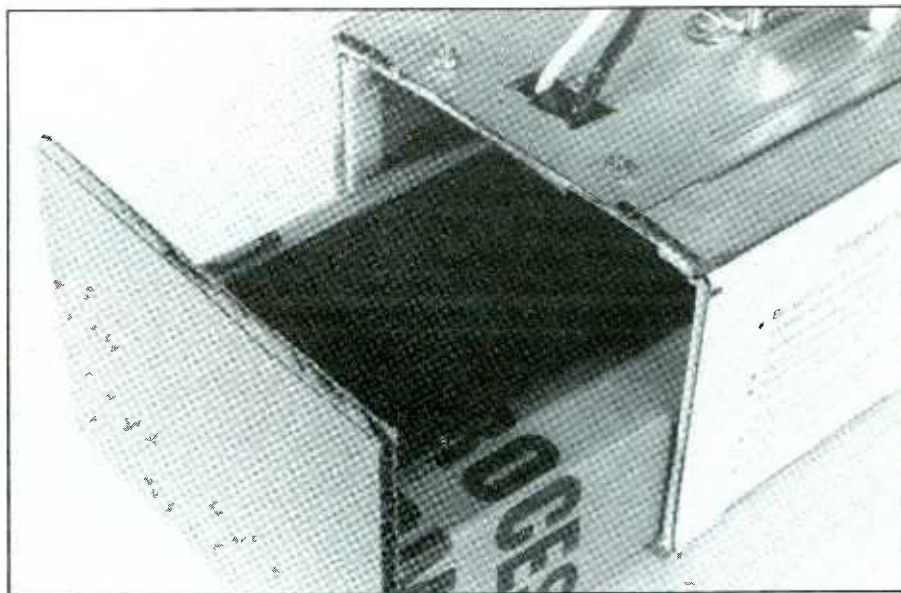

Fig. 5. Drawer must fit well enough to prevent UV light from being visible from outside the enclosure.

until you've completed the box that makes up the main enclosure.

After the glue has completely dried, cut an opening in one end of the box, leaving a $\frac{3}{8}$ " border around the opening at one end of the box. Make a diagonal cut in the border to each of the four corners of the box. This creates the flaps required to reinforce the drawer opening of the

box. Liberally coat with white glue the inside surfaces of the flaps thus created. Fold the flaps back flat against the inside walls of the enclosure and clamp each until the glue has completely dried to keep the opening uniform and ensure a solid fit for the drawer.

Next, reinforce the top of the box with an additional layer of corrugat-

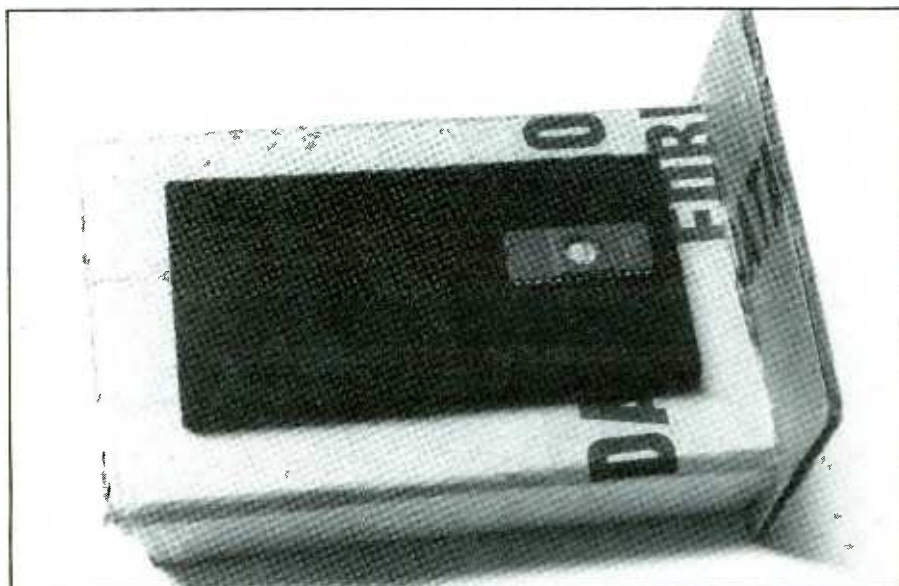

Fig. 6. Drawer with an EPROM ready for erasing.

BILL OF MATERIALS

Miniature 4-watt ultraviolet fluorescent tube (see text)

4-watt ballast for miniature fluorescent tube

Sockets for miniature fluorescent tube

Metal plate for hardware mounting

Rocker switch

Heavy-duty stranded wire

Conductive foam (see text)

Materials for enclosure (see text)

Note: The following items are available from Computer Automation Hardware, P.O. Box 830545, Richardson, TX 75083: Hardware kit consisting of 4-watt ballast, socket to fit 4-watt fluorescent tube and rocker switch for \$10.00 plus \$2.00 for P&H; 4-watt ultraviolet fluorescent tube for \$10.00 plus \$1.25 for P&H. When ordering both hardware kit and tube, add \$2.00 for P&H. Texas residents, please add state sales tax.

ed cardboard, cut to the same dimensions as the top of the box. Measure the width and length of the UV tube and its sockets, draw this rectangular shape on the cardboard panel you just cut, centering it all around, and cut away the cardboard within the marked outline to make the UV tube slot. Carefully mark off the locations for the four hardware mounting screws and drill or punch a $\frac{1}{8}$ " hole at each point. Place the panel on the top of the box and trace its outline on the top. Remove and set aside the extra cardboard panel and cut the outlined slot in the top of the box. Do *not* punch holes for the screws.

Place a 6-32 \times $\frac{3}{8}$ " or $\frac{1}{2}$ " oval-head machine screw in each of the holes in the extra panel. Liberally coat the top of the enclosure box with white glue, spreading it evenly and allow to dry until the surface is tacky. Place this panel on the top of the box, screw heads down and tube slots aligned and clamp the assembly until the glue has completely set. The threaded ends of the screws should now be pointing up, ready to accept the hardware plate. With a damp cloth, wipe away any glue that bleeds

out from between the panel and the top of the box around the perimeter of the panel and slot.

When the glue is dry, set the UV tube in its sockets and set the hardware assembly in place on the top of the enclosure. When the screw ends go through the holes in the metal plate and lockwashers and No. 6 machine nuts are snugged down, the tube should extend fully into the box (see Fig. 8) and all seams should be fully sealed so that the only possible place for the UV radiation to escape is through the drawer opening. If you suspect any joint, liberally flow on more glue and allow to completely dry or cover the joint with tape.

Now fabricate the EPROM drawer. This is perhaps the most difficult part of construction. This is not because special tools or skills are required, but because you must fabricate it so that it provides a light-tight seal against the front of the enclosure and elevates the platform bed to just the right distance from the UV tube for efficient EPROM erasing.

Measure the interior depth and width (make allowance in the latter measurement for the reinforcing flaps at the drawer opening). You now have two of the dimensions for the platform. Now measure the distance between the UV tube and the floor of the enclosure. Subtract about 1" from the measurement obtained to make allowances for clearance between the UV tube and top of the EPROMs to be erased and the thickness of the conductive foam into which the EPROM pins will plug during erasing. Make a box to these dimensions, leaving the bottom open (see Fig. 7).

It's very important that the top of an EPROM being erased be within 1" of the UV tube because light intensity—in this case, UV radiation—is inversely proportional to the square of the distance from the source to the target. If you double the distance from the UV tube to the

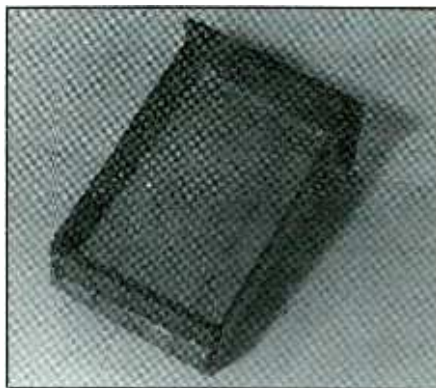

Fig. 7. Bottom view of simple drawer construction.

EPROM, only 25% as much UV energy will reach the EPROM and will take commensurately longer to erase. Hence, it's important that the platform elevate the EPROM as close to the UV tube as possible. Just make sure that the UV tube will not become scratched when you slide the drawer into the enclosure.

The easiest way to make the box is to use one large sheet of corrugated cardboard with flaps slightly larger than needed for the calculated depth of the platform. (It's better to make the box too deep than not deep enough and trim as needed.) Leave

additional flaps to make the corner joints. Fold down the flaps to obtain a rectangular box and glue and staple the corners.

Cut a strip of conductive foam to about 2" wide and about 1/2" shorter than the depth of the box. Glue this to the platform bed, centered all around. When the glue has completely dried, test fit the platform in the box to determine if the top of any EPROM plugged into the conductive foam will be about 1" from the glass UV tube. If it's too close, remove the platform and trim its height accordingly. Also, test for side-to-side play. If there is excessive play, you may have to glue another layer of cardboard to one side wall of the platform to eliminate it.

When the fit and height of the platform are just right, measure the external dimensions of the enclosure's drawer opening. Cut a final piece of corrugated cardboard to these dimensions and glue it to the front wall of the EPROM platform. Once again, clamp the pieces together and allow the glue to dry.

Once again, test fit the drawer. If when the drawer is pushed all the way in you note that the top of the

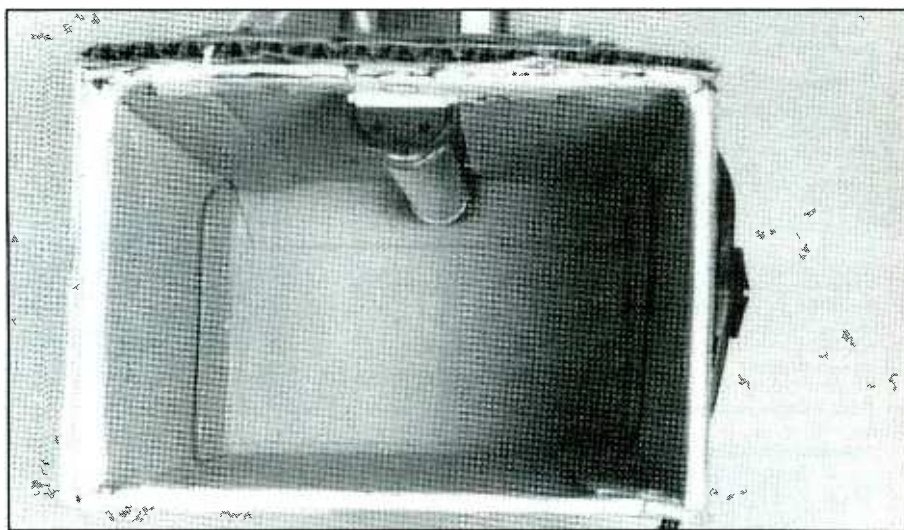

Fig. 8. Finished eraser built into enclosure made from corrugated cardboard. UV tube extends fully into cavity. Note reinforcing flaps on open end of box.

XT SYSTEM 3-BASIC TURBO

FCC approved • IBM™, PC, XT Compatible

Includes:

- XT-type case • 150-watt power supply
- 640K turbo motherboard with 256K on board No. 98999

\$263

YOUR COST

— SAVINGS —

- Name brand floppy drive No. 93140 **\$95**
- Magnavox green monitor No. 96710 **\$87**
- K-150L keyboard No. 90130 **\$45**
- K-150M AT-type keyboard No. 99020 **\$59**
- 150-watt power supply No. 90155 **\$52**
- Case for PC/XT compatible No. 90180 **\$33**

Mountain COMPUTER PRODUCTS

- 20 meg drive card for XT or AT No. 99620 **\$529**

- 30 meg drive card for XT or AT No. 99600 **\$619**

- 20 meg hard drive w/controller hardware and software 65MS No. 96835 **\$439**

- 30 meg hard drive w/controller hardware and software 65MS No. 96836 **\$509**

- 1 YEAR WARRANTY ON ALL MOUNTAIN PRODUCTS

MODEMS

FCC approved

SmarTeam

- Hayes compatible • 300/1200 BAUD • Auto answer/redial • LED lights No. 91990 **\$157**

Avatex Modem

- Auto answer, dial, & redial • PC talk III software included • Automatic self-test on power up No. 97070 **\$87**

Internal Modem

- 1/2 size card • 300/1200 BAUD • Bell 103/212A compatible • Hayes compatible No. 97085 **\$129**

COMPUTER BOARDS

FCC approved • IBM™/PC/XT compatible

Multifunction Board

- 384K expandable • Serial & Game ports
- Parallel printer port • Clock calendar w/battery backup • Manuals & cables No. 92290 **\$75**

Floppy Disk Controller

- Drives 2 internal drives • Includes cable No. 92260 **\$29**

Hard Drive Controller Board

- Controls 2 hard drives from 5 mb to 32 mb No. 96230 **\$110**

- Controls 2 hard & 2 floppy drives No. 96340 **\$130**

Monochrome Graphic Printer Board

- Built-in Parallel printer port • Text 25 line x 80 column, 720 x 348 resolution • TTL high resolution output No. 99010 **\$75**

- No. 96360 text only **\$54**

Color Graphics Board

- RGB & composite port • Light pen interface • Graphics 320 x 200 (color) 640 x 200 (B/W) • Text 25 x 80 No. 92280 **\$65**

- No. 96670 RGB & printer port only **\$73**

Multi I/O Card

- Built-in floppy controller that can drive 2 floppy drives • 1 RS 232 serial port • Calendar clock • Parallel printer port • Joystick adapter No. 96770 **\$88**

RS 232 Serial Port Board

- No. 92310 **\$27**

Clock/Calendar Card

- Built-in calendar • Real time clock No. 96350 **\$29**

Parallel Printer Card

- No. 92700 **\$21**

Game I/O Board

- 2 ports No. 92850 **\$21**

640K RAM Expansion Board

- No. 99630 **\$44**

THE WHOLESALE OUTLET

TO ORDER CALL (518) 459-7883

1 INTERSTATE AVENUE, DEPT. ME, ALBANY, NY 12205

CALL FOR CATALOG FOB Albany Customer pays freight and handling

MC/Visa accepted (Other orders shipped UPS COD (cash, money order or cashier's checks only) MINIMUM ORDER \$25.00 (Prices subject to change without notice. We are not responsible for typographical errors)

PHONE ORDERS TAKEN 24 HOURS A DAY!!!

drawer touches the front of the enclosure but the bottom doesn't meet flush, you have to glue a thickness of corrugated cardboard to the floor of the enclosure along the rear wall to compensate for the flap at the front. This piece need be no more than 1" wide and just 3" long. Its only purpose is to elevate the rear end of the platform to the proper height to alleviate the tilt condition. Under no circumstances should you or anyone else operate the project until the drawer squarely meets the front of the opening of the enclosure.

Checkout and Use

Before checking out the EPROM Eraser, keep firmly in mind at all times that the ultraviolet light it uses to erase EPROMs is dangerous to the human eye and can cause severe burns and even blindness if viewed directly. Though it has a visible-light element, the dangerous ra-

diation component is invisible to the human eye. *Never view this UV light directly and only very briefly if it is reflected from a light surface!* Because of the very real danger posed by short-wave UV radiation, make it a point to affix in prominent locations on the project one or more warning labels detailing proper usage of the eraser and cautions against direct viewing of the UV light.

For the following test, all you need is a *brief* view of the reflected UV light from the project. Total viewing time should be no more than a second or so. As soon as you see the reflected UV light and confirm that the UV lamp remains on after releasing the rocker switch, avert your eyes and disconnect the line cord from the ac outlet.

With the drawer out of the project, face the opening of the eraser away from you but directed toward a nearby light (preferably white, but *not* mirrored) surface. Plug the proj-

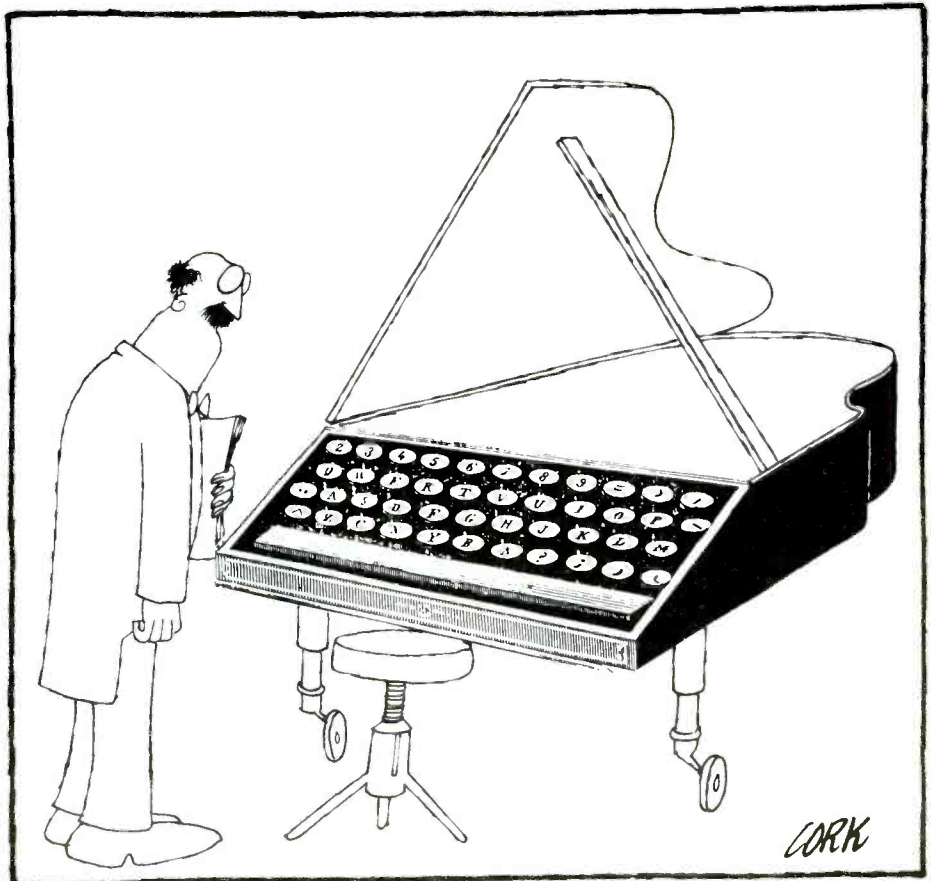

ect's line cord into an ac outlet and dim the room lights but don't turn them off altogether. Press and hold the rocker switch. After a few seconds, you should see a pale bluish or violet light reflected from the light surface, indicating that the system is working. Immediately release the switch; the reflected energy should remain, indicating that the UV tube is still on. Immediately avert your eyes from the reflected light and pull the cord from the ac outlet.

Now slide the drawer into the enclosure opening and snug it flush against the front edges of the box. Plug in the ac line cord and press and hold the rocker switch for about five seconds. Release the switch.

Without disturbing the drawer, examine the junction between drawer and box and all enclosure seams to see if any bluish or violet light is escaping. Do this with room lighting dimmed. If any radiation is escaping, power down the project and rectify the problem before attempting to use the project.

EPROM erasing time with any given UV tube depends heavily on the manufacturer of the specific EPROM. To determine the time required to fully erase a given EPROM type, you should erase the device in 2- or 3-minute intervals. Check for complete erasure after each interval until the job is done properly. Once you know how long it takes to erase a specific EPROM, add 25% to the total time and make a note of the result, along with the EPROM type and manufacturer. Keep a record of each type of EPROM you erase for future reference.

If you erase more than one EPROM at a time, increase erasing time by 10% for each additional EPROM you place in the drawer. Avoid erasing more than three EPROMs simultaneously with the 4-watt UV tube used in this project. Though frequent erasing is probably not harmful to an EPROM, don't overdo it.

ME

With the HEATHKIT ONLINE CATALOG

you can order over 400 kit and assembled computer and electronic products – with the press of a button.

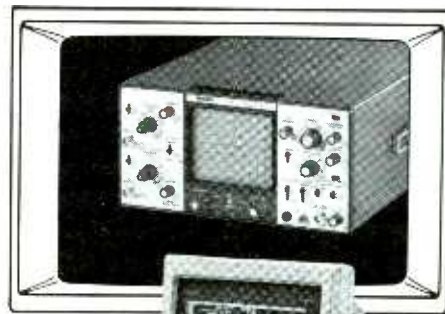

As a CompuServe® user, you want the full advantages this system can offer. And what better way to make CompuServe work for you than to let it bring you the Heathkit Online Catalog. Menu-Driven, our catalog lets you browse over 400 kit and assembled products from 17 major product categories. You can even order a free hardcopy version of our catalog.



Among the many high-quality products you'll find are:

- IBM AT-compatible advanced personal computers
- IBM PC-compatible compact personal computers • IBM PC-compatible expandable personal computers
- Portable and desktop PCs • Laptop computers with built-in software • Microcomputer-Aided Drafting and Design programs • the HERO® 2000 Robot • Test Instruments
- Home Security Systems • TV's and video recorders
- Amateur Radio gear and more

All of our products are meticulously engineered and backed by excellent service and support. And as an added plus, our kits offer you the satisfaction of building a high-tech quality product yourself.

You'll also find complete hands-on training courses in areas ranging from basic electricity and programming languages to microprocessors and robotics. All courses are designed by educators knowledgeable in their respective fields.

And for added convenience, you can place your order through your computer using your Visa, MasterCard or Heath Revolving Charge – it's that easy.

To benefit from this unique opportunity, type

GO HTH

at any "!" or "OK" prompt on the system

The Heathkit Online Catalog – your direct line to quality high tech products

Heathkit®

Heath
Company

CompuServe is a registered trademark of CompuServe Inc. An H&R Block Company.

CL-785R1

MAC INKER™

MAC INKER™, Automatic Ribbon Re-inker. Re-ink any fabric cartridge or spool for less than 5 cents. Over 70,000 in the field and



\$68.50.

We have cartridges re-inkable in 10 colors. Ask for your printer type or for complete listing. Bottle ink \$3.00/each. Shipping \$3.00.

we support **ALL** printers. Universal Cartridge or Universal Spool **MAC INKER**

PROTEUS™, the 'Siamese' Buffer. It is a **Data Switch** with buffer on both ports. Switch manually or via software. Saves time, space and money. Or ask about our **MAC MASTER** line of Universal Buffers and Printer Controllers (serial or parallel up to 1 MEG).



PROTEUS 64 K-199.00

256 K-299.00 Shipping \$4.00.

Of course we have **Data Switches**, serial/parallel, 2 way, 4 way, crossed etc., at most competitive prices (all lines switched).

CABLES priced \$10-30. We carry cables for all common computers and peripherals. Rapid turn-around on custom orders.

MERCURY MODEM. Really 100% Hayes* Compatible. 300/1200 baud, speaker, full status light display and 2 year warranty. **\$149.00**



Quick Link Communications Software—fast, quick, easy to learn. **\$29.95** (available for IBM PC or Macintosh)

*Hayes is a trademark of Hayes Microproducts.

MAC THE RIPPER. Our newest, original and welcome printer companion. Pulls off paper perforations and tears the sheets apart. Takes little space and will pay for itself almost immediately in saved time and tedium. Ask for brochure. Introductory Price **\$299.00**. Shipping \$10.00.

Order Toll Free.

Call or write for free brochure.

1-800-547-3303

In Oregon 503-626-2291 (24 hour line)

We are and always will be your

Computer Friends®

14250 N.W. Science Park Drive
Portland, Oregon 97229 Telex 4949559
Dealer inquiries welcome.

CIRCLE 97 ON FREE INFORMATION CARD

NEW PRODUCTS...

tion from full stereo (strong signals) to full mono (weak signals). Also featured are 6 AM and 6 FM presets and manual/seek tuning.

Dolby B and C noise reduction, metal-tape capability and a super-hard permalloy head are offered in the cassette deck. The tape head automatically disengages from the cassette when the vehicle's ignition is turned off.

Output amplifier power is rated at 12 watts/channel with both channels driven into 4 ohms at 1% THD, 1 kHz (4.5 watts/channel all four channels driven). Preamp line-level outputs provide for multi-amp/multi-speaker systems. A fader balances



between the speaker outputs of the amplifier and line-level outputs to an external amplifier.

Controls are arranged according to size priority, with special ridges on them to help you find the correct one without your having to take your eyes off the road. \$360.

CIRCLE 54 ON FREE INFORMATION CARD

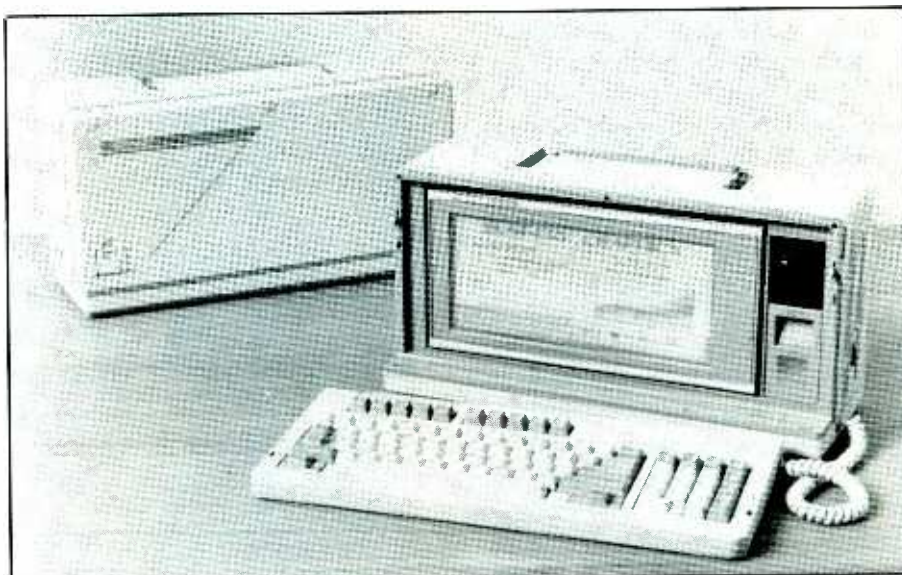

Hard-Disk-Based Portable PC

Sharp's new Model PC-7100 is a hard-disk-based portable personal computer designed to have a high degree of compatibility with software written for the IBM PC. In addition to a built-in 20M hard-disk system with 49-millisecond access time on an expansion card, the unit has a 5.25-inch floppy-disk drive. Supplied standard is 320K of user RAM, and on-board sockets permit expansion to 704K. A new "Supertwist" liquid-crystal display (LCD) screen is

illuminated to provide significantly increased character-to-background contrast ratio. It displays a full 25-line by 80-character "page." In addition, an optional color/monochrome CRT adapter for use with an optional video display monitor is available that makes it easy for the computer to be used as a small-footprint replacement for a desktop computer. The detached IBM AT-style keyboard is full-size. Both serial and parallel ports are supplied as standard equipment. The computer comes with MS-DOS 2.1. \$2,795.

CIRCLE 55 ON FREE INFORMATION CARD

Long-Play Video Battery

RCA has announced availability of a new rechargeable nickel-cadmium power pack for portable VCRs, camcorders, TV receivers, cameras, etc. The 12-volt Model AV046 battery is rated at 4.5 amperes. It has 11 cells, rather than the usual 10 cells, for increased capacity and longer run time. Also, its sealed maintenance-free construction prevents leakage.

Dual protection against battery damage is provided by a self-reset-



ting internal circuit breaker and a user-replaceable fuse. Long storage does no harm. The battery can be recharged overnight.

The battery is housed inside a contoured case that is designed for carrying comfort. A woven adjustable shoulder strap is provided as well. A recessed universal cigarette-lighter type receptacle (with sliding door) is protected from dust and damage and permits easy connection with an optional dc car cord. The compact battery weighs just 4.4 lbs.

CIRCLE 56 ON FREE INFORMATION CARD

Computer Power Director

Part of Data Spec's new Director Series, the Model PC1025, is a multi-function control unit that features three-way surge suppression, A/B data switching, a digital LED clock and individual switching capabilities for up to five components. Five front-mounted on/off switches for computer, printer, monitor and two auxiliary devices provide power for each component separately as need-



ed. Additionally, a master switch powers up/down the entire system plugged into the PC1025.

Included in the PC1025 is a 25-pin data switch that allows the user to switch between two printers, a print-

er and a modem, or any two other peripherals. Slim-line styling (it is only 1 1/4" high) enables the PC1025 to serve as a convenient base for a video display monitor. \$199.

CIRCLE 57 ON FREE INFORMATION CARD

Two things a technician shouldn't be without ...

#1. The Telephone

#2. The *NEW* MCM Electronics Catalog

Your telephone is a very important part of your business. It saves you time ... it helps you run your business smoothly and efficiently ... it's dependable ... and it's convenient.

Like your telephone, the new MCM Catalog offers you many of the same advantages.

With our wide selection of product lines, you'll save time looking for parts. Our fast, friendly and dependable service will help you operate smoothly, and you'll like our low prices.

Convenient too! Our nationwide toll free numbers make us as close as that other important business tool — your telephone!

Call today for your FREE copy of the latest MCM Catalog. No obligation to buy!

Catalog #14 Now Available
Call TOLL-FREE 1-800-543-4330
(In Ohio call 1-800-762-4315)
(In Alaska or Hawaii 1-800-858-1849)

MCM ELECTRONICS
858 E. CONGRESS PARK DR.
CENTERVILLE, OH 45459
A PREMIER Company

Source No. ME-23

CIRCLE 99 ON FREE INFORMATION CARD

Build the Pattern-8 Generator

Up to eight patterns can be programmed into this low-cost instrument for quick, accurate digital equipment troubleshooting

By Desi Stelling

Troubleshooting digital equipment can be very complicated and sometimes even impossible to do without very expensive test analyzers and high-resolution storage equipment. Though logic analyzers tend to be among the most helpful instruments for digital troubleshooting, it is occasionally necessary to generate synchronized data lines with very complicated data formats. A pattern generator is by far the best instrument for this purpose. The pattern generator lets you debug hardware right down to the precise problem area.

With a pattern generator, you divide digital equipment into simple, easy-to-understand circuit blocks. The generator produces all required input data and tells you if the logic is performing properly. For example, in a simple processor with input/output ports and system RAM or ROM, you can use a pattern generator to isolate the processor control lines, to simply and effectively verify the steering logic of the hardware. In this application, the pattern generator simulates the "brain" of the computer with a simple machine.

Though pattern generators have traditionally been very expensive instruments, using low-cost digital integrated circuits, you can build the Pattern 8 Generator at a cost that is far less than you would have to pay for a commercial model. The build-it-yourself Pattern 8 Generator discussed here is a reliable and versatile

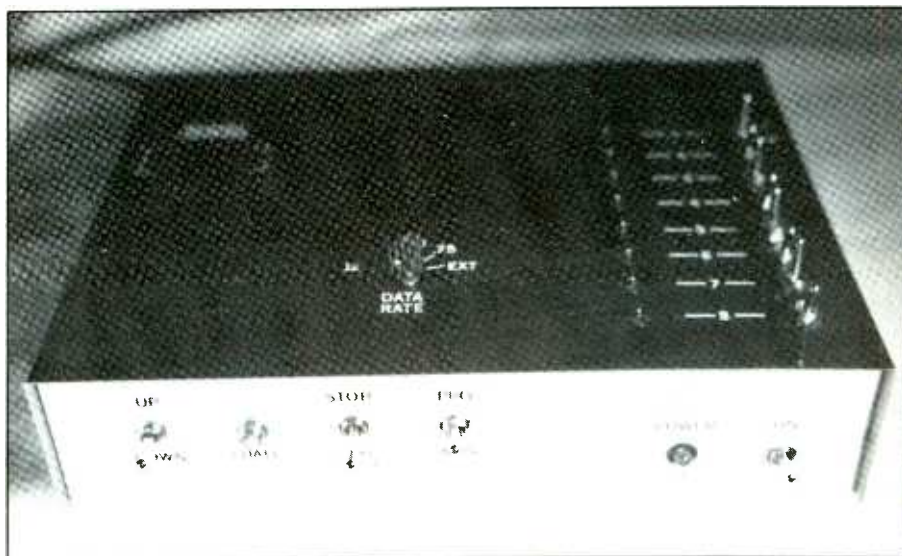

eight-line instrument. Though it costs you less than \$50 in components to build, the Pattern 8 offers virtually all the performance features and versatility of commercial models costing several times more than your component cost. It also offers easy-to-use programming functions so that users who have only minimal technical experience can use it effectively.

About the Circuit

The Pattern 8 Generator is simply a controlled memory device that can be manually programmed in step-by-step fashion and then be automatically addressed by a variable clock frequency. A three-digit, seven-segment LED display system reads out the memory address the data is to be written into or read from. Eight discrete LEDs show the data present at

each address. Programming is via eight switches, and loading is via a LOAD switch. If you wish to program a repetitive waveform, a STOP switch lets you set the Pattern 8 to loop from 000 to the address location set by the eight toggle-type programming switches. This allows you to program only a portion of memory while providing continuous data flow.

Shown in Fig. 1 is the complete schematic diagram (minus ac power supply) of the Pattern 8 Generator. All action begins with IC1, a set/reset latch that also debounces UP/DOWN switch S1. The output at pin 4 of IC1 controls the direction in which IC6 and IC7 count when switch S2A is set to PROGRAM. If both inputs to AND gate IC2 (pins 1 and 2) are high, the output from the gate, at pin 3, will also be high. If either input goes low, the output will

PARTS LIST

Semiconductors

D1 thru D4—1N4001 rectifier diode
 IC1—74LS279 quad SR latch
 IC2—74LS08 quad AND gate
 IC3—74S124 dual multivibrator
 IC4—74LS04 hex inverter
 IC5—74LS32 quad OR gate
 IC6, IC7, IC14—74LS191 up/down counter
 IC8, IC9, IC10—75LS185 binary-to-BCD converter
 IC11, IC12, IC13—TIL311 decoder/driver/display
 IC15—12-MHz integrated crystal oscillator (Vectron)
 IC16—74LS374 octal latch
 IC17, IC18—2114 1K × 4-bit RAM
 IC19, IC20—74LS244 tri-state octal buffer
 IC21—LM109 +5-volt regulator in TO-3 case
 LED1 thru LED9—Red panel-mount light-emitting diode

Capacitors (all 16-volt)

C1—22- μ F electrolytic
 C2—8,000- μ F electrolytic
 C3—10- μ F electrolytic
 C4—1- μ F electrolytic

Resistors (all 1/4-watt, 5% tolerance)

R1 thru R24—2,000 ohms

Switches

S1—Spdt momentary toggle switch with center-off
 S2—Dpdt toggle
 S3, S6 thru S14—Spdt toggle
 S4—6-position nonshorting rotary
 S5—Spst normally-open pushbutton switch

Miscellaneous

F1—0.5-ampere slow-blow fuse
 T1—6.3 volt, 3-ampere transformer
 Perforated board and suitable soldering or Wire Wrap hardware or printed-circuit board (see text); suitable enclosure (see text); sockets for IC1 through IC20; heat sink for IC21; panel-mount bayonet-type fuse holder or chassis-mount fuse block (see text); pointer-type knob for S4; ac line cord with plug; small rubber grommet; lettering kit; plastic lens for displays; cement for filter; small-diameter heat-shrinkable tubing; clear spray acrylic; 1/2" spacers for mounting circuit board; machine hardware; hookup wire; solder, etc.

also go low. When this occurs, IC3 is enabled and begins clocking when either the UP or the DOWN count mode is selected with center-off switch S1.

Fed to the pin 3 input of IC4, the clock signal emerges inverted at pin 4 of this IC to provide proper OR logic for the pin 2 input of IC5. The pin 3 output from IC5 provides IC6 and IC7 with a 1-Hz clock signal. The pin 2 input to IC5 is used to clock IC6 and IC7 when S2 is set to RUN, incrementing or decrementing the counters at the clock frequency determined by the setting of DATA RATE switch S4.

Since IC6 and IC7 are binary counters, their outputs must be converted to the BCD format required by IC11, IC12 and IC13. This task is accomplished by binary-to-BCD converters IC8, IC9 and IC10. Contained within each of the IC11, IC12 and IC13 devices are all the circuitry needed to decode the BCD input and

drive the on-board dot-matrix LED numeric seven-segment displays. Use of the TIL311 devices for the display portion of the system considerably simplifies the design and component count of the project.

An internal system oscillator is provided by IC15. The output from this integrated 12-MHz oscillator is divided four times by counter IC14 to provide selectable outputs at frequencies of 6, 3, 1.5 and 0.75 MHz. DATA RATE switch S4 provides the means for selecting any of these four frequencies, as well as the full 12 MHz directly from the output of IC15 and any other desired frequency of up to 20 MHz from an external source plugged into EXTERNAL CLOCK INPUT jack J9.

Eight-bit latch IC16 has tri-state outputs. The floating output is controlled by output control pin 1 of IC16. When the logic at this pin is low, the output is enabled so that data stored in the internal latch circuit

can be displayed. All that is needed to latch the data is a rising-edge clock pulse on pin 11 of IC16.

The inputs of IC16 are directly connected to the address bus, and the IC's output is connected to the preset inputs of the address counter. When a "stop" is programmed, counters IC6 and IC7 are preset to that same address and go to that address every time a carry output is generated by counter IC7.

A carry output occurs whenever the counter increments past 000. For example, if you set a stop in address 003 and S2 set to RUN, the address would count 3,2,1,0,3,2,1,0 and so on continuously until you defeat the RUN function.

Only one stop location can be programmed at a time. When NO STOP is selected with S3, the switch ties pin 1 of IC16 high, causing this IC's output to float. This allows the counters to "see" their inputs as all highs (which corresponds to a preset condition of 255) so that the entire contents of memory can be sequenced.

Static RAMs IC17 and IC18 are organized as 1,024 words of four bits each. The Pattern 8 Generator utilizes only 255 locations of this memory. However, with a simple modification, all 1,024 locations can be used. These RAMs have a common I/O (input/output) bus that inputs and outputs data, depending on the level of the R/W (read/write) line at pin 10.

LOAD switch S5 both writes data into RAM memory and at the same time outputs data from eight-bit tri-state latch IC19 and enables the pin 1 output control line of this IC. Data to be programmed into memory is set up with switches S6 through S13. Tri-state octal buffer IC20 drives the LED1 through LED8 status display for all eight data lines.

An ac power supply for the Pattern 8 Generator is shown schematically in Fig. 2. This is a simple full-wave bridge rectifier circuit followed by hefty capacitor filtering and tight voltage regulation by IC21. Power-

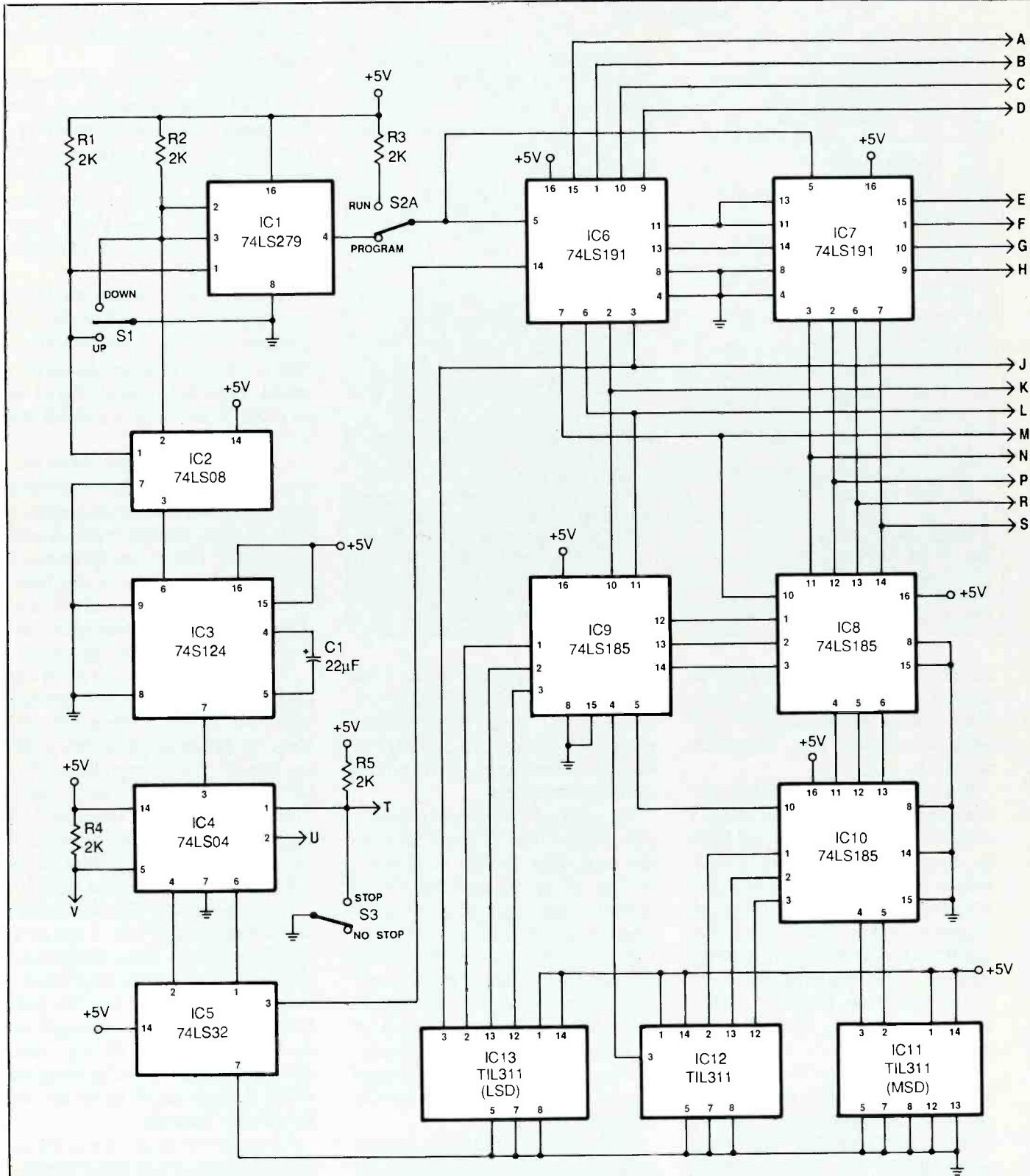

Fig. 1. Overall schematic diagram of the digital portion of the Pattern 8 Generator.

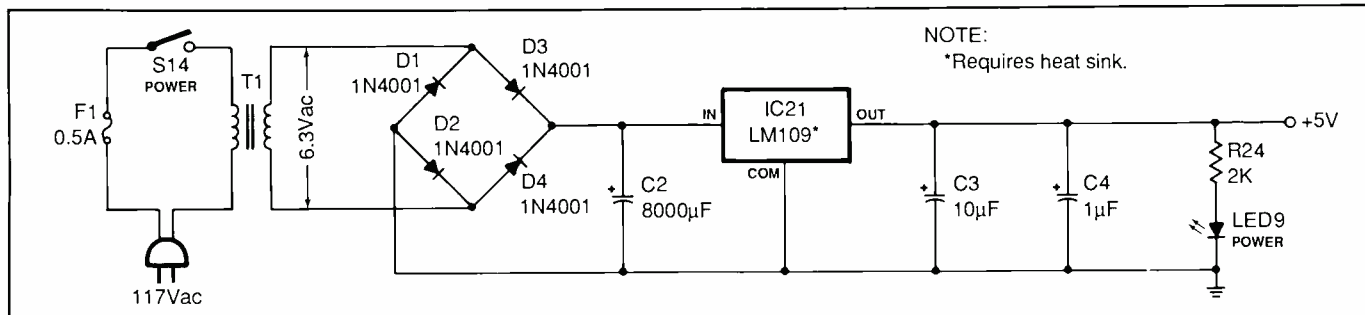

Fig. 2. The Pattern 8's ac power supply.

on indication is provided by *LED9*, whose current is limited to a safe level by resistor *R24*.

Construction

Assembly of the digital section in the Pattern 8 Generator can be done on standard perforated board with holes on 0.1" centers and suitable soldering or Wire Wrap hardware and point-to-point wiring. A typical example of the Wire Wrap method of construction is illustrated in the Fig. 3 photo of the assembled prototype of the project. If you make the board large enough, you can also mount

the rectifier diodes, filter capacitors and voltage regulator for the power supply on the same board as the rest of the circuit, as shown. If you prefer, you can design and fabricate a printed-circuit board on which to mount the components that make up the project.

Whichever method of construction you choose, use sockets for all integrated circuits. The only exception to this is *IC21*, which must be used with a finned heat sink to protect it from thermal damage. The heat sink is required because this three-terminal voltage regulator draws more than 650 mA and has a

drop of 2.5 volts dc. This means that more than 1.5 watts must be dissipated by the heat sink. Keep in mind, too, that adequate vent holes must be drilled in the enclosure to allow any heat that builds up as the project is operating to escape.

When you physically mount the components into place on the circuit board, install only the IC sockets—*not* the ICs themselves—during the wiring phase. The ICs will be installed in their respective sockets only after you perform the voltage checks after the project has been fully wired.

For the most compact layout of the circuit, it is a good idea to follow the one shown in Fig. 3. Note in this photo the locations of LED display/driver/decoders *IC11*, *IC12* and *IC13*. Arrange the layout so that these three devices are side by side with the most-significant digit (MSD) on the left and the least-significant digit (LSD) on the right.

The only critical component locations are those for *IC14* and *IC15*. Power supply decoupling is critical in this high-frequency portion of the circuit.

As you interconnect the various components of this fairly complex circuit according to Figs. 1 and 2, make sure you do not make any wiring errors. One way to prevent this from happening is to mark off each wire run as you make it on a photocopy of the schematics. Make only one wire run at a time to avoid confusion. When you finish wiring the circuit (remember, do not install the

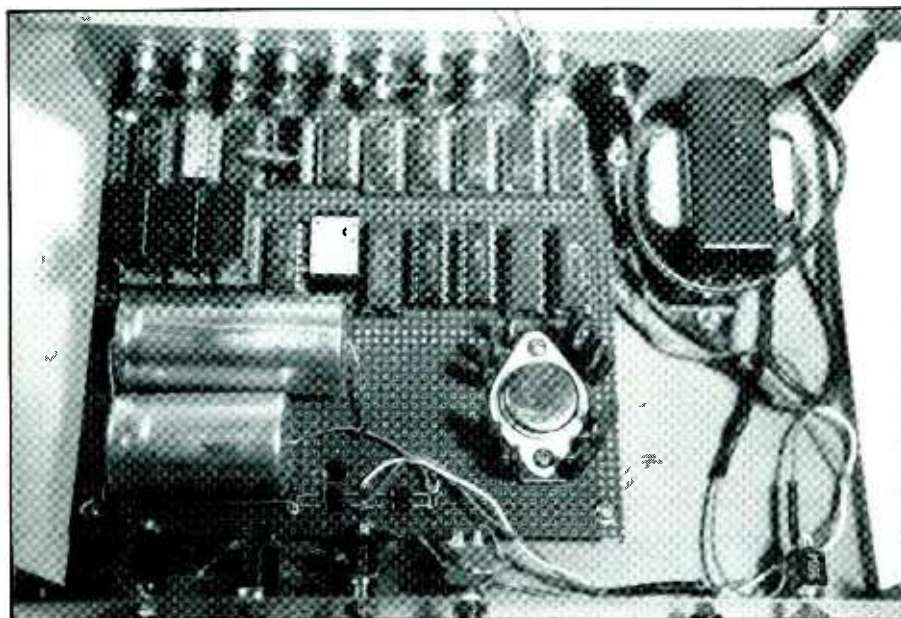

Fig. 3. Typical Wire Wrap circuit layout for the Pattern 8. Note the use of sockets for all DIP ICs and insulating heat-shrinkable tubing on wire connections.

Crack The Code

TRI-MODE CABLE TV DESCRAMBLER PARTS

We stock the exact parts, PC board and AC adaptor for *Radio Electronics* February 1987 article on building your own TRI-MODE CABLE TV DESCRAMBLER.

#301 PARTS PACKAGE \$39.⁹⁵

Includes all the original resistors, capacitors, diodes, potentiometers, transistors, integrated circuits, LED's, Toko coil (E520HN-3000023) and Plessey SAW filter (SY323).

#302 PC BOARD \$12.⁹⁵

Original 5 X 8.8 etched & drilled silk-screen PC board used in article.

#304 AC ADAPTOR \$12.⁹⁵

Original (14 to 18 volt DC @ 200ma) AC adaptor used in article.

SPECIALS

Add \$2.50 shipping & handling — \$4.50 for Canadian orders. We also offer quantity discounts on 5 or more units.

BOTH #301 and #302 \$49.⁰⁰

ALL THREE #301, #302, and #304 \$59.⁰⁰

FREE

Reprint of *Radio Electronics* Article (February 1987) on building your own TRI-MODE CABLE TV DESCRAMBLER.

60-CHANNEL CABLE CONVERTER \$69.⁹⁵ SC-60R CONVERTER

WITH INFRARED REMOTE CONTROL

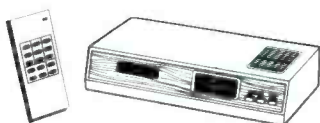

Add \$3.50 Shipping and Handling
\$4.50 on Canadian Orders

Thousands of these converters sold nationally for \$119.95. We offer you this same type of converter for only \$69.95. All converters are NEW, with Full manufacturer's WARRANTY.

FEATURES:

- Full 60 Channel Capability
- Cordless Infrared remote control
- Ultra-Stable Synthesized tuning
- Microprocessor controlled PLL
- Works on all TV models. Specify channel 3 or channel 2 output.
- Standard/HRC Switch for compatibility with all Cable Systems
- Will work with all types of external descramblers

ORDER TOLL FREE
1-800-227-8529

Inside MA: 617-695-8699
VISA, MASTERCARD OR C.O.D.



Not available to Massachusetts residents due to state law.

J & W
ELECTRONICS, INC.

P.O. BOX 800 • MANSFIELD, MA 02048

© Copyright 1986 by J & W Electronics, Inc.

CIRCLE 65 ON FREE INFORMATION CARD

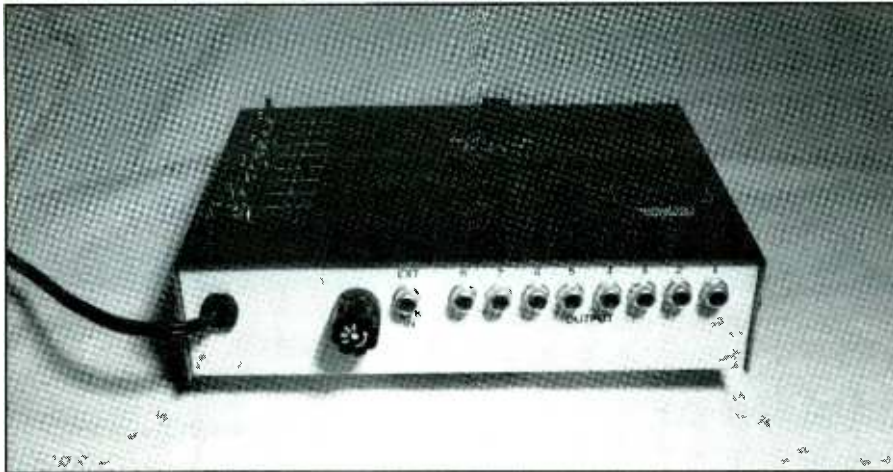

Fig. 4. All input and output jacks mount on the rear panel project.

ICs themselves yet), double-check your work, again marking off each interconnection as you go, this time with a different color pen or pencil.

Select an enclosure that is large enough to comfortably accommodate the circuit board assembly and the power transformer and has ample area on the front and rear panels in which to mount the various switches, jacks and fuse holder without crowding. An example of a suitable metal enclosure for this project is shown in the lead photo. The one chosen for the prototype is made up of two U-shaped metal sheets and came painted with contrasting colors for the top and bottom halves. By using this or a similar enclosure, you avoid having to paint it.

Machine the bottom half of the enclosure for the machine hardware that will secure the power transformer and circuit board assembly to the floor. Drill the mounting holes for the eight OUTPUT and one EXTERNAL CLOCK INPUT jacks and the fuse holder and the entry hole for the ac line cord in the rear panel. (Note: If you prefer, you can substitute a less-expensive chassis-mount fuse block for the panel-mount bayonet-type fuse holder. If you do make this substitution, only a $\frac{1}{8}$ " hole for mounting the fuse block is required.) Rear-panel layout details are shown in

Fig. 4. Now drill mounting holes in the front panel for the POWER switch and LED and the UP/DOWN, LOAD, STOP/NO STOP and PROGRAM/RUN switches (see lead photo for layout details).

Temporarily mount the circuit-board assembly in the enclosure and determine exactly where and how large a window is needed (make it about $\frac{1}{4}$ " larger all around than the

actual measurement) to make the IC11, IC12 and IC13 LED displays visible. Draw the outline of this window in the appropriate location on the top half of the enclosure. Then use a nibbling tool to cut the window. If you do not have a nibbler, drill as many interconnected holes as needed to remove the bulk of the unwanted metal and square up the window with a file.

Referring back to the lead photo, drill the holes for mounting the eight status LEDs and programming switches in two matched columns along the right side and the hole for mounting the rotary-type DATA RATE switch in the top half of the enclosure. Make sure that none of these components will interfere with or otherwise contact any part of the internal circuitry, except as needed via normal interconnect wiring.

When all machining has been completed, deburr all holes and test the components for proper fit. When everything fits as it should, remove the circuit-board assembly and use a dry-transfer lettering kit to label ap-

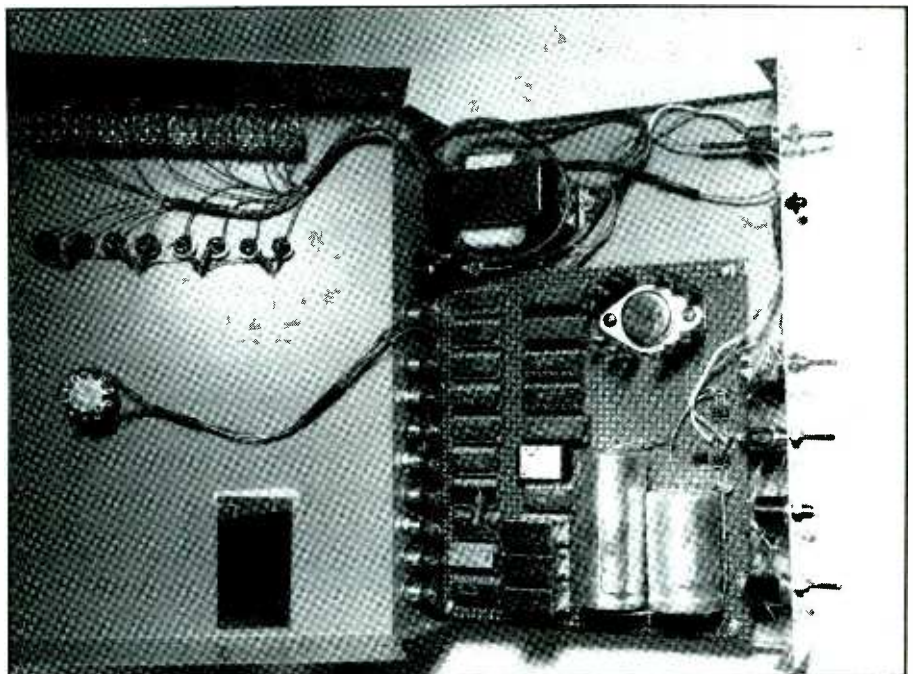
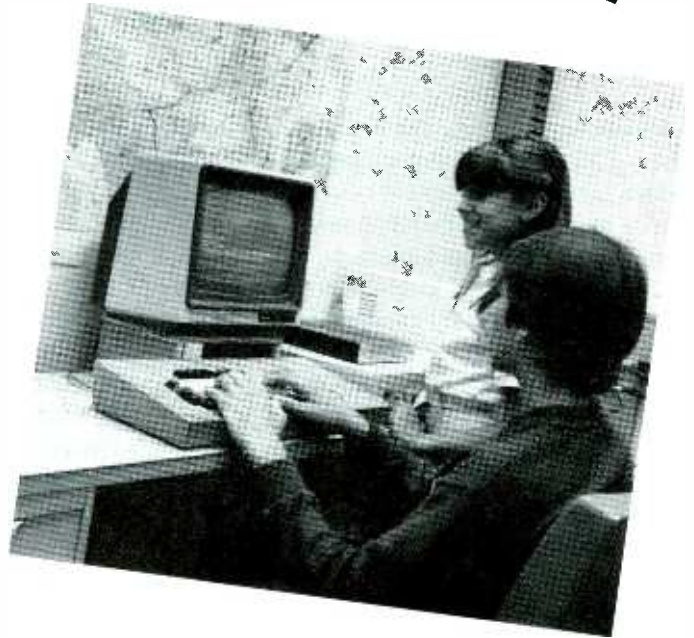

Fig. 5. Typical example of wiring between the main circuit and the switches and LEDs mounted on top panel of project's enclosure.

HAM RADIO

JUST BECAME MORE FUN!



Beginners get new privileges

Hams who have passed the beginner's (Novice class) exam are no longer limited to using only Morse code. They are now allowed to operate on certain frequencies using voice, and they may also link their home computers through packet radio networks. Just think of all the fun you'll be able to have talking to other hams all over the world when conditions permit. Then you can switch to a repeater for local coverage, perhaps using a handheld transceiver. The key to passing the Novice class exam is *Tune In The World With Ham Radio*. This kit contains a book with over 200 pages that tell in easy to understand bite-sized chunks all about the FCC regulations and electronics you need to know. The cassette code practice material makes that part of the exam a snap! The book alone is only \$8. The complete kit is \$10. Please include \$2.50 (\$3.50 for UPS) for shipping and handling. For more information and a list of local radio clubs that can help you get your license, just fill out the reader service card in this magazine.



THE AMERICAN RADIO RELAY LEAGUE, INC.
225 MAIN STREET
NEWINGTON, CT 06111

CIRCLE 14 ON FREE INFORMATION CARD

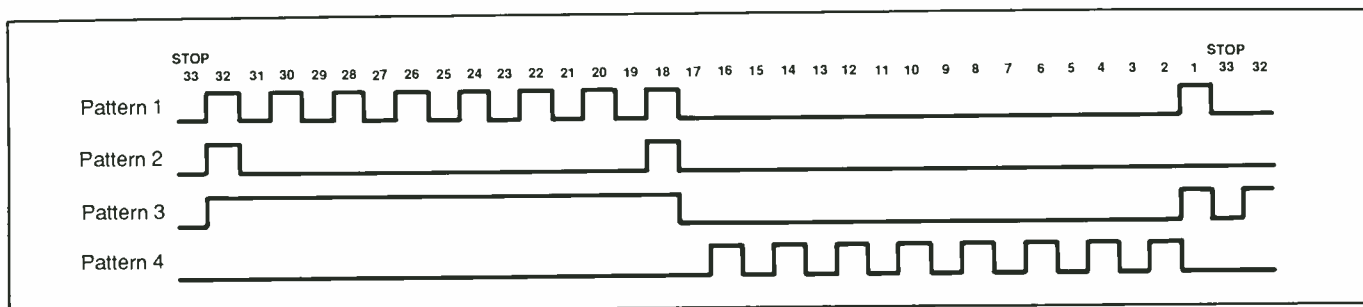

Fig. 6. An example of a sketch of the pattern to be programmed into project.

appropriate legends near the switches, jacks, LEDs and numeric display. Before labeling its positions, temporarily mount the DATA RATE switch (properly oriented) and place on its shaft a pointer-type knob. Rotate the knob to each of its positions and mark each stop location as well as the location for the legend. Remove the knob and switch and set them aside as you label the positions and switch identifier. When all lettering is done, spray two or three light coats of clear acrylic over it to protect it from scratching. (If you use a tape labeler, you can apply the legends after all components have been mounted in place and omit spraying on the clear acrylic.)

Cut a thin red plastic filter to a rectangular shape about $\frac{1}{2}$ " larger in length and width than the dimensions of the display window. Smooth the edges with a file or fine sandpaper and use plastic or fast-set epoxy cement to secure this lens to the inside surface of the enclosure symmetrically over the display window cutout.

Mount the power transformer, switches, LEDs, jacks, and bayonet fuse holder or fuse block in their respective locations. Line the ac power cord hole with a rubber grommet and pass the free end of the cord through it into the enclosure. Tightly twist together the fine wires in each conductor and sparingly tin with solder. Tie a knot in the cord about 5" to 8", depending on the size of the enclosure selected, from the prepared end to

serve as a strain relief. Then referring back to Figs. 1 and 2, finish wiring the circuit.

Before connecting any wires to the lugs of the POWER switch and the leads of the LEDs and power transformer, slide a 1" length of small-diameter heat-shrinkable tubing over the interconnecting wire. Make each connection, solder it and then slide the tubing over the exposed wiring and shrink it into place to assure that no short circuits will develop. Figure 5 is a photo of the wiring details for the LEDs and programming switches mounted on the top panel of the enclosure.

When you have finished all wiring, gather the wires into neat bundles, as shown in the photos, and use plastic cable ties or waxed lacing cord to keep things neat.

Checkout and Use

After the project is fully wired and *before* the ICs have been installed in their sockets, plug the line cord into an ac outlet. Set the POWER switch to on; the POWER LED should light. Now, set your dc voltmeter or multimeter (set to dc volts) to a range for convenient indication of about 5 volts. Connect the meter's ground or common lead to circuit ground and touch the positive probe to the +V IC socket pins. See Fig. 1 for the pins at which +V should appear. For 14-, 16- and 18-pin ICs, +V is normally at pins 14, 16 and 18, respectively.

If you do not obtain a +5-volt reading in all cases, check the output

terminal of the voltage regulator in the power supply. In any event, do not plug the ICs into the sockets until you do obtain the proper readings. Only after you obtain the proper readings should you proceed to installing the ICs in their respective sockets. Make sure that you install the ICs in the correct sockets and that each is properly oriented. In addition, take care to prevent any pins from folding under the bodies of the ICs or overhanging the sockets.

To properly use the Pattern 8 Generator, you need a schematic diagram of the circuit or equipment to be tested. Before using the Pattern 8 Generator, you must decide on the number of patterns you wish to program and their data formats. Not all eight outputs will be needed for all test purposes. Therefore, it is wise to think ahead about any alterations in the patterns you might need, and program those at the same time. Also, if stop functions are to be used, you can expand your different patterns to a number greater than the eight basic patterns the project offers.

After sketching the actual patterns you want to program (a typical example of such a sketch is illustrated in Fig. 6), determine if the clock frequency is correct. Remember, if the slowest clock frequency is twice as fast as needed, all you need do is program double bits. This allows only 128 equal-pattern spaces, but it does serve as a versatile option. Also, an external signal source of up to 20

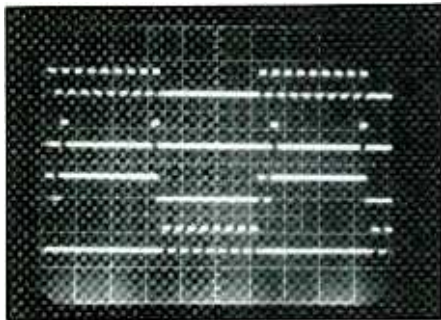

Fig. 7. Real-time photo of actual patterns generated by Pattern 8 after programming has been completed.

MHz can be used simply by plugging it into the EXTERNAL CLOCK INPUT jack. Make sure, however, to keep this external clock's signal amplitude at +5 volts or less.

As you examine Fig. 6, note above each bit location the number that represents the memory address that is to be programmed. When the Pattern 8 Generator is set to the RUN mode, the counter decrements (counts down—not up) in order to be able to utilize the stop-bit function. This simply means that you must program the last bit first and the stop bit last. Figure 7 is a real-time photo of the actual patterns generated by the Pattern 8 Generator after programming has been completed.

Applications

A pattern generator is extremely useful in many different applications. It provides an input stimulus for a digital electronic circuit. At a product verification station, for example, a

manufacturer might be required to test a particular product, such as a computer memory expansion board, before shipping it to his customers. By programming the pattern generator with the proper digital information, the memory board can be fully tested at every level. Using just a few external monitoring devices, the entire memory and interface circuitry can be verified and qualified. With the pattern generator, it is even possible to test the memory board under specific environmental conditions.

Figure 8 illustrates how a large block of memory can be tested with a pattern generator like the Pattern 8 for speed and memory storage. Using a pattern generator, the 6-bit address can be programmed to select any portion or block of memory under test. Data written into memory should be consistent with the requirements of the circuit, such as a stream of alternating 1s and 0s in our memory expansion board example.

Another example of a practical application for the Pattern 8 Generator would be in the testing of an electronic digital interface card that requires a series of synchronized events. As an example, most personal computers have an I/O port that can be used for many functions, such as remote monitoring of other equipment or control of that equipment. The I/O port can be controlled by a program contained in system ROM or on a disk.

If a problem causes the I/O port to malfunction, it may become very dif-

ficult to pinpoint the problem. By programming the Pattern 8 Generator with the proper signals, the I/O card will let you quickly and efficiently verify port operation. If you determine that the problem is one or more waveforms that are not being provided by the software, only a minor change in programming may solve the problem. Otherwise, you can plan on spending a lot of time coordinating software and hardware.

You can use the Pattern 8 Generator to speed troubleshooting in high-speed communications in which immense amounts of digital information is sent and received in RS-232, 1553 Manchester, ARINC 429, and IEEE formats, to name just a few. When different formats like these are used, you sometimes need a very versatile exercise machine to sort things out. By programming the Pattern 8 Generator in any combination of eight channels to drive the circuit you can convert the digital information into the proper format, such as RS-232 into single-ended TTL level using a single chip.

If you are a personal computer user, chances are that you have had printer troubles, such as garbled copy or a dense line of black indicating carriage return failure more than once during the printing operation. If so, you probably spent hours tracking down the cause and rectifying the problem. With the Pattern 8 Generator, you could have had the system up and running in short order. By knowing the RS-232 code for the instruction you are testing, you can program the Pattern 8 Generator to do all the sleuthing.

The above are only a few of the very many applications to which the Pattern 8 Generator is suited. As you become familiar with the operation of this versatile test instrument and learn how versatile a troubleshooting partner it is, you will find yourself reaching for the Pattern 8 almost as frequently as you do for your logic probe.

ME

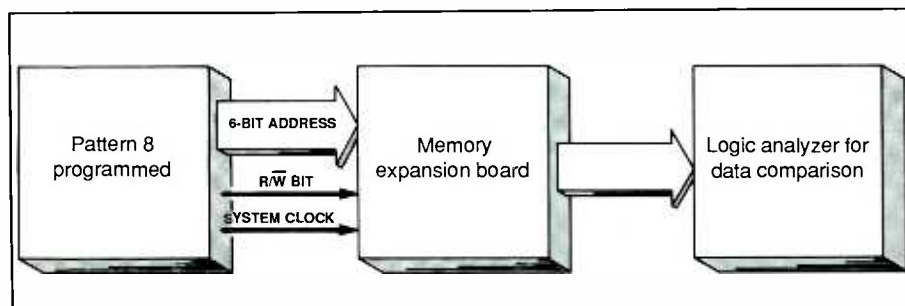

Fig. 8. Block diagram of a typical test setup for a computer memory expansion board using the Pattern 8 Generator and a logic analyzer.

The "PC Express"

Upgrading a 4.77-MHz IBM PC, XT or clone computer to a blazing 8 MHz

Crady M. VanPawlak

If you have an older IBM PC or XT or a true compatible computer, you've probably wished it operated faster. There are a number of ways you can boost the speed of an existing computer. For example, to obtain a modest increase in speed, you can replace the 8088 microprocessor with the \$20 or so NEC V20 or add the "\$30 Accelerator Kit" featured in the February 1987 issue of *Modern Electronics* . . . or both. You can also drop in a "turbo" card with an 80286 processor on it to really boost operating speed, but the penalty is high cost, which can range from \$400 to \$1,000 or more, depending on where you shop and the features you want.

If a big increase in operating speed is your aim, the cost of a turbo accelerator board might not seem like much when compared with what it

would cost to trade up to a newer, faster computer. However, there's a much less expensive approach you should consider: modify your present computer instead of plugging in a costly "turbo" board. The trick is to make your modifications without sacrificing compatibility and the ability to format disks and do a DISKCOPY without having to turn off your computer, flip a switch and reboot. The 8-MHz "PC Express" modification to be described provides the foregoing advantages.

My PC Express modification was performed on an XT clone built around an economy 4.77-MHz import motherboard. With my modified computer, I can run AutoCAD, Microsoft "Windows," Turbo Pascal and numerous utilities using an EGA board and monitor, a hard-disk system and a mouse—all running at a blazing (by comparison to 4.77 MHz) 8 MHz. I don't have to

change speed to format a disk or do a DISKCOPY, either.

To make the modification that will turn an existing 4.77-MHz PC or clone computer into a blistering performer, you need about \$80 in components (more if you have to upgrade your present RAMs to faster units), some electronics know-how (basically soldering) and the fortitude to dig into your computer.

Getting Started

The PC Express modification consists of three simple subassemblies and replacement of key integrated circuits. First, you must take inventory of what your computer already has in the way of chips. If your RAM chips are rated at anything slower than 150 nanoseconds, you must replace them with 150-nanosecond or faster chips. For example, if your present RAMs are 3764-250 devices, you must remove them and replace

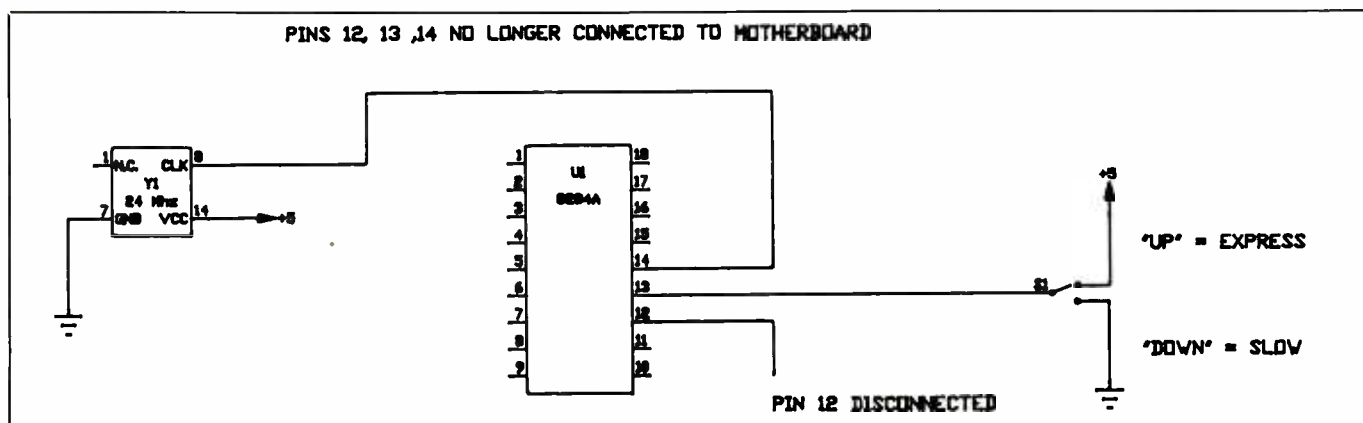

Fig. 1. Schematic of clock generator modification.

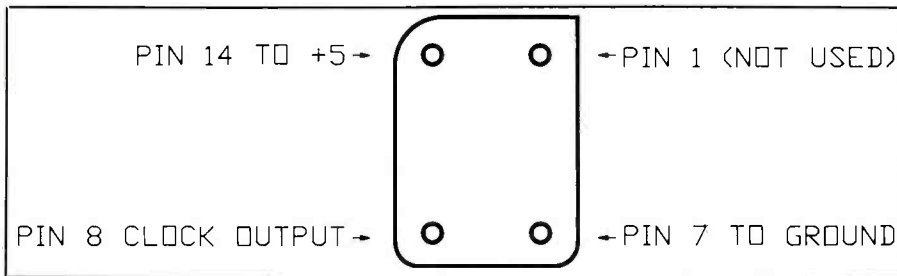

Fig. 2. Bottom-view pinouts for Fox integrated oscillator modules.

PARTS LIST

- 24-MHz integrated oscillator module (Fox or equivalent)
- 14.31818-MHz integrated oscillator module (Fox or equivalent)
- 4.9- or 5.0688-MHz integrated oscillator module—see text (Fox or equivalent)
- 18-pin IC socket with solder-tail pins
- 40-pin IC socket with solder-tail pins
- Spdt toggle or slide switch

Miscellaneous—22-gauge hookup wire for switch connections; 26- to 28-gauge Wire Wrap wire for all other wiring; silicone adhesive; solder; etc.

Note: One source for the 8-MHz NEC V20 and 82XX chips required to make the modifications described in this article is: IEC/Integrated Circuits Corp., 1750 12 Ave. NE, Bellevue, WA 98005 (1-800-562-1477 or 206-455-2727). One source for Fox oscillators is Active Electronics, P.O. Box 9100, Westborough, MA 01581 (617-366-9684 or 206-881-8191).

the vacated sockets with 3764-15 RAMs. You must also replace all 82XX-5 chips on the motherboard with the 8-MHz 87XX-2 versions (see Table). If you don't do this, I/O will cease to exist.

Most important, you must replace the existing 8088-5 microprocessor with the 8-MHz NEC V20 processor. There's a penalty involved if you've added an 8087-5 math coprocessor, however. It will, sadly, have to go or be replaced by an 8-MHz 8087-2 version at a cost of \$160 or more. On the positive side, though, you might find a buyer for your 8087-5 coprocessor at a user's group to offset some of the cost of a new 8087-2.

The first subassembly you must add to your computer is a clock-select circuit, shown schematically in Fig. 1. All you need for this subassembly are a miniature spdt switch, an 18-pin IC socket with solder-tail pins for the 8284 clock generator, a

24-MHz Fox TTL oscillator or equivalent and some wire to make the interconnections.

Locate a suitable mounting place for the speed-change switch. An unused expansion-slot cover plate is a good choice, or you can mount the switch on the computer's enclosure where it will be easily reachable but out of the way of the internal circuitry. Bend outward pin 13 of the 18-pin socket and connect and solder a wire from it to the center lug on the switch. Make this wire long enough to route from the switch to the socket when it is installed on the computer's motherboard where the 8284 is now plugged in. (Pin 13 is the 8284's clock-select pin.) Now bend outward pins 12 and 14 of the socket (the oscillator and external-frequency pins, respectively, of the 8284).

Positively identify pins 7, 8 and 14 of the 24-MHz oscillator module (see Fig. 2). Use a small daub of silicone adhesive—not epoxy or other hard-set cement—to secure the oscillator module to the motherboard as near as possible to the 8284. Secure the package so that its pins point upward, and make sure that the location in which the module is cemented doesn't interfere with any expansion cards in the computer and that its metal case doesn't come into electrical contact with any portion of the circuit or the computer's chassis.

Now locate a source of +5 volts and ground inside the computer near where the oscillator is mounted. You might try pin 14 (+5 volts) and pin 7 (ground) of a nearby 74LS00 chip. Connect and solder short lengths of wire from the +5-volt point selected to pin 14 of the oscillator module and from the same +5-volt point to one of the outer lugs of the speed-change switch you previously mounted to create the EXPRESS position. Connect and solder another wire from pin 7 of the oscillator module to the selected ground point and from ground to the other outer lug of the

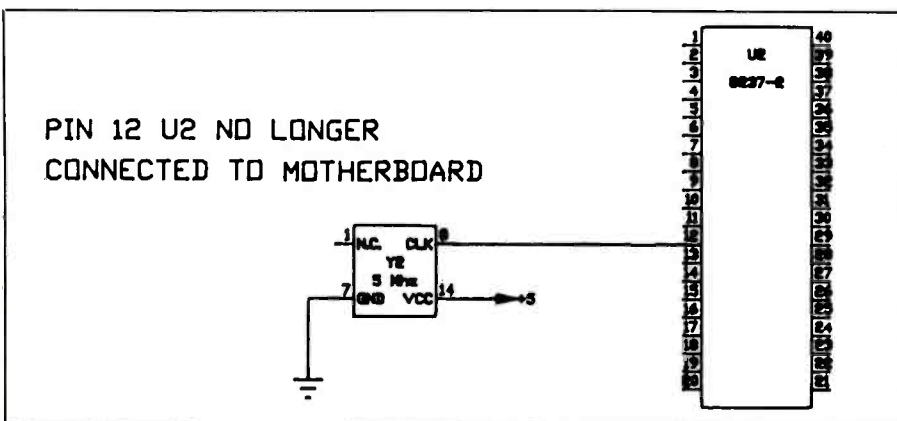

Fig. 3. Drawing identifies foil "finger" that goes to pin 30B on computer's bus.

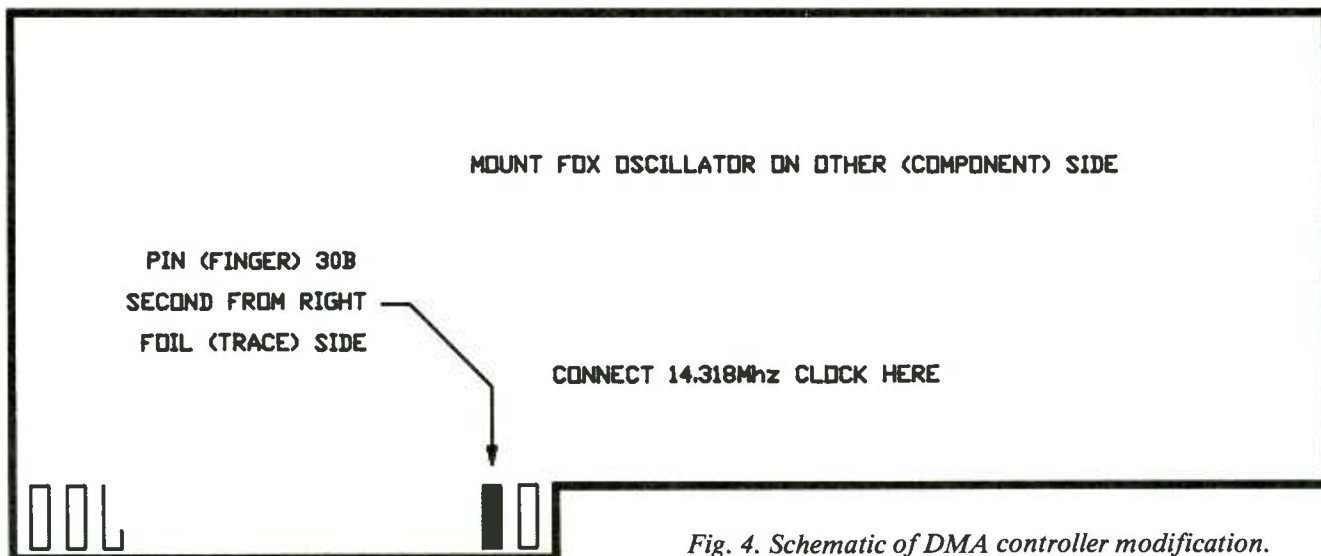

Fig. 4. Schematic of DMA controller modification.

switch to create the SLOW position. Finally, connect and solder a wire from pin 8 of the oscillator to pin 14 of the 18-pin socket.

Carefully remove the 8284 from its socket on the motherboard in the computer and plug the modified 18-pin IC socket into the socket just vacated. Make sure that the pins of both sockets are correctly matched (1 to 1, 2 to 2 and so on through 18 to 18) and that none of the pins that are bent outward make electrical contact with the original 8284 socket. Then plug the 8284 into the modified socket (observe the same orientation as before removal). This completes the first subassembly.

Dealing With Color

If you now use color or plan to do so in the future, you must provide a 14.31818-MHz clock signal at pin 30B of the expansion bus (see Fig. 3). This task was originally handled by pin 12 of the 8284. However, because of the dual-clock capability of the modified circuit, you must now provide what the 8284 no longer can. A simple way to accomplish this is with another Fox or similar modular os-

illator, this one operating at a frequency of 14.318 MHz (see Fig. 4).

As before, use silicone adhesive to secure the 14.318-MHz oscillator to either the floppy-disk controller or some other nearby expansion card. Use the component side of the board. Again, mount the module with the pins pointing up and make sure that it doesn't electrically contact any part of the circuitry.

Positively identify pins 7, 8 and 14 of the oscillator module, using Fig. 2 as a guide. Connect and solder a wire from pin 14 of the oscillator module to a source of +5V and from pin 7 of the module to circuit ground. To reach pin 30B of the car edge, you must route a wire from pin 8 of the oscillator module up and over the

top edge of the card and down the solder side and tack-solder it to the pin 30B card-edge "finger" shown in Fig. 3. Keep this wire as short as possible, and secure it to the card with a few small daubs of silicone adhesive along its run after soldering it to the appropriate points.

Dealing With DMA

So far, you've added a two-speed clock, updated your chips to their faster counterparts and corrected for your missing color clock. Now it's time to finish the PC Express conversion by making certain that the disk drives and other I/O devices aren't left mangling bits in the dust left by the faster microprocessor you've installed. To do this, you must install

8-MHz IC Replacements

Old IC Number	New 8-MHz Number	Device Type
8088-5	V20-8	Microprocessor
8255-5	8255-2	I/O Expander
8237-5	8237-2	DMA Controller
8253-5	8253-2	Interval Timer
8259-5	8259-2	Interrupt Controller

Change any old RAM devices that are slower than 150 nanoseconds

one last assembly, which is similar to that of the 8284, except that you will be modifying only one pin instead of the three in the former modification.

For this modification, you need a 4.9- or 5.0688-MHz Fox or similar integrated oscillator module, a 40-pin IC socket with solder-tail pins, an 8-MHz 8237-2 to replace the 4-MHz 8237-5 presently in your computer and some wire.

Your first step is to locate the 8237-5 DMA controller in your computer and remove it from its socket. Then bend outward pin 12 of the 40-pin socket. Connect and solder a 3" wire to this pin and then plug the modified socket into that vacated by the 8237-5. Make certain that the two sockets are oriented the same way and that pin 12 of the modified socket doesn't make electrical contact with pin 12 of the socket into which you are plugging it.

Use silicone adhesive to secure the oscillator module upside-down on the motherboard near the 8237's socket. Again, make sure that the case of the oscillator module doesn't electrically contact any portion of the circuit or chassis ground.

Connect and solder a wire from pin 14 of the oscillator (see Fig. 2 for pin identifications) to a convenient point in the motherboard circuit where +5 volts is always available with power turned on. Similarly, connect and solder a second wire from pin 7 of the oscillator module to a convenient ground point.

Locate the free end of the 3" wire you connected to pin 12 of the 40-pin socket. Connect and solder it to pin 8 of the 5-MHz oscillator module. Then carefully plug the new 8237-2 into the modified socket, making sure it's oriented the same as the device you previously removed from the motherboard socket.

Before going further, carefully check and recheck all your work. Do not attempt to power up the modified computer until you're certain

that everything has been done as it should. Check your work at least twice and, if possible, have a friend check it once again to be sure. Keep in mind that any errors in wiring can result in a ruined motherboard!

Operation

On boot-up, the first thing you'll notice is the higher-pitched "beep" that sounds for the BIOS before the drive is read. Also, if your BIOS counts off tested memory before booting up, it will do so noticeably faster. If you don't observe an obviously higher-pitched beep, or memory counting doesn't seem to be any faster than before you made the above modifications, the speed-selector switch is probably in the SLOW position. Try toggling to the alternate position of the switch and re-boot the computer.

When you're sure your system is operating at the faster 8-MHz speed, make a note of which position is which and label the switch accordingly. Then try formatting a diskette to test the DMA controller. If you have just booted up from a floppy disk and not a hard-disk drive, your DMA operation is okay.

If your system doesn't boot properly, you either have a wiring error or the ICs (RAMs and 82XX chips) aren't rated for 8 MHz. If you're concerned about other chips on the computer's motherboard not mentioned here, don't be; all 74XX-series logic chips, which make up the bulk of the ICs on the motherboard, can handle clocks operating well beyond 15 MHz.

Changing speed while running an applications program is *not* recommended. If you do change speed while a program is running, sometimes the turbocharging will work and everything will be okay. However, more often than not, data usually gets mutated into digital mush. So whenever you do want to change speed, leave whatever program

you're running, switch speed at the DOS prompt, and go back to work.

You may ask why go to the slower 4.77-MHz speed at all if the 8-MHz turbocharging works? The answer is simple: some older programs just won't work at the higher speed and others will work *too* fast. For example, if you play action games on your computer, you'll find trying to land a small airplane or maneuvering a tank away from descending attack satellites at the 8-MHz speed impossibly nerve-racking.

Beyond the speed problem with action games, the only other reason for having the 4.77-MHz speed is to put your mind at rest that should you encounter a program that doesn't run at the express speed, you can still run it at the more sedate speed. I have yet to come across such a program, but I'm sure it must be lurking out there somewhere.

You might be wondering if, with the PC Express upgrade, your computer is really operating any faster. You can judge for yourself by observing what happens from the time you boot up. You should notice that everything except disk I/O is much faster. Disk I/O times remain the same because the DMA runs at only 5 MHz. Hence, disk access speed is dependent solely upon the drive and its controller—not the computer's system clock.

If you plan on using Norton Utilities' "SI" to see just how fast your computer now is, forget it. It appears that because of some strange interaction with the V20 microprocessor, SI sends back a slower message in Express mode than in Slow mode on some machines. Running a benchmark on your own, however, should return something like 2.1 to 3.5 times faster operating speed in the faster mode than a standard PC does, depending on the applications software being run. (See Feb. 1987 *Modern Electronics* for SSE-V20 speed test program information.) **ME**

Unconventional Ultraminiature Circuits

By Forrest M. Mims III

Interconnecting surface-mountable components with conductive inks provides an amazingly versatile method of assembling miniaturized electronic circuits. Since a conventional circuit board is no longer required, it's now possible to build a circuit almost anywhere a suitable substrate can be found. For example, tiny circuits can be easily assembled on glass, wood, plastic and paper. Circuits can even be assembled directly on the holders for the batteries that power them.

Figure 1, for example, shows some of the miniature circuits I have assembled using surface-mountable components. Several of these circuits have been described in a previous article, but three of the circuits are unique in that they do not use a circuit board. Instead, one circuit is assembled directly on the surface of a paper business card. Two other circuits are assembled on the back side of miniature plastic battery holders.

Since conductive inks and adhesives provide an important yet simple method for assembling highly miniaturized circuits, I have spent a good deal of time evaluating samples and investigating their use. What follows is a brief description of conductive inks and adhesives and construction details for three projects made possible by conductive ink.

Conductive Inks & Adhesives

Conductive inks and adhesives consist of fine particles of gold, silver (pure or alloy), copper, nickel, carbon or graphite suspended in a base such as urethane, polyester, acrylic or epoxy. Gold- and silver-filled inks have the lowest resistance. For example, silver-filled epoxy ink may have a sheet resistivity of only 0.015 ohm/sq/mil. Silver-filled polyester ink may have a sheet resistivity of 0.5 ohm/sq/mil. Carbon-filled ink, which is considerably less expensive, may have a sheet resistivity of 100 ohms/sq/mil.

Printed-circuit board makers use silver-, copper-, and nickel-filled conductive inks to bridge hairline gaps in etched circuit traces and to form new traces on a previously etched board. Hybrid micro-circuit makers use conductive inks to

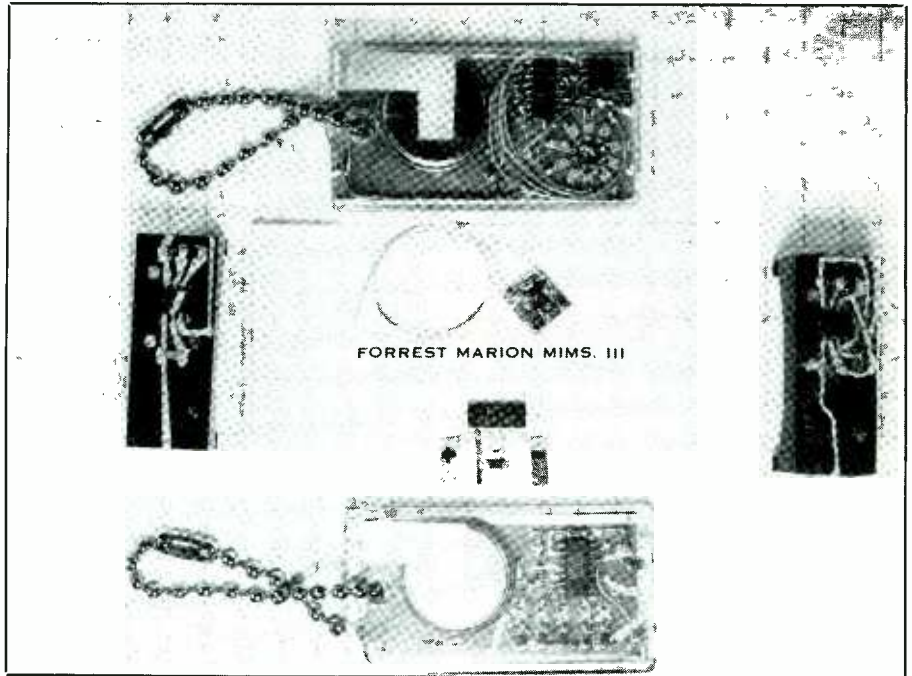

Fig. 1. Miniature surface-mount circuits.

form traces on ceramic substrates. The ink, usually silver- or gold-filled, is applied to the ceramic through a trace pattern formed on a fine-screen mesh. The inked ceramic is then fired in a furnace to fix the ink much like glaze is fixed on ceramic pottery.

Though many kinds of conductive inks are available, most are difficult to purchase in the very small quantities re-

quired for evaluation and experimentation. Nevertheless, some conductive inks are readily available in small quantities.

For example, automotive supply stores that stock NAPA parts may carry the Loctite Quick Grid™ Rear Window Defogger Repair Kit. This kit, which retails for about \$7.25, includes a tiny bottle containing 0.05 fluid ounce of copper-filled conductive ink. Though this ink

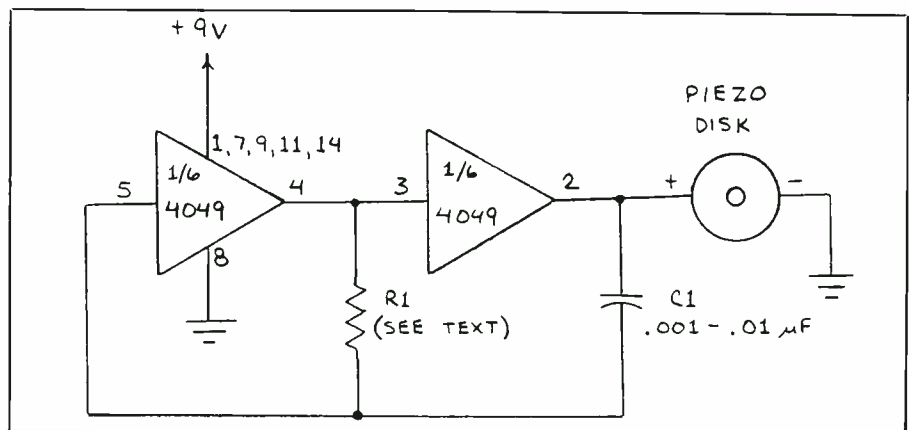

Fig. 2. Business-card tone generator.

has a higher resistance than silver inks, I used it to assemble two of the circuits described below.

Another good source of small quantities of conductive ink is GC Electronics. Their Silver Print (Cat. No. 22-201) retails for \$21.62 (0.5 troy ounce). GC's Nickel Print (Cat. No. 22-207) has a higher sheet resistance than Silver Print, but it's very inexpensive. A bottle containing 2 fluid ounces costs only \$3.83.

Dynaloy, Inc. is a major manufacturer of conductive inks, coatings and adhesives. Dynaloy sells an evaluation kit containing 50 grams each of three silver and silver-alloy epoxy adhesives. Dynaloy also sells an evaluation kit containing four 50-gram samples of either epoxy or polyester base silver inks. The price of each kit is \$100. For specification sheets and additional information about these kits, write the company at the address provided below.

Two subsidiaries of the W.R. Grace Co., Amicon Corp. and Emerson & Cuming, Inc., are major manufacturers of conductive inks, coatings and adhesives. Both companies make a wide range of silver-filled adhesives and inks. Emerson & Cuming also makes a carbon-filled ink. Write the companies for specification sheets and pricing.

The Hysol Division of The Dexter Corp., a major manufacturer of printed-circuit resists, makes silver-filled epoxy and acrylic conductive inks. I used the acrylic ink to assemble one of the circuits described below. Contact the company for specifications and pricing.

Several other companies also make conductive inks and adhesives. For additional information, consult trade directories and trade publications that emphasize hybrid microcircuits and surface-mountable components.

Conductive inks and adhesives have several drawbacks. Most of them contain solvents that pose a health hazard if not used in a well-ventilated location. Silver-based products are expensive. Most products have a relatively short life of a year or much less. For instance, Emerson & Cummings No. C-250 carbon ink and C-120 silver ink have maximum shelf lives of, respectively, 6 and 12 months. All such products must be stored in tight-

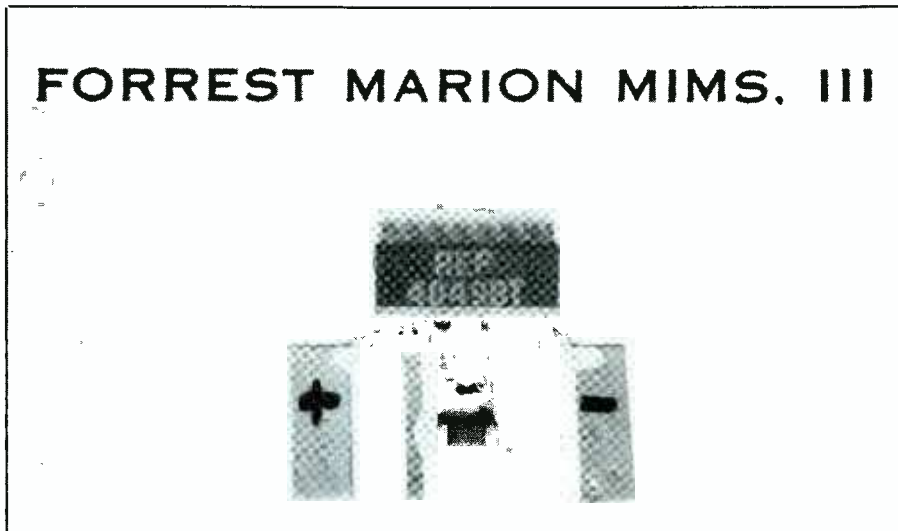

Fig. 3. Schematic diagram of the businesscard tone generator.

ly stoppered containers at room temperature or below. Because the particles tend to settle out during storage, the material must be stirred or shaken before use.

Using Conductive Inks and Adhesives

Conductive inks are usually applied to a substrate by screen printing. Conductive adhesives are applied by screen printing, automated machine application or with such hand dispensers as a syringe or squeezable plastic applicator.

Using conductive adhesive to bond surface-mountable components to copper traces etched on a board is very simple. Though a syringe or similar applicator is preferred, it's possible to apply small dots of adhesive with a toothpick. Alternatively, the leads or terminals of a component can be touched to a glass microscope slide to which a thin layer of adhesive has been applied. The component is then placed on the circuit board.

Forming conductive traces with conductive ink is best accomplished using a screen printer. However, this is hardly practical when only one or two versions of a circuit are needed. Therefore, I have experimented with several methods of hand-drawing conductive traces using both copper- and silver-filled inks.

The ideal dispenser for hand drawing conductive traces would resemble a conventional drawing pen. Thus far, however, I have been unable to locate such a pen. I have tried various drafting and drawing pens, but with poor success. That's because conductive inks are very viscous, resembling paint more than ink.

It's possible to dilute a conductive ink with a suitable solvent so that it can be used with a pen, and I intend to present details about this method in a future column. Meanwhile, a crude but effective method of drawing traces is to dip a toothpick into conductive ink and form traces from short line segments or connected dots. Though the traces will be uneven, this method permits the circuit pattern for a simple circuit to be drawn very rapidly.

Special-Purpose Applications

The construction projects that follow each use conductive inks in a rather unconventional manner. Though conductive inks are normally applied to conventional circuit-board substrates, they can also be applied to many other materials. Mylar, a particularly tough plastic, is an excellent flexible substrate for conductive ink. Paper, glass, wood, and many other materials can also be used as substrates.

It's even possible to apply conductive ink directly to the encapsulant that protects an integrated-circuit chip. In this fashion two or more terminals on a chip can be interconnected directly via paths on the upper and lower side of a chip without the need for traces on the circuit board. Indeed, small components such as chip resistors and capacitors can be attached directly to both surfaces of a standard DIP or a small outline (SO) surface-mountable integrated circuit using conductive ink or adhesive.

Business Card Tone Generator

The advent of musical greeting cards once convinced me that the experimenter could never build a circuit as compact. But soon after learning to work with surface-mountable components, I decided to go one step further.

The circuitry of the musical greeting cards I have examined is installed on a small board that is trapped or cemented inside the card. The battery holder, switch (two movable contacts) and piezoelectric sounder are also attached to the inside of the card.

My plan was to assemble a demonstration circuit without a board. Instead, the circuitry would be attached directly to paper. For the initial project, I decided on a simple tone generator based on two CMOS inverters. Figure 2 shows the circuit for the tone generator, and Fig. 3 is a photograph of the completed circuit assembled on a business card.

Many different conductive inks can be used to assemble this project. For best results, select an acrylic or lacquer based silver- or copper-filled ink. Since the Loctite Quick Grid™ Rear Window Defogger Repair Kit is readily available, I used its copper-filled ink for this project.

Begin assembly by interconnecting pins 1, 7, 9 and 11 on the back side of the 4049. I used a toothpick for a "pen." First, form a bar of conductive ink along the underside of the chip. Then place a small blob of ink below each indicated pin. Next, connect the ink under each pin with the bar. The entire procedure requires only a few minutes.

After the ink dries, attach the chip to

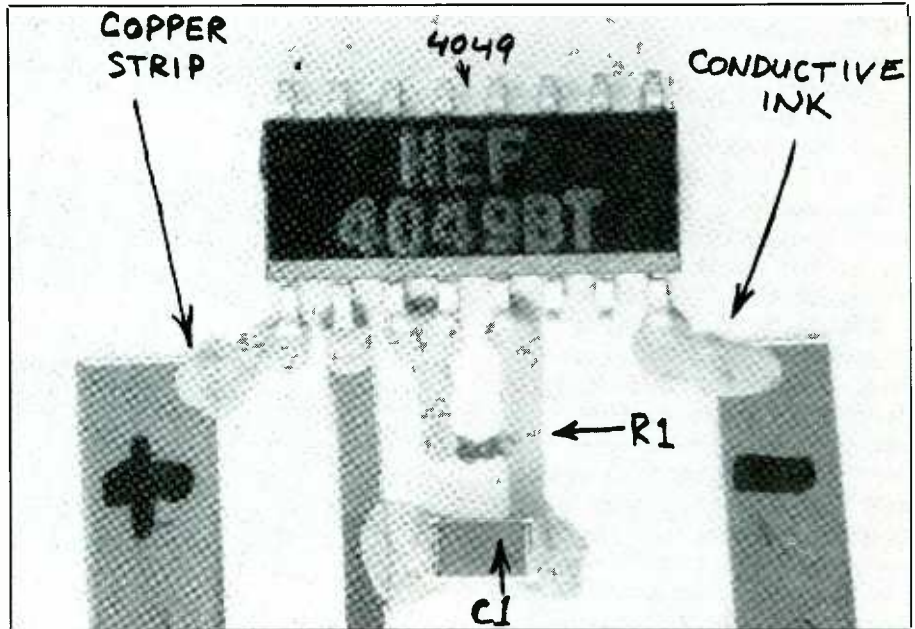

Fig. 4. Close-up of tone-generator circuitry.

the card with a small bit of reusable adhesive such as Plasti-Tak™, Fun-Tak™ or Stikki-Wax™. Next, cut some adhesive-backed copper foil (Datak No. CF-3 or similar) into thin strips and apply the strips to the card as shown in the close-up view of the circuit in Fig. 4. The outer two strips should be ½ inch apart to

match the terminal spacing on a 9-volt battery. Unless you plan to install the piezoelectric sounder disk on the same side of the card as the circuitry, all three strips shown in Fig. 4 should fold over to the opposite side of the card as illustrated in Fig. 5.

After the copper strips are in place,

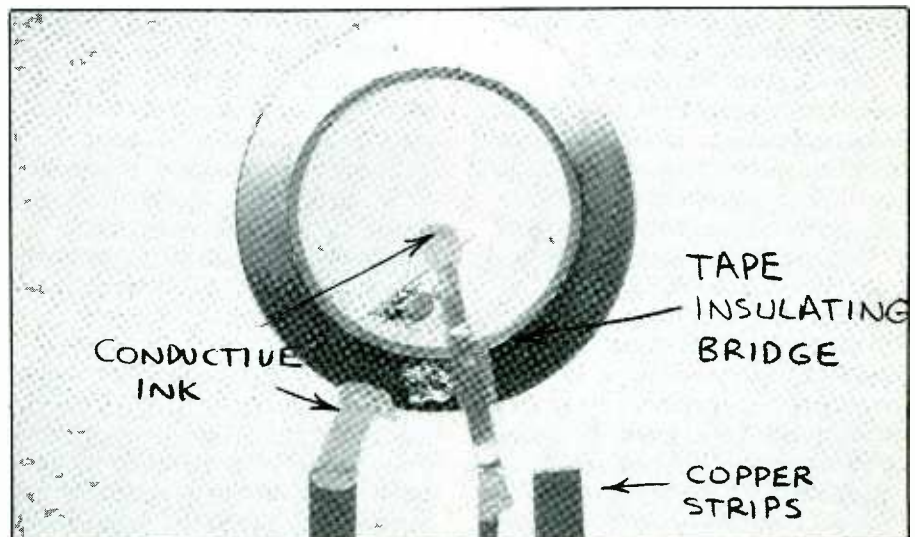

Fig. 5. Tone generator's piezoelectric disk.

connect each strip to the 4049 with conductive ink (pins 1, 2 and 8). Again, a toothpick will suffice as an applicator. Be especially careful to avoid bridging adjacent pins of the IC.

Connect together pins 3 and 4 of the IC with conductive ink, and then draw a strip of ink outward from this junction as shown in Fig. 4. Draw a longer strip of ink outward from pin 5. Place a 0.001- to 0.01- μ F chip capacitor between the ink extending from pin 5 and the copper strip extending from pin 2. Secure the capacitor in place with small blobs of ink. Use care; the ink may flow under the capacitor and cause a short.

Next, attach the piezoelectric disk to the card with reusable adhesive. Contact is made to the center terminal of the disk via a strip of adhesive-backed copper foil as shown in Fig. 5. Note that a piece of tape is placed over the disk's outer terminal to serve as an insulating bridge. Use conductive ink to connect the copper strips to the disk.

Finally, *R1* is installed. Though a standard chip resistor can be used (10k to 100k ohms), I made a resistor by using a graphite pencil to bridge the conductive ink traces extending from pins 3/4 to 5. It's necessary to determine if the graphite lead you wish to use is suitable for this application. This is easily done by stroking the lead across a piece of paper and

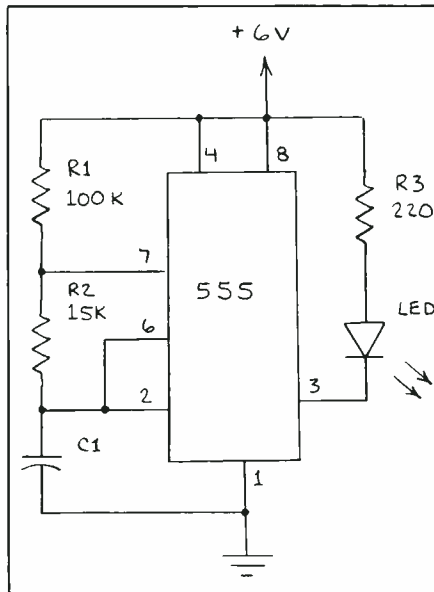

Fig. 6. Boardless LED tone transmitter.

measuring the resistance. A suitable lead will give a resistance in the range given above when the probes are a few millimeters apart.

Test the circuit by using clip leads to connect the outer two copper strips to a 9-volt battery. If the circuit is functioning properly, a tone will be heard. The frequency of the tone can be altered by adding more graphite to *R1* or by careful erasing part of *R1*.

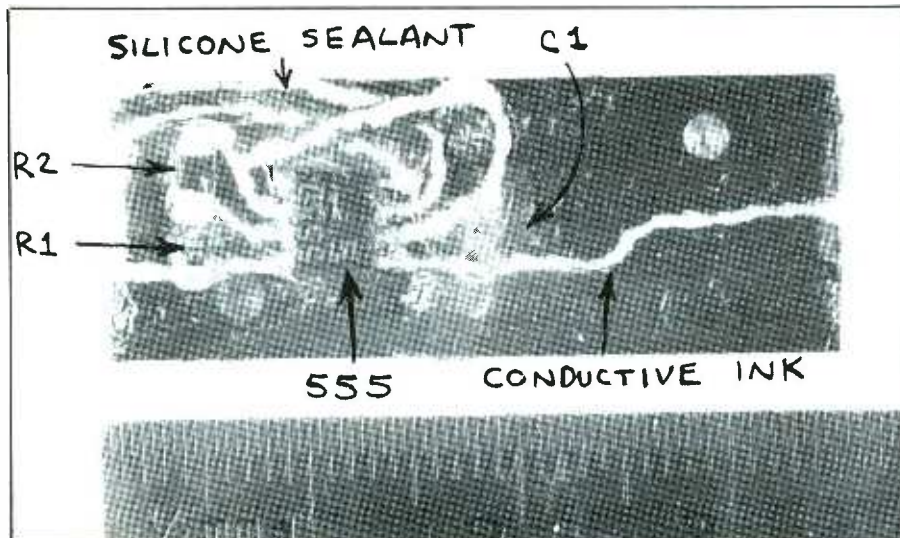

Fig. 7. First version of boardless LED tone transmitter.

COMPUCOVER®

COVER YOUR INVESTMENT

Macintosh Monitor & Keyboard	12.95
Macintosh Plus Keyboard	add - 1.00
with Mac Bottom	add - 3.00
Image Writer	12.95
Image Writer II	14.95
External Drive	5.95
IBM PC or XT or AT	22.95
IBM Pro Printer	16.95

Epson - C.Itoh - Dkidata
Over 3000 covers to choose from.
You name it - We got it!

Anti-Static-different colors

ORDER LINE
1-800-874-6391
FLORIDA ORDER LINE
1-800-342-9008
Dealer Inquiries Invited

CompuCover
P.O. Box 310 Dept. D
Mary Esther, FL 32569

Customer Service
(904) 243-5793
Telex 469783

CIRCLE 16 ON FREE INFORMATION CARD

Be an FCC LICENSED ELECTRONIC TECHNICIAN!

Earn up to \$30 an hour and more!

Learn at home in spare time
No previous experience needed!

No costly school. No commuting to class. The Original Home-Study course prepares you for the "FCC Commercial Radiotelephone License". This valuable license is your "ticket" to thousands of exciting jobs in Communications, Radio-TV, Microwave, Computers, Radar, Avionics and more! You don't need a college degree to qualify, but you do need an FCC License.

No Need to Quit Your Job or Go To School
This proven course is easy, fast and low cost! **GUARANTEED PASS** - You get your FCC License or money refunded. **Send for FREE facts now. MAIL COUPON TODAY!**

COMMAND PRODUCTIONS
 FCC LICENSE TRAINING, Dept. 220
 P.O. Box 2223, San Francisco, CA 94126
 Please rush **FREE** details immediately!

NAME _____
 ADDRESS _____
 CITY _____ STATE _____ ZIP _____

In view of the apparently fragile nature of this circuit, it's reasonable to have doubts about its reliability. As of this writing, the circuit has been in existence for some two months and I have tested and demonstrated it at least a few dozen times. It still works.

A Boardless LED Tone Transmitter

Figure 6 is the circuit of a simple pulse generator that directly drives an LED. My objective in designing this circuit was to keep it as compact as possible. Since I planned to power the circuit with a miniature 6-volt lithium battery, the obvious way to keep the size down was to use surface-mountable components, eliminate the traditional circuit board, attach the components directly to the back of the battery holder and interconnect their terminals with conductive ink.

To prove this concept, I assembled a working circuit on the back of a battery holder. The circuit actually worked. Moreover, only 15 minutes were required to assemble it. Since the circuit worked so well and was so easily assembled, I built a second version. It also worked well.

Figure 7 shows the first version of the circuit. The components appear blurred since the entire back side of the battery holder is coated with silicone sealant. The second version of the circuit is easier to duplicate, and full instructions are given below. First, here's how the first version was assembled.

The first step in assembling the circuit was to use a small piece of reusable adhesive to attach a small-outline 555 to a battery holder (Radio Shack Cat. No. 270-405 or similar). The interconnections were made with a toothpick dipped in silver-filled acrylic ink.

The LED is a near-infrared chip LED (Stettner No. CR10 or similar). The LED, R1, R2, R3 and C1 were not attached to the battery holder prior to applying the conductive ink. Instead, these chip components were attached directly to the sticky inked traces before the ink dried. A small blob of ink was then placed against each terminal to provide a strong physical bond, as well as a good electrical connection.

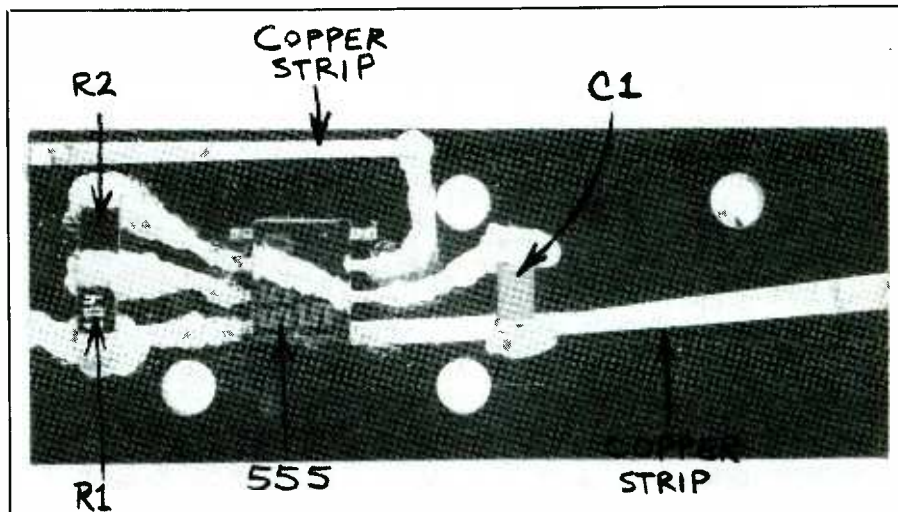

Fig. 8. Second version of boardless LED tone transmitter.

Connections to the battery holder terminals were made by daubing ink against the edges of the terminals. The connection between pins 2 and 6 of the 555 required an insulating bridge over the traces extending from pins 3 and 4. The bridge was made by placing a small piece of plastic tape over the two obstructing traces and drawing the trace between pin 2 and pin 6 over the bridge. The circuit has no switch. Instead, the LED emits a stream of pulses when the battery is installed.

Building a Boardless LED Transmitter

As noted above, the circuit shown in Fig. 7 worked so well I decided to build another. The resulting circuit is shown in Fig. 8. It's very easy to duplicate. Here are the details.

Begin assembly by connecting pin 2 to pin 6 of the 555 with a bridge of conductive ink applied across the top of the chip. Then connect pin 4 to pin 8 with a bridge of ink across the bottom of the chip. Make sure the ink makes good contact with the terminals by applying a small blob of ink between each terminal and the chip's package. These bridges are easily formed with a toothpick dipped in the ink.

Though a silver-filled ink will provide best results, I intentionally assembled the

circuit using readily available copper-filled ink from the Loctite Quick Grid Rear Window Defogger Repair Kit described above.

Figure 8 shows how the components are arranged on the back of the battery holder. After the ink applied to the 555 has dried, attach the chip to the battery holder with a small piece of reusable adhesive. To save time, I used think strips of adhesive-backed copper to connect pin 1 of the 555 to the negative battery terminal and pin 3 of the 555 to the LED. Conductive ink applied with a toothpick

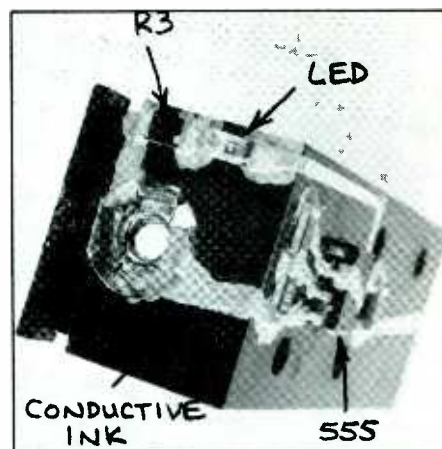

Fig. 9. LED end of second version of boardless LED tone transmitter.

Addresses

Amicon
25 Hartwell Ave.
Lexington, MA 02173
(617) 861-9600

Datak Corp.
3117 Patterson Plank Rd.
North Bergen, NJ 07047
(201) 863-7667

Dynaloy, Inc.
7 Great Meadow Lane
Hanover, NJ 07936
(201) 887-9270

Emerson & Cuming, Inc.
(see Amicon Corporation)

GC Electronics
(Local Electronics Dealers)
(815) 968-9661

Stettner Electronics, Inc.
P.O. Box 21947
Chattanooga, TN 37421
(615) 892-0291

The Dexter Corp.
Hysol Div.
15051 E. Don Julian Rd.
Industry, CA 91749
(818) 968-6511

establishes the connection between the strips and the IC. If you prefer, you can replace the copper strips with conductive ink.

The LED, R1, R2, R3 and C1 are attached directly to the conductive-ink traces before they have dried. Be sure to reinforce each terminal with a small blob of additional ink. Figure 9 shows the business end of the transmitter and reveals the chip LED and its series resistor (R3).

Note the conductive ink applied to the positive battery terminal.

Going Further

Whether or not you choose to duplicate the circuits presented here, I hope they stimulate your imagination. I plan to develop additional circuits using the techniques described here. If they work, they will be described in a future column. **ME**

SUPER LONG PLAY TAPE RECORDERS

10 Hour Model — \$95.00*
14 Hour Model — \$159.00*



Modified Panasonic Slimline. high quality. AC-DC Recorders provide 5 or 7 continuous hours of quality recording & playback on each side of cassette for a total of 10 or 14 hours depending on model. • Voice level control. • Digital counter etc. TDK DC 180 Cassette Furnished.

PHONE RECORDING ADAPTER

Records calls automatically. All Solid state connects to your telephone jack and tape recorder. Starts recording when phone is lifted. Stops when you hang up. **\$24.50***



VOX VOICE ACTIVATED CONTROL SWITCH

Solid state. Self contained. Adjustable sensitivity. Voices or other sounds automatically activate and control recorder. Uses either recorder or remote mike. **\$24.95***



*Add for ship & hdlg. Phone Adapter & Vox \$150 ea. Recorders \$40.00 ea. Cal. Res. add tax. Mail order. VISA, M.C. COD'S OK. Money Back Guarantee. Free data. avail., Dealer Inquiries invited. Dept. M9335 Lubec
AMC SALES INC. St., Box 928, Downey, CA (213) 90421 Phone 869-8519

CIRCLE 31 ON FREE INFORMATION CARD

PC XT/AT ADD-ON BOARDS

- MS DOS/QW Basic 3.2 \$80
- XT Mother Board/Bios \$83
- XT Turbo Board/Bios \$103
- Monochrome/Graphic/Printer Card \$66
- Monochrome Graphic Card \$60
- Color Graphic/Printer Card \$60
- Color Graphic Card \$50
- XT Multi I/O Card \$73
- XT I/O Plus II \$45
- Floppy Disk Controller
 - 1 port \$25
 - 2 port \$35
- RS232 Interface Card
 - 1 port \$22
 - 2 port \$27
- Parallel Printer Card \$19
- Clock Card \$25
- Game Card \$18
- Hard Disk Controller Card \$100
- Hard Disk/Floppy Disk Controller Card \$123
- XT 2 MB RAM Card \$195
- AT Mother Board/Bios \$490
- AT 3 MB Multifunction Card \$178
- AT 4 MB RAM Card \$210
- AT 1.2M Floppy Disk Card \$72
- EGA Card \$245
- AT HDC/PDC Controller w/Cable \$2215

KEYBOARDS

- 5151 Style AT/XT Keyboard \$68
- 747 AT Style AT/XT Keyboard \$53

POWER SUPPLY

- 150 Watt XT Power Supply \$53
- 200 Watt AT Power Supply \$85

MONITORS



PARCO (Sony)
Height Resolution
12" 90° Monitor 800
x 700 Lines With
Non-Glare
Screen/Swivels
Base Amber. \$115

- SAMSUNG — Amber \$79
- TAXAN 620 Color \$375
- TAXAN 630 Super Hi-Res. Color \$445
- TAXAN 640 Super Hi-Res. Color \$445
- TAXAN 760 EGA Monitor \$499

PRINTERS

- RITEMAN PLUS (120 cps. 80 col.) \$175
- RITEMAN - 15 (160 cps. 136 col.) \$345
- BROTHER M1509 (180 cps. 136 col.) \$395

DRIVES

- TEAC 360K Floppy Drive \$90
- FUJISU 360K Floppy Drive \$82
- CHINON 360K Floppy Drive \$85
- 20MB Hard Disk / WD \$Call
- 30MB Hard Disk / WD \$Call
- 1.2MB TEAC AT Drive \$135

CHASSIS

- Flip Top XT Case \$29
 - Slide Off XT Case \$36
 - AT Jr. Style XT Case \$37
 - AT Case \$85
- All Cases Include Speaker/Hardware

MODEMS

- Internal Modem-Everex \$137
- Select 300/1200 bps. powerful BitCom Communication Software Included. Auto answer/dial.
- External Modem-Smarteam \$160

PC/AT 2000 SYSTEM



- 80286 Processor (6/8MHZ)
 - 1024K RAM
 - 1.2MB Floppy Disk Drive
 - AT Hard Disk/Floppy Disk Controller Card
 - Clock/Calendar with Batter Backup
 - AT Style Keyboard
 - 200W Power Supply/Case
 - Runs All Major Software
 - Six Month Warranty
- \$1249**

PC/XT 2000 SYSTEM



- 640K RAM
 - 360K Half Height Floppy Drive w/Controller
 - AT Style Keyboard
 - 150W Power Supply
 - Slide Off Case
 - Runs All Major Software
 - Six Month Warranty
- \$495**

(201) 944-5002
2142 N. Hudson St.
Fort Lee, NJ 07024

IBM PC, IBM XT and IBM AT are trademarks of IBM corporation.
MS-DOS is a trademark of Microsoft Corporation.
Prices Subject to Change without Notice.

ORDER TOLL FREE:

1-800-367-1132

MONDAY — SATURDAY 9AM — 6PM EST.

Customer Service
(201) 944-5010
9AM — 5PM EST. M-F

ORDERS WHIPPED UPS COD
WITHIN 24 HRS.

SUNNYTECH INC.

CIRCLE 45 ON FREE INFORMATION CARD

Remote power control; laser die cutting; short time delays . . .

By Don Lancaster

It has been a real zoo around here lately since the whole new world of laser printing and desktop publishing is now literally bursting at the seams. Laser printing seems to be *the* opportunity of the decade and is something that no serious hacker can any longer afford to ignore. The potential here is absolutely astounding. I have lots of stuff to get you started in this, some free, some for a small fee, so be sure to write or call. You may want to start exploring this exciting new world.

Several readers have asked where to get that oddball "shrink DIP" socket for the M50734 microprocessor we looked at a few columns back. The *Electronic Molding* people have these for around \$3 each.

I have several versions of this micro up and running. It looks like it will be absolutely outstanding for such things as data logging, student trainers, and dedicated "blue-collar" uses. Write or call for a preliminary schematic.

While I am thinking of it, let's make one important update to your copy of the *TTL Cookbook*. This one has caused some grief to several recent callers. At the time the book was written, *Motorola* had an MTTL voltage-controlled oscillator that had the unfortunate choice of a 4024 part number. Several of the circuits in the book used this original part. You most definitely can *not* substitute any of today's 4024 CMOS binary counters for this chip. These are totally different devices from the MTTL VCO.

On to whatever it is we are doing here.

How can I remotely control ac power?

Those older BSR remote power controllers, such as the ones offered by *Sears* and *Heathkit*, are often ideal for this sort of thing. They use low-frequency radio signals sent through the power-line wiring to control up to 256 different appliances or dimmable lamps.

Unfortunately, the original BSR ver-

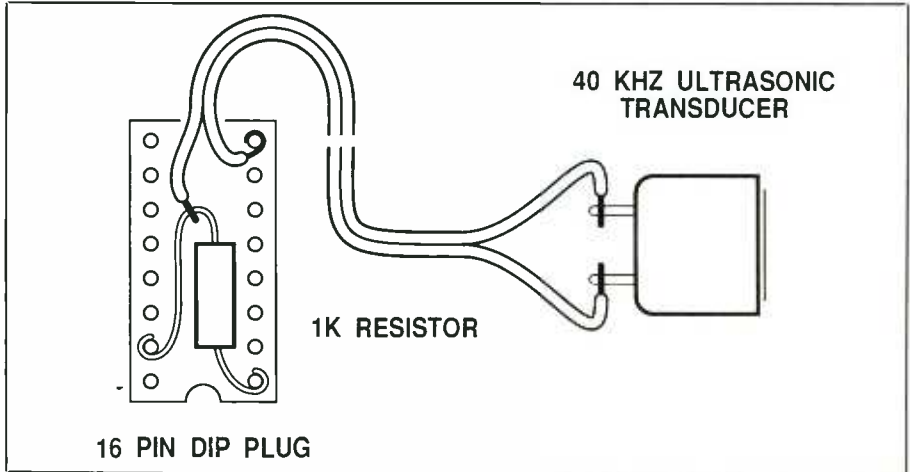

Fig. 1. Remote ac power controller interface construction details.

sions did not offer any means for direct computer control. Worse yet, these devices use a "hot-chassis" circuit that is difficult and unsafe to directly connect to your personal computer. A number of manufacturers offer plug-in BSR interface cards for Apples and PCs that can be quite expensive, particularly for preliminary experiments.

Instead, I would like to share with you a quick and simple \$1 Apple-to-BSR interface that I worked up some time ago. It works like a champ. What this dude does is connect an ultrasonic transducer to the game paddle output of your Apple. This transducer "whistles" at the BSR controller in the same way that the handheld remote controller does. The whistling is done from one-to-three-feet away, completely eliminating any hot-chassis problems and any need to modify the BSR controller itself.

Please note before we begin that this takes the type of BSR controller that supports a handheld remote ultrasonic controller. Some low-end *Radio Shack* versions do not. The way to tell is by whether or not the handheld controller is listed in the catalog. You can also open the unit and see if there is an ultrasonic microphone present in the front-center of the case.

\$0300:	A2	15	BD	5B	03	48	20	2D
\$0308:	03	20	1B	03	68	49	FF	20
\$0310:	1B	03	A2	F0	20	4D	03	20
\$0318:	4D	03	60	A0	05	0A	90	06
\$0320:	20	2D	03	18	90	03	20	3D
\$0328:	03	88	D0	F1	60	48	A2	A0
\$0330:	20	4D	03	8D	58	C0	A9	27
\$0338:	20	A8	FC	68	60	48	A2	30
\$0340:	20	4D	03	8D	58	C0	A9	32
\$0348:	20	A8	FC	68	60	8D	59	C0
\$0350:	48	68	EA	8D	58	C0	EA	EA
\$0358:	CA	D0	F2	60	60	E0	20	A0
\$0360:	10	90	50	D0	70	F0	30	B0
\$0368:	00	80	40	C0	08	18	28	38
\$0370:	48	58	00	A9	07	8D	72	03
\$0378:	20	00	03	A9	8D	20	A8	FC
\$0380:	CE	72	03	D0	F3	60	00	00

Fig. 2. An Apple IIe-to-BSR controller machine-language software driver.

The circuit works on an Apple II+, IIe, or IIGs in its slow mode. However, it will not run on a IIc.

As shown in Fig. 1, all you need are a DIP plug that fits the game I/O connector, a short piece of two-conductor wire, a pull-up resistor, and a 40-kHz ultrasonic transducer. The transducers are avail-

First, select a BSR command from this list:

CODE	HEX	DEC	CODE	HEX	DEC
Unit 1	\$01	1	Unit 13	\$0D	13
Unit 2	\$02	2	Unit 14	\$0E	14
Unit 3	\$03	3	Unit 15	\$0F	15
Unit 4	\$04	4	Unit 16	\$10	16
Unit 5	\$05	5	Clear	\$11	17
Unit 6	\$06	6	All On	\$12	18
Unit 7	\$07	7	On	\$13	19
Unit 8	\$08	8	Off	\$14	20
Unit 9	\$09	9	Dim	\$15	21
Unit 10	\$0A	10	Bright	\$16	22
Unit 11	\$0B	11			
Unit 12	\$0C	12			

Then poke this value into location \$0301 or decimal 769.

To send a single command, do a JSR \$0300 or CALL 768.

To send a more reliable burst of seven identical commands, do a JSR \$0363 or a CALL 883.

Fig. 3. Steps to follow to use the BSR interface software driver.

able for as little as 50 cents from many surplus houses. *Mouser Electronics* also stocks them new.

Construction hint: Whenever you solder to a DIP plug, first plug it into a socket or two to keep the plastic from melting and knocking the pins out of alignment.

Also, it is usually a very good idea to "double up" all of your game I/O connectors by plugging them into a *machined-contact* DIP socket and then plugging the new plug into the actual port. This *must* be the type of socket with smooth, round pins that can be safely plugged into another socket. This way, when (*not* if) the pins bend or break, all you have to do is snap a new socket onto your "sandwich," rather than having to rewire everything.

You will also need the machine-language software driver shown in Fig. 2, which runs in the usual \$0300 stash. Figure 3 shows you how to interface this driver to your controlling BASIC or other machine-language routine. The driver itself starts at \$0300 or decimal

768, and is called as a subroutine, after you put the desired command into \$0301 (decimal 769).

Just like the mule with the 2x4, it is best to "whap" the controller several times to make sure you get its attention. Entry to a simple routine at \$0373 (decimal 883) will whap the main sub seven times. For lamp-dimming applications, though, you will have to experiment some with the repeats and the delays between those repeats to get the smoothest operation.

This interface works by creating bursts of 40-kHz square waves that the ultrasonic transducer converts to sound energy that it transmits to the receiving transducer on the BSR controller. The needed information consists of a long serial pulse-modulated code that is 12 units long.

A start unit or a "one" unit is on for 4 milliseconds and off for 4 milliseconds. A "zero" unit is on for 1.2 milliseconds and off for 6.8 milliseconds. Finally an "end" unit must be on for not less than 12 milliseconds.

The actual information needed by the BSR controller is a 5-bit command code. Various combinations of 1 and 0 in this 5-bit command code correspond to codes created by the buttons on top of the controller. The transmitted code consists of a start unit followed by the five-unit command code.

Next, to pick up some noise immunity and to ignore key jangles, the *complement* of the command code is transmitted. To complement a code, you make all of the 1s into 0s and vice-versa.

Finally, an end unit is transmitted. Thus, there are 12 units to the serial ultrasonic code, all but the last of which takes 8 milliseconds. You have a start unit, five command-code units, five complements to the command-code units, and then the final stop unit.

Let me know the most unusual use for remote power control that you come up with using this super-cheap circuit.

How can I create short electronic delays?

I got a call from some students that were working up a dynamic memory demo as a class project and wanted to avoid buying a very-expensive short time-delay generator.

For quick, dirty, and cheap time delays in the 1-nanosecond to several microsecond region, just use ordinary small coax cable or twisted pair wiring. You will get around 1.6 nanoseconds per foot, or 1 microsecond for each 600 feet or so.

The bandwidth is very high and can accommodate analog and digital signals with equal ease. Both ends of the cable should be properly terminated to eliminate reflections.

Can I do die cutting on a laser printer?

The amazing answer to this question is that, yes, you can easily do die cutting on a laser printer. You can also do any of a number of other mind-bogglin things, including direct printed circuits, T-shirts, full vibrant color from plain old black

HARDWARE HACKER...

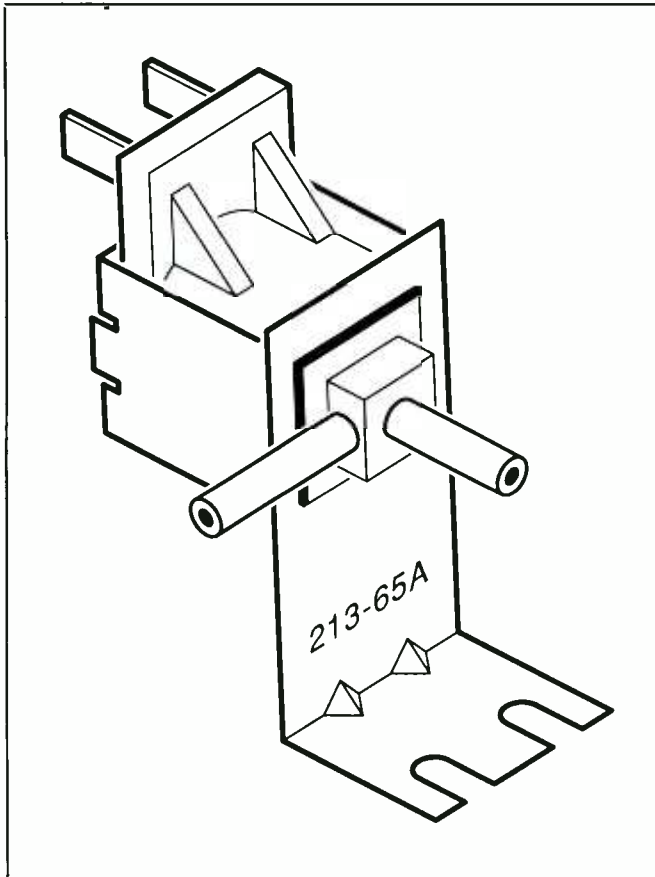

Fig. 4. This three-way valve is ideal for hacker robotics.

toner originals, silk screening, translucent overhead transparencies and much more. We've covered some of these in previous columns, but the die cutting is brand new and reported here for the first time anywhere.

Kroy Kolor has a super new material that is more or less like the sticky-back vinyl and carrier used by professional sign people, except for one major difference. This material is not cross-linked properly until it is exposed to light and treated with a simple chemical.

Here is how you use it: With your laser printer, print the die cut outlines onto a clear acetate sheet. Then place the sheet in contact with the diecut material and expose it to strong sunlight or the usual UV exposure boxes. The toner prevents

the light from cross-linking the material. when you next wipe the material with a developing chemical, every place that toner was will dissolve, leaving you with perfect "die-cut" letters or whatever ready to peel and use. Neat stuff.

Contact Randy Bailey at *Kroy* for samples and more info on this exciting new material.

What's worth hacking this month?

There are so many unique new components that need looking into that it is hard to pick a starting point. To quote Pogo, "We are beset with insurmountable opportunities." At any rate, here goes.

We'll start off with my perennial favo-

NAMES AND NUMBERS

Amperex Electronic Corp.
George Washington Hwy.
Smithfield, RI 02917
(401) 232-0500

BSR
Route 303
Blauvelt, NY 10913
(914) 358-6060

Electronic Molding
96 Mill St.
Woonsocket, RI 02895
(401) 769-3800

Eastman Kodak
343 State
Rochester, NY 14650
(716) 724-4000

Jerryco
601 Linden Pl.
Evanston, IL 60202
(312) 475-8440

Kroy Sign Systems
14555 N. Hayden Rd.
Scottsdale, AZ 85260
(800) 521-4997

Micronetics Inc.
36 Oak St.
Norwood, NJ 07648

Motorola Semiconductor
Box 20912
Phoenix, AZ 85036
(602) 244-6900

RCA
Route 202
Somerville, NJ 08876
(201) 325-1885

Reticon Corp.
345 Potero Ave.
Sunnyvale, CA 94086
(408) 738-4266

Revere
845 N. Colony Rd.
Wallingford, CT 06492
(203) 269-7701

Tektronix
Tektronix Industrial Park
Beaverton, OR 97005
(503) 644-0161

Texas Instruments
P.O. Box 9066
Dallas, TX 75380
(800) 232-3200

rite, the 30-cent three-way pneumatic valve shown in Fig. 4. These remain available from *Jerryco* and many other surplus houses and are an outstanding bargain part that has gone begging. Low-pressure air has great hacker robotics potential, but it has been virtually ignored.

A premounted strain gauge useful for electronic scales and whatever is available from *Revere* as the Model FT-30 force translator transducer. It is available in ranges from 1 to 40 pounds and in resistances from 0.5 to 25 ohms.

The *Hewlett Packard Journal* is a good free source of technical details on sophisticated electronic devices. The February 1987 issue has a good tutorial on wide-range optical and infrared sensors in it.

Speaking of IR sensing, *Amperex* has

some miniature and sensitive pyrolytic infrared detectors whose prices start at \$3.50. These look like really great components, but I have not yet had the chance to test them. One obvious application is in "hot-spot" detectors for use by the fire service. Current devices are ridiculously expensive and many of the volunteer fire departments simply cannot afford them.

For some new information on electronic noise, and noise diodes for testing in particular, check out the *Micronetics* noise-diode catalog, which also contains a tutorial on noise and noise testing.

We seem to be turning the corner on solid-state imaging devices. These should soon be cheap enough to open up all sorts of new low-end hacker stuff, including image scanners, simple robotic vision, various desktop publishing accessories, and whatever. There's now even a toy camcorder being introduced that should list for under \$150 and actually be sold in toy stores. Just as hackers ripped open the early *Speak and Spell* toys to get at the sound chips, you might now see a new generation of hackers ripping apart these "toys" for the imaging electronics.

The leader in charge-coupled-device CCD image sensors is now *Reticon*. But *Texas Instruments* has TC210, 220, 230, and 240 sensors and evaluation kits available, which include a 488 x 754 full-color or RGB evaluation board.

Other companies that are introducing lower-cost CCDs include *RCA* with its SID504DD device.

As usual, be sure to write or call with any tech questions per the "Need Help?" box. I'll send you the usual free-stuff list plus some other goodies. **ME**

NEED HELP?

Phone or write your **Hardware Hacker** questions directly to:

Don Lancaster
Synergetics
 Box 809
 Thatcher, AZ 85552
 (602) 428-4073



Free Product Information

Readers can obtain free information on products advertised by certain companies, as well as for some editorially mentioned products. Simply circle the appropriate number printed below an advertisement onto the Modern Electronics "Free Information Service" card bound into this issue. After filling in your name and address, just mail the postpaid card. Your request will be forwarded directly to the advertiser with a mailing label prepared by our reader-service department to ensure speedy response.

ELENCO PRODUCTS AT DISCOUNT PRICES!



20 MHz DUAL TRACE OSCILLOSCOPE
\$349. MO-1251

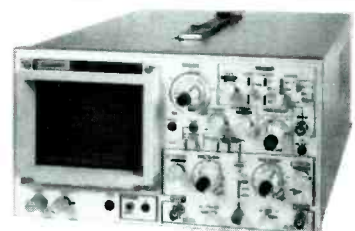

35 MHz DUAL TRACE OSCILLOSCOPE
\$498. MO-1252

Top quality scopes at a very reasonable price. Contains all the desirable features. Elenco's 2 year guarantee assures you of continuous service. Two 1x, 10x probes, diagrams and manual included. Write for specifications.



MULTI METER with CAPACITANCE and transistor tester
\$65 Model CM-1500
 Reads Volts, Ohms, Current, Capacitors Transistors & Diodes



TRUE RMS 4 1/2 DIGIT MULTIMETER
\$135 Model M-7000
 .05% DC Accuracy
 .1 % Resistance with Freq. Counter & Deluxe Case



AUTO RANGING plus MANUAL RANGING 3 1/2 DIGIT METER 28 FUNCTIONS
 M-1180 .7% ACY \$36.95
 M-1182 .25% ACY \$39.95
 M-1181 .1% ACY \$42.95



GF-8016 Function Generator with Freq. Counter
\$219
 • Sine, Square, Triangle, Pulse, Ramp, 2 to 2 MHz
 • Frequency .1 thru 10 MHz



10 MHz OSCILLOSCOPE
\$199 S-3000
 10 MHz DC or AC Triggered Sweep
 Calibrated Vert & Hor
 Reads Volts & Freq



BREADBOARD
 Shown 9434
 9430 1,100 pins \$15
 9434 2,170 pins \$25
 9436 2,860 pins \$35



Triple Power Supply XP-660
\$14950
 0-20V @ 1A
 0-20V @ 1A
 5V @ 5A
 Fully Regulated, Short Circuit Protected with 2 Limit Cont. 3 Separate Supplies.



50 MHz LOGIC PROBE
\$23
 LP-700
 20 nsec with memory



LOGIC PULSER
\$25
 LP-600
 2 us pulse @ 1A

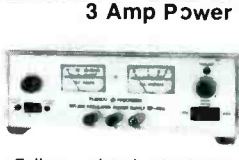

3 Amp Power Supply XP-650
\$11950
 0-40V @ 1.5A
 0-20V @ 3A
 Fully regulated, short circuit protected current limit control



DIGITAL LCR METER
 Model LC-1800
 Measures: Inductors Capacitors, Resistors
\$148
 Inductors 1 μH to 200 H
 Capacitor 1 pF to 200 μF
 Resistor .01 Ω to 20 M Ω
 Ranges 6 Ind, 7 cap, 7 res

C&S INC., 8744 W. North Ter. Niles, IL 60648 800-292-7711 (312) 459-9040 **15 DAY MONEY BACK GUARANTEE** ASK FOR CATALOG
 2 Year Limited Guarantee! Add 5% for Postage (\$10 max.), IL Res., 7% Tax

CIRCLE 40 ON FREE INFORMATION CARD

Best Portable Yet: The NEC MultiSpeed

By Eric Grevstad

It may not be as dramatic as a newspaper's printing an extra edition or banner headline, but this is the first time I've devoted a whole "PC Papers" column to one product instead of the usual two or three. It's partly because the product offers lots to write about—after I review the hardware, there are a bunch of built-in software programs to cover—but also because one of my favorite market categories has finally fulfilled its promise. I've found an affordable, full-powered, no-excuses-necessary briefcase portable.

Except for a few complaints, most caused by no-win compromises between light weight and extra features or battery life and screen brightness, the NEC (NEC Home Electronics, 1255 Michael Dr., Wood Dale, IL 60191; 312-860-9500) MultiSpeed is a sensational machine. It tops the excellent Toshiba T1100 Plus and Zenith Z-181, and makes the PC Convertible look like something IBM should publicly apologize for and offer to buy back. It's the most complete, ready-to-use computer I've ever taken out of a box, big or little. It has specifications that make other portable owners gnash their teeth, starting with 640K standard RAM and ending with nearly triple a desktop PC's processing speed. And it's fairly priced at \$1,995.

The Hardware

When you first heft a MultiSpeed by its slide-out carrying handle, you might wish for a little less; it's trimly sized at 13.75 by 12.5 by 3.25 inches, but its 11-pound weight makes a noticeable difference in the average briefcase. Scanning its back and side, however, you'll notice two 720K microfloppy drives, full-sized parallel and RS-232C serial ports, a video port for an external RGB monitor, and a disk controller port for use with a hook-up kit (\$99) that lets a desktop PC use the NEC's drives.

An extra \$399 buys a Hayes-compatible 1,200-bps modem the size of a playing card; it slides into a slot in the MultiSpeed's side. (One of my minor com-



NEC's new portable: Speed, memory, pop-up software, and one heck of a keyboard.

plaints: Despite pushing with considerable force, my modem stuck out an extra fraction of an inch, preventing me from replacing the plastic covering panel.)

The Software

The MultiSpeed deserves raves as a straight DOS machine; the icing on its cake is 512K of built-in ROM programs, one or more of which are available from the middle of your RAM-based program at the press of the Pop-Up key. The six pop-ups are impressively executed and easy to use, borrowing the Microsoft interface of commands along the bottom of the screen chosen by moving the space bar or typing an initial letter; pressing a Help key at any time summons short but context-sensitive help screens, appearing at ROM speed. A fellow could get spoiled.

The pop-ups vary in size and appeal. For modem owners, Dialer stores, quickly finds, and calls your favorite (voice, not data) names and numbers; it can

move frequently called numbers to the top of your list, or dial a number from the screen of another program. Outliner, a simple outline processor, lets you expand, collapse, or cut and paste material in indented headings and subheadings; it works nicely, though I don't like outline processors and wish NEC had put a pop-up calculator (a major omission in the software) in its place.

Others are more sophisticated. Telcom is a complete communications program supporting ASCII and Xmodem transfers, VT52 and VT100 terminal emulation, auto-dial and auto-answer, the ability to see a screen of text that's already scrolled by, and a somewhat complex script language to automate log-on or transfer procedures. Once you get used to "on line" meaning COM2 (the modem) and "off line" meaning COM1 (the serial port), you may never need a terminal program on disk.

Filer is a swift little index-card database with a couple of quirks about ac-

cepting field names (they must end with a colon and have underline characters instead of spaces in fields like "First Name:"), but suitable skill at sorting, saving, or editing records and searching for text strings or numerical ranges. The modem can call a Filer phone number.

The name Notepad implies a simple jotter, but NEC's is a nearly complete clone of WordStar—with no dot commands or mail-merge, but adequate print formatting and the enhancements of word and line undeletion, Microsoft-style commands, and import and export between Notepad and RAM applications. There's even a spelling checker that lets you skip a word, retype it, see a suggested correction, or add it to a personal dictionary on floppy or RAM disk.

The final ROM program, Setup, accommodates your preferences for color shades, CPU speed, and whether you're using an external CRT, linking to a PC's disk drives, or leaving standby disk power off to help battery life at the expense of slower (restart before reading or writing) disk access. It also lets you decide how much memory to set aside, below user RAM, for pop-up work space, disabling Outliner or allowing larger Notepad doc-

uments. The NEC normally reserves 128K for itself and gives you 512K for DOS and programs; you can reverse that balance, select something in between or run a small program on the MS-DOS 3.2 disk to disable ROM and have a conventional 640K machine. (Another program reinstalls the pop-up defaults.)

Besides pop-up space, Setup also controls a maximum 126K RAM disk, seen as drive C. It's normally used for such things as your Notepad dictionary or Dialer phone list, but feel free to put your own utilities or small programs there—it's battery-backed static RAM, retained when the computer is turned off. The more I look at the MultiSpeed, the more I find myself saying, "This is really slick."

It could be slicker yet; the detachable screen and two empty ROM sockets give buyers hope of future upgrades. But for now, if you fit into that majority of folks who don't need Above Board memory or EGA graphics, use primarily just one or two programs and a few utilities that don't require a hard disk, and maybe own an RGB monitor for use after dark, the NEC MultiSpeed could genuinely be your only computer. No other battery-powered portable can make that claim.

ME

```

NOTEPAD 1.02          DANGER.JH          16K    95%
  "My name is Hound. James Hound."
  The tall man with the grey-blue eyes turned slowly away from the
  window. As soon as she saw him, Poodle knew this cruel, rather dashing man
  would affect her life as not even the evil Dr. Duncan could have
  OUTLINER 1.01          10k    98% free
  + Introduction
  + Opening anecdote
  + Three men, wheelbarrow, land mine
  + Passing herd of cattle
  - Sudden appearance of Mariette Hartley
  DIALER 1.01          1 K    76 % free
  NAME          PHONE          DESCRIPTION
  Phaenon Corporation 1-603-555-5272  Publication consultants
  Art Salsberg      1-516-681-2922  Ed., Modern Electronics
  Computer Haven    1-555-9920      Dave R. -- clone repair
  Pizza Mall        555-0186        Avoid the peppers
  Time of Day       1-203-524-8123  Connecticut
  Boot, FAT, & Table 555-2907        Attorneys at Law
  T. Johnson        1-213-555-0392  Never call this man
  Disk Busters      555-6691        Hard disk fragmentation
  C:DIALER.DAT          Data: 4 of 8
COMMAND: Add Call Delete External Find Help Modify Option Quit
Dials a phone number from the phone directory.
Select command then press ENTER, or type first letter of command name.
  
```

Pop till you drop: Pop-ups Dialer over Outliner over Notepad, all over a RAM application are illustrated in this screen printout.

RF TEST EQUIPMENT

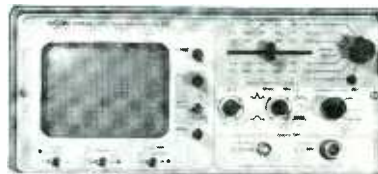

PSA-35A Portable Spectrum Analyzer \$1965
Battery or line operated with frequency coverage from 10 - 1750 MHz and 3.7 - 4.2 GHz. Measure and document satellite communication system performance after installation or service. Troubleshoot system problems by observing output signals from LNA's, BDC's, line amplifiers and splitters, and other RF signal components. Measure block system signal balance. Identify and resolve terrestrial interference problems quickly and precisely by displaying offending signals on the PSA-35A. Numerous accessories are available.

STA-70D Test Analyzer \$1960
Displays SCPC and FM signals over a frequency range of 50 to 110 MHz, including audio demod.

STA-10D Test Analyzer \$1965
Frequency coverage 50 to 10 MHz, observe and listen to audio subcarriers including SCS and data transmissions.

MSG-1000A Microwave Sweep Generator \$1565
100 KHz to 1000 MHz, CW, 1 KHz FM Modulation, AC & Battery.

MSG-5 Microwave Sweep Generator \$1087
3.7 to 4.2 GHz, CW, 1 KHz FM Modulation, AC & Battery.

MSG-1750A Microwave Sweep Generator \$1275
950 to 1750 MHz, CW, 1 KHz FM Modulation, AC & Battery.

MSG-2000A Microwave Sweep Generator \$1282
1000 to 2000 MHz, CW, 1 KHz FM Modulation, AC & Battery.

Other Sweep Generator frequency ranges available, call with your requirements.

MTG-3600 Microwave Tracking Generator \$1865
Turns your HP 8566 in to a network analyzer with scalar frequency response. (Tracking Generators for other spectrum analyzers available, inquire.)

AVCOM 500 SOUTHLAKE BOULEVARD
RICHMOND, VIRGINIA 23236
TELEPHONE 804-794-2500 TELEX 701-545 FAX 804-794-8284

CIRCLE 28 ON FREE INFORMATION CARD

ATTENTION! ELECTRONICS TECHNICIANS



EARN YOUR B.S.E.E. DEGREE

THROUGH HOME STUDY

Our New and Highly Effective Advanced-Placement Program for experienced Electronic Technicians grants credit for previous Schooling and Professional Experience, and can greatly reduce the time required to complete Program and reach graduation. No residence schooling required for qualified Electronic Technicians. Through this Special Program you can pull all of the loose ends of your electronics background together and earn your B.S.E.E. Degree Upgrade your status and pay to the Engineering Level. Advance Rapidly! Many finish in 12 months or less. Students and graduates in all 50 States and throughout the World. Established Over 40 Years! Write for free Descriptive Literature

COOK'S INSTITUTE
OF ELECTRONICS ENGINEERING
347 RAYMOND ROAD
P.O. BOX 20345
JACKSON, MISSISSIPPI 39209

CIRCLE 15 ON FREE INFORMATION CARD

A Solid-State Spelling Checker

By Art Salsberg

PC Type Right, \$199.95. An electronic dictionary by Xerox Corp., manufactured and distributed by Microlytics, E. Rochester, NY. For IBM PC, XT, AT and compatibles.

Spelling checkers for computers abound today. PC Type Right™, however, is different. It's not provided on a disk or an expansion board. Instead, the speller resides in a small, rectangular enclosure that's connected between the keyboard and the main micro section of an IBM PC, XT, AT or compatible personal computer by a short cable.

Like an option on Borland's Tubo Lightning spelling checker, it causes the computer to beep if it detects a misspelled word while you're typing. Unlike it, however, it does not reside in your computer's internal memory or require maintaining program files on your disk. Thus, it uses none of your RAM or disk space. And unlike most spelling checkers, it doesn't require you to spend extra time checking text for errors after you've typed it into your computer.

The device contains a 100,000-word dictionary developed at Xerox's Palo Alto Research Center (PARC). Further, up to 1,200 words can be added to a built-in personal dictionary.

Setup couldn't be simpler. One just disconnects the keyboard's coiled-cable connector from the CPU section and plugs in the proper connector end of the PC Type Right cable in its place, plugs the other end into the device's appropriate receptacle, and then plugs in the keyboard's cable to the remaining receptacle. An AT-type model computer requires use of an alternate cable. There's a special connecting cable for the Leading Edge Model D computer, as well as one for the AT&T 6300, Xerox 6060 and Olivetti personal computers.

There are six different modes that can be set to complement software since not all programs use the same keys for cursor



Xerox' PC Type Right from Microlytics, Inc. checks your spelling as you type with a dictionary of over 100,000 words. The outboard device connects between the keyboard and the computer's keyboard receptacle, using no disk space, random-access memory or expansion slot.

movement. These are easily set by pressing the Alternate key and another specified key to automatically set a desired mode. A choice of eight beep tones, from very low to loud, is available, too. In addition, the speller can be turned on or off from the keyboard.

Testing Type Right

We typed away and noted the words that caused the PC Type Right device to instantly beep (twice) and then compared it to Webster's Spelling Checker program that was loaded into memory. Both caught essentially the same misspelling of words, though PC Type Right gave some false beeps once in a while. Interestingly, the word Webster's caused PC Type Right's dictionary to give erratic beeps at time's. Repeated words were discerned by both, too. PC Type Right's, dictionary, however, includes a host of modern

words not usually contained in computer dictionaries, as well as common surnames, such as Goldberg, that Webster's doesn't have. Xerox's PARC certainly did their research here.

I did not find the beeps to be disconcerting at all. Indeed, it was nice to immediately know and be able to quickly correct misspellings. Even a false beep could be overlooked at a glance.

Given a choice of spelling checkers, I'm still more comfortable with Webster's, which has a similarly large dictionary and lists a choice of words that you likely intended to use as well as displaying the words in context. It takes up more time as compared to PC Type Right's instantaneous feedback, though. However, if you don't have a hard disk drive on which to load Webster's, or you're being squeezed for free user memory, then I'd choose PC Type Right. In any event, it's a fine alternative. **ME**

Computer Parts Galore, Inc.

LINE ADJUSTING AUTOTRANSFORMER

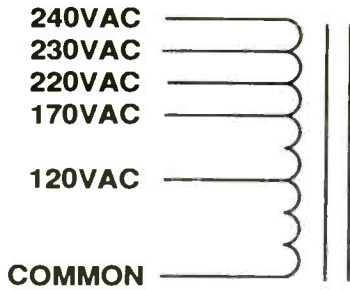

**1400 WATTS
OPEN FRAME TYPE
\$29.95**

**LET YOUR COMPUTER
ORCHESTRATE YOUR
NEXT MILLION SELLER**

What an AMAZING invention. Imagine having the ability to prepare full bed tracks at home or making a three piece band sound like six by having the computer play the other three pieces! A MIDI board can do all this and more!!

"A" for IBM® types

**Wired & tested . . . \$129.95
Just a circuit board . \$19.95**

You do all the assembling. Comes with a parts list and a schematic. One part you might want to order when choosing the assemble it yourself route is the PROM listed below.

PROM \$4.95

"B" for Apple® types

**Wired & tested \$99.95
Just a circuit board . \$14.95**

Apple® version does not require a prom

**MIDI SOURCEBOOK
\$19.95**

This book contains valuable data for either IBM® or Apple® users (specify) version. Comes with starter software.

EPROM PROGRAMMER

A GREAT EPROM Programmer for all standard 5V EPROMS from 2716 to 27512, and does all the funny program voltage with automatic selection of power voltage under menu driven software control. Has a full edit feature for splitting / combining / proportionation / selective changes on the PC/XT/AT compatible system. Mounts in one slot and has a ZIF clamp socket on a small stand with cable to allow the lid to be closed while programming. There are two styles. The 901 has 1 external socket for 1 at a time, and the 904 has 4 external sockets to do four at a time. High efficiency unit draws little power and the fast algorithm is very, very quick to finish.

**EW901 \$119.95
EW904 \$199.95**

MOTHERBOARDS

XT COMPATIBLES

All the boards listed below have the following attributes in common: 8 expansion slots, exact same footprint as Big Blue's board, 8087 math coprocessor socket (8087 not included), socket for BIOS in a 2764 EPROM, four other EPROM sockets (for things like a ROM based BASIC), high quality construction, will hold 640K of memory on board.

TYPE 1 Just the bare circuit board. You do the assembling, comes with parts list. Not a turbo board. Runs at 4.77MHz. Suggest you purchase the mapping PROM as you will need it to populate the board with a full 640K.

TYPE 2 FULLY ASSEMBLED & TESTED. This is a two layered motherboard. Speed is keyboard selectable (4.77MHz and 8 MHz). Comes with BIOS. There is no memory installed. This board can have as little as 64K of memory installed (9 4164) or all the way up to the max of 640K.

TYPE 3 Just like TYPE 2 but VERY HIGH QUALITY 4 Layered Construction

THE BEST

**Type 1 \$29.95
Type 2 \$129.95
Type 3 \$149.95
PROM for Type 1 \$6.95**

ATTAK - 286

Yes this is an 80286 based board. Fully compatible with AT™ type boards. Features 80287 coprocessor socket (not included), 8 expansion slots, on board battery and CMOS clock calendar. Same footprint as PC-AT™.

**Just the circuit board . . \$99.95
Fully assembled \$479.95**

The bare board come with a parts list and a schematic. The assembled board is a set to go complete with a Phoenix® BIOS, but it does not have any memory installed (it can hold a max of 1M). The parts below are for those who wish to build their own.

**Phoenix Bios \$49.95
VLSI Chip Set (5) \$99.95
Keyboard BIOS \$29.95
Technical Manual \$29.95
62 pin edge connectors \$2.00
5 pin DIN keyboard connector \$0.99
14.318MHz XTAL \$1.49
16.00MHz XTAL \$1.49
32.768KHz XTAL \$1.49**

RAM BANK II EMS RAM CARD \$189.95

This clever little card has the Lotus/Intel RAM format for extended memory space (EMS) and far, far cheaper, but just as good. Comes ready to stuff with 64K or 256K DRAMs, and will accept 2MB of 256K, 512K of 64K DRAM. Comes with driver disk for RAMdisk or spooler.

**TOLL FREE
1-800-431-9008**

EXPANSION BOARDS

Parallel Port A 1/4 size card that gets your computer talking with your printer. This card is fully addressable (i.e., LPT1, LPT2, LPT3). We also supply directions to make this card a BIDIRECTIONAL 8 bit I/O

port! Comes fully assembled or just the bare board.

**Wired & tested \$29.95
Bare board \$9.95
Rear panel bracket \$1.50
Rt. angle DB-25 connector (female) . \$2.49
IC socket set \$2.50**



**Big Blue Seed
Apple Seed I,
Apple Seed II**

The famous SEED manuals contain the essentials of assembling all manner of APPLE and IBM clone motherboards & plug in cards. Organized into 3 main areas for economy.

(A) Big Blue Seed Over 75 IBM XT motherboards and cards listed with all parts and placement for easy work on the bare PCB. Tells where to get the various bare PCBs. Has XT, AT, Turbo etc. Constantly updated. \$17.95

(B) Apple Seed I For the many II+ and IIE clone motherboards. With lots of data on each one \$9.95

(C) Apple Seed II Plug ins for Apple II+ and IIE. 85 cards listed with all parts, placements, hints etc. . . \$14.95

Buy two or more and save 10%

PANASONIC

5.25" and 3.5" for DOS 3.2 The old standby from PANASONIC, the JU455A5.DSDD Hi-rel unit \$99.00
And the new 720K, DOS3.2 drives for laptops etc., small XT's etc. \$99.00

SCOPE PROBES

We have sold 100's of these great scope probes to hobbyists all over the USA. A well made probe with 1x, 10x and Ref. Sw. With up to 10 meg I/P Imp. useable to 100 MHz, low capacity, short rise time, and 600V AC+DC capable for \$29.95

ASCII KEYBOARD

A great ASCII keyboard for general use, made with a 5V micro it only needs 5v to run. Has word processing layout with a large return key and 20 keys for special macro use under software control. Cost AES DATA over \$100, MICROSWITCH HALL type keyswitches for eternal use.
With pinout \$19.95

TERMS AND CONDITIONS: MINIMUM ORDER \$10.00. FOR ORDERS LESS THAN \$60.00, PLS ADD \$5.00 FOR PACKING & FREIGHT. OVER \$60.00 ADD 5% FOR PACKING & SHIPPING. HEAVY ITEMS MAY NEED EXTRA FREIGHT. ALL ORDERS SENT BY UPS GROUND UNLESS REQUESTED OTHERWISE, ANY EXTRA FEE WE PAY IS CHARGED. UPS RED, BLUE ARE AVAILABLE. C.O.D. BY US MAIL OR UPS ADD \$3.00 C.O.D. FEE. WE ACCEPT VISA, MASTERCARD, AMERICAN EXPRESS. WE ACCEPT CERTIFIED CHECK, MONEY ORDER, SCHOOL, COLLEGE, UNIVERSITY, OR STATE & FEDERAL INSTITUTION PURCHASE ORDERS. PERSONAL CHECKS NEED 14 DAYS TO CLEAR. ALL GOODS SHIPPED AS SOON AS POSSIBLE. ALL ITEMS SUBJECT TO PRIOR SALE. PRICES ARE SUBJECT TO CHANGE WITHOUT NOTICE

56 Harvester Avenue • Batavia, NY. 14020 USA 1-716-343-6133

CIRCLE 18 ON FREE INFORMATION CARD

★ TAX FREE JOBS ★

NOW IN EUROPE — MIDEAST — ASIA
S. AMERICA — AFRICA — OTHERS

OVER 15,000 OPENINGS AVAILABLE
TODAY. OUR CLIENTS ARE HIRING NOW!!

- We guarantee to match you with existing jobs
- FREE TRAVEL
- FREE HOUSING
- FREE FOOD
- FREE MEDICAL

Our Clients are hiring NOW:

PETRO-CHEMICAL • ADMINISTRATION
ENGINEERING • MEDICAL/DENTAL • EX-MILITARY
CONSTRUCTION • HVAC • FINANCE
DATA PROCESSING • MATERIAL CONTROL
TECHNICIANS • MANY, MANY OTHERS . . .

OPEN SUNDAY THROUGH FRIDAY

Call now or send resume to:



(213) 739-8080

3460 Wilshire Blvd., Suite 908MD Los Angeles, CA 90010

OR CONTACT (208) 344-0442

290 Bobwhite Ct Suite 240MD, Boise, ID 83706

FOR the following states only Idaho, Montana, N. Dakota, Oregon, S. Dakota, Washington, Wyoming

OR CONTACT (813) 985-7300

7402 N. 56th St Suite 800MD, Tampa, FL 33617

FOR the following states only Alabama, Arkansas, Florida, Georgia, Kentucky, Louisiana, Maryland, Mississippi, S. Carolina, Tennessee, Virginia, Washington D.C., W. Virginia

OR CONTACT (201) 624-3700

Gateway One (at Penn Station), Suite 501MD, Newark, NJ 07102

FOR the following states only Connecticut, Delaware, Maine, Massachusetts, New Hampshire, New Jersey, New York, Pennsylvania, Rhode Island, Vermont, Minnesota, Canada.

ADVANCE FEE • LICENSED AND BONDED
WORLD'S OLDEST AND LARGEST
OVERSEAS EMPLOYMENT AGENCY
EMPLOYMENT NOT GUARANTEED

CIRCLE 60 ON FREE INFORMATION CARD

"Made in U.S.A."



Since
1965

We've been supplying quality
crystals since 1965 —
long before the flood of
cheap imports.

We're still supplying quality
crystals with

- Quick Turnaround
- Low Price
- High Quality

TO SOLVE
CRYSTAL
PROBLEMS,
GET THIS
CATALOG



JAN CRYSTALS

P.O. Box 06017

Ft. Myers, FL 33906

(813) 936-2397



CALL 1-800-237-3063
FREE (Except Florida)

CIRCLE 61 ON FREE INFORMATION CARD

BOOKS

The Cellular Connection by Josef Bernard. (Quantum Publishing. Soft cover. 152 pages. \$9.95.)

Whether you now use a cellular telephone, plan on buying or leasing one, or just want to know what this exciting communication medium is all about, this book will put you on the right track. It leads off with a brief history of radio telephone communications and closes with a short chapter on the future of cellular phones as regards area coverage, advances in equipment and how service will evolve in the near future. Between these two chapters is a virtual encyclopedia of cataloged information that is broken down into specific categories for easy look-up. Separate chapters are devoted to descriptions of cellular phone equipment, how and where to obtain cellular service, billing, how to use a cellular phone, using your cellular phone outside of your "home" cell area and much more. Later chapters deal with portable and transportable phones, options and accessories, dealing with operational difficulties and safety and security issues.

Throughout, the book is written in an absorbing, easy-to-understand style and is basically a nontechnical overview of cellular technology. It is well supported by drawings and photos, as well. Separate appendices are devoted to antennas, a glossary of technical terms and buzz words, and roamer access numbers.

Marketing High Technology by William H. Davidow. (Free Press, Div. of Macmillan, Inc. Hard cover. 194 pages. \$23.95.)

Have you ever wondered what ingredients go into making a given product a resounding success or why an obviously better product goes down as a miserable failure? As this author points out in this very incisive book, success is more a marketing stratagem than a physical product. Drawing on his successful marketing experience at Intel, the famous maker of IBM-standard microprocessors, he outlines basics of good marketing strategy, emphasizing that a product is complete for selling to a customer only when servicing and support are part of the overall package. Clearly spelled out are 16 principles that are almost certain to increase the effectiveness of any marketing program.

Eminently readable, this "insider's view" to the marketing of high technology is almost guaranteed to hold the reader's attention from first page to last. It goes behind the scenes to give a bird's-eye view of the clashes between IBM and Apple in the microcomputer marketplace, Visicorp's battle with Lotus, and much more that sales-oriented professionals and others will find riveting. Re-

counting his own involvement in Intel's marketing offensive against Motorola to corner the microprocessor market, the author provides a blow-by-blow description of the art of waging a winning high-tech campaign.

Some of the material contained in this book challenges traditional marketing theory. But high technology is innovative and, as a consequence, requires innovative marketing. Judging by Intel's clear victory over Motorola in the microprocessor market, practice eclipses theory, as this book makes abundantly clear.

Build Your Own Fiberoptic, Infrared, and Laser Space-Age Projects by Robert E. Iannani. (Tab Books. Soft cover. 400 pages. \$15.95.)

This book describes construction of equipment that require chassis and sub-assembly fabrication procedures rarely encountered in published projects. It describes projects ranging from a fairly simple solid-state laboratory IR laser to an exotic and highly complex ruby-laser gun and a high-power continuous CO₂ laser. Between these two extremes are a device for seeing in the dark, a fiber-optic communication system, a means for voice-modulating a He-Ne laser, an optical light detector and receiver and a laser light detector/target. Plans are also included for building a continuous-wave solid-state laser, a universal He-Ne laser power supply, a high-voltage dc generator, and a "Plasma Tornado Display Lamp/Sculpture Lamp" that puts safely behind a glass bulb a lightning-like effect that you draw to you with your hand.

Several of the projects are potentially lethal if they are not built and used correctly. A couple are also very expensive to build, like the ruby-laser gun and CO₂ laser, both of which are said to be powerful enough to punch holes in plate steel! So it is important that you heed the author's warnings. But even if you do not plan to build the more expensive projects, there is a sufficient variety of less-costly projects to interest advanced experimenters and students who want exotic science-fair projects.

NEW LITERATURE

Pressure-Transducer Selection Guide. New from the Controls Division of Ametek, Inc. is a six-page illustrated bulletin that fully describes a complete line of sol-

(Continued on page 95)

Computer Input/Output (I/O). In this application, the bandwidth-compression effects of CVSD results in a smaller amount of data storage on-disk or in RAM memory.

Optical Data Links. By driving a light-emitting diode (LED) with the digital signal and using a phototransistor and comparator at the receiving end, you have a data link.

If you wish to know more about delta modulation, the following are just a few publications to which you can refer: *Analog Data Manual* and Application Note 607 ("Delta Modulation for Voice") from Harris; *Transmission* from Dow Jones; *Telecommunications Device Manual "Telephone Quality CVSD Codecs Using New Bipolar Linear I²L I.C."* by Stephen H. Kelley and John J. Price from Motorola; and *Data Acquisition and Conversion Handbook* from Datel-Intersil.

Build a Simple Delta Modulator/Demodulator

Perhaps the best way to understand delta modulation (or any circuit, for that matter) is to actually build it. The circuits shown in Figs. 4 and 5 illustrate a simple delta modulator and demodulator, respectively. Although they're adequate for voice communication, don't expect terrific performance. Devices are available that will outperform a simple delta modulator on a single chip. However, hooking up a single chip (which is difficult to find) wouldn't lead to a very good understanding of delta modulation.

Almost any operational amplifier will work in the Figs. 4 and 5 circuits, except for the low-power types whose bandwidths can be measured with a stopwatch. You can experiment with the clock frequency, which doesn't even have to be very stable. However, don't expect too much from a clock frequency of less than about 10 kHz.

Not all pinouts or power-supply pins are shown in the schematics be-

cause this is not a blow-by-blow construction piece. Rather, it's meant to serve as an introduction to an old idea, and since different op amps can be used, their pinouts would be different. Therefore, you should refer to the data sheet of the op amp selected for pinout and other pertinent information.

Since the circuit is fairly simple in design, you can use perforated-board construction techniques to wire the modulator and demodulator. Feel free to experiment with the circuits. There's no better way to learn how they operate and perform and what their limitations are than by experimenting. **ME**

**SALE PRICES ON FLUKE DMM'S!
JOSEPH ELECTRONICS HAS THE LOWEST PRICES
PLUS FREE SHIPPING***



FLUKE 3 1/2 DIGIT 3200 COUNT ANALOG/DIGITAL MULTIMETERS		Reg.	Sale
73	Value Leader—World's Most Popular DMM—Autoranging	\$ 79	\$ 69
75	Autoranging + Range Hold Audible Continuity Function	\$109	\$ 95
77	Touch-Hold Feature + Features of Model 75	\$145	\$125
37	Bench/Portable, 0.1 VDC Accuracy 10 A. Range, 2 yr. Warranty	\$229	\$199

3 YEAR WARRANTY



FLUKE 3 1/2 DIGIT HIGH-ACCURACY HAND HELD		Reg.	Sale
8021B	0.25% DC Accuracy, Audible Continuity Function	\$169	\$149
8020B	0.1% DC Accuracy, Audible Continuity & Conductance Function	\$199	\$175
8024B	0.1% DC Accuracy, 11 Functions Peak Hold, Temperature	\$249	\$219
8026B	0.1% DC Accuracy True RMS AC Volts & Current	\$219	\$195

2 YEAR WARRANTY



4 1/2 DIGIT TRUE RMS HAND HELD		Reg.	Sale
8060A	Measures True RMS AC Volts & AMPS, dB + Frequency From 12 Hz to 200 kHz, Resistance to 300 M Ω	\$359	\$315
8062A	Same as 8060A, but Less Frequency & dB	\$295	\$265

1 YEAR WARRANTY



FLUKE TRUE RMS BENCH DMMS		Reg.	Sale
8010A	3 1/2 Digit 10 AMP Range	\$289	\$255
8010A-01	With Rechargeable Battery	\$329	\$295
8012A	3 1/2 Digit Two Low Ω Ranges	\$359	\$319
8012A-01	With Rechargeable Battery	\$399	\$355
8050A	4 1/2 Digit Relative Ref. Function 0.03% DC Accuracy	\$399	\$355
8050A-01	With Rechargeable Battery	\$439	\$389

*True RMS ac to 50kHz
*Conductance Function Checks High Resistance
1 YEAR WARRANTY

HURRY! QUANTITIES LIMITED AT ABOVE SALE PRICES!

ORDER TOLL-FREE: 1-800-323-5925

IN ILLINOIS: 312-297-4200

CHECK • MONEY ORDER • VISA • MASTERCARD • DISCOVER
Open Account to Rated Companies. Illinois Residents Add 7% Tax.
*FREE SHIPPING ON FLUKE TO UPS SHIPPABLE DESTINATIONS.

SINCE 1947
Joseph Electronics
8830 N. Milwaukee
Niles, IL 60648

Included with the Macintosh II is the Apple Desktop Bus (ADB) standard interface for input peripherals, which is also used in the Macintosh SE and Apple IIGS computers. ADB lets users connect up to 16 input devices concurrently, including keyboard, mouse and graphics tablet.

Two different keyboards are available for the Macintosh II. The Apple Keyboard includes a typewriter-style layout, numeric keypad and cursor keys, while the Apple Extended Keyboard includes the numeric keypad, function keys and special-purpose keys for using alternative operating systems like MS-DOS and terminal-emulation programs. Keyboards are packaged and sold separately from the computer.

Internal accommodations are provided for up to two 800K floppy-disk drives and one 20-, 40- or 80-Mb hard-disk system. In addition, up to

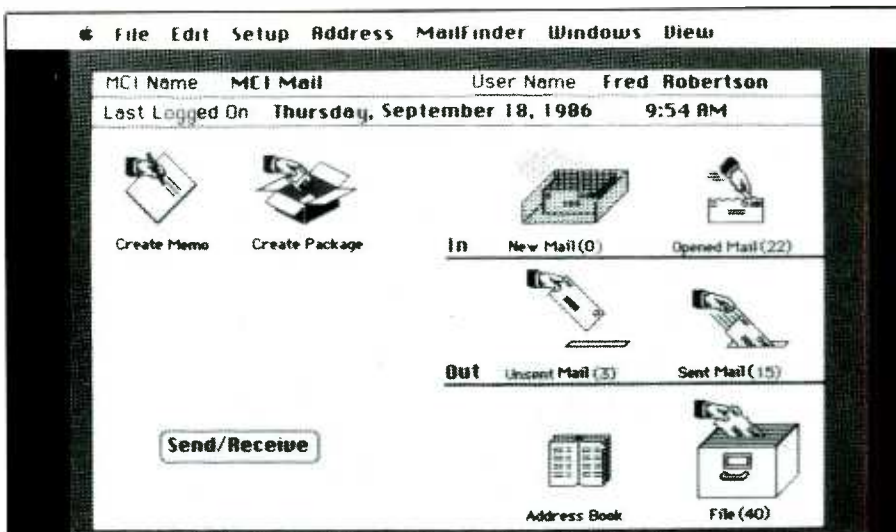

"Desktop Express" gives users electronic mail and document-delivery services, including the ability to send/receive graphics, via the MCI Mail network.

six storage devices can be daisy-chained via the SCSI port.

Operating Systems

Apple announced that it will offer A/UX, which is a version of the UNIX operating system for the Macintosh II. (To use this OS, an optional Motorola 68851 paged memory-management unit, or PMMU, must be installed in the computer.) A/UX is a full implementation of the AT&T UNIX, System V, Release 2, Version 2 operating system that includes features from Berkeley's 4.2 DBS version that provides easy portability of programs from 4.2 DSB to A/UX and communications capabilities.

A Macintosh II running A/UX offers the traditional user interface of a UNIX operating system—a high-powered command-line interpreter. Standard UNIX System V applications can be easily ported to A/UX. Additionally, a key enhancement from Apple lets A/UX users have full access to the Macintosh toolbox to give A/UX applications the look and feel of Macintosh programs. Properly designed, new applications can operate in both environments.

A/UX also offers, via plug-in cards, connections to Ethernet, AppleTalk and serial communications networks using standard UNIX communications and electronic mail facilities. It can also act as a server or client on a Sun Microsystems Network File System Ethernet network. The Apple EtherTalk Interface Card provides direct connectivity to Ethernet networks for the Macintosh II.

InterFile, file-transfer software, a 5¼" floppy-disk drive and drive controller card give the Macintosh II the capability of running software written for the IBM PC-DOS/MS-DOS operating system. MS-DOS coprocessor cards available from third-party suppliers are what make it possible for the Macintosh II (and SE) to be able to play on the same team with MS-DOS software.

With the Apple-supplied floppy-disk drive and drive controller card, the Macintosh is "somewhat" MS-DOS-compatible. With this arrangement, a user can, for example, read a Lotus 1-2-3 data file for use in a spreadsheet program like Microsoft Excel. Users who go whole hog with the coprocessor card from a third-party supplier can run dBase III or

TRANS-AM

ELECTRONICS

383 CANAL ST NYC, NY 10013
(212) 226-3893

	LED CHASER KIT	\$8.95
An electronic kit designed to help learn the basics of digital IC circuits. 10 LEDs chase in one direction at variable speeds.		
	16 LED BACK & FORTH KIT	\$14.95
More challenging, more fun! Both come with instructions. Specify red yellow or green. Works on 9VDC.		
	RIGHT ANGLE LED	\$9.95/200 pcs.
Clear red LEDs packaged 200 per bag. A closeout special while they last.		
	PROJECT BOX	\$3.95
A 4" x 6" x 3" metal box with 4 RCA jacks on one end and rubber feet. Comes apart with screws. Very well made.		
	HEAVY DUTY SIREN	\$14.95
Weatherproof 12 Vdc siren 5" high impact ABS white plastic. Swivel base. Uses 500 MA.		
	RECTANGULAR LEDs	\$5.95/100 pcs.
Diffused red LEDs. Very bright. 100 per bag.		
	WALL TRANSFORMERS	
All plug directly into 120 Vac outlet.		
	6 Vdc @ 500 MA	3.95
	12 Vdc @ 300 MA	2.95
	12 Vac @ 930 MA	4.95
	14 Vdc @ 500 MA	3.95

TERMS: \$10 MINIMUM ORDER. ADD 2.50 FOR SHIPPING. IN NYS ADD 8.25% TAX. CALL IN ORDER OR MAIL IN ORDER WITH CHECK. VISA/MC/AMEX OK. ALL ITEMS SUBJECT TO PRIOR SALE.

CIRCLE 89 ON FREE INFORMATION CARD

Lotus 1-2-3 in a window on the Macintosh II's screen.

Closing Comment

The first Macintosh model caused waves of excitement to course through the marketplace. Its bit-mapped, icon-driven interface, a takeoff on the Xerox Star, did it. With hands-on experience, however, its limited user memory, most of which was used for graphics, and employing the CPU for bit-map control, made it a poor performer. Ensuing models doubled memory capacity, thanks to the advent of 256K chips, but a great limitation was still its closed system that shut out third-party developers.

The new models' open architecture changes this picture, aside from other improvements. Starting out with wine code names, Cabernet and Chablis, the resulting harvest bodes well. Graphics cards that plug into

their ES bus are said to be similar to a PC-type bus. That is, a card in any slot is recognized by the CPU by using a configuration ROM on each card for identification. With other PC-bus similarities, an IBM-type card can run in a new Mac as if the Mac was a PC, it's been said.

The fact that IBM's (and clone makers') PCs and incompatible computers from Apple continue to coexist in today's marketplace is proof positive that there is, indeed, room out there for more than one "standard" in personal computing. Now that Apple has laid the foundation for the two to come together (there are already cards for IBM-standard machines to work with Apple files) through the new Mac's open architecture and higher performance, corporate America may take a closer look at Macintosh.

Detractors might say that Apple, with its open-architecture Macintosh

II that makes it possible for third-party suppliers to make the machine MS-DOS-compatible, has bowed to pressure. This is not the case, however. The Macintosh II still emphatically retains the Apple Mac "flavor" and only minimally (from Apple at least) bows to the so-called "IBM standard." This is still a Mac and, as such, retains its superb graphics capabilities and other functions that have made this computer the choice of so many users.

Without clones to drive down prices, though, there's a price to be paid. The new models don't come cheap. Also, though software written for the earlier models are said to be upwardly compatible and that virtually all this software can be run on the new models, it's important for buyers who already have a large Mac software investment to check out their programs on the advanced models Apple recently introduced. **ME**

BioMetal

Electro-Mechanical Motion
Without Motors Or Solenoids.

BioMetal is Toki Company's tradename for their highly processed, extremely uniform Ni-Ti alloy. When heated, the thin BioMetal wire actually contracts in length - up to 5%. Designed to be electrically activated, BioMetal outperforms and outlasts traditional Nitinol. BioMetal can run for millions of cycles with virtually no change in its operating parameters, making possible an exciting new range of electro-mechanical devices.

Space Wings

*Simple Electronics
Revolutionary Robotics*

Sleek silver wings flap continuously using only 10cm of BioMetal wire. Assemble this futuristic electronic kit in under an hour. Stands six inches high. Perches on your PC or desk lamp. Annoys cats. With circuit board, parts, and complete instructions. Requires a 3 Volt, 200 mA Adapter (Radio Shack #273-1435, or unit below).
3-001 Space Wings Kit \$19.95

3 VOLT ADAPTER - Powers Space Wings kit above. For 110 VAC input
3-012 3 Volt Adapter \$5.95

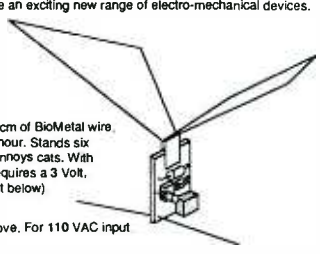

BioMetal Project Kits

DH-601 LINES, ANGLES AND LEVERS - Explore the basics of BioMetal mechanics. Make simple devices for straight and angled pulls, simple levers, and direct lifting. With 5cm of BioMetal wire, workbase, tacks, spring, AA battery holder and 8 page guidebook. Requires one AA battery.
3-013 DH-601 Kit \$4.95

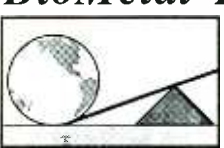

DH-603 SWITCHES, RELAYS & OSCILLATORS - A relay that switches 110 AC with just a 1-1/2 Volt battery? Yes! Also self-limiting contact, simple oscillating switch. With BioMetal wire, spring, switch, tacks, battery holder, and guidebook. Needs one AA cell. Makes exciting and practical devices.
3-015 DH-603 Kit \$9.95

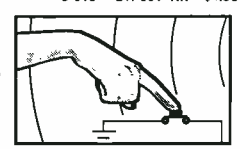

TOKI'S BIOMETAL GUIDEBOOK - Information on shape memory alloys and BioMetal. Shows sample devices, activation methods, BioMetal specs, application notes and more. 56 pages, illustrated.
3-009 BioMetal Guidebook \$5.95

Get Moving with BioMetal - Order Today. Send check or money order (sorry, no credit cards). California orders please add 7% tax. All orders add \$2.00 P & H. Mail to:

mondo-tronics 20090 Rodrigues Avenue #1
Cupertino, California 95014

(408) 255-7055 • 8 am - 5 pm Mon. - Fri.

BioMetal is a trademark of Toki Company and Space Wings is a trademark of Mondo-tronics.

MEI

* QUALITY PARTS * DISCOUNT PRICES * FAST SHIPPING!

SEND FOR FREE CATALOG... 48 PAGES!

ALL ELECTRONICS CORP.
905 S. VERMONT • P.O. BOX 20406 • LOS ANGELES, CA 90006

10 AMP SOLID STATE RELAY

CONTROL: 3 - 32 vdc
LOAD: 140 vac 10 amp
SIZE: 2 1/2" x 3/4" x 1/4"

\$9.50 EACH 10 FOR \$90.00



LIGHT ACTIVATED MOTION SENSOR

This device contains a photocell which senses sudden changes in ambient light. When an object or person passes within its field of view (about 15') it beeps for several seconds then resets. Could be used as a door annunciator or modified to trigger other devices.
5 1/2" x 4" x 1". Operates on 6 Vdc. Requires 4 AA batteries (not included).
Catalog # LSMD \$5.75 per unit



RECHARGEABLE NI-CAD BATTERIES

AAA SIZE 1.25V 500MAH \$1.85
AA SIZE 1.25V 500MAH \$1.85
AA with solder tab \$2.00
C SIZE 1.2V 1200MAH \$3.50
SUB-C SIZE solder tab \$3.50
D SIZE 1.5V 1200MAH \$3.50



48 KEY ASSEMBLY

NEW T.J. KEYBOARDS Originally used on computers, these keyboards contain 48 S.P.S.T. mechanical switches. Terminates to 15 pin connector. Frame 4" x 9"
CAT # KP-48 \$3.50 each
10 for \$30.00



3rd TAIL LIGHT ?

Sleek high-tech lamp assembly. Could be used as a third auto tail light, emergency warning light, or special-effects lamp. Red reflective lens is 2 3/4" x 5 1/2". Is mounted on a 4" high pedestal with up-down swivel adjustment. Includes 12V replaceable bulb.
CAT # TLB \$3.95 each.



COMPUTER GRADE CAPACITORS

1,400 mfd. 200 Vdc 3" x 2" dia. \$2.00
6,400 mfd 60 Vdc 4 1/4" x 1 3/8" dia. \$2.50
7,500 mfd 200 Vdc 5 3/4" x 3" dia. \$4.00
12,000 mfd 40 Vdc 4 1/4" x 2" dia. \$2.50
22,000 mfd 25 Vdc 4 3/4" x 2" dia. \$2.50
48,000 mfd 10 Vdc 3" x 2 1/2" dia. \$2.50



FLASHER LED

5 volt operation jumbo T 1 1/4 size
RED FLASHER \$1.00 each
NEW GREEN FLASHER CAT # LED-4G \$1.00



D.R.S.T. LIGHTED ROCKER SWITCH

115 vac lighted rocker snap mounts in 7/8" x 1 1/4" hole
Orange lens, 16 amp contact \$1.50



ULTRA-MINIATURE 5 VDC RELAY

Fujitsu # FBR21NED005M20
High sensitivity coil - 120 ohms \$1.25 each
CONTACTS: 1 amp 10 for \$10.00
Mounts in 14 pin DIP socket



MINI-PUSH BUTTON

S.P.S.T. momentary normally open 1/4" bushing
Red button 35¢ each
10 for \$3.00



TOLL FREE ORDERS

1-800-826-5432

(IN CA: 1-800-258-6666)

INFO • (213) 380-8000

TWX - 5101010183 ALL ELECTRONIC

• QUANTITIES LIMITED • MINIMUM ORDER \$10.00

• USA \$3.00 SHIPPING • NO P.O. #

• FOREIGN ORDERS INCLUDE SUFFICIENT SHIPPING

• CALIF. RES. ADD 6.12%

CIRCLE 33 ON FREE INFORMATION CARD

CIRCLE 26 ON FREE INFORMATION CARD

Put Your Electronic Skills to Work in ROBOTICS NOW!

BECOME A
ROBOT VEHICLE PILOT/TECH

Financial Aid
Placement Assistance



**HIGH PAY
HIGH TECH
EXCITING CAREERS**

Electronic, Hydraulic & Robotic Skills Taught.

Call or Write for
FREE BROCHURE TODAY.

Ask About Our
Correspondence Course
(713)690-0405

UNDERWATER VEHICLE TRAINING CENTER
10046 Chickasaw, Houston, TX 77041

CIRCLE 96 ON FREE INFORMATION CARD

**NEW
20-PAGE
CATALOG FREE**

7 MILLION TUBES

Includes all current, obsolete, antique, hard-to-find receiving, transmitting, industrial, radio/TV types. **LOWEST PRICES.** Major brands in stock. **Unity Electronics Dept. M**

P.O. Box 213, Elizabeth, N.J. 07206



PICKS UP A WHISPER 50 FEET AWAY!

The model WAT-50 miniature FM transmitter uses a 4-stage circuit NOT to be confused with a simple wireless microphone. Simply snap the unit on top of a 9V battery and you can hear every sound in an entire house up to 1 mile away! Use with any FM radio. Tunes to any frequency from 70mhz - 130mhz. Easy to assemble kit includes all parts and instructions. Only 29.98 tax incl.



The **WIRELESS TELEPHONE TRANSMITTER** model WTT-20 is only about the size of a dime, yet transmits both sides of a telephone conversation to any FM radio with crystal clarity. Completely automatic. Uses power from the telephone line itself - never needs a battery! Up to 1/4 mile range. Tunes from 70mhz - 130mhz. Easy to assemble kit includes all parts and instructions. Only \$29.98 tax incl.

Call or send MO, VISA, MC for immediate delivery. Single kit orders include \$1.50 S&H. **FREE SHIPPING** on orders of 2 or more. All orders shipped by U.S. Mail. COD add \$4.00. Personal checks allow 21 days.

DECO INDUSTRIES
BOX 607, BEDFORD HILLS, NY 10507
914-232-3878

CIRCLE 95 ON FREE INFORMATION CARD

92 / MODERN ELECTRONICS / May 1987

MODERN ELECTRONICS MART

Classified Commercial Rates: 90¢ per word, 15-word minimum (\$13.50) prepaid. (Word count includes name and address, ZIP code and abbreviation each count as one word; P.O. Box number and telephone number count as two words each.) Indicate free category heading. A special heading is available for a \$6 surcharge. *First word only is set boldface caps at no charge.* Add 20% for additional boldface words.

Mart Display Rates: 1" x 1 col., \$120; 2" x 1 col., \$230; 3" x 1 col., \$330. Prepayment discount 5% for 6 issues; 10% for 12 issues prepaid at once.

(All advertisers with PO Box addresses must supply permanent address and telephone number. Copy is subject to publisher approval.)

Mailing Information: Copy must be received by the publisher by the 20th of the third month preceding the cover date. Send Advertising material with check or money order to: Modern Electronics, Classified Department, 76 N. Broadway, Hicksville, NY 11801.

VIDEO

DESCRAMBLE the latest video cassette copy protection scheme. Our simple LINE ZAPPER circuit takes the jitter out of your picture. Complete plans and theory only \$13.95 plus \$1.50 postage and handling. Printed circuit board or complete kit also available. Elephant Electronics Inc., Box 41865-M, Phoenix, AZ 85080 (602) 581-1973.

PROJECTION TV . . . Convert your TV to project 7 Foot picture . . . Results comparable to \$2,500 projectors . . . Total cost less than \$30.00 . . . **PLANS AND 8" LENS \$21.95 . . .** Illustrated information **FREE.** Macrocoma-MI, Washington Crossing, Pennsylvania 18977. Credit card orders 24 HRS. (215) 736-3979.

SCIENTIFIC ATLANTA - Cable equipment. Lowest prices around. 8500 series cable units original and all turned on. Also, new unit for Scientific Atlanta boxes! This is not a tag-along piece! Plug-in installation revives the box and gives you total channel capability. This new product (**URNS ON**) your disarmed unit. Brand new to the public and only from **ADVANCED TECHNOLOGY SYSTEMS** Box 316, Auburn, MA 01501 - (617) 832-2339.

CABLE TV EQUIPMENT. All major brands. Specializing in Scientific Atlanta, Jerrold, and Zenith **ADD-ONS.** **OUR UNITS HAVE WORKED WHERE OTHERS HAVE FAILED.** Send \$3.00 for catalog to K.D. VIDEO, P.O. Box 29538, Mpls., MN 55429.

STRANGE Stuff. Plans, kits, items. Build Satellite Dish \$69. Descramblers, bugs, adult toys. Informational photo package \$3. Refundable. Dirijo Corporation, Box 212-M, Lowell, NC 28098.

DECODE nearly any Gated Pulse signal with our new super simple circuit. Works on In-band, Out-band, AM or FM pilot tone- use with Hamlin, Jerrold, Sylvania. Complete plans and theory only \$13.50 plus \$1.50 P&H. Elephant Electronics Inc., Box 41865-M, Phoenix, AZ 85080 (602) 581-1973.

CABLE TV Secrets - the outlaw publication the Cable Companies tried to Ban. HBO, Movie Channel, Showtime, Descramblers, Converters, etc. Suppliers list included. \$8.95. Cable Facts, Box 711-ME, Pataskala, OH 43062.

59 DEGREE BRAND NAME LNA's! LNB's! Ku-Band LNB's! Discount pricing! Catalog \$1.00 (Refundable); LNA, 201 E. Southern, Suite 100, Tempe, AZ 85282.

CABLE TV CONVERTERS. Scientific Atlanta, Jerrold, Oak, Zenith, Hamlin. Many others. "New" **VIDEO HOPPER** "The Copy Killer". Visa, M/C & Amex Accepted. Toll Free 1-800-826-7623. B&B Inc., 10517 Upton Circle, Bloomington, MN 55431.

ELECTRONICS

PROGRAMMABLE POWER SUPPLIES. Proven schematics and well written details are provided on several digitally programmable power supplies. Easy interface to PC and other devices or stand alone capability. \$10PPD. J. BELL, 416 Dale Terrace, Clarksville, TN 37042.

LINEAR PARTS—Transistors: MRF454 \$15, MRF455 \$12, MRF477 \$11, MRF492 \$16.75, MRF421 \$22.50, SRF2072 \$13, SRF3662 \$25, 3800 \$18.75, 2SC2290 \$19.75, 2SC2879 \$25. **Tubes:** 6KD6 \$10.50, 6LQ6 \$9.75, 6LF6 \$9.75, 8950 \$16.75. Best Prices on Palomar Road Noise Mics, Ranger AR3300. New 16 page Catalog listing radio/amplifier tricks—Channel Modification, PLL-Sliders, Peaking for Range, Hard-to-Find Linear Parts—Mail \$1.00 to: **RFPC**, Box 700, San Marcos, CA 92069. For Same Day Parts Shipment, Call (619) 744-0728.

TUBES: 59¢. Year Guarantee. Free Catalog. Tube Tester \$8.95. **CORNELL**, 4213-17 University, San Diego, CA 92105.

FREE RFI Technical Note tells how to keep RF out of TV's, telephones, etc. with ferrite beads. Palomar Engineers, Box 455, Escondido, CA 92025.

VOICE DISGUISEERS! FM Bugs! SWL Active Antenna! Receivers! More! Catalog \$1.00 (Refundable): **XANDI ELECTRONICS**, Box 25647, "H", Tempe, AZ 85282.

INTEL, RCA, NATIONAL, OKI, SGS, and more. Factory prime and surplus parts catalog. **LYNBAR Industries**, 205 Main, Box 822, St. Joseph, MI 49085-0822.

ROBOTICS Experimenters Manual—photos, diagrams, electronic circuits for computer controlled robots \$8.00. Syntronics, 514 Wanda Drive, Nashville, TN 37210.

COMPUTERS

TI-99/4A Software/Hardware bargains. Hard to find items. Huge selection. Fast Service. Free Catalog. **TYNAMIC**, Box 690, Hicksville, NY 11801.

Say You Saw It In Modern Electronics

1-800-344-4539

CORPORATION AK, Puerto Rico - 218-81-8674 Telex - 62227914 FAX - 218-811-3830 TWX - 910-358882 DIGI KEY CORP

NATIONAL SEMICONDUCTOR • PANASONIC MACHINE • EWC, INC. • INTERSIL • AD EAC, INC. • J. W. MILLER • AAVD ENGINEER E. F. JOHNSON • ATLANTIC SEMICONDUCTOR

256K (262,144 x 1) DRAM 150NS \$5.70 / \$39.95/91
Factory Firsts

JONES • DIAMOND TOOL • UNGAR • E.C. • CW INDUSTRIES • AMDEK • G.E. JGAR • YAGEO • J. W. MILLER • LUXO SC CHEMICALS • ARIES • PLESSEY

INTEGRATED CIRCUITS

Part No.	Manufacturer	Package	Price
7400 TTL	74LS125N	14DIP	88
7401N	74LS125N	14DIP	88
7402N	74LS125N	14DIP	88
7403N	74LS125N	14DIP	88
7404N	74LS125N	14DIP	88
7405N	74LS125N	14DIP	88
7406N	74LS125N	14DIP	88
7407N	74LS125N	14DIP	88
7408N	74LS125N	14DIP	88
7409N	74LS125N	14DIP	88
7410N	74LS125N	14DIP	88
7411N	74LS125N	14DIP	88
7412N	74LS125N	14DIP	88
7413N	74LS125N	14DIP	88
7414N	74LS125N	14DIP	88
7415N	74LS125N	14DIP	88
7416N	74LS125N	14DIP	88
7417N	74LS125N	14DIP	88
7418N	74LS125N	14DIP	88
7419N	74LS125N	14DIP	88
7420N	74LS125N	14DIP	88
7421N	74LS125N	14DIP	88
7422N	74LS125N	14DIP	88
7423N	74LS125N	14DIP	88
7424N	74LS125N	14DIP	88
7425N	74LS125N	14DIP	88
7426N	74LS125N	14DIP	88
7427N	74LS125N	14DIP	88
7428N	74LS125N	14DIP	88
7429N	74LS125N	14DIP	88
7430N	74LS125N	14DIP	88
7431N	74LS125N	14DIP	88
7432N	74LS125N	14DIP	88
7433N	74LS125N	14DIP	88
7434N	74LS125N	14DIP	88
7435N	74LS125N	14DIP	88
7436N	74LS125N	14DIP	88
7437N	74LS125N	14DIP	88
7438N	74LS125N	14DIP	88
7439N	74LS125N	14DIP	88
7440N	74LS125N	14DIP	88
7441N	74LS125N	14DIP	88
7442N	74LS125N	14DIP	88
7443N	74LS125N	14DIP	88
7444N	74LS125N	14DIP	88
7445N	74LS125N	14DIP	88
7446N	74LS125N	14DIP	88
7447N	74LS125N	14DIP	88
7448N	74LS125N	14DIP	88
7449N	74LS125N	14DIP	88
7450N	74LS125N	14DIP	88
7451N	74LS125N	14DIP	88
7452N	74LS125N	14DIP	88
7453N	74LS125N	14DIP	88
7454N	74LS125N	14DIP	88
7455N	74LS125N	14DIP	88
7456N	74LS125N	14DIP	88
7457N	74LS125N	14DIP	88
7458N	74LS125N	14DIP	88
7459N	74LS125N	14DIP	88
7460N	74LS125N	14DIP	88
7461N	74LS125N	14DIP	88
7462N	74LS125N	14DIP	88
7463N	74LS125N	14DIP	88
7464N	74LS125N	14DIP	88
7465N	74LS125N	14DIP	88
7466N	74LS125N	14DIP	88
7467N	74LS125N	14DIP	88
7468N	74LS125N	14DIP	88
7469N	74LS125N	14DIP	88
7470N	74LS125N	14DIP	88
7471N	74LS125N	14DIP	88
7472N	74LS125N	14DIP	88
7473N	74LS125N	14DIP	88
7474N	74LS125N	14DIP	88
7475N	74LS125N	14DIP	88
7476N	74LS125N	14DIP	88
7477N	74LS125N	14DIP	88
7478N	74LS125N	14DIP	88
7479N	74LS125N	14DIP	88
7480N	74LS125N	14DIP	88
7481N	74LS125N	14DIP	88
7482N	74LS125N	14DIP	88
7483N	74LS125N	14DIP	88
7484N	74LS125N	14DIP	88
7485N	74LS125N	14DIP	88
7486N	74LS125N	14DIP	88
7487N	74LS125N	14DIP	88
7488N	74LS125N	14DIP	88
7489N	74LS125N	14DIP	88
7490N	74LS125N	14DIP	88
7491N	74LS125N	14DIP	88
7492N	74LS125N	14DIP	88
7493N	74LS125N	14DIP	88
7494N	74LS125N	14DIP	88
7495N	74LS125N	14DIP	88
7496N	74LS125N	14DIP	88
7497N	74LS125N	14DIP	88
7498N	74LS125N	14DIP	88
7499N	74LS125N	14DIP	88
7500N	74LS125N	14DIP	88

INTEGRATED CIRCUITS

Part No.	Manufacturer	Package	Price
4000 CMOS	74VHC00	14DIP	88
74VHC01	74VHC01	14DIP	88
74VHC02	74VHC02	14DIP	88
74VHC03	74VHC03	14DIP	88
74VHC04	74VHC04	14DIP	88
74VHC05	74VHC05	14DIP	88
74VHC06	74VHC06	14DIP	88
74VHC07	74VHC07	14DIP	88
74VHC08	74VHC08	14DIP	88
74VHC09	74VHC09	14DIP	88
74VHC10	74VHC10	14DIP	88
74VHC11	74VHC11	14DIP	88
74VHC12	74VHC12	14DIP	88
74VHC13	74VHC13	14DIP	88
74VHC14	74VHC14	14DIP	88
74VHC15	74VHC15	14DIP	88
74VHC16	74VHC16	14DIP	88
74VHC17	74VHC17	14DIP	88
74VHC18	74VHC18	14DIP	88
74VHC19	74VHC19	14DIP	88
74VHC20	74VHC20	14DIP	88
74VHC21	74VHC21	14DIP	88
74VHC22	74VHC22	14DIP	88
74VHC23	74VHC23	14DIP	88
74VHC24	74VHC24	14DIP	88
74VHC25	74VHC25	14DIP	88
74VHC26	74VHC26	14DIP	88
74VHC27	74VHC27	14DIP	88
74VHC28	74VHC28	14DIP	88
74VHC29	74VHC29	14DIP	88
74VHC30	74VHC30	14DIP	88
74VHC31	74VHC31	14DIP	88
74VHC32	74VHC32	14DIP	88
74VHC33	74VHC33	14DIP	88
74VHC34	74VHC34	14DIP	88
74VHC35	74VHC35	14DIP	88
74VHC36	74VHC36	14DIP	88
74VHC37	74VHC37	14DIP	88
74VHC38	74VHC38	14DIP	88
74VHC39	74VHC39	14DIP	88
74VHC40	74VHC40	14DIP	88
74VHC41	74VHC41	14DIP	88
74VHC42	74VHC42	14DIP	88
74VHC43	74VHC43	14DIP	88
74VHC44	74VHC44	14DIP	88
74VHC45	74VHC45	14DIP	88
74VHC46	74VHC46	14DIP	88
74VHC47	74VHC47	14DIP	88
74VHC48	74VHC48	14DIP	88
74VHC49	74VHC49	14DIP	88
74VHC50	74VHC50	14DIP	88

TTL SOCKETS

Part No.	Manufacturer	Package	Price
74VHC00	74VHC00	14DIP	88
74VHC01	74VHC01	14DIP	88
74VHC02	74VHC02	14DIP	88
74VHC03	74VHC03	14DIP	88
74VHC04	74VHC04	14DIP	88
74VHC05	74VHC05	14DIP	88
74VHC06	74VHC06	14DIP	88
74VHC07	74VHC07	14DIP	88
74VHC08	74VHC08	14DIP	88
74VHC09	74VHC09	14DIP	88
74VHC10	74VHC10	14DIP	88
74VHC11	74VHC11	14DIP	88
74VHC12	74VHC12	14DIP	88
74VHC13	74VHC13	14DIP	88
74VHC14	74VHC14	14DIP	88
74VHC15	74VHC15	14DIP	88
74VHC16	74VHC16	14DIP	88
74VHC17	74VHC17	14DIP	88
74VHC18	74VHC18	14DIP	88
74VHC19	74VHC19	14DIP	88
74VHC20	74VHC20	14DIP	88
74VHC21	74VHC21	14DIP	88
74VHC22	74VHC22	14DIP	88
74VHC23	74VHC23	14DIP	88
74VHC24	74VHC24	14DIP	88
74VHC25	74VHC25	14DIP	88
74VHC26	74VHC26	14DIP	88
74VHC27	74VHC27	14DIP	88
74VHC28	74VHC28	14DIP	88
74VHC29	74VHC29	14DIP	88
74VHC30	74VHC30	14DIP	88
74VHC31	74VHC31	14DIP	88
74VHC32	74VHC32	14DIP	88
74VHC33	74VHC33	14DIP	88
74VHC34	74VHC34	14DIP	88
74VHC35	74VHC35	14DIP	88
74VHC36	74VHC36	14DIP	88
74VHC37	74VHC37	14DIP	88
74VHC38	74VHC38	14DIP	88
74VHC39	74VHC39	14DIP	88
74VHC40	74VHC40	14DIP	88
74VHC41	74VHC41	14DIP	88
74VHC42	74VHC42	14DIP	88
74VHC43	74VHC43	14DIP	88
74VHC44	74VHC44	14DIP	88
74VHC45	74VHC45	14DIP	88
74VHC46	74VHC46	14DIP	88
74VHC47	74VHC47	14DIP	88
74VHC48	74VHC48	14DIP	88
74VHC49	74VHC49	14DIP	88
74VHC50	74VHC50	14DIP	88

5% Carbon Film Resistors

Part No.	Value	Price
RA001	100 Ohm	1.00
RA002	200 Ohm	1.00
RA003	300 Ohm	1.00
RA004	400 Ohm	1.00
RA005	500 Ohm	1.00
RA006	600 Ohm	1.00
RA007	700 Ohm	1.00
RA008	800 Ohm	1.00
RA009	900 Ohm	1.00
RA010	1K Ohm	1.00
RA011	2K Ohm	1.00
RA012	3K Ohm	1.00
RA013	4K Ohm	1.00
RA014	5K Ohm	1.00
RA015	6K Ohm	1.00
RA016	7K Ohm	1.00
RA017	8K Ohm	1.00
RA018	9K Ohm	1.00
RA019	10K Ohm	1.00
RA020	15K Ohm	1.00
RA021	20K Ohm	1.00
RA022	30K Ohm	1.00
RA023	40K Ohm	1.00
RA024	50K Ohm	1.00
RA025	60K Ohm	1.00
RA026	70K Ohm	1.00
RA027	80K Ohm	1.00
RA028	90K Ohm	1.00
RA029	100K Ohm	1.00
RA030	150K Ohm	1.00
RA031	200K Ohm	1.00
RA032	300K Ohm	1.00
RA033	400K Ohm	1.00
RA034	500K Ohm	1.00
RA035	600K Ohm	1.00
RA036	700K Ohm	1.00
RA037	800K Ohm	1.00
RA038	900K Ohm	1.00
RA039	1M Ohm	1.00
RA040	1.5M Ohm	1.00
RA041	2M Ohm	1.00
RA042	3M Ohm	1.00
RA043	4M Ohm	1

SUPER ANTENNA

For FM, VHF/UHF TV and Police Scanners

This super mono-pole pulls in signals like a magnet. Can be made directional or omni-directional. Beautiful all black finish. Mount on back of TV, place on shelf, or hold it. Boost 50 to 900 MHz signal. 120w 75ohm output. 110V AC operation. Order Model RF 36 \$79.95 plus \$3.00 postage and handling. Send check. Visa MasterCard or American Express number and expiration date. 30-day satisfaction guarantee. Phone: (615) 381-9001



RHOADES P.O. Box 1316, Dept. BM9
Columbia, TN 38402

SPEAKER CATALOG

1001 bargains in electronics. Save up to 50% call toll free 1-800-346-2433 for ordering only. Order by VISA/MC/AMX. No COD's. Missouri, Alaska, Hawaii call 1-816-842-5092, or write McGee Radio, 1901 McGee St., K.C., MO 64108. Postage for catalog \$1.00.

LED LAPEL / TIE PIN

A REAL CONVERSATION PIECE!! Bright red miniLED with long-life miniBattery built into clasp. Perfect for jacket lapel or tie!

Send \$4.95 plus \$.75 Shipping/Handling to: BritLite Creations, P.O. Box 2476, Dept. ME1, Mesa, Arizona 85204. Get Glowing today!

Order Back Issues of

MODERN ELECTRONICS

BASIC Computers, 10 lesson correspondence course, \$39.50. Certificate. Details free. **AMERICAN TECHNICAL INSTITUTE**, Box 201, Cedar Mountain, NC 28718.

FINAL Closeout of new, Surplus, MS-DOS Software, and Manuals!! 10% Off with this ad. Free Catalog. **GIL Electronics**, Dept. 2, P.O. Box 1628, Soquel, CA 95073.

SOFTWARE. Get the best through the modern. Complete guide \$4.00. **CompuHelp**, 4317 Milam, Bryan, TX 77801.

COMMUNICATIONS

COMMUNICATIONS PLANS, BOOKS, KITS! AM/FM broadcasting (licensed/unlicensed), 1750 Meter transceivers, ham/CB amplifiers, surveillance bugs, more! **FREE** catalog, **PAN-COM**, Box 130-ME5, Paradise, CA 95967.

COCO II UPGRADES (PARTS)

COCO II Upgrade Kits, RGB Interface, 256K Memory, ETC - Electronic Parts all types - Free catalog. **Inventive Solutions**, P.O. Box 286, Stanfordsville, NY 12506.

EXPERIMENTERS

INTERESTING Electronic Parts, Kits, Plans; High Voltage, Laboratory, Laser, Stroboscopic Devices. Catalog and Technical Newsletter—Send \$1—Refunded first order. **ALLEGRO ELECTRONIC SYSTEMS**, 3A Mine Mountain, Cornwall Bridge, CT 06754.

INVENTORS

INVENTORS! Have idea for product or invention, don't know what to do? Call **AIM** we present ideas to manufacturers - Toll Free 1-800-225-5800.

INVENTORS

INVENTORS! Can you profit from your idea? Call **AMERICAN INVENTORS CORPORATION** for free information. Over a decade of service, 1-800-338-5656. In Massachusetts or Canada call (413) 568-3753.

DIGITAL AUDIO

DIGITAL AUDIO RECORDER Commodore-64. Excellent Sound! Plans, P.C.B., & **DRUM SOFTWARE:** \$19.95. **KIT** \$49.95. PostPaid, **ORDER NOW!! TAD PAINTER**, P.O. Box 166055, IRVING, TX 75016.

HACKERS

Pay TV and Satellite Descrambling 100 pages. 13 cable and 7 satellite systems. Schematics, theory. Countermeasures included. \$14.95. **Experiments With Videocipher.** Bypasses, turnons \$12.95. **Cable TV** two-way systems, security \$12.95 **MDS/MMDS Handbook.** For microwave Hackers \$12.95. **Build Satellite Systems Under \$600.** \$12.95. Any 3/\$26. Catalog \$1. **Shojiki Electronics Corp.**, 1327P Niagara St., Niagara Falls, N.Y., 14303. COD's 716-284-2163.

TV/RADIO

MICROWAVE ANTENNAS from \$69.95, Call 1-800-247-1151.

MISCELLANEOUS

ASIAN LADIES want correspondence for friendship, marriage, **SUNSHINE INTERNATIONAL**, Dept. TW, Box 260, North Hollywood, CA 91603.

ASIAN women seek friendship, marriage. Correspondence Club. Photos, Details: **GRE**, Box 555, Elmont, NY 11003.

SAI SYSTEMS LABORATORIES, INC.

TURBO XT MONOCHROME COMPLETE SYSTEM: \$659.

- 640 K MEMORY
- TURBO INTEL 8086-2 (4.77 & 8 MHZ)
- TWO FUJITSU 360 K FLOPPY DRIVES
- FLOPPY DISK CONTROLLER
- MONOCHROME HERCULES COMPATIBLE GRAPHICS ADAPTOR WITH PRINTER PORT
- HI/RES. MONOCHROME MONITOR
- INDUSTRY STANDARD ROM BIOS
- HEAVY DUTY METAL SLIDE OFF CASE WITH SPEAKER
- HEAVY DUTY 150W POWER SUPPLY
- AT STYLE KEYBOARD
- 8 EXPANSION SLOTS
- ASSEMBLED AND FULLY TESTED IN U.S.A.
- F.C.C. APPROVED
- 1 YEAR LIMITED WARRANTY



TURBO AT MONOCHROME COMPLETE SYSTEM: \$1199.

- 640 K MEMORY
- INTEL 80286 (6 - 10 MHZ)
- 1.2 MB FLOPPY DRIVE
- FDD/HDD FLOPPY CONTROLLER
- MONOCHROME HERCULES COMPATIBLE GRAPHICS CARD
- HI/RES. MONOCHROME MONITOR
- AT KEYBOARD
- INDUSTRY STANDARD ROM BIOS
- 200W POWER SUPPLY
- ASSEMBLED AND FULLY TESTED IN U.S.A.
- F.C.C. APPROVED
- 1 YEAR LIMITED WARRANTY

XT UPGRADE OPTIONS

TTX RGB COLOR MONITOR (640x200)	\$199.00
TTX EGA COLOR MONITOR (720x400)	\$499.00
(w/adaptor)	\$499.00
XT/AT SWITCHABLE ENHANCED KEYBOARD	\$49.00
(w/12 functions)	\$49.00
S/P/G WITH CLOCK-CALENDAR	\$49.00
20 MB SEAGATE ST-225	\$399.00
W/DIGITAL CONTROLLER	\$469.00
30 MB SEAGATE ST-238	\$469.00
W/DIGITAL CONTROLLER	\$469.00
LDT MORE XT EXPANSION CARDS	
CALL FOR DETAILS	

AT UPGRADE OPTIONS

TTX R.G.B. COLOR MONITOR (640x200)	\$199.00
TTX E.G.A. COLOR MONITOR (720x400)	\$499.00
(w/adaptor)	\$499.00
SEAGATE 20 MB ST225 / 69 msec	\$325.00
SEAGATE 30 MB ST4038 / 39 msec	\$599.00
SEAGATE 40 MB ST4051 / 39 msec	\$759.00
ADDITIONAL 360 K DRIVE	\$99.00
SERIAL / PARALLEL / GAME CARD	\$69.00
FULL 1-MB MEMORY EXPANSION CARDS	\$59.00
LOTS MORE EXPANSION CARDS - CALL	

NO SURCHARGE   

OPEN 7 DAYS FOR YOUR CONVENIENCE
9:00 am to 7:00 pm
NATIONAL TOLL FREE — 1-800-331-0488
In Florida, call: 1-305-296-6083

100% SATISFACTION GUARANTEED

If you are not satisfied with our computers, return within 14 days for refund less shipping and \$50 re-stock charge.

SAI SYSTEMS LABORATORIES, INC.
103 Fitzpatrick Street • Key West, FL 33040

ATTENTION volume buyers, we offer substantial discounts. We accept purchase orders from Fortune 500 companies / universities / institutions. Call and ask for Bob Gurban.
TERMS: Shipping and handling 5% (minimum \$6.00) C.O.D. and second day air available at small additional charge. No sales tax on orders out of Florida. IBM/AT is a registered trademark of IBM Corp.

INNOVATIVE PROJECTS FOR THE ELECTRONICS ENTHUSIAST AT AFFORDABLE PRICES

GREAT FOR: COMPUTER ROOM, RADIO STATION, HAM SHACK

12/24 HOUR DISPLAY
QUARTZ TIME BASE
6.25 INCH RED LED DIGITS
STYLISH PLEXIGLAS CASE



\$69.95 KIT \$99 ASSEMBLED

320 WATTS PEAK POWER FOR YOUR CAR STEREO!



100W/CH RMS PWR
LESS THAN 1% THD
FAN COOLED

DIGITAL AMP DESIGN! COMPACT SIZE 6"x6"x4" AMPLIFIER KIT.....\$150

ASSEMBLED AND TESTED.....\$200

SPEED UP YOUR PC BY 30% WITH THE PC ACCELERATOR!



WORKS WITH IBM PC & CLONES
DUAL XTAL DESIGN
FLEXIBLE INSTALLATION
HARDWARE RESET PUSH BUTTON
ATTRACTIVE CONTROL BOX
WORKS WITH NEC V20
PLUG-IN PC BOARD
REPLACES 8284A CHIP

COMES WITH SSE (SPEED EVALUATION SOFTWARE)

MOST ECONOMICAL SPEED ACCELERATOR ON THE MARKET

KIT.....\$29.95
ASSEMBLED.....\$49.95

LABEL FLEX FLEXIBLE SOFTWARE TOOL \$19.95

MAXIMIZE YOUR POWER

LABELS, ENVELOPES, ROLDEX CARDS & MORE

T-100 DIGITAL THERMOMETER WORKS WITH ANY VOLTMETER



C or F OUTPUT
AD590 SENSOR

\$19.95 KIT

ENERGY MANAGEMENT PROJECTS



REDUCE YOUR AC/HEAT COSTS
4 DIGIT LED DISPLAY OF ELECTRICITY COST

FAN DELAY KIT \$29.95 AUDITOR KIT \$34.95

NRG ORDER BY MAIL PREPAID OR COD FROM NRG ELECTRONICS, PO BOX 24138 FT LAUDERDALE, FL 33307 OR BY PHONE (305) 971-3823
INCLUDE \$3 SHIPPING, FRE RESIDENTS ADD SALES TAX

NEW LITERATURE (from page 88)

id-state piezoresistive pressure transducers in the ranges from 0 to 6 through 0 to 5,000 PSIG; 0 to 15, 60 or 100 PSIA and 0 to 6 through 0 to 300 PSID, with millivolt, volts dc or 4-to-20-mA outputs. In addition to complete product specifications, dimensions and ordering information, the bulletin gives applications information. For a free Bulletin No. TG-100, write to: Ametek, Inc., Controls Div., 820 Pennsylvania Blvd., Feasterville, PA 19047.

Tools Catalog. A full-color catalog that introduces new service and maintenance tool kits and hard-to-find tools for modern computer, telecommunications and electronics technology is available from Jensen. The catalog contains complete descriptions, including prices, for products designed for on-site and in-the-field work. Included are VCR alignment and communications adapter kits. AT&T handsets, digital test equipment, working devices, tool cases, heavy-duty

aerospace/military transport cases, soldering stations, hand and power tools, computer accessories, cleaning supplies and more. For a free copy, write to: Jensen Tools Inc., 7815 S 46 St., Phoenix, AZ 85044.

Electronics Supplies Catalog. Contact East's 1987 product guide contains listings and full descriptions of a complete line of test instruments, tools and accessories for electronics. Highlighted are the latest in static control, an expanded toolkit line and fiber-optic equipment. Emphasis is on test instruments (DMMs, oscilloscopes, counters, power-line monitors, disk-drive testers, etc.), soldering supplies, and a line of toolkits for a variety of specialized electronic applications. A color photo accompanies each item listed, and all product descriptions include complete specifications and prices. For a free catalog and one year of technical supplements, write to: Contact East, P.O. Box 786, N. Andover, MA 01845.

State of the Art Kits by Hal-Tronix, Inc.

TOUCH-TONE DECODER AND ENCODER KITS

HAL-567-12 \$39.95
TOUCH-TONE DECODER, SINGLE LINE IN 12 LINES OUT. COMES COMPLETE WITH P.C. BOARD AND ALL PARTS. NO SOCKETS. CASE OR POWER SUPPLY.

HAL-567-16 \$59.95
TOUCH-TONE DECODER, SINGLE LINE IN 16 LINES OUT. COMES COMPLETE WITH P.C. BOARD AND ALL PARTS PLUS SOCKETS. NO CASE OR POWER SUPPLY.

HAL-EC-12 \$29.95
TOUCH-TONE ENCODER, 3 x 4 1/2 CHARACTER USE FOR DIALING. COMES COMPLETE WITH ALL ELECTRONIC PARTS. INCLUDES SPEAKERS FOR AUDIO COUPLING AND L.E.D. FOR VISUAL INDICATION. CRYSTAL CONTROLLED SINGLE IC CHIP & ALUM CASE.

HAL-EC-16 \$39.95
TOUCH-TONE ENCODER, 4 x 4 1/2 CHARACTER USE FOR DIALING. COMES COMPLETE WITH ALL ELECTRONIC PARTS. INCLUDES SPEAKER FOR AUDIO COUPLING AND L.E.D. FOR VISUAL INDICATION. CRYSTAL CONTROLLED SINGLE IC CHIP & ALUM CASE.

PRE-AMPLIFIERS

HAL PA 19 \$9.95
WIDE BAND - 2-200 MHZ - 19 DB - BUILT AND TESTED

KEYERS AND OPTIONAL REVISION KITS

ACCUKEYER KIT \$16.95
THIS ACCUKEYER KIT IS A REVISED VERSION OF THE FAMOUS WB4VFP ACCUKEYER, BUT WITH SIDE TONE ON BOARD. COMES COMPLETE WITH ALL ELECTRONIC PARTS. LESS SOCKETS, POWER SUPPLY AND CASE.

ACCU-MEMORY 1101 \$16.95
LOW COST METHOD OF ADDING MEMORY TO THE ACCUKEYER COMES WITH TWO 1101 MEMORIES GIVING YOU CHANNELS CAPABLE OF 30 CHARACTERS PER CHANNEL. COMES COMPLETE WITH ALL ELECTRONIC PARTS INCLUDING SOCKETS. LESS CASE AND POWER SUPPLY.

ACCU-MEMORY 2102 \$21.95
LOW COST METHOD OF ADDING LARGER MEMORY TO THE ACCUKEYER. PROVISIONS FOR 2102'S (ONLY 12102 COMES WITH THE KIT) HAS THE CAPABILITY OF 4 CHANNELS WITH 120 CHARACTERS EACH. COMES COMPLETE WITH SOCKETS. LESS 3 OF THE 2102'S. LESS POWER SUPPLY AND CASE.

SPECIAL OFFER

#1 BUY THE ACCUKEYER AND 1101 OPTION TOGETHER (ONLY) \$32.00
#2 BUY THE ACCUKEYER AND 2102 OPTION TOGETHER (ONLY) \$37.00
#3 BUY THE ACCUKEYER AND 2102 OPTION ALONG WITH THREE EXTRA 2102'S AND SOCKETS (ONLY) \$40.00

PROXIMITY KEYS \$19.95
TOUCH-PADDE ENABLES ONE TO GENERATE DOTS AND DASHES WITH THE TOUCH OF A FINGER (NO MOVING PARTS) COMES COMPLETE WITH ALL ELECTRONIC PARTS LESS CASE AND POWER SUPPLY.

"HAL" HAROLD C. NOWLAND W8XHZ

HAL-TRONIX, INC.
12671 Dix-Toledo Hwy.
P.O. Box 1101, Dept C
Southgate, MI 48195
(313) 281-7773
Hours: 12:00 - 6:00 EST Mon.-Sat.

CIRCLE 62 ON FREE INFORMATION CARD

MICRO MART

508 Central Ave.
Westfield, N.J. 07090
(201) 854-8008

TOKO COILS FOR FEB 1984 TV PROJECT

Toko #s BKAN-K5552AXX(2), #E520HN-300023 (071uH) & L-2(12uH) Fixed. 1 Set Of 4 Pcs 6.00, 3 Sets 15.00, 10 Sets 45.00

Diode Ass't-65 Pcs Total-Includes 1N4148, 1N914, 1N4004, 1N4007 1.95

Zener Ass't-65 Pcs Total-Includes Minimum 3 Different 1W Devices 1.95

LED Ass't-Jumbo, Medium, Mini, Red, Green And Amber-25 Pcs 1.95

Resistor Ass't-11,000 Pcs 35 Values Minimum Popular Values (1K, 10K, 100K) Included. Mostly 1/4 & 1/2W. Some 1 & 2W. Lots Of Precisions Carton Film. Taped And Reeled For Easy Sorting 9.95

Regulator Ass't-7 Pcs Includes 7805, 7806, 7812, 7824, 7905, 7912, LM309 1.95

LM317T Adjustable Reg (#5630196) .75

Mica Insulators For TO-220 Material. About 2000 Self Adhesive Rubber Stripping-Cut To Any Lengths You Choose (3M-Bumpun), 3 Feet/2.00, 10 Feet/5.00, 50 Feet/20.00

Jumpers Plugs (Caution-Male To Male For Breadboard & Connectors) 101.25

7400 TTL Ass't-20 Pcs, Minimum 10 Different Device Types (7410, 32, 42, 74, 92) Etc-2.95

74 LSXX Ass't-30 Pcs, Minimum 15 Different Device Types (LS02, 04, 05, 10, 14) Etc-2.95

4000 CMOS Ass't- Minimum 8 Different Device Types (4001/11, 49, 51) Etc-20 Pcs/3.75

74SCXX SERIES IC'S LOW POWER, HIGH SPEED ISO-CMOS (PIN COMPATIBLE TO LSXX & SIMILAR TO HCXX)

74SC137	45	74SC373	35
74SC138	45	74SC374	60
74SC139	60	74SC533	50
74SC237	60	74SC534	50
74SC239	60	74SC540	50
74SC240	50	74SC553	1.50
74SC241	60	74SC564	60
74SC244	35	74SC573	2.00
74SC245	35	74SC584	2.00

Data Book For All Above #s 2.50

DIP IC SOCKETS

8 PIN/07, 14 PIN/13, 16 PIN/15, 18 PIN/17, 20 PIN/19, 22 PIN/21, 24 PIN/23, 28 PIN/26, 40 PIN/39

Zero Insertion Test Socket 28 Pin 1.50

MAN6910-Double Digi 7 Segment Display, Hi Efficiency Red, 56" Comm Ann 1.25

MM5481-14 Segment Driver Chip 1.50

1.5A 50V Bridge (TO-5) .75

6A 600V Bridge 5/8" Square 1.00

10A 600V Bridge 5/8" Square 1.15

25A 200 Bridge (Solder Lug Type) 2.00

12VDC SPST Reed Relay PC Mount 60

DPDT "Snap in" Rocker With Bulb Socket 75

Push-Lighted Switch (No Bulb) Off-Mom 95

Pushbutton DPST Off-Mom PC Mount 3/10

DPDT Push Button 6A 125V 65

TPDT "Bat" Handle Toggle (On Off On) 1.65

DPDT RT Angle PC Toggle (On Off On) 95

Low Fluid Level Detector Kit-Parts, PC Board & Instructions 4.95

11 LED Bar Graph Display, 2 3/4", Rectangular w/LED's (Specify Red, Green, Amber) 2.69

Giant Alpha Numeric Display 1 1/2" x 2" x 7 x 5 (35 Total) Red LED Matrix 4.95

Electrolytic Cap Ass't-Includes 2.2uF, 4.7uF, 10uF, 47uF, 220uF, 470uF, 1,000uF, 3,300uF & Others (Voltages & Lead Configurations Vary) 15 Pcs Total 1.95

Resistor Networks-High Quality Dip Circuits (Beckman, Dale, Bourns) 6 Pcs/6 Va use- 2.00

Connector/Header Ass't-Ribbon Cable, Edgecard, "Snap-Off" Headers Etc. 10 pcs/2.95

22uF 35V Solid Tantalum (Kemet) 4/10

100uF 20V Solid Tantalum (Kemet) 3/10

1,000uF 75V Axial 75

3,200uF 50V Twist Lock 1.00

3,300uF 50V Axial Lytic 75

5,000uF 40V Computer Grade (Mallory) 2.50

Monolithic Cap Ass't 25/1.95

Crystal Clock Oscillator 14.9760 MHz 50

UCN4116B-OSC/Freq Div Circuit 5/1.00

AM/FM Radio IC W/Data Sheet (#2204) \$5/1.00

2N3643 (TO-92 Silicon Gen Purp-NPN) \$0/1.00

Slide Pots-1 Each 50K, 100K, 1.2M 2M, 5M 1.00

ULN2231 (Deico DM50) Dual Preamp IC 2/1.00

?Mystery? Bag #1 The "OHM" Bag 1.00

?Mystery? Bag #2 The "Volt" Bag 1.00

?Mystery? Bag #3 The "Circuit" Bag 1.00

?Mystery? Bag #4 The "Frequency" Bag 1.00

?Mystery? Bag #5 The "Tolerance" Bag 1.00

Kit, Returns/Exchanges With Mystery Bags 2.45

IC Storage "Bug" Box 1.80

Heavy Duty Alligator Clips (10 Sets) 2.30

Regular Alligator Clips (10 Sets) 1.80

Wire Strippers (Spring Loaded, Adjust.) 2.50

5" Needle Nose Pliers (Spring Loaded) 3.95

4 1/2" Diagonal Cutters (Spring Loaded) 3.00

Nut Driver-Set For 3/16", 1/4", 5/16" Jeweler's Screwdrivers (4 Pcs) 2.65

Desoldering Pump (Solder Sucker) 4.00

Replacement Tips For Solder Sucker 2/3.00

25W Precision Soldering Iron 5.00

Safety Goggles 2.95

De-Soldering Braid (5 Foot Roll) 1.00

Solder Aid Tool Kit (4 Pcs) 3.00

Soldering Iron Convenience Stands 5/1.00

Model 610B Logic Probe (Pencil Type) 18.95

Model 620B Logic Puzler (Pencil Type) 18.95

Switching Power Supply-Pic & Minus 5 & 12 Volts 200W, By Conv. 49.95

Voltage Mate Switching Regulator Kit 18.95

MRF901 (Hobby-You Test) 10/1.00

Pine PT110V 38" Horizontal Mount Trimpots 100 OHM, 1K, 5K, 20K, 50K, 100K, 200K, 500K, 1M, Single Turn 4/1.00

Multi-Turn Precision Trimpots (Copal), 100 OHM, 500 OHM, 1K, 10K, 20K, 50K, 100K, 1M, 1.00 Each. 7 Segment Display Ass't 6/2.75

Zenith TV Replacement IC Special 1.00 Each 221-42, 221-43, 221-48, 221-69, 221-79, 221-87, 221-96, 25C1172B (Toshiba-Hi Output Trans) 2.50

Motion Detector Module (Includes ULN2232 IC & Caps), 2.00 Each, 7/10.00, 25/25.00

Motion Detect, ULN2232 IC Only 3/2.00, 20/10.00

Black Plastic Case For Detector 2.25

Miniature Speaker For Detector 75

XN-3 Solderless Breadboard-1.380 Tie-Point Matrix, 2 Vert Dist Buses 14.95

Model SG-105 Signal Generator-20Hz To 150 kHz, Low Distortion, 46 Step 19.95

40 PIN IDC Ribbon Cable Connector 45.95

50 PIN IDC Ribbon Cable Connector 40

36 PIN RT Angle "Snap Off" Header 50

14 PIN Header For Ribbon Cable 3/1.00

0.1uF 100V Mylar Cap 20/1.00

1uF 200V Mylar Cap 5/1.00

12 pf Disc 40/1.00

18 pf Disc 40/1.00

0.01uF Disc 20/1.00

0.022uF Disc 40/1.00

0.7uF 16V Disc 30/1.00

9V Battery Snaps 7/1.00

22 Or 27 AWG Wire (Specify) 50/1.00

BLITZ EPROM PROGRAMMER KIT

Attached To The Parallel Printer Port Of An IBM PC, XT, Or Compatible. The Blitz Programs 2716, 2732, 2764, 27128, & 27256 Eproms. Standard & Fast Programming Algorithms. Supported Voltage Selectable 12.5V, 21V & 25V. Diskette Included Provides Assembly Instructions & Programming Procedures. Kit-\$69.95. Assembled-99.95

Cypher IV Micro-Controller Kit-\$129.50

- 4 MHz, 8-Bit Microprocessor (NAT 1N8073)
- Control Basic Interpreter On-Chip
- Auto-Start Operation At Power-On
- Fast 16-Bit Multiply And Divide
- RS-232 Supports CRT & Serial Link
- 24 Bit Directional I/O Lines (B255A)
- RAM Memory-2K Expandable To 16K
- Eprom Memory-Expandable To 16K
- Built In Eprom Programmer
- Parallel (Centronics) Printer Interface
- Optional Real-Time Clock W/ Backup

Pay TV Hardware Installation Kit Blow Out As Low As \$2.95 + \$5.00 Shipping Per Unit

All Kits Contain 5 F Connectors, 100 to 75 Ohm Balun, 300 OHM Terminal Block 2/1, 75 Ohm Patch Cord 2 F 300 Ohm Twin Lead Nylon Cable Ties, And UHF Antenna

Model #4124-\$2.95 Includes All Of The Above Plus 25 Feet Coaxial Cable And Mounting Hardware For Indoor Wall Ceiling Installation

Model #4880-\$2.95 Includes All Of The Above Plus 25 Feet Coaxial Cable And Attractive Expandable Pole U-Bolt For Easy Indoor Installation

Model #4845-\$3.95 Includes All Of The Above Plus 65 Feet Coaxial Cable And All Necessary U-Bolt Hardware

MODEL 705 Digital Multimeter

DC Voltage	100uV to 1000V
AC Voltage	100uV to 750V
DC Current	0.1uA to 10A
AC Current	0.1uA to 10A
Hi-Z Resistance	0.1Ω to 20MΩ
Capacitance	1pF to 20uF
Diode Test	forward voltage testing
Hr test	transistor testing

\$51.95

UHF-TV PREAMP

(As featured in Radio Electronics March/May articles, 1982)

This inexpensive antenna mounted preamp can add more than 25 dB of gain to your system. Lots of satisfied customers and repeat orders for this high quality kit, which includes all component parts, PC, BD, Case, Power Supply and Balun \$36.50 Assembled Version \$57.50

Terms: MICRO-MART accepts Visa, MC and telephone. GOD's Minimum order \$10.00 Shipping—US orders, \$2.00 Canada and other countries \$3.50 (minimum) Shipping rate adjusted where applicable. NJ residents add 6% sales tax.

MICRO-MART • 508 CENTRAL AVE., WESTFIELD, N.J. 07090 • (201) 854-8008

**NEW FROM
DON LANCASTER**

HANDS-ON BOOKS

Ask the Guru Reprints	24.50
CMOS Cookbook	14.50
TTL Cookbook	12.50
TV Typewriter Cookbook	12.50
Active Filter Cookbook	14.50
Micro Cookbook vol I or II	15.50
Enhancing your Apple vol I	15.50
Enhancing your Apple vol II	15.50
Applewriter Cookbook	19.50
Apple Assembly Cookbook	21.50
Incredible Secret Money Machine	7.50
Postscript Ref. Man. (Adobe)	22.50
Postscript Cookbook (Adobe)	16.50

UNLOCKED SOFTWARE

Absolute Reset IIe & IIc	19.50
Applewriter/Laserwriter Utilities	49.50
Postscript Show & Tell (IIe/Mac/PC)	39.50
Postscript Tech Illustrations	39.50
Laserwriter Demo Pack	FREE
Apple Ram Card Disassembly Script	24.50
Enhance vol I Companion Disk	19.50
Enhance vol II Companion Disk	19.50
Assembly CB Companion Disk	19.50
Applewriter CB ProDOS C. Disk	24.50

FREE VOICE HELPLINE VISA/MC

SYNERGETICS

Box 809, ME
Thatcher, AZ 85552
(602) 428-4073

CIRCLE 30 ON FREE INFORMATION CARD

**A temperature controlled
soldering and
desoldering station.**

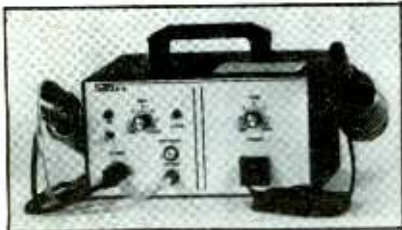

Model S-2 offers a new concept in soldering & desoldering equipment. Features a solid state, spike free, temperature control which converts a standard soldering iron into a temperature regulated soldering station. Use with any easily obtainable soldering iron for inexpensive replacement.

Includes an electrically powered vacuum pump and convenient handpiece for efficient desoldering. A solid state control provides desoldering temperature adjustment.

Priced at \$289.95

SIBEX, INC.
1088 Kapp Drive
Clearwater, FL 33575
(813) 441-8525

CIRCLE 66 ON FREE INFORMATION CARD

LETTERS...

(from page 5)

en for the core of T1. The ferrite beads are probably not critical, but I believe the other magnetics are and must be identified if the project is to be built.

Therefore, I would like to suggest that authors of articles be required to identify key parts by manufacturer and number. They should be "reasonably" available and at prices experimenters can afford.

Name Withheld Upon Request

Transformer T1's toroid is a Magnetics Inc. permalloy 80 tape-wound Part No. 50029-1D. The ferrite beads and output-inductor toroids aren't critical. The beads can be almost any magnetic material with a hole in it. The 74-microhenry output inductors consist of 21 turns of wire wound on MPP cores that are 1.570"OD x 0.95"ID x 0.57"H and have a permeability of 125. The parts are available by mail order through the articles's listed source, NRG Electronics.

Updates

• There is a discrepancy between the schematic diagram and pc pattern shown in Figs. 1 and 4 of the "Radio-Controlled Doorbell" (February 1987). Figure 1

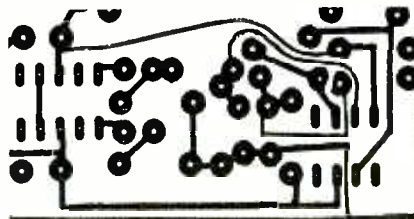

shows R5 connected between ground and the C8/R4/R6 junction, while Fig. 6 shows it going from ground directly to pin 2 of IC2. Which is correct? Also, the resistor to the left of C6 in Fig. 6 should be labeled "R3."

Tom Ripple
Houston, TX

The pc-board artwork is in error. If you already fabricated the board from the artwork and have already wired the circuit, desolder the left lead of R5 and tack solder it to the lower lead of R4. If you haven't already wired the board, enlarge the lower hole for R4 and plug the leads of both resistors into this hole. Readers who haven't yet fabricated the board should substitute the artwork shown here for the lower-right portion of Fig. 4, matching it exactly with the original.—Ed.

Using Op Amps (from page 28)

must be matched as closely as possible to assure reliable operation. Use of 1-percent metal-film resistors is almost mandatory because of their accuracy and fairly good immunity to drifting off value with changes in temperature. Also, be sure to use only polystyrene, polyester or polypropylene capacitors in this circuit. Ceramic capacitors is a poor choice because they're notorious for drifting off value as temperature changes and they can have values that can vary as much as ±100 percent of their printed values.

Always use the best-quality dual potentiometer you can find for the variable-frequency Wien-bridge oscillator. If your oscillator stops oscillating when the dual potentiometer is set to either end of its rotation, or the circuit has a limited frequency range, the two sections are probably not matched well enough for practical application in this circuit. **ME**

ADVERTISERS' INDEX

RS#		Page #
31	AMC Sales, Inc.	77
14	ARRL	61
28	AVCOM	85
17	Ace Communications	25
26	All Electronics	91
	Britelite Creations	94
40	C&S Sales	81
171	Cleveland Institute of Elec	45
	Command Productions	75
16	CompuCover	75
97	Computer Friends	50
18	Computer Parts Galore, Inc.	87
15	Cook's Institute	85
	Dak Industries	1, Cov. II
95	Deco Industries	92
4	Digi-Key Corp.	93
38	Digital Research	5
27	Electronic Equipment Bank	5
	Electronics Book Club	34
	Electronics/Control Engr. Book Club	38, 39
	Grantham College of Engrg.	7
62	Hal-Tronix, Inc.	95
76	Heath Co.	49, Cov. III
65	J & W Electronics	59
61	Jan Crystals	88
32	Joseph Electronics	89
99	MCM Electronics	51
	McGee Radio	94
63	Micro-Mart	95
33	Mondotronics	91
44	NRG	94
	NRI Schools	12, 15
60	Oversens Unlimited Agency Inc	88
	Pacific Cable Co., Inc.	7
	RCA	3
	RCA Direct Marketing	29
	Rhoades	94
	SAI Systems Laboratories	94
66	Sibex Inc.	96
45	Sunnytech, Inc.	77
30	Synergetics	96
	T.F.C. Wholesale	9
29	Test Probes, Inc.	4
89	Trans-Am Electronics	90
96	Underwater Vehicle Training	93
118	Uniden	Cov. IV
	Unity Electronics	92
59	Wholesale Outlet	48

Make your home into something special!

That's exactly what your home will be when you fill it with Heathkit electronic products - products that make your life easier and more enjoyable. Within our diverse line are kit and assembled products sure to enhance each room in your home.

1. Make your entryway more secure and easy to use with the Keyless Doorlock. You'll never again be locked out because of lost or forgotten keys. All it takes is a simple fingertip entry of a four-digit code, and the Keyless Doorlock unlocks your door.



2. Add a new dimension to your living room with your own Computerized Weather Station. This Digital Weather Station displays up-to-the-minute temperature, wind, and barometric pressure readings, along with time and date.



3. Give your kitchen a unique blend of style and efficiency with our Digital Wall Clock. This easy-to-build kit keeps time with quartz-crystal accuracy. And with its simulated oak wood-grain finish cabinet, you'll have a timepiece that fits into almost any decor.



4. Put your den to greater use with this IBM PC AT Compatible Computer. Do word processing, personal accounting and more when you run exciting IBM-compatible software on your fast and powerful HS-241. And you can build it yourself in just a few hours.



5. Bring the latest in digital technology to your bathroom. This Digital Scale lets you closely monitor your weight with electronic precision. And, it's battery operated so it's safe to use right out of the shower.



6. Add a video entertainment center to your bedroom. Our 19"-diagonal stereo TV kit gives you an extra-sharp color-corrected picture with full stereo sound, and convenient viewing that you can control from your bed. Comes in a simulated walnut cabinet that complements your room.



7. Transform your rec room into a haven for hobby fun. Put our Deluxe QRP CW Transceiver in this room and enjoy superb HAM radio operation that excels in performance and features. It offers expandable transmission and reception capabilities.



8. Give your workbench a touch of professionalism with this oscilloscope. Whether you're a service technician or a hobbyist, you'll love the wide range of measurement capability our laboratory-grade Dual Trace 10 MHz Oscilloscope gives you.



9. Add practicality to the utility room and save money, too. Avoid expensive food spoilage with our Freezer Alarm that



warns you when the inside temperature of your freezer rises too high. Prevent water damage with our Food Alarm that warns you of water that's where it shouldn't be.



10. Make your coming and going easier than ever. Your garage door will open with incredible ease and dependability with our Deluxe Garage Door Opener. Easy to install, this opener is durable and includes a handy security light.

You'll find fun and excitement with every Heathkit product. Whether they're in kit form or already assembled, our products will help you enjoy your home more than you ever dreamed possible.

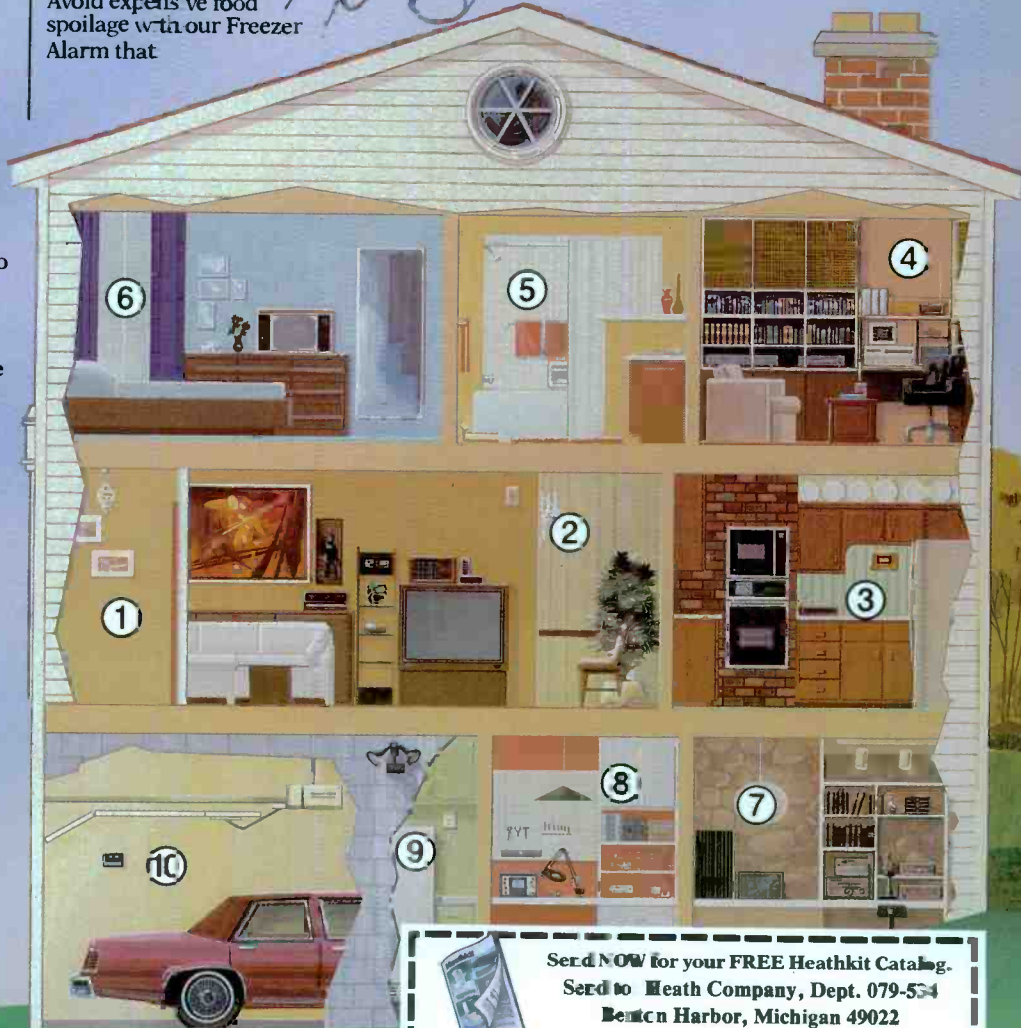

CIRCLE 76 ON FREE INFORMATION CARD

Heathkit
Heath
Company



Send NOW for your FREE Heathkit Catalog.
Send to Heath Company, Dept. 079-554
Benton Harbor, Michigan 49022

Name _____

Address _____

City _____ State _____ Zip _____

A subsidiary of Zenith Electronics Corporation CL-789A

70 XLT Pocket Size 20 Channel Programmable Scanner



The 70XLT sets a new standard for portable Scanners in performance, dependability and size. This hard working unit has 20 programmable channels and 10 bands of coverage. It has the most desirable features including Priority, Lockout and Delay. It also includes automatic and manual Search to find new active frequencies. Built-in rechargeable batteries give hours of trouble-free use and quickly charge overnight. A Charger/Adaptor allows the unit to run on 120 VAC and the LCD display includes selectable illumination for night time scanning. The superior engineering of will treat your ears to real life excitement and drama as you've never heard it before.

The Choice of Professional
Golfer Jack Nicklaus.
Winner of 20 Major Championships.



uniden[®]
A New Generation of Communications