

MicroComputer

The print forum for the MicroComputer professional and semi-professional

JOURNAL

September/October 1994

Affordable Drives Let You Roll Your Own CD-ROMs

- Using A Serial Port For Discrete I/O Operations
- Applying PIC16C71 And PIC16C84 Microcontrollers
- Setting Up A BBS

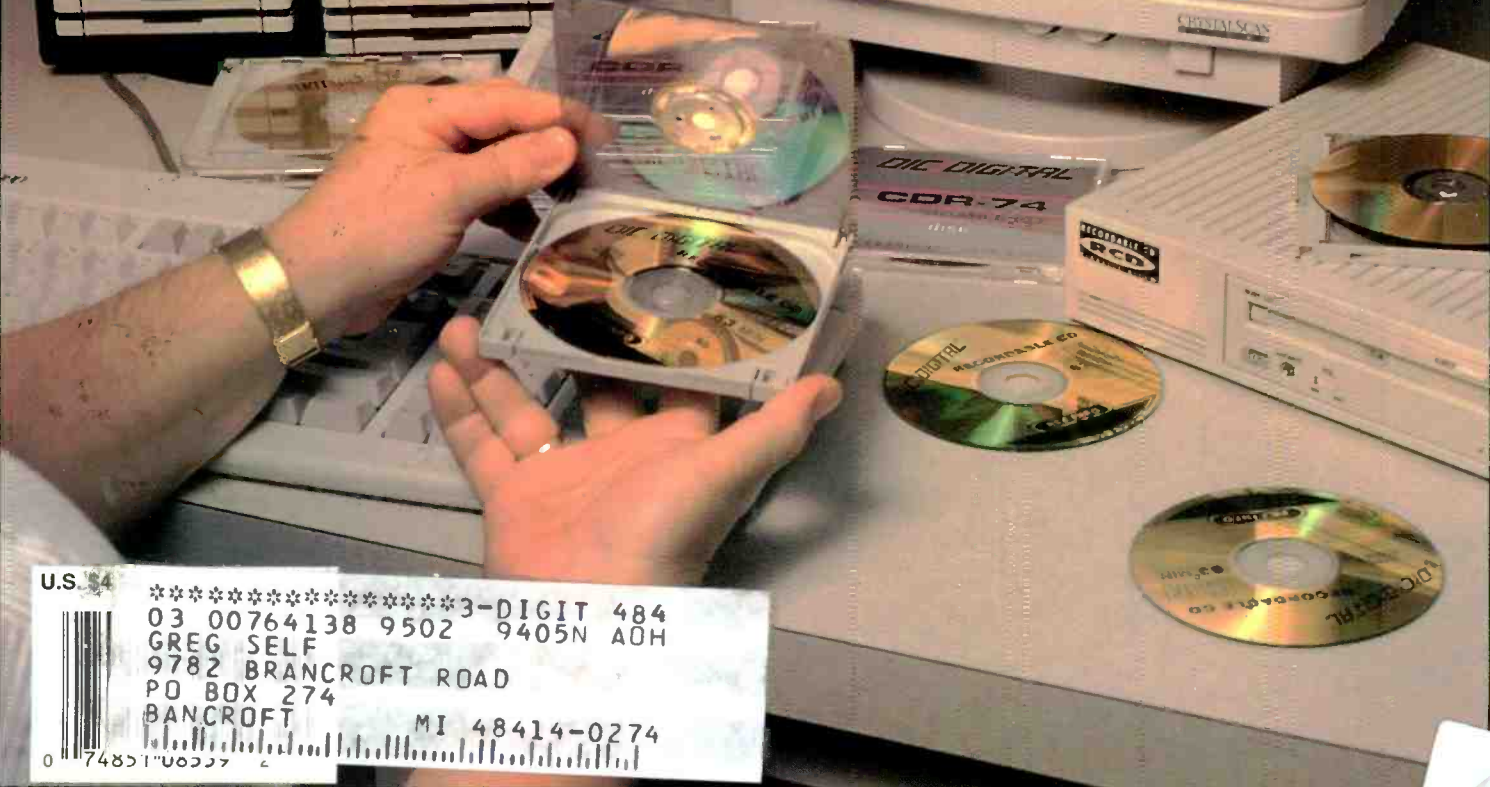

U.S. \$4
*****3-DIGIT 484
03 00764138 9502 9405N AOH
GREG SELF
9782 BRANCROFT ROAD
PO BOX 274
BRANCROFT MI 48414-0274
0 74851 00557 2

68HC11 Controller & Languages

Program it in **C** or

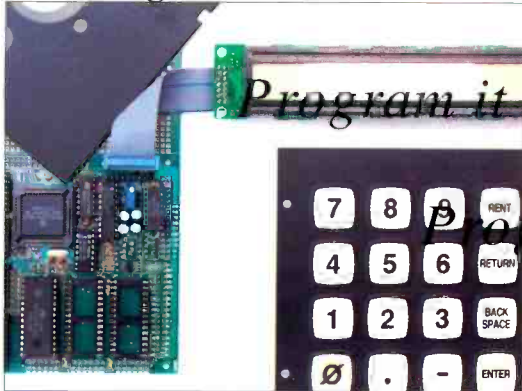

Program it in **Basic** or

\$99

Program it in **FORTH** or

Program it in **Assembly**

Low Cost Development Package: Controller + Languages + Manuals on disk included!

Package Price Breakthrough!

The NMIX-0020 Single Board Computer is perfect for dedicated controller with convenient interfaces for LCD displays and keypad. Intelligent LCD's up to 2 lines by 80 characters and matrix keypads up to 4x5 can be used. The processor is the popular F68HC11 with many features, including SCI and SPI serial channels, 8-bit 8-ch. A/D, 20 available I/O lines, Watch Dog Timer, 1/2K EEPROM and Max-FORTH w/Floating Point Package embedded in 12K internal ROM. SBC expands F68HC11 providing 3 28-pin JEDEC sockets for 8-32K RAMs, ROMs, EPROMs, EEPROMs, etc. RS-232 conversion supplied. Requires external regulated supply: 5V at ~30 mA. Based on NMIX-0020 board, so many features may be added as desired by the user (or by factory - call for details & prices).

Languages supplied on accessory disk: Small C, Basic, and Assembler. FORTH resident on chip (may be disabled). Languages come with manuals on disk. Communications utility, MAXTALK included to allow PC clone to act as terminal for download and development. WIPE utility included allows internal ROM, EEPROM, WDT to be enabled/disabled, and EEPROM to be erased. Manuals on disk: UM-MAX Max-FORTH Users Manual, HM-20 NMIX-0020 Hardware Manual, Small C manuals with examples, BASIC11E9 Manual.

SBC and utility disk - \$99. Keypad and LCD not included. Great value. Call today! New Micros, Inc. 214-339-2204



NEW MICROS, INC.
1601 Chalk Hill Road
Dallas, Texas 75212
Tel: (214)-339-2204

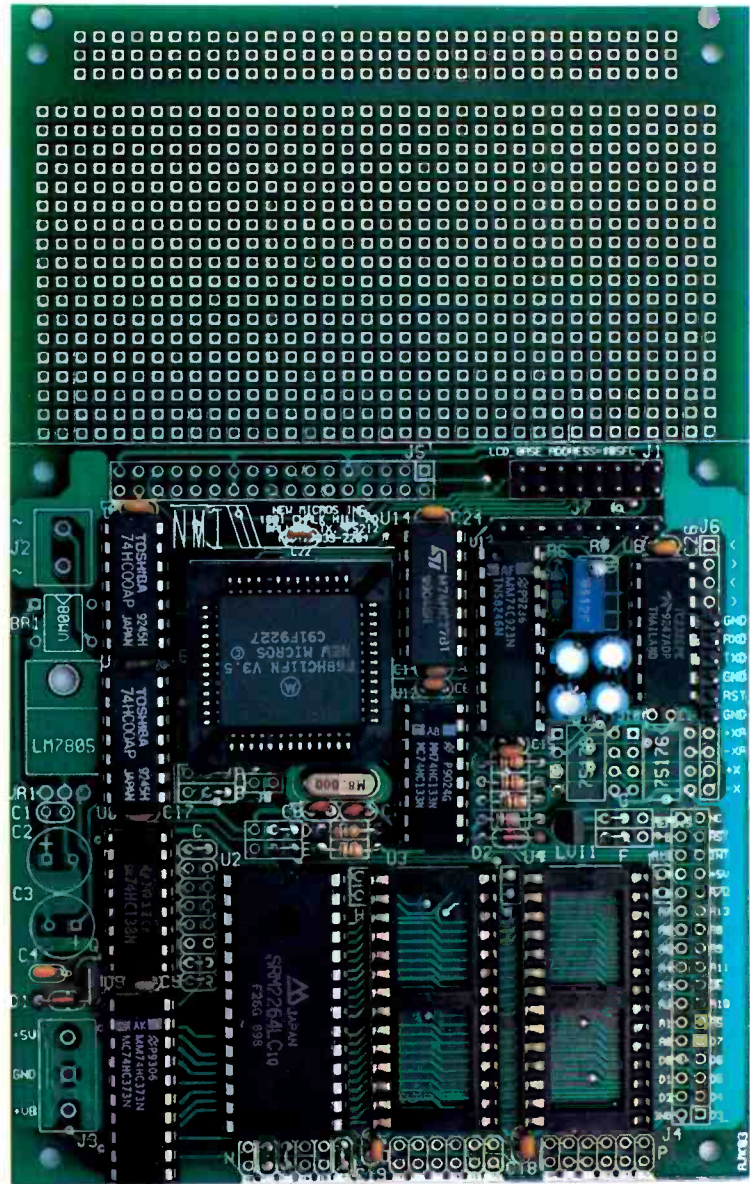

Call today for your **FREE** newsletter **“Fix any PC...FAST!”**



Get data back from crashed drives, *FAST!* *“Rescue works better than Norton Utilities or PC Tools.” - The ThinkTank*

RESCUE Data Recovery Software™ is the first program to easily recover lost data from crashed floppies & hard drives even when DOS can't read them! RESCUE recovers data other recovery programs cannot. RESCUE automatically recovers DOS & Windows files including data from compressed drives. Be prepared for any problem. RESCUE is the Insurance and security you need to safeguard your valuable data. Call now, don't wait until your data is lost, forever!

Troubleshoot any PC Problem, *FAST!* *“If you support PC's, The Troubleshooter is likely to become one of your most important tools...” - Infoworld*

The Troubleshooter™ is the most advanced PC diagnostic software available that really finds the bugs. The Troubleshooter bypasses DOS & tests all major hardware components directly for true accuracy while other programs often give erroneous test results! Loaded with all the tests you'll need to accurately isolate the source of PC failures! • The Discovery Card™ is the only accurate way to 100% resolve DMA and IRQ conflicts. • The PocketPost™ debugs even dead PCs that won't boot. Get all three in a kit to keep any PC out of trouble. Call now for specs & special package pricing!

Fix Windows, *FAST!* *“A model of elegance and clarity. Skylight stands out. The Editor's Choice is Skylight!” - PC Magazine*

Having problems with Windows? Skylight™ is the answer! Concise reporting and troubleshooting on Windows problems and conflicts makes Skylight a must have for any Windows user. Maximize speed and performance with PC Magazine's #1 Rated Windows Troubleshooting Tool. Call today for pricing!

Install, set-up & maintain hard drives, *FAST!* *“DrivePro makes installing & maintaining hard drives practically fool proof.” - PC World*

DrivePro™ provides fast, precise installation and maintenance for any hard drive. Override BIOS limitations for user-definable drive types. DOS format any size hard drive in under 30 seconds. IDE drives can be installed in less than 60 seconds. Allows the use of IDE drives with MFM/RLL or ESDI drives in the same system. Retrieves the manufacturers' recommended specs from the drive itself, plus much more! Call now for pricing!

Vital hardware specs & information, *FAST!* *“A gold mine for anyone who supports PCs.” - Computer Shopper*

The Technical Library on CD-Rom™ is compiled from over 50,000 pages of technical hardware manuals! Contains complete configurations, specifications, diagrams, settings, component locations and other vital hardware technical information all at your fingertips on CD-ROM. Includes main boards, network interface cards, hard drives, controller and I/O cards. A must for any service department. Call today for special pricing!

Call today for your **FREE** newsletter
“Fix any PC...FAST!”
 and learn how to resolve...

- Drive Crashes/Data Loss
- IRQ/DMA Conflicts
- Intermittent Failures
- Overheating
- Power Problems...and more!

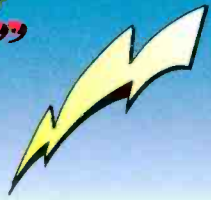

Free Technical Support • Next Day Shipping • Performance Guaranteed
(800) 653-4933

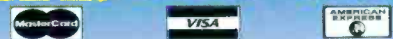

International: (813) 539-7283
 Fax: (813) 531-0200
AllMicro, Inc.
 18820 U.S. Hwy. 19 N., #215
 Clearwater, FL 34624

MicroComputer

JOURNAL

Volume 1, No. 5, September/October 1994

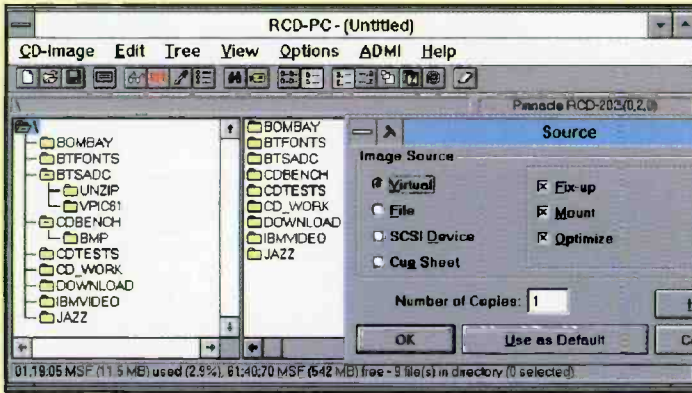

page 77

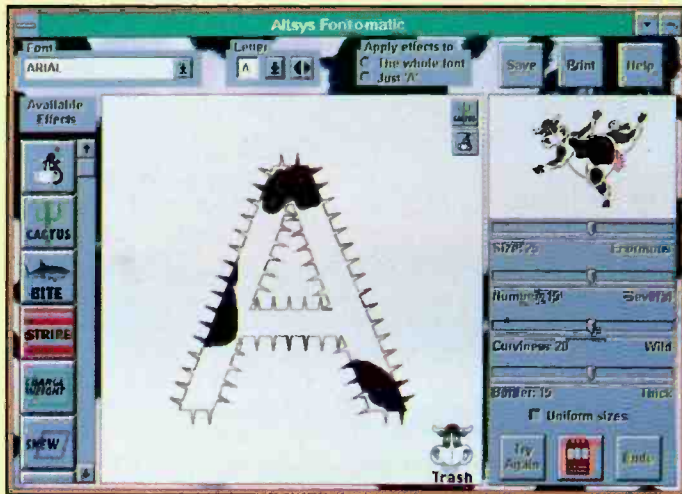

page 93



page 97

Features

15 Applying the 14-Bit PIC16C71 and PIC16C84

By Fred Eady

A practical primer on two of the most-versatile microcontrollers available.

23 All About Hard-Disk Drives

By TJ Byers

If your hard disk is showing its age, maybe its time for an upgrade. Here's what's hot and what's not.

33 Use a .BAT File to DISKCOPY Files between Dissimilar Floppy Disks

By Emerson M. Hoyt

34 Use a Serial Port for Discrete I/O Operations

By Robert Moon

All it takes are signal conditioning and a bit of programming.

46 The On-Line Obstacle Course

By David T. Kruchowski

The ins and outs of setting up a Bulletin Board System

60 Roaming the Internet

By Hardin Brothers

Getting up and running on the Internet, what you can expect and how to go about navigating it.

65 How to Use a PC's Parallel Port for Monitoring and Control Purposes, Conclusion

By Jan Axelson

Detecting and measuring.

77 Rolling Your Own CD-ROMs
By Tom Benford
Affordable writable CD-ROM units come of age.

85 Genealogy On Computers
By Tom Stevens, EPCUG
Tiny Tafel reduces the time and effort required to trace your family tree on a PC.

Columns

89 Computing On the Go
By Joe Desposito
Searching for the Ultimate Connection Strategy.

93 Microcomputer Musings
By Ted Needleman
Label Printing on PCs, Low-Cost Font Manipulator and an Uninstaller for Windows Apps.

97 Multimedia
By Tom Benford
A PCMCIA Audio Card, Tech-Support Update for Xingit! Board for Gateway Pentium Users, Interesting Software on CD-ROM.

104 Microcomputer Q&A
By TJ Byers
Answers to readers questions about all aspects of personal computing.

107 Industry Watch
By John Hastings
The Speed Game.

Departments

4 Editorial
By Art Salsberg
to come to come to come

6 What's Happening!
Latest PC News.

8 Corrections

9 What's New!
By Joe Desposito
A roundup of new computer products.

109 Advertisers Index



In This Issue

As the cover photo illustrates and Tom Benford explains beginning on page 77, you can now roll your own CD-ROMs, thanks to the availability of fairly affordable writable CD-ROM drive units and discs. Tom tells you about the hardware and then proceeds to walk you through installation and the means for creating your own productions.

Those of you who are into microcontrollers for monitoring and control purposes will want to check out Fred Eady's article on two of the most versatile PIC microcontrollers, beginning on page 14. Fred gives you a primer on these chips that should get you started in designing serious projects that take advantage of the PIC16C71 and PIC16C84.

TJ Byers tells you just about everything you need to know about one of the most vital parts of your PC—its hard drive. You'll want to closely check out this article, beginning on page 23, if you hope to maximize the use of your present drive or/and want to upgrade or supplement it.

Communicating with your PC is the subject of two of the articles in this issue. On page 46, David Kruchowski tells you how to set up and operate a BBS. Then Hardin Brothers takes you on a hands-on tour of the Internet.

On page 34, Robert Moon tells you how to use a serial port for discrete I/O operations, while on page 65, Jan Axelson concludes her series on using a PC's parallel port for monitoring and control purposes by covering detecting and measuring operations.

Finally, Tom Stevens shows you how to trace your family tree using your PC. His Genealogy on Computers article begins on page 85.

Cover Photo By Joe Abatto/The Photography Place

MicroComputer Journal on MCI Mail

You can contact *MicroComputer Journal* on MCI Mail directly or through an on-line service, such as CompuServe. Any questions, article proposals, comments, etc., are welcome on this electronic mail box (MCI ID No. 456-3433) or just type: ComputerCraft.

Computers In the Household

With about one-third of U.S. households said to contain a personal computer, the digital machine is surely a mass market device, alongside CD audio players and video camcorders. Indeed, according to the Electronic Industries Association (EIA), 37% of all households have at least one computer, while home CD players have penetrated 42% of households and camcorders made a 21% inroad. Fortifying this, a nationwide telephone survey conducted by "Times Mirror Center for The People & The Press" found that about one-third of U.S. households contained a personal computer.

And according to Link Resources, a market research firm, more than half of all U.S. households will have personal computers by 1998. The company says that home workers have already exceeded this percentage with 58% of such households having one.

Furthermore, the Times Mirror study reveals that about 23-million adults use a home computer every day, and more than one of 10-million households (12%) has a modem. Among its other findings, as many as 11-million people go "on-line," with half this number connecting to such commercial information services as Prodigy or to electronic bulletin boards.

Not surprisingly, the survey found that technology facilitates the work-at-home trend in evidence in the U.S. For example, among employed respondents, 45% said they work at home "sometimes" or "often" or had home-based businesses. Among this group that worked at home at least one day during the week prior to being contacted, 40% used a computer at home.

The ability to work at home is enhanced by being able to go on-line with a modem. For example, 60% of frequent on-line users reported working at home one day or more in the week preceding the survey, compared to 42% among PC users who don't have on-line capability.

Interestingly, the study indicates that people who have access to new information formats, such as on-line

services, don't ignore traditional sources. They read more, follow the news more with hard sources, such as TV's C-Span, etc. Moreover, the survey found that better-educated, affluent people were most likely to use computers and their on-line capability.

The Times Mirror study divulged interesting information about computer modem users. Fifty-three percent have at least a four-year college degree, compared to 21% of the general public.

Twenty-five percent have some post-graduate education, compared to 8% of the public. Modem-user respondents are also more affluent, with 53% reporting family incomes of \$50,000 or more, compared to 23% of the public. They're younger, too, with only 17% being over 50 years, compared to 35% of the general public. And only 14% of modem users say they never work at home, while 44% of the general public say this.

The most-common communications destination of computer modem users is the bulletin board (there are more than 40,000 of them across the U.S.). A close second is dialing up work or school computers. And third is the commercial information service (CompuServe, Prodigy, America On-Line, etc.). Almost 48% of modem users subscribe to one of them. (Check out one of the feature articles in this issue—The On-Line Obstacle Course—to get a better understanding of what it takes to start up and man a bulletin board system).

Clearly, computers have a firm foothold in the home for personal use (83%), for jobs (67%) and for school (46%). Recognizing this, computer manufacturers have extended product distribution into mass-market channels. And why not, since home computer dollar volume now exceeds every home electronic category except color TV receivers? There's no way to go but up.



EDITORIAL STAFF

Art Salsberg
Editor-in-Chief

Alexander W. Burawa
Managing Editor

Dorothy Kehrwieler
Production Manager

Emily Kreutz
Advertising Production

Elizabeth Ryan
Art Director

Barbara Terzo
Assistant Art Director

Susan Reale
Artist

Edmond Pesonen
Electronic Composition Manager

Pat Le Blanc
Phototypographer

Hal Keith
Illustrator

Larry Mulvehill
Photographer

Jan Axelson, Tom Benford, Hardin Brothers, TJ Byers, Joe Desposito, Ted Needleman, Wayne Yacco
Contributing Editors

BUSINESS STAFF

Richard A. Ross
Publisher

Art Salsberg
Associate Publisher

John Dorr
General Manager

Frank V. Fuzia
Controller

Catherine Ross
Circulation Director

Melissa Nitschke
Data Processing Manager

Carol Licata
Data Processing

Denise Pyne
Customer Service

ADVERTISING SALES

Margaret Milanese
(516) 681-2922
FAX: (516) 681-2926

Offices: 76 North Broadway, Hicksville, NY 11801.
Telephone: (516) 681-2922. FAX (516) 681-2926.
MicroComputer Journal is published bi-monthly by CQ Communications, Inc. Subscription prices (payable in U.S. Dollars only): Domestic—seven bi-monthly issues \$29.70, fourteen bi-monthly issues \$59.40; Canada/Mexico—seven bi-monthly issues US \$32.00, fourteen bi-monthly issues US \$64.00; Foreign—seven bi-monthly issues US \$34.00, fourteen bi-monthly issues \$68.00; Foreign Air Mail—seven bi-monthly issues US \$87.00, fourteen bi-monthly issues US \$173.00.

U.S. Government Agencies: Subscriptions to MicroComputer Journal are available to agencies of the United States government, including military services, only on a cash with order basis. Request for quotations, bids, contracts, etc. will be refused and will not be returned or processed.

Entire contents copyright 1994 CQ Communications, Inc. MicroComputer Journal or CQ Communications, Inc. assumes no responsibility for unsolicited manuscripts. Allow six weeks delivery of first issue and for change of address. Printed in the United States of America.

Postmaster: Please send change of address notice to MicroComputer Journal, 76 North Broadway, Hicksville, NY 11801.

ICS gives you the fastest, most powerful computer available from any comparable home-study course!

Get into a money-making career in personal computer repair

The U.S. Dept. of Labor states that many highly-qualified computer repair technicians are earning over \$30,000 a year. And the PC repair field is targeted for higher-than-average growth throughout this decade and beyond!

Comprehensive PC Repair Video

Takes you step by step through all of the most common PC malfunctions and how to repair them.

DOS 6
Comes with DOS installed

When it comes to PC Repair training at home, the choice is overwhelmingly clear...ICS is #1!

Here are just a few advantages ICS gives you that the competition doesn't...

NEW!
FASTER! 486DLC
computer

Why settle for a 486SX when ICS gives you a superior, faster 486DLC for less money...

Only ICS gives you:

- Cyrix's 486DLC/33MHz CPU greatly outdistances Intel's 486SX/25 in benchmark testing
- Cyrix's 33 megahertz 486DLC microprocessor.
- IBM-compatible 486DLC with true 32-bit architecture
- 1Kb internal cache plus a high-speed 64Kb external cache
- 2400 baud internal modem
- access to ICS Online with numerous exciting services to choose from
- 256+ color capacity Super VGA high-resolution monitor
- 1.44MB 3.5" floppy disk drive

Plus you also receive...

- Ready to use 80MB IDE hard disk drive
- 1MB RAM expandable to 32MB
- ISA expansion slots
- 101-key enhanced keyboard

ICS is the largest, most recognized at-home training institution in the world...

- Only ICS has trained over 10 million men and women for new careers.
- Only ICS training is used by over 2,000 leading corporations such as IBM, Xerox, Ford, Dupont, and Avon.
- Only ICS gives you easy low monthly payment options with 0% financing.
- Only ICS awards you the renowned ICS Diploma respected around the world.
- As a longstanding member of the National Home Study Council in Washington, D.C., our courses are nationally accredited.



PC Tool Kit Includes screwdrivers, chip inserter/extractor, torx screwdriver, nut drivers, insulated tweezers and more.

COURSE INCLUDES ALL THIS & MORE

Professional Diagnostic Card and Diagnostic Software

Enables you to locate and repair almost any computer problem.

Digital Volt-Ohm Milliammeter

Provides voltage, current and resistance measurements, and checks for circuit malfunctions.

Train at home in your spare time to enter one of the fastest-growing, highest-paying computer careers!

Only ICS, the world's leader in training at home, gives you hands-on practice with a high-performance 486DLC IBM-compatible computer with Cyrix microprocessor, color monitor and internal modem, so you master the latest techniques and innovations in PC servicing and repair. You get the same high-quality training taught at vocational and trade schools but without spending years attending classes. You can complete your training in just months...you'll even be able to start making money doing repair jobs before you finish your course.

Our computer specialists have spared no effort in ensuring that this is the finest PC repair course available through home study.

Compare ICS training—you get better equipment/lower tuition! Don't be confused by other schools that try to duplicate ICS training. Check the facts by sending for our free information package.

You receive a fully assembled 486DLC IBM-compatible personal computer system! This high-performance system is all you'll need to learn PC servicing and repair. Step by step you're taught how to troubleshoot, repair/replace all of the major components of this amazing system.

ICS hands-on training is the key to your successful future in PC repair! You receive practical, real-world computer servicing experience on your 486DLC computer, using the professional tools and diagnostic hardware

and software that's included with your course—everything is explained step by step.

Learn to service and repair every type of personal computer!

ICS makes you competent with the latest technology so you'll be able to handle any computer servicing job that comes your way. You'll learn how to set up and configure PC systems...how to replace central processing unit (CPU) components, hard drives, floppy drives, keyboards, monitors and printers...how to detect and deal with computer viruses...how to upgrade PCs and much more.

Your career in PC repair begins with the big, full-color FREE information package we send you when you mail the post-paid card at left.

Get the facts you need on our revolutionary PC repair course. Send for free information that tells how ICS training can start you toward a high-paying career as a PC Service Technician.



Mail the postage-paid card at left today. If card is missing, mail coupon at right.

OR CALL TOLL FREE:
1-800-596-5505 Ext. 4375
CALL ANYTIME—24 hours a day, 7 days a week.

ICS School of Computer Training,
SINCE 1890 Dept. PCES948, 925 Oak Street, Scranton, PA 18515

YES! Please send me free facts that tell how I can train at home to learn PC repair. I understand there is no obligation and no salesman will visit me.

Name _____ Age _____
Address _____ Apt. # _____
City/State _____ Zip _____
Phone () _____

What's Happening!

"PLUG AND PLAY" VIDEO MONITORS. The VESA Monitor Committee voted to release for formal approval a proposal that uses ACCESS bus as the control bus for the Display Data Channel (DDC) of computer monitors, allowing them to achieve full "Plug and Play" status. With DDC, video monitors will automatically notify the host computer on power-up of their specific capabilities and configuration, automatically calling up the appropriate software driver. Furthermore, DDC allows connecting ACCESS-bus peripheral devices—such as mice, modems and printers—directly to the monitor instead of hooking up each device separately at the rear of the computer.

COLOR PRINTER SALES BOOM. Ink-jet is the fastest-growing color printing technology on the U.S. market today, with more than 1.5-million installed printers reported in operation in 1993. Since 1989, color ink-jet printer sales have grown more than 70% annually, with a projected installed 1997 base expected to be more than 13-million color ink-jet printers. In comparison, there are only about 30,000 color laser printers now in operation in the U.S., while thermal wax-transfer color printers are estimated at only 130,000 units.

RADIO SHACK ADDS IBM BRAND. Radio Shack selected IBM as the first vendor in its policy to sell name-brand computers in addition to its line of PC-compatible Tandy computers. The pilot program will start with about 500 Radio Shack stores among its 6,500 selling IBM's PS/Note Model E35 monochrome notebook and PS/Note Model C45 color notebook computers. Both are based on the Intel 486SL/25-MHz processor.

SCANNER TEST TARGET. A new resolution test target that calibrates image scanners has been introduced by A&P International. The PM-189 Scanner Test Target, measuring 8-1/2" x 11", is a monochromatic photographic product that comes with 26 different test-pattern areas. These include horizontal and vertical, 360-degree range, half-tone and micro-copy resolution, reference B/W, type and handwriting, edge markets, mechanical drive uniformity, linearity square, single-line thickness, line-thickness references, TV/Camera/Monitor resolution. It's priced at \$125, with an optional 37-step grayscale available for \$25 more. For more details, call Paul Montgomery at 612-738-9329.

NEW CHIPS. IBM announced a new digital 16-bit signal processor (DSP) for its MWave family of products. It's said to be the first processor to integrate Wave Table and Sound Blaster support. On-chip features include a full suite of multimedia interfaces, high-speed analog and digital communication functions, a 32-voice wave-table synthesizer, extended audio and voice CODEC (coder-decoder) support and hardware-level support for industry-standard games.

Hall Technologies and Interactive Products have joined forces to create a very inexpensive command-and-control voice-recognition system-on-a-chip. Based on the pioneering work of a group of Russian software experts, the heart of the system is a version of IPI's software engine used in its current "VoiceMouse" software for Windows 3.1. It's said to have an average accuracy of 98% while ignoring background noises. The system reportedly requires only a one-pass voice read to understand a user. The basic engine requires only 12K of program memory. It has a typical software vocabulary of 100 command-and-control functions for a consumer product, requiring merely 50K of additional memory. Thus, the entire engine and vocabulary can be embedded on a small chip. The "ChipTalk" chipset will use John Hall's refractory gate merged-emitter chip design, which is said to run five times faster than conventional CMOS circuitry. The system is designed to be used for a variety of voice-recognition purposes in home appliances and everyday consumer electronics.

Datalight's ROM-DOS 6.2 has been released, which is an MS-DOS 6.2-equivalent operating system for Original Equipment Manufacturers of personal digital assistants and other types of embedded computers. Datalight has signed an agreement with Stac Electronics to sell Stacker 3.0 along with ROM-DOS. ROM-DOS is claimed to be the smallest of any compatible DOS on the market at about half the size of MS-DOS 6.x in ROM.



1-6-94 8:07 p.m.
Situation: Mother and two children in mall parking lot

The first alarm system designed to protect you as well as your car...

Revolutionary new vehicle security system is the first of its kind to focus on the safety of the vehicle driver as well as the vehicle itself.

By Charles Anton

Do you wonder why car alarms have countless features to protect your car, but nothing to protect you? After all, what's more important your car or the safety of you and your family?

Now there is a car alarm that will protect you and your family. It is the first of its kind to focus on the safety of the vehicle owner as well as the vehicle itself.

Protect yourself. It all begins with the panic button. Imagine you're walking to your car at night and a person approaches. Pushing the panic button on your transmitter lets your car come alive with a shrieking siren and flashing headlights. While the panic alarms of other vehicle security systems have a range of 100 feet, the Smart Alarm's panic alarm lets you call for help or scare away potential attackers from up to 400 feet!

Exclusive feature. Unlike other car alarm systems that begin and end their focus on per-

sonal protection with the panic alarm, that's just the beginning of the Smart Alarm. In addition to the panic alarm, the Smart Alarm also has a car finder feature. You'll never again have to wander around a dark and dangerous parking lot searching for your car. You will be able to know where your car is from anywhere within 400 feet by flashing its lights and briefly sounding the siren. You can activate and deactivate your car's headlights by remote control to light your way in a dark driveway or parking lot.

Carjacking. The Smart Alarm also addresses a growing hazard for today's motorists—carjacking. It's alarming how often drivers are hurt in their cars because they refuse to give them up to carjackers. Because of its anti-carjacking device, the Smart Alarm allows you to safely retain your car when confronted by a carjacker. This is made possible by a delayed panic alarm.

What makes Smart Alarm better?

- **Range.** Most car alarm features only work up to 100 feet away—all Smart Alarm features work up to 400 feet away.
- **Panic button.** Smart Alarm lets you call for help or scare away potential troublemakers by controlling a piercing alarm and your car's headlights.
- **Car finder.** Your car will be able to let you know where it is by flashing its lights and briefly sounding the siren.
- **Carjacking.** Its delayed panic alarm allows you to safely prevent theft of your car when confronted by a carjacker.
- **Easy installation.** Other car alarms are complicated or cost hundreds of dollars to install. Smart Alarm is inexpensive, and you can install it in just minutes.



Smart Alarm is the first car alarm that will protect you and your family.

Easy installation. Installing the Smart Alarm requires no fumbling with wires. Special Plug-In Connectors let you install the Smart Alarm without a single wire-cutter! Simply unplug the headlight connector, plug in the Smart Alarm connector, and then plug the headlight connector to the Smart Alarm. Connect the Smart Alarm to the battery cable with the special clip. In minutes, you and your car can enjoy complete 24-hour protection. Away from your car, you'll feel safer knowing that your car is protected! Near your car, you'll feel safer knowing that you are protected!

All you do is give up your car and activate the delayed panic alarm. When the assailant has reached a safe distance and is no longer a threat to you, a deafening 120dB siren and flashing lights will force him to flee your car, letting you recover it safely.

Vehicle protection. Smart Alarm's current sensor triggers the siren if the trunk or any of the doors are opened while the alarm is armed. To supplement the current sensor, a shock sensor triggers the siren when it detects a blow to your car. Together, these sensors provide your car with blanket protection.

An adjustable shock sensor prevents the siren from being triggered, eliminating false alarms. You can also adjust the shock sensor and the siren with your remote control at any time you choose. The siren's tone and volume can be adjusted to six separate tones. As a result, you'll never confuse it with any other alarm. You can also customize the siren, making it louder in noisy neighborhoods and quieter in more peaceful neighborhoods.

Risk-free home trial. With the Smart Alarm, you get a complete "No Questions Asked" 30-day money-back guarantee. If it's not everything we say, just return it for a full refund. The Smart Alarm is also backed by a two-year warranty. Your order will be shipped UPS in seven to ten working days.

The Smart Alarm Car Alarm..... \$99 \$9 S&H

Please mention promotional code 483-CC1105.
For fastest service call toll-free 24 hours a day

800-992-2966



To order by mail, send check or money order for the total amount including S&H (VA residents add 4.5% sales tax.) Or charge it to your credit card, enclosing your account number and expiration date.

CONTROL INDUSTRIES

2820 Waterford Lake Drive Suite 106
Midlothian, Virginia 23113

Corrections

During editing of Tom Benford's "Beyond Double Speed and Single Discs: Pioneer Breaks the CD-ROM Bottleneck" beginning on page 79 of the July/August issue, an editorial error was introduced into the first sentence of the second paragraph. The sentence should read: "This article gives you an in-depth look at Pioneer's DRM-604X mini-changer drive and compares it to NEC's 84 drive [not the triple-speed NEC MultiSpin 3x series as printed] to provide you with a perspective on what you can expect from the DRM-604's state-of-the-art features and performance." Our apologies to Tom and NEC for this editorial error.

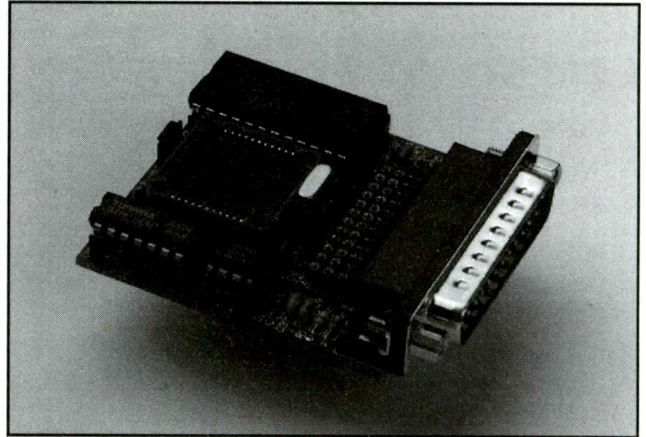

The photo shown for Blue Earth's Xplor-32 Digital Control Board on page 13 of the What's New!

section of the July/August issue is incorrect. The correct photo for this product is shown here.

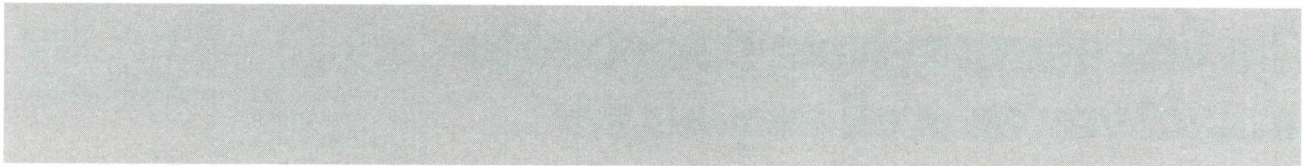

Cross Assemblers

- Local Labels and Cross Reference
- Powerful Macro Substitution Capability
- Machine Cycle Counting
- 32 Significant Character Labels and Symbols
- Unlimited Include File Capability
- Selectable Intel Hex or Motorola Hex Object File

Simulators

- Source View Symbolic Debugging
- Attach Keyboard, Screen or Data Files to Simulate I/O
- Machine Cycle Counting
- Ten User-definable Screens
- Unlimited Breakpoints, Memory and I/O Mapping
- Trace File to Record Simulator Session
- Ability to Step Backward through Simulation

Disassemblers

- Automatic Substitution of Defined Label Names for All Jumps and Branches
- Automatic Insertion of Supplied Comments and Expressions

Application Source Libraries

- 16 and 32 bit Integer Arithmetic and Numeric/String Conversion

PseudoCorp

921 Country Club Road, Suite 200
Eugene, OR 97401
(503) 683-9173

FAX: (503) 683-9186 BBS: (503) 683-9076

ACSBUSS Modular Control

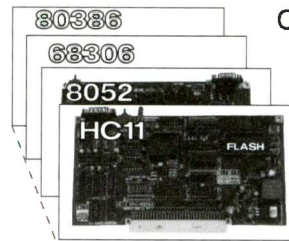

OUR CPU's HAVE
"CONNECTIONS" !

ACSBUSS "CONNECTIONS"
bring your development
& production costs
under CONTROL!

YOU'RE IN CONTROL with our

ACSBUSS "CONNECTIONS" for:

CONTACT INPUT, A.C. SENSE, CONTACT OUTPUT, TRANSDUCER,
TRIAC OUTPUT, PRECISION MOTION CONTROLLER, USER INTERFACE,
RAM EXPANSION, VIDEO DISPLAY, DIGITAL AUDIO, MODEM & FAX,
REMOTE PROGRAM LOADING, CEBus, and many more every day!

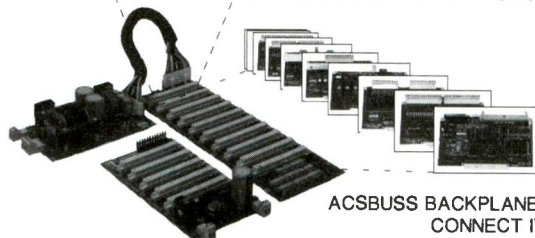

ACSBUSS BACKPLANES
CONNECT IT ALL!



Call or Write for more info!

On The Cutting Edge of Technological Evolution
4276 Lago Way • Sarasota, FL 34241
Ph.(813)377-5775 • FAX(813)378-4226



CIRCLE NO. 84 ON FREE INFORMATION CARD

CIRCLE NO. 51 ON FREE INFORMATION CARD

Hardware

Portable Hard Drives

The RoadRunner Express XD Series from Disk Technologies are external hard-disk drives that support the enhanced parallel port (EPP), extended capabilities port (ECP) and standard and bidirectional parallel ports. The drives work with any desktop, notebook or sub-notebook computer that has a parallel port. A BIOS is provided with the drives to support EPP/ECP.

RoadRunner drives are available in 210M, 340M and 540M capacities, with transfer rates of 1M/second. They weigh less than 2 lb. \$495/\$595/\$795. 210M/340M/540M. *Disk Technologies Corp., 925 S. Semoran Blvd., Ste. 114, Winter Park, FL 32792; tel.: 407-671-5500; fax: 407-671-6606.*

CIRCLE NO. 1 ON FREE CARD

PCMCIA Ethernet

Megahertz's PCMCIA Ethernet Adapter is a LAN interface that connects directly to Ethernet networks. The adapters are available in both 10Base-T and 10Base-2 cable configurations. DOS NDIS and DOS ODI drivers included with the adapter support Novell NetWare, Microsoft LAN Manager, IBM LAN Server, Banyan Vines and others. Menu-driven software walks users through installation and setup of the appropriate drivers for their network operating systems. \$259. *Megahertz, 605 North 5600 W, P.O. Box 16020, Salt Lake City, UT 84116; tel.: 801-320-7000.*

CIRCLE NO. 2 ON FREE CARD

Micro UPS

Liebert's microUPS is an uninterruptible power supply for applications where an economical off-line system is adequate protection. In the event of power disruption, microUPS provides a continual source of electricity for 5 minutes at typ-

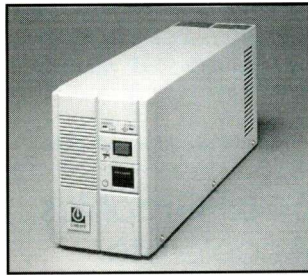

ical load. Three desktop models are available: 250 VA, 400 VA and 600 VA.

The UPS detects a change in input voltage above or below an acceptable level within 4 to 8 ms. Input range is 95 to 132 volts ac. Black start capability allows start-up of protected hardware and UPS using a battery. This gives you time to copy a disk, print a document or complete a critical task to effect an orderly shutdown. Internal circuitry prohibits battery discharge beyond inherent recovery levels. Audible and visual alarms warn of minimal battery time remaining so that microUPS can be shut down prior to loss of power. *Liebert Corp., 1050 Dearborn Dr., P.O. Box 29168, Columbus, OH 43229; tel.: 800-877-9222; fax: 614-841-6973.*

CIRCLE NO. 3 ON FREE CARD

Graphics Accelerator

The new LightSpeed VL graphics accelerator from STB Systems is a high-performance, 32-bit graphics device for the VESA Local Bus interface. Employing a design based on the Tseng W32P video controller chip and a 135-MHz, 16-bit data port RAM-DAC, LightSpeed VL has 2M of interleaved 60-ns DRAM. The accelerator can deliver a maximum of 16.7-million colors at resolutions ranging up to 800 x 600 with a 72-Hz refresh rate; 65K colors at 1,024 x 768; and 256 colors at 1,280 x 1,024.

LightSpeed VL provides full hardware support for bit-block transfers, line drawing engines, polygon fills, hardware cursor and other hardware-assisted operations. The card is shipped with a variety of drivers, including those for

Windows 3.1 and AutoCAD. \$349. *STB Systems, Inc., 1651 N. Glenville, Richardson, TX 75081; tel.: 214-234-9750; fax: 214-234-1306.*

CIRCLE NO. 4 ON FREE CARD

Digital Multimeter

UEI's DM383 digital multimeter measures up to 1,000 volts dc, 750 volts ac, ac and dc current, resistance, diodes and continuity. Its 200- μ A range permits measurement of most

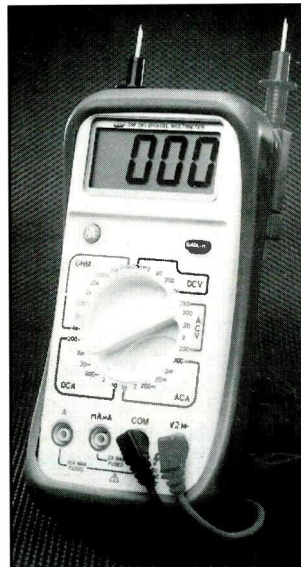

flame safeguard systems. Designed to meet UL and IEC safety standards, the DMM features a 2,000-count, 0.91" LCD display, color-coded front panel, auto-polarity, data-hold, overrange indication, low battery indication and audible continuity buzzer. It's ruggedized to withstand a 10-ft. drop. \$49.95. *UEI, 5500 S.W. Arctic Dr., Beaverton, OR 97005; tel.: 503-644-8723; fax: 503-643-6322.*

CIRCLE NO. 5 ON FREE CARD

VGA-to-TV Converter With Audio

Digital Vision's TelevEyes/Plus converts the output of any VGA computer to standard broadcast video. It connects between a computer's VGA output and video monitor to



provide output to both the VGA monitor and TV receiver. All desktop, laptop, and portable VGA computers are supported, running graphics modes up to 640 x 480 at any color depth. The audio portion of TelevEyes/Plus includes both microphone and line-level connectors for inputs and both line-level and 3-watt speaker connectors for outputs. \$449.95. *Digital Vision, Inc., 270 Bridge St., Dedham, MA 02026; tel.: 617-329-5400; fax: 617-329-6286.*

CIRCLE NO. 6 ON FREE CARD

VL-Board Tester

VL-EXT from ICS Electronics is a smart extender card for testing and debugging printed-circuit board assemblies for the PC VL bus. The card contains all of the logic to connect

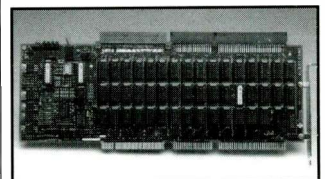

power and PC signals to the board under test without affecting the PC's operation. Operation of the VL-EXT card is controlled either by instructions from a test program or manually via on-board switches. To test a board, you insert it into a connector at the top of the VL-EXT card. \$595. *ICS Electronics Corp., 473 Los Coches St., Milpitas, CA 95035; tel.: 408-263-5500; fax: 408-263-5896.*

CIRCLE NO. 7 ON FREE CARD

Video-Monitor Analyzer

The Sencore CM2125 Computer Monitor Analyzer is designed to completely troubleshoot and performance-test all

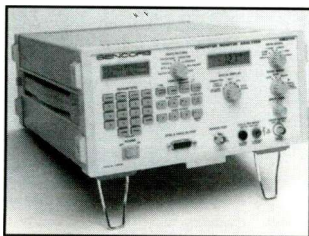

high-resolution and multi-sync video monitors. It has a fully programmable sync and pixel generator that provides signals for analyzing all computer monitor types. It provides bandwidth to 125 MHz, 2,048 x 2,048 pixels and a 70-monitor setup memory and is compatible with TTL, analog and ECL types of monitors.

A special "Sync-Locked" substitution signal pinpoints all monitor circuit defects. The unit also features the patented "Ringer" and High Voltage Multiplier Test to dynamically analyze all yokes, integrated high-voltage transformers and switching transformers. Additionally, the CM2125 has an integrated 2,000-volt dc and p-p ac meter for making voltage measurements. *Sencore, 3200 Sencore Dr., Sioux Falls, SD 57107; tel.: 800-SENCORE.*

CIRCLE NO. 8 ON FREE CARD

16C5x In-Circuit Emulator

Advanced Transdata's RICE-16-5x in-circuit emulator is a PC-based real-time development system for Microchip Technology's PIC16C5x series of microcontrollers. It links transparently to an IBM PC or compatible computer via the latter's parallel printer port and emulates the PIC16C5x family operating at up to 16 MHz. The device consists of the RICE16 emulator base unit and a PB-5x probe card. Changing the probe card enables the base unit to support



different members of the PIC-16C5x family.

The RICE16 base unit has 12 logic probes that comprise eight trace inputs, an external break input, a trigger output, a break output and a common ground pin. It also includes 40 different internal oscillator frequencies that range from 32 kHz to 20 MHz, for emulation. This internal clock supports all oscillator types of the PIC device.

RICE16 software features a windowed interface with pull-down menus. All information regarding the microcontroller is available on-screen. A TASM16 Macro Assembler is also included with the package. \$895. *Advanced Transdata Corp., 14330 Midway Rd., Ste. 104, Dallas, TX 75244; tel.: 214-980-2960; fax: 214-980-2937.*

CIRCLE NO. 9 ON FREE CARD

Hand-Held Data Logging

LogIT is a 12-bit compact data logging system from Science/

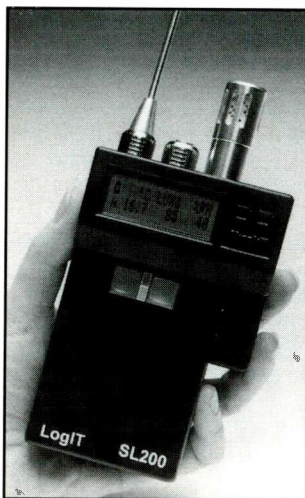

gent sensors. The 10-ounce unit features sensors for measuring temperature, light level, sound level, humidity, pH, dissolved oxygen, movement or position and voltage or current. Up to three sensors can be used simultaneously. LogIT software for both DOS and Windows lets you do real-time monitoring and on-line mathematical processing of data.

Science/Electronics, Inc., P.O. Box 986, Dayton, OH 45401; tel.: 513-859-5555; fax: 513-859-7930.

CIRCLE NO. 10 ON FREE CARD

64-Bit Graphics Accelerator

WindowsVGA 64 is a high performance 64-bit video graphics accelerator from Genoa Systems for the DOS/Windows environments. The card supports 16.8-million colors at 1,024 x 768 resolution,

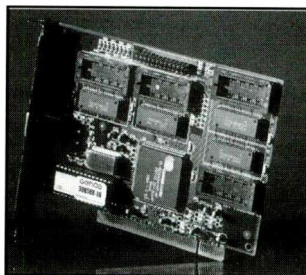

with a maximum resolution of 1,280 x 1,024. Based on the Cirrus Logic CL-GD5434 chip, WindowsVGA 64 utilizes a 64-bit memory interface in either PCI or VL version. Among the video drivers included with the card are those for Windows 3.1 and AutoCAD. \$199/\$289 1M/2M. *Genoa Systems, 75 E. Trimble Rd., San Jose, CA 95131; tel.: 408-432-9090; fax: 408-434-0997.*

CIRCLE NO. 11 ON FREE CARD

Printer Sharer

Belkin Components' ParaNet II printer-sharing device has an exclusive six-wire cable system that maintains consistent speeds as a network is expanded. It supports transmission distances up to 1,200 feet. Windows and DOS software are included. \$74.99. *Belkin Components, 1303 Walnut Park Way, Compton, CA 90220; tel.: 800-223-5546.*

CIRCLE NO. 12 ON FREE CARD

ICE Eliminator

The eBoard PC card from Highlands Electronics eliminates the hassle of an in-circuit emulator. You work with the

MS-DOS to the Max

By Dan Gookin

(Microsoft Press. Soft cover. 336 pages, one 3 1/2" disk. \$29.95.)

If you have a basic familiarity with the workings of DOS, Dan Gookin will help you push the operating system to fuller use so that you can exploit your computer's operation more fully. He works with MS-DOS 6.0, while also covering older DOS versions. From organizing to manipulating files to livening up your command prompt, he relentlessly covers little ways in which to get more power from a PC, as well as tips on buying a new hard drive. Accompanied by a disk that contains a bevy of new utilities, as well older tried-and-true commands, this is an easy-reading book to boost your PC operating know-how and productivity. It's written in a lively manner, too.

actual CPU from the start of your project. eBoard is supported by a development system that includes a cross-assembler, integrated developer's environment, resident Forth language and kernel. The card, which is externally powered, runs with a 6502 microprocessor. It comes standard with a breadboard, cable, experimenting supplies and instructions for a series of experiments. \$249.95. *Highlands Electronics, 13720 Lake Shore Dr., Clear Lake, CA 95422; tel.: 707-994-1024; fax: 707-994-5823.*

CIRCLE NO. 13 ON FREE CARD

PCMCIA Socket Tester

Sycard Technology's PCCtest 550 series of socket testers provides a quick and accurate way to verify the functionality of a PCMCIA host socket. Housed in a Type II PC Card, PCCtest is fully self-contained. It can verify all data, address and control signals on a PCMCIA release 2.x-compliant in-

Windows Configuration Handbook

By John Woram

(Random House Electronic Publishing. Soft cover. 1,152 pages. \$34.)

Here's a hefty *Windows* book that's crammed with meaningful information on how to avoid and solve problems when setting up, modifying and using *Windows* software. This text is the product of an enormous amount of personal research with *Windows*, not just a regurgitation of a user's manual. Using clear, step-by-step explanations, Woram shows you how to set up and troubleshoot in the *Windows 3.1* environment, including *Windows for Workgroups*. The material ranges from maximizing hardware efficiency to customizing files, all heavily supplemented by helpful screen illustrations.

You'll welcome a host of undocumented items, such as Dr. Watson, Microsoft's diagnostics utility, and the system editor. Among five Appendices is an Error Message Finder. Additionally, the book's Index is superlative with about 2,500 entries. This in-depth book on *Windows* is extremely valuable and should be a standard text on everyone's bookshelf.

terface. An on-board micro-controller provides test stimulus and controls an integrated A/D converter to measure the socket's supply voltages.

Included with the tester is software designed to run on a variety of host socket controllers. The test software supports the Intel 82365SL, Vadem VG365, VG465, VG468 and Cirrus CLPD6710/20 socket controllers. \$495. Sycard Technology, 651 Smoke Tree Way, Sunnyvale, CA 94086; tel.: 408-247-0730; fax: 408-247-3471.

CIRCLE NO. 14 ON FREE CARD

Voice/Data/Fax Modem

The 9624VF internal voice interactive data/fax modem from Cal Com Products combines a 9,600-bps send/receive fax modem with a 2,400-bps data modem that features voice recognition. An auto-detect feature distinguishes between incoming faxes and voice messages.

The 9624VF records, saves and plays back messages that can be accessed by more than one user. The three- and four-bit ADPCM voice modem plays messages through its on-board speaker or through an external speaker via a support jack or sound card. It records messages through an attached telephone handset or sound card. \$199. Cal Com Products, 181 W. Orangethorpe, Ste. A, Placentia, CA 92670; tel.: 714-961-1888.

CIRCLE NO. 15 ON FREE CARD

Camera/Capture Card

VideoLabs' FlexCap is a digital video camera and capture board combination. The camera head uses a high-resolution 1/3" color CCD imaging device with 510 x 492 pixels of resolution and provides digital pan/tilt at CIF or QCIF resolution. Designed to operate in high- and low-light environments, FlexCap has a sensitivity of 2.5 lux at f/2.0 and includes programmable white balance and programmable shutter with automatic gain control.

FlexCap includes a *Windows*-based API that enables

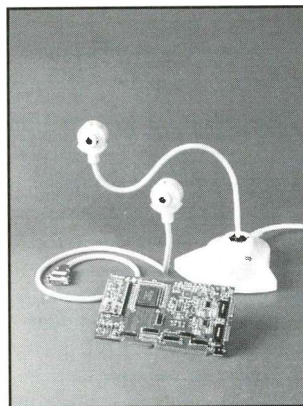

PC's & Parts

MOTHERBOARDS

386/33 SX \$129
386/40 64K CACHE \$149
486DL33 64K CACHE \$199
486/33 128K VESA \$399
486/66 128K VESA \$549
486/50 256K VESA \$549
486/66 EISA/VESA \$759

All Boards with CPU's. All are AMI BIOS with OPTI or other C/S. Mini size fits nearly all cases. Std. power conctrs. Fax Fact # 1115

COMPLETE PC's

486/33DX with 64k SRAM Cache, 4 megs RAM, 1.44 Floppy, 16Bit Dual (1:1) HD/FD controller, 1 Parallel 2 Serial Ports, 101 Key Enhanced keyboard, Mini tower case, SVGA Monitor w 1MB card, 130 meg HD. \$1195.00

SYSTEM OPTIONS

DRAM

386/40 64k cache — \$195
486/33 VESA + \$139
486/50 VESA + \$579
Add'l 4 MB DRAM + \$Call
Add'l 12 MB DRAM + \$Call
1MB SVGA card + \$15
S3 Accelerator + \$199
17" VGA + \$379
210MB Hard Drive + \$70
386/33 SX mb — \$229

To custom configure your system, start with the 486/33 PC on top and add or subtract components as desired for your custom designed system. Fax Fact #1200

HARD DRIVES

80MB 19 MS \$169
130MB 16 MS \$179
210MB 15 MS \$249
245MB 14 MS \$279
540MB 12MS \$379

All Drives are IDE type. Add \$19 for 16 bit controller card. Maxtor & Seagate drives. Fax Fact # 1120

FLOPPY DRIVES

1.44MB, 3.5 inch \$49
1.2MB, 5.25 inch \$55

MONITORS

12" Amber Mono \$89
14" VGA Mono \$129
14" SVGA .28 Int'lace \$249
14" SVGA .28 Non/IN \$299
17" SVGA Non/IN \$629
VGA Card 512k \$69
SVGA Card 1M \$89
VESA Accelerator 1M \$189

All Monitors Carry One year Factory warranty. Fax Fact #1114

ACCESSORIES

Printers, Modems, Fax Cards, "Mice" etc. Call Toll Free for info.

Dial 317 849 8683 to get instant tech information

FREE from your Fax! You can obtain specs and info on these products and more by dialing our Fax Facts automated service. Call our number from your fax, then request the document as listed above. Start your fax, and the document will begin printing immediately on your fax!

Order Toll Free 24 Hours a Day! Dial 1-800-445-7717

Fax in your order Toll Free, 1-800-448-1084

Use 800 numbers in all 50 states, plus Canada. International voice lines, 317-842-7115 or fax 317-849-8794. Use our BBS for information by dialing 317-579-2045

ACE Communications 10707 East 106th Street, Fishers, IN 46038

VISA

Checks, Approved P.O.'s & C.O.D. (add \$5.00) & AMEX. Prices, specifications and availability subject to change. Express shipping available. No returns accepted two weeks after original receipt without substantial restocking charge. All units carry full factory warranty. IN residents add 5% sales tax

MasterCard

CIRCLE NO. 102 ON FREE INFORMATION CARD

control of shutter speed, white balance, image size, image scale, sub-image position, signal gains, video mute and audio mute. The optical system is adjustable from infinity down to 1.4" (for 50:1 magnification). The camera head has two microphones, enabling audio to pass through the system directly to a third-party sound card. The camera also supports a second camera head for applications where two video inputs are required. \$595. *Video Labs, 5270 W. 84 St., Minneapolis, MN 55437; tel.: 612-897-1995; fax: 612-897-2597.*

CIRCLE NO. 16 ON FREE CARD

100-MHz PCI/VL PC

Micro Express' MicroFLEX-PCI/VL/100 personal computer is based on the Intel 486-DX4-100 microprocessor. The base configuration for the system includes 16M of RAM,

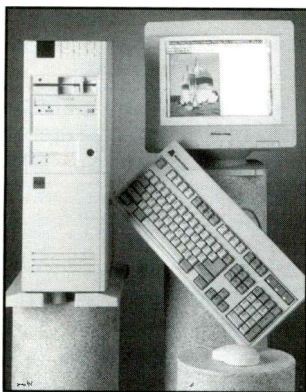

420M IDE hard-disk drive with a 1M VESA caching controller, 256K of RAM cache, FM-570 15" SVGA color video monitor, PCI video accelerator with 2M of RAM, 3 1/2" and 5 1/4" floppy-disk drives, mini-tower case, keyboard, mouse, DOS 6.2 and Windows 3.1. The proprietary motherboard uses a Phoenix BIOS and has eight expansion slots, including three 16-bit ISA slots, two VL slots and three PCI slots. Up to 128M of RAM is supported on the motherboard. \$2,999. *Micro Express, 1801 Carnegie Ave., Santa Ana, CA 92705; tel.: 714-852-1400.*

CIRCLE NO. 17 ON FREE CARD

PID Auto-Tuning Controllers

The 48VT and 96VT are microprocessor based, PID auto-tuning controllers from Extech Instruments that accept multiple thermocouples, RTDs or

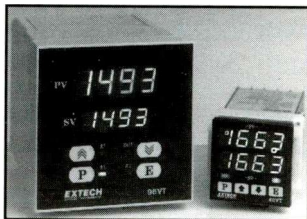

process units. Dual LEDs display process and setpoint values. The 48VT comes standard with one control output and one 5-ampere alarm relay.

Supplied is one control output and two 5-ampere alarm relays. Limit alarm relays include a programmable delay countdown timer. The control outputs can be either 5-ampere relay, pulsed 24 volts dc, or 4 to 20 mA. Additional features include selectable heat/cool control, eight alarm modes, front panel tactile switches and screw-type terminal connections. The 96VT has an optional RS-485 interface with software to set up control parameters and monitor up to 32 controllers from a PC. \$179. *48VT. Extech Instruments Corp., 335 Bear Hill Rd., Waltham, MA 02154; tel.: 617-890-7440; fax: 617-890-7864.*

CIRCLE NO. 18 ON FREE CARD

Sign-Making Cutter

Roland's CAMM-1 Model 500 professional cutting device is specifically designed for iron-on transfer applications. The unit also can be used to cut vinyl and other standard materials. It offers users a work area of 11" x 17" and can be operated at cutting speeds of



4" per second for iron-on transfers and 8" per second for vinyl cutting. The cutting mechanism achieves a maximum down pressure of 80 grams and a mechanical resolution of 0.0005" per step. \$1,995. *Roland Digital Group, 1961 McGaw Ave., Irvine, CA 92714; tel.: 714-975-0560; fax: 714-975-0569.*

CIRCLE NO. 19 ON FREE CARD

Fax/Memory PCMCIA Card

The FMM from SMART Modular Technologies combines 2M of expanded memory with a fax/modem and interface software in a single Type II

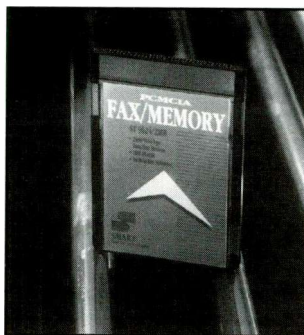

PCMCIA card. Intended for machines like the HP 100LX—which has only one PCMCIA slot, a minimum amount of memory and no disk drive—the FMM card includes a battery-saving ultra-low-power sleep mode of less than 2 mA. The modem sends and receives data at 2,400 bps and faxes at 9,600 bps. MNP and V.42 error correction is done in software. \$349. *SMART Modular Technologies, 45531 Northport Loop W., Bldg. 3B, Fremont, CA 94538; tel.: 510-623-1231; fax: 510-623-1434.*

CIRCLE NO. 20 ON FREE CARD

Windows RS-232

Sealevel Systems' DUOCOM: two-channel serial I/O interface for the IBM and compatible computers has user selectable IRQ settings and addresses to provide error-free Windows and DOS communications. Support for AT interrupts permits multiple devices to coexist without causing con-

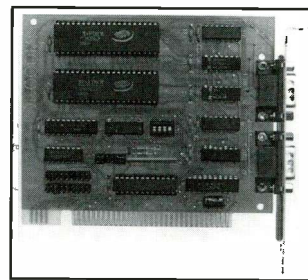

licts. The card comes standard with 16550 buffered UARTs, recommended for Windows communications. \$89. *Sealevel Systems, 102 W. Main St., P.O. Box 830, Liberty, SC 29657; tel.: 803-843-4343.*

CIRCLE NO. 21 ON FREE CARD

Motion-Control System

The Cybermation Motion Control System is an intelligent stepper-motor controller that can control two multi-axis 48-step motors per board and is expandable to 32 motors on

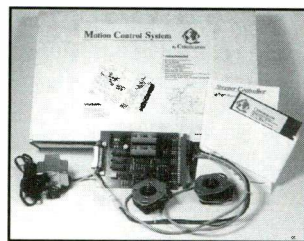

one LPT interface. The complete kit contains a controller card, two stepper motors, transformer, documentation, wiring harness and IBM/compatible software written in QBASIC and GW BASIC. \$249.95. *Cybermation, 1943 Sunny Crest Dr., Ste. 288, Fullerton, CA 92635; tel.: 714-992-2266; fax: 714-992-2082.*

CIRCLE NO. 22 ON FREE CARD

PCMCIA Ethernet Adapter

The Socket Communications EA+ Ethernet adapter is a PCMCIA network adapter that supports both 10BaseT twisted-pair and 10Base2 thin coaxial cable. It has the ability to sense the type of network cable being used, allowing you

Collimator Pen



Output: 2.5 mW (max.); Current 90-150 mA
Oper. Volt: 2.2-2.5 V; Wl: 820 nm - Infrared
Size: 11 mm dia. x 27 mm L; Data sheet inc.

Stock#	1-9	10-24	25+
S81052	49.99	47.49	42.74

Collimating Lens



Black anodized aluminum barrel; Glass lens with 7.5mm focal length. Fits 9mm laser diodes sold below. easy to focus and install.

Stock#	1-9	10-24	25+
LSLENS	24.99	23.74	21.37

Eprom Programmer

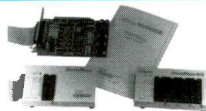

Programs all EPROMS, EEPROMS, including flash memories. Programs microcontrollers with optional adapters. Complete with software, programming module, cable & manual. Single Device programming.

Stock#	1-9	10-24	25+
ROMMAX	159.99	151.99	136.79

Eprom Eraser



Erases up to 9-28 pin or 6-40 pin eproms. Built-in presettable timer with LED interval indicator.

Stock#	1-9	10-24	25+
LA6T	89.99	85.49	76.94

Economy Laser Pointer



- 5 mW output (max.)
- 670nm
- 5.75" long
- 2 AAA batt. (inc.)

Stock#	1-9	10-24	25+
B500	99.99	94.99	85.49

Laser Module



- < 4.5 mW output
- 20 mm dia. x 70 mm long
- 150 meters range

Stock#	1-9	10-24	25+
LM4.5	99.99	94.99	85.49

16 More Reasons To Believe In



Switching Power Supply



- 115/230 V input
- 41 watt
- 5v @ 3.75 A, 12v @ 1.5 A, -12v @ 0.4 A
- 7" L x 5.25" W x 2.5" H

Stock#	1-9	10-24	25+
PS1003	19.99	18.99	17.09

Electronic Experimenters Kit

Professor Sparky, world famous inventor, takes you on an entertaining voyage into the world of electronics. No previous knowledge is needed. Choice of 110 (X1000) or 174 (X2000) problem free instructional electronic experiments.



Stock#	1-9	10-24	25+
X1000	43.99	41.79	37.61
X2000	79.99	75.99	68.39

Laser Diodes

Stock#	Mfr.	Wavelength	Output	1-9	10-24	25+
LS9200	Toshiba	670nm	3 mW	39.99	37.99	34.19
LS9211	Toshiba	670nm	5 mW	59.99	56.99	51.29
LS9215	Toshiba	670nm	10 mW	109.99	104.49	94.04
LS022	Sharp	780nm	5 mW	13.99	13.29	11.96
S81053	Phillips	820nm	10 mW	10.99	10.44	9.40

Robotic Arm Kit



Fascinating and educational, with lift/lower, grab/release, and pivot left/right functions. Uses 2 C batteries (not inc.); approx. 10" long. Use Y0118M interface to program from your PC!

Stock#	1-9	10-24	25+
Y01	43.99	41.79	37.61
Y0118M	39.99	37.99	34.19

1/4 Ton IDC Bench Assembly Press

Rotating base plate and platen. No tools required to change plates/cutting accessories. Additional accessories available. Weighs 5.5 lbs. 10" L x 8.75" w x 9" H



Stock#	1-9	10-24	25+
PV505	149.99	142.49	128.24

Computer Care Kit



A complete computer care kit. Contains cleaning diskette, head-cleaning fluid, cleaning swabs, anti-static cleaner, anti-static screen wipes. S81099 for 3.5" drives, S81100 for 5.25" drives.

Stock#	1-9	10-24	25+
S81099	3.99	3.79	3.41
S81100	3.99	3.79	3.41

Vacuum Base Vise



Panavise PV381 is a versatile, portable bench vise. a half turn of the mount lever attaches or releases the powerful suction pad and allows rapid set-ups in a variety of locations on smooth, non-porous surfaces

Stock#	1-9	10-24	25+
PV381	47.99	45.59	41.03

Telephone Kit

Build this high-tech, see-thru plastic telephone. Learn theory on how telephones work. Flashing neon lamps when phone rings. Redial system and wall mount included. Comes complete with manual



Stock#	1-9	10-24	25+
PT223K	15.99	15.19	13.67

PLUS
•
Low Prices
•
Super Selection
•
Prompt Service
•
Free Shipping
•
Order Toll Free
(800) 824-3432

Protoboard Design Station

Includes expanded instrumentation, breadboard, and power supply. Ideal for analog/digital/microprocessor circuits. Frequency and function generators, variable outputs, logic indicators, speaker & more.

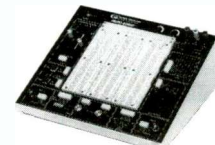

Stock#	1-9	10-24	25+
P8503	299.99	284.99	256.49

Programmable Robotic Kit



The pen mechanism included with the robot allows it to draw. In addition to drawing straight lines, it can also accurately draw circles, and even draw outwards & short phrases! MV961 comes with 128 x 4 bits RAM and 2K ROM, and is programmed directly via the attached keypad. With its built-in connector port, and the optional interface kit (W1118M), MV961 is ready to communicate with your PC! The interface kit

allows editing and transferring of any movement program, as well as saving and loading of programs.

Stock#	1-9	10-24	25+
MV961	79.99	75.99	68.39
W1118M	39.99	37.99	34.19

Order Line — (800) 824-3432

Fax Orders — (818) 998-7975

• Min. Order — \$15.00 • UPS Blue, Red, & Fed. Ex. Shipping Avail. • CA Res. Add 8-1/4% Sales Tax

• Open Mon-Fri 9:00 AM - 5:00 PM (PST) • Corporate Accounts / Quantity Discounts Available

• Call For FREE Catalog (\$2.00 Outside U.S.) • We Carry A Complete Line Of Electronic Components

*FREE Shipping On Pre-Paid Orders Delivered In The Continental United States

• International Orders — (818) 341-8833

• Technical Support — (818) 341-8833



Unicorn Electronics
10000 Canoga Avenue, Unit C-2
Chatsworth, CA 91311

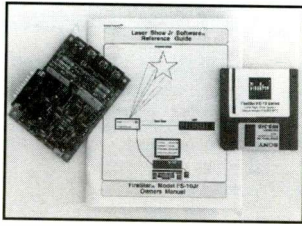

to move from one type of network to another without reconfiguring the software. The card is recognized by SystemSoft's *CardSoft* and *CardView* software.

EA+ features a 64K RAM buffer and internal and external 16-bit data paths. Low power consumption allows the EA+ to conform to the Intel ExCA power specification, without requiring an ac adapter. NE2000 emulation allows the EA+ to work with certified network drivers for a wide variety of network operating systems, including Novell *NetWare* 3.xx and 4.xx and Microsoft *Windows for Workgroups* 3.xx. \$369. *Socket Communications, Inc.*, 2501 Technology Dr., Hayward, CA 94545; tel.: 510-670-0300; fax: 510-670-0333.

CIRCLE NO. 23 ON FREE CARD

Universal Programmer

Xeltek's SuperproII PC-based universal programmer is reported to support more than



2,000 devices. It supports up to 8M EPROMs, EEPROMs and Flash EPROMs from most manufacturers and microcontrollers from major manufacturers, including Intel 87XX, Motorola 68HCXXX and 68XXX, Signetics 87XXX, Microchip PIC, National COP,

Zilog, Hitachi and AMD 87XXX. SuperproII also programs PALs and GALs, including the 16V8, 20V8, 22V10, PLD, EPLD and MACH series. Additionally, it performs functional tests for IC, CMOS and memory devices. Included software provides comprehensive control of various device functions. \$699. *Xeltek*, 757 N. Pastoria Ave., Sunnyvale, CA 94086; tel.: 408-524-1932; fax: 408-245-7084.

CIRCLE NO. 24 ON FREE CARD

Laser Light Show

Design Images' FireStar Jr. laser light show system for PCs consists of a logic card with a printer-port interface for desktop and notebook-type computers, DAC array, dual galvo amplifier, intelligent logic control through software, power supply, *Laser Show* software and users manual. *Laser Show* lets you run pre-programmed images or images you create yourself. Included on the card are two TTL-level output ports for adding a beam shutter or light controller, or for starting an electric fog machine. The unit requires a galvo set and laser, which are available from the company. \$295. *Design Images, P.O. Box 292125, Lewisville, TX 75029*; tel.: 214-221-9711; fax: 214-436-1817.

CIRCLE NO. 25 ON FREE CARD

Surge Arrester

Surgebreaker from Square D is a secondary surge arrester that provides protection for a circuit breaker box and branch



wiring. The device features a plug-on design for easy installation in Square D panels. *Square D Co.*, 3201 Nicholasville Rd., Lexington, KY 40503; tel.: 606-245-7924; fax: 606-245-7950.

CIRCLE NO. 26 ON FREE CARD

Circuit Protector

Circuit Guard International's Circuit Guard spray-on liquid protects computers and electronics from moisture, static and corrosion. It forms an at-

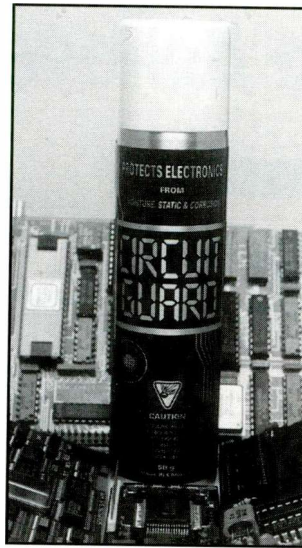

mospheric barrier around electronic components to actively encapsulate and chemically neutralize all ion-transferring electrolytes that cause corrosion and lead to circuit failure. \$19.95. *Circuit Guard Int'l.*, 1801 Weatherstone Dr., Safety Harbor, FL 34695; tel.: 800-365-5030; fax: 813-726-6774.

CIRCLE NO. 27 ON FREE CARD

Workstation Organizer

The InView Workstation Organizer is a work flow management system from Ring King Visible for personal computers that combines the functions of several computer accessories into a single unit. InView includes two interchangeable file panels that attach on either side of a computer's video monitor. Each can be configured as a document holder for more than 100



pages of copy. A reference guide magnifies text for increased readability. A file panel insert modifies a panel to function as a storage center for active files. The insert also has movable compartment dividers that snap in to create customized storage for media and office supplies. *Ring King Visible, Inc.*, 2210 Second Ave., P.O. Box 599, Muscatine, IA 52761; tel.: 319-263-8144; fax: 319-262-0512.

CIRCLE NO. 28 ON FREE CARD

Software

Photo Screen Saver

In Your Face for Windows Version 4 from Hilsoft is a personalized photo screen saver with the ability to play sound files. It also features special effects and the ability to add text to an image. The product lets you display any *Windows* standard format .BMP or compressed .RLE images. \$34.95. *Hilsoft, P.O. Box 120, Souderton, PA 18964*; tel.: 215-721-2120.

CIRCLE NO. 29 ON FREE CARD

Fuzzy Modeler

Fuzicalc Version. 1.5 is a fuzzy number modeling tool from FuziWare for modeling uncertain events that aren't statistical in nature. *Fuzicalc* creates a valid, mathematically rigorous analysis without the use of statistics or spreadsheet "what-if" scenarios. This latest version includes an expanded set of functions and a totally new set of onboard 3D graphics tools. \$179.95. *FuziWare, Inc.*, P.O. Box 11287, Knoxville, TN 37939; tel.: 800-472-6183; fax: 615-588-9487.

CIRCLE NO. 30 ON FREE CARD

Applying the 14-Bit PIC16C71 and PIC16C84

A primer on two of the most-versatile microcontrollers available

In the July/August issue, I introduced you to the PIC16C71 and described a PIC16C71/84/64 programmer you can build. This time around, I'll describe how to put the programmer to use. I concentrate here on the PIC16C71 and PIC16C84 microcontrollers from Microchip Technology. Since in previous PIC articles I've given you an in-depth look at common PIC architecture, with this outing, I'll focus on the "how-to" side with software and hardware examples. To this end, I'll cover the basic Intel HEX file layout as it pertains to the PIC16C71/84/64 programmer and present some PIC building-block circuitry and software that will help you get up to speed with your own designs.

Before continuing, I suggest that you gather together a solderless breadboard or perforated board that has holes on 0.1" centers and your Wire Wrap tool, the 1994 Microchip Data Book, your PIC16C71/84/64 programmer, the Microchip PIC assembler and some blank PICs. I'll begin this discussion by describing the Intel HEX file generated by the Microchip assembler and used by the PIC16C71/84/64 programmer.

Intel Hex File

With your PIC programmer powered up, perform a read operation on a blank PIC16C71 or PIC16C84 and save the file to disk with a CLEAN.OBJ filename. Examine the first line of the dump you just created. It should start with a ":" (colon). Notice that every line begins with a ":". For our purposes, the C programs (PIC71, PIC84 and PIC64) that communicate with the PIC16C71/84/64 programmer use the colon as a delimiter to determine the beginning of a line of hex data.

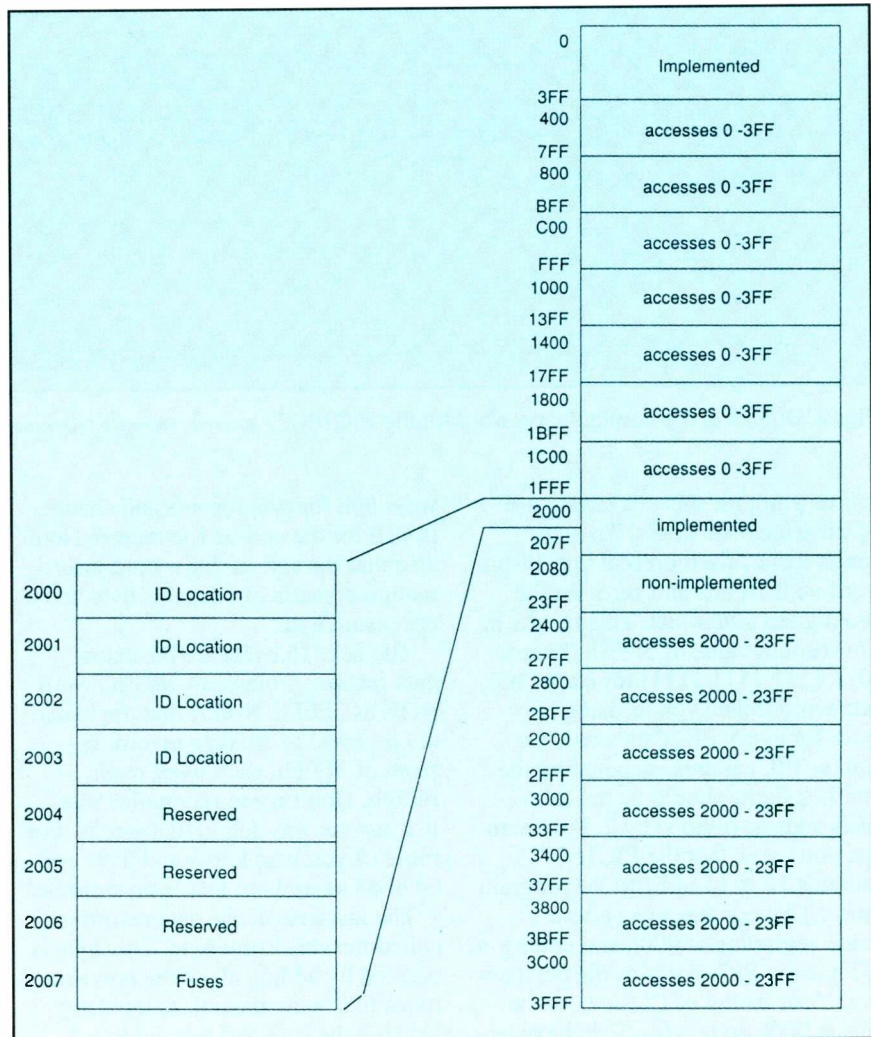

Fig. 1. Program memory mapping for the PIC16C71 microcontroller. (Courtesy Microchip Technology Inc.)

The byte immediately following the colon should be 10h (the "h" suffix denotes hexadecimal notation). This equates to 16 decimal and denotes the number of data bytes contained within this line or data record. As you can see, you'll always attempt to place 16 bytes or eight PIC words of data on

each line when possible to make it easier to read and allow the remaining free space to be judged at a glance.

The next four hex digits represent the starting address for the data record. Since this can cause some confusion, let's look at this from the PIC's perspective. Remember, the PICs

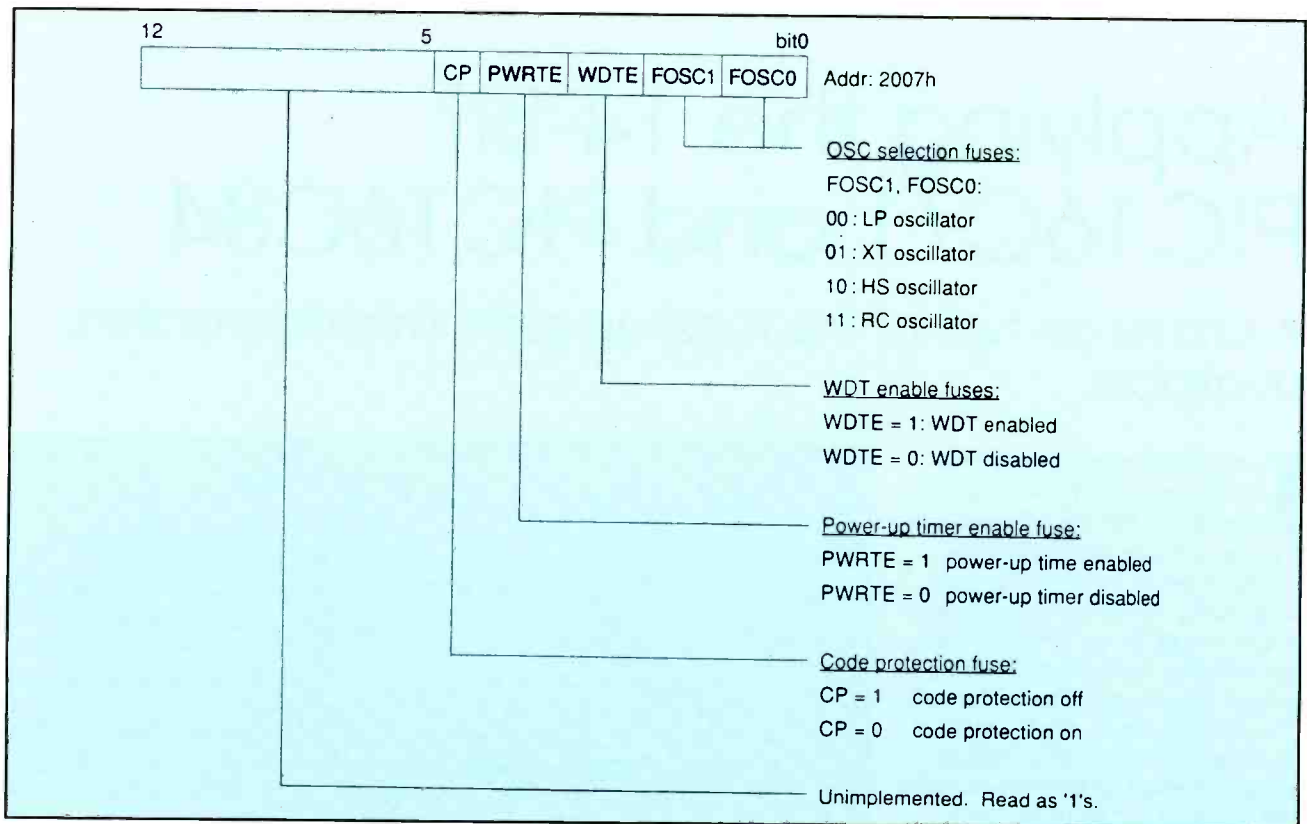

Fig. 2. Details of the configuration word for the PIC16C71. (Courtesy Microchip Technology Inc.)

you're using for this discussion use 14-bit-wide data words. To make things easier, we represent this 14-bit word with 16 bits and zero-out the two highest-order bits. This results in a maximum value of 3FFFh (binary 0011 1111 1111 1111) for each PIC data word. Since you're using two bytes for every PIC data word, the real (or PIC) address denoted by the four hex digits should be the Intel HEX address divided by 2. For example, you know that the PIC16C71 contains 1K x 14 of EPROM program space. That equates to an address space beginning at 000h and ending at 3FFh using PIC words as the perspective. Your listing of CLEAN.OBJ begins at 000h and ends at 7FF hexadecimal. (The last data record at address 800h is used by your system and will be explained in detail later.)

With address 000h counted as a physical byte, 000h through 7FFh equates to 2,048 bytes. Divide this by 2 to obtain the 1K x 14 defined as the PIC EPROM program memory space. Now that you understand the addressing methodology, reading left to right, the fourth byte from the colon denotes the end-of-file record. This byte is al-

ways 00h for data records and changes to 01h for the end-of-file record. Note also that the end-of-file record information consists of only this byte and a checksum byte.

The next 16 bytes are the actual data record. A blank 14-bit PIC word reads as 3FFFh. Notice that the bytes are reversed in the data record. Instead of 3FFFh, each word reads FF3Fh. Don't try to rationalize this. It's just the way Intel HEX works. For those of you who know and have coded 8088 assembler, this is no surprise.

The last byte of the data record is called the checksum byte. This byte is derived by adding all of the previous bytes following the colon, logically NOTing the sum and then adding 1. Only the low-order byte is used for the actual checksum byte.

This process of inverting the bits and adding 1 is commonly known as deriving 2's complement. For example, the sum of the bytes for the first data record is A00h, (1010 0000 0000 binary). Applying a logical NOT, you get 5FFh, which equates to 0101 1111 1111 binary. Adding 1 to 5FFh you obtain 600h, or 0110 0000 0000 binary. Dropping the high-order nibble 6

(0110) in order to use only the lower byte gives a checksum byte of 00h. Try this for the next line. Just add 10h to A00h and perform the 2's complement. You should get a result of 5F0h, which leaves F0h as the checksum.

You're probably asking what the point of all of this Intel HEX stuff was. Your ability to analyze the Intel HEX file will be useful when you have to debug problems you may incur with your home-brew PIC microcode. Another advantage is that with Intel HEX you don't need a binary editor. You can use the same editor with which you write your source code to inspect program memory and configuration of your PIC. It's also a good tool to use when gauging how much space is left for those additional routines you may need to add when developing your software.

Now let's parse and digest the last line of your dump of CLEAN.OBJ.

In Fig. 1, note that there are eight words of data beginning at location 2000h and ending at location 2007h. The data record at address 0800h on your dump of CLEAN.OBJ maps directly to locations 2000h through 2007h. This means that the first four

words are ID locations, and the last word of the data record is the configuration fuse information read from this particular PIC.

Figure 2 is a configuration fuse layout for the PIC16C71 and PIC16C84. Although the C terminal programs PIC71, PIC84 and PIC64 interpret the ID word and configuration fuse information automatically, it's still good to know where the raw data resides.

Serial Communications

The serial I/O routine for the PIC is only 41 words in length. The concept and the PIC code pertaining to serial or asynchronous communications is simple. There are only three parameters the programmer must be aware of to implement a serial link: baud rate; number of data bits; and number of stop bits.

A parity bit can also be added, if necessary. My example code assumes no parity. Reference the RS-232 Transmitter/Receiver schematic diagram shown in Fig. 3 and the accompanying PIC microcode as I discuss the details of serial communications and build a working 9,600-bps serial link.

First of all, data to be transmitted is normally represented as TTL voltage levels. That is, high and low levels within the 0- to +5-volt range. RS-232 levels are technically defined to be within a range of ± 15 volts. A potential of +3 volts or greater denotes the RS-232 space, or 0, while a potential of -3 volts and less is known as a mark, or 1. This wide variation in voltages implies that some sort of voltage conversion must take place to meet the RS-232 conventions and, subsequently, interface to TTL logic. ICs like the Dallas DS1275 and the MAX233 are designed specifically to suit this purpose.

You'll find that in some less-expensive serial equipment, the conversion ICs are replaced by discrete circuitry to save money. Under certain circumstances, TTL voltage levels can drive some RS-232 ICs. These "cheap" implementations rely on the equipment to recognize a mark at 0 volt and a space at +3 volts, which is somewhat gray as the standard goes. This ap-

Fig. 3. Schematic diagram of the RS-232 receiver/transmitter circuitry. →

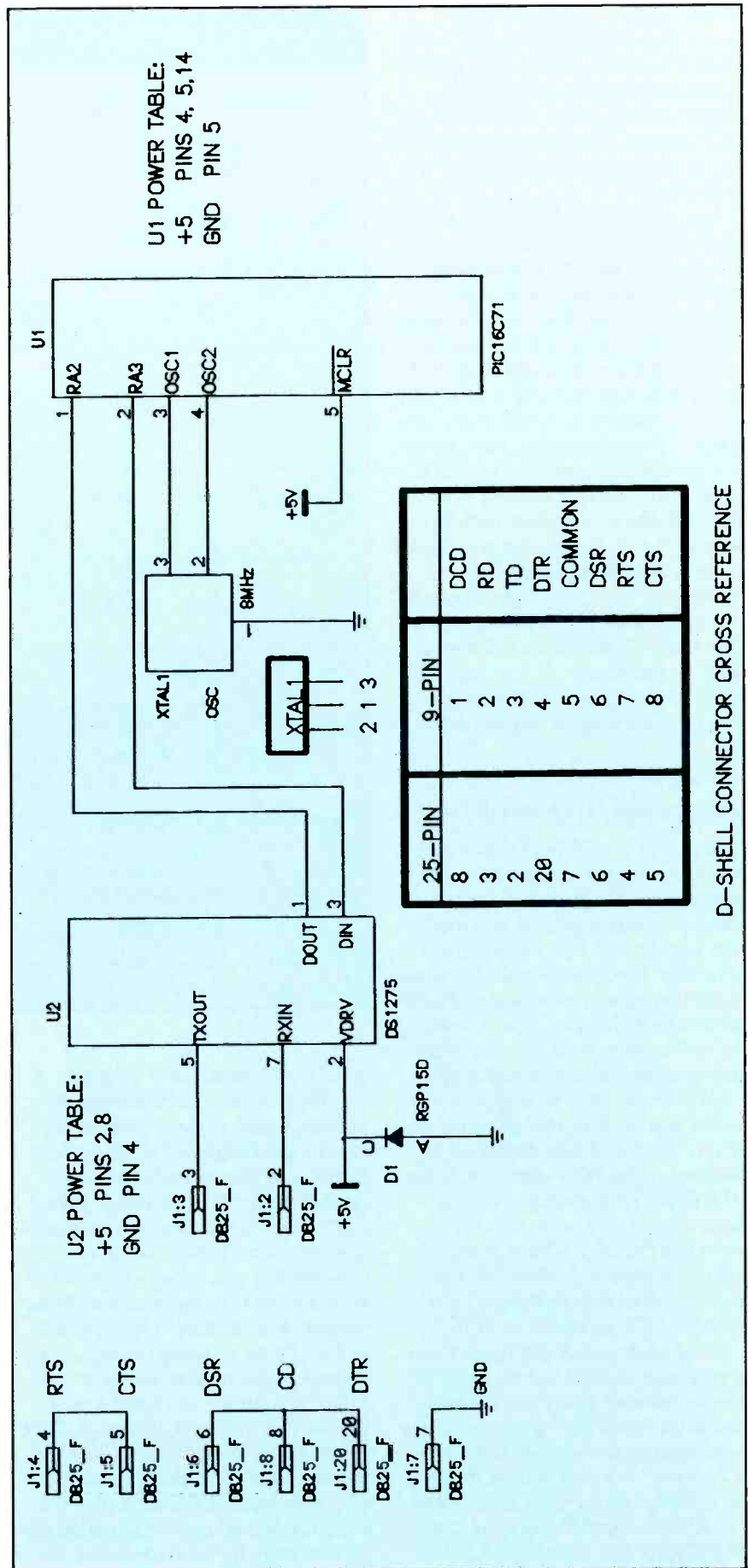

proach seems to work well if you have a short run of high-quality cable. The ± 15 -volt standard assures quality transmission and reception across longer and less-costly cable in noisier environments. Typically, specialized RS-232 ICs run at RS-232 levels of ± 10 volts.

A typical byte of data consists of a start bit, eight data bits and a stop bit. The width of each bit is what determines the baud rate. For example, to effect a 9,600-bps link, each bit width is 104 μ s. We arrive at this figure by equating 9,600 to frequency and 104- μ s to period and applying the formula $P = 1/F$, where P is period in seconds and F is frequency in Hz. Let's establish our design parameters for 9,600 baud, eight data bits, and one stop bit and build the circuit shown schematically in Fig. 3. This circuit is designed to connect to the serial port of your PC and echo any view-able character you key in back to your screen. You'll need terminal-emulation software to "talk" to this circuit. Set up your terminal program for 9,600 bps, eight data bits, one stop bit and no parity.

RS-232 Receiver/Transmitter

In Fig. 3, *J1* is a 25-pin D-shell connector commonly used for RS-232 communications purposes. Since a nine-pin arrangement has become very popular and may be what you have, Fig. 3 includes a cross-reference for the nine-pin connections to the 25-pin standard. The pins of *J1* shown shorted together form a null-modem arrangement. This ensures that the UART in your PC's serial port is fooled into thinking that an actual modem is attached. Following RS-232 standards, your PC's serial port is the DTE (Data Terminal Equipment), while the circuit you'll assemble looks like the DCE (Data Communications Equipment). Most port connectors follow the convention of female for DCE and male for DTE.

The modem you attach to your serial port is considered to be a real DCE device and most likely has a female connector. Your PC's serial connector is probably male, whether it has nine or 25 pins. Under normal conditions, the DTE device provides drive, or active RS-232 signal levels to *J1* pins 20 (DTR for Data Terminal Ready)

Listing 1. Code Programmed Into PIC16C71 Microcontroller

```

;E D TECHNICAL PUBLICATIONS 1994
;
;COMMUNICATIONS PARAMETERS EXAMPLE
;
;PIC16C71 BASED
;
INCLUDE "PICREG.EQU" ;INCLUDE STANDARD EQUATES FILE
;*****
;
RS232 EQU 5H ; DEFINE PORT A FOR RS-232 PORT
TX EQU 3H ; Transmit Pin ( Bit 3 of Port A )
RD EQU 2H ; Receive Pin ( Bit 2 of Port A )
;
;***** Data RAM Assignments *****
;
RCVREG EQU 0CH ; Data received
XMTREG EQU 0DH ; Data to be transmitted
COUNT EQU 0EH ; COUNTER for #of Bits Transmitted
DLYCNT EQU 0FH
;
;***** Communication Parameters
;
; BMHz CLOCK MIN AND MAX VALUES FOR 9600 BPS
;
; MIN MAX
;
BAUD equ 20H ; 1F 22
STARTDLY equ 30H ; start bit delay = 1 complete cycle + 1/2 cycle
;
;***** MAIN PROGRAM
;
;***** SETUP PORTS A AND B
;
ORG 0
MOVLW B'00000111' ;SET UP I/O FOR PORT A
BSF STATUS,RPO ;SWITCH TO PAGE 1
MOVWF TRISA ;DO SETUP
BSF ADCON1,PCFG1 ;RA0-1 ANALOG...RA2-3 DIGITAL
BCF ADCON1,PCFG0 ;SET UP PORT A
BCF STATUS,RPO
;
BSF RS232,RD ;MAKE SURE INPUT PORT IS HI-Z
BSF RS232, TX ;MARK THE SERIAL OUT LINE
;
ECHO
CALL GETBYTE ;GET A BYTE IN
MOVF RCVREG,W ;LOAD RECEIVED BYTE INTO W
;
CALL SENDIT ;SEND RECEIVED BYTE
GOTO ECHO ;DO THIS FOREVER
;
;***** RS-232 TRANSMIT SUBROUTINE
;

```

and 4 (RTS for Request To Send). A true DCE device, if it were actually present, would respond to these signals by asserting pin 6 (DSR or Data Set Ready) to respond to the signal present at pin 20 and activating pin 5 (CTS for Clear To Send) to acknowledge the signal present at pin 4.

Activation and acknowledgment of the RTS and CTS signals (sometimes termed "handshaking") is often used as flow control (pacing) during asynchronous communications sessions. DTR/DSR pacing can also be used but isn't normally implemented. DTR is more often used to signal the DCE to hang up or reset. DSR's usual purpose is to let the DTE know that the DCE is powered up. Pin 8 is normally driven active by the DCE device to

inform the attached DTE device that a valid carrier from a remote DCE device is sensed by the local DCE device and *vice-versa*. Since in this instance, you don't have to modulate data to transport it, no modem is required, and you can tie pin 8 active to make the PC serial port and terminal-emulation program comfortable. Pin 7 is common ground for both DTE and DCE devices.

RS-232 data flows from your PC's DTE serial port to a DCE device via pin 2 of *J1*. To get the converted TTL data to *U1*, TD pin 2 of *J1* is connected to the RS-232 receive input at pin 7 of DS1275 RS-232 converter *U2*. Conversely, data flows into your PC's serial port from a DCE device via pin 3 of *J1*. Notice that RD pin 3 is con-

```

SENDIT      MOVWF  XMTREG      ;LOAD DATA TO BE SENT
XMTR
MOVWLW  8      ;LOAD NUMBER OF BITS TO SEND
MOVWF  COUNT
BCF  RS232,TX  ;WRITE 0 TO SERIAL PORT
CALL  DELAY1   ;WAIT 1 BIT PERIOD
XNEXT      BCF  STATUS,C      ;CLEAR CARRY
          RRF  XMTREG,1      ;ROTATE TRANSMIT REGISTER RIGHT THRU CARRY
          BTFSZ STATUS,C     ;CHECK CARRY STATUS AFTER THE ROTATE
          BSF  RS232,TX      ;IF CARRY IS SET, WRITE A 1 TO SERIAL PORT
          BTFSZ STATUS,C     ;CHECK CARRY STATUS AFTER THE ROTATE
          BCF  RS232,TX      ;IF CARRY IS CLEAR, WRITE A 0 TO SERIAL PORT
          CALL  DELAY1
          DECFSZ COUNT,1     ;DECREMENT THE COUNT REGISTER
          GOTO  XNEXT        ;NOT DONE, GO GET NEXT BIT AND SEND IT
          BSF  RS232,TX      ;Send Stop Bit
          CALL  DELAY1      ;WAIT ONE BIT PERIOD
          RETLW  0          ;DONE, RETURN TO CALLER

;***** RS-232 RECEIVE SUBROUTINE
;
GETBYTE
          CLRWF RCVREG      ;LOOK FOR A START BIT
          BTFSZ RS232,RD
          GOTO  GETBYTE
          CALL  STARTBIT    ;go do start bit delay
RCVR
          MOVWLW  B          ;load W with B
          MOVWF  COUNT      ;load w to count
R_NEXT
          BCF  STATUS,C      ;clear the carry bit
          BTFSZ RS232,RD     ;look for data bit
          BSF  STATUS,C      ;if 0 .skip this instruction
          RRF  RCVREG,1      ;ROTATE BIT FROM CARRY INTO REGREC
          CALL  DELAY1      ;go wait 104 uS
          DECFSZ COUNT,1     ;decrement COUNT .skip if 0
          GOTO  R_NEXT      ;skip this instruction if COUNT=0
          RETLW  0

;***** BIT DELAY SUBROUTINE
;
STARTBIT
          MOVWLW  STARTDLY   ;DELAY FOR 156uS
          GOTO  STARTUP
DELAY1
          MOVWLW  BAUD       ;104uS for 9600 BAUD
          STARTUP
          MOVWF  DLYCNT
REDO1
          NOP                ;FINE TUNING WITH NOP
          NOP
          NOP
          DECFSZ DLYCNT,1    ;DELAY LOOP
          GOTO  REDO1
          RETLW  0
          END

```

nected to the RS-232 output pin at pin 5 of *U2*. This arrangement of pins 2 and 3 of *I1* completes the null-modem circuit as all active modem signal levels and data paths are provided to both the DTE and DCE devices. The purpose of *U2* is to convert incoming RS-232 voltage levels from the DTE device to TTL voltage levels for input to *U1* and to convert TTL voltage levels emanating from *U1* to RS-232 voltage levels for the DTE PC serial-port interface. Schottky diode *D1* prevents destructive latch-up of *U2*.

Chip *U1* is programmed with the code given in Listing 1. This circuit and software look for a character from the PC serial port and echo it to the PC serial port for display on your screen. Ceramic oscillator *XTAL1* is

an 8-MHz device that provides clocking pulses for precise software timing loops.

Starting at the top of Listing 1, note the INCLUDE statement. This assembler instruction says to include the contents of the file PICREG.EQU in the assembly process. PICREG.EQU contains all of the standard equates for the PIC16C71. You can obtain this file from the E D Technical Publications BBS (see Source List for details). The contents of PICREG.EQU are given in Listing 2 for those of you who want to key it in by hand.

Following along with Fig. 3, you'll find that RA2 and RA3 of *U1* are designated RD for receive and TX for transmit, respectively. These pins receive and transmit bit patterns using

TTL voltage levels to and from DS-1275 *U2*. Since serial data moves one bit at a time, holding registers RCVREG, register 0Ch, and XMTREG, register 0Dh, have been set aside for buffering the incoming and outgoing data bytes. Two other registers, COUNT and DLYCNT, are defined for use within the serial subroutines.

To transmit serial data, you need only place each bit of data, including start and stop bits, out for a specific amount of time. For 9,600 bps, 104 μ s is the correct time slice.

Figure 4 depicts transmission of the letter "A" from the TTL point of view. The first bit to be transmitted is the start bit. The purpose of the start bit is to allow the receiver to synchronize with the transmitter. The link should always be in a marking, or logical 1, state before the start bit is sent. Once the receiver senses a start bit, it waits for exactly 1.5 bit periods, or 156 μ s for 9,600 bps, before sampling the status of the link. The idea is for the receiver to sample each bit frame as close to the center as possible. After the first 1.5 bit period wait, the receiver reverts to sampling the incoming bit stream at the standard 104- μ s per frame rate. If everything goes as planned, the rest of the data byte will be sampled near the center of each bit time.

The BAUD declaration is equated to 20h for the 9,600-bps timing loop. STARTDLY is equated to 1.5 times the BAUD number. As you might have guessed, STARTDLY is used in the receive subroutine to time the start bit detection and, subsequently, place the sample time in the center of the 104- μ s window. Using these declarations makes this set of serial routines universal.

You can change baud rate by simply changing the values of BAUD and STARTDLY. Notice in the comments that MIN and MAX values are specified. Note also that the actual BAUD setting is between the MIN and MAX values. To go below 1Fh would make the sample window too short. Going beyond 22h makes the sample window too wide. Any number between 1Fh and 22h will work, but remember that you want to keep the bit width as close as possible to 104 μ s to avoid transmission or reception errors.

I tested the RS-232 code using *QuickLink II* as the PC's terminal pro-

gram. I didn't have to lash-up a null-modem arrangement to communicate with the COM port. The terminal software at the other end of the communicating PIC module is beyond the scope of this article. However, for the adventurous among you, there are bountiful examples of home-brew terminal programs on the E D Tech Pubs BBS for the taking.

Applying the PIC16C84

The PIC16C84 differs from other PIC family members in that it's implemented as EEPROM. The next application puts the EEPROM characteristic to good use. So let's get right to it.

The problem for this application was to design a fail-safe circuit for hobby aircraft. It had to adhere to certain design criteria. For example, it had to be compact and light in weight and simple to build. Furthermore, it had to have low power consumption, provide nonvolatile parameter storage, operate between +4.0 and +4.8 volts and provide control for a hobby servo motor. In addition, it had to monitor Ni-Cd battery voltage, react to low-voltage conditions, monitor loss of receiver signal and react to such an occurrence.

Checking the Microchip Data Book, you'll discover that the PIC-16C84 meets all of the foregoing design requirements. For this application, you'll employ a PIC16C84 with an XT clock, which permits operation down to +4.00 volts and up to +6.00 volts.

If you aren't familiar with hobby aircraft, a quick overview of the electronic components involved is in order. A typical hobby aircraft electronic suite consists of a transmitter, an on-board receiver and on-board servos. The transmitter is hand-held and outputs a sequence of pulses that the receiver in the aircraft decodes and passes along to the attached servos. The servos provide up to 180° of mechanical motion, depending upon the width of the pulse taken from the receiver. Servos are usually responsible for moving the aerodynamic control surfaces and controlling engine throttle. Most aircraft hobbyists are very innovative and have servos perform tasks like throwing switches or opening access panels as well. Pulse

Listing 2. Contents of the PICREG.EQU File

```

;*****      PICREG.EQU
;
;
PIC54 equ 1FFH      ; Define Reset Vectors
PIC55 equ 1FFH
PIC56 equ 3FFH
PIC57 equ 7FFH
PIC71 equ 0H
;
RTCC equ 1h
PC equ 2h
STATUS equ 3h      ; F3 Reg is STATUS Reg.
FSR equ 4h
;
Port_A equ 5h
Port_B equ 6h      ; I/O Port Assignments
Port_C equ 7h
;
ADRES equ 9h      ;16C71 Special-purpose registers
ADCON0 equ 8h      ;16C71 Special-purpose registers
ADCON1 equ 88h     ;16C71 Special-purpose registers
PCLATH equ 0AH     ;16C71 Special-purpose registers
INTCON equ 0BH     ;16C71 Special-purpose registers
TRISA equ 85H      ;16C71 Special-purpose registers
TRISB equ 86H      ;16C71 Special-purpose registers
;
;
;*****
;
;          ; STATUS REG. Bits
CARRY equ 0h      ; Carry Bit is Bit.0 of F3
C equ 0h
DCARRY equ 1h
DC equ 1h
Z_bit equ 2h      ; Bit 2 of F3 is Zero Bit
Z equ 2h
P_DOWN equ 3h
PD equ 3h
T_OUT equ 4h
TO equ 4h
PA0 equ 5h        ;16C5X Status bits
PA1 equ 6h        ;16C5X Status bits
PA2 equ 7h        ;16C5X Status bits
;
;
RPO equ 5h        ;16C71 Status bits
RP1 equ 6h        ;16C71 Status bits
IRP equ 7h        ;16C71 Status bits
GIE equ 7h        ;16C71 INTCON register bits
ADIE equ 6h        ;16C71 INTCON register bits
RTIE equ 5h        ;16C71 INTCON register bits
INTE equ 4h        ;16C71 INTCON register bits
RBIE equ 3h        ;16C71 INTCON register bits
RTIF equ 2h        ;16C71 INTCON register bits
INTF equ 1h        ;16C71 INTCON register bits
RBIF equ 0         ;16C71 INTCON register bits
ADCS1 equ 7h       ;16C71 ADCNO register bits
ADCS0 equ 6h       ;16C71 ADCNO register bits
CHS1 equ 4h        ;16C71 ADCNO register bits
CHS0 equ 3h        ;16C71 ADCNO register bits
GO equ 2h          ;16C71 ADCNO register bits
ADIF equ 1h        ;16C71 ADCNO register bits
ADON equ 0         ;16C71 ADCNO register bits
PCFG1 equ 1h       ;16C71 ADCN1 register bits
PCFG0 equ 0        ;16C71 ADCN1 register bits
;
;
Same equ 1h
;
LSB equ 0h
MSB equ 7h
;
TRUE equ 1h
YES equ 1h
FALSE equ 0h
NO equ 0h
;
;*****

```

widths at the transmitter are controlled by mechanical switches or variable-resistor assemblies commonly known as joysticks.

Most transmitters have a minimum of four and a maximum of eight distinct digital channels. Each digital channel controls at least one hobby

servo by issuing TTL-compatible pulses that are decoded by the receiver. A pulse between 1.0 and 2.0 ms duration is sent sequentially to each channel every 16 ms. A 1.00-ms pulse forces a servo fully counterclockwise, while a 2.00-ms pulse forces full clockwise rotation. Obviously, any

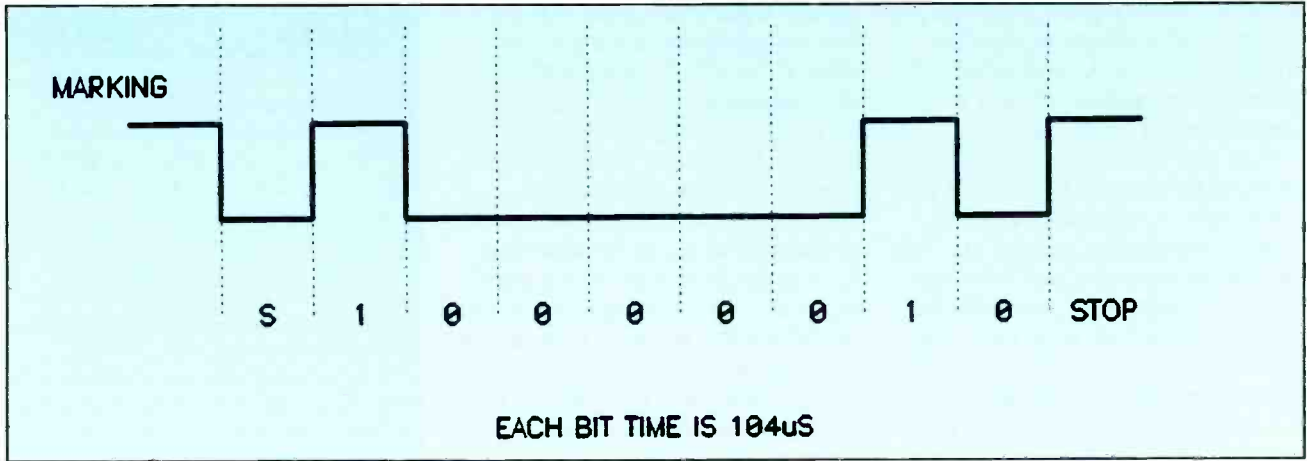

Fig. 4. Depiction of transmission of the letter "A" from the TTL point of view.

pulse width between 1.00 and 2.00 ms will place the servo rotor at some point between these extremes. In fact, a 1.5-ms pulse will center the servo rotor.

Now you know how hobby servos work, and you can use this knowledge to emulate a receiver by simply applying the correct pulse widths in the correct time frames to an off-the-shelf hobby servo. Up to this point, you've met the first seven design requirements mentioned above.

The eighth design requirement excludes the odor of analog-to-digital conversion. However, the PIC16C84 has no onboard A/D converter. Following the design criteria, you can't afford the space of complexity of adding one. So, you resort to basic transistor theory to find a solution. Follow along with the Radio-Control Fail-Safe schematic diagram in Fig. 5 as I describe how the low-voltage detector circuitry operates.

Transistor *Q1* requires between

+0.60 and +0.70 volt at its base to conduct emitter-to-collector current. When an aircraft Ni-Cd battery is delivering more than 4.1 volts, you want *Q1* to be conducting. Hobby aircraft electronics can't operate reliably when the Ni-Cd battery pack delivers to 4.1 volts or less. Therefore, when the battery potential falls to 4.1 volts, you want to signal a low-voltage condition and turn off *Q1*. You can turn off *Q1* by allowing the base-to-emitter potential to fall to less than 0.60

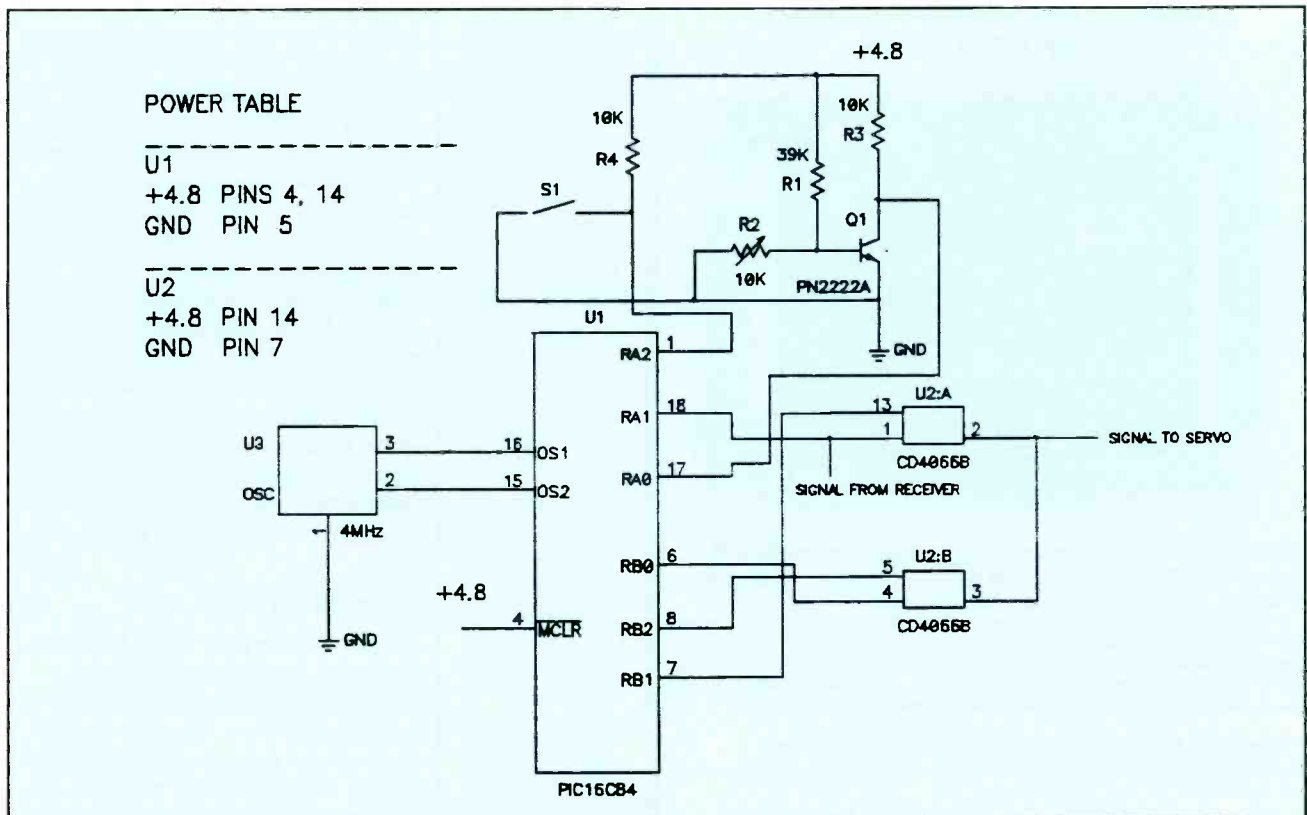

Fig. 5. Schematic diagram of the Radio-Control Fail-Safe circuitry.

volt at the 4.1-volt point. Resistors *R1* and *R2* form a voltage divider that provides sufficient base drive for *Q1* as long as the applied potential is greater than 4.1 volts.

With base drive, *Q1*'s collector feeds a TTL low to RA0 pin 17 of *U1*. In this state, *R3* prevents excessive current from flowing through *Q1*. The internal programming in *U1* sees this TTL low condition as good and takes no action. However, when base drive falls below the minimum required by *Q1*, the transistor turns on and *R3* acts as a pullup to pin 17 of *U1*. The PIC's internal microcode sees the TTL high as a low voltage indication and reacts accordingly.

The trip point for the base of *Q1* is set by applying 4.1 volts to the circuit and adjusting *R2* until the collector of *Q1* toggles from TTL low to TTL high. Applying Ohm's Law, you can instruct *Q1* to turn off and on at almost any voltage level by simply changing the values of *R1* and *R2*.

Here's what occurs when the voltage of the Ni-Cd battery falls to the minimum. Chip *U1* constantly polls the RA0 pin, looking for the collector of *Q1* to go TTL high, an indication

that the battery has failed. When a low-voltage failure occurs, *U1* disables switch *U2:A* via *U1*'s RB1 line and enables switch *U2:B* via *U1*'s RB2 line. Enabling *U2:B* allows *U1* to emulate the receiver pulses with pre-programmed user-selected pulse widths and drive the servo to a predestined location. At the same time, *U2:A* is disabled to block any signal received from the ground transmitter. In effect, *U1* is now the "receiver," as far as the servo is concerned. In that a battery failure isn't considered a recoverable one, the Fail-Safe circuit remains in control until *U1* undergoes a power-on reset. Of course, when all is well, *U2:A* is active and the aircraft receiver signal is passed to the servo unhindered via pins 1 and 2 of *U2*.

The other failure condition exists when for 1 second no pulses are received from the transmitter. The microcode inside *U1* constantly monitors the pulses from the receiver via input RA1. When the algorithm is allowed to execute for 1 second without sensing a pulse, the program proceeds to a routine that takes over the servo, just as with the battery-fail routine, with one exception. Since the trans-

Source List

The following programmers and software are available from E D Technical Publications, P.O. Box 541222, Merritt Island, FL 32954-1222 (tel./fax: 407-454-9905): PIC-16C5X Programmer, \$69.95; PIC16C71/84/64 Programmer, \$49.95. Add \$7.50 S&H for each programmer. Florida residents, please add state sales tax. All code examples are available for downloading from the E D Technical Publications BBS by dialing 407-454-3198. PIC cross assemblers are available from the Microchip BBS. See the Microchip Data Book for instructions on how to get on the Microchip BBS.

mitter can possibly recover, this is not a permanent routine. When pulses reappear, the PIC relinquishes control to the receiver. The slaved servo here can be a throttle control or a rudder control that would either power down the aircraft or put it in a turn for a least-damaging recovery.

By now, you're probably wondering how to pre-position the servo. The answer is, with software and a switch, of course. Pushbutton switch *S1* and resistor *R4* feed a TTL level to RA2 input pin 1 of *U1*. When *S1* is pressed, a TTL low is presented to RA2. The PIC's internal program senses this condition and jumps to a routine that moves the servo rotor fully clockwise and fully counter clockwise with a 1 second delay between extremes. While the servo rotor is paused at either stop, you can release the switch at the desired point the position is flagged and loaded into EEPROM data memory. This is where the servo will go from then on when a failure condition is detected, even when power is removed and subsequently restored to the Fail-Safe circuitry. This is detailed in the source code, which is too lengthy to give here. Once again, you can get a fully commented listing of this microcode from the E D Tech Pubs BBS.

Coming Up

As you can see once again from the foregoing discussion, PIC development doesn't have to be expensive or complicated. Next time, I'll discuss applications and give theory information for the newest and more-powerful member of the Microchip PIC family, the 40-pin PIC16C64. ■

HIGH PERFORMANCE 8051 CONTROLLERS

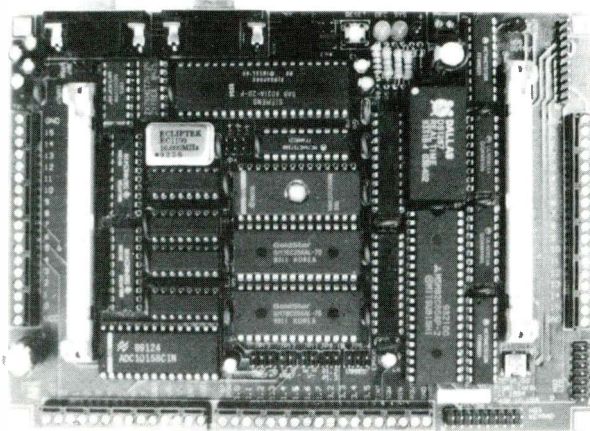

Designed to handle demanding control applications, the **RIC320** is optimized for the DS80C320 at 24 MHz or SABC501 at 40 MHz (accepts any 40 pin dip 8051 including the Intel 8052 Basic)

Features: 32K EPROM, 64K EEPROM/RAM, 8, 10 or 10 bit with sign A/D converter, real-time clock/calendar, serial I/O's (RS232 / RS422), 16 bits TTL I/O, 16 bits of opto-isolated inputs, and 16 bits of high-voltage/high-current outputs, LCD, keypad interfaces with software drivers, standard 50-pin headers to drive industrial input/output modular boards (Grayhill, Opto 22), industrial noise immunity with ground and Vcc planes

Program the **RIC320** using C, Basic, Forth, or Assembly.

An integrated assembly language environment with example software programs comes with the RIC320.

RIGEL CORPORATION

PO BOX 90040, GAINESVILLE, FL 32607
(904)373-4629 BBS (904)377-4435

CIRCLE NO. 86 ON FREE INFORMATION CARD

All About Hard-Disk Drives

If your hard disk is showing its age, maybe its time for an upgrade. Here's what's hot and what's not.

Next to the CPU, your hard drive is the most-important component in your PC. Without a way to store and retrieve data, your PC is little more than a very-expensive calculator. It's because of the hard disk that you can create complex spreadsheets and write books using a PC. Telecommunications, too, would still be in the dark ages if it weren't for the hard disk's ability to save messages in a format that's considerably more-flexible than hard copy.

As your computing needs grow, so do the size and number of files your hard disk must store. It's not surprising, therefore, that many readers are considering the purchase of a new hard disk to meet today's pressing application demands. But which hard disk to buy? If you talk to five people, you get five different answers. This question is as loaded as asking someone which car is the best to buy. There's no simple answer. It all depends on your needs, which explains why there are so many makes and models of disk drives on the market.

As is the case with just about any other product you might consider purchasing, you need to know something about disk drives before you can make an intelligent buying decision. For example, what makes one drive larger or faster than another? Should you replace your old drive or supplement it with a second drive? Can you plug the drive you buy directly into your system, or do you need supporting hardware and/or software? Can you judge permanence by price? Which is the least-expensive way to go? How do removable media and portable drives fit into the scheme of things?

To answer these and many other questions, you first must know how a hard-disk drive works. Then, armed with such information, you'll know

why some drives are larger and faster than others and why some drives are more expensive, even when their specifications are identical. Knowing how a drive works will also clear up the mysteries surrounding removable media and portable drives.

In this article, I answer these and many more questions about disk drives. I'll also show you what to look for when you go shopping for your next drive.

Inside Your Hard Drive

At the heart of the hard drive is a rotating glass or aluminum platter that's coated with a thin magnetic film. The diameter of the platter varies according to form factor. Originally, the platter measured 8" across. That has been reduced to 5 $\frac{1}{4}$ " and 3 $\frac{1}{2}$ " for use in desktop systems. Because of size and weight restraints, notebooks typically use platters that measure just 2 $\frac{1}{2}$ " or 1 $\frac{7}{8}$ " in diameter.

Positioned above the platter is a magnetic recording head. When the recording head is placed in close proximity with the platter, the magnetic particles directly beneath it realign themselves according to the



Syquest's SQ1080 PCMCIA hard drive.

strength and direction of the magnetic field. If the magnetic field is modulated with data, a pattern of information is recorded on the platter. Subsequent playback with a magnetic-sensing device reproduces the original signal. In actuality, the recording and playback heads are combined into a single read/write head.

A small motor drives the platter,

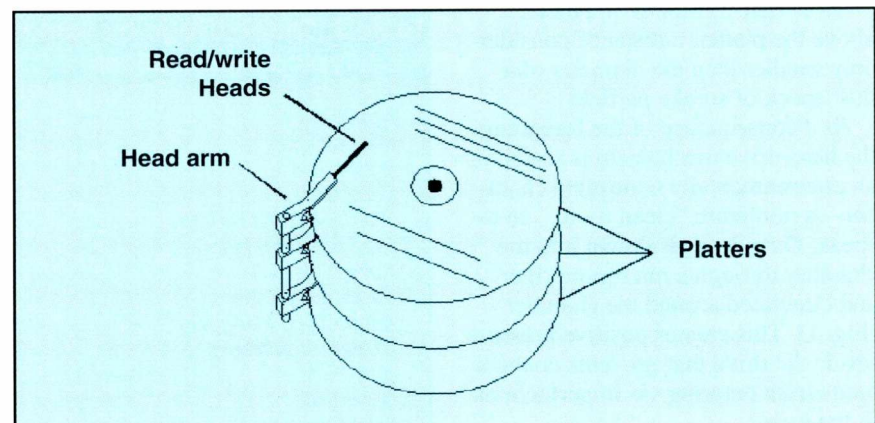

Fig. 1. Interior view of a typical hard-disk drive.

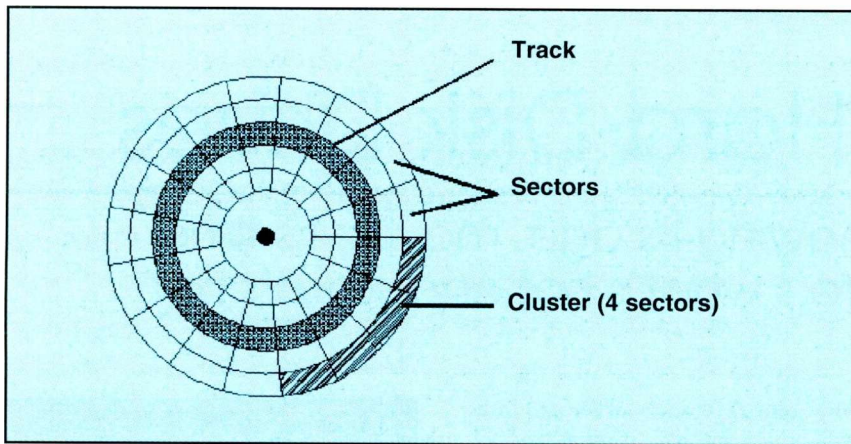

Fig. 2. Details of a hard-disk platter show tracks, sectors and clusters.

Table 1. Sector and Cluster- Sizes for Hard Drives

Drive Size	Sectors	Cluster Size
16M to 127M	4	2K
128M to 255M	8	4K
256M to 512M	16	8K

which is attached to a spindle and spins the platter so fast that the read/write head actually becomes airborne. This phenomenon, which was first described by the 16th century mathematician, Jacques Bernoulli, is exactly the same an airplane experiences when flying low to the ground (pilots call it the ground effect). Essentially, the head rides on a cushion of air just above the surface of the disk and the two never touch.

The density of the data recording is inversely related to the flying height of the head. The lower the head, the greater the density and the more data you can store on the platter. In practice, the head flies just about 0.5 microns (a half-millionth of a meter) above the platter, a distance considerably smaller than the diameter of a dust speck or smoke particle.

As a consequence of the foregoing, the hard-drive mechanism is sealed in an environmentally controlled chamber—a miniature “clean room,” so to speak. Outside air is drawn into the chamber through a micropore filter and circulated around the chamber (Fig. 1). This creates positive pressure inside the drive that prevents contaminants from entering via imperfections in the case.

Like money, the more disk space

you have, the more you spend. It doesn't take a mathematical genius to figure out that you can put only so much information on a platter, even when you use both sides of the disk. One way hard-drive manufacturers increase capacity is to go from an aluminum platter to a glass platter, which is dimensionally more stable and capable of tighter tolerances. Coating the platter with a higher-coercivity magnetic material is another way to increase data density. But even this technology has its limits. The secret to gigabyte (1,000M) capacity is to use more than one platter.

If you remember the old automatic record changers that let you stack LPs one atop the other on a common spindle, you have the basic concept behind the modern hard-disk drive. By stacking two platters, capacity is doubled, three platters triple the capacity, etc. Since it would be impracticable to move the platters up and down on the spindle like a record changer does, the platters are permanently attached to

Table 2. Space Usage by Some Typical Applications

Application	M
MS-DOS 6.2	10
Windows 3.1	12
Excel 5.0	12
Word for Windows 6.0	25
PC Tools for Windows	24
PowerPoint 4.0	17
Ventura Publisher	12
Adobe Type Manager	6
HiJaak for Windows	4
dBASE IV	5
CrossTalk	2
Total Space Used	129

the spindle at equally-spaced intervals. Each platter has two read/write heads, one for each side.

Similar to an LP record, concentric magnetic “grooves,” called *tracks*, are laid down on the platter using the read/write head. The tracks are numbered from the outside in, with track 0 farthest from the center of the platter. It's in these tracks, which can number up to 1,024 and more, that the data is stored. To keep track of the data, the tracks are divided into sections called *sectors* (Fig. 2). The number of sectors varies from 17 to 63, depending on drive type. Each sector holds 512 bytes of data.

While this arrangement provides the fastest data access in the smallest space, it poses an inventory problem. Because each sector holds only 512 bytes of data, it takes hundreds of sectors to store an application or file. Herein lies a problem. Not only do you have to keep a map of the sectors for each file, you also have to know which track in the sector, which platter and which side to access.

Sorting all this out is the job of the File Allocation Table, or FAT. The FAT is a look-up table that keeps track of all the tracks and sectors for all files on the drive. It's always located on the outside track of the drive (track 0). If you think the required bookkeeping is a tall order, you're correct. To simplify things, the FAT concatenates a small number of sectors into groups called *clusters*. The FAT treats a cluster as a single entity that can't be divided. Once a file is assigned to a cluster, no other file can use its sectors, even though one or more of the sectors may be unused. This reduces the number of table entries. The size of a cluster depends on the size of the hard disk. It ranges in size from 4 to 16 sectors per cluster, as illustrated in Table 1.

As shown in Table 1, the larger the disk drive, the more sectors per cluster, which wastes disk space when a cluster isn't completely filled. You can reduce the size of the cluster and increase disk usage by partitioning a large disk into smaller logical drives.

This still leaves a lot of bookkeeping to keep track of the read/write head positions. To simplify this task, all the heads are attached to a common positioning device so that when one head moves, they all move in uni-

Are You Spending More Time Working On Your Hard Drive Than With Your Computer? **HIRE A PRO**

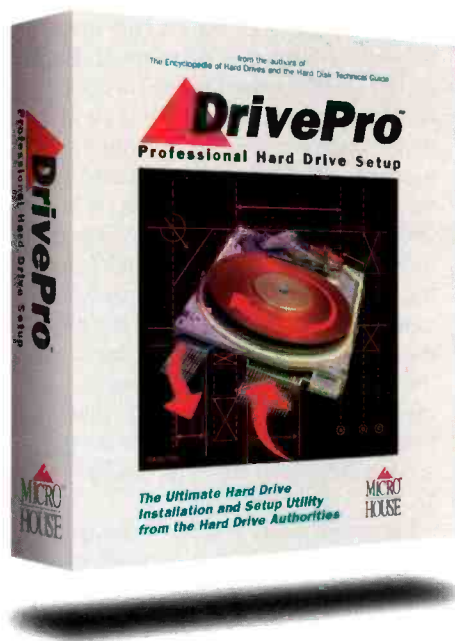

Installation • Preventive Maintenance • Diagnostics
Simplify all Installations • Prevent Future Disasters
Slash Diagnostic and Maintenance Downtime

CALL 1 (800) 926-8299

Micro House International, Inc. • 4900 Pearl East Circle • Suite 101 • Boulder, CO 80301 • 303 443-3388 • Fax 303 443-3323

**MICRO
HOUSE**

A Removable Disk Within A Removable Drive

Got a notebook PC that doesn't have a removable hard disk and can't afford the price of a hard disk upgrade? If you have a Type III or stacked Type II PCMCIA slots, your woes may be over. Picture this: a PCMCIA card with a removable data disk. No kidding. SyQuest's new SQ1080 PCMCIA mass-storage option provides a Winchester-based removable drive with a removable cartridge. The SQ1080's 80M cartridge lets you remove your data without removing the drive. Cartridge removability also means you can add infinite storage capacity to your drive, one cartridge at a time. Unfortunately, the drive doesn't let you concatenate data from one disk to the next. Each 80M cartridge must have its own logical drive designation.

Although the drive's average access time is a lukewarm 16 ms, its rotational speed of 5,400 rpm has it performing like a disk with a 10-ms access time. The 1.8" disks are hermetically sealed and easily slip into your shirt pocket. For notebook users—and lots of desktop jockeys as well—mass storage doesn't get any better than this—except for the cost, which is about twice that of an internal IDE or SCSI hard disk.

son. Next, the tracks are organized into *cylinders* such that all the same-numbered tracks are assigned one cylinder value. For example, all the outside tracks on all platters (track 0, both sides) belong to cylinder 0, the next row of tracks is cylinder 1, etc. This reduces the bookkeeping to a single cylinder entry, plus a head number, in a matrix format.

As you can see, we now have a manageable method for keeping tabs on all the tracks and sectors associated with any file on a drive. However, should the slightest glitch occur in the FAT, pieces of a file may be lost. Which is why there are *two* FATs to ensure the tables are consistent.

Removable-Cartridge Disk Drives

The problem with fixed hard-disk drives is that when they're full,

they're full. While you can erase files to make room for others, this isn't always a practical solution. For example, suppose you've been working on an *AutoCAD* design that's progressed over a period of several weeks from one iteration to the next. Then, finally, your boss says the customer likes the design you submitted two weeks ago and that's the one the company will go with. Arghhhh! Does he mean the one you deleted for lack of disk space?

Sure, you probably have the file somewhere on one of your backup tapes. But with daily, weekly and monthly backup tapes to pore through—and with no certain date on which you saved the drawing he's talking about—it could take longer to find the file than it would to redraw it. If only the capacity of your hard disk grew as your needs grew. The most practical way to accomplish this is to make the platters *removable*.

The concept of a removable hard-disk cartridge goes back to the invention of the hard-disk drive itself. Back in 1973, IBM experimented with a drive that contained two 30M rigid disks—one removable, the other permanent—that eventually resulted in the hard disk we use today. As a historical note, IBM dubbed the experimental hard-disk drive the 3030 (for the two 30M storage compartments), which jokingly evolved into the nickname "Winchester" (with reference to the rifle) that's still used today to identify hard-disk drives. The two most-popular removable-disk drives are the Bernoulli Box and the SyQuest/SyDOS drives.

• **Bernoulli Box.** The most-recognized disk drive with a removable cartridge—and the only one that lets you concatenate cartridges without assigning them new drive letters—is the Bernoulli Box from Iomega. The original Bernoulli Box cartridge had a 10M capacity—small by today's standards, though a giant one for its day. Since that humble beginning, things have changed dramatically. The new Bernoulli MultiDisk 150 drive supports cartridges that range in size from 35M to 150M and is the first Bernoulli drive to handle disk cartridges of various capacities. It's also able to read and write from and to older Bernoulli 90 disks and read from Bernoulli 44 disks. If you own a

10M Bernoulli Box, rest assured that Iomega still makes the cartridge for it, although it's not supported by the MultiDisk 150.

Unlike other removable hard-disk media, which use rigid platters, the Bernoulli cartridge uses a *very* floppy plastic disc. As the product name implies, the Bernoulli Box's cartridge works on the Bernoulli principle, where the thin floppy disk spins at a speed so fast that it actually becomes airborne. What happens is that a thin cushion of air builds up between the cartridge's base and the spinning disk, which, in turn, supports the platter as if it were skating on millions of tiny ball bearings.

The MultiDisk 150 drive has an average access time of 19 ms and an actual data throughput that compares favorably with a hard-disk drive.

Price is about 75 cents per megabyte. • **SyQuest/SyDOS.** Despite the Bernoulli Box's longevity and high profile, removable-disk drives made by SyQuest and SyDOS are immensely more popular. Unlike the Bernoulli Box, though, these drives don't let you concatenate data from one disk to the next. Each cartridge must have its own logical drive designation, which limits the total number of cartridges to 23 at the most (22 if you use a C: drive to boot the system).

Effectively, the two companies are one and the same. SyQuest is the parent company, and SyDOS is the division originally set aside for PC products. But the line separating the two is fuzzy. Initially, SyDOS made removable hard-disk cartridges in the 5¹/₄" PC format, while SyQuest made removable hard-disk drives for customers like Apple and DEC. The most-popular SyDOS products are 44M and 88M removable-media drives based on the 5¹/₄" format. Recently, though, SyDOS took a plunge in the 3¹/₂" removable-media market, selling drives with 105M and 270M capacity, which is the long suit of SyQuest. To make a long story short, it was decided that SyDOS would continue to pursue the 5¹/₄" market and cede its 3¹/₂" technology to SyQuest.

SyDOS is firmly entrenched in its 44M and 88M cartridges. Its newest drive is the 88 Extra, which can both read from and write to 44M and 88M cartridges. Average access time is 20 ms, and the drive throughputs data at

about half the rate of a hard-disk drive. SyQuest makes drives mostly for the high-end market and has a line of PC drives that includes cartridges of 105M and 270M capacity. Prices range between \$1 and \$2 per megabyte.

Portable Hard Drives

Do you need to split your computing time between two locations? If so, maybe what you need is a portable hard disk. While they're no speedsters, portable hard drives are truly plug-and-play devices that interface with your PC's parallel port. Portable hard drives are also handy if your PC's hard drive is bursting at the seams.

Portable drives range in capacity from 20M all the way up to 1.3G. The smallest of the lot are about the size of a slice of bread and weigh less than a pound. More-capacious drives weigh in at 11 pounds and measure as large as a Webster's Collegiate dictionary. About half are battery-powered, and the rest run off your PC's power source. This means you definitely want a battery-powered unit with a sleep mode if you plan to use it with your notebook PC. Battery life runs between 2 and 8 hours, and—in most cases—the battery is rechargeable. Expect to pay about \$3 per megabyte. Prices start as low as \$300 and go as high as \$3,000.

Bear in mind that the parallel port isn't the PC's fastest interface. It moves data at about 40K per second. A few notebook and fewer desktop PCs, notably those based on Intel's SL chipset, can transmit data at 1M per second. By comparison, the ISA slot that most internal disk drives plug into can move data at about 2.5M per second. The slowdown is most-noticable with *Windows* applications, especially graphics programs. With most DOS text-based applications, such as MS *Word*, you probably won't notice the delay.

Don't let the average access time of a portable hard disk fool you. Just because the drive has an advertised access time of 13 ms, don't believe it. The bottleneck is the parallel-port interface. Still you can compare one portable to another using disk rotational speed and cache size. Just don't expect a whole lot of difference between 19 ms and 10 ms.

In addition to the speed hit of the

parallel-port interface, you're going to need special software supplied by the portable drive before the PC recognizes the existence of the satellite drive. You'll also need that software to do very basic things, like partitioning and formatting the disk. Simply put, such DOS commands as *FORMAT*, *CHKDSK*, and *FDISK* don't transcend the parallel-port interface. Moreover, the included utilities may not react as you expect. For example, *Windows* may not work with the caching software, and it's highly unlikely you can create a *Windows* swap file. To use a portable drive, you'll probably have to re-learn some basic disk-drive procedures.

Because portables are so slow, the best game plan is to download your working files to your desktop's or notebook's internal hard drive and use it for your work. When you're finished working, simply copy the files back over to the portable for your next sojourn. A couple of small batch files can simplify the process. Here's an example of a batch file for moving data from the portable drive to your internal hard disk:

```
REM downloading from the portable disk
COPY D:*.DOC C:\PORTABLE
WIN C:\WINWORD
```

After you've finished with your work and are ready to take your portable drive on the road again, the upload batch file might look something like:

```
REM uploading to the portable disk
COPY C:\PORTABLE*.DOC D:
```

Of course, these batch files simply illustrate the process and most likely won't work. The batch file that works for you depends on the portable you buy. And the more capacity your portable hard disk has, the greater the number of paths you'll have and the more-complex the batch file becomes.

Buying Considerations

Buying a hard disk involves a lot more than picking up the phone and ordering one. Before you buy, you need to consider your present and future capacity needs, disk speed, physical size and interface connection, among other variables.

Once an expensive specialty item, hard drives are now priced like com-

Enhanced IDE: Should SCSI Be Scared?

Until now, the IDE interface has taken a back seat to SCSI because the latter can manage up to seven hard drives, each with a capacity of 2G, or juggle a 2G hard drive plus six other SCSI devices, such as a CD-ROM, tape backup and a scanner. However, the new Enhanced IDE interface can handle up to eight peripherals. Moreover, the device parameters are built into the BIOS, instead of requiring software drivers like SCSI demands. This takes no system RAM and is faster than SCSI's software device drivers. Maximum hard-disk capacity is now a whopping 8G. You can already find IDE-compatible CD-ROM drives on dealer shelves.

Does the foregoing put IDE in the driver's seat? The answer is: Probably not. So far, the only IDE-based products are hard drives and a handful of CD-ROM drives. Chances are good these aren't supported by your current BIOS. So until the market matures to include streaming tape backup and scanners, IDE has to be content to be a passenger.

modities and cost less than a dollar a megabyte. This is fortunate because today's applications go through disk space like kids go through candy. Here's what to look for when shopping for a hard-disk drive, in order of importance:

- **Capacity.** It's no mystery that data expands to fill all available disk space. So no matter how large the capacity of your hard disk, there's going to come a time when it simply runs out of storage room. *Windows* applications, in particular, aggravate an already crowded situation. In fact, *Windows* applications have such a voracious appetite that it's next to impossible to fit a full suite of *Windows* applications on a 100M drive and leave enough room for your data (see Table 2). Moreover, as *Windows* runs, it often uses your hard disk as virtual memory, creating huge swap files. Applications often create large temporary files, too. This is why you shouldn't consider buying anything less than a 300M drive.

That's just for today. Tomorrow's operating environments, such as *Win-*

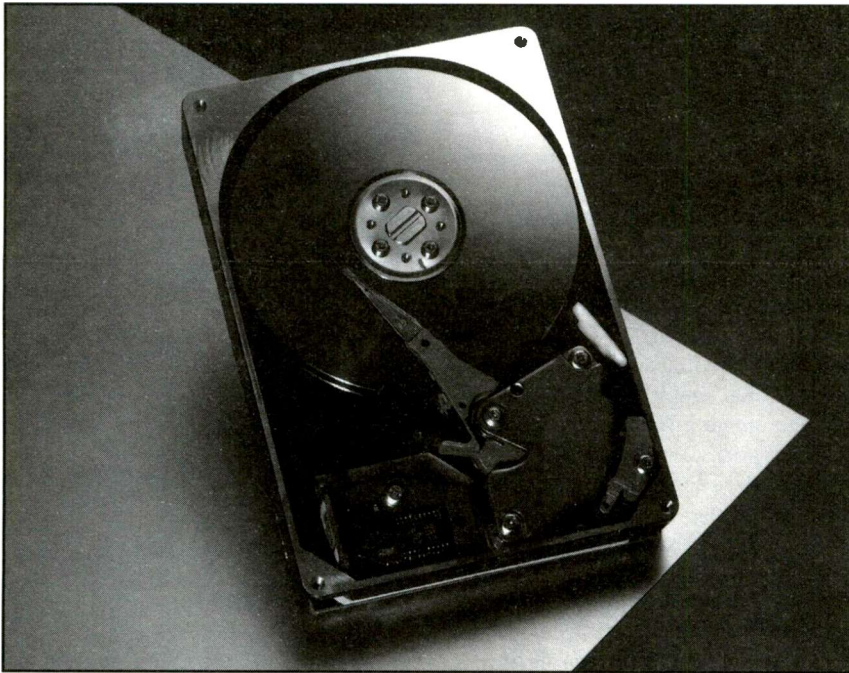

Maxtor's 7546 3 1/2" hard drive shows platters and head/positioner mechanism.

dows NT and its related files, consume a demanding 200M. On top of this, you still need room for your DOS files. Table 2 is a breakdown of popular DOS and *Windows* applications versus the room they require on a hard disk. The entries listed in the second column are for just the programs and don't take into consideration the drive space required for related data files.

• **Speed.** No matter how fast your processor is, if you have a slow hard disk, you have a slow computer. Drive speed has always been an important factor, but now it's even more critical because today's applications and files are larger than ever. It takes a lot more time to read a 5M file than it does a 20K file. Here are the parameters commonly used to express hard disk speed.

Average Access Time. This is the most-commonly-used measure of a hard drive's speed. This is the average time it takes the read/write head to reach and read a random spot on the disk. Generally, the smaller the number, the faster the drive. Most drives have an access time of 12 ms to 16 ms. Supposedly, the smaller the number, the faster the disk drive.

Unfortunately, average access time doesn't give a true indication of how fast a hard disk is in the real world. For example, the very popular Quantum ProDrive LPS family of disk

drives has an average access time of 16 ms, yet their data throughput is faster than most drives with a 12-ms access time.

Data Transfer Rate. This is another popular measure of disk-drive speed, which tells you how fast data moves from the drive to your PC's memory. For most hard drives, these figures range from 1.4M to 3M per second. A related measurement, the *burst transfer rate*, measures the transfer rate for a small block of data to move from the drive to system memory in a single burst. These figures typically range from 4M to 10M per second. In theory, larger numbers should mean faster throughput. However, like average access times, data-transfer rates bear little relationship to real speed.

Rotational Speed. This is a better measure of data throughput speed of the platter. To understand why, you have to remember that part of the latency is caused by the head-positioning mechanism that locates the head over the track containing the data requested. Just placing the read/write head on the right track doesn't guarantee instant data access. It still has to wait for the sector that contains the data to pass under the head. The faster the platter rotates, the more often that sector passes under the head, thus reducing wait time. The speed gain is especially noticeable when data is stored in

sequential sectors. Until recently, speeds of 3,600 rpm were the norm. Today's drives now spin up to 4,500 rpm and faster. The faster the platter rotates, the faster the data throughput. **Cache Size.** In many cases, the requested data has already been asked for one or more times. So it's really a waste of time and effort to locate the sector and read it again when the data can be stored in a cache located on the drive itself. In fact, this is generally the case with modern drives. The on-board cache, which is often called buffers (not to be confused with the DOS BUFFERS statement), range in size from 64K to 256K. Generally, the larger the cache, the more likely the desired data is in it, which can supply data many times faster than reading it from the disk. So shop for the largest-size cache you can find.

The Interface

The computer and hard disk communicate with each other via an electronic interface. There are four standard interfaces for hard disks, but only the IDE (integrated drive electronics) and SCSI (small computer system interface) are in popular use. Both the IDE and SCSI drives have their controller electronics built into the drives themselves. Therefore, you don't need to buy a controller card for these drives. All that's needed is a data channel that moves the information to and from the CPU and hard disk. The interface that's right for you depends on the type of system you have and the type of peripherals you plan to add in the future.

• **IDE.** Most systems sold today come with IDE interfaces either built into the motherboard or on an adapter card plugged in one of the motherboard expansion slots. If your system has an IDE interface, your best bet is to replace or supplement the existing drive with an IDE drive. All versions of the IDE standard support two IDE devices. With the advent of local buses, the IDE interface has taken a turn for the better. While disk rpm and buffer size will continue to be the determining factors for performance, a part of the hard disk's speed limit has to do with the disk-to-PC interface.

The original IDE spec has the hard disk plugged into the ISA bus, which tops out at 8 MHz. The new IDE

The Four-Year Electronics Degree Program That Really Hits Home!

Bring The Technology Home With A Bachelor Of Electronics Engineering Degree. No Hassles. No High Cost!



Now's the time to prepare for a profitable career.

We've lowered the cost of higher education.

It's true! You can earn a four-year Bachelor of Electronics Engineering Technology degree today ... and prepare yourself for a high-paying electronics career ... without quitting your job or ever leaving your home. Because World College, an affiliate of the Cleveland Institute of Electronics, offers you the total flexibility of independent study programs proven effective for people like you who truly want to succeed! World College independent study lessons help you build valuable skills

**Mail/Fax Today
or Call
1-800-696-7532**

step-by-step, and expert instructors are personally available to you with a toll-free call. What a way to earn an education!

A world of opportunity.

Where is your career headed? With a four-year bachelor's degree from World College, you call the shots, choosing from incredible, high-paying opportunities in electronics, telecommunications, computer, electrical power, and many other growing fields.

World College gives you the skills, the knowledge, the power to take advantage of your best opportunity in electronics. And you can do it all at your own pace!

Without leaving home.

World College continually works to provide its students with the most advanced education tools. From the latest equipment and reference books to breakthrough computer-simulated experiments, students are exposed to the latest technological advancements.

All the equipment, parts, and software you need are included in your affordable tuition, including more than 300 hands-on lab experiments you can complete in your home.

Choose your own pace.

Earn your bachelor's degree on your time — and at your pace — because you pay tuition to World College only as you complete the upper-level semesters close to graduation. The faster you make it through, the less you pay. So you have an incentive to make your future happen quickly — yet the freedom to choose your own pace!

Send today for your FREE course catalog — and give yourself that future you've always wanted — with an electronics degree education from World College.

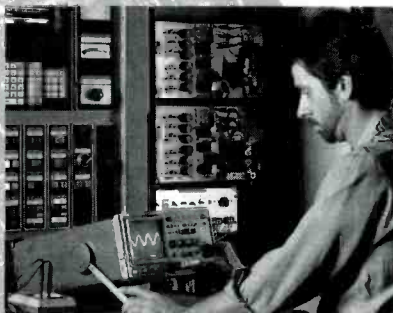

Take charge of your future in electronics.

Four Powerful Reasons To Connect With World College Today:

- 1. Earn your four-year degree!**
- 2. Self-paced training!**
- 3. Independent study in your home!**
- 4. Expert instruction!**

Give Me The Power!

Send me a FREE World College course catalog today!



(Please Print Neatly)

Name _____

Address _____

City _____

State, Zip _____

Phone () _____

Age _____

**For faster service, call
1-800-696-7532,
or call
1-804-464-4600.**

**Or fax this coupon to
1-804-464-3687.**



Lake Shores Plaza
5193 Drive, Suite 113
Virginia Beach, VA 23455-2500



Affiliated with
Cleveland Institute of Electronics

WAC007

Organizing Your Hard Disk

Imagine, if you can, a room with 512 filing cabinets. Each cabinet has 300-quadrillion (that's 300-million-trillion) drawers, and each drawer can hold 300-quadrillion folders. Each folder can hold 300 quadrillion files, each of which can hold 300-quadrillion records, which can hold...well, you get the message...until the levels reach 32 total. Sound impossible? Well, this is how your hard disk is organized and it will hold this much information—if you could ever find one with a large enough capacity.

So what's the best way to keep a hard disk organized? This depends a lot on your work habits. Here are some guidelines that should help you put all that potential space to good use.

• **FDISK Partitions.** The first decision you have to make is whether to partition your drive into smaller logical drives or leave it as one large drive. The pros and cons on this issue are evenly divided. One camp tells you that you should divide a 500M drive into three or more logical drives because multiple partitions use the disk more efficiently and make handy division between types of files. The other camp contends that one large partition gives you room to grow in any direction. I'm not claiming that one is better than the other, but I personally prefer the multi-partition option.

Whichever you choose, rule number one is to keep your data in one

place and your application in another. If you keep your data in the same directory as the program that created it, you're asking for trouble. Keeping your data separate from your application keeps it safer and easier to back up. Let's see how it works.

• **Nooks and Crannies.** Let's say you have a client called Widget, and his company manufactures a wide range of products. How would you go about organizing his files on the hard disk?

First off, you want to create a directory for each product. For example, if one of the products is an XYZ gizmo, then an example of a directory would be C:\XYZ. Inside this directory, you can have subdirectories that further define the product. For instance, one of the subdirectories may be a spreadsheet that you call C:\XYZ\SALES that details sales. This directory can be further subdivided into regions or sales persons. For example, you can have C:\XYZ\SALES\JOHN or C:\XYZ\SALES\SEATTLE. Let's say another product is XXX. Logically, this would go into the C:\XXX directory. Of course, you don't have to call your parent directory C:\XYZ. If you've partitioned the disk, it could be D:\XYZ or E:\XYZ. Or it could be D:\CLIENT\XYZ. The choice is yours.

• **A File By Another Name.** The main gripe with DOS is its eight-dot-three (8.3) filename limit that applies to both files and directories. Face it,

it's pretty difficult to put "Widget's April Correspondence" into eight characters. But it can be done. By inventing some codes and sticking to them, you can make this limited system work. For example, I'd start with C:\WIDGET and then create a directory called C:\WIDGET\APRIL and divide this into billing and correspondence, plus whatever else I need in that time frame. So now I have C:\WIDGET\APRIL\MAIL. You get the idea.

• **Follow The Yellow Brick Road.**

Now that you have all your data files pigeonholed, the next trick is finding them. You can write batch files that lead you down the path, such as C:\WIDGET\APRIL\MAIL. But this doesn't have to be all that complicated. A little-used command called SUBST can put all that to rest.

Using the SUBST command, you can assign your longest path to a single logical drive. For example, let's put the C:\WIDGET\APRIL\MAIL path into a single stroke by adding

```
SUBST H:  
C:\WIDGET\APRIL\MAIL
```

to your AUTOEXEC.BAT file. Now, instead of typing the whole path, all you have to ask for is H: and you're there.

• **The Bottom Line.** With so much to work with, I find it difficult to find an excuse to not have a neatly-organized hard disk.

specification lets the hard-disk interface with the faster local bus, which increases throughput about three times (up to 13.3M/s). As a bonus, the new IDE standard lets you install up to four devices without special hardware. With disk-caching adapter cards, the ante can go as high as eight IDE devices. Of course, to take full advantage of this, you need to buy a hard disk that pumps out data three times faster than a regular IDE drive. Fortunately, there are plenty such drives out there. They go by different names. For example, Western Digital calls it Enhanced IDE. Seagate calls it Fast ATA. Maxtor prefers High Performance ATA. You'll also need a BIOS upgrade for your PC.

So what happens if you buy an Enhanced IDE drive and plug it into a standard IDE connector? Nothing happens, other than that it runs at the

slower speed of the ISA interface.

Built into the new spec is backward-compatibility with existing IDE connectors and adapters. Because every IDE drive is compatible with every IDE connector, adding or replacing an IDE drive is a simple matter of attaching the cables and properly configuring the CMOS setup to recognize the new drive.

• **SCSI.** If your storage requirements are massive or you plan to add other SCSI devices to your system, SCSI is the way to go. One SCSI adapter can handle up to seven SCSI devices, including additional hard disks, CD-ROM drives, tape backup systems and optical drives. However, an SCSI interface is rarely built into the motherboard, which means you'll have to buy a SCSI adapter if your new drive doesn't come bundled with one. This can cost you an extra \$50 to \$500,

depending on the speed and features you want.

Installing a SCSI device can be tricky because DOS and other common operating systems require a software translation layer between a SCSI device and the rest of the system. The problem is that different adapters use different translators, and your SCSI adapter and each SCSI device in the system have to use the same translator. Think of it as having to use software drivers written using the same programming language. So far, the job of writing the SCSI software driver has fallen to the SCSI vendors or systems integrators, with mixed results and compatibility problems. But things are changing. For example, Corel (makers of *CorelDRAW*) has a library of SCSI drivers called *Corel-SCSI* that are compatible with most popular SCSI peripherals. However, it

doesn't completely solve the problem of compatibility for all situations.

Recently, Future Domain built on this technology to create *PowerSCSI!*, a universal application interface for DOS and *Windows*. *PowerSCSI!* allows software drivers written to any SCSI software interface to be used by any Future Domain SCSI adapter.

Due to this large software overhead, the majority of SCSI drives (sometimes referred to as SCSI-1) are slightly slower than IDE drives. But for most desktop applications, you'll never notice the speed difference. For network application servers and multimedia work, there's the improved SCSI-2 version that offers much greater throughput (up to four times faster than SCSI-1). SCSI-2 drives and adapters are typically more-expensive than IDE or SCSI-1.

Form Factor

A hard drive won't do you any good if it doesn't fit inside your machine. The physical dimensions of the hard drive define the *form factor*, which is actually the diameter of the platters and not the measurements of the outside enclosure of the drive. For example, a 3 1/2" drive actually measures 4" across. A smaller form factor will fit in a larger drive bay (the compartments in the PC's case into which the drives bolt), but there's no way to stuff a larger drive into a smaller bay. The most-common form factors for desktop PCs are 3 1/2" and 5 1/4". Drives and drive bays come in full- (3"), half- (1 1/2"), and third- (7/8") height.

Most drives of 300M and less capacity are half-height 3 1/2" or smaller units. Virtually all desktop PCs, even the small-footprint systems, have room inside for one or more of these drives. Many disk drives come with an installation kit that contains all the mounting hardware you need. If you are installing one of these drives in a 5 1/4" bay, you may need to buy an optional mounting bracket to fill the gap.

At 500M and greater capacity, expect the form factor of the drives to increase to 5 1/4" and probably full height as the drive nears 2G capacity. While installation is no more difficult than for a 3 1/2" drive, you'll need a full-size AT case or a tower with an empty 5 1/4" drive bay to accommodate such a drive. Sometimes, the comput-

Multiple hard disks

Do you have a hard disk that you've simply outgrown but cringe at the thought of trashing to make way for a greater-capacity drive? Well, you don't have to. In most cases, you can add a second drive to your system without too much difficulty. Moreover, the disk sizes are cumulative such that two 200M disk drives add up to 400M of total capacity. However, there are some rules you must observe. The most important is an empty drive bay. Most systems have two or more drive bays, usually in a variety of sizes. The trick is to match your drive to the form factor of the drive bay. If you have no open drive bays, you could remove an existing drive, such as one of the floppy drives.

As a rule, the drives should be of the same type and, preferably, from the same vendor. It usually doesn't pay to mix IDE and SCSI drives in the same system because you need a different controller for each. All hard-disk controllers can handle two drives, and some can manage up to eight. In a lot of cases, the hard disks have to be reasonably close in capacity (such as pairing a 100M drive with a 170M drive) to get them to work together. Also, you may have to set a jumper or DIP switch on the drives to identify them as the first (master) and second (slave) drives. This is especially true of SCSI drives and is all too common in the case of IDE drives.

er will have unusual drive bays that require special mounting brackets or adapters. Check with your hard-drive vendor first to make sure the drive you select will fit into your system.

Notebook computers, a different breed altogether, require a different form factor. A few notebooks will accommodate a 3 1/2" drive, but most have room for only a 2 1/2" drive. Sub-notebooks and palmtops generally require 1 7/8" drives. As a rule, the smaller the form factor, the more-expensive the drive.

Except for notebooks (which should always be taken to a dealer for service), installing a new drive isn't a tough job, and it only takes half an hour. But if you have a fear of screwdrivers, consider professional installation. It isn't all that expensive, and it's a whole lot cheaper than repairing

BoardMaker PC Layout software for IBM PC's

BoardMaker 1 - Entry level (no net list support) \$95

Up to 8 layers - SMD support
Part libraries and library editor provided
User definable tracks and pads
Easy and intuitive to use
Ground plane copper fill
Copper highlight and clearance checking

BoardMaker 2 - Advanced level \$295

All the features of BoardMaker 1 PLUS:
Full net list support - OrCad, Schema, Tango, CadStar
Rascal, Mentor and Protel
Netlist generation and export for checking
Integrated net editing
Full design rule checking - mechanical/electrical
Top down modifier from the schematic
Component renumber with back annotation
Full report generator - Database, ASCII, BOM
Thermal power plane support with full DRC

BoardMaker 2 with BoardRouter \$495

Simultaneous multilayer gridless routing
Full interrupt, resume, pan and zoom while routing
Routing of SMD's on both sides of board

BoardCapture - Schematic capture software \$395

Undo / Redo up to 50 operations
Supports hierarchical and multi page designs

Output drivers included with all packages

DEMO's available on Bulletin board (300-14.4K, N,8,1)

ASAtch, Inc SALES 1-800-626-4460 Master Card
P.O. Box 247 FAX 1-603-635-9229 and
Pelham, NH 03076 BBS 1-603-635-3247 VISA

CIRCLE NO. 109 ON FREE INFORMATION CARD

Are You Moving? Let us know.

Mail your subscription label along with your new address, to us, so you can be sure you don't miss a single issue.



FREE CATALOG TEST INSTRUMENTS & HARD-TO-FIND TOOLS

Packed with over 10,000 quality products for testing, repairing, and assembling electronic equipment. A full selection of test instruments, power protection equipment, precision hand tools, tool kits, soldering supplies, and much more. Products are shown in full color with detailed descriptions and pricing. All products come with a 100% satisfaction guarantee. SAME-DAY shipment program.

In a hurry to receive your catalog?

Call 1-800-225-5334

Contact East, Inc., Dept. R531
335 Willow St., No. Andover, MA 01845

CIRCLE NO. 113 ON FREE INFORMATION CARD

Sources

Hard Drives

AmeriQuest Technologies, Inc.

2722 Michaelson Dr.
Irvine, CA 92715
Tel.: 800-237-2707 or 714-222-6000

CIRCLE NO. 161 ON FREE INFORMATION CARD

Conner Peripherals, Inc.

3081 Zanker Rd.
San Jose, CA 95134
Tel.: 800-526-6637 (West Coast), 800-230-5638 (East Coast) or 408-456-4500

CIRCLE NO. 162 ON FREE INFORMATION CARD

Core Int'l., Inc.

7171 N. Federal Hwy.
Boca Raton, FL 33487
Tel.: 800/688-9910 or 407-997-6044

CIRCLE NO. 163 ON FREE INFORMATION CARD

Maxtor Corp.

211 River Oaks Pkwy.
San Jose, CA 95134
Tel.: 800-262-9867 or 408-432-1700

CIRCLE NO. 164 ON FREE INFORMATION CARD

Optima Technology

17526 VonKarmen
Irvine, CA 92714
Tel.: 800-367-3787 or 714-476-0515

CIRCLE NO. 165 ON FREE INFORMATION CARD

Procom Technology, Inc.

2181 Dupont Dr.
Irvine, CA 92715
Tel.: 800-800-8600 or 714-852-1000

CIRCLE NO. 166 ON FREE INFORMATION CARD

Quantum Corp.

500 McCarthy Blvd.
Milpitas, CA 95035
Tel.: 800-624-5545 or 408-894-4000

CIRCLE NO. 167 ON FREE INFORMATION CARD

Seagate Technology, Inc.

920 Disc. Dr.
Scotts Valley, CA 95066
Tel.: 408-438-6550

CIRCLE NO. 168 ON FREE INFORMATION CARD

Storage Devices Inc.

6800 Orangethorpe Ave.
Buena Park, CA 90620
Tel.: 714-562-5500

CIRCLE NO. 169 ON FREE INFORMATION CARD

Western Digital

8105 Irvine Circle Dr.
Irvine, CA 92718
Tel.: 800-832-4778 or 714-932-4900

CIRCLE NO. 170 ON FREE INFORMATION CARD

Removable-Cartridge Drives

Bernoulli Box

Iomega Corp.
1821 W. Iomega Way
Roy, UT
Tel.: 800-777-6654 or 801-778-1000

CIRCLE NO. 171 ON FREE INFORMATION CARD

Storage Devices, Inc.

6800 Orangethorpe Ave.
Buena Park, CA 90620
Tel.: 714-562-5500

CIRCLE NO. 172 ON FREE INFORMATION CARD

SyQuest/SyDOS

SyQuest Technology, Inc.
47071 Bayside Pkwy
Fremont, CA 94538
Tel.: 800-245-2278 or 510-226-4000

CIRCLE NO. 173 ON FREE INFORMATION CARD

Portable Hard Drives

The BSE Co.

2114 N. Fourth St.
Flagstaff, AZ 86004
Tel.: 602-527-8843

CIRCLE NO. 174 ON FREE INFORMATION CARD

AmeriQuest Technologies, Inc.

2722 Michaelson Dr.
Irvine, CA 92715
Tel.: 800-237-2707 or 714-222-6000

CIRCLE NO. 151 ON FREE INFORMATION CARD

DiscTec Corp.

925 S. Semoran Blvd. #114
Winter Park, FL 32792
Tel.: 800-553-0337 or 407-671-5500

CIRCLE NO. 150 ON FREE INFORMATION CARD

MicroSolutions Computer Prods.

132 W. Lincoln Hwy.
DeKalb, IL 60115
Tel.: 800-890-7227 or 815-756-3411

CIRCLE NO. 176 ON FREE INFORMATION CARD

Pacific Rim Systems

2655 Barrington Ct.
Hayward CA, 94545
Tel.: 510-782-1013

CIRCLE NO. 177 ON FREE INFORMATION CARD

Prima Storage Solutions

3350 Scott Blvd.
Bldg. No. 7
Santa Clara, CA 95054
Tel.: 408-727-2600

CIRCLE NO. 178 ON FREE INFORMATION CARD

Relax Technology, Inc.

3101 Whipple Rd.
Union City, CA 94587
Tel.: 510-471-6112

CIRCLE NO. 179 ON FREE INFORMATION CARD

Storage Devices Inc.

6800 Orangethorpe Ave.
Buena Park, CA 90620
Tel.: 714-562-5500

CIRCLE NO. 149 ON FREE INFORMATION CARD

Tulin Technology

2156 O'Toole Ave., Bldg. H
San Jose, CA 95131
Tel.: 408-432-9057

CIRCLE NO. 180 ON FREE INFORMATION CARD

any damage you might incur should you bungle the job.

Reliability

Because the disk drive is an electro-mechanical device, there's going to be wear and tear on the mechanical elements it contains. On average, you can expect today's hard disks to last

four or five years—about the life expectancy of a motherboard before it becomes obsolete. Some live longer and others are lemons. So insist on at least a one-year warranty that covers both parts and labor. A few drives have warranties that last up to five years. Several vendors have an extended warranty option that includes 24-hour replacement or an extended

warranty period. Generally, it's worth the few extra bucks it costs.

You can have all the backup tapes you want, but when your hard drive dies, there's no amount of tender loving care or screaming that'll bring it back to life. Replacement is the only solution, and the sooner the better—especially if tomorrow's work depends on a working drive. ■

Use a .BAT File to DISKCOPY Files Between Dissimilar Floppy Disks

Anyone who has sat at the keyboard of a PC has at one time or another had to perform a DISKCOPY operation between dissimilar floppy disks, whether between high and standard density or between 5 1/4" and 3 1/2". Although MS-DOS 6.2 does have an improved DISKCOPY routine that has removed the need for constantly swapping source and target diskettes during file transfers, it won't copy between different types/sizes of diskettes. For example, you still can't copy files from a 5 1/4" high-density floppy to a 3 1/2" low-density diskette. However, just because DOS doesn't allow you to mix and match diskettes doesn't mean you can't do a DISKCOPY operation between dissimilar diskettes.

I've written a simple batch file, shown here, that overcomes DOS's DISKCOPY limitation. To use it, you must have the DELTREE.EXE utility included in MS-DOS 6.2. This particular batch file copies from drive A: to drive B:. If you prefer a different arrangement—for example, A:>A:, B:>A:, etc.—just change the drive-letter designations as needed. One fact about batch files (or any other file for that matter) is that even though the number of bytes in a file may be small, each file requires as a minimum one disk allocation unit. For my 82M hard drive, this is 8,192 bytes. Thus, my 100 .BAT files, require 819.2K of hard-disk space even though the C:\BAT directory that contains all my .BAT files shows only 25K in use on my hard disk.

To determine the number of bytes in each allocation unit on your hard disk or in each partition on your drive, run CHKDSK for each drive and note the figure(s) obtained. These numbers are a function of the version of DOS you're using. The 8,192 allocation number I obtained for my drive was under MS-DOS 6.2. Typical numbers are 2,048, 4,096 and 8,192.

```
CLS
ECHO THIS UTILITY WILL DO AN
XCOPY /S FROM FLOPPY DRIVE A:
TO B:
ECHO HARD DRIVE C:\DCPY DIREC-
TORY IS USED AS THE TRANSFER
STORAGE MEMORY
ECHO BY EMERSON M. HOYT
02/07/94
C:\
CD\
MD DCPY
ECHO .....
ECHO PUT SOURCE DISK IN DRIVE
"A"
PAUSE
A:\
DIR
ECHO .....
ECHO OBSERVE SOURCE DISK
DIRECTORY AND NOTE ITS CON-
TENTS (BYTES)
PAUSE
XCOPY /S *.* C:\DCPY
ECHO PUT TARGET DISK IN DRIVE
"B"
PAUSE
C:\
CD\DCPY
XCOPY /S *.* B:\
B:\
DIR
ECHO .....
ECHO OBSERVE TARGET DISK
DIRECTORY CONTENTS AS A CHECK
PAUSE
ECHO COPY PROCESS COMPLETE
C:\
CD\DCPY
DELTREE /Y C:\DCPY
CLS
C:\
```

If you enjoy radio communications you'll love....

POPULAR COMMUNICATIONS

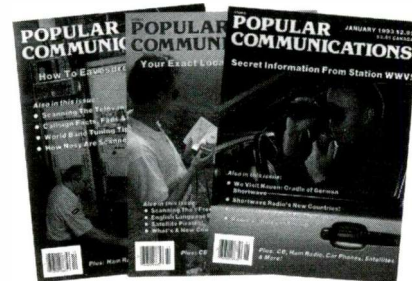

The World's largest, most authoritative monthly magazine for Shortwave Listening and Scanner Monitoring. Read by more active listeners than all other listening publications combined!

SUBSCRIBE TODAY!

POPULAR COMMUNICATIONS

76 North Broadway, Hickville, NY 11801

Get fast home delivery of Popular Communications and save \$15.45 a year over the newsstand price. Save even more on 2 or 3 year subs.

- 1 year - 12 issues **\$21.50**
(Save \$15.45)
- 2 years - 24 issues **\$41.00**
(Save \$32.80)
- 3 years - 36 issues **\$60.00**
(Save \$49.20)

Canada/Mexico—One year \$24.00, two years \$45.00, three years \$66.00; Foreign—one year \$26.00, two years \$49.00, three years \$72.00, Foreign Air Mail—one year \$79.00, two years \$155.00, three years \$231.00

(Please print clearly)

Name _____
 Street _____
 City _____
 State _____ Zip _____

Bill to Mastercard • VISA • AMEX

Account number:

--	--	--	--

Expiration date: _____

Note: Allow 6-8 weeks for delivery of first issue.

Use a Serial Port For Discrete I/O Operations

All it takes are signal conditioning and a bit of programming

Have you ever needed to know when a contact of a relay or switch closed or opened or when a motor started or stopped? Do you want to log data about the frequency and duration of the on-off cycles of your air conditioner or furnace? Do you want to turn on and off a device under control of your PC? If you answered yes to any of these questions, you should know that you can do all this and more through the serial communication port on your PC—without having to use serial communication.

Your PC's serial port can be used to monitor three input lines by generating an interrupt when there's a change on the line and control two output lines by changing the voltage polarity of the line. It's a rare PC, including the newer 32-bit ones, that doesn't have at least one serial port that can be used for discrete I/O (input and output) operations without modification. Any PC/XT/AT or compatible that has a standard serial adapter will work fine. However, signal conditioning and some programming are required to accomplish this.

I'll examine here a few signal-conditioning circuits for the Electronics Industries Association/Telecommunications Industries Association (EIA/TIA)-232-E standard for serial interface, explain the serial port's universal asynchronous receiver/transmitter (UART) and hardware interrupts and give you some programming examples. This won't be a tutorial on serial communications. I'm going to cover only the control or handshake lines, not the subjects of data transmission and reception.

Table 1. Pin Assignments for D-Shell Connectors

D-B9	DB-25	Name	Description
3	2	TD	Transmitted Data
2	3	RD	Received Data
7	4	RTS	Request to Send
8	5	CTS	Clear to Send
6	6	DSR	Data Set Ready
5	7	SG	Signal Ground (common line)
1	8	RSLD	Received Line Signal Detect (also known as DCD Data Carrier Detect or CD Carrier Detect)
4	20	DTR	Data Terminal Ready
9	22	RI	Ring Indicator

Asynchronous Communications Adapter

The serial communication port of a PC is located on the asynchronous communications adapter card that plugs into an expansion slot on the PC's motherboard. Normally, on dedicated serial adapters, there are two serial ports (although only one may be populated), known as COM1 and COM2. The addresses of COM1 and COM2 are 03f8h and 02f8h, respectively.

Each serial port has its own 40-pin UART that takes care of serial-to-parallel and parallel-to-serial conversion and serial data formatting and other features that vastly simplify asynchronous serial communication. The PC/XT uses the Intel 8250, also known as an asynchronous communications element (ACE). The AT uses the National Semiconductor 16450, and the PS/2 uses the National Semiconductor 16550. These latter UARTs are like-minded and functionally the same, but special software is needed to benefit from the greater performance of the

16450 and 16550. Therefore, regardless of which UART is used, I'll refer to it as the 8250.

EIA/TIA-232-E Standard

Various standards have been written to make equipment from different manufacturers compatible. The most popular was published in 1962 by the EIA. It was the Recommended Standard 232, "Interface Between Data Terminal Equipment and Data Communication Equipment Employing Serial Binary Data Interchange." RS-232 underwent several revisions. The one in effect the longest was RS-232C, published in 1969 and not superseded until 1986 by EIA-232D. The latest revision (as of this writing) is EIA/TIA-232-E published in 1991.

The EIA/TIA-232-E standard facilitates an affinity between computers and peripheral devices connected through serial ports. I'll refer to EIA/TIA-232-E as simply EIA-232. It defines the mechanical interface, functions of the interchange circuits, electrical signal characteristics and subset of signals for certain applications.

B. G. MICRO

P. O. Box 280298 Dallas, Texas 75228

Orders Only 1-800-276-2206

Tech Support 214-271-9834

Fax 214-271-2462



LCD DISPLAYS

OPTREX 2x16-DMC 1620H-8 Bit ASCII Input Dim. 3 1/8 x 1 3/4 x 3/8	\$5.99
Char. Height .19"	
OPTREX 2x20-DMC 20261-8 Bit ASCII Input Dim. 4 9/16 x 1 7/8 x 3/8	\$7.99
Char. Height .19"	
OPTREX 1 x 16 "Backlit"-DMC16187- 8 Bit ASCII Input Dim. 3 1/8 x 1 3/8 x 9/16 Char. Height .11"	\$9.95
OPTREX 1 x 20-DMC 20171-8 Bit ASCII Input Dim. 7 3/16 x 1 5/16 x 1/2 Char. Height .42"	\$9.95
OPTREX 2 x 40-DMC 40218-8 Bit ASCII Input Dim. 7 3/16 x 1 5/16 x 13/32	\$9.95
Char. Height .19"	

VERY EASY TO INTERFACE TO ALMOST ANY MICROPROCESSOR!

COOL IT DUDE!

Finned Heat Sink with Fan. Fits on CPU.

\$11.45

DTMF

SSI-202 Decoder	2.25
8870 Decoder	2.25
5087 Generator	2.00
5089 Generator	1.25

EPROM SPECIAL

We bought a large quantity of 2708s, 2716s, 2532s, 2732s, 2764s, 27128s, 27256s, and 27512s from a computer manufacturer who redesigned their boards. We removed them from their sockets, erased and verified them, and now we offer the savings to you. Complete satisfaction guaranteed.

Your Choice	
2708.....1/20	10/8.00
2716.....1.75	10/15.00
2532.....2.00	10/17.50
2732.....2.00	10/17.50
2764.....2.00	10/17.50
27128.....2.50	10/20.00
27256.....3.00	10/25.00
27152.....4.75	10/40.00
1 Meg.....8.50	10/77.50

EPROM

8741.....	7.00
8742.....	7.00
8748.....	7.00
8749.....	7.00
8751H.....	12.95
8755.....	7.00

8000/80000

8001 5.20	8237 1.90	8088-2 3.25	8257 1.50
8002 2.50	8237-5 2.80	8155 2.25	8259 A 1.85
8010 4.95	8243 1.75	8156 2.25	8259C-5 2.10
8031 2.95	8250 2.95	8202A 8.00	8275 10.95
8032 3.95	(16450) 6.50	8212 1.25	8279 2.25
8035 1.00	(18550) 10.95	8214 2.00	8284 1.49
8036 4.95	8251 1.10	8216 1.25	8286 3.50
8039 1.00	8253-5 1.75	8224 1.25	8287 2.49
8085 1.55	8254 1.80	8228 1.75	8288 3.50
8086 1.55	8255 1.50		8530 3.00
8088 2.20	8255-5 1.75		

TERMS: (Unless specified elsewhere) Add \$3.25 postage, we pay balance on Orders Under \$150. Orders over \$50.00 add .85 for Insurance. No C.O.D. Texas Res. add 8 1/4% Tax. 90 Day Money Back Guarantee all items. All items subject to prior sale. Prices subject to change without notice. Foreign order US funds only. We cannot ship to Mexico or Puerto Rico. Canada, add \$7.50 minimum shipping and handling. Countries other than Canada, add \$15.00 minimum shipping and handling.

LOCAL AREA NETWORK

NETWORK

Little Big Lan
 * Peer to Peer LAN to 250 nodes.
 * \$75 total software cost!
 No matter how many nodes!
 * Use ARCnet, serial, parallel or Ethernet to link your computers.
 * Mixed mode routing.
 Any combination of the above connectors is possible on any given node.
 * RAM needed approx. 35-45K.
 * Uses DOS version 2 and above, 3.1 and above preferred.
 * Print spooling.
 * Record locking via DOS SHARE.
 * Open network, API provided.
 * Runs okay with Windows 3.0.
 * Drive A-Z can be redirected to reference any drive on any computer. LPT1-LPT3 can print to any computer.
 * *Start small, grow as you grow.*

\$75.00

CUSTOM CABLES

Cables also available for Little Big Lan Serial (5 Wire null modem) - \$10.00 for first 6 ft. \$25 after 6 ft. (Custom cable non-refundable).

Parallel adapter \$1.50

Adapt most 25 pin to 25 pin cables to meet the parallel interface requirements.

Archnet - \$.50 ft. (Twisted pair only)
 Ethernet - \$.50 ft. (ThinNet RG58)

LAN CABLE

Another B.G. Micro Exclusive, 25 feet of Ethernet RG 58A/U Coax with a BNC connector, a BNC "T", and a BNC terminator on each end.

No one can beat this price.....\$7.95
 Additional "T".....\$.99



NETWORK CARDS

- * 16 TB Model-complies with IEEE 802.3
- * Standards for 10Base-T and 10Base 2
- * Works with most popular network softwares including Netware, TCP/IP, Windows for Workgroups, LANTASTIC,
- * On-board 16K RAM for multiple-packet buffers
- * Four LEDs to indicate link, transmit/receive, polarity/Jabber, and collision status
- * Automatic polarity detection and correction of writing errors
- * Jabber function (watchdog timer).
- * Novel approved NE 2000 compliant.

\$67.99

* NE 1000 available (Call)
 * Arcnet available (Call)

SWITCHING POWER SUPPLIES

DELTA Switching Power Supply

Heavy duty switcher - A full 280 watts completely enclosed w/fan - UL and CSA approved

- + 12V @ 7 amps
- + 5V @ 37 amps
- 5V @ .75 amps
- 12V @ .75 amps

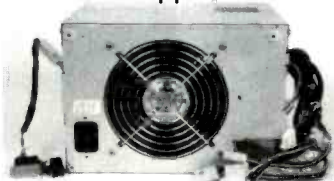

Measures:
 8 1/2" x 5 15/16" x 7 3/8"

\$17.95 + \$4.50 shipping

MFM CARD

MFM Hard Drive Controller

6 Bit Western Digital Hard Drive/Floppy Controller. WD1003-WA2 Brand New Full Length.

\$17.95

These controllers are getting very scarce.

LINE CORD

6 Ft. 3 Wire Line Cord IEC on one end AC on the other.
GREAT COMPUTER CORD

\$1.59



MONITOR CORD

1 Ft. IEC Female to IEC Male

From monitor to power supply.

\$1.49

IF YOU DON'T SEE WHAT YOU NEED CALL US. 1-800-276-2206

CALL OR WRITE FOR FREE CATALOG. 1-800-276-2206

• **Mechanical Interface.** Though the standard specifies a 25-pin connection but not a specific type of connector, the D-series subminiature connector is commonly used. You can expect to see the ubiquitous DB-25 on most equipment, configured either as plugs or sockets. IBM and compatibles have a plug on the serial adapter identified as DB-25P. A mating socket designated DB-25S is used to connect, usually through a cable, external devices to the serial port.

• **Interchange Circuits.** Twenty-five interchange circuits are defined and assigned pin numbers on the connector. IBM has implemented nine of the most-used circuits and uses the DB-25 on the PC/XT and PS/2. The DB-9 is used on the AT, and the pin assignments are IBM's own and, thus, don't represent a standard.

Pin assignments and definitions are detailed in Table 1. Pin 1 is protective ground (PG), also known as frame ground (FG). Sometimes, it's connected to pin 7, sometimes to the chassis. It's also often not connected to anything at all. I'll use DB-25 when referring to the connector. If you use a DB-9, just substitute the appropriate pin numbers for this connector.

• **Signal Characteristics.** The standard specifies bipolar voltage and positive logic for control lines. The output range is -5 to -15 volts for logic 0 and +5 to +15 volts for logic 1. Input range is -3 to -15 volts for logic 0 and +3 to +15 volts for logic 1. Maxi-

Table 2. Summary of Control-Line Conditions

Voltage	Logic	Meaning
+3 to +25	1	On/Active/Asserted/Space
-3 to -25	0	Off/Inactive/Disasserted/Mark

mum input and output on any line is -25 to +25 volts.

Table 2 is a summary of the control-line conditions. Note that the range between -3 to +3 volts is indeterminate. In contrast, the data lines, use negative logic.

• **Line Translators.** The standard also specifies the properties of the line drivers and line receivers that accomplish translation of TTL-to-EIA-232 and EIA-232-to-TTL. Drivers and receivers are located on the serial adapter and interface the UART to the control lines.

The SN75C188 quad line driver IC contains four drivers in one package and requires a bipolar voltage supply (-4.5 volts to -15 volts $-V_{cc}$ and +4.5 to +15 volts V_{cc}). Most implementations use -12 and +12 volts, as do IBM and compatibles, but driver output voltage on the control lines may measure slightly less. The SN75C189 quad line receiver IC contains four receivers, but it needs only a single supply (+5 volts V_{cc}) and accepts an input in the range of -30 to +30 volts. Both ICs have inverted outputs. Also, since the UART inverts the control lines, inversion of the signal is negated. The

driver accepts TTL-level (0 to +5 volts) output from the UART and translates it into the EIA-232 bipolar voltage for the output control line. The receiver accepts the EIA-232 bipolar voltage from the input control line and translates it to TTL-level for input to the UART.

Many variations of line drivers and receivers from many different manufacturers exist. They're usually pin-compatible if an "88" or "89" is in the chip designation. Examples shown are quadruple low-power versions from Texas Instruments. The logic diagram of the driver shown in Fig. 1 reveals that three of the drivers have two inputs, but they're normally tied together and used as a single input. Figure 2 shows that each receiver has a response control, but this control pin isn't usually connected.

Signal Conditioning

Signal conditioning is a process that makes a signal comprehensible to or congenial with a given device.

Typically, you'll amplify, attenuate, rectify, convert, delay, filter or translate the electrical quantity. A combi-

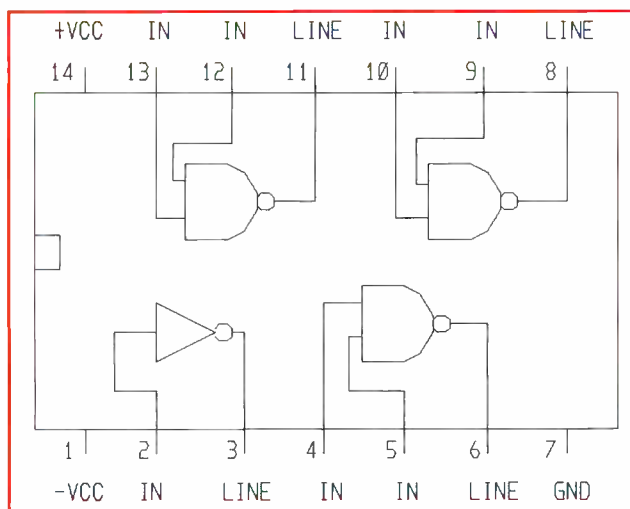

Fig. 1. Logic diagram of a line driver reveals that three drivers have two inputs but are normally tied together and used as a single input.

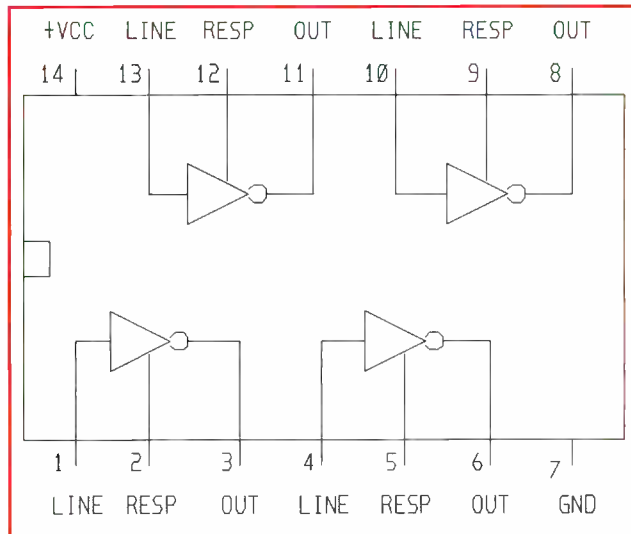

Fig. 2. Each receiver has a response control, but this control pin isn't usually connected.

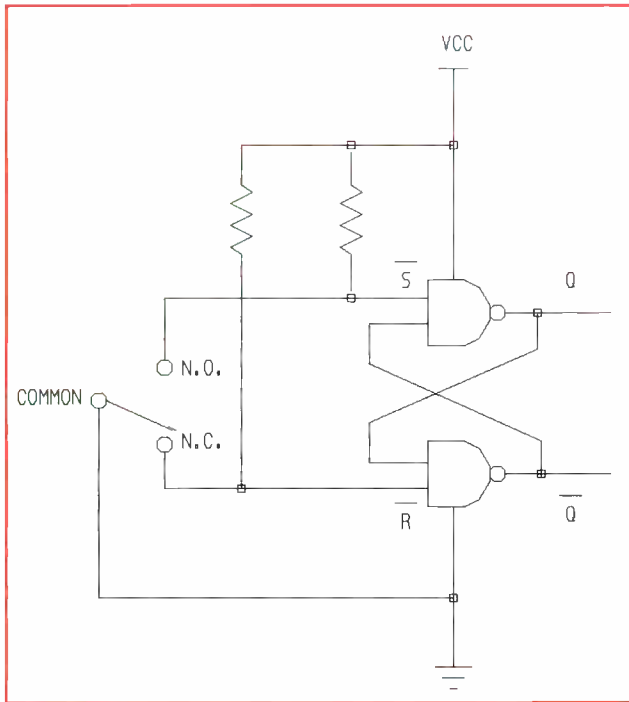

Fig. 3. Switch contacts can be conditioned ("debounced") with cross coupled NAND gates from a quad package like the SN7400, CD4011 or similar gate chip.

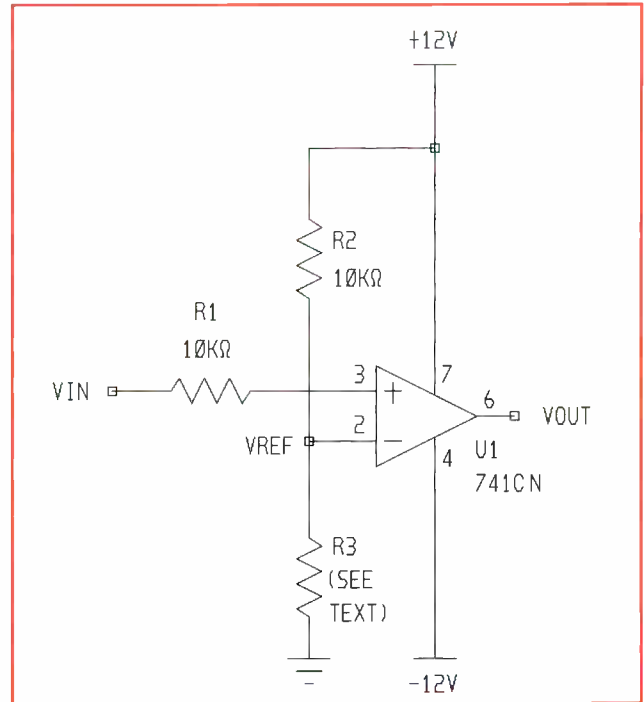

Fig. 4. Hysteresis prevents output oscillation should the input line contain noise in the signal. The value of the feedback resistor isn't critical, but it should be much greater than the value of input resistor *R1*, but too great a value will result in no hysteresis at all. The smaller the resistor value, the greater the hysteresis. Any value from 100,000 ohms to 1 megohm will be satisfactory in this circuit.

nation of methods is sometimes necessary, such as amplify and then translate. Circuits that accomplish this are known as signal conditioners. Signals are classified as being static (slow-changing) or dynamic (fast-changing). The on/off nature of switched sensors, mechanical or solid state, normally results in infrequently changing (on and off times relatively long) direct-current static input signals that mainly use level translation that accepts input at one pair of voltage levels, such as 0 and +5 volts, and delivers output at a different pair of voltage levels, such as -12 and +12 volts.

• **Switch Bounce.** Mechanical switch contacts normally bounce for a few milliseconds after closure. This repeated make-and-break contact can produce multiple signals that play havoc with input circuits by false triggering or inaccurate counts. Switch contacts can be conditioned ("debounced") as shown in Fig. 3 with a pair of cross-coupled NAND gates from a quad package like the SN7400, CD4011 or similar gate chip.

This circuit is a bistable multivibrator called a set-reset (RS) latch or

flip-flop, which has two inputs, not-S and not-R (indicated by a bar over the letter, which means active-low when using positive logic) and two outputs, Q and not-Q, that are complements of each other. When not-S is grounded, Q is high and not-Q is low. Conversely, when not-R is grounded, Q is low and not-Q is high. If both inputs are high, no change occurs in the flip-flop's output. The condition of both inputs being low isn't defined because of unpredictable outputs and, therefore, not allowed (shouldn't be used).

The two pull-up resistors in Fig. 3 hold the inputs high until grounded by the switch (pulled low). A set flip-flop isn't affected by additional set signals. When reset, it isn't affected by additional reset signals, which prevents multiple switch (bouncing) signals from reaching the output.

• **Input.** An obvious choice for an input-signal conditioner is an EIA-232 driver. If you have only a +5-volt supply, you can use one of Maxim's EIA-232 interface chips that combine drivers and receivers in one package and is powered by a single +5-volt supply. These transceivers supply -10 and

+10 volts for the driver output, using an on-chip charge pump dc-to-dc voltage converter. The disadvantage of using the driver is the TTL-level input limit, but it works well if your inputs are within 0 to +5 volts.

• **Comparator.** You can make more-versatile level translator using an operational amplifier without the negative feedback resistor. The resulting very high gain will enable it to function as a level detector, or voltage comparator, that monitors input voltage V_{in} and reference voltage V_{ref} . The op amp lets you use a wider range of input voltage than the line driver. Figure 4 shows a 741CN op amp in such a configuration with a bipolar power supply of -12 and +12 volts. A voltage divider consisting of $R2$ and $R3$ is connected from the positive supply to ground. V_{ref} is developed by $R3$ and applied to the inverting (-) input and can be adjusted by changing the value of $R3$. For example, if $R2$ and $R3$ each have a value of 10,000 ohms, V_{ref} will be about +6 volts. If the value of $R3$ is decreased to 5,100 ohms, V_{ref} will decrease to about +4 volts, and if the value of $R3$ is increased to 20,000

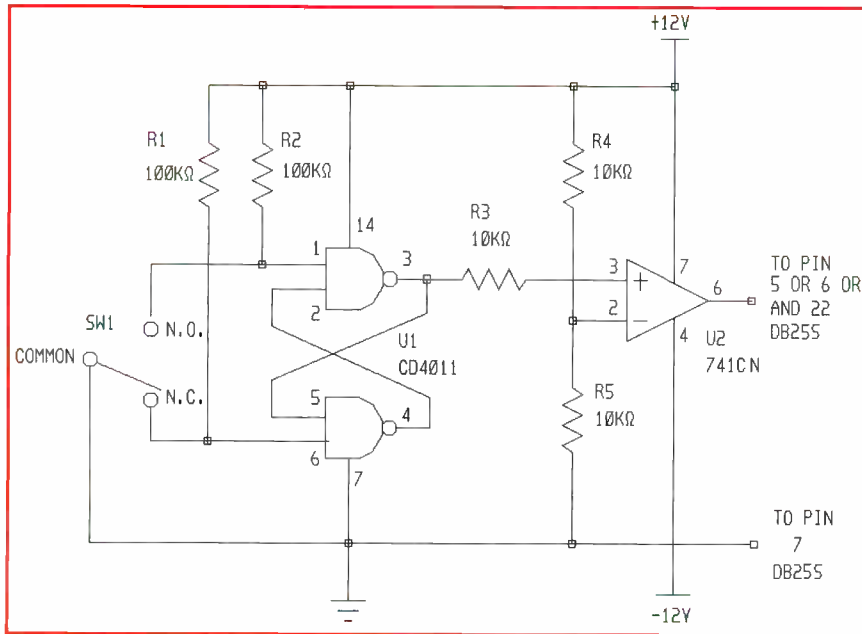

Fig. 5. An example of an input circuit.

If V_{in} to $U2$ taken from the Q output, V_{in} at pin 3 is less than V_{ref} at pin 2, and the output of the comparator at pin 6 will be about -12 volts, indicating an off condition.

When the door is opened, the switch closes the N.O. contact and opens the N.C. contact. This grounds the not-S input at pin 1, flipping the flip-flop to high at the Q output and low at the not-Q output. V_{in} is now greater than V_{ref} , and the comparator's output goes to about $+12$ volts, indicating an on condition. There's a switch already there, the one that controls the interior light, that could possibly be pressed into dual service, but be aware that it's switching 120 volts ac.

You can monitor the door and determine how often it's opened and how long it remains open by connecting the comparator's output to one of the EIA-232 control-line inputs to the serial card (pin 5, 6 or 8 and pin 22) of the DB-25S connector and connecting ground to pin 7.

This may seem a frivolous application, but it illustrates the ease with which you can use a simple single-pole, double-throw (spdt) switch as an input sensor. It also suggests monitoring of similar items, such as windows, doors, drawers, etc.

If the signal from the sensor to the input of the op-amp comparator is slow, changing about the trip point, such as from a thermistor, the slow ramp-up from off to on and *vice-versa* could be quite long, causing the op amp's output to make several transitions as V_{in} approaches trip point V_{ref} . This output jitter can be prevented by connecting a resistor from the output of the op amp to the $-$ input. This positive feedback causes the input to have two trip thresholds, the upper threshold point and the lower threshold point. The difference between these two points is the hysteresis, or dead band, in which the input has no effect on the output and ensures a snap-action (single rapid-transition) output change.

Hysteresis also prevents output oscillation if the input line contains noise in the signal. The value of the feedback resistor isn't critical, but it should be much greater than that of the input resistor ($R1$ in Fig. 4). Be aware, though, that too great a value will result in no hysteresis at all. The smaller the value, the greater the hys-

ohms, V_{ref} will increase to approximately $+8$ volts.

V_{in} is applied through $R1$, a value of 10,000 ohms in this example, to the non-inverting (+) input. When V_{in} is less than V_{ref} , the output is negative (about -12 volts). If V_{in} becomes greater than V_{ref} (the trip point), the output goes positive (about $+12$ volts).

Figure 5 gives an example of an input circuit. Imagine that miniature momentary snap-action switch $SW1$ is mounted on your refrigerator and held normally closed (N.C.) by an actuator mounted on the door, grounding the not-R input at pin 6 of flip-flop $U1$. The Q output at pin 3 will be low, and the not-Q output at pin 4 will be high.

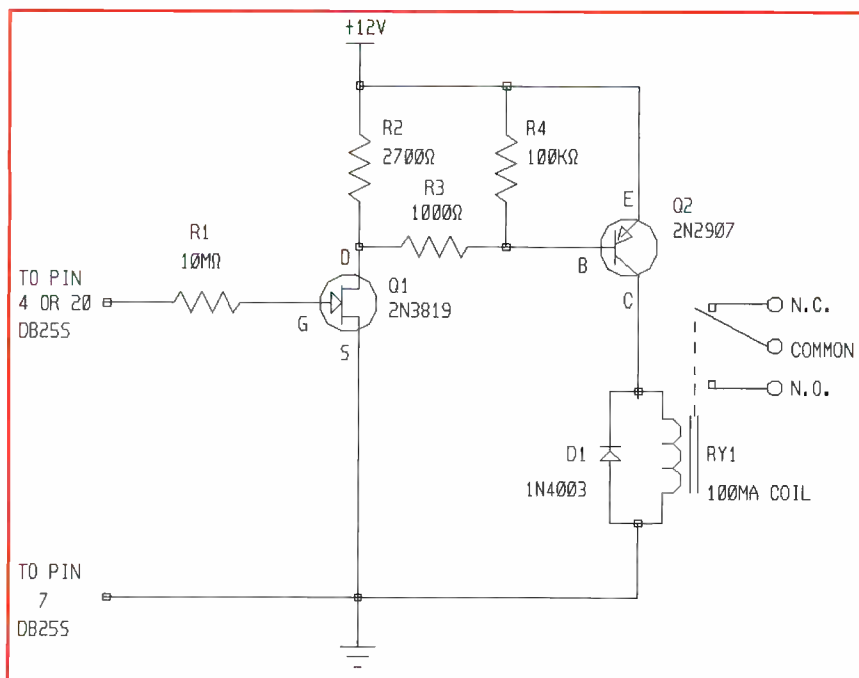

Fig. 6. An n-channel JFET output circuit using a +12-volt supply. Power supply output depends upon the transistor and series load used.

teresis. Any value from 100,000 ohms to 1 megohm will be satisfactory in this circuit.

• **Output.** You might find that a 0.1- μ F bypass capacitor connected from the IC's power pin(s) to ground is needed if you experience any strange circuit behavior. I didn't need to use bypass capacitors in the prototypes. Other sensors can activate the switch or function as the switch. Thermostat, float, light, tilt (mercury switch), limit, current and proximity are a few of the goodly number available.

If you opt for the line driver as a level translator, you'll use the not-Q output of the switch debouncer as the input to the driver because of the driver's signal inversion.

You can use the EIA-232 line receiver as an output-conditioning circuit. But, like the driver, it's limited to TTL-logic-level inverted outputs. A transistor switch can be used as a simple alternative output circuit with a more-flexible voltage range.

• **Transistor Switch.** When a transistor's gate or base is reverse biased by a sufficient voltage, negligible current flows through the transistor. In this state, the transistor looks like an open switch, with maximum voltage across it and minimum voltage across the series load (turned off). If bias voltage polarity is reversed so that the transistor is forward biased, it begins to conduct current as the amplitude of the forward-bias voltage increases. At a great enough forward-bias voltage, the transistor saturates and there's no further increase in current, even if the bias voltage continues to increase. The transistor then has maximum current through and minimum voltage across it. In this state, it appears as a closed switch, with maximum voltage across the series load (turned on).

• **FETs.** Since the EIA-232 control-line voltage is negative when off and positive when on, the field-effect transistor (FET), being a voltage controlled device, is a good output-circuit component to use as a switch that accommodates a wide range of output voltages. Two classes of FETs are the junction FET (JFET) and the metal-oxide semiconductor FET (MOSFET), sometimes called an insulated-gate FET (IGFET). There are also two polarities of each class: n-and p-channel. The two modes of FET operation are depletion and enhancement. De-

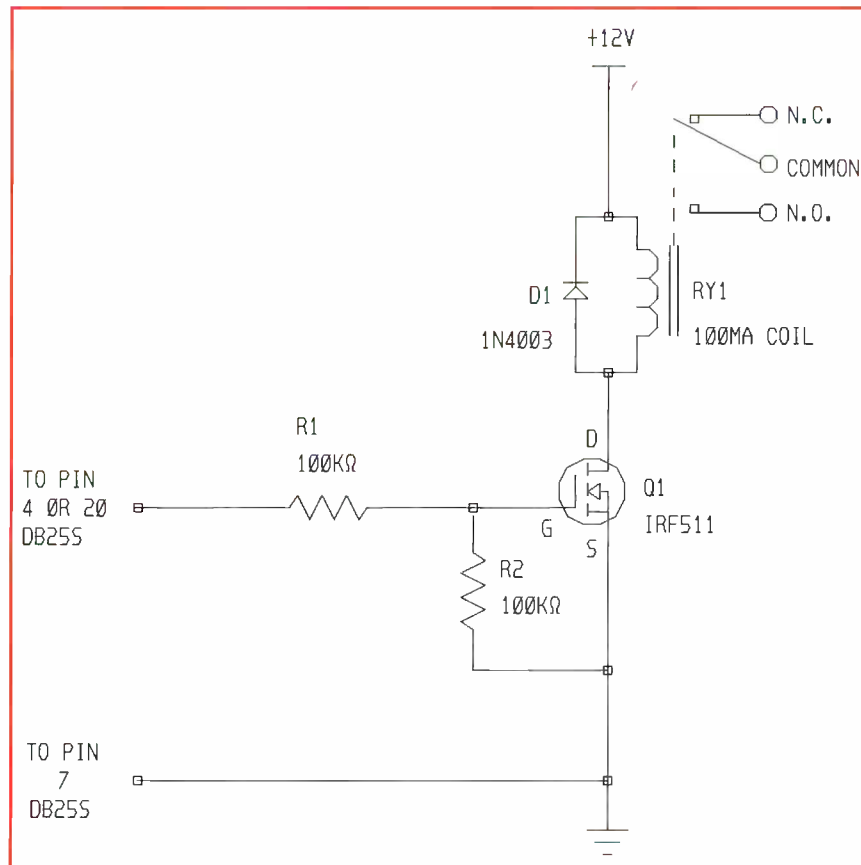

Fig. 7. This simpler but a bit more output circuit uses an n-channel enhancement-mode power MOSFET that's capable of switching much greater current than the JFET.

pletion mode must deplete the channel to turn off, and enhancement mode must enhance the channel to turn on. Mode of operation is a function of the transistor fabrication process, not of circuit design.

JFETs can be constructed to operate in only depletion mode. The n-channel JFET switches on when gate potential is equal to or greater than 0 volt and is switched off when gate potential attains a sufficient negative amplitude. The p-channel JFET is identical in operation, except that voltage polarity is reversed.

The MOSFET can be constructed to operate in depletion, enhancement or depletion-enhancement mode, enhancement mode being most common. The n-channel enhancement MOSFET switches off when gate potential equals or is less than 0 volt and switches on when gate potential reaches enough positive amplitude. The p-channel enhancement MOSFET is identical in operation, except that voltage polarity is reversed.

An n-channel JFET output circuit is shown in Fig. 6 using a +12-volt supply. Power-supply output depends on the transistor and series load you use. Since 2N3819 JFET *Q1* has a maximum drain current of only 10 mA, it's paired with 2N2907 pnp bipolar transistor *Q2*, which has a maximum collector current of 500 mA. When the EIA-232 control line is turned on, the positive voltage drives the JFET into saturation, quickly turning it on. This pulls negative the base of *Q2*, spurting *Q2* into saturation and energizing the series-load relay coil. The relay's N.O. contacts close and the N.C. contacts open. When the EIA-232 control line is turned off, the negative voltage turns off *Q1* and *Q2*, deenergizing the relay coil so that the contacts revert to their original positions.

The n-channel JFET is normally operated with a negative gate-bias voltage. So when the EIA control voltage swings positive, the gate is forward biased and could draw appreciable current. A large value for *R1*

Table 3. Registers and Addresses For the 8250

Receive Buffer/Transmitter Holding	Base Address
Interrupt Enable	Base Address + 1
Interrupt Identification	Base Address + 2
Line Control	Base Address + 3
Modem Control	Base Address + 4
Line Status	Base Address + 5
Modem Status	Base Address + 6

Table 4. Details of Modem Control Register

Bit	Name	Function
0	DTR	Writing a 1 to this bit produces a positive voltage on the out put line. Writing a 0 to this bit produces a negative voltage on the output line.
1	RTS	Same as above
2	OUT1	This user defined output is not used.
3	OUT2	This user defined output is used by IBM and compatibles as a master UART interrupt enable switch and must be set to allow 8250 interrupts.
4	LoopBack Test	Enables diagnostics testing mode.
5 Thru 7		Always 0.

limits this current. Resistor *R2* is a passive load that limits drain current through *Q1* to a value that's less than the 10-mA maximum. Base resistor *R3* has a relatively small value to permit ample *Q2* base current so that *Q2* will saturate (BJTs are current-operated devices). Resistor *R4* pulls the base positive to ensure that *Q2* remains off when not turned on.

Diode *D1* across the relay coil pre-

vents damage to the transistor that might otherwise result from the inductive voltage spike generated by the coil when it's switched off. Power to the controlled device (a motor, for example), connects to the common and N.O. contacts of the relay.

Gate voltage is lost when you turn off your computer. With circuit power on and 0 volt on the gate, the JFET may turn on. Connect the gate to -5 to

-12 volts through a 1-megohm resistor to ensure that the JFET remains off.

Figure 7 illustrates a preferred circuit that's simpler but a bit more costly than the one shown in Fig. 6. This circuit uses an n-channel enhancement-mode power MOSFET that's capable of switching much greater currents than the JFET. IRF511 hex-FET *Q1* has a maximum drain current of 3 amperes. When the control line is turned on, the positive voltage at the gate drives *Q1* into saturation and switches on the relay. When the EIA-232 line goes negative, *Q1* turns off and switches off the relay. Resistor *R1* isolates the gate of *Q1* from the EIA-232 control line, and resistor *R2* provides a static discharge path for the gate by connecting it to the source.

In the above examples, the relay contacts are rated at 10 amperes and 120 volts ac. Direct current can be switched, but at much lower potential of 28 volts. (Direct current isn't easy to turn off because it doesn't pass through 0.) If the device you want to control requires greater current, choose a relay that has appropriately rated contacts, but make sure that coil requirements don't exceed the limit of the transistor switch.

Some devices you can control include: motors (pumps, fans), solenoids (valves, locks), lights, alarms and or heaters. Low-power devices can be connected directly to the transistor, eliminating the relay.

The above examples aren't the only input and output circuits you can have. There are many others and, since this I/O scheme offers an opportunity to experiment with a very small investment in money and time, you can try different circuits and components to accomplish your specific requirement in an elegant way.

Components

All the components needed to build the input and output circuits shown in the examples are stock items from your local Radio Shack or other electronics parts store. The resistors should be rated at 1/4 watt, 5% tolerance. Here's a rundown on the remaining components:

- **UART.** The 8250 contains seven byte-sized registers that are accessible via sequentially assigned port addresses, starting at the base address of

Table 5. Bit Functions For Modem Status Register

Bit	Name	Function
0	ΔCTS	This bit is set whenever the CTS input line changes state from OFF to ON or from ON to OFF since last read. It is cleared when the CPU reads the register.
1	ΔDSR	Same as bit 0, for the DSR input line.
2	TERI	(Trailing Edge of Ring Indicator) This bit is set whenever the RI line changes state from ON to OFF since last read. It is cleared when the CPU reads the register.
3	ΔRSLD	Same as bit 0, for the RSLD input line.
4	CTS	Asserted if high, not asserted if low.
5	DSR	Same as bit 4.
6	RI	Asserted on phone line ringer pulses.
7	RSLD	Same as bit 4.

Table 6. Register Functions For Modem Status Register

Register Value	Interrupt	Meaning (Arbitrary Assignment)
1	ΔCTS	Input 1 On
2	ΔDSR	Input 2 On
4	TERI	Input Off
8	ΔRSLD	Input 3 On
5	ΔCTS & TERI	Input 1 Off
6	ΔDSR & TERI	Input 2 Off
0ch	ΔRSLD & TERI	Input 3 Off

the port (03f8h or 02f8h). Values to put into the registers are sent to the appropriate address using the CPU (Central Processing Unit; actually, it's a Microprocessing Unit, or MPU, or microprocessor—an Intel 8088, 8086, 80286, 80386, 80486, or Pentium) OUT instruction. Registers to be read are accessed by the IN instruction, together with the register address. The 8250 registers and addresses are detailed in Table 3. There's an additional register in later production 8250s, the scratch pad located at base address + 7, that can be used to store a byte.

Only the registers used for discrete I/O will be explained.

• **Interrupt Enable.** The bits of this register enable the four types of interrupts supported by the 8250. An interrupt is enabled by setting the desired bit. Details of the register bits are as follows:

Bit	Interrupt
0	Received Data Available
1	Transmitter Holding Register Empty
2	Receive Line Status
3	Modem Status (EIA-232 Control Line Inputs)
4-7	Always 0

This I/O concept uses only the interrupts from the modem status register. Therefore, Bit 3 is the one to set because you want the UART to generate an interrupt when any of the EIA-232 input lines changes state.

• **Modem Control.** This register controls the state of the EIA-232 control outputs. Details for the Modem Control register are given in Table 4. Obviously, Bits 0 and 1 are the outputs you'll use to control external devices, and Bit 3 must be set to utilize 8250 interrupts. The outputs are cleared during power-on initialization of the UART. This lets you begin with a known state of all outputs being off.

• **Modem Status.** This register indicates the status of the EIA-232 control-line inputs. Individual bits have the functions detailed in Table 5. Any change in the state of CTS, DSR and RSLD lines and when the RI line changes from high to low (on to off) will effect an interrupt, setting the appropriate delta (Δ) bits, 0 through 3. The Δ bits can be checked to determine the interrupting event. Table 6 will clarify this arrangement.

From a monitor and control perspective, the UART is the key to this

Table 7. Bit/IRQ Details For IBM PC/XT

Bit/IRQ	Device
0	System Timer
1	Keyboard
2	Network, EGA/VGA Display
3	COM2 & COM4
4	COM1 & COM3
5	Hard Drive
6	Floppy Drive
7	Printer

Table 8. Storage Locations to be Saved in Main Section of Program Code

OLDOFF	dw ?	;Storage for old ISR address offset
OLDSEG	dw ?	;Storage for old ISR address segment
NWHNDLR dd DC_INPUT		;Far pointer to new ISR (named DC_INPUT)

I/O scheme. It detects changes on the control input lines and sets the polarity of the control output lines.

Interrupts

An interrupt is an event that causes the CPU to suspend execution of the current program to perform special operations. After the operations are completed, the CPU continues the current program.

Interrupts are controlled by the Intel 8259A Programmable Interrupt Controller (PIC). The PIC is a complicated 28-pin chip located on the motherboard that expands the CPU's one maskable interrupt to eight prioritized interrupts. With about twice the number of interrupts, the AT has two cascaded PICs. The UART doesn't interrupt the CPU directly because all

hardware interrupts go to the PIC, which then requests the interrupt of the CPU.

You must program the PIC for the UART interrupts to get to the CPU. The PIC is programmed through four initialization command words (ICWs) and three operation control words (OCWs). You don't have to bother with ICWs because this is taken care of by the initialization process during power-on, but you do have to fiddle with OCW1 and OCW2.

OCW1, at port 21h, sets and clears the mask bits in the Interrupt Mask Register (IMR). Each bit corresponds to an interrupt request (IRQ) number assigned to a specific device (the lower the number, the higher the priority). When the bit is set, the IRQ is masked (disabled), and when the bit is cleared, the IRQ is unmasked (enabled). The

Listing 1. Sample Code to Get & Save Old Interrupt Handler Pointer

```

mov ah,35h ;DOS function to get ISR pointer
mov al,12 ;COM1 interrupt number
int 21h ;DOS software interrupt service
mov OLDOFF,bx ;Store old ISR address offset
mov OLDSEG,es ;Store old ISR address segment

```

Listing 2. Sample Code to Install New Interrupt Handler Pointer

```

mov ah,25h ;DOS function to set ISR pointer
mov al,12 ;COM1 interrupt number
push ds ;Save the ds register contents
mov dx,word ptr NWHNDLR ;Offset of new handler address
mov ds:word ptr NWHNDLR+2, ;Segment of new handler address
int 21h ;DOS software interrupt service
pop ds ;Restore ds contents

```

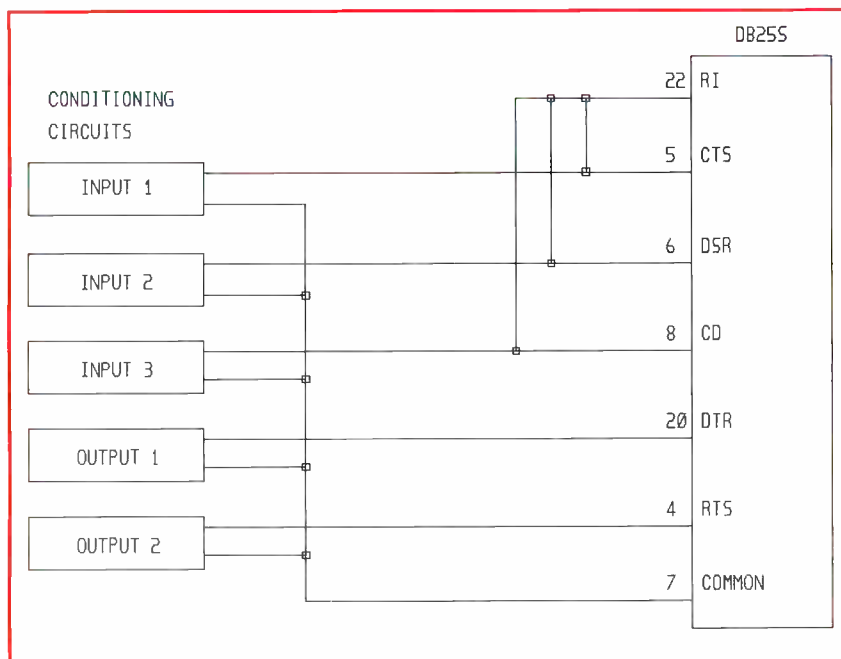

Fig. 8. Cable details for connection between the computer and the I/O circuits. Note that pin 22 is tied to pins 5, 6 and 8, and pin 7 is common to all circuits.

Listing 3. Add This to the List of Equates After Installing Program Handler

```
COMBASE equ 03f8h ;COM1 serial port address
INTREN equ COMBASE+1 ;Modem Interrupt Enable Register
OUTPUT equ COMBASE+4 ;Modem Control Register(RTS,DTR,OUT2)
INPUT equ COMBASE+6 ;Modem Status Register(CTS,DSR,CD,RI)
```

Listing 4. Code to Enable UART Interrupts

```
mov dx,OUTPUT ;Modem Control register address
mov al,0ah ;Set OUT2 to enable UART interrupts
out dx,al ;Send to the Modem Control register
```

Listing 5. Code to Enable UART Modem Status Register Interrupts

```
mov dx,INTREN ;Modem Interrupt Enable register address
mov al,08 ;Enable only the Input interrupts, bit 3
out dx,al ;Send to the Modem Intr Enable reg
```

assignments for XT and compatible PCs are detailed in Table 7.

There's only one of two interrupt requests you'll use: IRQ3 or IRQ4 (the same interrupts AT and compatibles use for the serial port). Before the input circuit can cause an interrupt, the IRQ must be unmasked. Assuming that COM1 is the I/O port being used, IRQ4 will be unmasked. You want to clear only the bit associated with IRQ4 and not disturb any of the others. You

can do this by reading the port at 21h, ANDing the current contents with mask 0efh and writing the result back to port 21h. Before exiting your program, you should disable IRQ4 by reading port 21h, ORing the contents with mask 10h and writing the result back to port 21h.

OCW2, at port 20h, contains only one bit you'll use (Bit 5), known as the End of Interrupt (EOI). When set, Bit 5 informs the PIC that the inter-

rupt is over. You can do this by writing 20h to port 20h. The PIC won't permit any more interrupts of equal or lower priority until advised that current interrupt processing is complete.

• **Interrupt Vectors.** During power-on initialization the BIOS chip sets up a vector table that points to the Interrupt Service Routines (ISRs) that are called to handle the interrupts when they occur. The pointers consists of two words—offset and segment—with offset being stored first and segment stored second. You can substitute your interrupt handler for the one stored by locating its vector (pointer) and changing it to point to your handler.

When the PIC activates the interrupt request (INTR) line, the CPU breaks off execution of the present program after the current instruction is finished, saves its place and the flag register, disables system interrupts, acknowledges the interrupt request, reads the interrupt code type (a number between 0 and 255 that identifies the device requesting the interrupt—COM1 is 12 and COM2 is 11—and calls (diverts program execution) the interrupt handler for the device initiating the interrupt.

Programming

The program for discrete I/O consists of the main part and the interrupt handler. The main part saves the current (old) interrupt handler and installs your new interrupt handler and then sets up the PIC and UART for serial port interrupts. You can manipulate the information gathered by the interrupt handler and, if required or desired, turn on or off one or both of the output lines and include a loop for the CPU to run while waiting for an interrupt. When you've collected the needed data and want to leave the program, restore the PIC and UART to their original states. These clean-up functions are also in the main part.

The interrupt handler is the part of the program that performs the special operations required whenever the CPU is interrupted. The interrupt handler isn't entered from the main part of the program. Rather, it's called and executed by the CPU only when an interrupt occurs.

I used MASM 5.1 for the examples, but you can use any programming language that you prefer.

Listing 6. Code For Programming PIC to Recognize UART Interrupts

```
in    al,21h      ;Get the IMR contents
and   al,0efh    ;Enable COM1 interrupts
out   21h,al     ;Put contents back into the IMR
```

Listing 7. Code For Turning Off Outputs

```
mov   dx,OUTPUT  ;Modem control register address
mov   al,0       ;Clear OUT2 and turn off other outputs
out   dx,al      ;Send to modem control reg
```

Listing 8. Code For Clearing UART Interrupt Enable Register

```
mov   dx,INTREN  ;Modem interrupt enable reg address
mov   al,0       ;Turn off all interrupts
out   dx,al      ;Send to modem intr enable reg
```

Listing 9. Code to Turn Off PIC Acknowledgment of COM1 UART Interrupts

```
in    al,21h      ;Get IMR contents
or    al,10h     ;Mask to disable only COM1
out   21h,al     ;Send back to IMR
```

• **Main.** Here are some code examples you can use in your program. You should reserve the storage locations in the data segment as detailed in Table 8.

You can save the pointer to the current interrupt handler in a memory location by using DOS function 35h, Get Interrupt Vector. The description is:

```
set-up
ah = 35h
al = interrupt number
```

```
returns
es:bx = segment:offset of current (old) ISR
address
```

Sample code to get and save the old interrupt handler pointer is given in Listing 1.

The new interrupt handler pointer can now be installed by using DOS function 25h, Set Interrupt Vector. The description is:

```
set-up
ah = 25h
al = interrupt number
ds:dx = segment:offset of the new handler
address
```

```
returns
none
```

Sample code to install the new inter-

rupt handler pointer is given in Listing 2.

Once your new handler is installed, you can program the PIC to recognize the serial port interrupts and the UART to generate interrupts. Add Listing 3 to the list of equates. Sample code to program the PIC and UART to enable interrupts is as follows:

```
cli ;Clear the interrupt enable flag
```

First turn off system interrupts while programming the PIC and the UART so that this code won't be disturbed while executing. Then enable the UART interrupts per Listing 4. Next, enable the UART Modem Status register's interrupts with Listing 5. Then program the PIC to recognize the UART interrupts, using Listing 6. Finally, turn system interrupts back on with the following:

```
sti ;Set the interrupt enable flag
```

The serial port is now ready to generate an interrupt whenever an input line changes state. Your productive routines will go here to wait for an interrupt. Before accessing data from a variable updated by your ISR, you should disable interrupts with a cli

instruction and immediately after getting the data-enable interrupts with an sti instruction. Otherwise, the ISR could change the data before your program gets it, and the data needed at that time would be lost.

Before exiting the program, undo the changes that were made by restoring all the original values.

• **Clean-Up Code.** Turn off the system interrupts, as follows:

```
cli ;Clear interrupt enable flag
```

Then disable UART interrupt capability and turn off outputs, using Listing 7. Next, reset (clear) the UART Interrupt Enable register using Listing 8. Turn off PIC acknowledgment of COM1 UART interrupts, using Listing 9. Then turn back on system interrupts using:

```
sti ;Set intr en flag
```

Finally, you must put back into the interrupt vector table the old interrupt vector, using Listing 10. The program is now ready to be terminated and control returned to DOS.

• **Interrupt Handler.** This is the program that's called to take action when an interrupt is generated by the UART. Some examples of code to write an ISR follow. Add Listing 11 to the listing of equates.

The interrupt handler is named DC_INPUT. When DC_INPUT is called, it must ensure that no system interrupts are lost by immediately setting the interrupt enable flag as follows:

```
sti ;Set intr enable flag
```

You must save the registers used so that data they contain isn't lost. Push the registers onto the stack with the following:

```
push ds
push ax
push bx
push dx
```

DC_INPUT must know where the data segment is so that it can store and access data as necessary. This is done by initializing the ds register as follows:

```
mov ax,_DATA ;Data segment
                pointer
mov ds,ax ;Put into ds register
```

The input event that caused the in-

Listing 10. Code to Put Back Old Interrupt Vector Into Vector Table

```

mov  ah,25h      ;Set Interrupt Vector
mov  al,12       ;Com1 interrupt number
push ds          ;Save ds contents
mov  ds,OLDSEG   ;Get old intrhndlr address segment
mov  dx,OLDOFF   ;Get old intrhndlr address offset
int  21h         ;DOS interrupt service
pop  ds          ;Restore ds contents

```

Listing 11. Add This to the List of Equates

```

IN1ON   equ 01    ;CTS on
IN2ON   equ 02    ;DSR on
IN3ON   equ 08    ;CD on
IN1OFF  equ 05    ;CTS off (CTS and RI)
IN2OFF  equ 06    ;DSR off (DSR and RI)
IN3OFF  equ 0ch   ;CD off (CD and RI)

```

Listing 12. Code to Reset Modem Status Register, Identify Input and Jump(to Appropriate Routine

```

mov  dx,INPUT    ;Modem status register address
in   al,dx       ;Register cleared, interrupt in al
cmp  al,IN1OFF   ;Input 1 off?
jz   ONEOFF      ;Yes, go to input 1 off routine
cmp  al,IN2OFF   ;No, is input 2 off?
jz   TWOOFF      ;Yes, go to input 2 off routine
cmp  al,IN3OFF   ;No, is input 3 off?
jz   THREEOFF   ;Yes, go to input 3 off routine
test al,IN1ON    ;No, is input 1 on?
jnz  ONEON       ;Yes, go to input 1 on routine
test al,IN2ON    ;No, is input 2 on?
jnz  TWOON       ;Yes, go to input 2 on routine
test al,IN3ON    ;No, is input 3 on?
jnz  THREEON     ;Yes, go to input 3 on routine
jmp  INTROVR     ;Should not get here

```

Listing 13. Code to Set and Clear a Bit in UART Modem Control Register

```

OUT1ON  equ 01    ;DTR control line turn on mask
OUT2ON  equ 02    ;RTS control line turn on mask
OUT1OFF equ 0feh  ;DTR control line turn off mask
OUT2OFF equ 0fdh  ;RTS control line turn off mask

```

interrupt must be identified and whether the event is on or off determined by comparing the interrupt with each input until a match is found. When the UART Modem Status register is read, it's cleared to ensure that further input interrupts won't be lost. The sample routine given in Listing 12 resets the Modem Status register, identifies the input and jumps to the appropriate routine.

After identifying the input, your handler must take appropriate action to service it. You may want to get the

time tick, compute time and date, perform a calculation or update a variable. Processing the information gathered from the ISR can also be done in the main part of the program after returning from the interrupt.

The following is a sample code outline for processing event one:

ONEON:

Your routine to service input 1 when it turns on is put here.

```

jmp  INTROVR;Service routine complete, return

```

ONEOFF:

Your routine to service input 1 when it turns off is put here.

```

jmp  INTROVR;Service routine complete, return

```

The sample code to service events two and three are similar:

TWOON:

```

jmp  INTROVR;Service routine complete, return

```

TWOOFF:

```

jmp  INTROVR;Service routine complete, return

```

THREEON:

```

jmp  INTROVR;Service routine complete, return

```

THREEOFF:

```

jmp  INTROVR;Service routine complete, return

```

Note that the jmp instruction immediately above isn't necessary if execution falls into the INTROVR routine.

When the interrupt operations are completed, the PIC is told that the interrupt is over, the registers are restored and control is returned to the interrupted program:

Interrupt is over:

```

INTROVR:
mov  al,20h     ;EOI
out  20h,al     ;Send it to PIC

```

Restore registers as follows:

```

pop  dx
pop  bx
pop  ax
pop  ds

```

Return to the interrupted program as follows:

```

iret ;Return from interrupt

```

This is all that's necessary to service the dc inputs to the computer via the serial port.

Programming the outputs is simply a matter of setting or clearing a bit in

the UART Modem Control register. The following examples show how this is done. Add the code in Listing 12 to the equates.

Sample code to turn on off Control Line 1 (DTR) are given in Listings 13 and 14, respectively. You program Control Line 2 (RTS) in the same manner as Control Line 1. Just substitute OUT2ON and OUT2OFF for the masks used in the above examples and, of course, RTS for DTR and Bit 2 for Bit 1 in the remarks.

I/O Cable

Shown in Fig. 8 are the cable details for connection between the computer and the I/O circuits. Note that pin 22 ties to pins 5, 6 and 8 and pin 7 is common to all circuits. How long can the cable be? Beats me, but probably several hundred feet.

In Conclusion

I've presented here an unorthodox use of the serial port that results in a sim-

Listing 14. Sample Code to Turn On Control Line 1

```
mov dx,OUTPUT ;Modem control register address
in al,dx ;Put contents into al
or al,OUT1ON ;Set only bit 1 (DTR)
out dx,al ;Put contents back into register
```

Listing 15. Sample Code to Turn Off Control Line 1

```
mov dx,OUTPUT ;Modem control register address
in al,dx ;Put contents into al
and al,OUT1OFF ;Clear only bit 1 (DTR)
out dx,al ;Put contents back into register
```

ple, reliable and very economical monitoring and control system. I got the idea when I needed to monitor a submerged pump in a sump tank buried underground. Since the only access was the power cable at the breaker box, I used a current transformer as a sensor to detect when the pump motor turned on and off. It worked obligingly well, the computer logged the times the pump turned on and off and

calculated total run time. Since I didn't need outputs for this application, I used the RTS and DTR output lines as a bipolar power supply for the signal-conditioning input circuit.

I've covered the basic plan in a very simplified manner (some of you may think too simplified). There are probably other methods to implement this I/O scheme, but I'll leave that to you and your imagination. ■

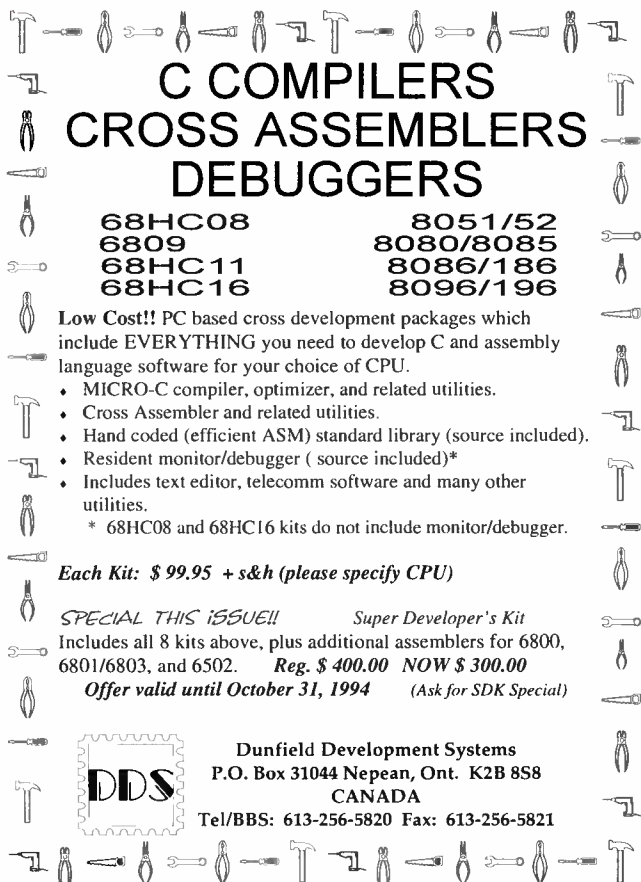

C COMPILERS

CROSS ASSEMBLERS

DEBUGGERS

68HC08	8051/52
6809	8080/8085
68HC11	8086/186
68HC16	8096/196

Low Cost!! PC based cross development packages which include EVERYTHING you need to develop C and assembly language software for your choice of CPU.

- MICRO-C compiler, optimizer, and related utilities.
- Cross Assembler and related utilities.
- Hand coded (efficient ASM) standard library (source included).
- Resident monitor/debugger (source included)*
- Includes text editor, telecomm software and many other utilities.

* 68HC08 and 68HC16 kits do not include monitor/debugger.

Each Kit: \$ 99.95 + s&h (please specify CPU)

SPECIAL THIS ISSUE!! Super Developer's Kit
Includes all 8 kits above, plus additional assemblers for 6800, 6801/6803, and 6502. **Reg. \$ 400.00 NOW \$ 300.00**
Offer valid until October 31, 1994 (Ask for SDK Special)



Dunfield Development Systems
P.O. Box 31044 Nepean, Ont. K2B 8S8
CANADA
Tel/BBS: 613-256-5820 Fax: 613-256-5821

* THE BEST * 8085 MICROPROCESSOR TRAINING SYSTEM

No other training system we know of comes close to matching the PRIMER's features at this low price. The PRIMER teaches more and is easier to use than other comparably priced trainers. The over 100 page Self Instruction manual takes you from binary number systems, to processing interrupts, to interfacing temperature sensors. The 8085 based PRIMER TRAINER comes complete with Monitor Operating System software, digital I/O, A/D, D/A, timer, speaker, display and keypad. Learn how

to program and interface at the machine level with the PRIMER TRAINER. Start programming with machine language, then move on to Assembler, and then continue on with multitasking BASIC or Forth

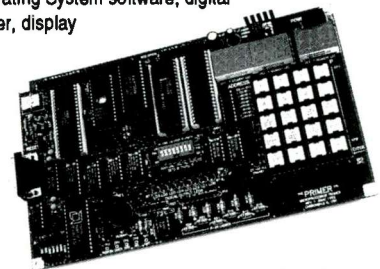

compilers. Ideally suited for beginners as well as advanced high-level programmers and engineers.

THE PRIMER IS \$99.95 QUANTITY 10 OR ONLY \$119.95 QUANTITY 1 IN KIT FORM. THE PRIMER ASSEMBLED & TESTED BY EMAC IS \$169.95. ORDER NOW AND RECEIVE A FREE POWER SUPPLY WHEN YOU MENTION THIS AD. PLEASE ADD \$5.00 FOR SHIPPING.

EMAC, inc.

618-529-4525

FAX: 618-457-0110

P.O. BOX 2042 CARBONDALE, IL 62902

CIRCLE NO. 63 ON FREE INFORMATION CARD

The On-Line Obstacle Course

The ins and outs of setting up and operating a BBS

Some of you are involved in running a BBS (bulletin-board system), while others contemplate starting one. This article is designed to make you aware of some problems you'll encounter in setting up and operating a BBS and measures you can take to eliminate or alleviate them.

Individuality Factor

In setting up a BBS, one of the first things you need to do is establish a theme for your board. You'll want to select something relatively unique to your area. If there are already a number of boards with a medieval theme, for example, don't add another. The BBS world is inundated with not only the medieval theme, but the haunted-house/crypt, asylum, science-fiction and White House themes as well. Stray into new territories. Among the more-original BBS motifs I've seen are the library, lounge, garage, mafia operation and convenience store.

Configure as much as possible around the theme. If your BBS allows sysop-definable access levels, in a mafia tone, you might rename the sysop access level as "godfather," cosysops and subops as "dons," preferred users as "family members," normal users as "hitmen" and new users as "gangsters." Name the subs in your message base to fit your theme as well. Maintaining the mafia example, you might call the sub you use to pass along information to users "The Word From Underground," the area for selling used equipment "Offers You Can't Refuse," and so on.

Take some time to custom-design menus and logon/logoff screens to add to the theme. Many ANSI screen generators, such as The Draw, allow you to create ANSI screens with minimal

effort. Be sure to change them every so often, though, as users will grow tired of looking at the same logon screen time after time. Create some seasonal pictures to display during the holidays for that personal touch.

Rather than a theme, your board's specialty might lend itself to the focus. A BBS specializing in a large file base might become "Download Domain" or "Filemaster," one that hosts a large number of on-line games might be called "The Circus" or "The Playground," or if your BBS is one with a multitude of networked message base subs, you might decide to name it "The Grapevine" or "The Newsroom."

Some sysops opt for an adult theme, but this opens up a whole new area of problems. As the nature of files and conversations on this type of BBS should be kept off the computer screens of minors, a more-stringent access policy must be developed to ensure that only adults are permitted on-line. You may want to request a photocopied driver's license be mailed before users are granted access. You'd assuredly want to use voice validation (see next section) as a follow-up after receiving identification. Alternately, you may even want to have new users show up in person with proof of age. This is a very sensitive theme, and special precautions must be taken.

"Mods" (short for modifications or modules) will be available to further customize your BBS. These can generally be found on the BBS program author's board and on BBSes running the same software as you. Some mods will even work on multiple BBS types. Among more-prevalent types of mods are the "today in history" mod, which informs users what hap-

pened on each particular day throughout past years; "top ten," which displays a list of the top ten and worst ten users in the categories of upload/download and post-to-call ratios; and "news flash," which allows the sysop to input bulletins and nice-to-know information on simulated teletype paper rendered in ANSI. Mods have also been developed to display BBS hourly-usage charts (helpful for those who complain that they can't get on because the BBS is always busy) and special birthday messages, often accompanied by a "present" of on-line time or credits.

Different mods will be available dependent on your particular BBS type. WWIV, which provides the program's C source code with registration, provides the most potential for modification. Literally hundreds of subroutines have been developed by WWIV sysops for you to download, insert the source code and recompile.

You'll also want to decide whether to settle for message-base activity on a local scale or become a member of a national network. Fidonet has become the largest of these, though such BBS packages as VBBS and WWIV have their own networks as well. Fidonet has literally thousands of subs (known in the Fido community as "echoes") from which to choose. They range from the helpful, such as the numerous physical-disability and mental-health support groups, to hardware and software technical assistance, to the downright bizarre, such as the bartering, ferret and zymurgy (homebrewed beer) subs.

To become a member of Fidonet, you must first obtain a front-end mailer for your BBS type. This allows the BBS to call and receive calls from other front-end programs during net-

You might be wondering about the kinds of on-line games available for installation on your BBS. This very much depends on your particular BBS software, as many games are designed for one specific system. However, the more-popular doors are available for different BBSes, as are interfaces that convert the data in your board's userfile to a different board's format. Following are descriptions of some of the more-universal doors and door types.

• **Tradewars.** You'll find far more boards that include this in their door directories than those that don't. This highly-acclaimed game not only includes instructions on setup for multiple BBS programs, it has even been ported to different computer types. Within, users start out in command of a fleet of fighter ships and explore the huge galaxy sector by sector. As they grow in power, they can become ruthless mercenaries, stalking their fellow users and destroying their ships; galactic overlords, conquering planets and taxing them dry; peaceful traders, buying goods in one port and selling them at another for a profit; or any combination therein. In addition to other users, players must also watch out for the Ferrengi, a race of hostile aliens who are intent on destroying anything in their path. Players can also form corporations with their fellow travelers for a strength-in-numbers approach. This door may take a few hours to install, as it randomly generates an entire universe, but you're guaranteed to get many active players with it.

• **Global War.** This is another very-popular door that also includes instructions for setting up on different BBS types. It's basically the board game *Risk*, with a few added features. Users get points for defeating other players and winning games and advance in rank at set increments of points. Points are lost by being defeated, possibly resulting in a demotion. Games can be set up by the players for team or individual play, with user names shown or hidden,

and limited or unlimited fortifications. Once a game has the chosen number of players, it begins. An accompanying term program, *GWTerm*, can be put in your file base for users to download for enhanced graphics and mouse support.

• **The Pit.** This medieval combat game can be run on most BBS setups. It's the first game to include ANSI sound support, in addition to graphics (though the sound is, at best, rudimentary). Players arm themselves with weapons, don armor and take on monsters, humans and other users in the arena. Players get experience for defeating opponents in the Pit and gain more power as they advance levels. Like *Global War*, there's a user interface that allows an EGA, rather than ANSI, display.

• **Operation Overkill II.** This is a game of post-holocaust exploration in an irradiated world. All players begin in a central base, selecting one of three humanoid races. In the base, they can gamble with other players in such games as cockroach races and meat darts, outfit themselves with equipment and weapons and exit into the wastelands to explore. Outside the compound, users fight an array of mutants and gain money and equipment along the way. Once they've accumulated enough crystals (the game's equivalent of cash), they can establish their own bases of operation. This one is designed to run on multiple BBS types as well.

• **Empire.** This game of tyranny is set in the dark ages. Players begin with a set amount of land and must be the first to get a certain amount of acreage to become the emperor. Users gain land by warring with fellow users or purchasing acres from neighboring countries. Gold is accumulated by investing in such items as mills and stores, and land is protected by hiring nobles and soldiers (each noble can command a set number of soldiers). The serfs of the land harvest grain each year, a portion of which must be given back to the people, the remainder of which can be sold. If you can't

find a version of *Empire* for your BBS type, look for one of its variations. *Space Empire* adds a stellar theme in which you must gain planets, rather than acres. A more tongue-in-cheek version has been developed, *DeWayne Suggs*, in which you operate a redneck-esque bootlegging operation.

• **Trivia.** A variety of trivia doors is available for all BBS types. Some allow sysops to create their own question files, while others feature a number of pre-designed files for use with the door. These normally don't maintain a user's interest for an extended period, but they provide a nice break from the standard "kill-or-be-killed" games.

• **Chess.** A number of on-line chess games have been developed for different BBSes. You probably won't get a great deal of participation out of this door, as only one move may be made by each user at a time. After their turn, players must wait until their opponents move to get their turns again. This being the case, it can literally take months to complete a game of on-line chess.

• **Gambling Games.** From blackjack to roulette to craps, there are gambling games of one type or another for all BBS types. While some give the player a starting amount of money, others can be configured to allow users to gamble credits or on-line time.

Door Prizes

If your doors area is stagnating, you'll be able to boost participation by offering prizes to users who attain a certain level or score in a month's time. Talk to managers of local restaurants, computer stores, and the like. Most will be willing to provide merchandise in exchange for on-line advertisement. As most doors include a message that can be edited by the sysop, put in a "sponsored by" blurb for the establishment that provided the prize for a particular door. Alternately, if you run a system that uses credits, you can offer these as a reward instead.

work mail time (usually an hour in the early morning) you'll set. You'll also need to find a mail-tosser, which converts posts in your message base to Fido format and assembles incoming messages into your message base. Once these are operational, you'll

need to speak with your local Fidonet coordinator (you can find out who this is by talking to other sysops in your area who are members of Fidonet). He'll assign you a Fido address and ensure that you're correctly sending and receiving network mail. If you

don't have a local coordinator, you'll need to speak with the regional coordinator for your area. This will result in a long-distance call nightly to receive your Fido mail, but it doesn't take long to transfer the package.

A master list of Fidonet echoes will

be available on your local net coordinator's BBS for you to select subs you want to carry. The list is huge—more than a megabyte decompressed. So expect to spend a bit of time looking through it. Once you've gone through the list, you need to let your local coordinator know which ones you've designated. If he doesn't support some of the particular subs you'd like to carry, he'll contact the regional coordinator, then the zone and international coordinators, until he finds the echoes you want.

The same basic principles apply to

the many other networks available. It may require a little more research to find your nearest coordinator, and you can expect to pay long-distance fees if you go with a network that doesn't have a coordinator in your local calling area. However, the rewards can be great in introducing something unique to your area.

Another item you'll want to consider is the availability of an off-line mail reader if you're installing a network. As many network echoes are very active, this can swallow up a large amount of users' on-line time

while subscribers read all new messages, possibly deterring some of them from participating. An off-line mail reader assembles new messages on-line into a packet the user can download, read off-line and upload any replies to the BBS. The QWK standard has been established among off-line mail readers to provide compatibility among the multitude of computer types. Users simply need to find a QWK-compatible mail reader for their computer type, such as Silver Express or SLMR (Silly Little Message Reader, believe it or not).

If your hardware and BBS type support it, you may want to consider running a multi-line BBS. Though system requirements differ from package to package, you'll want at least 1M of RAM for every two to three lines. Speed is a major factor as well. Though some BBS software compensates for more lines, I recommend running no more than four lines on 20 MHz, six lines on 25 MHz, eight lines on 33 MHz and 16 lines on 40 MHz. This should allow you to comfortably run a multitasking environment, if your BBS type permits it. If you do choose to multitask, the least-expensive setup is *Windows*, the fastest is *Desqview* and the most-reliable is *OS/2*.

You must also decide how you're going to install multiple modems. Though they're available, multi-line modems are expensive, and at the relentless pace technology is moving, in but a few years their speed will be dwarfed. A more cost-effective solution for running just a few lines is to purchase the modems individually. Modems that operate at 14,400 bps have dropped to under \$200, forcing the price of 9,600-bps modems even lower, and there are still enough 2,400 bps users out there to support a low-speed node. A setup of two or three 14,400-bps modems, two 9,600-bps modems and one or two 2,400-bps modems would work ideally. As technology starts to pass you by, you could replace the 2,400-bps modems with the latest model.

Eventually, though, you'll run out of room for expansion on your computer. A few companies make expansion cards that have several serial connections on each card. The Digi-board, which retails for around \$400, includes eight ports per card. STB has

Looking to challenge your building skills?

Want to explore beyond Amateur communications?

Well here's the publication for YOU!

COMMUNICATIONS QUARTERLY, the journal of communications technology. You are invited to become part of an elite group of Radio Amateurs and technical professionals as a subscriber. Circulation will be strictly limited.

This new quarterly publication has been put together with YOU in mind. Articles will explore, in-depth, areas that no Amateur Magazine is currently covering.

State-of-the-art electronics like direct synthesis, digital signal processing, and computer control are fully investigated and explained so that you can take advantage of these new technologies. COMMUNICATIONS QUARTERLY articles cover high speed data communications, the latest in antennas using computer designed models, plus much more. Articles examine many areas of professional electronics in a way that trade publications can't. Insights into areas that are only whispered about are normal fare. A major effort is made to show how applications can be translated into Amateur Radio operations.

Each quarterly has approximately 100 pages of technical material; advertising is limited. Articles flow from page to page, without the interruption of ads placed in the middle. The open layout accentuates each author's work and lets you make notes, calculations, or comments for later reference. Graphs, photos, computer program listings, and charts are presented in an easy-to-use format. COMMUNICATIONS QUARTERLY is printed on a high-quality stock and "perfect bound" (square backed). It is such a valuable resource, you'll want to file each copy away in your technical archives for future reference. In fact, over time you'll find much of what is presented in COMMUNICATIONS QUARTERLY will become the standard in the Amateur and professional communications field.

Act now. Subscribe today!

1 year—\$29.95 Foreign—1 year \$39.95 Foreign Air Mail—1 year \$ 60.00
 2 years 56.95 2 years 76.95 2 years 118.95

Name _____ Call _____

Address _____

City _____ State _____ Zip _____

Check Money Order MasterCard VISA AMEX

Card No. _____ Expires _____

Signature _____

Mail to: CQ Communications, Inc.
 76 North Broadway, Hicksville, NY 11801
 Phone: 516-681-2922/ FAX: 516-681-2926

a four-port expansion card for around \$100. Be forewarned that not all software will work correctly with an expansion card, however. Even though the BBS runs fine, doors might not. The latter card seems to provide less compatibility problems than the former.

If you opt for the same modem speed throughout all lines, you may want the telephone service feature that allows users to call just one number to cycle through all lines until an open one is found. If you've set up lower-speed nodes, you'll want to keep the numbers separate so as not to have a 2,400-bps user tying up a 14,400-bps line. If you have only two or three lines, you may still want to leave the numbers separate to save a little money on your phone bill, though monthly charges for the cycling phone lines run under a dollar.

A very popular feature among multi-line BBSes is teleconference, an arena in which users can carry on a conversation via their modems. Some BBSes are even moving in the direction of national teleconference networks (Galacticomm's Chatlink has been active for some time now). You must monitor your teleconference en-

vironment, though. Sexual harassment, unfortunately, is very much at large in the BBS community. This is the primary reason why the ratio of men to women is so high therein. Similarly, you must ensure that conversations are kept family-oriented when minors are present in teleconference.

Your hard-drive space will determine what sort of file support you'll want to include. A few years ago, I ran a BBS on a 40M hard drive and found myself constantly dumping files to floppy for off-line storage. As you can imagine, this gets to be quite a hassle. 100M to 200M is a decent amount of space for file support, though the more storage you have, the more file support you'll be able to provide. Depending on the area in which you live, you may want to include files for multiple computer types (if there's a demand for it) to attract more users.

CD-ROM has become somewhat of a standard in telecommunications as well. The drive itself costs around \$400, and many companies now offer discs full of PD and shareware files pre-compressed in the price range of \$15 to \$50—not a bad investment for 650M of downloads. If you opt to add

CD-ROM to your BBS, you'll most likely have to install a special software interface for your BBS to recognize the files and arrange them in a special format. Mods are available for all BBS types that don't include built-in CD-ROM support so users can access the CD-ROM as either a door or a special menu command.

One disadvantage to CD-ROM is that, like anything computer-related, software becomes obsolete. CD-ROM doesn't give you the option to update the files, though companies will no doubt seize the opportunity to provide upgrades in exchange for old discs and a small fee. Another disadvantage is that you still need to maintain a file section for users to upload to. You need to check and be sure that files uploaded aren't the same as those on CD-ROM, and users will have to check both the file area and the CD-ROM when looking for a specific type of file.

You may also want to consider setting up a RIPscript BBS (see Spotlight on BBS Software box). RIP (short for Remote Imaging Protocol) is a terminal emulation that displays digitized pictures and acts as a graphical user

ELC31 Microcontroller Board

The lowest cost 8031 controller intelligence

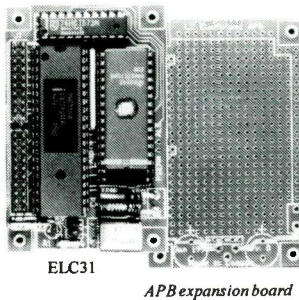

- 8031AH CPU
- 11.0592 MHz clock
- Socket for 16K EPROM or 32K Flash
- 16 I/O lines
- Size 1.9x3.0 inches
- Prototype piggy back expansion board

ELC31 board, printed manual and APB expansion board US\$33.00

Develop your own programs on any 8051 development board including our EMC32 microcontroller board.

We also offer a selection of Application Projects:

- A 12 Bit Serial Analog to Digital Converter and a Six Digit Serial Numerical Display
- An Infrared Remote Receiver with 13 Key Inputs
- A Digital 0-999 Seconds Timer with Optical Encoder Input and 3 Digit Display
- A Digital Combination Lock
- Morse Code Generator & Iambic Keyer
- A 24 Hour Digital Clock with Settable Start/Stop Timer

Please ask for a complete list of our Application Projects!

Each Application Project Package includes a printed manual, source code files on 3.5" disk and pre-programmed EPROM. US\$13.75 each

Ordering:
Send cheque or money order. (Add \$6.00 for postage)



L.S. ELECTRONIC SYSTEMS DESIGN
2280 Camilla Rd. - Mississauga, ON L5A 2J8
Canada Ph.: (905) 277 4893 Fax: (905) 277 0047

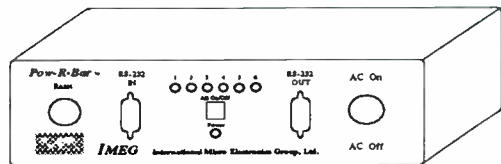

Pow-R-Bar™

\$149⁹⁵ (msrp)

is an intelligent, programmable, six outlet power strip which connects to a computer's serial port and operates via RS-232 protocol. Pow-R-Bar™ is the perfect solution for controlling multiple AC outlets.

With Pow-R-Bar™ connected to a computer, each of the six AC outlets on the back of Pow-R-Bar™ can be turned on/off from the computer, by typing in a simple command or through custom programming.

Up to 26 Pow-R-Bar™s can be daisy chained together providing up to 156 outlets individually controllable from a single computer.



IMEG

International
Micro Electronics
Group, Ltd.

155 W. Tiverton Lexington, Kentucky 40503
P.O. Box 25007 Lexington, Kentucky 40524
800-274-8699 606-271-0017 Fax: 606-245-1798

A myriad of different BBS packages is available on the market. No one particular program can be recommended for everyone. The single-line enthusiast who is running a free system will have different wants and needs than someone who is setting up a BBS for his company's email and reports or a multi-line subscription service. Below are some of the programs that are available on the commercial and shareware markets.

Commercial

Commercial systems are aimed toward those who are setting up a multi-line charge system or are operating on a corporate budget.

Documentation is normally printed in book form, and program updates are less frequent as a result. Among the systems you'll find in the market place are:

- **Synchronet**, marketed by Digital Dynamics, is first and foremost a RIPscrip BBS. It requires a 486/50-MHz or faster computer to run 10 high-speed nodes, but it has a built-in I/O Executive that optimizes BBS speed if running under an OS/2 or *Desqview* environment. Included in the package are QWK off-line mail reader support, Fido support and 900 and 976 area-code billing, in addition to the standard time/credit charge methods. A software development kit has also

been added, as well as a sysop-configurable artificial-intelligence chat module.

For enhanced security, the sysop can opt for BBS-assigned passwords, rather than allowing users to choose their own, with the option of forced periodic password changes. Ninety-nine teleconference channels, unlimited external file-transfer protocols and up to 500 doors can be set up, with a different credit charge per door, if desired. Patches for doors designed to run on different BBS types are integrated into the software.

If you're planning to set up less than 10 lines and want the most for your money, this seems to be the one for you. The two-node license is \$99, four-node is \$149, 16-node is \$199, and 250-node is \$399. For questions, call 714-529-6328, or call the BBS at 714-529-9525 (2,400 bps) or 714-529-5313 (9,600+ bps).

- **The Bread Board System (TBBS)**, available from ESoft, is the oldest commercial BBS software package. It's capable of running up to 16 nodes on only 2M of RAM, and the degradation in response time between eight and 16 lines is only about 10%. Passwords are case-sensitive for added security. The package includes a utility to edit the program, a menu template system for ease in customizing menus, multilingual support, and configurable branching questionnaires

with multiple user-input formats. *TBBS* is easily upgraded to additional lines, with the full retail price of the old system refunded in trade for the new. Sysop Option Module permits DOS emulation and a memory-allocation display for \$99.95 The Integrated Mail System allows Fido support and is priced at \$149. A system that permits a node to be used for a term program or as a patch to another computer system, Interchange, is also priced at \$149. QWK support can be added for \$99.95. A recently-developed RIP support module is available for \$25. The Data Base System, which allows you to use *dBASE III* files and applications on-line, is available for two nodes at \$395, 16 nodes at \$995, 32 nodes at \$1795, and 64 nodes at \$2395.

Since doors must be run from a second computer for optimum performance, this appears to be best suited to a business environment. Hayes, Microsoft, WordStar, the Small Business Administration and the IRS apparently feel the same way, as they use *TBBS* for their telecommunication needs. Orders can be placed at by calling 303-699-6565. The main package lists for \$295 for two nodes, \$395 for 16 nodes, \$1,495 for 32 nodes and \$1,995 for 64 nodes. The support BBS number is 303-699-8222.

- **Oracomm** Though this BBS package, released by Surf Computer Service, doesn't have a utility to edit the

interface through which users can select menu options with their mouse rather than the keyboard. Though only a handful of doors are available at present that take advantage of enhanced graphical capabilities, those that are out are very impressive. Programs are available, such as *RIPdraw*, for you to custom-design your own RIP screens.

Though some of the pictures are stored in the user's terminal program to be displayed when the appropriate signal is sent by the BBS, many must be sent through the modem. Because these files are large, you'll want to use RIPscrip only if you're running a high-speed modem. Be sure to make a term program available in your downloads area that supports RIP, such as *RIPTerm* or *QModem*. At present, there isn't an abundance of term programs that support it, though the fa-

miliar names, such as Telemate, are working to get compatibility installed.

People Factor

By and large, the most problems you'll probably have are with your users. People are spontaneous and unpredictable and will occasionally astound you with something out of the blue. There is also a large number of "hackers" out there whose malicious intent is to get an account on your system and wreak havoc. They may even set up multiple accounts using bogus information. And in a different category altogether, there are those who have just begun the telecommunications hobby and may cause problems unintentionally simply because they know no better.

The latter users, innocently gaining knowledge in modem-ing while

sometimes leaving a swath of destruction in their path, are by far the easiest with which to deal. Remember that these folks won't be novices forever. The more the experience they get, the more they'll learn, and they'll be blazing their way around your system like a pro in no time. Fortunately, there are a few things you can do to help ease the transition. The first and foremost is to simply have patience. It may be tempting to pull them into chat mode as they sit at the main menu, unsure of where to go next, but don't. Let them find their way around on their own. You, too, were once new to the wide world of telecommunications, and sysops may have gotten a chuckle out of some of your antics. But if they're having serious problems, help them out. Chances are, you can remember at least one sysop who aided you in your quest for knowl-

program file, it's unique in that Surf Computer's own programmers will make any changes to the source code for a modest fee. An off-line mail reader, screen saver, memory test and multitasker are provided in the main package. It hosts 32,000 sysop-definable security levels, a general-purpose database that can convert *dBASE* files and a matchmaking system. Foreign-language support is available for French, German, Italian and Spanish.

Though it's capable of running 32 nodes on a 386/25-MHz computer with 2M of RAM, doors must be run on a separate computer. The one-node system is \$90, two-node system is \$290, five-node system is \$390, nine-node system is \$490, 16-node system is \$690 and 32-node system is \$990. For more information, call 612-894-558 (voice) or 612-894-5879 (BBS).

• **PCBoard** from Clark Development, which also includes foreign-language support, is used in such corporate atmospheres as WordPerfect, VISA, IBM, NBC and the US Army, US Air Force and US Navy, to name a few. It features built-in RIP, QWK and CD-ROM support, as well as an automatic modem-configuration utility. *PCBoard* also touts more third-party door and module support than any other BBS type on the market.

The *PCBoard Programming Language*, available for \$80, allows you to edit the source code with your own

modifications. The *PCBoard C/C++ Door Development Toolkit* assists you in creating your own doors. And for \$100, you can purchase the *PCBoard* multi-line support software that optimizes multitasking.

With the multitude of add-ons, *PCBoard* lends itself as easily to personal or business needs. The two-line version costs \$170, 10-line version costs \$340, 100-line version costs \$680, 250-line costs \$1,000 and 1,000-line version costs \$2,500. Clark Development's voice number is 801-261-1686, and its modem line number is 801-261-8976.

• **Wildcat**, RIP-compatible as of May, is offered by Mustang Software, Inc. As of this writing, there are more than 22,000 registered users of WBBS, including the US Postal Service for its Delivery Activity Report system, used to track time-sensitive material. According to the literature, it's easy to install, taking one hour from opening the package to coming on-line. It features comprehensive on-line help, 1,000 security levels and up to 65,000 internal/external events.

The *PRO! Series Utilities* package costs \$99 and includes enhanced user-database, message-base and file-base utilities. Also in this package is CATEYE, a system for monitoring multi-line systems and alerting the sysop when pre-defined key events occur, such as logons, chat pages and

downloads. It also comes with a fax module for users to send text and .PLX files directly to a fax machine, and a bar-charting system to track baud rates, uploads and downloads, calls per day and calls per hour.

At \$129 for one node, \$249 for 10 nodes and \$499 for 250 nodes, *Wildcat* is a very-affordable candidate for either a business or personal BBS. MSI can be reached at 805-395-0223, or call the company's BBS at 805-395-0650.

• **Major BBS** from Galacticomm has become prevalent in the worlds of both independently-owned subscription boards and corporate systems. It hosts RIP graphics and CD-ROM and QWK support. Security levels are virtually unlimited; subsystems—such as the message base and email—can be assigned a "lock," and certain users can be given keys for their "keyring" profile. On a dedicated system, using the *Major BBS's* built-in multitasking capabilities, a sysop can run up to 100 high-speed lines on a 486/50-MHz computer with 8M of RAM. However, it's not designed to run in a multitasking environment. Under OS/2, it's capable of running only about eight lines. A number of add-on modules are available from Galacticomm that, upon installing them, incorporate themselves into the program through *Major BBS's* open architecture for optimum speed. There's no delay between se-

edge, and you no doubt frequented that bulletin board as a result.

Make use of your BBS's capabilities. Most programs have a new-user bulletin that's automatically displayed during the initial logon sequence. Use this to let users know what help is available to them, where they can find it and what hours you're available for chatting. If your BBS system includes user documentation, make it available for downloading. If it's small enough, you may even want to put it in your text files or bulletins menu. Most importantly, conspicuously post your BBS rules and standards of conduct. You can't expect someone to follow the rules when he doesn't even know what they are.

The user with a more-spiteful nature, can pose more of a problem. I'll further break this category down into three sub-categories: John Does, Rab-

blerousers and Demolitionists. John Does prefer not to use valid information in their user registry. They may invent a name, address or telephone number to maintain total anonymity on your system. The fact that they're coming into your home via phone line and using your computer eludes them. They're convinced that their user information will be used against them. Though your policy on security may be less-stringent than mine, I don't allow these users on-line whatsoever. If they'd like me to trust them to use the system I've paid for and labored to set up, they must reciprocate and be honest with me.

The easiest way to hinder these secretive individuals is by making use of a call-back verifier. Available either built-in or as a modification for almost all BBS types, a CBV restricts a user to a low access level until he

allows your computer to call his.

Once call-back verification has succeeded, the user gains a higher access level. If one isn't available for your system, or if you're simply skeptical about a user's identity, voice validation can be used as well. I've done this in the past, and though I was initially afraid that it would be an unwelcome intrusion, I discovered that instead it gave me an opportunity to introduce myself to the user and answer in person any questions he or she may have. Finally, keep a telephone book handy when you're reviewing new accounts. More often than not, the information will be right there in black-and-white to compare with what the user has entered. Unfortunately, John Does often use false information as a cover for other nasty activities.

Rabblers use the anonymity

lecting a module from the menu and its execution. German- and Spanish-language files cost \$249 each, though multilingual support is integrated into the program for the sysop to enter his own data. A database system can be purchased for \$495. For \$249 you can add a shopping mall through which users can order select items. It will soon even support credit-card validation and graphical representation of merchandise. An Internet gateway is in the testing stages and will be available for \$249 upon its release. A search-and-retrieve feature can be added for \$199 to allow users to manage text, such as in the case of an on-line encyclopedia. For \$249, a Fax On-Line, allows users to send text to a fax machine or fax documents to the BBS. Another \$199 module allows users to call other boards through *Major BBS*. The sysop can charge either for long-distance fees or through a packet-switching network. Galacticomm also has a \$249 entertainment package that includes a number of on-line games. Doors for other systems can be run as well, but this requires connection to a separate computer. There's a firm base of third-party support in the areas of on-line games, language files and Fido support. Third-party support modules are available from \$25 to upwards of \$500, depending on what sort of features you're looking for.

Though *Major BBS* will run with standard hardware, such as Digiboard,

Galacticomm offers a 16-port expansion chassis for \$1,695. An eight-port expansion board is also available for \$575. The two-user license costs \$259, and every additional six-node packet is priced at \$249. With the variety of add-on modules, *Major BBS* works beautifully as either a personal or business system. Galacticomm can be reached by calling 305-583-5990 (voice) or 305-583-7808 (BBS).

Shareware

Though you can save a considerable amount of money by going with a shareware BBS, you might be sacrificing some support. Whereas the commercial systems have voice numbers to call, rarely will you get the same from a shareware package. However, you'll receive the phone numbers for the author's BBS and volunteer support boards through which not only will you be able to request technical assistance via email, but you'll be able to download the newest versions of the BBS as they become available and a number of doors and mods compatible with the BBS type.

An advantage of shareware systems is that they're ubiquitous. While some commercial companies offer to mail a demo version of their software, shareware programs are as near as your local BBS and include full documentation. You can download and examine as many different types as you like. Too, unregistered shareware

packages tend to be less limited than demo copies of commercial software. Following are descriptions of just a few of the various systems available in the IBM world:

- *WWIV (World War IV)*, written by Wayne Bell, has become somewhat of a standard in the BBS community. There can be little doubt at least one *WWIV* BBS is running in your area. It's one of the most-customizable. The C++ source code is available upon registering, and a vast number of mods have been written to enhance the code. Included in the program is partial support for *WWIVNet*, a network similar to Fidonet. License for use of the external patch is included in the board's registration fee, and it can be downloaded from any *WWIV* support BBS.

WWIV is configured through its very thorough INIT utility. Sysops can establish a post-to-call ratio to inhibit downloading for those who don't meet the required limit, choose a line-by-line or split-screen chat mode, configure upload events (such as an automatic virus scanner and ZIP comments to new uploads) and install any external full-screen editor. Sysops can also set a user's access level to display the subop menu for individual message base subs only.

There are a sizable number of *WWIV*-specific doors, and interfaces are available to run doors designed for other system types. Users are required to enter the last four digits of

they've been provided to run rampant on the board. They'll incite riots in the message bases, attacking other users (aka "flaming"), using profanity in their messages and committing sexual harassment. Though usually futile, I give these users one warning to clean up their act. If you have a message base that tends to go a little crazy from time to time, the user in question may simply have misinterpreted the mood. However, most of my warnings are returned with a note regarding my origin, sexual preference and/or where I can relocate my BBS package.

Demolitionists, usually under the guise of a John Doe as well, are undoubtedly the worst kind of user—and the most dangerous. They seek their thrills by crashing BBSes and usually have the in-depth computer knowledge to do it. Though most BBS setups have a high degree of

built-in security, the Demolitionist will often find a way around it. This type of user is also notorious for uploading viren and virus-laden archives to your system. If you've never been hit with a virus, you might be skeptical when listening to the horror stories others tell about what happens to an infected computer. Believe them—it's true. A virus will wipe out your hard drive quicker than you can say Michelangelo.

You can, however, protect yourself by using a virus scanner, such as those released by McAfee & Associates. You should be able to set up programs to run at a set time of day by the BBS (known as "events"). Set up a virus scanner as an event to run at least once per day. Some BBS programs even feature routines that will un-archive new uploads, test them for viren and re-archive them while the

user is still on-line. If this option is available in your package or as a mod, by all means, enable it.

What can be done about these computer vandals? In addition to computer hacking being a federal offense, it also constitutes a form of telephone harassment. Let users know that you're not afraid to prosecute for this offense should you feel so inclined. Just because you've opened your computer to the public, this doesn't mean you've waived your rights. Many modems now feature caller identification, which will display the number from which the user is calling (call your local phone company first to ensure this service is available in your area). Many BBSes also feature some sort of "baduser" file in which you can enter fields, such as handles or phone numbers, that the BBS will automatically reject if entered by the user.

their telephone number after their password when logging on for enhanced security. Each user can configure three macros to use on-line; Ctrl-A, Ctrl-D and Ctrl-F. A "gold" system is recognized. Though not used in the standard program, modifications are available to reward gold for posts and uploads and taken away for downloads. *WWIV* can even be modified to use gold for on-line games, such as the logoff lottery.

Registration for a two-node license is \$80; additional licenses are available on a graduated scale. Since multi-line support is new to *WWIV*, at present, only a rudimentary internode chat is included in the package, though an external chat module can be downloaded and added to the program. *WWIV* doesn't support RIP at present, but this is coming soon. If you can't find *WWIV* in your area, call Mr. Bell's BBS at 310-798-9993.

• **VBBS**, designed by Roland De Graaf, incorporates a self-contained system with ease in installation. According to sales and marketing manager Richard Shell, the average sysop can be up and going in less than five minutes. The standard package includes network interfaces for Fido, UUCP, *WWIV*, and WK-type networks, including Virtualnet, *VBBS*'s own network. An IP-compatible version is now in beta test. Users can interact on a multi-line system through teleconference and real-time on-line games. It's easily modified through its

built-in VScript language. More than 800 utilities, scripts and source code modifications are available for *VBBS*, and the program is capable of converting user data to run virtually any BBS's doors. Both DOS and an OS/2 versions of the software are available.

Eight-line registration costs \$129, 16-line registration costs \$199, 32-line registration costs \$275 and 64-line registration costs \$399. The source code (DOS version only) and lifetime upgrades are provided upon registering. Direct any questions to the author's BBS at 616-399-4818.

• **Spitfire BBS**, according to its programmer, Mike Woltz, eliminates all the unnecessary flash and cuts to what's important: a full-featured, fast, reliable BBS system that's simple to install and is virtually maintenance-free. It includes WK and support for nearly every type of network. The author is currently at work on an interface to the Internet. The package also includes CD-ROM and RIP support. Though there are doors specifically designed for *SFBBS*, it's capable of running other door types as well. A very basic internode chat feature is available for multi-line systems, but no plans exist to make it more elaborate.

Only one license is available. For \$85 you receive support for 255 nodes and free upgrades. The source board can be reached at 515-225-8496.

• **Maximus**, the creation of Canadian author Scott Dudly, includes complete control for personalization in prompts,

linked menus and questionnaires. A 386DX or better computer with at least 8M of RAM running an OS/2 environment is required to set up more than two lines. Configuration options are vast. *Maximus* takes quite a bit of time to set up exactly the way you want it. The configuration file even lets the sysop to select one of the included tunes to play as a chat page!

Though no data files are available yet, *Maximus* includes a foreign-language compiler for multilingual support. It also provides built-in Fido, QWK and RIP support (the latter on the remote screen only). It's internally capable of generating files to run doors for nearly any BBS type.

Non-commercial use (charging only for the board's operation, not to make a profit) is free. Commercial licenses are available on a sliding rate scale. Scott Dudly's BBS can be reached at 613-389-8315. Be forewarned that this is an Ontario number. So be sure to call during non-prime hours.

• **TriBBS** from Mark Goodman doesn't include Fido and QWK support, but the mods to obtain such support so are available free of charge. It can support up to 255 lines, with node-to-node chat and group teleconference. It also includes internal support for any BBS's door type. *TriBBS* supports RIP graphics and has a built-in multitasker for multi-line systems. Registration is a flat fee of \$75 for the full license. Mark Goodman's BBS number is 207-941-0805.

Deletion is always an option, but if you feel that a user is capable of reforming, you may want to give the deviant another chance. Lower his access level, at least temporarily, and place him on probation. Make him aware that calling a BBS is a privilege, not a right, and if it wasn't for the small-scale BBSes, the only places he'd be calling with his modem are the major on-line services, some of which charge a good deal of money for access and use. Make him own up to what he's done. If he was causing problems in the message base, have him post a public apology there. If he's been intentionally crashing the board, take a statement from him and post it in the logon announcements as an explanation as to why other users haven't been able to get on-line. Be sure to make the punishment fit the crime.

Now the good news. These three

problem types normally constitute well under 5% of those who will call. The vast majority of users you encounter will be cooperative, and many will offer to help out in any capacity they can. You'll never be at a loss for volunteers when you request someone to moderate a message base sub or file area, and you'll find that many users will even propose new subs and offer to moderate them. A good deal of users will also leap to your defense when someone is getting out of hand in the message base, reiterating your rules to those who go astray.

Software Factor

When installing a new BBS, you'll almost certainly run into at least one problem that requires a few hours of research as to the source. It's frustrating and often irritating enough to keep

you at it well into the wee hours of the morning (much to the chagrin of your significant other). It's a remarkable sense of triumph, however, to overcome a hurdle in your path, and, oddly enough, it almost makes it worth the time you've invested. Once in a while, though, you'll run into a problem that has you stumped. You've worked at it until your patience level has redlined and you've become so focused on the problem that you're incapable of seeing anything but the problem. You may need a fresh perspective or the assistance of an expert. The following details some of your options.

Your most-valuable resource is the program's documentation. Familiarize yourself with it, and refer back to it frequently. Sections that may not make sense at one point may all of a sudden be clear to you with a little ex-

Glossary of Computer Communication Terms

This glossary serves as a reference for those of you who aren't familiar with certain concepts. It includes definitions to most telecommunications terms and phrases used throughout this article. Terms given in parentheses are alternatives you may read or hear for the terms shown in boldface.

Access Level (Security Level) a category into which users are placed that controls what commands they have available and how much time they can use per day on a BBS.

Account a user's membership.

American National Standards Institute, commonly abbreviated ANSI, this is terminal emulation that includes color and special characters.

Archived (Compressed) is a descriptor that indicates all of a program's files have been shrunk together into one master file.

Beta Tests are diagnostics measures taken to ensure that a program is working fine. Beta-testing involves two or more parties.

Bits Per Second (bps) is a measurement of modem speed.

Bulletin Board System (Board, System) often abbreviated BBS, this is computer program that can be connected via modem by other computer users.

Bulletins are news items entered by the sysop that display upon logging onto a BBS.

Call-Back Verifier, commonly abbreviated CBV, this is program or subroutine, used by the BBS for security purposes to ensure that a user has entered a correct telephone number in the registry.

CD-ROM stands for compact disc read-only memory and describes a data/program disk used by a computer, as opposed to music and video CDs. CD-ROM discs can only be read from, not written to.

Chat Mode is a BBS feature in which a user can speak with the sysop (or another user). In chat mode, each character typed is instantaneously displayed on both terminals.

Chat Page is the alarm sent by the BBS to alert the sysop that user wishes to speak with him.

Communications Driver is a program used to monitor modem connection.

Cosysop (Co-System Operator) is one who assists the system operator in running a BBS. A cosysop normally has more duties than a subop.

Crash (Freeze-Up, Lockup) signifies a software error causing the BBS to cease operation.

Credits are units of BBS currency that allow users to perform certain activities.

Demo Copy is an unregistered shareware program, usually more limited in its features than the registered version.

Documentation refers to a program's instructions.

Doors are programs (normally games) that execute while a user is connected to a BBS.

DOS Emulation is a BBS feature that permits the computer's operating system commands to be entered.

Download, commonly abbreviated DL, refers to a user copying a file from the BBS to his computer via modem.

Echoes are networked message base subs.

Electronic Mail (email) is a private message sent from one user to another.

Events are programs set up to run at certain times by the BBS.

External Programs are programs that are separate from the BBS program.

Feedback is email sent to a BBS's sysop.

File Base is an area of programs available for users to download.

File Transfer Protocol refers to communication used by computers when

transmitting a file through modem.

Flaming is a term that signifies one user who is attacking another in the message base.

Front-End Mailer is a program that allows a BBS to send and receive network information.

Graphical User Interface, commonly abbreviated GUI, is a program that allows a user to select icons with his mouse, rather than typing them.

Hacker describes a person who uses false information on a BBS or uses the account of another to do damage to the computer.

High-Speed Modem is a modem that operates at 9,600 bps or faster.

Interface (Patch) is a program that allows a BBS to use another program not designed for use with the BBS.

Internet is a huge national network with file, email and message-base features.

Internet Gateway is an interface that allows a BBS to connect to internet.

Internode is an activity that takes place on more than one BBS line.

Local Mode refers to the BBS being used on the same computer as the one on which it's run.

Macroinstruction (Macro) is a configurable string executed simply by pressing a key combination.

Mail Tosser, used in conjunction with a front-end mailer, sorts incoming network messages into the BBS's message base format, inserts them into the appropriate place and arranges message-base entries into network format.

Maintenance is a set of tasks performed by the sysop to keep the BBS operational.

Memory Allocation refers to areas of a computer's memory that are partitioned so more than one program can run at a time.

Message Base is an area in which users can enter messages.

perience. Keep in mind that the majority of BBS documentation isn't written by writers, but programmers. That vital bit of information you need to solve your latest dilemma might be documented but not included in the index or table of contents.

Another step you'll want to take is to ensure that your BBS software is compatible with other programs you may have running in the background. One sysop I know traced problems he

was having with his message base to a certain hard drive space enhancer (we later found an advisory against using that particular utility with the BBS in the program's documentation). Another who was experiencing lockups pinpointed it to be his multitasking package.

When you've exhausted your list of possibilities and need to look elsewhere for help, try the local area before running up your phone bill with

calls to the author's BBS. If someone in your area is running the same BBS program, he may have encountered the same problem in the past. An added benefit is that he may even be willing to come to your house and assist you in-person.

Support boards are also a viable alternative. Generally, the author's BBS is quite busy and you may have to wait a couple of days for a response to your message. If program documenta-

Modem, which stands for modulator/demodulator, is an electronic peripheral device used to communicate with another computer via telephone lines. A modem modulates data, or encodes it into an audible tone; the second modem demodulates the information, or converts it back into binary computer data.

Modifications (Modules), commonly abbreviated mods, are subroutines and programs that can be added to a BBS to customize or enhance it.

Multi-Line refers to a BBS that permits more than one user to be on-line at a time through use of multiple modems and telephone lines.

Multilingual Support (International Support) is a BBS feature that interprets information into a foreign language.

Multitasker is a program or subroutine that allows more than one program to be active at the same time.

Network refers to communication among a group of BBSes, usually in the form of message-base subs.

Network Coordinator is the point-of-contact for becoming a member of a network.

New User is a person who has logged on to a BBS for the first time or has been a member for a very short time.

Node is one line of a multi-line BBS.

Off-Line indicates disconnection from a BBS.

Off-Line Mail Reader is a program used for reading message-base entries without being connected to a BBS.

Off-Line Mail Readers allow users to reply to messages and then upload their responses while on-line to the BBS at a later time.

On-Line indicates connection to a BBS via modem.

On-Line Games are entertainment programs on a BBS.

Password, commonly abbreviated

PW, is a security code entered by the user to protect his account from unauthorized use.

Post is a message entered by a user in the message base.

Post-to-Call (PC) Ratio is an optional setting for a BBS in which a user must enter a message in the message base each set number of calls or be restricted from certain BBS activities.

QWK is a standard developed to permit compatibility among the various types of computers and off-line mail reader programs.

Registration is a fee paid to use a shareware program.

Registry is a user's account information.

Remote Imaging Protocol (RIPscrip), commonly abbreviated RIP, is a terminal emulation that uses digitized graphics.

Screen Blanker is a program that displays moving pictures on the video screen after a set amount of time to prevent burn-in.

Script is a subroutine inserted in a program's source code.

Shareware is software that can be legally copied and distributed but must be paid for after a trial usage period, normally one month.

Source Board is a BBS run by the author of a particular bulletin-board program.

Source Code is the instructions a program follows. A source code can't be executed because it's in a programming language. It must be compiled, or converted to machine language, to run.

Sub is an area of the message base that relates to a specific topic, such as sports or want ads.

Subscription Service (Pay Board) is a BBS that charges users for access.

Subop (Moderator) is a person who assists the system operator by maintaining a sub or file section.

Support Board is a BBS designed to

assist others running the same type of BBS software.

System Operator, commonly abbreviated Sysop, is the person who runs a BBS on his computer.

Teleconference is an area of a BBS that permits users to communicate with each other.

Teleconference Network is a BBS feature that permits users to enter the teleconference area of a number of different BBSes.

Template is a standard format into which data is entered in certain fields.

Terminal Program is a program used to call a BBS.

Theme is the motif, or focus, of a BBS.

Third-Party Support refers to programs written by anyone outside the company that developed the BBS to run on a BBS.

Trial Period is the length of time one may use a shareware program before being required to register it.

Uninterruptible Power Supply, or UPS, is a hardware device used to monitor electricity. In the event of a power failure, it supplies battery power to keep the computer running.

Upload, commonly abbreviated UL, is a user copying a file from his computer to the BBS via modem.

Upload/Download Ratio refers to the number of files or bytes a user may download for every file uploaded.

User is a person who calls a BBS.

Validation is the process of a sysop converting a user's account from that of a new user to the standard access level.

Virus is a program or subroutine that causes harm to a computer, usually by deleting files.

Virus Scanner is a program that searches disks for viren.

Voice Validation is a security measure in which the sysop calls the number entered in a user's registry to ensure that it's valid.

tion doesn't list support boards, check the source board. There's often a list of experienced sysops running the same BBS type who have volunteered to provide technical assistance. These are especially helpful if the programmer lives in a different country. One BBS program I ran was written by a Canadian (I quickly downloaded the list of US support boards).

If you still can't get the answers to your questions, by all means call the

author's BBS. The programmers for two of the BBS systems I've run have even given me their voice phone numbers to provide person-to-person troubleshooting for problems that require immediate attention. If you should happen to get the author's voice number, keep in mind that such people tend to be very busy. Call only when you've taken every measure you can to solve the problem by other means, and be *certain* that the complication

didn't arise due to an error you made.

Doors tend to cause a great deal of difficulty as well. There are a number of patches and interfaces available to port games designed for one BBS type to another, but keep in mind that not every door will work with every BBS system, no matter what you do. Interfaces are often generic, converting user data from one format to another, whereas doors sometimes require specific information that isn't

**Analog & (NEW RELEASE) Digital
Circuit Design & Simulation
for the Macintosh & PC with Windows**

B² Spice is a "very good moderately priced program"

- Professor Anthony Seigman, Stanford University

B² Logic v2.2 is "the ideal program for logic design students"

- Professor Eugene Henry, University of Notre Dame

B² Logic® v.3.0 NEW

for Digital Circuits

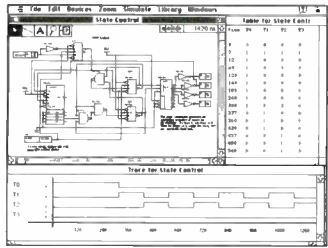

B² Spice®

for Analog Circuits

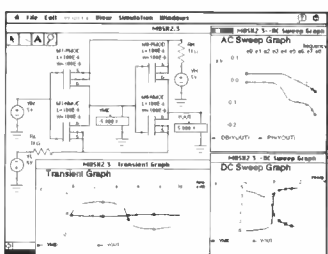

• **INTEGRATED SCHEMATIC CAPTURE & SIMULATION** •
Now in use in over 75 major universities & leading corporations around the globe. (University of Michigan, Stanford, University of Illinois, Sony, NASA, Argonne Nat'l Labs... to name a few)

Beige Bag Software Ph.: (313) 971-4227

Fax: (313) 971-3632 • 2000 Hogback Rd., Suite 2, Ann Arbor, MI 48105

• U.S.A. •

(VISA/MC Accepted)

We offer unmatched service and quality products. Call, write, or fax us for more information.

Prices start at \$149.00 • University & Student Pricing • Dealer Inquiries Welcome

CIRCLE NO. 54 ON FREE INFORMATION CARD

HARD TO FIND

Call for FREE Catalog with Specs!

- **Text to Speech Board** serial I/O **\$89**
 - **Temperature boards:** w/16 sensors **\$239**
w/8 sensors plus 8 analog inputs **\$179**
both boards: - 40° to 146°F, serial I/O
 - **Digital I/O ISA cards:** 48 I/O ports **\$125**
96 I/O ports **\$169**
192 I/O ports **\$249**
 - **Infrared transmitter & receiver pair** **\$89**
hook to PC w/digital I/O, 16 commands
 - **4-Port ISA Serial Board** w/16550s **\$129**
com1-com8 & irq's 2,3,4,5,10,11,12,15
 - **Servo controller board** serial I/O **\$89**
 - **Programmiers X-10 Library for C** **\$95**
100+ functions, w/cable(PC to TW523)
 - **Picture-In-Picture box w/TV Tuner** **\$170**
 - **Windows NT TelcomFAX Personal** **\$99**
 - **Windows NT TelcomFAX Server** **\$495**
More items available including X-10 products.
- Try our two new customer services
Automation BBS | Fax on Demand
315-455-8728 | 315-455-8368

800-455-9853
Visa • MC • Amex • COD

Tech•Arts Orders 800-455-9853
103 Lind Avenue Support 315-455-1003
Syracuse, NY 13211 Fax 315-455-5838
Promotions and prices are subject to change without notice. Call for guarantee and warranty information.

CIRCLE NO. 91 ON FREE INFORMATION CARD
56 / MICROCOMPUTER JOURNAL / September/October 1994

converted. Usually, if you call a door's author and request a version that will run on your system, he'll be more than willing to do a conversion if you provide him with the documentation for your BBS type.

It's just as essential to read the full documentation for a door as it is your BBS manual. The instructions may advise you to install a communications driver, such as X00.SYS or BNU.SYS. Do so because it will maintain communication with the modem while the user is in an external program. Some front-end mailers may require this as well (see Fidonet in The Individuality Factor box).

Improperly installed doors will lock up a board more frequently than will anything else, often because they can't find either the correct game data files or the required user information. If all else fails, call the door author's BBS to request his aid. These people like to see their products run on as many bulletin boards as possible. A quicker solution might be to call a support board for your BBS type that has the door you wish to install operational and find out what the sysop did to get it to work.

As doors are usually developed by third-party programmers, they're released into the shareware marketplace. The version you download, unless no registration fee is requested, will be limited in some way. There may be a delay screen upon starting the door, a limited amount of users who can play or certain functions or commands in the game that are disabled. Before rushing your registration check to the mailbox, be sure that the door works with your BBS type. This is the purpose of a demo copy. Have a friend test the door while you're sitting at the computer to be sure it doesn't lock up the BBS and information is being communicated with the remote terminal (keep an eye on the SD and RD lights, if you have an external modem). If it doesn't work, call the author's BBS to make sure you have the most-current version of the program. Oftentimes many bugs are fixed in later versions.

If the door works fine but there's no user interest in it, there's no sense in registering it, either. But after the trial period indicated in the program's documentation, be sure to either register or delete the program. Support the

shareware concept.

If you do register, you'll receive the latest full-featured copy of the program, as well as access to the author's support board. In addition, the package may include a sysop editor so you can modify the game. You may also receive a copy of the documentation printed out on a laser printer, free program upgrades and/or discounts on other doors developed by the particular programmer.

Hardware Factor

Running your computer 24 hours a day, seven days a week is bound to cause problems. Hopefully, they'll be minor ones. For the most part, experts agree that keeping your CPU running constantly is actually better for it than the surges they undergo during power-ons. While on the subject of surges, be sure that you have your computer and peripherals connected to a surge suppresser. This is a must. You may even want to invest in an uninterruptible power supply (UPS) if you live in an area in which the electricity is apt to flicker. For around \$150, you can get a unit that will switch to battery power for about 10 minutes if power is lost. In the \$250 range, you can purchase a UPS that additionally monitors for times of low power and uses the battery to compensate for the shortage.

Though monitors are built considerably better than they were a decade ago, you still want to install a screen blanker to prevent burn-in if your BBS package doesn't already have one built into it. There are a number of these available on the PD/shareware market. Once you get one, you simply insert the command to start it in your AUTOEXEC.BAT file and, after the predetermined amount of time of non-activity, it will bring up a screen of fireworks, stars or other constantly-moving pattern. I recommend shutting off your monitor when not in use. The same applies to your printer, unless you have a scheduled event that sends a listing to it.

Hard drives, especially when in constant use, are prone to come up with errors. Be sure you do a backup of key data files, such as your user list and BBS configuration, at least weekly. A batch routine can be quickly written to save only the important

files to disk. For example, the files USER.DAT that contains your users, CONFIG.DAT that contains your customized BBS settings, LOG.DAT that contains your sysop log and your ANSI screens (for the sake of the example we'll assume they end in .ANS) could all be backed up by executing this sample batch file, were all your files in the directory \BBS:

```
@ECHO OFF
CD C:\BBS
COPY *.DAT A:
COPY *.ANS A:
ECHO ALL FILES SAVED
```

You could save other files from other directories as well, such as game data files, by changing to the proper directory and adding more copy statements. To save all data files in the BBS\GAMES\WAR directory, you'd simply add:

```
COPY C:\BBS\GAMES\WAR*.DAT A:
```

before or after the other COPY statements. You might even consider making this backup a nightly event. This requires a disk to be kept in the floppy drive. As most sysops modify their AUTOEXEC.BAT file to start up the BBS in the event of a power failure, keeping a disk in the floppy drive would normally disable the AUTOEXEC.BAT file from running. Therefore, if you opt to have the backup run as a nightly event, you'd want to make the floppy bootable and create an AUTOEXEC.BAT file on it that would change to the hard drive and run the BBS automatically.

A backup of your entire hard drive should be done monthly. You might also want to do a low-level format of your drive after your monthly backup and reload the information back to the hard drive. Optimizing your disk (running a program that organizes file segments into sequential order to reduce disk access time) may help, but be sure that your BBS package will work under an optimized condition.

Success Factor

You'll no doubt want your BBS to be a success, whether you gauge your popularity by message-base activity, number of calls per day, number of uploads or number of customers, in the case of a board that charges for

use. But rarely is a board successful merely by virtue of its existence. You have to make it this way.

To get users, you've got to spread the word. This doesn't necessarily mean taking out an advertisement in a magazine (though you may want to consider doing so in a regional computer publication). There are a number of free sources available. Some computer magazines print lists of nationwide BBSes by area code free of charge. Ask the manager of your local computer store to post your BBS number. Find out what computer users groups are in your area and request that they mention your number. Most groups maintain a list of local BBSes. And if local boards have a BBS lister installed, add your number to it. Some sysops may have the numbers of other boards on their logoff screens as well. Ask if they wouldn't mind adding yours to it.

Some sysops enforce post-to-call and upload/download ratios as a way to encourage participation. Though I don't discourage doing so, keep in mind that users log on to do what they want to do, not what you want them to. A user who logs on just to play games isn't going to be a willing participant in message-base conversations, and users are going to have a hard time finding files to upload if you have a CD-ROM installed.

The way you treat your users also has a bearing on how often they'll call. Help them out in any way you can, especially if they're paying to use your system. Answer feedback promptly and courteously. Fix, or at least attempt to, any problems that they report. As tempting as it may be, don't ignore your chat page. Set hours when you'll be available to answer it. Above all, be patient with new users. Keep in mind that without users, you don't have a BBS.

To Fee or Not to Fee?

BBS and door registration, extra telephone lines, hardware upgrades and the electricity to run the computer constantly can all add up quickly in terms of cost. Phone rates are controlled locally and differ from area to area, but you can expect to pay around \$20 per phone line each month, not considering installation. Though your intentions may be to run the BBS as a

Learn MICROCONTROLLERS EMBEDDED SYSTEMS and PROGRAMMING with the AES-10

The AES-10... a complete learning system, a complete embedded control system. Extensive manuals guide you through your 8051 development project. Assembly, BASIC, and C programming. All hardware details, complete schematics. Learn to program the LCD, keypad, digital and analog I/Os for your applications.

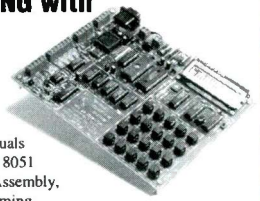

80C32 Computer/Microcontroller board with:

- 32K ROM, 32K RAM • 2 by 16 Liquid Crystal Display • 4 by 5 Keypad • Digital, A/D, D/A, and PWM, I/O • Built in Logic Probe • Power supply (can also be battery operated) • Extended AES BASIC and AES Monitor in ROM • RS-232 cable to connect to PC for programming • 8051/52 DOS Cross Assembler • Program disks with well documented examples • User's Manual, Language Manual, and Textbook • AES-20 (a smaller board without Keypad and LCD)

AES-10 \$365
Money Back Guarantee

AES-20 \$245
Free Brochure, M/C Visa
714 - 744-0981
Fax 714 - 744-2693

AES
Advanced Educational Systems

800 - 730-3232

1407 North Batavia Street, Orange, California 92667, USA

45,296

ELECTRONIC COMPONENTS

Whether you order 1 part or all 45,296...MOUSER stocks and...ships same day!!

CALL...(800) 992-9943

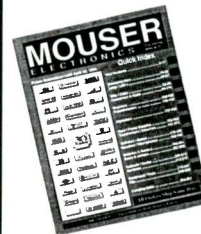

for your
FREE
CATALOG

2401 Hwy 287 N.
Mansfield, TX 76063

MOUSER
ELECTRONICS
Sales & Stocking Locations Nationwide

CIRCLE NO. 79 ON FREE INFORMATION CARD

Modular Insect Robotics

Build this bug and train it with *Insecta™* neural net software! Beta sites available NOW - *Prometheus™* kits available this Fall.

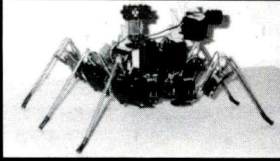

(*Prometheus™*)

We offer an evolving and expanding line of LOW-COST, INTEROPERABLE insect robot kits and components.

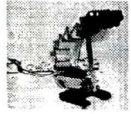

Compound Eye Experiment Kit - \$49

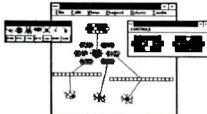

Insecta™ H/W-in-the-loop neural net S/W



Compound Eye Unit - \$59

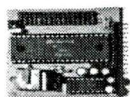

Upgradable 16-servo Controller - \$89

Other components and consulting available.



Ublige Software and Robotics Corporation

Please send a SASE envelope to receive an informative brochure, or send \$3 (refunded on purchase) for a complete catalog and Video for *Windows™* disk of our robots in action.

Check or money order only please. *Insecta™* is a trademark of Ublige Software and Robotics Corporation. *Windows™* is a trademark of Microsoft Corporation.

P.O. Box 18034
Huntsville, AL 35804
usr@delphi.com
205-518-9422

CIRCLE NO. 110 ON FREE INFORMATION CARD

To Order Back Issues

Send \$3.50 Per Issue
(Check, Money Order,
Mastercard, VISA, Discover
and AMEX).

Send All
Correspondence To:

CQ Communications
76 North Broadway
Hicksville, NY 11801
Or Call
516-681-2922
FAX 516-681-2926

ORDER YOUR
BACK ISSUES
TODAY!

hobby, you need to assess how much money you want to invest in your system. Some sysops feel that they're running a BBS simply because they enjoy it and pay all costs out of their own pockets. Others feel that they're providing a service to the community and charge callers for use. Still others, myself included, operate on a "donation-incentive" basis in which users who contribute to the BBS receive a higher access level than those who don't. All are acceptable means, but keep in mind that if a user is paying to use the system, he's rightfully going to expect something in return. The following is the criteria I personally would expect when paying to use a bulletin board:

(1) A unique theme or software package; evidence that the sysop has worked to individualize it, such as customized ANSI screens and menus, rather than using everything stock out of the archive.

(2) More than one telephone line so that I have more of an opportunity to take advantage of my investment.

(3) Message-base subs networked nationally through such means as Fidonet or WWIVnet that are active and interesting.

(4) A registered BBS. I'd expect doors, if they prove themselves active and bug-free after their trial period, to be registered as well.

(5) A file area that doesn't stagnate, preferably frequently-changed CD-ROM discs.

Subops

As your BBS grows, you may find yourself overwhelmed by the chores required to maintain it. This is where subops come into the picture. By giving users more time per day and a higher access level, they in turn help you run the BBS. You will, of course, want to give subop access only to those you trust, but there should be several users who fall into this category.

Rather than put a user on the spot by asking him if he'd like to be a subop, post an announcement in your logon files describing the position and duties. You'll be surprised at the number of users who'll be happy to help out. You can then select the user(s) you feel most comfortable with and who you think will do the best job.

Unless you have several different

computer types in your home, you need someone to test software uploaded for the different models you support, such as Amiga, Atari, Mac, etc. You'll want someone with a high-speed modem, as he'll have to download each file to check it out. It also helps to have someone search through the file areas for duplicate files and to move files that were inadvertently uploaded to the wrong area to their correct locations.

You'll want to appoint someone to the message base, whether it's one person for the entire base or one person per individual sub. Message-base subops can help keep posts active and enforce your standards. It's also good to have someone keep an eye out for posts that need to be moved to a different sub or deleted altogether.

You may opt to have an assistant in validating accounts if your board has a high volume of users. Many systems let you configure who you want new user feedback to go. If this option isn't available, you should be able to forward your email to the appropriate user. As this subop has access to user files, yours and their own included, you'll want to delegate this position only to someone you trust wholeheartedly. You don't want your average user being able to drop to DOS.

Treat your subops well. Give them more additional on-line time than it will take for them to perform their duties. If you run a system that charges, give subops at least part of their time free. And give credit where credit is due: put their names on the logon screen.

Sysop Support

An immeasurable amount of information awaits you in your local organization of sysops. If one doesn't exist, talk to regional sysops and see if they're receptive to one. Chances are good that they've thought of the benefits of attending one.

Within such an organization, there are a wide variety of topics to discuss. Sysops can provide warnings of problems they've had with particular users. Many seasoned veterans will have technical information to share. There may be a new BBS utility on the PD market that one of the members has, such as a new ANSI screen maker or off-line mail reader. If nothing else,

there will be some good stories to share, such as the one about the new user who opted to use call-back verification, and when the BBS called, he picked up the phone and greeted the modem with, "Hello?" It's also good for the users to know that the area sysops are acting as colleagues rather than competitors. If they cause problems on one board, they know that they may be jeopardizing their accounts on several.

Giving Back to the BBS World

Once you've gained experience in your software package, it's time to assist other people the way you were once helped. If you feel comfortable in your knowledge of installing doors and mods and are troubleshooting problems on your own, contact the program's author and offer your services as a support board. You'll most likely get unlimited downloads on the

author's BBS so you can get the latest mods and doors, and the sysops of other support boards might grant you the same.

If you choose to act as a support sysop, you have to set up file areas for doors, mods and the latest version of the BBS. You might want to consider setting up a message base for questions about the software as well. If a sysop leaves you feedback about the BBS package to which you don't know the answer, either refer him to another support board or find the answer. If you just "wing it," word may get back to the author and your status as a support board operator revoked. To make things easier, you may want to set up a special account for sysops, disabling your upload/download ratio, if used, for support file areas.

If you don't want to go the extent of becoming a support board but still want to help, here are a few suggestions. Type up detailed, step-by-step instructions on installing specific mods or doors that might be trouble-

some and upload it to support boards. Offer advice to the author on how the documentation could be clarified or improved (don't worry about offending; he'll probably be grateful). If you have a flair for writing, offer to revise the documentation yourself. If your board logs who downloads which files, keep an eye out for anyone who downloads the BBS program you're running and offer assistance.

Author David T. Kruchowski has run his own BBS, The Enchanted Land, on a variety of different systems since its conception in 1989. It started as a C-64 board, running Color 64; moved on to IBM first as a WWIV system, and later Telegard; and then to Amiga, initially running Falcon. It is now run on the Amiga RPGBBS system, averaging 40 callers per day on a single line. He's currently on contract with Tiare Publications for The Electronic Gateway, a how-to book on computer communications, and has begun research for a book designed to assist sysops and those who are considering running a BBS.

CONTROL





RELAYS • LIGHTS • MOTORS

MEASURE

TEMPERATURE • PRESSURE • LIGHT LEVELS • HUMIDITY

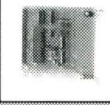
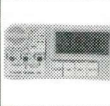
INPUT

SWITCH POSITIONS • THERMOSTATS • LIQUID LEVELS

MODEL 30 \$79  <ul style="list-style-type: none"> • PLUGS INTO PC BUS • 24 LINES DIGITAL I/O • 8 CHANNEL-8 BIT A/D/IN • 12 BIT COUNTER • UP TO 14K SMP/SEC 	MODEL 30 SOFTWARE SCHOONER . . . \$39 <ul style="list-style-type: none"> • REAL TIME DATA PLOT • DISK DATA LOGGING • SOFTWARE CALIBRATION PROTEUS (REQUIRES SCHOONER) . . . \$39 <ul style="list-style-type: none"> • GRAPHICAL DATA VIEW • ANALYSIS OF DATA
MODEL 150-02 . . . \$179  <ul style="list-style-type: none"> • RS-232 INTERFACE • 8 DIGITAL I/O • 8 ANALOG INPUTS • 2 ANALOG OUTPUTS • 2 COUNTERS-24 BIT 	MODEL 45 \$189  <ul style="list-style-type: none"> • RS-232 INTERFACE • 8 DIGITAL I/O • 8 ANALOG INPUTS • 2 ANALOG OUTPUTS • 2 COUNTERS-24 BIT
MODEL 40 \$99  <ul style="list-style-type: none"> • RS-232 INTERFACE • 28 LINES DIGITAL I/O • 8 ANALOG INPUTS • PWM OUTPUT 	MODEL 70 \$239  <ul style="list-style-type: none"> • RS-232 INTERFACE • 16 BIT A/D • S.S DIGIT • UP TO 60 SMP/SEC

Prairie Digital, Inc.

PHONE 608-643-8599 • FAX 608-643-6754

846 SEVENTEENTH STREET • PRAIRIE DU SAC, WISCONSIN 53578

CIRCLE NO. 82 ON FREE INFORMATION CARD

Low Cost CAD Software

for the IBM PC and Compatibles

Now In Windows™

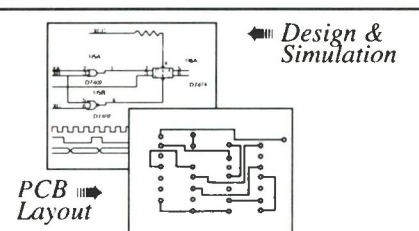

- Easy to use schematic entry program (SuperCAD) for circuit diagrams, only \$149. Includes netlisting, bill of materials, extensive parts libraries, More parts, and automatic wiring available in enhanced CAD package (SuperCAD+) for only \$249.
- Powerful, event-driven digital simulator (SuperSIM) allows you to check logic circuitry quickly before actually wiring it up. Works directly within the SuperCAD editor from a pull-down menu and displays results in "logic analyzer" display window. Starting at \$149 this is the lowest cost simulator on the market. Support for PALs, a larger library, and a separate interactive logic viewer are available in full-featured SuperSIM+ for only \$399. Library parts include TTL, CMOS and ECL devices.
- Circuit board artwork editor and autorouter programs (SuperPCB), starting at \$149. Produce high quality artwork directly on dot matrix or laser printers. You can do boards up to 16 layers including surface mount. Includes Gerber and Excellon file output. Autorouter accepts netlists and placement data directly from the SuperCAD schematic editor.
- Low cost combination packages with schematics and PCB design: 2-layer for \$399, 16-layer for \$649.
- DOS version available.

Write or call for free demo disks:

MENTAL AUTOMATION, INC. 

5415 - 136th Place S.E.
Bellevue, WA 98006
(206) 641-2141

CIRCLE NO. 72 ON FREE INFORMATION CARD

Roaming the Internet

Getting up and running on the information superhighway, what you can expect to find and how to go about navigating it

I bought my first modem, a state-of-the-art 300-bps model, almost 15 years ago. Ever since, I've haunted the electronic "hallways" of commercial services like CompuServe and Prodigy and the nooks and crannies of local and national BBSes. But I've always felt like something was missing. I've finally taken the big step and joined the Internet "information superhighway." Now, instead of connecting my computer to a single BBS machine or one information service, I'm connected to more than 1,500,000 computers and local networks all over the world and, literally, terabytes of information. I'm not yet an expert at using all of this information, which I estimate will probably take me a year or two of constant practice to achieve, but I can find my way around, gather the information I need and use the Internet's major features.

Users swear by, and occasionally swear at, the Internet. On a good day, it's an information superhighway like nothing else that has ever existed, the most-important information source in the world, and the greatest invention of mankind. Even on a bad day, the Internet is still an amazing collection of ideas, polemics and information, at least until there's trouble at a local host or one of computers to which it's connected.

Net Growth

Nearly everyone has heard of the Internet. It's mentioned in news stories, by radio and TV talk-show hosts, on television in general conversation and even in comic strips. If you've never used it, you can think of the Internet as a large information service, much like CompuServe.

Oddly enough, the Internet isn't a

centralized service at all. It's a cooperative venture among millions of computer users located in universities, government and businesses. Guidelines for cooperation have been worked out or come about through consensus, but there's no formal governing body to supervise the net at all.

Its lack of organization gives Internet its unique character and power. Virtually any computer or local network anywhere in the world can become part of the Internet quite easily. There are costs involved for the school, agency or company that owns the local computer. The operator of the local computer must pay for tele-

phone lines and either some specialized hardware and software or the fees of a service provider. But these costs are low in comparison to the benefits obtained by being part of the Internet. For the individuals who have accounts with the school or company, virtually all parts of the Internet are free. You don't have to worry about costs at all.

This combination of cooperative services and low cost has led to a phenomenal growth in the Internet. No one knows for sure how many Internet users there are around the world, but most experts estimate that at least 10,000 new users a day, or 3-million a

Computer Names on the Internet

U.S. Domains

Domains	Meanings
.com	Commercial Organization
.edu	Educational Organization
.gov	Government
.int	International Organization
.mil	Military
.net	Networking Organization
.org	Non-Profit Organization

Some Common Geographical Domains

Domains	Meanings
.at	Austria
.au	Australia
.ca	Canada
.ch	Switzerland ("Cantons of Helvetia")
.de	Germany ("Deutschland")
.dk	Denmark
.es	Spain ("Espana")
.fi	Finland
.fr	France
.gr	Greece
.ie	Republic of Ireland
.jp	Japan
.nz	New Zealand
.uk	United Kingdom
.us	United States

Learn to Use Your Computer's Full Potential.

New Career Course from CIE!

If you've been hesitating about upgrading your computer skills because you couldn't find the time or locate the right program to teach you everything you need to know to be successful in today's world of computers, you'll be happy to hear that CIE's new career course can provide you with the computer technology curriculum you seek in an independent study program you can afford to invest your time in.

CIE's COMPUTER OPERATION and PROGRAMMING course was designed and developed by CIE to provide a complete overall understanding of the unlimited potential today's computers offer, once you learn and discover their full capabilities, in today's high tech environment. CIE's new computer course quickly provides you with the electronics fundamentals essential to fully understand and master the computer's technological potentials for your personal and professional advancement. Upon mastering the fundamentals you will move into high level language programming such as BASIC and C-Language and then use that programming in order to relate the interfacing of electronic hardware circuitry to programming software. As a graduate of the Computer Operation and Programming course, you will be able to successfully understand, analyze, install, troubleshoot, program and maintain the various types of electronic equipment used in business, manufacturing, and service industries.

Since 1934, CIE has been the world leader in home study electronics by providing our 150,000-plus graduates with the curriculum and hands-on training they've needed to become successful in



today's highly competitive and computer oriented society. As a CIE student you'll receive a first rate education from a faculty and staff with only one desire. Your future success!

We encourage you to look, but you won't find a more comprehensive computer course anywhere!

And it's a course designed to fit around your lifestyle and commitments today, so you can be assured of professional successes and financial gains tomorrow.

Please, do yourself a favor and send the attached card or fill out and mail the coupon below for more information about CIE's

Computer Operation and Programming course. Do It Today!

Computer not included with course



YES! I want to get started. Send me my CIE school catalog including details about the Associate Degree program (for your convenience, CIE will have a representative contact you - there is no obligation).

Print Name _____

Address _____ Apt. _____

City _____ State _____ Zip _____

Age _____ Area Code/Phone No. _____

Check box for G.I. Bulletin on Educational Benefits Veteran Active Duty

CIE CLEVELAND INSTITUTE OF ELECTRONICS, INC.

1776 East 17th Street • Cleveland, Ohio 44114 • (216) 781-9400



*A school of thousands.
A class of one.
Since 1934.*

AO38

year, join the net. This number is expected to increase sharply over the course of the next year or two.

Net Services

Traditionally, the Internet has been built on four services: mail, news, file transfers and telnet. A modern Internet site will have additional services available, but new services are built on the backbone of these traditional services. Let's take a closer look at each of the four basic services.

• **Internet Mail** is part of a much larger electronic-mail, or e-mail, system that connects the Internet with other world-wide networks like Bitnet, which is a loose collection of IBM mainframe computers. Internet mail can also connect to information services like CompuServe and America Online and to a growing number of local BBSes.

One of the advantages of electronic mail is that it's usually instantaneous. A client can send a document to my e-mail address while we're talking on the telephone, and I can read and comment on the message during the phone conversation. Of course, we could do the same with a fax, but we'd face two difficulties in doing so. One is that a fax generally requires a long-distance telephone call and attendant charges. The other is that a fax is a graphics medium. If I want to work with the document as text, I have to use an OCR program to translate it and then proofread the translation. E-mail is faster and easier for most purposes.

Of course, e-mail isn't always instantaneous. Many BBSes and some local networks send and receive mail only once or twice a day. Occasionally, too, an electronic message goes astray. But generally speaking, e-mail is much faster, more reliable and more convenient than the U.S. Postal Service and the various courier services like Federal Express.

The most difficult part of using e-mail is collecting (and understanding) the addresses for the people you need to contact. Most Internet mail addresses are in two parts that are separated by an "@" sign. The section before the @ is a user's login name, which may or may not be the same as the person's real name or title. The section of the address after the @ is a

Quick Reference of Internet Resources

Anonymous FTP—File transfer from public files.
Archie—Search for public files.
Electronic Magazines—Journals published electronically.
Electronic Mail—Fast message transfer between any Internet users.
Finger—Short information statement about any Internet user.
Games—Special interactive on-line games.
Gopher—Menu-driven information retrieval.
Internet BBSes—Similar to standard BBSes but reached via Telnet.
Internet Relay Chat—Real-time group discussions.
Mailing Lists—Thousands of public and private discussion groups run through e-mail.
MUD—"Multiple User Dimension" games that use virtual reality to combine several players in a real-time game.
Talk—Real-time, on-line conversations.
Telnet—Remote login to another Internet computer.
Usenet—Thousands of discussion groups.
Veronica and Jughead—Search programs for Gopher.
Wais—Promising information search service.
White Pages Directories—Directories of Internet users.
World Wide Web—Hypertext information retrieval.

name for the computer the person you're trying to contact uses, or, more technically, the "domain" of the address. For example, in the e-mail address "president@whitehouse.gov" the domain is "whitehouse.gov" and the name of the recipient is "president." By the way, this is President Clinton's actual e-mail address, in case you wish to send him a letter.

The domain of Internet computers usually ends with either two or three letters after the last period. Names that end with a two-letter suffix are geographical. The last two letters are an international country abbreviation. Those that end with three letters are usually in the United States. The three-letter suffix identifies the kind of organization or institution that sponsors the domain. For an abbreviated list of common suffixes, see Table 1.

If you don't wish to send e-mail to President Clinton, you might want to write to Al Gore, using the address "vice-president@whitehouse.gov;" Bill Gates, using the address "billg@microsoft.com;" Rush Limbaugh, using the address "70277.2505@compuserve.com;" or even Beavis and Butthead, using the addresses "beavis@mtv.com" and "butthead@mtv.com." You can find other e-mail addresses in both electronic and printed "white pages," but most of us who use the Internet build up our address books by simply asking for the addresses of the clients and colleagues we write to most often.

• **The Daily News**, or the "news," is the next most-popular Internet service. The quotation marks are deliberate. Any similarity between most of Usenet and a newspaper or news broadcast is purely coincidental.

Usenet is really a series of discussion groups, much like the forums on an information service or the topics you might find on a BBS. There are currently more than 6,000 discussion groups, about half of which are of local and regional interest and the rest garnering participation from around the world. Several new groups appear almost every day.

Usenet requires a news reader program. Your local network administrator "subscribes" to a series of groups, which means that these discussions are sent to your network or computer every day. You can then select the groups you want to follow and use your news reader to read and react to the various discussion threads in a particular group.

Some discussion groups are aimed at professionals, such as "sci.engr.biomed," which focuses on biomedical engineering, and "k12.ed.special," which focuses on teaching children with handicaps or special needs. Some discussion groups respond to social needs, such as "alt.missing-kids," which helps locate missing children and "soc.culture.french," which is one of many discussions of national cultures. Finally, some discussion groups range from the silly ("rec.humor" is a collection of jokes,

some of them offensive) to the ridiculous ("alt.stupidity" is a discussion of "stupid" news groups).

Most groups aren't moderated, which means that no one reads or censors messages before they appear before millions of people around the world. The coherence of the news group and its success depend on the cooperation of the people who take part in the group. Other groups have a moderator, who previews messages before they're distributed.

One large set of groups, each of which starts with the prefix "clari," are discussions of current events and text of actual news articles. Unfortunately, there's a charge for these groups that many system administrators aren't willing to pay. Therefore, clari groups aren't as widely accessible as are other Usenet groups.

• **Transferring Files** from one site to another is the third important Internet service. By tradition, this service is called FTP, an abbreviation for File Transfer Protocol and the name of a Unix program that transfers files from one computer to another.

Of course, most of the files on Internet computers are private and contain proprietary or secret data or information that no one but the owner would want (for example, you wouldn't want a copy of my Christmas-card mailing list). But there are also terabytes of data on university and government computers that you, as a taxpayer, have paid for and to which you have a right. Also, many companies make some of their data files available to the general public.

The facility for these file transfers is called "anonymous FTP," which is a phrase that's used as both a noun and a verb. What it means is that you use a version of the FTP program to connect to a remote computer and log in as "anonymous." By doing this, you gain restricted rights to the remote computer so that you can browse through some public directories and copy the files in them to your machine. In many ways, getting a file by anonymous FTP is similar to downloading a file from a BBS, except that number of files from which to choose is so much greater on the

Internet than on a typical BBS.

You'll find the same shareware and freeware programs on the Internet that are available elsewhere, plus some you've never heard of before. You also have access to thousands of text files, including FAQs (Frequently Asked Questions and their answers) compiled from many Usenet groups and other sources and the complete works of many authors. Do you want an electronic copy of the *Bible*, the *Quran* or the *Book of Mormon*? How about the complete works of Shakespeare or the poems of Carl Sandburg? There are also dozens of journals that are published only as text files available through the Internet.

Of course, there are frivolous files to go along with the serious ones. How about a list of all of Norm's quips from the TV show Cheers or episode guides to Seinfeld?

The biggest problem with anonymous FTP is finding the information you want. There are guides available to do this in book stores, like the 400-page *Internet Yellow Pages* by Harley Hahn and Rick Stout (Osborne

✓ CHECK these great values! Do YOU need ...

- ✓ CHEAP embedded controller card \$75
- ✓ 8ch16b WINDOWS A/D card - K16/PC \$399
- ✓ RS232 to RS422 / RS485 converters
 - need no power supply • K422/485 \$69
 - isolated version - NO GROUND LOOPS! \$139
- ✓ I²C Card for PC's - I²C bus monitor master/slave/control • ICA-90 \$299
- ✓ RS232 data/protocol/format converter text/string search/replace etc. • PPC \$699
- ✓ Credit-card size PCAT Put a PC in impossible places! 12BIT A/D, PCMCIA • GCAT \$699

Making a datalogger?

TDS2020 - a very LOW POWER compact controller-logger with high-level FORTH language on-board. NO NEED for in-circuit emulator! Program with PC. 20MHz H8/532 3MIPS processor. Easy hook-up to keyboard, lcd, I/O, PCMCIA, I²C, 2 x RS-232 ports. Interrupts, multi-tasking, editor, assembler. Store 8 ch 10-bit data on NVRAM, PCMCIA cards, or 40 Mbyte HP KITTYHAWK harddrive.

TDS2020 FORTH CONTROLLER STARTER PACK \$499

- 6 - 16 v @ 30ma • 300µa sleeping
- 3" x 4" CMOS modules

CALL FOR DETAILS!

Saelig Co

(716) 425-3753

fax: -3835

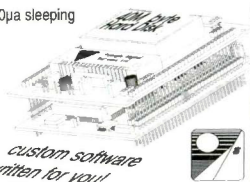

The Real Logic Analyzer



Test your Logic circuits with the printer port of your IBM or compatible computer!

- ✓ 5 Input capture channels via printer port
- ✓ High Speed 64K input capture buffer
- ✓ Glitch capture and display
- ✓ Full triggering on any input pattern
- ✓ Automatic time base calibration
- ✓ 4 cursors measure time and frequency
- ✓ Save, print or export waveforms (PCX)

The Real Logic Analyzer is a software package that converts an IBM or compatible computer into a fully functional logic analyzer. Up to 5 waveforms can be monitored through the standard PC parallel printer port. The user connects a circuit to the port by making a simple cable or by using our optional cable with universal test clips. The software can capture 64K samples of data at speeds of up to 1.2µs (Depending on computer). The waveforms are displayed graphically and can be viewed at several zoom levels. The triggering may be set to any combination of high, low or Don't Care values and allows for adjustable pre and post trigger viewing. An automatic calibration routine assures accurate time and frequency measurements using 4 independent cursors. A continuous display mode along with our high speed graphics drivers, provide for an "Oscilloscope-type" of real time display. An optional Buffer which plugs directly to the printer port is available for monitoring high voltage signals.

LOGIXELL
ELECTRONICS
61 Piper Cr.
Kanata, Ontario
Canada K2K 2S9

Requires 286, or higher with EGA or VGA display.

LA20 Software Only \$79.95us
Software With Test Cable \$99.95us
BUFF05 Buffer \$39.95us

Tel: (613)599-7088
Fax: (613)599-7089



CIRCLE NO. 71 ON FREE INFORMATION CARD

McGraw Hill). You can also get pointers to information if you ask in appropriate Usenet groups. Fairly recently, a series of tools has appeared that can search the Internet for you to find the files you want.

• **Telnet** is the last traditional Internet service. It gives you the ability to run a different computer. When you run the telnet program on your host computer, it connects with another computer, which requests that you log in. Normally, of course, you can't log in unless you use both a user name and a password. In other words, you can't log in unless you have an account on the remote computer. However, many Internet sites have a section set up for public use. You'll find the computer address and, when necessary, the login name for these public accounts in Internet directories and Usenet discussions.

As an example of the foregoing, if you want to use the Library of Congress information system, which provides access to both card catalogs and documents, you can telnet to the computer "locis.loc.gov." The Library of Congress computer will display a menu that lets you select the kind of information you need and then a dialog box that lets you specify search information. If you want information about UFOs, you can telnet to "grind.isca.uiowa.edu" and login as "iscabbs."

Public telnet links are less popular than anonymous FTP, partly because telnet doesn't provide an easy way to download files. Nonetheless, there are hundreds of public telnet sites to choose from.

New Services

FTP and telnet are handy tools for experienced users, but they make the Internet difficult to use for novices, especially those who have no experience with Unix. Many newer services with easier interfaces are available and growing in popularity on the Internet. My favorite, by far, is Gopher, a menu-based program that was originally developed at the University of Minnesota in 1991. There are more than 1,000 gophers now running on the Internet, each with clear and easy-to-use menus. Each menu choice can lead to another menu, display a text file or an image file, perform an FTP or telnet command for you or even link to

another gopher in a different location.

Gopher includes commands to search through the local menus, plus a link to a program called *Veronica* that can search through all of the gophers in "gopherspace," which is the complete set of menus on the Internet. Together, Gopher and *Veronica* create a very powerful tool for finding information on the Internet that's also very easy to use.

Another important tool is *Archie*, which is a program that can find files by title. Special programs regularly survey all known anonymous FTP sites and make a list of all available files. The lists are kept in a database that the *Archie* program searches. There are five public *Archie* servers in the United States and a dozen or so others spread throughout the world.

Using *Archie* is something like performing a selective directory of every subdirectory on your hard disk. *Archie* returns a list of the computer, directory and file name for every file that fits your search criteria.

Getting On to the Internet

Many people have access to the Internet without knowing they do. For example, your company's LAN may be connected to the Internet, even though no one told you that the entire Internet is available to you. Or you may be a student or staff member at a school that has an Internet connection. Finally, several cities and, soon, at least two or three states will have free Internet access for anyone who wants it through a dial-in service called FreeNet.

If you don't have Internet access through any of the traditional routes, don't despair. Many communities have dial-in Internet providers who, for \$20 or so per month, will give you unlimited or off-hours Internet access. Or, as an alternative, you can join Delphi, the first major on-line service that offers full Internet access. According to rumors I've heard, other on-line services will soon follow suit, perhaps before you read this article.

If you elect to pay for a dial-in link through a local Internet provider, you may have several choices. I have an account with a local provider, for example, that lets me dial in at 14,400 bps using a terminal program and then work as if I were sitting at a terminal

in the provider's office. The only inconvenience is that when I use FTP to get a file, it's stored on the disk in the provider's computer. If I want to transfer the file to my own computer, I must perform one extra step. I also must use the Unix commands that the host computer expects instead of the DOS, *Windows* and OS/2 commands I'd normally use on my own computer.

To overcome these small problems, you can often choose a PPP (Point-to-Point Protocol) or SLIP (Serial Line Internet Protocol) to turn your computer into an Internet host. You still call into a host with a modem, unless you want to install a dedicated telephone line, but you'll then be able to use your computer and the tools you're used to. If you use one of these methods (pick PPP if you have a choice) and a modem, you'll have to arrange for the remote computer to hold your e-mail for you when you aren't connected.

I haven't discussed all of the Internet services here, simply because there isn't room to do so. For example, I've mentioned nothing about Talk, which lets you converse on-line with another person, or about Internet Relay Chat, which lets you drop in on group conversations that continue all day and night. Nor have I mentioned more-advanced user-interface programs like the World Wide Web, Hytelnet and WAIS. Once you get on the Internet, you'll probably want to invest in a good guide book and resource catalog, just so you'll know what's available.

I find the Internet fascinating and exciting. It's vast and filled with a huge assortment of information and discussion. One evening, while I was strolling through Gopher, I found myself connected to a computer in Russia, for example, and later to one at Oxford University in England.

I also marvel that such a large conglomeration of services can be held together by the goodwill and generosity of so many people. People on the Internet are fiercely protective and proud of their service. If you post an inappropriate message to a Usenet group, you'll hear about it. If you ask nicely for help, you'll receive it. The Internet is an international treasure, far beyond the control of any government or agency. I hope it stays this way and continues to grow. ■

How to Use a PC's Parallel Port for Monitoring and Control Purposes

Conclusion

Detecting and measuring

Most people think of the PC's parallel port as an output port, because its most common use is to send data to a printer. But the parallel port also has nine status and control lines you can use for input. On some ports, you can use the eight data lines as inputs as well. This article presents a sampling of ways to use the parallel port's input abilities. The circuits include simple unlatched nine-bit input, latched eight-bit input, expanded input port of up to 40 bits, interface to an eight-channel analog-to-digital (A/D) converter and a primer on how to use the parallel port's hardware interrupt to detect when to read the port or take other action.

Although the focus here is on a PC standard parallel port, you can use the basic ideas to interface to any digital input port, such as those found on an I/O expansion board or microcontroller.

The Basics

In this article, I build on the information presented in Parts 1 and 2 in the last two issues of *MicroComputer Journal*. As a prerequisite, I assume you're familiar with the parallel port's 17 bits and how to read from and write to their registers. I've included short program listings that demonstrate the operation of the circuits shown. These programs are written in PowerBASIC, which is very similar in syntax to Microsoft's QuickBASIC and QBASIC, except that it has added

Listing 1. Subroutine of Basic Port Definitions. (Add to Listings 2 Through 7)

```
PortDefinitions:
DataPort=&h3BC
StatusPort=DataPort+1
ControlPort = DataPort+2
StatusMask = &h80

ControlMask = &hB

RETURN
```

'add this subroutine to Listings 2-7
'change this value to match your port's
'base address

'status register contains complement
'of S7. XORing with 80h returns
'the value at the connector.
'control register contains complements
'of C0,C1,C3. XORing with 0Bh returns
'the value at the connector.

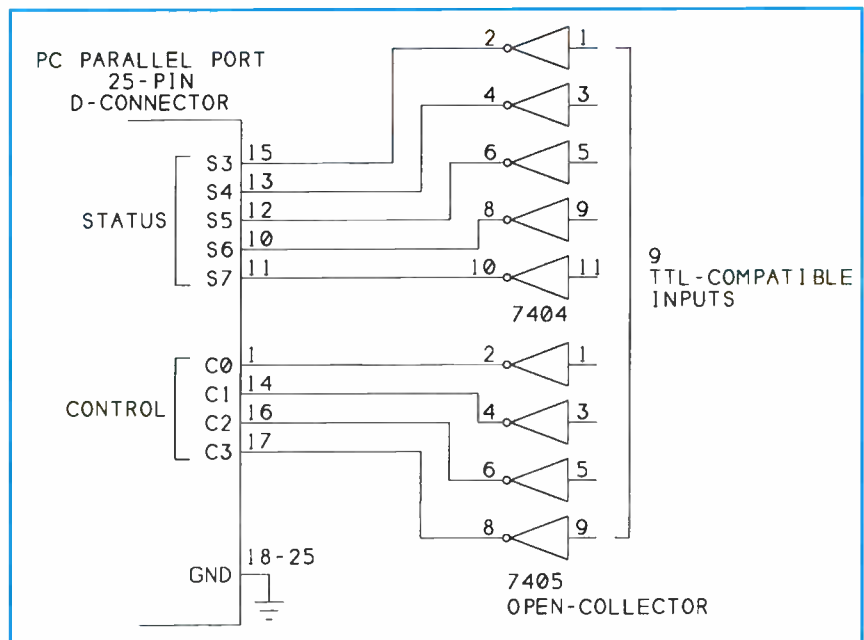

Fig. 1. You can read nine inputs at the parallel port's status and control inputs.

Listing 2. Reads Nine Bits at Parallel Port's Status and Control Ports

```
CALL PortDefinitions
OUT ControlPort, &hF XOR ControlMask      'bring C0-C3 high to allow use as
                                           'inputs
DO
  C = INP(ControlPort) XOR ControlMask      'read control port
  C = C AND &hF                             'ignore bits 4-7

  PRINT "Control Port = "; HEX$(C)         'display hex value of C0- C3 at
                                           'connector
  FOR I = 0 TO 3
    PRINT "Control Port Bit "; I; " = "; (C AND 2 ^ I) / 2 ^ I 'display each bit individually
  NEXT I
  S = INP(StatusPort) XOR StatusMask        'read status port
  S = S AND &hF8:                          'ignore S0-S2

  PRINT "Status Port = "; HEX$(S)         'display hex value of S3- S7 at
                                           'connector
  FOR I = 3 TO 7
    PRINT "Status Port Bit "; I; " = "; (S AND 2 ^ I) / 2 ^ I 'display each bit individually
  NEXT I

  PRINT "Press any key to continue..."
  DO: LOOP WHILE INKEY$ = ""              'wait for user to press a key
LOOP
END
```

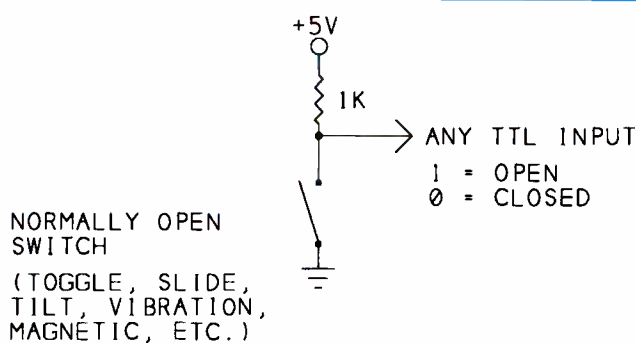

Fig. 2. By adding a pull-up resistor, you can read the state of toggle or other switches at the parallel-port's inputs.

features, like the ability to use hardware interrupts. PowerBASIC also has convenient operators that set, clear, toggle and read individual bits in a byte, though I didn't use these in the examples presented here so that the programs would be compatible with other BASICs wherever possible.

Comments are also included in the listings to help you adapt the programs to other programming languages. To this end, I've tried to write the programs to be easy to understand, rather than to contain the fastest or most-efficient code.

In this article, the bits on the parallel port are referred to as follows: the data port consists of output bits D0 through D7, the status port consists of input bits S3 through S7 and the control port consists of bidirectional bits C0 through C3.

Listing 1 is a subroutine called by Listings 2 through 7. It defines the locations of the parallel port's data, status, and control registers. Change the address of the data register to match the base address of your parallel port. Also, because the parallel port's registers contain the complements of S7, C0, C1, C2 and C3, the subroutine creates mask bytes for re-inverting these bits to make the values you read or write match the logic states at the port's connector. You must add the Listing 1 code to Listings 2 through 7.

The examples in this installment assume the minimum parallel-port configuration, in which the data bits are output-only. If your parallel port's data port is bidirectional, you can adapt many of these examples to use the eight data bits for input, rather than the status and control bits.

The schematic diagrams in this article include all components, except for decoupling capacitors (0.1 μ F at each IC is recommended) and line terminations on the parallel-port cable, which you can add as described in the May/June issue. Also not shown are power-supply and ground pins for digital ICs with standard pinouts.

Input Schemes

Figure 1 shows how to read nine bits using the parallel port's status and control bits. The status inputs are driven by five of the six inverters in a 7404. The control inputs are driven by four of the six inverters in a 7405 open-collector inverter.

Listing 2 reads the nine input bits shown in Fig. 1 and displays the value of each. Because the nine bits use both the status and control ports, you can't read them simultaneously. Instead, you must read first one port and then the other. Remember that you must write 1s to C0 through C3 before you use them as inputs.

I used the 7405 open-collector inverters at C0 through C3 to protect the outputs of the bidirectional control port. On the original parallel port, the control bits had open-collector outputs. Connecting a TTL totem-pole or similar output to one of these outputs can result in damaging currents, the result of the low-resistance path created if a low open-collector output connects to a high totem-pole output.

Although not all parallel ports have this problem, and you can always avoid it by writing 1s to the control outputs before you connect other outputs to them, I used the open-collector gates for safety reasons. You shouldn't have to add pull-up resistors to the control lines, since the parallel port's input circuits pull the outputs high.

Instead of the 7404, you could use a 74LS366 or 74LS68 hex inverter. You could also use a 7405 to drive the status inputs, though you'd need to add a pull-up resistor (4,700 ohms) from each output to +5 volts.

If you don't want to invert the signals, you can use a 74LS365 or 74LS367 buffer for the status inputs and a 7409 quad open-collector AND gate for the control inputs, with one input of each AND gate tied high.

You can connect any 5-volt digital signal to the nine inputs. You can also

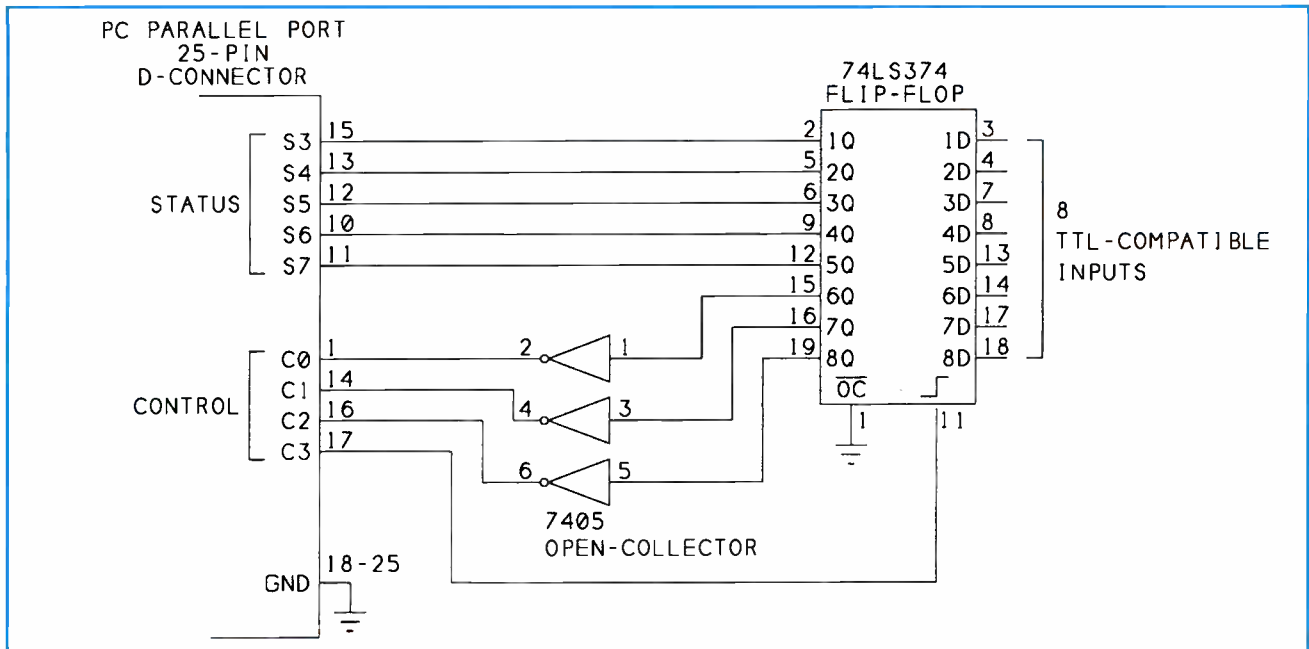

Fig. 3. Bringing output C3 high latches eight inputs to S3 through S7 and C0, C1 and C2.

read switch states, as illustrated in Fig. 2. For manual operation, you can use toggle or slide switches. A mercury switch makes a simple tilt detector, a magnetic switch detects when two objects (such as a door and its frame) are near or apart and a vibration switch detects sudden motion. You can find magnetic and vibration switches in the home-security section of Radio Shack and other stores.

One problem with the Fig. 2 circuit is that there's no way to latch, or store, the inputs before you read them. Since you must access two ports to read all of the bits, there will always be a short delay between reads. If you want to know the value of eight bits at a single point in time, you can store their logic states in flip-flops and read them at your leisure.

The Fig. 3 circuit stores eight bits in a 74LS374 octal flip-flop. Bringing high C3 causes the D inputs to be latched to their corresponding Q outputs. Even if the inputs change, the outputs remain at their latched values until C3 goes low and then high again. I again used open-collector inverters to protect the control inputs.

Listing 3 latches eight bits of data to the status and control ports, displays the value of each bit read and then combines the bits into a single value and displays it.

Shown in Fig. 4 is an alternate way to latch eight bits of input. This circuit stores two four-bit nibbles and reads

each in sequence at the status port. One control bit latches the data and another selects the nibble to read. With this setup, you don't have to use the control port for input, and you use

just six port bits, compared to nine bits in the previous example.

The latch is the same 74LS374 used in Fig. 3. A 74LS244 tri-state buffer presents the nibbles to the status port,

Listing 3. Latches and Reads Eight Bits at Parallel Port's Status and Control Ports

```
CALL PortDefinitions
OUT ControlPort, 7 XOR ControlMask      'bring C0-C2 high to allow use as
                                         'inputs
                                         'also bring output C3 low to initialize

DO
  OUT ControlPort, &hF XOR ControlMask  'bring C3 high, then low, to latch
                                         'data

  OUT ControlPort, 7 XOR ControlMask

  C = INP(ControlPort) XOR ControlMask    'read control register
  C=NOT(C)                                'invert result because using 7405
                                         'inverters

  C=C AND &h7                             'ignore bits 3-7
  PRINT "Control Port = "; HEX$(C)        'display hex value of C0- C2
  FOR I = 0 TO 2                            'display each bit individually
    PRINT "Control Port Bit "; I; " = "; (C AND 2 ^ I) / 2 ^ I
  NEXT I

  S = INP(StatusPort) XOR StatusMask      'read status register
  S = S AND &hF8                          'ignore S0-S2
  PRINT "Status Port = "; HEX$(S)        'display hex value of S3- S7
  FOR I = 3 TO 7                          'display each bit individually
    PRINT "Status Port Bit "; I; " = "; (S AND 2 ^ I) / 2 ^ I
  NEXT I

  'combine the 8 bits into a byte and display
  PRINT "Byte read (C0-C2 + S3-S7) = "; HEX$(C+S)

  PRINT "Press any key to continue..."
  DO: LOOP WHILE INKEY$ = ""              'wait for user to press a key

LOOP
END
```

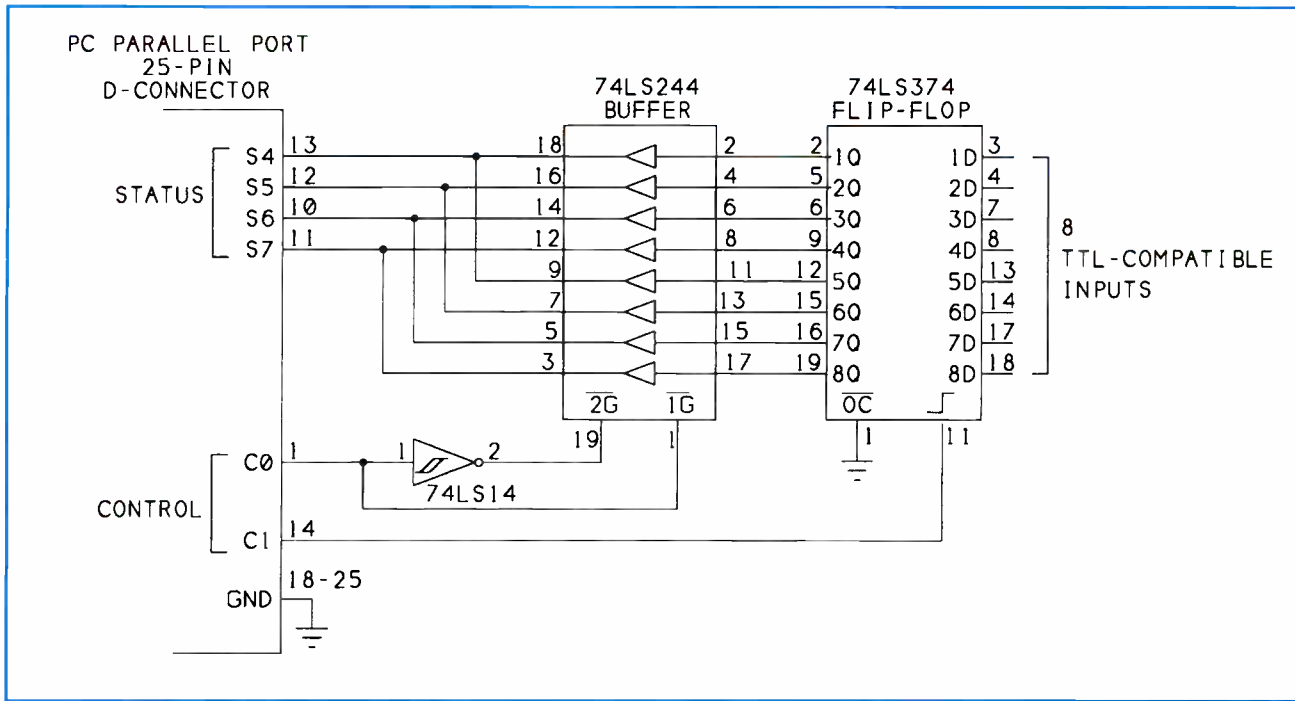

Fig. 4. This circuit allows you to read eight inputs at the status port, four bits at a time.

four bits at a time. When 1G is low, the top four outputs are enabled and you can read inputs 1D through 4D. When 2G is low, the bottom four outputs are enabled and you can read inputs 5D through 8D. I used a Schmitt-trigger inverter at C0 to provide noise immunity.

Listing 4 latches a byte of data,

reads it in two nibbles and displays the result.

Input expansion

Figure 5 shows how you can read up to 40 bits at the status port, five bits at a time. For this circuit, I used five outputs of a 74LS244 octal buffer to

drive S3 through S7 and the other three bits to buffer the inputs from C0, C1 and C2.

Outputs C0, C1 and C2 select one of eight inputs at up to five 74LS151 data selectors. The selected input appears at output Y and also in inverted form at \bar{W} of each 74LS51. An output of each 74LS151 connects through a buffer to one of the status inputs. To read a bit from each 74LS151, you write to C0, C1 and C2 to select the bit and then read S3 through S7. Since the 74LS151 has both normal and inverted outputs, I used the \bar{W} output at S7 to eliminate having to re-invert the bit in software.

Listing 5 reads all 40 bits by writing 0 through 7 in sequence to the control port and reading the status port after each write. The program displays each value read.

Listing 4. Reads Eight Bits at Status Port, Four Bits at a Time

```
CALL PortDefinitions
OUT ControlPort,0 XOR ControlMask          'initialize with C0,C1 = 0

DO
  NibbleSelect = 0
  OUT ControlPort,2+NibbleSelect XOR ControlMask 'select low nibble
  OUT ControlPort,NibbleSelect XOR ControlMask 'bring C1 high, then low,
  'to latch data

  SL=INP(StatusPort) XOR StatusMask          'read status port
  SL=SL AND &hF0                               'ignore S0-S3
  SL=SL / &h10                                  'move S4-S7 to bits 0-3
  PRINT "low nibble = ";HEX$(SL)

  NibbleSelect = 1
  OUT ControlPort,NibbleSelect XOR ControlMask 'select high nibble
  SH=INP(StatusPort) XOR StatusMask          'read status port
  SH=SH AND &hF0                               'ignore S0-S3
  PRINT "high nibble = ";HEX$(SH)

  S=SL+SH 'combine nibbles into a byte
  PRINT "byte = ";HEX$(S)

  PRINT "Press any key to continue..."
  DO: LOOP WHILE INKEY$ = ""                  'wait for user to press a key

LOOP
END
```

Reading Analog Signals

The circuit shown schematically in Fig. 6 enables you to read eight analog voltages using an A/D converter. I used an ADC0809 converter chip because it's inexpensive, widely available and easy to interface to the parallel port. The ADC0808 is the same, except that it has greater accuracy; so you can use it instead if you prefer.

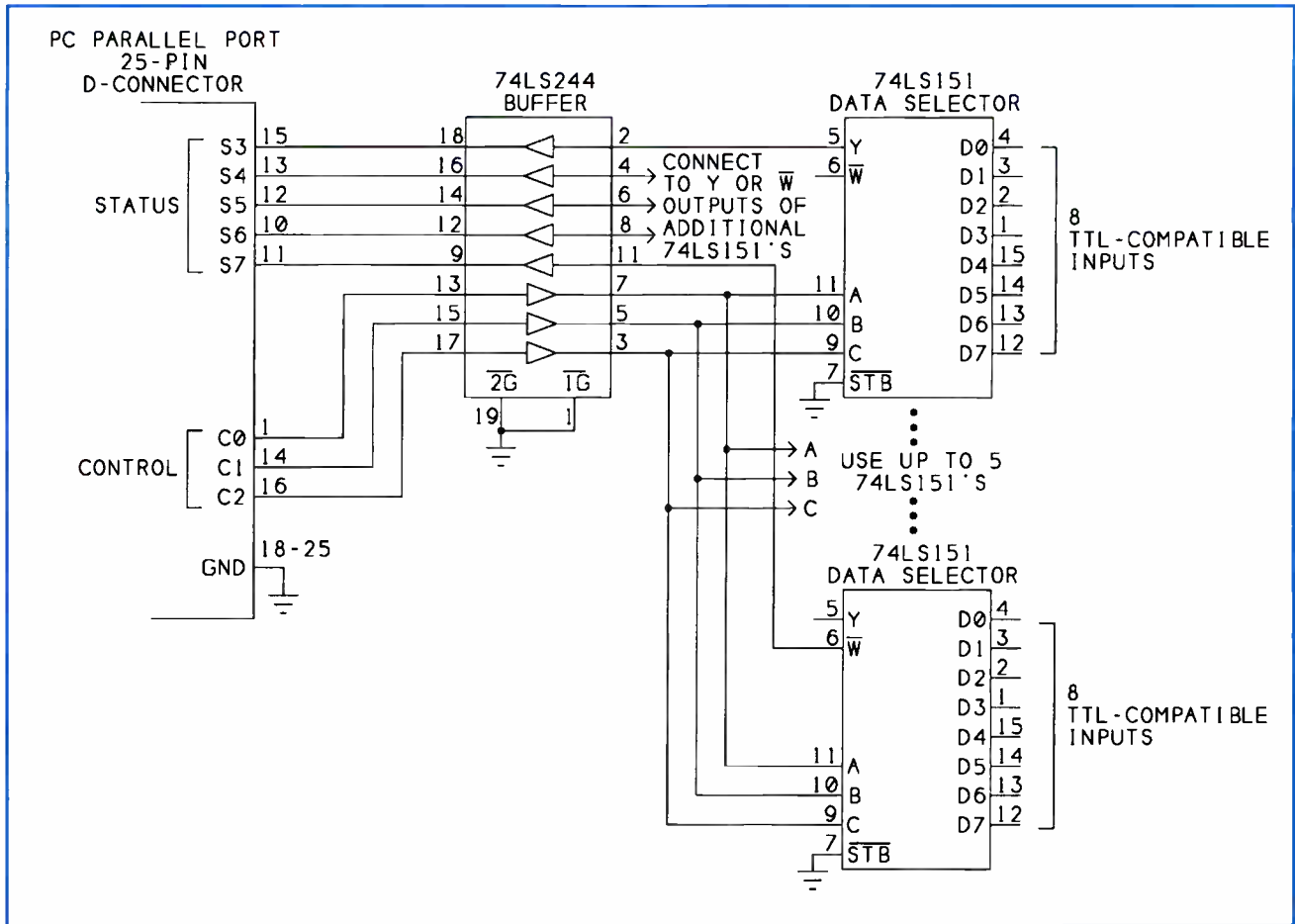

Fig. 5. By adding 74LS151 data selectors, you can read up to 40 bits at the status port, five bits at a time.

The ADC0809 has eight analog inputs (IN0 through IN7), which may range from 0 to +5 volts. To read the value of an analog input, you select a channel by writing a binary number from 0 to 7 to inputs A through C and bringing START and ALE high and then low to begin the conversion. When conversion is complete, EOC goes high and the digital outputs hold a value that represents the analog voltage read.

The chip requires a clock signal to control the conversion. A 74HC14 Schmitt-trigger inverter provides a simple way to create the clock. The frequency can range from 10 kHz to 1,280 kHz. If you prefer, you can use a 555 timer for the clock, but the maximum frequency of the 555 kHz is 500 kHz. Conversion time for the A/D converter is 100 μ s with a 640-kHz clock.

Inputs V_{ref+} and V_{ref-} are references for the analog inputs. When an analog input equals V_{ref-} , the digital output is 0. When the input equals V_{ref+} , the dig-

ital output is 255. You can connect the reference inputs to the +5-volt supply rail and ground or, if you prefer a more-stable reference or a narrower range, you can connect other sources from 0 to +5 volts to the references.

The circuit reads the digital data in two nibbles at S3, S4, S5 and S7. Out-

puts D0, D1 and D2 select the channel to convert, D3 starts the conversion and D4 selects the nibble to read. Optional input S6 allows you to monitor the state of the A/D converter's end-of-conversion (EOC) output.

A 74LS244 drives the status bits. When D4 is low, you can read the

Listing 5. Reads 40 Bits at Status Port, Five Bits at a Time

```
CALL PortDefinitions
DO
  FOR InputSelect = 0 TO 7
    OUT ControlPort, InputSelect XOR ControlMask 'select a bit to read
    S=INP(StatusPort) 'read status port
    PRINT "Input ";InputSelect,
    PRINT "S3 = ";(S AND 8)/8; 'display each bit
    PRINT "S4 = ";(S AND &h10)/&h10;
    PRINT "S5 = ";(S AND &h20)/&h20;
    PRINT "S6 = ";(S AND &h40)/&h40;
    PRINT "S7 = ";(S AND &h80)/&h80
  NEXT InputSelect

  PRINT "Press any key to continue..."
  DO: LOOP WHILE INKEY$ = "" 'wait for user to press a key

LOOP
END
```

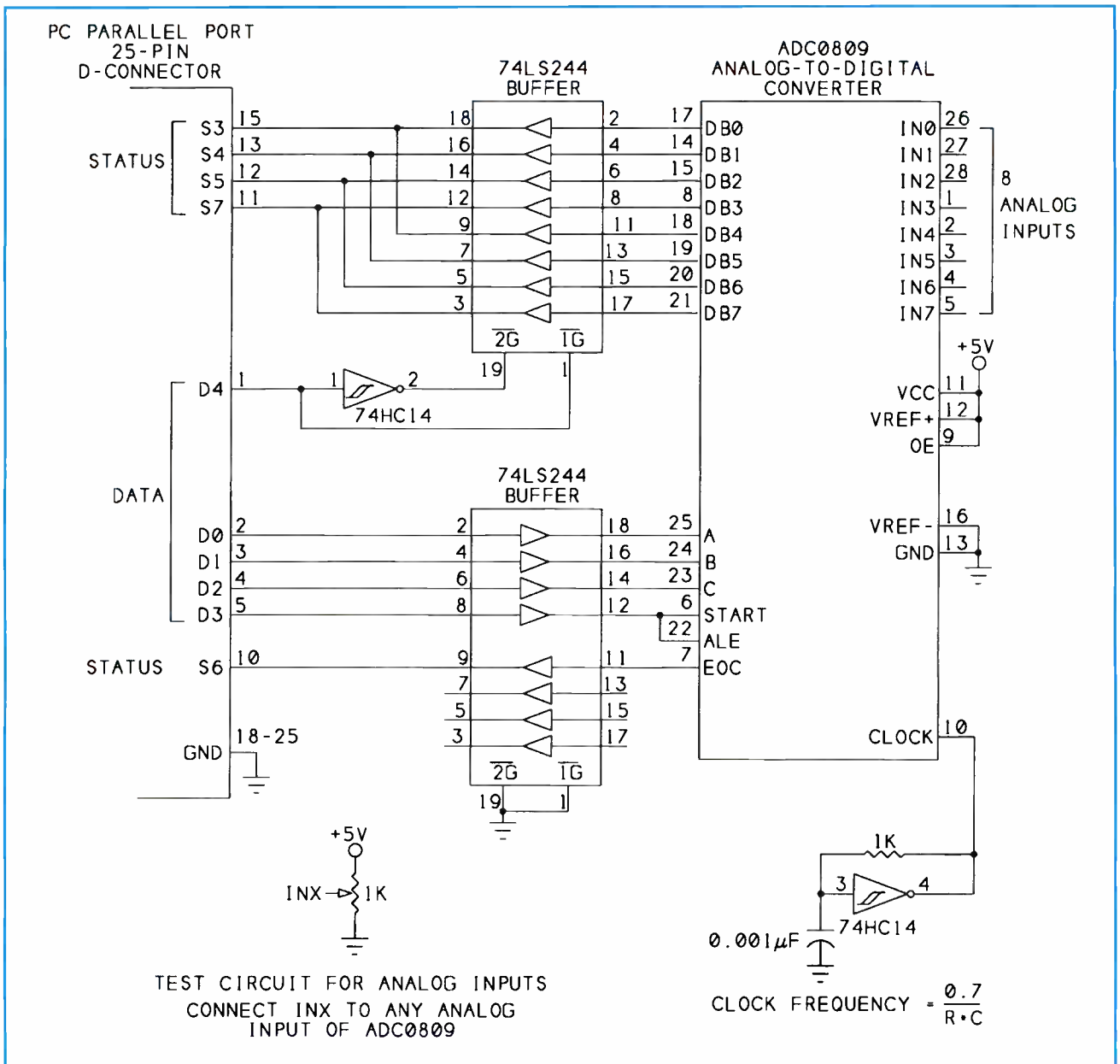

Fig. 6. With an ADC0809, you can monitor up to eight analog voltages at the parallel port.

A/D converter's DB0 through DB3 outputs at the status port. When D4 is high, you can read DB4 through DB7.

A second 74LS244 interfaces the other signals to the A/D converter. Bringing D3 high latches the channel address from D0, D1 and D2, and bringing D3 low starts a conversion. The delay between D3 going high and low must be at least 3 µs if your clock is faster than 500 kHz.

Bit S6 goes high when the A/D converter has completed its conversion. You can monitor S6 for a logic high that signals when the conversion is complete, or you can use the rising edge at S6 to trigger an interrupt, or

you can ignore S6 altogether and use a programmed delay, if necessary, to ensure that conversion is complete before you read the result.

Listing 6 reads all eight analog channels and displays the results. It waits for EOC to go high after each conversion before reading the result.

To test the circuit's operation, you can connect a potentiometer to each channel as shown and compare the voltage at the input with the corresponding reading. Once you've verified that the circuit is working, you can connect any sensor or other component with an output from 0 to +5 volts to each analog input.

For more information on the ADC-0808/9, see National Semiconductor's data sheet and application note #AN-247 titled "Using the ADC0808."

Parallel-Port Interrupts

The next topic is the most-involved: how to use a parallel port's hardware interrupt to automatically trigger an action by your program. You might want to use interrupts when your program needs to respond quickly to external events that occur unpredictably. Examples include a warning signal or alarm, an A/D converter's end-of-conversion signal or any signal that

tells the computer that something requires immediate attention.

Programming with interrupts is challenging for several reasons. One is that to use the interrupt in a program, you must know where the interrupt routine resides in memory. Since many programming languages, including QuickBASIC, have no way of determining this, you're out of luck entirely unless you can use assembly language, PowerBASIC or another language with the required abilities.

Another difficulty is programming errors in an interrupt-driven program that are extremely likely to crash the computer or cause other problems that won't go away until you reboot. Getting an interrupt-driven program up and running tends to take more time and effort than other programs.

A final difficulty is that although most parallel-port interrupts work in a similar way, there are enough exceptions to make it challenging to develop an application that will work on all computers.

Interrupts do have advantages, though. For one, interrupt response is fast. If you want your program to detect and respond to an event as quickly as possible, a hardware interrupt will do the job. But other things affect response time as well, including the programming language you use, the computer's clock speed and the programming code itself. So you may be able to get the speed you need without having to use interrupts.

Interrupts are also efficient. If you don't use an interrupt, the only way to detect if an external event has occurred is to check periodically. For example, you might read an input bit whose state tells you whether or not an event has occurred. If you check the bit often, you'll know quickly if the event occurred, but you'll probably waste a lot of time looking when nothing has occurred yet. If you check the bit less often, you won't waste as much time looking, but you also won't be able to guarantee a fast response. Interrupts eliminate the waste because the ability to detect the event is built into the computer's hardware.

To use the parallel-port interrupt, you must do three things: write an interrupt-service routine, or ISR, that performs the actions you desire; install the ISR by telling the computer where in memory to find it; and en-

```

Listing 6. Reads Output of ADC0809 at Status Port

CALL PortDefinitions
DO
  FOR ChannelSelect = 0 to 7
    OUT DataPort, ChannelSelect           'select analog channel
    OUT DataPort, ChannelSelect+8         'bring Start high to start
conversion
    OUT DataPort, ChannelSelect           'bring Start low &
select low nibble
    DO: LOOP UNTIL (INP(StatusPort) AND &h40)/&h40 = 1 'wait for EOC (S6=1)

    S=INP(StatusPort) XOR StatusMask      'read status port
    Bit3=(S AND &h80)/&h80*8               'save S7 as bit 3
    Bit2=(S AND &h20)/&h20*4               'save S5 as bit 2
    Bit1=(S AND &h10)/&h10*2              'save S4 as bit 1
    Bit0=(S AND 8)/8                       'save S3 as bit 0

    OUT DataPort,ChannelSelect+&h10 'select high nibble
    S=INP(StatusPort) XOR StatusMask      'read status port
    Bit7=(S AND &h80)/&h80*8               'save S7 as bit 7
    Bit6=(S AND &h20)/&h20*4               'save S5 as bit 6
    Bit5=(S AND &h10)/&h10*2              'save S4 as bit 5
    Bit4=(S AND 8)/8*8*8*8*8*8*8*8*8*8   'save S3 as bit 4

    ADCOut=Bit0+Bit1+Bit2+Bit3+Bit4+Bit5+Bit6+Bit7 'combine bits into a
byte
    PRINT "Channel ";ChannelSelect; " = ";HEX$(ADCOut) 'display ADC output
  NEXT ChannelSelect

  PRINT "Press any key to continue..."
  DO: LOOP WHILE INKEY$ = ""              wait for user to press a
key
LOOP
END

```

able the interrupt, which tells the computer to respond to interrupt signals that occur. In addition, when your program finishes executing, it should return the system to its original state by disabling the interrupt (if it was disabled to begin with), and reinstalling the ISR that was present before you ran your program. To do these, the program must save information about the original configuration before changing it.

Shown in Fig. 7 is the schematic of a circuit you can use to test your computer's ability to respond to interrupts. Pressing a momentary-action switch results in a pulse of about 200 μ s duration for triggering interrupts.

The circuit uses a 4538 dual one-shot multivibrator. The first one-shot generates a 1-second pulse, which masks extra pulses that might occur due to mechanical switch bounce as you press and release the switch. A rising edge at pin 10 triggers the second one-shot, which outputs a 200- μ s pulse. You can experiment with different pulse widths as described later, by varying RT and CT.

The output of the second one-shot

connects through a buffer or driver to S6 on the parallel port. On a printer interface, this bit is called ACK (Acknowledge), and says that the printer has received the data sent to it and is ready for more.

To test the circuit, Listing 7 installs an interrupt-service routine (ISR) that sounds a beep and displays a message when an interrupt is detected at S6. To use this circuit to generate an interrupt, press and release the switch. Listing 7 should detect one interrupt for each switch closure. Because of switch debouncing, you must wait at least 1 second between switch presses.

Listing 7 performs these actions: it saves information about the system's original interrupt settings; it installs the new ISR and enables the interrupt; and it then waits for interrupts and responds when they occur. When you press ESCAPE, the program restores the original interrupt settings and ends.

I created Listing 7 by adapting an example program called UEVENT-.BAS, which I downloaded from PowerBASIC's forum on CompuServe. Below is more on installing and using Listing 7 and other ISRs.

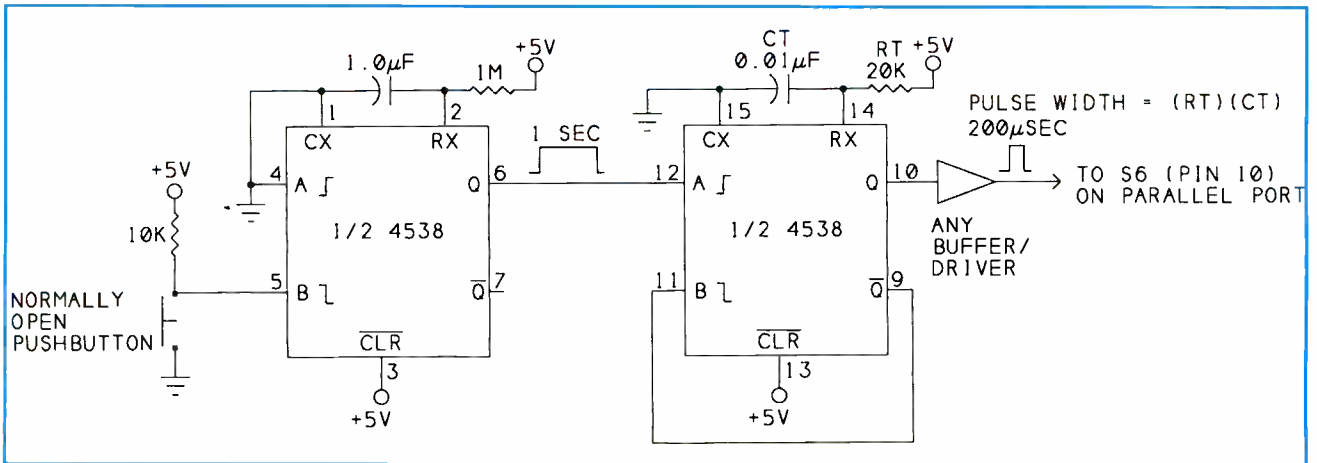

Fig. 7. Use this pulse generator to test your port's interrupt response.

Listing 7. Tests Parallel Port's Hardware Interrupt by Beeping and Displaying Message When S6 Goes High

```

CALL PortDefinitions
IntRequestNo=7                                'change this value to match your port's
                                              'interrupt-request number

IntVectorNo%=IntRequestNo+8

NewSeg??=CODESEG(ParalInt)                   'stores address segment of assembly
                                              'language ISR ParalInt
NewPtr??=CODEPTR(ParalInt)                   'stores address offset of assembly
                                              'language ISR ParalInt

Count =0

'Step 1: save original setup
OldPicMask=INP(&h21)                          'save PIC interrupt mask register
PRINT "original pic mask = ",HEX$(OldPicMask)
OldControlPort = INP(ControlPort)             'save control register
PRINT "original control register = ",HEX$(OldControlPort)

CALL GetInterruptVector(IntVectorNo%,OldSeg??,OldPtr??) 'save current
                                              'interrupt vector

'Step 2: enable the interrupt
'clear bit corresponding to IRQ# to enable interrupt on PIC
NewPicMask = OldPicMask AND (&hFF -2^IntRequestNo)
OUT &h21, NewPicMask                          'write new value to PIC's interrupt-
                                              'mask register

PRINT "new pic mask = ",HEX$(NewPicMask)

'set C4 to enable parallel port interrupt
OUT ControlPort, (OldControlPort OR &h10)

'Step 3: install the new ISR
DECLARE SUB SetUevent() 'Declare PowerBASIC internal procedure

'install the new interrupt vector
CALL SetInterruptVector(IntVectorNo%,NewSeg??,NewPtr??)
ON UEVENT gosub InterruptAnnounce            'on interrupt, call InterruptAnnounce
                                              'subroutine

UEVENT ON
'main program loop
DO:LOOP WHILE INKEY$<>CHR$(27) 'endless loop until user presses ESCAPE key

'on ESCAPE, restore original settings
'restore interrupt vector
CALL SetInterruptVector(IntVectorNo%,OldSeg??,OldPtr??)
OUT &h21,OldPICMask                          'restore PIC mask
OUT ControlPort, OldControlPort 'restore control register
UEVENT OFF                                    'turn off UEVENT response

```

Saving the Original Setup

To permit restoring the system to its original state when the program ends, the program reads and saves three values. First is the programmable interrupt controller's (PIC) mask register at port 21h. This register enables and disables interrupt requests, or IRQ0 through IRQ7. Second is the control register, whose Bit 4 must be high to enable interrupt detection at the port. The third value saved is the 32-bit starting address of the parallel port's current ISR, if any. The computer stores this address, which is called the

interrupt vector, at fixed locations in memory.

In Listing 7, the subroutine GetInterruptVector finds and saves the current interrupt vector for the IRQ level specified by the variable `Intr%`. The subroutine uses MS-DOS's software interrupt 21h, function 35h, which is intended for this purpose. The subroutine saves the interrupt vector in the variables `OldSeg??` and `OldPtr??`. In PowerBASIC, the `??` suffix indicates a 16-bit unsigned number.

You can calculate the address of an interrupt vector with the formula:

$$\text{interrupt-vector address} = (\text{IRQ level} + 8) * 4$$

The 32-bit interrupt vectors require four bytes each. For IRQ7, the interrupt vector is stored at locations 3Ch through 3Fh, and for IRQ5, it's at 34h through 37h.

Enabling the Interrupt

Several steps are involved in enabling the parallel port's interrupt. First, you must do whatever your system requires to select and enable the interrupt on the circuit board. Often, this requires setting one or more jumpers on the parallel-port card. Some ports may allow you to select and enable the interrupt from a software utility.

END

```
InterruptAnnounce:
BEEP
Count=Count+1
PRINT "Interrupt ",Count
RETURN
```

'display number of interrupts
'detected so far

```
PARAINT:
ASM PUSH AX
ASM PUSH BX
ASM PUSH CX
ASM PUSH DX
ASM PUSH SI
ASM USH DI
ASM USH BP
ASM USH DS
ASM USH ES
ASM CALL FAR PTR SetUEvent

ASM MOV AL,&h20
ASM OUT &h20,AL
ASM POP ES
ASM POP DS
ASM POP BP
ASM POP DI
ASM POP SI
ASM POP DX
ASM POP CX
ASM POP BX
ASM POP AX
ASM IRET
```

'assembly-language ISR
;save registers

;tells BASIC to run the subroutine named in an
'ON UEVENT statement on parallel-port interrupt
;reset PIC by writing 20h to Port 20h

;restore registers

```
'Set an interrupt vector by calling MS-DOS interrupt 21h, function 25h
SUB SetInterruptVector(Intr%,Segment??,Offset??)
REG 1,&H2500 + Intr%
REG 4,Offset??
REG 8,Segment??
CALL INTERRUPT &H21
END SUB
```

```
'Get an interrupt vector by calling MS-DOS interrupt 21h, function 35h
'Variables OldSeg?? and OldPtr?? contain the segment and offset
SUB GetInterruptVector(Intr%,OldSeg??,OldPtr??)
REG 1,&H3500 + Intr%
CALL INTERRUPT &H21
OldSeg??=REG(9)
OldPtr??=REG(2)
END SUB
```

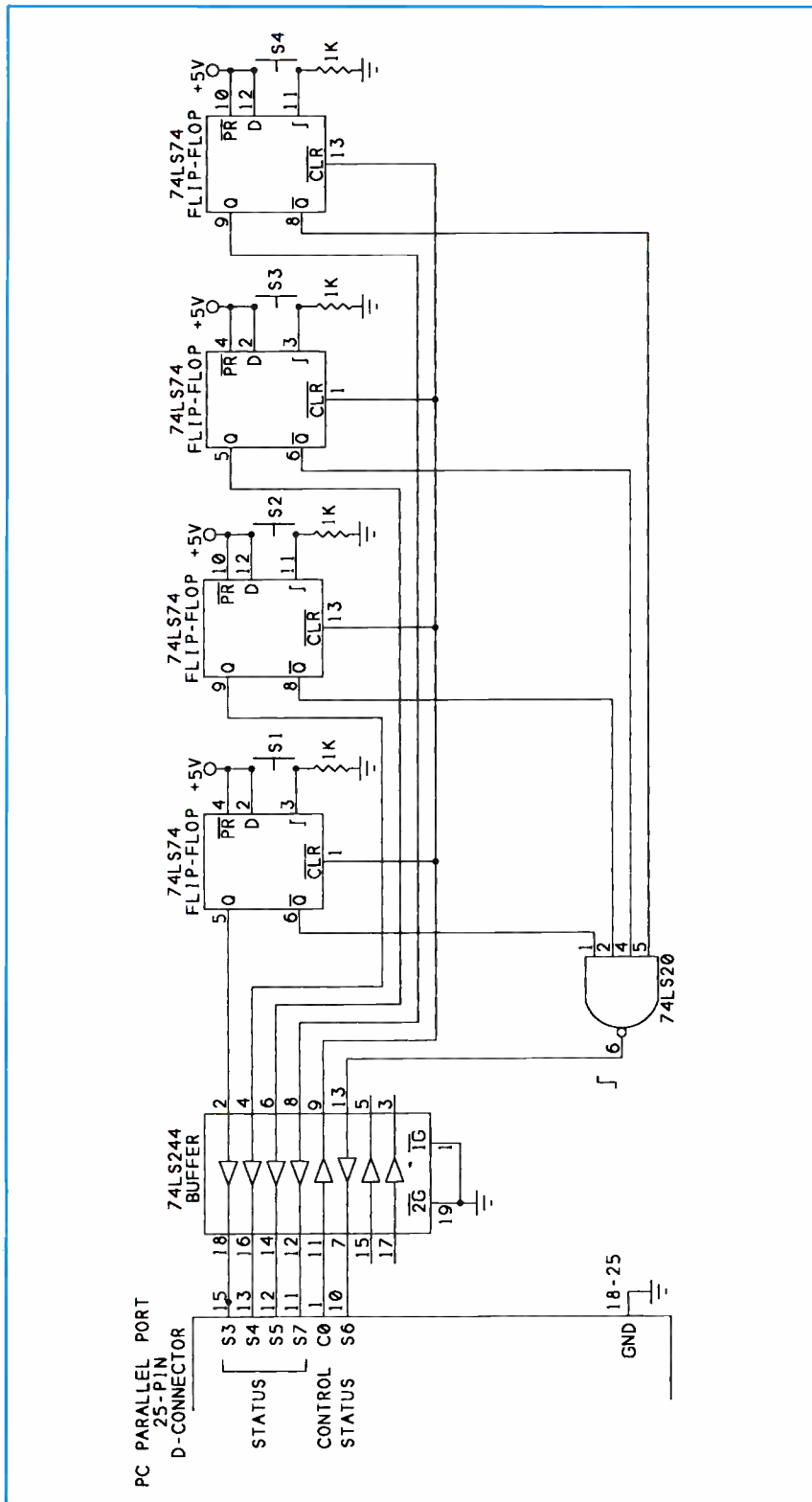

Fig. 8. This circuit generates an interrupt when any of four switches is pressed. Reading the status port tells you which switch was pressed.

Some may have a fixed IRQ number, or level, with no choice allowed. Since many printer drivers don't use interrupts, being able to print from a port is no guarantee that the interrupt

is enabled or working properly.

Table 1 lists the conventional assignments for IRQs, but you can vary from these if you need to and your hardware permits it, for example, by

assigning IRQ5 to a port at 3BCh.

The chip that ultimately detects and responds to the interrupt is the programmable interrupt controller (PIC), which originally was Intel's 8259. In later computers, a different chip may carry out the PIC's functions, though the operation should be equivalent.

Before you can use the parallel-port interrupt, you must also clear the corresponding bit in the PIC's mask register at port 21h. To enable IRQ7, you write 0 to Bit 7 at Port 21h. To avoid disaster, you must be careful to avoid changing any of the other bits in the register. This is why Listing 7 takes the value read previously, clears only the bit corresponding to the desired IRQ and then writes the new value back to the register.

Another step in enabling a parallel-port interrupt is writing 1 to Bit 4 of the port's control register. This bit doesn't appear at the port connector, but you can read from and write to it, and it must be high to enable the interrupt.

Installing the ISR

Your program won't respond to your ISR until you tell the computer where to find it. This is called installing the interrupt. The program code to do this varies with the programming language you use, but the underlying principles are similar in most programming languages.

One aspect unique to PowerBASIC is that when a hardware ISR occurs, the ISR calls a PowerBASIC internal subroutine called SetUevent. In turn, SetUevent tells the program to run the subroutine named in the program's ON UEVENT statement. In Listing 7, this subroutine is SwitchDetect. Before you can use SetUevent, you must DECLARE it. So Listing 7 includes a statement that does so.

Listing 7 installs the interrupt by calling the subroutine SetInterruptVector, which uses MS-DOS's interrupt 21h, function 25h, to store the segment and offset of the new ISR in the required locations in memory. The subroutine uses PowerBASIC's CODESEG and CODEPTR operators to find the address of the ISR. These are the critical operators that are missing from many programming languages.

In Listing 7, the subroutine PAR-INT is the ISR that executes on a par-

Listing 8. On Parallel-Port Interrupt, Reads Status Port to Determine One of Four Interrupt Sources When Added to Listing 7

```
'add these lines to the beginning of Listing 7, after CALL PortDefinitions:
OUT ControlPort,&h1E XOR ControlMask      'bring C0 low to clear the flip-flops
OUT ControlPort,&h1F XOR ControlMask      'bring C0 high to enable the flip-
flops

'change the line ON UEVENT GOSUB InterruptAnnounce to this:
ON UEVENT GOSUB SwitchDetect

'add this subroutine at the end of the program, to replace InterruptAnnounce:
SwitchDetect:
Switches=INP(StatusPort) XOR StatusMask   'read status port to find interrupt
'source
OUT ControlPort, &h1E XOR ControlMask      'bring C0 low to clear flip-flops
OUT ControlPort, &h1F XOR ControlMask      'bring C0 high to enable flip-flops
beep
PRINT "Status port = ",Hex$(Switches)
IF (Switches AND 8)/8=1 THEN PRINT "switch S1 was pressed"
IF (Switches AND &h10)/&h10=1 THEN PRINT "switch S2 was pressed"
IF (Switches AND &h20)/&h20=1 THEN PRINT "switch S3 was pressed"
IF (Switches AND &h80)/&h80=1 THEN PRINT "switch S4 was pressed"
RETURN
```

Table 1. Conventional Parallel-Port Interrupt Assignments

Interrupt Request Level	Interrupt Vector Number	Interrupt Vector	Conventional Parallel-Port Address
7	Fh	3Ch-3Fh	3BCh
5	Dh	34h-37h	378h

**Compact & Versatile
8051/8052
Microcontroller Board
For Production Applications**

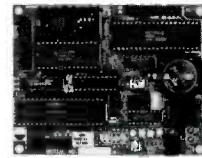

- Low power CMOS technology
- Only 3.5" x 4.5" with mounting holes
- Supports R5232 or R5485
- Battery-backed RAM socket
- Watchdog timer and power-fail interrupt circuitry
- Parallel I/O: 4 1/2 8-bit I/O ports
- Configurable for all known byte-wide devices
- 4 Jumper-Selectable Memory Maps

508-369-9556 • FAX 508-369-9549

Call for detailed brochure and quantity pricing



Binary Technology, Inc.
P.O. Box 541 • Carlisle, MA 01741



CIRCLE NO. 55 ON FREE INFORMATION CARD

**Are You Moving?
Let us know.**

Mail your subscription label along with your new address, to us, so you can be sure you don't miss a single issue.

TIRED OF WAITING FOR THE PROMPT ?

Speed up with a ROM DRIVE! Boots DOS and programs instantly. Also used to replace mechanical drive completely in controllers or diskless workstations. The only perfect protection from viruses. Easy to install half-size card.

MVDISK1 128K \$75
MVDISK2 720K 150
MVDISK3 2.88m 195

\$75

Quantity discounts!

DOS IN ROM!



\$95 EPROM PROGRAMMER

SUPER FAST PROGRAMMING
EASIER TO USE THAN OTHERS
DCES 2764-27080 (8 MEG)



WORLDS SMALLEST PC !!!

ROBOTS ALARMS RECORDERS DOS

THREE EASY STEPS: **\$27** 1K QTY
1. Develop on PC
2. Download to SBC **\$95** 5GL QTY
3. Burn into EPROM

-2 PARALLEL -LCD INTERFACE
-3 SERIAL -KEYBOARD INPUT
-PC TYPE BUS -REAL TIME CLK
-BIDS OPTION -BATTERY OR SV

FREE SHIPPING IN U.S.

5 YEAR LIMITED WARRANTY



MVS Box 850
Merrimack, NH 03054
MTWF (508) 792 9507

8088 SINGLE BOARD COMPUTER

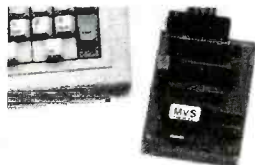

The **only** 8051/52 BASIC compiler that is **100 % BASIC 52 Compatible** and has full floating point, integer, byte & bit variables.

- Memory mapped variables
- In-line assembly language option
- Compile time switch to select 8051/8031 or 8052/8032 CPUs
- Compatible with any RAM or ROM memory mapping
- Runs up to 50 times faster than the MCS BASIC-52 interpreter.
- Includes Binary Technology's SXA51 cross-assembler & hex file manip. util.
- Extensive documentation
- Tutorial included
- Runs on IBM-PC/XT or compatible
- Compatible with all 8051 variants
- **BXC51 \$ 295.**

**508-369-9556
FAX: 508-369-9549**



Binary Technology, Inc.

P.O. Box 541 • Carlisle, MA 01741



CIRCLE NO. 73 ON FREE INFORMATION CARD

CIRCLE NO. 55 ON FREE INFORMATION CARD

allel-port interrupt. PARAINT is an assembly-language routine that calls SetUevent. PARAINT also writes 20h to port 20h, which signals End-of-Interrupt (EOI) to the PIC and enables the computer to respond to new interrupts. Neglecting to write EOI to the PIC will cause problems. The other lines of code save the values in the computer's registers and restore them before exiting the routine.

Since PowerBASIC permits in-line assembly code, you can add PARAINT to the program without separate assembly or linking steps.

If you were programming entirely in assembly language, you'd place the complete ISR in the PARAINT routine, rather than having it call another routine by running SetUevent.

SwitchDetect is the PowerBASIC subroutine that PARAINT causes to execute. For this test routine, the only actions are a beep and display of a message to let you know that the interrupt was detected. Of course, you

can elaborate on this simple test, if you wish.

The main program in Listing 7 just waits for a parallel-port interrupt. Pressing Esc causes the program to restore the original ISR and other settings and ends the program. If you quit the program by pressing Ctrl-Break, you won't restore the original settings.

Port Variations

Not all parallel-port interrupts work in exactly the same way. On the original IBM PC, when the interrupt is enabled, a rising edge at S6 triggers an interrupt. However, on the original PC and many imitators, the interrupt signal isn't latched, and these computers may not respond properly to a very brief pulse at S6.

Although the PIC on most PCs is edge-triggered, the interrupt signal must remain high until the computer acknowledges it. This may take anywhere from 10 to 100 μ s or more, depending on your computer's speed and what other interrupts the computer is servicing (which may further delay response). A 100- μ s pulse should be long enough in duration for most systems. Another option is to latch the interrupt signal externally and have your ISR clear it.

Another problem is that a few computers trigger interrupts on the falling edge of S6. In this case, you should use pin 7 of the 4538 in the Fig. 7 circuit as your interrupt pulse. An easy way to determine on which edge your system triggers is to increase the pulse width at S6 to 1 second. If you then notice a 1-second delay before your program responds to interrupts, you're triggering on the falling edge.

Getting an ISR to work the first time out can be frustrating. If you accidentally re-program the PIC or change other critical settings, your ISR and possibly other computer functions won't work right. Even if the computer hasn't crashed, you may need to reboot to return your system to restore proper operation.

Figure 8 expands on the Fig. 7 basic test by allowing you to detect when a user presses any of four switches. Each switch sets one of four flip-

Sources

PowerBASIC, Inc.
316 Mid Valley Ctr.
Carmel, CA 93923
Tel.: 1-800-780-7707 or 408-659-8000;
fax: 408-659-8008

CIRCLE NO. 152 ON FREE INFORMATION CARD

National Semiconductor
2900 Semiconductor Dr.
P.O. Box 58090
Santa Clara, CA 95052-8090
Tel.: 408-721-5000 or 1-800-272-9959

CIRCLE NO. 153 ON FREE INFORMATION CARD

flops, the outputs of which you can read at S3, S4, S5 and S7.

The -Q output of each flip-flop drives an input to a 74LS20 four-input NAND gate. When any -Q output goes low, a rising edge at S6 triggers an interrupt. The ISR then reads the status port to determine which switch was pressed and clears the flip-flops by bringing low C0.

Listing 8 includes a PowerBASIC subroutine that responds to the switch presses in Fig. 8. To use Listing 8, combine it with Listing 7, as described in the listing's comments. In a similar way, you can use Listing 7 as the base for other interrupt-driven applications, by revising the interrupt subroutine and other code as needed.

You can reach me on CompuServe at 71163,3555, on Internet at 71163.3555@compuserve.com, or by mail at Box 3374, Madison, WI 53704-0374. For a personal reply by mail, please include a self-addressed, stamped envelope. ■

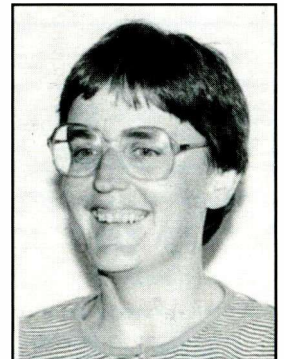

Jan Axelson

Home Study

ACCREDITED B.S. DEGREE in Computer Science

Easy-to-study lessons written by the Grantham staff, and supplied to students along with software and instructional assistance—personal help by mail, phone, fax, BBS, whatever is appropriate in each case.

You are a *class of one* when asking for assistance from your instructor, all included in the regular tuition. Professional software, no additional charge. Our emphasis is on teaching you computer science and guiding you to professional competence as well as your B.S. degree. Our degrees are accredited by the Distance Education and Training Council, Washington, DC.

Free Catalog: 1 (800) 955-2527

**GRANTHAM
College of Engineering**

34641 Grantham College Rd.
Slidell, LA 70469-5700

CIRCLE NO. 65 ON FREE INFORMATION CARD

Rolling Your Own CD-ROMs

Affordable writable CD-ROM units come of age

Until recently, CD-ROM disc production was limited to large replication houses equipped with expensive mastering and pressing machines. With the advent of CD-recordable (CD-R) media and drives that can write data to it, however, all this has changed. Golden-colored discs now open the door to myriad possibilities by making CD-ROM a two-way street on which you now have the ability to record to this CD-ROM medium. Virtually any format currently available on production discs—CD-ROM, CD-I, CD-XA, Photo-CD, audio CDs, Mac/ IBM hybrids, mixed-mode discs—can be produced on a desktop using a PC in little more time than it takes to copy the data files themselves.

A CD-R disc that has data written on it is called a "one-off" disc, a name that traces its origin to the fact that, since only single discs are created (written) in real-time, only one comes off the CD-R drive at a time. CD-R media are available in two sizes, both measured in minutes that reflect the total audio recording time they yield. A 63-minute blank can hold up to 500M of data, while a 74-minute blank holds 600M. The price difference between the two is only a couple of dollars.

Producing Your Own CD-ROMs

CD-R makes it possible for users to utilize the efficient CD-ROM medium for storing huge databases, archiving vast amounts of information and distributing hundreds of megabytes of data to other users effectively and inexpensively. The appeal of CD-R to corporate users that have multiple branches or offices in remote locations is particularly attractive.

One example of a corporate user that takes advantage of the medium is

a major distributor of automotive parts that uses CD-R to issue a monthly inventory, parts number and pricing disc to each of its 37 retail outlets in the Northeast. Several insurance companies are also sending CD-Rs that contain actuarial tables and other such data to their agents around the country. And dozens of software developers are using CD-R to prototype their programs and applications for bug testing prior to mastering and replicating them. The list goes on, limited only by the imagination. Wherever there's a need to publish, archive or distribute lots of computer data, CD-R provides a viable vehicle.

Three additional benefits accrued from producing discs in-house are that CD-R gives you full control of the disc's layout and content, it affords excellent security for protecting the integrity and secrecy of your data by keeping it all "under your roof," and it permits you to create a disc from start to finish in hours, rather than days or weeks.

Opportunities also abound for the entrepreneur with CD-R. An enterprising user with a CD-R setup can find plenty of work making limited-run CD-R discs for local businesses, by acting as a service bureau for programmers and software developers to turn their code into one-off CDs and as a service bureau for musicians and small recording studios by making audio CDs using the CD-R equipment and media. There's gold in them thar hills for the savvy opportunist, and I'm not just talking about the color of the media here.

Economies of Scale

CD-R is an economical and practical medium for any application that's most efficiently handled on optical, rather than magnetic, media and requires 50 copies or fewer to be produced. Let's look at each of these

qualifiers a bit more closely.

Because CD-ROM can hold upwards of 600M of data, it's the ideal medium for any application that requires copious amounts of storage space. Typical uses include such applications as full-motion video, high-resolution imagery (including Photo-CD images), high-quality (Redbook standard) audio, extensive graphics and animation, or combinations of any or all of these. With any application that consists of more than 30M of code, distribution on floppy diskette suffers disadvantages that include requiring a large number of diskettes, high duplication costs, lengthy and inefficient installation and the possibility of easy software piracy. CD-R does much to overcome these disadvantages.

After the purchase price of the CD-R drive unit (\$3,500 or more) is amortized, the materials cost of producing CD-R discs is determined solely by the cost of the blank media. Blank CD-R media can be had for about \$22 per disc when purchased in quantity. I'll use this figure in the following example.

In standard CD-ROM manufacturing, it generally costs about \$1,000 for the data to be mastered (transferred and metal stampers to be made), plus approximately \$2 per CD. Using these figures, the cost for 50 CD-ROMs would be \$1,100. With a CD-R unit, 50 blanks at \$22 each would also run \$1,100. Of course, nothing has been added for the labor and time involved in producing the finished CD-R discs. But this does serve to illustrate the point that for "short runs" of 50 or fewer discs, CD-R makes a lot of sense.

The special construction of the CD-R medium makes it possible to create single-copy CD-ROMs in the first place. Consequently, this is a logical place to begin our technical exploration of the subject.

Media Carries the Message

To understand CD-R media and how it permits data to be written onto it, it's best to compare it to conventional CD-ROMs to illustrate the differences. A conventional CD-ROM takes only a few seconds to manufacture, in comparison to the real-time recording of a one-off CD-R disc. A manufactured disc begins as molten polycarbonate injected into a molding machine that contains the metal matrix of the CD-ROM image. The finished product that issues from the molding machine is a clear disc that contains microscopic indentations in it called "pits." The areas between the indentations are called "lands." The combination of pits and lands makes up the binary encoding scheme that stores data on the disc.

From the molding machine, the disc is moved to the metalizing chamber, in which the pitted side of the polycarbonate disc receives a shiny 1 μ -thick reflective surface by exposing it to vaporized aluminum oxide. A CD player (drive) uses a low-powered laser that reflects the coherent laser light at different intensities from the pits and lands to a sensor that passes the signals to electronic circuitry that converts them back into data.

The pits and lands are incredibly small. A single particle of dust can obscure up to 50 pits. Consequently, protecting them is a major concern during the manufacturing process. A thin coating of optically-clear lacquer is immediately applied over the aluminum to prevent it from oxidizing. The entire manufacturing operation takes place in a "clean" room. After the lacquer coating is applied, the opposite side of the disc, which contains no readable data, is imprinted with the label information.

Both commercially-pressed and one-off CD-ROMs have some things in common. Both are based on a polycarbonate substrate, utilize pits and lands and have a protective lacquer coating on their "read" sides. The main differences are the material used to provide reflectivity for the laser light and how the pits and lands get on the discs.

Commercial CD-ROMs use aluminum as the reflective coating, which is applied as soon as the disc is pressed.

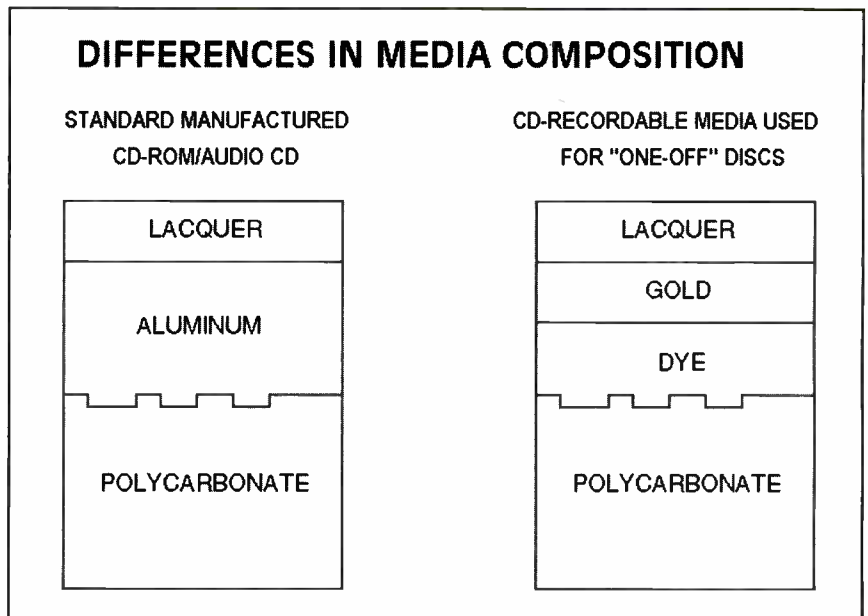

Fig. 1. Similarities and differences in composition of standard CD-ROM and CD-Recordable disc show that both discs have polycarbonate bases and protective lacquer outer coatings. Only layers in between differ.

On the CD-R medium, there's a layer of organic dye and gold sputtering over the polycarbonate substrate that's susceptible to the heat of the high-power laser inside the CD-R drive unit. The laser burns pits into the surface. Areas that aren't hit by the laser are unaffected, becoming the lands between the pits. Because gold has high reflectivity and non-corrosion characteristics, it's the material of choice for the CD-R medium. One-offs are immediately distinguishable from commercially pressed discs by their rich gold color on the label side and dark emerald green color on their data (dye) side.

The pits of a production disc are molded into the polycarbonate. With a one-off disc, they're actually burnt in with the drive's laser through a dye layer. Shown in Fig. 1 are cross-section views of both types of discs to illustrate the differences in their composition.

Cyanine and phthalocyanine are the two dyes most commonly used in producing CD-R media because of their optical sensitivity. Phthalocyanine is the more-widely-used of the two because it's properties are more stable. Cyanine is very susceptible to sunlight, which considerably shortens its shelf-life.

Another way CD-R media differs

from standard-pressed discs is that the one-off discs have grooves stamped into their polycarbonate substrates that act as guides for the laser beam. Such grooves aren't present with production discs, since the discs are replicated in molding machines, rather than being burnt in real-time.

The Hardware

Several manufacturers, including Pinnacle, JVC, Philips, Sony and others, currently offer CD-Recordable units that have suggested retail prices that range from less than \$4,000 to more than \$8,000, depending on brand and model. While all of these units will presumably do what they're supposed to do, the ease with which they do it and purchase prices make some smart shopping the rule of the day. Of the CD-R units on the market, I have first-hand experience with two. These are the Philips CDR-521 and Pinnacle RCD-202.

The Philips CDR-521 was plagued with problems that were probably due to rough handling during transit from the trade show it had been used at before arriving at my office for review. After numerous tech support calls I was unable to complete a CD-R session with the CDR-521. Then, after trashing more than a half-dozen CD-R blank discs, I gave up and returned

Table 1. Adaptec 1520A Card Factory-Default Settings

SCSI Disconnection	=	Enabled
SCSI Address	=	7
SCSI Parity	=	Enabled
Terminators	=	Installed
Terminator Power	=	Host adapter supplied
Synchronous Negotiation	=	Enabled
Interrupt Channel	=	11
AT Port Address	=	340h
AT BIOS Address	=	DC000h, Enabled
Data Transfer Mode	=	Programmed I/O

the unit to Philips for service.

With the Pinnacle RCD-202, I fared somewhat better, although my journey with it was far from trouble-free. Gary Wong, Pinnacle's chief technician, was extremely attentive and helpful in helping me work out the small problems that arose. I received four different revisions of the RCD software, each an improvement over the previous one regarding enhancing performance and/or overcoming a few problems.

The RCD-202 drive is an external unit that can be used with a Mac or PC, depending on the interface/software combination ordered with it. This is particularly attractive if you'll be doing one-offs for both platforms or if you wish to produce "hybrid" (combination Mac and PC) discs. The writable media is held in a disc caddy, which is supplied with the RCD-202.

Since all Macintosh computers have built-in SCSI ports, all that's required to use the RCD-202 with this platform

is the Mac version of the RCD software and a SCSI connecting cable. The PC installation kit is more elaborate in that it provides the software, a SCSI cable, an Adaptec 1520A 16-bit SCSI interface card, Adaptec EZ-SCSI software and a terminator plug.

Both Mac and PC versions of the RCD-202 user manual are exceptionally well-written and logically organized. So getting everything set up and ready is easy, even for a novice.

Installing It

Installation begins with plugging the Adaptec 1520A SCSI adapter into an available 16-bit slot in a PC. The half-length card has three banks of jumpers that are capped to change the card's settings. An internal 50-pin SCSI connector and an external D-shell SCSI connector are also provided for connecting devices to the card, as is a triple-bank of terminating resistors. One of the nicest features

about this card is inclusion of a red LED that lights whenever SCSI activity is going on. This LED proved to be invaluable as a troubleshooting aid.

The Adaptec 1520A card is shipped with factory default settings that work with most AT-class and later computers. The factory defaults, as shipped, are detailed in Table 1.

Such aspects as whether or not the host adapter BIOS re-routes INT19 when booting, host adapter's SCSI ID, interrupt channel and other such items are modified by changing the position of the jumper caps on these three banks. In most installations, however, everything should work without a problem or conflict when using the factory default settings.

Once the adapter is plugged in, you use the SCSI cable to connect it to one of the two D-shell connectors on the rear of the RCD-202 unit. The other D-shell connector is used for daisy chaining additional SCSI devices to the RCD-202. Also located on the rear panel of the RCD-202 are the power and SCSI ID switches. The RCD must be set to a unique ID to prevent conflicts with any other installed SCSI device on the system. A pass-through terminator is also provided with the interface kit. Whether or not it's required depends largely on the specific system configuration and what other SCSI devices may be present on the daisy chain. Attaching the power cord and turning on the unit completes the hardware aspects of the installation.

The next step is to boot your PC and run the Adaptec EZ-SCSI installation program. This program automatically scans the system bus to locate and identify the host adapter and any SCSI devices connected to it (Fig. 2). Accepting the defaults all the way through rapidly completes the installation. You then re-boot the system for the devices to be acknowledged and available for use.

Since the RCD-202 software is Windows-based, you must install it from Windows. The software installs in a couple of minutes, requiring only your name and company information to "brand" it. The opening installation screen builds your optimism by telling you that you're only a few minutes away from publishing your own discs (Fig. 3).

When the installation is complete,

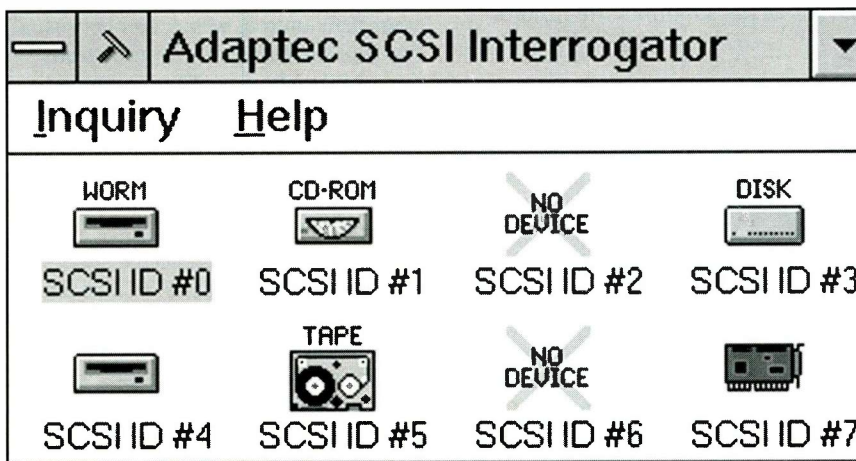

Fig. 2. Adaptec's EZ-SCSI software sets up a program group in Windows that includes SCSI interrogator applet. This handy utility shows status of all installed devices. Clicking on Inquiry provides additional information on each device. RCD-202 unit is identified as SCSI device #0 and Adaptec 1520A adapter is device #7 on this system. Each SCSI device must have a unique ID number to avoid conflicts; #2 and #6 are still available in this example.



Fig. 3. Opening install screen for the RCD-202 software. Software runs from *Windows* and is very easy and intuitive to use.

you must re-boot the PC for the configuration changes to take effect and the RCD-202 device drivers to become active.

The next step after re-booting is to run *Windows* and click on the RCD-202 icon in the newly-created RCD program group. Doing so launches the main program, from which all operations are carried out. Before you can begin using the RCD-202, however, you have to click on the ADMI manager to select it as the device of choice (Fig. 4). This has to be done only once, prior to beginning the initial RCD-202 session.

Once the Pinnacle RCD-202 is selected via the ADMI Manager, the

“action” icons become active on the main screen of the program. I call them the “action” icons because they’re the ones that get the ball rolling for recording your discs.

Having concluded the software setup, you’re ready to “burn” your first disc.

Producing a One-Off Disc

When the RCD-PC software is started, a File Manager applet is opened simultaneously with it (Fig. 5). By logging onto the desired source device in the File Manager section, you can select the subdirectories and/or

individual files or groups of files you wish to write as a CD. The operation is as simple as dragging and dropping using File Manager for any other file moving or copying operation. Hence, there’s no learning curve for using the software.

A few words about the differences between DOS-legal and ISO-9660 file names are in order here. Some characters that are acceptable in DOS file names, such as the hyphen, aren’t permitted according to the ISO-9660 standards.

The RCD-PC software automatically suggests a legal ISO-9660 name for the file (Fig. 6), or, if you prefer, you can override the ISO stipulation and proceed with the DOS filename. The override feature is very handy, especially if you’re copying programs that will look for subordinate data files, such as libraries or database records, that use these “reserved” characters. Without the ability to override the ISO-9660 names, some programs would bomb or stop when they fail to find the file by the name expected.

Once the filenames have been substituted or overridden to make everything acceptable, you have the option of storing the assembled “image” for further editing or writing to CD-R at a later time (Fig 7). Of course, you can proceed with processing and writing at this time as well.

When you click on the REC button (Fig. 8), you initiate the process of writing to CD-R. You’re presented with a screen asking you to select your data source, which can be virtual file transfer (directly from the transferred File Manager files), a stored image file, a direct transfer from another SCSI device that already has an ISO-9660 image format, such as a CD-ROM, or a cue sheet for “cutting” an audio CD.

When you’ve specified the source of the data for your transfer, you’re presented with the options to fix, mount and optimize the file image (Fig. 9). These options defragment files, put the data in logical contiguous order and do other little bits of file-management housekeeping to ensure that the data transfer proceeds as smoothly and quickly as possible when writing to the disc. You can also specify the number of duplicate discs you wish to burn from this data at this session.

Prior to actually burning the data

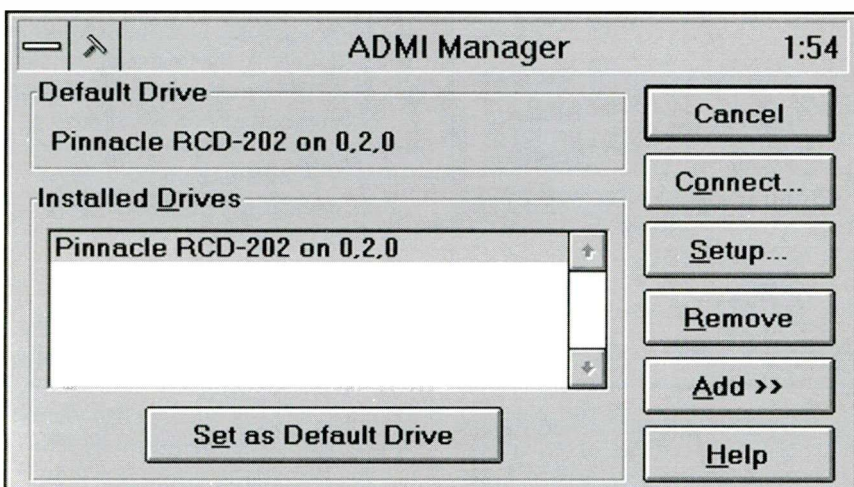

Fig. 4. ADMI Manager must be invoked from the RCD-PC program when beginning initial RCD session to select RCD-202 as default device for making CD-ROMs.

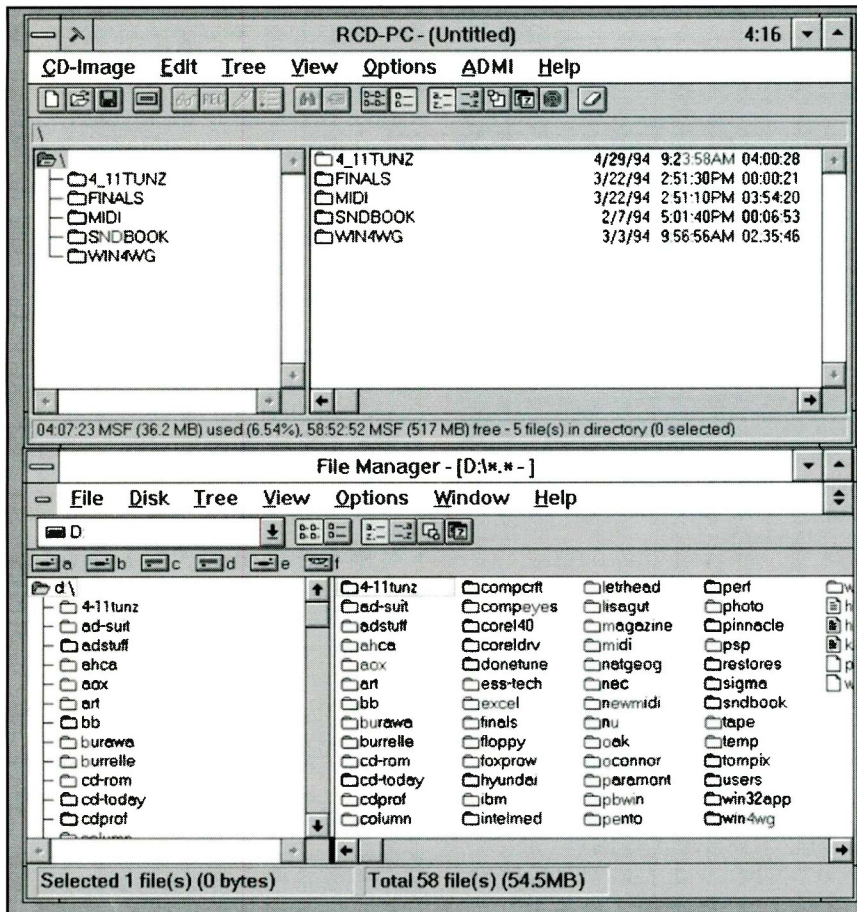

Fig. 5. Clicking on RCD-PC icon brings forth application and invokes a File Manager applet. After logging on to desired file source drive, you drag and drop desired files/subdirectories into RCD-PC file area as first step of transferring them onto a writable CD disc.

into the CD-R's surface, you can run a test to make sure that everything is in order. The test is also valuable to ensure that your source device can transfer the data at a rate fast enough to keep up with the RCD-202. From

the Write screen (Fig. 10), you're also given the options of verifying the data after it's written, finalizing the disc, prohibiting data copy by placing an archival attribute on the files and displaying a progress meter as the test/

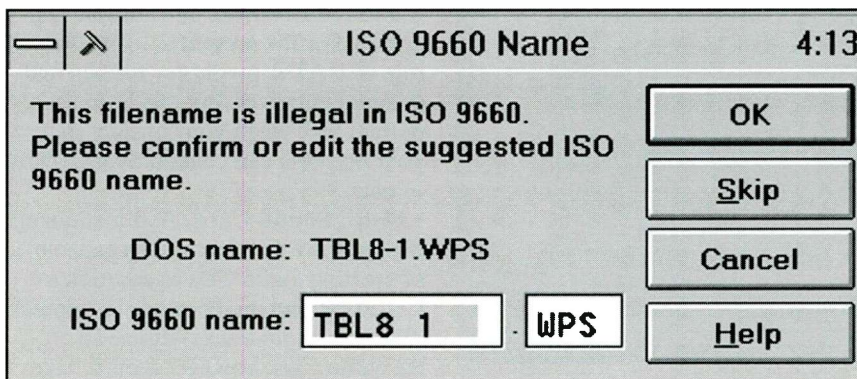

Fig. 6. Certain characters, such as the hyphen, are acceptable in DOS filenames but are illegal according to ISO-9660 standards. RCD-PC software automatically alerts you to any illegal names encountered, provides a suggested alternative name or gives you opportunity to skip it and take other courses of action.

transfer takes place. If you don't finalize the disc, additional sessions can be written to it at a later time. There's also a provision for including UPC (Unique Product Code) number information on the disc.

When you're satisfied with the test, you merely click on Write, and the actual data transfer and burning process commences. Depending on the amount of data you'll be writing and the speed of your host system and source device, you should be able to write and finalize a 600M disc in about an hour. The finalizing process merely closes the table of contents on the disc and sets up write-protect bits to prevent any additional data to be written to the disc. This takes about 5 to 8 minutes after the data is actually transferred.

Creating an audio CD is almost identical to creating a data disc, except that all of the audio material must first be converted to 16-bit, 44.1-kHz format .WAV files if it isn't already in this format. A .WAV utility, included with the RCD-PC software, handles the conversion automatically for you.

Audio files for transfer are assembled in the desired order via a cue sheet (Fig. 11). Again, the same drag-and-drop method is used for selecting the files from the source and placing them in the cue sheet. Audio discs produced with the RCD-202 can be played on any audio CD player and a CD-ROM drive. Cutting CD "demo" discs for local bands and other audio applications can be a lucrative means of amortizing the expense involved in procuring a CD-R setup.

One-off audio and data CDs are perfectly acceptable as sources for mastering and mass-replication should you eventually need more than 50 copies of a disc. In fact, they're the preferred medium for supplying data for replication, and many mastering and replication plants offer a discounted price on their services for data supplied on CD-R media.

If you'd like to get additional information on mastering and replicating costs and specifications for data or audio CDs, Nimbus Information Systems is one of the leading companies in this field. Contact information is supplied at the end of this article.

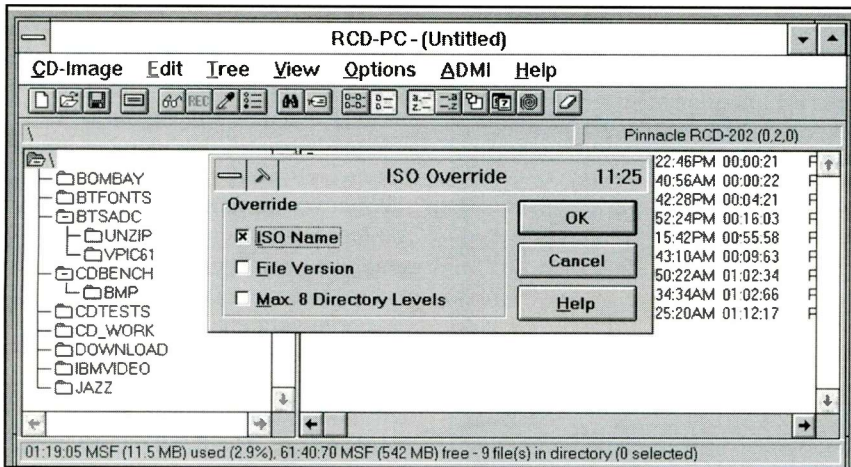

Fig. 7. Options menu provides you with ability to override several ISO-9660 restrictions that aren't present in DOS file handling. This feature is very handy for creating discs that conform to DOS operating standards.

Putting it Together

There are some other items you'll need in the way of equipment to utilize the RCD-202 (and any other CD-recording device, for that matter) effectively and efficiently. I'll cover each one individually, though briefly.

• **PC system.** Even though Pinnacle recommends a 386/33-MHz machine with 4M of RAM as its base platform, for doing CD-R work, you'll want to use an 80486-based system running at a minimum of 25 MHz and equipped with at least 4M of RAM, which is

just a marginal base-level system. For respectable performance, I'd recommend at least a 486DX33 with 8M or more of RAM available. Don't forget that the software is running under *Windows*. So you'll want to have as much speed and muscle available as possible. I've found an IBM Value-Point DX2/66 with 12M of RAM to be a great platform for CD-R, although I wholeheartedly recommend a setup like the Gateway 2000 P5-60 Pentium system with 32M of RAM shown in the cover photo as the way

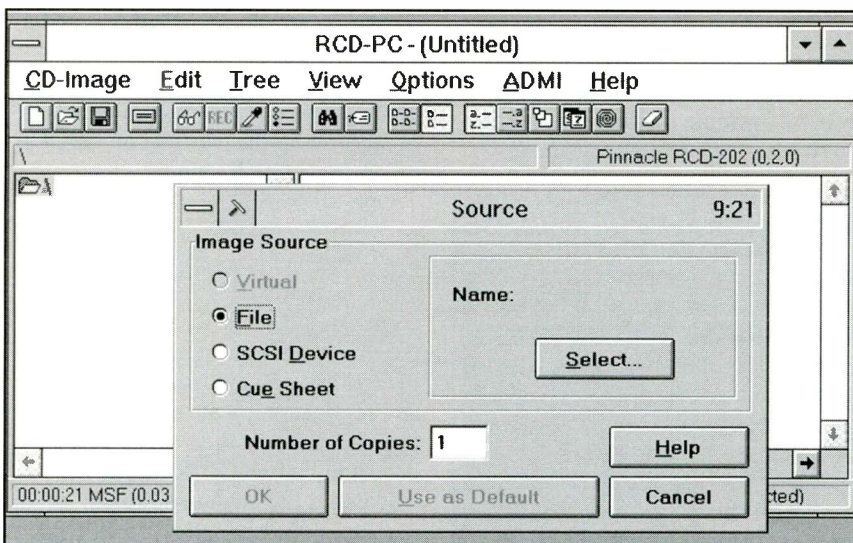

Fig. 8. Clicking on REC button initiates CD-R writing process, which first asks where source data is to come from. If no files have been dragged and dropped into RCD-PC file manager window, Virtual option is unavailable. Stored file images and other SCSI devices with legal ISO-9660 images. Cue-sheet files can also be used as source of data for transfer to CD-R.

to go if you can afford it. Having used this setup, I can attest to its snappy performance and greatly enhanced throughput.

• **Hard Drive.** Since the RCD-PC software and the entire *Windows* system must reside somewhere, an internal hard drive with decent storage capabilities is mandatory. The minimum hard-disk size should be 200M, with larger capacities being preferable. The reason for this is that you'll probably want to store CD-ROM image files and other temporary files (such as audio "cue" sheets) on the system disk to leave the other system storage devices free and uncluttered to hold the actual data to be transferred to CD-R.

• **SCSI Hard Drive.** A high-capacity and high-speed SCSI drive is required for transferring your data to CD-R. A minimum of 0.5G is called for here, with 1G or larger being the preferred way to go. In addition to capacity, make sure you get the fastest access time possible (15 ms or less) on the drive. I can't stress the importance of this enough. A drive that has a slow access time probably won't have a transfer rate fast enough to keep the CD-R data buffer full. This is a problem I ran into several times during my initiation into rolling my own CDs until I purchased a faster SCSI drive.

• **DAT Drive.** An ounce of prevention is worth a pound of cure, and a good DAT drive will give you lots of peace of mind by creating safe copies of your CD-R image data. At the time of this writing, the RCD-202 doesn't support DAT tape drives for direct data transfer, except the Exobyte unit. However, by the time you read this, 4-mm DAT formats may also be supported. For the present at least, the role of DAT is purely for backup and archival purposes, but this is an important task when you consider that your one-offs can contain over 0.05G of data.

• **16-Bit Sound Card.** As I mentioned earlier, the RCD-202 is also capable of creating audio CDs in addition to CD-ROM and mixed-mode (computer data plus audio tracks) discs. To create audio CDs, however, you'll have to prepare your source material by recording it at 44.1 kHz with a 16-bit sampling rate to produce .WAV files, and to do this, you'll need a decent sound card capable of recording 16-

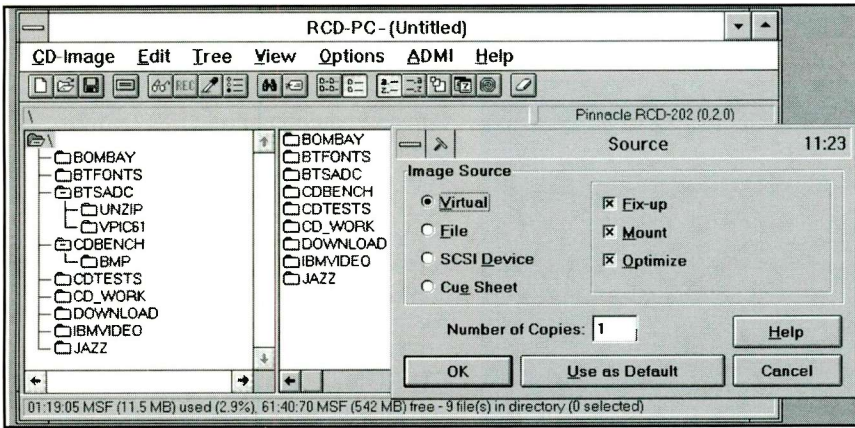

Fig. 1-9. After telling program what data source will be for this session, it provides options to fix, mount and optimize file "image" for best data transfer. You can specify number of discs you wish to make of this data from this screen as well.

bit sound at 44.1 kHz. I should also note that stereo sound at this rate takes approximately 10M of disk space per minute. So if you're going to record a 45-minute audio CD, for example, you'll need at least 450M of free space on the SCSI drive to hold the .WAV files, plus several additional megabytes to hold the cue sheet data and other miscellaneous files. By now, the need for a large-capacity SCSI disk drive and the insurance a DAT drive can provide should be quite apparent.

• **Blank Recording Media.** It makes sense to keep several blank CD-R discs on hand and to make sure you

have some DAT cartridges available before you start doing a CD-R session. Blank CD-R discs will undoubtedly come in handy if you encounter an error during the recording process, which isn't an unheard-of occurrence. One of the most annoying and frustrating things that can occur is to have all your files queued up, run a test to make sure everything is okay and start recording, only to have a blip in the current, a bad spot on the disc, a "data buffer empty" or other error occur that stops you cold. In many instances (depending on the type of session you're doing), once the writing process has begun and is abruptly inter-

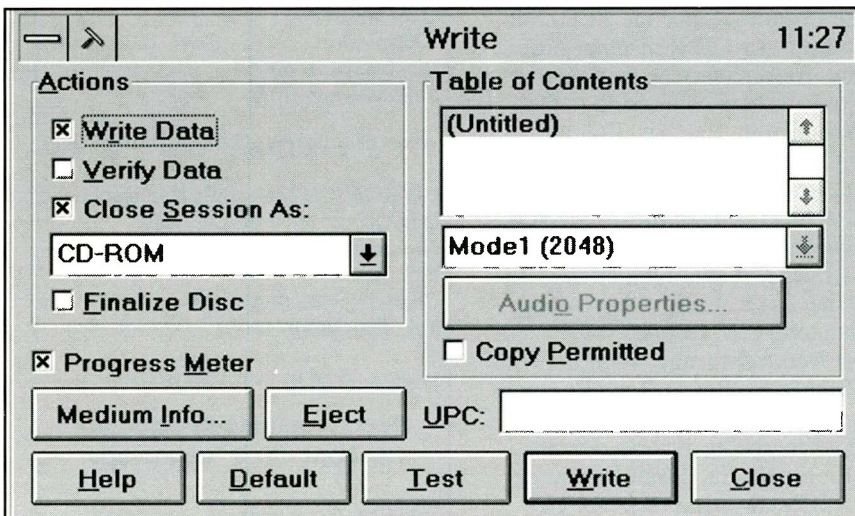

Fig. 10. Write screen permits you to test session before actually writing data to CD-R media. During test, RCD-202 goes through all motions of transfer, except that it doesn't turn laser on to burn in pits. Medium Info button on this screen provides information about disc currently in RCD-202, such as how much space is available, what types of data it may already contain, and number of sessions already written to it.

DC/CAD

introducing . . .

THE TERMINATOR

Super High Density Router
(Complete with Schematic & PCB Editor)

Features the following powerful algorithm & capability:

- No copy protection
- Rip-up Retry
- Pre-routing of SMT components
- User defined strategies
- Real-Time clean up and via minimization
- Window 3.0 capability as DOS Task
- 1-mil Autoplacer and Autopanping
- Two-way Gerber and DXF
- Automatic Ground Plane w/Cross-Hatching
- Complete w/Schematic & Dolly Libraries
- Optional simulation capability & enhanced mode for 386 users

Call for DC/CAD
Price range: \$295-\$2,500
*Promotional Offer
Now Available*

PCB LAYOUT SERVICE AT LOW COST
LEASE PROGRAM & SITE LICENSE AVAILABLE

**DESIGN
COMPUTATION**

1771 State Highway 34, Farmingdale, NJ 07727
(908) 681-7700 • (908) 681-8733 (FAX)

"DC/CAD . . . The focal point of future CAD market"

CIRCLE NO. 61 ON FREE INFORMATION CARD

The Pocket Programmer

Only \$129.95

The portable programmer that uses the printer port of your PC instead of an internal card. The software has 24 functions and programs Eprom, Flash & Ram 27/28(C)XXXX from 16K - 8Meg (2k-1Meg X 8) with a 32 pin socket. Adapters available for 874X, 875X MCU's, 40-Pin Eproms, Serial Eproms and Eprom Emulation to 32K X 8.

Mac EZ Programmer

The Only Eprom programmer made for Macintosh. The software has 15 functions including File Editing with a 32-Pin socket supports Eprom, EEprom (27/28(C)XXX) and Dallas Ram from 16K-4Mega Bit. **Only \$299.95**

Intronics, Inc.
Box 13723
Edwardsville, KS 66113
Tel. (913) 422-2094 Fax (913) 441-1623
Add \$4.00 Shipping Add \$4.50 COD
VISA/Master Charge Accepted

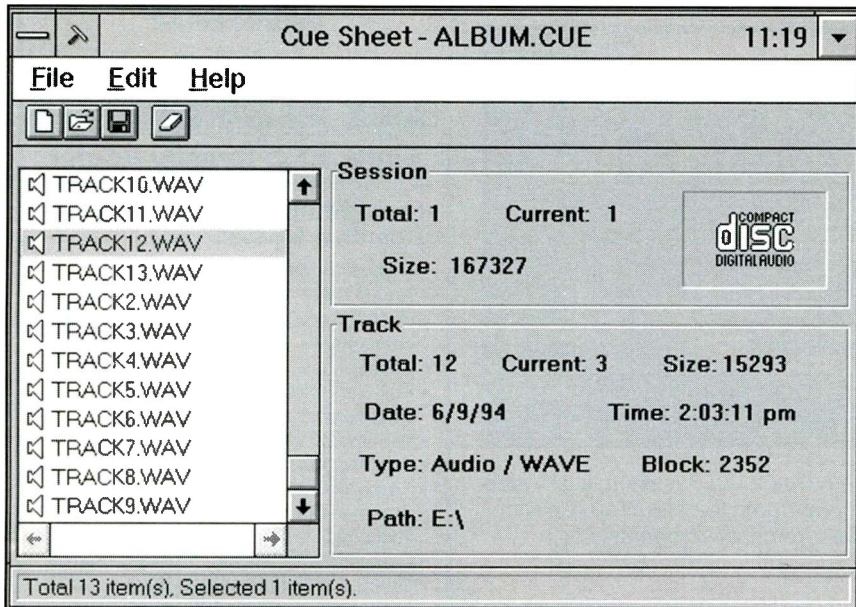

Fig. 11. Audio CDs can also be created with the RCD-202. Audio files must be 16-bit, 44.1-kHz .WAV format, and an included .WAV utility automatically converts files to this format. Files to be transferred are assembled via a "cue sheet" to put them in desired order. Other procedures, including running a test before actually writing files to CD-R, are identical to those used in producing a data disc.

In Sum

Clearly, producing CD-ROMs, audio CDs and other format compact discs isn't for everyone due to the expenditure and equipment required. However, if you need to produce discs for your own use, this technology can, indeed, be a boon. For more-enterprising users, the technology can both serve their own needs and generate additional income by producing discs for other paying customers.

CD-R has much going for it and, as CD-ROMs continue to gain widespread acceptance and become a standard medium for data delivery, the role CD-R plays will become increasingly important. ■

PRODUCTS MENTIONED

Pinnacle RCD-202 CD-R Drive
Pinnacle Micro
 19 Technology
 Irvine, CA 92718
 Tel.: 800-553-7070

CIRCLE NO. 154 ON FREE INFORMATION CARD

CD-R Blank Media, DAT Tape, Other Media
DIC Digital
 500 Frank W. Burr Blvd.
 Teaneck, NJ 07666
 Tel.: 201-692-7700

CIRCLE NO. 155 ON FREE INFORMATION CARD

Caddies, CD TurnFiles, CD-R Blank Media
QB Products
 1260 Karl Ct.
 Wauconda, IL 60084
 Tel.: 800-323-6856

CIRCLE NO. 156 ON FREE INFORMATION CARD

CD-ROM/CD Mastering, Replication, One-Offs, Publishing Services
Nimbus Information Systems
 P.O. Box 7305
 Charlottesville, VA 22906
 Tel.: 800-782-0778

CIRCLE NO. 157 ON FREE INFORMATION CARD

Recommended Reading on CD-ROM, CD-R Technology:

Welcome To...CD-ROM
 By Tom Benford
 MIS:Press, 264 pages, \$19.95

The CD-Recordable Bible
 By Ash Pahwa, Ph.D.
 Eight Bit Books, 185 pages, \$24.95

Analog and Digital I/O from Your PC/Clone Printer Port

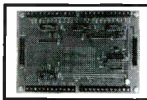

Can be cabled together for additional I/O. Easily programmed in BASIC or C. Disk with examples included.

M2801 (shown above)
 (4) 0-5V 8 bit analog inputs
 (1) 0-5V analog output
 24 bits digital I/O
 2 sq. in proto area
 Requires 5V at 50mA
 Terminal strip for easy connection
\$99.95
 \$134.95 w/cabinet & cable

M2802 (not shown)
 8 5A SPDT relays
 Relay "on" LEDs
 Terminal strip for easy connection
 Requires 5V at 800mA (all relays on)
\$99.95
 \$134.95 w/cabinet & cable

80C52-BASIC Microcontroller

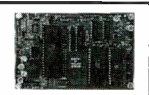

BASIC interpreter
 32K RAM 8K/16K EPROM
 RS232 terminal & printer interface.

Save BASIC programs to EPROM with on board programmer. 40 pin expansion connector. Piggy back to perf board with user circuits. Bare board \$22.95
 Assembled and tested \$104.95
 MD residents include sales tax

Check, MO, company PO

Prologic Designs
 Baltimore, MD 21204
 P.O. Box 19026
 410-661-5950

CIRCLE NO. 85 ON FREE INFORMATION CARD

rupted, that disc becomes a candidate for the garbage pail since it can't be used again. (You can't pick-up where the error occurred and continue.) There's also some economy to be realized by buying the blank media (both CD-R and DAT tape) in quantity, since many suppliers provide case discounts. Depending on how much recording you'll be doing, the savings can be substantial.

- **Disc Caddies.** Since the RCD-202 and most other CD-R machines use caddies for disc serving, it's a good idea to have several on hand to facilitate production. Caddies offer the added benefit of protecting the CD-R media when it isn't in the drive, since the dye (data) side of the disc is vulnerable to both strong light sources and scratches, both of which may impede the disc's ability to have data written to or read from it.

- **Disc Access/Storage.** Working with CD-ROMs, blank CD-R media, audio CDs and other disc formats is easier done when you have some organization for the media. Several manufacturers offer trays and racks for CD storage, although my personal favorite is the lazy Susan TurnFile that optimizes precious desktop real estate. The four sides of the TurnFile make it easy to segregate the blank from written media, audio from data ROMs, etc.

Genealogy On Computers

Trace your family tree with a PC

Genealogy, the study of one's family tree, is a rapidly-growing hobby. Not long ago, family histories were written exclusively from mountainous stacks of notes, photocopies of old records and such. This resulted in much tedium and difficulty when trying to organize a comprehensive family history. Computer genealogy makes this pursuit a lot easier. Dozens of genealogy software packages are on the market, available as both commercial packages and shareware. Before you rush out to purchase one to input thousands of names into your genealogical database, however, you should be armed with some important information on genealogy. I'll cover such details in this article.

Before I get down to the nuts and bolts, you should familiarize yourself with the term GEDCOM, which stands for GENEalogical Data COMmunication, and what it means in the genealogical software area. GEDCOM was developed by the Projects and Planning Division in the Family History Department of the Church of Jesus Christ of Latter Day Saints. This ASCII-based standard permits transfer of data from one program to another. There are well in excess of a dozen programs that permit GEDCOM transfer, and the few that did not have it before are now getting into the act. This being the case, the best advice I can offer up front here is: Don't buy any genealogical software that doesn't support GEDCOM.

What makes GEDCOM so appealing is that it lets you move your data from program to program until you find the one(s) with which you're most satisfied. Especially enjoyable is swapping GEDCOM files with other researchers, permitting multiple parties to add hundreds of ancestors to their files with just a few keystrokes.

Genealogy Software

Though there are dozens of decent

genealogy programs on the market, in this article I'll elaborate on just two. These are *Personal Ancestral Files* and *Brother's Keeper 5.1*.

Personal Ancestral Files is available for \$35 from the LDS Church, 50 E. Temple, Salt Lake City, UT 84150 (tel.: 800-537-5950). This excellent, easy-to-use and powerful genealogy program is completely menu-driven and has a help feature and extensive documentation. There are also more than 100 utilities/add-ons (mostly shareware) designed specifically for *PAF*. Popular for its quick search and sort capabilities and ease of entering and appending ancestral information, *PAF* comes highly recommended by this author.

Brother's Keeper 5.1 is shareware that carries a registration of \$45 and can be obtained from John Steed, 6907 Childsdale Rd., Rockford, MI 49341. This program holds up to one-million names and generates some interesting and attractive reports, such as box pedigree charts, Tiny Tafels (more on this later) and register reports in narrative form from your data. Not quite as easy to use as *PAF*, *BK* offers more options and nicer printouts.

Here are a few additional GEDCOM-compatible genealogy programs:

Everyone's Family Tree
The Dollarhide Systems, Inc.
 203 W Holly St. - M
 Bellingham, WA 98225
 Tel.: 206-671-3808

Family Reunion
FAMware
 41580 E Dawn Dr.
 Salt Lake City, UT 84121

Family Origins
Parsons Technology
 One Parsons Dr.
 PO Box 100
 Hiawatha, IA 52233-0100

Family Scrapbook
Christopher E Long
 632 Camelia St.
 Atlantic Beach, FL 32233

Family History Centers are genealogy-oriented libraries that are maintained by the Church of Latter Day Saints (the Mormons) in hundreds of locations across the US. Here you'll find a wealth of books, periodicals, microfilms and microfiches that are chock full of ancestral information. The FHC's big attraction is its computer systems equipped with CD-ROM discs crammed with data that can be printed to hard copy or transferred to floppy disk and then added to your personal genealogical database. Researchers are permitted one hour per day on the computer, and you'll probably have to sign a register and wait your turn. Records are searched by ancestor surname, either by exact or similar spelling. You can also limit a search to names within a specific geographic or time frame.

Here are some CD-ROM discs at the FHC:

- **Social Security Death Index** contains listings for 39.5-million people whose deaths were reported to the Social Security Administration, mostly between 1962 and 1988. These are listed by name at time of death, date and place of birth and death and Social Security number. You don't need the ancestor's Social Security number because searches are by name.

- **International Genealogical Index** is a compilation 187-million names garnered from such records of events as birth, death and marriage from a variety of sources. *IGI* records are available on microfiche for photocopying and can be transferred to floppy disk in GEDCOM or ASCII format.

- **Ancestral File** contains 14-million names submitted by LDS and non-LDS church members. Especially attractive here is inclusion of linked ancestral pedigrees, often spanning several generations. Also listed are the name and address of the person who submitted the records, allowing you to contact him or her for further exchange of information. You can trans-

Table 1. Breakdown of Tiny Tafel Data Line

Column	Description
1 thru 4	Soundex code
5	Space delimiter
6 thru 9	Earliest ancestor birth year
10	Interest flag for earliest ancestor
11 thru 14	Latest descendant birth year
15	Interest flag for latest descendant
16 thru 16+SL	Surname string area (SL = total surname length)
Above+PL	Place name area (PL = total place name length)
Above+1	Carriage Return

fer this to GEDCOM or ASCII text.

Genealogy bulletin-board systems provide a great way for you to get in touch with other researchers and to stumble upon long-lost cousins you never knew existed. Most commercial BBSes (Genie, Prodigy, CompuServe, *et al*) have areas for genealogists. The National Genealogical Society Computer Interest Group (4527 17th. St. N., Arlington, VA 22207-2399; tel.: 703-528-2612 Fido 1091/302) has a free BBS system that connects genealogists worldwide via Fidonet.

Tiny Tafel (tiny table) displays family surnames in an easy-to-search format, along with other pertinent information. An excellent way to display a cross-section of genealogical names is to generate a Tiny Tafel and upload it to a BBS. Submitter names and addresses are listed at the top of the Tafel for contacting purposes. *Brother's Keeper* and *Family Scrapbook* are two of a number of programs that will create a Tiny Tafel for you.

Tiny Tafel

One of the nicest things that can happen to any genealogical researcher is for him to find that someone else is researching his line, perhaps a long-lost cousin, who has information to share with him. Suddenly he has family lines that he may never have found or may have taken years to locate by himself. The fastest, easiest and most-efficient way to let others know what families you're researching and to find others who are researching your ancestry is through the Tiny Tafel.

A Tiny Tafel is a chart created specifically to list genealogical research data in a compact format that can easily be scanned by the eye or a computer. The Tiny Tafel format was first defined by Paul Andereck. It was later

refined and formalized by Commsoft Corp. (Commsoft, 2257 Middlefield Way, Mountain View, CA 94903) and presented as a specification for its Tafel Matching System.

An example of a Tiny Tafel follows:

```
N Tom Stevens
A P.O. Box 4858
A Elkhart, IN, U.S.A.
A 46514-0858
S Fidonet 1:227/2
B Peppergrass Express (219) 674-0056
C //Zmodem
D /MSDOS/360-1.4
F Personal Ancestral File v2.2
R This it may be freely distributed
Z 333 Tiny Tafel Editor v2.10
B424 1821*1971*BLACKALL\,Butler, OH,
USA/Scottsburg, Scott, IN
H463 1739*1960*HILLIARD\Easton,
Northampton, PA, USA/,Noble, IN
M622 1827*1950*MARCHESSEAU\CANA-
DA/Elkhart, Elkhart, IN
M463 1600*1942:MILLARD\ENGLAND/
San Antonio, Bexar Co., TX
W 28 Dec 1993
```

Each non-surname line in a Tiny Tafel is prefaced by a significant letter, as in:

```
N Tom Stevens
```

This is the mandatory first line of a tiny tafel, which contains the name of the person who has custody of the data. If a Tafel doesn't start with the letter "N," the Tafel matching system won't recognize the file as a Tiny Tafel.

Optionally, up to five lines can be entered as an address, such as:

```
A P.O. Box 4858
```

Other optional header lines include:
T—Telephone number (including area code)

S—Communication Service (Fidonet, CompuServe, Internet, etc.)

B—Bulletin-board telephone number (including area code)

C—Communications (baud rate, protocol, etc.)

D—Diskette format (size, format, capacity)

F—File format (*PAF 2.2*, *Family Scrapbook 2.0*, etc.)

R—Remarks

Z—This is the other mandatory last header item that contains the number of data items, such as database name, etc.

The data lines appear like this:

```
M622 1827*1950*MARCHESSEAU\CANA-
DA/Elkhart, Elkhart, IN
```

This translates to "I am very interested in my research on the MARCHESSEAU family from 1827 to 1950, starting in Canada and ending in the city of Elkhart, Elkhart County, Indiana."

Table 1 is a columnar breakdown of the Tiny Tafel data line.

The Soundex Code is used to represent surnames based on how they sound, rather than how they're spelled. In the 1930s, previous US census records were indexed using the soundex system. A name like Marchesseau is often misspelled. The soundex displays the various spellings of a surname as one group. A soundex code consists of the first letter of the surname, followed by three Numbers that correspond to the remaining surname characters as follows:

```
1 = B,F,P,V
2 = C,G,J,K,Q,S,X,Z
3 = D,T
4 = L
5 = M,N
6 = R
```

The letters A, E, H, I, O, U, W and Y aren't used. Duplicate letters (ss, rr, etc.) are coded only once. If all letters were used before three numbers are generated, 0s are added.

Most decent genealogical programs feature a soundex code generator. There are also several shareware programs that can do the job, such as Chris Long's *SNDX200*.

The two Interest Flags note how interested you are in both the earliest ancestor and the latest descendant of a

Table 2.
Tiny Tafel Interest Flags
Details

Flag	Priority	Level
[space]	no interest	0
.	low interest	1
:	moderate interest	2
*	highest interest	3

given line. The flags are given in Table 2.

The surname is then followed by birth locations. The \ (backslash) prefix represents the birthplace of the earliest ancestor and the / (forward slash) prefix represents the birthplace of the latest descendant.

Creating a Tiny Tafel

Besides typing your Tiny Tafel manu-

ally, two excellent genealogical database programs, *Brother's Keeper* and *Family Scrapbook*, can automatically create Tiny Tafels. If your genealogy program doesn't generate Tiny Tafels but can export to GEDCOM, use the shareware *GED2TT* program (registered copy is \$20 from Andy Koppenhaver, 13224 Old Chapel Rd., Bowie, MD 20720) to convert a GEDCOM file to a Tiny Tafel.

Another shareware product, *TTGEN* (registered copy is \$15 from Tom P. Douglas, 753 E. Walden CT, Highlands Ranch, CO 80126) helps you create a Tiny Tafel and checks your work to be sure your Tafel matches specifications.

A highly recommended tool for anyone who works with Tiny Tafels is the shareware *Tiny Tafel Editor* (registered copy is \$15 from Visionary

Endeavors, PO Box 330439, Atlantic Beach, FL 32233-0439). Not only is this a fine Tiny Tafel editor, it also features an indispensable matching system. The *Tiny Tafel Editor* matching system allows you to compare your Tafel with literally thousands of others and generate a report of any matches that include the surname lines, contact names and addresses and BBS/communications services, if available, to exchange genealogical data electronically. It also has lots of information about how and where to use your Tiny Tafel.

Fidonet is the largest BBS network in the world, with more than 23,000 computer systems linked together. A specific genealogy echo on Fidonet is known as GenData. The GenData echo is reserved exclusively for Tiny Tafels. When you upload your Tiny

Table 3. TMS Node List as of 09/18/93

Node	BBS Name and Location	SysOp	Telephone No.
104/330	Root Cellar Too!l, Littleton, CO	Charles Simpkinson	303-770-3217
363/18	Cornucopia TBBS, WinterPark, FL	Jim Howard	407-645-4929
114/22	Rare Readers, Tempe, AZ	Ron Stalzer	602-756-2855
125/30	Roots(SF!) San Francisco, CA	Brian Mavrogeorge	415-584-0697
271/300	Relatively Speak', Williamsburg, VA	Hershel Kreis	804-566-0219
209/720	The Gene Splicers BBS, Las Vegas NV	John Le Duc	702-731-9453
105/212	Northwest Genealogy BBS Tualatin OR	Gary Roth	503-692-0927
105/222	N.W. Family Hist., Oregon City, OR	Wayne Silsbee	503-657-6578
370/70	Options Unlimited, Athens, GA	Ben Bedell	706-543-5468
112/8	River City Roots, Jacksonville, FL	John Boots	904-384-1407
106/117	PasTracks Genealogy, La Porte, TX	Edward Hayden	713-470-8657
106/270	TRACE!, Houston, TX	Susan King	713-862-6400
109/422	CPAFUG, Columbia, MD	Walter Anderson	301-989-8960
264/152	Intercity BBS, Richmond, VA	Tyronne Foy	804-353-4160
274/33	RamsGateWest, Fredericksburg, VA	Gary T. Moore	703-898-4821
3639/16	Visions_Past and Pr. Spartanburg, SC	Mike Champion	803-587-9133
3647/3	Vangaard Keep, Sumter, SC	Derek Cosby	803-469-3184
109/465	The Relative Connection,	Chuck Haine	301-762-6813
280/9	So of the River BBS, Overland P, KS	John Schnake	913-642-7907
159/525	Colonial Family Rsrch, Lansing, MI	Bill Korroch	517-882-0717
234/29	Northwest Ohio Roots, Vanlue, OH	Bob Wells	419-387-7393
250/414	OGS/Kintracers, Toronto, Ont.	Ray Whidden	416-932-9781
154/501	City-Flags Genealogy, OakCreek WI	John Robins-Wells	414-761-2582
124/110	Mainframe Exchange, Dallas, TX	Doug Light	214-221-8931
124/700	Xanadu, Grand Prairie, TX	Don Wills	214-647-8125
221/177	K-W Amateur Radio, Kitchener, Ont.	Fred Hicks	519-578-9314
108/107	The Mountain Top BBS, Cincinnati OH	Gerald Ellison	513-921-5568
226/130	Genealogy Hotline!, New Albany, OH	Carol Montrose	614-855-0955
347/3	The Idaho Root Cellar, Boise ID	Don Haacke	208-362-1441
342/67	Zarahemla (genealogy), Onoway, AB	John McCaslin	403-967-3642
440/50	Roots (UK)!, Guildford, England	Mike Fisher	44-483579631
800/807	PC Media Access, Morphett, Australia	Ken Richards	1-8-326-2843
285/152	Walburgh, Zwijndrecht, Netherlands	Bastiaan Bosman	31-78-129670
512/130	Gendata, Son, Netherlands	Willem Lanfermeier	31-499077612
280/603	GensData, Alkmaar, Netherlands	Johan Robert Poot	31-72-643533
500/44	HCC Delft 1, Delft, Netherlands	Paul Scholte	31-15-624590
500/14	Eindhoven, Eindhoven, Netherlands	Hans van Melis	31-40-481792
292/867	Roots(B), Antwerp, Belgium	Harry Goegebeur	32-3-2268648
2405/24	Comp-Gen.Box, Darmstadt, Germany	Dieter Zwinger	496151424941
7104/7	Diakonos, Herold, South Africa	Deon Strydom	27-441-81652

Tafel to this echo, it will quickly be seen by a large number of other researchers, who can then contact you to share information.

Tiny Tafels uploaded to the Gen-Data echo are later compiled into large files that contain about 100 Tafels each. These files are then distributed internationally by the Genealogy Software Distribution Network (GSDS). These Tiny Tafel files can be downloaded and compared using the *Tiny Tafel Editor*.

In addition to containing a Tafel-matching function, the *Tiny Tafel Editor* includes a collection of other Tiny Tafels to use for comparison. I also maintain the Tiny Tafel collection (TTCSTT.ZIP), which you can obtain in any of the following ways:

(1) Download it from the Visionary Endeavors BBS by dialing 1-904-249-9515. (Fidonet sysops may freq from 1:112/10)

(2) Download it from the CompuServe Genealogy Forum. (type GO ROOTS).

(3) Send for it by mail on disk for \$3 (\$5 outside North America) to cover diskette and shipping cost from Visionary Endeavors, PO Box 330439, Atlantic Beach, FL 32233-0439. Specify diskette size.

You can add your Tiny Tafels to the collection in either of two ways: (1) If Christopher E. Long finds a TT in which the creator has included some type of statement in it or with it that states it can be freely distributed, he adds it to the collection. (2) The creator sends it to Christopher E. Long to add to the collection.

If you want to send your TT to Chris, he can be contacted in the following ways:

(1) Post the Tiny Tafel as a message to the Sysop (Chris Long) or upload it as a file on the Visionary En-

deavors BBS at 1-904-249-9515.

(2) As a CompuServe message to Christopher Long at 76500,2073.

(3) As a Fidonet netmail message to CHRIS LONG at 1:112/10.

(4) As a Fidonet echomail message addressed to ALL over a genealogy-related echo in which Chris is a regular. He uses the name CHRIS LONG over Fidonet. The Tiny Tafel *must* have some sort of note in it or with it that states it can be freely distributed if you decide to send it this way. This method has the additional benefit that many other people can also see it.

(5) As an Internet message to chris.long@medinfo.jax.fl.us.

(6) Mail it on diskette to Visionary Endeavors, PO Box 330439, Atlantic Beach, FL 32233-0439. Due to the time and expense of managing this project, your disk won't be returned.

The Tafel Matching System is a database of Tiny Tafels. There are 30 to 40 BBSes in North America linked to the Tafel Matching System Network, called TMSnet. You can upload your personal Tiny Tafel to any node on the TMSnet and request a matching report. Your Tiny Tafel will then be passed around the network, each BBS doing its own matching report, and a complete report will be posted to the BBS on which you originally uploaded your Tiny Tafel. The process may take two to three weeks and sometimes longer. Your final report will contain the surnames that match and contact information so that you can exchange information. The TMS was developed and is copyrighted by Commsoft Inc. It can be used by any BBS, as long as no fee is charged. BBSes participating in the Tafel Matching System are listed in Table 3.

Summing Up

The Tiny Tafel is the most-powerful, easy-to-use tool available to you to contact other people who are researching your family tree. I hope this article helps you and others who read it take advantage of this tool. Happy hunting!

Sources for this article include the text file known as TTSPEC.ZIP by the Commsoft Corp., providing exact Tiny Tafel specs for its Tafel Matching System, and the documentation files from the *Tiny Tafel Editor* by Chris Long. ■

Use Your Free Reader Service Card For More Information On Companies Advertising In This Issue.

IEEE 488.2/GPIB/HP-IB PC CONTROLLER CARD

With new, easy-to-use command libraries

- Controls all GPIB, IEEE 488.2 and SCPI devices.
- Includes drivers and examples for all major languages
BASIC, Quick Basic, C/C++, Pascal and
Visual Basic for Windows
and DLL for GPIB control from Windows programs
- High data transfer rate on 1/2 size card

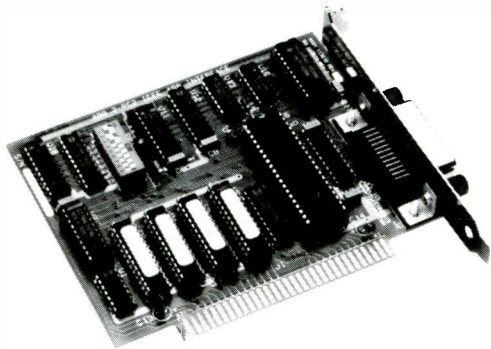

488-PC2 GPIB Controller for all PC/AT computers

Call today for information
on this and our other
GPIB interfaces.
800-952-4499
Fax: 408-263-5896

 **ICS
ELECTRONICS
CORPORATION**



By Joe Desposito

Computing On the Go

Searching for the Ultimate Connection Strategy

The **light weight** of a subnotebook computer is pretty much defeated if you have to lug around a power supply, external floppy disk drive and carrying bag. Once you go under 5 pounds with your subnotebook, you want to stay there.

Last time around, I described installation of the Protégé ATA/X PCMCIA drive in my desktop computer. This has worked out very well. With minor exceptions, I haven't had to use the external floppy drive with the Epson ActionNote 4000 subnotebook computer. Instead, I transfer files back and forth from the desktop with a SunDisk PCMCIA flash disk. Sometimes I carry around only the flash disk.

Never one to be content with a good thing, I thought I'd try some interesting alternatives to installing a PCMCIA drive in a desktop computer. In this column, I'll cover two products, Moses Computer's MosesDOCK! docking system 3Com's and EtherLink III PCMCIA network adapter. Whether you'd choose one product or the other depends on how your desktop is connected at home or at the office. If your desktop is connected to a network, you can use either product. If your desktop is a stand-alone system, MosesDOCK! is the one to use.

Before getting into these two products, I want to discuss a little about a docking station I have in the office. As you probably know, a docking station is a piece of hardware that a notebook or subnotebook conveniently slides into. Monty, one of my coworkers, has a docking station for his NEC Ultralite. This \$695 docking station sits on his desk and includes such amenities as a hard disk, expansion slots and a power supply. If he wanted to, he could connect a VGA monitor and full-size keyboard to the station, but he doesn't. The docking station is connected to the office's Novell network through a network card that Monty plugged in one of the station's expansion slots. I believe that at the time he purchased the docking station, PCMCIA cards weren't as abundant as they are now. So there was never any thought to hooking directly into the network with a PCMCIA networking card like as the EtherLink III. Later on, I'll tell you what Monty thinks about his docking station versus one of these alternatives. But for now, let's get on with MosesDOCK!

MosesDOCK!

The MosesDOCK! PC docking system for connect-

ing a portable to a desktop PC for a single user is a low-cost alternative to traditional docking stations like the one described above. The thinking is: "Why pay a premium for a docking station when you can get the same functionality from MosesDOCK! for a couple of hundred dollars?"

The MosesDOCK! package contains a combina-

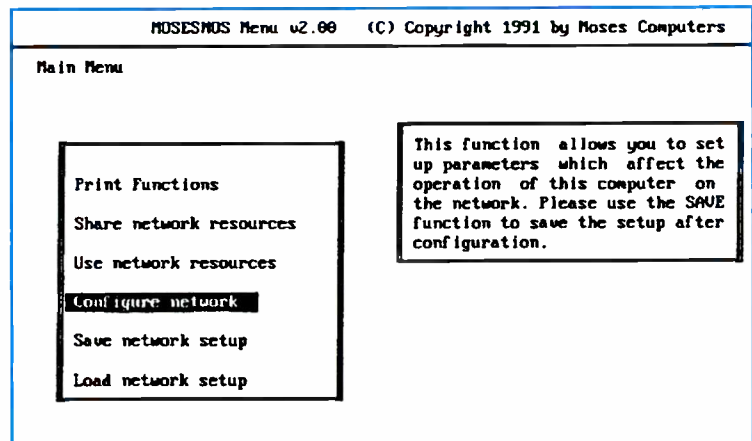

Main Menu of MosesDOCK! NetMenu program.

tion of hardware and software. The hardware includes a dual-port internal Netcard that plugs into an expansion slot on the desktop PC and an external adapter about the size of a pocket modem that connects to the parallel port of the notebook or subnotebook computer. Card and the adapter are connected together with telephone wire—about 12 feet of which is included in the package. Also included in the package are a battery and ac adapter, which are needed to power the external adapter. The software that comes with the system is the MosesNOS network operating system. The package includes both 3 1/2" and 5 1/4" diskettes.

I began the installation by inserting the Netcard into a slot on my desktop PC. I didn't bother to change any jumpers on the card, figuring that the defaults for I/O address would work fine. Next, I plugged one end of the telephone wire into the rear of the card and the other end into the external adapter. Since the adapter needs a power supply, the company supplies both a 9-volt battery and ac adapter. I decided to use the battery, but I was surprised to find that you don't place it inside the adapter. Instead, you attach a connector to it and plug the connector into the adapter. Then you lay the battery beside the adapter. The company quotes a battery life of just 8 hours, which persuaded me to use the ac adapter, since I often leave my desktop PC on for long periods of time. I figured I'd leave the adapter on all the time so that it would always be

ready to accept the ActionNote.

Next came installation of the software. MosesNOS must be installed on both the desktop the notebook computers and be configured on both. Since the documentation states that the software must be installed from the A: drive, I needed to bring the ActionNote's external floppy drive back into service for this procedure. Installation for both machines went smoothly.

A little aside is in order here. This installation requirement could pose a problem for some notebooks and subnotebooks that lack an internal or external floppy drive. Therefore, in my opinion, Moses Computer should provide some other way to do the installation in these cases. Hewlett-Packard's Omnibook 300 is a case in point, since it has neither an internal nor an external floppy drive.

Once installation of the hardware and software was complete, I needed to configure the software on each computer. At first, I thought I'd set up the software so that the ActionNote could access the hard disk on the desktop and also print on the laser printer attached to the desktop. Although this is possible, I noticed from the documentation that you also can set up a peer-to-peer relationship between the portable and desktop. A peer not only can share its resources, but it can use other resources as well. In other words, besides the ActionNote being able to access the hard disk on the desktop, the desktop would be able to access the hard disk on the ActionNote.

To set up the network, you need to load a utility program called NetMenu. This is a DOS-based menu-driven utility. The main menu provides six menu choices, as shown in Fig. 1. If you haven't installed DOS programs in a while, you might have a little trouble becoming accustomed to this program. I know I felt a bit off-balance at the start. (At the time of this writing, Moses Computers was just getting ready to release a *Windows* version of NetMenu.) In any case, first I configured the desktop as a peer and then I configured the ActionNote as a peer, using as many default answers as possible.

After a little bit of booting and re-booting, I was able to access the desktop's hard disk from the ActionNote and the ActionNote's hard disk from the desktop. Then I added the laser printer as a resource on the desktop. At this point, I tried to print a document from *Windows* on the ActionNote. Nothing occurred. I got a message that informed me that the printer was off-line, but it wasn't. So I closed down *Windows* and tried to print from DOS, using the DIR > PRN command. As soon as I pressed the Enter key, I heard the laser printer humming. Now, at least, I

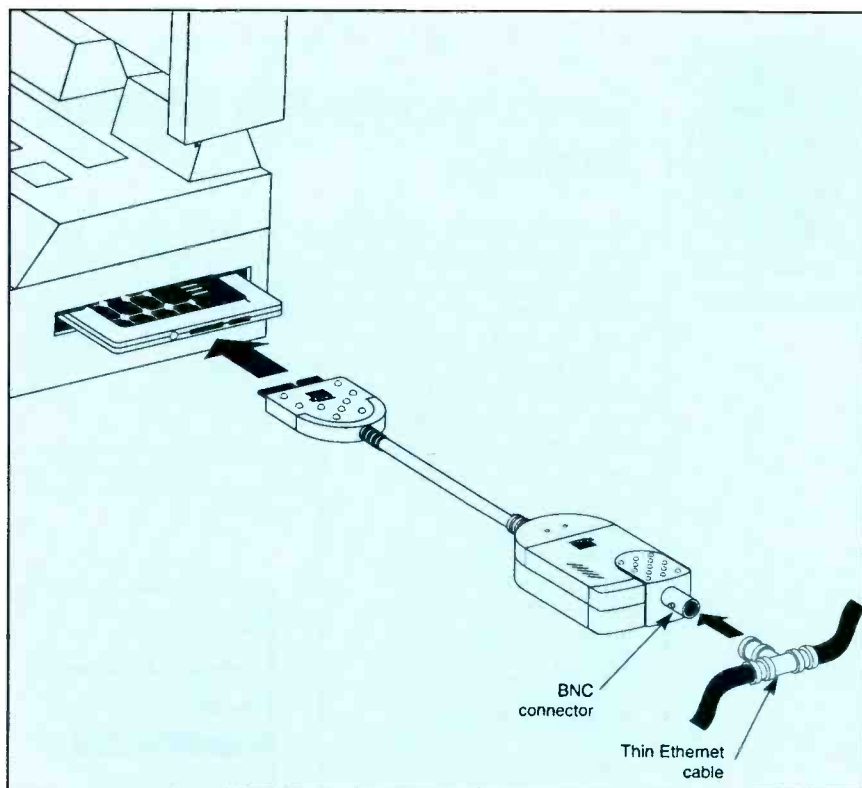

Coax connecting cable attaches to EtherLink III adapter and network.

knew the connection was working.

I checked the index of the User's Manual but found nothing under *Windows*, or even a W, for that matter. So I figured it was time to call technical support. I got through right away and explained the problem. The tech support person to whom I spoke asked if I had set up *Windows* for use on a network. This simple procedure, which I've done before, had slipped my mind. I thanked the support

person for the advice, rang off and implemented the procedure. I could now print from the ActionNote on the laser printer hooked up to the desktop machine.

Later, while I was browsing through the User's Manual, I came across a section titled "Windows Settings for the Network." Somehow this section didn't make it into the index. The simple two-step procedure is: (1) click on "Windows Setup" icon, open "Options" and "Change The System

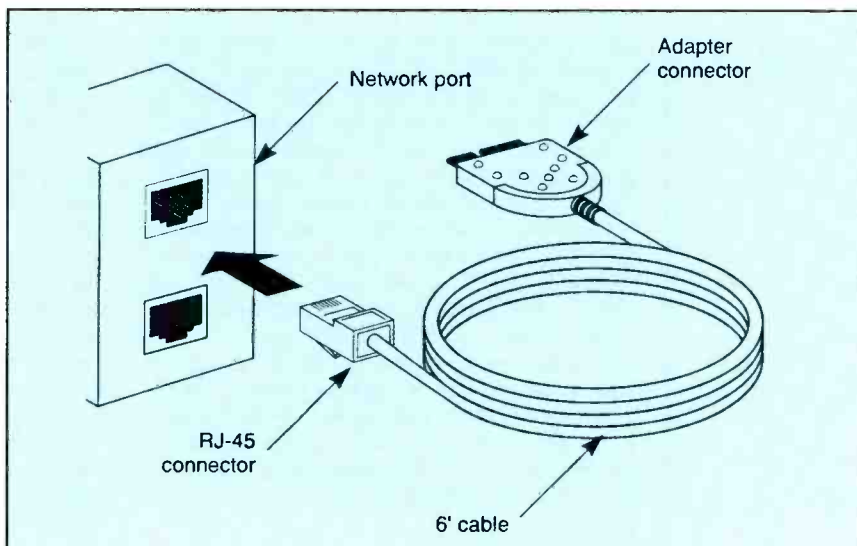

Attaching EtherLink III's 10BASE-T connecting cable to network.

Settings" and (2) Set the network to "Microsoft Network (or 100% compatible)."

Now that I had everything working, I decided to test the system for the way I expected to use it. I shut off the ActionNote and disconnected it from the external adapter. The events that followed this action are a little fuzzy since I couldn't figure out completely what was happening. Suffice it to say that the system worked once or twice, then stopped working, then I re-booted, and everything started working again, then everything stopped working and then, finally, both systems hung up trying to connect to each other. At this point, I gave up trying to get the peer-to-peer system to work consistently.

I settled for re-configuring the ActionNote as a redirector and the desktop as a server. As a redirector, the ActionNote can access the resources of the desktop, but the desktop can't access the resources of the ActionNote. This is fine with me and was my original plan, anyway. This is the configuration I'm working with now, and all is fine. The hard disk on the desktop becomes the E: drive on the ActionNote when it's docked. As such, I can transfer files and do anything else I might do with a hard disk, such as run a program that resides on it. For instance, I was able to run *Arts & Letters* from the ActionNote, even though it resides on the desktop. This feature could be useful in some situations. For example, if your desktop's video monitor suddenly goes on the blink.

Why would you use a program like MosesDOCK! over one like LapLink? One of the main reasons is speed. As a comparison, MosesDOCK! has a transfer rate of 3.58M bits/s, while Laplink's fastest speed is about 115.2K bits/s. Also, with MosesDOCK! you can access all of the desktop's peripherals, not just the hard disk and printer. You can also access floppy disks, CD ROMs, modems, etc. Another advantage is that MosesDOCK! lets you run programs that are on your desktop from your portable PC.

Although MosesDOCK! gave me some problems, my overall impression of the product is that it's a useful and affordable solution for anyone who wants to connect a notebook to a desktop computer. Additionally, some people may benefit from the networking orientation of MosesDOCK!. The product is a relatively easy first step for anyone who wants to begin networking computers.

EtherLink III

Continuing my pursuit of the ideal connection strategy led me to try EtherLink III, a PCMCIA combo network adapter for both 10Base-T and coaxial cable. This product requires a 16-bit Type II or III

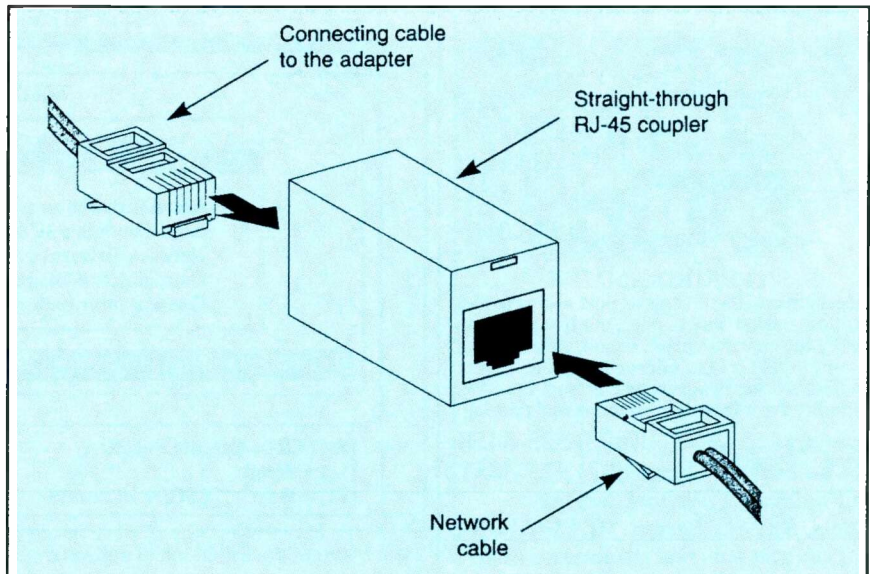

Using EtherLink III 10BASE-T cable connector with straight-through RJ-45 coupler.

card slot, a 3 1/2" drive, access to a network operating system and DOS 3.1 or later.

I first tried installing EtherLink III on the Epson ActionNote computer. The hardware part is easy. You simply slide the PCMCIA card into the slot on the sub-notebook. As with MosesDOCK!, to install the software, I had to attach the 3 1/2" external drive to the ActionNote. Also as before, I didn't even try to use EtherLink III with the HP Omnibook due to its lack of a 3 1/2" drive.

The software seemed to be installing okay, when it just stopped and gave me the following message: "It appears that there are no 3Com EtherLink III adapters installed in the system." Then the software stopped loading. I fiddled around with the card to make sure it was seated properly. It seemed okay. When I popped it out and put it back in, I heard a couple of beeps

that told me that the ActionNote was sensing the card. I tried installing the software again but got the same message. Finally, I checked the documentation. It suggested not loading Card Services or Socket Services on the computer, to minimize the possibility of conflicts. So I renamed the AUTOEXEC.BAT and CONFIG.SYS files and tried the installation one more time. Again, I received the same message. I checked with Monty about this and he said that 3Com had guaranteed operation of the adapter on his NEC Ultralite and Jon's (one of the other guys in the office) Toshiba T-1910CS, but couldn't guarantee that it would work on the ActionNote. 3Com also states on the package that EtherLink III has been tested and is *not* compatible with the GRiD Convertible, HP Omnibook and Toshiba 3300.

Since Jon has been using EtherLink III

INTELLIGENT DIGITAL INTERFACE

OP100 Intelligent Digital Interface for OPTO22 style I/O racks. Fully programmable with drivers and interface code for MS C/C++ and VX86 Kernel. The OP100 will interrupt the PC on input or output and provide pulsed inputs and outputs.

Also Available:
ACM100 - ASYNC Communications Monitor
VX86 - 80X86 Multitasking Kernel

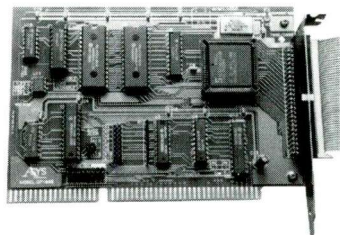

ASYS Corporation
15 Jonathan Drive, Unit 3
Brockton, MA 02401
508-580-5080 Fax: 508-580-4870

CIRCLE NO.99 ON FREE INFORMATION CARD

Low Cost Miniature Controllers

Save time.
Save money.

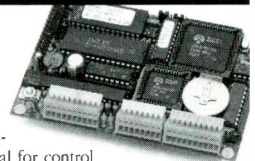

Our wide range of C-programmable miniature controllers are ideal for control applications, data acquisition, and test and measurement. Compact and low in price (the Little PLC™ above is 2"x3" and \$195), these controllers are programmed with our easy-to-use Dynamic C™ development system. Our controllers feature digital I/O, ADCs and DACs, relays and solenoid drivers, RS232/RS485 serial ports, battery-backed memory and time/date clock, LCDs, keypads, enclosures and more!

1724 Picasso Ave.
24-Hour AutoFax Davis, CA 95616
916.753.0618. Call 916.757.3737
from your FAX. 916.753.5141 FAX



CIRCLE NO. 95 ON FREE INFORMATION CARD

NEW
68HC11 PROGRAMMER

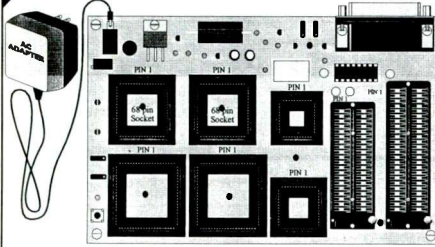

P11 PROGRAMMER

Connects to an IBM PC serial port and provides the fastest, easiest way to read, modify, program & verify the eeprom/prom memory and config. register of 68HCx11xx microcontrollers. Prices from \$349.00 for Programmer & host PC S/W. Call today for a free development tool catalog.

TECI Tel: (802) 525-3458
Fax: (802) 525-3451
The Engineers Collaborative, Inc.
Route 3, Box 8C, Barton, VT 05822 USA

CIRCLE NO. 90 ON FREE INFORMATION CARD

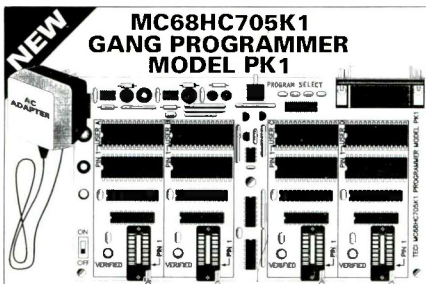

Motorola's great little 16 pin microcontroller just got better! The PK1 provides the fastest, easiest and most convenient ways to program these marvelously flexible and inexpensive devices. In production PK1 is a stand alone gang programmer that programs and verifies the EPROM, PEPPROM, and MOR of 4 devices in less than 5 seconds... and it requires little or no operator training! Master EPROMs store eight switch selectable K1 programs so production run setup is a snap. In the lab engineers will use its PC hosted mode for development work or short production runs.
\$499.00 includes programmer, host PC software and utilities.

TECI TEL: (802) 525-3458
FAX: (802) 525-3451
The Engineers Collaborative, Inc.
Route 3, Box 8C, Barton, VT 05822

CIRCLE NO. 89 ON FREE INFORMATION CARD

Turn ANY Printer
Into A Plotter!
for \$99 ~~SAVE \$100~~

PRINTAPLOT 3.0

"...it is unbeatable." - CADalyst

- ▶ Convert HP-GL files
- ▶ Select 255 pens/colors
- ▶ Change pen width, patterns, colors
- ▶ Tile "A" to "E" size drawings
- ▶ Adjust scaling/rotation
- ▶ Pops up over application
- ▶ 20 times faster than a pen plotter
- ▶ Supports over 1,200 printers

800-825-4115

Insight Development
2420 Camino Ramon Ph: 510-244-2000
San Ramon, CA 94583 Fax: 510-244-2020

CIRCLE NO. 68 ON FREE INFORMATION CARD

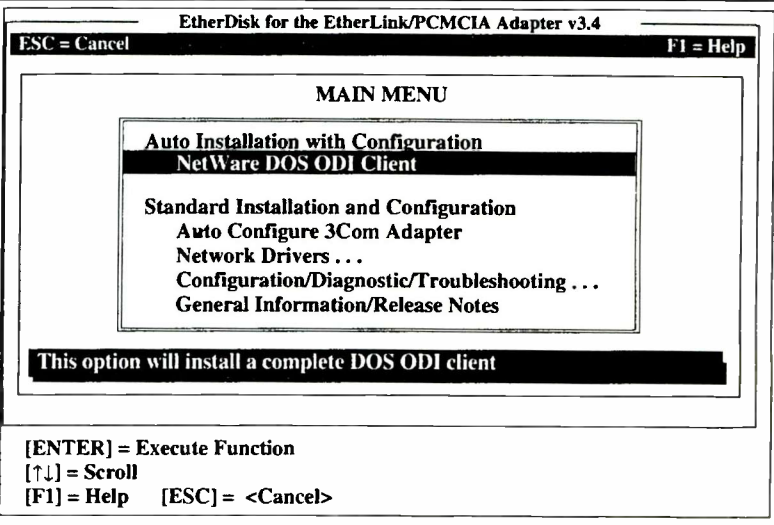

Main Menu of the EtherLink III software installation program.

for about a month now, it definitely works with his T-1910CS notebook. He uses the coaxial cable connector to connect to a thin Ethernet cable of the network. The package also includes a 10Base-T cable connector.

When you install the software, you're given a choice between auto or standard installation, as shown in Fig. 5. If your network is running Novell NetWare 2.X, 3.X or 4.X, you can select auto installation. This is what we have in the office. So Jon selected this option. Installation went smoothly.

To hook into the network, the manual tells you to follow a procedure for installing files on the server, which is outlined in a README file on the installation disk and includes such things as creating a user account with the name "3Install," editing the 3Install account's login script, setting the directory and file rights of the 3Install home directory, using a batch file on the installation disk to copy the required files to the server and copying the latest version of the NetWare client software to the server. In actuality, Jon said that the installation software did all of this automatically from his notebook. He didn't have to do anything special to load files onto the server. He referred to EtherLink III as "true plug and play."

As mentioned, Jon has been working with EtherLink III for a while now. He's not really moving files from his notebook to a desktop PC. Instead, he just links to the network with his notebook and continues working from his notebook.

Monty is doing pretty much the same thing when he slides his Ultralite into its docking station. Here, though, the docking station is connected to the network through a standard Arcnet card. If either of them also used a desktop, the network connec-

tion could be used to transfer files.

I asked Monty if he would have purchased the docking station if a card like EtherLink III were available at the time. He thought about it for a moment and then said he'd have gone with EtherLink III. But then he qualified this by saying that he doesn't have the proper cable for hooking into EtherLink III in his office right now so that he isn't able to use it, anyway.

Summing Up

As you can see, the ideal connection strategy doesn't depend completely on the connecting product. It also depends on the notebook or subnotebook computer you're using. In the case of the ActionNote, MosesDOCK! is a solution but EtherLink III isn't. For a subnotebook like the HP Omnibook, neither product can be used, unless you figure out a way to do the software installation without a floppy drive. For such notebooks as the NEC Ultralite and Toshiba T-1910CS, either solution can be used.

Products Mentioned

MosesDOCK!, \$199
Moses Computers
15466 Los Gatos Blvd., Ste. 201
Los Gatos, CA 95032
408-358-1550

CIRCLE NO. 126 ON FREE INFORMATION CARD

EtherLink III, \$299
3Com Corp.
5400 Bayfront Plaza
P.O. Box 58145
Santa Clara, CA 95052

CIRCLE NO. 127 ON FREE INFORMATION CARD



By Ted Needleman

Microcomputer Musings

Label Printing on PCs, Low-Cost Font Manipulator and an Uninstaller for Windows Apps

Something very interesting occurred recently, and it didn't really get much notice. Microsoft announced that it was phasing out "Suggested Retail Prices" as being artifacts of the price-fixed fifties. In some ways, this is long overdue. After all, if you look in any store or magazine, it's highly unlikely that you'll find any product on sale for list price. On the other hand, list price does provide some frame of reference for making price-comparison estimates. For example, with a list price of \$50, you can be pretty sure that a software package will be available at a "street price" of between \$32 and \$40. On hardware, discounts of 30% or so off from "list" are a fair yardstick.

With no suggested list prices, you actually have to shop around to get an idea of what a product will sell for. This makes for a rather interesting situation for those of us who are in the trade press and who routinely get press releases announcing products that won't ship for weeks or months. Will we have to wait for the product to actually ship before we can print some sort of price? Or will vendors start quoting an "estimated street price" instead of "list price"? We live in interesting times, indeed.

Love Those Labels

If you work in an office, chances are good that you use labels. In my office, there seem to be several dozen different types of labels we routinely use—address labels, laser-printed envelope labels, file-folder labels, labels on reports, labels on disks, labels on filing cabinets, and the list goes on. At home, if anything, the label situation is even worse. With four kids running around loose, you can be sure that anything that can be labeled probably is. A typical discourse goes something like: "That's mine!" "Oh yeah, look at whose label is on it!" Add in the office I maintain at home and several dozen VCR tapes, the contents of which change frequently, and I sometimes feel that I should have each of the kids labeled with his name on his forehead.

Over the years, I've had plenty of opportunity to play with the various labeling systems that have appeared in the marketplace. Each has had advantages to recommend it, but not a one has come close to being perfect. The latest one I've tried, Brother's P-TouchPC, comes pretty close, though.

To appreciate P-Touch, you need to know that there are three basic kinds of labeling systems. One uses paper-based labels that are backed with a self-stick adhesive. Avery and other vendors make different sized pre-punched labels that are stuck onto a

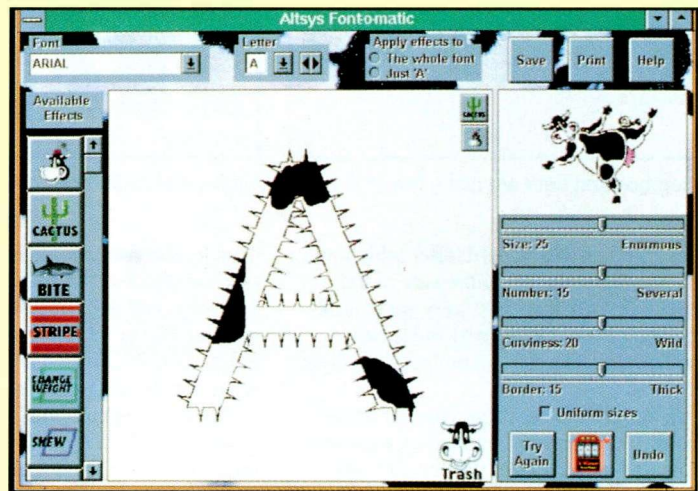

From *Font-o-matic's* main screen, you can do a sophisticated job of editing and manipulating fonts.

carrier sheet so they can be fed through a laser or inkjet printer. Earlier versions of these labels, still available, put one or more labels across on a pin-feed carrier sheet so that they can be fed through a tractor-equipped dot-matrix printer. The newest wrinkle in paper-based label printing are the dedicated label printers from Seiko, Avery and CoStar. These use a thermal paper label stock that feeds through a small printer unit. With the appropriate software, it's easy to capture the address from a letter on which you're working in your word processor and print out a label for the envelope that goes with it. I reviewed the Seiko label printer a while back in this column and liked it very much.

The other approach in labels evolved from the familiar Dymo plastic-tape label printer. This device, available in both inexpensive hand units and upscale typewriter styles, uses a circular print wheel that has on it alphabetic and numeric characters that emboss a multi-layer self-stick plastic tape. Where the tape is embossed, the characters change color, creating a multi-colored label. The Dymo label system was very popular in the late 1960s through the 1970s. You can still buy them almost everywhere.

The major problem with Dymo labels is that, although they're fairly inexpensive, most of the time they look pretty chintzy. For heavy-duty office use, Dymo lost a lot of ground to the Kroy labeling systems that printed a label tape. With the Kroy system,

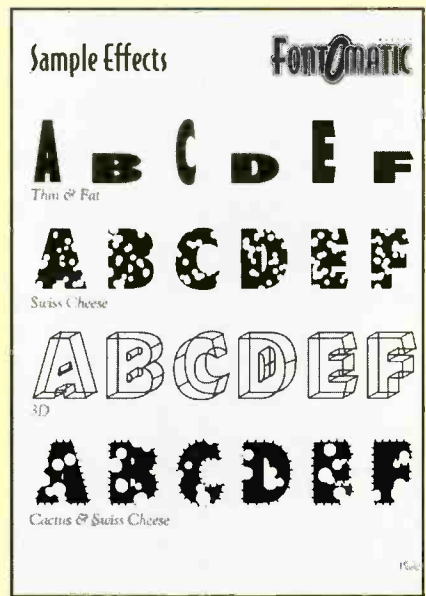
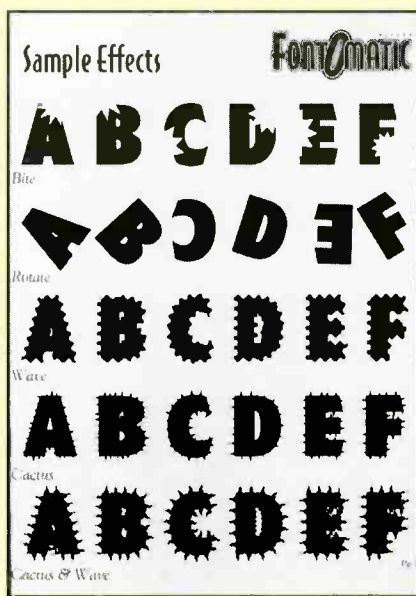
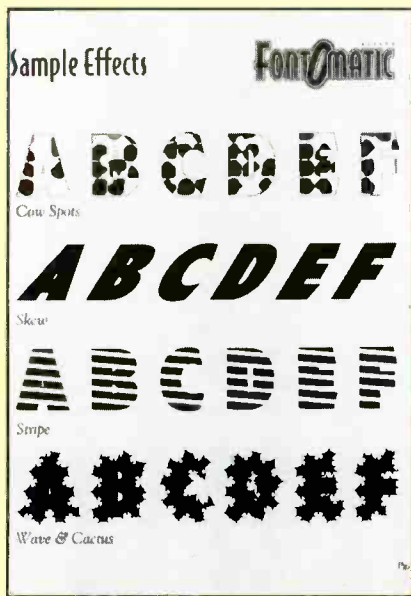

Represented here are just a few of the many sample effects you can generate with *Font-o-matic*.

you typed on a keyboard, after which, the label came out a slot in the side of the machine. This was easy, very good looking and affordable only by those organizations that had big budgets and deep pockets.

A couple of years ago, Brother broke the office label-printing market wide open with its P-Touch label printer. For less than \$200, you could do just about the same things as you could with a much more expensive Kroy labeling system. Not only were P-Touch label printers snatched up by office workers, lots of end users bought them for home label printing as well. P-TouchPC is the evolution of the P-Touch label printer line. It trades in the keyboard for a serial interface to your computer (PC or Mac), and it includes an editor that lets you create and print almost any label you can envision.

Physically, the P-Touch isn't very large, measuring just 8.9" x 6.6" x 3.2", which doesn't take up much room on a desk top. And at less than 3 pounds, you won't get a hernia if you have to move it to a different location. Inserting a tape cartridge is very much like placing an audio cassette tape into a cassette recorder. Tape cartridges come in 1", 3/4", 1/2", 3/8" and 1/4" widths and numerous color combinations. Each cartridge contains 50 feet of tape.

P-Touch tape is available in two forms. Most of the tape for P-Touch is a laminate. Printing takes place beneath a clear layer of plastic. This makes the labels you produce very durable. This type of tape cartridge lists for about \$40. For large database printing runs, Brother also offers less-expensive—and also less-durable—non-laminated label stock.

You can buy a dedicated Brother P-

Touch labeler or a similar unit from Kroy or Casio for less than \$200 these days. So, you may well ask, why should you spend another \$50 or more for a unit you have to hook up to your PC? The answer lies in what you can do once it's attached to your computer. You can print to P-Touch from either the P-TouchPC Editor, which runs under *Windows*, or from a variety of *Windows* applications like *Word for Windows*, *Lotus 1-2-3 for Windows* and even *Windows Paint* and *CorelDRAW*. There's even a separate P-Touch Print Manager that lets you set such parameters as minimum label length for the auto-cutter fea-

ture, which assures that you won't wind up with tiny unusable labels.

The Editor that Brother provides is well-documented, but if you have even a little experience using *Windows* applications, you won't spend much time with the manuals. You use the Editor to create either a custom label or a label format that will be used with a database. Within the Editor, you can combine type, line drawing of boxes and lines and graphics. Brother provides a clipart library of 250 graphics and symbols that can be re-sized, or you can use any graphic that you can size to fit the particular tape width you're

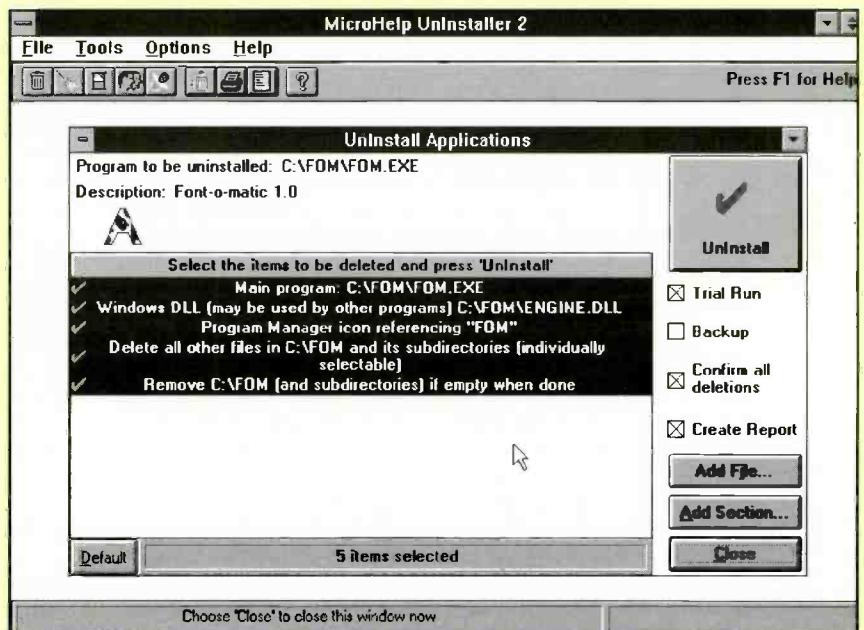

MicroHelp's *UnInstaller* main screen with *Font-o-matic* set up for removal.

using. Available fonts are whatever you have installed in *Windows*, and you can apply a variety of effects, like dropped shadows, onto the typeface.

P-TouchPC is a very different kind of label printer when compared to label printers from Seiko, Avery and others. The laminated labels it produces are much more durable and, in fact, are even suitable for outdoor use. In terms of price, the P-TouchPC printer is about \$100 or so more expensive than the others listed here. Brother hasn't yet joined Microsoft in getting rid of suggested retail prices, and the SRP on PC-TouchPC is \$449. My local CompUSA store has it priced at \$290, and makes it available only on 10-day special order. Hence, it hasn't yet hit the retail market in a big way. Granted, almost \$300 is a lot to pay for a specialized printer. But if you use labels in your business, it's money well spent.

A "MOOVing" Experience

I admit it, I'm a font junky. Whenever I install an application that includes fonts, I always load up my hard disk. Right now, there are probably 30 fonts installed in my *Windows* system, and that's after cleaning out more than 25M of fonts I uninstalled in the control panel but forgot to delete from my hard disk! Of course, I probably don't use more than a half-dozen of these fonts. But if I need a particular style, I stand a good chance of already having it installed.

Luckily, I'm not alone in this character flaw. Altsys' *Font-o-matic* was conceived just for people like me. Though you may not recognize the name, Altsys is pretty well known by those people who work with type and graphics. This is the company that developed *Freehand Graphics*, which is sold by Aldus. And the company's *Fontographer* line for *Windows* and the Mac is the standard font-manipulation package for professional typographers.

Font-o-matic, however, is font manipulation positioned in a lighter vein. Just how seriously can you take a package that features Lulu the cow on the box and, for that matter, in the program? And when the cow is telling you to "Milk your fonts for all they're worth..." well, you get the gist.

But even though the entire approach of this package is somewhat tongue-in-cheek, what it does is actually a very sophisticated job of font editing and manipulation. It performs this on the *TrueType* and *PostScript* fonts you already have (though it does include seven new fonts, just in case your font supply is a little sparse). What *Font-o-matic* actually does is apply any of 14 different effects to the font of your choice. The effect options included are Cow Spots, Rotate, Bite, Fat &

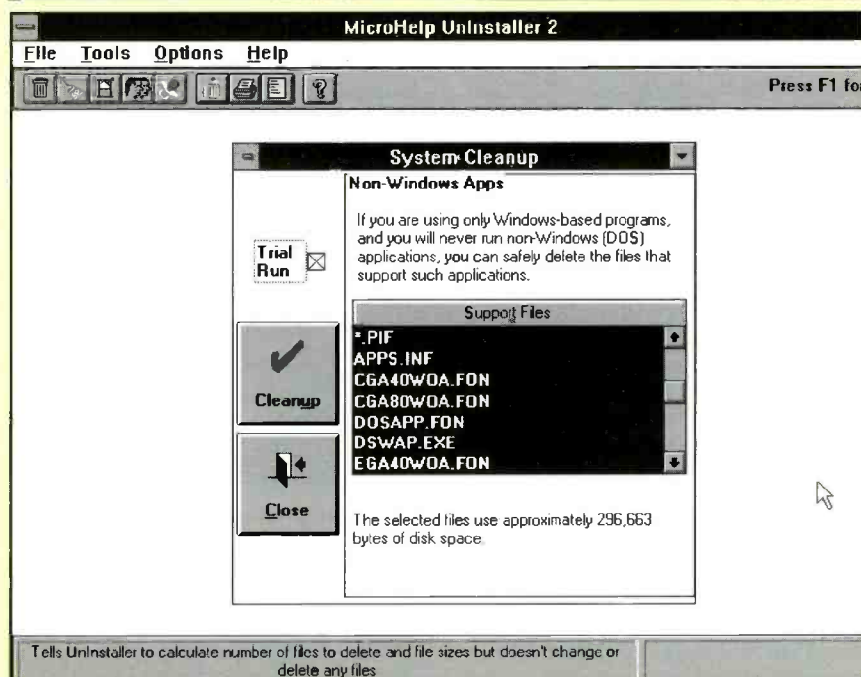
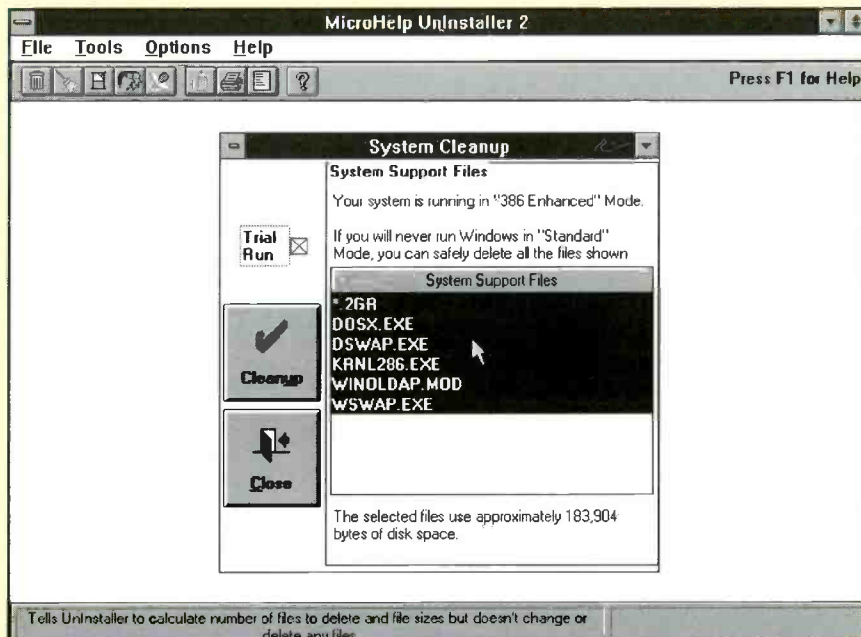

These two Uninstaller screens are set up for System Cleanup for (upper) System Support Files and (lower) Non-Windows Apps.

Thin, Mangle, Wave, Skew, Stripe, 3-D, Shattered, Warp, Swiss Cheese, Cactus and College.

The names of the effects are pretty much descriptive of what happens to your font, and you can combine effects (lots of them, in fact) to get some pretty weird-looking typefaces. Slide-type controls determine how much of different parameters will be applied as the font is generated, and you can preview your masterpiece before generating a new font. In fact, if you'd like, you can generate only one or a few specific characters.

How long it takes to generate fonts depends on how powerful a PC you're working on and how elaborate you've gotten in applying effects. While playing with *Font-o-matic*, I managed to come up with a font that took almost 20 minutes to generate on a 486DX2/66. If you have a sound card in your PC, *Font-o-matic* will play a variety of snappy tunes while it generates the font. That is, it will play it until you turn off the option, which should take no more than 5 minutes or so for a normal human adult. After all, how long can you listen to the same snappy little tune?

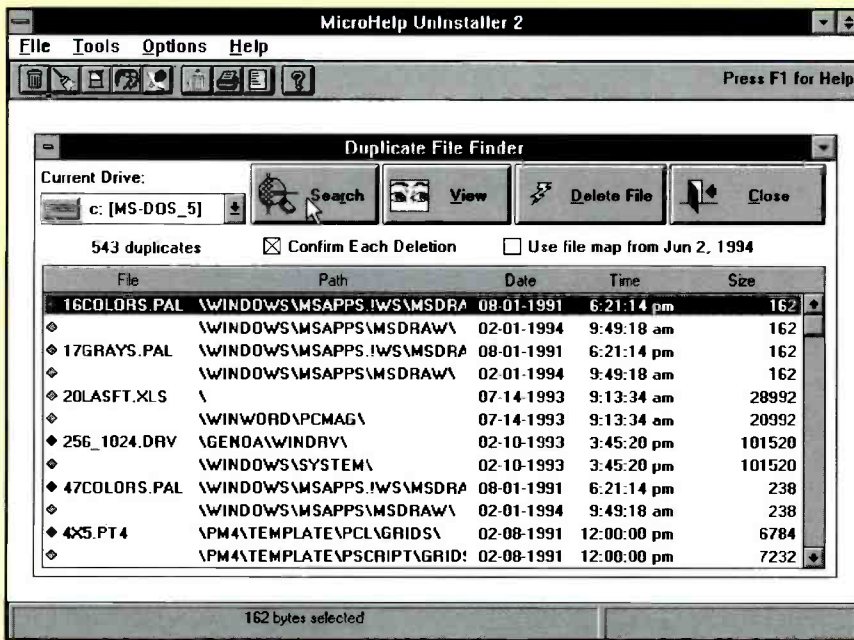

Here's an example of *UnInstall's* Duplicate File Finder window.

Altsys has also stayed with the suggested list price scheme and shows *Font-o-matic's* as \$59.95. I've seen it in mail-order catalogs for considerably less. My main interest in cows is kind of limited to a nice medium-rare Porterhouse steak. But you gotta love a product that impertunes you to "Choose udderly sensational effects...." I'll probably wipe these fonts off my disk after I've played with them for a while, but in the interim, Lulu is sure showing me a good time.

Lose 10M in Days

When it comes to *Windows*, there's one big problem being a reviewer. I probably install a half-dozen *Windows* programs on my PC every month. Of course, I don't wind up writing about more than a fraction of these, and over a period of months keep even less on the drive. With DOS programs, getting rid of a no-longer-wanted application is pretty easy. DOS 6.x lets you delete entire subdirectories. Even with earlier versions of DOS, it's just a matter of logging into a subdirectory, doing a DEL *.* and then removing the directory.

With *Windows*, it's not quite so easy. Sure, you can click on the program group and keep hitting the Delete key as each component of the group gets blown away, but this doesn't actually wipe the programs off the disk. To do this, you have to go into File Manager, click on the subdirectory and then hit Delete. A dialog box will come up that lets you choose "Delete All." This actually deletes the application's programs and files. What it doesn't delete are all of the references to the application that the software's original installa-

tion has placed in files all over the place. Just some of the files that can be effected during an installation are WIN.INI and SYSTEM.INI. And most applications also create their own .INI files that are never deleted when you try and wipe an application from your disk.

Over a period of time, what happens is that WIN.INI and other files that *Windows* uses become loaded with references to applications that haven't been on your disk for a year or more. While this won't blow *Windows* off your machine, it can significantly slow down the performance of your system and waste large amounts of hard-disk space. I know it's time to do some housecleaning when *Windows* starts to take almost a minute to load on my machine.

In the past, I've achieved this housecleaning by examining WIN.INI and SYSTEM.INI with the *Windows* Notepad, deleting references to software I knew was no longer installed. But it's a lot of work to do this, and I know that I missed references and that plenty of files remained on my hard disk that could have been ditched. That was before *UnInstaller 2*, from MicroHelp, Inc. *UnInstaller 2* is one of those handy utilities that most of us always mean to buy, but somehow don't get around to.

What *UnInstaller 2* does is pretty simple. It removes *Windows* applications from your Program Manager group and your hard disk. It does this by scanning the WIN.INI, SYSTEM.INI, the application's .INI files and other places in which there might be references to the applications. When it removes an application, it also removes all references to the applica-

tion that it can find and that you are sure enough of to approve. Don't worry about *UnInstaller* going berserk and randomly deleting your important (and wanted) applications hither and yon. You have to approve every modification before it occurs. In fact, the software even goes through a "mock" removal before it does everything you command it to so that you can see what the net result will be.

UnInstaller also has some terrific additional tools that operate in the same vein. SystemCleanup searches your PC for unused fonts, video drivers and other unwanted *Windows* components. Using this tool, I found more than 25M worth of fonts I had uninstalled in the Control Panel but forgot to delete from the disk. Dupe-Finder finds and, if you wish, deletes duplicate files located in different directories. When it does find duplicates, you get to choose which one goes and which one stays. OrphanFinder finds and removes remnants of applications that have been manually uninstalled. I found plenty of these on my system when I ran it. Finally, INIClean helps you to keep your .INI files to a manageable size.

I found *UnInstaller 2* pretty easy to use, and the comprehensive manual that comes with it answered most of my questions. But there's one caveat in using this powerful tool. You pretty much aren't the judge of what does and what doesn't get blown off your hard disk. So *UnInstaller 2* isn't really suitable for novice users. But if you're like me, trying to perform manual housekeeping to reduce *Windows* bloat, you'll love *UnInstaller 2*. It retails for \$69.95 but sells for about \$50 or so and, believe me, it's well worth it!

Products Mentioned

P-TouchPC, \$449
Brother International Corp.
 200 Cottontail Lane
 Somerset, NJ 08875
 Tel.: 908-356-8880

CIRCLE NO. 128 ON FREE INFORMATION CARD

Font-o-matic, \$59.95
Altsys Corp.
 269 W. Renner Pkwy.
 Richardson, TX 75080
 Tel.: 214-680-2060

CIRCLE NO. 129 ON FREE INFORMATION CARD

UnInstaller 2, \$69.95
MicroHelp, Inc.
 4359 Shallowford Industrial Pkwy.
 Marietta, GA 30066
 Tel.: 404-516-0899

CIRCLE NO. 130 ON FREE INFORMATION CARD

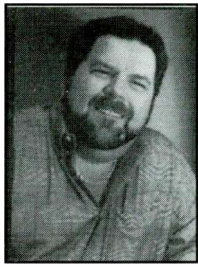

By Tom Benford

Multimedia

A PCMCIA Audio Card, Tech-Support Update for the Xingit! Board for Gateway Pentium Users, Interesting Software on CD-ROM

The speed and power of notebook PCs has continued to increase, to the point where they're the full equals of desktop machines—in most respects. However, notebooks have always fallen short for me in the area of multimedia audio. All this has changed with the advent of the PCMCIA audio card. I'll cover here the first available one on the market. I'll also give you some information on a tech support update on the Xingit! board for Gateway Pentium users, and let you in on a few of the many interesting software titles recently released on CD-ROM.

PCMCIA Sound Card

New Media's .WAVjammer 16-bit stereo sound card is the size of a credit card, but it delivers sound that rivals the best full-size FM-based audio cards available. This PCMCIA mighty-mite is loaded with high-quality, no-compromise features and comes bundled with a microphone, Sony Twin-Turbo Fondotid dynamic stereo earphones and *Windows Sound System 2.0* software.

Fully compliant with PCMCIA Release 2.1 standards, .WAVjammer features hot insertion and removal so that you can take the card out and put it back in again without having to shut off your notebook PC. This feature also permits you to interrupt

audio tasking by removing the card and resume it when you reinsert the card. This capability is handy, especially if your notebook has only one PCMCIA slot, in situations where you might want to download a file from a BBS and resume working with audio after the file transfer is complete. In this example, you could remove .WAVjammer, plug in your PCMCIA modem card, do your download, swap the modem card for .WAVjammer and resume your work in a multimedia audio environment without the need to exit *Windows* or reboot.

The card is a PCMCIA Type 1 device, requiring a single-height PCMCIA slot for installation. A 6" cable attaches to the outboard end of the card. This cable is terminated on the opposite end by the Media Access Module (MAM). The MAM contains three 1/8" miniature phone jacks that handle the stereo line input, stereo microphone input and stereo headphone/speaker output. A 32K DMA buffer is built into the device. Hence, audio transfers are smooth and uninterrupted in both record and playback modes. The card has a very low current draw of 100 mA while in operation and 1 mA in standby mode. Consequently, it won't deplete the usable charge time of your notebook PC's battery.

.WAVjammer is *Microsoft Sound System*-, AdLib- and SoundBlaster-compatible. It supports .WAV,

```

DEVICE=C:\WINWG\HIMEM.SYS
DEVICE=C:\DOS\EMM386.EXE NOEMS X=D000-D7FF
DOS=HIGH,UMB
FILES=20
BUFFERS=10
STACKS=9,256
DEVICEhigh=C:\DOS\SETVER.EXE
SHELL=C:\DOS\COMMAND.COM C:\DOS /P
DEVICEhigh=C:\DOS\POWER.EXE
rem ===== PCMCIA Device Drivers =====
rem == If PCMCIA Cards are not used in your system, these drivers
rem == can be remarked to save system memory area.
rem =====
rem == This driver is loaded for "Loads the driver for an IDE type drive"
DEVICEhigh=C:\CARDSOFT\SSCIRRUS.EXE
DEVICEhigh=C:\CARDSOFT\CS.EXE /IRQ B
DEVICEhigh=C:\CARDSOFT\CSALLOC.EXE C:\CARDSOFT\CSALLOC.INI
DEVICEhigh=C:\CARDSOFT\ATADRV.EXE
DEVICEhigh=C:\CARDSOFT\SRAMDRV.EXE
DEVICEhigh=C:\CARDSOFT\CARDID.EXE
rem == "Driver for the Interface - must remain for PCMCIA Support"
rem == "Driver for Card Services - must remain for PCMCIA Support"
rem == "This is the memory card driver for SRAM support
rem == "Driver for Client Device Driver - must remain for PCMCIA Support"
rem ===== PCMCIA Device Drivers =====
DEVICEhigh=C:\WINWG\MOUSE.SYS /Y
DEVICEhigh=C:\WINWG\IFSHLP.SYS
[COMMON]
DEVICEhigh=C:\NMCSSND\NMCSSND.SYS /wave=340

```

Fig. 1. Optional switches and parameters .WAVjammer's README file. While helpful, exact information (IRQ= and WAVE=) values I needed for Versa E were obtained by calling New Media's tech support.

The NCMCSSND.SYS client device driver that is loaded from within your CONFIG.SYS file supports a number of command line options. The command line options for NCMCSSND.SYS are:

DEVICE=[<path>]NCMCSSND.SYS
/WAVE=<www>] [/NOMIDI] [/IRQ=<q>]
[/IBM] [/V] [/D]

Command line options can be entered in any order. The letters can be either upper or lower case. Specifying command line options will override any corresponding default values.

Note: Unless a special configuration is required, command line options **DO NOT** need to be used.

Options:

/WAVE=<www>

This option allows specification of the base address of the digital audio playback and record features provided by the .WAVjammer. The three digit hexadecimal parameter, represented above as "<www>", can have any value from 001 through FFF.

However, many of these values are reserved for other system resources and may not be used. The following values are frequently available for use with this option: 300, 340, 390, F40, and F80. If you need to specify this option you should try each of these values respectively before any others.

NOTE: Be aware that if you select 380 as your base address, the MIDI support normally provided by the .WAVjammer will

be disabled automatically. This is due to the fact that the two address windows would overlap otherwise. Thus, 380 should be avoided unless no other choice seems to work.

/NOMIDI

Specifying this option disables the MIDI playback capability of the .WAVjammer. This capability is provided by default, but may conflict with another MIDI device present in your system. This option can be used if MIDI support is not desired or if it is provided by another system board such as an Adlib sound board. If MIDI support is provided by another sound board, your card and socket services may not be able to configure the .WAVjammer unless this option is specified.

/IRQ=<q>

This option allows specification of the .WAVjammer's required interrupt request line (IRQ). Because the .WAVjammer is designed to automatically select any available IRQ for its use, you should rarely have to use this option to manually specify this value. The single digit hexadecimal parameter, represented above as "<q>", can have any one of the following values: 3, 4, 5, 6, 7, 8, 9, A, B, C, D, E, or F.

However, several of these values are reserved for use by other system resources such as COM or LPT ports, a floppy disk drive, etc. Some amount of experimentation may be required to determine which of the above values is available for use by the .WAVjammer in your computer system. Contact New Media technical support if you experience difficulty with this determination.

/IBM

Specifying this option allows the client driver to support the IBM Card and Socket Services. The IBM Card and Socket Services are usually shipped with (and should be used with) IBM portable computers, such as any from the Thinkpad line. If you are using the IBM Card and Socket Services, you should append this switch to the end of your NCMCSSND.SYS client driver in your CONFIG.SYS file.

/V

Specifying this option enables the client driver's verbose mode. This can be useful if you are experiencing difficulty in configuring your .WAVjammer card. The information that may be displayed when this option is specified should be communicated to the New Media technical support staff as they assist you in troubleshooting any card configuration problem you might encounter.

/D

Specifying this option enables support for the Databook Incorporated TCIC-2/N PC Card Controller chips. This will enable the .WAVjammer to work properly with most computers incorporating Databook PCMCIA controllers. This switch should not be used in computers that do not have a Databook PCMCIA controller.

NOTE: If you are not sure whether your computer has a Databook PCMCIA controller please refer to the technical manual that may have accompanied your computer, or contact your computer vendor.

Fig. 2. My CONFIG.SYS file shows the required manual modifications in italics. While helpful, user's manual didn't give specific information on what required values would be for my NEC Versa E color notebook, which necessitated a telephone call to New Media's tech support.

.AIF, .VOC, .SND, .MID, .AMI and .AVI file extensions. Furthermore, it can sample from four-bit mono up through 16-bit, 44.1-kHz stereo (Redbook audio) for CD sound quality. It's also capable of simultaneous MIDI playback with .WAV mixing, making it an ideal choice for multimedia presentations and other applications in which having a narrative/sound-effects track playing over a musical selection is desired.

Supplied documentation consists of an 18-page user's manual, along with the standard-issue *Microsoft Sound System* manual. While the user's manual is good, I wasn't successful in getting .WAVjammer to work with the NEC Versa E color notebook I used to review it without resorting to outside help.

Seven 3 1/2" high-density diskettes come with .WAVjammer. One is a SystemSoft Card and Socket Services installation disk. Another is the .WAVjammer installation disk. The remaining five discs are for installation of the *Windows Sound System*.

The first step of the installation consists of installing the Card Services client device driver that communicates with other PCMCIA software on your machine to configure the card. You're prompted all the way through the installation procedure and are given choices to make automatic modifications to your CONFIG.SYS file or let you do this manually. After this, driver software is installed. Following this, you must reboot your machine to load the driver.

The next phase of installation is loading the Microsoft *Windows Sound System* software on your hard disk, which is done from within *Windows*. When this five-disk installation is completed, *Windows* must be restarted for the .WAVjammer card and WSS software to initialize. This is where I ran into a problem.

The first time you boot *Windows* after installation, you're told to insert the .WAVjammer card, at which time you should hear an audible double beep that signifies that the card has been recognized. Then the *Windows* device driver

automatically loads and configures itself. I didn't get the beeps as expected. So I tried removing the card (which, oddly enough, did produce the beeps) and reinserting it, again in silence. I ran through the installation again a second time, just to be sure I hadn't botched any of the steps, but still I couldn't get the beeps when I inserted the card. Option #2 on this screen is to press Esc, which loads *Windows* without benefit of the audio services and allows life to proceed as normal, aside from the warning screen that tells you the .WAVjammer driver hasn't been loaded each time you enter *Windows*.

One of the required configuration modifications is to exclude memory range D000 through DFFF in the device=EMM386.EXE line of your CONFIG.SYS file. This change must also be made if you're using *QEMM* or *386MAX* as your memory manager. Additionally, I had to make a corresponding change to the SYSTEM.INI file in *Windows* under the [386Enh] section to exclude this range as well.

While I don't look forward to installation problems, when they do crop up, they afford me the opportunity to assess the manufacturer's technical support, as in this instance. New Media backs .WAV-jammer with a lifetime guarantee, and the company's toll-free 800 number is listed on the back of the card and prominently displayed in the user's manual. I called the number and spoke with Steve Patterson, one of New Media's support technicians, who proved to be a wealth of knowledge on exactly what had to be done to get .WAVjammer working with the Versa E.

The fix required for the Versa E consisted mainly of adding some optional switches and parameters to entries in my CONFIG.SYS file. Both the printed user's manual and on-disk README files cover some the switches for specific machines and configurations. However, I didn't locate enough detail about the specific switches required to get the NEC notebook up and running with the .WAVjammer card. So a call to New Media's tech support department was necessary. A portion of the README.NMC file giving information on the switches and optional parameters is shown in Fig. 1.

Steve went over the entire installation procedure with me to establish what I'd already done. He then suggested that we redo the installation from the ground up, after erasing an .INI file in the CardSoft subdirectory that configures and controls the memory allocation areas. When this failed to work, he put me on hold for a minute or so while he conferred with a colleague and then proceeded to tell me I'd have to include some of the optional parameters to get the Versa E to recognize and communicate with .WAVjammer card.

My Versa E's CONFIG.SYS file is shown in Fig. 2, with the manually-inserted changes appearing in italics. Kudos to Steve Patterson, not only for his conscientious and thorough handling of my tech-support call, but also for his patience (I was on the phone with him for over 20 minutes) and sense of humor.

After making these changes to my CONFIG.SYS file, I rebooted, started *Windows*, inserted the card when prompted and—lo and behold!—heard the “beep beep” at last. As soon as *Windows* came, up I went to the SoundFinder in the Microsoft *Windows Sound System* group and started playing .WAV files. Next, I played some .MID files and then I recorded my own voice with the supplied microphone. Everything worked perfectly, and I was more than pleasantly surprised at the quality of the sound.

All of the standard elements of the *Windows Sound System* are present in this bundled version supplied with the .WAV-jammer card, including the Audio Control,

Sound Finder, Music Box, Quick Recorder (Standard and Expanded View), Voice Pilot and ProofReader applets, in addition to the WSS Setup applet.

Using a portable NEC 3XP battery-powered CD-ROM drive (interfaced with the NEC EPP Parallel-to-SCSI kit) and the New Media .WAVjammer 16-bit Sound Card in one of the Versa E's two PCMCIA slots, I have all the advantages of desktop multimedia capabilities with the ability to take it all with me wherever I go. New Media has done a great job with .WAVjammer, and company sources tell me the documentation is currently being expanded to cover a wider variety of notebook configurations. Since I received one of the first production units to be shipped, it's understandable that, in the rush to get a product to market, the documentation isn't as complete as one could wish. However, with a such a good tech-support department to lend assistance, if required, I wouldn't put off getting a .WAVjammer for my notebook if I were you.

Xingit! Update

In my last column, I told you about the Xingit! MPEG video card from Xing Technologies. Since writing that column and using the Xingit! card in an IBM PS/2 ValuePoint DX2/66, I upgraded my personal system to a Pentium-based Gateway 2000 P5-60. To my chagrin, I was unable to find a compatible port address/IRQ combination that would permit the Xingit! card to work properly with my P5-60 system. A call to Jay Christie, head of tech support for Xing Technology, disclosed the following fix, which I'm providing here as a service to any other Gateway P5-60 users who have 16M or more of RAM installed (mine has 32M).

The Gateway P5-60 Pentium computer uses a customized AMI BIOS with a shadow-RAM feature that's designed to compensate for the limitations of the ISA bus running in a Pentium system. Implementation of this feature creates a conflict with the Xingit! board, which requires exclusive use of a 32K memory bank beyond 640K. In a system that has less than 16M of RAM, no conflict exists because Xingit! can use a memory bank address of 14M or 15M. In systems that have 16M or more RAM installed, however, Xingit! must be configured to use an address in the upper memory range, and this address must be excluded for all other purposes.

In Gateway P5 systems that have greater than 16M of RAM, memory bank exclusion is accomplished by adding a parameter to the EMM386.EXE device line in the CONFIG.SYS file. This exclusion is required to keep the memory manager from using the 32K bank area. The optimum

upper memory area is D000h. C800h would be available to some ISA video cards, but PCI video cards typically make use of this area when loading their *Windows* drivers.

In a system that contains more than 16M of RAM with the Special Shadow RAM feature, an additional exclude procedure is required. In the ADVANCED CMOS SETUP section of CMOS, there are two critical settings, one for the size of the Shadow RAM exclude (“Disable Shadow Memory Size”) and the other for the starting address of this exclude (“Disable Shadow Memory Base”). Size should be set to 32K, and starting address should be D000h or whatever the corresponding exclude address is set to in the CONFIG.SYS file. This is the setting that should also be set in Xingit's configuration menu.

Once the memory-bank conflict has been resolved, the other configuration settings are fairly straightforward. The default base address of 280 should work without a problem in most situations, although selection of an interrupt is slightly more complicated in the Gateway system since it has built-in, BIOS-controlled I/O and mouse ports. For this reason, it's wise to avoid using Interrupts 2 through 5. Interrupt 11 should be okay for most configurations, unless you're using a CD-ROM interface, SCSI card or sound card that's already using Interrupt 11 (since my Adaptec 1540 SCSI card hogs IRQ11, I used IRQ3 without experiencing a problem). With these changes, Xingit! should work just fine in a Gateway P5-60, as mine does—now.

On The Optical Front

Nowadays, it seems that just about everyday sees release of a dozen or more CD-ROM titles. Of the many that cross my desk, I've selected a few that should prove to be of more than passing interest to you. Here are my picks this time around.

• **Hollywood: The Bizarre.** The premiere title in ScanRom's line of CD-ROM-based software, *Hollywood: The Bizarre*, is subtitled *The Lives and Deaths of Hollywood's Greats—and Not So Greats!*. This disc is a fascinating compendium of trivia on the stars of the silver screen, as well as many little-known facts, facets and kinky quirks of those people who have made their residence in Tinsel Town.

The material contained on this disc is distilled from nine print books, featuring *The Hollywood Death Book* by James Robert Parish. It covers the amazing—and too-often tragic—finales of Hollywood's well-known players over the last nine decades. More than 140 detailed biographies and the necrology of 5,000 notable actors and directors are included, as is a guide to

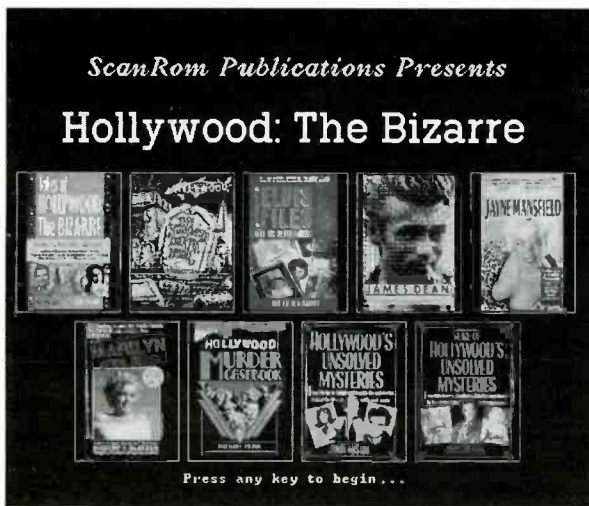

Hollywood: The Bizarre is a compilation of nine books on Tinsel Town and stars of big screen. Disc runs from DOS or Windows and requires VGA monitor for best viewing.

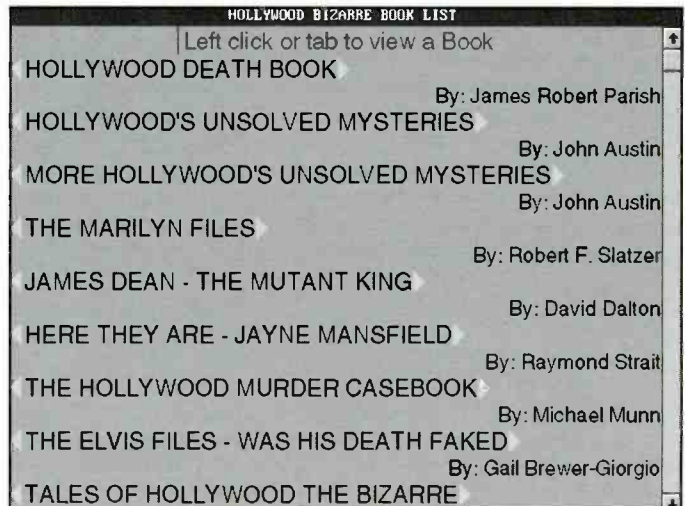

Menu system for *Hollywood: The Bizarre* is hot-linked to corresponding subject areas. Clicking on a triangular icon brings you directly to desired book, from which you can further refine your exploration. Text searches are also supported so that you can type in a key word, name or phrase and bring up all matching references.



Marilyn Monroe is just one of high-profile personas whose deaths are covered in depth on *Hollywood* disc. Hundreds of photos and over an hour of audio files are included.

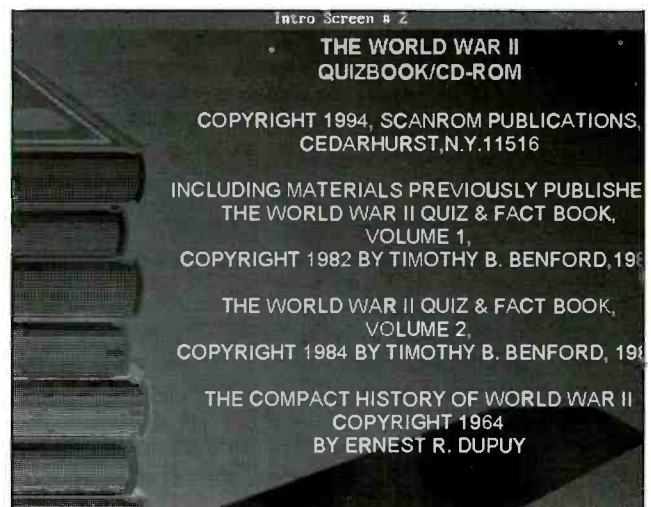

Hyper-linked "hot buttons" take you directly to desired area of *World War II Quiz Book on CD-ROM*. Text of three books, hundreds of photos and an hour of audio clips make this an outstanding source of information on World War II.

where the notables are buried.

Other volumes on this disc are *James Dean: The Mutant King* by David Dalton; *Tales of Hollywood The Bizarre* by John Austin; *Here They Are: Jayne Mansfield* by Raymond Strait; *The Hollywood Murder Casebook* by Michael Munn; *The Elvis Files* by Gail Brewer-Giorgio; *Hollywood's Unsolved Mysteries* by John Austin; *More of Hollywood's Unsolved Mysteries* by John Austin; and *The Marilyn Files* by Robert F. Slatzer.

In addition to the textual material of the books, hundreds of black-and-white and color photos of the stars are included, as are more than 60 minutes of audio sam-

ples, including some of the most memorable lines from movies and other choice sound bytes. Anyone who is interested in the lives of some of the most famous stars who have gone on to give their performances in another dimension of existence will find *Hollywood: The Bizarre* a unique disc that makes a fascinating and entertaining resource.

• *The World War II Quiz Book CD-ROM* (\$39.95). World War II was one of the most-catastrophic man-made events of this millennium and undoubtedly changed the course of history. As such, it was made up of little-known facts and ordinary people, as well as brilliant generals and

great battles. My older brother Tim is the author of several books on "The Big One." Two of his works, *The World War Quiz and Fact Book Vol. I* and *Vol. II*, provide a huge portion of the subject matter found on this CD-ROM from ScanRom Publications.

In addition to the question-and-answer section of the CD, this disc contains *The Compact History of World War II* by R. Ernest Dupuy, a noted military historian. Hundreds of war photos taken by combat photographers and from the archives of the United States, German and British governments add visual impact to the disc, including the graphically-chilling cover-

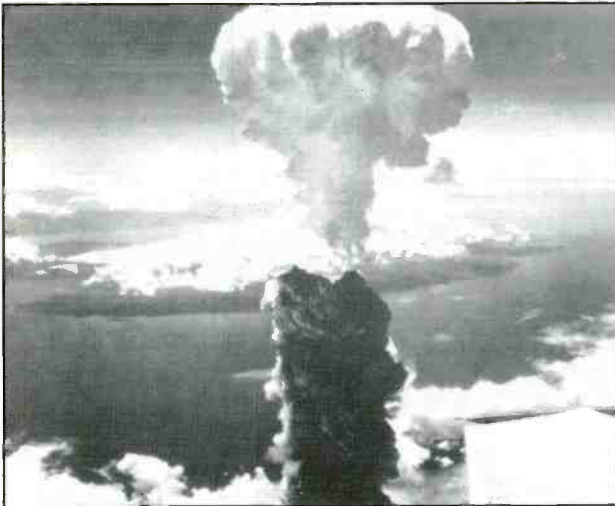

Hundreds of photos on *The World War II Quiz Book CD-ROM* document and graphically underscore the horrors of war, including atomic bomb that helped bring war to an end.

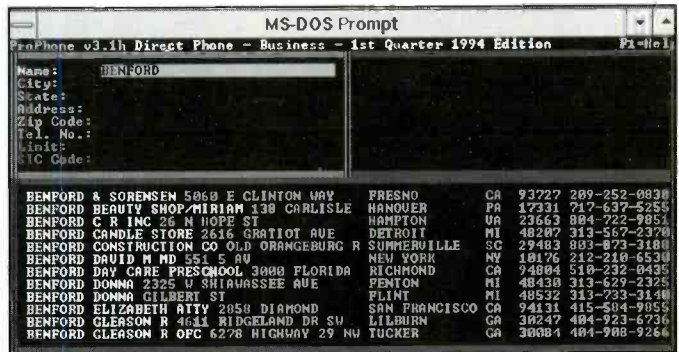

Using the *selectPhone* discs, I found 656 residential listings and 25 business listings for other people named Benford (the vast majority of whom I don't know). Information can be exported to any popular database application for printing mailing labels or used with autodialers for marketing purposes. A search such as this took less than a minute on a Pentium-based PC with a double-speed drive, while it would take weeks—maybe even months—to find all of these entries using conventional printed telephone books.

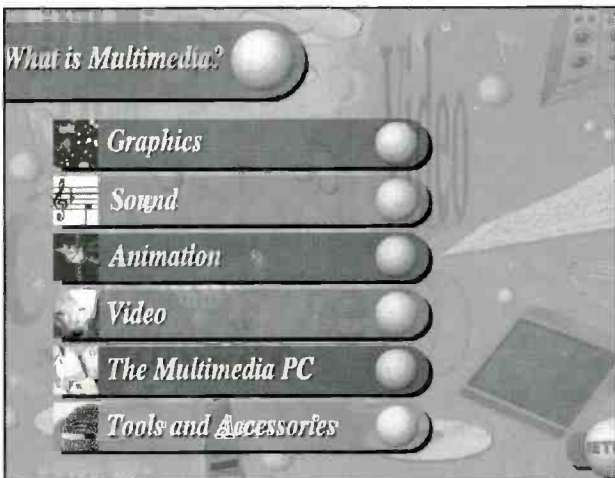

Professor Multimedia takes user on interactive tour of multimedia using the technology itself to provide examples, explain concepts and components and keep interest level high. Even seasoned PC users may learn a thing or two from this CD-ROM.

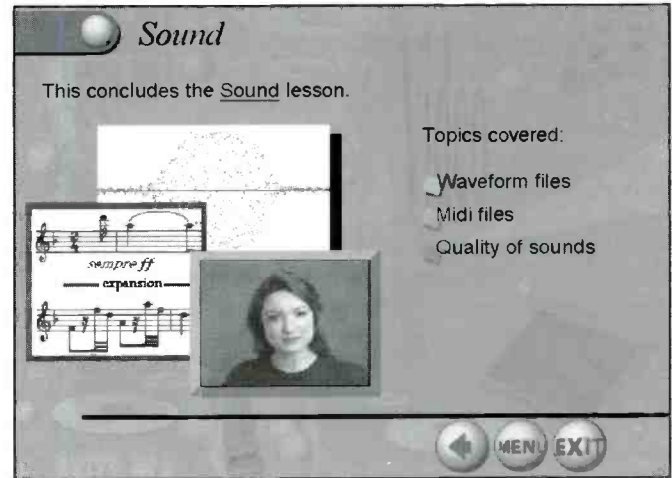

Each segment of *Professor Multimedia* disc is introduced using full-motion video to highlight key points to be covered. Action buttons at bottom of screen make moving through program part of interactive multimedia experience.

age of the carnage of Pearl Harbor, Hiroshima, Nagasaki and battlefields of the Atlantic and Pacific theaters.

This CD-ROM runs from DOS or *Windows* and contains more than 2,000 questions, answers and facts on WWII compiled by Tim. Some of the priceless trivia tidbits include the American baseball player who spied on Japan, the song the British stole from the Germans, Mussolini's mistress, the first member of Congress to enlist after Pearl Harbor, the first U.S. unit to cross the Rhine, the youngest German general, the future Pope hunted by the Gestapo, the top air ace of all nations and the top submarine and U-boat commanders, Adolph Hitler's dog, and much, much more.

An hour of audio is also included on this disc, which accurately captures the sounds of war as well as some of the most-interesting moments of the WWII experience. Among the great audio moments captured on the CD-ROM are FDR's famous "Day of Infamy Speech," Winston Churchill's "Blood, Sweat and Tears" speech and numerous live eyewitness accounts of such events as the Battle of Britain and the signing of the peace agreement that ended the war in the Pacific aboard the Battleship *Missouri* in Tokyo Bay.

This disc is a most worthwhile addition to any CD-ROM library and is particularly valuable as a student resource. As a special offer for *MicroComputer Journal*

readers, Tim Benford is making personalized and autographed copies of his eight books available by direct order at their published cover prices. His contact information is provided at the end of the Products Mentioned box.

• *ProPhone* Telephone Directories on CD-ROM: (*EuroPage*; *freePhone*; *CanadaPhone*; *directPhone*; *selectPhone*). If you use the telephone a great deal in your business dealings and have to call directory assistance or consult the phone directory frequently, you'll be very interested in these *ProPhone* CD-ROMs from Pro CD, Inc. All use the same straightforward and easy-to-use front-end. *ProPhone* discs are divided into five separate volumes that provide the names, addresses and tele-

phone numbers for millions of residential and business telephone customers across the U.S., Canada and Europe. The five products in the *ProPhone* line have different databases and various searching capabilities.

directPhone. This two-disc set lets you look up listings by name and contains the white-pages directories for 80-million listings in the United States (72-million residential listings on one disc and 8-million business listings on the other disc).

selectPhone. This four-disc set permits you to look up listings by any field: name, address, city, state, ZIP code, area code, telephone number and business heading/SIC code. Its more-than-80-million listings are broken into 72-million residential and 8-million business. Reverse-search capability is supported.

freePhone. This single-disc package consists of more than 250,000 listings of AT&T's Toll-Free Directory. The listings are sorted by business classification, and there are 2,700 business headings provided for searching.

CanadaPhone. This single disc contains nearly 10-million listings derived from every white- and yellow-pages directory published in Canada. Listings can be searched by name, address, telephone number and type of business.

EuroPages. This single disc contains listings for more than 150,000 major suppliers from 16 European countries. The database is updated by a consortium of 33 European and Eastern European directory publishers and includes listings for selected businesses from Austria, Belgium, Switzerland, Germany, Denmark, Spain, France, Finland, Great Britain, Greece, Italy, Ireland, Luxembourg, Norway, The Netherlands, Sweden, Hungary, Croatia, Poland, Slovenia and Slovak Republic. Businesses can be identified by name or from nearly 6,000 key words.

You're permitted unlimited usage and unlimited downloading into any database, word processor, spreadsheet or contact management software product for further processing by your PC, making the *ProPhone* CDs not only the most-comprehensive telephone resources available, but also the most-flexible with regard to what you can do with the information. If you do lots of telephone-intensive work or have to locate people and/or businesses, these discs are most worthwhile investments.

• **Professor Multimedia.** Multimedia is a term that's been bandied about all over the place in recent months, and most savvy

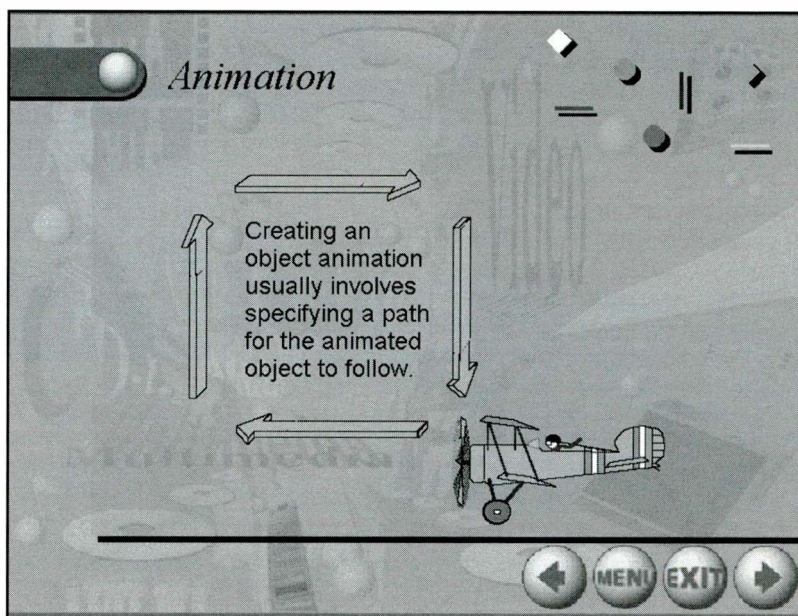

Concepts and components of multimedia are explained in clear detail that's geared to educate while being entertaining at same time.

computer users understand (more or less) what "multimedia" encompasses. I say "more or less" because there are some aspects of multimedia that aren't as readily recognized or publicized as are others. For computer novices and those seasoned users who haven't taken the plunge into multimedia yet, there exists an area of confusion regarding what it's all really about, what can be done with it and what's required in the way of computing power, peripherals and software. *Professor Multimedia* fills in all the blanks for these users by using multimedia itself to fullest advantage.

Running under *Windows*, *Professor Multimedia* is an interactive learning program that teaches the elements of multimedia, how it will affect our lives and how it can be effectively used to improve communication. The program is broken into four major segments titled "Pizzazz," "What is Multimedia?," "Everyday Multimedia" and "Multimedia In Business," each of which contains topics that are germane to that aspect, and motion video.

Pizzazz provides examples of multimedia and serves as an overall introduction for the program.

What is Multimedia? explores each component (graphics, sound, animation, video, the multimedia PC, tools and accessories) of multimedia.

Everyday Multimedia covers the vari-

ous multimedia technologies designed for home use and emerging technologies like Interactive TV and provides the opportunity to sample 10 education and entertainment multimedia titles (*Myst*, *PC Karaoke*, *Arthur's Teacher Trouble*, *Dinosaurs* and more). Such aspects as Photo-CD, CD-I, 3DO, the Information Highway and Kiosks are also covered in this segment. The content of this segment is extremely valuable for those who want to get a glimpse of what the future holds regarding emerging technologies that will soon become mainstream.

Multimedia in Business provides advice on making multimedia presentations and includes hints on layout, getting and making media files and the equipment required. You're also given the opportunity to "create" multimedia presentations using the *Compel*, *Action!*, *Freelance*, *Powerpoint* and *WordPerfect Presentations* programs. Limited functionality for these is built into *Professor Multimedia*.

Professor Multimedia is designed to take 8 to 10 hours to complete in its entirety, including the time it takes to "create" a multimedia application. Anyone who goes through all the segments of this disc will have a clear and thorough understanding of what multimedia is, what it can do and what's required to produce it on a PC. This disc is an excellent introductory and educational resource on the subject. ■

Products Mentioned

.WAVjammer 16-Bit Stereo PCMCIA Sound Card. \$399
New Media Corp.
Irvine Spectrum
15375 Barranca, Bldg. B101
Irvine, CA 92718
Tel.: 800-453-0550

CIRCLE NO. 120 ON FREE INFORMATION CARD

Hollywood: The Bizarre, \$69.95; *The World War II Quiz Book on CD-ROM*, \$39.95

ScanRom Publications
P.O. Box 72
Cedarhurst, NY 11516-0072
Tel.: 800-269-2237

CIRCLE NO. 121 ON FREE INFORMATION CARD

Professor Multimedia, \$59.95)

Individual Software Inc.
5870 Stoneridge Dr., #1
Pleasanton, CA 94588
Tel.: 510-734-6767

CIRCLE NO. 122 ON FREE INFORMATION CARD

ProPhone CD-ROM Telephone Directories
directPhone, \$149; *selectPhone*, \$299;
freePhone, \$49; *CanadaPhone*, \$149;
EuroPages, \$49)

Pro CD Inc.
8 Doaks Lane—Little Harbor
Marblehead, MA 01945-9866
Tel.: 617-631-9200

CIRCLE NO. 123 ON FREE INFORMATION CARD

Personalized/Autographed Copies of Books by Tim Benford, Call for Prices (*World War Quiz & Fact Book Vols. I and II*, *W.W.II Flashback*, *The Space Program Quiz & Fact Book*, *The Royal Family Quiz & Fact Book*, *Hitler's Daughter*, *The Ardennes Tapes*, *Righteous Carnage*)

Benford Associates
1464 Whippoorwill Way
Mountainside, NJ 07092
Tel.: 908-232-6701

CIRCLE NO. 124 ON FREE INFORMATION CARD

Xingit! MPEG Video Capture Board
Xing Technology Corp.
1540 W. Branch St.
Arroyo Grande, CA 93420-1818
Tel.: 800-2-XINGIT;
BBS: 805-473-2680

CIRCLE NO. 125 ON FREE INFORMATION CARD

ORGANIZE AND PROTECT YOUR COPIES OF *MicroComputer Journal*

Now there's an easy way to organize and keep copies of your favorite magazine readily available for future reference.

Designed exclusively for *MicroComputer Journal* by Jesse Jones Industries, these custom-made titled cases and binders provide the luxury look that makes them attractive additions to your bookshelf, desk or any location in your home or office.

Whether you choose cases or binders, you'll have a storage system that's durable and well organized to help protect your valuable copies from damage.

- Cases and binders designed to hold a year's issues (may vary with issue sizes).
- Constructed of reinforced board, covered with durable green leather-like material.
- Free personalization foil for indexing year.
- Cases V-notched for easy access.
- Binders have special spring mechanism to hold individual rods which easily snap in. This allows magazines to be fully opened for easy readability.
- Title hot - stamped in gold.

MicroComputer Journal
Jesse Jones Industries, Dept. MCJ
499 East Erie Avenue,
Philadelphia, PA 19134

Quantity	Cases	Binders
One	\$ 7.95	\$ 9.95
Three	\$21.95	\$27.95
Six	\$39.95	\$52.95

Please send _____ cases; _____ binders

Add \$ 1 per case/binder postage and handling. Outside USA \$2.50 per case/binder. (U.S. funds only)

Enclosed is \$ _____

Charge my: (Minimum \$15)

American Express

Visa

Mastercard

Diners Club

Card # _____ Exp. Date _____

Signature _____

Print Name _____

Address _____

No P.O. Box Numbers Please

City/State/
Zip _____

PA Residents add 7% sales tax
Call TOLL FREE 7 days,
24 hours 1-800-825-6690

Microcomputer Q & A

By TJ Byers

As the World Turns

Q. I was most interested in a recent event (June 30, 1994) that had the whole world setting ahead clocks by one second. What's the purpose of this, and how does it affect my PC's clock?

A. It's called a leap second, and it has occurred 19 times during the past 22 years. Basically, this time adjustment is needed to correct for the slowing down of the earth's rotational speed, which is caused by friction from tidal forces and other natural events. There's no noticeable effect to your PC's clock because you gain or lose more time than this over a period of just a month. It mostly applies to the atomic clocks at the National Institute of Standards and Technology (NIST) and other world standards laboratories, including the master clock at Greenwich, England. Essentially these clocks are used for navigation purposes. However, it's quite easy to synchronize your PC's clock with the atomic clock using a shareware program called PCCLOCK (see Fig. 1).

Nervous Rodent

Q. Lately, my mouse pointer has been jumping all over the place when I move my mouse slightly. I went into Windows' Control Panel and decreased the Mouse Tracking Speed, but the pointer still sometimes leaps dramatically. Is my mouse broken?

A. I've seen several cases in which computers have spontaneously reverted to another mouse driver in

SYSTEM.INI. Why? I don't know, except that maybe installing a program with a glitch did it. Most of the time, it was a Logitech Mouse that was trying to run on a Microsoft or Genius driver. Unless you have a mouse driver like the Kensington Expert Mouse 4.0, which deliberately jumps your cursor around from one user-defined spot to another, your mouse is probably just dirty. Over time, the rollers inside your mouse pick up dirt and dust, which can really gum them up. Symptoms include jumpiness, stickiness or movement along only one axis. Your mouse manual should provide instructions for cleaning. For Microsoft and compatible mice, the rubber ball is removable by twisting the retainer a quarter turn (90°) counterclockwise.

Be aware that it may take a bit of scrubbing to get all the gunk off the ball, and don't forget to use a cotton swab to remove build-up from the pickups. Whatever you do, *never* use a household cleaning solvent because these can damage the rubber parts inside the mouse. Soap and water works for the ball, and plain old rubbing alcohol does a good job on the plastic and metal pieces. Make sure everything is dry before you power up your mouse again.

Games and Dad

Q. I use Windows with a Super VGA driver for maximum resolution. My problem is that when my children want to use their games in Windows, they need them in standard VGA to be able to use the full-

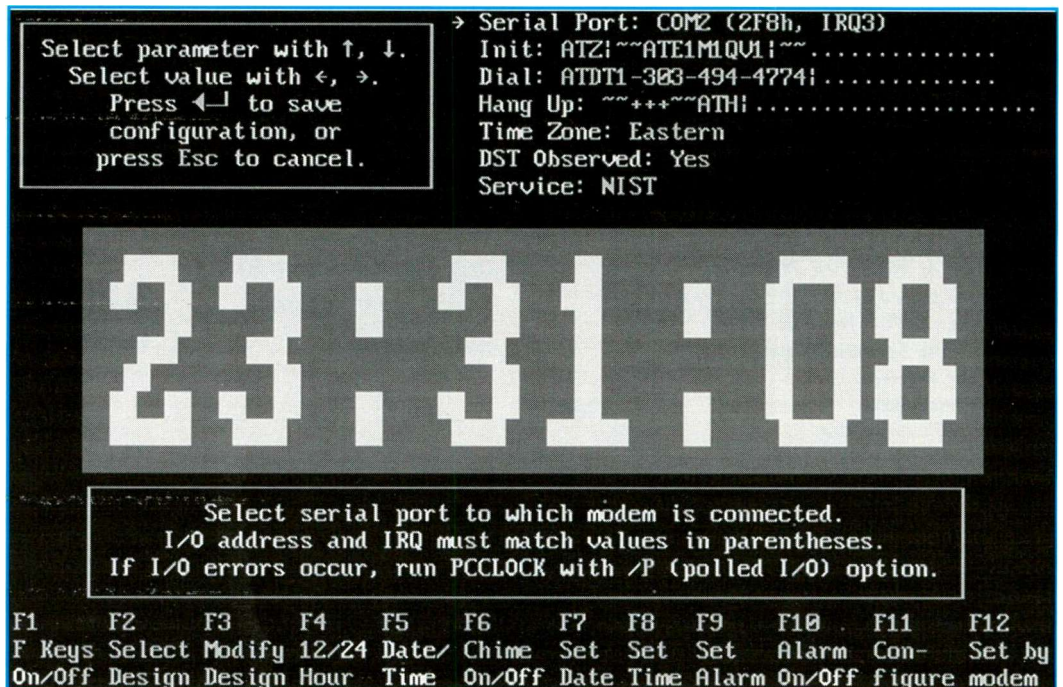

Fig. 1. This shareware program dials into the atomic clock at the US Naval Observatory and resets your PC's clock/calendar, by modem, to the totally accurate time and date. Check your local BBS or on-line service for the file PCK300.ZIP.

screen mode, since in Super VGA they fill up only a small portion of the screen. I don't want the kids playing around in Windows setup to change the video drivers, but I don't want to deny them access to the system, either. Any suggestions?

A. The solution is to use a small batch file to exchange the SYSTEM.INI file in which the settings for the video display lie. First make a copy of the SYSTEM.INI file in the Windows directory under the name SVGA (copy C:\WINDOWS\SYSTEM.INI C:\WINDOWS\SVGA). Then go into Windows Setup and make the change to the VGA display driver. Now copy the "changed" SYSTEM.INI file to VGA.SET (copy C:\WINDOWS\SYSTEM.INI C:\WINDOWS\SVGA.SET). Finally, create a batch file (name it anything you wish, such as VIDEO.BAT, perhaps), or add the lines shown in Fig. 2 to your AUTOEXEC.BAT file.

To understand how this program works, type HELP CHOICE from the DOS prompt. You can also change the shell in the SYSTEM.INI file to Program Manager, where you can customize to show only the game program icons (see Help, Icons under Windows). This way, the kids can have their own Program Manager and not interfere with yours.

WinWord 6.0 Can't Spell

Q. I use Word for Windows 6.0 in my work and have noticed something really strange when a file from a college came across my desk the other day: I can't do a spell check on it! I get a message that states that all the unformatted words have been checked for spelling—not the formatted ones. But there are no unformatted words in the document. If the spell checker works on my formatted documents, why not this document?

A. This is a bug in WinWord 6.0 that's not exactly clear—not even to Microsoft. It has something to do with the style sheet, and it affects the grammar checker as well. I'm sure that there's a simple fix, probably something like going into one of the .INI files and changing a line, but the technicians are still trying to define the problem before they commit to a fix. However, I discovered that if you save the file to a DOS word-processing format, such as Word for DOS or WordPerfect for DOS and then convert it back into WinWord format, the spelling and grammar checker work just fine. Furthermore, you don't lose any of your formatting.

Windows is RAM-Hungry

Q. According to my MS-DOS manual, the SmartDrive disk-caching utility's hit/miss rate should be about 7.5. get I only 2.5. As far as I can tell, I'm set up okay. I have a

```
echo off
rem select video mode
:start
cls
echo A: SuperVGA
echo B: Games
choice /c:AB /N      Press A or B
if errorlevel = 1 goto games
if errorlevel = 0 goto svga
:svga
copy C:\WINDOWS\SVGA.SET C:\WINDOWS\SYSTEM.INI
win
goto start :games
copy C:\WINDOWS\SVGA.SET C:\WINDOWS\SYSTEM.INI
win
goto start
```

Fig. 2. If you wish to use Windows with a Super VGA driver for maximum resolution and a lower resolution for playing games without having to change system settings, add these lines shown to your AUTOEXEC.BAT file.

486SX system with 2M of RAM—which should be enough to run my Windows applications according to the requirements listed in their manuals. I even ran MemMaker. Any suggestions?

A. Well, 2M is actually the bare minimum for Windows. You'd be better off with 4M, and most business applications today recommend 8M. With just 2M of RAM, SmartDrive's cache defaults to 256K—and then only under the best of conditions. For example, if you don't specify a minimum cache size, a program can reduce the cache size to 0, which results in no hits. My suggestion is to upgrade to 4M or more of RAM, and you'll notice a significant performance improvement.

Small Files, Wasted Space

Q. My hard disk is filling up rapidly. While I was doing some basic disk cleanup, I noticed that many of my small files are taking up more space than they should because the file is smaller than the allocated

Drive Size	Sectors	Cluster Size
0M to 15M	16	8K
16M to 127M	4	2K
128M to 255M	8	4K
256M to 512M	16	8K

Fig. 3. The larger the capacity of the disk drive, the greater the number of sectors per cluster. This wastes disk space when a cluster isn't completely filled. You can reduce the size of the cluster and increase disk usage by partitioning a large-capacity disk into smaller-capacity logical drives.

EARN YOUR COLLEGE DEGREE AT HOME

- B.S. & M.B.A. in Business
- B.S. in Environmental Studies
- M.S. in Management/Environmental Studies
- Approved for tuition reimbursement by major companies.

CHADWICK UNIVERSITY

For a free catalogue call 1-800-767-CHAD.
Member of World Association of Universities and Colleges.
A Global Accreditation Association

B.S. & M.S. In Computer Science

- ALL COURSES HOME STUDY
- Using Windows, C++ and Ada courses available.
- Approved for tuition reimbursement by leading corporations

AMERICAN INSTITUTE OF COMPUTER SCIENCES

For free information call 1-800-767-AICS
Member of World Association of Universities and Colleges.
A Global Accreditation Association

CIRCLE NO. 59 ON FREE INFORMATION CARD

TEACHING TEXTS FOR URDA PRODUCTS

URDA®, INC. manufactures and markets educational trainers for microprocessors which are so good that authoritative faculty members write teaching textbooks about them.

One of these is the SBC-51, an 8051 educational trainer for which I. Scott MacKenzie has authored the textbook:

The 8051 Microcontroller, by I. Scott MacKenzie, Paramount Career, Education, and Technical, New York, 1992

There are additional textbooks which cover other educational trainers manufactured and distributed by URDA®, Inc. For a complete list and catalog, call or write URDA®, Inc.

A partial list of the Educational Trainers available now:

8 Bit SDK-85 8 Bit SDK-51 16 Bit SDK-86
32 Bit SDK-386™* 32 Bit SDK-486

*386 is a trademark of Intel Corporation. Used by permission

Call or Write:

URDA®, INC.
1 8 1 1 Jancey Street, Suite #200 (Rear)
Pittsburgh, PA 15206-1065

1-800-338-0517 or (412) 363-0990

CIRCLE NO. 92 ON FREE INFORMATION CARD

No Hidden Charges - Guaranteed - Best Value per Dollar

68HC11 System

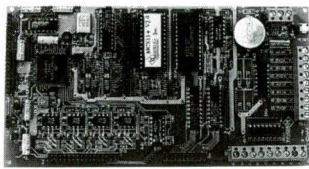

Order with Basic-11 or Real-Time Kernel No Extra Charge

STANDARD FEATURES

- FAST 2.45 Mhz Bus Speed
- RS-232 Host Interface
- 32K RAM - 32K EPROM
- Trimmable Crystal Oscillator
- Configurable Analog Input Buffers
- Buffered and Optically Coupled I/O
- Single Supply - Local Power Regulation
- Full Reset/Power Supply Management
- Battery Backup the RAM or Entire Board
- Banked Memory Logic allows up to 2Meg
- Four Pre-Decoded Chip-Selects Available
- Buffalo Monitor Supplied on EPROM
- BASIC 11 and Real-Time Kernel Available

\$159 Plus \$5 S&H
CT Residents please add 6% Sales Tax

(203) 669-0401

Wheatstone
MicroSystems, Inc.
Suite 418, 105-14 Elm St. Old Saybrook, CT 06475

Call for FREE 68HC16 Info

CIRCLE NO. 94 ON FREE INFORMATION CARD

tion unit, which is reported at 8,192 bytes under MSD (Microsoft Diagnostics). I was thinking about upgrading to Stacker 4.0 for its 2.5:1 compression, but I don't see much benefit going this route if my allocation unit remains so large. I think that if I could reduce the size of the allocation unit to a smaller size (say, 512 bytes), the real space savings on my drive would be much better and I wouldn't have to resort to disk compression. Unfortunately, my DOS manual doesn't give any clues as to how to reduce the size of the allocation unit. Is there a way to do so?

A. Your timing couldn't be more perfect because you'll notice that my "All About Hard Disks" article in this issue deals with hard-disk drives—and your allocation problem. For your convenience, the cluster allocation table from the article is shown in Fig. 3.

Missing Megabytes

Q. I just bought a Western Digital hard-disk drive. The drive has all the specifics printed right on it, including number of cylinders, heads, sectors per track and

disk capacity. I typed these numbers into my CMOS setup exactly as printed on the drive's label (I used user-defined drive Type 47) with WPrecomp=0(zero) and Landing zone=0(zero), as explained in the installation guide. The drive was sold to me as a 212M unit. However, as soon as I entered the last number, the CMOS setup table gave me a value of 203M. What happened to the other 9M? Does CMOS setup predetermine the size of the drive after formatting or will those 9M be lost forever?

A. Actually, you never had those 9M. Hard disk drives are specified using the amount of data the disk will hold before it's formatted. But by the time you divide the tracks into segments and partition them into clusters, the drive size decreases. Part of the disk is used by the FAT (File Allocation Table) and partition table. Another chunk is used for the "blank" space between the sectors that's needed to define the borders between adjacent segments. And there may be a few sectors that DOS determines are bad or unstable, which DOS permanently locks out. While

each by itself doesn't seem like much, adding them up will account for your "missing" 9M.

Missing Disk Space Using Windows

Q. I installed Windows 3.1 and noticed a severe drop in free disk space. While searching for the source of the problem, I found a hidden file in the root directory called "386spart.par" that takes about 8.5 M of disk space. Is this file important? Can I delete it without causing problems?

A. What you found is Windows' permanent swap file, which emulates system RAM when your application needs more RAM than your PC has installed in it. It does this by shuttling files between system memory and the hard disk and is an essential part of any serious Windows environment. If you're hard pressed for disk space, you can change the permanent swap file to a temporary swap file using the "386 Enhanced" icon found in the Control Panel of the Main menu. Simply choose the Virtual Memory option and change the permanent selection to temporary. Be aware, though, that the temporary swap file will probably run slower than your present permanent swap file. On the plus side, you gain extra disk space when working with DOS and several Windows applications. Also, be warned that you can't place the swap file on a compressed disk. You must put it on an *uncompressed* drive.

Windows 32-Bit Disk-Drive Tip

Q. I just installed a Maxtor 7546 hard-disk drive—a dynamite piece of gear—in my 486 PC. But now I'm having problems with the system locking up. What's happening?

A. Windows is what's happening. The secret is to set the cylinders for 1,024, not 1,060 as stated in the documentation. If you don't do this, Windows will have a problem accessing through the Control Panel's 32-bit Disk Access feature, which causes the system to lock up. In fact, you can use this trick on most drives that have more than 1,024 cylinders to eliminate the 32-bit Disk Access problem. As a rule, you don't have to use the exact specifications of the drive to install it because all IDE and SCSI drives use a sector translator—which means that what you see isn't what's actually taking place inside the drive. As long as you use numbers that are close to the original—but not exceeding the original value—the drive should work properly, as the above example demonstrates.

Product Focus

Morphing On Your PC

By Dave Mason

(Waite Group Press. Soft cover. 200 pages. Two 31/2" floppy disks. \$29.95.)

You've seen it in motion pictures like "Terminator 2" and in all sorts of TV commercials and no doubt have been fascinated by the visual effect known as "morphing," the changing of one image into another with smooth transitions between the two images. Perhaps you've even wished you could do the same thing on your PC. If so, Dave Mason's new book/program package from the Waite Group. Unlike other computer books you'll currently find on the market, this package is really a pair of programs on a pair of floppy disks that you can use on a reasonably fast PC to create morphing and animation effects plus hard-copy instructions (the book). In all, this package offers you an interesting and fascinating application that takes you well beyond your mundane everyday operations like processing words and filling in spreadsheets and databases. It provides a hands-on means for you to express your creativity!

The two programs supplied on floppy disk include *DMORPH* (Dave's Morphing) and *DTA* (Dave's Targa Animator). With *DMORPH*, you can create smooth transitions between both still and animated images. *DTA* then lets you convert synthetic images to flicks that you can run as animation sequences. Once you get down the procedures, which are covered in minute detail in the accompanying book, you'll be a pro at morphing and animation. Throughout the book, you're made privy to tips and techniques you can use to obtain stunning special effects.

Included along with the programs on the floppy disks are more than 50 morph examples you'll use in the tutorial provided in the book. As you work your way through the tutorial, you'll be exposed to the six easy steps to follow to achieve morphing success. Just don't expect to obtain the kind of effect of floor becoming bad guy as in "Terminator 2" (you'd need a multi-thousand-dollar program, probably a \$10,000+ computer and a degree in graphic arts and animation to achieve such sophistication), but you'll certainly get the feel of how things like this are done and have your appetite whetted for more, more, more.

DMORPH and *DTA* are both fairly easy programs to master and both do a creditably good job of the tasks they're designed to do. Supported by a well-written and well-illustrated hard-copy book, this package represents an unbeatable combination at a blockbuster price. I've played with this package on and off for several months now and have never come away from it putting less than three hours in a session. In fact, most of the time I had to exercise a great deal of effort to shut down my PC once I got started, especially with the *DMORPH* program. If you're adventurous and relish the thought of getting in on the ground floor of cutting-edge computing technology as I am, you can't afford to pass up Dave Mason's *Morphing On Your PC!*

—Alexander W. Burawa

The Speed Game

In 1993, Intel's Pentium sales generated more than \$300-million. Some analysts expect the figure to increase to over \$3.5-billion in 1994. This revenue increase must occur while chip prices are tumbling, which could put the company's target at a fifteen-fold increase in the number of chips sold.

New technology developed by International Meta-Systems Inc. may allow the new PowerPC chips, as well as Digital Equipment's Alpha chip and other RISC processors, to run all software designed for 486 and Pentium chips at unprecedented speeds.

John Hastings is the president of the American Computer Exchange Corp., which matches buyers and sellers of used microcomputer equipment. For more information, call 800-786-0717.

IBM has developed similar technology for its PowerPC 615 chip, which is due next year. However, the IMS technology is touted as being more-portable than IBM's. If incorporated into Digital's Alpha chip, the performance could be three times faster than Intel's fastest Pentium chip. If this technology proves reliable, it could pose an enormous threat to Intel's dominance in the industry. Because RISC processors normally have less than half as many transistors as the CISC technology that Intel uses, they are smaller, run cooler, consume less power and are cheaper to manufacture.

Proving that they can pre-announce unavailable products as well as Intel, IBM and Motorola have announced that a 100-MHz PowerPC chip will be available by this fall. This move was intended to top

Prices of Used Computer Products as of April 28, 1994

Machine	Average Buyer's Bid	Average Seller's Ask	Close	Change
IBM PS/2 Model 30/286, 20M	\$250	\$450	\$275	-25
IBM PS/2 Model 70, 60M	400	700	550	—
IBM ThinkPad 350	1,000	1,550	1,025	-100
IBM ThinkPad 700	1,300	1,700	1,400	-100
IBM ThinkPad 720	1,600	2,000	1,800	-150
AST 386/20, 80M	450	850	525	-50
Dell 325SX, 60M	400	800	575	-50
Dell 386/20, 120M	600	900	700	—
Gateway 386SX/20, 80M	400	850	525	-50
Gateway 386/25, 80M	500	800	650	-25
Gateway 486/33, 120M	900	1,300	925	-125
Clone Notebook 286, 40M	350	700	425	-100
Clone Notebook 386SX, 40M	500	900	725	-75
Clone 386/25 80M, VGA	450	850	650	+25
Clone 386/33 80M, VGA	550	950	700	—
Clone 486/251, 20M, VGA	800	1,250	900	-50
Compaq SLT/286 20M	250	500	350	-50
Compaq LTE 286 40M	400	775	425	-125
Compaq Deskpro 386/20e, 100M	500	800	650	-25
Compaq Contura 320, 60M	500	1,000	750	-25
Macintosh Classic, 40M	350	600	425	+25
Macintosh SE/30, 40M	375	800	575	-25
Macintosh II, 40M	350	650	525	+100
Macintosh IIcx, 80M	400	700	500	-50
Macintosh IIci, 80M	700	1000	800	-25
Macintosh IIfx, 80M	800	1400	1,000	-50
PowerBook 100, 20M	525	900	650	—
PowerBook 140, 40M	900	1,400	1,025	+25
PowerBook 170, 40M	1,200	1,700	1,300	—
PowerBook 180, 80M	1,400	1,800	1,575	-50
LaserWriter IINT	700	1,000	775	-25
Toshiba 1200XE	300	650	525	—
Toshiba 1900 120M	1,000	1,700	1,175	-75
Toshiba 3200SX, 40M	400	800	550	+25
Toshiba 5200, 100M	850	1,250	1,000	-250
HP LaserJet II	400	850	750	+50
HP LaserJet IIIP	375	950	575	—
HP LaserJet III	750	1,100	900	—
HP LaserJet IV	1,000	1,300	1,125	—

Intel's announcement of a 100-MHz Pentium slated for introduction later this year. Intel countered by divulging its plans to sell a 150-MHz Pentium during the first half of 1995. Sounding more like a game of liar's poker, Intel also said a 171-MHz version might be available by the fall of 1995.

Cyrix has introduced its new MI CPU chip. This clone of Intel's Pentium chip is reportedly 30% faster. The major obstacle was Cyrix's lack of manufacturing capacity. This obstacle may have disappeared in late April, when IBM signed an agreement to produce the chip for its own computers as well as for Cyrix to distribute to other vendors.

Most of the software for the Macintosh is currently being converted to take advantage of the phenomenal speed increase available from the new PowerMacs. Some of these conversions are relatively simple matters, involving a process known as "recompiling." Other applications may have to be essentially rewritten. Over the course of the next year, virtually all applications will be available in PowerMac format. IBM-compatible users will face a similar transition next year when the next version of *Windows* is released. Because *Windows* 4.0 will be a 32-bit operating system and *Windows* 3.1 is a 16-bit operating system, most of the *Windows* applications will need conversion efforts ranging from minor to major. Unfortunately, *Windows* users won't see the same speed improvement as will the Macintosh users. However, Microsoft does plan to put a completely new and different user interface on the new version of *Windows*. The new interface may be optional to eliminate retraining for those people who are familiar with the current version. The new interface is said to be easier for first time users to learn.

Apple is expected to announce a new family of PowerBook notebook computers next month. The new models will utilize the 68040 CPU chips running at 33 MHz. These notebooks should have a performance level comparable to that of the fastest 486 notebooks currently on the market. A system-board upgrade should be available for previous models of the PowerBook Duo. In addition, PowerPC upgrades should be available by the end of this year. Other PowerBook models appear to have no upgrade path. Prices for these PowerBooks are expected to drop rapidly in the used market over the next six months.

Apple is trying to capitalize on the video capabilities built into many of its

Prices of Used Computer Equipment as of June 2, 1994

Machine	Average Buyer's Bid	Average Seller's Ask	Close	Change
IBM PS/2 Model 30/286, 20M	\$250	\$450	\$275	—
IBM PS/2 Model 70, 60M	400	700	525	-25
IBM ThinkPad 350	1,000	1,550	1,000	-25
IBM ThinkPad 700	1,300	1,700	1,325	-75
IBM ThinkPad 720	1,600	2,000	1,700	-100
AST 386/20, 80M	450	850	500	-25
Dell 325SX, 60M	400	800	500	-75
Dell 386/20, 120M	600	900	625	-75
Gateway 386SX/20, 80M	400	850	500	-25
Gateway 386/25, 80M	500	800	600	-50
Gateway 486/33 120M	900	1,300	950	+25
Clone Notebook 286, 40M	350	700	475	+50
Clone Notebook 386SX, 40M	500	900	700	-25
Clone 386/25, 80M, VGA	450	850	675	+25
Clone 386/33, 80M, VGA	550	950	725	+25
Clone 486/25, 120M, VGA	800	1,250	950	+50
Compaq SLT/286, 20M	250	500	400	+50
Compaq LTE 286, 40M	400	775	475	+50
Compaq Deskpro 386/20e, 100M	500	800	625	-25
Compaq Contura 320, 60M	500	1,000	750	—
Macintosh Classic, 40M	350	600	375	-50
Macintosh SE/30, 40M	375	800	525	-50
Macintosh II, 40M	350	650	525	-25
Macintosh IIcx, 80M	400	700	550	+50
Macintosh IIci, 80M	700	1,000	800	—
Macintosh IIx, 80M	800	1,400	975	-25
PowerBook 100, 20M	525	900	625	-25
PowerBook 140, 40M	900	1,400	1,100	+75
PowerBook 170, 40M	1,200	1,700	1,325	+25
PowerBook 180, 80M	1,400	1,800	1,525	-50
LaserWriter IINT	700	1,000	700	-75
Toshiba 1200XE	300	650	550	+25
Toshiba 1900, 120	1,000	1,700	1,075	-100
Toshiba 3200SX, 40M	400	800	525	-25
Toshiba 5200, 100M	850	1,250	1,000	—
HP LaserJet II	400	850	800	+50
HP LaserJet IIIP	375	950	575	—
HP LaserJet III	750	1,100	950	+50
HP LaserJet IV	1,000	1,300	1,175	+50

new models. It's expected to announce a device that will allow TV programs to be displayed on the computer's screen. While this isn't the first device to accomplish such a feat, it may be the first to sell for less than \$100.

At times, adding upgrades to an IBM-compatible computer can be an absolute nightmare. Whether it be additional memory or expansion cards, most computers require appropriate settings of jumpers, DIP switches and software settings to make everything work in harmony. Microsoft, Intel and Compaq have been working together to adopt a standard for hardware and software that will eliminate the nightmare. "Plug and Play" will allow the computer to make the appropriate determination and adjustments to all nec-

essary settings. Close coordination between all software and hardware makers is required to make the standard work. The Apple Macintosh has had this feature for 10 years, but that was due to Apple's ability to control the operating system software and hardware. Microsoft, on the other hand, must be able to deal with hundreds of computer, printer and peripherals manufacturers. In spite of this, the "Plug and Play" standard should be universally adopted during the next two years.

Most modems operate at 2,400, 9,600, or 14,400 bits per second. While some more-expensive models can operate at 28,800 bps, Zoom Telephonics is shipping its VFX 28.8 for \$299. This should be the first of many low cost, high speed modems.

An enormous amount of computer merchandise is purchased through the mail. The price of this merchandise may go up soon if Senator Dale Bumpers' new bill is passed. This bill will allow states to collect sales taxes on interstate commerce. Said to level the playing field for local *versus* out-of-state vendors, the net effect is more taxes and higher prices.

More News

Intel has set an extremely ambitious goal to sell more than 7-million Pentium CPU chips before the end of this year. Some people estimate the company has sold fewer than 1-million chips during the past 13 months. For Intel to realize its goals in the face of mounting competition, chip prices will surely fall. Intel has stated that its prices on the Pentium CPU chips will drop dramatically before the end of this year. In some cases, prices will fall by 50%. This could enable manufacturers to deliver Pentium-based desktop computers for less than \$2,000. At that time, Intel expects the 486 chip to be used primarily for notebook computers, with most new desktops running the Pentium chip. This aggressive pricing is an attempt to pre-empt unprecedented competition in the chip industry.

In less than a year Cyrix and IBM will be marketing the Cyrix M1 chip and Advanced Micro Devices will introduce its K5 chip. The M1 is expected to equal the performance of the Pentium, while the K5 is expected to run 50% faster than the Pentium. During the next year, some RISC-based CPU chips will incorporate hardware emulation of the Pentium processor. The PowerPC should be the first to outrun the Pentium. The most-powerful chip available should be Digital Equipment's Alpha CPU.

Some experts feel Intel is attempting to force the industry to adopt the Pentium CPU chip by curtailing production of 486 chips. If computer makers can get Pentium chips only in the quantities they need, they'll be forced to place their marketing efforts behind this processor. Intel has stated it expects to sell 6-million Pentium chips this year, but it's well behind this pace. Meanwhile, Motorola announced the next version of the PowerPC chip. The 603 chip offers Pentium-level performance in a low-power chip that's suitable for portable computers. At less than one-third the price of most Pentiums, Motorola's pricing surprised the industry.

Apple is expected to lower the prices on some low-end Macintosh computers soon. These are the models that have the greatest effect on used-computer prices. Hence,

used-equipment prices could be forced lower as a result. Color Classics are expected to sell for between \$600 and \$700, but supplies are limited, and the impact on the used computer market could be short-lived. Quadra 605 prices may drop by several hundred dollars. This could force used-equipment prices down by an equal or slightly greater amount on a more-permanent basis.

Most of the software for the Macintosh is currently being converted to take advantage of the phenomenal speed increase available from the new PowerMacs. Some of these conversions are relatively simple matters, involving a process known as re-compiling. Other applications may have to be essentially rewritten. Over the course of the next year virtually all applications will be available in PowerMac format. IBM-compatible users will face a similar transition next year when the next version of *Windows* is released.

Computer sales to large corporations have fallen flat lately due to saturation. Meanwhile, small-business sales have grown dramatically. Graphical interfaces have allowed more small businesses to computerize with less effort and training. In addition, lower prices have made computers more affordable. Small businesses today account for more than half of all computer sales.

Many notebook computer users have upgraded from monochrome screens to color. While pleased with the newer screens, most users have been disappointed with the resultant shorter battery life. The problem with color screens is due to the bright back-lighting necessary with color. Unlike the case with monochrome screens, back-lighting isn't optional with color screens. The design of the screen makes back-lighting mandatory. In some notebooks, back-lighting consumes up to 70% of battery power. A new color screen just announced by Sharp eliminates the need for back-lighting. It uses a highly reflective film instead. With battery life comparable to monochrome screens, this could give a significant boost to the demand for color notebook computers. Sharp expects the new screens to appear before the end of the year.

The ability to print on multi-part forms will keep the dot-matrix printers alive, but they'll never regain the prevalence they once held. Prices of other technologies have dropped to competitive levels. In addition, print quality and sound levels make laser and ink-jet printers more popular. Last year, laser printers outsold dot-matrix printers for the first time. ■

Advertisers' Index

R/S #		Page #
51	ACS.....	8
-	AES.....	57
109	ASA Tech.....	31
99	ASYS Corp.....	91
102	Ace Communications.....	11
62	AllMicro.....	1
52	Andromeda Research.....	110
56	BG Micro.....	35
53	BSoft Software.....	110
54	Beige Bag Software.....	56
55	Binary Technology.....	75
57	Blue Ridge Micro.....	110
-	CIE.....	29,61
58	Capital Electro-Circuits.....	110
59	Chadwick Univ./Amer Instit.	105
60	CompuBoost.....	111
-	Comtrad.....	7
113	Contact East.....	31
-	Contract Systems Group.....	111
61	Design Computations.....	83
-	Dunfield Development	45
103	EE Tools.....	110
63	EMAC.....	45
64	Educational Laboratories.....	110
65	Grantham College of Eng.....	76
66	Highlands Electronics.....	110
114	ICS Electronics Corp.....	88
69	IMEG Ltd.	49
68	Insight Development Sys.....	92
70	International Computers.....	111
-	International Corres School.....	5
-	Intronics.....	83
-	L.S. Electronic Sys. Design.....	49
71	Logixell Electronics.....	63
72	Mental Automation.....	59
73	Merrimack Valley Sys.....	75
74	Micro Computer Controls.....	111
75	MicroEngineering Labs.....	111
76,77	Micro House.....	25,Cov IV
78	Midwest Microtek.....	111
79	Mouser Electronics.....	57
80	New Micros.....	Cov. II
-	Parallax, Inc.	Cov. III
82	Prairie Digital.....	59
83	ProBorg Circuits.....	111
85	Prologic Designs.....	84
84	PseudoCorp.....	8
86	Rigel Corporation.....	22
-	Saelig Company, The.....	63
87	Software Innovations.....	111
88	Software Science.....	111
112	Startime.....	111
111	Sylva Energy Systems.....	111
89,90	TECI.....	92
91	Tech Arts.....	56
92	URDA.....	105
93	Ultra Link.....	111
110	Ublige Software & Robotics.....	58
105	Unicorn Electronics.....	13
-	Vanguard Labs.....	110
94	Wheatstone Microsystems.....	105
95	Z-World Engineering.....	91
96	Zero Surge.....	110

We'd like to see your company listed here too. Contact Margaret Milanese at 516-681-2922 to work out an advertising program tailored to meet your needs.

SuperMart

This new advertising section highlights products in an easy-to-locate format for reader convenience. Call Margaret Milanese today for deadlines and additional details at 516-681-2922 (FAX 516-681-2926).

EPROM+ PROGRAMMING SYSTEM USES PARALLEL PORT

SUPPORTS OVER 500 CHIPS

EPROMS (24, 28, 32 & 40 PIN - 27C & 28F)
2708, 16, 32, 32A, 64, 64A, 128, 128A, 256, 512, 513, 1011
010, 101, 1001, 1000, 1024, 2, 10, 020, 2001, 220, 2048
4001, 040, 240, 2516, 2532, 2564, 68764, 66, TMS2716

E2PROMS (24 & 28 PIN PLUS 28CXX)
2804, 2816, 2816A, 2718, 2864, 2864A, 2865, 28256

SERIAL EEPROMS (8 PIN PLUS CXX)
9306, 46, 50, 66, 244, 240, 020, 04, 25X, FR, 400

BIPOLAR PROMS - 74SXX, 82SXX

MICRO CONTROLLERS * 8741, 42, 48, 49, 8751
87C5X, 87C751, 752, 68705, 68HC705, TMS742

* ADAPTER REQUIRED - DIAGRAMS INCLUDED

SOFTWARE - READ, VERIFY, PROGRAM, COPY, DISK FILE LOAD & SAVE
CHECKSUM, BUFFER EDITOR W/20 COMMANDS, HEX & BINARY FILES

FAST! - MOST DEVICES PROGRAM IN UNDER 60 SECONDS

RUGGED (9" X 7" X 3"), PORTABLE. ENCLOSURE WITH CARRY HANDLE

MADE IN THE U.S.A. - 10 DAY MONEY BACK GUARANTEE - 1 YR. WARRANTY

SYSTEM INCLUDES: UNIT, POWER PACK, CABLE, MANUAL & SOFTWARE

ANDROMEDA RESEARCH

P.O. BOX 222

MILFORD, OHIO 45150

(513)831-9708 FAX (513)831-7562



\$289

ADD \$5.00 SHIPPING \$5.00 C.O.D.

VISA/MASTERCARD

CIRCLE NO. 52 ON FREE INFORMATION CARD

AFFORDABLE ENGINEERING HARDWARE / SOFTWARE

Engineering Software - PC-MSDOS

- Electronic Circuit Design \$ 49
- Schematic Drawing Program \$ 49
- PCB Design & Circuit Diagram \$169
- PC-SCOPE Oscilloscope \$ 49

PC Bus Plug-In Cards

- 24 Bit TTL I/O - 48 Bit TTL I/O \$39, 49
- 12 Bit Data Acquisition & TTL I/O \$ 89
- 16 Bit Counters & TTL I/O \$ 89

- More Hardware & Software is available -

Call or Write for FREE Catalog

BSOFT Software, Inc.

444 Colton Road

Columbus, OH 43207

(614) 491-0832

Fax (614) 497-9971



CIRCLE NO. 53 ON FREE INFORMATION CARD



**AIIMax
\$645
Universal
Programmer**

- Programs PLDs, PROMs, E(E) PROMs, and microcontrollers
- Tests TTL/CMOS, DRAM/SRAM
- Supports standard 48-pin GOLD-ZIF socket
- AM-PRT connects via printer port
- Lifetime Free Updates via B.B.S.
- Two (2) year Warranty, Made in U.S.A.



Electronic Engineering Tools

544 Weddell Drive, Suite 6

Sunnyvale, California 94089

(408) 734-8184, 734-8185 FAX

CIRCLE NO. 103 ON FREE INFORMATION CARD

SINGLE BOARD COMPUTERS



MCB8052

- 80C52-BASIC processor • Programs eeproms, eeproms, nv ram • Three 8-bit parallel ports • RS232 port • Serial printer port • Four decoded outputs • Three 16-bit timer/counters • Six interrupt sources • Expansion headers • \$119 A&T

MCB8031

- 8031 processor • 8k to 32k ram/rom • +5v only operation • Two 16-bit counter/timers • Five interrupt sources • Expansion headers • \$79 A&T

TO ORDER ADD \$5 SH PER ORDER.
TN RESIDENTS ADD 8.25 S.T.



BLUE RIDGE *Micros*

2505 Plymouth Rd. Johnson City, TN 37601
Tel: 615-335-6696 • Fax: 615-929-3164

CIRCLE NO. 57 ON FREE INFORMATION CARD

8051 Development Courses

8051 Microcontroller Based Computer Design
Learn how to design and build your own 8051 based microcontroller system. Easy to follow labs guide you through designing, building and utilizing your 8051 board.

Includes the following:

- * Complete Board Schematics
- * In depth study of memory, I/O, and peripheral interfacing
- * How to interface a PC to your 8051 board using RS232 port
- * Discussion of board design issues such as crosstalk and noise

Programming 8051 Based Computers

Learn how to program an 8051 using assembly language. Complete course and labs teach everything from microcontroller initialization to advanced peripheral management.

Includes the following free software:

- * 8051 Cross Assembler
- * 8051 Simulator
- * On Board Monitor

One Course - \$19.95 Both Courses - \$29.95
add \$3.50 S/H



Educational Laboratories

P.O. Box 1326 Folsom, CA 95763-1326

CIRCLE NO. 64 ON FREE INFORMATION CARD

Capital Electro-Circuits

PRINTED CIRCUIT BOARDS

Superior Quality at Competitive Prices!

- Single Sided, Double Sided & Multi-Layer
- Prototype & Production Quantities
- Photo Plotting & Electrical Testing Services

Call us for an instant quote

Phone: (301) 977-0303

Fax: 990-6715 Modem: 990-9628

7845-J Airpark Rd. Gaithersburg, MD 20879

CIRCLE NO. 58 ON FREE INFORMATION CARD

Actual Circuit Emulation

A better method than ICE!

- Much more power with less cost **The eBoard** ..
- Drivers for LCD, DTMF, and more
- Versatile Interface
- Adapter on eBoard
- Simple expansion
- External power supply for 24 hour a day operation
- Cable, Breadboard, and Power supply
- All source included.
- Kerrel, Forth, PC Debugger, Assembler and Environment.
- Runs independently of PC or use as a programmable PC card



\$195.95

This price is a limited time offer
includes shipping and handling.

Highlands Electronics
13720 Lake Shore Drive
Clear Lake, CA 95422
Phone 707 894-1024
Fax 707 894-5825



CIRCLE NO. 66 ON FREE INFORMATION CARD

SPY ON THE EARTH

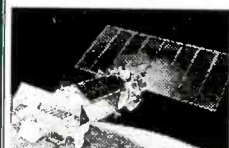

See live on your PC what satellites in orbit see

Capture live breathtaking images of the Earth for fun or profit with our SpySat software and hardware package that does it all. Track, capture, display, zoom and analyze images directly from 6 or more environmental satellites. Complete Earth station package includes antenna, LNA, satellite receiver, demodulator, A-D converter and software, all for only \$399 plus \$25 shipping. For FREE information log-on to our bulletin board anytime at: (718) 740-3911. For information by mail send \$5 (includes demo disk).

VANGUARD Electronic Labs
Dept. C, 196-23 Jamaica Ave.
Hollis, NY 11423 Tel. 718-468-2720

CIRCLE NO. 96 ON FREE INFORMATION CARD

Low Cost Embedded Controllers

MMT-188EB
MMT-2180
MMT-HC11
MMT-196
MMT-EXP
- FOUR MORE IN DEVELOPMENT

MMT-188EB \$191.00 (100 Quantity)

If you're interested in getting the most out of your project, put the most into it. Call or Fax us for complete data sheets and CPU options. Custom work welcome.

MIDWEST MICRO-TEK
2308 East Sixth Street Brookings, SD 57006
Phone 605.697.8521 Fax 605.697.8109

MIDWEST Micro-Tek

CIRCLE NO. 78 ON FREE INFORMATION CARD

Prototype it... FAST!

with ProtoQuick 8051 and Z8



- Complete 8051 and Z8 single board computers.
- Large prototype area with power bus and I/O.
- RS232 C serial port with standard DB25 connector.
- Sockets for up to 32K EPROM and 8K static RAM.
- Fully assembled, plated thru board - 5 volt operation.
- Opsys in EPROM - RS232 control of I/O and RAM.
- MS-DOS x-asm and opsys source code included.

Test and run prototype applications or experimental hardware from the serial port - **WITHOUT PROGRAMMING!**

Complete ProtoQuick 8051 or Z8 system, including board, disk and docs **ONLY - \$99.00 ea**

Software Science
3750 Roundbottom Road
Cincinnati, OH 45244
(513) 561-2060 FAX (513) 271-3181

CIRCLE NO. 88 ON FREE INFORMATION CARD

\$199

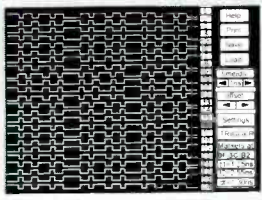

24 sampling pods
High speed Sampling and Storage Module
RS232 Serial Link (9600)

24 CHANNEL LOGIC ANALYZER

- 50MHz sampling speed
- VGA graphics PC based interface
- RS232 link to host
- Programmable trigger
- Up to 192K bytes RAM
- Fully assembled and tested
- ONE YEAR WARRANTY**

Get this powerful new tool at this incredibly low price!

ProBoard Circuits
Phone (305)721-9062 Fax (305)726-7360
6031 NW 80th Avenue, Tamarac, Florida 33321

CIRCLE NO. 83 ON FREE INFORMATION CARD

Computer Too Old?

Save Money!
Complete Kits, Easy Install

UPGRADE

XT/AT/286 → 386-486
For Office/Home

1-800-362-5053

\$149 386-40
\$249 486-33
\$349 486-66
and More!

CompuBoost
The Computer Upgrade Company
27101 Aliso Ck Rd. #124
Aliso Viejo, CA 92656
tel 714-362-5053 fax 714-362-5390

Do it yourself and save!

CIRCLE NO. 60 ON FREE INFORMATION CARD

SL SCOPE™

The PC RS-232 Analyzer

SL_SCOPE is a comprehensive serial data scope that enables users to examine and interact with the activity on any serial line **LIVE!**

- Capture and Analyze at Baud Rates up to 115k.
- Selectable Formats Including ASCII & EBCDIC.
- Pattern and Signal Searching.
- Microsecond Timestamp Accuracy on Data.
- Manual and Cable Included.
- 30 Day Money Back Guarantee.

"Easy to use and a great tool!" M. Hicks, Clement Industries.

For More Information Contact:
Software Innovations Inc.
63 Rock Cut Rd.
Newburgh, NY 12550
(914) 567-0805
CompuServe 75013,3310



CIRCLE NO. 87 ON FREE INFORMATION CARD

C Compiler Kit

8051

MICRO/C-51™

- Supports 8051 Derivative Parts.
- Interrupt Driven C Functions.
- Power-Up Your Boolean Processor.
- Supports ALL 8051 Memory Maps.
- Includes Assembler, Linker, Librarian and User's Guide with Examples.
- Optional C/ASM Simulator \$79.95.
- Student/Educational Discounts.
- VISA, MasterCard or COD.

MCC MICRO COMPUTER CONTROL Software Development Tools

PO Box 275
Hopewell, NJ 08525
USA
Fax: (609)466-4116

\$99.95

CALL (609)466-1751

CIRCLE NO. 74 ON FREE INFORMATION CARD

PARALLEL PORT TO ISA BUS



Run ISA I/O cards from any PC - including laptops

- Add up to 16 remote ISA cards.
- 8 or 16 bit ISA I/O cards supported.
- Interrupt and address space expansion.
- Local CLK and OSC signals.
- Electrically quiet expansion backplane.
- Expansion power down without host PC shutdown.
- Compatible with normal and enhanced parallel ports.
- OBASIC and C utility programs provided.

Model 120 **\$159** MC/VISA

ULTRA LINK
Phone (702) 782 9758
PO Box 1809
Minden NV 89423

CIRCLE NO. 93 ON FREE INFORMATION CARD

YOU CAN GET COST EFFECTIVE VIDEO PRODUCTS

from the same source as: GE, NASA, AT&T, IBM, US Government, US Department of Education. . .

VideoOut Send VGA to TV
Supports color, B&W, graphics, text, standard and some extended VGA modes. Even works with Windows. Outputs standard NTSC composite video (S-VHS with cable upgrade). **\$99 (\$77)**

Closed Caption Decoder Display Closed Captions on your PC. Displays ALL caption channels in realtime on your computer. Save or print any channel. Save the CI caption channel for a transcript of the current program or save one of the text channels for useful news and weather reports, program listings, etc. **\$89 (\$77)**

ImageCapture Color
Digitize color images in real-time from your video source (TV, VCR, camcorder). Supports color and B&W printers, multiple file formats. (VGA required to display.) Price slashed was \$569. **NOW \$199 (\$12)**

ImageCapture PLUS
Digitize B&W Was \$269. **NOW \$99 (\$77)**

HiColor VGA card
Reviewed in BYTE, and Computer Shopper. 1280x1024, 32K colors. Enhances VO and ICC performance. VO utilizes the full interlace display capability and ICC utilizes the 32K colors to display better color images. **\$133 (\$77)**

International Computers
12021 West Bluemound Road Wauwatosa, WI 53226
(414) 764-9000 Orders: (800) 992-9000 FAX: (414) 281-3522
Visa, Mastercard, Checks & Money Orders Accepted

CIRCLE NO. 70 ON FREE INFORMATION CARD

PIC Protos

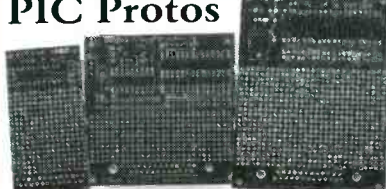

High-quality blank prototyping boards for PIC microcontrollers. Each holds 5v reg, caps, crystal or RC, DB9-25, and large prototyping area.

- PICProto18 for all 18 pin PIC16Cxx (1.5" x 3") - \$9.95
- PICProto-Dual for 18 and 28 pin PICs (3" x 3") - \$14.95
- PICProto64 for 40 pin PIC16C64, 74 (3" x 4") - \$16.95
- Demo Kit including PICProto18 - \$29.95

microEngineering Labs
Box 7532, Colorado Springs, CO 80933
(719) 520-5323 (719) 520-1867fax

CIRCLE NO. 75 ON FREE INFORMATION CARD

Never Buy Another Ticket Order Again!

When you use **TKTKMR**®, the best-selling PC ticket program that styles, prints and numbers!

Fonts furnished, or use your own. DOS or Windows Editions.

Order VERSION 3.1 for US\$89 / CAN\$123. Includes ground shipping and over 500 ticket blanks.

To order: 1 800 223-0350

SERVO MOTOR CONTROLLER



- Desktop Robotics
- Motion Controls
- Automation
- IR remote interface to PC (SV100C)

*Drives RC type servos through serial port (RS 232).
*Easy to interface, use with software provided or write your own.
*Control up to 4 servos per board with 4-bit digital I/O.
*Onboard EEPROM for stand alone applications (SV100B/C).
*IR receiver allow control through TV remote controller (SV100C).

Control Servos with a TV/VCR remote (module SV100C)

PONTECH
401 E. 17th St. Suite B
Costa Mesa, CA 92627
Voice: (714)642-8458
FAX: (714)642-8458
VISA/MC accepted
US \$5.00 Canada \$7.00 International \$12.00 (ex. \$24)

SV100 SERVO CONTROLLER BOARD with CASE & SOFTWARE **\$49.95**
SV100B SV100 with Stand alone option **\$69.95**
SV100C SV100B with IR Receiver option **\$79.95**
SERVO MOTOR (1.590/171) 4 ea **\$16.95 ea**
PLAN#1 5 motor manual for building no logged walking robot **\$9.95**

CIRCLE NO. 112 ON FREE INFORMATION CARD

BASIC PROGRAMMABLE CONTROLLER \$299US

Outstanding Features:

- *Plug-on screw terminal IO connections *10 H.C. relays and 3 LED outputs *16 opto-isolated inputs *8-10 bit analog in *2-8 bit analog out
- *two-way power line interface *RS-232 or RS-485
- *I/O expansion on a high speed local serial bus
- *real time clock *lithium backed 32K SRAM
- *watchdog *LED indicators *single 12V operation
- *excellent documentation *free PC utility program
- *assembled & tested *application ready! *RS-485 LCD & Keypad supporting products also available

SYLVA ENERGY SYSTEMS INC.
519 Richard St. Thunder Bay, ON.P7A1R2
Ph 807-683-6795 Fax 807-683-6485
BBS 807-345-0626 Logon : SYLVA

CIRCLE NO. 111 ON FREE INFORMATION CARD

Classified Commercial Rates: \$1 per word, 15-word minimum (\$15.00) pre-paid. (Word count includes name and address; Zip code and abbreviation each count as one word; P.O. Box number and telephone number count as two words each.) Indicate free category heading (Computers, Software, Electronics, Video or Miscellaneous). A special heading is available for a \$6 surcharge. First word only is set boldface caps at no charge. Add 25¢ for each additional boldface word.

Non-Commercial Rates: FREE to subscribers, as space permits; maximum 15 words. A recent MicroComputer Journal mailing label must accompany ad. (All advertisers with P.O. box addresses must supply permanent address and telephone number. Copy is subject to publisher approval.) Mailing Information: Copy must be received by the publisher by the 25th of the third month preceding the cover date. Send Advertising material with check or money order or credit card information (Visa or MasterCard only) with number and expiration date to: **MicroComputer Journal, Classified Department, 76 N. Broadway, Hicksville, NY 11801.**

BUSINESS OPPORTUNITIES

ENTREPRENEUR'S HOTLINE BBS! Money-Making Reports, Email Technical Assistance, Specialized Files, Online Chat, Post Ads, Free Look! BBS# 206-678-4033.

FREE REPORT. Turn any Computer and Modem into a Money Machine! **Millionaire reveals amazing secrets.** Call 24 hours 1-800-221-3813 Operator MC-01.

BRAND new Hitachi's 20 inch color monitor good for electric publishing, CAD, windowing and multimedia applications. Ask \$1,300.00. Please call: (201)377-5642.

MICROCOMPUTER JOURNAL back issue wanted, Jan/Feb. 1994. Send price. Willingham, 810 via Tripoli, Punta Gorda, FL 33950.

CABLE TV

CABLE TEST CHIPS. Jerrold, Tocom, S.A., Zenith. Puts cable boxes into full service mode! \$29.95 to \$59.95. 1-800-452-7090.(310)902-0841.

CABLE DOCTOR

Stop the bullet and ID signals in cable lines, send \$20.00 to R.R. ENTERPRISE, DEPT. M, BOX 3532, EASTON, PA 18043.

TEMPERATURE MEASUREMENT

Microprocessor controlled temperature monitors: -55C to +200C with datalogging software for PC serial port. Prices start at \$97. Call (803)951-3479 to order or request literature. General interface, 104 Tall Timber Trail, Lexington, SC 29072.

SOFTWARE

FREE CATALOG. We have the latest versions of shareware for the lowest prices. Our service is the best and fastest. Hundreds of great programs for the IBM and compatibles. The Software Shoppe, PO Box 2440-D, Matthews, NC 28106.

FREE Catalog. Thousands of IBM, Shareware programs. Low prices, Bonuses, CDROMS. **Prestige Distributor,** P.O. Box 27, Yaphank, NY 11980.

ELECTRONICS

FASCINATING, useful, fun and educational kits! Lasers, voice changers, message recorders, gas detectors, talking clocks and more. We supply ALL the parts. You build using our detailed manual. Send \$1.00 (refundable) for catalog: LNS Technologies, 20993 Foothill Blvd., Suite 307C, Hayward, CA 94541-1511.

RESTRICTED Top Secret Hacker Information. Cellular / Cable / Surveillance / Satellite / Video-Cipher / Books / Videos - More. Catalog - \$3.00. **TELECODE** P.O. Box 6426-MJ, Yuma, AZ 85366-6426.

T.V. NOTCH FILTERS AND BULLET STOPPER, FREE BROCHURE. MICRO Thinc. BOX 63/6025, MARGATE, FL. 33063 1-(305)-752-9202

COMPUTERS

MAGAZINE supporting Z80, CP/M, S100, Kaypro, 8031, 6809 and more. **The Computer Journal.** 10th year of classic computer projects. Hardware, software, Forth, assembler. Micro-C Kaypro disks and schematics. 6 issues, \$24, Free sample. (800) 424-8825. TCJ, P.O. Box 535, Lincoln, CA 95648

RF VISION. Convert your IBM compatible into an RF Spectrum Analyzer/Monitor Receiver tuning 2-1700 MHz. Includes 3-D Surface Plot & Color Spectrogram vs time. Basic kit & software \$196. Send SASE to Science Workshop, Box 310MC, Bethpage, NY 11714.

MEASURE and record **TEMPERATURE** with **LAPTOP** or PC using parallel printer port. Pocket-sized system under \$100. Boone Technologies, P.O. Box 15052, Richmond, VA 23227. (804) 264-0262.

MISCELLANEOUS

ASIAN LADIES want correspondence for friendship, marriage. SUNSHINE INTERNATIONAL-Dept. TW, Box 5500, Kailua-Kona, Hawaii, 96745. (808)325-7707.

BASIC STAMP™

(actual size)

Stamp-Sized Computer Runs BASIC

The BASIC Stamp is a small single-board computer that runs BASIC programs. It has 8 I/O lines, which can be used for a variety of digital and analog purposes. The Stamp's BASIC language includes familiar instructions, such as GOTO, FOR...NEXT, and IF...THEN, as well as SBC instructions, such as SERIN, PWM, and BUTTON. Each instruction takes 2-3 bytes of the Stamp's 256-byte EEPROM, resulting in a maximum program size of 80-100 instructions. Programs execute at about 2,000 instructions per second.

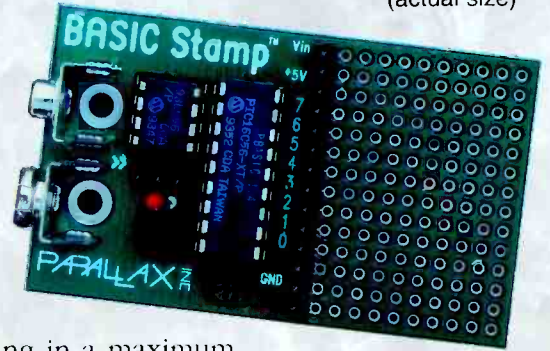

The BASIC Stamp Programming Package contains everything you need to program Stamps using your PC. The package includes our editor software, programming cable, manual, application notes, and free technical support. The package is available for \$99; Stamps are sold separately for \$39.

Stepper Motor Controller

This circuit makes the Stamp into a remote stepper motor controller. Using serial communications, the Stamp sends out a request for number of steps and delay between each. When it receives the data, the Stamp steps the motor as directed.

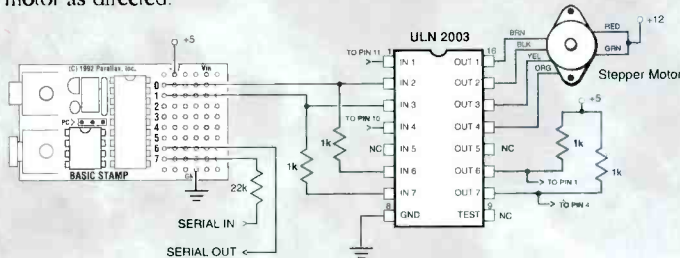

Micro-Terminal

In this application, the Stamp receives serial data and displays it on the LCD. The state of the four buttons is then transmitted serially.

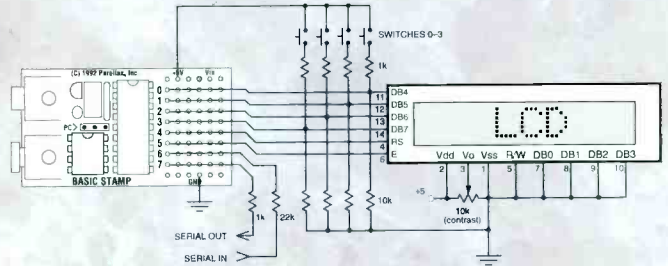

PIC[®]16Cxx MICROCONTROLLERS and TOOLS

In price and availability, nothing compares to PICs.

PICs are the answer to many small controller needs, especially if price is an issue. A typical PIC is the PIC16C54-RC/P; it's an 18-pin DIP package with 12 I/O lines, 512 words of PROM, and 32 bytes of RAM, all for around \$4.00 in small quantities. And newer PICs have interrupts, A/D, and up to 33 I/O lines.

For the past three years, we've been helping people get started with PICs. We offer a growing line of development tools, documentation, application notes, and technical help, as well as the PICs themselves.

If you'd like information on our PIC tools, or you'd like a copy of our complete catalog, please let us know. We'll be happy to send whatever materials you need.



3805 Atherton Road, #102 • Rocklin, CA 95765 • USA
(916) 624-8333 • Fax: 624-8003 • BBS: 624-7101

Reflection, ClearView, BASIC Stamp, and the Parallax logo are trademarks of Parallax, Inc. • PIC is a registered trademark of Microchip Technology, Inc. Features and prices subject to change without notice.



PIC Chips \$4 - \$27

We offer PICs in the "RC" and EPROM versions.

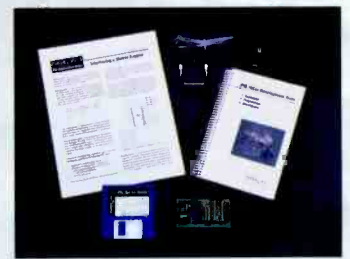

PIC16Cxx Programmer \$199

Supports PIC16C5x, '71, & '84. Also PIC16C64 with 40-pin adapter.



Reflection '5x™ \$249

I/O simulator provides software simulation and in-circuit I/O.



ClearView '5x™ \$699

In-circuit emulator provides full hardware debugging at 20 MHz.



50,000 pages of technical hardware information at your fingertips.

The Complete PC Hardware Reference.

The Micro House Technical Library on CD-ROM provides technical specifications and configuration information on over 1500 different manufacturer's products. We've taken thousands of hardware product manuals and extracted the vital information you need. Locating main boards, network interface cards, hard drives, hard drive controllers, and I/O cards (video, sound, modem, serial, parallel, CD-ROM, etc.) is now a reality. This feature rich CD-ROM even includes drivers and support software, from the manufacturers themselves!



Microsoft is a registered trademark and Windows and the Windows Logo are trademarks of Microsoft Corporation.

The Micro House Logo is a registered trademark.

Micro House International Inc. • 4900 Pearl East Circle • Suite 101 • Boulder, Colorado 80301 • 303 443-3388 • Fax 303 443-3323

Call
800-926-8299
for additional
information!

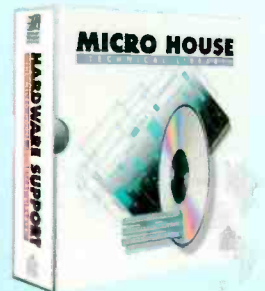

Ref: Part# TCMCJD

CIRCLE NO. 76 ON FREE INFORMATION CARD