

THE PRACTICAL MAGAZINE FOR PERSONAL COMPUTERS & MICROCONTROLLERS

ComputerCraft

Formerly

**MODERN
ELECTRONICS**

August 1991 \$2.95
(Canada \$3.95)

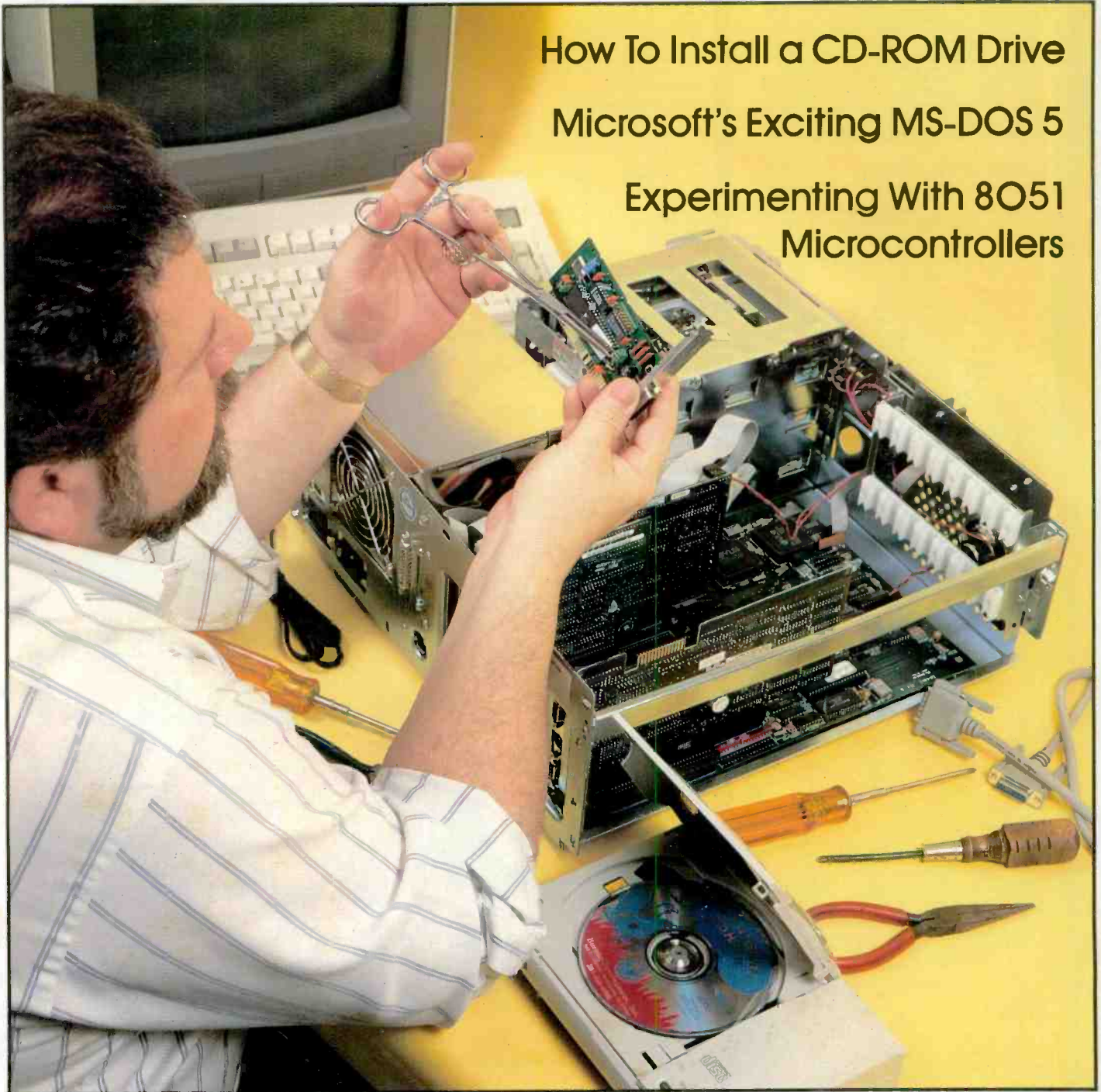

How To Install a CD-ROM Drive

Microsoft's Exciting MS-DOS 5

Experimenting With 8051
Microcontrollers



Adapter Runs Parallel Printer From Serial Port

AC Power Protection For Your Computer System

The Winning Ways Of QuickBASIC

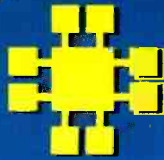

JDR Microdevices

2233 Samaritan Drive, San Jose, CA 95124

BUY WITH CONFIDENCE FROM JDR!

- 30-DAY MONEY BACK GUARANTEE
- 1 YEAR WARRANTY
- TOLL-FREE TECH SUPPORT



MOTHERBOARDS

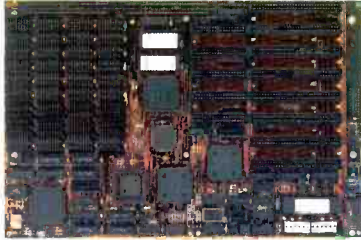

16MHz MINI 386-SX \$399⁹⁵

• NORTON SI 15.3 • LANDMARK AT SPEED 20.8

- EXPANDABLE TO 8MB ON-BOARD • AMI BIOS • CHOOSE 0 OR 1 WAIT STATE FOR USE WITH SLOWER RAM • FIVE 16-BIT AND THREE 8-BIT SLOTS • CHIPS & TECHNOLOGY "NEAT" CHIPSET • SOCKET FOR 80387-SX CO-PROCESSOR • 8.5" X 13" SIZE FITS MINI-286 & FULL-SIZE 286 CASES

| | | | | |
|---------------|---------------------------|--|--|-----------|
| MCT-386SX | | | | \$399.95 |
| MCT-386SX-20 | 20MHZ MINI 386-SX | | | \$499.95 |
| MCT-M386-25 | 25MHZ MINI 386 | | | \$799.00 |
| MCT-386MBC-33 | FULL-SIZE 33MHZ CACHE 386 | | | \$1195.00 |
| MCT-386MBC-25 | 25MHZ VERSION | | | \$999.00 |
| MCT-486MB33 | 33MHZ CACHE 486 | | | \$2495.00 |
| MCT-486MB25 | 25MHZ CACHE 486 | | | \$1995.00 |
| MCT-M286-20N | 20MHZ 286 W/NEAT | | | \$389.95 |
| MCT-M286-16N | 16MHZ 286 W/NEAT | | | \$289.95 |
| MCT-M286-12 | 12MHZ 286 | | | \$199.95 |

INTERFACE CARDS

16-BIT IDE MULTI I/O \$89⁹⁵

- 286/386/486 COMPATIBLE
- SUPPORTS 2 IDE HARD DRIVES & 2 FLOPPIES (360K, 720K, 1.2MB & 1.44MB)
- TWO SERIAL, ONE PARALLEL & ONE GAME PORT
- SUPPORTS COM1 THRU 4 LPT1, 2, & 3
- ALL FUNCTIONS CAN BE INDIVIDUALLY DISABLED

| | | |
|---------------|------------------------|----------|
| MCT-IDEIO | | \$89.95 |
| MCT-FDC-HD | 1 44MB FLOPPY(2X) CARD | \$49.95 |
| MCT-FDC-HD4 | 4 FLOPPY VERSION | \$59.95 |
| MCT-HDC | HARD DISK CARD | \$79.95 |
| MCT-RLL | RLL HARD DISK CARD | \$89.95 |
| MCT-FAFH | 16-BIT F/H 1 1 CARD | \$149.95 |
| MCT-AFH-RLL | 16-BIT RLL F/H CARD | \$199.95 |
| MCT-IO | MULTI I/O CARDS | \$59.95 |
| MCT-MIO | MULTI I/O FLOPPY | \$79.95 |
| MCT-AIO | 16-BIT MULTI I/O | \$59.95 |
| MCT-MGEOI | 16-BIT ALL-IN-ONE | \$129.95 |
| MCT-AEMS | 16-BIT EMS CARD | \$129.95 |
| MCT-EEMS | 16-BIT EEMS CARD | \$149.95 |
| MCT-VGA | 8/16-BIT VGA CARD | \$149.95 |
| MCT-VGA-1024 | 1024 X 768 VGA | \$169.95 |
| MCT-VGA-1024+ | 1024 X 768/256 COLORS | \$199.95 |



\$79⁹⁵

BREADBOARD ON-A-CARD

Simplify the creation of new interface circuits and eliminate the repetitious task of decoding and buffering!

- Includes address decoding logic, data buffering, 2LSI circuits for programmable digital I/O & counter timing functions
- Logically grouped • Accesses all 62 I/O signal connections & clearly labelled bus lines • Accepts up to 24 14-pin IC's
- Accepts 9,15,25, or 37-pin D-SUBS

| | | |
|---------|-----------------------------|---------|
| PDS-601 | 8-BIT CARD | \$79.95 |
| PDS-611 | 16-BIT CARD WITH I/O DECODE | \$89.95 |

MORE PROTOTYPE CARDS...

JDR's FR-4 epoxy laminate with gold-plated edgeward fingers & silk-screened legends

JDR-PR1 8-BIT WITH +5V & GROUND PLANE ... \$79.95

JDR-PR2 AS ABOVE WITH I/O DECODE LAYOUT ... \$89.95

JDR-PR10 16-BIT WITH I/O DECODE LAYOUT ... \$79.95



101-KEY \$69⁹⁵

| | | |
|----------|--|---------|
| BTC-5339 | 101-KEY WITH 12 FUNCTION KEYS • 286/386/486 COMPATIBLE | \$69.95 |
| FC-3001 | 101-KEY 12 F-KEYS & CALCULATOR | \$74.95 |
| BTC-5060 | 84-KEY WITH 10 FUNCTION KEYS | \$59.95 |

UPRIGHT CASE

\$249⁹⁵

- FOR STANDARD, FULL SIZE AND MINI-MOTHERBOARDS
- 250 WATT POWER SUPPLY
- MOUNTS FOR 3 FLOPPY AND 4 HARD DRIVES
- TURBO AND RESET SWITCHES
- SPEED DISPLAY, POWER, DISK LEDS
- MOUNTING HARDWARE, FACEPLATES AND SPEAKER INCL.

| | | |
|----------|--|----------|
| CASE-100 | | \$249.95 |
|----------|--|----------|

MORE CASES...

| | | |
|----------|----------------------------|----------|
| CASE-200 | UPRIGHT HOLDS 11 DRIVES | \$499.95 |
| CASE-120 | MINI-UPRIGHT W/200 WATT PS | \$199.95 |
| CASE-70 | FULL-SIZE 286 STYLE CASE | \$89.95 |
| CASE-50 | MINI-SIZE 286 STYLE CASE | \$59.95 |

800-538-5000

CALL FOR OUR FREE CATALOG!

FOR PC'S, MONITORS, DISK DRIVES, KEYBOARDS, INTERFACE CARDS, MODEMS, LAPTOPS, CABLES, CONNECTORS, SOFTWARE, PROGRAMMING PRODUCTS, TEST EQUIPMENT, ICS AND MORE!

Call toll-free and request our latest 100 page full color catalog. You'll find over 5000 PC-compatible products plus many useful "Tech Tips" written by our experienced Technical Support staff.

DYNAMIC RAMS

| PART# | SIZE | SPEED | PINS | PRICE |
|------------|-----------|-------|------|-------|
| 4134-100 | 65536x1 | 100ns | 16 | 1.99 |
| TM54464-12 | 65536x4 | 120ns | 18 | 3.49 |
| 41256-150 | 262144x1 | 150ns | 16 | 1.85 |
| 41256-120 | 262144x1 | 120ns | 16 | 1.89 |
| 41256-100 | 262144x1 | 100ns | 16 | 1.99 |
| 41256-80 | 262144x1 | 80ns | 16 | 2.19 |
| 414256-100 | 262144x4 | 100ns | 20 | 6.95 |
| 414256-80 | 262144x4 | 80ns | 20 | 7.95 |
| 1WB-120 | 1048576x1 | 120ns | 18 | 6.89 |
| 1WB-100 | 1048576x1 | 100ns | 18 | 6.95 |
| 1WB-80 | 1048576x1 | 80ns | 18 | 7.95 |
| 1WB-70 | 1048576x1 | 70ns | 18 | 8.95 |
| 1WB-60 | 1048576x1 | 60ns | 18 | 9.95 |

SIMM/SIP MODULES

| PART# | SIZE | SPEED | FOR | PRICE |
|--------------|----------|-------|----------|-------|
| 4-256A9B-80 | 256K x 9 | 80ns | SIMM/PC | 21.95 |
| 421000A8B-10 | 1MB x 8 | 100ns | SIMM/MAC | 64.95 |
| 421000A9B-10 | 1MB x 9 | 100ns | SIMM/PC | 64.95 |
| 421000A9B-80 | 1MB x 9 | 80ns | SIMM/PC | 69.95 |
| 421000A9B-60 | 1MB x 9 | 60ns | SIMM/PC | 89.95 |
| 256KX9SIP-80 | 256K x 9 | 80ns | SIP/PC | 21.95 |
| 256KX9SIP-60 | 256K x 9 | 60ns | SIP/PC | 25.95 |
| 1MBX9SIP-10 | 1MB x 9 | 100ns | SIP/PC | 64.95 |
| 1MBX9SIP-80 | 1MB x 9 | 80ns | SIP/PC | 69.95 |

MATH CO-PROCESSORS



- Manual
- Software Guide
- 5 Year Warranty



| PART# | SPEED | PRICE |
|------------|--------|--------|
| 8087 | 5 MHz | 89.95 |
| 8087-2 | 8 MHz | 129.95 |
| 8087-1 | 10 MHz | 169.95 |
| 80287-XL | 12 MHz | 199.95 |
| 80287-XLT | 12 MHz | 199.95 |
| 80387-16 | 16 MHz | 359.95 |
| 80387-20 | 20 MHz | 399.95 |
| 80387-25 | 25 MHz | 499.95 |
| 80387-33 | 33 MHz | 649.00 |
| 80387-SX | 16 MHz | 299.95 |
| 80387-SX20 | 20 MHz | 399.95 |

POWER SUPPLIES

| | | |
|---------|--------------------------|----------|
| PS-135 | 135 WATT FOR 8088 | \$59.95 |
| PS-150 | 150 WATT FOR 8088 | \$69.95 |
| PS-200X | 200 WATT FOR 8088 | \$89.95 |
| PS-200 | 200 WATT FOR 286/386/486 | \$89.95 |
| PS-250 | 250 WATT FOR 286/386/486 | \$129.95 |

1024 x 768 \$599 VGA PACKAGE

- 286/386/486 COMPATIBLE CARD & 1024 X 768 INTERLACED MONITOR
- 1:1 ASPECT RATIO 0.28 DOT PITCH
- 256 COLORS FROM 262,000
- 8/16-BIT CARD HAS 512K VIDEO RAM EXPANDABLE TO 1MB

| | | |
|---------------|-----------------------|----------|
| VGA-PKG-1024+ | | \$599.00 |
| VGA-PKG | 640 X 480 VGA PACKAGE | \$499.95 |

MORE MONITORS...

| | | |
|--------------|------------------------|----------|
| NEC-MULTI-3D | 14" MULTISYNCH MONITOR | \$649.00 |
| JDR-MULTI | 14" MULTISYNCH MONITOR | \$429.95 |
| CM-1440 | SEIKO 14" MONITOR | \$599.00 |
| VGA-MONITOR | VGA MONITOR | \$379.95 |
| MONO-VGA | PAPERWHITE VGA MONITOR | \$139.95 |

2400 BAUD MODEM \$89⁹⁵

- 2400/1200/300 BPS INTERNAL DATA MODEM • FULL HAYES AT COMPATIBILITY • INCLUDES PROCOMM SOFTWARE
- | | | |
|----------|------------------------------|----------|
| MCT-24I | | \$89.95 |
| MCT-FAXM | AS ABOVE W/4800 BPS FAX SEND | \$119.95 |
| PRO-96EF | 9600 BPS EXTERNAL W/FULL FAX | \$679.00 |

ETHERNET CARDS

- 100% NOVELL COMPATIBLE
- FOR THICK OR THIN ETHERNET
- 8-BIT OR 16-BIT VERSIONS

| | | |
|-------------|------------------------------|----------|
| DFINET-300 | NE-1000 COMPATIBLE | \$159.95 |
| DFINET-400 | NE-2000 COMPATIBLE | \$189.95 |
| RG58-6 | 6 FOOT ASSEMBLED COAX CABLE | \$5.95 |
| RG58-12 | 12 FOOT ASSEMBLED COAX CABLE | \$8.95 |
| RG58-100 | 100 FOOT ASSEMBLED CABLE | \$29.95 |
| BNC-TERM-50 | 50Ω DUMMY LOAD TERMINATOR | \$1.99 |

HARD DRIVES

| | | | | | |
|----------|---------|---------|------|------|-----------|
| ST-251-1 | 42.8 MB | 5.25" | MFM | 28MS | \$249.00 |
| ST-157A | 41.1 MB | 3.5" | IDE | 28MS | \$239.00 |
| ST-277-1 | 65.5 MB | 5.25" | RLL | 28MS | \$289.00 |
| ST-1144A | 125 MB | 3.5" | IDE | 19MS | \$229.00 |
| ST-1201A | 180 MB | 3.5" | IDE | 15MS | \$799.00 |
| 1654 | 161 MB | 5.25" | ESDI | 16MS | \$899.00 |
| 1664 | 345 MB | 5.25" | ESDI | 14MS | \$1449.00 |
| 1568 | 676 MB | 5.25"FH | ESDI | 16MS | \$2195.00 |

ASK ABOUT OUR KIT PRICES

FLOPPY DRIVES

| | | |
|-----------|----------------------------------|---------|
| FDD-1.44X | 1.44MB 3.5" FLOPPY - BLACK | \$99.95 |
| FDD-1.44A | 1.44MB 3.5" FLOPPY - BEIGE | \$99.95 |
| FD-55GFV | 5.25" TEAC DOUBLE-SIDED HD 1.2MB | \$99.95 |
| FDD-1.2 | 5.25" DOUBLE-SIDED HD 1.2MB | \$89.95 |
| FD-55B | 5.25" TEAC DOUBLE-SIDED DD 360K | \$89.95 |
| FDD-360 | 5.25" DOUBLE-SIDED DD 360K | \$69.95 |



SALES 800-538-5000

Customer Service 800-538-5001 Local/Int'l 408-559-1200
 Technical Support 800-538-5002 Fax 408-559-0250

TERMS: Minimum order \$10.00. For shipping & handling include \$5.00 for ground and \$7.50 for air. Orders over 1 lb. and foreign orders may require additional shipping charges—contact our Sales Dept. for amount. CA residents must include applicable sales tax. Prices subject to change without notice. We are not responsible for typographical errors. We reserve the right to limit quantities and to substitute manufacturer. All merchandise subject to prior sales. A full copy of our terms is available upon request. Items pictured may not be representative. JDR, the JDR logo, JDR Microdevices, and the MCT logo are registered trademarks of JDR MICRODEVICES, INC. Modular Circuit Technology, and trademarks of JDR MICRODEVICES, INC. Copyright 1991 JDR MICRODEVICES.

KEY CODE #1801

CIRCLE NO. 163 ON FREE INFORMATION CARD

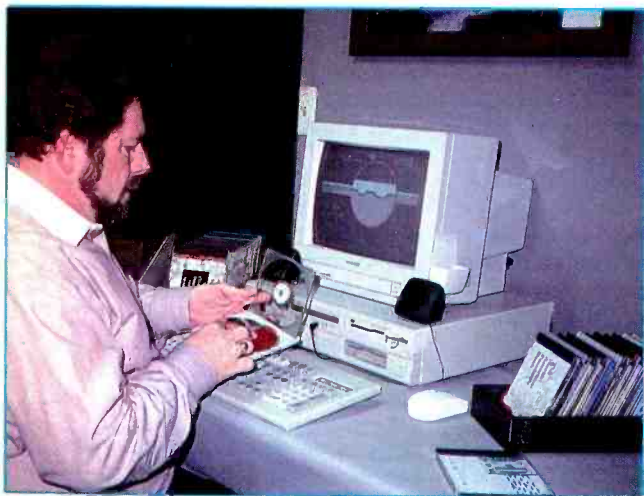

18

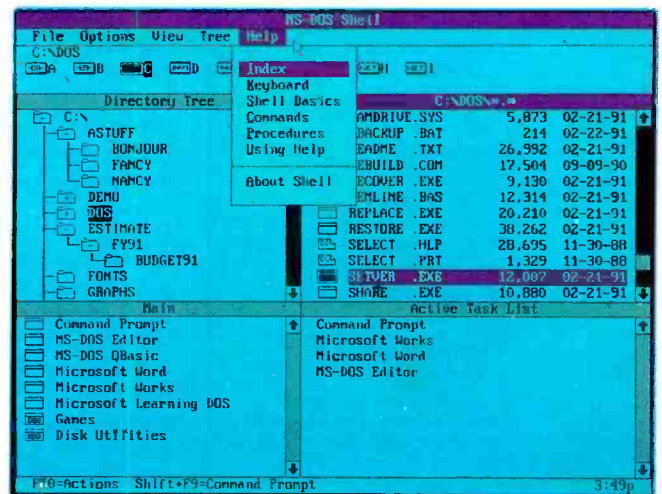

26

UPGRADING & ENHANCING

- 18** **Installing A CD-ROM Drive**
By Tom Benford
Guide to selecting and installing a CD-ROM drive in your PC.
- 34** **Operating A Parallel Printer From Your Serial Port**
By Nick Goss
Adapter runs a parallel printer from a serial port and gives a host of additional benefits.
- 42** **Power Protection For Your Computer System**
By Roger C. Alford
Protecting your computer system against ac-line-borne hazards.

APPLICATIONS

- 26** **Microsoft's MS-DOS 5.0**
By John Woram
New MS-DOS version adds important features like memory management, full-screen editor, on-line Help—all with reduced memory requirements.
- 52** **Experimenting With 8051 Microcontrollers**
By Jan Axelson
Book/disk package for the 8051 and a low-cost development system based on the 80C32 microcontrollers.

- 58** **The Winning Ways Of QuickBASIC**
By Hardin Brothers
Modern versions of BASIC and GWBASIC give new life to an old programming language.

REVIEWS

- 40** **A Whole House Surge Suppressor**
By Art Salsberg
Mounts to a circuit-breaker panel box to protect all electronic equipment in a home from demaging power surges and spikes.
- 74** **The Secret Of Monkey Island**
By SF Sparrow
A swashbuckling, offbeat graphic adventure.
- 75** **Harpoon**
By SF Sparrow
A modern naval-warfare game.

COLUMNS

- 65** **Forrest M. Mims III**
Practical Guidelines For Interfacing Circuits.
- 69** **Joseph Desposito**
Cache RAM Chip; Micro Softener Chip; All-Digital Answering Machines; A Voltage Multiplier/Regulator IC.

- 72** **Stan Veit**
The World On-Line For Novices
A starter guide to computer telecommunications.
- 80** **Ted Needleman**
More On Digital Imaging; The Complete Flatbed Scanner; CAT ScanAdapter LPT/Image Enhancer.

DEPARTMENTS

- 4** **Editorial**
By Art Salsberg
- 6** **Letters**
- 8** **What's Happening?**
By John McCormick
Latest PC News.
- 10** **What's New!**
By Peter R. O'Dell
A roundup of new computer and electronic products.
- 90** **Advertisers Index**

ON THE COVER: A CD-ROM disk drive puts enormous volumes of information, data, applications programs, utilities and more at your fingertips for fast retrieval. Installation is a fairly easy procedure, as detailed in the lead article of this issue, beginning on page 18.

Cover Photo: Joe Abatto/The Photography Place

EDITORIAL STAFF

Art Salsberg
Editor-in-Chief

Alexander W. Burawa
Managing Editor

Dorothy Kehrwieler
Production Manager

Emily Kreutz
Production

Elizabeth Ryan
Art Director

Barbara Terzo
Artist

Pat Le Blanc
Florence V. Martin
Linda Romanello
Phototypographers

Hal Keith
Illustrator

Bruce Morgan
Photographer

Roger C. Alford, Jan Axelson,
Hardin Brothers, TJ Byers, Joe Desposito,
Nick Goss, John McCormick, Martin Meyer,
Forrest Mims III, Ted Needleman,
Peter R. O'Dell, SF Sparrow
Contributing Editors

BUSINESS STAFF

Richard A. Ross
Publisher

Art Salsberg
Associate Publisher

Dorothy Kehrwieler
General Manager

Frank V. Fuzia
Controller

Catherine Ross
Circulation Director

Melissa Kehrwieler
Data Processing

Carol Minervini
Data Processing

Karen Nauth
Customer Service

ADVERTISING SALES

ELECTRONIC ADVERTISING

Jonathan Kummer
(516) 681-2922
FAX: (516) 681-2926

COMPUTER ADVERTISING

Ken L. Wood
(407) 264-0545
FAX: (407) 264-0473

Offices: 76 North Broadway, Hicksville, NY 11801. Telephone: (516) 681-2922. FAX (516) 681-2926. ComputerCraft (ISSN 0748-9889) is published monthly by CQ Communications, Inc. Subscription prices (payable in US Dollars only): Domestic—one year \$18.97, two years \$36.00, three years \$53.00; Canada/Mexico—one year \$21.00, two years \$40.00, three years \$59.00; Foreign—one year \$23.00, two years \$44.00, three years \$65.00. Foreign Air Mail—one year \$76.00, two years \$150.00, three years \$224.00.

U.S. Government Agencies: Subscriptions to ComputerCraft are available to agencies of the United States government, including military services, only on a cash with order basis. Requests for quotations, bids, contracts, etc. will be refused and will not be returned or processed.

Entire contents copyright 1991 by CQ Communications, Inc. ComputerCraft or CQ Communications Inc. assumes no responsibility for unsolicited manuscripts. Allow six weeks for delivery of first issue and for change of address. Printed in the United States of America.

Postmaster: Please send change of address notice to ComputerCraft, 76 North Broadway, Hicksville, NY 11801.

The Shrink

Over the years, we've observed a lot of movement toward reducing the amount of space that a personal computer takes up on one's work area. A computer's "footprint" is among a machine's specifications, much as is the number of I/O ports, though not as high up on the priority list.

A host of developments reduced the amount of space required inside a computer, ostensibly making it possible to encase it in a smaller cabinet. These include the use of half-height drives, smaller-size drives and diskettes, half-length expansion cards, surface-mount construction, higher-density ICs, etc. But employing more drives, more memory, larger power supplies and more expansion slots brought all but limited-expansion computers right back to their starting point in physical size.

Alternatively, vertically positioned CPU sections that rest the entire system case on the floor can clear a desk area if the video monitor is located on a shelf or atop a platform attached to a movable arm to sort of hang it in the air.

Much that has been done to shrink the size of a computer has taken place in the portable computer area, however. It started with Osborne's early luggable CP/M-based machine that incorporated a small monochrome CRT. With the advent of 16-bit computers, Compaq made its mark with a sleek all-in-one luggable, followed by the bargain-priced Kaypro. They were all ac-powered machines with built-in CRTs, though, and very heavy.

The development of flat-panel LCD screens, CMOS devices, controllers integrated on a hard drive and Ni-Cd battery power changed all this. They made possible lighter, though still heavy and bulky so-called "laptops" that weigh in the 16-pound area. These machines often provide the power of a desktop, although missing the video quality of a CRT, color and expansion provisions.

A spate of "handheld" computers surfaced, too. Lacking the power of a desktop, full-size keyboards, and even compatibility, they nevertheless attracted many buyers who trade off the foregoing for very small size and light weight. Atari's Portfolio and Poquet come to mind.

The next evolutionary step was the "notebook" computer, reducing weight to 4 pounds and less. NEC and Compaq led the way here. Reduction in size and weight was made possible by a variety of steps. Some notebooks do not include a hard drive. Others use a 2½" hard drive with a much smaller form factor than previously used. Lighter cases, fewer cables and connectors and other structural

approaches reduced size further. Today, the notebooks are hot sellers. Many people use them as desktop machines, too, connecting to a color video monitor.

With some 1½-million portable computers said to have been sold in 1990, the market for them is certainly burgeoning. High-tech travelers, however, often complain about the lack of hotel/motel facilities to connect their portables to a telephone line in order to communicate with home offices.

Interestingly, the Association for Computer Training & Support (ACTS) appealed to hotel chains to provide a listing of modem-ready capacity at each property to travel agents and for 800-phone-reservation numbers. (If you're a high-tech traveler, get a free copy of "Traveling with a Laptop Computer" by sending a self-addressed envelope to ACTS, 27 Sagamore Road, Raquette Lake, NY 13436.)

Is there a laptop or notebook computer in your future? There well might be if you've got the extra bucks to spend on these premium-priced machines, as compared to desktop machines, or if you truly need it for your professional work. Do bear in mind that LCD screens cannot match the quality of a traditional CRT screen; nor is color readily available. Moreover, if you're a Windows user, you will find an LCD screen wanting. Other irritations include limited (if any) expansion provisions, losing sight of the cursor, and limited (up to a few hours) battery life before recharging is necessary.

But if you want battery power, light weight and small size in a computer, and the ability to maintain a clearer desk while using the machine on it whenever you wish to, then the prospect of portable computer ownership for you is good. Many people, in fact, have made a portable their only home computer, which also serves them for travel purposes.

Any shrinkage in size or weight from here on in is expected to be very gradual and rather minimal. Advances will likely be in the technological area, such as better hard drives, flash memories to hold the BIOS and provide faster boot-up, greater disk capacity, extended-life batteries, improved screen display quality, and so on. The biggest boost for notebook and laptop computers in the near future will hopefully be substantially lower prices, though.





"Dave sez... all ACP drives include no-hassle 30-Day Guarantee* and 1-Year Replacement policy.**"

Hard Drives!



the Hard Drive King!

Western Digital



40Mb... ^{w/AT Kit} \$249. ^{Bare} \$209.
WD93044A, 28ms, IDE
80Mb... \$389. \$349.
WDAC280, 17ms, IDE

CONNER

AT Embedded Hard Drives

CP2024 21.4Mb, 23ms \$ 399.
CP3000 42.8Mb, 28ms 239.
CP3184 84Mb, 25ms 459.
CP30104 120Mb, 18ms 549.
CP3104 104.9Mb, 25ms 449.
CP3204 209.7Mb, 19ms 799.

SCSI Hard Drives

CP3040 42.8Mb, 25ms, 1" .. \$ 289.
CP3100 104.9Mb, 25ms 489.
CP3200 209.7Mb, 19ms 849.

...call for controllers and adaptors



Tape Backup

Colorado Killer!!!

BACKTRAX **\$299.**
Phantom 750

Twice the storage as Colorado...
250Mb (internal). Reg. Retail \$379.

KLÖK Hard Drives

| Model | Size and description | AT Kit | Bare |
|-------|-----------------------------------|----------|---------|
| KL320 | 21.4 Mb, 40ms, 3.5", HH, MFM | \$ Call. | \$ 149. |
| KL330 | 30 Mb, 40m, RLL, HH | Call. | 169. |
| KL343 | 42.57 Mb, 30ms, 3.5" AT, Embedded | 259. | 219. |

...specify Gray or Black Faceplates for 5-1/4" installation kits

MICROPOLIS ESDI/SCSI Drives

| Model | Size and description | PC PAK | Bare |
|------------|-----------------------------------|---------|---------|
| MC1355 | 159 Mb, 23ms, ESDI, 5-1/4", FH | \$ 562. | \$ 478. |
| MC1654-7D | 161 Mb, 16ms, ESDI, 5-1/4", HH | 935. | 799. |
| MC1558-15 | 338 Mb, 18ms, ESDI, 5-1/4", FH | 1414. | 1254. |
| MC1664-7 | 345 Mb, ESDI, 5-1/4", HH | 1395. | 1275. |
| MC1568-15 | 676 Mb, 16ms, ESDI, 5-1/4", FH | 1995. | 1875. |
| MC1375 | 153 Mb, 23ms, SCSI, 5-1/4", FH | 562. | 478. |
| MC1674-7D | 158 Mb, 23ms, SCSI, 5-1/4", FH | Call. | 975. |
| MC1578-15 | 332 Mb, 18ms, SCSI, 5-1/4", FH | 1472. | 1268. |
| MC1684-7 | 345 Mb, 14ms, SCSI, 5-1/4", FH | 1395. | 1275. |
| MC1588-15D | 668 Mb, 16ms, SCSI, 5-1/4", FH | 1995. | 1875. |
| MC1598-15 | 1049 Mb, 14ms, SCSI, 5-1/4", FH | 2795. | 2695. |
| MC1528-15 | 1345 Mb, 14.5ms, SCSI, 5-1/4", FH | 3995. | 3895. |

PC PAKS inc. controller/cables/mount hardware/software/manual

Maxtor® **\$249. \$339.**
Hard Drive Sale 40Mb, M7040A 80 Mb, M7080A

TOSHIBA Hard Drive

104Mb \$499.

22ms, 3-1/2", HH, IDE, MK 234



Floppy Drives

Toshiba TEAC
360K 5-1/4" .. \$54. \$59.
720K 3-1/2" .. 59. 64.
1.2Mb 5-1/4" .. 69. 74.
1.44Mb 3-1/2" .. 69. 74.

Hard Drives • Card Drives • Tape Backups • Controllers
Never a surcharge at ACP! Government, Institutional, OEM orders welcomed!



Advanced Computer Products, inc.

1310 E. Edinger, Santa Ana, CA 92705 • FAX 714-558-1603 • Customer Service 714-558-1356 • Sales 714-558-8813

We accept MC/VISA/AMEX. no surcharge for credit cards. Your card not charged until we ship. *Our 30 Day Guarantee does not refund shipping and handling charges. Drive must be in original package and in original undamaged condition. 1 Year replacement may have same restrictions. Prices and availability subject to change without notice. We ship FEDEX or UPS.

call your order toll-free 800-FONE-ACP



CIRCLE NO. 168 ON FREE INFORMATION CARD

Safety, Security, Convenience, Entertainment and Energy Management

Home Automation from Heath, the catalog that has it all...

Enter the world of Home Automation. Remote lighting and appliance controls. Security alarms and lighting. Automated thermostats. Video monitoring systems. Whole-house security systems. They're all yours in the Heath Home Automation Catalog. To receive your FREE copy, call today toll-free.

1-800-44-HEATH
(1-800-444-3284)



Heath Company

Marketing Dept. 079-080
Benton Harbor, MI 49022

079-080

CIRCLE NO. 100 ON FREE INFORMATION CARD

More Reader Support

• I really like your new *ComputerCraft* magazine. The April and May issues were right up my alley, and I read them from cover to cover. *ComputerCraft* is slanted to my kind of people, the builders and shakers, instead of only the users of computers. Keep up the good work.

Joe F. Sobieski
Johnstown, PA

• Just a short note to say that I concur with the favorable sentiments expressed by a number of your other readers. I was *thrilled* to find this magazine! At a glance, I could sense that *ComputerCraft* was going to fill a niche and scratch an itch that other computer periodicals are missing.

It's a godsend for the computer hobby-

ist and anyone who just has a yearning to better understand what is taking place under the hood of his or her computer and how to take more personal control over it all. Keep this good stuff coming!

Ryan D. Harnishfeger
Ft. Wayne, IN

• The appearance of *ComputerCraft* came as a complete surprise to me. I was pleased to see that my "I/O Port Interface" project was published complete with MLP code listings. As a die-hard computer hardware nut, I welcome the new direction in *ComputerCraft*.

All articles published in the first issue [April 1991] are excellent. I especially appreciate Hardin Brothers' "Timing and Counting Circuits."

Adolph A. Mangieri

• My wife bought me a copy of the April 1991 issue. I echo the plaudits of the readers who responded in your Letters column. Although I'm most sure what the program submitted by Mr. Richard Alex-

ander is doing, I can't resist sending the following modification of lines 150 through 430:

Albert J. Hock, Jr.
Ft. Washington, PA

```
145 REM Assign the bit values to an array.
146 DIM BIT(7)
147 REM Set array elements and DEC = to zero.
149 For I = 0 to 7 : BIT(I)=0 :NEXT:DEC=0
150 A$=INKEY$
151 IF A$ = CHR$(27) THEN CLS: System
154 REM Select numeric input
155 IF ASC(A$) < 48 or ASC(A$) > 57 or A$ = "" THEN BEEP GOTO
150
159 REM Assign the numerical value of A$ to a variable.
160 AA = VAL(A$)
169 REM The array element and associated value of DEC is then
selected according to the value of AA .
170 IF BIT(AA) = 0 THEN BIT(AA) = 1 : DEC = DEC + 2^AA ELSE
BIT(AA) = 0 : DEC = DEC - 2^AA
430 OUT 888,DEC : LOCATE 14,28: FOR I = 7 TO 0 : PRINT
BIT(I): IF I > 0 PRINT " + "
431 NEXT I : GOTO 150
```

Coming In September

- Serial Communications Guide
- Make Your Own RS-232 Cables
- Comparing Intel's Microprocessors
- Using Dot-Matrix LCD Modules
- MIDI: The Musical Instrument Digital Interface



SUMMER SPECIALS

FEATURING QUALITY SYSTEMS BY EVEREX, CLUB AMERICAN & AGI

LEASING OPTIONS
NOW AVAILABLE.
BUDGET YOUR LOW
MONTHLY PAYMENTS
CALL FOR DETAILS

Call for Custom
Configuration on
Everex,
Club American,
AGI & DTK

DTK SYSTEM SPECIALS

DTK 386SX

2 MB RAM
1.2, 1.4 Floppy
44 MB SEGATE Drive I/O
VGA PACKAGE (640X480)
101 Keyboard
2 Serial/1 Parallel Port **\$ 1549**

DTK 286-16MHZ

2 MB RAM
1.2, 1.4 Floppy
44 MB SEGATE Drive
VGA Package (640 X 480)
101 Keyboard
2 Serial
1 Parallel Port **\$ 1379**



DTK 386-25 DESKTOP

4 MB
1.2, 1.4 Floppy
125 MB IDE Drive
VGA Package (640X480)
101 Keyboard
2 Serial, 1 Parallel Port **\$ 1999**

DTK 486-25

4 MB RAM
1.2, 1.4 Floppy
125 MB IDE Drive
VGA Package (640X480)
101 keyboard
2 Serial, 1 Parallel Port **\$ 3479**

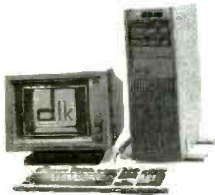

ALL ABOVE SYSTEMS ADD \$200 FOR TSUNG, 1 MB CARD & SUPER VGA

VIDEO CARDS

EVEREX VIEWPOINT . . . \$139
RENAISSANCE GRX2+ . . . \$99
PARADISE 1024 512K . . . \$199
VEGA 1024 . . . \$199
MONO GRAPHICS W/PRINTER \$35
COLOR GRAPHICS W/PRINTER \$35
ATI WONDERPLUS . . . \$189
VEGA VRAM 512K . . . \$409
EVEREX VRAM, 512K . . . \$259
SPEEDSTAR 1MB . . . \$199
BOCA BASIC VGA . . . \$89

HARD DRIVES

SEAGATE ST225 (20 MB KIT) \$235
SEAGATE ST238 (30 MB KIT) \$255
SEAGATE ST251-1 (40 MB) \$239
SEAGATE ST4096 (80 MB KIT) \$489
SEAGATE ST277 (60 MB RLL) \$269
SEAGATE ST125 . . . \$249
SEAGATE ST157A (40 MB IDE KIT) \$269
SEAGATE ST4144 (120 MB RLL) \$585
SEAGATE ST138 . . . \$279
SEAGATE ST296N (SCSI Host 2) \$379
SEAGATE ST151 (40 MB) . . . \$299
SEAGATE ST4182 (160 MB) ESDI \$379
SEAGATE ST1144A (125MB IDE KIT) \$449
SEAGATE 1239 210 MB IDE . . \$575

PRINTERS

EPSON ALL MODELS . . . SCALL
STAR ALL MODELS . . . SCALL
PANASONIC ALL MODELS . . . SCALL
CITIZEN ALL MODELS . . . SCALL

HP LASER PRINTERS

HP LASERJET III . . . \$1575
425-1 FONT CARTRIDGE . . . \$225
LASERJET TONER CARTRIDGE \$87
HP LASERJET IID . . . \$2775
HP LASERJET IIP . . . \$965
HP LASERJET II . . . \$1065

MONITORS

SAMSUNG IMTEQ MONO . . . \$79
SAMSUNG MULTIMODE . . . \$419
INTEQ VGA RELYSIS . . . \$339
SEIKO 1450 . . . \$629
QUME 1024 . . . \$359
QUME MULTISYNC . . . \$469
ICOMM VGA 1024 . . . \$369
RELYSIS VGA BASIC . . . \$299
RELYSIS SUPER VGA . . . \$349
RELYSIS PAPERWHITE VGA . \$129

NEC MONITORS

NEC 2A 800x600 . . . \$455
NEC 3D 1024x768 . . . \$589

CALL FOR NEC
pricing on NEC 4D & 5D

EXPANSION CARDS

XT DISK I/O CARD . . . \$45
AT I/O CARD . . . \$45
XT TURBO MOTHERBOARD . \$72
384K MULTIFUNCTION . . . \$72
1.4 XT FLOPPY CONTROLLER \$45

NETWORKS

LANTASTIC ETHERNET Startup Kit \$539
SMC ARCNET PC 130 . . . \$95
SMC ARCNET PC 130E . . . \$119

EVEREX PRODUCTS

MAXI MAGIC 2 MB EMS for XT or compatible . . . \$75
EVERCOM 1200 BAUD internal Modem . . . \$65
EVERCOM 2400 BAUD internal Modem w/MNP +5 . . . \$139
EVERCOM 2400 external modem w/MNP + 5 . . . \$189
EVERFAX plus internal modem \$249
EVERFAX plus external modem \$309
RAM 3000 Intel 4.0 EMS 3 MB Ram for AT . . . \$90
RAM 8000 Intel 4.0 EMS 8 MB Ram . . . \$239
RAM 10000 Intel 4.0 EMS 10 MB Ram . . . \$129

CALL FOR OTHER
EVEREX PRODUCTS

FLOPPY DRIVES

TEAC 55B 360K . . . \$69
TEAC 55G 1.2 MB . . . \$79
TEAC 1.4 MB . . . \$79
FUJITSU 360K XT . . . \$61
FUJITSU 360K AT . . . \$65
FUJITSU 1.2 MB AT . . . \$72
TOSHIBA 3-1/2" 720K . . . \$69
TOSHIBA 3-1/2" 1.4 MB . . . \$72

LOGITECH/DFI

256 GREY SCAL SCANMAN . . \$282
SERIAL C-9 MOUSE . . . \$69
BUS C-9 MOUSE . . . \$79
SCAN MAN . . . \$159
CATCHWORD OCR . . . \$109
LOGITECH TRACKBALL SER . \$79
LOGITECH TRACKBALL BUS . \$89
DFI HAND SCANNER . . . \$169
CARRET PROFESSIONAL . . . \$159

HP LASER MEMORY

1 MB II . . . \$139
1 MB IIP . . . \$139

CALL FOR PRICING ON 2MB OR 4MB
MEMORY UPGRADES. CALL FOR
PRICING ON ALL PACIFIC DATA UP-
GRADE PRODUCTS FOR YOUR
LASERJET. MEMORY UPGRADES
NOW AVAILABLE FOR IIP.



FD MICROSYSTEMS
144 CHURCH STREET, N.W., VIENNA, VIRGINIA / 22180
FOR ORDERING CALL...
(800) 548-2660



FOR INQUIRES & SUPPORT (703) 281-0001 FAX LINE (703) 255-3359
(15% Restock charge on all returned merchandise. 3% Surcharge on all Credit Card Orders)

Please note that prices are subject to change without notice.
All "specials" are available only while current supplies last.
CIRCLE NO. 97 ON FREE INFORMATION CARD

FDM SPECIALIZES IN ANY & ALL PARTS
NEEDED TO CUSTOM BUILD YOUR PC
FROM THE GROUND UP. INCLUDING
MOTHERBOARDS, CACHE, POWER
SUPPLY'S, FLOPPY AND HARD DRIVES,
MONITORS, KEYBOARDS AND POWER
UPS SYSTEMS

Easy VGA. A \$100 VGA card that automatically configures itself for the system it's installed in has been announced by Everex. Unlike other PC-bus video cards, this one has no confusing switches, making installation simple, even for novice users.

Wall TV. Sharp's new thin-film technology color video screens will put an entire 9" screen TV in a package only 2¾" thick that mounts on a wall just as a large painting does. Larger models are also a possibility. If these high-resolution thin screens become popular in Japan, they could lead to low prices on flat-monitor computer screens.

More Do Windows. Central Point Software announced the latest version of *PC Tools*, which is a very popular set of MS-DOS utility programs. This release includes added support for Microsoft *Windows 3.0*. A new CP back-up for MS-DOS and *Windows* (included in *PC Tools*) will be available as a stand-alone package by summer, as will a new program named *Central Commute*, intended to provide remote access to computers connected to a LAN or a modem. *Commute* would be one of a growing number of utilities that allow laptop systems to access all files and programs on a home or office computer from any telephone connection.

Symantec has also jumped on the *Windows* icon-o-wagon with *JustWrite*, a word processor; *The Norton Backup for Windows*; and *On Target*, project planning software. All are in new *Windows 3*-compatible versions.

Price Cuts. Computer sales competition is getting tough, and practically everyone dropped prices on desktop and laptop computers since last issue. Toshiba reduced laptop prices from about 20% to 33%, with the popular T1000 going from \$999 to \$799 list. Compaq lowered prices on systems by from 8% to 34% and cut the list price of some hardware options by nearly 70%.

The Compaq LTE 386/20 Model 30 decreased from \$6,499 to \$4,399, still far above similarly equipped clone notebooks. Some clone builders are offering 386SX systems below \$2,000 list! IBM lowered prices modestly on its high-end Model 90 and Model 95 systems. But the small price cut is deceptive because entry-level systems now come with much more memory, making new prices considerably lower than they appear at first glance.

OS/2 Lives? With Microsoft virtually ignoring OS/2, while concentrating on its big-selling *Windows* and new DOS 5.0, IBM is running full-speed ahead with the multitasking operating system. IBM drastically reduced prices and started a media campaign to push the versatile and powerful operating system. Right now you can try out a full version of OS/2 for well under \$200 . . . this version doesn't even use up as much memory as earlier versions, although you will still need several megabytes.

OS/2 1.3 Standard Edition was lowered to only \$150 from a previous list price of \$340, and the extremely powerful OS/2 1.3 Extended Edition now sells for \$690, down from \$830. MS-DOS users can upgrade to SE for only \$99, a very attractive deal for those interested in what a "real" operating system looks like.

New Floppy Standard. Look for a new 2.88-megabyte 3½" floppy drive to be included in IBM computers starting this summer. Microsoft's new DOS 5.0 includes driver software for it. The drive, developed by Mitsubishi, will continue to read and write 720K and 1.44M disks. The new higher-density floppy disks themselves will be produced and sold under Mitsubishi's Verbatim label.

New Notebooks. As I predicted in an earlier column, there's a flood of new notebook systems hitting the showrooms this summer. Leading Edge finally entered the market with its first notebook systems, 16- and 20-MHz 386SX systems that weigh in at just under 7 pounds. Priced around \$2,600 and \$2,900 for the different clock-speed systems, they're equipped with 1M of memory and 20M hard disks . . . Magnavox, now a brand name owned by Philips, has entered an interesting notebook which, at nearly \$2,700 for a 286, is unique in offering a 4-hour battery life and the ability to switch batteries without rebooting the system.

Intel Chips. The new, less expensive 486SX chips with the coprocessor stripped from the 80486 and clock speed lowered to 20 MHz finally made its official debut. Three companies are already shipping computers based on the new chips, with several others announcing prices and near-future ship dates.

Dell Computer is already showing desktop 486SX-based systems and even a powerful 50-MHz 486DX (full 80486) system based on soon-to-be-released faster Intel chips.

AST entered the 486SX field with a 4M, 20-MHz system priced around \$3,000. It offers a user-installable upgrade system that lets you move from a 386 AST system to 486SX or even full 486DX by replacing the processor chip and all accessory circuits on a single plug-in board.

IBM also introduced two new 486SX systems, along with several other new PS/2 systems and some massive price reductions.

Advanced Logic Research, better known as ALR, has new EISA and Micro Channel 486SX systems already shipping. The ALR systems offer easy upgrades to full 486DX capabilities and room for the new 487 math coprocessor that will work with the new 486SX chips.

IBM Won't Kill DisplayWriter. Despite very strong comments by some IBM insiders, IBM has stated that, although it's buying a new word processor from XyQuest, it doesn't intend to kill *DisplayWriter*. IBM is in an embarrassing situation since it has acknowledged that *DisplayWriter* is virtually unsalvageable as a modern advanced word processor but has promised big corporate buyers for years that it will continue to support the antiquated program.

Windows' Help. Despite all the hype about GUIs, such as *Windows* being extremely easy to learn and use, Microsoft recently announced improved support for the environment, including a 200-page *Windows Resource Kit* to help those struggling with the nearly useless *Windows* error messages.

Borland "C's" The Future. With a recent announcement that it has delivered more than 350,000 Borland C++ language packages, Borland is making a very strong showing and may do even better when its rumored dBASE-like *Windows* database program hits the street. The new database will be dBASE-compatible and capable of using existing dBASE code in the new *Windows 3* environment.

Don't confuse the \$500 Borland C++, which is an object-oriented *Windows*-compatible language, with the \$99 Turbo C++ that's also reportedly selling very well. With Borland so solidly behind the C language, it could become a really dominant force, even for hobbyist programmers. However, with Microsoft's new BASIC, with syntax to match its QuickBASIC, in the next version of MS-DOS, you can't count on BASIC being dead just yet.

PARTS PLACESM

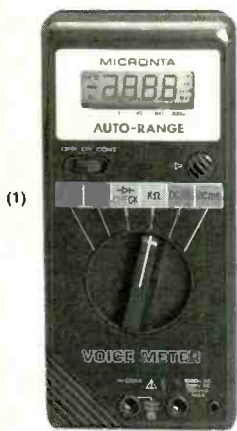

(1)

(1) **Talking Multimeter.** Timesaving *speech* output! Press a button on the probe and this meter calls out the reading in clear English while displaying it. Features include full autoranging, liquid crystal display with low-battery and over-range indicators, continuity beeper, diode-check mode. #22-164 **99.95**

(2) **NEW! Building Power Supplies.** Easy-to-understand, 96-page book explains linear and switching supplies. Includes complete plans for building five useful supplies with Radio Shack parts. #276-5025, **4.95**

(3) **Mini Audio Amplifier.** Great for computer voice/music synthesis, signal tracing and more. Has a built-in speaker, 1/8" headphone jack, 1/8" input jack and volume control. #277-1008 **11.95**

(4) **Digital Logic Probe.** LEDs and tone outputs reveal logic states instantly. It's the fast way to check operation and pinpoint problems in all types of digital circuits. #22-303 **16.95**

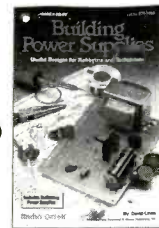

(2)



(4)



(3)

Parts Special-Order Hotline. Your local Radio Shack store stocks over 1000 popular electronic components. Plus, we can special-order over 10,000 items from our warehouse—linear and digital ICs, transistors and diodes, vacuum tubes, crystals, phono cartridges and styli, even SAMS[®] service manuals. Your order is sent directly to your Radio Shack store and we notify you when it arrives. Delivery time for most items is one week and there are no postage charges or minimum order requirements.

(1) **Shielded RS-232 Jumper Box.** Top-quality inline D-sub 25 adapter. Wire the included jumper wires and board to suit your need. #276-1403 **9.95**

(2) **RS-232 Tester.** Dual-color LEDs monitor seven data/control lines to help you spot problems quickly. D-sub 25. Connects inline. #276-1401 **14.95**

(3) **Grounded-Tip Soldering Iron.** 15W. #64-2051 **7.49**

(4) **Vacuum-Type Desoldering Tool.** #64-2120 **6.95**

(5) **Locking Forceps.** 6" long. Stainless. #64-1866 **4.95**

(6) **Rosin Soldering Paste Flux.** #64-021 **1.79**

(7) **Lead-Free Solder.** 0.25 oz. #64-025 **1.99**

Over 100 soldering items and tools for electronics work are in stock at Radio Shack!

(8) **10A Microwave Oven Fuses.** #270-1256 Pkg. of 2/1.29

(9) **2-Amp Fast-Acting Fuses.** #270-1275 Pkg. of 3/79c

(10) **5-Amp "Blade" Car Fuses.** #270-1205 Pkg. of 2/89c

Big selection of fuses, holders and accessories in stock!

Computer/Business Machine AC Power Cords. 6 feet long.

(11) **Extension.** #278-1259 **4.99**

(12) **With Space-Saving 90° CEE Connector.** #278-1260 **5.99**

(13) **With Straight CEE Connector.** #278-1257 **3.99**

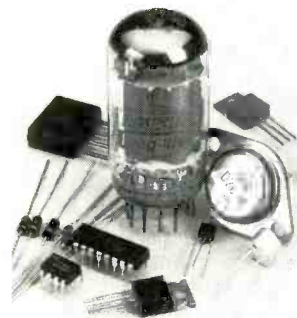

(1)

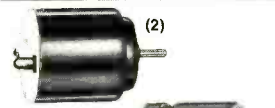

(2)



(3)

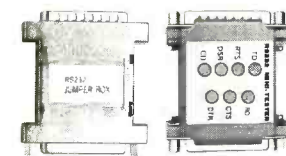

(1)

(2)

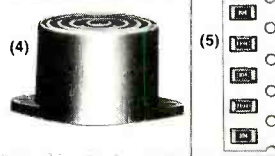

(4)

(5)

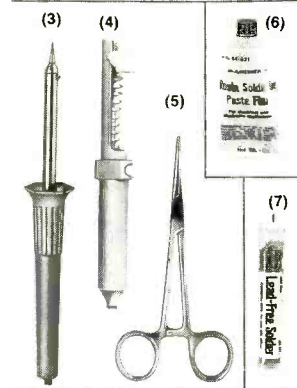

(3)

(4)

(5)

(6)



(6)



(7)

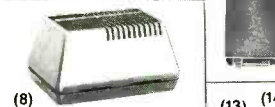

(8)



(9)



(10)



(11)



(8)

(9)

(10)



(11)

(12)

(13)



(11)



(12)



(13)



(14)



(15)

(1) **Voltage Regulator ICs.** Feature built-in overload protection and thermal shutdown. Maximum input: 35VDC.
7805. 5V. #276-1770 **1.19**
7812. 12V. #276-1771 **1.19**

(2) **Low-Voltage Motor.** Just the thing for science projects, robotics and solar power demos. Operates 1 1/2 to 3VDC. About 1 1/2" long. #273-223 **99c**

(3) **High-Speed 12VDC Motor.** Up to 15,200 RPM, no load. About 2" long. #273-255 **2.99**

(4) **"Ding-Dong" Chime.** This IC and mini-speaker combo is ideal for a customer-entry alert or doorbell. Produces 80 dB sound pressure at 12 VDC. Operates 6 to 18 VDC. #273-071 **8.99**

(5) **Surface-Mount Resistors.** 200-piece assortment of 15 popular values. Rated 1/8 watt, 5%. #271-313 **Set 4.99**

Radio Shack Has 20 different project enclosures in stock!

(6) **Metal Project Cabinet.** An attractive, easy-to-drill housing at a low price. 3 x 5 1/4 x 5 7/8". #270-253 **6.79**

(7) **Project Labels.** Four sheets of rub-on letters, numerals and calibrations. #270-201 **2.99**

(8) **Power Supply Case.** Vented 2 1/2 x 4 5/8 x 3 1/4" molded case. #270-287 **3.99**

(9) **0 to 15 DC Voltmeter.** Panel-mount. #270-1754 **7.95**

(10) **Box/Board Combo.** Molded enclosure plus predrilled 2 x 3 1/8" board, labels and more. #270-291 **4.99**

(11) **Eight-Position Phono Jack Board.** #274-370 **1.39**

(12) **1:1 Audio Transformer.** Z: 600-900Ω. #273-1374 **3.59**

(13) **Three-Pin XLR Mike Plug.** Metal body. #274-010 **2.99**

(14) **Three-Pin XLR Mike Inline Socket.** #274-011 **2.99**

(15) **Three-Pin XLR Mike Panel Socket.** #274-013 **3.69**

Since 1921 Radio Shack has been the place to obtain up-to-date electronic parts as well as quality tools, test equipment and accessories at low prices. Over 7000 locations to serve you—NOBODY COMPARES

Prices apply at participating Radio Shack stores and dealers. Radio Shack is a division of Tandy Corporation

Radio Shack[®]
AMERICA'S TECHNOLOGY STORE

CIRCLE NO. 172 ON FREE INFORMATION CARD

Palmtop 1-2-3

Hewlett Packard and Lotus have teamed up to bring to market the first palmtop IBM/compatible with Lotus 1-2-3 built in. The HP 95LX is designed to work as a companion to desktop and laptop PCs. Jointly developed by HP and Lotus, the HP 95LX will



be manufactured and marketed by HP. In addition to Lotus 1-2-3 release 2.2 and MS-DOS 3.22, the 11-ounce palmtop features one-key access to all applications, built-in organizer tools, support for third-party applications and extensive communications capabilities. The palmtop comes standard with 512K RAM and provision for plug-in ROM cards for additional software packages. \$699.

CIRCLE NO. 1 ON FREE CARD

Inexpensive I/O Converter

B&B Electronics has a new Parallel Port Input/Output (PPIO) Converter that allows you to connect your computer to the outside world. Any of

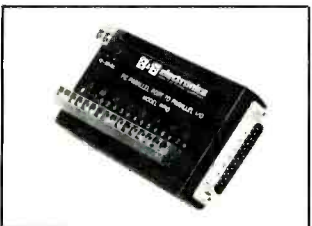

its eight I/O points can be used to control voltages as high as 50 volts dc, with a threshold of 2.5 volts. The input lines can be used to monitor thermostats, relays, or anything that has a contact that can be opened or closed. PPIO comes with sample programs written in BASIC, Pascal and C. \$100.

CIRCLE NO. 2 ON FREE CARD

HP Makes The LaserJet III Personal

Hewlett Packard introduced the IIIP "personal" laser printer, a compact (16" x 14" x 8") model that retains the basic low cost four-ppm HP IIP engine with the scalable font handling and Resolution Enhancement of the costlier III series. HP's page description language, PCL, is upgraded to PCL5, which speeds up graphics printing as well as permits scaling of fonts. In addition to eight internal "fonts," you can add a PostScript cartridge (along with additional memory) to print



PS documents. The IIIP comes with 1M of RAM, which can be expanded to a total of 5M. A multi-purpose paper tray has a 70-sheet capacity and can be adjusted to handle a variety of paper and envelope sizes. List price is \$1,595, with street price around \$1,000.

CIRCLE NO. 3 ON FREE CARD

Pocket Engineering Computer

Sharp Electronics' PC-E500 pocket computer features built-in engineering software, equation reference library, graphics capabilities, high-speed performance and expanded storage capacity for custom equations or BASIC programs. It features double-precision accuracy. Readout is from a 40-character, four-line LCD array featuring 240 x 32-dot graphics. A serial I/O port is standard. Basic RAM memory is 32K, which is expandable to 96K with a plug-in RAM card. Options include a pocket disk drive, thermal printer and plug-in RAM card. The PC-E500 weighs only 0.6 pound and measures 7" x 3". \$250.

CIRCLE NO. 4 ON FREE CARD

Tech Support On A Disk

Mark Twain Computing (La Grange, MO) supplies virtually all the information needed to construct or troubleshoot an IBM-compatible computer on seven 5.25" disks. All post-error codes, all audio beep codes, specifications for virtually all hard drives and diagnostic software are included in the 2M of information. Requires a word processor for on-line reading. \$70.

CIRCLE NO. 5 ON FREE CARD

Extra K For Symphony

Lerman Associates' (Westford, MA) upgraded *Symphony* add-in, *Extra K*, extends and enhances memory management in Lotus's recently released *Symphony* Version 2.2. With *Extra K*, *Symphony* 2.2 users can load large worksheets and still have enough memory to run add-ins and other applications. *Extra K* users can selectively unload, in any combination, *Symphony's* four non-spreadsheet modules to reclaim up to 90K of conventional memory. On-line help and macro processing can also be removed. *Extra K* works with earlier versions of *Symphony* and any machine that runs them. Price is \$80 plus shipping.

CIRCLE NO. 6 ON FREE CARD

Industrial Data Acquisition

The NEMA Acquisitor is packaged for use in hostile environments. It uses an RS-232 or RS4-22 serial interface to transfer data to a remote IBM/compatible computer. It includes a sensor/PC interface (no transmitters are generally required) and easy-to-use software with real-time graphics, alarms, etc. Source code is provided. The system measures 6 to 1,000 inputs with an accurate 16-bit resolution. Supplied with hinged,

Phone/FAX/Modem on One Line

The SouthTech Instruments FoneFilter can automatically route calls from one incoming line to three separate devices. Routing is based on a separate number with a distinctive ring assigned to each number (a service offered by many phone



companies for about \$10). Installation is as simple as plugging FoneFilter into the incoming telephone line and then the respective devices into FoneFilter. \$99.

CIRCLE NO. 7 ON FREE CARD

New Bench-Mark

DiagSoft is shipping Version 1.7 of *Power Meter*, an easy-to-use diagnostic software tool that measures, monitors and compares the performance of IBM and compatible computers. The software permits the user to measure overall system performance as well as specific job performance. Also included are a new user interface and database that can be used to save test results for quick comparison of the performance of systems and components. \$100.

CIRCLE NO. 8 ON FREE CARD

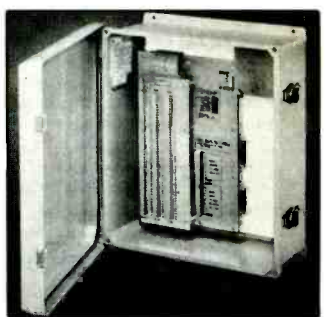

gasketed, locking door, the Acquisitor is suitable for most harsh factory environments. It measures 17.5"H x 15.5"W x 6.75"D. \$1,995.

CIRCLE NO. 9 ON FREE CARD

Digital And Microprocessor Fundamentals

By William Kleitz
(Prentice Hall. Hard cover. 482 pages. \$52)

Aimed at the "digital novice" who must be brought up to speed on microprocessors, this book provides the fundamental concepts that are essential for a solid foundation in digital electronics and microprocessors. "Nice to know" topics have been omitted. The text starts with digital number systems and moves on to gate operation, with emphasis on combinational logic circuits and reduction techniques. Data control devices, sequential logic, counters and shift registers and interfacing to the outside world are discussed. The microprocessor chapters use the 8085A microprocessor and 8051 microcontroller to explain the fundamentals of microprocessor architecture, programming and hardware.

Mastering Electronics

By John Watson
(McGraw-Hill. Soft cover. 427 pages. \$19.95)

Watson emphasizes the systems and applications of modern technology. The book covers both the fundamentals and the theory of electronics and presents material on compact discs,

camcorders and TVRO systems. Scores of detailed circuit diagrams provide an opportunity for hands-on experience with construction projects. This book should be an ideal resource for hobbyists and technical professionals who work in fields other than electronics.

Introductory Electronic Devices And Circuits

By Robert T. Paynter
(Prentice Hall. Hard cover. 866 pages. \$44)

This book provides a thorough and practical study of electronic devices and the circuits that use them. It is written to serve as a textbook for a second course in an electronics or engineering technology course. Devices covered range from the most fundamental diode to various FET and MOSFET to multivibrators to LEDs to IC voltage regulators. Circuit design is discussed, too, with a great deal of emphasis on practical uses of each of the devices. The troubleshooting section of each chapter sets this book apart from numerous others written on similar topics. They are based on the author's experiences. Emphasis is constantly placed on "outside" factors that can affect operation and troubleshooting of various components and circuits. Also, there is a

strong emphasis on how things work. Circuit theory is used to explain the mathematics, rather than mathematics being used to explain theory. The text is written in an informal style, and judicious use of two-color printing makes for a pleasant reading experience.

Electrostatic Discharge Protection For Electronics

By Neil Sclater
(Tab Professional and Reference Books. Hard cover. 227 pages. \$29.95)

Electrostatic discharge (ESD) is a hot subject in modern electronics. Each step forward in terms of reduction in size and increase in speed presents a corresponding increase in susceptibility to damage or destructions from static-electricity discharge. To demonstrate the truly destructive nature of ESD, Sclater provides several photographs taken with a magnification of 3,000 that show "large" holes blown into semiconductor devices by static discharges.

Sclater covers the basic principles of ESD, board and system protection, protective materials and packaging, protecting the workplace, personal protection, ESD test equipment and more.

MS Mail Version 2.1

Microsoft Mail Version 2.1 is available for PC networks. It supports all major PC networks and desktop environments, including, naturally, Windows 3.0. Microsoft Mail provides connectivity with other key messaging environments through a broad set of gateways. Concurrent with shipment of Microsoft Mail, Microsoft also announced a new more flexible product configuration of Network Courier (free upgrade offer) and expanded technical support. Starts at \$1,100 for a five-station package.

CIRCLE NO. 11 ON FREE CARD

Transparent File Compression

PKWARE's (developer of the "ZIP" compression format) new PKLITE allows IBM/compatible .COM and .EXE files to be reduced in size yet execute as if there had been no compression. In operation, a user runs PKLITE and specifies which .EXE or .COM file is to be compressed. The result is a new .COM or .EXE file that is typically 40% smaller in size when stored to disk. Normal operation is transparent to the user. Should the need arise, the compressed file can be restored to its full size in a matter of seconds. Less than \$50.

CIRCLE NO. 12 ON FREE CARD

286 Notebook Computer

Radio Shack introduced the Tandy 2810 HD notebook-size business computer with an 80C286 microprocessor running at 16 MHz. Weighing only 6.7 pounds with battery, the 2810 sports VGA graphics, a 23-ms 20M hard drive, and a 1.44M floppy. Battery life is up to 3.5 hours. On-board memory can be expanded from the standard 1M to 5M. MS-DOS 4.01, DeskMate 3.5, and TEMM memory manager are factory installed on the hard disk. The



Ni-Cd battery pack is replaceable and comes with a wall charger/adaptor. The 2810 is priced in the \$2,500 range, and it can be seen at local Radio Shack stores and computer centers.

CIRCLE NO. 10 ON FREE CARD

New Multimeter

Global Specialties introduced the Protometer 4000 that combines a 3 1/4-decade digital multimeter, autoranging frequency counter to 4 MHz, transistor/capacitance meter and logic probe into a single palm-size portable instrument. Features include a large 60 x 40-mm LCD display, 4,000-count accuracy, peak hold and a high-voltage warning indicator. Rugged construction makes the DMM ideal for field service and industrial maintenance applications. Heat-resistant compo-



nents extend the current-measuring range up to 20 amperes ac/dc. Battery life is said to be 300 hours. \$140.

CIRCLE NO. 13 ON FREE CARD

BBS Add-On Catalog

Galacticomm offers a free catalog of add-on hardware and software for The Major BBS. Over 75 products are covered in this 16-page catalog. Multiuser databases, connectivity solutions, billing options, operator enhancements and a wide range of multi-player games and amusements are listed.

CIRCLE NO. 14 ON FREE CARD

JDR Catalog

JDR Microdevices' new catalog features several new "power-up" products, including a bus extender and instruction execution detector, in one package. Other new items in the 100-page catalog include an Accelerator Card for Amiga 2000 with a high-speed 28-MHz 68030 CPU, a Modular Circuit Technology 486 motherboard and numerous software products.

CIRCLE NO. 15 ON FREE CARD

Free Catalog

Pomona Electronics' free 1991 "Catalog of Electronic Test Accessories" highlights a new 32-pin PLCC clip for popular new EEPROM devices and 100- and 132-pin QFP SMT test clips for Mo-

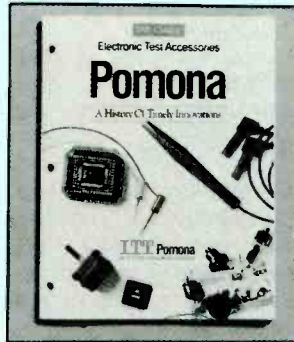

torola 68020/68030 and Intel 80386SX microprocessors. It also features new IC clip kits, coax/BNC universal adapter kits, digital multimeter test lead kits, cable and patch accessories and jumper kits.

CIRCLE NO. 16 ON FREE CARD

Bar-Code/Magnetic-Stripe Reader

PERCON's Series 20 features auto-host recognition, four decoder programming methods, selective editing of data input and reading of multiple barcode and magnetic-stripe formats. By simply changing the interface cable attached to a 25-pin corrector, the same Series 20 decoder can be used

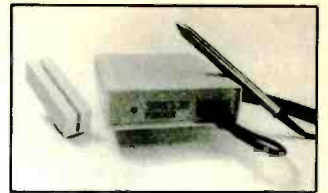

as either an RS-232C serial interface or keyboard interface decoder on multiple computers and terminals from more than 15 major manufacturers.

CIRCLE NO. 18 ON FREE CARD

Graphics Index

Dynamic Graphic's *image QUEST* is an electronic visual and key-word indexing system. By simply typing in a key word, *image QUEST* displays thumbnail representations of all artwork in the index that fits the description. This interactive system allows users to add their own art and key-word descriptions to the index.

Dynamic Graphic's monthly offering of clip art, Designer's Club, has been increased by 25% to more than 50 EPS and TIFF images, including a greater variety of subjects. Each month's edi-



tion carries seasonal art in a wide assortment of styles and effects.

Two CD-ROM collections of clip art are available. Each contains more than 500 images and includes the *image QUEST* indexing system. The package also includes a printed pictorial index in a loose-leaf binder.

CIRCLE NO. 19 ON FREE CARD

New Fluke Meters

Fluke replaced its venerable 70 Series family of hand-held multimeters with the 70 Series II models. This new line of eight models includes three all-new ones and enhanced versions of existing five models. The all-new Models 79 and 29 can check capacitance from 10 pF to 9,999 μ F, eliminating the need for a dedicated capacitance tester. An innovative frequency function can simultaneously display frequency up to 20 kHz on a

digital numeric display and ac voltage on an analog bargraph. A new 63-segment bargraph updates as fast as the eye can follow, simulating the functionality of an analog pointer for observing trends, peaking and nulling. A smoothing function provides a running average of eight readings, providing stable readings, even with unstable signals. Prices start at \$70 and range up to \$185.

CIRCLE NO. 17 ON FREE CARD



LAN Wiring Tester

Paladin Corporation's Patch Check is a hand-held instrument designed to test telephone (RJ-11) and computer data-link (RJ-45) wiring. Patch Check identifies open, shorted and cross-connected wires with a clear LED display. To operate, the user sim-



ply presses a button to review a sequential comparison of the wire position and continuity of the modular plugs at each end of the cable. \$50.

CIRCLE NO. 20 ON FREE CARD

TVRO Diagnostics

The Baylin (Boulder, CO) *TVRO System Analysis And Satellite Locator* Version 1.1 for IBM and compatible computers includes a new system-



configuration screen that should prove to be useful for refining program operation. The analysis subcomponent accurately calculates picture quality from user-entered system parameters. The aiming subcomponent calculates azimuth and elevation angles and range to all satellites within "view" of a TVRO. \$50 plus shipping.

CIRCLE NO. 21 ON FREE CARD

Altex Electronics, Inc.



Mail Order Dept., 11342 IH-35 North, San Antonio, Texas 78233 • (512)637-3200 • Hours 7am-7pm Monday-Friday, 10-2pm Saturdays. FAX: (512) 344-2965
TERMS: For C.O.D. orders add \$3.75 Minimum \$25. For orders under \$99 add \$3.00 handling charge plus FRT. For orders over \$99, actual FRT charges apply. Federal Express your order: \$8 up to 20lbs. - 2nd Day Economy, \$17.50 up to 20lbs. - Overnight. P.O.'s accepted from approved accounts. Texas residents add 8-1/4% sales tax. All returns require RMA# and must be returned in original condition. Subject to 15% restocking fee. Prices subject to change without notice. Prices and product descriptions subject to change. We are not responsible for typographical errors.

SWITCHBOXES



**DB-25
25 LINE**

| Part# | Description | Each |
|---------|----------------|---------|
| AB25-2 | 2 Way | \$18.95 |
| AB25-2E | 2 Way Economy | 11.95 |
| AB25-3 | 3 Way | 23.95 |
| AB25-4 | 4 Way | 26.95 |
| AB25-4E | 4 Way Economy | 18.99 |
| AB25-5 | 5 Way | 37.95 |
| AB25-6 | 6 Way | 49.95 |
| AB25-X | X-Over | 27.95 |
| AB25-XE | X-Over Economy | 16.99 |



**CENTRONICS
36 LINE**

| Part# | Description | Each |
|---------|----------------|---------|
| AB36-2 | 2 Way | \$21.95 |
| AB36-2E | 2 Way Economy | 14.99 |
| AB36-3 | 3 Way | 28.95 |
| AB36-4 | 4 Way | 33.95 |
| AB36-4E | 4 Way Economy | 22.99 |
| AB36-5 | 5 Way | 44.95 |
| AB36-X | X-Over | 36.95 |
| AB36-XE | X-Over Economy | 19.99 |



**DE-9
9 LINE**

| Part# | Description | Each |
|---------|---------------|---------|
| AB09-2 | 2 Way | \$19.95 |
| AB09-2E | 2 Way Economy | 9.99 |
| AB09-4 | 4 Way | 29.95 |
| AB09-X | 9 Pin X-over | 32.95 |



**MONITOR-
KEYBOARD**

| Part# | Description | Each |
|----------|---------------|---------|
| ABMKB-2 | 2 Way | \$29.95 |
| ABMKB-4E | 4 Way Economy | 35.95 |



**TWIN-AXIAL
SWITCHBOXES**

| Part# | Description | Each |
|---------|-------------|---------|
| ABTWX-2 | 2 Way | \$31.95 |
| ABTWX-4 | 4 Way | 38.95 |



**IEEE-488
24 LINE**

| Part # | Description | Each |
|--------|-------------|---------|
| AB24-2 | 2 Way | \$39.95 |
| AB24-4 | 4 Way | 49.95 |



**MODULAR
RJ11 & RJ45**

| Part# | Description | Each |
|-----------|---------------|---------|
| ABRJ11-2 | 2 Way | \$18.95 |
| ABRJ11-2E | 2 Way Economy | 11.99 |
| ABRJ11-4 | 4 Way | 26.95 |
| ABRJ11-4E | 4 Way Economy | 15.99 |
| ABRJ45-2 | 2 Way | 19.95 |
| ABRJ45-2E | 2 Way Economy | 12.99 |
| ABRJ45-4 | 4 Way | 29.95 |
| ABRJ45-4E | 4 Way Economy | 17.99 |

SPECIALIZED SWITCHBOXES

| Part# | Each |
|---|---------|
| AB252-36 | \$29.95 |
| 2 DB25 connectors to a 36 pin Centronics connector | |
| AB362-25 | \$33.95 |
| 2 36 pin Centronics connectors to a DB25 connector | |
| AB253-X2 | \$46.95 |
| All DB25 connectors, switches 3 input to 2 output devices | |
| AB15HD-2 | \$33.95 |
| 15 pin high density type connector switchbox | |
| AB5750-2 | \$56.95 |
| 50 pin Telco type switchbox | |
| AB50-2 | \$56.95 |
| 50 pin "D" sub type switchbox | |



**WANG
BNC-TNC**

| Part# | Description | Each |
|----------|-------------|---------|
| ABBNTN-2 | 2 Way | \$31.95 |
| ABBNTN-4 | 4 Way | 46.95 |



**MINI DIN
8 LINE**

| Part# | Description | Each |
|---------|-------------|---------|
| ABMD8-2 | 2 Way | \$24.95 |
| ABMD8-4 | 4 Way | 33.95 |
| ABMD8-X | X-Over | 37.95 |



**AUTOMATIC
SWITCHBOXES**

Parallel Auto Switchboxes

| Part# | Description | Each |
|--------|-------------|-------|
| MP-401 | 4 in 1 out | \$ 89 |
| MP-801 | 8 in 1 out | 139 |

Serial Auto Switchboxes

| Part# | Description | Each |
|--------|-------------|-------|
| MS-401 | 4 in 1 out | \$ 89 |
| MS-801 | 8 in 1 out | 139 |

These automatic switchboxes are used to connect up to 8 pcs to one peripheral such as a printer or modem. They come in either serial or parallel formats. All units come with DB-25, 25 pin female connectors for the output and input ports.



LINE BOOSTERS

| Part# | Description | Each |
|-------|---------------------------------|---------|
| PB-1 | Parallel line booster (36S-36S) | \$29.95 |
| SB-1 | Serial line booster (25S-25S) | 29.95 |

These line boosters double the distance you can run between your computer and peripherals.

DA-15 15 LINE

| Part# | Description | Each |
|--------|-------------|---------|
| AB15-2 | 2 Way | \$25.95 |
| AB15-4 | 4 Way | 36.95 |



**BNC
COAXIAL**

| Part # | Description | Each |
|----------|---------------|---------|
| ABBN-2 | 2 Way | \$23.95 |
| ABBN-4 | 4 Way | 29.95 |
| ABBNC-2E | 2 Way Economy | 10.00 |

DC-37 37 LINE

| Part # | Description | Each |
|--------|-------------|---------|
| AB37-2 | 2 Way | \$25.95 |
| AB37-4 | 4 Way | 39.95 |

CABLES



**PC/AT
PARALLEL
PRINTER
CABLES**

| Part# | Description | Each |
|-------------|------------------------------|--------|
| PPC301-6 | DB25-36P 6 ft. | \$6.95 |
| PPC301-6RA | DB25-36P 6 ft. (Rt. angle) | 8.95 |
| PPC301-6D | Diablo API 10 ft. (DB25-50P) | 14.95 |
| PPC301-10 | DB25-36P 10 ft. | 7.95 |
| PPC301-10RA | DB25-36P 10 ft. (Rt. angle) | 10.95 |
| PPC301-15 | DB25-36P 15 ft. | 11.95 |
| PPC301-20 | DB25-36P 20 ft. | 14.95 |
| PPC301-25 | DB25-36P 25 ft. | 17.95 |



**DB25
25 LINE
CABLES**

| Male to Male | | Part# | Desc. | Each |
|----------------|---------|-------|-------|--------|
| 25MM-6 | 6 ft. | | | \$6.95 |
| 25MM-10 | 10 ft. | | | 8.95 |
| 25MM-15 | 15 ft. | | | 11.95 |
| 25MM-20 | 20 ft. | | | 14.95 |
| 25MM-25 | 25 ft. | | | 17.95 |
| 25MM-50 | 50 ft. | | | 33.95 |
| 25MM-100 | 100 ft. | | | 62.95 |
| Male to Female | | Part# | Desc. | Each |
| 25MF-6 | 6 ft. | | | \$6.95 |
| 25MF-10 | 10 ft. | | | 7.95 |
| 25MF-15 | 15 ft. | | | 11.95 |
| 25MF-20 | 20 ft. | | | 14.95 |
| 25MF-25 | 25 ft. | | | 17.95 |
| 25MF-50 | 50 ft. | | | 33.95 |
| 25MF-100 | 100 ft. | | | 62.95 |



**CENTRONICS
36 PIN
CABLE
ASSEMBLIES**

| Male to Male | | Part# | Desc. | Each |
|----------------|--------|--------|-------|------|
| 36MM-6 | 6 ft. | \$7.95 | | |
| 36MM-10 | 10 ft. | 9.95 | | |
| 36MM-15 | 15 ft. | 12.95 | | |
| 36MM-20 | 20 ft. | 14.95 | | |
| 36MM-25 | 25 ft. | 17.95 | | |
| Male to Female | | Part# | Desc. | Each |
| 36MF-6 | 6 ft. | \$7.95 | | |
| 36MF-10 | 10 ft. | 9.95 | | |
| 36MF-15 | 15 ft. | 12.95 | | |
| 36MF-20 | 20 ft. | 14.95 | | |
| 36MF-25 | 25 ft. | 17.95 | | |



**DE-9 9 LINE
CABLES**

| Male to Male | | Part# | Description | Each |
|----------------|--------|-------|-------------|--------|
| 9MM-6 | 6 ft. | | | \$5.95 |
| 9MM-10 | 10 ft. | | | 9.95 |
| 9MM-25 | 25 ft. | | | 14.95 |
| Male to Female | | Part# | Description | Each |
| 9MF-6 | 6 ft. | | | \$5.95 |
| 9MF-10 | 10 ft. | | | 9.95 |
| 9MF-25 | 25 ft. | | | 14.95 |



**DRIVE
CABLE
ASSEMBLIES**

| Part# | Description | Each |
|----------|---|--------|
| DFC-XTS | Dual floppy cable (34S-34E-twist-34E) | \$4.95 |
| DFC-XTE | Dual floppy cable (34E-34E-twist-34E) | 4.95 |
| HDC-XT | Single hard drive cable set (20S-E & 34S-E) | 4.95 |
| 2HDC-22 | Dual hard drive cable set (2/20S-E & 34S-E-twist-34E) | 7.95 |
| DFCEX-XT | External dual floppy cable (37P-34E-twist-34E) | 12.50 |
| TEXTD-4 | Toshiba external drive cable (25P-34E) | 16.95 |
| YAD-4 | Drive power "Y" cable | 2.50 |
| HD-IDE | 40S-40S Single IDE Hard Drive Cable | 2.95 |
| 2HD-IDE | Dual IDE Hard Drive Cable | 3.95 |



**IEEE-488 CABLE
ASSEMBLIES**

| Part# | Description | Each |
|-------|-------------|---------|
| 488-1 | 1 meter | \$39.95 |
| 488-2 | 2 meters | 43.95 |
| 488-4 | 4 meters | 49.95 |



**MODEM
CABLE
ASSEMBLIES**

| Part# | Description | Each |
|---------|------------------------------|--------|
| ATM-1 | AT to Modem 1 ft. (9S-25P) | \$4.95 |
| ATM-6 | AT to Modem 6 ft. (9S-25P) | 6.95 |
| ATM-10 | AT to Modem 10 ft. (9S-25P) | 7.95 |
| 25MF-6 | PC to Modem 6 ft. (25S-25P) | 6.95 |
| 25MF-10 | PC to Modem 10 ft. (25S-25P) | 7.95 |

POWER CABLES

| Part# | Description | Each |
|---------|---------------------------------|--------|
| ACPC-02 | PC power cord | \$3.95 |
| ACPC-03 | PC power adapter cable | 4.95 |
| ACPC-04 | Monitor power ext. cable, 6 ft. | 4.95 |



POPULAR PC CABLE ASSEMBLIES

| Part# | Description | Each |
|----------|---|--------|
| KEC-6 | Keyboard extension cable 6 ft. | \$3.95 |
| MEC-6 | Monitor extension cable 6 ft. (9M-9F) | 5.95 |
| PS2-MEC6 | VGA monitor extension cable 6 ft. (HD15P-HD15S) | 14.95 |
| PS2-KEC6 | PS2 Keyboard extension cable 6 ft. | 7.95 |
| 9P-RCA | Composite video cable 6 ft. (9P-RCA) | 6.95 |
| VMC-6 | RCA-RCA 6 ft. | 1.95 |

TO ORDER CALL 1 (800) 531-5369



CIRCLE NO. 25 ON FREE INFORMATION CARD

Quick C: The Complete Reference

By Werner Feibel

(Osborne McGraw-Hill. Soft cover. 1092 pages. \$29.95)

As the title suggests, this book is organized by topics. Thus, it is more suitable as a reference for those who have some C experience than it would be for someone learning to program in C. Several dozen complete programs serve to illustrate the material covered in the text. An optional set of disks is available from the author that contains all programs in the book. The author highly recommends experimenting with the programs. Microsoft Quick C versions 2.0 through 2.5 are covered.

Teach Yourself GW Basic

By Bob Albrecht

(Osborne McGraw-Hill. Soft cover. 408 pages. \$19.95)

This book is for people who have no previous programming experience. The tutorial is designed to teach GW-BASIC while the reader solves problems and performs tasks such as number crunching, text manipulation, and graphics and sound creation. An optional disk with most of the programs from the exercises is available from the author for a nominal charge. Writing is clear and concise; examples and assignments are well chosen to illustrate the main points made in the text.

Surface-Mount Components

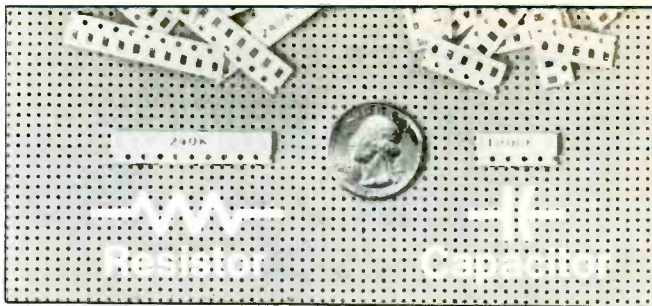

Communications Specialists accepts small-quantity orders for any components included in its CC-1 and CR-1 Kits. Resistors are furnished in strips of 10 and sell for \$2.50 per

strip. Capacitors are furnished in strips of 5 and sell for \$1.25 per strip. Minimum order is \$10. For more information, telephone 800-854-0547.

CIRCLE NO. 24 ON FREE CARD

Miniature CCD Camera

The CCTV Corp. CCD-100 is a big camera in a small package—measuring just 3" × 2" × 1". It electronically compensates for all light changes and requires no auto-iris lens. The camera utilizes a variable high-speed electronic shutter. Specifications are: image sensor, 1/3"; lens, 4-mm wide-angle (78° angle of view); electronic shutter, 1/60 to 1/5,000 second; geometric distortion, none; sensitivity, 0.2 foot-candle faceplate; S/N, 44 dB



minimum; grayscale, 10 shades minimum; video output, 1.0 volt p-p; supply source, 7 to 12 volts dc; temperature range, 0° to +122° F; power consumption, 1 watt; weight, 3.5 ounces.

CIRCLE NO. 25 ON FREE CARD

PS/2 Memory Checker

Aristor Computers offers a PS/2 Memory Module Adapter for the SIMCHECK memory tester. The adapter enables testing of 72-pin modules used in most IBM PS/2 computers. Defective mod-

ules are fully analyzed to provide explicit fault indications, including identification of defective bits and open/short wiring problems. The PS/2 adapter is \$295, and SIMCHECK is \$995.

CIRCLE NO. 26 ON FREE CARD

Ethernet PC Adapter

Telebyte Technology's Model 516 Tri-Port Adapter is a 16-bit Ethernet PC Adapter card that is compatible with thick coax, thin coax and unshielded twisted-pair cable. Full compliance is maintained for IEEE 803.2 10Base2, 10Base5 and 10BaseT, eliminating PC adapter obsolescence as changes are made to local-area-network configurations. The 516 also features complete software compatibility with Novell Netware Ad-

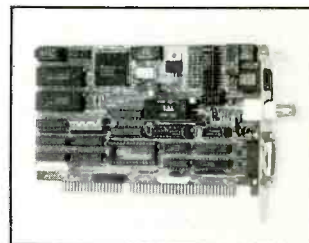

vanced, ELS, SFT and 286 and 386 Net Bios. A boot ROM socket and optional ROM permit the 516 to be used with diskless workstations. Price is \$395.

CIRCLE NO. 27 ON FREE CARD

Component ID Labels

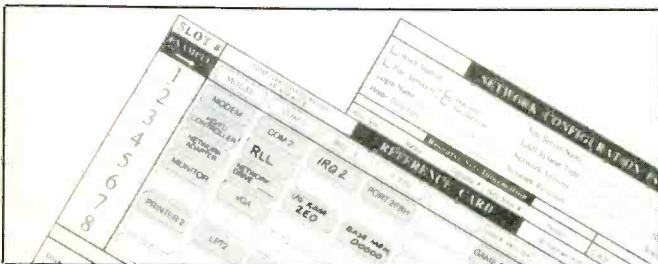

AMT Communications offers a collection of ready-to-use vinyl labels to identify cables, ports and peripherals. Label Logic contains more than 200

labels detailing all common description and configuration combinations for IBM/compatible, Macintosh and network systems. \$7.

CIRCLE NO. 22 ON FREE CARD

Data Collection Interface

Heidenhain's IK-110 interface card can be used to connect up to two of the company's measuring units (linear or rotary) directly to an IBM/compatible for data collection and processing. A measuring step of 1/200th part of the signal

period is possible because the interface card permits a measuring pitch to be divided 200 times per signal period. A demonstration diskette is available that illustrates the interface capabilities.

CIRCLE NO. 23 ON FREE CARD

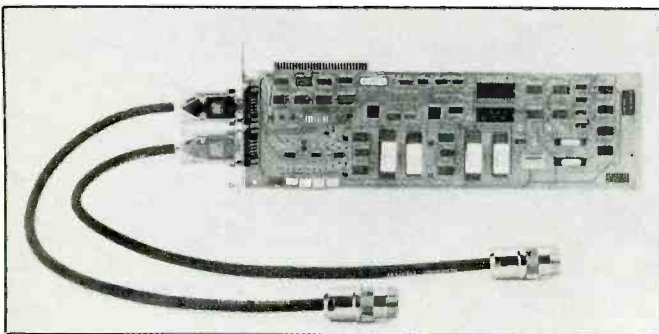

No other training—in school, on the job, anywhere—shows you how to troubleshoot and service computers like NRI

DIGITAL MULTIMETER

Professional test instrument for quick and easy measurements.

LESSONS

Clearcut, illustrated texts build your understanding of computers step by step.

SOFTWARE

Including MS-DOS, GW BASIC, word processing, database and spreadsheet programs.

HARD DISK

20 megabyte hard disk drive you install internally for greater data storage capacity and data access speed.

NEW! AT-COMPATIBLE COMPUTER

High-speed 80286 CPU (12 MHz clock, 0 wait states), 1 meg RAM, 1.2 meg, 5 1/4" high-density floppy disk drive.

MONITOR

High-resolution, non-glare, 12" TTL monochrome monitor with tilt and swivel base.

TECHNICAL MANUALS

With professional programs and complete specs on your computer.

DIGITAL LOGIC PROBE

Simplifies analyzing digital circuit operation.

DISCOVERY LAB

Complete breadboarding system to let you design and modify circuits, diagnose and repair faults.

Only NRI walks you through the step-by-step assembly of a powerful AT-compatible computer system you keep—giving you the hands-on experience you need to work with, troubleshoot, and service all of today's most widely used computer systems. You get all it takes to start a money-making career, even a business of your own in computer service.

No doubt about it: The best way to learn to service computers is to actually build a state-of-the-art computer from the keyboard on up. As you put the machine together, performing key tests and demonstrations at each stage of assembly, you see for yourself how each part of it works, what can go wrong, and how you can fix it.

Only NRI—the leader in career-building, at-home electronics training for more than 75 years—gives you such practical, real-world computer servicing experience. Indeed, no other training—in school, on the job, *anywhere*—shows you how to troubleshoot and service computers like NRI.

You get in-demand computer servicing skills as you train with your own AT-compatible system—now with 20 meg hard drive

With NRI's exclusive hands-on training, you actually build and keep the powerful new AT-compatible West Coast 1010 ES computer, complete with 1 meg RAM and 20 meg hard disk drive.

You start by assembling and testing the 101-key "intelligent" keyboard, move on to test the circuitry on the main logic board, install the power supply and 1.2 meg 5 1/4" floppy disk drive, then interface your high-resolution monitor. But that's not all.

Only NRI gives you a top-rated micro with complete training built into the assembly process

Your NRI hands-on training continues as you install the powerful 20 megabyte hard disk drive—today's most wanted computer peripheral—included in your course to dramatically increase your computer's storage capacity while giving you lightning-quick data access.

Having fully assembled your West Coast 1010 ES, you take it through a complete series of diagnostic tests, mastering professional computer servicing techniques as you take command of the full power of your computer's high-speed 80286 microprocessor.

In no time at all, you have the confidence and the know-how to work with, troubleshoot, and service every computer on the market today. Indeed you have what it takes to step into a full-time, money-making career as an industry technician, even start a computer service business of your own.

No experience needed, NRI builds it in

You need no previous experience in computers or electronics to succeed with NRI. You start with the basics, following easy-to-read instructions and diagrams, quickly

moving from the fundamentals to sophisticated computer servicing techniques. Step by easy step, you get the kind of practical hands-on experience that makes you uniquely prepared to take advantage of every opportunity in today's top-growth field of computer service. What's more—you learn at your own pace in your own home. No classroom pressures, no night school, no need to quit your present job until you're ready to make your move. And all throughout your training, you have the full support of your personal NRI instructor and the NRI technical staff always ready to answer your questions and give you help whenever you need it.

Your FREE NRI catalog tells more

Send today for your free full-color catalog describing every aspect of NRI's innovative computer training, as well as hands-on training in robotics, video/audio servicing, electronic music technology, security electronics, telecommunications, and other growing high-tech career fields.

If the coupon is missing, write to NRI School of Electronics, McGraw-Hill Continuing Education Center, 4401 Connecticut Avenue, Washington, DC 20008.

AT is a registered trademark of International Business Machines Corporation

NRI

School of Electronics

McGraw-Hill

McGraw-Hill Continuing Education Center
4401 Connecticut Avenue, Washington, DC 20008

For career courses approved under GI bill
 check for details

Check one FREE catalog only

| | |
|---|--|
| <input type="checkbox"/> Computers and Microprocessors <input type="checkbox"/> Robotics <input type="checkbox"/> TV/Video/Audio Servicing <input type="checkbox"/> Computer Programming | <input type="checkbox"/> Security Electronics <input type="checkbox"/> Electronic Music Technology <input type="checkbox"/> Basic Electronics <input type="checkbox"/> Telecommunications |
|---|--|

Name _____ (please print) Age _____

Address _____

City/State/Zip _____

Accredited Member, National Home Study Council

4-081

Installing a CD-ROM Drive

A guide to selecting and installing a CD-ROM drive in your PC

Compact discs have completely revolutionized the way music is recorded and played back. CD-ROM (compact disc-read-only memory) promises to do the same for information storage and retrieval on personal computers.

CD-ROM offers truly enormous storage capacity—more than 550 megabytes on a silvery plastic disc that measures only about 4¾" in diameter. This translates into real-world capacities of over 190,000 pages of text or 5,000-plus high-resolution color images or more than an hour of high-quality audio information. And since all this information is digital, image and audio can be combined with text data to produce true multimedia presentations and such interactive applications as atlases, encyclopedias, databases and catalogs, to name just a few.

Prices have fallen dramatically since CD-ROM drives were first introduced a few years ago. It's now possible to obtain an internally-mounted CD-ROM drive for \$400 or less (external CD-ROM drives are usually about \$100 to \$150 more costly than equivalent internal units). Moderate prices, coupled with more than 1,500 CD-ROM discs currently available, have made CD-ROM drives the new peripheral of choice for more and more PC owners.

While buying and installing a CD-ROM drive in your PC doesn't require an engineering degree, some basic considerations should be taken into account. We should, however, start off with a brief overview of how data is stored on a compact disc and retrieved by your computer's operating system.

Data Encoding

CD-ROM is based on the same opti-



cal and digital storage technology used for audio compact discs. Data is encoded and stored on a highly reflective metalized subsurface that's enclosed inside a clear polycarbonate disc. The data (which can be text, audio, video or a combination of all three) is stored on a single continuous spiraling track that starts at the center (hub) of the disc and continues outward toward the edges.

Each successive turn of the spiral is just under 1.6 microns from the next. This yields slightly more than 16,000 tracks per inch (a considerably more compressed environment than the 96 tracks per inch found on high-density 5¼" magnetic floppy disks). The track itself is composed of billions of microscopic pits separated from each other by flat areas called "lands."

A gallium-arsenide (GaAs) laser beam housed in the optical read head inside the CD-ROM drive passes through a special collimating lens that makes light rays travel in parallel. Another lens converges these parallel light rays into a single point

that's then focused on the spinning CD. The disc, by the way, is a CLV device, which means that its rotational speed varies with the position of the laser on the disc's radius. That is, the disc rotates faster when reading inner tracks than it does when reading outer tracks.

Pits on the disc surface scatter the light so that only a small portion is reflected back to the optical read head. Conversely, lands reflect a significantly greater amount of light to the read head. A photodetector reads the intensity of the reflected light and converts it into current, assigning a low current to the proportionately low reflectivity of the pits and giving it a 1 value. The higher reflectivity of the lands results in a 0 value assignment because of the increased current flow generated.

Assignment of 1 and 0 values is what produces the binary digital code required by your computer. This binary code is read by the drive at a rate of 75 2,048-byte sectors (or 150K-bytes) per second.

Construction Of A CD-ROM Disk And How It Is "Read" By A Drive's Laser Pickup

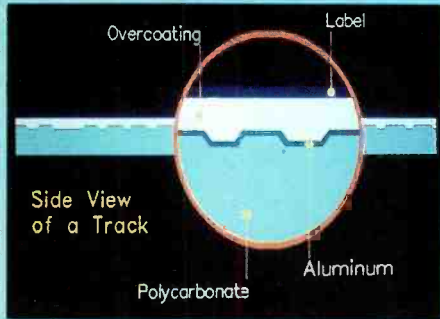

Side view of CD-ROM shows its various layers of construction. Disc is made of polycarbonate plastic, thinly coated with aluminum to provide reflectivity for laser light. Protective lacquer coating keeps aluminized surface from oxidizing and becoming contaminated with fingerprints, airborne particles, etc.

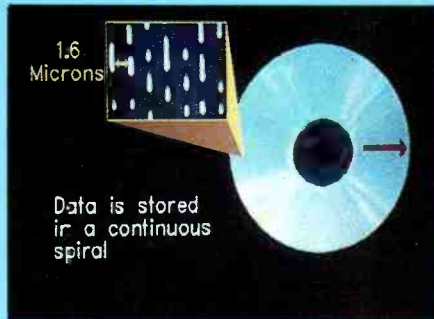

Unlike magnetic computer disks, which store data on concentric data tracks, CD-ROM streams data in a continuous, spiral track that starts at center of disc and works outward. Adjacent layers of data along the spiral path are less than 1.6 microns apart.

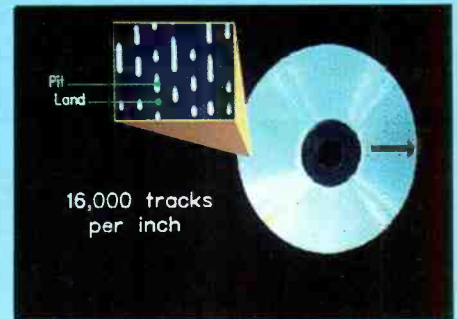

Data tracks are composed of "pits" and "lands," each of which produces a different reflectivity level for laser light. Reflected laser light is "read" by a photodetector to produce 1 and 0 binary patterns. Huge data storage capacity is result of less than 1.6-micron track width, yielding a whopping 16,000 tpi!

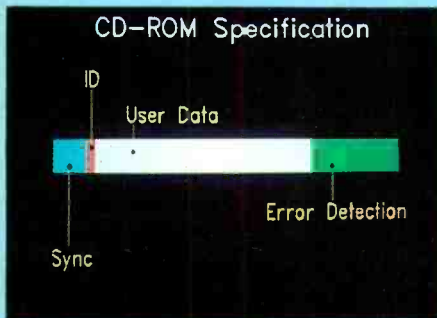

Data tracks on a CD-ROM are arranged in 2,048-byte sectors for user data. Each block has additional space allocated for sync, ID, user data and error-detection. Sync/ID indexing uses time marks to permit fast access to any section of disc despite spiral track format.

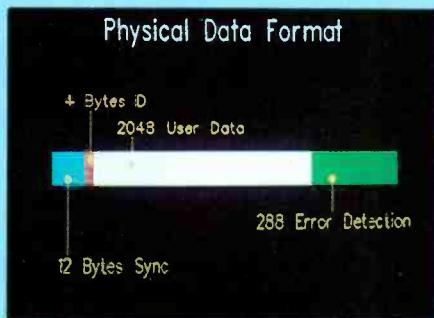

Physical data format of CD-ROM allocates 12 bytes for sync, four bytes for ID and 288 bytes for error detection for each 2,048-byte data sector. This accounts for extraordinary accuracy (less than 1 error per quadrillion reads).

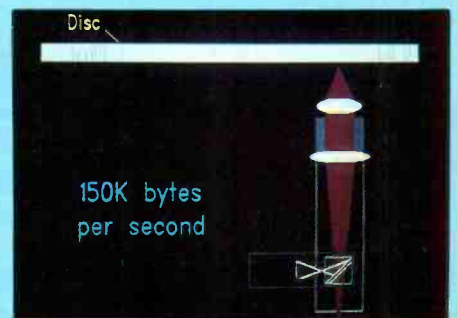

While initial seek time may be about 350 milliseconds, data transfers at a very respectable rate of 150 kilobytes (75 2,048-byte blocks) per second once appropriate sector on CD-ROM disc is located.



Because CD-ROM disc is a CLV device, its rotational speed varies with position of laser on its radius. Disc rotates faster when reading inner tracks than when reading outer tracks since track radius is smaller near the center than toward edges of disc.

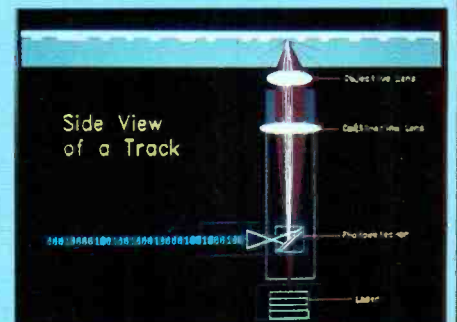
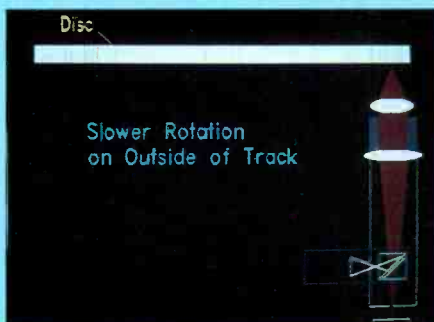

A gallium-arsenide laser beam passes through a collimating lens and is focused through an objective lens onto surface of spinning disc to read pits and lands. Reflected light is interpreted by a photodetector, which assigns values of 1 and 0 to enable PC to utilize data.

Photos this page courtesy of Discovery Systems

Installing A CD-ROM Drive



CD-ROM components for our internal installation consist of the Hitachi CDR-3600 CD-ROM drive and proprietary interface card with ribbon cable, CD disc caddy and diskette containing Microsoft disc extensions, drivers and other setup software.



First step in the installation, whether for internal or external drive, is to remove cover mounting screws from rear of PC system unit.

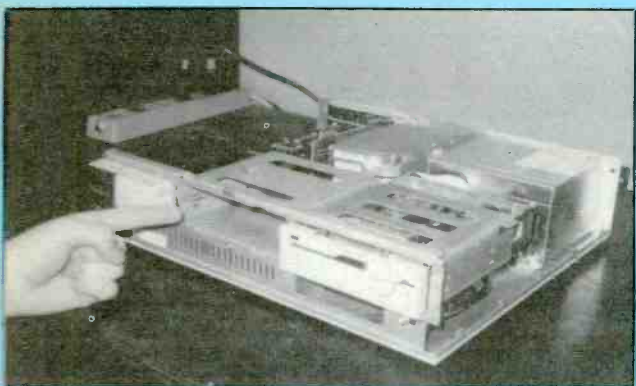

Mounting location for CD-ROM drive must permit access from front of system unit to permit insertion and removal of CDs. Powerful magnetic fields created at the bottom of the CD-ROM drive, obviate possibility of mounting CD unit above a hard drive. In this installation, a 40M hard drive is mounted at rear of system unit, where it is not influenced by CD-ROM drive's magnetic field.

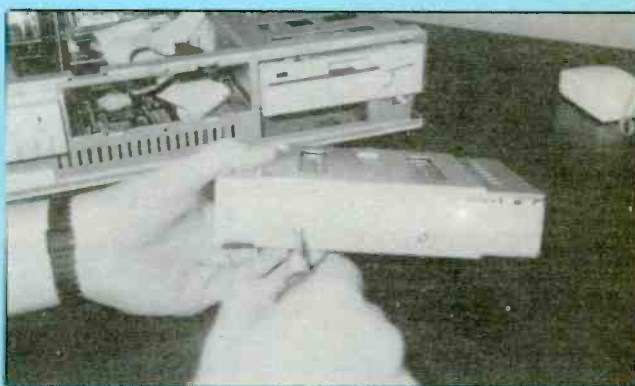

Secure CD-ROM drive in selected bay with two screws on each side. Some installations may require mounting rails on side of drive before it can be inserted into drive bay.

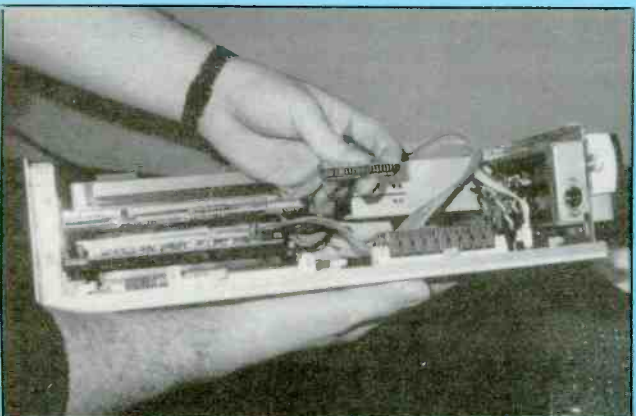

Plug interface card into any available eight-bit expansion slot on computer's motherboard (or backplane if applicable). Opposite end of 40-conductor ribbon connector attaches to pins on rear of CD-ROM drive. Make this connection and plug power cable into drive before securing drive in bay.

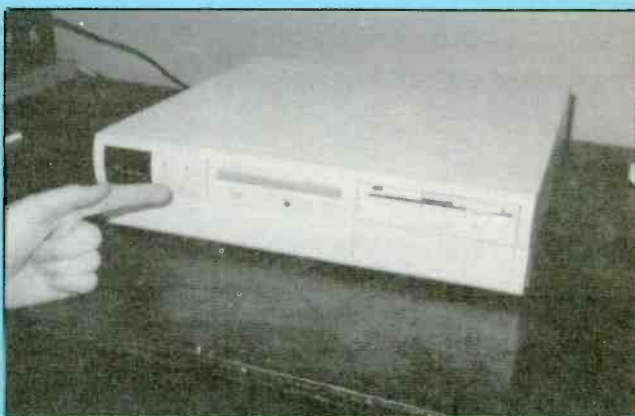

Completed installation shows CD-ROM drive mounted next to a 5 1/4" high-density floppy drive in this 286 PC.

It goes without saying that arrangement and spacing of the pits and lands must be quite exact. Due to microscopic sizes of the pits and lands, dust and other foreign particles can really wreak havoc in the overall scheme of things. Error correction, therefore, is essential.

Dual error correction techniques are used to provide a fail-safe mechanism of retrieving and/or restoring data. One technique involves mixing a redundant level of data with the original data, and scrambling it within a block so that logically-contiguous data isn't physically contiguous. The other method involves error-correction algorithms performed by the host computer from information provided on the ECC (error-correction coding) tracks on the disc itself. The result is a remarkably reliable system for retrieving data from the compact disc, which has a reconstructive rate failure of only 1 bit in a quadrillion!

Two standards dominate for encoding data on a CD-ROM: High Sierra standard and ISO-9660. In 1985, a group of pioneering CD-ROM industry representatives held a meeting at the High Sierra Hotel in Lake Tahoe, Nevada and agreed upon uniform encoding standards for reading from and writing to CD-ROM devices, hence the name for this standard. Shortly thereafter, the International Standards Organization launched an effort to adopt the High Sierra standards and, with some very minor modifications, made the revised standards the *de-facto* international standards for CD-ROM devices worldwide. This revision is now known as the ISO-9660 standard.

For all practical purposes, virtually every CD-ROM drive sold today can read both the High Sierra and ISO-9660 formats without any problem, provided Microsoft disc extensions version 2.0 or newer are used on the host computer. In short, unless you have a very old CD-ROM drive you shouldn't have any problem reading CD-ROM discs formatted to either one of these standards.

Choosing a Drive

Though price is almost certain to be a factor in your decision for selecting a CD-ROM drive, other things should

also be considered. CD-ROM drives can be internally mounted in the computer or housed in external units with their own cabinets and power supplies, with connection via a cable to the computer. Another important consideration is how the CD-ROM drive interfaces to the computer, which can be through a SCSI (Small Computer Systems Interface, or "scuzzy" for short) or a proprietary interface. Lastly, you must decide before buying whether you want a "single-play" CD-ROM drive (holds one CD at a time) or a "jukebox" that can access multiple CDs via a multi-load magazine. Let's take these items point by point:

•**Internal or External Drive.** The type of system unit enclosure your computer is built into and the availability of a "bay" that can be accessed from outside the system unit will determine whether or not you'll be able to use an internally-mounted CD-ROM drive. For internal mounting, you need a full-size, half-height bay to accommodate an internal drive, which is approximately the same physical size as a half-height 5¼" floppy or hard drive. Access to the drive from the front of the system unit is essential so you can insert CDs into and remove them from the drive.

Mounting location of the drive with regard to its closeness to floppy and/or hard drives should also be considered. For example, the Hitachi CDR-3600 CD-ROM drive in my computer has a warning label on the drive that cautions against mounting it atop a hard drive due to strong magnetic fields generated at the bottom of the CD-ROM drive. In this installation, the hard drive is mounted at the rear of the system unit and the CD-ROM drive is at the front and to the side of the 5¼" and 3½" floppy drives. Consequently, there's no magnetic interference.

Several technicians have assured me that the "magnetic field" warning is valid and that such a field will, indeed, wipe out any floppy disk that comes into contact with the bottom of the CD-ROM drive. They also conjectured that the CD-ROM drive's linear-drive motor would be highly likely to affect any hard drive mounted beneath it without proper shielding. The caveat is that you should definitely follow the manufacturer's

mounting instructions and heed any such advisories provided in the documentation with the CD-ROM drive.

Another important consideration to keep in mind when choosing an internal drive is whether or not your computer's power supply can handle the drive. You need a cable from the power supply to plug into the CD-ROM drive to supply it with juice. A power supply with a rating of at least 150 watts should be considered the minimum in a system that supports a hard disk, floppy drive and CD-ROM drive. Go with a 200-watt supply if you have anything more than this configuration, such as a second floppy drive or a second hard drive.

An external CD-ROM drive obtains power from a standard ac outlet via a power cord. So having a beefy power supply in your computer shouldn't be a concern. Since external CD-ROM drives are housed in their own separate enclosures, they also give greater flexibility in positioning them for optimal user comfort. The separate enclosure and power supply, of course, makes them a bit more expensive than comparable internally-mounted units. On the plus side, they don't take up space inside your computer, which may be needed for another floppy or hard drive or tape back-up unit.

•**Interface Card.** An interface card is required whether you choose an internal or an external CD-ROM drive. Consequently, you need at least one available expansion slot in your PC to accommodate the half-length card. The decision to go with a SCSI or proprietary interface is a personal one, since many manufacturers offer their drives interfaced either way. (For example, our project Hitachi CDR-3600 drive came with with a Hitachi proprietary interface. The Hitachi CDR-3650 is the exact same drive, except that it's configured for a SCSI interface.)

Proprietary interfaces are usually supplied bundled with the drive. SCSI interfaces are typically sold separately at additional cost (about \$100 to \$150). The SCSI interface allows "daisy-chaining" together as many as eight SCSI devices, which may be additional CD-ROM drives, high-capacity hard drives and anything else designed to interface via the SCSI device. All use the same sin-

A Host of Choices

When the time comes to select a specific CD-ROM drive to install in your computer system, you'll be faced with a wide range of choices. You'll have to make decisions based on strictly physical parameters (should you go internal or external; your choices here are dictated as described in the main article), technical details (specification figures to be compared) and how much you can spend on a drive and CD-ROM disc library. In most cases, all three considerations will have a bearing on the particular drive you select.

To help you in making your CD-ROM selection, we offer the following:

- *Internal or External.* See main text for guidance here.
- *Single-Play or Multiple-Play.* See main text for guidance here.
- *Price.* The cost of the CD-ROM drive you select will depend on a variety of factors. Among these are whether the drive is an internal unit or an external one, drive speed (see below), ability to play a single or multiple discs and other factors. As a general rule, external drives cost more than internal ones because they have their own separate enclosures and power supplies, and multiple-play drives are more expensive than single-play units.

Prices for CD-ROM drives currently range from just below \$500 and on up to a high of about \$1,500 and more. You might find lower prices from dealers, who may even bundle in with their drives some CD-ROM software.

- *Technical Details.* As with just about everything else electronic, your shopping decision will almost certainly be based on comparing specification numbers. The important ones to look for

when making such comparisons include average access time, maximum throughput and size of on-board buffer, if any. Average access times for CD-ROM drives are considerably greater than for those for magnetic disk drives, ranging from less than 300 to as much as 600 milliseconds. Faster drives generally cost more than slower ones. Maximum throughput runs from 150 to in excess of 176 kilobits per second and isn't generally an indication of price (some high-end drives actually run slower than lower-priced ones). The size of the buffer can be anywhere from zero to 64K, with popular capacities being 8K, 32K and 64K. As with caching hard-disk drives, the larger the buffer, the faster the apparent data-access time.

Among other technical details to be on the alert for is the type of adapter/controller used—SCSI or proprietary. The main text goes into this in detail. Also, be sure the drive supports version 2.2 of Microsoft's MS-DOS CD-ROM Extensions.

- *Other Considerations.* If you plan on mounting your CD-ROM drive vertically inside your system unit, make sure the one you select permits this; some don't. Almost all CD-ROM drives are compatible with DOS and Macintosh systems (the notable exception appears to be Hewlett-Packard's offering, which is a DOS-only drive). So this isn't really a consideration, unless you're planning to install your drive in an Apple Macintosh computer. Also check on whether or not the drive that interests you has CD audio capability (again, Hewlett-Packard's offering is fairly unique in this area by not providing this capability). You may not care to listen to audio CDs while you're working at

your computer, but you do need high-quality audio reproduction if you're using multimedia CD-ROM discs.

If you intend to use a CD-ROM drive for multimedia purposes, you'll be combining text, color graphics, hi-fi/stereo sound, both analog and digital, and animation. Highly important here is fast data transfer, large buffers and at least a 10-MHz 80286 PC. Furthermore, standards for multimedia are still in the churning stage, requiring video compatibility with such other standards as DVI (full-motion video) and synchronized sound.

In this respect, Kodak has introduced its Photo CD for writable CD-ROM. It's not expected to be available until next year, but Tandy has already announced that it will offer multimedia PCs compatible with it and a read-only CD-ROM drive for it that retails for \$400. It requires different software extensions, though, and operates with a special version of *Windows 3.0*. The company also offers multimedia upgrade kits. Interestingly, it doesn't use a caddy for the compact discs, unlike other CD-ROM drives.

As you comparison shop for a CD-ROM drive, don't be surprised—or intimidated—by the wide range of products available. This can be almost as mind-numbing an experience as shopping for a hard-disk drive. But if you use common sense and approach the task forearmed with the guidance given here and in the main article, you should have little difficulty obtaining a CD-ROM drive that suits your needs and budget. We can't promise that selecting CD-ROM software will be any less harrowing an experience than selecting software on magnetic disk, though.

gle interface card. In fairness, though, the Hitachi proprietary bus also permits daisy chaining up to eight Hitachi CD-ROM drives). The SCSI interface also provides a standard that's hardware-independent, allowing dealers to sell the same CD-ROM drive to a Macintosh owner (since the Mac has its own built-in SCSI port) or to a PC owner with a SCSI interface kit.

Performance differences between proprietary and SCSI models of the same drive are negligible (if any). In some cases, the proprietary interface actually performs better since it's a

custom-fit, rather than a universal, solution. Some external drives are available only as SCSI models; so take this into consideration also.

- *Single Play or Jukebox.* With more than 550 megabytes of storage capacity at your disposal, it seems almost incredulous that someone would want more. If you do, though, you may want to consider a "jukebox" CD-ROM drive instead of a single-disc unit. Several manufacturers now offer jukebox CD-ROM drives that hold two or more CDs simultaneously and allow selective access. Pioneer's DRM-600 Minichanger, for

example, can hold up to six CD-ROM discs in a magazine. For only a couple of hundred dollars more than some single-play CD-ROM drives (suggested retail price is \$1,295), it may be the way to go for power users and others who require access to multiple databases, if their budgets can handle it. This drive is certainly less expensive than adding CD-ROM drives via a daisy chain.

Access & Retrieval

To access and retrieve information from a CD-ROM drive, Microsoft's



Lycocomputer Marketing & Consultants

Since 1981



PRINTERS

Panasonic

| | |
|--------------|-----------|
| 1123 | \$224.95 |
| 1180 | \$149.95 |
| 1241 | \$294.95 |
| 1695 | \$409.95 |
| 1624 | \$369.95 |
| 4450i Laser | \$1225.95 |
| 4420 Laser | \$829.95 |
| 4455ps Laser | \$2024.95 |

Star

| | |
|---------------|-----------|
| NX-1001 | \$134.95* |
| NX-2420 | \$259.95 |
| NX-1020 Color | \$184.95 |
| NX-2420 Color | \$299.95 |
| NX-1500 | \$297.95 |
| NX-2410 | \$219.95 |
| NX-2415 | \$379.95* |
| XR-1500 | \$415.95 |
| XR-1000 | \$297.95 |
| XB-2410 | \$415.95 |
| XB-2415 | \$539.95 |

star NX-1001



- 180CPS draft
- 12cpi
- 45CPS NLQ
- 12cpi
- 4 resident fonts
- 2 year warranty

\$134.95*

Brother

| | |
|--------------------|-----------|
| M1309 | \$155.95 |
| M1324L | \$225.95* |
| M1809 | \$309.95 |
| M1824L | \$399.95 |
| M1909 | \$409.95 |
| M1924L | \$539.95 |
| M2518 | \$739.95 |
| M4018 | \$1075.95 |
| HL8ps(Post Script) | \$2259.95 |
| HL8v | \$1499 |
| HL4 Laser | \$895.95 |
| HL4PS Laser | \$1689.95 |

Citizen

| | |
|-----------------|----------|
| 120 D | \$139.95 |
| 120 D Serial | \$159.95 |
| 200GX | \$159.95 |
| 200GX Color | \$199.95 |
| GSX-140 | \$286.95 |
| GSX-140 (COLOR) | \$327.95 |
| GSX-145 | \$395.95 |
| HSP-500 | \$319.95 |
| HSP-550 | \$449.95 |

Okidata

| | |
|--------------|-----------|
| 172 | \$185.95 |
| 182 Turbo | \$219.95 |
| 320 | \$317.95 |
| 321 | \$445.95 |
| 390 Plus | \$445.95 |
| 391 Plus | \$595.95 |
| 393 Plus | \$948.95 |
| 393C (color) | \$1015.95 |
| Laser 400 | \$629.95 |
| Laser 800 | \$942.95 |
| Laser 820 | \$1239.95 |
| Laser 840 | \$1885.95 |

Epson

| | |
|---------|----------|
| LX-810 | \$184.95 |
| LO-510 | \$279.95 |
| FX-850 | \$309.95 |
| FX-1050 | \$429.95 |
| LO-850 | \$469.95 |
| LO-1010 | \$399.95 |
| LO-1050 | \$629.95 |
| LO-2550 | \$899.95 |

*QUANTITIES LIMITED

Why shop at Lycocomputer? Lycocomputer offers quality name brand computer products at prices 30% to 50% below retail. If you do not see the product you want advertised, call Lycocomputer toll free. How do I know I will get the product I need? Our marketing staff receives continuous formal training by our manufacturers. Through our strict guarantee on providing only new merchandise prohibits free trial periods and a guarantee on compatibility, a wealth of knowledge is available to our customers. As thousands of people every week capitalize on our savings and services, we hope you too, will make Lycocomputer your first choice. What about warranty or service? Our Customer Service Department is available at (717) 494-1670 to assist you. We back all of our manufacturer's stated warranty terms. Before returning any item that appears to be defective, we ask that you call our Customer Service Department. Will you rush an item to me? We offer next day air, two day air, standard UPS, and postal international shipping services. Temporary shortages are normally filled within 10 days. How do I order? We have always offered C.O.D. orders through UPS. Prepaid cash orders over \$50 are shipped freight-free in the continental U.S. Simply send your order to Lycocomputer, P.O. Box 5088, Jersey Shore, PA, 17740. For orders under \$50, please add \$3 for freight. Personal and company checks require a 4 week clearing period. Visa, MasterCard, American Express and Discover Card orders are accepted for your convenience. Purchase orders are accepted from Educational Institutions. We charge sales tax on deliveries in Pennsylvania. For APO, FPO, and international orders except IBM add \$5 plus 3% for priority mail. Advertised prices and availability are subject to change. Return restrictions apply. Not responsible for typographical errors.

HARD DRIVES

By SEAGATE

| MODEL | SIZE | SPEED | TYPE | PRICE |
|----------------------------|--------|---------|-------|-----------|
| 3 1/2" Half Height | | | | |
| ST 1120A | 10 MEG | 18 MSEC | MMFM | \$159.95 |
| ST 1120B | 10 MEG | 18 MSEC | MMFL | \$184.95 |
| ST 1120C | 10 MEG | 18 MSEC | DE AT | \$309.95 |
| ST 1144A | 10 MEG | 18 MSEC | DE AT | \$409.95 |
| ST 1144B | 10 MEG | 18 MSEC | DE AT | \$579.95 |
| ST 1144C | 10 MEG | 18 MSEC | DE AT | \$675.95 |
| ST 1144D | 10 MEG | 18 MSEC | DE AT | \$649.95 |
| ST 1144E | 10 MEG | 18 MSEC | DE AT | \$219.95 |
| ST 1144F | 10 MEG | 18 MSEC | DE AT | \$225.95 |
| ST 1144G | 10 MEG | 18 MSEC | DE AT | \$241.95 |
| ST 1144H | 10 MEG | 18 MSEC | DE AT | \$235.95 |
| ST 1144I | 10 MEG | 18 MSEC | DE AT | \$339.95 |
| ST 1144J | 10 MEG | 18 MSEC | DE AT | \$591.95 |
| ST 1144K | 10 MEG | 18 MSEC | DE AT | \$659.95 |
| ST 1144L | 10 MEG | 18 MSEC | DE AT | \$704.95 |
| ST 1144M | 10 MEG | 18 MSEC | DE AT | \$213.95 |
| ST 1144N | 10 MEG | 18 MSEC | DE AT | \$247.95 |
| ST 1144P | 10 MEG | 18 MSEC | DE AT | \$260.95 |
| 5 1/4" Half Heights | | | | |
| ST 1225 | 10 MEG | 18 MSEC | MMFM | \$177.95 |
| ST 2511 | 4 MEG | 18 MSEC | MMFM | \$233.95 |
| ST 238R | 10 MEG | 18 MSEC | RL | \$184.95 |
| ST 2778 V | 10 MEG | 18 MSEC | RL | \$252.95 |
| ST 225 RP | 20 MEG | 18 MSEC | RL | \$195.95 |
| ST 238 RP | 20 MEG | 18 MSEC | RL | \$219.95 |
| ST 255 RP | 20 MEG | 18 MSEC | RL | \$229.95 |
| ST 288R | 20 MEG | 18 MSEC | RL | \$289.95 |
| ST 2120N | 10 MEG | 18 MSEC | SCSI | \$819.95 |
| ST 2120E | 10 MEG | 18 MSEC | SCSI | \$559.95 |
| ST 238 E | 10 MEG | 18 MSEC | END | \$1226.95 |
| ST 1120 A | 10 MEG | 18 MSEC | DE AT | \$269.95 |
| ST 1120 B | 10 MEG | 18 MSEC | DE AT | \$1198.95 |
| 5 1/4" Full Heights | | | | |
| ST 1120A | 10 MEG | 18 MSEC | MMFM | \$499.95 |
| ST 1120B | 10 MEG | 18 MSEC | RL | \$585.95 |
| ST 1120C | 10 MEG | 18 MSEC | END | \$769.95 |
| ST 1120D | 10 MEG | 18 MSEC | END | \$1289.95 |
| ST 1120E | 10 MEG | 18 MSEC | END | \$1459.95 |
| ST 1120F | 10 MEG | 18 MSEC | SCSI | \$1423.95 |
| ST 1120G | 10 MEG | 18 MSEC | END | \$1449.95 |
| ST 1120H | 10 MEG | 18 MSEC | END | \$2199.95 |

Price includes Seagate Controller Card

Seagate
89 Meg Drive
ST-1102A
AT/IDE 19msec
\$309.95

FLOPPY DRIVES

By CHINON

| | |
|--------------------------------------|----------|
| FZ-502 5 1/4" 360K PC/XT Compatible | \$57.95 |
| FZ-506 5 1/4" 1.2MB PC/AT Compatible | \$65.95 |
| FZ-354 3.5" 720K PC/XT Compatible | \$56.95* |
| FZ-357 3.5" 1.44MB PC/AT Compatible | \$62.95* |

By TOSHIBA

Toshiba disk drives offer you the latest in VLSI technology & low power consumption.

| | |
|---------------------------------|----------|
| 5 1/4" 360 KB PC/XT Compatible | \$59.95 |
| 5 1/4" 1.2 MB PC/AT Compatible | \$69.95 |
| 3 1/2" 1.44 MB PC/AT Compatible | \$67.95* |

* Standard Installation Kit Included.

MONITORS

Magnavox

| | |
|--------------------|----------|
| 7BM749 VGA Mono | \$129.95 |
| 1CM135 RGB Analog | \$244.95 |
| CM9032 VGA 640x480 | \$229.95 |
| 9CM062 VGA 720x480 | \$267.95 |
| 9CM082 VGA | \$305.95 |
| 6CM320 Super VGA | \$349.95 |
| 7CM320 Super VGA | \$349.95 |

GoldStar

| | |
|----------------------------|----------|
| 2105 A Composite | \$74.95 |
| 1210A TTL Amber | \$79.95 |
| 1401A 14" Amber TTL | \$109.95 |
| 1220W VGA Mono | \$99.95 |
| 1405 Plus Paper White | \$145.95 |
| 1423 Plus VGA | \$206.95 |
| 1425 Plus VGA 39DP | \$262.95 |
| 1430 Plus VGA 31DP | \$289.95 |
| 1450 Plus VGA 800x600 | \$299.95 |
| 1460 Plus VGA 1024x768 | \$324.95 |
| 1610 Plus VGA 16" 1024x768 | \$689.95 |
| 1440 Superscan | SCALL |

NEC

| | |
|---------------------------|-----------|
| MultiSync GS-2A White VGA | \$202.95 |
| MultiSync 2A VGA | \$449.95 |
| MultiSync 3DS VGA | \$585.95 |
| MultiSync 4D VGA | \$979.95 |
| MultiSync 5D VGA | \$2239.95 |

Panasonic

| | |
|---------------------------|----------|
| C1381 Panavsync Multimode | \$379.95 |
|---------------------------|----------|

GoldStar 1460 +



- VGA
- 14" display
- 1024x768
- 16x256 colors

\$324.95

Everex Video Cards

| | |
|--------------------|----------|
| Evergraphic | \$139.95 |
| Viewpoint VGA | \$139.95 |
| Viewpoint VGA 512K | \$175.95 |

Cardinal Video Cards

| | |
|----------------------|----------|
| Cardinal VGA 402K | \$89.95 |
| Cardinal 700 512K | \$114.95 |
| Cardinal 700 1MB | \$149.95 |
| Cardinal VGA 732 1MB | \$168.95 |

MODEMS

Cardinal Modems

| | |
|-------------------------|----------|
| MB2400EX EXT | \$94.95 |
| 2400 MNP EXT. MNP 5 | \$154.95 |
| 2450 MNP Int. MNP 5 | \$115.95 |
| MB2450 INT | \$72.95 |
| MB1200EX EXT | SCALL |
| MB1250 INT | SCALL |
| MB2296F 9600 bd SendFax | \$89.95 |
| 9650 V32 Int. | \$449.95 |

Everex Modems

| | |
|--------------------------|----------|
| Evercom 12 (INT) | \$49.95 |
| Evercom 24 (INT) | \$104.95 |
| Evercom 24 + MNP (INT) | \$139.95 |
| Evercom 24E + MNP (EXT) | \$189.95 |
| Everfax 24/96 MNP (INT) | \$245.95 |
| Everfax 24/96e MNP (EXT) | \$299.95 |

COMPONENTS

Build your own computer clone with components manufactured by OTK computer.

You Specify

- *System Memory
- *Drive Configuration
- *Video Card
- *Add-on Cards
- *Keyboard

Base Systems include:

Motherboard, Case, & Power Supply

| | |
|----------------------------------|-----------|
| 8088 4 77 10MHz System | \$129.95 |
| 80286 8 12MHz System | \$235.95 |
| 80286 16MHz System | \$259.95 |
| 80386SX 16MHz | \$469.95 |
| 80386SX 20MHz | \$559.95 |
| 80386 10 25MHz | \$699.95 |
| 80386 10 33MHz Tower W/64K Cache | \$999.95 |
| 486 25MHz W/64K Cache | \$1589.95 |

Base models have 0 memory

Memory - Installed memory prices available upon request. Call for details.

More C-Card

| | |
|----------------------------|---------|
| Advance VGA 16 bit 800x600 | \$19.95 |
| Advance VGA 16 bit 800x600 | \$85.95 |

Add-On Cards

| | |
|---------------------------|---------|
| XT Multi I/O | \$37.95 |
| 286 Multi I/O | \$47.95 |
| Parallel Printer Port | \$11.95 |
| RS-232 Port | \$14.95 |
| Game I/O | \$14.95 |
| Clock Calendar | \$17.95 |
| Floppy Controller | \$24.95 |
| IDE Floppy Controller 286 | \$27.95 |

Customized Hardware Service Available.
386, SX, 486 are trademarks of Intel Corporation

TAPE BACK-UPS

By EVEREX

INTERNAL

| | |
|-----------------------------------|-----------|
| Excel-60F 60 MB | \$199.95* |
| Excel-40 T 40 MB PC/XT/AT | \$529.95 |
| Excel-60 60 MB half height 5 1/4" | \$669.95 |
| Excel 250 250 MB | \$764.95 |

*Uses system's floppy controller. Not included.

EXTERNAL

| | |
|-----------------------------------|----------|
| Excel-40T 40 MB 5MB/min | \$599.95 |
| Excel-60 60MB Full Height 5MB/min | \$799.95 |
| Excel 250 250 MB | \$889.95 |

All tape back-up systems include controller, software and data cartridge

EVEREX Excel 60F 60MB (Internal)



\$199.95*

LAPTOPS

Bondwell

| | |
|----------------|-----------|
| Bondwell 310 + | \$1225.95 |
|----------------|-----------|

Leading Edge

| | |
|-----------------|-----------|
| Leading Edge SX | \$1869.95 |
|-----------------|-----------|

Panasonic

| | |
|---------|-------|
| CF 150B | SCALL |
| CF 270 | SCALL |

Full Toshiba Line Available Call for Models and Prices.



Sales: 1-800-233-8760 or 717-494-1030
Fax: 717-494-1441
Hours: Mon-Fri. 9a.m.-5p.m.
Sat. 10a.m.-6p.m.
Customer Service: 717-494-1670
Hours: Mon-Fri. 9a.m.-5p.m.

1-800-233-8760

CIRCLE NO. 166 ON FREE INFORMATION CARD

Disc Extensions (MSCDEX.EXE) and appropriate device drivers must be written into your computer's configuration file. The required software, extensions and drivers are provided with the installation disk that comes with the CD-ROM drive. Once installed, they require no additional attention.

Extensions and drivers allow the host computer to address and access the CD-ROM drive. They assign a logical identifier to the CD-ROM drive, such as device "D" or "E." They also permit you to log onto the drive as if it were a floppy or hard drive, list the directory, change sub-directories, copy files from it and perform other routine tasks.

Due to the enormous file and directory capacity of a CD-ROM disc, however, you'll soon discover that the usual file utilities like *X-Tree*, *Still River Shell* and others fall woefully short of being able to handle such a large file volume. For this reason, most CD-ROMs come with their own file cataloging and retrieval utilities, either on the CD itself or on an accompanying floppy disk you use for installing the software.

There's also a very useful utility called CHKCD.EXE that performs equivalent functions of the DOS CHKDSK command, but it's on the disc in the CD-ROM drive instead. CHKCD also identifies the media format, volume ID and other pertinent information. An actual screen dump of the CHKCD utility with the *Compton's Multimedia Encyclopedia* in the CD-ROM drive is shown in Fig. 1. Note the 400-plus megabytes of information on the disc, and there's still room on the disk to spare!

Installing the Drive

Installing a CD-ROM drive is a fairly straightforward process for both internal and external units. All you need in the way of tools are a couple of screwdrivers (Phillips and/or flat-blade) and a clean, well-lit area in which to work. The equipment you need includes the CD-ROM drive and its mounting hardware, an interface card and connecting cable, the installation instructions, a disc caddy, a software diskette with the MSCDEX extensions/device drivers and a CD-ROM disc to check out the

```
C:\CDSYS >CHKCD E:

CHKCD version 1.00
Copyright (C) 1989, Trantor Systems, Ltd.

HSC (High Sierra Group) standard media.

          Volume ID: COMPTONS110
          Creation date: 02-19-1990

          417611276 bytes total disk space
            27648 bytes in 2 directories
          417583628 bytes in 201 user files

          655360 bytes total memory
            527008 bytes free

C:\CDSYS >
```

Fig. 1. An actual screen dump of the CHKCD utility with the "Compton's Multimedia Encyclopedia" in the CD-ROM drive.

system. (At least one CD-ROM will come with the drive, usually a "sampler"/test disc.)

Installation is as follows:

(1) Turn off your computer and unplug its video monitor, printer, keyboard and any other peripherals that are attached to it so that the system unit cover can be removed without encumbrances. Remove the screws that retain the cover from the back of the system unit. Then lift off the cover to expose the internal components of the PC.

(2) Examine the interior of your computer to determine where you will install the CD-ROM drive if it's

an internal. Remember, you need a half-height drive bay that's accessible from the front of the PC (adhere to any precautions about mounting over a hard drive, referring to the manufacturer's instructions for suggested mounting location details for your particular drive).

(3) Most CD-ROM drives permit the connection of more than one unit. For these, DIP switches are provided for identifying each CD-ROM drive to the host computer. Refer to the instructions provided with your CD-ROM drive for setting the DIP switches. These switches are usually located on the back of the CD-ROM

```
AUTOEXEC.BAT contents:

@ECHO OFF
PROMPT $p $g
set CDPATH=C:\BKSHLF;E:\SOFTWARE;E:\BOOK
set CDRAM=
C:\CDSYS\MSCDEX /D:MSCD001 /M:8
PATH
C:\;C:\DOS;C:\286_CD;C:\PCTOOLS;C:\GDR;%PATH%
MOUSE

CONFIG.SYS contents:

LASTDRIVE=Z
BREAK=ON
BUFFERS=30
FILES=41
DEVICE=C:\HIMEM.SYS
DEVICE=C:\DOS\ANSI.SYS
SHELL=C:\COMMAND.COM /E:256 /P
DEVICE=C:\CDSYS\HITACHIA.SYS /D:MSCD001

/U:1 /M:
```

Fig. 2. This typical configuration shows how the AUTOEXEC.BAT and CONFIG.SYS file contents are altered during software installation of the CD-ROM drive used for this project.

Drive Choices And Connection Details

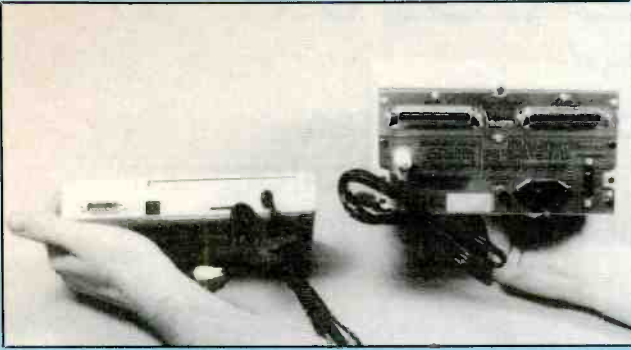

Philips CM50 External CD-ROM Drive (left) has proprietary interface, while Pioneer DRM-600 External "jukebox" drive (right) uses a SCSI interface.

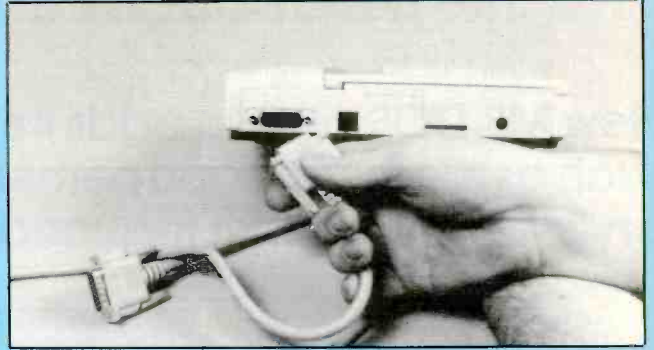

Rear view of Philips unit shows interface jack and cable that connects it to the host PC. Low-cost unit uses a 15-pin "D" connectors at drive and interface card ends but cannot be daisychained like other units.

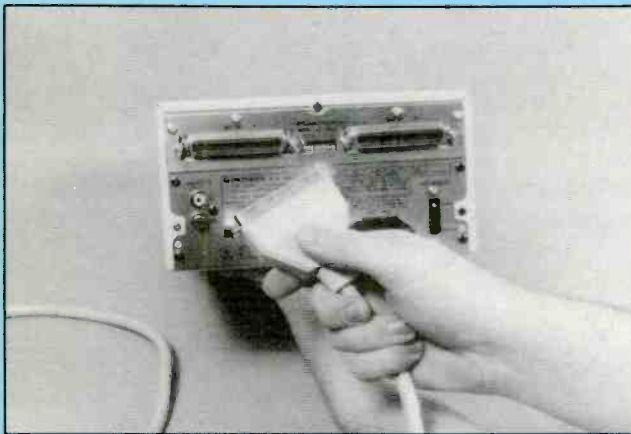

Rear view of Pioneer DRM-600 multi-disc drive shows dual SCSI ports. Interface cable has 25-pin "D" connector at computer end and 50-pin Amphenol connector at the drive end. Cable connects to left SCSI port on drive; right port is used to daisychain additional drives or other SCSI devices.

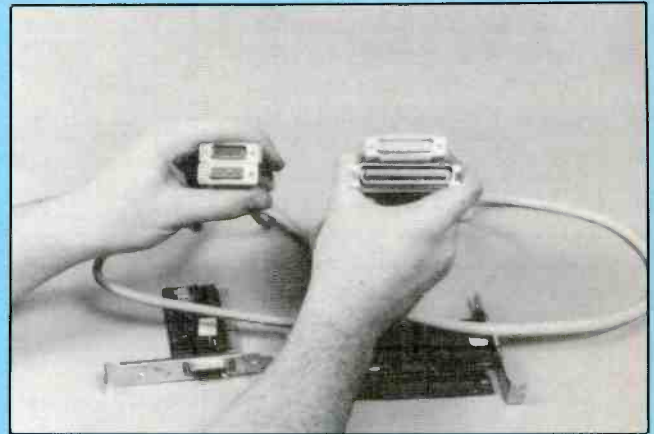

Comparison view of cable ends for both types of external CD-ROM drives shows Pioneer cable at left, Philips cable at right.

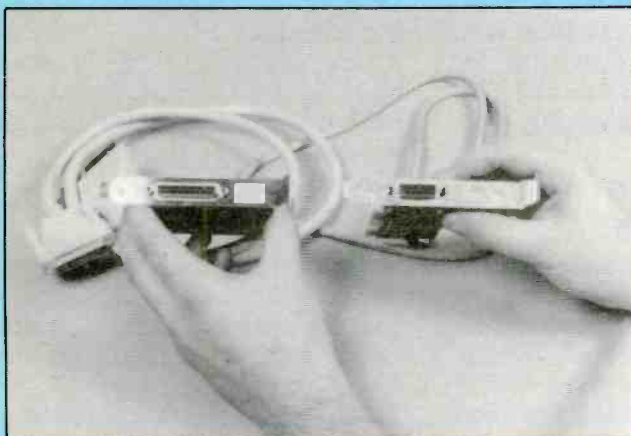

Side views of cable ports on Pioneer SCSI interface card (left) and the Philips proprietary interface card (right).

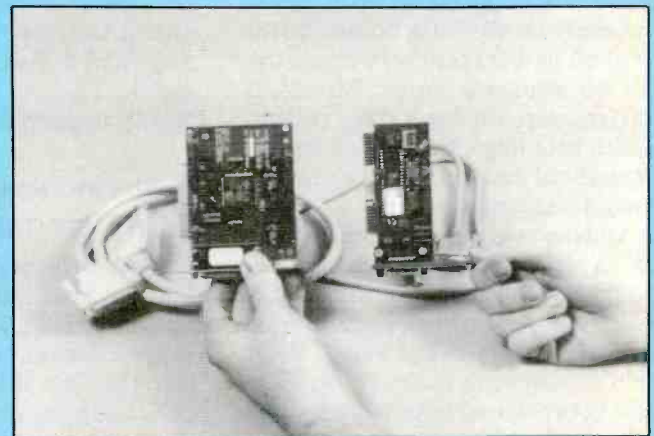

SCSI interface card (left) made by Future Domain and supplied with Pioneer DRM-600 drive is larger and more densely populated than the Philips proprietary CD-ROM interface card. Both cards have jumpers for changing configuration interrupt I/O addresses to resolve conflicts with other peripherals on host PC systems.

Photos this page by Joe Abatto/The Photography Place

(Continued on page 84)

Microsoft's MS-DOS 5.0

New MS-DOS version adds important features, such as memory management, full-screen editor, on-line Help—all with reduced memory requirements

If the latest version of Microsoft's operating system doesn't render overnight obsolescence to all that has gone before, it won't be because Bill Gates and Company haven't been doing their homework. Their earlier offering, MS-DOS 4.0, did not exactly take the IBM-compatible world by storm. In fact, many users never did get around to trading up from whatever DOS 3 version they had been using. And with OS/2 and Digital Research's DR DOS 5.0 now nibbling away at the market pie, there was no reason to think that a Microsoft 5.0 would do any better than its predecessor, unless it could offer the customer lots of new features.

To make sure the company got it right this time, Microsoft redefined the term "Beta Test." More than 7,000 pre-release copies went out the door to trusted reviewers sworn to keep their collective mouths shut until after the product was publicly released. The company set up an extensive electronic bulletin board and invited all its beta testers to come on-line to compare notes. Microsoft staffers were on hand daily to help squish beta bugs, to give and receive suggestions and to clarify the preliminary documentation.

And then about a year ago, rumors began circulating that MS-DOS 5.0 would make its official debut at a major computer show, the Fall 1990 COMDEX show in Las Vegas. But it didn't quite work out that way. The beta network had been working well—in fact, perhaps *too* well. It was clear that a little more development time was needed; so the debut was put off for a few months . . . and later on for a few months more. As an indirect result, some announcements carefully timed for COMDEX release appeared to have jumped the

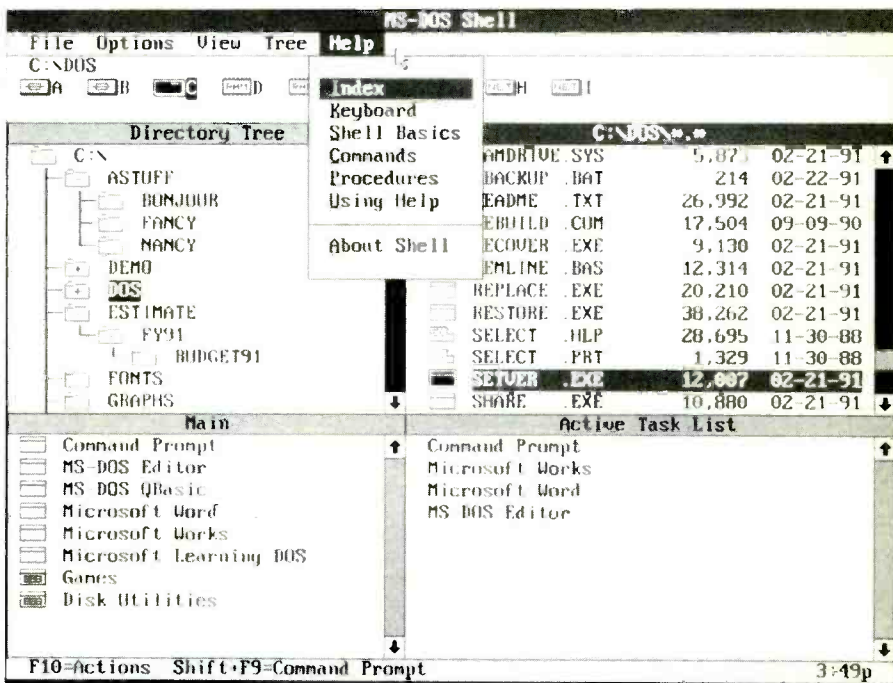

gun, and the public went off in search of a product that did not yet exist. But at last, on June 11 of this year, MS-DOS 5.0 was presented to that public. This new DOS is available for \$99.95 in upgradeable version.

New and Revised DOS Commands

Despite all the sophisticated bells and whistles built into the operating system itself, DOS 5.0 installation is far simpler than its predecessors. Just insert the first diskette, type SETUP and follow the very clear instructions that appear on-screen. During installation, your old DOS (if any) is saved in an OLDDOS subdirectory, and if you should ever have second thoughts about DOS 5.0, an included Uninstall utility will restore your previous version. Once you're confident that this won't be necessary, another util-

ity (DELOLDOS) gets rid of the old DOS for you, thus freeing that space for other use.

Once you've got DOS 5.0 up and running, here's an alphabetical overview of some of those new bells and whistles:

- **The Attribute Command.** The ATTRIB command now permits any file attribute to be changed, which formerly required the services of the *Norton Utilities* (or similar). If you're wondering what hidden files lurk in a directory, simply log onto that directory and type ATTRIB. You'll see a list of every file in the directory, along with the status of its file attributes. To change the status of any attribute, simply type ATTRIB again, followed by the appropriate parameter and the file name. Thus, ATTRIB -S -H *.SYS unhides all hidden system files (for example, IO.SYS and MSDOS.SYS).

B. G. MICRO

P. O. Box 280298 Dallas, Texas 75228

(214) 271-5546

FAX (214) 271-2462



FAN

Brand New from McLean Eng.
A Division of Zero Corp.
Square 4-11/16" by 1.5"
Thick 10" Wire Leads
120V - 60hz - .12 amps - 110CFM
Metal Housing - 5 Plastic Blades
UL and CSA Approved
\$5.95 ea.

BATTERY

Brand New - '91 Date Code
Rechargeable Sealed Battery
6 Volts @ 4 Amp/h
Measures: 4" Tall - 2-3/4" Wide
1-3/4" Thick - A Steal at
\$6.95 ea. or 4 for \$25.50

DISPLAY DEVICES

4MT07 By Futaba
Vacuum Fluorescent Clock
And Timer - 4 Digit Display
Easy to Read - Easy to Use.
.3" Character Height
With Data 79c

LPT 1157AE
1.2" 5x7 Matrix Displays
5x7 Array with x,y select.
This Red Orange Matrix Can Be
Stacked Horizontally. Choice of
Two Matrix Orientation-Cathode
Column, Anode Row. Great For
"Moving Message" Signs.
\$1.19 Ea., 8/\$6.95, 100/\$75.00

74LS

| | | |
|-----------|---------------|------------|
| LS00 .14 | LS122 .35 | LS241 .60 |
| LS02 .14 | LS123 .45 | LS242 .65 |
| LS03 .14 | LS125 .30 | LS243 .50 |
| LS04 .14 | LS126 .35 | LS244 .55 |
| LS05 .14 | LS132 .35 | LS245 .55 |
| LS08 .14 | LS133 .25 | LS251 .45 |
| LS09 .14 | LS138 .35 | LS253 .40 |
| LS10 .14 | LS139 .35 | LS257 .35 |
| LS11 .14 | LS145 .75 | LS258 .45 |
| LS12 .20 | LS148 .35 | LS259 1.00 |
| LS13 .25 | LS151 .35 | LS260 .40 |
| LS14 .30 | LS153 .35 | LS266 .30 |
| LS15 .20 | LS154 .85 | LS273 .75 |
| LS20 .14 | LS155 .50 | LS279 .30 |
| LS21 .16 | LS156 .42 | LS280 .80 |
| LS26 .14 | LS157 .30 | LS283 .35 |
| LS27 .20 | LS158 .25 | LS290 .70 |
| LS28 .15 | LS160 .25 | LS298 .65 |
| LS30 .14 | LS161 .35 | LS323 2.25 |
| LS32 .16 | LS162 .45 | LS353 1.00 |
| LS33 .25 | LS163 .36 | LS357 .80 |
| LS37 .24 | LS164 .45 | LS363 .75 |
| LS38 .24 | LS165 .60 | LS365 .30 |
| LS42 .35 | LS166 .75 | LS367 .35 |
| LS51 .15 | LS169 .90 | LS368 .30 |
| LS54 .20 | LS173 .60 | LS373 .50 |
| LS55 .20 | LS174 .35 | LS374 .45 |
| LS74 .22 | LS175 .35 | LS375 .35 |
| LS75 .25 | LS181 1.25 | LS377 .75 |
| LS83 .30 | LS191 .45 | LS378 .80 |
| LS85 .45 | LS192 .65 | LS390 .80 |
| LS86 .20 | LS193 .65 | LS393 .75 |
| LS90 .35 | LS194 .40 | LS399 1.00 |
| LS92 .30 | LS195 .52 | LS541 1.20 |
| LS95 .30 | LS196 .55 | LS645 .75 |
| LS107 .28 | LS197 .75 | LS646 .75 |
| LS109 .20 | LS221 .50 | LS670 .80 |
| LS112 .25 | LS240 .50 | |
| LS113 .25 | 26LS32 .75 | |
| LS114 .25 | 25LS2569 1.50 | |

THE \$25 NETWORK

Try The 1st Truly Low Cost LAN

- Connect 2 or 3 PCs, XTs, ATs
- Uses serial ports and 5 wire cable
- Runs at 115 K baud
- Runs in background, totally transparent
- Share any device, any file, any time
- Needs only 14K of ram

Skeptical: We make believers!

SUPER BUYS

2016 P-15
2K x 8 N-MOS
Trimmed Leads,
But will Fit in Sockets.
Super Buy
10/2.95 105/22.00

2N4401
Super 2N3904 NPN
Switching Transistor
40V-TO-92 — P.C. Leads
15/1.00 1000/20.00

80C32
C-MOSS By Matra
12MHZ
3.95

| | |
|------------------|------|
| LM350T | 2.65 |
| LM338K | 4.95 |
| 16L8-15 TI-B-PAL | 1.25 |
| 8088-2 | 3.25 |
| 8742 | 7.00 |

CLOCK CIRCUITS

| | |
|---------|------|
| SAF3019 | 2.50 |
| 58321 | 2.50 |
| 146818 | 3.50 |

SOCKETS

| | |
|-------------------------|---------|
| Low Profile SOLDER TAIL | |
| 6 Pin | 14/1.00 |
| 8 Pin | 13/1.00 |
| 14 Pin | 13/1.00 |
| 16 Pin | 13/1.00 |
| 18 Pin | 13/1.00 |
| 20 Pin | 13/1.00 |
| 22 Pin | 13/1.00 |
| 24 Pin | 8/1.00 |
| 28 Pin | 7/1.00 |
| 40 Pin | 7/1.00 |

BUY \$10
GET \$1.00 - FREE CHOICE

6500/6800

| | | | |
|--------|------|---------|------|
| 6502 | 2.00 | 6821 | 1.00 |
| 6520 | 1.25 | 6845P | 2.20 |
| 6522 | 2.70 | 6845S | 2.20 |
| 6530 | 3.00 | 6850 | 1.75 |
| 6532 | 4.25 | 6852 | 3.50 |
| 6545 | 2.10 | 6860 | 3.95 |
| 6551 | 2.40 | 68681 | 3.00 |
| 6800 | 1.40 | 68A09EP | 1.29 |
| 6802 | 2.50 | 68A40 | 4.00 |
| 6803 | 3.00 | 68A54 | 3.00 |
| 6805 | 2.95 | 68B09 | 4.00 |
| 6809EP | 2.75 | 68B10 | 2.00 |
| 6809P | 2.50 | 68B45 | 4.95 |
| 6810 | 1.25 | 68B54 | 4.00 |

TEXT TO SPEECH BOARD

PC/XT COMPATIBLE. MAKE YOUR COMPUTER TALK!

PRICE CUT \$69.95

ASSEMBLED & TESTED
ADD \$3.50 SHIPPING
& HANDLING

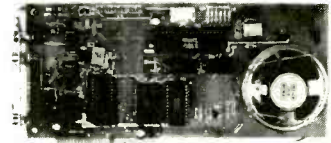

A VERY POWERFUL AND AMAZING SPEECH CARD. USES THE GENERAL INSTRUMENTS SPO256-AL2 SPEECH CHIP AND THE CTS256A-AL2 TEXT TO SPEECH CONVERTER.

THIS BOARD USES ONE SLOT ON THE MOTHERBOARD AND REQUIRES A COM SERIAL PORT. BOARD MAY ALSO BE USED IN A STAND ALONE ENVIRONMENT (EXTERNAL POWER SUPPLY) WITH ALMOST ANY COMPUTER THAT HAS A RS232 SERIAL PORT. TO USE THE BOARD IT IS ONLY NECESSARY TO SEND ENGLISH TEXT TO THE RS232 INPUT ON THE BOARD. THE BOARD INCLUDES A 1500 BYTE TEXT BUFFER AND HANDSHAKE LINE TO ALLOW YOU TO SEND DATA TO THE BOARD; THE SAME AS YOU WOULD SEND DATA TO AN RS232 SERIAL PRINTER. YOU CAN SET UP BATCH FILES THAT WILL MAKE YOUR COMPUTER GREET YOU WITH "GOOD MORNING MASTER," ETC. EVERY TIME YOU TURN IT ON. DEMONSTRATION SOFTWARE AND A LIBRARY BUILDING PROGRAM ARE INCLUDED ON A 5 1/4 INCH PC/XT DISKETTE. FULL DOCUMENTATION AND SCHEMATICS ARE ALSO INCLUDED.

FOR INFORMATION ON A LOW COST SPEECH SYNTHESIZER SYSTEM FOR THE VISUALLY IMPAIRED, PLEASE SEND FOR FREE PACKET T.M.1.

STAND ALONE POWER SUPPLY
FOR ABOVE
ADD \$2.50 SHIPPING & HANDLING

\$19.99

STATIC RAM

| | |
|-------------------------|------|
| 2016-2KX8 200 n.s. | 1.00 |
| 2101-1 - 256X4 500 n.s. | .75 |
| 21L02-1 350 n.s. | .65 |
| 2102AL-4 L.P. 450 n.s. | .49 |
| 2111-1 256X4 500 n.s. | 1.00 |
| 2112A-2 | 2.50 |
| 2114L-3 1KX4 300 n.s. | .45 |
| 2125A-2 1KX1 70 n.s. | 1.70 |
| 2147 4KX1 | 1.95 |
| 6116P-4 | 1.20 |
| 6117 | 1.20 |
| 6264-15 | 1.40 |
| 62256 32KX8 | 6.50 |

EPROM SPECIAL

We bought a large quantity of 2708s, 2716s, 2532s, 2732s, 2764s, 27128s, 27512s and 27256s from a computer manufacturer who redesigned their boards. We removed them from sockets, erased and verified them, and now we offer the savings to you. Complete satisfaction guaranteed.

| | |
|-------------|---------------|
| Your Choice | |
| 2708 | 1.20 10/ 8.00 |
| 2716 | 1.75 10/15.00 |
| 2532 | 2.00 10/17.50 |
| 2732 | 2.00 10/17.50 |
| 2764 | 2.25 10/20.00 |
| 27128 | 3.20 10/27.50 |
| 27256 | 3.85 10/32.50 |
| 27512 | 5.50 10/48.50 |

DYNAMIC RAM

| | |
|------------------------|------|
| 2108-4 8KX1 | 1.50 |
| 2118-4 16KX1-5Volt | .70 |
| 4027-4KX1-250 n.s. | .80 |
| 4116-16KX1-250 n.s. | .40 |
| 4116-16KX1-200 n.s. | .75 |
| 4116-16KX1-150 n.s. | .90 |
| 4164-64K 200 n.s. | .80 |
| 4164-150 n.s. | 1.00 |
| 4164-120 n.s. | 1.30 |
| 4164-100 n.s. | 1.60 |
| TMS4416-16KX4-150 n.s. | 2.75 |
| 4464-150 n.s. | 1.75 |
| 4464-120 n.s. | 1.90 |
| 4464-100 n.s. | 2.10 |
| 4464-80 n.s. | 2.25 |
| 41256-150 n.s. | 1.50 |
| 41256-120 n.s. | 1.60 |
| 41256-100 n.s. | 1.65 |
| 41256-80 n.s. | 1.75 |
| 41256-60 n.s. | 2.55 |
| 1 Meg - 100 n.s. | 5.25 |
| 1 Meg - 80 n.s. | 5.40 |
| 44256-80 n.s. 256 x 4 | 5.75 |

THREE CHIP SET

16450, 1488, 1489

B.G. SPECIAL

\$6.95

8000/80000

| | | | |
|---------|--------|--------------|--------|
| 8031 | 2.95 | 8251 | 1.10 |
| 8035 | 1.00 | 8253-5 | 1.75 |
| 8039 | 1.00 | 8254 | 1.80 |
| 8085 | 1.55 | 8255 | 1.50 |
| 8086 | 1.55 | 8255-5 | 1.75 |
| 8087 | 87.50 | 8257 | 1.50 |
| 8087-1 | 167.50 | 8259A | 1.85 |
| 8087-2 | 127.50 | 8259C-5 | 2.10 |
| 8088 | 2.70 | 8275 | 10.95 |
| 80C98 | .40 | 8279 | 2.25 |
| 8155 | 2.25 | 8284 | 1.49 |
| 8156 | 2.25 | 8286 | 3.50 |
| 8202A | 8.00 | 8287 | 2.49 |
| 8212 | 1.25 | 8288 | 3.50 |
| 8214 | 2.00 | 8530 | 3.00 |
| 8216 | 1.25 | 8741 | 7.00 |
| 8224 | 1.25 | 8742 | 7.00 |
| 8228 | 1.75 | 8748 | 7.00 |
| 8237-5 | 2.80 | 8749 | 7.00 |
| 8243 | 1.75 | 8755 | 7.00 |
| 8250 | 2.95 | 80286-8 PLCC | 8.50 |
| (16450) | 6.50 | 80287-8 | 125.00 |
| (16550) | 12.00 | 80287-10 | 135.00 |
| | | V-20-10MHZ | 6.50 |

TERMS: (Unless specified elsewhere) Add \$2.50 postage, we pay balance. Orders over \$50.00 add 85c for insurance. No C.O.D. Texas Res. a 8 1/2% Tax. 90 Day Money Back Guarantee on all items. All items subject to prior sale. Prices subject to change without notice. Foreign order - US fun only. We cannot ship to Mexico. Countries other than Canada, add \$4.50 shipping and handling.

SEND FOR FREE CATALOG!

SEND FOR FREE CATALOG!

• *A Few DIRectory Enhancements.* Another way to find all files with a certain attribute is to follow the DIR command with the /A: switch and the initial of the desired attribute. For example, DIR /A:D displays directories only, while DIR /A:-D displays no directories—that is, it shows file names only. Likewise, DIR /A:H lists hidden files, DIR /A:R shows read-only files, and so on.

The /S switch can be used to search out duplicate file names or to display a list of all backup files. For example, DIR /S *.BAK shows the name of any directory containing a backup file, along with each such file name. If the /B switch is added to the command, each backup file is preceded by its complete path name.

As another enhancement, the /O: switch sorts the directory listing by date, extension, file name or size, depending on the letter following the colon. A minus sign between the colon and the letter sorts the list in reverse order.

If you find yourself consistently using a particular sort order, you can change the default directory listing by adding a SET DIRCMD command to your AUTOEXEC.BAT file. For example, if you add SET DIRCMD = /A:-D /O:-D to the batch file, subsequent use of the DIR command will display file names only and the sort order will be by date and time, with the latest files at the top of the listing.

The DOS 5.0 directory listing also reports the number of bytes taken up by all files in the current directory.

• *DOSKEY.* The DOSKEY utility remembers your recent DOS commands, which can be recalled by pressing the up- and down-arrow keys or the page-up and -down keys. Repetitive presses of an up- or down-arrow key toggles forward or backward through the entire list, one command at a time. When the first (or last) command is reached, the next key press returns to the top (or bottom) of the list, and subsequent key presses will again toggle through the list of commands.

• *EDIT.* The old DOS EDLIN utility is still around, and it is still useful for knocking off a quickie batch file or making a minor change to an existing text file. However, the new EDIT is a full-screen ASCII text editor that goes far beyond the limitations of

EDLIN. Of course you will still want a full-blown word processor for serious letter writing, but for the fast memo or interoffice note, EDIT will do quite nicely.

• *Formatting.* DOS 5.0 introduces yet another diskette format: 2.88M on a 3½" diskette. That is, it almost introduces it. To take advantage of it, you still need a new drive and diskettes whose magnetic coating tolerate 36 data sectors per track.

As another added attraction, the default format mode, is now that of a "safe format," in which only the file-allocation table (FAT) and root directory are wiped clean. The data itself is left intact, although, of course it will eventually be overwritten when you write new data to the diskette. However, if you realize you really did not mean to do that format in the first place, an UNFORMAT command can be used to reconstruct the FAT and directory, thus restoring the diskette to its pre-format condition. The safe format can be disabled—and formatting speeded up—by appending /Q and/or /U switches.

The /Q ("quick") still deletes the FAT and root directory, but the information is saved elsewhere on the disk surface for subsequent use by the UNFORMAT utility. The data area is left intact, and the disk surface is not scanned for bad sectors. The /U ("unconditional") switch also deletes the FAT and root directory, but the information is not saved

for later use by the UNFORMAT utility. The data area is overwritten as the surface is scanned for bad sectors; so the diskette cannot be unformatted later on.

• *Help Screens.* DOS 5.0 offers two levels of on-line help screens. For a quickie review of each command, just type HELP at the DOS prompt. A one- or two-line summary of each command is displayed. For more information about a specific command, type HELP and the name of the command, or type the command and follow it with a /? switch. In either case, the screen shows an explanation of the command, followed by a summary of all parameters and switches that can be used with that command.

• *Memory-Management Features.* As programs get bigger and bigger, that old 640K ceiling on the conventional memory area begins to get in the way of RAM-guzzling applications. And, of course, DOS itself has grown bigger with each new version, thus requiring more of that now-precious 640K for itself, which means less for whatever it is you want to do. But at last, MS-DOS 5.0 offers relief to any 80286-or-better system with extended memory available. The so-called HMA (high memory area) is the first 64K block of RAM at the 1M starting address for extended memory, an area previously limited to use by an electronic disk. In conjunction with a new device driver (HIMEM.SYS) for

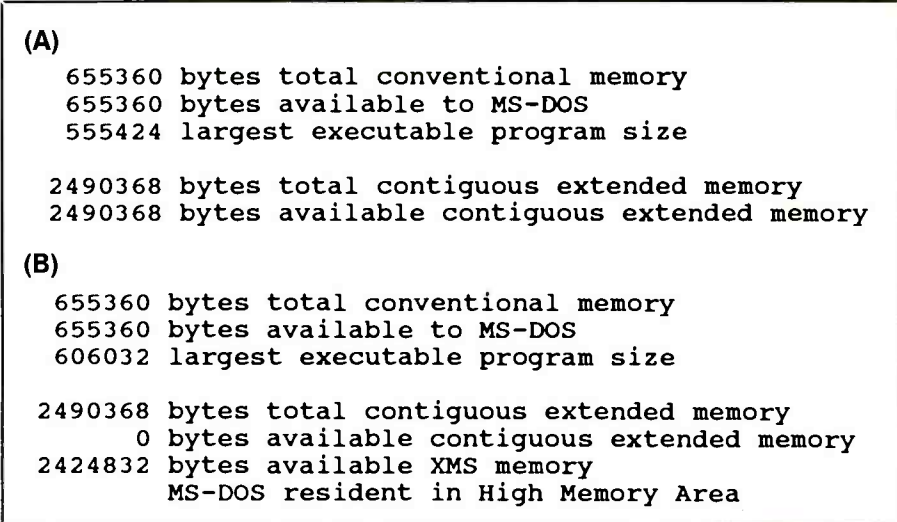

Fig. 1. A DOS 5.0 MEM report that shows conventional memory usage before (A) and after (B) using DOS = HIGH and the HIMEM.SYS device driver to load part of DOS itself into the high memory area.

the CONFIG.SYS file should contain the following lines:

```
DOS=HIGH,UMB
DEVICE=HIMEM.SYS
DEVICE=EMM386.EXE
```

Subsequent device drivers are now loaded into UMBs by changing each DEVICE = line to DEVICEHIGH = .

Within an AUTOEXEC.BAT file, most TSR programs can also be loaded into UMBs by inserting the LOADHIGH command in the line immediately before the name of the program to be loaded. Here, a little "cut-and-try" experimenting may be required; some TSRs behave themselves well in a UMB, and others don't.

To get a better idea of what's where in conventional and upper memory, a /C (Classify) switch been added to the MEM command to produce a report like the one shown in Fig. 2. The report shows that MSDOS now occupies only 14.6K of conventional memory. The SETVID line is one of those TSRs that did not work well in upper memory.

In the Upper Memory report, the first item (SYSTEM) represents video memory and other system devices permanently stationed in the reserved memory area. Everything else represents drivers and other TSRs that have been moved from conventional memory into UMBs within the remaining reserved memory area.

• **MIRROR.** A TSR MIRROR.COM utility saves disk-recovery data for subsequent use by the UNFORMAT and UNDELETE commands. If a MIRROR command line is written into your AUTOEXEC.BAT file, then copies of the FAT and root directory for each specified drive are saved every time the system is booted. This makes recovery from an accidental FORMAT or DELETE (or ERASE) considerably faster and less susceptible to error. The MIRROR utility can also save hard-disk partition information to a diskette. This is for subsequent use by the UNFORMAT utility, should the need arise.

• **A QuickBASIC Interpreter.** The old familiar GWBASIC has been replaced by a QuickBASIC Interpreter, which offers many features of Microsoft's complete QuickBASIC program, although it is not possible to compile BASIC programs created with the interpreter. For that, you

Conventional Memory :

| Name | Size in Decimal | Size in Hex |
|--------------|-----------------|-------------|
| MSDOS | 14912 (14.6K) | 3A40 |
| HIMEM | 1184 (1.2K) | 4A0 |
| EMM386 | 9424 (9.2K) | 24D0 |
| COMMAND | 2624 (2.6K) | A40 |
| SETVID | 736 (0.7K) | 2E0 |
| FREE | 64 (0.1K) | 40 |
| FREE | 626176 (611.5K) | 98E00 |
| Total FREE : | 626240 (611.6K) | |

Upper Memory :

| Name | Size in Decimal | Size in Hex |
|--------------|-----------------|-------------|
| SYSTEM | 163840 (160.0K) | 28000 |
| SE^VER | 400 (0.4K) | 190 |
| SMARTDRV | 22928 (22.4K) | 5990 |
| ANSI-UV | 1664 (1.6K) | 680 |
| RCD | 10912 (10.7K) | 2AA0 |
| RAMDRIVE | 1184 (1.2K) | 4A0 |
| AMDEK | 11344 (11.1K) | 2C50 |
| MOUSE | 15536 (15.2K) | 3CB0 |
| UV | 19456 (19.0K) | 4C00 |
| DE | 2256 (2.2K) | 8D0 |
| FREE | 12416 (12.1K) | 3080 |
| Total FREE : | 12416 (12.1K) | |

Total bytes available to programs (Conventional+Upper) : 638656 (623.7K)
 Largest executable program size : 626016 (611.3K)
 Largest available upper memory block : 12416 (12.1K)

4456448 bytes total contiguous extended memory
 0 bytes available contiguous extended memory
 1692672 bytes available XMS memory
 MS-DOS resident in High Memory Area

Fig. 2. The DOS 5.0 MEM /c command summarizes conventional and upper memory allocation.

extended memory management, DOS 5.0 can now load much of itself into this high memory area. This frees up and makes available valuable conventional memory space.

With DOS 5.0 loaded in the usual manner, Fig. 1(A) displays memory usage as reported by the MEM command. Note that DOS 5.0 has chewed up 99,936 bytes of the available conventional memory, leaving 555,424 bytes available for program execution. The last two lines in the illustration show the extended memory, which in this example is not in use.

To release some of that conventional memory occupied by DOS, just add the following lines to your CONFIG.SYS file:

```
DOS=HIGH
DEVICE=HIMEM.SYS
```

These lines instruct DOS to set up the HMA in extended memory and to load much of itself into that area. Figure 1(B) shows the result; the largest executable program size is now

606,032 bytes, thus releasing an additional 50,608 bytes that can be used for other applications.

The last four lines in Fig. 1(B) report the changes made to extended memory. The total (2,490,368) is still the same, but now there are only 2,424,832 bytes left over for XMS (extended memory specification) use. The missing 64K is, of course, the HMA, which now holds part of DOS, as reported by the last line in the figure.

More memory saving is possible on a system with an 80386 or i486 MPU. Another device driver (EMM386.EXE) functions as a UMB (upper memory block) provider. It maps extended or expanded memory into UMBs that the driver sets up within the reserved memory area between 640K and 1,024K. With the UMBs enabled, device drivers (other than HIMEM.SYS and EMM386.EXE) and other TSR programs can be loaded into this area, thus freeing up even more conventional memory space. To enable the upper memory blocks,

must buy the complete program, which is sold separately.

•**SETVER.** Sometimes an application will not run under DOS 5.0, for no other reason than that it expects to find some other DOS version in place. When it discovers DOS 5.0, the application displays a Wrong DOS version error message and quits. As a work-around solution, DOS 5.0 maintains a version table within the SETVER.EXE hidden file. To view the table, just type SETVER at the DOS prompt. When you press the Enter key, you will see a table of program names and DOS version numbers.

If your favorite WHATSIT.EXE program wants to see DOS 3.31, and this information is not already in the table, just type SETVER WHATSIT .EXE 3.31 at the DOS prompt. A stern message warns you that Microsoft will not be held responsible for data loss or damage as a result of adding your program to the version table—after all, it is possible there's some other reason why WHATSIT objects to DOS 5.0. In any case, you are advised to ask your software vendor if

the program will function properly under the circumstances. If you decide to chicken out until you can ascertain whether or not all is well, just type SETVER WHATSIT.EXE / DELETE to remove the program from the version table.

Note that since SETVER modifies the internal structure of MSDOS .SYS, a virus-detection utility may recognize the change and flash some sort of virus warning message. Therefore, you might want to do a virus check immediately before running SETVER, then do whatever needs to be done, ignore the virus warning and re-run the virus checker to take the "new" SETVER.EXE file into account.

•**Task Swapping.** The DOS 5.0 shell now features a multi-tasking option known as the "Task Swapper." To use it, just start any application from within the shell and then press the Ctrl and Esc keys to return to the shell display. Now start some other program. You can toggle between two or more such programs by holding down the Alt key and pressing the Tab key until you see the name of the desired program. Then release the Alt key to view the selected program. Task Swapper is not quite the DOS answer to OS/2, but it may be an attractive feature for DOS shell fans.

•**Undeleting and Unformatting Procedures.** Unless yours are fingers that never make mistakes, you have to reach for your *Norton Utilities* (or similar) every time you do one of those "oops!" things that no one really means to do but everyone does anyway sooner or later. Or you can install DOS 5.0 and use the new UNDELETE or UNFORMAT utilities, depending on the gravity of the situation. If you fear your diskette is missing a few critical files, just type UNDELETE, and the screen will display the good (or possibly bad) news.

As an example of the above, each erased file will be listed as say, ?ONFIG.SYS (size and file creation info here). This is followed by either a prompt to undelete the file (by answering "y" and supplying the missing first initial of the file name) or, by a message to the effect that "This file cannot be recovered by the UNDELETE command."

The new UNFORMAT command will do just what its name suggests,

provided the disk was formatted under DOS 5.0's default "safe format" mode and that no new files have been written to the disk prior to unformatting it. File recovery will be total or partial, depending on whether the MIRROR command had been used previously. If so, all root directory files, subdirectory names and files contained therein are restored. Otherwise, root directory files and the original subdirectory names remain lost. However, the files in each subdirectory are restored, and the subdirectory names become SUBDIR.1, SUBDIR.2, and so on.

The UNFORMAT utility will also restore a corrupted hard-disk partition table, provided you previously saved the partition data to a diskette, via the MIRROR command.

DOS 5.0 Documentation

DOS 5.0 comes with a completely new 668-page *User's Guide and Reference* manual. It's a mixed bag of basic information, operating tips and an extensive chapter (14) on DOS commands. In addition to the commands themselves, the chapter lists and describes DEBUG and EDLIN parameters, as well as batch and configuration file commands. All entries are contained within a single alphabetical listing; so it's actually possible to find whatever needs to be found. For users of the IBM DOS 4.0 manual, this feature alone should make MS-DOS 5.0 the operating system of choice.

Some of the other chapters still need a bit of work. For example, chapters on customizing and optimizing your system contain seemingly endless references to information found elsewhere in the same chapter, making it difficult to study a specific topic without reading the entire chapter. Naturally, it is a good idea to do just that, but it would be more helpful if related information were better organized.

Summing Up

DOS 5.0 should put to rest all those DOS-is-dead (or at least, dying) tales. If you've got an 80286 system, it is worth a close look. If you have anything better, you probably cannot afford not to buy it, if only for its memory management facilities. ■

LEARN VCR

CLEANING/MAINTENANCE/REPAIR

EARN UP TO \$1000 A WEEK, WORKING PART TIME FROM YOUR OWN HOME!



Secrets Revealed!

NO Special Tools or Equipment Needed.

EARN UP TO \$60 AN HOUR AND MORE!

THE MONEY MAKING OPPORTUNITY OF THE 1990'S

IF you are able to work with common small hand tools, and are familiar with basic electronics (i.e. able to use voltmeter, understand DC electronics) . . .

IF you possess average mechanical ability, and have a VCR on which to practice and learn . . . then we can teach YOU VCR maintenance and repair!

FACT: up to 90% of ALL VCR malfunctions are due to simple MECHANICAL or ELECTRO-MECHANICAL breakdowns!

FACT: over 77 million VCRs in use today nationwide! Average VCR needs service or repair every 12 to 18 months!

Viejo's 400 PAGE TRAINING MANUAL (over 500 photos and illustrations) and AWARD-WINNING VIDEO TRAINING TAPE reveals the SECRETS of VCR maintenance and repair—"real-world" information that is NOT available elsewhere!

Also includes all the info you'll need regarding the BUSINESS-SIDE of running a successful service operation!

FREE INFORMATION
CALL TOLL-FREE 1-800-537-0589
Or write to:
Viejo Publications
5329 Fountain Ave., Dept. ME
Los Angeles, CA 90029

Why take chances in today's job market?

Graduate as a fully trained electronics professional.

To get ahead and stay ahead in today's economy, you need the electronics training CIE has been providing its 150,000-plus successful graduates with for nearly 60 years.

Meet the Electronics Specialists.

When you pick an electronics school, you're getting ready to invest time and money. And your whole future depends on the education you receive in return. That's why it makes so much sense to go with number one... with the specialists... with CIE!

There's no such thing as a bargain education.

If you talk to some of our graduates, and we recommend you do, chances are you'd find a lot of them shopped around for their training. Not for the lowest priced, but for the best training available. They pretty much knew what was available when they picked CIE as number one.

Because we're specialists we have to stay ahead.

At CIE we have a position of leadership to maintain. Here are just a few of the ways we hang onto it...

Programmed Learning.

That's exactly what happens with CIE's Auto-Programmed Lessons®. Each lesson uses famous "programmed learning" methods to teach you important electronics principles. You explore them, master them completely, before you start to apply them. You thoroughly understand each step before you go on to the next. You learn at your own pace.

And, beyond theory, some courses come fully equipped with electronics equipment to actually let you perform hundreds of hands-on experiments.

Experienced specialists work closely with you.

Even though you study at home, CIE's faculty and staff stand ready to assist via CIE's toll free number. And, each time you return a completed exam you can

be sure it will be reviewed, graded and returned with the appropriate instructional help, you get it fast and in writing from the faculty technical specialist best qualified to answer your question in terms you can understand.

Pick the pace that's right for you.

CIE understands people need to learn at their own pace. There's no pressure to keep up...no slow learners hold you back. If you're a beginner, you start with the basics. If you already know some electronics, you move ahead to your own level.

"Same Day" grading cycle.

When we receive your lesson, we grade it and mail it back the same day. You find out quickly how well you're doing!

State-of-the-art laboratory equipment.

Some courses feature the CIE Microprocessor

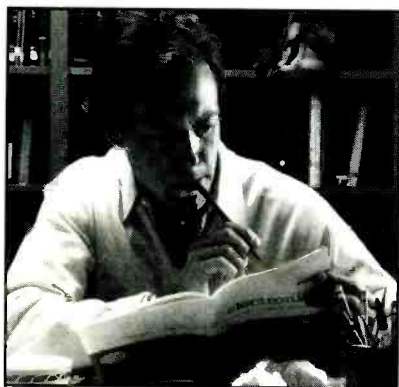

Training Laboratory. An integral part of computers, microprocessor technology is used in many phases of business, including service and manufacturing industries. The MTL gives you the opportunity to program it and interface it with LED displays, memory devices and switches. You'll gain all the experience

needed to work with state-of-the-art equipment of today and tomorrow.

New Courses!

CIE now offers two new career courses: Automotive Electronics and Computer Operation and Programming.

CIE offers you an Associate Degree.

One of the best credentials you can have in electronics — or any other career field — is a college degree. That's why CIE offers an Associate in Applied Science in Electronics Engineering Technology. And all CIE career courses earn credit toward your degrees.

Which CIE training fits you?

Beginner? Intermediate? Advanced? CIE home study courses are designed for ambitious people at all entry levels. People who have: No previous electronics knowledge, but do have an interest in it; Some basic knowledge or experience in electronics; In-depth working experience or prior training in electronics.

At CIE you start where you fit and feel comfortable where you start, then go on from there to your Diploma, Associate Degree and career!

Today is the day. Send now.

Fill in and return the postage-paid card attached. If some ambitious person has already removed it, cut out and mail the coupon below. You'll get a FREE CIE school catalog, plus complete information on independent home study. Mail in the coupon below or, if you prefer, call toll-free 1-800-321-2155 (in Ohio, 1-800-523-9109).

YES! I want to get started. Send me my CIE school catalog including details about the Associate Degree program. (For your convenience, CIE will have a representative contact you — there is no obligation.)

AO15

Print Name _____

Address _____ Apt. _____

City _____ State _____ Zip _____

Age _____ Area Code/Phone No. (_____) _____

Check box for G.I. Bulletin on Educational Benefits Veteran Active Duty

CIE CLEVELAND
INSTITUTE OF
ELECTRONICS, INC.
1776 East 17th Street • Cleveland, Ohio 44114 • (216) 781-9400



A school of thousands.
A class of one.
Since 1934.

Operating a Parallel Printer From Your Serial Port

Adapter to run your parallel-interface printer from a serial port gives you a host of additional benefits

Computer printers are commonly designed to use your computer's parallel port. There are many instances, however, when it's more desirable to run the printer from a serial port. Here's an adapter you can build that allows your parallel-interface printer to run connected to a serial port, gaining these advantages: the ability to run more than one printer at a time; eliminating the need to swap printer cables; and being able to operate your printer from a greater distance away.

Printers run at very low data-transfer rates, compared with the operating speed of your host computer. For this and other reasons, the RS-232 serial interface on your PC becomes an ideal printer port. The Cyber Print Controller described here allows you to connect any parallel (Centronics-compatible) printer directly to your PC's serial interface. CyberPrint lets you experiment with all aspects of serial-to-parallel protocol conversion. In addition to driving your printer, it also can be used to experiment with parallel data I/O and acquisition applications. Before beginning construction of this project, though, let's review some serial interface basics, which will give you a better insight into Cyber Print's circuitry.

Serial-to-Parallel Conversion

The standard serial interface con-

vention used in personal computers, called RS-232, defines a method for transferring information (data) among computers, modems, printers and other specialized peripheral equipment. While RS-232 is a "standard" interface, so many variations and permutations exist that entire books are dedicated to the subject.

Perhaps you have worked with RS-232 serial applications in the past. If so, you probably had some frustrating experiences getting the computer to "talk" to the peripheral connected to the serial port. Cyber Print eliminates RS-232 serial printer confusion without sacrificing performance, accomplishing this with a minimum of hardware and software. As your needs grow, you have only to add more Cyber Print units for each serial port you wish to convert.

You don't have to know much about RS-232 and serial protocols to use Cyber Print, though it's strongly recommended that you find some good reference material on RS-232 interfacing. This will let you experiment with Cyber Print and develop a strong background in serial communications.



About the Circuit

Cyber Print is composed of only three ICs. Integrated circuit *U1*, a Motorola MC68705P3 microcontroller, constitutes the heart of the unit. This particular chip was chosen for this project for its low cost, ability to be programmed and erased for reprogramming, its compact 28-pin DIP configuration and its simple yet powerful instruction set.

The self-contained '705P3 microcontroller requires only one capacitor and a crystal to operate. In Fig. 1, *U1* is user-programmed, using a 2732 EPROM and programmer or a development system. Alternatively, you can purchase this chip pre-programmed from the source given in the Note at the end of the Parts List.

Microcontroller *U1* communicates with the host computer through Maxim MAX232 RS-232-to-digital converter *U2*. Conventional RS-232 interfaces utilize bipolar power supplies to create the +12 and -12 volts required for proper operation. The MAX232 synthesizes these special voltages directly from the +5-volt supply line. Converter *U2* requires

four capacitors, C8 through C11, to form charge pumps for producing the ± 12 volts.

Incoming print data is received from the host computer at pin 2 of the DB-25 female connector shown at the left in Fig. 1. Once applied to pin 13 of U2, it's internally inverted and level-shifted to either a logic 1 (+5 volts) or logic 0 (0 volt) at pin 12 of this chip. This data is routed on to pins 26 (data input) and 2 (interrupt) of chip U1.

Control and "handshake" information is returned to the host computer from pin 25 of U1, through pins 10 and 7 of U2. In this section of U2, digital-level signals are again shifted to standard RS-232 levels and applied to DB-25 connector pins 5 and 6. These two pins are monitored by the host PC's serial interface. Thus, the host processor can control the transfer of information to Cyber Print very predictably.

Data is buffered in U1 and transferred one byte at a time from pins 12 through 19 of U2. After each data byte is set up on the output pins, a strobe pulse is created at pin 20 of U1. This signals the printer that one byte of data is stable and ready for transfer. Likewise, a return bit from printer ACK is applied to pin 7 of U1. This tells the microcontroller that the printer has accepted the previous data byte and is ready to accept the next byte in the series.

A series of switches are accessible through Cyber Print's front panel. These are connected directly between U1 and ground and provide a means to set up the microcontroller's operating mode. Each input line to U1 is pulled-up by a 10,000-ohm resistor. Also, pins 21 and 22 of U1 are debounced by 0.1- μ F capacitors C3 and C4 to keep U1 from reacting to bounce created in the switch contacts and inhibit consequent multiple form-feeds and carriage returns. Crystal X1 forms a master timing clock that's used to precisely synchronize data transferred from the host computer to Cyber Print.

Two monitor LEDs on the project indicate data activity to and from Cyber Print. Red LED1 indicates a "halt" message has been sent to the host PC to instruct it that no further data can be accepted by Cyber Print. Green LED2 indicates that data is be-

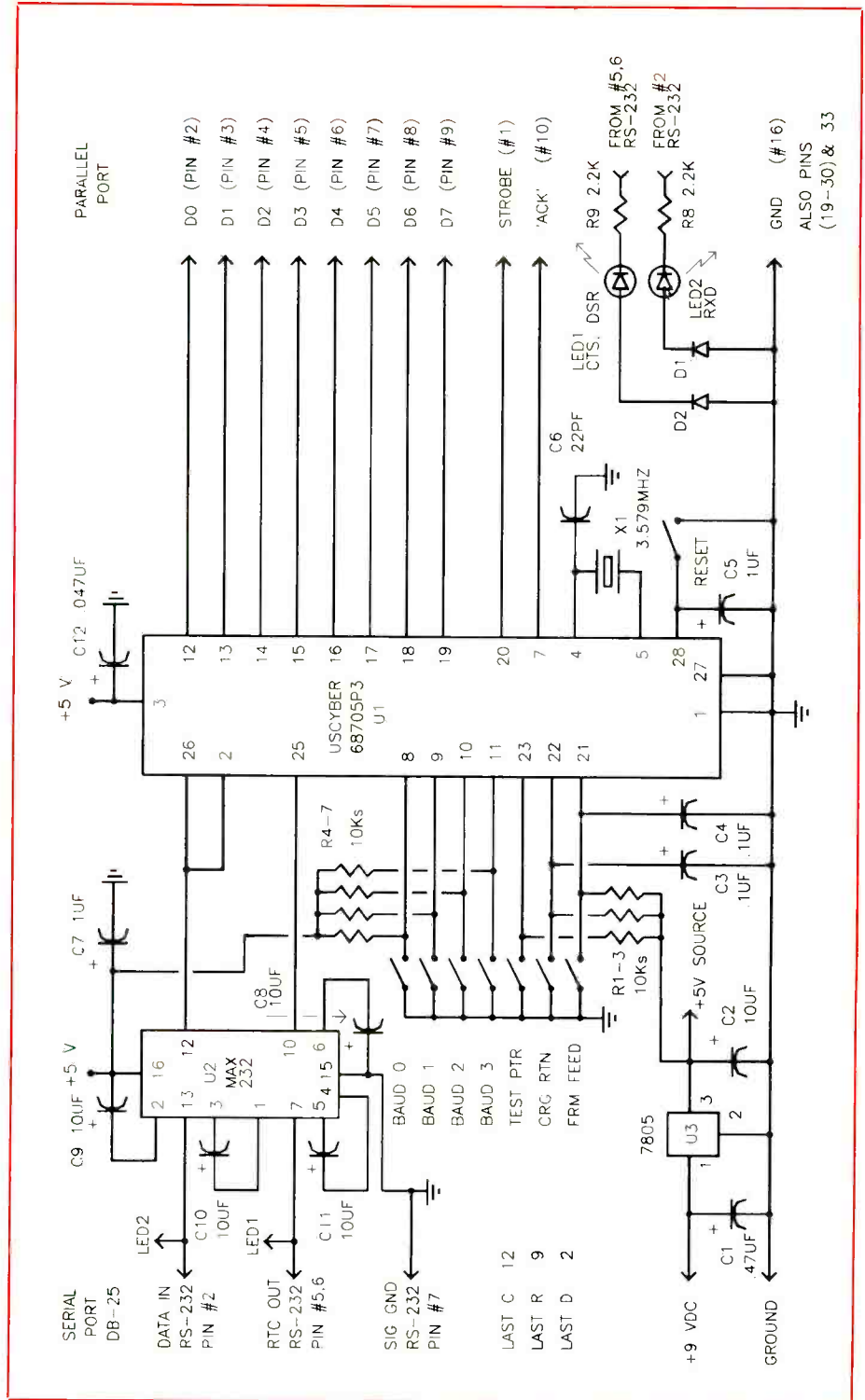

Fig. 1. Complete schematic diagram of project.

ing received by the unit normally on and flickers as data bytes are being received.

Voltage regulator U1 provides clean +5 volts to the circuit from the +9-volt line and is decoupled by capacitors C1, C2, C7 and C12. Reset

capacitor C5 provides a short delay during reset switch operation.

Construction

Cyber Print is best assembled on a printed-circuit board, the actual-size

PARTS LIST

Semiconductors

D1,D2—1N4148 signal diode
 LED1—Red light-emitting diode
 LED2—Green light-emitting diode
 U1—MC68705P3 (preprogrammed) microcontroller (Motorola)
 U2—MAX-232 RS-232 interface (Maxim)
 U3—7805 fixed +5-volt regulator

Capacitors

C1—0.47- μ F, 16-volt tantalum
 C2,C8 thru C11—10- μ F, 16-volt tantalum
 C3,C4—0.1- μ F, 16-volt tantalum
 C5,C7—1- μ F, 16-volt tantalum
 C6—22-pF, 100-volt ceramic disc
 C12—0.047- μ F, 16-volt tantalum

Resistors ($\frac{1}{4}$ -watt, 5% tolerance)

R1 thru R7—10,000 ohms
 R8,R9—2,200 ohms

Miscellaneous

X1—3.579545-MHz crystal
 Printed-circuit board; suitable enclosure (Pactec HP series black or similar); 9-volt, 200-mA plug-in power supply; eight-position DIP switch; pc-mount DB-25 female connector; IDC-type AMP CHAMP connector (plug); materials for making cables (see text); machine hardware; hook-up wire; solder; etc.

Note: The following are available from U.S. Cyberlab, Inc., Rte. 2, Box 284 Production Facility, West Fork, AR 72774 (501-839-8293): Complete kit of parts, including front panel, enclosure, pc-board, connectors and all components, \$89.95; pc board, \$9.95; preprogrammed MC68705P3, \$24.95; software documentation package with transfer ROM to program MC68705P3, \$9.95. Add \$4.95 P&H. Arkansas residents, please add 5% state sales tax.

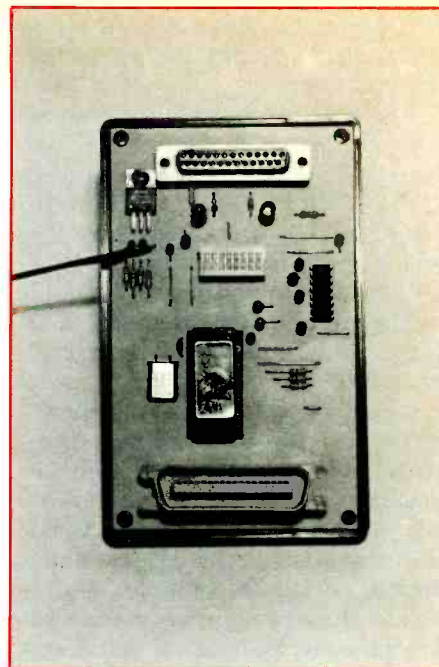

Interior view of author's prototype.

etching-and-drilling guide for which is shown in Fig. 2 if you wish to fabricate the board yourself. You can also obtain a ready-to-wire pc board from the source given in the Note at the end of the Parts List.

If you make your own board, use a No. 68 bit to drill component-mounting holes after etching is done. Also, use a No. 60 bit for the DB-25 connector pads. The CHAMP (Centronics) connector recommended for this project is an insulation-displacement (IDC) type and requires holes drilled with a No. 54 bit. The mounting hole for U3 requires a No. 30 bit, and the

mounting holes at the four corners of the board a $\frac{1}{4}$ " bit.

Referring to Fig. 3, begin wiring the pc board by mounting and soldering into place the resistors, capacitors and jumper wires. Next, mount the crystal and DIP switch in place and finish up with the LEDs and diodes. Make sure the LEDs and diodes are oriented properly before soldering their leads into place.

Now mount and solder the voltage regulator and secure it to the board with a $4-40 \times \frac{1}{4}$ " machine screw and nut. Using a dc voltmeter or ohmmeter set to the dc-volts function, check the output voltage polarity of the 9-volt dc power-supply module. Mark each lead according to polarity and then plug the two leads into the polarity-correct holes on either side of C1 and solder into place. Do *not* install U1 or U2 at this time.

Now make the cables required for use of this project. Much of the problems with RS-232 cables results from the myriad possibilities that exist. For this project, you need a straight cable that connects to the serial interface port on your PC on a one-to-one basis; that is, pin 1 to pin 1, pin 2 to pin 2, etc.

Start cable construction with the RS-232 cable, for which you should use two male DB-25 IDC connectors and 25-conductor ribbon cable. Use

scissors to cut the ribbon cable to the length needed (4 to 6 feet should be sufficient). One side of the cable has a colored stripe on the end conductor, which you must use as a reference for pin 1 on both connectors. When you assemble the cable and connectors, match this conductor with pin 1 of the connectors. (If the ribbon cable lacks a colored conductor, just pay close attention to which side of the cable is which.)

To secure a connector in place, slip the ribbon cable into the connector until it's flush with the back, making sure the cable lines up directly over the insulation-piercing tines on the connector. Next, compress the backplate of the connector into the ribbon cable, using a vise or channel-lock pliers. (A vise works much better. If you use channel-lock pliers, you should use a piece of sheet metal or printed circuit material to keep the pliers from damaging the pins in the connector.) The IDC connector snaps into a locked condition when it has been compressed into proper position.

Check the integrity of the connection to make sure all pins are solidly connected. Then repeat the process with the connector at the other end of the cable. To validate the cable, check it with an ohmmeter or audible continuity tester. That is, check continuity from pin 1 of one connector

Table 1. Selecting Baud Rate

| Baud Rate | Switch Conditions | | | |
|-----------|-------------------|--------|--------|--------|
| | SW1 | SW2 | SW3 | SW4 |
| 45.5* | Closed | Closed | Closed | Closed |
| 50.0* | Open | Closed | Closed | Closed |
| 56.8* | Closed | Open | Closed | Closed |
| 110 | Closed | Closed | Open | Closed |
| 300 | Open | Closed | Open | Closed |
| 600 | Closed | Open | Open | Closed |
| 1,200 | Open | Open | Open | Closed |
| 2,400 | Closed | Closed | Closed | Open |
| 4,800 | Open | Closed | Closed | Open |

*If you wish to use Cyber Print with Ham-radio projects, use these switch positions for Baudot.

to pin 1 of the other connector, pin 2 to pin 2, pin 3 to pin 3 and so on to pin 25 to pin 25.

Use ribbon cable and IDC connectors to make the parallel printer cable as well. The original Cyber Print was built using a male CHAMP plug mounted on the circuit board. If you use a male connector on the board, your printer cable must be equipped with a male connector on one end and a female connector on the other end. However, if you want to have a male connector at each end, simply use a female connector on the circuit board. Either way, construction is the same as for the serial cable.

Make two or more same-size photocopies of Fig. 4 for the front panel of the project. Use rubber cement or contact spray adhesive to tack one photocopy to the front panel of the enclosure, and use this to transfer the hole dimensions to the actual front panel of the enclosure. This done, use a hot knife to cut the various holes for the DB-25 and CHAMP connector and to provide access to the toggles on the DIP switch. A hot knife is a small razor-sharp knife fitted to the end of a soldering iron and is used to very precisely cut holes in

plastic. If you don't already have one, you can obtain a hot knife from a hardware store. It's a good investment and will be used over and over again, whenever you build a project that requires a home-machined plastic enclosure.

When using a hot knife, work very carefully. If you haven't used a hot knife before, start by making the holes for the connectors under-size until you're comfortable with the cutting process. You can always trim to final dimensions later. Next, determine where the holes must be cut for the LEDs. You can use an electric drill or the hot knife to make these holes. Finally, use the hot knife to cut a small slot in the top of the enclosure for the power-supply cord. Thoroughly clean the tip of your hot knife, allow it to cool and then stow it safely away for the next project.

Test fit everything in the enclosure. Make sure there's plenty of clearance around the connectors so that they mate properly with the interconnect cables. When you're satisfied with hole sizing and spacing, peel the initial front panel artwork off the enclosure and apply the second photocopy. Before doing this,

however, trim the artwork for a perfect fit on the enclosure's front panel.

It is sometimes useful to run a No. 2 pencil around the inside of the connector holes where the edge of the front panel photocopy meets the plastic. This masks the cut marks and blends the front panel into the black plastic of the enclosure.

Checkout & Use

With a voltmeter or oscilloscope, plug the power-supply module into an ac-line receptacle and then quickly unplug it. Monitor the voltage regulator leads as you do this. Look for approximately +5 volts at pin 3 of the regulator. If this voltage doesn't appear or is too high, immediately stop your tests and rectify the problem. Do not attempt to install and solder into place *U1* and *U2* until you're absolutely certain that your wiring is correct.

When you're satisfied that everything is okay, power down and install and solder *U1* and *U2* into place. Make certain each IC is properly oriented before soldering into place.

Operating Cyber Print is easy. Simply connect one end of the serial

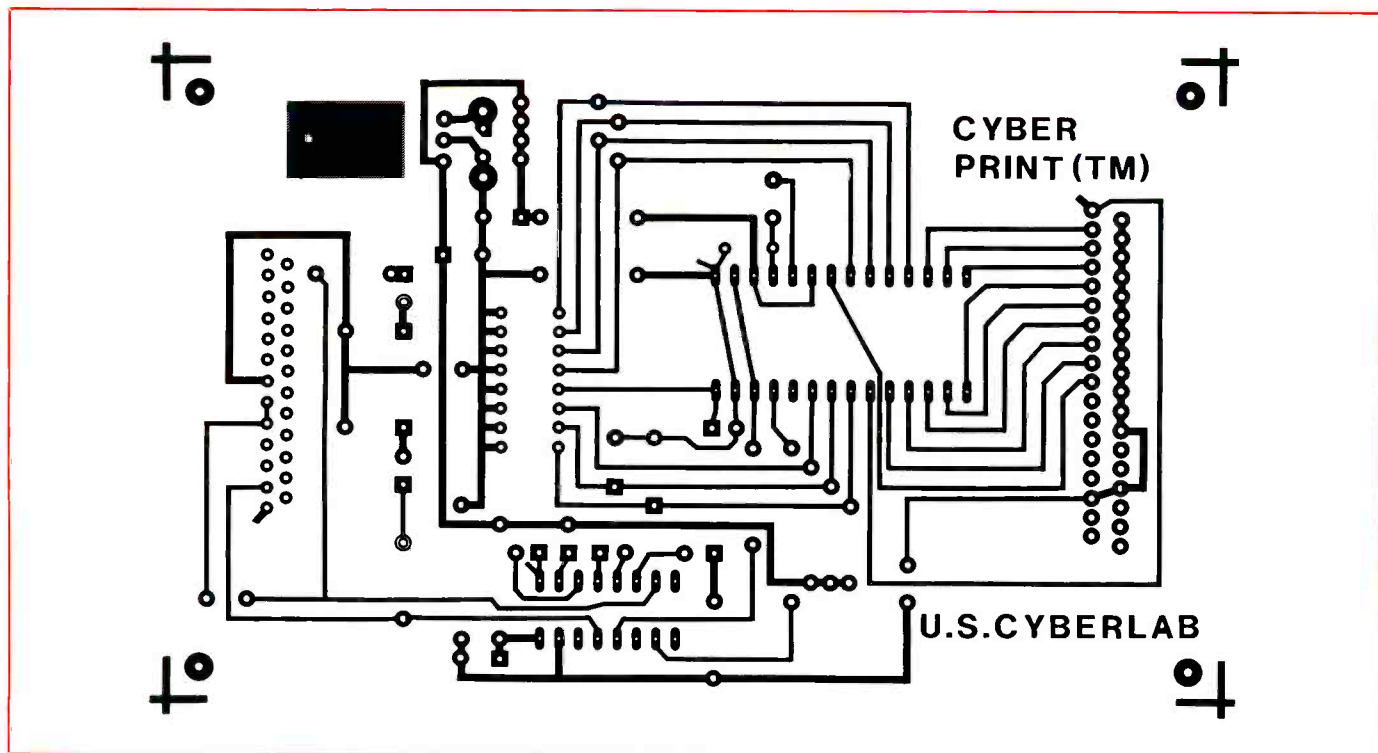

Fig. 2. Actual-size etching-and-drilling guide to use for fabricating your own printed-circuit board.

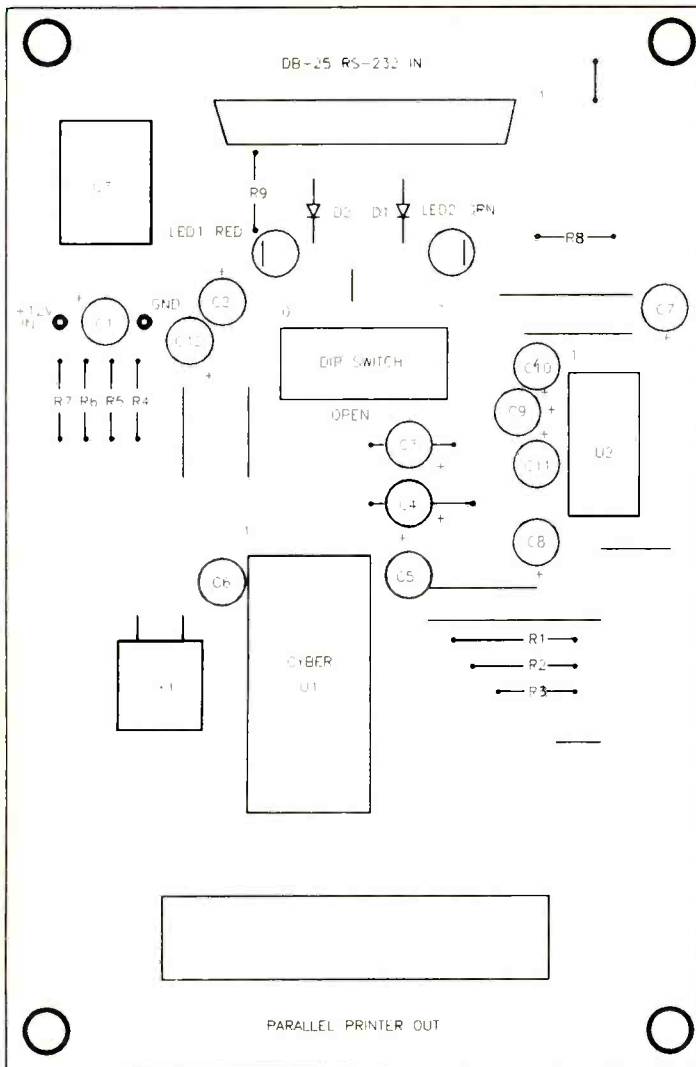

Fig. 3. Wiring guide for pc board.

cable to the serial port of your PC and the other end to project, and connect the printer cable to your printer and to the project. Plug Cyber Print's power supply into an ac outlet. Turn on your computer and allow it to boot up. Then turn on your printer and put it on-line. If the red and green LEDs on Cyber Print are off, don't worry; this is normal. (It's possible that the green LED will be on during initialization.)

To configure your PC for printer output using a serial port, refer to your DOS documentation. Most popular operating systems have provisions for rerouting system input and output. For the IBM and compatibles, simply enter the following:

```
MODE LPT1: = COM1:
MODE COM1:1200,N,8,1,P
```

to tell DOS that you wish to route all data normally ported to the parallel line printer port (LPT1) to the serial port (COM1). If you're using a serial port other than COM1, simply change the number following the COMx. The second MODE command sets the serial port configuration for 1,200 baud, no parity bit, eight data bits, one stop bit and the printer option that disallows port time-outs. The last keeps you from losing data when changing paper or pausing the printer for any reason.

After you've initialized the host computer, set the correct baud rate on the front panel of the project. The table lists the baud configurations to use for normal operation.

After selecting baud rate, simply press and release Cyber Print's RESET switch to program (set) the

correct baud rate in U1. Now, each time you turn on Cyber Print, baud rate will be automatically set in U1. Make sure that the baud rate you select on Cyber Print matches that at which your computer expects to transmit; otherwise, the project will ignore received data.

If you're using an IBM-compatible computer try pressing Print Screen and note if your printer springs into action as the computer dumps the contents displayed on its video monitor to Cyber Print. If you'd like to experiment with the RS-232 interface features, simply run your terminal communications software so that it can communicate directly with your printer via Cyber Print.

If everything has gone well up to this point, you're in business. You've successfully convinced your comput-

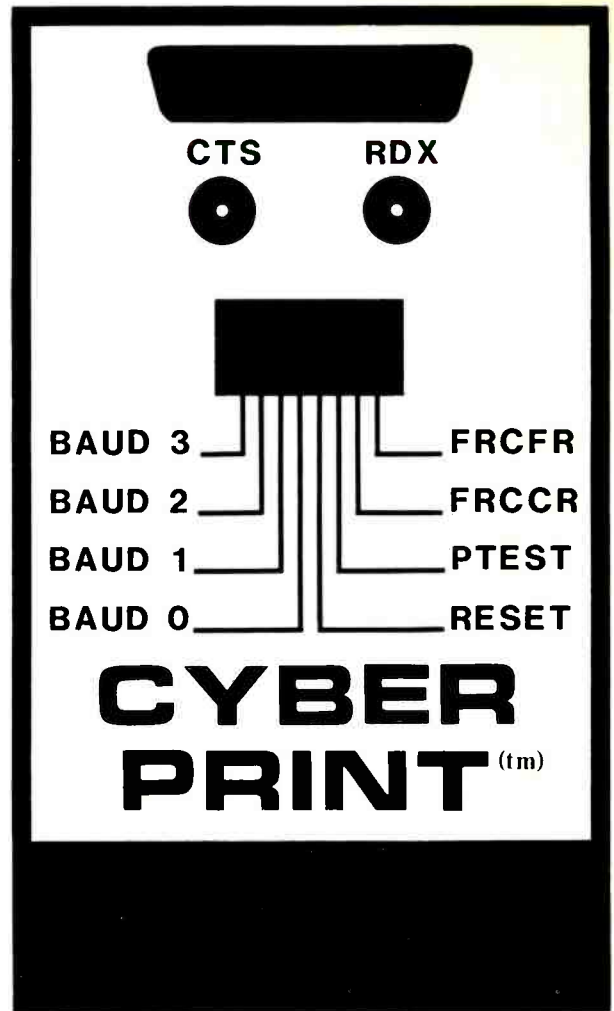

Fig. 4. Actual-size artwork for front panel of project.

er that your parallel printer is really a serial device! Just make sure to configure your computer as needed each time you power-up. If you want to automate this process, write a small batch file to handle the details each time you bring the system up.

Other Uses

There are many ways you can put Cyber Print to work around your lab or office. Here are a few suggestions:

- Use Cyber Print and an older dot-matrix printer as a secondary "documentation" printer. Leave your letter-quality printer connected to the standard parallel printer port, but use Cyber Print for making quick-printing hard-copy documentation during program debugging.
- Use Cyber Print to produce hard-copy of your on-line modem activity. To do this, connect only pin 2 of the DB-25 connector to your modem and print modem data in realtime.
- Use Cyber Print when you wish to locate your printer remotely from the host system. The RS-232 interface works well out to about 100 feet.
- Create a community printer controller using multiple Cyber Print units (and dedicated serial ports) for individual users.
- Connect Cyber Print to a plotter that can be remotely located.
- Use Cyber Print as a convenient interface for products that normally use the line-printer port: EPROM programmers, stepper motor controllers, development system programmers and the like.

Once you begin using Cyber Print, your imagination will be the only application limit! With a few simple modifications, the device can easily be converted into an intelligent sensor input for use with your RS-232 interface.



Nick Goss

SUBSCRIBE NOW & SAVE!



Save \$140

Palmtop PC
with
Lotus®
1-2-3®

HP 95LX



\$559.00
(HP List \$699)

*PC power
in the palm of your hand*

Built-in:

- Lotus 1-2-3, Release 2.2
- Complete set of organizer tools
- HP financial calculator
- Data communications
- Plug-in card slot
- 512K RAM



Link to your PC with optional Connectivity Pack

SEND FOR FREE CATALOG

EduCALC
27953 Cabot Road
Laguna Niguel, CA 92677
(714)582-2637



CIRCLE NO. 158 ON FREE INFORMATION CARD

Low Cost CAD Software

for the IBM PC and Compatibles

Starting at only \$99

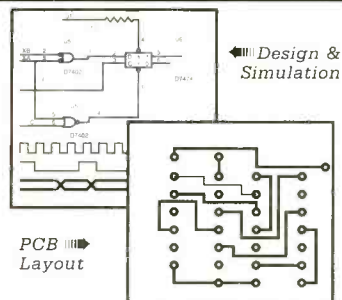

- ★ Easy to use schematic entry program (**SuperCAD**) for circuit diagrams, only \$99. Includes netlisting, bill of materials, extensive parts libraries, dot matrix printer output. More parts, HPGL plotter and laser printer output available separately or in enhanced CAD package (**SuperCAD+**) for only \$199.
- ★ Powerful, event-driven digital simulator (**SuperSIM**) allows you to check logic circuitry quickly before actually wiring it up. Works directly within the **SuperCAD** editor from a pulldown menu and displays results in "logic analyzer" display window. Starting at \$99, this is the lowest cost simulator on the market. Support for PALs, a larger library, and a separate interactive logic viewer are available in full-featured **SuperSIM+** for only \$395. Library part models include TTL, CMOS and ECL devices.
- ★ Circuit board artwork editor and autorouter programs, starting at \$99 each. Produce high quality artwork directly on dot matrix or laser printers. Separate plotter driver available for \$49. You can do both single or double-layer boards with plated through holes. Includes drill hole listing utility. Autorouter accepts netlists and placement data directly from the **SuperCAD** schematic editor.
- ★ All software comes with complete documentation and 30-day money-back guarantee.

Write or call for further information and free demo disks:

MENTAL AUTOMATION, INC.

Mental Automation, Inc.
5415 - 136th Place S.E.
Bellevue, WA 98006

(206) 641-2141



CIRCLE NO. 167 ON FREE INFORMATION CARD

August 1991 / COMPUTERCRAFT / 39

A Whole House Surge Protector

New device mounts to a circuit-breaker panel box to protect all electronic equipment in a home from damaging power surges and spikes

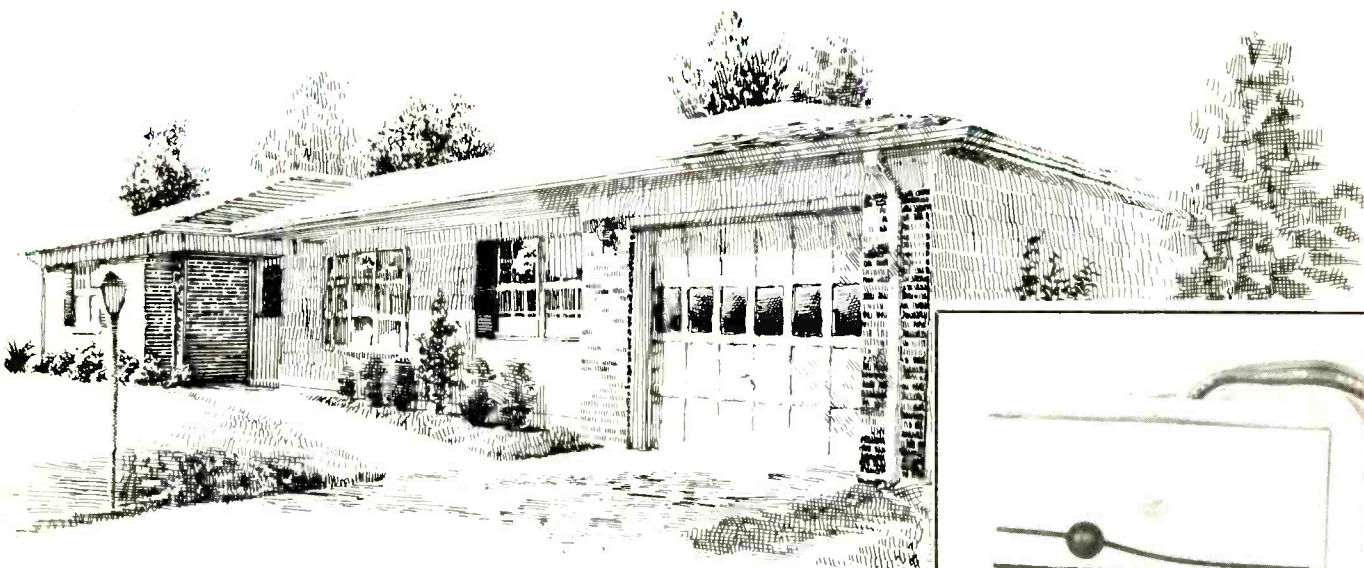

More and more homes today have a sprinkling of electric power surge protectors plugged into ac outlets to protect particular pieces of computer or electronic equipment. Intermatic Inc. (Spring Grove, IL) has played one-upmanship with its new Electra Guard EG24ORC. This single device guards against power surges and spikes right at the incoming point in a circuit breaker panel so that *all* ac outlets are protected without using individual surge protectors.

The device hard-wires to the panel, protecting everything electrical and electronic, from personal computers to refrigerators, from power surges. At \$79.95 list, it's also moderately priced.

Response time is specified at less than 1 nanosecond, and energy capacity is rated at 400 Joules, with a maximum surge current of 20,000 amperes. Protection circuitry has five stages, with transverse and common protection modes. Electric rating is 120/240 volts ac.

Installation

Hard-wiring to a circuit-breaker panel can be dangerous, of course; so extreme

caution is necessary when installing this device. You *must* shut off the main power by moving the master switch on the breaker panel to OFF. If you don't have a master switch, don't even attempt to install the device; call an electrician!

Every circuit breaker I've seen does have a master switch; so let's assume yours has one, too, as we proceed. At the panel—whether located in a basement, garage or closet—set the main breaker to OFF (or carefully remove the main fuse with an insulated fuse puller if you have a fuse box). Remove the panel's trim plate and then, before proceeding further, *check the incoming power cable to be doubly certain it's not hot!*

With everything assured to be electrically dead, hold up the surge protector near the bottom of the circuit-breaker panel to get an idea of where you'll mount it on the wall. There are four wires coming out of the center-top of the device that will be inserted into a conveniently located knockout hole that's at the bottom of your wall-mounted circuit-breaker panel.

The Protector should be mounted below the panel, as pictured in Fig. 1. Plac-

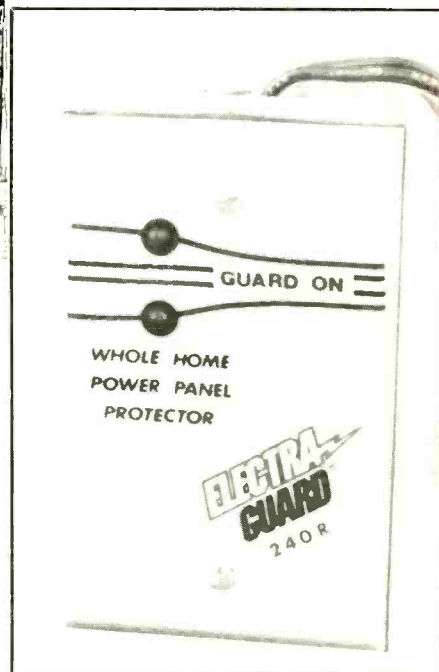

ing the Protector aside, tap out the appropriate knockout through which the Protector's wires will be drawn into the panel. (If your panel is recessed in the wall, you have some extra work to do, which I'll discuss later.) Mount the Protector to the selected wall location and insert the four wires and the Protector box spacer through the knockout hole. Then secure it with the locknut supplied.

Place a plastic bushing (also provided) over the wires that entered the panel box to prevent possible fraying of insulation from rubbing on the metal edge of the hole. Then tighten it onto the close nipple of the Protector.

Refer to Fig. 1 and first connect the green (ground) wire to the panel's ground connector. Then connect the white (neutral) wire to the appropriate connection point. If your circuit breaker doesn't have a separate ground bus, connect the green wire (first connection to be made) to the neutral bus (where the white wire is to be connected).

Next, you'll be connecting the black wires. A problem here is that different panel-box manufacturers employ different methods in setting up their circuit-breaker sequences. With about 240 volts ac coming into the panel from the electric meter, circuit breakers may be split alternately for 120 volts from one leg and 120 volts from another leg. In other instances, the 240 volts may be split between circuit breakers in a left row and breakers in the right row.

You'll have to experiment to see which set-up you have because one of the Protector's black wires must be connected to one of the 120-volt ac lines, while the second black wire must be connected to the other 120-volt ac line. This can be checked out easily enough with an ac voltmeter. Firstly, the black wires from the Protector must be connected to separate breaker output connection lugs. Furthermore, the breakers used for this purpose must be 15- or 20-ampere capacity ones. (Do *not*, for example, use a 40-ampere breaker that might be employed for, say, an electric dryer.)

Let's say you think the system used in your panel is the alternate breaker method. You should use the bottom-most 20-ampere breakers, which should be ones next to each other in a vertical row. Check the voltage with a meter, placing leads on the respective output lugs. If the alternate-breaker system is used, the meter should read about 240 volts ac. If not, you should get a reading of 0 volt. In this case, your panel likely employs incoming 240 volts ac that's split between opposite sides of the breaker line-up.

To verify this, check the voltage between the bottom 20-ampere breakers in each row. Naturally, you'll have to switch the master switch to ON to be able to do all this. When you're through, *make sure to set the master switch to OFF again!* Also turn off the circuit breakers to which you'll be connecting the black wires. After doing this, check the voltage again to be doubly certain that it isn't hot.

Now you'll connect the black wires coming from the Protector to the appropriate screw lugs. Keep in mind that more than two wires shouldn't be connected to a breaker, and only one load-bearing wire should be connected. The Protector isn't a load; so its addition doesn't matter.

Connecting the black wires to the prop-

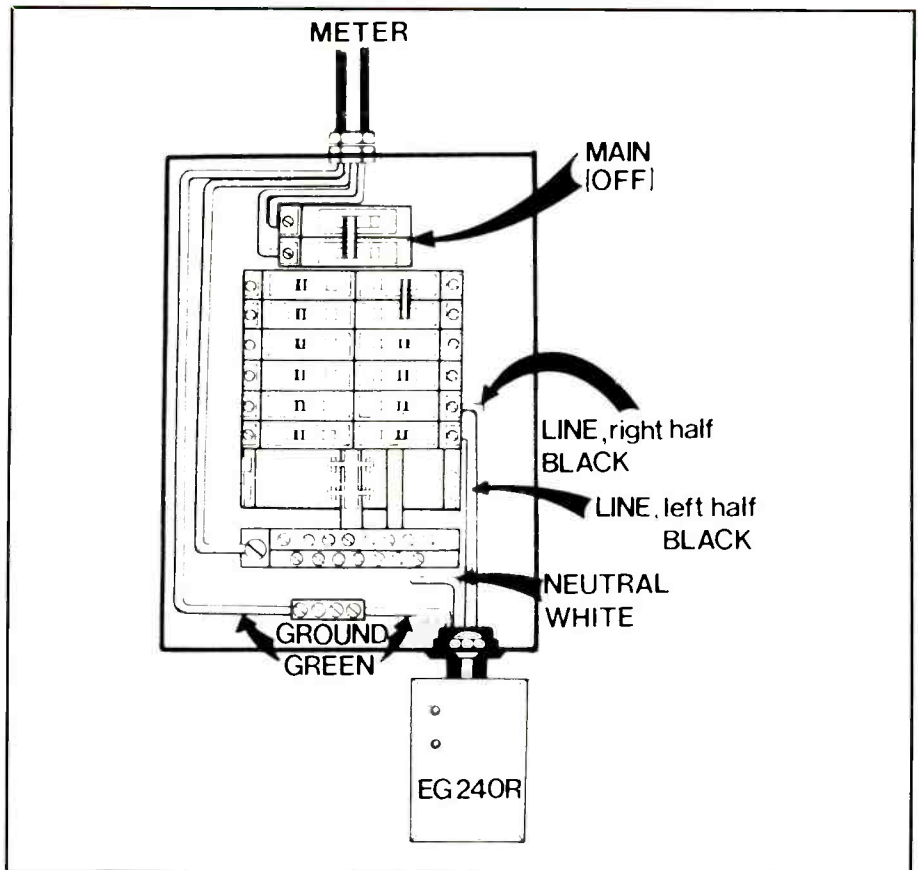

Fig. 1. The whole-house protector should be mounted below the circuit-breaker panel as shown.

er two separate 15- or 20-ampere circuit breakers, make sure that the wires are secure and that the screws are tight. Now turn on the master breaker switch (or replace the main fuse). Then switch on the circuit breakers to which you just connected the black wires. The Circuit Breaker Protector's twin indicator lamps, one for each 120-volt ac leg, should then light to verify that the device is operating passively.

Finally, replace the front-panel trim plate on the circuit-breaker panel.

Comments

The concept of protecting your equipment from electrical power surges and spikes right at the electric source is certainly an excellent one. This way, everything connected to any ac outlet is covered.

The Electra Guard EG240R Circuit Breaker Panel Protector from Intermatic, enclosed in a solidly constructed metal enclosure, is based on a fine concept: provide protection at the source for all equipment plugged into any ac outlets in a home. It's priced right, too.

Its main drawback is that you have to go into the main circuit panel to make connections, which some people will be

reluctant to do themselves. If you're in this category, taking advantage of the Whole-House Protector will up the price by the amount an electrician asks for doing the job.

If your circuit-breaker panel is recessed into a wall, you'll have some extra work to do, naturally. If you have dry-wall, which is most common, the job isn't too bad since you can easily cut a hole in it to route wires to the bottom of the panel box and then restore the piece you cut out, finishing it properly. But if your wall is plaster, the job is more challenging. What's needed, really, is an escutcheon plate that allows you to recess the Protector itself, as well, while providing the means to cover up all the exposed edges. If you're recessing the Protector, you should change the nipple provided for one that's 2-inches long.

Also, the Protector doesn't incorporate radio-frequency-interference (rfi) protection, which for personal computers is especially important. In conclusion, this is a fine product that still leaves some desirable features out, but it offers sufficient benefits to make it appealing to a lot of people.

CIRCLE NO. 121 ON FREE INFORMATION CARD

Power Protection For Your Computer System

Practical advice for protecting your computer system against the hazards of ac-line-borne noise, spikes, transients, surges, brownouts and blackouts

You are what you eat. I'm sure you've heard these words many times before in various contexts, and they also apply to your computer. The condition of the power entering your computer is important and may determine how reliably your computer does its work. The power coming into your house isn't as pure as you might think. Noise and other power-line disturbances that are often present can wreak havoc with your com-

puter. They can cause your system to become completely disabled, data stored on-disk could be corrupted or your machine can exhibit "flakiness," such as occasional parity errors and other problems.

Similar phone-line disturbances can also make your modem or fax machine unhappy. But these power- and phone-line disturbances can be overcome with the right protection devices. You've probably spent

thousands of dollars on your computer and peripheral equipment. Isn't it worth a little more to make sure these devices are well fed? Let's look at the disturbances that can plague your computer and the solutions available to alleviate them.

Power-Line Disturbances

A wide variety of disturbances can appear on your power lines. These include noise, spikes, transients, voltage sags, voltage surges, chronic overvoltages, brownouts and blackouts. Each of these can pose a threat to proper operation of your equipment. Fortunately, modern PC power supplies are generally much less susceptible to power-line noise and other minor disturbances than the microcomputers of several years ago, but they still don't go far enough to protect your system from destructive line disturbances.

My TRS-80 Model I of years past, for example, would exhibit a "dancing" video display when noise or other fluctuations were present on the power line, and any moderate-level line spike or transient would send the computer into Never-Never Land, taking along my latest programming efforts. Before we look at how these disturbances can be overcome, let's take a closer look at the line problems that can occur.

Electrical line noise is a succession of interference that appears on the ac sine wave. Shown in Fig. 1(A) is an idealized ac sine wave as it would appear at a wall outlet and goes to your computer, and Fig. 1(B) shows a sine wave with noise "riding" on the sig-

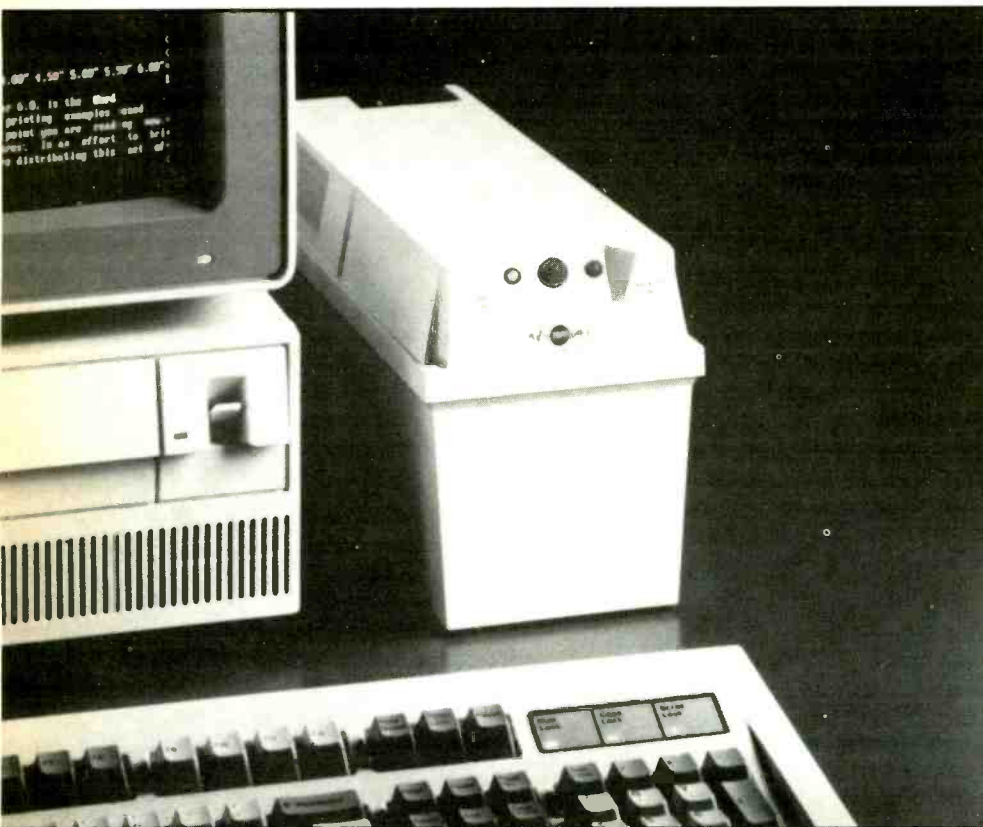

nal. Note in Fig. 1(B) that the waveform is still generally correct, but it's distorted by the noise.

Noise is often classified as emi (electromagnetic interference) or rfi (radio-frequency interference). It can be induced onto your ac power line by other ac devices in the area, such as fluorescent lights, small appliances and other computers and peripherals. Even TV and radio waves can induce noise onto power lines. Most personal-computer power supplies are capable of limiting the amount of incoming power-line noise being coupled to its dc outputs, but some supplies aren't as good at this as others. In some cases, high-frequency line noise can be passed through to your system, causing memory data bits to be altered, resulting in parity errors or erratic system operation.

A voltage spike is a fast, high-voltage peak of up to 6,000 volts and lasting between 100 microseconds and one-half ac cycle (about 8.5 milliseconds at 60 Hz). A transient is similar, reaching up to 20,000 volts and lasting between 10 and 100 microseconds. Spikes and transients tend to be the most damaging power-line disturbances for personal computers. They are generally caused by lightning strikes some miles away that travel through utility lines, power-switching operations, arcing faults or static discharge. On/off operation of an air conditioner, furnace igniter and the like could generate harmful high-voltage spikes.

They can affect your system in many different ways. They may cause memory loss, resulting in parity errors or sending your system "into the weeds." They may stress certain components, compromising their long-term integrity and resulting in intermittent operation that may make your software seem buggy. They can even result in total catastrophic system failure. In any case, it's not a pleasant situation. Fig. 1(C) illustrates a spike on the power line.

Voltage spikes and transients can also occur on phone lines, which can act as antennas during thunderstorms. They're the biggest concerns in terms of their potential impact on modems and fax machines.

A *voltage sag* (or dip) occurs when line potential drops below about

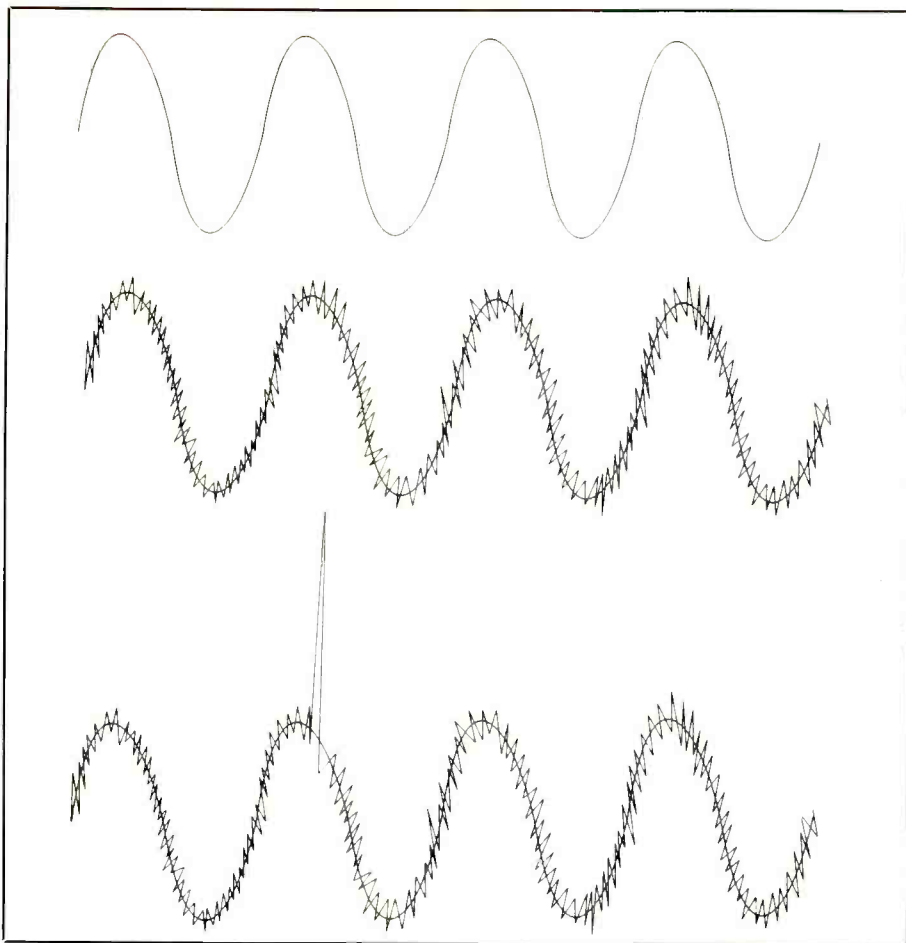

Fig. 1. Anatomy of electrical noise: (A) an idealized ac sine wave with no electrical noise present; (B) a sine wave with noise riding the signal; (C) a spike on the ac-line sinusoid.

85% of its rated voltage for one or more cycles. This is often caused by heavy equipment or large inductive loads (such as large motors) being turned on or by certain office equipment with heated fusers (such as copiers and laser printers). Power-main switching—either locally or at the utility's power-distribution center—can also cause this problem.

A voltage sag is a shorter-duration event than a brownout and can usually be easily recognized by its brief light-dimming effect. Most power supplies will accept common voltage sags without disrupting dc output voltages to the system, but some poorer-quality supplies may exhibit a drop in dc output voltages, which can cause your system to halt or reboot.

A *voltage surge* is the high-side counterpart of the sag. It occurs when the ac line voltage goes above 110% of its rated voltage for one or more cycles. As you might expect, a

surge is often caused by large inductive loads being turned off and is often visible in the form of lights briefly increasing in brightness. As with sag, most computer power supplies are designed to accommodate common surges, but some lesser units may allow incoming surges to affect dc output voltages, potentially disrupting the operation of your system. This may take the form of data alteration or even equipment shut-down.

A *chronic overvoltage* occurs when the line reaches a higher steady-state voltage than its rated value—essentially a long-term surge. Duration of the chronic overvoltage condition depends on the cause and may last seconds, days or even longer. A chronic overvoltage can be caused by wiring errors, utility errors and internal voltage generation from heavy equipment. The effect this has on your system will, again, depend on the quality of your power supply. It

could cause your system to gradually deteriorate over time (because of excessive component stress), and may even cause your power supply to "burn out."

The low-side counterpart of chronic overvoltage is the *brownout*. A brownout occurs when the power line exhibits a lower steady-state voltage than is specified for the line. This can be caused by circuit overload or utility error. Depending on the severity of the brownout and design of your power supply, a brownout may cause your supply to reset your system, or the supply may lower its dc output voltages, resulting in unpredictable system operation. A brownout can also cause your monitor to misbehave, distorting its normal image. Figure 2 illustrates brownout and chronic overvoltage conditions.

The easiest power-line disturbance to detect—for both you and your computer—is the *blackout*. A blackout is the complete loss of power lasting more than one ac cycle. This can be caused by a tripped circuit breaker, power distribution failure, or utility power failure. Where I live, it's often caused by a squirrel checking out the internals of a distribution transformer (but he never repeats the mistake). Results of a blackout are obvious. They can be particularly disastrous if one occurs during a write to your hard-disk drive because in a fleeting moment megabytes of data can be swept away forever.

Fast Relief

Fortunately, the electronics industry has come to the rescue of its own. A range of protection devices is available that can cover any or all line disturbances described above. As you might expect, the level of protection you get is generally proportional to the amount of money you're willing to spend.

The low end of the protection devices includes power strips with spike and transient protection; wall-mount units are also available. These units typically incorporate MOVs (Metal-Oxide Varistors) to clamp and safely dissipate incoming spikes and transients. Unfortunately, these devices are sometimes destroyed by high-energy spikes (such as from a direct or nearby lightning strike), rendering

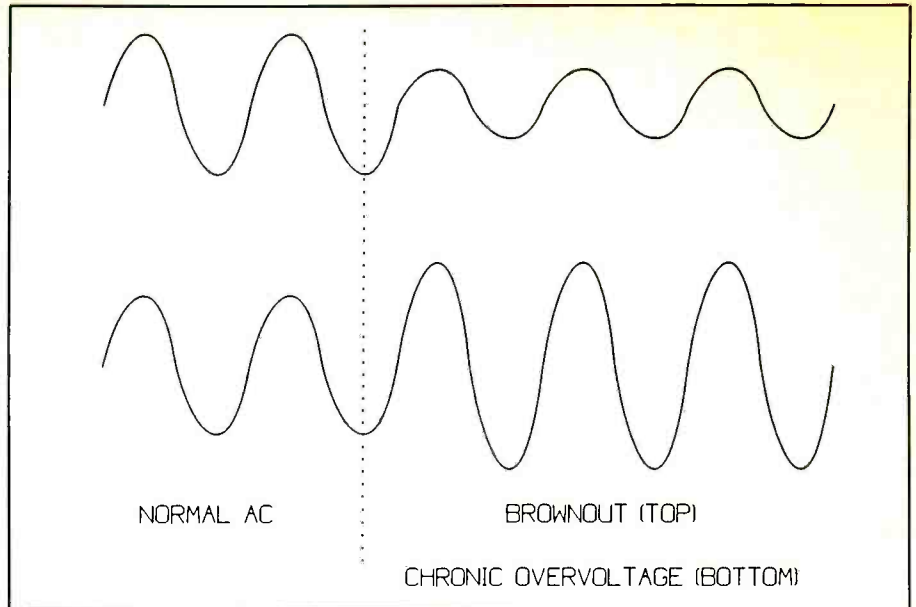

Fig. 2. Brownout and chronic overvoltage conditions.

them ineffective against later spikes and transients. Many of these spike-and transient-protection units, however, now include a neon light that stays lit as long the protection elements are active. When the light goes out, the unit is no longer protecting your system and it's time for a replacement.

Keep in mind, though, that MOVs are continually buffeted by electrical power surges. As a result, their effectiveness diminishes over time. Moreover, they don't offer protection below their clamping voltage. Protection is limited to only very high spikes.

Spike and transient protectors can cost as little as \$8 for simple, single-line protectors, to as much as \$30 and more for multiple-outlet units. Very few devices are now sold as "transient protectors." They're generally sold as surge suppressers.

Surge suppressers are similar to the spike- and transient-protection devices described above, with additional protection against power-line surges by following industry standards to ensure the effectiveness of these devices. The Institute of Electrical and Electronics Engineers offers its 1980 IEEE 587 standard, and Underwriter's Laboratories has published its 1987 UL TOSS 1449 guideline. When searching for a surge suppresser, look for a unit that conforms to both of these industry standards.

The older IEEE 587 (sometimes

called ANSI/IEEE C62.41) standard classifies maximum surges within location of a power-wiring network, setting transient waveforms in categories. Category A, for example, relates to power-protection devices plugged into a long branch circuit, a typical ac outlet, and sets ringwaves as a maximum of 6,000 volts and 200 amperes. Category B, in turn, is for devices plugged into major feeders and short branch circuits, say, at distribution panels in a factory. Maximum ringwave severity here is 6,000 volts and 500 amperes, plus withstanding impulses at 6,000 volts and 3,000 amperes. The later standard 1449 establishes a host of different performance and construction tests required to be passed in order to be listed by Underwriters Laboratories (UL). Ratings cover suppressed voltage (let-through voltage), the maximum peak voltage occurring within 100 microseconds after applying a test wave. The rating is sometimes called clamping voltage. Other tests relate to leakage current and temperature, among others.

Surge suppressers can range in price from about \$8 to \$50 or more, depending on circuitry included, number of outlets, light indicators, resettable circuit breakers and on/off power switches. Some costlier units fit under your display monitor and provide convenient power control switching to your system and va-

Protection Examples

Protection from power losses and over- and undervoltages takes a number of forms. At the minimal end are simple surge protectors, while at the maximum-protection end, you'll find hefty UPSs that can, with the aid of software that monitors them, automatically save work in progress to disk, conduct an orderly shut-down of the system and then, after the power problem clears, fire up your system and return you to where you left off.

A good example of a minimal protection system is Intermatic's \$44.95 Electra Guard EG12 strip protector. This low-cost device responds quickly—in less than 1 ns—to potentially damaging power surges, voltage spikes and transients. It continuously monitors the ac line and goes into operation at the onset of a power problem, absorbing the overload but permitting normal voltage to pass through. When the problem condition ceases, the EG12 protector automatically resets itself to normal monitoring mode.

This surge protector features a lighted master power switch, resettable circuit breaker, circuit-working indicator lamp and a 6-foot, three-conductor power cord. It also has an internal fuse to assure greater safety.

The 15-ampere EG12 provides protection against surges on all three lines

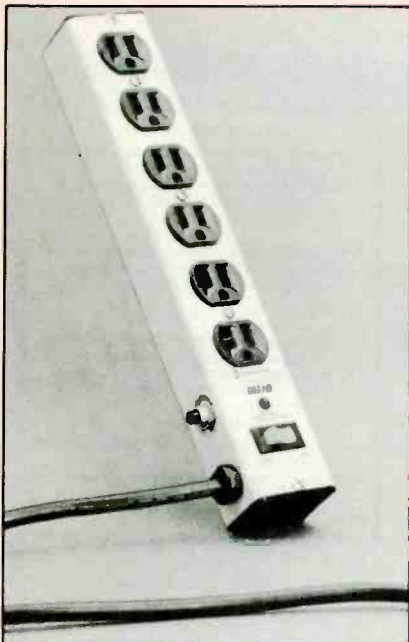

Intermatic's Electra Guard EG12 protects against power surges, voltage spikes and transients.

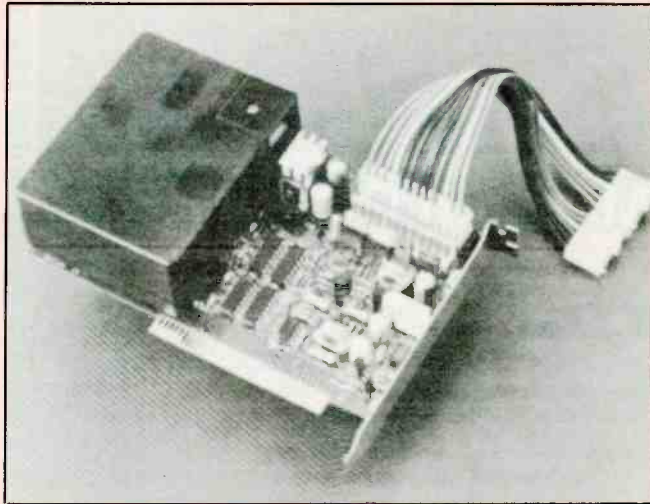

Accucard from Emerson is a bus-pluggable UPS for MS/PC-DOS computers. Different models deliver between 150 to 1,400 VA of conditioned power to computer.

(hot, neutral and ground) while it protects against emi/rfi with across-the-line filtering and transverse- and common-mode noise. It has a surge/current capability rated at 6,000 volts/5,000 amperes and is designed to clamp at 345 volts, 500 amperes.

UPSs are currently the most effective bulwark against problems occurring on the ac line that can affect computer operation and health. Most are stand-alone units that sit on a floor or under a computer workstation or alongside a system unit or between system unit and video monitor. Others mount inside the system unit, where they plug into the expansion bus.

An example of an internal unit is the Accucard Series from Emerson. This bus-pluggable UPS for MS/PC-DOS computers offers users most of the advantages of an outboard unit without the need to sacrifice precious desktop or under-desk space and at less cost than for a stand-alone UPS. It's designed specifically for micropower applications. When plugged into a PC's expansion bus, it occupies only one slot if that slot is located nearest the power supply or two slots if plugged into any other slot on the bus. It's claimed to have enough battery power to automatically save active work when ac power fails.

Five models make up the Accucard Series line. These units deliver from 150 to 1,400 VA of conditioned power to critical loads and backup power during brownouts and blackouts. Each model is designed for a specific class of com-

puter, ranging from single desktop workstations to large LAN file servers.

Tripp Lite's BC-450 LAN battery backup system (see lead photo) is a typical example of a desktop UPS. It supplies 450 VA of continuous power while providing spike, line-noise and emi/rfi filtering. Brownout protection starts at 103 volts incoming ac for the four ac receptacles located on its rear panel and its DB-9 LAN connector. With optional UPS monitoring software and cabling, this UPS can provide automatic, unattended shut-down of a LAN in the event of a power failure.

Another product worthy of note is *Power Sleuth* from Sola, which provides *Windows* users with a way to monitor power at all times. It can signal power problems while other *Windows* applications are running, even when iconized. Its icon can be made to flash and sound a beep when a power-related problem occurs.

While running, *Power Sleuth* displays bar and line graphs for important UPS parameters like input, output and battery voltages and output current. This information is updated every 2 seconds, in real-time, so that *Windows* users can pinpoint the time, duration and nature of their power problems, even when the system is unattended.

Power Sleuth requires *Windows* 3.0 and a free serial port. It works best on 80286 and later computers equipped with at least 1M of RAM. A mouse is recommended for this program designed to be used with Sola's UPSs.

Electrified

WE WILL TRY TO BEAT ANY PRICE ON ANYTHING FROM ANYWHERE!!!
A TRULY PROFESSIONAL STAFF WITH A COMMITMENT TO SERVICE!!!

COMPUTER COUNTRY

386-33MHz / 64K CACHE SYSTEM

1 MB Installed - Expands to 32 MB — Mini Tower Case w/ Digital Display
Hard Wired Technology — AMI BIOS — 7 Slots (1-32 Bit, 4-16 Bit, 2-8 Bit)
Socket for Intel 80387 or Weitek 3167 Math Coprocessor
Page Interleave Memory Controller — Keylock Interface
Real Time Clock/Calendar w/Battery Back-up — CPU Speed is Switchable by
Hardware or Software — Up to 5 Storage Devices - ONE - 3-1/2" Half Ht. Bay
Four 5-1/4" Half Ht. Bays (3-Open, ONE Hidden)
Turbo-Power-Hard Disk LED's — Reset-Power Switches
200 Watt Power Supply — 101 Deluxe Keyboard
1-Year Warranty Parts and Labor

UNBELIEVABLE!!

\$995

Full Size TOWER Case Available! Quantity Discounts Available!!!

386-25MHz

1 MB Installed - Expands to 8MB
Mini Tower Case w/Digital Display
Hard Wired Technology - AMI BIOS
8 Slots (1-32 Bit, 5-16 Bit, 2-8 Bit)
Socket for Intel 80387 or
Weitek 3167 Math Coprocessor
Real Time Clock/Calendar w/ Battery
Back-up - CPU Speed is Switchable
by Hardware or Software - Up to 5
Storage Devices - One 3-1/2" - Half Ht.
Bay - Four 5-1/4" - Half Ht. Bays (3 Open,
One Hidden) - Turbo-Power-Hard Disk
LED's - Reset - Power Switches - 200 Watt
Power Supply - 101 Deluxe Keyboard
1-Year Warranty Parts & Labor

AMAZING

\$795

Full Size TOWER Case Available -
Quantity Discounts Available!!!

BONDWELL B-200 LAPTOP

Fast - 80C88-8MHz - 640K-RAM-(2) 3.5" - 720 Drives - High
Definition Super Twist LCD Nonglare Display 640x200 CGA
Resolution - 81 Key - Keyboard - Parallel/Serail/RGB1 Video Port -
Clock/Calendar - Rechargeable - Removable Nicad Battery Pack -
AC to DC Power Adapter - DR DOS Included - Only 6.9 lbs. -
13"x12"x2.2" Full One Year Warranty From BONDWELL
-Options Available.

AMAZING

\$499

MORE LAPTOPS FROM BONDWELL

BONDWELL B310-40 Laptop

80C286-40MB (25MS) - 1MB -
1.44FD - Supertwist Nonglare
LCD - DOS

\$979

BONDWELL B310-PLUS

Same as above with BACKLIT
LCD

\$1,195

8088 TURBO SYSTEM NOW 10/12MHz

Available — Call For Pricing

SYSTEM OPTIONS

386/386SX/286 SYSTEM OPTIONS

| | | | |
|---|--------|---|---------------|
| 512K Upgrade for 386SX/286 (1 Full Meg) | \$ 99 | AT&T 40 MB Tape Backup Kit | \$199 |
| MEMORY Upgrades Available | CALL | AT-Parallel/Serail/Game Card | \$ 29 |
| Controller — Dual HD-FD | \$ 79 | DOS 9.1, 3.2, 3.3, 4.01 | \$39/49/69/79 |
| 1.2MB or 360K - 5 1/4" Drive | \$ 79 | Parallel or Serial Card | \$ 19 |
| 720K — 3 1/2" Drive | \$ 79 | VGA Monitor and VGA Card | \$299 |
| 1.44MB — 3 1/2" Drive - requires DOS 3.3 | \$ 99 | 14" RGB Color Monitor w/Color Card | \$149 |
| 20MB — Hard Drive | \$ 149 | Color Graphics w/Printer Port | \$ 99 |
| 30MB — Hard Drive | \$ 179 | NCR 15" GREEN with NCR Card | \$ 99 |
| 40MB — Hard Drive (SPECIAL) | \$ 189 | AT&T 12" Black & White TTL and AT&T Card | \$ 99 |
| 60MB — Hard Drive | \$ 279 | 12" Monochrome Hi-Res — TTL | \$ 59 |
| 80MB — Hard Drive | \$ 499 | Monochrome Graphics Card with Printer Port | \$ 39 |
| 110MB - Hard Drive- SPECIAL | \$ 399 | | |
| LARGER HARD DRIVES AVAILABLE | CALL | | |
| IRWIN 20MB — Tape Back-Up System | \$ 149 | | |

DRIVE WARRANTIES VARY
CALL FOR DETAILS

286 SYSTEMS

QUADRANT 286/6 Mhz System

512K - Full Size Case - BRAND NEW
200 Watt Power Supply - Deluxe Keyboard
- 8 Slots - 6-16 Bit and 2-8 Bit
Clock Calendar w/Battery Backup
Quantity Discounts
CALL **\$249**

AWESOME

80286-TURBO 10/16 Mhz
Fully IBM Compatible Zero Wait State!!

512K Installed - Full Size Case - 200 Watt Power
Supply - Award BIOS - 101 Keyboard -
Up to 4MB on Motherboard
7 I/O Slots - 80287 Socket - Reset and Turbo Button
- Keylock and 3 LEDS - Clock/Calendar
1 YEAR WARRANTY

NOW
16MHz

\$349

386SX - 16MHz

512K Installed - Full Size AT Case
200 Watt Power Supply - AMI BIOS -
ZERO WAIT STATE
80387SX - Socket - Clock/Calendar
Up to 20 MB on the Motherboard
101 Deluxe Keyboard - 8-Slots
Reset and Turbo Buttons - Keylock
3 (1/2HT, 5 1/4") and
2 (1/2HT, 3 1/2") Drive Bays
Mini Tower or Full Tower Available
1-Year Warranty

\$549

HARD DRIVE DEALS

COMPUTER PRODUCTS

| | |
|--|-------|
| AT&T 40 MB Tape Backup Kit- Internal | \$199 |
| MICROSCIENCE 4070-62MB-MFM-T8MS | |
| 3-1/2" w/5-1/4" Frame - 1 Year Warranty- NEW | \$349 |

MINISCRIBE 30 MB HARD CARD
Fits in a 8-Bit Slot - No Controller Required
Low Voltage - 3-1/2" - Design for PC/XT/AT
Brand New **15** Month Warranty **\$229**

| | |
|---------------------------------------|-------|
| MINISCRIBE 3675-62MB-RLL-5 1/4"-NEW | \$229 |
| MINISCRIBE 8450-40MB-RLL-3 1/2"-NEW | \$199 |
| SEAGATE-ST-138R-32MB-RLL-3 1/2" | \$189 |
| SEAGATE-ST-238-30MB-RLL-5 1/4"-1/2HT | \$179 |
| SEAGATE-ST-225-20MB-MFM-5 1/4"-1/2HT | \$149 |
| WESTERN DIGITAL-MFM-XT Cont. w/Cables | \$ 49 |

RLL Controllers for XT and AT's Available
MINISCRIBE Warranty - 6 Months - NEW DRIVES
Seagate Warranty - 90 Days - OEM Pulls
QUANTITY PRICING AVAILABLE — CALL

SEAGATE SWIFT ST-1100/ 94355-100

100MB Unformatted - 84 MB - Formatted
Access Speed **15 MS** MFM
3.5" Raw Drive - BRAND NEW
6 Month Warranty
Quantity Discounts Available!
AMAZING \$449

MICROSCIENCE MODEL 4090

111MB (Unformatted) 93 MB (Formatted)
Access Speed - 18 MS
3-1/2" w/5-1/4" Frame-RLL
4 MS Access Track to Track-VOICE COIL DRIVE - 1 Year Warranty
\$399

SEAGATE ST-4051

40MB - Full Ht. - 40 MS - Seagate Pulls
15 Month Warranty Brand New Condition **\$169**

—Computers—

Acer Altos • Apple • Citizen • Compaq • Goldstar •
JCC • Leading Edge • Quadrant • Mitsubishi • NEC •
Packard Bell • Panasonic • Samsung • Sharp •
Toshiba • Trintity • Unisys • WYSE

—Laptops—

Bondwell • Compaq • Goldstar • Leading Edge •
Mitsubishi • NEC • Packard Bell • Panasonic •
Samsung • Sharp • Texas Instruments • Zenith

—Monitors—

Amdek • Apple • AT&T • Goldstar • Hitachi • IBM •
Magnavox • Mitsubishi • NCR • NEC •
Packard Bell • Panasonic • Princeton Graphics •
Samsung • Seiko • Sony • Tatung • Zenith

—Printers—

ALPS • Apple • Brother • Canon • Citizen • C-ITOH •
Diablo • Diconix (Kodak) • Epson • Fujitsu •
Genicom • Hewlett Packard • IBM • Mannesmann •
Tally • NEC • Okidata • Panasonic • Printronics •
Seikosha • Televideo • Texas Instruments • Toshiba

Financing Available!

Electrified Discounters

HOURS: Mon-Thurs 9AM-7PM
Fri-Sat: 10AM-6PM
1066 Sherman Avenue
Hamden, CT 06514
FAX 203-248-8680
FAX ORDERS AND BIDS ACCEPTED!

Orders
Only

(800) 678-8585

Customer Service & Technical Support (203) 287-1976
Mon-Fri 9:00 am - 5 pm EST

30-DAY MONEY
BACK GUARANTEE!
Full Refund of HARDWARE
Price on all Advertised Products
Catalog Sent With All Orders

Dealer Inquiries Invited

All Prices listed are Cash Discounted. Add 2-1/2% for
MasterCard, VISA, or AMEX. Not responsible for
typographical errors. Prices are subject to change
without notice. Conn. residents add 8% sales tax. NY
Sales - add NY Tax. Quantities are limited! Prices do
not include freight. Allow 3 weeks for personal
company check clearance. Compatibility is not guar-
anteed. IBM is a registered trademark of International
Business Machines, Inc.



DENON CD-ROM DRIVES

Mass Amounts Of Information Are At Your Finger Tips
Waiting To Be Unleashed — YOU NEED IT NOW!!

- 600 MB Storage Capacity • Embedded SCSI Controller with Versatile Command Message Sets • High Capacity, High Transfer Rate Buffer — Up to 176 KB/Sec
- 5.25" Half Height Drive • Quick Access Time
- 400 MS Typical Seek Time • 32 K Disk Buffer • Front Loading Cartridge System For Easy Handling and Disc Protection
- Horizontal and Vertical Installation Compatibility • High Fidelity Audio Output
- Stereo Headphone Jack • Includes CD Caddy
- One Year Parts and Labor Warranty

Internal Kit For PC/XT/AT Complete Hardware Kit
- Internal Mounting
LIST PRICE \$799

External Kit For PC/XT/AT Complete Hardware Kit
- External Mounting Kit Includes Case and Power Supply
LIST PRICE \$999

YOUR COST

\$369

YOUR COST

\$469

We Currently Have The Following CD ROM Bundle Available

ONLY **\$169**

ENCYCLOPEDIA - From Grotier - All 21 volumes of the Academic American Encyclopedia with 33,000 entries, over 1,000 pictures and more than 9 million words. **REFERENCE LIBRARY** - Includes Webster's New World Dictionary, Dictionary of Quotable Definitions, Dictionary of 20th Century History, New World Guide to Concise Writing, National Directory, and J.K. Lasser's Legal Forms for Smaller Businesses. **WORLDBALLS** - Over 240 Detailed EGA/VGA color maps and thousands of facts on government, economy, communications, and over 70 other topics. **USATLAS** - Maps and information on more than 200 US regions. **GAME PACK** - Includes the 5 following games: Beyond The Black Hole, Life & Death, Gin King, Bruce Lee Lives, and Chessmaster 2000. The Software Bundle is Sold at \$169 With CD-ROM Hardware Purchase. CD-ROM Bundle Without Hardware is \$299. Software Bundles Are IBM Compatible. Additional Titles Available CALL!

SCANNING SCANNERS

CHINON FULL PAGE SCANNER FLAT BED CAMERA TYPE

Includes: Utility Software
Serial Scanner Cable
(Hooks Up To Your Serial Port)
No Kit Required
Resolution: 200, 150, 120, 100 DPI
PCX and TIF Format-Zoom In Image
Character Mode or Graphics Mode/Contrast Control
READRIGHT - OCR Software Only \$199*
Macintosh Interface Option Available
Parallel Interface Option Available
FAX Boards Are Available
Full Manufacturers Warranty To The End User

FREE*

OCR Compatible Software



Model DS-2000

List \$595

\$349

*W/Chinon DS-2000 Purchase

Quantity Discounts Available

AT&T FULL-PAGE SCANNER **SAVE OVER 75%**



MODEL SC-60 **BRAND NEW**
Sheet Feed Series
Includes - IBM Compatible Interface Card
Not Micro Channel Compatible
Includes - AT&T PAGE POWER SOFTWARE
(Draw, Scan and Fax Package)
Includes - Microsoft Runtime Windows • Resolution 200 DPI Full-Page/
400 DPI Half-Page - OCR Compatible
OCR Software Now Avail. ONLY \$169
Half-Tone feature for Photographs

List \$1190

1 Year Warranty List \$1190

AMAZING ONLY **\$299**

FREE Microsoft Windows 3.0 Upgrade

Electrified

WE WILL TRY TO BEAT ANY PRICE ON ANYTHING FROM ANYWHERE !!!
A TRULY PROFESSIONAL STAFF WITH A COMMITMENT TO SERVICE !!!

HITACHI - CDR-1503S - External CD-ROM System

Audio Output - Slim Design and Reinforced Body 15"x13"x3"
Includes MS-DOS Extensions
Refurbished - Like New Condition
- 6 Month Warranty

WOW!!! **\$379**

PRINTER POWER

IBM 5182 COLOR PRINTER Heavy Duty • Wide Carriage (132 Column)

- 200 CPS Draft - 110CPS Correspondence - 35 CPS NLQ **BRAND NEW**
- Prints Black, 4 Colors, and 8 Colors • BiDirectional Dot Matrix
- 9 Wire-Parallel Interface • Tractor Included **List \$1,995**

FRONT - BOTTOM - REAR PAPER FEED
Paper Rack Available - Only \$12.95
Easy Change Cartridge Ribbons - Available

Quantity Pricing — CALL 90 Day Warranty

\$399

SEIKOSHA-SL-80AI PRINTER

24-PIN Narrow Carriage - W/Tractor

135 CPS - 54 NLQ - Parallel Interface Epson/IBM Emulation **List \$499**
2 Year Warranty

Renewed

Mint Condition **\$149** Brand New

\$169

| | | |
|-------------------------|----------------|---|
| PANASONIC KXP-4420 | Renewed \$ 749 | 8PPM, HP Compatible 1 Year Warranty |
| DIABLO-D80IF | \$ 499 | 80 CPS-Ltr, Qty-w/Sheet Feeder-Refurbished |
| PANASONIC KXP-1695 | Renew \$ 349 | 330 CPS - 66 NLQ - Wide Carriage |
| PANASONIC KXP-1624 | Renewed \$ 339 | 24-Pin, Wide Carriage, 192 CPS, 63 NLQ |
| CENTRONICS-136B | New \$ 299 | 180 CPS -34 NLQ - Wide - Heavy Duty |
| CITIZEN MSP-50 | New \$ 249 | 300 CPS-50 NLQ - Narrow - Color Optional |
| PANASONIC KXP-1124 | Renewed \$ 229 | 24-Pin, 192 CPS, 63 NLQ - 2 Year Warranty |
| TOSHIBA 301(Below Cost) | New \$ 199 | Laptop Printer - 24 Pin - 180 CPS |
| SEIKOSHA SL-1600AI | New \$ 129 | 160 CPS - 40 NLQ - Narrow - 2 Year Warranty |
| RITEMAN by C.ITOH | New \$ 119 | 120 CPS - 80 CPS Exp. - Narrow Carriage |

MONITOR MANIA

Panasonic 1381 - 13" - MultiSync, .28 DP, 1024 x 768 - ..Renewed \$309
Magnavox 9CM082 - 14" VGA Color, 31DP, 800x600 2 yr Warranty, Renewed \$279
Magnavox CM-9032 - 14" VGA Color - 720x480 - Tilt/Swivel Renewed \$229

AMSTRAD COLOR VGA

ULTRA-Res-12" VGA-PC-Model 12HR
Tilt & Swivel-720x480-Anti-Glare Screen **1 YEAR WARRANTY**

.28

BRAND NEW

\$299

DOT PITCH

ONLY \$99

STB-VGA Extra Card

Hi-Res
800x480

AT&T CRT-327-12" TTL **BRAND NEW**

Tilt & Swivel Black & White Monitor - INCLUDES AT&T 1024HP Card
List 90 Day Warranty

Works on All IBM AT/XT's & Compatibles

\$1390

ONLY **\$119**

6-\$115, 12-\$109, 24-\$105, Over 24-CALL

NCR - 15" - Green - TTL **BRAND NEW**

with NCR - Monitor Card 640x400 **1 YEAR** List **\$99**
Warranty \$438 **Save over 75%**

Financing Available!

Electrified Discounters

HOURS: Mon-Thurs 9AM-7PM
Fri-Sat: 10AM-6PM
1066 Sherman Avenue
Hamden, CT 06514
FAX 203-248-8680
FAX ORDERS AND BIDS ACCEPTED!

Orders Only

(800) 678-8585

Customer Service & Technical Support (203) 287-1976
Mon-Fri 9:00 am - 5 pm EST

30-DAY MONEY

BACK GUARANTEE!

Full Refund of HARDWARE
Price on all Advertised Products
Catalog Sent With All Orders



Dealer Inquiries Invited

All Prices listed are Cash Discounted. Add 2-1/2% for MasterCard, VISA, or AMEX. Not responsible for typographical errors. Prices are subject to change without notice. Conn. residents add 8% sales tax. NY Sales - add NY Tax. Quantities are limited. Prices do not include freight. Allow 3 weeks for personal/company check clearance. Compatibility is not guaranteed. IBM is a registered trademark of International Business Machines, Inc.

CIRCLE NO. 96 ON FREE INFORMATION CARD

rious peripherals. Some devices called "surge suppressers" are actually power-line filters that offer more protection.

Power-line filters, the next higher level of protection, incorporate all the functionality found in surge suppressers and add capacitor/inductor filters to limit emi and rfi noise from entering (or exiting) your system's power supply. Ideally, the filter circuit used in a power-line filter should match the impedance of the power supply it protects.

Power-line filters for use with personal computers are designed for the impedances generally found in personal-computer supplies and, thus, work well with most systems. A variety of noise-filter circuit configurations are used to attenuate noise, including dual-wound toroid inductors and proprietary filtration systems. Their typical cost ranges from \$40 to more than \$100.

Power Conditioners incorporate the functionality of power-line filters, including surge and spike protection, but they go a large step further toward fully guarding your system, protecting it from everything but a blackout. Unlike the power-line filter, a power conditioner can also handle power-line sags, as well as brownouts and chronic overvoltages (at a noticeably higher price than power-line filters).

Power conditioners usually incorporate a multi-tap transformer. When a change (increase or decrease)

in the incoming power-line voltage beyond certain limits is detected, the conditioner quickly switches the line to a different tap, stepping the voltage up or down as required to compensate for the voltage change. Power conditioners generally cost from about \$100 to several hundred dollars, depending on how great a load is supported.

Of course, even a power conditioner won't help if ac power fails entirely (a blackout). In many cases, you'll lose only what you've been working on since you last saved your work to disk, but a blackout *can* occur during a write to your hard disk—perhaps when it's updating the FAT—and the results could be disastrous. *Uninterruptible power supplies* (UPSs) are designed to keep your computer running when the lights go out—at least long enough to perform an orderly system shutdown (typically 5 to 20 minutes). They incorporate an internal battery and 117-volt ac generation circuit (known as an inverter) to keep your system running in the absence of ac line power.

Two basic flavors of UPSs are currently available: *continuous on-line* (or *true*) type and *standby* (or *off-line*). Operation of the standby UPS—also called a standby power source, or SPS—is illustrated in Fig. 3. Incoming ac power is routed directly to the output during normal operation, while the inverter is dormant and the internal battery is also being trickle charged to maintain full

charge. When an ac power failure occurs, or with some designs voltage falls below a preset value, the UPS quickly switches its output to the internal ac generator, allowing the battery-operated circuit to supply ac power to your system.

With internal capacitors storing energy, most personal-computer power supplies can handle a one-cycle ac loss (about 16.7 milliseconds at 60 Hz). When the incoming ac power is lost, most modern standby UPSs switch to backup power within 5 ms, which is usually sufficient margin. Units that take longer than 10 ms to switch should be avoided. Some industry observers have raised concern that standby units may fail when switching to internal power, but experience has shown such concerns to be generally unwarranted.

Since the standby UPS routes incoming ac power directly through to its output during normal operation, no other power protection is necessarily provided by the unit. Spikes, transients, noise and other power-line disturbances can be free to pass through. To provide more protection, however, many standby UPS manufacturers incorporate surge-protection or power-conditioning circuitry into their units, which provides improved ac power in addition to blackout protection. Prices for standby UPSs start at around \$250 and go up to \$1,000 and higher.

Operation of the continuous on-line UPS is illustrated in Fig. 4. As

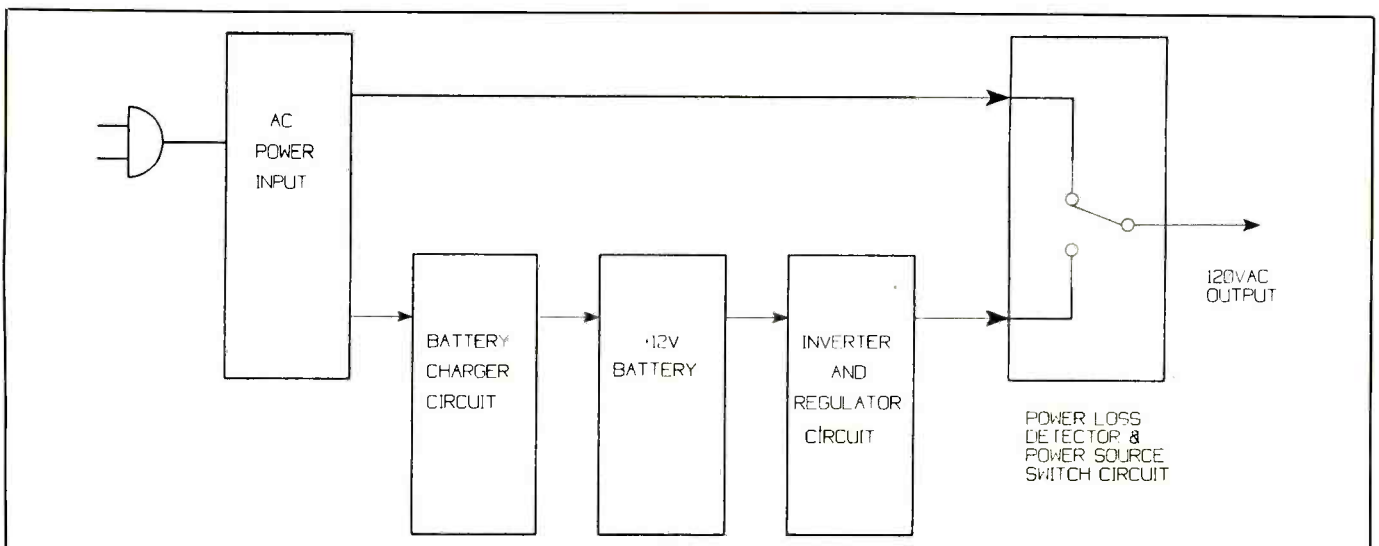

Fig. 3. Operation of a standby UPS. Voltage from ac line is routed to output until line power is lost.

shown, the output is continuously driven by the UPS's battery-operated ac generation circuitry. Thus, the output always provides a pure ac signal, independent of what disturbances may be present on the incoming ac power line. Thus, in addition to blackout protection, these units provide protection against noise, spikes, transients, voltage sags, voltage surges, chronic overvoltages and brownouts. The perfect solution. Because of the hefty charging circuit required in the on-line units as compared to their standby cousins, these units typically command a 50% to 100% price premium over comparable standby units.

Uninterruptible power supplies, like power conditioners, are sized by load watts or volt-amperes (VA), which are essentially the same when dealing with computers. To determine the size you need, determine the number of watts for each device you want to include on the UPS (typically your computer and monitor, and possibly a printer) and add about 25% for safety margin and future expansion. For your computer, the

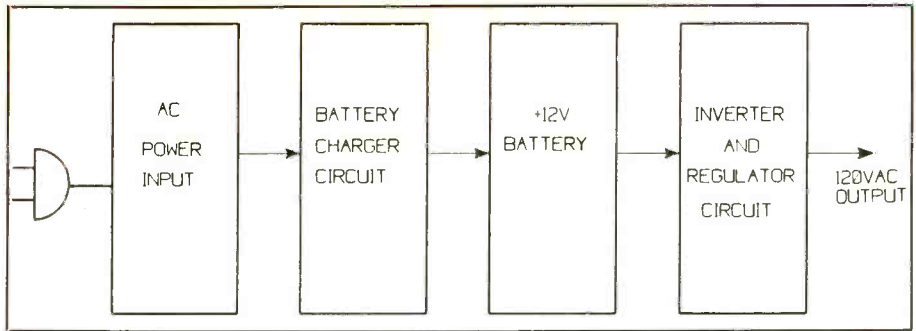

Fig. 4. Operation of a continuous on-line UPS. With this design, output is always driven by battery circuit.

power-supply wattage will serve as an adequate (conservative) estimate of its power consumption.

While most UPSs output a true sine wave that closely approximates that generated by your local power company, some less-expensive units generate more of a square-wave-type output instead. Although supplies with a square-wave output will generally work, they're sometimes the source of compatibility problems. Therefore, use sine-wave units for best operation.

Some UPSs have special "LAN-

compatible" circuitry that allows them to generate a message to an external device (such as a LAN server) via a serial or parallel port, indicating that an ac power failure has occurred and that a system shutdown should take place. Software, such as *Safe Watch* from Safe Power, can be used on the server to automatically close system files and turn off UPS power in a safe, orderly fashion.

Of course, modems and faxes have become integral parts of modern computing, and the power-protection companies haven't left support

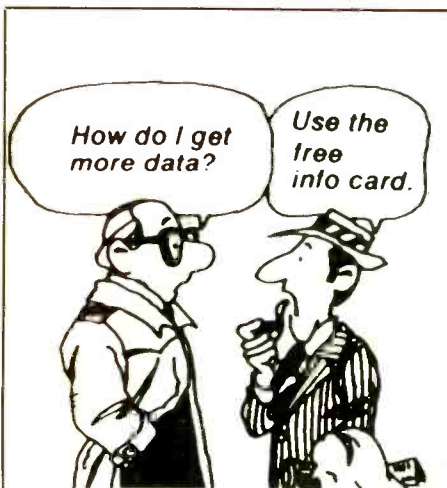

Free Product Information

Readers can obtain free information on products advertised, as well as for some editorially mentioned products. Simply circle the appropriate number printed below an advertisement onto the CC "Free Information Service" card bound into this issue. After filling in your name and address, just mail the postpaid card. Your request will be forwarded directly to the advertiser with a mailing label prepared by our reader-service department.

SAVE MONEY. DON'T RENT!

CABLE TV DESCRAMBLERS, CONVERTERS, & ACCESSORIES.

Save hundreds of dollars owning instead of renting from the cable company.

Easy to order and install.

Name brands—Pioneer, Oak, Panasonic, Jerrold, Scientific Atlanta and more.

We're famous for lowest prices, excellent service and immediate delivery.

All products fully warranted. Your satisfaction is 100% guaranteed.

CABLE READY Company

CALL FOR FREE FULLY ILLUSTRATED 16-PAGE COLOR CATALOG.

(800) 234-1006

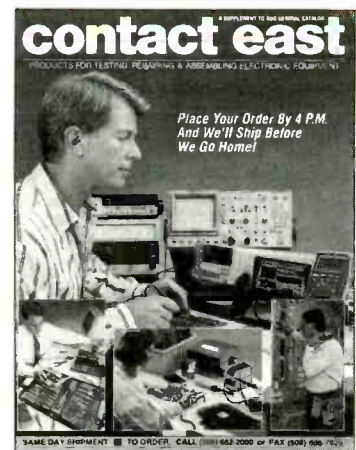

FREE CATALOG TEST INSTRUMENTS & HARD-TO-FIND TOOLS

Packed with over 10,000 quality products for testing, repairing, and assembling electronic equipment. A full selection of test instruments, power protection equipment, precision hand tools, tool kits, soldering supplies, and much more. Products are shown in full color with detailed descriptions and pricing. All products come with a 100% satisfaction guarantee. SAME-DAY shipment program.

In a hurry to receive your catalog?

Call (800) 225-5370

In Massachusetts call (508) 682-2000

Contact East, Inc., Dept. R486
335 Willow St., No. Andover, MA 01845

CIRCLE NO. 154 ON FREE INFORMATION CARD
August 1991 / COMPUTERCRAFT / 49

Earn Your B.S. Degree in ELECTRONICS or COMPUTERS

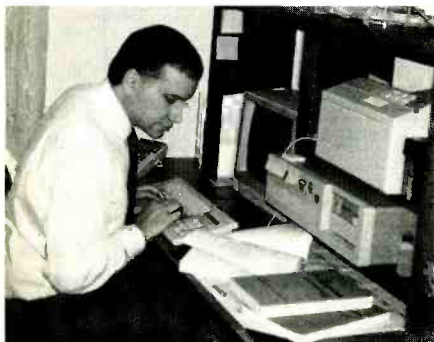

By Studying at Home

Grantham College of Engineering, now in our 41st year, is highly experienced in "distance education"—teaching by correspondence—through printed materials, computer materials, fax, and phone.

No commuting to class. Study at your own pace, while continuing on your present job. Learn from easy-to-understand but complete and thorough lesson materials, with additional help from our instructors.

Our Computer B.S. Degree Program includes courses in BASIC, PASCAL and C languages — as well as Assembly Language, MS DOS, CADD, Robotics, and much more.

Our Electronics B.S. Degree Program includes courses in Solid-State Circuit Analysis and Design, Control Systems, Analog/Digital Communications, Microwave Engr, and much more.

An important part of being prepared to *move up* is holding the right college degree, and the absolutely necessary part is knowing your field. Grantham can help you both ways—to learn more and to earn your degree in the process.

Write or phone for our free catalog. Toll free, 1-800-955-2527, or see mailing address below.

•
Accredited by
the Accrediting Commission of the
National Home Study Council
•

GRANTHAM
College of Engineering
Grantham College Road
Slidell, LA 70460

for them out of their product lines. Spikes, transients and surges tend to be the problems most likely to afflict your phone line, and many phone-line surge protectors are now available. In fact, they're sometimes a part of an ac surge protector, allowing your computer or fax machine to be power-line protected, as well as your modem or fax to be phone-line protected to ac ground.

Bells & Whistles

Depending on the model you purchase, stand-alone UPSs are likely to be equipped with one or more indicators that let you know operating conditions. At the most basic level, the UPS will have visual or/and audible indicators to alert you to when a power failure or serious voltage sag or surge has occurred. Light-emitting diodes are the common visual indicators, while a variety of buzzers and beepers serve as audible warning indicators.

More elaborate UPSs supplement the basic indicators with others that tell you something about their conditions. Typically along these lines are LEDs that indicate normal ac line power, as well as over- and under-voltage conditions. Other LEDs on still more elaborate units keep you informed of the level of the internal battery's charge and how much load is placed on the UPS. Almost universally, the LEDs used as indicators are color coded, with green meaning normal or safe conditions, yellow (or amber) indicating a condition on the verge of causing a problem and red indicating full alert.

Depending on its output power capacity, a UPS may have as few as two or as many as four ac receptacles on it into which you can plug your computer and any self-powered peripherals. The more powerful the UPS, the greater the number of ac outlets available into which to plug devices. Bear in mind, though, that you should *never* exceed the manufacturer's recommended load when plugging devices into a UPS. If the UPS has a LOAD indicator, always maintain the load so that it registers in the "safe" area (though it's okay if the indicator occasionally strays into the potential-problem—yellow or amber indication—area. If the load indica-

tor mostly goes into the potential-problem indication and occasionally goes into the danger—red—area, disconnect one or more peripherals from the UPS.

Conclusion

It seems that the software industry became aware of the need for power protection even before the hardware industry did, after searching for "bugs" that were really problems caused by power-line disturbances. Years of experience have confirmed the importance of at least surge-protector level of power protection for today's personal computers, with power-line filtering being a preferable alternative. With a wide variety of power-protection alternatives available from which to choose, you can pick the one that suits you best and fits your budget.

In considering which type of protection you need to guard your hardware and software against damage, you should give thought to your electrical environment and geographical location. For the former, are you in a commercial building, where elevators cause electrical problems, where there's a photocopy machine nearby, a factory with electric motors switching on and off constantly? Are you located in a tropical or temperate zone where lightning strikes are common? Two-thirds of the US has 40 days or more of lightning strikes during a single year, mostly in summer months. Tampa, Florida, for example, averages 100 strikes per year; Dallas, Texas, 60 strikes; and San Francisco, California, only five.

One more thing you should keep in mind, no matter what kind of power-protection device you may have on your computer, is that nothing substitutes for regular backups of your hard disk. ■



Roger Alford

SPEED TEST YOUR PC

You've seen the Landmark Speed Rating advertised by many major PC manufacturers, now you can have your own copy of the Landmark System Speed Test™

Accurately measure CPU, math, and video speeds to make an informed purchasing decision, determine the best PC for the job or maybe just win some bets in the office on whose PC is really faster! Includes the Landmark AT CMOS RAM Setup program to update your system configuration on-the-fly. \$29.

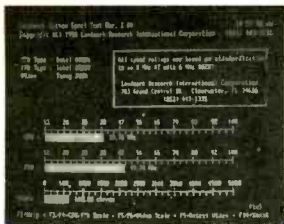

THE 5 MINUTE SOLUTION TO FLOPPY DRIVE FAILURE

With AlignIt™ you can clean, diagnose, and align your floppy drives in minutes without a scope. Patented technology requires only a screwdriver to perform ANSI-accurate alignments (.3 mil).

AlignIt is ideal for corporate users with 2 or more PCs because it includes a "GOLD STANDARD" feature so you can align all your PCs to the same in-house standard, guaranteeing that all your floppies are perfectly interchangeable between PCs.

80% of all floppy drive failures can be fixed with AlignIt. So don't replace your drive, save time and money instead.

Includes dual size floppies, (both high and low density) and no-mess pre-lubricated cleaning diskettes (both sizes) good for 180 uses. Replacements and single drive size versions available. For all PCs and compatibles. \$249 (single size \$149).

HARD CORE TESTING FOR PROFESSIONALS

Landmark/SuperSoft Service Diagnostics™ is ideal for professionals requiring the most exhaustive diagnostic test capabilities. Each module is CPU specific, including PC, XT, AT, 386/486, and PS/2. Since 1981 major manufacturers like Wang, Xerox, Prime, Sony, DEC, NEC, and NCR have relied on Service Diagnostics to tackle their toughest operating problems.

Intended for professional service and repair technicians, Service Diagnostics is also easy to use for the novice. Clear, concise on-line help and intuitive menus make finding system problems a breeze. Tests all CPUs, math chips, all memory, floppy, fixed and non-standard disk drives, standard/non-standard printers, system board, video, com ports and all keyboards. Utilities include low-level reformat, log bad sectors, edit bad sector table; the partition editor allows you to set up multiple partitions; back-up program transfers hard disk image on unformatted floppies and allows for restore after reformat.

Ideal for UNIX and other operating systems, the self-booting version doesn't require DOS. The manual offers troubleshooting tips to the component level. Also available in a complete Kit including, all CPU specific software, dual size floppy alignment software (see AlignIt), and PC/XT & AT ROM POSTS. Winner of the PC Magazine Editor's Choice Award in August 1990.

PC WON'T BOOT? THEN JUST KICKSTART IT!

Don't replace your motherboard, don't call service, use KickStart 2™. When serious hardware problems occur, nothing gets you up and running as fast. KickStart 2 measures power within 2.5% on all four voltages, shows Power-On Self-Test (POST) failure codes, and features on-board ROM-based diagnostics allowing you to determine and remedy the problem quickly, easily, and inexpensively!

Built-in serial and parallel I/O allows for testing via modem, or simply logging results to a remote terminal, printer or laptop. You can configure your own test routines and store them in KickStart 2's battery backed-up CMOS RAM saving valuable setup time. Includes serial and parallel loopback plugs and Landmark JumpStart AT ROM BIOS for testing PCs that don't issue POST codes. KickStart 2 tests your system regardless of O/S (even UNIX).

On-board switches, LEDs, and digital displays allow complete control over testing in systems lacking video or disk (ideal for motherboard or system burn-in).

KickStart 2 is the ultimate SECURITY CARD too! With both supervisor and user levels of password protection, you can prevent unauthorized use of your PC and accidental running of destructive tests. \$599.

"KickStart 2 system diagnostics board helps users check out virtually every aspect of a PC's hardware system... the board is a worthy investment for computer maintenance." David Claiborne, PC Week - December 24, 1990.

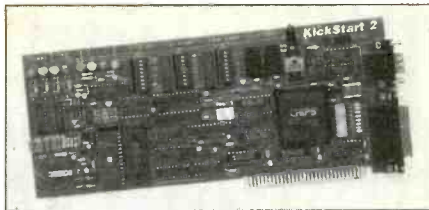

KickStart 2 is ideal for permanent installation. It eliminates the need for an I/O card, provides remote and on-site diagnostic capabilities for quick repair time and offers a solid hardware based solution to unauthorized access with impenetrable password protection.

SLASH DOWNTIME AND OPERATING PROBLEMS

With PC Probe™ you'll save time and money when your PC starts acting up. In one easy-to-use package you get Diagnostics, Benchmarks, Performance Enhancement Utilities, and System Information. Combined, this arsenal of tools will keep your system up and running at peak performance and remove the mystery about what's inside.

PC Probe diagnostic testing quickly isolates the source of hardware problems, even locating bad RAM chips. It tests system board, RAM, video, keyboard, com ports, floppy drive, hard drive, Ethernet card and more. Run PC Probe tests in batch mode or single pass, remote or on-site.

PC Probe allows you to increase your hard drive data transfer rate by determining optimum interleave and changing it, prevent catastrophic data loss by performing data revitalization, reformat the hard drive, run external programs, display and edit CMOS RAM on-the-fly, prevent accidental hard drive data destruction with passwords, diagnose problems with device drivers installed.

The 200 page on-line manual has built-in table of contents, topic/text search, and troubleshooting tips. PC Probe comes with dual size floppies and 9 & 25 pin serial/parallel port loopback plugs. For PC XT, AT, 386, 486 and compatibles using DOS 2.0 or higher. \$149.

HOW TO DEBUG A DEAD PC

Need an inexpensive solution for dead or problematic PCs and motherboards? Try KickStart 1™ or JumpStart ROM POST™, two quick and easy to use debugging tools.

KickStart 1 test card shows power status on all four voltages and binary PORT 80 Power-On Self-Test codes. The manual translates error codes for easy failed circuit isolation.

JumpStart ROM POST is a plug-in chip designed to replace your motherboard BIOS for testing purposes. Tests include CPU register and logic, 8087 math coprocessor, 8253 timer, 8237 DMA controller, 8259 interrupt controller, parity error and memory refresh logic, erroneous maskable/non-maskable interrupt detection, display adapter (MDA, CGA, EGA), keyboard, keyboard controller, floppy controller, drive A: read Base memory at normal & slow refresh rates, and POST checksum. Display of motherboard switch configuration. \$199 (AT version) \$99 (XT version).

CONFUSED BY TECHNICAL COMPUTER JARGON?

Finally, with a single keystroke, you can define virtually every computer term known in a matter of seconds. This award-winning, easy-to-use utility, defines over 4200 computer terms and concepts for you without having to leave the program you're in.

The Computer Glossary™ (a software version of the best-selling book by Alan Freedman) installs as an application or hot-key accessed TSR. The definitions are written in concise, standard English. Plus, The Computer Glossary provides colorful industry "backgrounders" fascinating to the beginner and expert alike.

Get the most out of your software, manuals and computer magazines, buy The Computer Glossary and become a true PDWER USER. Runs under DOS or MS-DOS 2.0, or later, with 32K of RAM and 1.4 MB of hard disk space on IBM PC, XT, AT PS/2 and compatible computers. \$59.



"SuperSoft's Service Diagnostics: The Kit is a technicians dream, with all the tools necessary to accurately analyze all phases of computer operations... it is well worth its performance potential." Bill O'Brien, PC Magazine - August, 1990.



- Service Diagnostics XT/AT Kit \$595
- Service Diagnostics PS/2 Kit \$495
- XTROMPOST \$99
- ATROMPOST \$199

• Individual pricing available on all kit components. please inquire

CALL (800) 683-6866

Fax (813) 443-6603 • Voice (813) 443-1331
CA, WA, NV, HI, OR, AK use (800) 275-9933

Visa • MC • Amex • CODs Accepted • Dealer Inquiries Welcome



LANDMARK/SuperSoft
First in PC Testing... Since 1981

703 Grand Central Street • Clearwater, Florida 34616

Copyright © 1991-1991 Landmark, SuperSoft, PC Probe, AlignIt, KickStart, JumpStart, ROM POST, and Service Diagnostics are trademarks and registered trademarks of Landmark Research International Corp. All Rights Reserved. Other names are trademarks of their associated owners.

Experimenting With 8051 Microcontrollers

A book/disk package for the 8051 microcontroller and a low-cost development system based on the 80C32 microcontroller

When you're designing and building a microcontroller project, two things that can speed up and simplify the process are (1) circuit and programming examples that you can use as models in designing your own system and (2) development tools that make it easy to test and debug your design, allowing you to isolate and rectify those inevitable

errors that slip through in spite of your best efforts.

This month we'll look at two items in these categories. The first is a book/disk combination consisting of *The 8051 Microcontroller: Architecture, Programming, and Applications* by Kenneth J. Ayala, which describes the popular 8051 microcontroller family and includes a disk

containing an assembler and simulator for 8051 chips. The other item is Iota Corporation's EC-32 embedded controller board and monitor EPROM, which provide a low-cost development system based on the 80C32 microcontroller, a member of the 8051 family.

The focus this time is on assembly-language programming, rather than

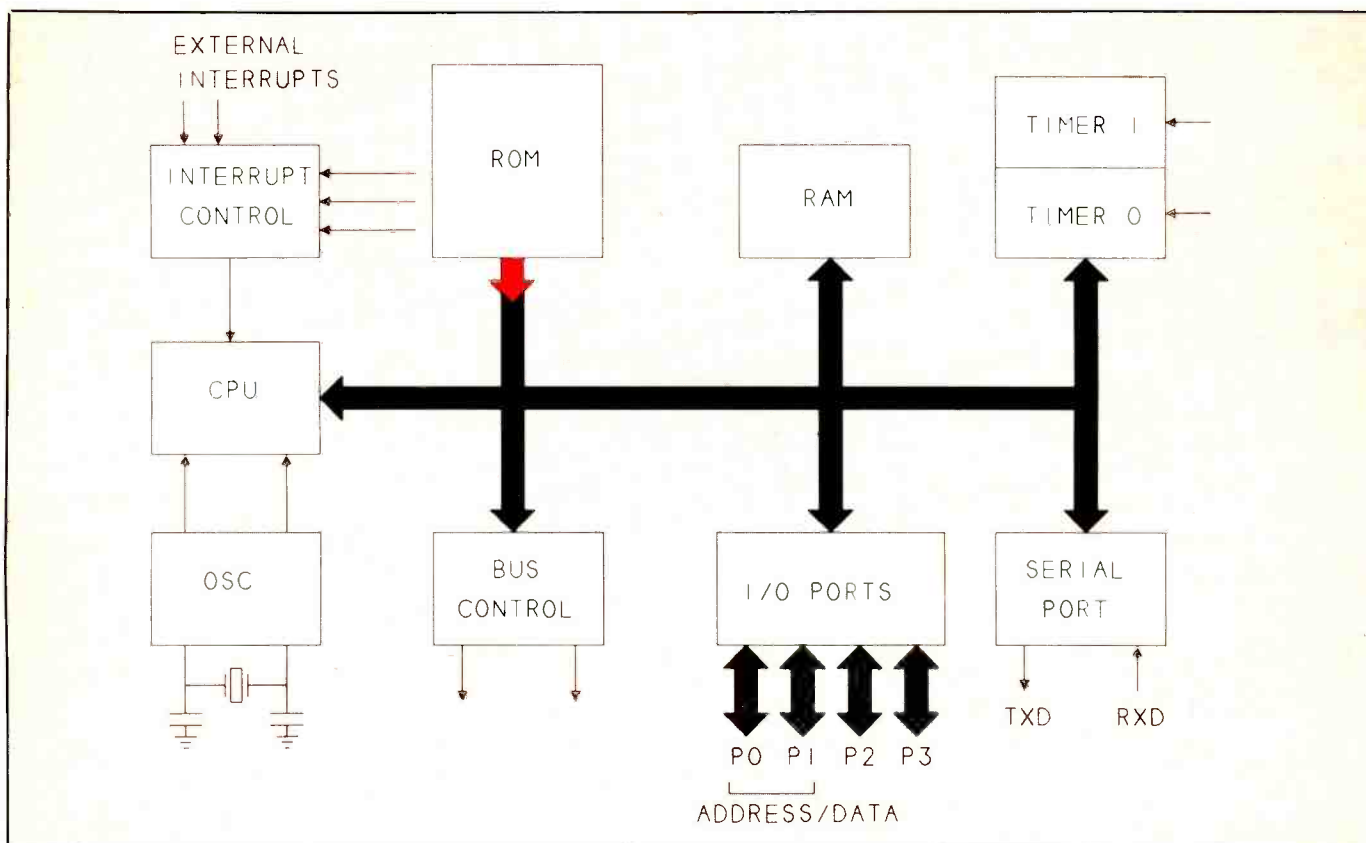

Fig. 1. Block diagram of the 8051 core shared by all 8051 family members.

higher-level languages like BASIC and C (with the exception of BASIC-52 PLUS, described briefly below). Higher-level languages are more convenient to program in, but they do have limitations.

Because assembly language is fast and concise, it's a natural choice when a program must execute quickly. For example, a motor-control program might sample information about motor speed and position, using this information to determine control signals to output to the motor. The program has to be able to sample the information, process it, and react quickly enough to keep the motor under control. A slower higher-level language may not be up to the task.

Assembly language is also the way to go when the program code must be kept as short as possible to fit into a limited amount of memory.

8051 Basics

All members of the 8051 family share a minimum configuration, which is illustrated in Fig. 1. All have an eight-bit data bus and are optimized for use in control applications, where the microcontroller senses and/or controls real-world conditions, events, processes or mechanisms, including motor control, environmental monitoring, power control, and other tasks.

The family members differ in the amount and types of on-chip memory, timers and input/output (I/O) ports. For example, the basic 8051 has 4 kilobytes of ROM, while the 83C51FB has 16 kilobytes. Some chips, like the 8031, have no ROM or EPROM; so program storage must be off-chip. Members with "C" in their part number, like the 80C32, are CMOS (low-power) versions.

The 8051 originated at Intel Corp., but other manufacturers now offer it and its variations, including AMD, Fujitsu, Siemens, Signetics, OKI, Harris and Dallas Semiconductor. Each manufacturer publishes data-books with information on its chips, and these are still the best place to look for details like timing diagrams, electrical specifications and instruction sets for a particular IC.

But sometimes it's hard to make the leap from the specifics of the data

```

.org 0000h
MOV A,0A0h ;Move the port 2 pin data to A
MOV 0F0h,R3 ;Move the data in R3 to the B register
MUL AB ;Multiply the data; A has lower order result byte
MOV R0,#11h ;Set R0 to point to external RAM location 11h
MOVX @R0,A ;Store the LSB in external RAM
DEC R0 ;Decrement R0 to point to 10h
MOV A,0F0h ;Move B to A
MOVX @R0,A ;Store the MSB in external RAM
.end

(A)

000001 0000 .org 0000h
000002 0000 E5A0 MOV A,0A0h ;Move the port 2 pin data to A
000003 0002 8BF0 MOV 0F0h,R3 ;Move the data in R3 to the B register
000004 0004 A4 MUL AB ;Multiply the data; A has lower order result
000005 0005 7811 MOV R0,#11h ;Set R0 to point to external RAM location 11h
000006 0007 F2 MOVX @R0,A ;Store the LSB in external RAM
000007 0008 18 DEC R0 ;Decrement R0 to point to 10h
000008 0009 E5F0 MOV A,0F0h ;Move B to A
000009 000B F2 MOVX @R0,A ;Store the MSB in external RAM
000010 000C .end

:0C000000E5A08BF0A47811F218E5F0F2F6
:00000001FF

(C)

```

Fig. 2. (A) shows the source file created from an example in the book *The 8051 Microcontroller*. (B) is the listing file created by assembling the source file, and (C) is the object file for the same program. The program multiplies two numbers and stores the result.

book to the reality of designing and programming a circuit. This is where additional resources can help.

An 8051 Book

The 8051 Microcontroller is one such resource. The book begins with an overview of microcontrollers and microprocessors, followed by chapters describing 8051 architecture (internal hardware) and instructions, grouped into the functional categories of Moving Data, Logical Operations, Arithmetic Operations and Jump and Call Opcodes.

The final three chapters of the book focus on circuit design, applications and serial communication, with many examples presented. I found these to be the most useful parts of the book.

An example schematic shows a basic 8031 circuit with external EPROM and RAM. Another schematic shows how to expand I/O us-

ing an 8255 programmable interface adapter. Example programs show how to test memory and generate time delays.

Other schematics and programs show how to interface the 8051 with keypads, keyboards, seven-segment and intelligent displays, digital-to-analog (D/A) and analog-to-digital (A/D) converters and serial communication devices.

To help you use what you've learned, along with the book you get a 5¼" MS-DOS disk containing student versions of an assembler and simulator, which you can use to try out the examples or other programs you write. An appendix in the book contains brief instructions on how to use the assembler and simulator. A more complete assembler manual is included on-disk.

The assembler is based on the *PseudoSam 51* A51 assembler by PseudoCorp Software. According to the documentation provided, the stu-

dent version includes most of the features of a \$50 professional version, but without macro features or options.

The assembler creates two files from the source code you provide. Figure 2 shows examples of these.

MULT.ASM is a source file taken from an example in the book. The source file consists of a series of mnemonics, or abbreviations for 8051 instructions, that perform operations to achieve the desired results. Comments can be added after a semicolon. The example program multiplies two numbers and stores the result in external RAM.

Unfortunately, the examples from the book aren't included on-disk; so to assemble an example, you must first create your own source file. You can do this with any text editor that produces files consisting of pure ASCII text.

When the source file is assembled, two new files are created: a listing file and an object file.

The object file (MULT.OBJ) contains the code that will be loaded into the microcontroller system's memory. The code is presented in Intel hex format, which includes checksums and memory addresses that are used when loading the program into an 8051 system (or simulator).

Listing file MULT.LST helps you to

see how the assembler translated the source file into object code. For each program line, MULT.LST shows the line number, a hexadecimal address, the hexadecimal code to be stored at that address and the original mnemonics and comments from the source file. For example, at line 4, the address is 0004 and the hexadecimal instruction A4 tells the microprocessor to multiply the values stored in registers A and B.

From the address count, you can determine how much memory is required to store the program. As the listing file shows, a single instruction may require one or more bytes.

The simulator included with the book lets you try out example programs, even if you don't have an 8051 system. The simulator runs on IBM-compatible personal computers, where it shows you what would happen inside an 8051 chip if it were to run the program you provide.

Like the assembler, the simulator is based on a professional product sold by PseudoCorp. An important limitation is that the simulator included with the book limits you to 1,024 bytes each of program and data memory. Since 8051 circuits can and do use as much as 64 kilobytes each of program and data memory, the student version, as its name suggests,

is useful only as a tool for learning and experimenting with simple, short programs (or as a demo for the professional version). Serious program developers need the \$100 professional version.

The simulator's screens show you the contents of memory, registers and ports in your simulated system. Figure 3 shows one of the four screens you can view. You also can create your own custom screens that display the information you want.

You can single-step through a program, set breakpoints where you want execution to stop, initiate interrupts, and change the contents of memory and internal registers as you wish.

For example, to test MULT.OBJ on the simulator, you could write sample numbers to be multiplied to Port 2 and R3, and then step through the program to check the result in external memory locations 10h and 11h.

In fact, running MULT.OBJ on the simulator uncovered a bug in the book's example program and nicely illustrates the simulator's usefulness. After loading and stepping through the program, I switched to the screen displaying external memory to verify that the product of the multiplied numbers was stored in external memory as expected. On doing so, I found that locations 10h and 11h remained

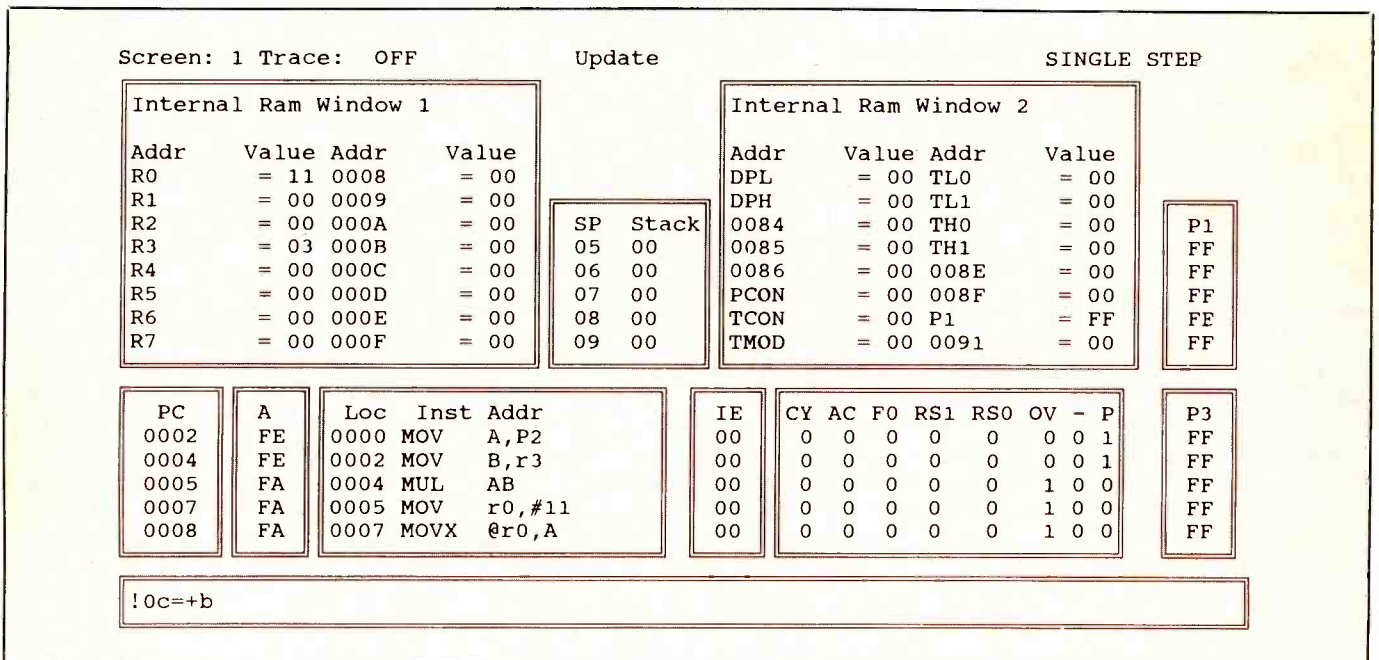

Fig. 3. This is one of four screens you can observe when running the S51 simulator. Other screens show more internal RAM, external RAM and ROM. You can also design your own screens.

at 0. Paging through the simulator's screens, I eventually found the expected values stored in *internal* memory locations 10h and 11h.

Seeking an explanation, I reviewed the listing file and noticed that in the original source file, lines 6 and 9 used a MOV instruction, which accesses internal memory, rather than MOVX, which accesses external memory. Changing MOV to MOVX in these lines and reassembling caused the result to appear in the proper locations in the simulator.

This simulator and others do have some unavoidable limitations. Because the simulator doesn't contain an actual 8051 microcontroller, but instead imitates one using the resources of a desktop computer, its execution speed will be different, compared to a real 8051 system. Also, it's difficult to accurately simulate some external hardware and I/O operations in software.

An 80C32 Board

When it's time to turn off the simulator and try out a real circuit, the EC-32 embedded controller board shown in Fig. 4 and its monitor firmware can help you get a program up and running quickly. The EC-32 contains an 80C32 microcontroller, which is similar to the 8051 but with 256 bytes of RAM (instead of 128) and three timers (instead of two). It has no on-chip ROM or EPROM, but instead runs programs stored in external memory.

The EC-32 is especially suited for experimenting and building prototypes or one-of-a-kind projects. Uses for the EC-32 have included alarm systems, oven controllers, controlling a mixing console in a music studio, test fixtures and other process-control applications.

The board has three 28-pin sockets that will hold eight-kilobyte or 32-kilobyte RAM, EPROM or EEPROM chips. The microprocessor uses an 11.0592-MHz crystal. (A 20-MHz version is also available.) An RS-232 port permits easy communication with a desktop computer or other serial device. All ICs are socketed.

Eight general-purpose I/O lines, two timers and two interrupts are available for interfacing with your own circuits. A 50-pin dual header

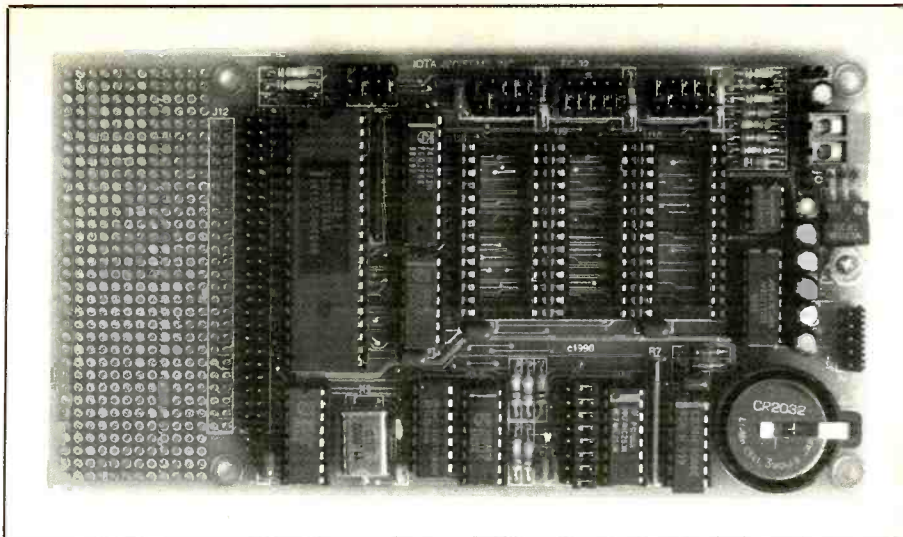

Fig. 4. The EC-32 board contains an 80C32 microcontroller, serial port, three sockets for memory and a back-up battery for RAM.

for connecting add-on boards has address, data and control lines, including eight decoded address lines.

A nice touch is a 1.2" × 3.5" breadboard area for adding your own circuits that interface to the EC-32. You could easily add an A/D converter in this space, or an 8255 programmable interface adapter or other custom circuits. If you need more breadboarding space, a separate prototyping board is available.

The board can be powered by a single regulated +5-volt supply, or you can use an unregulated dc supply that outputs from 7 to 15 volts (even a 9-volt battery), and the on-board regulator will output the required 5 volts. A 3-volt lithium battery provides battery back-up for RAM chips; so you can store your programs and data entirely in RAM and the back-up battery will save the contents in RAM. This means you don't have to use expensive EEPROMs or less-convenient EPROMs during program development or even in a final product.

Typical operating current for the board is 35 milliamperes. Special programmable idle and power-down modes on the 80C32 can reduce current consumption of the board to just 100 microamperes. The low operating current and on-board regulator make it especially easy to use battery power.

One feature of the 8051 family that

often causes confusion is that the microprocessor differentiates between data memory (which is frequently altered and usually implemented with RAM) and program or code memory (less frequently altered and usually implemented with EPROM or EEPROM).

Most microprocessors access a single memory area, which can contain program code or data. For example, code memory might reside from 0 to 7FFFh, and data memory from 8000h to FFFFh, but no two bytes can share the same address.

In the 8051 family, different instructions and control signals access each memory type. Data reads are initiated with an RD signal, and code reads are initiated with a signal called PSEN. You can have code memory addressed from 0 to FFFFh and data memory also addressed from 0 to FFFFh, without causing conflicts. To further complicate things, if you wish, you can combine data and code memory and create a single memory area by logically ORing RD and PSEN.

On the EC-32 board, jumpers give you flexibility in choosing between data, code and combined memory areas for the on-board memory chips. Once you understand the options, you can configure the board as you wish it to be.

The board comes with a 38-page manual that includes hook-up and jumper-configuration details, com-

```

MONITOR-52 V1.2
(c) Franklin Software, Inc. 1987

#help
memory      display      modify      fill      utility
bit:  >DB range  >EB address  >FILLB range value  >A address - assemble
code: >DC range  >EC address  >FILLC range value  >U range - disassemble
data: >DD range  >ED address  >FILLD range value  >X [register] - disp/change
idata: >DI range  >EI address  >FILLI range value
xdata: >DX range  >EX address  >FILLX range value

      program execution      breakpoint(s)      program load/save
>G [address] [,breakadd; - go  >BD bp - disable  >:hex_rec - load intel hex
>T [count] - trace step      >BE bp - enable  >S range - save intel hex
>P [count] - procedure step  >BK bp - kill
                                >BL - list
                                >BS address - set

>HELP - display menu
#x
RA RB R0 R1 R2 R3 R4 R5 R6 R7   PSW   DPTR  SP   PC
00 00 00 00 00 00 00 00 00 00  ---R0--- 0000 07 8000
#

F1=Help | COM2 9600,N,8,1 | Echo: N | Add LF: N | Strip LF: Y | Prompt Line: Y

```

Fig. 5. This printout of the HELP screen for the Monitor-52 monitor program shows the available commands.

plete schematic diagrams, development hints and example interfaces plus a list of resources for supplies, software and information.

Program Development

Iota offers several products to help you use its EC-32 board. One is an EPROM containing a Monitor-52 program (from Franklin Software) that allows you to load, store, run and test assembly-language programs from your "host" desktop computer. The monitor EPROM plugs into one of the sockets on the EC-32 board. Figure 5 is a printout of Monitor-52's help screen, showing the commands available.

As an example of how you can use the EC-32 and its monitor program in loading and testing a program, let's say that you've assembled the example program from Fig. 2, or that you have another assembled program of your own. You've tested your program on the simulator, but now you'd like to try it out on an actual system. To do so, you plug the Monitor-52 EPROM and a RAM chip into two of the EC-32's sockets. Following instructions in the manuals, you set the board's jumpers to match your configuration.

You then cable the EC-32's serial-port connector to the serial port of a desktop computer. This requires connecting the EC-32's 10-pin dual

header to (usually) a DB-9 or DB-25 serial connector on your host computer. Cables are available from Iota, or you can make your own. The host computer doesn't have to be IBM compatible, but it must have a serial port and terminal-emulation software. Your power supply connects to the EC-32, using the screw terminals provided.

To establish communication between the EC-32 and your desktop computer, you turn on your host computer and run a terminal-emulation program, such as *Procomm* or the TE emulator available from Iota. Press the space bar at your computer, and the monitor program will boot.

From here, you can use the monitor's commands to download your assembled program to the EC-32 board's memory. You can run the program, set breakpoints and observe and change memory locations, much as you did on the simulator. In addition, you can use a logic probe or oscilloscope to monitor signals on the board. You can add circuitry, change individual lines of program code, run the program in real time and experiment with the idle and power-down modes.

When you're finished experimenting, if you've made any changes to your program, you can save the new program to disk in your desktop computer. When program development is complete, you can store the

program in EEPROM, RAM or EPROM on the EC-32 (though EPROMs must be programmed off-board).

Iota also offers other disks for IBM compatibles, at \$10 each. One contains a series of application notes with schematics (on paper) and example programs for an LCD interface, A/D converter, real-time clock and auto-baud-rate detection.

Another disk has a variety of user-supported software, including an assembler similar to the one offered with the 8051 book, table-driven cross assembler, disassembler, editor and limited BASIC compiler.

For those who prefer BASIC to assembly language, Iota offers two BASIC-52 EPROMs: one has a full-featured BASIC interpreter similar to the one contained in ROM in the 8052AH-BASIC and 80C52-BASIC chips, which I wrote about in the May issue.

An important difference is that this BASIC-52's PROG and FPROG commands, which originally were intended for programming EPROMs, have been altered to program RAMs and EEPROMs (but not EPROMs). This means that you can easily store multiple programs in RAM or EEPROM and select and run the programs using BASIC-52's ROM and RUN commands. By using RAM or EEPROM, you're freed from having to provide an EPROM's special pro-

Sources

EC-32 Embedded Controller (\$100)
 Monitor-52 EPROM (\$40)
 BASIC-52 EPROM (\$10)
 BASIC-52 PLUS EPROM (\$20)

Iota Systems, Inc.

P.O. Box 8987
 Incline Village, NV 89450
 702-831-6302
 FAX: 702-831-4629

The 8051 Microcontroller: Architecture, Programming, and Applications (\$49)

West Publishing Co.

Attn: COP Dept.
 P.O. Box 64833
 3773 Hwy. 149
 Eagan, MN 55123
 1-800-328-9352

Assemblers, simulators

PseudoCorp.

Professional Development Products Group
 716 Thimble Shoals Blvd.
 Newport News, VA 23606
 804-873-1947
 FAX: 804-873-2154

gramming voltages and ultraviolet source for erasing.

BASIC-52 PLUS adds monitor-type commands to BASIC-52, including the ability to send and receive Intel-hex-formatted code or data, and to display, alter and fill memory. This gives you the functions of a monitor program, along with the capabilities of BASIC, and allows easy interfacing of assembly language programs with BASIC.

Both the Monitor-52 and BASIC-52 EPROMs come with user manuals. Also available from Iota is *The 8051 Microcontroller* book that I reviewed above.

If you're looking for an easy-to-use and flexible board for prototyping, developing, or for a final project, take a look at the EC-32. And if you hunger for more information on the 8051 family, give *The 8051 Microcontroller* book/disk combination a try.

One final tip relating to the 8051 family and other Intel microprocessors: Intel's on-line Embedded Controller Operation's Technical Bulletin Board System (BBS) has programs and other information about

Intel microcontrollers, flash memory and evaluation boards. Dial 602-554-8167 to access the BBS.

If you have comments, suggestions and questions on topics that relate to designing, building and programming microcontrollers and other small, dedicated computers, send them to Jan Axelson, Computer-Craft, 76 North Broadway, Hicksville, NY 11801. If you'd like a reply, please include a self-addressed, stamped envelope. Though I can't guarantee a personal response, I'll try to cover requested topics in future installments.

Next time: using dot-matrix, alphanumeric liquid-crystal displays. ■



Jan Axelson

LEARN TO CLEAN/MAINTAIN/REPAIR FAX MACHINES

HUGE NEW UNTAPPED MARKET!



Over 8 million Fax machines in homes/offices - predictions are for over 25 million by 1992!

- Work from your home/van
- Home study program gets you started servicing fax machines in 2 weeks!
- No special tools/equipment needed
- Earn additional profits selling fax supplies!
- Fax machines are not cheap - therefore, you can get good \$\$ for the repair
- Average Fax machine requires professional service every 18 months
- Home study training program includes full instructions on EVERY ASPECT of Fax maintenance/repair. FULL COVERAGE of how to set up your home-based service business

FREE DETAILS

CALL 1-800-537-0589

Or Write To: Viejo Publications, Inc.
 5329 Fountain Ave., Dept. ME/FX
 Los Angeles, CA 90029

CIRCLE NO. 178 ON FREE INFORMATION CARD

BUILD A DIGITAL STORAGE SCOPE

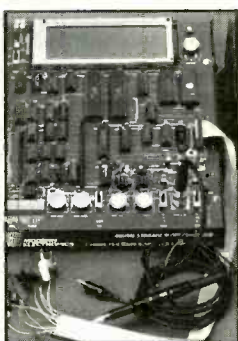

As Part Of The Complete **\$199.95** Modern Electronics Computer Lab.

FEATURES

- 20 Mhz/sec Sample Rate
- .5 us to 5 sec/div Sweep Rates
- LCD with 64 x 240 Dot Resolution
- Provisions for Adding Optional Second Channel (Requires 5V, +/-12V Power Supply)

- Vertical Sensitivity .01 v/div AC/DC Coupled
- Ext. Trigger Input
- Single Sweep Mode
- Screen Freeze Mode

\$199.95

Postage & Handling (\$6.50)

OPTIONS: Add an 8 channel Logic Analyzer and view up to 8 digital signals simultaneously. . . . perfect for viewing CPU Bus signals . . . **\$59.95** + Postage & Handling (\$3.00)
 Power Supply Kit . . . **\$34.95** + (\$4.00) P.H. • Matching Black Steel Cabinet . . . **\$37.50** + (\$4.50) P.H.
 Deluxe 100 Mhz Scope Probe with 10:1 Switch . . . **\$27.50** + (\$3.50) P.H.

EXPAND YOUR LAB . . . Add A Dual Channel Function Generator With An Add On 23 Channel Digital Signal Generator

- The Function Generator features two separate Sine, Triangle, Ramp and Square wave generators. 10 Hz to 100 KHz. Ideal for upcoming Analog and Modulation theory experiments. (Requires 5V, +/-12V Power Supply) **\$69.95** + Postage & Handling (\$4.00)
- Add a 23 channel Digital Signal Generator + an 8088 based Computer Experimenter Platform to the Function Generator Board . . . This project operates as a stand alone Digital Signal Generator, capable of generating 23 different digital signals simultaneously. Custom signal generator programs, as well as 8088 based computer experiments can be down loaded from any IBM compatible. Learn about Computers, Digital Circuits and Assembly Language Programming in upcoming articles. . . . **\$69.95** + Postage & Handling (\$4.00)

OPTIONS: Power Supply Kit . . . **\$34.95** + (\$4.00) P.H. • Matching Black Steel Cabinet . . . **\$37.50** + (\$4.50) P.H.

COMPLETE YOUR LAB . . . With A Prototyping Station

- Features both solderless and wire wrapping prototyping systems. With cables connecting 80 signals from the Digital Signal/8088 Computer Experimenters Platform to the Prototyping Station.

\$69.95 + Postage & Handling (\$4.00)

OPTIONS: Power Supply Kit . . . **\$34.95** + (\$4.00) P.H.
 Matching Black Steel Cabinet . . . **\$37.50** + (\$4.50) P.H.

MasterCard / Visa Accepted

(203) 355-2659



NETRONICS RESEARCH AND DEVELOPMENT LIMITED
 333 Litchfield Road • New Milford, CT

CIRCLE NO. 169 ON FREE INFORMATION CARD

The Winning Ways of QuickBASIC

Modern versions of BASICA and GWBASIC give new life to an old programming language

I wrote my first computer program about 15 years ago, devising a five-line program in my head. Then I walked into a computer store for the first time and sauntered over to the only computer in the store, typed my program and waited for something to happen.

It did. But instead of displaying my name 10 times, the computer filled the screen with random characters, slowly at first and then with increasing rapidity. When the screen was filled with a mixture of Greek, Kanji and Hittite, the computer's speaker sounded a low growl. Embarrassed, I quickly left the store, jumped into my car, and sped away, certain that I had somehow broken a machine that I would never be able to afford.

I've since written thousands of programs and never had another computer growl at me. I wrote more than half of those programs in the same language as my first computer disaster: BASIC. Created in the 1960s at Dartmouth University, BASIC is an acronym for Beginner's All-purpose Symbolic Instruction Code. Don't be fooled by the "Beginner" in the title; it evolved considerably over the years. Today, with its many enhancements, BASIC is as powerful as other professional computer languages. Yet it still seems to be the easiest language to learn and understand.

BASIC isn't perfect, of course, but neither is any other language (ignore the inflated claims of C snobs, Pascal phreaks, and assembly zealots). Some other languages do a better job of handling the intricacies of DOS and interrupts, but BASIC does an admirable job of protecting the programmer and computer from each other. It won't let you accidentally destroy a hard disk or the computer itself; so you can try any of its fea-

tures with a wild abandon that could result in chaos with other languages.

If you don't know how to program, BASIC may be the best language to start with. But be aware that not all versions of BASIC are created equal. I'll try to explain why and what versions you might want to try, but first you need to understand something about how computer languages in general work.

Do It Now or Later?

At their heart, computers understand only "machine language," which consists of a series of 1s and 0s that instruct the microprocessor (MPU or CPU). Creating complex programs entirely in 1s and 0s is nearly impossible; so programmers use computer "languages" to translate human-readable "source code" into machine-language instructions. Languages are often classified by their level of abstraction.

Assembly language, for example, is classified as low-level because it forces a programmer to focus on the

workings of a specific CPU. Each device has its own set of mnemonics that must be used, though many are shared. In turn, BASIC, Pascal, Fortran, COBOL and C are high-level languages because, to different degrees, they let you ignore the CPU and other hardware and focus on how to solve a particular problem.

Theoretically, computer languages can also be divided into two groups, based on their method of operation: compilers and interpreters. Compilers take the source code that you write and translate each line into one or more (sometimes hundreds of) machine instructions. If, for example, you want to add two numbers and store the result in memory, you might write something like $A = B + 11$ in source code. A compiler will generate the machine instructions to load one number into a CPU register, add the second number to that register and store the result in memory.

Working with a compiler can be tedious, however. Traditionally, a programmer writes a small part of a program with an editor, saves the source

This sample of a help screen explains one use of a DO ... LOOP statement.

code, exits to the operating system, and runs the compiler. The compiler often finds typing and syntax errors, which means that the person doing programming has to re-edit the file and compile it again.

Once the program is successfully compiled, it probably won't work correctly. So the programmer tries to figure out what went wrong, and then makes corrections to the source code and starts the entire process over. Modern compilers often include an integrated editor, compiler and debugger that make the process less painful, but it still can be slow.

The other group of languages is based on interpreters instead of compilers. The interpreter takes the code that you write and executes it one line or statement at a time. Instead of creating a stand-alone program (a .COM or .EXE file in the DOS world), an interpreter simply runs your source code. Programmers still have to test and rewrite code, but they don't have to wait for a compiler to read and translate the entire program before the program can run.

There are advantages to both systems. Compilers ensure that an entire program is syntactically correct—they don't produce anything while the code contains typing errors. Interpreters, on the other hand, only look at one line at a time; so they may never check lines that don't happen to be executed. But interpreters start to run a program as soon as they read the first line of source code. In essence, compile each line as it's running.

It's generally easier to write and debug a program for an interpreter. But the program will always run more slowly, since the interpreter is never free of the job of translating each line, one at a time. Also, if you want to share an interpreted program with someone else, you have to make sure that you both have a copy of the same interpreter. And you can't be sure that someone else won't read your program and use your ideas in his or her own programs.

Languages like Fortran, C and Pascal have traditionally been implemented as compilers, and languages like BASIC, dBASE and most spreadsheets have been implemented as interpreters. The earliest micro-computer BASICs integrated a simple line editor with the interpreter.

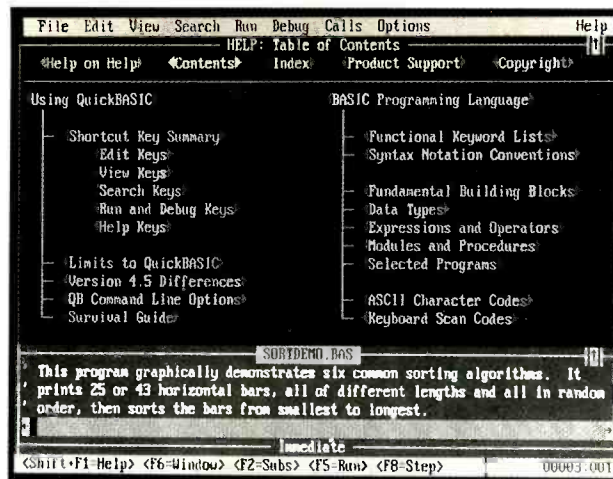

Help table of contents, along with a bit of a program.

This enables a programmer to type and run a program without ever leaving the interpreter and returning to the operating system. That ease of use makes BASIC ideal for quick and simple projects.

BASIC and DOS

When IBM produced the first PC, it put a small version of BASIC in the computer's ROM chips. A user could turn on the machine without a disk, and BASIC would appear, just as it did on other microcomputers like the Apple II and TRS-80. The first version of PC DOS included a disk-based BASIC called BASICA, which was an extension of the BASIC in ROM. Every version of PC DOS since then, and every IBM personal computer, has continued to split BASIC between built-in ROMs and a disk-based program.

Most versions of MS-DOS also include a version of BASIC called GWBASIC. BASICA and GWBASIC have the same functionality, but GWBASIC is self-contained because non-IBM computers can't legally contain IBM's BASIC ROM code. It's possible to run GWBASIC on an IBM computer, but if you try to run IBM's BASICA on a non-IBM computer, you face certain lock-up. This incompatibility between PC-DOS and MS-DOS seems to confuse users but serves little other purpose, except that BASICA.EXE is smaller than GWBASIC and loads from disk slightly faster. (Some versions of MS-DOS have renamed GWBASIC as

BASICA or have a short loader program called BASICA. These conflicting names seem to confuse users even more.)

BASICA and GWBASIC are little changed from their early eight-bit ancestors. By today's programming standards, they're archaic and outdated languages. This doesn't mean that they're useless; many good programs have been written in BASICA and it's possible to write others. But most good BASIC programmers have moved on to more modern versions of the language.

The most popular modern versions of BASIC are QuickBASIC (QB) version 4.5, BASIC Professional Development System (PDS) 7.0, and PowerBASIC. The first two are published by Microsoft; the third is from SPECTRA Publishing. PowerBASIC was originally distributed by Borland International as TurboBASIC. When Borland discontinued the product, SPECTRA Publishing (1030D E. Duane, Sunnyvale, CA 94086) bought the program and has been updating and distributing it ever since. (Upgrades are available for \$65 when accompanied by the old version's serial number.)

My favorite of the trio is QB 4.5; PDS 7.0 is much the same but with a lot more advanced features and a much higher price tag. QuickBASIC and PowerBASIC have list prices just under \$100 and street prices less than \$70.

If you need to write very large and complex programs in BASIC, PDS 7.0 is your best compiler choice.

PowerBASIC is good if you want to upgrade from an earlier version of TurboBASIC, but I find it somewhat awkward to use compared to QB 4.5. For 95% of my BASIC programming, QB 4.5 is powerful enough and fast enough to satisfy all my needs. Most of the comments below about QuickBASIC also apply to PDS and, to a lesser extent, to PowerBASIC.

Why buy a BASIC when a "free" version is included with DOS? My major reason is that programming with QB is so much easier and faster than with GWBASIC. QB will run virtually all GWBASIC programs, but the reverse certainly isn't true. The first difference most people see between the two is that QuickBASIC doesn't require (but does allow) line numbers. Which of these two examples is easier to read and understand?

```
80 GOSUB 140
90 GOSUB 385
100 GOSUB 1240
110 END
```

```
OpenFiles
BuildNewData
PrintReport
END
```

The first example is written in GWBASIC. If you know BASIC at all, its operation is clear: the program calls three subroutines and then ends. But the purpose of each subroutine is a complete mystery. The second example is written in QB. It calls three subprograms (which are similar to but more powerful than subroutines) and ends. The difference is that you can tell at a glance what the second program is up to, assuming that the programmer picked reasonable subprogram names. And a QB programmer never has to worry about messing up line references by deleting or adding lines to the program.

Working without line numbers is nice, but many of us had tools (homemade or commercial) to do that under GWBASIC. Much more important, to my mind, is QuickBASIC's support for modular programming. When a program is written in a modular style, it's divided into separate source-code files, each of which solves one part of the entire programming problem. Modules can be reused in different programs. For example, a module that contains context-sensitive help routines could

be used in both data-handling and numerical-calculation programs.

QB's modular programming implies several other changes in BASIC. Instead of writing a program with dozens or hundreds of subroutines reached with GOSUB commands, a QB program tends to be written as a collection of procedures called subprograms and functions. Subprograms perform an activity; functions do the same and also return a numeric or string value to whatever line called them. Both subprograms and functions can receive values from the routines that call them.

Modular programming also means that variables must have limited

scope, so that variable names don't conflict accidentally. In a QB program, variables can be visible in one subprogram or function, in one source-code module, in specified source-code modules, or in an entire program. Variables with the same name can exist independently in different modules or procedures as long as they don't have conflicting scope. For example, you could use a variable called TOTAL in 15 different procedures without any conflict, as long as each one has local scope. Variable scopes eliminate the name clash that caused many mysterious bugs in large GWBASIC programs.

If you write a program in individu-

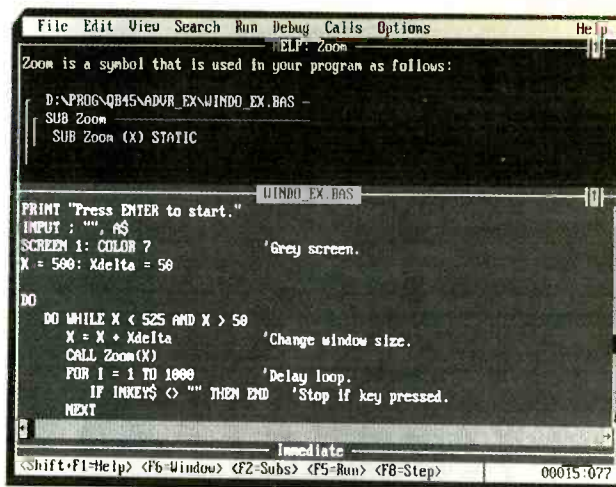

How help identifies a program symbol, in this case, a symbol called Zoom, which is the name of a SUBprogram.

| Feature | 2.0 | 3.0 | 4.0 | 4.5 |
|---|-----|-----|-----|-----|
| On-line QB Advisor (detailed reference) | No | No | No | Yes |
| Selectable right mouse button function | No | No | No | Yes |
| Instant Watches for variables and expressions | No | No | No | Yes |
| Set default search paths | No | No | No | Yes |
| User-defined types | No | No | Yes | Yes |
| IEEE format, math coprocessor support | No | Yes | Yes | Yes |
| On-line help | No | No | Yes | Yes |
| Long (32-bit) integers | No | No | Yes | Yes |
| Fixed-length strings | No | No | Yes | Yes |
| Syntax checking on entry | No | No | Yes | Yes |
| Binary file I/O | No | No | Yes | Yes |
| FUNCTION procedures | No | No | Yes | Yes |

This help screen details some of the differences between QuickBASIC 4.5 and earlier versions.

al modules, QB compiles each into a standard object (.OBJ) file. The object files are then combined into an executable (.EXE) file by a linker supplied with QB and most other programming languages. The linker doesn't care what language was used to create an object file. Therefore, a programmer can, with some work, combine or add modules written in other languages like C, Fortran and assembly language, to a QuickBASIC program, choosing the most appropriate language for each part of the final program. All the modules work together when .OBJ files are linked into a single .EXE executable program.

QB really has two different programs: a programming and editing environment and a stand-alone compiler. Most programmers do all development work inside the programming environment and then the compiler to create the final version of the program.

As a programming environment, QB is a full-screen text editor with context-sensitive help. If you can't remember how to use a BASIC command or can't remember how you used a variable name, you can click a mouse button or press a keyboard key, and a help screen appears. Help topics are linked together as hypertext; so you can move from one display to another (and back again) to find the information that you need. Many help screens contain sample code you can move directly into your own programs with a simple cut-and-paste feature.

The QB programming environment can put text in either one or two windows so that you can see different parts of one program or two different programs at the same time. It also has an "immediate" window that evaluates expressions and prints a result, much like typing a line without a line number in GWBASIC. Other windows display debug information when you're testing a program.

QB's editing environment displays each subprogram and function separately and has a menu that lets you load any routine into either edit window. If you're working on a program with multiple modules, QB loads them all at the same time and puts every routine of every module into the menu. Hence, you can edit any

```

File Edit View Search Run Debug Calls Options Help
Untitled
INPUT X
IF X = 1 THEN
  PRINT "one"
ELSEIF X = 2 THEN
  PRINT "two"
ELSEIF X = 3 THEN
  PRINT "three"
ELSE
  PRINT "must be Integer from 1-3"
END IF

SELECT CASE X
CASE 1
  PRINT "one"
CASE 2
  PRINT "two"
CASE 3
  PRINT "three"
CASE ELSE
  PRINT "must be Integer from 1-3"
END SELECT
Immediate:
(Shift+F1 Help) (F6 Window) (Enter Execute Line) 00001.001

```

Problem solved with extended IF/THEN/ELSEIF/END IF and then SELECT CASE construction.

part of the program you wish to.

The editing environment pre-compiler each line as you type it. The pre-compiler finds typing and syntax errors and immediately points to the location of each error. In GWBASIC, errors aren't found until a line is executed, and the location of an error within a line can be difficult to determine. In QB, the pre-compiler points to the error, pops up a message identifying the error and has a help screen available that describes in detail both the error and how to fix it.

The pre-compiled lines execute very quickly, so that a program in the QB editing environment can run two to three times faster than the same program written in GWBASIC. Also, because QB includes support for math coprocessors, floating-point calculations can be up to 10 times faster than in a comparable GWBASIC program.

One of QB's strongest features is its debugging support. In the QB editing environment, you can single-step through a program and watch it execute. QB shows your location in the program with a moving cursor bar and can put one or more variables into a watch window so you can see the values change as the program runs. It lets a programmer set breakpoints in a program or places where execution will automatically stop.

It also has support for watchpoints that stop a program when a variable changes or an expression becomes true. If a variable seems to be chang-

ing unexpectedly, you can set a watchpoint for the program to automatically stop (with the cursor bar on the current line) when the change occurs. And a history feature in the debugger lets you see which lines executed before the one that triggered the watchpoint or which lines led to the current cursor position.

Once a program is written and debugged, QB compiles it into a stand-alone executable (.EXE) program. This program can run on any PC and is often two or more times faster than the same program running inside the QB environment (and up to 10 times faster than a GWBASIC program).

Besides the features cited above, QB's version of BASIC is much more powerful (and easier to use) than GWBASIC. It supports strings up to 32K bytes long (instead of 255 bytes), arrays greater than 64K bytes in size, user-defined data types and long (four-byte) integers, which can often be used to avoid round-off errors in financial programs. It also supports multi-line IF/THEN/ELSE statements, several new kinds of loops in addition to WHILE/WEND and a SELECT/CASE construction that's common in languages like C and PASCAL but has been sorely missed in GWBASIC.

Finally, QB has much more power than GWBASIC to interact with DOS, the BIOS and the computer's hardware. If you want to experiment with the timer circuits, serial ports or the video BIOS, QB will let you do so

They're Here!

MODERN ELECTRONICS

FUN PROJECT BOOKS

Order both books and pay only \$22.95 plus shipping.

You'll want these two exciting project books, packed with complete plans for building a wide variety of useful electronic devices. The *First and Second Books of Modern Electronics Fun Projects*, both Howard W. Sams publications, are now available.

You'll find all the how-it-works information, schematics, photos, drawings, printed-circuit guides and the parts sources to make it a snap to build almost 50 useful, unique electronic devices at modest cost.

Discover how these circuits and modern electronic devices perform their magic. Learn practical electronic technology the painless way and enjoy doing it!

All projects are based on material published in *Modern Electronics*, with updates and revisions. They've been built and tested by the original authors. Chapters are divided into; Intro To Electronic Projects, Home Electronics, Audio/Video Electronics, Security Electronics, Computers, Test Equipment, and Electronic Designing. There's something for everyone!

Look at what you can build and take pride in:

- * Digital voltmeter accessories—high-frequency ac probe, true-rms adapter, temperature probe
- * Car projects—anti-theft alarms, engine tachometer
- * Life-saving detectors—gases & microwave leaks



- * Computer system power controller
- * Dual-pulse generator
- * Surround-sound audio enhancer
- * Security—telephoned status reporter, alarm control center
- * Home convenience—selectable phone ringer musical tunes, touch-sensitive light controller.
- ... and so much more.

The Fun Projects are capped by introductory information on building projects and kits (tools needed, parts sources, etc.) and advanced design techniques that illustrate how a designer thinks and plans when putting together a practical end product.

From beginning to end, MODERN ELECTRONICS FUN PROJECT BOOKS are for you! Order them today for a fast start in the world of electronics.

MODERN ELECTRONICS
76 N. Broadway, Hicksville, NY 11801

Name _____
 Address _____
 City _____
 State _____ Zip _____
 () Check () MasterCard () VISA
 Card No. _____
 Expires _____
 Signature _____

(Signature required on all charge orders)

Order Date: _____

| QTY | Title | Price | Total |
|-----|--|------------------|-------|
| | First Book of Modern Electronics Fun Projects | \$12.95 ea. | |
| | Second Book of Modern Electronics Fun Projects | \$12.95 ea. | |
| | Both Books | \$22.95 | |
| | | *Shipping | |
| | | Total | |

Order both books and pay only \$22.95 plus shipping.

*Shipping charges \$2 per order. Orders processed day received, but please allow 30 days for delivery.

without a lot of fuss or assembly-language routines. It's also possible to write "ROM-able" QB programs with some add-on tools from third-party vendors.

Making a Choice

I've been a convert to QuickBASIC for several years and can't think of any situation in which I'd rather work in GWBASIC. QB is easier to use, easier to learn and more powerful all around. But I can hear some of you asking why you should spend some \$70 when a "free" BASIC interpreter was included with your computer. If you've never written a program and never intend to write one, you probably don't have a reason to buy QB. But even if you write only a few small programs a year, the cost is worthwhile if you value your time and productivity.

But you don't have to pay anything to give QuickBASIC a test run. For more than a year, Microsoft has offered a free demo version of QB called *TryQuickBASIC*. This version has the editor and interpreter used in QB 4.5, but it doesn't include the compiler. And the new MS-DOS 5.0 (which should be available by the time you read this) contains a version of QuickBASIC (again, without the compiler) instead of GWBASIC.

If you want a free copy of *TryQuickBASIC*, you can download it for free from a number of bulletin boards and information services like CompuServe or from shareware and public-domain disk distributors. If you want to get *TryQuickBASIC* directly from Microsoft, it's included in a book from Microsoft Press called *Learn QuickBASIC Now* (\$39.95).

Whether you're new to programming or want to create programs as quickly and easily as possible, QuickBASIC is an excellent language choice. As mentioned above, I've used BASIC for more than half of the programs I've written (I used C and assembly language for most of the others). Since I first loaded QB 4.5 into my computer, I've used it exclusively for programming in BASIC. But I no longer have a copy of GWBASIC on my hard drive. Life's too short to waste time with archaic interpreter programs when better, more modern, powerful programming tools are available.



Practical Guidelines for Interfacing Circuits

If interfacing electronic circuits doesn't seem particularly important or interesting to you, you might want to reconsider this view. Interfacing components and circuits to each other ranks among the most important areas of electronics.

Often, the interfacing of one electronic circuit to another is such a routine procedure that we take for granted what may have involved some very important principles of software or/and circuit design. For example, when you dial up a bulletin-board service (BBS) with your modem-equipped computer, you take advantage of complex software and hardware that automatically establishes the connection and transfers data between your computer and the BBS. When you plug a printer cable into a computer's parallel port, you complete the final link in a carefully designed interface between the electronics in the printer and the computer's bus. When you connect a light-emitting diode to a logic gate, you establish a simple but vital interface between the gate and the LED.

Interfacing is such an important topic that it deserves much more attention than it usually gets. Therefore, this month I describe a variety of interfacing methods and explain how they're used.

Interfacing Basics

Broadly speaking, interfaces can include both software and hardware. This discussion, however, will cover primarily hardware interfacing, though we'll look at an example or two of how software can be used to implement a hardware interface.

Hardware interfaces we'll examine include connections between various families of digital integrated circuits, connections between linear and digital ICs, and optically-isolated interconnections. We will also look at how interfaces between digital ICs within the same family can be controlled by machine-level code.

When an interface is established between two circuits or systems, what are actually connected in most cases are individual components in each of the two circuits. This holds true for everything from LED status indicators to direct-connect modems. Therefore, many of the principles that apply to interconnecting com-

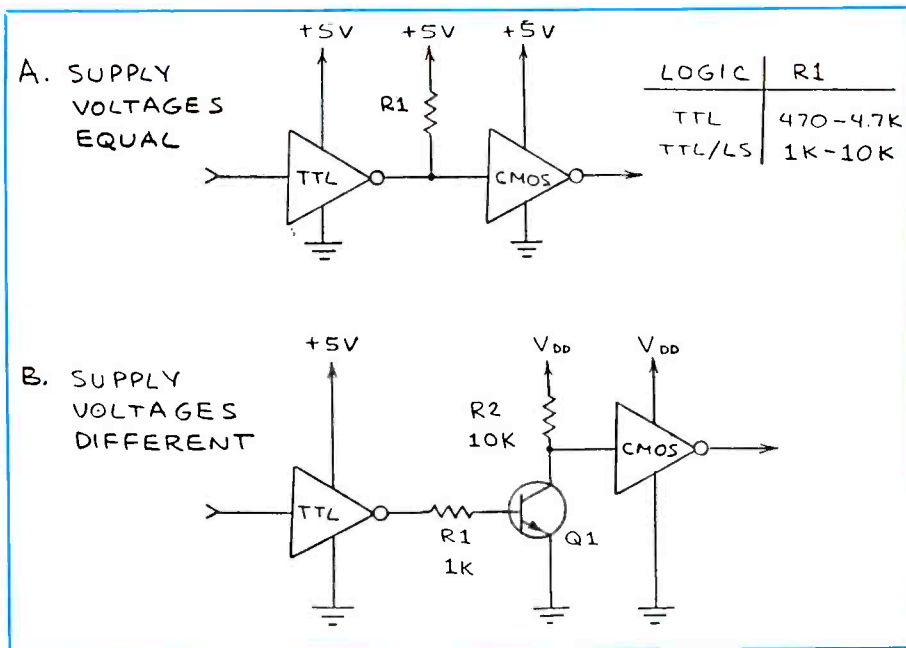

Fig. 1. Details for interfacing TTL to CMOS devices.

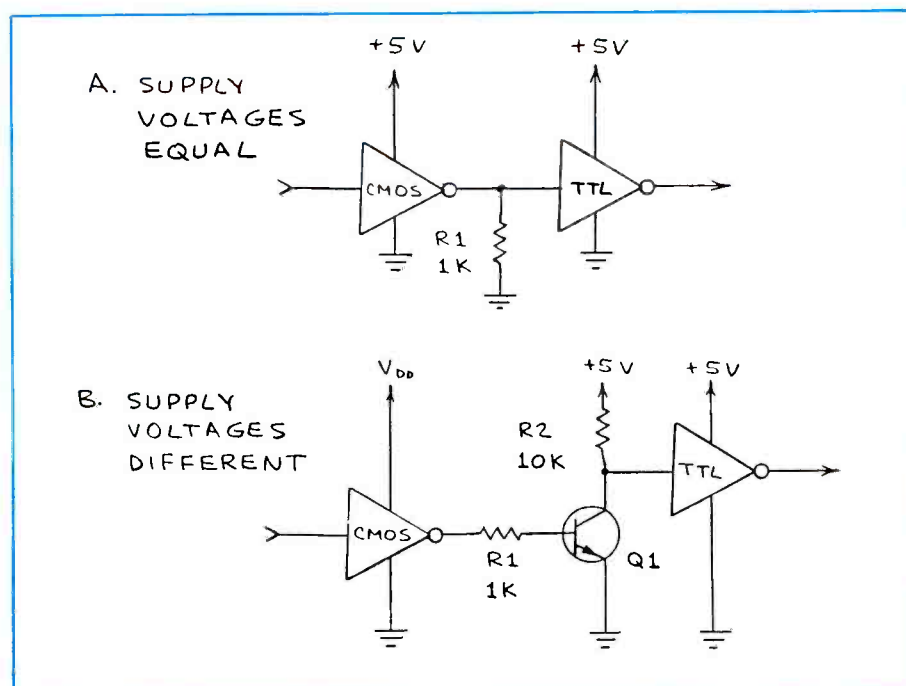

Fig. 2. Details for interfacing CMOS to TTL devices.

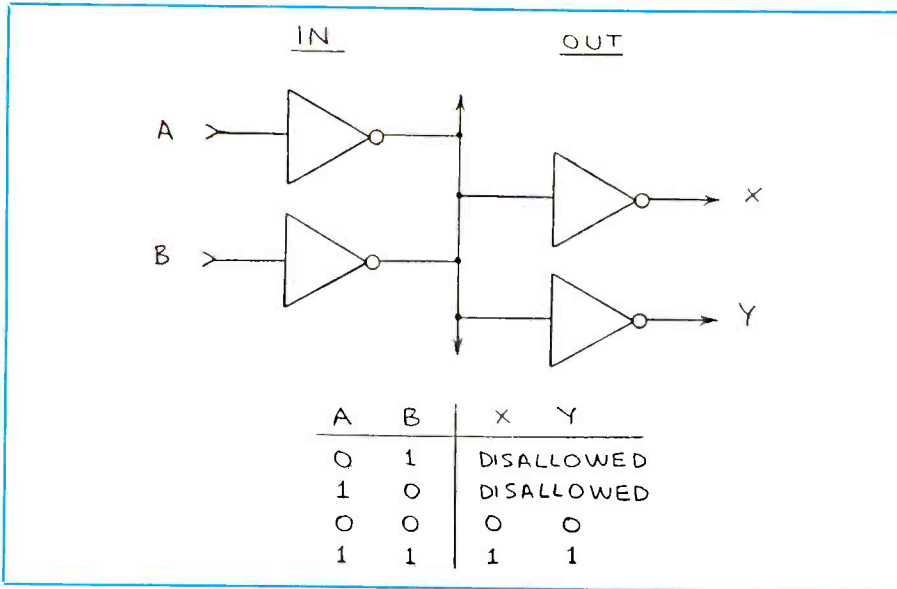

Fig. 3. An example of an unusable logic bus.

ponents within a circuit apply to the interfacing of two separate circuits.

In the case of a wire interface, probably the most important exception to this general observation is that the two separate circuits being interconnected may not be powered by the same supply voltage or voltages. This problem can be solved in various ways, including use of optical coupling.

Interfacing Logic ICs

The two major families of logic ICs fav-

ored by experimenters are TTL (which is on its way to extinction) and CMOS. Both TTL and CMOS can be easily interfaced with the same kind of logic chips and sometimes with each other. The most important restriction is that the maximum fanout of a chip (the number of inputs to which an output can be connected) not be exceeded. A typical TTL output will drive 10 TTL inputs or 20 TTL/LS inputs. A typical TTL/LS output will drive five TTL inputs or 10 TTL/LS inputs. A typical CMOS output will drive up to 50 CMOS inputs.

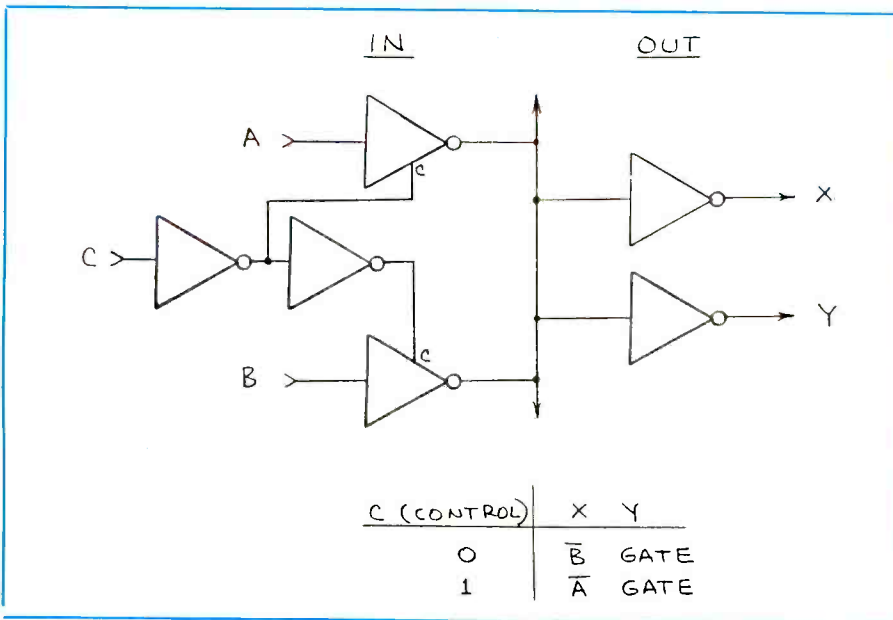

Fig. 4. An example of a tri-state logic bus.

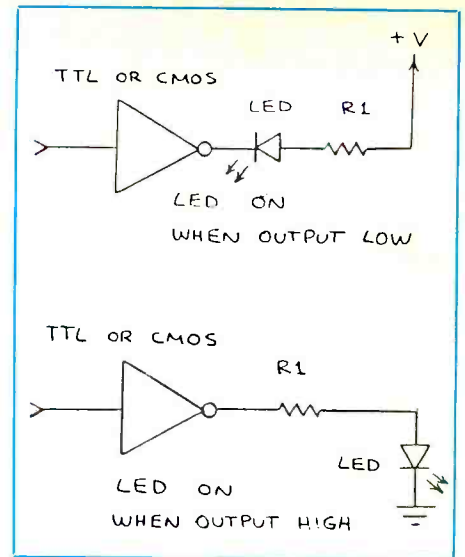

Fig. 5. LED drivers for TTL and CMOS applications.

Another important interfacing consideration is that long interconnection leads should be avoided. Since TTL chips consume a fair amount of current, they tend to cause fluctuations in power-supply voltage when they change states. The resulting voltage spikes can cause false triggering.

The simplest way to eliminate the effects caused by fluctuations in power-supply voltage is to connect so-called decoupling capacitors across the power supply pins of the individual TTL chips. Use 0.01- to 0.1- μ F capacitors and place them as close as possible to the chips being decoupled. While one capacitor will decouple up to 10 gate packages and several counter and register chips, you can connect a capacitor across every chip for the utmost in protection from noise.

Still another thing to remember is that all unused CMOS inputs must be connected to V_{DD} or ground. A common complaint from experimenters is that a CMOS logic circuit triggers randomly. The usual cause is one or more floating inputs, each of which acts like a miniature antenna that picks up stray noise signals and causes the chip to switch states seemingly randomly or when the chip or its circuit is touched or approached.

Often, it's necessary to interface TTL and CMOS circuits, especially when an existing circuit is being modified or when all the desired circuit functions aren't available in a single logic family.

Some CMOS logic is designed to be driven by TTL logic levels. If not, Fig. 1 shows how a pull-up resistor can be used to implement a TTL-CMOS interface when both TTL and CMOS gates are

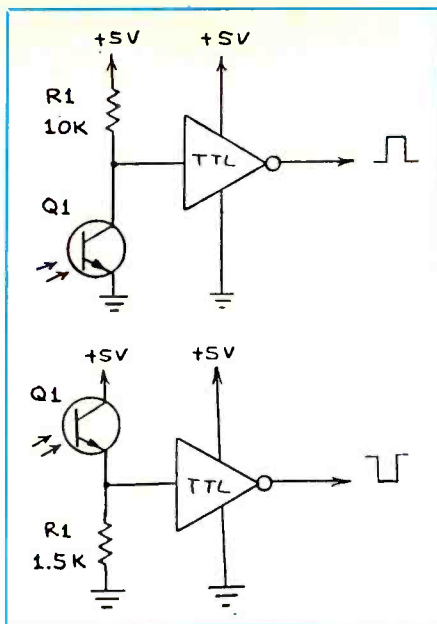

Fig. 6. Details for interfacing a phototransistor to TTL logic.

powered by +5 volts. Many CMOS circuits are powered by more than the 5-volt standard used for TTL. Figure 1 also shows how a transistor stage can be used to interface a 5-volt TTL gate with a CMOS gate powered by a higher voltage.

Some CMOS logic chips, like the 4049 hex inverter, are designed to directly drive TTL logic. A fast way to interface a CMOS logic circuit with a TTL circuit is to insert a 4049 between the two circuits. If this method isn't convenient, Fig. 2(A) shows a possible alternative in which a pull-down resistor is used. When the CMOS is powered by more than the 5 volts that powers the TTL gate, the transistor stage shown in Fig. 2(B) can be used.

Controlling a Logic Line or Bus

If you've ever designed a working logic system more complex than a simple counter, you've probably learned to appreciate the value of tri-state logic. Figure 3 shows why. Here the inputs and outputs of a couple of chips are all connected to the same data line so that either of the two input chips can supply an output signal to both output chips.

Conventional logic chips won't work on the input side of the Fig. 3 circuit, because the outputs of the two input gates might be at different logic levels. Instead, some way must be found to disconnect the gate from the line that isn't carrying the desired logic level.

This vital task is easily accomplished with tri-state logic gates, as shown in Fig.

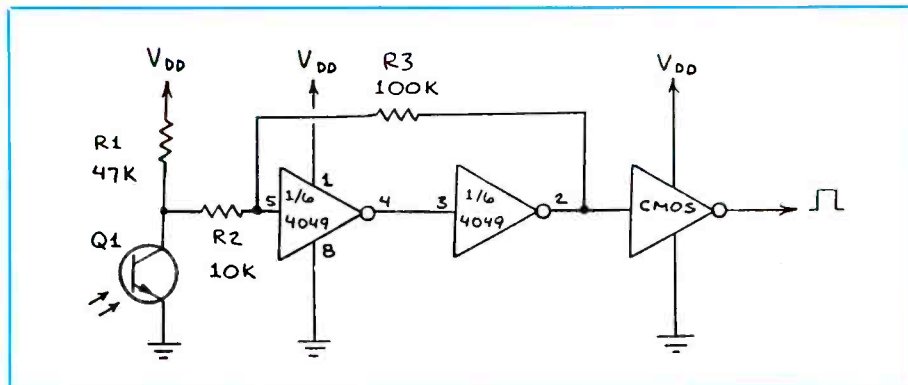

Fig. 7. How to interface a phototransistor to CMOS logic.

4. These gates have a special control (C) input that determines if the output of the gate is active (either high or low) or in a high-impedance state that is, for practical purposes, disconnected from the line.

Gates with a tri-state output are widely available. If you need a tri-state output for a conventional gate that doesn't have a built-in tri-state capability, you can insert an analog switch between the output of the gate and whatever it's connected to.

Even though the Fig. 3 circuit is extremely simple, it nicely illustrates how data and address bits can be placed on a data/address bus in a microcontroller or microcomputer. If a pulse generator is used as a clock, then the outputs from input Gates A and B can be sequentially placed on the single data line. The same clock can also control which of various flip-flops or registers accepts the output status of the two output gates.

A more advanced method of controlling which gate is connected to the data bus is to apply a list of predetermined instructions to the control input. Such a list is an ultra-simple program. The program can be stored as holes in a plastic or paper tape or card, magnetic domains on a tape or disk or in various other ways. The most convenient way is to store the program as patterns of lows and highs in a memory chip. The clock circuit then increments a counter that cycles through all the addresses in the memory chip, sequentially outputting each instruction in turn.

Interfacing Devices

- **Optical Couplers.** Optical couplers consist of a light source and detector housed in a light-tight package. They provide almost total electrical isolation between a circuit connected to the light source and a second circuit connected to a light detector. Therefore, they're important when interfacing two circuits that are

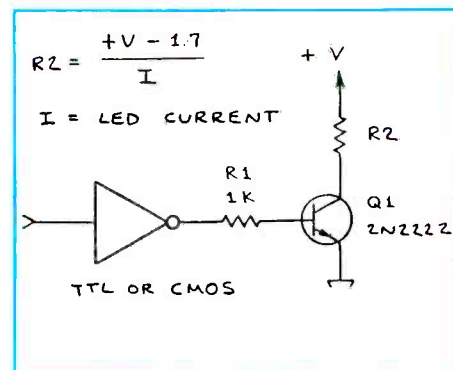

Fig. 8. How to drive a switching transistor with a TTL or CMOS logic gate.

operated at different voltage levels and when the danger of possible electrical shock exists.

The techniques used to interface logic chips with light-emitting diodes and phototransistors also apply to optocouplers. Figure 5 shows straightforward TTL and CMOS LED drivers. In both cases, *R1* restricts current through the LED to a reasonable level. The approximate resistance to use can be found by subtracting 1.7 from the supply voltage and dividing the result by the desired LED current in amperes. When the supply is 5 volts and desired LED current is 10 milliamperes, approximate series resistance is $(5 - 1.7)/0.01$, or 330 ohms.

Interfacing phototransistors to logic gates is even simpler since you don't have to worry about current levels. Figure 6 shows how a phototransistor can be interfaced in either a noninverting or inverting fashion to a TTL gate. Figure 7 shows one way to interface a phototransistor to a CMOS gate.

- **Logic Chips to Transistors.** Most logic chips aren't capable of directly driving components or circuits that consume more than a few tens of milliamperes. In

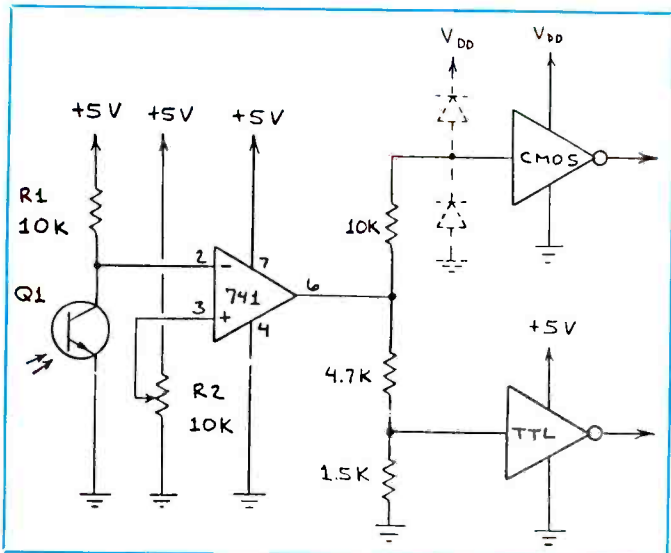

Fig. 9. Interfacing a comparator or op amp to TTL and CMOS logic.

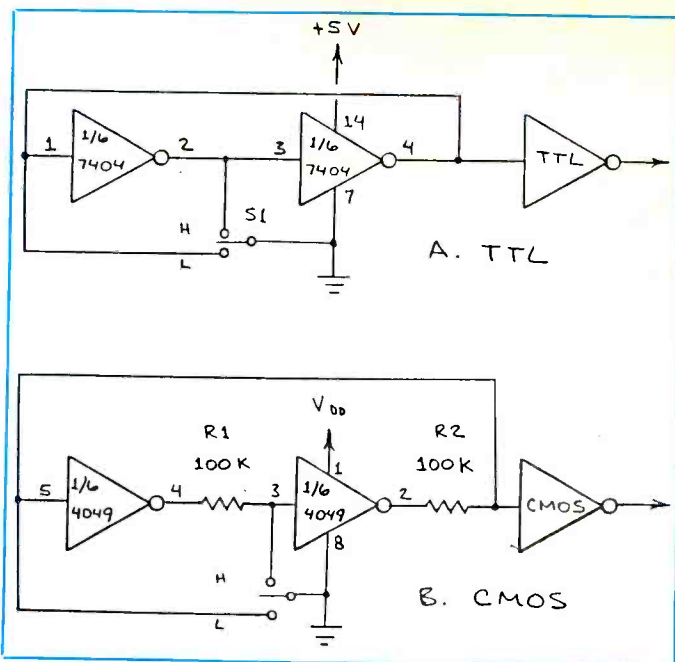

Fig. 10. Details of TTL and CMOS switch debouncers.

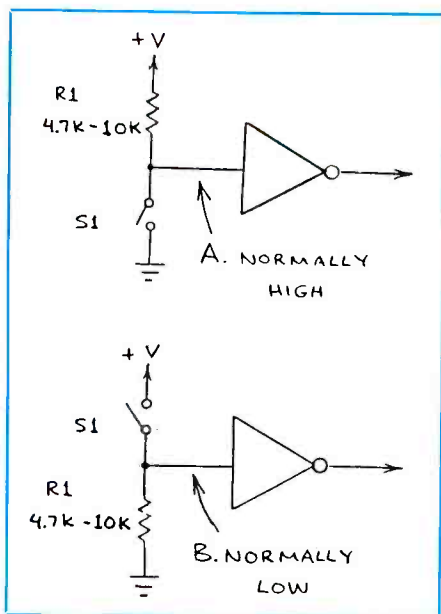

Fig. 11. How logic switching is accomplished with a single-pole switch.

such situations, a driver transistor is usually used as a current switch.

Figure 8 shows how a TTL or CMOS gate can drive an npn transistor that, in turn, switches the current through a LED. The transistor can switch much higher currents than the few tens of milliamperes required for most LEDs. In these cases, it's important that the driver transistor be able to switch the required load without overheating. A power transistor and external heat sinking may be

necessary. Another good approach is to use a power MOSFET with a low turn-on resistance and, hence, high power-handling capability.

• *Op Amps to Logic Chips.* Many important applications are made possible by interfacing an op amp or comparator to a logic circuit. This is one way an analog-to-digital (A/D) converter can be implemented. Another important application is use of a comparator as a switching circuit that delivers a low or high logic level in response to an external signal.

Figure 9, for example, shows how an ordinary 741 op amp can be used as a comparator that interfaces a phototransistor to a TTL (or TTL/LS) or CMOS gate. Resistor *R1* serves as the phototransistor's load resistor. Resistor *R2* sets the circuit's triggering threshold. Diodes *D1* and *D2* are used with a CMOS gate only if V_{DD1} exceeds V_{DD2} .

• *Switches and Logic Gates.* The best way to manually switch a gate input between low and high is to use a double-pole switch. One pole connects to the circuit's low, the second pole to the circuit's high. The moving pole is connected to the gate's input.

The inputs of sequential logic circuits like flip-flops, counters and registers don't mind being connected directly to a mechanical switch. The only problem is that they may change states several times each time the switch is toggled. This is caused by the phenomenon known as switch "bounce." The contacts of most mechanical switches don't open and close in a neat on/off manner. Instead, the contacts rub and bounce against each

other slightly so that the act of closing a switch may actually cause several very brief switch openings and closures during the time the switch is being closed.

There are several ways to eliminate switch bounce, two of which are illustrated in Fig. 10 (TTL and CMOS versions). Here the logic state applied to the output gate always follows the previous status of switch *S1*. This circuit works for both TTL and CMOS.

Recently, two circuit designers working on separate projects wanted to use a single-pole pushbutton switch to toggle a gate input between low and high. Figure 11 shows how this can be done with the help of a single resistor. In Fig. 11(A), the gate input is always tied to the positive supply through a pull-up resistor and is, therefore, high. Closing the switch connects the input directly to ground and brings the input low. The reverse situation occurs when a pull-down resistor is used as shown in Fig. 11(B).

More About Interfacing

This discussion has only touched on the most basic aspects of interfacing. For example, I didn't discuss line drivers and receivers, the ICs designed to send and receive signals along wires.

One of the best sources for additional information on this topic is data books published by semiconductor manufacturers. Many books about solid-state electronics and data communications include sections on interfacing, as does *Engineer's Mini-Notebook: Digital Logic Circuits* (Radio Shack, 1986).



Cache RAM Chip, Micro Softener Chip, All-Digital Answering Machines and a Voltage Multiplier/Regulator IC

Though 80386-based systems are fast, memory is still a bottleneck. A new chip from Samsung is designed to eliminate this bottleneck and take full advantage of 80386 CPU processing power. This chip starts off this month's column.

Cache RAM Chip Replaces 26 ICs

High-performance cache memory subsystems for 80386-based microcomputers are the target of Samsung's (3725 N. First St., San Jose, CA 95134) new 20-ns cache data RAM, the KM78C80. This chip replaces as many as 26 ICs, saving power and pc-board real estate.

Designed to interface directly with Intel's 82385 cache controller (Fig. 1), the KM78C80 is a high-speed SRAM that can be configured as a single 8K × 16-bit device for direct-mapped cache designs or as two 4K × 16-bit devices for two-way set associative cache memories. The device has address access time as fast as 20 ns and output enable time as fast as 8 ns.

Today's microcomputer system performance is limited by memory bandwidth, not CPU processing power. Breaking the roadblock requires sophisticated cache memory subsystems designed to support zero-wait-state memory accesses. Intel's designers did their part by providing the 80386 with a powerful single-chip cache controller, the 82385. To make the combination effective, system designers have had to implement cache memories with 16 very-fast 4K × four-bit SRAMs, eight F245 data buffers and two F373 address latches.

This implementation, which consumes valuable board space and is quite power hungry, is replaced completely by one KM78C80. With its on-chip address latches, output enable control and flexibility in configuration, the K78C80 significantly improves memory system access margin, component count, pc-board real estate and power consumption.

The KM78C80 has two output-enable inputs for precise control of data outputs, and two chip-select and write-enable inputs for design flexibility. It also has TTL-level three-state outputs and operates from a single 5-volt power supply. Operating current is less than 230 mA.

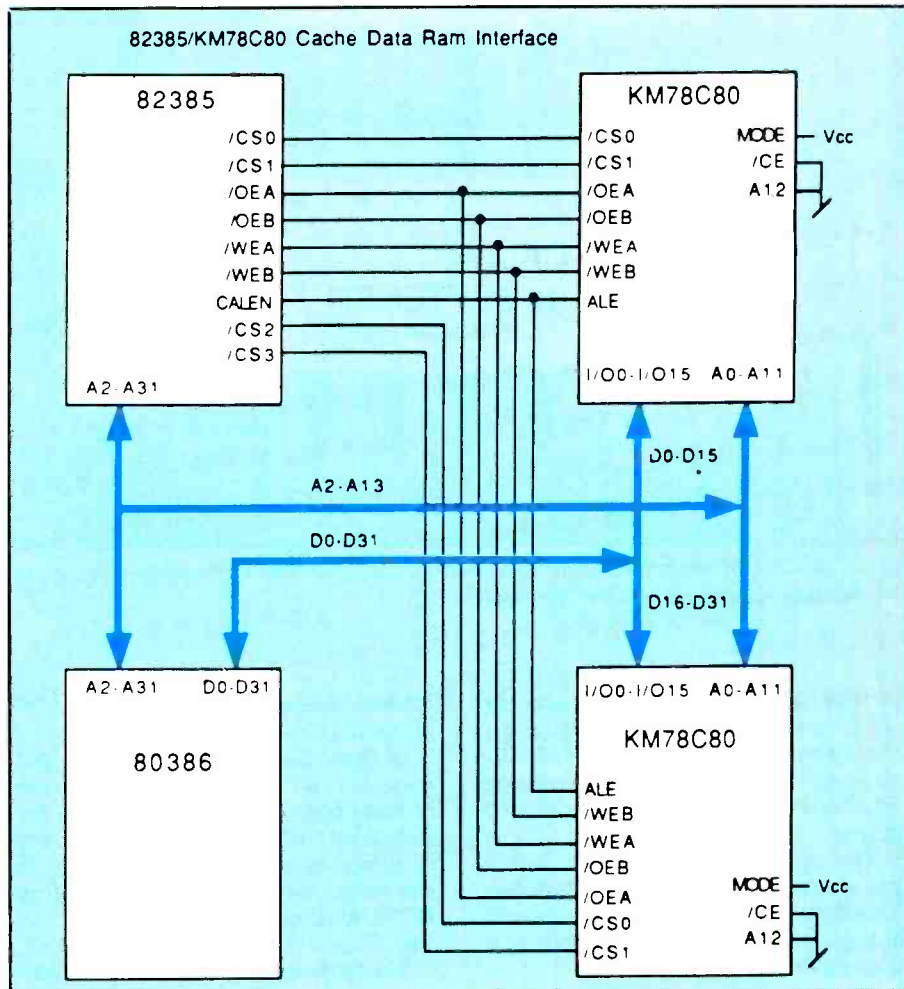

Fig. 1. Samsung's 82385/KM78C80 cache data RAM interface.

The KM78C80 is packaged in a standard 52-pin plastic leadless chip carrier (PLCC) for high-density board assembly. It is rated for normal operation over the commercial temperature range of 0°C to +70°C. When purchased in a quantity of 1,000 or more, the device is priced at \$14.50 each.

Peripheral Chip "Softens" Microprocessors

The Micro Softener Chip from Dallas Semiconductor (4401 S. Belwood Pkwy., Dallas, TX 75244) safeguards popular

microprocessors, including the V40, 6303, 68HC11 and 80C196. Circuitry in the Micro Softener maintains calibration information as well as program and data storage via an uninterruptible lithium back-up supply. Whether the main power merely fluctuates or is absent for years, upon its return, computing resumes where it left off as though the outage had not occurred.

In systems that incorporate the Micro Softener Chip (so named because it "softens" the microprocessor), software updates or changes can be installed and re-programmed in the field via the proces-

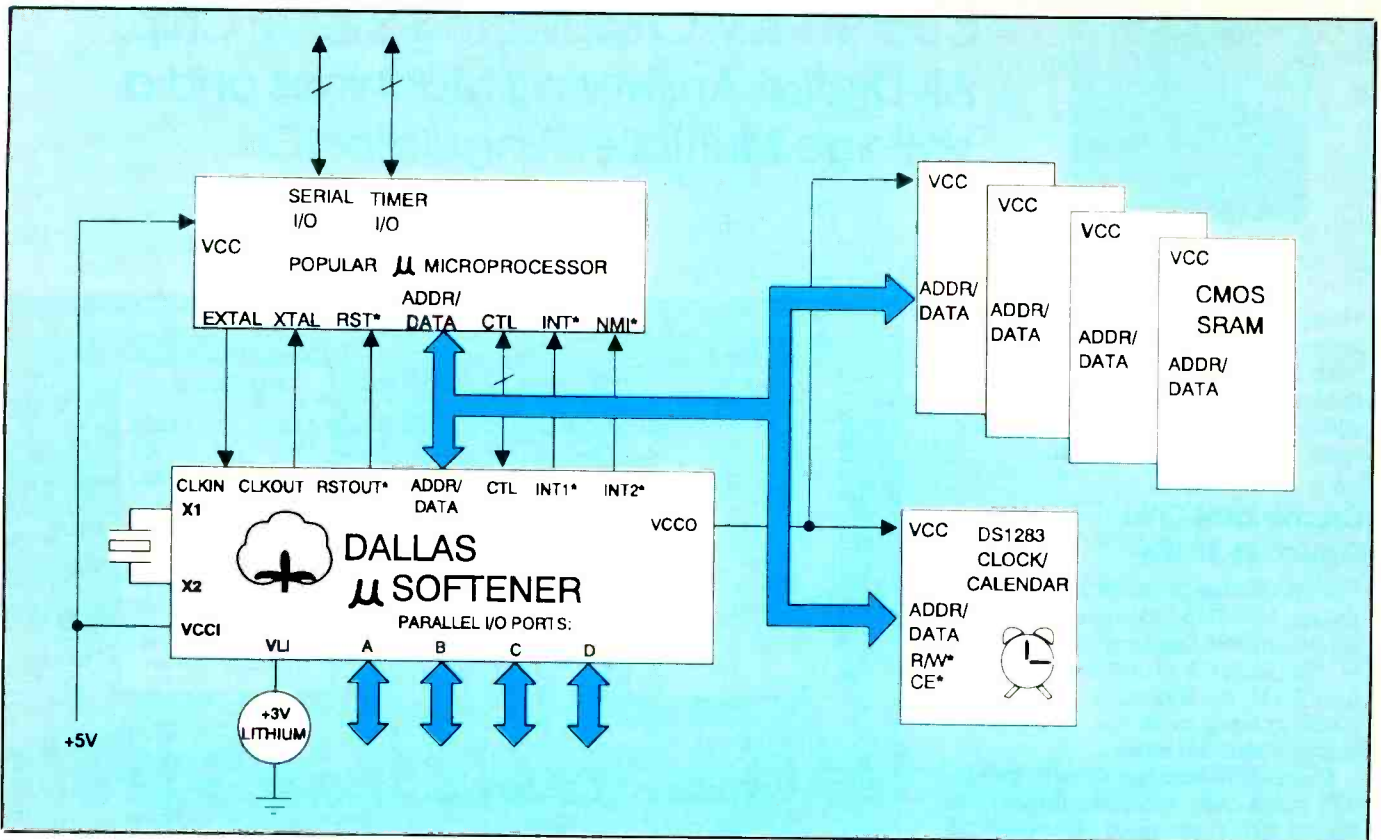

Fig. 2. The Micro Softener Chip from Dallas Semiconductor allows a processor of choice to reload programs or data through the serial port and crash-proof and "soften" the system.

sor's serial port, without even opening the system (see Fig. 2). This feature allows a product to take advantage of software improvements over its life because information can be updated without changing chips.

The on-chip bootstrap loader initializes storage with application code downloaded from a PC via the processor's serial port, which eliminates the need for a boot EPROM.

The Micro Softener Chip also enables "load-and-go" customization. Companies can make one standard product and customize it for each customer simply by loading into it new software, even at the shipping dock.

The Micro Softener Chip provides additional input/output capabilities for sensors, indicators, pushbuttons, etc. It supplies an extra 32 port pins.

The Softener also features provisions for trouble reporting. A voltage detector determines when power goes out of tolerance. A watchdog timer monitors software execution, and a built-in memory tester validates memory contents.

When a problem occurs, the chip can initiate a call for help through a Dallas Semiconductor Teleservicing modem. Diagnostic software can then be down-

loaded from a remote PC via the telephone to pinpoint the difficulty.

In providing its crash-proofing and softening functions, the Micro Softener replaces eight chips commonly used for embedded control by integrating a power monitor, watchdog timer, nonvolatile controller, address decoder, bootstrap ROM, parallel I/O ports, dual-port register file and interrupt controller.

The Softener also features some functions that would not be cost-effective to implement using a discrete logic design. As an example, it partitions the nonvolatile SRAM into write-inhibited areas for program storage and read/write areas for data.

While the Micro Softener Chips share a basic design, there are different versions for different microprocessors. The Metal Mask layer configures the chips for the specific processor and its bootstrap loading requirements.

Applications for the chip include portable data recorders, barcode readers, medical instrumentation, home informational terminals, building security systems, automotive diagnostic equipment and industrial control. Versions and prices (1,000 piece quantities) of Micro Softener Chips are as follows: DS5340FP

(V40, 8.0 MHZ) \$9.20; DS5303FP (6303, 1.0 MHZ) \$7.00; DS5311 (68HC11, 2.0 MHZ) \$8.10; DS5396FP (8096, 12.0 MHZ) \$8.10.

Tapeless Telephone Answering Machines

DSP Group, Inc. (4050 Moorpark Ave., San Jose, CA 95117), a leading supplier of Digital Signal Processing (DSP) chip sets for consumer electronic products, has announced the D6005, a new member of its D6000 family for all-digital telephone answering devices (TAD).

The D6005 chip set stores phone messages on solid-state memory, rather than audio tape like conventional TADs, eliminating all moving parts and increasing reliability and ease of use of the TAD. In addition, the D6005 performs all the functions for featurephones and cordless phones, permitting designers of telephone equipment to develop a range of products, from a stand-alone TAD to a complete phone center combining TAD, featurephone and cordless telephone.

The D6005 chip set consists of a digital signal processor to perform speech compression, storage and other TAD and phone functions; an application-specific

integrated circuit (ASIC) to handle the memory and host interface; a Codec for analog-to-digital (A/D) and digital-to-analog (D/A) signal conversions; and from one to 16 audio-grade RAMs (ARAMs) for message storage.

Two key issues for designers of digital TADs are storage time and voice quality. Some very-low-end digital TADs offer only two or three minutes of storage time, which is inadequate for most users. Seven minutes of storage—14 30-second messages—is considered a typical minimum configuration for most households and home businesses. The D6005 can address up to 16 megabits of memory, or 26 minutes of storage time. This is more than 50 30-second messages.

In addition to high voice quality and long recording time, the D6005 chip set offers the following features:

- Instantaneous Message Retrieval/Playback/Repeat**—The D6005 permits instantaneous access to any message in the queue. Messages can be played back in any order. All or part of any messages can be instantly repeated. Playback can be paused and continued at any point.

- Message Skip/Message Offset**—This feature provides instantaneous skip to the beginning of, or to any offset position of any message, permitting the user to listen only to relevant portions of a message.

- Selective Erase**—Messages can be erased selectively. This feature is not available on cassette-based TADs, where erasing messages is "all-or-nothing".

- Date/Time Stamping**—Date and time can be attached to each incoming message (ICM).

- Voice-Activated Recording**—Included in the D6005 is a patented feature called SMART VOX, which activates recording only upon detection of speech, thus saving storage space.

- Secret Mailbox**—Messages can be stored in a secret mailbox and retrieved only by entering a password code.

- Private Incoming Messages**—Similar to voice-mail machines, ICMs can be stored in multiple directories, permitting messages to be left for specific persons.

- Message Transfer**—Recorded messages can be transferred to another phone.

- Multiple Outgoing Messages (OGM)**—The D6005 treats the outgoing message as any other message and will play the outgoing message number specified by the host controller.

- Voice Instruction**—TAD designers can implement voice instruction to guide users in the use of the machine or provide voice prompts to confirm various TAD operations.

- DTMF Receive/Transmit**—Dual-Tone/Multi-Frequency (DTMF) tone transmission and reception provides feature-

phone support and permits remote activation of all TAD functions from a cordless phone.

- Near-End Echo Cancellation**—Remote operation of any TAD is accomplished by transmitting DTMF tones from the remote phone to the TAD while the OGM is playing. During OGM playback, however, sound from the TAD speaker is picked up by the TAD microphone, producing an echo that often renders the remote DTMF tones undetectable. The D6005 cancels out this echo, providing consistent DTMF tone detection and assuring reliable remote operation.

A D6005 chip set with four ARAMs (7 minutes of recording time), costs under \$30 in volume.

Voltage Multiplier/Regulator IC

A high-precision step-up-and-down switching voltage regulator in a small eight-pin SOP is now available from the Semiconductor Products Group of Seiko Instruments, USA, Inc. (Semiconductor Products Group, 1150 Ringwood Court, San Jose, CA 95131).

The new model S-8430AF CMOS IC keeps output voltage levels constant,

even when the input potential drops 1 to 3 volts below the set output voltage. This device is of particular value in such battery-powered portable equipment as pagers, cameras, telecommunications gear and laptop computers because it allows the manufacturer to extend battery life.

The low-power IC is a high-precision dc-to-dc converter that includes a CR oscillator circuit, switching regulator, series regulator and Schottky diode. In operation, when input voltage is higher than the specified output voltage, the device serves as a series regulator. Alternatively, when input voltage is lower than output voltage, the device serves as a step-up switching regulator.

Output potential can be changed from 3 to 5 volts and vice-versa via an external signal. The device's internal oscillator circuit can be stopped to provide a stand-by function, also via an external signal.

The S-8430AF features low current consumption of 11 μ A operating, typically, and 0.2 μ A standby, maximum. Low-voltage operation is 0.9 volt min. Selectable output voltages are 3.0 volts \pm 5% and 5.0 volts \pm 4%. Maximum output current is 30 mA. Typical 1,000 piece quantities are priced at \$1.55 each. ■

AWARD BIOS ROMS

Upgrade your IBM XT, AT, or XT/286/386 Compatible. Add support for 3.5" 1.44Mb Floppies, 101/102 Keyboard F11 & F12 keys, ESDI and IDE Hard Drives. Full Technical Support - Call or write for FREE Catalog.

Authorized Award Distributor.

KOMPUTERWERK

851 Parkview Blvd., Pittsburgh, PA 15215

Orders 800 423-3400 - Technical Support (412) 782-0384

CIRCLE NO. 164 ON FREE INFORMATION CARD



CONSOLIDATED ELECTRONICS
VOLUME I - TEST EQUIPMENT
CONSOLIDATED & INDUSTRIAL ELECTRONICS 18TH EDITION

CONSOLIDATED ELECTRONICS

Get two of the most valuable electronic catalogs ever! These 2 catalogs contain over 16,000 hard to find electronic parts & equipment. VOL. I - features 112 pages of high quality test equipment. VOL. II - features 144 pages of electronic parts, tools & cross references. Send \$5 check or money order, or call today & use your VISA or MasterCard.

1-800-543-3568



CONSOLIDATED ELECTRONICS
VOLUME II - PARTS & ACCESSORIES
CONSOLIDATED & INDUSTRIAL ELECTRONICS 18TH EDITION

CONSOLIDATED ELECTRONICS, INCORPORATED 705 WATERLIET AVENUE DAYTON, OHIO 45420-2599
FAX: 1-(513) 252-4066 / TEL: 1-(513) 252-5662 / TELEX: 288-229 / COMPUSERVE: 76057, 3347 / EASYLINK: 62850013

CIRCLE NO. 156 ON FREE INFORMATION CARD

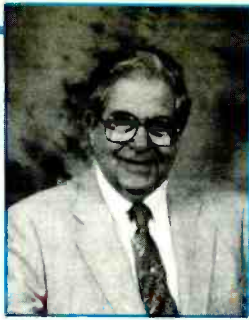

The World On-Line For Novices: A starter guide to computer telecommunications

Computer telecommunications is a major activity for both work and recreation. The reasons are: it's fast; it's often modestly priced, even free, except for telephone charges; it provides useful information; and it's easy to gear up for since all you need is a computer, a modem and a telephone.

The worldwide computer network has three parts. First is the network of amateur, user-operated, public bulletin boards (BBSs). These boards exist in almost every community in the United States, Canada, England and parts of Europe. They range from boards running on the smallest of home computers to huge multi-line ones with massive collections of software and commentary.

The second leg of this triad is composed of many commercial information networks, such as CompuServe, GENie, Prodigy, Dow-Jones, Delphi and Quantum Computer Services, among others. They serve special-interest groups of computer users.

The third leg is made up of common-carrier organizations that provide access to both commercial and amateur bulletin boards and/or E-Mail service. These include major communications carriers like MCI-Mail, Telenet and Tymenet, as well as smaller ones devoted to linking BBSs, such as PC Link and Starlink.

New ideas, information and personal contacts result from using your computer as a means of communicating. You can start by contacting other people in your own area who maintain public bulletin boards systems (BBSs). A local computer club is the best way to find out about a local BBS. On these bulletin boards, you can find help for problems on almost any subject and there is also an almost never-ending source of free and near-free software. In addition, many BBSs are joined into networks that enable you to send messages to others across the country or around the world.

In most cases, a BBS is free and your only cost is the telephone charge to access the board. In some instances, the BBS will have a very nominal charge to help defray the cost of maintaining the board and to screen out undesirables. One advantage of sending messages via a BBS

network, compared to direct contact, is that you do not have to schedule a mutual time for communication. This is a great convenience because it lets you avoid problems of communicating across different time zones.

A second method of joining the worldwide computer communications network is by signing up for one or more of the commercial information services. There are thousands of these services that provide every conceivable kind of information service. Of greatest interest to readers of this magazine will be the commercial on-line services that provide information, communications, entertainment, education and vast collections of software, all for an hourly fee.

The oldest and largest of all these services is *CompuServe*, which provides so many services that it takes a book to list them. While *CompuServe* is the most complete service, it is also the most expensive. Second is *GENie*, owned by General Electric Corp. *GENie* provides many valuable interactive services, including many Round-Table groups of interest to hobbyists. Another service, *Prodigy*, was started by IBM and Sears; it is the least expensive and by far the easiest to use and to join. Also, it is the most graphics-oriented and seems mainly devoted to selling you things. *Prodigy* does provide news, inter-user communications and access to many services and products. *Delphi* is another service with many features for computer users. It attempts to do everything that *CompuServe* or *GENie* does, but it operates on a much smaller scale. However, it's low in cost.

There are also interactive services devoted to specific computers like Commodores, Apple IIs, Macintoshes and Tandys. Many of these are provided by Quantum Computer Services. Furthermore, a host of BBS services, like BIX (BYTE Information Exchange), are sponsored by publications. Finally, there are services that started as local BBSs and grew into large commercial services, such as EXEC-PC, which has 96,000 files of software, Channel 1 and PC-Library.

Some commercial information networks have their own telephone access networks, with nodes in principal cities

throughout the United States. However, most use services of common carrier packet switching networks. The most common of these are the *Tymenet* and *Telenet* networks, which provide access to most of the information networks.

To use them, you dial a local telephone number, which connects you to a data-collection point called a "local node." Your data is joined with others and transmitted to the office of the service you select. There is a charge for this packet service, but it is far lower than that of the regular telephone company's switched network.

MCI-Mail is a service whose main purpose is public data communications. It offers a method of sending E-Mail messages to both members and non-members. Additionally, it offers hard-copy overnight delivery, printing matter on paper with your logo and other amenities. *MCI Mail* also provides gateways into E-mail services of other networks, such as *CompuServe*. In addition, it provides connection to Dow Jones and the Easy-Sabre Airline Reservations service, and it has a fax service.

What You Need

When you join the network world, you are following a well-worn path and there is plenty of help available. There are also many books on telecommunications; some are reference works and others are tutorials.

The three essentials you need for on-line telecommunications are a telephone line, a modem and a communications program. The type of modem and communications program you need depend upon your computer. Almost every personal computer in use today has the ability to join the on-line world. No matter if you are using a Commodore 64 or 128, Amiga, Atari, Apple II, Macintosh a PC/XT/AT clone, or an IBM PS/1 or PS/2, you can join in.

When you are on the networks you can communicate in spite of differences in operating system or computer configuration. You'll need a modem (MODulator/DEModulator), a device that enables your computer to communicate over a telephone line. This is required so that a

computer can send and receive an output stream of digital data bits over the telephone switched network.

The modem converts the data stream of voltage-level data bits into tones that can be transmitted over the telephone network. When Transmitting (sending), we use the tone of one frequency (1,270 Hz) to represent a digital "1" and another frequency (1,070 Hz) to represent a digital "0." In the Answer mode, we use tones of 2,225 Hz for "1" and 2,025 Hz for "0." This is called "frequency-shift keying," or FSK.

We also have to provide a method of indicating the start and end of a word and of a message. We take care of this by agreement as to the data structure of a word, using start bits and stop bits to frame it. All this is controlled by communications software.

In the early days of telecommunications, maximum speed of data communications over the ordinary switched telephone system was 300 bits-per-second (300 baud). Anything faster than that required special conditioned telephone lines. Since then, the quality of the telephone system has greatly improved and so have our modems. The normal transmission rate has grown from 300 baud to 1,200 baud to 2,400 baud . . . and 4,800 baud is gaining popularity, while 9,600 baud is expected soon.

The question for you to decide is how fast a modem should you buy? Slower-speed modems are cheaper than faster ones, but because of their lower rate of speed, you will spend more time on line and, consequently, pay for more telephone time and connect charges to a service that charges by the minute. Typically, it will take about 30 seconds to transmit a page of data at 1,200 baud and less than 10 seconds at 2,400 baud. With the price difference between a 1,200-baud modem and a 2,400-baud modem being very small today, it makes sense to buy a modem that can operate at least up to 2,400 baud (which also handles 300- and 1,200-baud transmissions).

Modems are made either for internal installation in a computer or for installation outside the computer. Internal modem cards are cheaper because they do not need a power supply or case. They plug into the computer motherboard just as any expansion board does. However, they do use a precious slot in your computer; sometimes that is very important. Prices will vary, too, according to the bells and whistles incorporated into a modem, such as self testing, indicator lights and the like.

Every modem requires a serial port in your computer to be used, regardless of whether it is an external or internal type.

The serial port is built into the internal modem, while the external one connects to the computer's serial I/O card through a serial connector and a cable.

PC/XT/AT computers designate their serial ports as COM1, COM2 and so-on. Early versions of MS-DOS only supported COM1 and COM2, while later versions offer additional serial ports. The important thing to keep in mind is that two devices cannot use the same COM port. If you use another serial device, such as a mouse, in addition to your modem, be sure it and your new modem are installed on different serial ports. Documentation for your computer or expansion card that includes serial ports will describe what serial ports are available.

If you chose an external modem and you only have one serial port that is used for a mouse or another serial-port device, you will have to buy another serial card and install it in your computer. When you install additional ports, you also have to modify your operating system and software to inform them that additional ports are in use.

For Commodore 64 and 128 computers, most modems connect directly to the computer. Most of these direct-connect modems are 300- or 1,200-baud units. If a 2,400-baud modem is desired, it must be connected through a special cable. Apple and Macintosh computers, as well as Atari computers, mainly make use of external modems.

In the early days of telecommunication, there was no standard for modems. Every manufacturer used a different set of procedures for dialing phone numbers and holding or hanging up the line. However, a set of modem operating codes called AT-codes, originated by Hayes Computer, became the *de-facto* standard. Today, most communications software for asynchronous communication use the Hayes codes. So unless you buy a Hayes-make modem, be sure that the one you do buy is Hayes-compatible.

The communications software you use is as important as the modem itself. A good software package takes all the trouble out of making connections and getting you on-line. It also provides for downloading software from a source or uploading to another computer, a BBS or a network. *Smartcomm* from Hayes and *CrossTalk* are typical popular commercial packages. *PC-Talk* and *Qmodem*, which are shareware programs, are now the most popular PC-communication packages. *Red Ryder*, in turn, is one of the most popular communications programs for the Apple Macintosh, although there are many others.

In order for you to communicate with any source, you must set your communi-

cations software to recognize the data pattern in use by the data source. The data software provides the capability for you to set your system for each data source you call. This consists of the number of start bits, the number of data bits and the number of stop bits for each character transmitted or received.

In addition, each data source may use a particular method to check that the receiver accurately receives the character transmitted by the sender. This is called "parity checking." It can be either negative or positive parity, or no parity at all. Your communications software also must know if the data source will send data two ways (full duplex) or only handle data in one direction at a time (half duplex). It is just as important to find out these things about a BBS or information network as it is to find out the telephone number of the service. If you contact a data source and your system is not set correctly, all you will get is gibberish.

The foregoing introduction to communicating with a personal computer only gives you an overview of what this activity is all about, of course. Obviously, there are plenty of ins and outs in services, equipment and software to make such telecommunications more effective, informative and enjoyable. I'll be digging into these aspects in following issues.

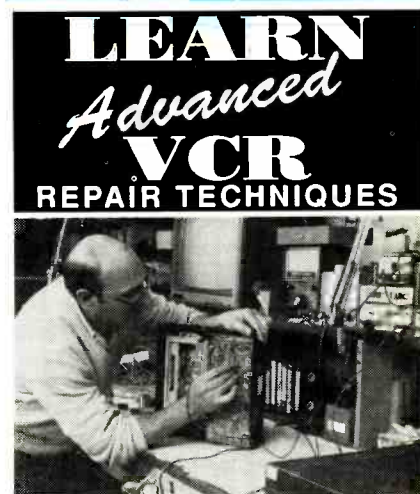

LEARN Advanced VCR REPAIR TECHNIQUES

Now, in a **complete** multimedia package consisting of a 200-page training manual and a 1-hour 22-minute video training tape, you can learn **secrets** of Advanced VCR Repair. (Also includes Color Bar Test Tape.)

Includes many examples of VCR make/model specific troubleshooting tips . . . Learn how to quickly isolate most "tough" VCR malfunctions, whether electrical or mechanical.

Complete coverage of Theory of Operation — Read manual, view 1-hour 22-minute video!

FREE INFORMATION PACKAGE!

Call 1/800-537-0589

Viejo Publications, Inc.
5329 Fountain Ave., Dept. CA
Los Angeles, CA 90029

CIRCLE NO. 179 ON FREE INFORMATION CARD

The Secret of Monkey Island: A Swashbuckling, Offbeat Graphic Adventure

Stories and legends of toothless pirates who terrorized the Caribbean with passion and violence have a strong tug on the imagination. Bold exploits of colorful figures are recounted with romance and a certain sparkle in the eye. In reality, though, those sea-going cutthroats were brutal and merciless. Their lives are hardly to be envied. In contrast to the arduous life of the buccaneer, Lucasfilm Games presents *The Secret of Monkey Island*, a comical, offbeat look at pirating.

Monkey Island follows the path of such previous Lucasfilm graphic adventures as *Indiana Jones* and *Loom*. Both games were fun and easy to play, using a game interface that's nearly trouble-free. Lucasfilm's emphasis on an enjoyable story and minimal frustration actually started some years ago with Zack McKracken and *Maniac Mansion* games.

Like previous Lucasfilm games, *Monkey Island*, achieves success largely as a result of a user interface that's nearly transparent to the player. For use in *Monkey Island*, though, a refinement that has to do with the point-and-click method of operating the game has been made to the interface. In past games, every function—from examining objects to talking to game characters—could be done with a computer mouse, without any need to type text. Though this technique is still put to good use in *Monkey Island*, now the interface tends to anticipate player action.

As you play *Monkey Island*, when you click on a game object, the interface assumes you want to next examine that object. When you approach a closed door, the interface assumes you want to open the door. When you contact a game character, the interface assumes you want to talk to that character.

The further streamlining of an already efficient playing system helps save time and effort. This is good news for working adults who don't have a lot of spare time.

The story of *Monkey Island* concerns a young lad named Guybrush Threepwood. Guybrush has pounced upon the shores of Melee Island and he wants to be a pirate. Players direct the would-be pirate to the local Scumm Bar, where he learns that he has to solve three trials before he can be rightly called a pirate. This is when the adventure begins.

Guybrush has to solve a strange mystery that involves voodoo and ghost ships and that frightens even the toughest of pirates. Eventually, he must make his way to fabled Monkey Island where things really get strange.

One of the more enjoyable aspects of *Monkey Island* is its built-in wit and humor. Guybrush Threepwood must become a swordsman of the highest order before he can embark upon the quest to find Monkey Island and rescue the woman with whom he has fallen in love. One might think that all it takes is some practice, and young Threepwood could brandish his sword with the best.

Well, anyone can wave around a piece of metal. But it takes a truly stalwart pirate to have a wit sharper than his sword. The right insult at the right time can cut the most accomplished swordsman right down to incompetence. Accordingly, players help Threepwood learn the more common sword-fighting insults and appropriate responses. This is done by dueling with local pirates of Melee Island.

(Continued on page 76)



Threepwood embarks on his quest.



An uncertain adventurer seeks spooky knowledge.



A bit of Monty Python-like humor.



Harpoon: A Modern Naval-Warfare Game

Operation Desert Storm has reminded us that the reality of war is terrifying to contemplate. The potential for a third global conflict is even more horrendous when one considers the great potential for international death and destruction on a large scale. Nonetheless, war remains fascinating from the view of the strategist. In this vein, Three-Sixty's *Harpoon* is a naval war strategy game that's more complete than any other of its genre for the PC. The action occurs in scenarios called "Battlesets," of which there are three ready for use.

The Battleset that comes with the *Harpoon* game is the GIUK gap. The frigid Norwegian Sea is enclosed by Greenland, Iceland, the north polar ice cap and Norway. There are three ways of entering this body of water. One is the opening between Iceland and the Faeroe Islands—the famed GIUK gap. In an imaginary Third World War, this area is defended by task forces from the United States, Great Britain and Norway. Meanwhile, NATO forces attack Soviet forces as the enemy skulks along the Norwegian coast.

Twelve scenarios make up GIUK. Each has computer commanders controlling a different NATO unit with the aim of implementing NATO strategy. Battle units can be as small as a squadron of missile boats or as large as the entire strike fleet. A player pits his command units against the well-trained Soviet Northern Fleet of two aircraft carriers, guided-missile cruisers, frigates, destroyers, nuclear and diesel submarines and hundreds of naval aircraft.

Another Battleset, *North Atlantic Convoys*, is more progressive than GIUK. It focuses on the mid-1990s, when Perestroika and Glasnost have failed. Soviet hard-liners have ousted Gorbachev and seized the Kremlin. In desperate efforts to divert attention away from a worsening Soviet economy, an all-out attack is launched at NATO. NATO is somewhat vulnerable because of a soft economy and recent defense cuts. The few remaining land forces on the European continent are ill-prepared for the Soviet lighting attack.

Since Soviet plans depend on early victory, NATO must keep

Western Europe supplied via vital sea convoys. Player goal is to move as many merchantmen and planes as possible across the North Atlantic, waging a mainly defensive battle. This means alert anti-sub and anti-air tactics. The Soviets, on the other hand, must destroy NATO supply convoys because of their own inability to support a sustained engagement. This scenario sees the use of very large airfields, AWACs, air superiority fighters and Los Angeles and Seawolf class submarines.

The newest Battleset, the *Mediterranean Conflict*, doesn't emphasize a US-USSR battle. Rather, the Middle East is the hot spot. Until Desert Shield, Western military action toward the Middle East had been limited to minor isolated occurrences. Therefore, the *Med* Battleset looks at the regional countries and

(Continued on page 76)



Harpoon's Control Screen.

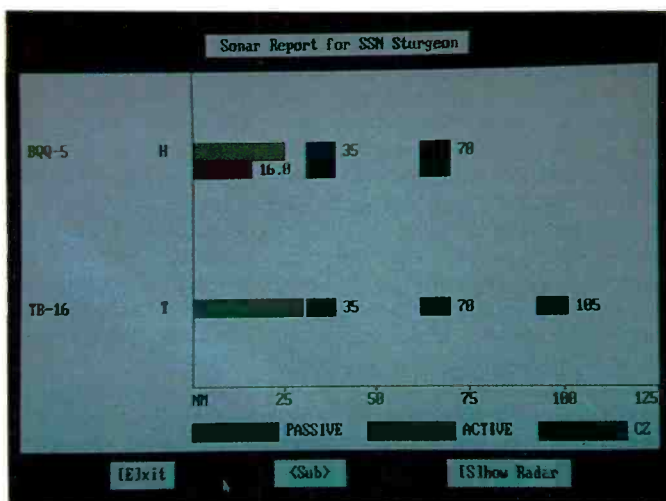

Checking a submarine's sonar.

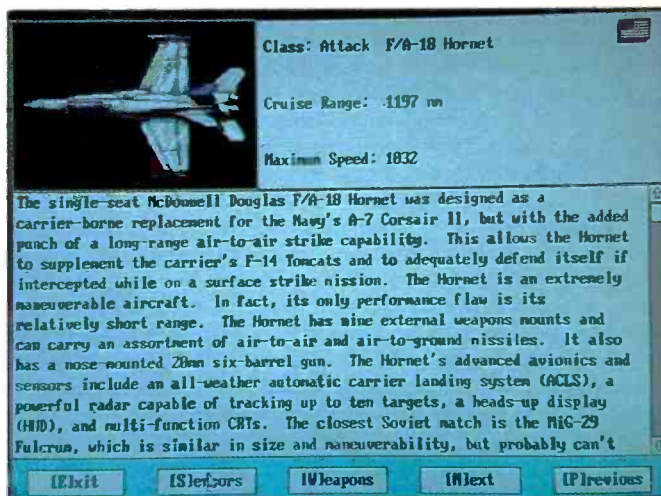

A look at the indispensable database.

Each pirate has something to teach, be it smart replies or better insults. The trading of lashing remarks and glib replies goes on until Threepwood is ready to face the awesome tongue of the Sword Master of Melee Island. Even when the time comes, game players must be quick on their mental feet because the Sword Master is no pushover when it comes to verbal affronts.

The adventure continues as Threepwood seeks the elusive location of Monkey Island. Legend has it that a certain ship, piloted solely by a crew of monkeys, made the miraculous voyage to Melee Island. With a leaking, rickety old ship and a lackadaisical crew, Threepwood sets off to face giant monkeys, bananas and cannibals, who belabor the finer points of dining etiquette.

Game documentation is a short seven pages. That's just perfect for a game like this, which depends on its user interface, ease of play and good story-telling. The manual is useful for understanding game mechanics, but an experienced player doesn't need it. The game interface is so informative and easy to use that anyone who's had just a little experience with graphic adventures will take right to it.

Monkey Island was first released in 16-color graphics that has excellent resolution. In these days of artfully crafted 256-color VGA games, you might think 16 colors would be lacking in some way. This isn't the case. A second 256-color edition of *Monkey Island* was released shortly after the 16-color version. Playing both versions reveals little difference in game appearance. Interestingly, some players prefer the 16-color version because of its higher resolution. But it doesn't matter which version you play, the story is still good, the humor is still raucous and the wit is still sharp as the blade of ghost pirate Captain Le Chuck.

Monkey Island is a well-prepared game that's fun and very easy to play. Its excellent user interface, humor and good story line are

a pleasure to experience. Lucasfilm games and designer Ron Gilbert and his assistants are to be congratulated for a well-rounded game that makes players look forward to more. ■

CIRCLE NO. 119 ON FREE INFORMATION CARD

Bird's Eye View

The Secret of Monkey Island, \$59.95

Lucasfilm Games

Electronic Arts

1810 Gateway Dr.

San Mateo, CA 94404

800-245-4525

Requirements:

| | |
|--------------------|---------------------------------|
| Memory | 640K |
| Graphics | VGA, MCGA, EGA, CGA, Tandy |
| Sound | Roland, AdLib, Sound Blaster |
| Controllers | Mouse |

Evaluation

Documentation Good

Graphics Good

Learning Curve Short

Complexity Easy

Playability Excellent

In Brief: Easy to operate and fun to play. Lucasfilm has taken the frustration out of adventure games.

Harpoon (from page 75)

their potential conflicts. Superpower forces are introduced for contrast and comparison.

With the recent Middle East activity going on, I asked Three-Sixty if *Med* could be used to simulate any part of the Persian Gulf War. The reply was both positive and negative. Persian Gulf action proper will have to wait for release of the Indian Ocean Battleset.

Tim Jacobs of Three-Sixty gave some helpful advice, as follows. *Med* can be used to somewhat simulate Iraqi-Saudi conflicts. The Iraqi air force is very similar to Syria's. By putting Syrian bases and naval units in Libya and using Libyan bases as "cannon fodder" (targets with no air support), Iraq can be approximately simulated. Tripoli can be used as Baghdad because it has a similar damage potential. Egypt can then be used as a close approximation to Saudi Arabia.

It's necessary to move Israeli bases into the far-middle of Egypt and give them mostly American aircraft. Then station an American carrier in the northeast Mediterranean. For control of sea lanes, station a Tarawa in the Med, too. This will give a rough approximation of the situation seen in Iraq. Finally, placing an enemy air base in France could simulate the safe haven for fleeing Iraqi aircraft. All of these changes to the *Med Conflict* or any other Battleset can be done with the *Harpoon Scenario Editor*, which is sold separately.

Each Battleset has at least 12 different scenarios to play. The first is the least-difficult, the later ones becoming more and more difficult and complex, culminating with the final one that's the

most difficult and complex.

A typical scenario from *North Atlantic Convoys* involves several kinds of vessels. Cargo ships are escorted by anti-submarine warships that may carry helicopters (helos). Each helo can be readied and launched at the command of the player. Furthermore, each helo can be outfitted for specific missions, whether patrolling for enemy subs or attacking an identified and target. That's just one warship with a few helos.

Things become more complex when a player has several warships, an aircraft carrier with varying kinds of airborne platforms, a group of submarines and one or two ground bases. You must decide course, speed, formation and destination for the various groups. If sensor contacts are made, you must decide which vehicles and how many should be sent to investigate the contact.

These decisions aren't much trouble as long as a commander doesn't get more than one or two of them at a time. Imagine the stress, though, when events begin happening very quickly. Perhaps unseen enemy vessels launch an attack with missiles and/or torpedoes. Several defensive and offensive engagements may occur simultaneously. This is tricky, heady business that can keep the heartiest tacticians very occupied.

The objective of the game is survival for one's own forces and to kill as many enemy vessels as possible, given a particular scenario, objective and weapon platforms. However, the enemy must first be located. This part of *Harpoon* is a testy but intriguing chess game of electronic warfare. Commanders must send out helo patrols often and respond to sensor contacts quickly. It's im-

Bird's Eye View

Harpoon (with GIUK), \$59.95
North Atlantic Convoys, \$29.95
Mediterranean Conflict, \$29.95
Scenario Editor, \$39.95

Electronic Arts

1820 Gateway Dr.
San Mateo, CA 94404
800-245-4525

Requirements:

Memory 640K
Graphics VGA, MCGA,
EGA, CGA, Tandy
Sound Sound Blaster,
AdLib, Roland,
Tandy, Covox,
Innovation
Controllers Keyboard, Mouse

Evaluation:

Documentation Good
Graphics Good
Learning Curve Long
Complexity Difficult
Play Length Long
Playability Good

In Brief: Intense, long play game that is difficult to master. Requires full attention and a love of strategy. Mouse and 20-MHz '286 or better are recommended.

COMPUTER SHOW SCHEDULE

PRODUCED BY KGP PRODUCTIONS SINCE 1980

- July 27 Edison, NJ - Raritan Center Expo Hall NJ
Sat. Turnpike Exit 10 - Rte. 514 West 700 Indoor
10 to 3 Vendor Tables - **BIG SHOW!**
- August 3 Marlborough, MA - Royal Plaza Trade Ctr.
Sat. West of Boston - I-495 Exit 24-B-1 mi.
10 to 3 400 Tables - Fully Air-Conditioned
- August 10 Long Island (NY) Huntington Hilton - for-
Sat. merly Royce Carlin Rte. 110 - Melville, NY -
10 to 3 Use LIE, Exit 49 to Rte. 110 South 1 mile on
right. 200 Tables
- August 17 Fairleigh Dickinson Univ. - Rothman Center -
Sat. Hackensack, NJ - Off Rte. 4 - Hackensack
10 to 3 Ave. South left at light - 500 Tables
- Sept. 7 Woburn, MA - Northeast Trade Center -
Sat. North of Boston - Exit 35 - I-95 (Rte. 128) -
10 to 4 Next to Shopping Center - 400 Tables

SHOW OFFICE: (908) 297-2526
OR FAX US AT (908) 422-0076

CIRCLE NO. 161 ON FREE INFORMATION CARD

perative that they know the capabilities and weaponry of offensive and defensive tools.

The game has a colossal database of information that lists necessary facts about any air or sea vessel likely to play a part in World War III. This is the heart of *Harpoon* and is where the smart player learns about his arsenal so that he can make intelligent tactical judgments. The on-line database alone is worth the purchase price of the game.

Other things make *Harpoon* an excellent buy, too. Despite the game's complexity, it's surprisingly easy to operate, once you figure out how to manage the vast forces at your disposal. You'll have to spend some time reading the accompanying manual and becoming familiar with the game's generalities. A mouse or the keyboard can be used to play, though neither of them work well, but a mouse may be smoother than the keyboard.

Events occur in real-time. Missiles travel much faster than torpedoes, and enemy subs may stalk your convoy for hours before they strike. Time compression is available for speeding up the dull moments, but players should remember that all aspects of game activity, including that of the enemy, are sped up, too, if this option is used.

Harpoon is a powerful, time-consuming, no-nonsense game that patterns itself after the harsh calculations of real war. It isn't a game for novices and takes a lot of time to master. But the challenge, strategy and thrill are extremely rewarding for those who like to exercise their brains. *Harpoon* is a powerfully intellectual look at the strategy of naval warfare in the technologically '90s.

CIRCLE NO. 120 ON FREE INFORMATION CARD

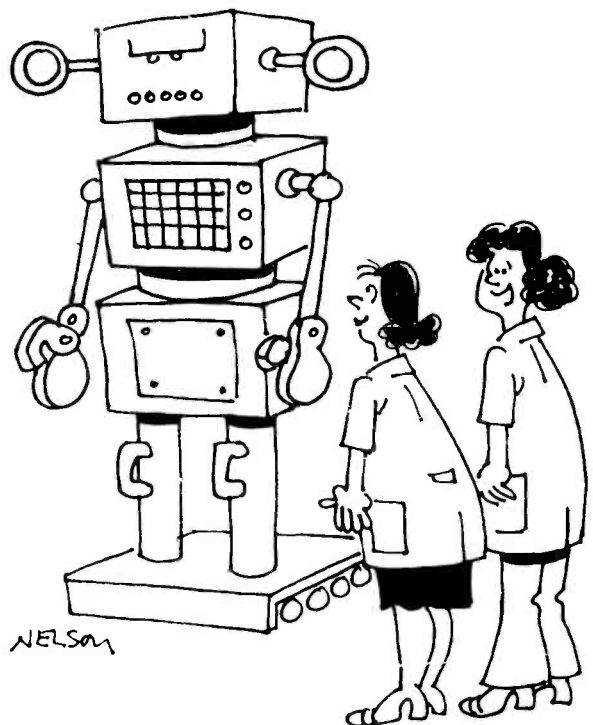

It's not perfect, but what man is?



More on Digital Imaging; The Complete Flatbed Scanner; and CAT ScanAdapter LPT/Image Enhancer

Last month, our odyssey into the world of digital imaging began with a primer on how sensors measure the presence and absence of light and its intensity (if present) and convert it into a grayscale representation of a continuous-tone image. Before I go on to look at hardware and software used to capture and process an image, I'd like to make one small point that may not have been completely obvious from my previous discussion.

The term digital imaging is somewhat of a misnomer. An image is converted into a digital representation and stored as a bit-by-bit representation of the pixels (picture elements) that are eventually displayed or printed. The front-end to this process, the equipment that first captures the image, isn't actually a digital device. Most commonly, the sensor in scanners and video cameras is a CCD (charge-coupled device).

The individual elements of a CCD are similar to a photosensitive capacitor. The degree of charge an element maintains between one interrogation and the next is dependent on the intensity of light that falls on it. The amount of charge the element maintains varies from only that expected over the polling time period (black, or no light) to full discharge between polls (white). The increments of discharge between these two values represent, and are extrapolated as, varying levels of light intensity between black and white (shades of grayscale).

The number of grayscales obtained from a sensor is relatively arbitrary and depend on the resolving power of the sensor's supporting circuitry—and, to a large extent, on where we want to draw the line between a range of values representing one level of gray and the next.

Another consideration is the ratio between levels of gray and dot-per-inch (dpi) resolution. The more gray scales you wish to resolve for each dot (pixel), the more storage you require for the file that represents that image. At 300 dpi, a common scanner resolution, the 64-level grayscale image of the photo accompanying this column had to be cropped substantially to fit on a 1.2M 5¼" floppy disk. The actual scanned image area captured was about 4½" × 3".

Scanning at 300 dpi in 24-bit color is even more taxing on your hard disk. A 5"

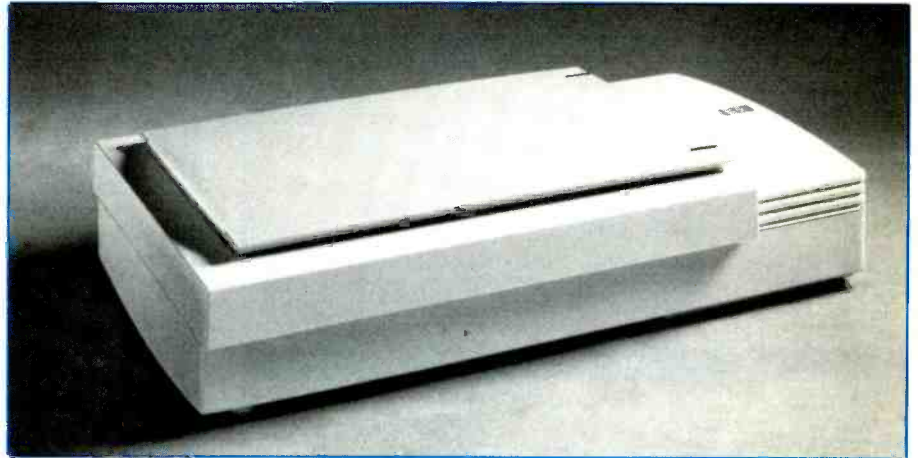

The Complete Flatbed Scanner.

× 7" photo scanned on an Epson color scanner reviewed in this column last year yielded a file size in excess of 11 megabytes!

Fortunately, you don't always have to scan at the highest resolution available with a scanner. The best resolution at which to scan depends on a number of factors, including how many shades of gray you're using, brightness and contrast of the image, type and resolution of the output device and whether or not you'll be enlarging or reducing the image. For example, a 4" × 4" image scanned at 150 dpi and reduced to 2" × 2" yields an apparent 300 dpi resolution. Furthermore, if you'll be printing the image on a 300-dpi laser printer, scanning at a higher resolution than 300 dpi won't yield a better image.

The manual that comes with some versions of Astral Development's *Picture Publisher* (and can be ordered for a few dollars with other versions of the software package), has an excellent discussion of how these factors relate to each other. The bottom line for most of us, though, is to try scanning an image at various settings until we find a usable set. Experimenting like this is a time-consuming project, but it's the only way to get a really good feel for the process.

The Complete Flatbed Scanner

In addition to the innovative communi-

cations products it's known for, like the Portable/FAX I reviewed a few issues back, The Complete PC was the first company to have an affordable hand scanner, and the sheet-fed The Complete Page Scanner is the least-expensive full-page scanner on the market. Now Complete PC has a line of grayscale scanners, including 4" scan-width hand unit, a grayscale version of its sheet-fed page scanner, and the the flatbed scanner reviewed here, which is capable of scanning a legal-size (8½" × 14") document in 64 shades of gray.

The flatbed scanner is different from the Complete Page Scanner. In the sheet-fed unit, a page must be pulled across the scan head. In a flatbed scanner, the image to be scanned is placed on a glass platen, beneath which the scan head is moved as it scans a document.

Flatbed scanners usually yield better results than sheet-fed units. One reason is the cover, identical to that on a fixed-platen photocopier machine, that shuts out extraneous light. The main reason for the better quality of the flatbed scanner, though, is that the platen movement can be controlled much better than when a piece of paper is mechanically pulled over a scanner head. In a sheet-fed scanner, rubber rollers grab the page and pull it through. Different areas of the page may have less friction than other areas or the rollers may wear differently, both of which result in traction differences that

can cause the page to skew while being moved through the scanner, as well as uneven rate of pull over the scan head. In either case, the result is a distorted image.

A number of other differences exist between flatbed and sheet-fed scanners. One is size. The flatbed is large, measuring 21" long by 13" wide and standing 4" high. Hence, you need a fair amount of desk space for it. The flatbed scanner also interfaces differently. Because so much information must be transmitted to the PC (these grayscale files are *large!*), the simple interface the Page Scanner uses would be much to slow.

The Flatbed scanner comes with a SCSI interface card and, unlike the less-expensive Page Scanner, won't directly plug into The Complete PC's fax cards. However, you can scan a document, save it as a .TIF file and transmit that image from the fax. Though at the present time this requires you to exit the scanning software and activate the fax card software, a spokesman at The Complete PC tells me a well-known Windows-based fax package will soon be available for the company's fax products. As the scanner software, *Picture Publisher*, is also a Windows package, you should soon be able to fax a document directly from the Flatbed Scanner.

Software is another area of difference between the two units. The Page Scanner comes with a very nice scanning package developed by The Complete PC, but this software lacks the image manipulation capabilities needed for a grayscale scanner. Rather than spend a lot of time upgrading the software, The Complete PC wisely went with the leader—Astral Development's excellent *Picture Publisher* Version 2.1, which is included in the package. This is an OEM version of *Picture Publisher* (which was reviewed in this column last year).

While the version of *Picture Publisher* included with the Flatbed Scanner has all the features of the standard version, it doesn't include some frills, like an on-line tutorial, a 12-step grayscale for calibrating the scanner when needed and the Scanning and Printing Guide discussed above. However, an order form is included for these items that will get you the Scanning and Printing Guide for \$12 and 12-step grayscale wedge for \$10, both well worth the money.

The SCSI interface and *Picture Publisher* software make the Flatbed Scanner a bit more involved to install. The scanner itself is OEMed from AVR (Advanced Vision Research), though the interface is produced to The Complete PC's design specifications. AVR makes great scanners, but it has the worst documentation I've ever seen. Unfortunately,

the Flatbed Scanner's installation manual follows AVR's. It's a tiny booklet with almost no technical or troubleshooting information. There's no discussion of addressing conflicts or what to do if the scanner doesn't work. Fortunately, The Complete PC's technical support is excellent. I know because I had to call the company before I got things up and running properly.

The first time I used it, the software refused to recognize the scanner. After exhausting every possibility I could think of, I reached for the phone. There appear to be a few 386SX PCs the scanner doesn't work with, mine possibly being one of them. The tech specialist I talked to recommended I move the unit to another system. When I did, the software suddenly woke up to the fact that there was a scanner on the other side of the SCSI cable. The only trouble was that I had another SCSI device on that particular system, a terrific Chinon external CD-ROM drive. Whenever *Picture Publisher* tried to do something with a scanned image, I got a message that the CD-ROM drive wasn't ready, even when it was. I moved the Chinon drive over to the SX machine, and now both the CD-ROM drive and scanner seem to be happy.

I'm also having a slight problem with *Picture Publisher*. When the software is first set up, you must specify the scanner you're using and its base address (the RAM address at which *Picture Publisher* will look for the scanner). I keep having to reset this every time I use the software. There's probably some simple answer to this, but it's such a minor annoyance that I haven't taken the time to call the company about it.

Aside from these somewhat minor problems, the scanner works great. At \$1,595, it's not cheap, but it does come with both the SCSI interface card and *Picture Publisher* bundled in. This list price (you can expect to find it at a substantial discount from vendors) is several hundred dollars less expensive than for its

Various levels of printed scanning results. From bottom: original photo; scanned directly as grayscale file from CHPS/400; scanned with CAT *Image Enhancer* with CHPS/400/grayscale mode, printed with *Image Enhancer*; hand-scanned image converted to .TIF grayscale, printed from CAT *Image Enhancer*; Complete HalfPage Scanner/400—half-tone, dithered, scanned with line-art setting from within *Image Enhancer* at 300-dpi resolution; Complete Flatbed Scanner grayscale .TIF file imported into *Page Maker* 4; Complete Flatbed Scanner *Picture Publisher* scatter print.



ATTENTION! ELECTRONICS TECHNICIANS

EARN YOUR
**B.S.E.E.
DEGREE**
THROUGH HOME STUDY



Our New and Highly Effective Advanced-Placement Program for experienced Electronic Technicians grants credit for previous Schooling and Professional Experience, and can greatly reduce the time required to complete Program and reach graduation. No residence schooling required for qualified Electronic Technicians. Through this Special Program you can pull all of the loose ends of your electronics background together and earn your B.S.E.E. Degree. Upgrade your status and pay to the Engineering Level. Advance Rapidly! Many finish in 12 months or less. Students and graduates in all 50 States and throughout the World. Established Over 40 Years! Write for free Descriptive Literature.

**COOK'S INSTITUTE
OF ELECTRONICS ENGINEERING**



4251 CYPRESS DRIVE
JACKSON, MISSISSIPPI 39212

CIRCLE NO. 155 ON FREE INFORMATION CARD

SUPER LONG PLAY TAPE RECORDERS

12 Hour Model —
USES 120 TAPE
\$119.00*

Modified Panasonic Slimline, high quality AC-DC provide 6 continuous hours of quality recording & playback on each side of cassette for 12 hours total. Includes • Voice level control • Digital counter, etc. TOK - 120 Cassette Furnished.



PHONE RECORDING ADAPTER

Records calls automatically. All Solid state connects to your telephone jack and tape recorder. Starts recording when phone is lifted. Stops when you hang up.

\$28.50*

FCC APPROVED



VOX VOICE ACTIVATED CONTROL SWITCH

Solid state. Self contained. Adjustable sensitivity. Voices or other sounds automatically activate and control recorder. Uses either recorder or remote mike.

\$28.50*



* Add for ship & handling. Phone Adapter & Vox \$2.00 each. Recorders \$5.00 each. Calif. Res. add tax. Mail order, VISA, M/C, COD's OK. Money Back Guarantee. Quantity discounts available. Dealer Inquiries invited. Free data.

AMC SALES INC. Dept. M 9335 Lubec Street
Box 928, Downey, CA 90241
Phones (213) 869-8519 1-800-926-2488
FAX (213) 923-1478
Mon-Fri 8-5 PAC TIME

CIRCLE NO. 151 ON FREE INFORMATION CARD

Ted Needleman

nearest competitor. An Automatic Document Feeder that replaces the platen cover and lets you scan a pile of documents (up to 100 pages) automatically is available for \$95.

A spokesperson at The Complete PC assures me that the scanner's documentation is being redone in a version that's up to their excellent standard and will be available soon, probably by the time this review is published.

I really like this scanner. It's the best buy of the half-dozen or so grayscale scanners I've looked at recently, but I advise you to call The Complete PC before you buy one to check on whether it will work with your particular system and inquire about whether or not the revised scanner documentation is available.

CAT ScanAdapter LPT/ Image Enhancer

Back a few columns ago, when I was reviewing The Complete PC's Portable/FAX, I was bemoaning that the Portable/FAX let you send word-processing document files via fax but didn't provide full fax capabilities while on-the-go because few notebook-sized PCs offer a slot for a hand scanner. Unless the document you wanted to fax was created electronically, you were out of luck.

A few weeks ago, I ran into the folks from Computer Aided Technologies at a local computer show. This Dallas, Texas-based company is responsible for the CAT Reader OCR software I reviewed in this column last year. They handed me a box containing the ScanAdapter LPT, which completes not only the last bit of the solution to scanning and faxing on-the-go but also lets me use a hand scanner with any PC that doesn't contain an expansion slot (or whose expansion slots are all taken up).

The ScanAdapter LPT is a simple device, a bit less in dimension than a 3" x 5" card and about as thick as a deck of playing cards. It comes with a small power-cube type transformer and plugs into the parallel port of a desktop or laptop PC. Plug in one of the supported hand scanners, install the software and you're in business. What the ScanAdapter does is also simple; it allows the scanner to be operated from the parallel printer port, rather than the adapter card with which the scanner is supplied. As all the laptops/notebooks I've ever seen have a printer port, assuming you have one of the supported hand scanners (which include models from CAT, Complete PC, DFI, GeniScan, Logitech, Marstek, Mitsubishi, NISCAN and SkySCAN), your portable is now also a scanning platform.

A portable computer equipped with a

hand scanner, ScanAdapter and Portable/FAX or similar card, is a full-featured fax system. When you need to fax a diagram or other paper document, you just scan it with the hand scanner, save it as a .TIF or .PCX file and fax it wherever it needs to go.

ScanAdapter is such a simple, useful device, especially if you travel with a PC and fax board, that it deserves consideration on its own. Along with the ScanAdapter, you also get a copy of CAT's *Image Enhancer* software. This version of *Image Enhancer* does a number of things. For one, it lets you operate a supported hand scanner without the special scanning software provided by the scanner's vendor. Whether or not you're using the LPT ScanAdapter, *Image Enhancer* permits you to scan, capture and print an image.

Once you install the software by creating a new directory on your hard disk and copy the files to it from the provided floppy, all you do is move along *Image Enhancer's* menu bar to CONFIGURE, where you choose the scanner you're using, whether it's connected to a bus card (the scanner's own interface card) or the ScanAdapter LPT, and change the default I/O address and interrupt if you're using settings other than the scanner's normal default. Then, to scan, just move to the SCAN menu selection and hit the F10 key. Click the scanner's START key and scan away.

Image Enhancer has another important function in addition to providing scanner control. It allows you to convert a dithered half-tone image captured by a non-grayscale hand scanner into a grayscale image. Dithering is a technique of simulating a grayscale by the placement of dots closer and farther away in the displayed or printed image. The density of the dot image fools the eye into thinking that it's seeing a grayscale image. The people at CAT don't say how *Image Enhancer* does this, but the most likely way is to divide the scanned image into small areas, say four pixels square, and analyze the dot pattern in each square. This way, depending on whether a dot has a dot next to it in each (or either) of the four directions, each can be assigned a dot/pixel a grayscale value.

Image Enhancer converts the image to 16 levels of gray. This may not be as pleasing an image as a 64-level grayscale, but it's enough to greatly subdue the very apparent patterns that develop as a result of dithering a pure black-and-white hand-scanned image. If you look at the sample images shown here, you'll notice a number of things. The 64-level scan produced by the Complete Flatbed Scanner is noticeable better than any of those

produced by The Complete Half Page/400 hand scanner used with *Image Enhancer*. The grayscale conversion performed by *Image Enhancer* has gotten rid of some of the annoying dithering patterns and softened the image somewhat, but it has introduced a noticeable vertical pattern into the image.

Image Enhancer also gives you one other important capability: you can scan directly into a grayscale file from a standard non-grayscale hand scanner. Conversion to grayscale is performed on the fly, and *Image Enhancer* can save files in a number of grayscale formats, including *Pagemaker* .TIF, *Ventura Publisher* .TIF and several .PCX grayscale formats. Non-grayscale .TIF and .PCX image files created by other applications can be imported into *Image Enhancer* and converted to grayscale.

CAT *Image Enhancer* is available by itself for \$99, or included with the ScanAdapter LPT for \$149. I recommend the ScanAdapter for anyone who has a laptop or notebook and wants to be able to use a hand scanner for just capturing an image or scanning documents for fax purposes. It also allows you easily move a hand scanner between a number of different systems without having to open the PC to move the scanner's interface card. Nor will you have to install the scanner's software on every machine on which you use the device (though you'll have to install the *Image Enhancer* software on each of these systems).

There are some limitations of *Image Enhancer* that you should be aware of before you run out to buy it. One is that most hand scanners have a maximum scan width of 4". If you're trying to scan a standard letter-size page, you can work around this. You can scan the top half of the page, then the bottom half. *Image Enhancer* lets you specify a scan as left-to-right (or top-to-bottom).

With sideways scan, the software automatically rotates the image after the scan has been performed. Transmit each scan as a separate file if you're faxing the scanned image, or use another CAT product, *ImageLINKs* (\$195) to stitch together the two scanned images.

You're also limited to the size of the swatch you can scan. This is a function of the width of the scan (usually 4") and resolution at which you're scanning. When you scan a file with *Image Enhancer*, the size of the file created is limited to around 300K. With a 4" scanner, scanning at 400-dpi resolution limits you to about a 4"-long scan. At the 300-dpi resolution most used for desktop publishing and graphics, this length increases to about 7", and the 200-dpi resolution, which is the maximum fax resolution, yields a 15"

scan length.

CAT's *Image Enhancer* and ScanAdapter are really nice products, especially if you already own a hand scanner. If you have a laptop you use for fax, they'll greatly extend its capability. ■

Products Mentioned

The Complete Flatbed Scanner, \$1,596
Automatic Document Feeder, \$495

The Complete PC
1983 Concourse Dr.
San Jose, CA 95131
415-434-0145

CAT ScanAdapter LPT (includes *Image Enhancer* software), \$149
Image Enhancer, \$99

Computer Aided Technology, Inc.
10132 Monroe Dr.
Dallas, TX 75229
214-350-0888

USE YOUR FREE INFORMATION CARD

CABLE-MATE, INC. Are You Tired of Paying Outrageous Fees?

All makes and models of cable equipment shipped within 24 hrs.
Quantity discounts. For free catalog send S.A.S.E. to:
Cable-Mate, Inc., 450 Shag Bark
Algonquin, IL 60102
C.O.D. orders accepted
CALL FOR PRICES TODAY!!

800-422-0525

(708) 658-2121

*No Illinois orders

Hours—8:00 am-5:00 pm central time



AUTOMOTIVE ELECTRONICS



LEARN ABOUT THIS EXCITING NEW FIELD!

WE HAVE:

KITS, PLANS, BOOKS, & VIDEO TAPES

S&M ELECTRO-TECH, INC.



FREE CATALOG CALL 1-800-535-3091

OR WRITE: PO BOX 34334, BLAINE, MN 55434

CIRCLE NO. 175 ON FREE INFORMATION CARD

U.S. CYBERLAB



'EXTREME' HIGH TECHNOLOGY

KITS, PRODUCTS, MATERIALS
Nick Goss says, "This catalog is a 'must' for every serious Scientific Experimenter! Better order your copy today. These are the products you have been waiting for!"
Come join the Cyberlab Team and start living the adventure by building scientific kits that contribute directly to your own personal technological power base!

U.S. CYBERLAB, INC.
RT 2 BX 284, CYBER FACILITY
WEST FORK, AR 72774
(501) 839-8293 VOICE MAIL

CIRCLE NO. 173 ON FREE INFORMATION CARD

SAVE YOUR COPIES OF ComputerCraft

These custom-made titled cases and binders are ideal to protect your valuable copies from damage. They're designed to hold a year's issues (may vary with issue sizes), constructed with reinforced board and covered with durable leather like material in (color), title is hot-stamped in (gold/silver), cases are V-notched for easy access, binders have special spring mechanism to hold individual rods which easily snap in.

CASE

BINDER



Cases: 1—\$7.95 3—\$21.95 6—\$39.95
Binders: 1—\$9.95 3—\$27.95 6—\$52.95

ComputerCraft

Jesse Jones Industries,
499 East Erie Ave., Philadelphia, PA 19141

Enclosed is \$_____ for _____ Cases,

Binders. Add \$1 per case/binder for postage & handling. Outside USA \$2.50 per case/binder (US funds only). PA residents add 6% sales tax.

Print Name _____

Address _____
No PO Box Numbers Please

City _____

State/Zip _____

CHARGE ORDERS (Minimum \$15): Am Ex, Visa, MC, DC accepted. Send card name, #, Exp. date.
CALL TOLL FREE 7 days, 24 hours
1-800-972-5858

SATISFACTION GUARANTEED

CD-ROM Drive Manufacturers

Here's a listing of manufacturers of IBM-compatible CD-ROM drives and their current models. Though every effort was made to assure that pricing and specifications were as complete and accurate as possible as this was being written, new models are constantly being introduced and prices are dropping steadily on CD-ROM hardware. Call the manufacturers listed here for more information on these models and names and addresses of dealers/distributors of their products in your area.

CD Technology Inc.

1-408-432-8698

Porta Drive, \$895

683M, 350-ms access time

Fast, portable drive with SCSI interface. Compatible with IBM and Macintosh Portable computer. Optional battery pack.

Colby Systems Corp.

1-415-949-9090

Pocket CD PAC, \$3,000

650M, 1,500-ms access time

Portable, battery-powered CD-ROM player. Provisions for keyboard or voice control. Output can be audio or video. Video output is displayed on a small, private eye display that produces the equivalent of a 14" video monitor picture.

Denon America, Inc.

1-201-575-7810

DRD-253, \$1,100 (host adapter and cable kit \$199)

0.4 second average access time

Has embedded SCSI controller with versatile command and message sets in accordance with the ANSI recommendations. Front-loading cartridge system and allow audio CDs to be played. DRD-253 is a self-powered stand-alone version.

EMAC (div. EVEREX Systems Inc.)

1-415-683-2155

Metro CD, about \$900

550M, less than 500-ms access time

Premium performance makes this drive a great value and reliable choice. Patented SCSI Sentry protective circuit provides a level of protection from SCSI bus shorts or problems not available from any other manufacturer. Comes with all cables, manuals, data, audio drives and sampler CD-ROM disc.

Genesis Integrated Systems

1-612-544-4445

Gen Star 2000, \$499 (drive & CD audio)

600-ms access time

External drive with interface card, cable, caddy and system disk.

Gen Star 3000, \$499

400-ms access time

Internal drive with SCSI interface.

Hitachi Corp.

1-213-537-8383

CDR-1503S, \$995

552M, 800-ms access time

Stand-alone drive compatible with IBM PC/XT/AT and PS/2. Audio output. Can daisychain up to four units.

CDR-3600, \$895

553M (mode 1)/630.7M (mode 2), 450-ms average access time

Serial-interface (Hitachi bus) internal drive compatible with IBM PC/XT/AT and 100% compatibles features double door mechanism, automatic lens cleaning, audio output and daisy-chaining up to eight units.

CDR-3650, \$775

553M (mode 1)/630.7M (mode 2), 450-ms average access time

Same as CDR-3600 but with SCSI interface.

IBM Corp.

1-914-642-5408

PS/2 CD-ROM Drive, \$1,250

600M, 380-ms average access time

Internal drive attaches to the PS/2 system via SCSI interface. For floor standing PS/2 models 60, 65 SX and 80. Audio output.

PS/2 External CD-ROM Drive, \$1,550

600M, 380-ms average access time

Stand alone drive attaches to the PS/2

drive. (Factory default settings are usually correct when only a single drive is to be installed.)

(4) Mount the CD-ROM drive in the selected drive bay using the mounting hardware supplied with the drive. In some installations (as with ours, for example), the drive bay is removable and slides right over the CD-ROM drive snugly with four screws to secure it. Other installations may require mounting rails to the sides of the drive and then sliding the unit into the bay via the rail channels.

(5) Before securing the drive in the bay, plug the power cable from the PC's power supply into the socket located at the rear of the drive. Plug the interface cable into the drive. This cable will be keyed so that it can be attached only the right way. If you're

not sure about this step, refer to the installation instructions provided with your CD-ROM drive. Never force a cable onto or into a connector!

(6) Once these two cable connections are made and the DIP switches are set, secure the drive in the bay. Be sure to attach the chassis grounding wire to the CD-ROM drive or bay housing according to instructions.

(7) Select a convenient available expansion slot on your computer's motherboard into which to plug the interface card for the CD-ROM drive. Remove the blocking plate that covers the slot opening on the back of the system unit. Check instructions to see if any jumpers on the interface board must be set (again, default factory settings are usually fine for single-drive installations). Being careful not to touch any of the components

on the board (they may be static-sensitive), plug the interface card firmly into a selected slot on the motherboard and secure its metal backing plate with the screw you removed earlier from the "dummy" plate.

(8) Plug the other end of the interface cable coming from the CD-ROM drive into the appropriate connector on the interface card. Tuck all cables and wires safely and neatly inside the system unit. These should be routed so that they don't obstruct any components or interfere with the system unit's cover.

(9) Check to make sure all cables inside the computer are still plugged into their respective locations. Replace the cover on the system unit, taking care to avoid disturbing internal cables, and secure it in place with screws you previously removed.

system via SCSI interface. For all Micro Channel PS/2s. Audio output. Daisy-chaining capability.

JVC Information Products

1-201-794-3900

XR-R100

800-ms maximum access time

Stand-alone player with front-loading cartridge mechanism.

XR-R1001

800-ms maximum access time

Half-height version of XR-R100.

Micro Design Int'l.

1-407-677-8333

Laserbank 600CD, \$1,800

600M, 500-ms average access time

Internal drive with SCSI interface compatible with IBM PC/AT and PS/2s.

Laserbank 600CD, \$1,800

600M, 500-ms average access time

External drive with SCSI interface compatible with IBM PC/AT and PS/2s.

NEC

1-708-860-9500

CDR-35

540M (DOS)/560M (Apple), 700-ms average access time

Stand-alone drive (portable with optional battery pack) compatible with Macintosh, IBM PC/XT/AT, PS/2 and 100% compatibles. Audio output.

CDR-72

540M (DOS)/560M (Apple), 400-ms average access time

Stand-alone drive compatible with Macintosh, IBM XT/AT, PS/2 and 100% compatibles. Audio output.

CDR-82

58M (DOS)/560M (Apple), 400-ms average access time

Internal drive with SCSI cable compatible with Macintosh, IBM PC/XT/AT, PS/2 and 100% compatibles.

Pioneer

1-201-327-6400

DRM-600, \$1,295

3.2G (540M on each of two discs), 600-ms average access time

Stand-alone CD-ROM changer drive with SCSI interface holds up to six discs. Can daisychain up to seven units. Audio output.

Sony Corp.

1-408-432-0190

CDU-520

500-ms average access time

Half-height internal drive can be used horizontally or vertically.

CDU-541

380-ms average access time

Half-height internal drive with SCSI interface and built-in audio headphone circuitry can daisychain up to seven units.

Sun Moon Star

1-408-452-7811, 1-800-545-4SUN

CD-Set

553M, 450-ms access time

External drive with extensive software package included.

Toshiba

1-714-583-3000

XM-2200A

599M (mode 1)/683M (mode 2), 350-ms average access time

Stand-alone drive with SCSI interface compatible with IBM AT, PS/2 and Macintosh. Horizontal or vertical mount. Audio output.

XM-2200S

599M (mode 1)/683M (mode 2), 350-ms average access time

Stand-alone drive with SCSI interface compatible with IBM AT, PS/2 and Macintosh. Horizontal or vertical mount. Compact version of XM-2200A. Audio output.

XM-3201B

599M (mode 1)/683M (mode 2), 350-ms average access time

Half-height internal drive with SCSI interface compatible with IBM AT, PS/2 and Macintosh. Audio output.

XM-5100A

600M, 380-ms average access time

External drive with cable, software and IBM PC/XT/AT interface card. Audio capability.

Then reconnect the keyboard, monitor and power cables.

(10) If you're installing an external drive, now is the time to attach one end of the interface cable to the back of the interface card and the other end to the back of the external CD-ROM drive. Now connect the power cable to the drive.

(11) Turn on the computer and video monitor. If you are using an external drive, also turn on power to it. With power applied, the system should boot as usual. If it doesn't, you've accidentally disturbed something inside the PC chassis (like a ribbon connector from the hard drive), so you'll have to disconnect everything and open it up again to retrace your steps and put everything right.

(12) Locate the software diskette supplied with your CD-ROM drive

and place it in your floppy drive. This diskette contains the needed MSCDEX extensions and device drivers that permit you to integrate the drive into the system. It will also probably have an automated installation program that will automatically copy necessary files onto your hard drive and make modifications to your AUTOEXEC.BAT and CONFIG.SYS files so that your system recognizes the CD-ROM drive.

When you begin installation, essentially what will happen is that a subdirectory will be created on your hard disk (for example, CDSYS) that will hold the extension files and any other required set-up software for the CD-ROM drive. The AUTOEXEC.BAT file will be modified to include a couple of extra lines that set the path variable to include the

CDSYS subdirectory and set the CDRAM allocation and the required parameters for it. The CONFIG.SYS file will be modified to add a LAST-DRIVE line if required, add a DEVICE line to acknowledge the CD-ROM drivers and set the required parameters for it. A typical configuration is illustrated in Fig. 2, which shows the AUTOEXEC.BAT and CONFIG.SYS file contents of our project system.

Using a CD-ROM Drive

Apart from its huge capacity, using a CD-ROM is pretty much the same as using a hard drive with these three notable differences:

(1) Keep in mind that the ROM portion of CD-ROM means read-only memory. You won't be able to

write any data to the compact disc in the CD-ROM drive (its like having the write-protect notch covered on a floppy diskette). Some WORM (write-once, read-many) CD drives are available, but they're quite expensive and aren't practical unless you have huge amounts of informa-

tion to save once and access repeatedly. Eventually, writable CD drives will find their way into the affordable consumer marketplace, but that's still in the not-too-near future.

(2) The CD must be placed in a caddy before it can be used in a CD-ROM drive. The caddy is simply a

protective plastic device that holds the CD in readable position within the drive and allows access to the data pits through a sliding metal sleeve. I've found that having a couple of caddies on hand speeds up CD swapping and reduces the amount of physical handling associated with frequently used CDs.

(3) Access speed of a CD-ROM drive is considerably slower than that of even the slowest hard-disk drive. Typical access time is in the 350 millisecond range, compared with 28 milliseconds for popular 40M hard drives. Some real "bargain" CD-ROM drives that are starting to appear for less than \$500 have access times of 500 milliseconds and longer. Larger look-ahead buffers and improved firmware will speed up the access times of future CD-ROM drives, but the days of under-100-ms access time are still a long way off.

Viewing & Listening

Because CD-ROM is a multimedia vehicle, a color monitor and VGA card are essential for viewing at its best. Many CDs contain high-resolution video images and animation in addition to text and provide music, narration and sound effects as well for a spectacular presentation. You'll also want stereo headphones or portable personal stereo speakers to plug into the headphone jack of your CD-ROM drive so you can listen to the audio portions. (Don't forget that you can also play music CDs on your CD-ROM drive as well when you're not using the drive for data retrieval. Audio playback is usually "background," allowing you to use your computer for other tasks while the CD-ROM drive plays your audio compact discs).

A Bold New Medium

CD-ROM promises to have a profound impact on information storage and retrieval. As we stand on the brink of fabulous new developments in personal computing, CD-ROM is right at the front of this new wave. You'll be surprised at how quickly you'll become a real CD-ROM "power user," and you'll soon wonder how you got along without it! ■

48 HOUR SHIPPING

ELENCO & HITACHI PRODUCTS AT DISCOUNT PRICES

48 HOUR SHIPPING

Hitachi RSO Series

(Portable Real-time Digital Storage Oscilloscopes)

| | |
|---------------------------|-----------|
| VC-6023 - 20MHz, 20MS/s | \$99/mo* |
| VC-6024 - 50MHz, 20MS/s | \$120/mo* |
| VC-6025 - 50MHz, 20MS/s | \$136/mo* |
| VC-6045 - 100MHz, 40MS/s | \$125/mo* |
| VC-6145 - 100MHz, 100MS/s | \$200/mo* |

RSOs from Hitachi feature roll mode, averaging, save memory, smoothing, interpolation, pretriggering, cursor measurements. These scopes enable more accurate, simpler observation of complex waveforms. In addition to such functions as hysteresis via a plotter interface and waveform transfer via the RS-232C interface. Enjoy the comfort of analog and the power to digital.

LEASING AVAILABLE

For all Hitachi Scopes - Call for details
*Based on 24 months except V-1150 VC-6045, VC-6145 (36 months)

Hitachi Portable Scopes

DC to 50MHz, 2-Channel, DC offset function, Alternate magnifier function

| | |
|-----------------------------------|---------|
| V-525 - CRT Readout, Cursor Meas. | \$1,025 |
| V-523 - Delayed Sweep | \$895 |
| V-522 - Basic Model | \$895 |
| V-422 - 40MHz | \$795 |
| V-223 - 20MHz delayed sweep | \$695 |
| V-212 - 20MHz | \$425 |

HITACHI COMPACT SERIES SCOPES

This series provides many new functions such as CRT Readout, Cursor measurements (V-1085/1085/665), Frequency Ctr. (V-1085), Sweeptime Autoring, Delayed sweep and Tripper Lock using a 6-inch CRT. You don't lose the compactness in terms of performance and operation.

| | |
|-------------------------------|-------------|
| V-660 - 60MHz, Dual Trace | \$1,195 |
| V-665 - 60MHz, DT, w/cursor | \$1,345 |
| V-1060 - 100MHz, Dual Trace | \$1,425 |
| V-1085 - 100MHz, DT, w/cursor | \$1,085/mo* |
| V-1085 - 100MHz, QT, w/cursor | \$1,25/mo* |
| V-1100A - 100MHz, Quad Trace | \$1,25/mo* |
| V-1150 - 150MHz, Quad Trace | \$1,15/mo* |

20MHz Elenco Oscilloscope

\$375

MO-1251

- Dual Trace
- Component Tester
- 6" CRT
- X-Y Operation
- TV Sync
- 2 P-1 Probes

FREE DMM
with purchase of
ANY SCOPE

SCOPE PROBES
P-1 65MHz, 1x, 10x \$19.95
P-2 100MHz, 1x, 10x \$23.95

Elenco 35MHz Dual Trace

Good to 50MHz **\$495**

MO-1252

- High luminance 6" CRT
- 1mV Sensitivity
- 8KV Acceleration Voltage
- 10ns Rise Time
- X-Y Operation + Z Axis
- Delayed Triggering Sweep
- Includes 2 P-1 Probes

All scopes include probes, schematics, operators manual and 3 year (2 yrs for Elenco scopes) world wide warranty on parts & labor. Many accessories available for all Hitachi scopes. Call or write for complete specifications on these and many other fine oscilloscopes.

BECKMAN TEST EQUIPMENT

All Models Available

Call for special price

Digital Capacitance Meter

CM-1550B

\$58.95

9 Ranges
1pt 20,000pF
5% basic acy.
Zero control w/ Case
Big 1" Display

Digital LCR Meter

LC-1801

\$125

Measures:
Coils 1uH-200H
Caps 1pF-200uF
Res 0.1-20M

Multimeter with Capacitance & Transistor Tester

\$55 CM-1500B

Reads Volts, Ohms
Current, Capacitors,
Transistors and
Diodes / with case

FLUKE MULTIMETERS

All Models Available

Call for special price

Quad Power Supply

XP-580

\$59.95

2-20V @ 2A
12V @ 1A
5V @ 3A
5V @ .5A

Fully regulated and short circuit protected

Triple Power Supply

XP-620

Assembled \$85
Kit \$45

2 to 15V @ 1A
-2 to -15V @ 1A
(or 4 to 30V @ 1A)
and 5V @ 3A

All the desired features for doing experiments.
Features short circuit protection, all supplies

AM/FM Transistor Radio Kit

with Training Course

Model AM/FM 108

\$26.95

14 Transistors • 5 Diodes
Makes a great school project

True RMS 4 1/2 Digit Multimeter

M-7000

\$135

.05% DC Accuracy
.1% Resistance
with Freq. Counter
and Deluxe Case

Soldering Station

Temperature Controlled

SL-30 \$99

Digital display
Temp range:
300F-900F
Grounded tip
Overheat protect.

Color Convergence Generator

SG-200

\$69.95

Finest in the industry
10 rock steady patterns

Digital Triple Power Supply

XP-765

\$249

0-20V at 1A
0-20V at 1A
5V at 5A

Fully Regulated, Short circuit protected with
2 Limit Cont., 3 Separate supplies
XP-660 with Analog Meters \$175

Four-Function Frequency Counters

F-100 120MHZ

\$179

F-1000 1.2GHZ

\$259

Frequency, Period, Totalize,
Self Check with High Stabilized Crystal Oven
Oscillator, 8 digit LED display

GF-8016 Function Generator

with Freq. Counter

\$249

Sine, Square, Triangle
Pulse, Ramp, 2 to 2MHz
Freq. Counter: 1 - 10MHz

GF-8015 without Freq. Meter \$179

Function Generator

Blox

\$9600

\$28.95

Provides sine, triangle, square
wave from 1Hz to 1MHz
AM or FM capability

MOVIT EDUCATIONAL ELECTRONIC ROBOT KITS

The MOVIT line is a series of computerized battery robot kits that can teach the basic principles of robotic sensing and locomotion. Each of the kits features pre-assembled PC boards, hardware and mechanical-drive systems. Only basic hand tools are required for assembly. These fascinating robots allow you to experience and learn any one of the following features: sound sensor, remote control, infrared sensor, wired control and/or programmable memory.

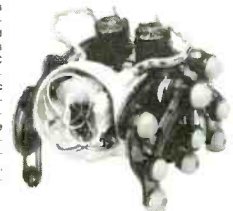

| | | | |
|-----------------------------------|---------|----------------------------------|---------|
| MV 812 - Another Infrared | \$49.95 | MV 938 - Medusa Sound Sensor | \$29.95 |
| MV 815 - Piper mouse Sound Sensor | \$45.95 | MV 963 - Line Tracker Infrared | \$45.95 |
| MV 816 - Peppy Sound Touch | \$29.95 | MV 966 - Mantle Sound Touch | \$29.95 |
| MV 831 - Mr. Bootman Wire Control | \$35.95 | Y-01 - Robotic Arm Robotic Cont. | \$45.95 |
| MV 832 - Carrot Remote Control | \$45.95 | BT 832 - Grand Piano Elec. Piano | \$29.95 |
| MV 908 - S-Cardo Sound Sensor | \$45.95 | BT 805 - Roulette Digital Wheel | \$35.95 |

Learn to Build and Program Computers with this Kit

Includes: All Parts, Assembly and Lesson Manual

Model MM-8000

\$129.00

Starting from scratch you build a complete system. Our Micro Master trainer teaches you to write into RAMs, ROMs and run a 8085 microprocessor, which uses similar machine language as IBM PC.
Robotics Kit for above (MM801D) 71.95

Wide Band Signal Generators

SG-9000 \$129

RF Freq 100K-450MHz AM Modulation of 1MHz Variable RF output
RF-9500 w/ Digital Display & 150MHz built-in Counter \$249

C & S SALES INC.

1245 Rosewood, Deerfield, IL 60015
(800) 292-7711 (708) 541-0710

WE WILL NOT BE UNDER SOLE

UPS Shipping: 48 States \$5*
(\$3 Min \$10 Mgs) Shipping
IL Res.: 7% Tax. FAX: 708-520-0085

15 Day Money Back Guarantee
2 Year Warranty Prices Subject to Change
WRITE FOR FREE CATALOG

CIRCLE NO. 153 ON FREE INFORMATION CARD

86 / COMPUTERCRAFT / August 1991

Say You Saw It In ComputerCraft

www.americanradiohistory.com

TOP SECRET

CONSUMERTRONICS

2011 CRESCENT DR., P.O. DRAWER 537
ALAMOGORDO, NM 88310

1-505-434-0234

FAX 1-505-434-0234 (orders only). Mon.-Sat. 8AM-9PM MST Voice & Manual FAX, 9PM-8AM Auto. FAX. Add \$4 ship. (USA, Canada). All items are in stock. COD (UPS cash only), VISA, MasterCard OK. FREE CATALOG with order, else \$2. In business since 1971. As seen on TV John Williams - former Senior Engineer (Lockheed), NMSU Professor of Computer Science.

OFF-THE-SHELF HARDWARE

Van Eck System, Shriek Module, Voice Disruptor, Hearing Assistant, Diabetes Alarm, 6th Sense Communicator, The Levitator, Resonant Coils, Biomedical Stimulators, Fax Junk Call Killer, Long Range Eavesdropper - more! Assembled and tested (no kits) \$7 for descriptions.

COMPUTERS

HARD DRIVE MANUAL

Relates to all hard drive and controller implementations (emphasis on PCs). How to select, interface, initialize, set up, use, maintain, troubleshoot and repair them. How to protect them from mistakes, sabotage, prying eyes, sticky fingers. How to recover damaged and lost files. Includes software reviews. Loaded with info, advice and tips. \$29.

DISK SERVICE MANUAL

Maintain, troubleshoot, repair, adjust, align floppy drives without special equipment or software - 5.25"/3.5"/8", PC/XT/AT/386/486, Apple, Commodore, Kaypro, Tandy, Epson, Atari, TI, HP, DEC, etc. systems. All floppies need regular upkeep. \$29.

DISK DRIVE TUTORIAL

Theory and practical facts on floppy drives, disks, FDCs, formatting, software protection. Systems described above. Invaluable advice and tips on how to best select, interface and use drives and disks. \$19.

PRINTER/PLOTTER MANUAL

Types, descriptions, specs and 100+ interfaces (parallel, serial). Detailed plans for X-switchers, buffers, and serial-to-parallel and parallel-to-serial interfaces, breakout devices. Many buy, use, service, repair tips. \$19.

SUPER RE-INKING METHOD

Re-ink cloth ribbons for about 50 cents and 10 minutes each. Plans for el cheapo motor-driven re-inker. Commonly used ink (5 colors) and carner described. \$9.

COMPUTER PHREAKING

TROJAN HORSES, VIRUSES, WORMS, etc and countermeasures. Includes disk with 250K+ of hacker text files and utilities, and legendary FLUSHOT+ protection system (Ed. Choice, PC Magazine). Dozens of computer crime and abuse methods and countermeasures. How systems are penetrated. BBS advice, password defeats, glossary, much more! Manuals + Disks* \$39.

BEYOND VAN ECK PHREAKING

Eavesdropping on VDT and TV video signals using an ordinary TV! Ranges up to 1 KM. Plans, countermeasures. Includes legal Van Eck uses, and original Top Secret Van Eck design! \$29.

ABSOLUTE COMP. SECURITY

Dozens of simple, versatile, secure computer security methods and tips. Plus our invulnerable Cipher Program (in COM and its BAS source). Plus \$1,000 CIPHER CONTEST rules with cipher text. Manual + Disk* \$29.

CRYPTANALYSIS TECH.

Five powerful menu-driven crypto programs (in COM and their BAS sources) to analyze, decrypt "secure" ciphertexts. Worked-out examples. Recommended in the prestigious COMPUTERS & SECURITY. Manual + Disk* \$29.

SOFTWARE PROTECTION

Unique system that highly discourages costly software piracy while not interfering with legit archival copies. No known way to defeat. No special equipment required. Easy, automatic to install on your disks. Can be used with any other protection system. Manual + Disk* \$59.

BRAIN VIRUS ANTIDOTE

The PAKISTANI BRAIN VIRUS plagued dozens of institutions, businesses. The mildly destructive original version has been hacked into highly virulent strains. BVA consists of the antidote, source code and write-up. Disk* (NOT infected) \$19.

AL DEVELOPMENT SYSTEM

Powerful program for creating/editing AL source code. Like sophisticated wordprocessor with many unique and powerful AL features. Includes tutorial and program for integrating AL routines into compiled BASIC programs. Manual + Disk* \$29.

C DEVELOPMENT SYSTEM

Powerful program for creating/editing C source code. Like sophisticated wordprocessor with many unique and powerful C features. Manual + Disk* \$29. *****

*Software supports PC DOS, MSDOS, PS/2, Mono., Herc., CGA, EGA, VGA, 5.25", 3.5", hard (specify your floppy drive size).

ELECTRONICS

PHONE COLOR BOXES

Designed by Phone Phreaks! 15 phone color boxes described. Dozens circuits, programs. Plus call forwarding, conferencing, phreak history. Plus 50 useful and legal phone circuit plans. More! Manual \$29.

ROBOFONE AUTODIALER

Powerful, versatile, menu-driven program allows you to dial any number (up to 10K) or mix of local and long distance numbers in any order, over any length of time, whether busy or answered (your choice) and log the times, commands and results to monitor, printer and/or disk. Quick-dial directory of up to 600 numbers. BUSY redial options. Direct modern command and control. All result codes, including Voice and Ringing. Optional shell to terminal program upon Connect. Exit to menu or DOS (for batching). Ideal "Wargames" power dialer, phone call logger and telemarketing dialer. Manual + Disk* \$29. With compatible LABELS and LETTERS programs \$49.

VOICE MAIL BOX HACKING

How Voice Mail Box (VMB) systems are used and the specific ways they are hacked. Includes ASPEN, MESSAGE CENTER, BIX, EZ, SYDNEY, PHONE MAIL, AUDIX, etc. Absolutely required for all sysops, users! \$29.

VOICE DISGUISER

Plans for neat devices to change voice pitches. Effective against snoops using voice analyzers; to conceal gender for women living alone; for anti-intrusion systems; for music accompaniment; for gags. Voice sounds natural. \$19.

PHONE RECORD INTERFACES

Plans for undetectable (ultra-hi input impedance), indestructible TELERECORDER to record phone conversations. Also monitors for bugs and taps. Plus simple FM xmitter addition and the ear-piercing SHRIEK CIRCUIT plans. \$14.

RADIONICS MANUAL

Exciting electronic and electromagnetic therapeutic and diagnostic devices (mostly experimental). History, descriptions, plans (dozens), availabilities of Radionics Devices from early to modern. \$29.

HEAL THYSELF

Many electronic medical devices are now licensed by the FDA for therapies. Plans for three major different devices that you can build and use yourself. Save \$ Thousands! Plus details on many other devices. \$19.

BIO-SPECTRUM ANALYSIS

Summary of the biologic effects of electromagnetic fields from DC to the near-infrared (0-300 GHz). Bands include: 6 ELF, VLF, LF, MF, HF, VHF, UHF, SHF, EHF. Special emphasis on DC, 50 HZ, 60 HZ, 2.45 GHz (microwave ovens), 3 GHz (radar). Graphical spectrum display includes frequency, researcher, date, source, effects, subject type and signal attributes. Also includes FCC assignments and physical properties. \$29.

EM BRAINBLASTER

Tutorial and plans for powerful ELECTROMAGNETIC WEAPONS and LAB DEVICES. Opium circuits, freps, waveforms, intensities. Comprehensive. MIND BOGGLING! \$29.

UNDER ATTACK!!

ELECTROMAGNETIC INTERFERENCE (EMI) and ELECTRONIC WEAPONS cause INEXPLICABLE MANIFESTATIONS! These attacks can cause cancer, birth defects, psychological and neurological disorders, cardiovascular and immune system failures, etc. Destructive to people, pets, livestock, plants, equipment. INCLUDES ACTUAL CASES (which we have investigated and documented) OF ATTACKS ON PEOPLE BY EM WEAPONS! And includes how you can verify and pinpoint the source of the EMI/electronic attack, and specific countermeasures you can take. \$39.

HIGH VOLTAGE DEVICES

HV devices plans. Stun Gun, Taser, Prod, Cane, Umbrella, Zapper, RF/Radar/Audio Jammer, Flasher, Blaster, Jacob's Ladder, Plasma and Van de Graaff Gens., Fence Charger, Geiger Counter, Ozone Gen., Fish Stunner, Pest Killer, Plant Stimulator, Kirlian, Magnetizer, etc. SHOCKING! \$29.

SECRET & SURVIVAL RADIO

Optimum survival and security radio equipment, methods, frequency allocations and voice/data scrambling/encoding. Includes small receivers/xmitters, telemetry, antenna optimizations, remote monitoring and control, security, surveillance, and ultrasonic, fiberoptic and infrared commo. More! 70+ circuit plans, tables. \$29.

TV DECODERS/CONVERTERS

Tutorial and plans for several TV decoders and converters. Plus satellite TV component purchase and use tips. \$14.

STEALTH TECHNOLOGY

Police radar is fascinating. It also has error rates of 10%-20%! Every known: Error mode - Method and material to minimize radar reflections - Strategy and tactic to fight unjust radar tickets (that cost you a fortune in insurance) - Method to detect and jam signals - fully described! \$19.

THE "GOLDFINGER"

Tired of digging up rusty nails and bottle caps? The "Goldfinger" detects GOLD, SILVER, PLATINUM, COPPER and ALUMINUM while rejecting all ferromagnetics. Plans. \$14.

THE "SILKWOOD"

The "Silkwood" detects X- and Gamma Rays, and Alpha and Beta particles. Simple, pocketsize, 9-volt battery-operated rad detector requires no Geiger-Mueller tubes or high voltages. 95+% linearity between 10-1,000 rads/min. Indicates to less than 0.1 rad/min. Check out your job, home, possessions. Prospect for minerals. And a lifesaver for nuclear survival situations. Plans. \$14.

POOR MAN'S SUPER LASER

Ruby rod laser plans. Used in intrusion systems, weapons targeting, precise optical alignments, seismography, signaling and commo, strobes, holography, science projects, etc. Includes a list of dozens of sources for ruby rods and other parts. \$14.

AIR COILS

AIRCOWLS is a powerful scientific program for designing round and square air coils. Returns inductance/number-of-turns when number-of-turns/inductance and dimensions are specified. Returns min. wire gauge for any current, and capacitance for LCs. Disk* \$19.

ENERGY

KW-HR METERS

How watt-hour meters work, calibration, error modes (many), ANSI Standards, etc. Demand, Pole and Polyphase Meters. Experimental results. \$19.

STOPPING POWER METERS

As reported on CBS 60 MINUTES! How certain electrical loads (simply plug into an outlet) can slow down watt-hour meters - even stop them - while drawing full loads! Also describes meter creep, overload droop. \$19.

THE I.G. MANUAL

External magnetic ways to slow down and stop watt-hour meters while drawing full loads. \$19.

GAS FO' ALL

Every known vulnerability of gasoline and diesel fuel pumps and dispensers. \$19.

LIBERATE GAS & WATER

How gas and water meters can be reversed using simple household equipment. \$19.

VORTEX GENERATOR

Heat/cool with simple, amazing 3-port device. Uses no moving parts, electricity, fossil fuel, liquid or freon. Guaranteed scientifically sound. Plans. \$14.

LOADFINDER

Quick, simple, accurate and inexpensive method to determine the inductance and resistance of any AC load (in situ) between 0.1 and 100 amps, and the capacitance for PF-1. Real power, imaginary power, and apparent power explained, and how each affects your bill! Requires only an AC voltmeter, the simple circuit described and high school algebra ability. Completely worked out example. Save energy! \$9.

MDVR METHOD

Plans for the effective and inexpensive MDVR Method to legally save electrical energy (30%-60%)! Develops optimum efficiency, safety and versatility, and saves wear and tear - all without significant loss of performance or service. \$12.

RIPPLED OFF!

Line ripple and transients waste money, cause equipment to malfunction, lose data and endanger users. And utilities use line current ripple to remotely control your equipment and the dreaded Peak Demand Meter! Includes plans for ripple/transient eliminator. \$9.

FINANCIAL

ATM'S

ATM crimes, abuses, security, vulnerabilities. 100+ methods described - from Reg. E to ciphers. Case histories, law, countermeasures, detailed security checklist. Internal photos, figures! Still unsolved: One crook stole \$237,000 from one bank's ATMs! \$39.

CREDIT CARD SCAMS

Cardholders, merchants and banks suffer \$ Billions losses annually because of credit card fraud. Describes every known means of credit card fraud and scams. Protect yourself! \$29.

CREDIT REPORTING ENTITIES

Giant commercial and government databases now contain millions of financial, employment, medical, family history, lifestyle, criminal, religious and political files on most Americans. These files are instantly accessible to thousands of people. Data is often erroneous, incomplete, obsolete or repetitious - often costing people credit and jobs - even their freedoms! How to protect your privacy and security. Comprehensive. \$29.

ULTIMATE SUCCESS MANUAL

Underpaid? Harassed? Manipulated? Stuck in a dead end job? Expect to be laid off or fired? Suck in office politics? Job/division/company moving to Timbuktu? The ultimate no-hold-barred Machiavellian techniques for finding, obtaining, optimizing and keeping top jobs and benefits. THE RULES OF THE GAME FOR A GAME WITHOUT RULES! From resume to CEO. \$29.

GOVERNMENT LAND GRAB

You can force the Government to sell you prime land at ridiculously low prices with no competing bids allowed because of a little-known 100+ year old Federal Law! One man legally forced the Government to sell him 160 acres of prime forest land for \$400 - appraised at \$1,600,000! Another got 19 prime acres in Phoenix, AZ for \$47 - appraised at \$376,000! Complete details and proof. \$19.

STOCKPRO

Unique, powerful, shrewd, unconventional common stock investment strategy. Created for NMSU, and basis of expensive consulting system. Manual + Disk* \$29.

PHYSICAL SURVIVAL

ORDER OF THE MAGNITUDE

THE MOST COMPREHENSIVE SURVIVAL BOOK EVER WRITTEN! Topics include electronics, computers, energy, weapons, concealment, revenge, alarms, etc. Helps you survive today and in the Day After. Absolutely required! Field-expedient use of technology typically in a lower-intensity conflict environment. C4I emphasis. \$49.

SURVIVAL GUNS & AMMO

THE ULTIMATE FIREARMS SURVIVAL MANUAL! Describes optimum guns and ammo, conversions, silencers, explosive devices, improvised weapons, End Times scenarios, retreats, etc. \$19.

SILENCE IS GOLDEN

How acoustic silencers are designed from simple, cheap, commonly-available materials. \$9.

ROCKET'S RED GLARE

How to design and build solid-propellant amateur and survival rockets. Special emphasis on the formulation, manufacture and installation of propellants, motors, igniters, etc. Includes list of commonly available materials. And the design of launch pads and electronics. \$29.

COMBAT/SURVIVAL FITNESS

Weight training for combat, survival, police, martial arts, contact sports, brawling and street fighting! Scientifically designed to maximize the explosive power, speed, quickness, agility, endurance and hardness for combat and survival. SURVIVAL OF THE FITTEST - There are no second-place winners! \$19.

FIREWORKS!

Describes how firecrackers (M-80s, blockbusters, cherry bombs), rockets (match, bottle, large), volcanoes and fountains, sparklers and safety fuses are made and colored. \$9.

MISCELLANEOUS

TECH. RESEARCH SERVICES

Unique 51+K electronic and computer design articles in databases accessed by title and subject. Digital, uP, uC, analog, hybrid, nomograph, software. Provide us keys, we return list. \$25 search fee (1-20 keywords/phrases; you may combine unrelated topics). Saves you R&D \$\$\$! Powerful RES-SNAP program will allow your own searches thru popular electronic books, magazines and your files. Disk* \$95.

SPECIAL PROJECTS

We design, build, repair, modify, maintain and consult on any device, system or project - computerized, electronic, electrical, mechanical, optical. Many invention prototypes. Confidentiality guaranteed. Describe and include \$25 fee (does not obligate you). We then provide you cost, time estimates.

MMPI PERSONALITY GAME

What exactly is your personality? How does it compare with others you care about? Do you have more than one? Much more than just a game, the MPG is a zany, satirical, insightful, realistic and critical hands-on education about personality testing. Mind-boggling and a real blast! Manual + Disk* \$49.

NUMEROLOGY PROGRAM

Religion and science are filled with numbers that have special meanings. Enter a name or phrase into NUMERNAM and watch the dozens of equivalent numbers displayed - derived from ancient and modern algorithms. Whether numbers have special meaning to you or just for fun and games, NUMERNAM is numero uno! Disk* \$19.

PREVENT/CURE

DENTAL DISEASE

About 70% of all tooth losses are caused by "gum disease" - not tooth decay! Simple little-known method developed by a Government scientist is inexpensive and really works. \$9.

TAP NEWSLETTER

TAP was a controversial technological survival newsletter published by the Yippies until the mid-1980s, and is a goldmine of hard-to-find technological information from ATMs to Zapping (just about everything). And of great historical and nostalgic value. Issues 1-91. \$2 per back issue, \$150 for entire set.

SOLD FOR EDUCATIONAL PURPOSES ONLY.

BIOS Upgrades

For The IBM PC, XT, AT & 386 Or Compatible.

AMI, Phoenix & Award
Latest Versions

- 1.2 & 1.44 Floppy Support
- Complete Set Up In ROM
- Supports VGA
- Novell & Netware Compatible
- User Defined, Hard Drive Support
- 101 & 102, Keyboard Support
- Complete Documentation
- 30-Day Money Back Guarantee

CALL FOR PRICE

1-800-TEL-BIOS
1-800-835-2467 Good In Both U.S.
& Canada
603-432-1532 In N.H.

ADVANCED SOFTWARE

CIRCLE NO. 152 ON FREE INFORMATION CARD

107 **SPECTRUM PROBE™** \$249.

converts any scope into a

100MHz spectrum analyzer

60dB display dynamic range

SMITH DESIGN 30 day refund, VISA/MC
1324 Harris, Dresher, PA 19025 (215) 643-6340

CABLE TV CONVERTERS

Attention Cable Viewers!

Jerrold, Zenith, Oak, Scientific Atlanta,
Hamlin, Tocom, and many others.

BEST PRICES! • 1-800-826-7623
B&B Inc. • 4030 Beau-D-Rue Dr., Eagan, MN 55122

WHY PAY SKY HIGH MONTHLY FEES?



If you find a better deal, We'll beat it!
JERROLD • TOCOM • HAMLIN • OAK
• SCIENTIFIC ATLANTA • ZENITH •
ask about our warranty program C.O.D.
Visa, M/C, AM, EX. welcome. FREE
CATALOG • FREE CALL • OPEN SAT-
URDAYS

GTV 1464 Garner Station Blvd #315 Raleigh,
NC 27603

1 800 328-0198

CIRCLE NO. 159 ON FREE INFORMATION CARD

Classified Commercial Rates: \$1 per word, 15-word minimum (\$15.00) prepaid. (Word count includes name and address; ZIP code and abbreviation each count as one word; P.O. Box number and telephone number count as two words each.) Indicate free category heading (**Computers, Communications, Electronics, Video** or **Miscellaneous**). A special heading is available for a \$6 surcharge. First word only is set boldface caps at no charge. Add 20% for additional boldface words.

Non-Commercial Rates: FREE to subscribers, as space permits; maximum 15 words. A recent **COMPUTERCRAFT** mailing label must accompany ad.

(All advertisers with P.O. Box addresses must supply permanent address and telephone number. Copy is subject to publisher approval.)

Mailing Information: Copy must be received by the publisher by the 25th of the third month preceding the cover date. Send Advertising material with check or money order or credit card information (Visa or MasterCard only) with number and expiration date to: **COMPUTERCRAFT**, Classified Department, 76 N. Broadway, Hicksville, NY 11801.

VIDEO

T.V. NOTCH FILTERS, PHONE RECORDING EQUIPMENT, BROCHURE \$1.00. MICRO THinc., BOX 63/6025, MARGATE, FL 33063 1-(305) 752-9202.

VHS-VCR Repair Solutions Sets I, II, III, IV, V, VI. Each contains 150 symptoms and cures, updated cross reference chart, free assistance, \$11.95 each all six \$59.95. Eagle Electronics Box A, 52053 Locks Lane, Granger, IN 46530.

CABLE T.V. DESCRABLERS, Converters, Guaranteed, LOWEST PRICES, CNC Concepts Inc., P.O. Box 34503, Minneapolis, MN 55434, 1-800-535-1843.

ELECTRONICS

SURVEILLANCE / COUNTERSURVEILLANCE devices catalog. Cameras, bug detectors, video camera detectors, transmitters, communications, and much more. Catalog \$3.00. DSP, P.O. Box 1275-ME, Redondo Beach, CA 90278.

KINETIKITS from **KINETICO:** electronic kits outputting light or sound. Free catalog: **KINETICO**, P.O. Box 1634, NY, NY 10114-0508.

MINIATURE FM TRANSMITTERS! Tracking Transmitters! Voice Disguisers! Bug Detectors! Phone Devices! More! Available in kits or assembled and tested! Catalog \$2.00: **XANDI ELECTRONICS**, Box 25647, "B14", Tempe, AZ 85285-5647.

PAN-COMM INT'L CATALOG. Over 350 Kits, Plans, Books about Licensed/unlicensed AM/FM broadcasting, Ham/CB/SW/DX electronics amplifiers, 1750M transmitters, Surveillance devices, Computers/Software, Science Projects, MORE. \$1.00 refundable. Box 130-ME-6, Paradise, CA 95967.

THE ELECTRONIC DEFENDER An effective, non-lethal deterrent to those who wish you harm. It will protect you and your property. Detailed plans \$6.95 part & PC board also available. **TYLER TECHNOLOGIES** P.O. Box 493, Richmond Hill, NY 11418.

MINIATURE Electronic Surveillance Devices, Catalog \$5.00, refundable. F & P Enterprises, Box 51272, Palo Alto, CA 94303-H

SURVEILLANCE—Audio/Video/Infra-red/Laser, Law Enforcement, Industrial, Private. 500 Item Catalog \$7.00. Security Systems, 3017D Hudson, New Orleans, LA 70131.

SWR and POWER METER, assembled, kit or plans, with Alarm and Set Points. **FREE** information. Rupp Electronics, 5403 Westbreeze, Fort Wayne, IN 46804 219-432-3049.

SAMS books and Photofacts, TV, VCR, and Computer, new and surplus, ARRL books. Aim audio and video accessories and connectors, EKI Kits, NTE replacement parts, Surplus tubes. **ATKINSON & SMITH, INC.,** 17 Lewis St., Eatontown, NJ 07724 1-800-542-2447.

CABLE Converters ALL MAJOR BRANDS
• For information & orders call 1-800-782-0552
• **FREEWAY, INC.** s.m.p. P.O. Box 5036, Burnsville, MN 55337.

REMOTE CAR STARTER PLAN. UNIVERSAL, SIMPLE, EASY, 30PGS; ILLUSTRATIONS, SCHEMATICS, TEMPLATE, INSTRUCTIONS, PHOTOS. INEXPENSIVE, WORKS! \$12.75. SCHLITZER, 414 ALVA, GRAND PRAIRIE, TX 75051.

TELEPHONE Caller Identifiers displays incoming callers telephone number. Kit \$49.95 ppd. **SURVEILLANCE** catalog \$5.00, **EDE**, P.O. Box 337, Buffalo, NY 14226.

MAKE \$75,000 TO \$250,000 YEARLY OR MORE FIXING IBM COLOR MONITORS, (AND MOST BRANDS). NO INVESTMENT, RECESSION PROOF. START DOING IT FROM YOUR HOME (A TELEPHONE REQUIRED) BASIC ELECTRONICS OK. INFORMATION: USA, CANADA \$2.00 CASH FOR BROCHURE, OTHER COUNTRIES \$15.00 US FUNDS. RANDALL DATA DISPLAY, BOX 2168-M, VAN NUYS, CA 91404, USA.

EZ LEARN DIGITAL SIGNAL PROCESSING IBMPC based TMS320 board \$199 plus utilities, software development tools -299 1409 West 14 Mile Road, Madison Heights, MI 48071.

SURVEILLANCE - COUNTERSURVEILLANCE. Guaranteed lowest prices! Unbelievable, Detectors, Jammers, Transmitters, Phone Security, Cameras, Personal Protection, Books, More! Huge catalog \$5.00 (Refundable) **PROTECTOR** P.O. Box 520294-B, Salt Lake City, UT 84152.

NEGATIVES/positives from your originals. SASE for information. J & E Enterprises, 2457 N. Marmora, Chicago, Illinois 60639.

DAZER Personal Protection Devices! Lasers! AM/FM/Infrared Transmitters! Detectors! More! Kits/Assembled. Catalog \$2.00. QUANTUM RESEARCH 16645-113 Ave., Edmonton, Alberta T5M 2X2.

COMPUTERS

COMPUTER owners never buy software again borrow or rent. Send \$2.00 for catalog T.E., Suite 353, 164-11 89 Avenue, Jamaica, NY 11432.

8052-AH-BASIC microcontroller board. 32K RAM, 16K EPROM, RS232 interface, audio out, EPROM programmer, expansion connector. Bare board with manual \$19.95 + \$3 P&H. MD. residents add \$1 sales tax. SASE for details. Prologic Designs, P.O. Box 19026, Baltimore, MD 21204.

DISCOUNT AT/XT COMPATIBLE systems and components. Complete line of components required to build or upgrade your system. Catalog \$2.00, refunded with first order MPS ENTERPRISES, BOX 1048, Lemon Grove, CA 91946.

NEW checkers game for IBM and compatible PC owners. Requires at least 128k and color monitor. Challenge your mind! Friendly game. Order now \$19.95 + shipping & handling. PC DAMIER, P.O. Box 8132, Poughkeepsie, NY 12601.

COMMUNICATIONS

MORSE Code? No Problem. You can increase your speed, no matter how many times you've failed before. **Results guaranteed** when you follow the instructions. PASS Publishing's **CW Mental-Block Buster** program helps you **explode mental blocks** that hold you back. Based on 40 years of research, the **CW Mental-Block Buster** uses guided meditation, dynamic visualizations, and powerful affirmations to blast through mental blocks. **You can do code!** That means new bands, more contacts, more fun! (This is not a CW practice tape.) The **CW Mental-Block Buster** audio cassette and practice booklet are only \$24.95 ppd. in the US (NY residents add \$1.87 sales tax). (Quantity discounts available for classes.) PASS Publishing, P.O. Box 570, Stony Brook, NY 11780.

HUGE COMMUNICATIONS CATALOG. 88 pages including amateur, shortwave and scanner equipment. Universal Radio, 1280 Aida Drive #ME, Reynoldsburg, OH 43068.

CLUBS

P.C. MODEM CLUB Correspond with **Business** and **Enthusiast**, **LINK/UP** with Creative members, Free Details, P.O. Box 4534, Waterbury, CT 06704. Also, List **FAX** and **1-900** numbers.

BUSINESS OPPORTUNITIES

MAKE \$\$\$ Become an American Electronics Dealer! Profit opportunities since 1965. Call Jerry Norville, 1-800-872-1373.



PICKS UP A WHISPER 50 FEET AWAY!

The model WAT-50 miniature FM transmitter uses a 4-stage circuit NOT to be confused with a simple wireless microphone. Simply snap the unit on top of a 9V battery and you can hear every sound in an entire house up to 1 mile away! Use with any FM radio. Tunes to any frequency from 70mhz - 130mhz. Easy to assemble kit includes all parts and instructions. Only 29.98 tax incl.



The **WIRELESS TELEPHONE TRANSMITTER** model WTT-20 is only about the size of a dime, yet transmits both sides of a telephone conversation to any FM radio with crystal clarity. Completely automatic. Uses power from the telephone line itself - never needs a battery! Up to 1/4 mile range. Tunes from 70mhz - 130mhz. Easy to assemble kit includes all parts and instructions. Only \$29.98 tax incl.

Call or send **MO, VISA, MC** for immediate delivery. Single kit orders include \$1.50 S&H. **FREE SHIPPING** on orders of 2 or more. All orders shipped by U.S. Mail. **COD** add \$4.00. Personal checks allow 21 days.

DECO INDUSTRIES
BOX 607, BEDFORD HILLS, NY 10507
914-232-3878

CIRCLE NO. 157 ON FREE INFORMATION CARD

CLASSIFIED ADVERTISING ORDER FORM

Mail this form with payment to **COMPUTERCRAFT**, Classified Dept., 76 N. Broadway, Hicksville, NY 11801.

Name: _____

Street Address: _____

City: _____ State: _____ Zip: _____

PRINT EACH WORD SEPARATELY. \$1.00 per word, 15 word minimum. Note that P.O. Box numbers* and telephone numbers must be counted as two words each. Circle additional words you wish boldfaced at 20% more each (initial boldface word is free).

| | | | |
|---------------|----|-----------|-----------|
| Free Boldface | 2 | 3 | 4 |
| 5 | 6 | 7 | 8 |
| 9 | 10 | 11 | 12 |
| 13 | 14 | 15 (\$15) | 16 (\$16) |

TOTAL PAYMENT ENCLOSED (Check or Money Order): \$ _____

Payment may also be made by MasterCard or Visa. For this, please fill in information below.

Credit Card Number _____ Expire Date _____

Print Full Name _____ Signature _____

*If a box number is used, please supply your permanent address and telephone number for our records.

CABLE TV **DESCRAMBLERS**
ALL TYPES 800-582-1114
FREE CATALOG
M.K. ELECTRONICS • 7958 Pines Blvd
Suite 276 • Pembroke Pines, FL 33024

Order Back Issues of ComputerCraft

**CALL DOCTOR
DESCRAMBLER**

...for symptoms relating to scrambled cable T.V. signals. We have **JERROLD • TOCOM • ZENITH • HAMLIN OAK • SCIENTIFIC ATLANTA**. Six month warranty! We ship C.O.D. Lowest retail/wholesale prices. **FREE CATALOG: Global Cable Network 1032 Irving St. Ste 109 S.F., CA 94122** **NO CALIFORNIA SALES!!!** **OPEN SATURDAYS**

1-800-327-8544

CIRCLE NO. 160 ON FREE INFORMATION CARD

| RS# | | Page # |
|----------|--------------------------------|------------|
| 151 | AMC Sales..... | 82 |
| 168 | Advanced Computer Products.. | 5 |
| 152 | Advanced Software..... | 88 |
| 25 | Altex Electronics..... | 13 |
| - | B & B Electronics..... | 88 |
| 87 | BG Micro..... | 27 |
| - | Brunelle Instruments..... | 90 |
| - | CIE..... | Cov.III,33 |
| 153 | C&S Sales..... | 86 |
| - | Cable-Mate Inc..... | 83 |
| - | Cable Ready Company..... | 49 |
| 156 | Consolidated Electronics..... | 71 |
| 92 | Consumertronics..... | 87 |
| 154 | Contact East..... | 49 |
| 155 | Cook's Institute..... | 82 |
| 157 | Deco Industries..... | 89 |
| 158 | Educalc..... | 39 |
| 96 | Electrified Discounters.... | 46,47 |
| 97 | Fd Microsystems..... | 7 |
| 159 | GTV..... | 88 |
| 160 | Global Cable Network..... | 89 |
| 161 | Gordon, Ken..... | 79 |
| - | Grantham..... | 50 |
| 100 | Heath Co..... | 6 |
| 163 | JDR Microdevices..... | Cov.II |
| - | KD Video..... | 90 |
| - | Kelvin Electronics..... | 90 |
| 164 | Komputerwerk..... | 71 |
| 165 | Landmark/Supersoft..... | 51 |
| 166 | Lycy Computers..... | 23 |
| - | M.K. Electronics..... | 89 |
| 167 | Mental Automation..... | 39 |
| 105 | Microsphere..... | Cov.IV |
| - | NRI Schools..... | 17 |
| 169 | Netronics R & D Ltd..... | 57 |
| 172 | Radio Shack..... | 9 |
| 175 | S & M Electro..... | 83 |
| - | School Of VCR Repair, The..... | 90 |
| - | Smith Design..... | 88 |
| - | Trans World Cable Co..... | 90 |
| 173 | U.S. Cyberlabs..... | 83 |
| 176 | Video Tech..... | 90 |
| 177,178, | Viejo Publications..... | 32,57, |
| 179 | | 73 |

CABLE TV "BOXES"
Converters-Descramblers
Remote Controls-Accessories
 ★ Guaranteed Best Prices ★
 ★ 1 Year Warranty - C.O.D.'s ★
 ★ Immediate Shipping ★
 ★ FREE CATALOG ★
 Call or Write
NAS/TRANS-WORLD CABLE CO.
 3958 North Lake Blvd. • Suite 255
 Lake Park, Florida 33403
 1-800-442-9333
 1-800-848-3997

TEST EQUIPMENT
 Oscilloscopes • Multimeters
 Function Generators • Frequency Counters
 Power Supplies • Video Head Testers • Etc.
 Since 1972 **CALL OR WRITE FOR OUR FREE CATALOG**
BRUNELLE INSTRUMENTS INC.
 P.O. Box 1223 • Newport Vermont 05855
 Tel: 1-800-567-3506 Fax: 1-819-569-1408

PRO 400
 AC/DC VOLTAGE
 AC/DC CURRENT
 DIODE TEST
 LOGIC TEST
 LED TEST GOOD/BAD
 5 FREQ RANGES
 5 CAPACITANCE RANGES
 LOW BATTERY Warning
 CONTINUITY TEST/BUZZER
 TRANSISTOR CHECKER
20 MHZ FREQ COUNTER
 Stock No. 990092
\$69.95
30 DAY MONEY BACK GUARANTEE!
KELVIN Electronics
 7 Fairchild Ave., Plainville, NY 11803
 (516) 349-7620 1(800) 645-9212
 FAX (516) 349-7830

Great money in VCR repair!
 Home study. Learn high-profit repairs without investing in high-tech instruments.
FREE BOOKLET: 800-223-4542.
 Name _____
 Address _____
 City _____ State _____ Zip _____
 The School of VCR Repair, 2245 Perimeter Park, Dept. VJ349, Atlanta, Georgia 30341

K.D. VIDEO
FOR ALL YOUR CABLE TV NEEDS
WE SPECIALIZE IN DEALER PRICING

| QTY | 1 | 10 | 20 |
|--|--------|--------|--------|
| Jerrold (Type) SB-3 | 89.00 | 56.00 | 48.00 |
| Jerrold (Type) Tri-Bi | 119.00 | 69.00 | 65.00 |
| Scientific Atlanta SA-3 | 129.00 | 80.00 | 75.00 |
| Hamlin MLD-1200 | 99.00 | 59.00 | 45.00 |
| Oak N-12 Vari-Sync | 99.00 | 59.00 | 58.00 |
| Jerrold 550 Converter | 99.00 | 75.00 | 68.00 |
| Jerrold 400 DRX-3DIC (With Built in SB-3) | 169.00 | 109.00 | 100.00 |

1-800-327-3407
 Call us for prices on large quantities
K.D. Video PO Box 29538, Mpls., MN 55429

I'LL HAVE MINE DESCRAMBLER



If you find a better deal, We'll beat it!
JERROLD • TOCOM • HAMLIN • OAK • SCIENTIFIC ATLANTA • ZENITH
 • ask about our warranty program C.O.D. Visa, M/C, AM, EX. welcome. **FREE CATALOG**
FREE CALL • OPEN SATURDAYS
1 800 562-6884
 VIDEO TECH
 3702 S. Virginia St. Ste. 160-304
 Reno, NV 89502

CIRCLE NO. 76 ON FREE INFORMATION CARD

CABLE TV EQUIPMENT

CABLE. TV converters and descramblers discount center. Jerrold, Tocom, Hamlin, Scientific Atlantic, Oak, Zenith. Order yours today 800-962-6836.

CABLE

TOCOM VIP TEST CHIP. For Models 5503 VIP and 5507. Unlike any other turn-on, this one works! Easily installs in just seconds. \$50.00 each. No Calif. sales. Call (213) 867-0081.

CABLE DESCRABLERS - Jerrold 400, 450, Tri-Bi SB-3. Scientific Atlanta, Oak, Tocom. Lowest Prices. Example: Jerrold from \$25.00. No Calif. Sales. Call us last and see! (213) 867-0081.

ZENITH Z-Tac. Special "test" board installs easily in minutes, and turns-on decoder for all modes. Great for "flashing" problems. Only \$50.00. No Calif. Sales. Call (213) 867-0081.

CABLE EQUIPMENT

CABLE TV SECRETS - the outlaw publication the cable companies tried to ban. HBO, Movie Channel, Showtime, Descramblers, Converters, etc. Suppliers list included. \$9.95 Cable Facts, Box 711-ME, Pataskala, Ohio 43062.

DISTRIBUTORS NEEDED

NEW Mini Satellite antenna. Tremendous demand. 100% profit. No Experience necessary. Serious inquiries only. (800)762-7952 Ex 774 24 Hours.

FOR SALE

FREE CABLE AND SATELLITE DESCRAMBLER PLANS. Send SASE. MJO Industry, Box 531, Bronx, NY 10461-0208.

FOR SALE

DESCRAMBLER KITS Complete cable kit \$44.95. Complete Satellite kit \$49.95. Add \$5 shipping. Free Brochure. Summit MO, Box 489, Bronx, NY 10465.

MISCELLANEOUS

ASIAN LADIES want correspondence for friendship, marriage. SUNSHINE INTERNATIONAL-Dept. TW, Box 5500, Kailua-Kona, Hawaii 96745. (808) 325-7707.

AMATEUR RADIO no Morse code requirement license approved by FCC effective Feb. 14, '91. Complete details with question and answer pools, rules & regulations. Send \$15.00 for everything you need to obtain Amateur license to Dan Mobley, 1800 Williams St., Valdosta, GA 31602.

THAILAND Women seek Marriage, Correspondence. Photographs, Brochure \$2., Escorted Tours. Club Thai, Miami, Florida 33233-0974.

INVENTOR SEEKS qualified individual or concern to develop prototypes to my specification and then mass produce miniature electronic LCD counters for use in a new patented sport. Contact: Charles C. Vanderpool, R.D. #3, Box 309, Waverly, NY 14892, Phone: (607) 565-9568.

Learn to Use Your Computer's Full Potential.

New Career Course from CIE!

If you've been hesitating about upgrading your computer skills because you couldn't find the time or locate the right program to teach you everything you need to know to be successful in today's world of computers, you'll be happy to hear that CIE's new career course can provide you with the computer technology curriculum you seek in an independent study program you can afford to invest your time in.

CIE's COMPUTER OPERATION and PROGRAMMING course was designed and developed by CIE to provide a complete overall understanding of the unlimited potential today's computers offer, once you learn and discover their full capabilities, in today's high tech environment. CIE's new computer course quickly provides you with the electronics fundamentals essential to fully understand and master the computer's technological potentials for your personal and professional advancement. Upon mastering the fundamentals you will move into high level language programming such as BASIC and C-Language and then use that programming in order to relate the interfacing of electronic hardware circuitry to programming software. As a graduate of the Computer Operation and Programming course, you will be able to successfully understand, analyze, install, troubleshoot, program and maintain the various types of electronic equipment used in business, manufacturing, and service industries.

Since 1934, CIE has been the world leader in home study electronics by providing our 150,000-plus graduates with the curriculum and hands-on training they've needed to become successful in



today's highly competitive and computer oriented society. As a CIE student you'll receive a first rate education from a faculty and staff with only one desire. Your future success!

We encourage you to look, but you won't find a more comprehensive computer course anywhere!

And it's a course designed to fit around your lifestyle and commitments today, so you can be assured of professional successes and financial gains tomorrow.

Please, do yourself a favor and send the attached card or fill out and mail the coupon below for more information about CIE's

Computer Operation and Programming course. Do It Today!

Computer not included with course



YES! I want to get started. Send me my CIE school catalog including details about the Associate Degree program (for your convenience, CIE will have a representative contact you - there is no obligation).

Print Name _____

Address _____ Apt. _____

City _____ State _____ Zip _____

Age _____ Area Code/Phone No. _____

Check box for G.I. Bulletin on Educational Benefits Veteran Active Duty

CIE CLEVELAND INSTITUTE OF ELECTRONICS, INC.

1776 East 17th Street • Cleveland, Ohio 44114 • (216) 781-9400



A school of thousands.
A class of one.
Since 1934.

AO15

1

Your Upgrade Headquarters

TENEX makes it easier than ever to enhance your existing system. Imagine more hard disk space, more RAM, modems, VGA boards, sound and video boards. They're all in our catalog—all at the lowest prices! And all with TENEX customer service reps and technicians ready to help. There's never been a better time to upgrade so call 1-800-776-6781 now for our FREE catalog!

2

Your Best Resource for IBM-Compatible Hardware & Software

The more you know about computers and catalog savings, the more you'll love TENEX. In 9 years we've built the best team of friendly professionals in computing. We use our buying power to offer you the lowest prices possible without sacrificing support. We make computing what it should be: powerful, worry free, and fun!

FREE!! Upgrade Guide



TENEX™ Computer Express

starting at
\$429⁰⁰

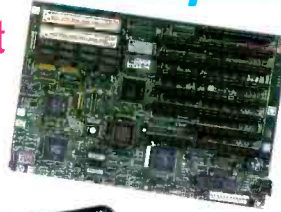

SX Motherboard

The board has 1MByte RAM memory, Chips and Technologies' chip set, and the advanced DTK BIOS with shadow RAM, LIM EMS, and utilities. The board is available in a 16MHz version for \$429.00 and a 20MHz version for \$549.00.



\$13⁹⁵

Tool Kit

Kit includes a chip insertion tool, chip extraction tool, tweezers, four screwdrivers, four nutdrivers, and a Torx screwdriver, all in a zippered vinyl case.

\$324⁰⁰



ComputerEyes Professional

Easily capture full-color and grayscale still video images from any source at up to 640x480 pixels, 24 bits/pixel. VGA compatible.

starting at
\$139⁹⁵

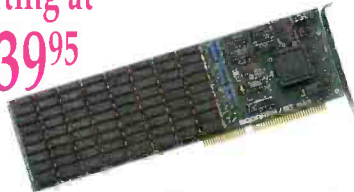

BOCARAM /AT+

Add RAM using a simple plug-in board with five-year warranty. Includes RAM disk and print-spooler software.

Bare board available for \$139.95.
Board with 2MByte for \$319.00.
Board with 4MByte for \$479.00.
Board with 6MByte for \$639.00.
Board with 8MByte for \$819.00.



only
\$7⁹⁵

Monitor AC Adapter

Just plug your monitor cable into the female power socket at the back of your computer and turn on your monitor when you turn on your computer.

starting at
\$99⁹⁵



Stacker

The Cadillac of disk compression tools! Stacker is the fastest and easiest way to "double" your disk space. Software version available for \$99.95. Coprocessor version available for \$199.95.

Ultimate Floppy Controller Board

Four-drive controller for use with any combination of 360KByte, 720KByte, 1.2MByte, and 1.44MByte drives. Includes all cables.

\$49⁹⁵

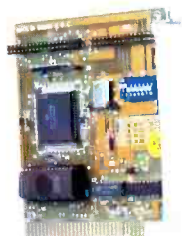

For Fast Service call our Toll-Free Number

8a.m.-8p.m. Weekdays

10a.m.-2p.m. Saturdays

1-800-PROMPT-1

(1-800-776-6781)

No fee for Visa, Mastercard, and Discover.

Shipping and handling 2.5%.

CIRCLE NO. 105 ON FREE INFORMATION CARD