

13 JAN 1965

5

TRANSISTOR DIVISION
LIBRARY

ELECTRICAL COMMUNICATION

ITT

VOLUME 39 • NUMBER 3 • 1964

ELECTRICAL COMMUNICATION

Technical Journal Published Quarterly by

INTERNATIONAL TELEPHONE and TELEGRAPH CORPORATION

320 Park Avenue, New York, New York 10022

President: Harold S. Geneen

Secretary: John J. Navin

CONTENTS

Volume 39	1964	Number 3
This Issue in Brief		330
Recent Achievements		333
International Mobile Radio Equipment <i>by G. Sidow, G. Niros, and M. Bruley</i>		346
Digitrac for Handling Radar Data <i>by S. M. Eriksson</i>		360
Analysis of Diode Modulators Having Frequency-Selective Termi- nations Using Computers <i>by Carl Kurth</i>		369
Microwave Telephone Relay Network in Mexico <i>by H. Carl</i>		379
Geographic Relay System for Railroad Interlocked Routing <i>by W. Schmitz</i>		383
High-Power Reflex Klystrons for Millimetre Wavelengths <i>by T. M. Jackson, A. D. Brisbane, and E. A. Ash</i>		403
Quartz-Crystal Frequency Standards <i>by K. Baulk</i>		413
Electromechanical Filters for 50 to 500 Kilohertz <i>by A. Russen</i> ...		423
Tandem Wire Drawing and Plastic Insulation Extruding <i>by P. N. Delves-Broughton</i>		435
Quasi-Electronic Translator in Telephone Direct Distance Dialing <i>by Th. Burian and H. Nordsieck</i>		444
World's Telephones—1963		451
United States Patents Issued to International Telephone and Telegraph System; May–July 1963		458

Copyright © 1964 by INTERNATIONAL TELEPHONE and TELEGRAPH CORPORATION

EDITOR, Harold P. Westman

ASSISTANT EDITOR, Melvin Karsh

Subscription: \$2.00 per year

50¢ per copy

This Issue in Brief

International Mobile Radio Equipment—Transmitter-receivers have been designed to fill both civilian and military needs for radiotelephone mobile operation in either the 2-, 4-, or 8-meter bands and with channel spacings of 50, 25, or 20 kilohertz as required. Technical specifications of the various European administrations were condensed into one all-inclusive specification, given in the Appendix, that was used as the basis for developing the equipment.

The receiver uses double frequency conversion, with a diode ring modulator as the first mixer. Its output goes to the 10.7-megahertz intermediate-frequency amplifier through an 8-crystal filter, which attenuates adjacent-channel signals by 85 decibels. All oscillators are crystal controlled.

The transmitter power amplifier and its driver are the only vacuum tubes in the equipment, which uses transistors and diodes extensively. Ancillary features include duplex operation, acoustic alarms for unattended receivers, and selective calling.

Digitrac for Handling Radar Data—Missiles and supersonic aircraft compel the use of sophisticated high-speed data-handling equipment to retrieve, process, present, and distribute information on which all related ground and air activity is based. A technical solution exists having an inherent capability to present and process normal radar information and to emphasize target signals by correlation to produce clear presentation in such form as to be capable of being transmitted over telephone lines.

High computing speed and easy programing are obtained by using one or more operating computers having both permanent and semipermanent stored programs. These computers are assisted by digital devices and fixed programed units.

The use of one or more computers having many identical circuits of relatively few types leads to a modular concept that makes it economically possible to meet specifications for both high capacity and high operating speed.

The choice of digital techniques for all major functions permits exclusive use of semiconductors as active devices. This leads to low power consumption, low long-term drift, high reliability, and easy maintenance.

Analysis of Diode Modulators Having Frequency-Selective Terminations Using Computers—In frequency translation or modulation by means of passive nonlinear resistances, the problem of their cascade connection with frequency-dependent networks arises; the simultaneously appearing unwanted modulation products must be suppressed by filters. Hence the magnitude of the output at frequency $\Omega \pm \omega$ in response to the input at frequency ω , with respect to frequency, is of special interest.

At the same time the magnitude of the unwanted modulation products still present at the input or output of the frequency translator despite filtering should be known. This results in the question: How should the networks preceding and following a modulating four-pole be dimensioned to obtain a specific response-frequency characteristic in the pass band while still meeting the given requirements for the unwanted modulation products at the input and output? The answer to this question leads to the synthesis of frequency translators.

The subject of this article is the steady-state analysis of frequency translators using diode ring modulators and their calculation or synthesis by computers.

Microwave Telephone Relay Network in Mexico—Operation began in 1962 of a 4-gigahertz radio relay system linking several major cities in Mexico. A spur connects to the Bell Telephone network in the United States. The system capacity is 960 telephone channels or 1 television channel, with provision for doubling this capacity in the future.

In a 920-kilometer (570-mile) 17-station network, measured noise power in the highest-frequency telephone channel was 1.5 picowatts

per kilometer. This is half of the maximum figure allowed by the Comité Consultatif International Radio.

Outage time averaged between 0.2 and 0.3 percent during the first year of operation. Dual operate and standby transmitters and receivers provide continuous service.

Geographic Relay System for Railroad Interlocked Routing—A new system of automatic railroad routing based on the previous design known as geographic circuits has been developed in Germany and is called Geographic System or Spurlplantechnik. The new design includes route setting, flank protection, and signal aspect control, which were not adequately provided for previously.

A rail switching route is selected by pressing push buttons at the entrance and exit tracks of a geographic diagram on a control desk. Automatically, all required switches are operated to reserve a path that is free of existing traffic, flanking tracks from which other trains might enter this path are blocked, and all signals are properly set.

Relay sets are manufactured in standard units that are adapted to each particular installation by the design of the interconnecting cables. By combining certain functions, the number of relays is reduced.

High-Power Reflex Klystrons for Millimetre Wavelengths—A reflex klystron design uses an internal cavity that is adjusted in manufacture to the approximate operating frequency. Its output goes to a circular waveguide having a ceramic window to retain the vacuum. An external tuner that forms a continuation of the output waveguide provides a circular-to-rectangular waveguide transition. At its circular end it contains two movable dielectric partitions, which form the end walls of a tuning cavity, adjustable to peak the output power at the exact frequency of operation.

A total frequency range from 18 to 100 megahertz is covered by a series of tubes. Power output varies from more than 2.5 watts at the lowest frequency to 0.01 watt at 110 megahertz. Tuning range for a specific tube is of the order of 5 percent. The beam is operated at 2 kilovolts and 40 milliamperes. The reflector has inner and outer elements operated at different voltages.

Quartz-Crystal Frequency Standards—Quartz-crystal oscillators have been used for the past 40 years as standards of time and frequency. In recent years they have been replaced in some countries by atomic frequency standards, but crystal-controlled oscillators continue to be widely used as primary as well as secondary frequency standards controlling communication and navigation systems.

For greatest stability and uniformity of frequency drift with time, the operating temperature of the crystal, and the amplitude of its drive voltage, must be maintained within close limits.

Development of the *AT*-cut fifth-overtone crystal permitted small portable standards to be produced with exceptional long-term stability, approaching 1×10^{-10} per month. Caesium gas-cell atomic standards have exceeded this figure.

Electromechanical Filters for 50 to 500 Kilo-hertz—Mechanical resonators made from the elinvar group of alloys have high Q values and frequency stabilities and are suitable for use in electromechanical filters in communication systems.

Design techniques are described that have been used successfully between 50 and 500 kilohertz in making filters for single-sideband, telegraph, and intermediate-frequency applications. These filters are small, simple, and robust, with performance that compares favorably with more-conventional types. The mechanical structures are well adapted to economical production using suitable manufacturing techniques.

Tandem Wire Drawing and Plastic Insulation Extruding—A fully automated line first draws copper wire to required size and then extrudes on it a thin wall of polythene or polyvinylchloride insulation.

This tandem line operates at wire speeds up to 3000 feet (900 meters) per minute, depending on the wire size and type of insulant. A water-cooled capstan that pulls the insulated wire out of the extruder and through a water trough sets the speed of the entire line. The wire drawing and extruder plastic feed are controlled from the capstan motor by tachometers.

Wire is taken up on reels that are changed automatically, the line slowing down during changeover. The wire going through the line at this time is loaded in an accumulator, which is unloaded later when the line resumes normal speed.

Quasi-Electronic Translator in Telephone Direct Distance Dialing—Subscriber dialing of toll telephone calls requires translation of the dialed digits into specific routing and billing

instructions. In the German network the digits corresponding to the regional, sectional, and junction centers are sent by the calling register to the translator, which returns through coincidence circuits the required instructions to the register.

Translators using Herkon relay contacts in evacuated enclosures are more economical than the all-electronic circuits that have been used and meet fully the required operating speed.

Jumpering frames permit simultaneous signals from a register to be connected to appropriate evaluation coincidence circuits by connecting vertical input wires from the register and horizontal wires to the evaluation circuits at their crosspoints. A similar arrangement provides flexibility in connecting to the register the outputs of the evaluation circuits that provide instructions on routing and zoning. A typical German installation requires between 80 and 120 evaluation circuits. Alternative routing is provided if trunks on the most-direct route to the desired party are not available.

Recent Achievements

Ace High Network Completed—The final link, completing the Ace High communication chain that extends from the northern tip of Norway to the eastern edge of Turkey over an 8300-mile (13 350-kilometer) route, was recently accepted by Supreme Headquarters Allied Powers Europe in behalf of the North Atlantic Treaty Organization. This is the largest communication system ever planned, engineered, installed, and placed in operation as a single internationally funded project. The stations are in Norway, Denmark, West Germany, Great Britain, The Netherlands, France, Italy, Greece, and Turkey.

More than 250 telephone and 180 telegraph circuits are provided to the Supreme Allied Commander in Europe by 82 stations operating almost equally over line-of-sight and tropospheric forward-scatter paths. The main route is equipped at present for 36 telephone channels, each of which can be converted to 12 or 18 telegraph channels.

The network grew as new stations were added to the original sections that had been in operation in Norway for several years. The first of the internationally funded stations was accepted over two years ago.

Master control is about 40 miles (64 kilometers) from Paris at a station equipped for both line-

of-sight and forward-scatter operation. Paris and Norway are connected by two routes; one through France, Germany, and Denmark, and the other through the United Kingdom.

International Standard Engineering performed the tasks of project management, system design and engineering, and installation engineering as well as equipment installation, testing, alignment, and maintenance. It provides engineers and technicians on a continuing basis and trains military personnel to operate the system.

The procurement of equipment was handled directly by Supreme Headquarters Allied Powers Europe through international competitive bidding. Electronic equipment was supplied from both sides of the Atlantic. Standard Telephones and Cables of London supplied telephone multiplex equipment and Bell Telephone Manufacturing Company of Antwerp provided telegraph multiplex apparatus.

In Figure 1, the 60-foot (18-meter) paraboloidal antennas are for forward-scatter links and the smaller reflectors on the tower are for line-of-sight operation.

*International Standard Engineering
United States of America*

Language Teaching—Equipment has been assembled for the teaching of spoken languages. The instructor's desk includes a control panel,

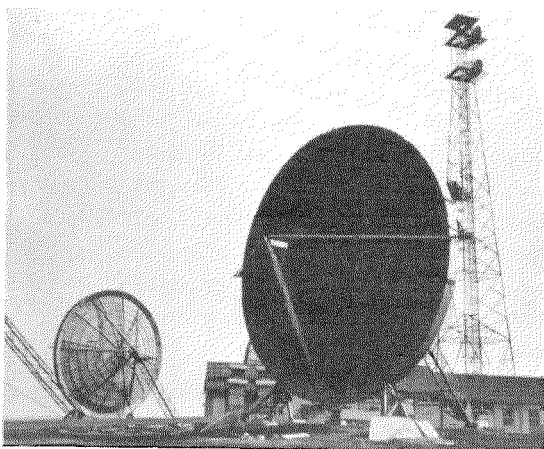

Figure 1—Antennas for tropospheric forward-scatter and line-of-sight paths for one of the 82 stations in the Ace High Network.



Figure 2—Student desks for teaching spoken languages.

Recent Achievements

microphone and receiver, record player, and magnetic recorder. Space is provided for storing records and tapes. A slide projector can be added to provide for audio-visual instruction.

Student desks, shown in Figure 2, are isolated by acoustic screens and each is equipped with a magnetic tape recorder as well as microphone and headset. All are connected to the control panel through which the teacher reaches the individual student.

In use, words spoken by the teacher are recorded on one track of the student's recorder.

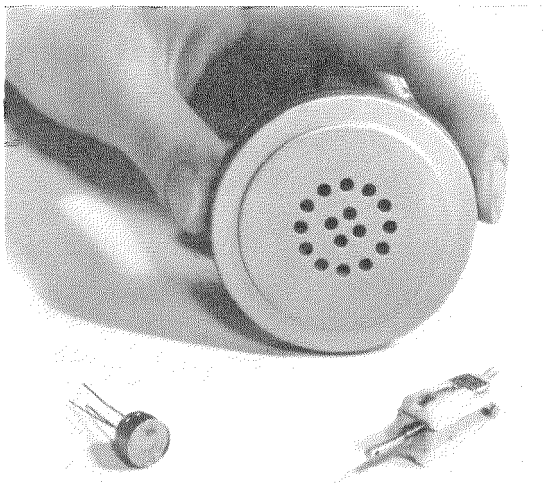

Figure 3—Semiconductor microphone and pickup in foreground. A comparable carbon microphone is held in the background.

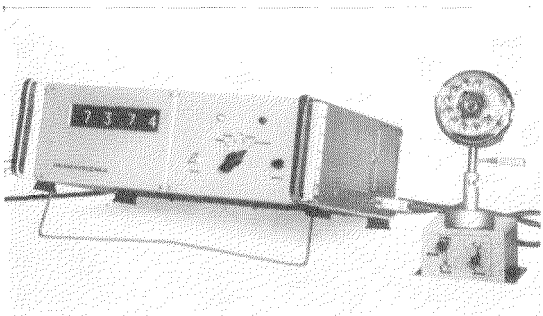

Figure 4—Time measuring set for telephone-dial inspection.

The student then records his pronunciation of the words on a second track and compares the two. A rewind provision permits the student to repeat his words until he and the teacher are satisfied. The magnetic tapes are of a size that permits lessons from 30 to 60 minutes.

*Bell Telephone Manufacturing Company
Belgium*

Semiconductor Microphone—A transducer has been developed in which a diamond probe bears on the region of a diffused planar transistor where the junction between the base and emitter comes to the surface of the semiconductor die. Mechanical forces applied to the probe cause proportional changes in the current gain of the transistor. The electric output is a close analog of the mechanical input. It operates on less than 5 percent of the electric power required by a comparable carbon microphone and is more linear and stable than such a unit.

This transducer has also been incorporated into a phonograph pickup as shown in Figure 3. It will deliver -10 decibels referred to 1 milliwatt at an impedance level of 1000 ohms at 1000 hertz from a standard record rotating at 33 revolutions per minute. It has other applications such as to lightweight accelerometers.

*Standard Telecommunication Laboratories
United Kingdom*

Highly Stable High-Power Rectifier—For operation of the famous big magnet in the Kamerlingh Onnes Laboratory of Leiden University, the first 112.5-kilowatt precision-stabilized rectifier has been put in service. Units from this size down to 5.5 kilowatts, previously designed and tested, are under construction for the Universities of Groningen, Amsterdam, Nijmegen, and Utrecht.

*Nederlandsche Standard Electric Maatschappij
The Netherlands*

Telephone Dial Performance Set—The 5582A test set (Figure 4) facilitates factory inspection

and adjustment of telephone dials. It may also be used in the laboratory for time measurements on dials, switches, and relays.

Time measurements are based on a 10-kilohertz frequency controlled by a quartz crystal. The measured time in milliseconds is displayed in illuminated numbers. The following measurements can be made on dials.

- (A) Duration of a pulse or a train of pulses.
- (B) Make times of the pulses in a train or of a single selected pulse.
- (C) Time between last closure of the pulsing contacts and the opening of the receiver-short-circuiting contacts.
- (D) Time from start of finger wheel return after release to first closure of the pulsing contacts.
- (E) Break time of a selected pulse.

Bouncing of the pulsing contacts does not affect the measurements. A jig may be used to simplify the adjustment of dials. It has two conveniently located switches that select the tests for the three fundamental adjustments and zero resetting, when the switch on the test set is placed in the remote-control position.

Using mostly transistors, the equipment requires only 33 watts. The case dimensions are 40 by 28 by 14 centimeters (15.8 by 11.1 by 5.5 inches).

*Standard Eléctrica
Spain*

High-Voltage Supply for Electrostatic Precipitator—Dust precipitators require high direct voltages to attract dust particles to a collecting electrode maintained at one polarity after the particles have been charged to the opposite polarity by a charging electrode. Under normal operation the arcs that may bridge the gap between the two electrodes must be extinguished quickly to protect the precipitator.

In the equipment shown in Figure 5, a transformer and selenium rectifier producing 35 000

volts at 0.1 ampere are at the right. The control cabinet at the left contains mostly static elements. A thyristor in the primary of the high-voltage transformer functions as a switch to extinguish within a half cycle of the supply frequency any arc that may occur. The delay in reconnecting the transformer is adjustable and automatically increases exponentially with the frequency of interruptions. An electronic integrator disconnects the supply voltage and gives an alarm if a preset number of interruptions per minute is exceeded.

The individual circuits in the control unit are mounted on plug-in cards for ease of maintenance. The control unit will operate with rectifiers of various types and ratings under all practical working conditions. Its dimensions are 546 by 402 by 586 millimeters (21.5 by 15.8 by 23.1 inches).

*Standard Téléphone et Radio
Switzerland*

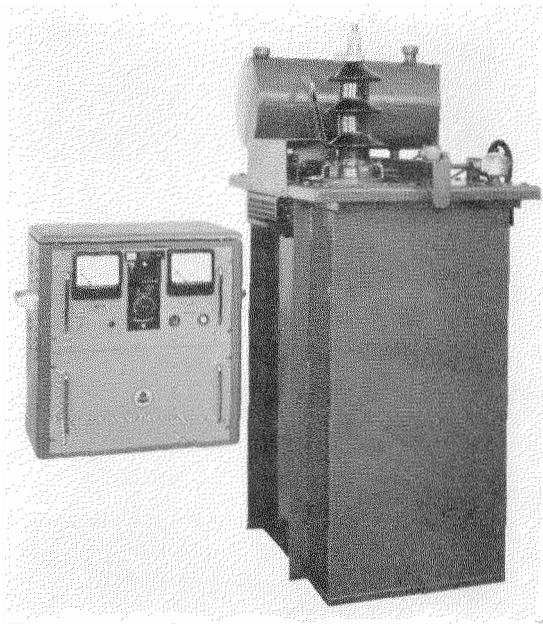

Figure 5—Control box and high-voltage rectifier for dust precipitator.

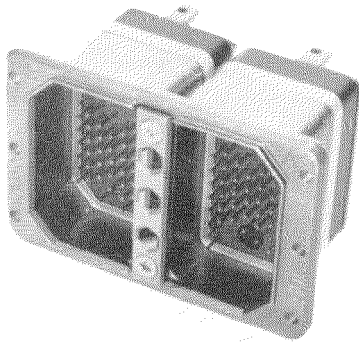

Figure 6—These multiconductor connectors are fitted with filters, within the protective housing, to reduce radio-frequency interference to the circuits they serve.

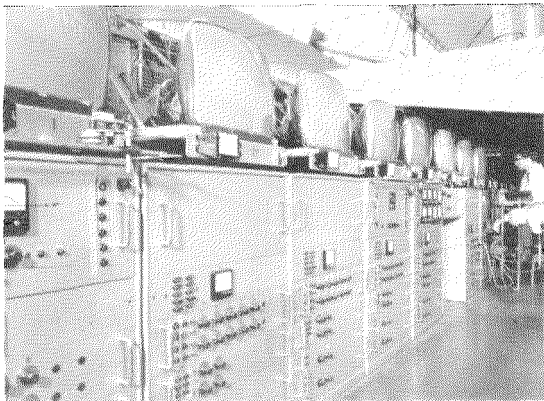

Figure 7—Partial view of equipment for automatic testing of television picture tubes.

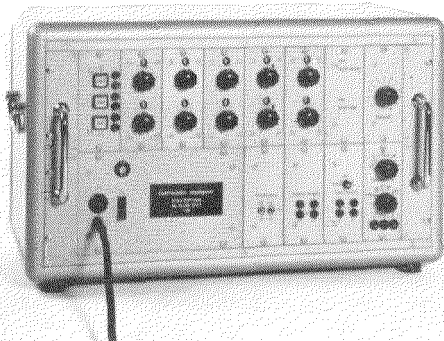

Figure 8—Pulse generator.

Filter Contacts for Connectors—Ferrite inductors and ceramic dielectric have been fitted on and around the contact pins of multiconductor connectors to serve as filters. Figure 6 shows such a unit. The filtered pins are encased in the protective housing. The susceptibility of complex equipment to radio-frequency interference may thus be reduced with a simple design having minimum weight and space requirements.

*ITT Cannon Electric
United States of America*

Data Interpolated in Speech Channels—In a 4-wire telephone channel, only the pair connecting the talker to the listener is occupied at a given time, the other pair being idle until the two parties reverse their talking and listening roles. Measurements have indicated that during normal use, these idle periods or gaps average about 65 percent of the time that the circuit would be held for the speech call.

A system has been developed to use such gaps for the transmission of data at modulation rates up to the full capability of the speech channel.

Speech is delayed by means of magnetic drums with suitably spaced record and replay heads to obtain advance knowledge of the presence and length of gaps suitable for the interpolation of data. When the gap length exceeds a predetermined amount in the range from 100 to 200 milliseconds, a control unit sets up the data transmission condition. On resumption of speech, the control unit returns the circuit to the speech condition. Such a system permits over 95-percent usage of circuit time.

*Standard Telecommunication Laboratories
United Kingdom*

Automatic Picture-Tube Testing—With the equipment shown in Figure 7, two operators can test as many as 170 cathode-ray television picture tubes per hour.

Different tests are made at each station. First, the tube is heated and its pressure is measured

as an indication of the condition of the evacuation equipment. In the next three positions, tests are for vacuum, stray emission, and flash-over. Next, the characteristic curve is taken with particular attention to the operating points. The operator in the next position checks the cathode efficiency, screen quality, and sharpness of focus with the aid of a test pattern. In the final position any additional test that may be desired can be applied manually.

All automatic test sets are self-monitoring and a fault in the test set is indicated both visually and audibly. The test results are recorded by counters.

A card is attached to the transport carriage for each tube and a roller-type printer marks the results of that test in a distinctive color on this tube card. The cards are taped to the screens of the tubes when all tests have been completed.

There are 123 transformers, 259 relays and contactors, and 320 vacuum tubes, stabilizers, and semiconductor devices in the equipment. The line is approximately 22 meters (72 feet) long.

*Standard Elektrik Lorenz
Germany*

Rome Long-Distance Direct-Dialing Exchange—About 600 telephone subscribers in Rome have been connected to a long-distance direct-subscriber-dialing exchange that gives access to the whole network connected to the Rome national and international exchanges.

A 2-wire group selector gives access to all of the 2-wire national toll lines. A 4-wire selector similarly serves the 4-wire national toll lines connected to the Rome transit exchange and the outgoing international lines using 2-voice-frequency signaling of either the Comité Consultatif International Télégraphique et Téléphonique or the simplified types.

The registers have been designed to work with both the national and international networks, using the signaling systems employed by these networks. Automatic call charging is by means

of memory circuits and high-speed Creed perforators.

*Fabbrica Apparecchiature per Comunicazioni
Elettriche Standard
Italy*

Silicon Planar Epitaxial Transistors—By a change in both the diffusion process and the structure of a silicon planar epitaxial transistor, the base, collector, and emitter are brought out on one plane of the semiconductor die. A metalized layer followed by a silver-solder dip prepares the contact areas. These areas are placed face downward in contact with the ends of the lead wires, and a brief heat cycle welds the leads simultaneously.

The new design meets military life and environmental requirements; no failures have occurred on centrifuge tests at 25 000 gravity units. The price is significantly reduced without sacrificing performance or reliability. The *BSY95*, a high-speed switching unit, is the first of the new series in production.

*Standard Telephones and Cables
United Kingdom*

Pulse Generator and Time-Frequency Counter—A pulse generator and a time and frequency counter, useful in telephone and telegraph switching and in automatic control engineering, have been developed in similar modular form. Both can be combined in a single smaller package than separate units would total.

The duration of pulses and the interval between pulses may be controlled independently in the pulse generator, which is shown in Figure 8. These times may be between 0.1 millisecond and 10 seconds. If a 100-kilohertz frequency is provided from an external source, the shortest time will be reduced to 0.01 millisecond. Pulses may be repeated continuously or in trains from 1 to 12 pulses. Pulse trains may be started and stopped by push buttons or by external control voltage. Either the contacts of a pulse-driven bounce-free relay or the pulse voltage is available as output.

Recent Achievements

The time and frequency counter operates from a crystal-controlled generator and two frequency dividers of 10:1 ratio each. Frequency measurements cover the range from 30 hertz to 300 kilohertz. Time measurements are from 0.01 millisecond to approximately 10 seconds. Direct readout is by four self-illuminated digits with automatic range selection. Two high-impedance ungrounded inputs are provided. An important feature is the ability to measure the pulses produced by the chattering of relay contacts. Also any pulse in a series of up to 12 pulses can be selected and evaluated.

As both the pulse generator and the timer depend on the frequency of a crystal-controlled oscillator, the combined unit needs only one such oscillator and auxiliary equipment for both purposes.

*Standard Elektrik Lorenz
Germany*

Geiger-Mueller Counter Tube 3G8B—Under license of the French Atomic Energy Agency, a wide-range counter operating in the Geiger-Mueller region has been developed for use in military equipment. In a suitable circuit, it will respond to fields from 0.001 to 1000 roentgens per hour without saturation. It will operate on 1 stroke per second per milliroentgen per hour.

The tube, shown in Figure 9, is operable from -40 to $+70$ degrees centigrade. The Geiger-Mueller threshold is 445 volts and a flat operat-

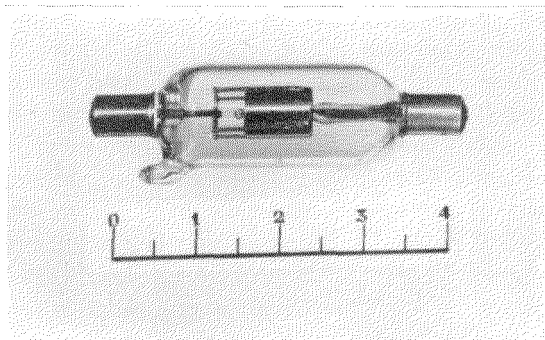

Figure 9—Geiger-Mueller tube type 3G8B.

ing range occurs over at least 100 volts. The minimum detectable gamma and beta energies are 50 and 2000 kiloelectron-volts, respectively. The tube is 46 millimeters (1.8 inches) long and 13 millimeters (0.5 inch) in diameter.

*Laboratoire Central de Télécommunications
France*

Resistivity Test Set—The type 74711 resistivity test set, shown in Figure 10, is particularly useful for production testing of the thin slices of semiconductor material used in transistors.

Operation is based on the damping effect on a lightly loaded tuned circuit of the semiconductor slice. No electrical contact need be made to the slice, which permits more-rapid testing than with the conventional 4-point probe method.

In slices of large area, changes in resistivity around discontinuities may be detected. If the resistivity of the material is known, the instrument will measure thickness.

*Standard Telephones and Cables
United Kingdom*

Ferrite Pot-Type Cores—Manufacture has been started of a series of ferrite cores meeting the



Figure 10—This test set measures the resistivity of thin slices of semiconductor material by its damping effect on a lightly loaded tuned circuit.

recommendations set up by the International Electrotechnical Commission. As shown in Figure 11, the core is in two halves with an adjusting device that fits into the center hole. Without protruding beyond the core, it permits the inductance of the winding encased by the core to be adjusted over a range between 5 and 15 percent. Cores are available in 5 sizes between 14 by 8 and 36 by 22 millimeters (0.55 by 0.32 and 1.4 by 0.87 inch).

*Standard Eléctrica
Spain*

Color Television Monitor—A high-quality receiver for monitoring the operation of a color-television transmitter and for laboratory purposes is shown in Figure 12. It can be arranged for either cabinet or rack mounting.

Except for the horizontal-line sweep circuit in which vacuum tubes are used, the set employs transistors, most being of the *BFY37* and *BFY39* types. The 406-millimeter (16-inch) rectangular picture tube is of the shadow-mask type and has screen dimensions of 210 by 280 millimeters (8.3 by 11 inches) for the 3:4 aspect ratio.

The components are mounted on printed-circuit boards. Hinged to the chassis to facilitate access, the boards may be extended during operation for servicing.

*Standard Elektrik Lorenz
Germany*

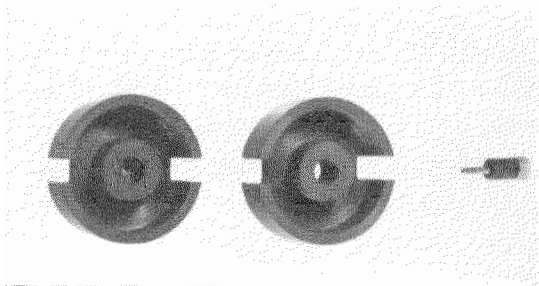

Figure 11—Ferrite pot-type core meeting recommendations of the International Electrotechnical Commission.

Printed-Circuit Card Tester—To reduce the time required for production testing of printed-circuit cards, the *KT 54-C* tester shown in Figure 13 is programmed through an automatic reader by a punched card prepared for each particular design of printed-circuit card.

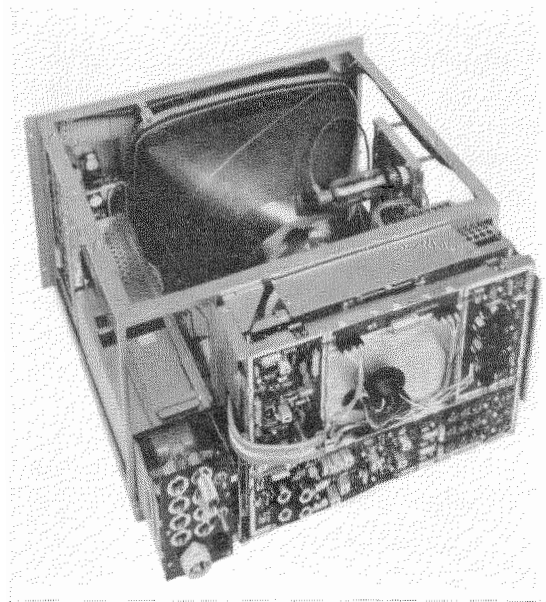

Figure 12—High-quality color-television receiver for use in the laboratory and as a transmitter monitor.

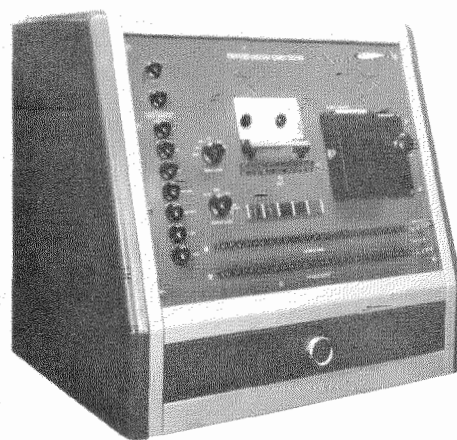

Figure 13—Printed-circuit cards are tested automatically under control of a punched card prepared for the particular circuit board.

Recent Achievements

There are 15 internally generated digital signals, of which 7 are adjustable from 0 to 12 volts and in duration from 2.5 microseconds to 5 milliseconds. A sine-wave generator may be adjusted between 200 and 10 000 hertz.

An input load switch controls the rise and fall times of the input pulses to meet the requirements of the card under test, and an output load switch permits the normal output load to be simulated. A cathode-ray oscilloscope may be used to display an input and output or two outputs.

*ITT Kellogg Communications Systems
United States of America*

Anglo-German Submarine Telephone Cable—

The first direct large-capacity submarine telephone cable between Great Britain and Germany is now in service. Participating in the inauguration were Assistant Postmaster General Mr. Roy Mawby, Member of Parliament, in London, and State Secretary Herr H. Bornemann, in Bonn.

The insertion of 20 low-cost shallow-water repeaters permits 120 standard telephone channels to be obtained over the 250 nautical miles (463 kilometers) of cable. Conventional armored cable of 0.62-inch (15.7-millimeter) diameter is used except for about 35 nautical miles

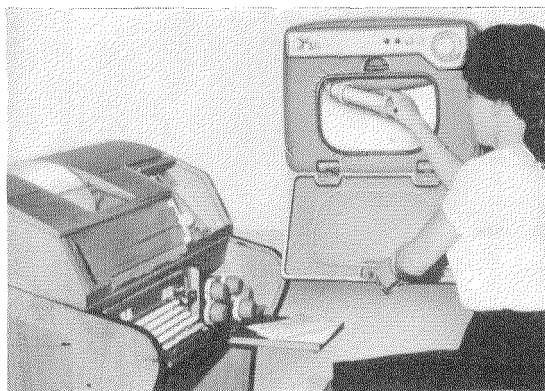

Figure 14—Operator inserting carrier in terminal of LR 65 pneumatic tube system.

(64 kilometers) between Borkum and Leer in which 0.935-inch (23.8-millimeter) cable was laid.

*Standard Telephones and Cables
United Kingdom*

Telex Exchange at Venlo—A telex exchange at Venlo, in the southern corner of the country, has been added to The Netherlands' network. It increases the installed capacity to 6700 lines of which 5500 are now connected. Using the 7E rotary switching system, subscriber calls are placed from the teleprinter keyboard and not from a telephone-type dial.

At least a dozen main exchanges will make up the ultimate telex network of 10 000 subscribers for national and international traffic. The equipment for Venlo was manufactured by Bell Telephone Manufacturing Company.

*Nederlandsche Standard Electric Maatschappij
The Netherlands*

Pneumatic Tube System LR 65—The LR 65 pneumatic tube system may include as many as 19 stations, all of which need not be installed initially. The maximum tube length is 200 meters (660 feet) with one blower and twice this length with two blowers. Carriers travel at 6 to 8 meters per second (20 to 26 feet per second).

The carriers are of transparent plastic and accommodate 400 letter-size sheets of stationery or a weight not exceeding 200 grams (7 ounces). The tubes are of corrosion-resistant plastic and the air blower is mounted in a sound-absorbing plastic housing.

The terminals are in sound-absorbing plastic housings suitable for either vertical or horizontal mounting. Carriers may be sent or received in either of two directions. As shown in Figure 14, a telephone-type dial at each station is operated to establish the destination of

each carrier. Colored lamps indicate the operating conditions at all times.

*Standard Elektrik Lorenz
Germany*

Notch Aerial for Concorde Aircraft—Notch aerials having been successfully designed and installed on two top military aircraft, Trident and Vanguard, design of a similar element has been undertaken for the Concorde, the new Anglo-French supersonic airliner. This type of aerial is beneath the skin of the aircraft, which acts as its own radiating element. There are no external fixtures to add to the aerodynamic drag of the aircraft in flight.

*Standard Telephones and Cables
United Kingdom*

Radio Guidance for Drone Aircraft—Ground-based radio equipment for ranging and communication to control drone aircraft is being supplied to Aerojet-General Corporation, the

prime contractor. It will continuously monitor and, if necessary, correct the guidance system of the drone. It will also provide information on the instruments and equipment in the drone and permit operational adjustments to be made.

*ITT Federal Laboratories
United States of America*

Submarine Telephone Cable to Link Spain and Canary Islands—A 12-day engineering survey on the *C.S. Cable Restorer* of the Commercial Cable Company, shown in Figure 15, has determined the route for a repeatered coaxial submarine cable between Cadiz, Spain, and Santa Cruz de Tenerife, in the Canary Islands.

Existing microwave systems connect Cadiz with the Spanish telephone network, Europe, and North America, which will be available to subscribers in the Canary Islands. A microwave system of about 50 statute miles (80 kilometers) will be provided to connect Santa Cruz to Las Palmas, on a neighboring island.



Figure 15—*C.S. Cable Restorer* at Cadiz, Spain.

Recent Achievements

The coaxial cable will be the lightweight type with a diameter of 1.25 inches (32 millimeters). Its 45 repeaters will provide for 160 two-way telephone channels over its 750-nautical-mile (1389-kilometer) length. All repeaters and equalizers will be housed in rigid cases similar to those already well tested in transatlantic and transpacific cables, in which they are operating at depths as great as 3100 fathoms.

Compañía Telefónica Nacional de España has placed the order for this cable.

*Standard Telephones and Cables
United Kingdom*

Tuning Indicator EMM803 for Stereophonic Receivers—With a tuning section similar in design

to the *EM84* tuning indicator,* this new unit includes a second section that indicates if the tuned-in signal is modulated stereophonically. It is operated by a 4-volt negative signal derived from the subcarrier in the stereophonic decoder of the receiver. The basic tuning indicator requires a negative voltage of only 15 volts compared with the 21 volts required by the *EM84*.

*Standard Elektrik Lorenz
Germany*

Instrument Landing System for Sofia—The first installation of the highly-accurate *STAN.7/8/9* instrument landing system in Eastern Europe will be a complete dual system in Sofia, Bulgaria.

Installed throughout the world, this system was demonstrated late in 1962 as the sole ground-based guidance element in the first completely automatic blind landing in thick fog at the London Airport (Heathrow).

*Standard Telephones and Cables
United Kingdom*

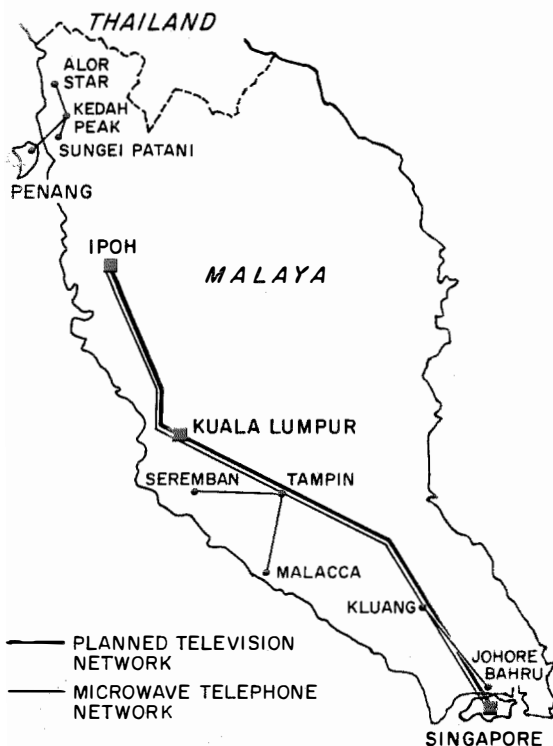

Figure 16—Present microwave telephone network in Malaya and planned television system that will use existing telephone structures.

Pentaconta and 7D Rotary Telephone Switching Interconnected in Spain—The 2000 subscribers in the Pentaconta 1000 central office in Igualada are now directly interconnected with the 7D rotary system of the Barcelona region and thence to the automatic toll network linking Madrid, Zaragoza, and Barcelona.

As Igualada and Barcelona are about 50 kilometers (30 miles) apart, signaling is at 50 hertz. The incoming junctors at Igualada convert the alternating current into direct-current pulses, which operate the registers as would subscriber dial pulses.

Outgoing signals are generated as direct-current pulses that are converted to alternating current at the outgoing junctor. As many as

*A. Lieb, "Electron-Beam Voltage-Indicator Tube EM84," *Electrical Communication*, volume 35, number 2, pages 76-82; 1958.

six translated selections may be necessary for routing a call through the 7D network. The outgoing junctors will handle calls from subscribers and from operators. A call-duration timer will operate the subscriber's meter at a maximum of 120 pulses every 3-minute period, which meets the needs of the billing plan.

*Standard Eléctrica
Spain*

Malaysian Television Network—A new television transmission system is planned for the 300-mile (480-kilometer) path from Singapore, through Kuala Lumpur, to Ipoh, as shown in Figure 16. This system will make additional use of towers and buildings that we installed about 5 years ago for a microwave telephone network.

The television equipment will operate in the 4-gigahertz band and is designed to handle standard 625-line picture signals in black and white or in color. It will provide for a complete television network along the west coast of the country.

*Standard Telephones and Cables
United Kingdom*

Airport Radio Beacon for Light Traffic—A low-cost ground beacon for airports having light traffic occupies less than 1 cubic foot (0.03 cubic meter) of volume and weighs only 30 pounds (13.6 kilograms). It provides continuous information on the distance between aircraft and the beacon, which is suitable for installation where the amount of traffic does not justify the cost of a conventional installation.

*ITT Federal Laboratories
United States of America*

Elevator (Lift) Floor Indicator—A new cold-cathode tube type *GN-4BG*, shown in Figure 17, indicates basement, ground, and floors 1 through 8 in an area approximating a circle 1.1 inch (28 millimeters) in diameter.

Normally, each level requires a complete set of indicator lamps, one lamp representing each

floor. As only one *GN-4BG* is needed for each level and as cold-cathode tubes have a longer life than incandescent lamps, maintenance is greatly reduced.

*Standard Telephones and Cables
United Kingdom*

Cordless 7E Manual Toll Exchange—Part of a new cordless 7E manual toll exchange is shown in Figure 18. In addition to 54 toll positions, there are 32 national and 8 international information desks.

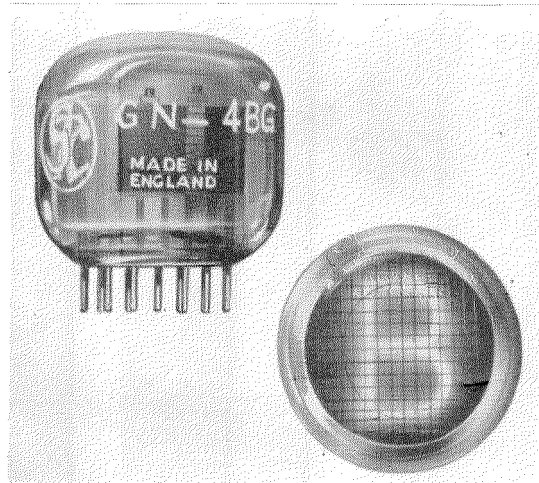

Figure 17—Cold-cathode tube for indicating the position of an elevator or lift.



Figure 18—Section of manual toll exchange using 7E cordless equipment.

Recent Achievements

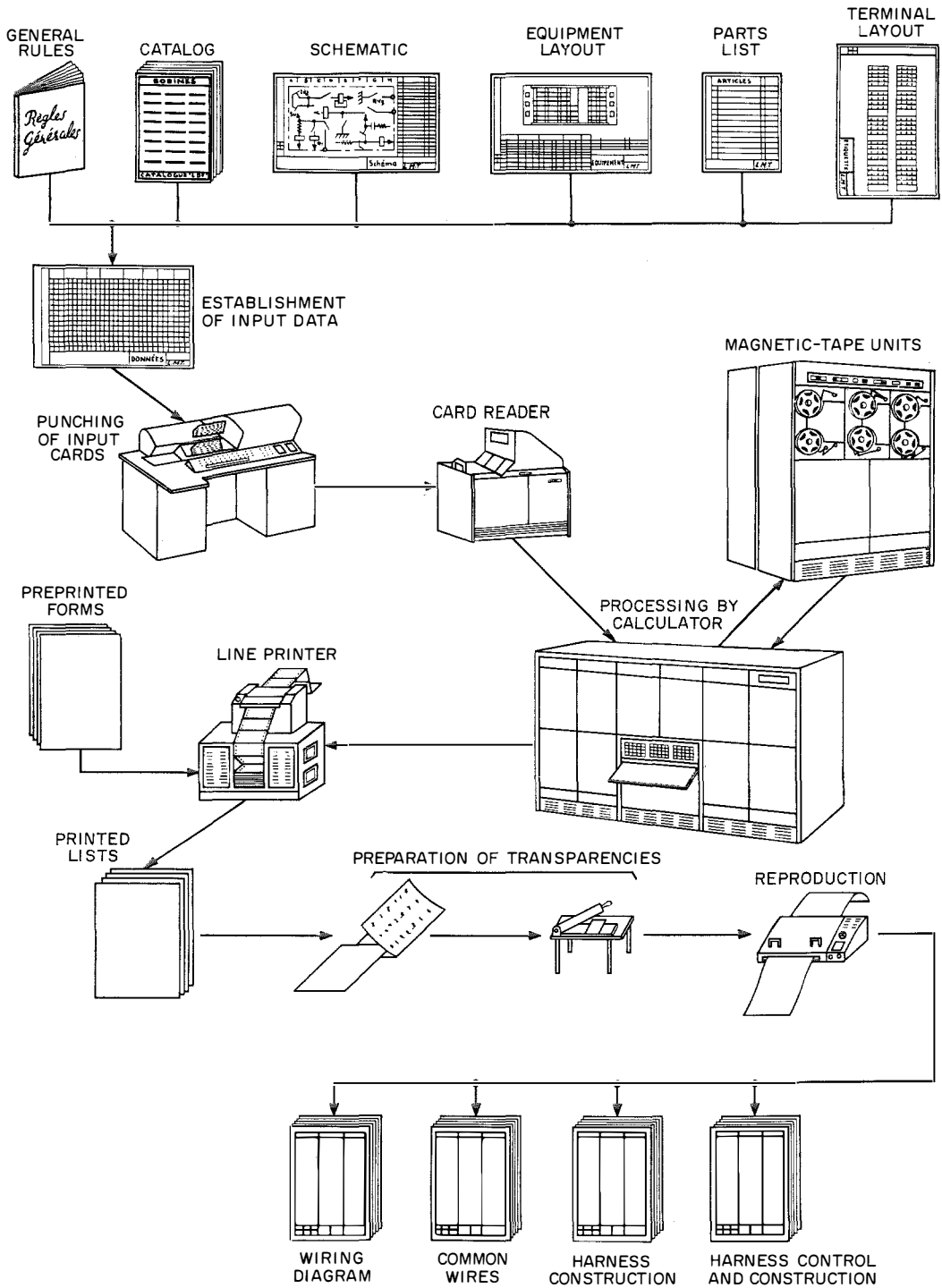

Figure 19—Computer processing of Pentaconta wiring.

Toll calls for national subscribers are placed through a new primary toll exchange located in the local area of The Hague. There are 100 toll and international lines connected to the exchange as well as 78 international lines using 2-voice-frequency signaling. Employing combined line and recording service, operators can dial directly into West Germany, Belgium, and England.

The operating desks and automatic switching equipment were supplied by Bell Telephone Manufacturing Company.

*Nederlandsche Standard Electric Maatschappij
The Netherlands*

Traffic Signals in Hamburg—Communication takes many forms, one of which is the equipping of 140 street intersections in Hamburg with traffic signals. The majority of them will be operated by a master controller having an ultimate load of 400 signals.

*Standard Elektrik Lorenz
Germany*

Power-Station Control Equipment—The Central Electricity Generating Board has ordered supervisory and alarm equipment for power stations at Ferrybridge, Tilbury, West Burton, Drakelow, and Eggborough.

The Ferrybridge project includes not only a complete alarm system but also equipment to control coal handling, precipitators, operating temperatures, and auxiliary apparatus. At Tilbury a new type of sequence control provides instructions to personnel over a number of 1-inch (25-millimeter) cathode-ray tubes that can display up to 500 instructions.

*Standard Telephones and Cables
United Kingdom*

Computer Assistance to Pentaconta Engineering—Some of the routine engineering of Pentaconta switching systems is now being performed by computers. In the modular construction of Pentaconta, the dimensions and placement of bays, frames, relay bars, relays, and other apparatus are standardized. Thus, although there may be a large number of points to which wires may be connected, it is nevertheless a finite number and the computer produces lists of connecting wires that can be used directly by the factory for wiring the equipment and for inspection. See Figure 19.

The program of about 6000 instructions has been developed for the Bull Gamma 30 computer, which has core-type storage for 20 000 bits and 6 tape units. The basic production unit is the frame, which is a chassis holding an average of 200 relays. Relays are mounted on vertical bars with an average of 22 relays per bar and 10 bars per frame.

Wiring is of two types, simple uncoded connections between relays of the same or adjacent bars and color-coded wires laced into a cable connecting equipment to terminal strips on the frame.

A typical circuit with 50 relays on 2.5 bars, 400 to 500 uncoded wires, and 100 to 200 color-coded wires, requires about half an hour of computer time; a 10-bar 200-relay circuit containing up to 3000 wires would need about 1 hour.

The savings in time and engineering staff through the use of computers is the result of a 3-year study by an international team of engineers.

*Le Matériel Téléphonique
France*

International Mobile Radio Equipment

G. SIDOW

Standard Elektrik Lorenz; Pforzheim, Germany

G. NIROS

Standard Electric Aktieselskab; Copenhagen, Denmark

M. BRULEY

Le Matériel Téléphonique; Paris, France

1. General

1.1 PURPOSE

In the past, major differences have existed among national specifications for mobile radio equipment; every country had to develop its own. Thanks to closer cooperation of the nations of Western Europe and to general acceptance of uniform operational requirements, the technical distinctions have diminished. They are no longer major, but mostly relate to the physical structure of the country.

The associated companies of ITT Europe have defined a specification containing all the various national requirements and have designed a mobile radio set that satisfies these requirements. The new specification is presented in the Appendix.

The objective was to produce a high-quality equipment reflecting our experience with production of related military and civilian units. The result was the Trans-ITT mobile set (Figure 1).

1.2 OPERATIONAL REQUIREMENTS

According to its specification, the transmitter-receiver must be capable of operating in the 8-



Figure 1—Trans-ITT mobile set.

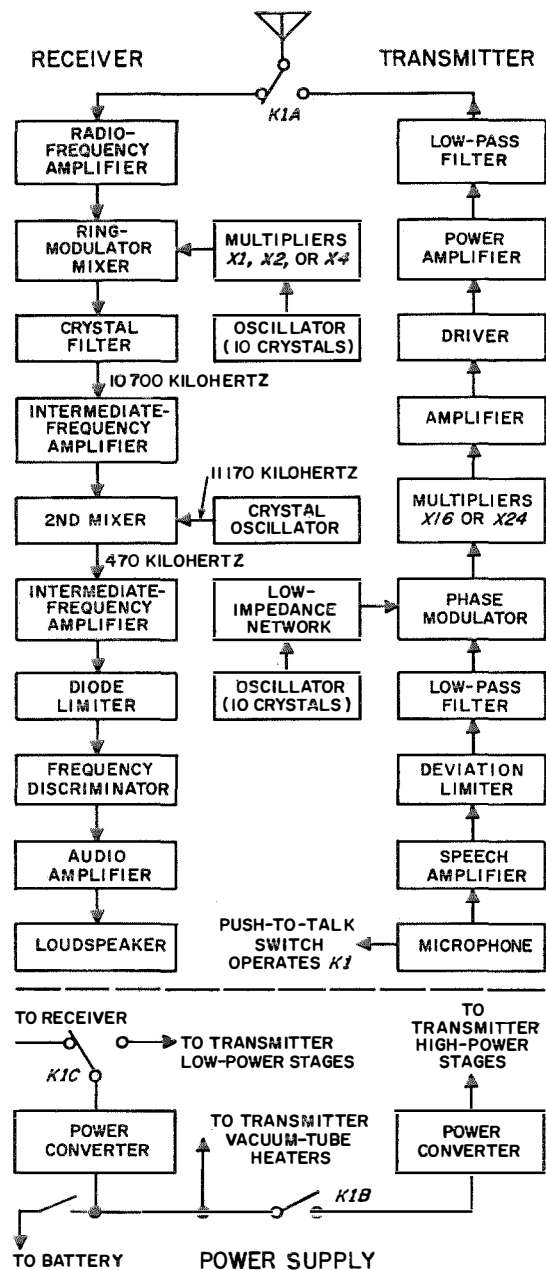

Figure 2—Diagram of transmitter-receiver.

4-, and 2-meter bands, with channel spacing of 50, 25, and 20 kilohertz. Simplex and duplex operation must be possible. The design had to be very flexible to meet these requirements and this led to the use of modular construction. Most of the modules are replaceable printed boards suitable for factory production.

The receiver can be equipped to respond to a single-frequency alerting signal or to respond to only one of 45 combinations of 2-frequency alerting signals.

The equipment is designed to operate from -25 to $+50$ degrees centigrade. Use of transistors has reduced standby consumption to such a low level that the set may be supplied directly from the car battery without a special generator. The risk of exhausting the car battery is substantially eliminated.

2. Electrical Design

The following discussion refers to the block diagram shown in Figure 2.

2.1 RECEIVER

To meet the high selectivity and intermodulation requirements, the receiver uses double frequency conversion. The receiver gain is thus split between two intermediate-frequency amplifier chains with sufficiently low gain in each (40 and 80 decibels, respectively) to ensure electrical stability even with printed-circuit-card construction.

The receiver uses only transistors as active elements and they all are adequately protected against thermal drift.

2.1.1 Radio-Frequency Input Circuit

A double-tuned filter is placed between the antenna relay and the first transistor to provide selectivity and direct-current isolation. Three tuned circuits are used between the first transistor and the mixer, to obtain the required 90-decibel rejection of image and spurious signals.

2.1.2 First Mixer

The first mixer is a diode ring modulator, which receives its local frequency from a 10-channel crystal oscillator. The intermediate frequency from the ring modulator passes through a matching circuit into an 8-crystal 10.7-megahertz filter with an attenuation of 85 decibels on the adjacent channel. The type of filter used depends on whether the channel spacing is 20–25 or 50 kilohertz. Filter curves are shown in Figure 3.

The crystal filter is located at the input of the first intermediate-frequency amplifier chain. This arrangement offers maximum protection against intermodulation, a well-defined selectivity characteristic largely independent of intermediate-frequency tuning and temperature, simple alignment, and change of channel bandwidth simply by replacing the crystal filter.

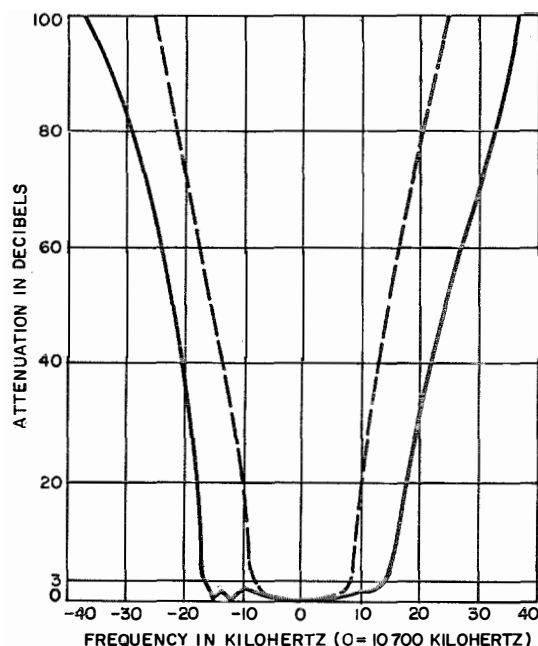

Figure 3—Selectivity of crystal filters. The broken line is for channel spacing of 20 or 25 kilohertz, and the solid line is for channel spacing of 50 kilohertz.

The careful design of receiver input circuits, particularly the use of a ring balanced modulator instead of a transistor, has considerably improved the spurious response, the intermodulation, and the blocking characteristics. Ferrite cores make it possible to design, for this modulator, transformers having very-low leakage inductance and covering the full range of 55 to 180 megahertz. Figure 4 shows the diagram of the ring modulator.

Figure 5 shows the comparative behavior of a ring modulator and a transistor, when supplied with the combination of (A) a desired signal at constant amplitude and frequency and (B) an adjustable-amplitude undesired signal at a different frequency. The output amplitude of the desired signal operates an indicator, which is isolated from the undesired signal frequency by a filter.

For the transistor, the interference voltage that produces a 3-decibel reduction in the output indication of the desired signal is 100 millivolts; for the ring modulator, the same reduction in desired signal is obtained only when the interfering level reaches 230 millivolts.

The attenuation of the mixer and of the crystal filter, as well as the noise of the first intermediate-frequency amplifier stage, must all be as low as possible. The attenuation of the mixer is 5 to 6 decibels, the insertion loss of the crystal filter is 3 decibels, and the noise factor of the intermediate-frequency amplifier is 3 to 3.5 decibels.

The gain of the radio-frequency amplifier must be high to achieve a good over-all noise factor;

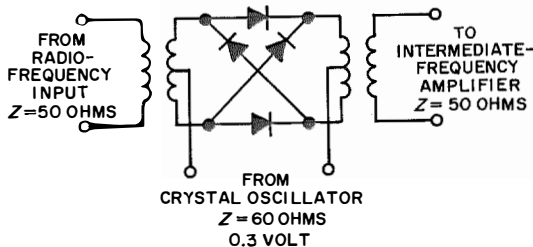

Figure 4—Diagram of ring modulator.

on the other hand, it must be kept as low as possible to reduce intermodulation and blocking by strong interfering signals. These two contradictory requirements must be compromised. The radio-frequency gain was designed to be 12 decibels and the resulting over-all noise factor is 6 to 9 decibels, with the intermodulation and blocking characteristics given in the Appendix.

2.1.3 Intermediate-Frequency and Output Circuits

The second intermediate frequency at 470 kilohertz is obtained by mixing the 10 700-kilohertz signal with 11 170 kilohertz from a crystal-controlled local oscillator. This amplifier chain has 3 stages followed by a diode limiter, a frequency discriminator, a 2-stage audio amplifier, and a class-B push-pull final amplifier directly connected without transformer to the loudspeaker. Negative feedback and thermistor stabilization hold the audio-frequency gain constant within ± 3 decibels throughout the temperature and frequency range (see Figure 6). If necessary, the use of tantalum capacitors can extend the lowest acceptable temperature limit to -30 degrees centigrade.

A muting or squelch circuit is used to suppress noise at the receiver output when there is no input signal, and also to reduce the power consumption of the receiver. Part of the noise voltage is amplified, rectified, and used to block

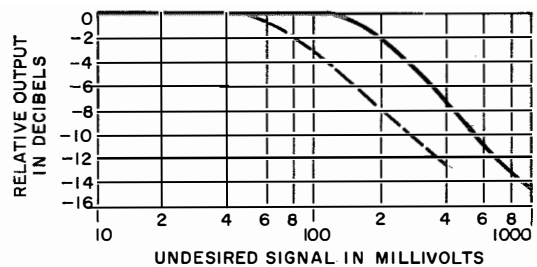

Figure 5—Relative behavior of drift transistor (broken line) and ring modulator (solid line) when supplied with the combination of a constant desired and an adjustable undesired signal. The desired signal input is constant at 1 millivolt and the oscillator delivers 100 millivolts to the mixer.

TABLE 1
RANGE OF CRYSTAL-CONTROLLED FREQUENCIES

Band	Receiver			Transmitter		
	Crystal Frequency Range in Megahertz	Multiplication Factor	Output Frequency in Megahertz	Crystal Frequency Range in Megahertz	Multiplication Factor	Output Frequency in Megahertz
2 Meters	33.8 to 40.8	4	135.3 to 163.3	6.08 to 7.25	24	146 to 174
4 Meters	28.6 to 39.9	2	57.3 to 79.8	2.83 to 3.77	24	68 to 90.5
8 Meters	42.4 to 51.7	1	42.4 to 51.7	1.98 to 2.56	16	31.7 to 41

the audio-frequency amplifier. The squelch sensitivity is controlled from the front panel.

2.2 CRYSTAL OSCILLATORS

2.2.1 Frequency Ranges

The desired radio-frequency channel is obtained by switching manually among 10 receive crystals that control the receiver local oscillator, and 10 transmit crystals that control the transmitter oscillator. Table 1 gives the range of crystal frequencies and multiplication factor for each operating band of the receiver and transmitter.

The frequency of the receiver local oscillator was chosen high enough to avoid spurious responses. Hence only a small number of medium-*Q* circuits are required in the multiplication stages, simplifying alignment of the equipment.

In the transmitter, the frequency of the crystal oscillator was chosen much lower to obtain the required frequency deviation with low distortion. One limiting factor was the difficulty of manufacturing high-stability low-frequency crystals.

2.2.2 Accuracy

In view of the high selectivity of the receiver crystal filter and of the required frequency deviation, the precision of both receiver and transmitter oscillators must be as high as possible. Another reason for this precision is that better receiver discrimination leads to better

cancellation of amplitude-modulated interfering signals. Typical values of the required relative frequency tolerance under all temperature and voltage conditions are 10×10^{-6} for channel spacing of 20 and 25 kilohertz, and 20×10^{-6} for channel spacing of 50 kilohertz. These tolerances are specified by European administrations.

For these reasons it is desirable to adjust the crystal oscillator initially to its exact frequency, with a relative error of the order of 1×10^{-6} . Individual trimmer capacitors are associated with the crystals and are switched with them. These trimmers are also used to compensate for aging of the crystals.

2.2.3 Stability

The frequency tolerance of 10×10^{-6} or 20×10^{-6} must be held under all circumstances.

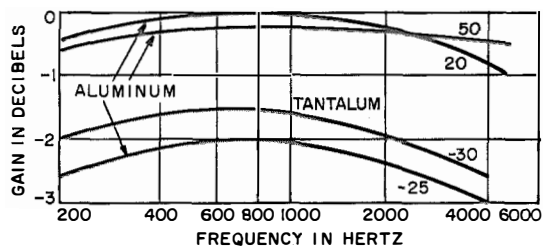

Figure 6—Audio-frequency gain variation as a function of temperature and frequency. The number on each curve is the ambient temperature in degrees centigrade. The temperature range can be extended to -30 degrees by using tantalum capacitors instead of aluminum electrolytic capacitors.

Supply voltage and temperature are the two main causes of frequency variations.

The variation of local-oscillator frequency (as applied to the first mixer) with battery voltage is shown in Figure 7. The frequency drift is of the order of 0.3×10^{-6} regulated and 2.5×10^{-6} unregulated for battery-voltage variation between 11.7 and 15.4 volts.

The problem of temperature is considerably more involved and difficult. Placing all 20 crystals in an oven was regarded as too expensive and wasteful of power. ITT Europe crystal manufacturers were therefore requested to produce crystal units showing temperature drifts as low as possible within the operating range of -25 to $+50$ degrees centigrade. To allow for the internal heat dissipation of the equipment, the limits for the crystals were set from -25 to $+60$ degrees centigrade. The frequency tolerance was specified at ± 400 hertz, or 10×10^{-6} for the 40.8-megahertz receive crystals, and ± 65 hertz, or 9×10^{-6} for the 7.25-megahertz transmit crystals.

Curve *A* in Figure 8 shows frequency variations of a typical crystal in the range from -30 to $+60$ degrees centigrade. The oscillator circuit used can partially compensate for the drift of the crystal proper. Tests on a great number of crystals have shown that the drift can be reduced within this temperature range by a factor of 2 (curve *B*). But other considerations, such as the radio-frequency level from the

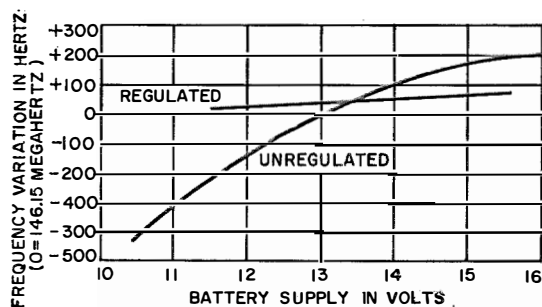

Figure 7—Variation of local-oscillator frequency applied to the ring modulator as a function of battery voltage.

oscillator, the variations of crystal drift characteristics, and the tolerance allowed in the cutting and grinding of crystals to frequency at ambient temperature, limit the compensation to a factor between 1.5 and 2 (curve *C*).

Better drift compensation can be achieved only with improved cutting accuracy and better control of other factors that influence crystal stability, such as aging.

2.3 TRANSMITTER

Transistors exist that can deliver an output power of 10 watts at 100 megahertz and it would have been possible to develop an all-transistor 80-megahertz transmitter. However, the cost of these transistors is still excessive and it will be some years before such a transmitter can compete with transmitters using vacuum tubes. Thus, despite the advantages in power consumption, heating, and power supply that result from the total use of transistors, it was decided to use tubes in the final two stages.

The economically feasible output power at 175 megahertz when using transistors is presently about 1 watt; as a matter of fact, an all-transistor portable transmitter-receiver, derived from the Trans-ITT mobile set and using most of the same circuits and subassemblies, is presently in production.

In the mobile version, it would therefore have been possible to use a transistor in the driver stage. However, it appeared to be more economical to use two tubes in the power amplifier assembly. These tubes are mounted on a chassis that forms a removable independent subunit, and heat transfer to all the transistor stages is effectively prevented. The heat is dissipated directly by the cover of the transmitter-receiver cabinet.

Another important point in the transmitter design is the compromise between modulation quality and spurious radiations. The modulation quality is better when the frequency-multiplication factor is higher, starting from the phase modulator. On the other hand, when the oscil-

lator fundamental is higher, there are fewer spurious emissions and their level is reduced more easily.

Finally, a multiplication factor of 16 or 24 was chosen, depending on the frequency band. The spurious and harmonic emissions are filtered out by 4 double-tuned circuits coupling the last 3 amplification stages at the final frequency. In addition, a harmonic filter has been inserted between the final power stage and the antenna.

Moreover, the transmitted signal has been protected against modulation and overmodulation products that might appear on adjacent channels. An instantaneous deviation limiter, described in Section 2.3.3, limits the frequency deviation to the value specified by the national administrations (± 5 kilohertz for channel spacing of 20 or 25 kilohertz, and ± 15 kilohertz for channel spacing of 50 kilohertz). In addition, converter-oscillator harmonics from the high-voltage power supply are effectively filtered to prevent sidebands that might be produced by amplitude modulation of the final stage.

2.3.1 Oscillator and Phase Modulator

The oscillator is controlled by 1 of 10 quartz crystals, selected by a switch on the front panel. It is coupled to the modulator stage by a low-impedance network, the purpose of which is to avoid any feedback from the modulator to the oscillator circuit.

The phase modulator is of the balanced type; the oscillator signal is applied to two transistors through two dephasing networks ($+90$ and -90 degrees), and the transistor bases are modulated out of phase by the low-frequency speech signals. If the modulator is properly balanced, the residual amplitude modulation is very low. The phase modulation obtained with a distortion lower than 5 percent is about ± 45 degrees ($\pm \pi/4$).

2.3.2 Frequency Multiplier

When a multiplication factor of 24 is used, the

output frequency deviation obtained for a modulation frequency of 1000 hertz is

$$24 \times \pi/4 \times 1000 = 18\,000 \text{ hertz.}$$

When using a multiplication factor of 16 (8-meter band), the frequency deviation is 12 000 hertz.

The specified harmonic distortion of less than 7 percent for a 10-kilohertz deviation is achieved with ample margin in both cases (refer to Appendix).

The phase modulator is followed by 1 frequency-tripler stage and 3 frequency-doubler stages, all using transistors and coupled by double-tuned filters to reduce spurious emissions.

2.3.3 Speech Amplifier and Frequency-Deviation Limiter

The speech amplifier has sufficiently high gain to permit the use of a dynamic microphone, which has much-better quality than a carbon microphone.

This amplifier includes both pre-emphasis and de-emphasis networks, a diode limiter, and a

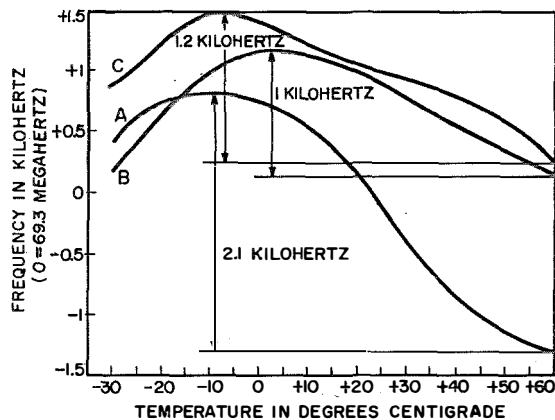

Figure 8—Frequency variation of typical crystal oscillator as a function of temperature. Curve A shows the variation of the crystal alone, curve B of the crystal-oscillator circuit with maximum compensation, and curve C of the same circuit using economically acceptable compensation.

International Mobile Radio Equipment

low-pass filter. The latter reduces harmonics produced by the limiter and thus avoids spurious emissions on adjacent channels in case of overmodulation.

The amplifier gain and the limiter threshold are adjustable.

2.3.4 10-Watt Power Amplifier

The driver tube is a low-power-consumption pentode, and the final amplifier tube is a twin tetrode with a dissipation of 12 watts. The usable output power is from 10 to 15 watts, depending on the frequency band and the maximum spacing between the highest and lowest channels to be used.

The power-amplifier tube is protected by a bias having a variable and a fixed component. The latter protects it against complete absence of drive signal, while the former provides suitable conditions for maximum power output with various levels of drive.

The over-all consumption from the battery is 12 watts with receiver on and transmitter in standby; with the transmitter operating, it is 50 watts.

2.4 POWER SUPPLY

2.4.1 Operational Requirements

The mobile set operates from the car battery, which may be either 6 or 12 volts. The positive or negative pole may be grounded without requiring modification of car wiring.

In standby, the power supply must provide 50 to 300 milliamperes at 13.5 volts despite bat-

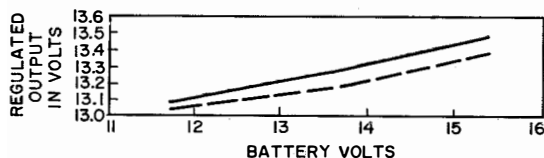

Figure 9—Characteristics of regulated converter. The solid curve is for an output of 75 milliamperes and the broken curve for an output of 300 milliamperes.

tery variations between 5.6 and 7.2 volts, and between 11.7 and 15.4 volts, which correspond to nominal battery voltages of 6.6 and 13.8, with tolerances of -15 and $+10$ percent.

For transmission, 3 additional voltages are required: 150 volts at 25 milliamperes, 300 volts at 80 to 100 milliamperes, (or 200 volts at 80 milliamperes for a transmitter with lower power), and 20 volts to bias the tubes.

The power supply must work at -25 degrees centigrade with minimum battery voltage of either 5.6 or 11.7 volts. It must operate continuously without damage at $+60$ degrees centigrade and also with maximum battery voltage of 7.2 and 15.4 volts and maximum power consumption of the transmitter-receiver.

No damage shall result if any power-supply output is short-circuited. In such case, the power supply shall stop operating or not start, even under maximum battery voltage.

2.4.2 Description and Results

The operational requirements are met by using two converters assembled in a single power-supply module. Both converters use only transistors as active elements.

One converter operates continuously as soon as power is applied to the set. It supplies the regulated voltage for either the receiver or the low-power transmitter stages. Its output is 4 to 7 watts. Regulation curves are shown in Figure 9.

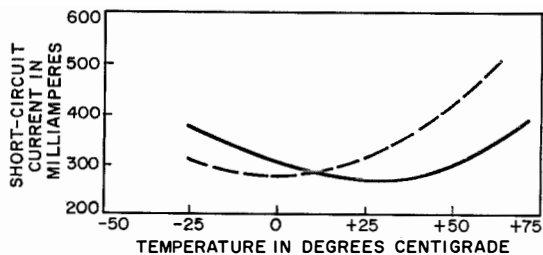

Figure 10—Short-circuit current of the high-voltage converter as a function of temperature. The solid curve is for a battery supply of 15.4 volts and the broken curve for a battery supply of 7.2 volts.

The second converter operates when the transmitter is turned on. It furnishes unregulated but well-filtered high voltage and bias to the two transmitter tubes. Starting and operating at extreme temperatures and voltages are accomplished with the help of a bias circuit using a diode, a thermistor, and an adjustable resistor. Figure 10 shows the variations with temperature of the short-circuit current from the two transistors in the high-voltage transmitter supply. This current is by no means negligible.

Very-low thermal resistance is necessary between the transistors and the aluminum-alloy case of the set to prevent thermal instability. Under continuous transmit conditions, operation is safe up to +60 degrees centigrade. Under alternate 20-percent transmit and 80-percent receive conditions, the maximum permissible ambient temperature is +70 degrees centigrade.

The equipment is operated from a battery of either 6 or 12 volts by using the appropriate strapping arrangement within the transmitter-receiver power plug. Thus the mobile sets are alike on the inside, a feature that simplifies maintenance of the many different types of installations.

3. Mechanical Design and Reliability

The mobile set is housed in a watertight aluminum die-cast case. Dividing the circuits into replaceable submodules (Figure 11) makes it easy to meet various specifications regarding frequency range, channel spacing, and calling of individual subscribers.

Most subunits are printed boards that are protected on one side by an insulating plate and on

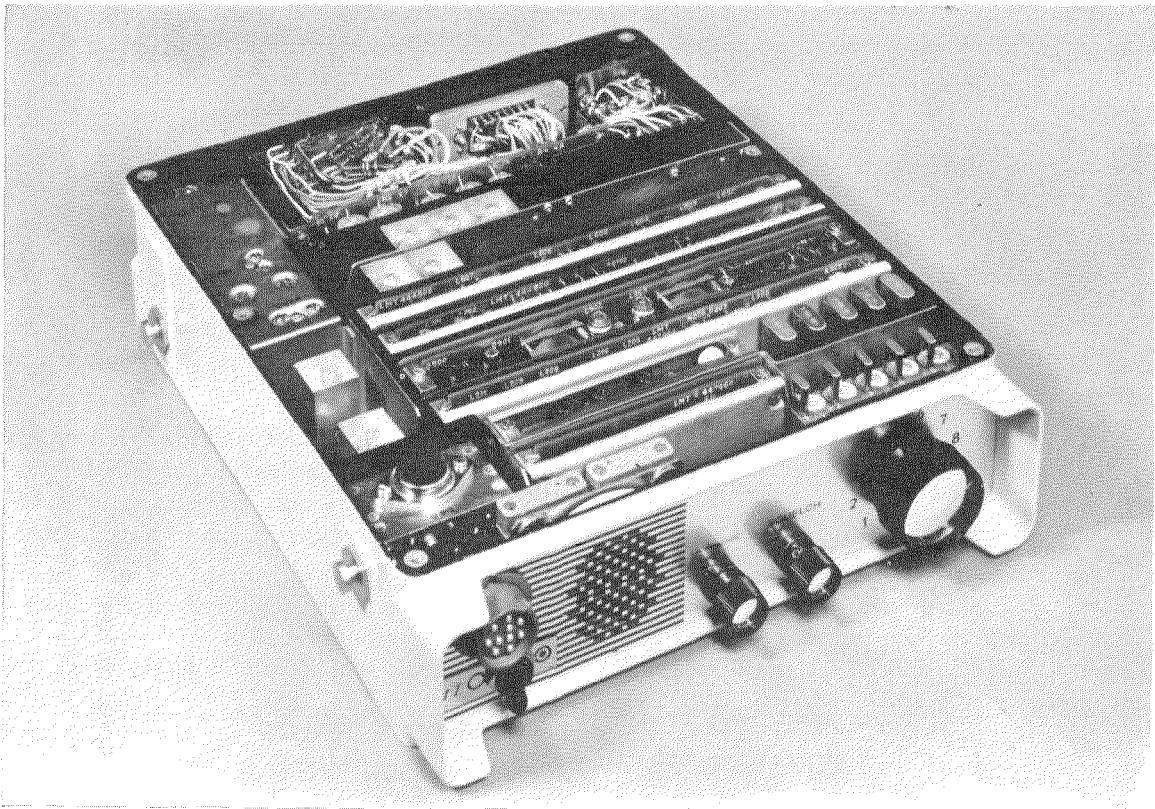

Figure 11—Interior of mobile set.

the other side by a metal shield, as shown in Figure 12. The whole assembly is very rigid.

The radio-frequency module of the receiver, the power-stage module of the transmitter, and the power supply are mounted on separate removable chassis. Connections to the modules are soldered and easily accessible on the rare occasion that a module has to be replaced. Conse-

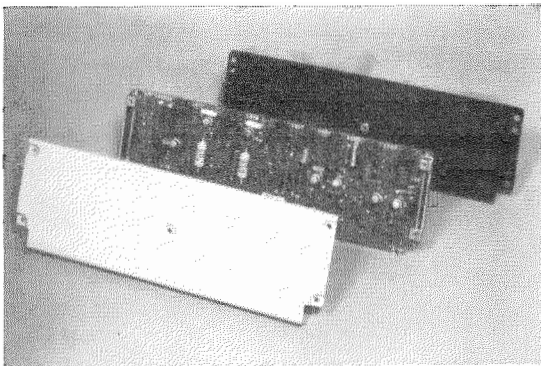

Figure 12—Printed board with insulating plate and metal shield.

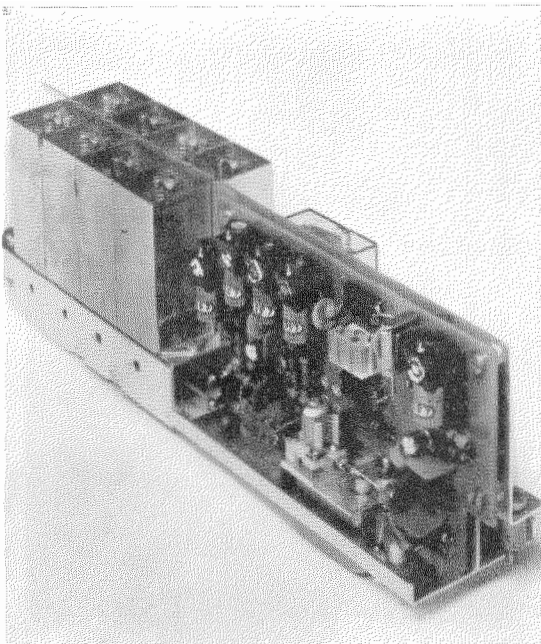

Figure 13—Radio-frequency module of the receiver for duplex and simplex operation.

quently, plugs and connectors were not used on modules and printed boards.

Reliability may be computed according to the findings of the Rome (New York) Air Development Center. The number of failures T per hour and the numbers of components in the set are

$$T = 30 \times 10^{-6} N_t + 15 \times 10^{-6} N_r + 2 \times 10^{-6} N_s + 0.5 \times 10^{-6} N_c$$

where N_t = number of tubes = 2

N_r = number of relays = 2

N_s = number of semiconductors = 73
(35 transistors and 38 diodes)

N_c = number of other components = 542.

The resulting $T = 507 \times 10^{-6}$ corresponds to a mean-time-to-failure of about 2000 hours, or 200 to 250 days for normal operating conditions. This figure is pessimistic, as the components used are of the commercial type and are conservatively derated, particularly transistors. Hence they cost more, but this increase is outweighed by the reduction in maintenance cost.

Furthermore, the equipment will usually operate far from extreme specified conditions. A typical network of 100 mobile sets of an earlier design has shown a mean-time-to-failure of 4000 hours, whereas calculations by the above method gave an expectation of 1600 hours.

All controls as well as the microphone plug are on the front panel. The antenna and battery plugs are at the rear.

Dimensions of 255 × 80 × 310 millimeters (10 × 3 × 12 inches) and weight of 6.4 kilograms (14.1 pounds) are sufficiently small to permit direct and easy installation below the dashboard of any type of car.

4. Ancillary and Optional Features

4.1 DUPLEX OPERATION

An outside filter has been designed to permit simultaneous operation of the transmitter and receiver on a single car antenna. The filter is

inserted between the antenna coaxial transmission line and the transmitter-receiver.

A receiver radio-frequency module permitting simplex and duplex operation with the same set has been developed. See Figure 13.

4.2 CALL RECEIVERS

It is not always possible for the mobile operator to remain in the vicinity of his receiver. Therefore a simple calling device has been designed.

The base station modulates its carrier with a characteristic audio-frequency tone. The mobile receiver, on standby with its squelch operated, receives this tone and actuates an acoustic alarm. The tone filter, detector, and relay are mounted inside the case.

4.3 SELECTIVE CALLING

It may be desirable to call one mobile subscriber without disrupting service to the others. For

this purpose, the base station sends 2-out-of-10 simultaneous tones, which operate the alarm system at the desired receiver. Up to 45 combinations of double tones are thus available for calling individual subscribers.

4.4 25-WATT TRANSMITTER

A version of the mobile set with higher output power has been developed for certain countries where communication over greater distances is desirable. The receiver and transmitter driver are the same. The power amplifier, shown in Figure 14, uses a double tetrode with a total plate dissipation of 20 watts. The output power is 25 to 30 watts. The high-voltage converter has the same dimensions but uses larger transistors.

5. Test Results

The full test results are given in the Appendix.

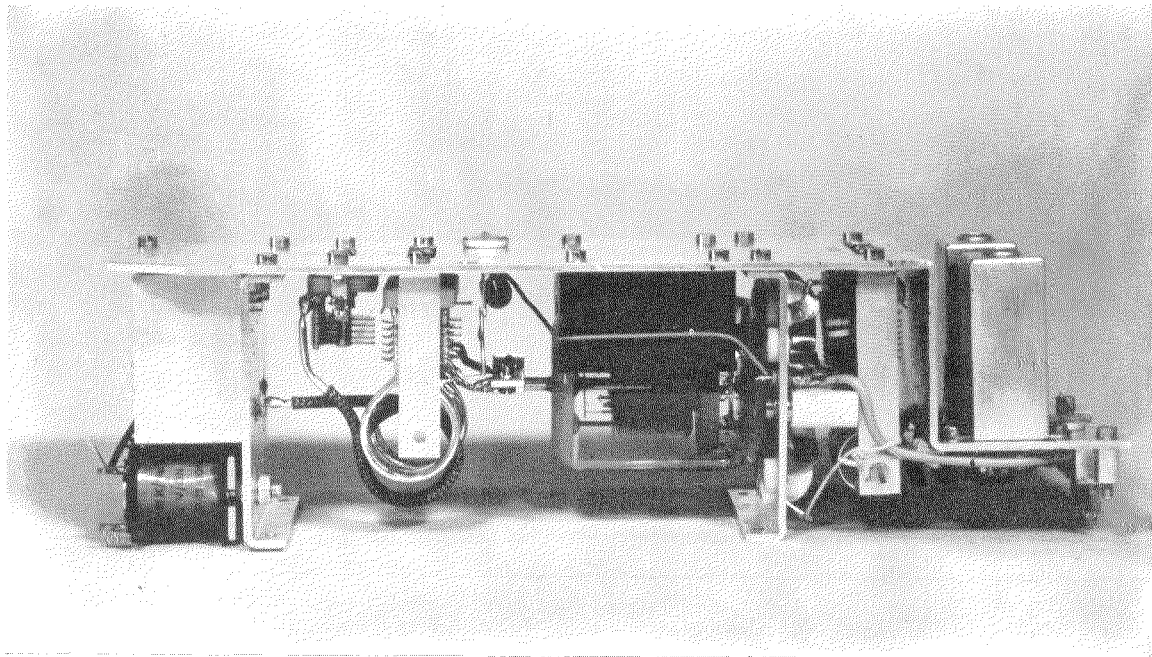

Figure 14—The output of this power amplifier is 25 to 30 watts.

5.1 RECEIVER

The attenuation of image frequencies and undesired signals was specified to be higher than 70 decibels, and a value of 85 decibels was desirable to meet the requirements of certain countries. The value actually obtained is higher than 95 decibels in the temperature range from -25 to +50 degrees centigrade.

The 2-signal selectivity (with the interfering signal on the adjacent channel) was similarly specified to be higher than 70 decibels and, if possible, higher than 80 decibels. The latter figure is obtained throughout the temperature range.

Protection against intermodulation produced by adjacent channels was specified to be higher than 60 decibels. A 70-decibel figure has been obtained by taking special care to fulfill the requirements of certain administrations. It is difficult to reach this level when using transistors in the input stage of the receiver. The result depends mainly on the amplitude of the interfering signal at the input-transistor collector.¹

¹ J. Reynolds, "Intermodulation in Transistors," *IEEE Transactions on Vehicular Communications*, volume VC-12, number 1, pages 88-92; September 1963.

TABLE 2
RECEIVER SPECIFICATIONS AND MEASURED VALUES FOR 50-KILOHERTZ CHANNEL SPACING

Characteristic	Unit of Measurement	At Room Temperature		At Extreme Temperatures		
		Original Specifications	Measured Values	Original Specifications	Measured Values at -25 Degrees Centigrade	Measured Values at +50 Degrees Centigrade
Sensitivity* for 12 decibels of $(S+D+N)/(D+N)$:						
2-meter band	microvolts	0.7	0.55	1.4	0.5	0.6
4-meter band	microvolts	0.5	0.45	1	0.4	0.55
Squelch threshold	microvolts	not specified	0.35	not specified	0.3	0.4
Residual noise:						
Unsquelled	decibels	40	>50	30	55	60
Squelled	decibels	50†	>55	—	—	—
Image rejection	decibels	70-85	>95	73†	>95	>95
Spurious-response attenuation	decibels	70-85	≥85	73†	90	90
2-signal selectivity	decibels	70-80	≥80	68†	75	80
Adjacent-channel intermodulation	decibels	60-70	64	—	—	—
Blocking‡	decibels	≤3	1	—	—	—
Undesired radiated power	watts	2×10^{-9}	$<1 \times 10^{-9}$	—	—	—
Audio-frequency distortion (10-kilohertz deviation)	percent	7	4	7	5	4
Audio-frequency output power	watts	1	1	—	—	—
Audio-frequency output attenuation	decibels	—	—	2	2	0.5
Audio-frequency response:						
300 hertz	decibels	+1	0	—	—	—
3000 hertz	decibels	-3	-2	—	—	—
Modulation acceptance bandwidth	kilohertz	—	—	≥12†	18	20
Power consumption (standby)	watts	≈10	12	—	—	—

* $(S + D + N)/(D + N)$ = (signal + distortion + noise)/(distortion + noise).
 † Specification of the Electronics Industries Association (United States of America).
 ‡ Attenuation of audio-frequency output of a desired 1-microvolt signal caused by a 33-millivolt spurious signal 150 kilohertz away from it.

To maintain the desired protection of 70 decibels, this voltage cannot be decreased without decreasing the minimum usable signal level. Therefore, any improvement in receiver sensitivity improves this protection against intermodulation; improvement can be achieved by an input transistor with higher gain and better noise figure, by higher efficiency and better symmetry of the ring modulator, by better selectivity and match of the quartz filter, et cetera.

5.1.1 Muting Device (Squelch)

The squelch level is easily adjustable and remains stable throughout the temperature range. The radio-frequency signal level needed to actuate the receiver audio output is between 0.25 and 0.4 microvolt.

5.2 TRANSMITTER

Two notable results given in the Appendix are the low modulation distortion of the transmitter (3 percent against 7 percent in the original specification) and the very-low level of harmonic and spurious transmitted signals.

TABLE 3
TRANSMITTER SPECIFICATIONS AND MEASURED VALUES FOR 50-KILOHERTZ CHANNEL SPACING

Characteristic	Unit of Measurement	At Room Temperature		At Extreme Temperatures		
		Original Specification	Measured Values	Original Specification	Measured Values at -25 Degrees Centigrade	Measured Values at +50 Degrees Centigrade
Output power for nominal battery voltage (6.6 or 13.8 volts):						
2-meter band	watts	10 to 15	12	10 to 15	11	11.2
4-meter band	watts	10 to 15	14	10 to 15	14	14
Output power for nominal battery voltage -15 percent (5.6 or 11.7 volts):						
2-meter band	decibels (watts)	-3*	-1.8 (8)	-3*	-2 (7)	-1.4 (8.2)
4-meter band	decibels (watts)	-3*	-1.5 (10)	-3*	-3 (7)	-1.5 (10)
Nominal deviation (A) for microphone input	(A) kilohertz	10.5	10.5	—	7	10
(B) at 1000 hertz	(B) millivolts	1.5 to 4	2	—	4	4
Audio-frequency distortion at nominal deviation	percent	7	3	—	—	—
Maximum deviation (A) for microphone input (B) at 1000 hertz	(A) kilohertz	15	14.5	15	15.5	13.5
	(B) millivolts	20	20	20	20	20
Residual noise	decibels	40	45	—	—	—
Spurious emissions	watts	2×10^{-7}	0.5×10^{-7}	—	—	—
Harmonics	watts	2×10^{-6}	1×10^{-6}	—	—	—
Harmonics in television bands	watts	2×10^{-7}	1.5×10^{-7}	—	—	—
Audio-frequency response:						
300 hertz	decibels	+1	-1	+1	+0.7	+0.5
3000 hertz	decibels	-3	-2.5	-3	-1.5	-2
Adjacent-channel radiated power	watts	10×10^{-6}	7×10^{-6}	—	—	—

* Specification of the Electronics Industries Association (United States of America).

TABLE 4
MEASURED VALUES FOR 2-METER TRANSMITTER-RECEIVER FOR 25-KILOHERTZ CHANNEL SPACING

Characteristic	Unit of Measurement	Temperature in Degrees Centigrade		
		+20	-25	+50
RECEIVER				
Sensitivity for 12 decibels of $(S + D + N)/(D + N)$	microvolts	0.45	0.35	0.45
Squelch threshold	microvolts	0.3	0.2	0.35
Image rejection	decibels	>90	>90	>90
Spurious-response attenuation	decibels	>90	>90	>90
2-signal selectivity	decibels	79	75	79
Adjacent-channel intermodulation	decibels	65	—	—
Blocking*	decibels	0	—	—
Audio-frequency output power	watts	1	0.7	1
Modulation acceptance bandwidth	kilohertz	9.5	9.8	10.5
TRANSMITTER				
Output power:				
Nominal battery voltage (6.6 or 13.8 volts)	watts	12	10	12.2
Nominal battery voltage -15 percent (5.6 or 11.7 volts)	watts	9.5	7.6	9.6
Nominal deviation (A) for microphone input (B) at 1000 hertz	(A) kilohertz	3.3	3	3.2
	(B) millivolts	4	4	4
Maximum deviation	kilohertz	4.6	5	3.2
Residual noise	decibels	42	42	41
Audio-frequency distortion at nominal deviation	percent	2.7	3	2.6
* Attenuation of audio-frequency output of a desired 1-microvolt signal caused by a 33-millivolt spurious signal 150 kilohertz away from it.				

6. Appendix

Tables 2 and 3 list important requirements of the original specification, plus the average re-

sults recorded from 50 equipments. Table 4 gives results measured from 1 particular set.

Gerhard Sidow was born in Berlin, Germany, on 4 April 1918. He studied precision mechanics and radio engineering at the Höhere Technische Lehranstalt in Berlin.

In 1937, he joined Standard Elektrik Lorenz as a laboratory engineer. He is now a department head, working on the development of transmitters and receivers for portable, mobile, and airborne equipment.

Gorm Niros was born in Lyngby (near Copenhagen), Denmark, in 1921. He graduated from the Royal Technical College in 1946.

He was employed by the Danish Air Force in 1946 and was sent to England to study radar.

In 1947, he joined the Scandinavian Airlines System. Two years later, he went to work for a Danish firm manufacturing mobile radio equipment.

International Mobile Radio Equipment

Mr. Niros joined Standard Electric Aktieselskab in 1951, where he is engaged in the development of mobile radio systems.

Maurice Bruley was born in Monts, France, in 1918. In 1942, he received the degree of engineer from the École Polytechnique and in 1943 the diploma of electrical engineering from the École Supérieure d'Électricité.

After 18 months in the electric power industry, he served in the French Signal Corps.

In 1945, he joined Le Matériel Téléphonique as a development engineer in the mobile frequency-modulation transmitter-receiver department.

Mr. Bruley is now in charge of the studies covering those equipments.

Digitrac for Handling Radar Data

S. M. ERIKSSON

Standard Radio & Telefon AB; Bromma, Sweden

1. Digital and Analog Techniques

Missiles and jet aircraft require surveillance over great areas for safe and economical traffic control. This calls for interconnection of many radar installations with coordinated display. Digitrac converts the usual analog outputs from radars into digital form that permits transmission over telephone lines. The broad outlines of Digitrac are given in this paper and detailed descriptions of many of the component equipments will be given in a following issue.

Techniques for radar data handling and presentation have long been dominated by analog equipments using vacuum tubes. Digital techniques have flowered since the use of semiconductors became practicable. Digital circuits require large numbers of active elements, for which semiconductors are particularly well suited in contrast to vacuum tubes.

The digital computer has many advantages over the equivalent analog computer, namely:

- (A) Large memory capacity
- (B) Variety of operations
- (C) Flexibility for programing
- (D) Superior long-term stability.

The latter is most important. In a digital system, target data such as identity and height are easily and permanently stored in ferrite core memories.

2. Radar Data System

The purpose of a radar data center is to gather target information from auxiliary sources, present it, evaluate it, and use it to assist operators, pilots, and others.

The radar function is to survey the entire air situation as the basis for control. The data system must present complementary data in the radar pictures to different operators for retrieval of target information (position, speed, height, course, identity, et cetera). The data system must help the operators to make the proper decisions, must provide communication

between operators, and must be able to deliver information to the weapon and/or flight-plan data system.

The main information sources are the surveillance radar stations, which may be primary as well as secondary types, and the height-finding radar stations. Special types of surveillance radar stations give more-detailed information, for example elevation angle to the target, from which height can be computed. These data as well as the target-reply message from the secondary radar are extracted and decoded by means of video correlators (one for each video channel), from which unambiguous messages are delivered to the computer.

The track data from the radar is displayed for the operators, who may then forward it to the data system. However, operator accuracy, speed, and capacity are limited, and automatic decisions are needed in congested areas or critical situations. Therefore the tracking and assessment systems have means to extract target information directly from the radar and to use it for computations. However, the automatic performance of the system must be operator controlled in most cases. Otherwise the system may make wrong decisions in ambiguous situations and also waste capacity on information that is not significant for solving the immediate problem.

2.1 SYSTEM CONCEPT

The Digitrac system is based on the use of building blocks. The most important of these are the computer, display, azimuth sweep unit, symbol generator, and links to other data centers.

The computer performs the operations necessary for tracking, control of the application of symbols, and intercept and/or flight-plan computations.

One computer can carry out all these functions for a small system. If a moderately larger tracking capacity is needed, the intercept or flight-plan computations will be performed in a sep-

arate computer. For a much-larger system, capable of tracking about 200 radar targets as well as processing information on a still-higher number of tracks and flight plans, a separate computer is used for each of the main functions.

It is clear from the above that a very-flexible computer must be used for greatest economy. The "Sensor" computer meets this requirement. A typical computing capability for a 200-track system would be: tracking computer with a memory of 8192 words, symbol computer of 4096 words, and a flight-plan or intercept computer of 8192 words.

To reduce the complexity and the workload of the computers, they are usually assisted by auxiliary units having fixed programs for performing repeated routine operations. Some of these auxiliary units are of a digital differential nature, such as the azimuth sweep units and the function generator, while others are autonomous. This paper will be written as if a separate computer is available for each operation.

To permit full integration, a display unit has been developed that operates from a digital sweep waveform. Radar information and computed tracks may be displayed simultaneously. To permit the presentation of symbols during interscan, the deflection circuit has a short recovery time, of the order of 60 microseconds for a 16-inch (41-centimeter) diameter tube. It is possible to control from the computer the start of each sweep on the display. Thus each picture may consist of processed video signals from several asynchronous radars; no information will be lost and the symbols will be presented as interscan information.

2.2 SWEEP SYSTEM

The display system must obtain sweep or X and Y coordinates in synchronism with the antenna rotation. A widely used analog method employs a servo-driven resolver, the output of which, by means of phase detectors, gives azimuth information as voltages corresponding to sine and cosine of the antenna azimuth. These

two voltages proceed to gated integrating amplifiers where they become sawtooth waveforms that produce the X and Y sweep voltages. The problems have always been to stabilize these integrating amplifiers against temperature variations and to superpose track and symbol information from the computer on the waveform.

Digitrac has bypassed analog sweep systems for a digital one that uses all transistors. This digital system (Figure 1) starts at the antenna with a digital encoder giving a train of pulses that are very-closely spaced. In addition, there is a north pulse from the antenna for synchronization.

The pulses are integrated at the data center, giving the azimuth angle in digital form. Further operation on the pulses results in both sine and cosine information, each in digital form and extremely accurate. The digital sweep generation system uses a high-stability crystal-controlled sweep oscillator, the frequency of which is determined by the required radial resolution. The oscillator pulses are integrated (or counted) in a binary counter, the output of which corresponds to the normal analog radial sweep waveform. This digital "waveform" is used not for presentation but in the tracking computer.

The presentation system must generate an X and Y sweep in digital form. Two digital multipliers are used for this purpose, both being supplied from the sweep oscillator. These two multipliers are controlled by the sine and cosine outputs from the azimuth system, producing two pulse frequencies that give the sweep waveforms for X and Y in parallel digital form when integrated in two counters in a display.

The digital sweep is converted to analog form in a high-speed digital-to-analog converter, which is essentially a high-gain amplifier receiving currents from a number of weighted resistors, each controlled by a transistor switch. The number of resistors corresponds to the number of digits employed for the sweep range. Finally, the voltage thus obtained is supplied to a high-power sweep amplifier. The use of

transistors in this amplifier permits employment of low-impedance deflection coils and gives considerably shorter sweep decay time than vacuum tubes give. The short decay time (about 60 microseconds) makes it possible to present much synthetic information as interscan signals, using the same amplifier and deflection coils for the radar sweep waveform as for the symbol waveform.

2.3 AUTOMATIC ECHO DETECTION

A video radar signal holds not only useful target information but also noise and false echoes. If such unwanted signals are not disregarded, they will occupy a considerable part of the computer capacity with the risk of overloading it. The video signals received in a pulse radar from a reflecting object have certain characteristics that distinguish them from noise and clutter. One such parameter is the pulse length, which within certain limits conforms to the transmitted pulse length. A second parameter is the characteristic number of successive hits

obtained when the antenna beam sweeps across the target. These hits are correlated whereas noise peaks are uncorrelated. A digital echo detector called a video correlator makes use of this distinction in its operation.

The video correlator divides the sweep into a number of quanta, the size of which gives the radial resolution. Each quantum normally corresponds roughly to the radar pulse length. The correlator has a bearing resolution of 500 meters (1640 feet) at maximum range, which is a convenient value for measuring position. As shown in Figure 2, the received video signals are compared as a function of range from sweep to sweep as the antenna rotates. The comparison logic uses certain correlation criteria to determine if the hit pattern of successive video signals originates from a target at a constant range or if they are to be considered as noise. The criteria are based on the previously mentioned characteristic number of hits per target for the radar.

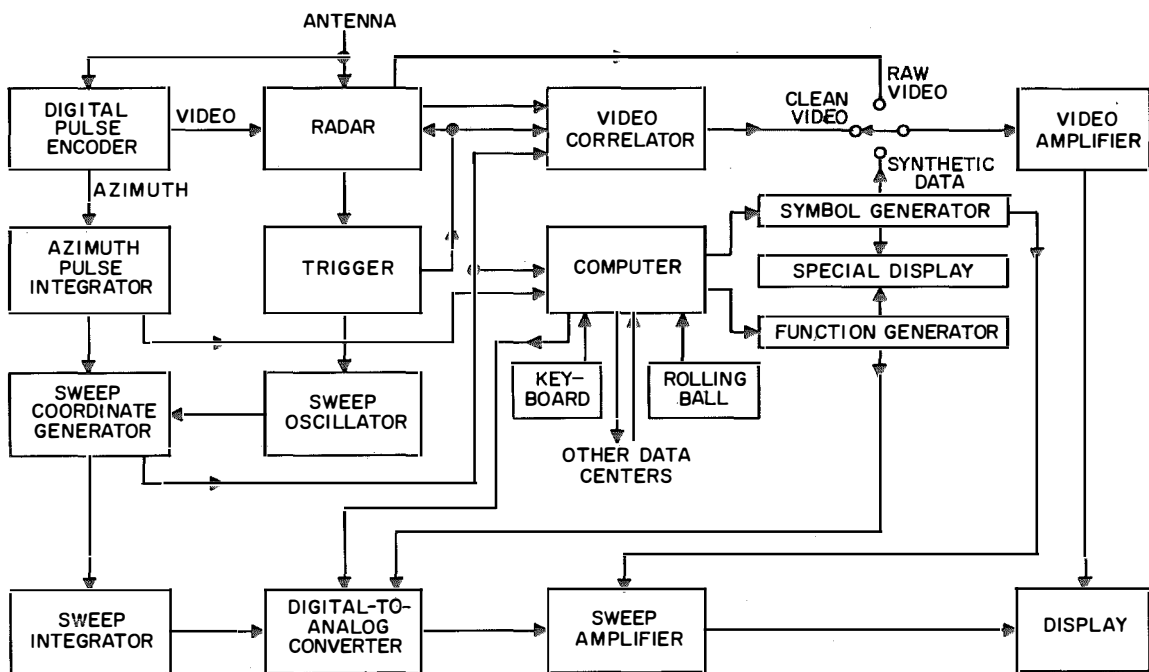

Figure 1—Diagram of Digitrac system.

However, this number may be influenced by noise and irregularities in the antenna pattern, affecting the grouping of echoes inside the hit pattern so that some disappear and some false ones appear. Changes in the hit pattern are generally small enough so that the target information can still be derived. In heavily jammed environments, however, the change in the hit pattern may be such that a target picture is unrecognizable, while at the same time noise signals can group themselves into a pattern fulfilling the criteria for a target. In the first case a target is lost and in the latter a false target indication is obtained. Therefore the criteria must be so chosen to permit the highest probability of target detection and the lowest probability of false alarms.

To limit the azimuth region inside which the video is inspected, the correlator forms its own inspection "window" that rotates with the antenna. The received video signals within this window are stored separately for each quantum and are compared with the correlation criteria by a special logic. Thus each quantum requires a memory for the signals within the window. The video signals are in digital form, and a ferrite core memory provides a cell for each quantum. When a radar pulse is received, a sequential search of the memory cells is started. The cell corresponding to one quantum is always interrogated exactly when the radar pulse travels through that quantum. During the search of each cell, stored video information is read out and added to new information from the corresponding quantum. Thereafter the complete signal pattern is inspected by the correlation logic before being written back into the memory.

The extension of the window in azimuth is mainly determined by the type of output desired from the correlator. Since the correlator is used for presentation as well as for echo detection outputs to the tracking computer, every target gives only one signal, preferably for the center of the hit pattern. Extensive echoes (for example ground echoes) that do not show target characteristics are thereby eliminated. For this

reason it is clearly necessary to measure the azimuth extension of the hit pattern. The window must be large enough in azimuth to cover a target of maximum extension plus a certain margin for the detection of target ends.

The memory word length consists of one part that is proportional to a fraction of the window width and another part only logarithmically proportional to the complete window azimuth extension. As only one pulse is delivered for each target in this system (although several might be sent and received by the radar), it is evident that the information from a number of radar stations can be presented simultaneously on one display without loss of information or accuracy.

2.4 COMPUTER

The Censor computer is designed for parallel operation with one or more other Censor computers having memory sizes ranging from 2048 words up to 32 768 words of 40 bits each. The parallel operation of the computers is made possible by an interconnecting computer transmission system, which has a transfer capacity of 166 000 words of 40 bits each per second. To make the computer operate in real time, a high-speed arithmetic unit provides addition

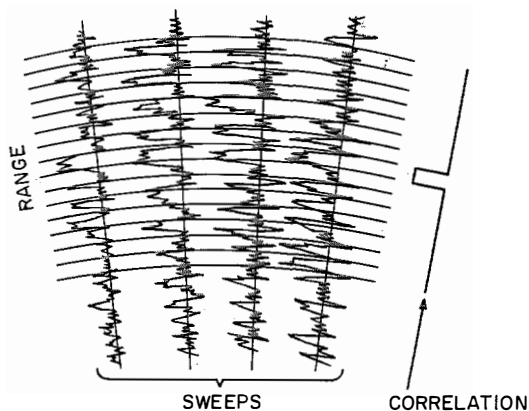

Figure 2—Signal correlation. The signal level in each range quantum is integrated and stored with preceding corresponding levels in a memory to produce a correlated output at the maximum level.

Digitrac for Handling Radar Data

time for the parallel adder as short as 0.75 microsecond for a 20-bit word. A semipermanent memory having 512 or 1024 words of 20 bits controls many frequently used subprogram operations.

Tables 1 and 2 list the main characteristics of the computer.

2.5 TRACKING PROCESS

The basic principle of the tracking process is to extract the coordinates of a target every time its echo is received by the radar. This operation could be done by the computer, but in the

Characteristic	Rating
Maximum instruction word length in bits (1 address)	36
Maximum address word length in bits	20
Arithmetic word length in bits (parallel)	20
Computer transmission-system word length in bits (parallel)	40
Computer transmission-system transfer capacity in 40-bit words per second	166 000
Number of external units* that can be connected	>200

* External units can have direct access to the memory according to preset priority.

Digitrac system it is carried out by the video correlator and azimuth sweep unit.

The coordinate information is delivered in real time to the computer, which then computes the speed and course, and predicts future positions. This is done according to

$$X' = X_0 + k_1 \frac{\Delta X}{\Delta t} t$$

where X_0 is the first noted position, which can be introduced manually by the rolling ball (Figure 1). Alternatively X_0 can be extracted automatically from a selected area of the radar coverage if noise and jamming conditions permit. ΔX and Δt are increments of position and time between two successive echoes from the same target. k_1 is a smoothing constant, which is selected automatically by the computer depending on either the signal quality, obtained from the video correlator, or on the prediction accuracy δX . The speed $v_{X'} = (\Delta X / \Delta t)$ is corrected on each new coordinate reading.

$$v_{X''} = v_{X'} + k_2 \frac{\delta X}{\Delta t}$$

where δX is the difference between the predicted position and the actually noted position. For good signal quality and $\delta X = 0$, k_1 and k_2 may be unity.

Operation	Speed in Microseconds		
	Semipermanent Program	Stored Program*	
		Non-Address Instruction	Complete Instruction
Addition	0.75	6	12
Multiplication	15.75	23.25	30
Division	16.5	24	30.75
Binary-to-decimal	16.5	24	—
Root extraction	31.5	39	—
$(x^2 + y^2)^{1/2}$ †	68.25	75.75	82.50

* Includes time for the memory logic to determine whether the arithmetic unit or external units have demanded access.
 † Instructions for macro problems of the type shown are stored in the semipermanent instruction memory and can be ordered from the working memory.

To reduce the load on the computer, a video window is placed around the predicted position of a target. The window information is delivered by the computer to the coordinate-reading circuits just before the antenna paints this position. At the start of the tracking process or when a target is lost, the window is made rather large to allow a wider search. Once automatic tracking is established, the window size is reduced to prevent disturbance by other tracks or noise. It may, of course, be increased to accommodate additional tracks or reduced further to exclude unwanted tracks, noise, or jamming.

2.6 SYMBOLS

For effective operation within and between radar centers, it is necessary to mark all significant targets for identification. This is done by attaching a symbol to each target being handled. The symbol usually consists of a group of letters, numbers, and a geometric figure. The symbol number can be generated locally in the data center and then assigned to the memory cell number holding information about the target. A symbol number can also originate outside the center (for example in an adjacent center) or may be permanently related to the call number for an aircraft. In commercial use, the symbol number may correspond to the flight number and accompany the aircraft as it passes from one center to another. Each operator in a center should also have available his own unique symbol for marking and reporting to other operators within a center or via data links to an adjacent center.

The operator can obtain a symbol number for an unidentified target by interrogating the administration computer, which places the symbol on the display.

The use of symbols for marking and reporting requires electronic switching that is performed by the Censor computer, which operates with the tracking and symbol units via the computer transmission system. Communication with other operators is accomplished from the keyboards

via a relay unit. The relay unit is operated directly by switches in the keys, translates each key pulse to a code number, and delivers it to the computer. The relay circuits also pass reply data to the originators, which reduces the load on the computer and simplifies programing.

The rolling ball is used to position symbols on the display. It produces a series of pulses for X and Y that are integrated to provide position coordinates to the administration computer. From there the information is delivered to the tracking computer, which returns target speed and course. The administration computer uses this information to compute successive positions of the target and delivers this information to the display system at a rate much higher than normal. The reason for this is the requirement to present the symbols as interscan information on displays supplied from any one of several asynchronous radar stations and obtain a smooth movement of the symbols. The positions are transmitted to the displays as binary numbers. However, the sweep has priority over the symbols, which only appear between sweeps. The original symbol presentation rate is so chosen that the effective presentation frequency is about 14 per second. If the symbol is used for presentation on a display without radar information, this is marked in the memory cell for that symbol. The same memory also stores information telling which display the symbol shall be presented on and which repetition rate shall be obtained. The latter information is necessary because it must be possible to show symbols at a low repetition rate to attract attention, as in reporting to other operators.

Besides the position coordinates, a waveform must also be generated for the X and Y deflections that produce a symbol. The symbol generator performs this function.

Every symbol character consists of 16 dots placed anywhere in a network of 32 by 32 dots by a special program stored in the administration computer. The administration computer provides digital instructions to the symbol generator for the symbol to identify the particular

track. A diode matrix within the symbol generator converts the digital codes to analog X and Y voltages, which are mixed with the other deflection voltages in the sweep amplifier.

2.7 COMMUNICATION WITH REMOTE TERMINALS

Communication with fixed or mobile remote radar data-processing equipment is via radio and telephone lines. The messages to be transmitted are stored in the computers. Transmitting and receiving terminal units having permanent or semipermanent programs provide suitable format and address to lessen the load on the computer. The transmitting and receiving units are largely identical. The transformation

between parallel and serial form is carried out in the transmitting unit, which also provides starting code, address, and redundancies. The clock signal is delivered from the modem equipment. The technical specification for the terminal equipments conforms with recommendations of the Comité Consultatif International Télégraphique et Téléphonique.

3. Organization and Operation

The use of the Digitrac equipment assumes the coordination of a number of operators. The man/machine interface is located at operating desks assembled in an operating center. The main unit on each operating desk is the radar display, around which are grouped other essential display units and telecommunication equipment.

The main operator input sources are the rolling-ball and the keyboard units. In addition, there are numerous push buttons that select radar inputs such as linear or logarithmic intermediate frequency, instantaneous automatic gain control, fast time constant, raw video, and processed video, from any one of the connected radar stations. Other forms of presentation may also be selected, such as a multiradar composite picture or a synthetic picture (symbols only). The organization of an air defense center can have many forms so long as it meets the operational requirements. Figure 3 shows a suggested organization for an air defense center.

An executive officer heads and is responsible for the entire air defense center. He is assisted by two groups of operators. The first group, headed by a display controller, identifies and tracks all observed or reported targets.

The second group, under a master weapon controller, is responsible for the assessment of weapons and the control of intercept operations by fighters or guided missiles. These operations are supported or wholly controlled by a Censor computer, which can hold several independent programs simultaneously and can be programed rapidly from tape units.

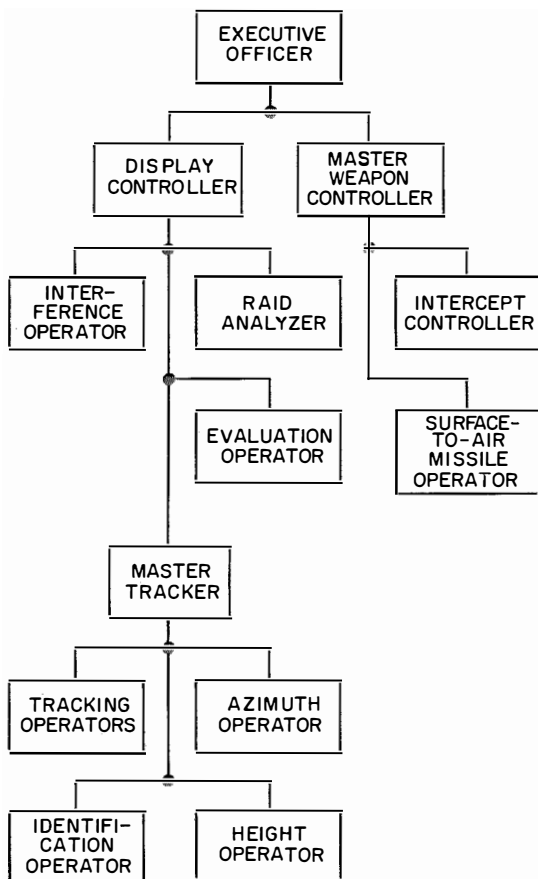

Figure 3—Chart of typical Digitrac organization for an air defense center.

The interference operator performs the electronic countercountermeasures for the entire center.

The raid analyzer collects information on all observed targets. An indicator at his disposal can magnify a small area of the main display for close study. To facilitate this, the indicator operates in 3 dimensions: target amplitude, range, and azimuth.

The master tracker is responsible for target tracking, including identification and height measurements. He supervises the tracking operators, who initiate and control the automatic tracking performed by the computer. The number of tracking operators depends on the total target capacity of the center.

One or more identification operators are used. They operate with identification friend or foe/selective identification feature (IFF/SIF) and surface search radar, information from which can be processed either manually or automatically using a correlator and decoder. Thus the tracking may be performed using data received from these special facilities and from normal radar.

Height data are very important to the intercept operation and therefore the equipment is designed to be compatible with 3-dimensional radar, if available. The height measurements are obtained by local and remote vertical-scan height finders, which can also be used to provide additional information for raid-analyzing purposes.

All height-measuring sources should be coordinated to make the system more effective. A request for height from any operator or from the weapon computer will be sent to one of the height-finding radars by a routine, the program for which is stored in the memory of the tracking or administration computer. This routine can be controlled and if necessary overridden by an azimuth operator. When remote height finders are used, the azimuth computation is performed at the center. Local height-finding radar stations are controlled by one or more

height operators depending on the extent of required automatic operation.

Most of the center's operations are based on information supplied directly by the radar stations. To support this information, especially under interfering conditions, the center can use target and related information received as data messages over narrow-band lines. All such information is handled by an evaluation operator. He is assisted by a synthetic display and can correlate received information with information derived within his center. This correlation is performed automatically in the computer and is studied by the evaluation operator before being distributed for operational use. The evaluation operator is also responsible for target information delivered to other centers.

In the second group there can be one or more intercept controllers, who provide the weapon computer with data essential for an intercept or a recovery operation. The intercept controllers use two special displays in addition to the main indicator. One display consists of a small rectangular tube, on which all available target information is presented in tabular form with alphanumeric text. Using the rolling ball and a symbol, which the operator puts in the target area on his main display, he can enlarge and present this area on the special display. On the other display, which also has a small rectangular screen, the results of the intercept computations appear as interscan information in the form of the predicted flight paths using the same scale as the radar picture. The operator can then evaluate the computed results easily and watch how his fighter plane complies with orders.

These flight path patterns are generated in a separate function generator (Figure 1), which operates on a digital principle. The function generator is actuated when it receives from the computer transmission system the same flight path parameters that are also delivered to the other data centers.

The surface-to-air missile operator may also be in the center. He is in charge of coordinating

missile batteries onto allocated targets. He can also handle and distribute information received from target illuminating radars at the missile batteries.

4. Maintenance

The digital technique, which is used consistently in Digitrac, is based on the use of a limited variety of standard circuits with the components assembled on printed cards. These cards are the bricks of which the building blocks are made. They can be given very-moderate operating requirements and make it possible to load all components conservatively. All this contributes to a long operating time before failure.

For simple maintenance, the cards are assembled in subunits that can be swung out from racks for inspection while operating. A faulty subunit can easily be removed. Furthermore, each card is provided with easily accessible test points.

Fault location is facilitated by fault indicating lamps, a continuous test program, and diagnostic programs on tape that are used exclusively for fault location.

Many standard power supplies, distributed among the equipment racks, are used instead of few central power supplies. Even the display units have self-contained power supplies.

Marginal tests may be conducted daily by changing the voltage outputs from one or more power units according to a predetermined schedule and by changing clock frequencies. Should any unit drift to the edge of its operating tolerance, the marginal tests will indicate this. Repairs can thus be made at a convenient time, for example when an interruption of operation can be tolerated, or when an adjacent center can take over.

5. Acknowledgments

The Digitrac system could not have been successfully developed without the inspiring teamwork of many engineers at Standard Radio & Telefon, too many to list by name here. The author particularly wishes to thank Messrs. K. Mellberg and S. Skåraeus for fruitful discussions during the preparation of this paper.

Stig M. Eriksson was born in Gamleby, Sweden, in 1917. In 1943, he received the degree of Master of Science in electrical engineering from the Royal Institute of Technology in Stockholm.

He worked for the Swedish Navy before joining Standard Radio & Telefon in 1944. He has been engaged in development of equipment for communication, servo systems, and radar data handling.

Since 1960, he has been chief engineer and head of research and development activities at the Electronic Systems Division.

Mr. Eriksson is a member of the Swedish Association of Engineers and Architects.

Analysis of Diode Modulators Having Frequency-Selective Terminations Using Computers

CARL KURTH

Standard Elektrik Lorenz; Stuttgart, Germany

The translation of frequency bands by means of passive modulators meets with some difficulties inasmuch as a wide spectrum of frequency bands is obtained while only one of them is in the required position. The unwanted frequency bands contain a portion of the signal energy to be translated. This energy is either lost in the unwanted frequency positions or remodulated, through reflections, into the useful band position. In the latter case it becomes—with uncontrolled amplitude and phase—part of the output signal. In conventionally dimensioned selective frequency translators this leads to unpredictable frequency responses, which are often difficult to hold within the required limits.

In single-sideband transmission, the ring-type modulator has been used advantageously for decades with most types of frequency translators. This paper, therefore, discusses the above problems for the ring modulator, although a shunt or Cowan modulator or networks with controlled reactive components could also have been chosen. A general theory is explained in [1] and [2].

The frequency translator shown in Figure 1 consists of a low-pass filter, a ring modulator, and a band-pass filter.

When applying a voltage with a frequency ω across the low-pass input, ω will also appear at the output and be supplied via the terminals B to the modulator, where a translation takes

place with the carrier frequency Ω . We then obtain at the modulator output, or rather across terminals C at the band-pass input, a spectrum with frequencies $m\Omega \pm \omega$ ($m = 1, 3, 5, \dots$). Of these frequencies, only $\Omega + \omega$ is in the pass band of the band-pass filter, which is relatively well matched in this range. All the other frequencies obtained must be in the upper or lower stop band of the band-pass filter, which, being a reactive filter, has a highly frequency-dependent reflection factor. The spectral components not within the pass band are therefore reflected almost completely into the modulator, where they are remodulated. This produces at terminals B a spectrum with the frequencies $m\Omega \pm (m\Omega \pm \omega)$, that is, even multiples of the carrier frequency $n\Omega \pm \omega$ ($n = 0, 2, 4, \dots$).

Thus one spectral component is again at exactly ω in the pass band of the filter, although its phase and amplitude may be different from those of the supply-voltage source, depending on the reflection from the band-pass filter. The reflected energy component of ω thus will either increase or decrease the power at terminals B . All the other spectral components at B that were produced through remodulation, fall into the stop band of the low-pass filter and are reflected into the modulator because of the mismatch of this filter. This process is repeated an infinite number of times. Figure 2 shows the spectral frequencies at the

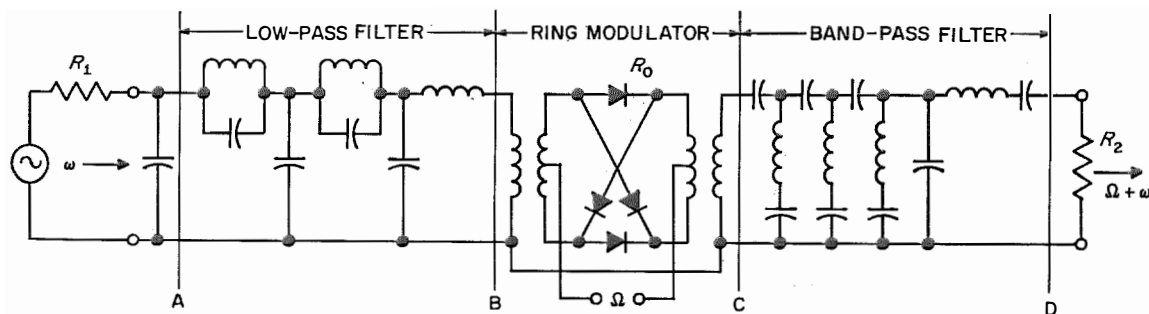

Figure 1—Selective frequency translator.

Analysis of Diode Modulators

individual terminal pairs. If it is assumed that the ring modulator does not have any heat dissipation and that the filters effect a complete reflection, the energy of the spectral components outside the pass band could be regained for the useful band through remodulation. This has been proved for idealized frequency translators and is described in detail [3-5].

These studies usually led to dimensioning rules for the terminations of the ring modulator. Ideal conditions, however, normally do not exist in practice. The reflection factor of very-selective frequency translators is largely frequency dependent both in the pass band and in the stop band. Therefore the remodulation products cause an unpredictably high frequency dependence of the loss in the pass band. To hold this loss within the predetermined limits, a synthesis of complete frequency translators must be made. This raises the question of how to dimension the respective preceding and following filters (or networks) to achieve the required frequency response. It grows to be a network problem rather than a modulator problem, and the

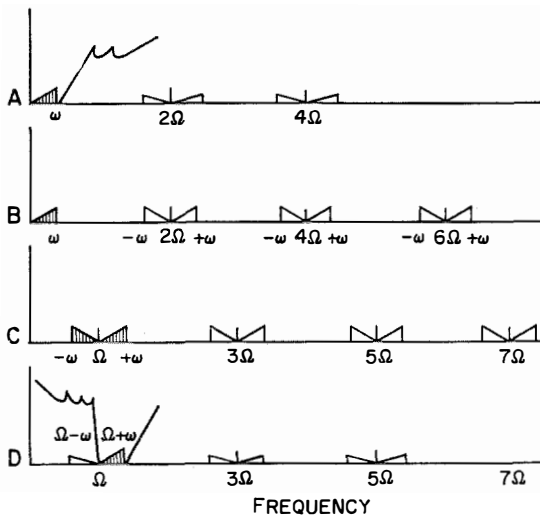

Figure 2—Frequency spectra at terminals A, B, C, and D of Figure 1. Significant filter characteristics are shown at A and D.

theoretical relations of such circuits first must be analyzed to find a solution.

As has been done in most studies, it will also be assumed here that the diodes used in the modulator circuits are resistances externally controlled by square-wave time functions such as

$$R_{\text{diode}} = R_0 \mp R_1 A(t) \quad (1)$$

where $A(t)$ is the Fourier series for a square wave

$$A(t) = \frac{4}{\pi} \sum (-1)^{(m-1)/2} \frac{1}{m} \cos m\Omega t \quad (2)$$

$m = 1, 3, 5, \dots$

$A(t)$ may generally represent any selected time function. For periodic behavior, it can always be expressed through a Fourier series. It should be noted further that external control of capacitances and inductances is also possible and that they can be expressed as time functions, for example

$$L(t) = L_0 \pm L_1 A(t) \quad \text{or} \quad C(t) = C_0 \pm C_1 A(t).$$

As is known, parametric amplifiers and reactance modulators can be designed with such controlled reactances nowadays. Thanks to their low thermal noise, they assumed a very-important position in high-frequency technology. All such circuits incorporating time-controlled components may be treated as general time-variant networks, although both time-variant and time-invariant components may be used in the same network. When defining the network through differential mesh equations, we obtain a set of differential equations that may ultimately be solved as a differential equation of the n th degree. The solution is simple if the network contains only time-invariant components, as the coefficients of the differential equation are independent of time. In that case we obtain

$$F(t) = \sum_{n=0}^{n=\zeta} K_n \frac{d^n x(t)}{dt^n}. \quad (3)$$

In this equation, $x(t)$ is the wanted time function (for example the output voltage of a

network or the current of a mesh), $F(t)$ the disturbance function, and ζ the degree of the differential equation (corresponding to the number of reactive components). The solution of such differential equations is known, the Laplace transform permitting a high precision of time function analysis in such networks.

The synthesis of steady-state networks is known today and may be considered almost concluded.

If a network also contains time-variant components such as $R(t)$, $L(t)$, and $C(t)$, (3) is substituted for by a linear differential equation having inconstant coefficients, for example

$$F(t) = \sum_{n=0}^{\zeta} K_n(t) \frac{d^n x(t)}{dt^n} \quad (4)$$

$K_n(t) > 0$ if $R(t) > 0$, $C(t) > 0$ and $L(t) > 0$ for $-\infty < t < +\infty$, which condition is always met in practice. Solving differential equations of this kind is more difficult, but is possible according to the Hill differential-equation theory. Even less advanced is the analysis of such circuits, but it already has been treated in literature in the past 15 years [1, 6-8].

No systematic synthesis is known for the steady-state time-variant networks. The solution of (4) for the steady state is known. It consists of the sum of all combinations possible between the infinite number of harmonics of Ω and the frequency ω . The complex time-dependent notation for any voltage across two nodes of the network is

$$u(t) = \sum_{m=-\infty}^{m=+\infty} u_m \cdot e^{j\omega t + jm\Omega t} = \sum_{m=-\infty}^{m=+\infty} u_m \cdot e^{pt + jm\Omega t} \quad (5)$$

or the conjugate complex value

$$u^*(t) = \sum_{m=-\infty}^{m=+\infty} u_m^* \cdot e^{-j\omega t - jm\Omega t}$$

$$= \sum_{m=-\infty}^{m=+\infty} u_m^* \cdot e^{-pt - jm\Omega t} \quad (6)$$

The full specific solution for (4) thus is

$$u(t) = \Re u(t) = \frac{u(t) + u^*(t)}{2} \quad (7)$$

Any one of these equations may be used in complex-quantity notation to define the steady-state system, for example (5). Let us assume $p = j\omega$ as the free frequency parameter. The voltages u_m are then complex quantities or vectors to be computed with a set of equations that will be shown later. Despite the inconstant coefficients, the differential equation (4) is still linear, which means that the entire network is linear. If the voltage between two nodes has been determined through (5), it is certain that only currents of the same spectral composition are flowing in all the other meshes. Currents or voltages with frequencies different from (5) cannot be present in the entire network, except that some frequencies may be absent in one or the other branch. In most cases a frequency translator, reactive modulator, or parametric amplifier will be a 4-terminal network; thus the same expressions can be used at the input and output values for the voltages or currents, respectively. The amplitudes and phases of the input quantities, however, will be different from those of the output quantities. By entering the time-dependent mesh equations of the ring modulators, the diodes having been assumed with $R_{\text{diode}} = R_0 \pm R_1 \cdot A(t)$ according to (1), the expressions for the primary current $i(t)$ and the primary voltage $u(t)$ as well as for the secondary current $I(t)$ and secondary voltage $U(t)$ according to (8), (9), (10), and (11), we obtain a set of equations having infinite rows and columns after subdivision into spectral frequencies. Let us assume for the ring modulator the input functions

$$u(t) = \sum_{n=-\infty}^{n=+\infty} u_n \cdot e^{pt + jn\Omega t}, \quad \text{only even} \quad (8)$$

$$i(t) = \sum_{n=-\infty}^{n=+\infty} i_n \cdot e^{pt + jn\Omega t}, \quad \text{only even} \quad (9)$$

and the output functions

$$U(t) = \sum_{m=-\infty}^{m=+\infty} u_m \cdot e^{pt+jm\Omega t}, \quad \text{only odd} \quad (10)$$

$$I(t) = \sum_{m=-\infty}^{m=+\infty} \mathfrak{S}_m \cdot e^{pt+jm\Omega t}, \quad \text{only odd.} \quad (11)$$

As is known, the ring modulator may be considered a cascade circuit comprising a time-variant attenuator and an ideal square-wave-

controlled pole-changing transformer [1, 2, 4, 5], as shown in Figure 3.

For such idealized ring modulator we obtain from the above expressions the mathematical proof that only odd multiples of Ω appear at the secondary and only even multiples at the primary. This well-known fact facilitates the treatment of ring modulators as time-variant networks because only these frequencies have to be considered. The instantaneous values of the equivalent circuit in Figure 3 are determined through (8), (9), (10), and (11).

$$\begin{pmatrix} u(t) \\ i(t) \end{pmatrix} = \begin{pmatrix} \cosh a & Z \sinh a \\ \frac{1}{Z} \sinh a & \cosh a \end{pmatrix} \begin{pmatrix} A(t) & 0 \\ 0 & A(t) \end{pmatrix} \begin{pmatrix} U(t) \\ I(t) \end{pmatrix} \quad (12)$$

or spectrally resolved (spectral matrix)

$$\begin{pmatrix} u_0 \\ u_{2-} \\ u_{2+} \\ u_{4-} \\ \vdots \\ i_0 \\ i_{2-} \\ i_{2+} \\ i_{4-} \\ \vdots \end{pmatrix} = \begin{pmatrix} \cosh a & 0 & 0 & \dots & Z \sinh a & 0 & 0 & \dots \\ 0 & \cosh a & 0 & \dots & 0 & Z \sinh a & 0 & \dots \\ 0 & 0 & \cosh a & \dots & 0 & 0 & Z \sinh a & \dots \\ 0 & 0 & 0 & \dots & 0 & 0 & 0 & \dots \\ \vdots & \vdots & \vdots & & \vdots & \vdots & \vdots & \\ \frac{1}{Z} \sinh a & 0 & 0 & \dots & \cosh a & 0 & 0 & \dots \\ 0 & \frac{1}{Z} \sinh a & 0 & \dots & 0 & \cosh a & 0 & \dots \\ 0 & 0 & \frac{1}{Z} \sinh a & \dots & 0 & 0 & \cosh a & \dots \\ 0 & 0 & 0 & \dots & 0 & 0 & 0 & \dots \\ \vdots & \vdots & \vdots & & \vdots & \vdots & \vdots & \end{pmatrix} \times \begin{pmatrix} 1 & 1 & -\frac{1}{3} & -\frac{1}{3} & \dots & 0 & 0 & 0 & 0 & \dots \\ 1 & -\frac{1}{3} & 1 & \frac{1}{5} & \dots & 0 & 0 & 0 & 0 & \dots \\ -\frac{1}{3} & 1 & \frac{1}{5} & 1 & \dots & 0 & 0 & 0 & 0 & \dots \\ -\frac{1}{3} & \frac{1}{5} & 1 & -\frac{1}{7} & \dots & 0 & 0 & 0 & 0 & \dots \\ \vdots & \vdots & \vdots & \vdots & & \vdots & \vdots & \vdots & \vdots & \\ 0 & 0 & 0 & 0 & \dots & 1 & 1 & -\frac{1}{3} & -\frac{1}{3} & \dots \\ 0 & 0 & 0 & 0 & \dots & 1 & -\frac{1}{3} & 1 & \frac{1}{5} & \dots \\ 0 & 0 & 0 & 0 & \dots & -\frac{1}{3} & 1 & \frac{1}{5} & 1 & \dots \\ 0 & 0 & 0 & 0 & \dots & -\frac{1}{3} & \frac{1}{5} & 1 & -\frac{1}{7} & \dots \\ \vdots & \vdots & \vdots & \vdots & & \vdots & \vdots & \vdots & \vdots & \end{pmatrix} \begin{pmatrix} u_{1-} \\ u_{1+} \\ u_{3-} \\ u_{3+} \\ \vdots \\ \mathfrak{S}_{1-} \\ \mathfrak{S}_{1+} \\ \mathfrak{S}_{3-} \\ \mathfrak{S}_{3+} \\ \vdots \end{pmatrix} \quad (13)$$

Z is the characteristic impedance of the ring modulator and a represents the losses in the diodes. Z and a are connected with (1) by

$$Z \cdot (R_0^2 - R_1^2)^{1/2} \quad \text{and} \quad \tan \frac{a}{2} = \left(\frac{R_0 - R_1}{R_0 + R_1} \right)^{1/2}$$

The numbers of the indexes at the primary and secondary currents and voltages in (13) reflect the number of the harmonic of the carrier and the sign of the upper or lower sideband, (for example, $3+$ means $3\Omega + \omega$). In spectral analysis, the ring modulator may thus be considered a network with an infinite number of input terminal pairs and the same infinite number of output terminal pairs (Figure 4). Each terminal pair is preceded or followed by the primary filter or secondary filter.

Both the primary and the secondary filters can also be defined by such spectral matrix (which is derived through frequency transformation from the normal cascade matrix of the filters). In this way the relationship between the amplitudes of input and output quantities is determined for the entire translator, similar to the cascade equations known from 4-terminal network theory. The input and output quantities in this case, however, are composed of an infinite number of spectral components. The cascade equation with the spectral matrix of an entire translator (Figure 4) thus is

$$\begin{bmatrix} u_0 \\ u_{2-} \\ u_{2+} \\ \vdots \\ j_0 \\ j_{2-} \\ j_{2+} \\ \vdots \end{bmatrix} = \begin{bmatrix} A_{01-} & A_{01+} & A_{03-} & \cdots \\ A_{2-1-} & A_{2-1+} & \cdots & \\ A_{2+1-} & \cdots & & \\ \vdots & & & \\ \vdots & & & \end{bmatrix} \begin{bmatrix} u_{1-} \\ u_{1+} \\ u_{3-} \\ \vdots \\ \mathfrak{J}_{1-} \\ \mathfrak{J}_{1+} \\ \mathfrak{J}_{3-} \\ \vdots \end{bmatrix} \quad (14)$$

where u , j , U , and \mathfrak{J} are now the voltages and currents of the input and output of the entire translator. The relations $E_0 + j_0 \cdot R_1 = u_0$; $u_n = j_n \cdot R_1$; $U_m = \mathfrak{J}_m \cdot R_1$ permit eliminating u_n , j_n , and \mathfrak{J}_m from (14). U_m can be determined as a function of the source E_0 with frequency ω

(Figure 4) and of the elements A_{nm} of the spectral matrix. The elements A_{nm} are rational functions of $p = j\omega$ and depend also on the characteristics of the modulator (13) and the primary and secondary filters. Thus it is possible to define the entire frequency translator as a network in the frequency domain.

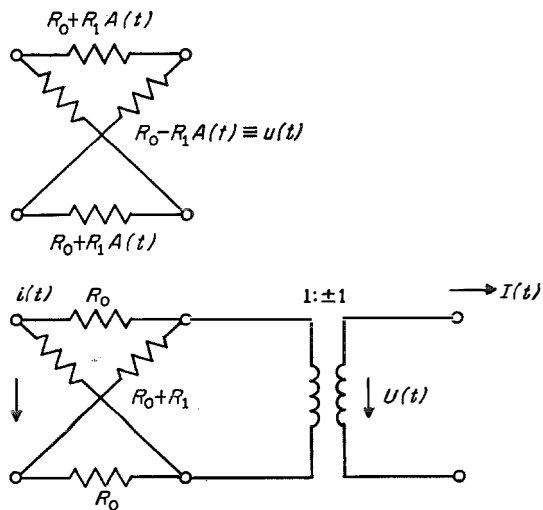

Figure 3—The ring modulator is shown at top as a 4-terminal network with time-controlled resistances. The equivalent circuit is shown at bottom with constant attenuator and pole-changing transformer.

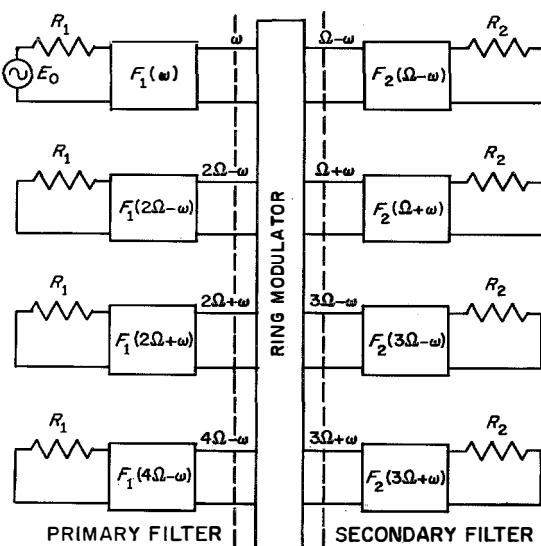

Figure 4—Equivalent circuit of a frequency translator.

Analysis of Diode Modulators

Furthermore, considering the transmission function notation

$$e^{g_{0m}} = \frac{E_0}{2U_m} \cdot \left(\frac{R_2}{R_1} \right)^{1/2} \quad (15)$$

it is possible to express the m transmission functions of the primary voltage source with the frequency ω on all frequencies appearing at the secondary through one set of equations.

$$\begin{bmatrix} \pi/2 \\ 0 \\ 0 \\ 0 \\ \vdots \end{bmatrix} = \begin{bmatrix} 1 \cdot S_{01-} & 1 \cdot S_{01+} \\ 1 \cdot S_{2-1-} & -\frac{1}{3} \cdot S_{2-1+} \\ -\frac{1}{3} \cdot S_{2+1-} & 1 \cdot S_{2+1+} \\ \vdots & \vdots \end{bmatrix} \begin{bmatrix} -\frac{1}{3} \cdot S_{03-} & -\frac{1}{3} \cdot S_{03+} & \dots \\ 1 \cdot S_{2-3-} & \frac{1}{5} \cdot S_{2-3+} & \dots \\ \frac{1}{5} \cdot S_{2+3-} & \dots & \dots \\ \vdots & \vdots & \dots \end{bmatrix} \begin{bmatrix} e^{-g_{01-}} \\ e^{-g_{01+}} \\ e^{-g_{03-}} \\ \vdots \end{bmatrix} \quad (16)$$

The matrix elements S_{nm} are again rational functions of p . The detailed mathematical derivation has been discussed in [2]. Results obtained with the aid of an electronic computer will be described in the following paragraphs.

It should be noted that (16) permits us to determine the values of the transmission factors $e^{g_{0m}}$ for any frequency $p = j\omega$. An exact result cannot be obtained, however, as (16) contains an infinite number of equations and unknowns, and calculations have to be terminated after a finite number of equations. Practical experience proved, however, that valuable results could be obtained with as few as 5 equations. It is interesting that the computed loss curves showed only a parallel displacement from those measured in the practical operation of frequency translators. With 5 equations, the calculated curve was displaced only about 0.25 neper (2.2 decibels) from the measured curve, and with 11 equations about 0.04 neper (0.35 decibel).

Figure 5 shows the differences in insertion loss between calculations using N and $N + 2$ equations as a function of N the smaller number of equations used. This means, for example, that we have a difference of insertion loss between calculations with 5 and 7 equa-

tions of about 0.6 decibel drawn on $N = 5$. The curve approaches zero asymptotically for $N \rightarrow \infty$.

With the aid of the above theoretically exact analysis of the ring modulator, it was possible to recheck the results obtained by Tucker [4] and Gensel [5] for ideal terminations. The termination conditions given in [5] proved to be a good starting basis for the exact calcula-

tion of modulators with primary and secondary filters. A number of examples calculated showed that the loss in the pass band of a modulator may be reduced almost to zero by merely keeping the ohmic loss in the diodes very small and giving the pass band of the filter conjugated-complex characteristics. The transmission-curve ripple can in all cases be held within the required limits through appropriate filter dimensioning.

It was further possible to prove theoretically that the transmission characteristics are reversible, for example from ω to $\Omega + \omega$. This means that it is irrelevant whether ω is supplied at the primary and $\Omega + \omega$ is measured selectively at the secondary, or vice versa. The transmission curve is a function of ω and remains the same in both cases. This can be proved with (16) and (14). Of course the unwanted frequencies (undesirable modulation products) will change with reversed operation, but they are to be suppressed so far as possible by the filters, anyhow.

For the analysis of the whole frequency translator, an existing program for the ER56 computer could be used. The program originally was written to calculate from predetermined rational functions the cascade matrix of a filter according to the well-known

methods of insertion-loss-parameter theory [9-11]. Thus a numerical relation was already available between the zero points and the poles of the characteristic filter functions, as well as their cascade matrix elements. With the cascade elements for primary and secondary filters of the ring modulator spectral matrix, the elements S_{nm} of (16) can be prepared with the aid of (14). Depending on the required accuracy of calculation (that is, the number of equations used), the preparation of the equation set takes 2 to 3 minutes of computer time. Subsequently, the machine computes for every point from (16) the transmission function as well as the spacing of the unwanted frequency bands. Approximately 8 minutes of computer time are required to compute 5 equations for 20 frequency points and primary and secondary filters of the 10th degree. The computer program was so flexible that only minimal effort was required to modify input data. Thus a correction of the transmission curves is possible through changes of both the matching and the zero points of the two filters. On calculation, the results are printed out in tabulated form by a high-speed printer.

As mentioned earlier, the transmission functions are derived from a set of equations having an infinite number of unknowns. Since computing operations have to be determined after a finite number of equations, the results are only approximations.

For this reason it is difficult to achieve a complete synthesis similar to the insertion-loss theory for reactive networks having constant parameters. It is, however, possible to change the input data of the described computer program—in this case primarily the zero points of the two filters—until the transmission properties meet the requirements. In the beginning, this procedure appears somewhat complicated, but with practice it is possible to achieve simulation of the networks in a relatively short time, in any event substantially quicker than by conventional laboratory methods. It will, of course, be practicable to

modify the program in such a way that the computer automatically changes the zero points until the loss curve maintains the required tolerance limits. The elements of the primary and secondary filters are then derived from the known zero position by the well-known methods of insertion-loss theory [9-11]. The circuit shown in Figure 1 was approximated according to these methods and then practically realized. Figure 6A shows the measured and calculated pass-band characteristics of the channel translator. The parallel displacement is clearly evident. The minor ripple deviations are due to the fact that frequency-dependence of the loss is somewhat different in practice than in theory. Furthermore, equal loss was assumed for inductors and capacitors, but in reality capacitors are better. Figure 6B shows the loss characteristics of the two filters with resistive terminations. Clearly the measurements and calculations correspond very well, but both show a high ripple that indicates the influence of the remodulation products on the pass-band characteristic of the translator, 6A. This characteristic has a very-low ripple and remains within 1/10 of the recommendations of the Comité Consultatif International

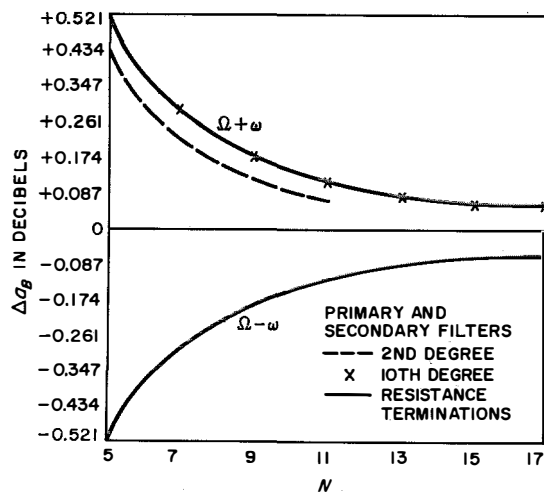

Figure 5—Insertion-loss differences in decibels of N to $N+2$, as a function of N .

Télégraphique et Téléphonique despite the ripple of each of the filters.

Figure 7 shows the stop-band attenuation for the upper and lower sidebands (also beyond the pass band). In this case, too, a parallel displacement of the measured values from the

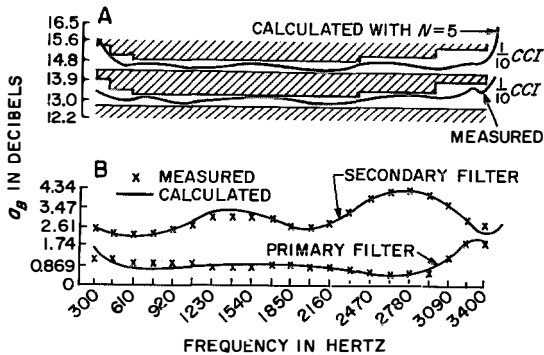

Figure 6—Calculation and measurement of the transmission loss as a function of frequency of (A) the entire translator pass band, and (B) of the primary and secondary filters separately with resistance terminations. The two areas delineated by the shaded regions (in which the curves of (A) lie) correspond to 1/10 of the maximum distortion permitted by the recommendations of the Comité Consultatif International Télégraphique et Téléphonique (1/10 CCI).

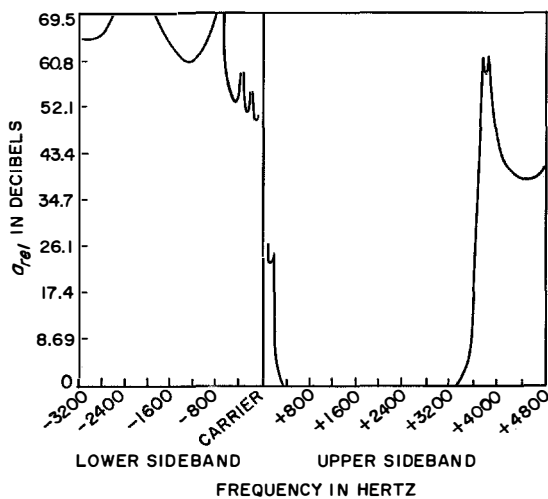

Figure 7—Attenuation characteristic of entire translator, referred to a zero level at 800 hertz in the pass band. Carrier = 16 kilohertz.

calculated values was to be noted. Figure 8 shows the parallel displacement in the pass band and stop band as a function of the number of equations N used for the calculation of (16). The parallel displacement without ripple increase is clearly evident. Figure 9 shows that it is possible to bring the fundamental attenuation of the translator down close to zero if the primary and secondary filters have an inverse response in the stop band. The modulator resistive loss (in the diodes) is designated a . Maximum regeneration of energy is clearly possible if the resistive loss a approaches zero.

Finally, the nonlinear properties of translators have been investigated. In wide-band modulators, pure resistors are often connected in series with the diodes to improve the nonlinear characteristics of the diodes. These additional ohmic resistors, however, increase the resistive loss (Figure 9), which in turn increases the insertion loss of the translator. To obtain a predetermined translator output power, the power lost in the pure resistors preceding the diodes must therefore be supplied additionally at the input. This raises the question whether the harmonic properties of a translator with a predetermined output will change if the linearizing resistors are omitted. Without these resistors the translator loss would decrease and thus make additional power input unnecessary. To find an answer to this question, the translator as shown in Figure 1 was calculated and assembled in two

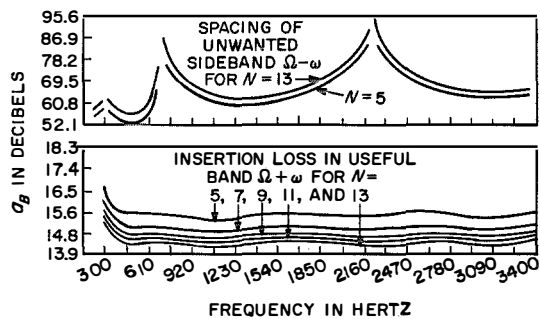

Figure 8—Calculated pass band and stop band of entire translator for different N .

versions, one with and the other without linearizing resistors. The frequency dependence of the two translator versions is shown in Figure 10. The translator with linearizing resistors has an insertion loss of 1.5 nepers (13 decibels), the other one of 0.4 neper (3.5 decibels).

In Figure 11, the measured attenuation of the third harmonic a_{K3} is plotted against power output for operation from low frequency to high frequency at *A* and for high frequency to low frequency at *B*. It is apparent that the harmonic attenuation with and without linearizing resistors is the same. This result suggests re-examination of the theory that linearizing resistors must be provided in translators to ensure high harmonic attenuation. As remodulation products can now be considered mathematically for quasi-linear behaviors, it is possible to design translators with very-low insertion loss. This has been difficult hitherto, and the ohmic resistors were in many cases a welcome means for decoupling or eliminating remodulated energy. The higher attenuation

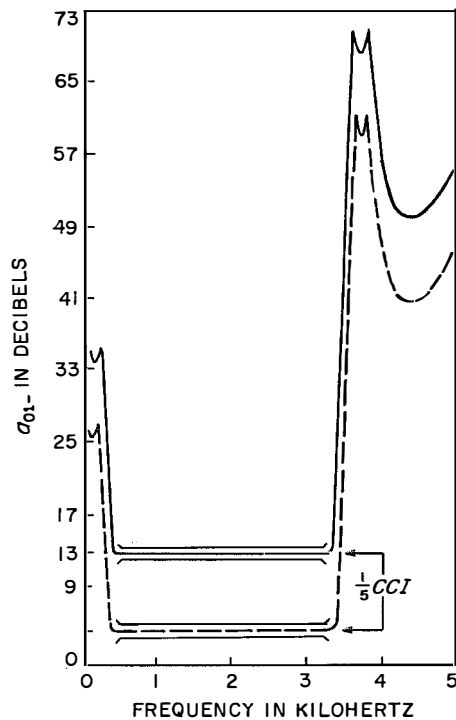

Figure 10—Selective response of two translators. The solid curve and broken curve are respectively for translators with and without linearizing resistors. The limits for $1/5 CCI$ are shown for both pass bands.

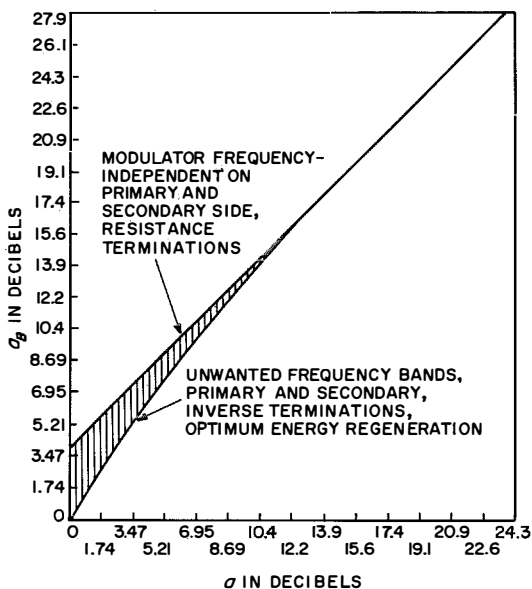

Figure 9—Insertion loss of translator as a function of resistance-modulator loss at optimum energy regeneration and with resistance terminations.

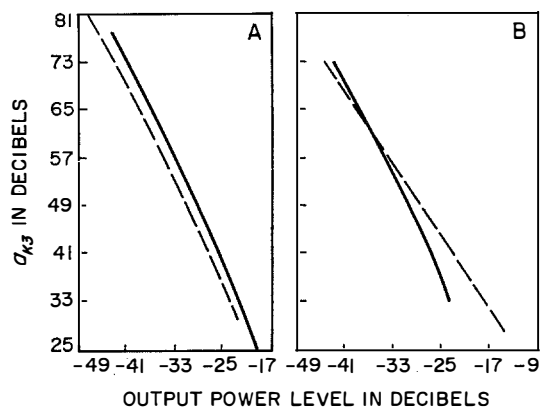

Figure 11—Measured attenuation of third harmonic a_{K3} plotted against translator output for (*A*) conversion from low to high frequency, and for (*B*) conversion from high to low frequency. The solid curves are with linearizing resistors and the broken curves are without linearizing resistors.

of the fundamental had to be accepted previously but can be avoided now.

On completion of the above investigations, it may be stated that the theoretical assumption of square-wave control of the diodes proves quite useful although it is not always possible in practice. It has been learned that matching problems and the influence of the remodulation products are the most-significant factors for calculation of frequency translators. To this extent, a quasi-linear approach to the problem is of great advantage. Evaluation of the theoretical relations for practical analysis and design, however, is possible only with the aid of electronic computers.

References

1. C. Kurth, "Die Analyse von zeitvarianten Netzwerken unter Verwendung einer Spektralmatrix im Frequenzbereich", *Archiv der Elektrischen Übertragung*, volume 17, number 5, pages 237–248; 1963.
2. C. Kurth, "Spectral Matrix for Analysis of Time-Varying Networks," *Electrical Communication*, volume 39, number 2, pages 277–292; 1964.
3. V. Belevitch, "Linear Theory of Bridge and Ring Modulator Circuits," *Electrical Communication*, volume 25, number 1, pages 62–73; 1948.
4. D. G. Tucker, "Rectifier Modulators with Frequency-Selective Terminations," *Proceedings of the Institution of Electrical Engineers*, volume 96, part 3, number 43, pages 422–428; September 1949.
5. J. Gensel, "Das Verhalten von Modulatorschaltungen bei komplexen, insbesondere selektiven Abschlüssen", *Frequenz*, volume 11, number 5, pages 153–159, and number 6, pages 175–185; 1957.
6. L. A. Zadeh, "Frequency Analysis of Variable Networks," *Proceedings of the IRE*, volume 38, number 3, pages 291–299; 1950.
7. L. A. Zadeh, "Time-Varying Networks," *Proceedings of the IRE*, volume 49, number 10, pages 1488–1503; 1961.
8. W. A. Taft, "Fragen zur Theorie der Netzwerke mit veränderlichen Parametern", Akademische Verlagsanstalt Geest & Portig K. G., Leipzig; 1962.
9. W. Cauer, "Theorie der linearen Wechselstromschaltungen", Akademie Verlag, Berlin; 1954.
10. R. Saal and E. Ulbrich, "On the Design of Filters by Synthesis," *IRE Transactions on Circuit Theory*, Volume CT5, number 4, pages 284–327; December 1958.
11. C. Kurth, "Übersicht über die Berechnung von Filtern mit Verlusten nach der Betriebsparametertheorie", *Frequenz*, volume 10, pages 391–396; 1956, and volume 11, pages 12–19 and 43–53; 1957.
12. C. Kurth, "Die Analyse von quasilinearen Frequenzumsetzern mit selektiven Ein- und Ausgangsnetzwerken", *Archiv der Elektrischen Übertragung*, volume 17, number 7, pages 325–337; 1963.
13. C. Kurth, "Die Anwendung von digitalen Rechenanlagen bei der Analyse und Berechnung von Frequenzumsetzern mit selektiven Ein- und Ausgangsnetzwerken", *Archiv der Elektrischen Übertragung*, volume 17, number 8, pages 381–390; 1963.

Carl Kurth. Biography appears in volume 39, number 2, page 292.

Microwave Telephone Relay Network in Mexico

H. CARL

Standard Elektrik Lorenz AG; Stuttgart, Germany

1. General

Teléfonos de Mexico inaugurated the first section of a long-distance microwave radio relay network in the autumn of 1962. This network ultimately will interconnect several large Mexican cities and also will provide for international connections.

The first operating section comprises the link from Mexico City to Monterrey and from there to the United States border near Nuevo Laredo, where the system is interconnected at radio frequencies with the radio relay network of the Bell Telephone system. This link has a length of approximately 1100 kilometers (700 miles) and includes 21 stations (see Figure 1).

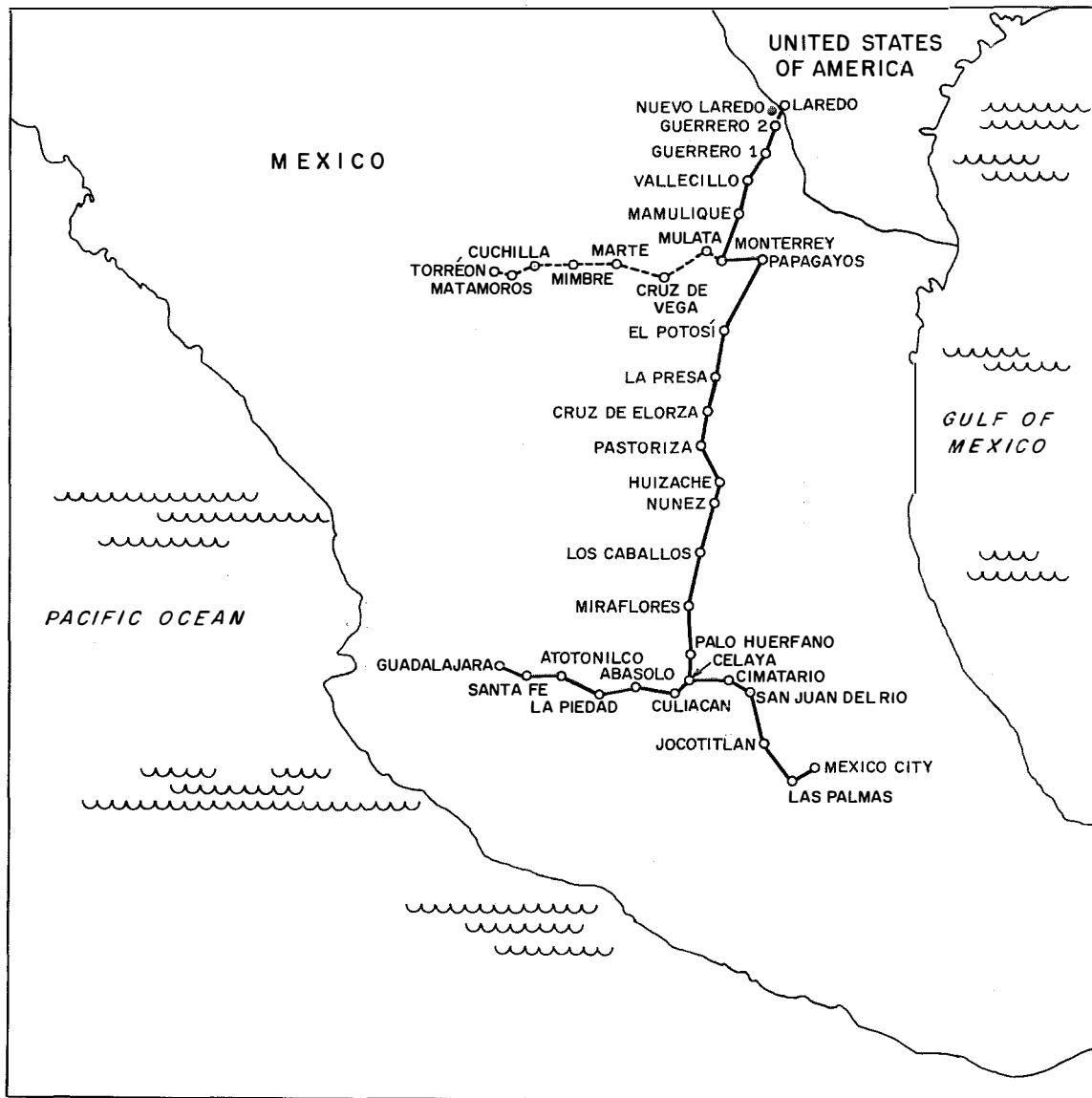

Figure 1—Mexican microwave radio relay network.

Microwave Telephone Relay Network in Mexico

An extension of 6 stations and 300 kilometers (185 miles) from Celaya to Guadalajara will be ready for operation in mid-1964. A second extension of 7 stations and 350 kilometers (215 miles) from Monterrey to Torréon will be built in 1965. The full network then will consist of 34 stations with a length of almost 1800 kilometers (1100 miles).

All links are equipped with the 4-gigahertz

wide-band radio relay equipment *FM960/TV-4000*, developed for the Deutsche Bundespost. It accommodates 960 telephone channels or 1 television channel including sound.

Dual transmitters and receivers for operate and standby permit uninterrupted service if one unit fails. The system was also designed to accommodate additional equipment that would double its present operating capacity.

TABLE 1
STATIONS IN NETWORK

Station	Altitude		Distance to Following Station		Supervised From
	Meters	Feet	Kilometers	Miles	
Guerrero 2	150	490	41	25	Monterrey
Guerrero 1	170	550	41	25	Monterrey
Vallecillo	340	1100	51	32	Monterrey
Mamulique	760	2500	63	39	Monterrey
Monterrey	550	1800	59	37	Monterrey
Papagayos	705	2300	109	67	Monterrey
El Potosi	300	975	61	38	Monterrey
La Presa	2100	6800	60	37	Monterrey
Cruz de Elorza	2040	6600	45	28	Cruz de Elorza
Pastoriza	1740	5700	53	33	Los Caballos
Huizache	1600	5200	31	19	Los Caballos
Nunez	1560	5050	70	43	Los Caballos
Los Caballos	2600	8400	71	44	Los Caballos
Miraflores	2160	7000	69	43	Los Caballos
Palo Huerfano	2400	7800	36	22	Los Caballos
Celaya	1757	5750	49	31	Los Caballos
Cimatario	2400	7800	43	27	Mexico City
San Juan del Rio	2280	7400	71	44	Mexico City
Jocotitlan	3700	12 100	58	36	Mexico City
Las Palmas	3240	10 600	30	18	Mexico City
Mexico City	2220	7200	—	—	Mexico City
Total			1111	688	
Celaya	1757	5750	27	16	Celaya
Culiacan	2820	9300	53	33	Guadalajara
Abasolo	2500	8150	72	45	Guadalajara
La Piedad	2300	7500	45	28	Guadalajara
Atatonilco	1890	6200	62	38	Guadalajara
Santa Fe	2300	7500	40	25	Guadalajara
Guadalajara	1567	5100	—	—	Guadalajara
Total			299	185	
Monterrey	550	1800	28	16	Monterrey
Mulata	1400	4550	82	51	Monterrey
Cruz de Vega	1700	5550	73	45	Monterrey
Marte	1100	3600	58	36	Monterrey
Mimbre	1000	3300	51	32	Torréon
Cuchilla	1100	3600	28	16	Torréon
Matamoros	1100	3600	31	18	Torréon
Torréon	1140	3750	—	—	Torréon
Total			351	214	

An auxiliary system was installed for order wire, remote control, and supervision. It also operates at 4 gigahertz.

Radio equipments operating in the same direction are each connected to a single antenna through an 8-branch filter that accepts 4 transmit and 4 receive frequencies.

The radio-frequency arrangement conforms with the 4-gigahertz recommendations of the Comité Consultatif International Radio, which were also followed for the interconnection with the Bell system in the United States. Only 2 microwave frequencies are used throughout the network. Each repeater station transmits to both directions at 1 frequency and receives from both directions at the other frequency.

Table 1 lists the stations in the system, giving information on their altitudes and distances apart. Switching between operate and standby is done automatically at the intermediate frequency of 70 megahertz. Faults are reported over the auxiliary system to the supervisory points at Monterrey, Los Caballos, and Mexico City. Each such protective section comprises 4 to 7 radio links and extends about 200 to 300 kilometers (125 to 200 miles) in length. All repeater stations are equipped for remote supervision to permit unattended operation. Figure 2 shows a typical unattended repeater station. Modulation and demodulation equipment is provided only at Mexico City and Monterrey.

2. Performance and Reliability

System performance corresponds very closely to predicted estimates. The noise computation for the link between Mexico City and Monterrey of 17 stations and 920 kilometers (570 miles) is given in Table 2 for the highest one of its 960 telephone channels.¹ Measurements made for longer periods of time are given in Table 3.

¹ H. Carl and G. Lupke, "4 GHz-Weitverkehrsnetz Mexico-Nordamerika," *SEL-Nachrichten*, volume 10, pages 147-159; 1962.

	Picowatts
Modem equipment and its intermodulation noise	60
Thermal noise with simultaneous fading of 6 decibels in all radio links	864
Intermodulation noise	800
Total computed noise	1724

	Picowatts
Modem and thermal noise	400
Intermodulation noise	750
Radio-frequency interference	150
Total measured noise	1300



Figure 2—Standard unattended repeater station.

Microwave Telephone Relay Network in Mexico

For the system length of 920 kilometers (570 miles), the total computed noise power corresponds to less than 2 picowatts per kilometer and the measured noise power is less than 1.5 picowatts per kilometer. These figures are much smaller than the 3 picowatts per kilometer allowed by the Comité Consultatif International Radio. No noteworthy fading has been observed during more than a year of operation. For the average simultaneous fading in all radio sections, a figure of 3 decibels is measured compared with the conservative estimate used of 6 decibels. The careful propagation measurements made on all radio paths before final station selection showed that certain paths

would be subject to heavy fading and these were avoided.

System reliability also meets expectations. The system outage caused by communication-equipment failure averaged 0.2 to 0.3 percent during the first year. This equals less than 2 hours per month for 4 attended and 17 unattended stations, at least 1 hour of which is spent for travel. A further reduction in outage time is expected.

The main function of the system is to provide multichannel telephony. It has also been used satisfactorily for the transmission of important television programs from the United States on the standby channel.

Helmut Carl was born in 1916 in Danzig, then part of Germany. He received a doctor of engineering degree from the Technical University of Danzig in 1943.

Dr. Carl joined Standard Elektrik Lorenz in 1939. He has done development work on radar, frequency-modulation broadcast transmitters, and microwave radio systems.

Geographic Relay System for Railroad Interlocked Routing

W. SCHMITZ

Standard Elektrik Lorenz; Stuttgart, Germany

“Spurplantechnik” is the name given to an interlocking system developed in Germany within the past decade. In English-speaking countries, the term “geographic circuits” is used for this or similar systems. Geographic circuits, however, have been known for a long time, while the first Spurplan interlock system was placed in service at the Dillingen (Saar) railroad station only in the spring of 1956. To avoid confusion when discussing this particular system, the term “geographic system” will be used instead of “geographic circuits.” There have been a number of descriptions of the structure and design of geographic systems [1-7], but the special features on which geographic circuits are based require a little more elucidation.

1. Geographic Circuits

Geographic circuits may be defined as a central assembly of controls and indicators having elements corresponding to the track switch points, signals, and track sections in the actual track layout.

Figure 1 shows a simple track layout with five points (1a, 1b, 2, 3a, and 3b), two signals (11 and 13), two entrance track circuits (11 and 13), two entrance track circuits (11 and 13), and three exit track circuits (12, 14, and 16). The necessary connections for this layout are illustrated in Figure 2 in nongeographic circuits. In this figure the initiation contacts for the circuits are 12K, 14K, and 16K on the exit side, and 11K and 13K on the entrance side.

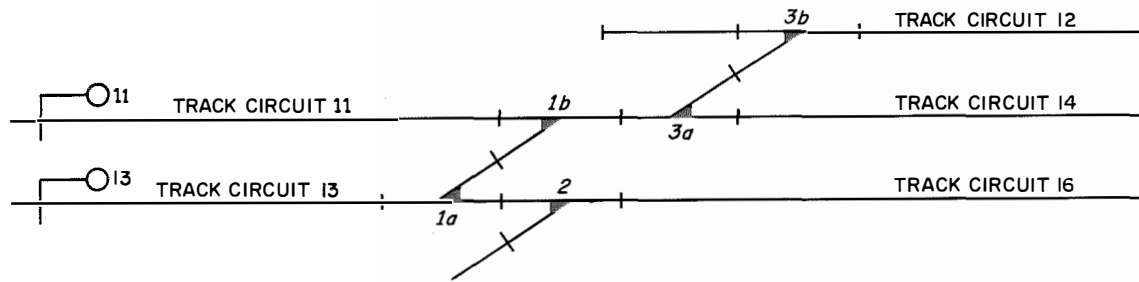

Figure 1—Track layout. (Refer to Section 5, page 401, for symbols.)

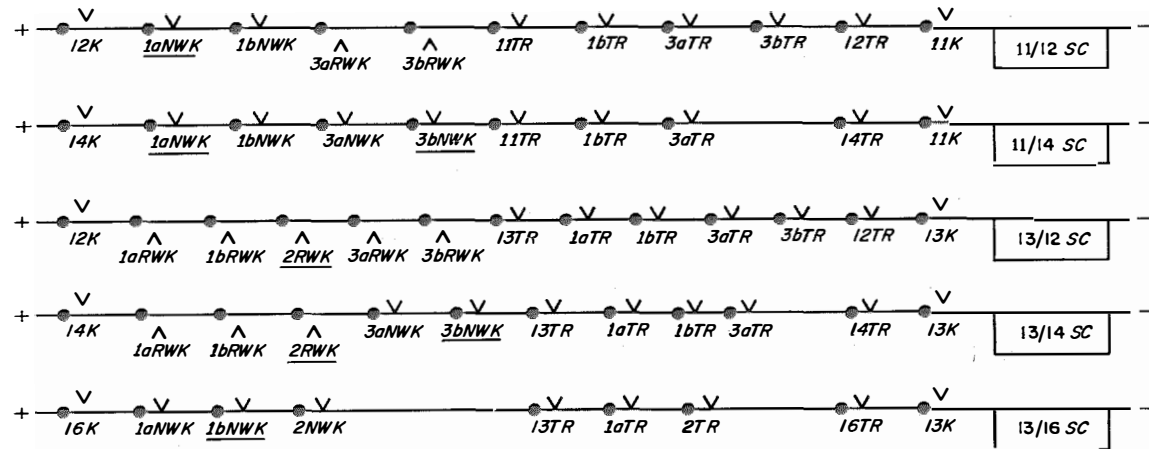

Figure 2—Nongeographic individual control circuits.

Geographic Railroad Interlocked Routing

side. Relays 11/12SC and 11/14SC are control relays for signal 11; relays 13/12SC, 13/14SC, and 13/16SC are control relays for signal 13. The second part of each numeral indicates the exit track. Point detection contacts *NWK* are assigned to the normal position and *RWK* to the reverse position of a point. Track relay contacts *TR*, which check whether the associated tracks and points are clear, are also shown.

It is evident that a signal control relay can be switched to the active position only when the points show correct detection and the tracks are unoccupied for the entire route involved. Since we are concerned here with the general principle, only the point detection and track relay contacts are included in the relay circuits, while other contacts, such as point locking contacts, have been omitted for simplicity. The devices normally used in railroad signaling to safeguard operation against line faults and so forth have also been disregarded.

Comparing Figures 1 and 2 we find, for example, that for the movement from signal 13 to track 16, not only are the normal positions of points 1a and 2 proved, but also that of point 1b, which must be in normal position as a flank protecting point for the movement 13/16. If the route is set by a push button in the panel near the 13 signal symbol and by a second push button on the exit side in track 16, then contacts 16K and 13K are closed and relay 13/16SC is energized if the points are in the correct positions and the whole route is clear. In the five individual circuits for the five possible routes, the detection contacts of the flank protecting points are underlined for emphasis. If we assume that the point detection relays are accommodated in a relay rack and the track relays in a second rack, the arrangement shown in Figure 2 results. The point detection contacts and then the track detection contacts follow in sequence. Figure 2 shows how circuits generally have been arranged since the early days, namely, in accordance with the way the relays are packaged. This arrangement provides

the shortest wire connections between the contacts.

If Figure 2 is changed so that the contacts and relays are arranged in the same sequence as the route items assigned to them, we obtain a geographic circuit in accordance with Figure 3. Again consider the circuit of relay 13/16SC for the route from signal 13 to track 16. After the initiating contact 16K come the track detection contact 16TR and the track detection contact of point 2 with the normal detection contact of point 2. Following flank protecting point 1bNWK come the normal detection contact and track detection contact of point 1a, then track detection contact 13TR and contact 13K at the entrance side. It is therefore clear that for every point in the route the detection contact and its track detection contact form one unit, the track contact facing and contacts *NWK* and *RWK* trailing. If we now trace the circuits in the direction of movement, we go from signal 13 (contact 13K) via contact 13TR to the facing side of point 1a (1aTR) where the branching takes place via the normal or reverse position of point 1a. On the reverse side of point 1a we come to the reverse side of point 1b, the normal side of which is detected from signal 11. On the facing side is track detection contact 1bTR. Point 3a brings the distribution to tracks 12 and 14. The detection contacts (again underlined) of the flank protection points are inserted in the circuit.

Some special features of geographic circuits may be seen by comparing Figures 2 and 3. The first thing to note is that the latter figure economizes on contacts. Furthermore, to keep the cost of wiring within reasonable limits, it permits closer physical arrangement of the control parts of a track section, namely, the track relays and the two point detection relays.

Although the words "geographic circuit" mean that the positions of the control parts of the circuit correspond to the route traversed, the detection contacts of the flank protection points are introduced into the circuit in a geographic manner. Another feature of geographic circuits

is that it is not possible to distinguish at one end of the circuit which other end is assigned to it. In Figure 3, if we consider the geographic circuit to the right of contact 13K, there must be again a distribution corresponding to the three routes possible on signal 13. It would be possible to use contacts 12K, 14K, and 16K for this; however, it would infringe on the geographic principle. Alternatively, as shown in Figure 3, it is possible to repeat the point detection contacts now in the reverse direction, namely, first that of point 1a, then point 3b, for the relays 13/16SC to 11/12SC. These additional circuits are emphasized by heavy lines.

In short, we can establish the following characteristics for the geographic circuits, according to Figure 3.

A channel must be formed that corresponds to the movement to be made. Thus, for example, if on the entrance and exit sides push buttons are operated that define the route, the signal control relay will not operate to admit a train unless the points are all in the correct positions for the desired route. This constitutes individual point control. However, if the points of a route are to be correctly set by a separate operation, this system of geographic circuits requires further modifications, discussed later. In geographic circuits only those controls and

signals that have their track parts also in the route can be arranged geographically at the control desk. This means that the flank protection cannot be introduced directly into the geography.

Things that happen at one end of the geographic circuits are not transmitted to the other end. Thus for example, the signal control relays cannot determine, without additional steps, the track on which the train movement is taking place. Nor is it possible to determine in track 12, 14, or 16, whether signal 11 or 13 is set. Selection of the proper signal aspects (for example full or reduced speed) therefore cannot be derived directly from the geographic circuit.

2. Geographic System

2.1 PURPOSE AND ACHIEVEMENTS

The geographic system originally developed in Germany was not necessarily intended to employ circuits in geographic order. The goal was a control system that could be constructed from standard factory-made relay units (building-block technique). It is common practice in interlocking systems to make the track diagram panels for points, tracks, signals, et cetera, from mosaics; thus any desired track layout can be represented with unit mosaics as a track

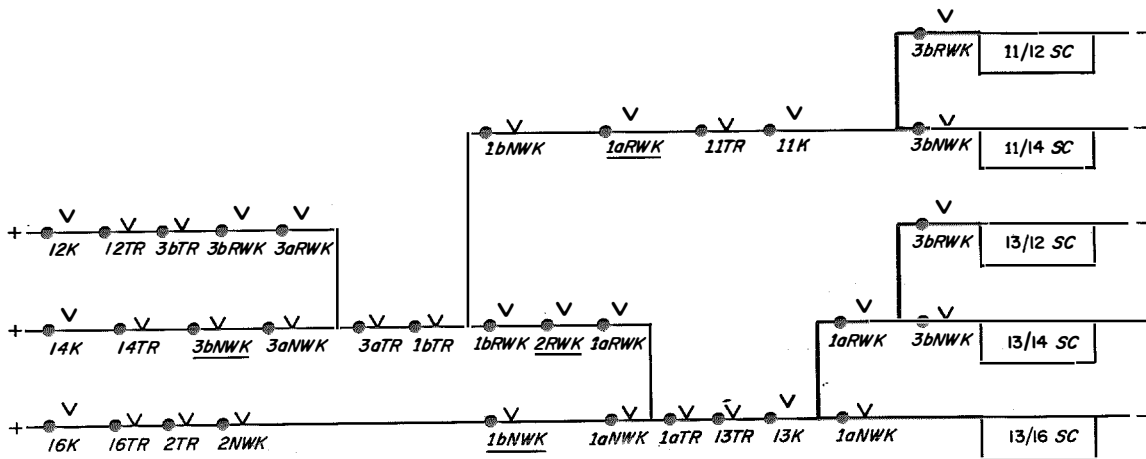

Figure 3—Geographic circuits.

Geographic Railroad Interlocked Routing

diagram panel. In the entire switching system therefore, relay units are constructed for the units of the track layout, making it possible for unitary factory-made relay sets to typify the more-complicated dependency interconnections between routes. The natural consequence of this is that the route selection circuits, insofar as they act on individual points, signals, track circuits, et cetera, must be split into parts assigned to these relay units and allocated to the control circuit parts for the units, so that they fit together in a logical way.

These relay sets can be combined logically only in the form of a simulation of the geographic track diagram, because that is the only source of recognizable connection between the units. From this follows the basic structure of a geographic interlocking system using geographic circuits.

The aim of the geographic technique is thus to create a system using standard relay units. Interconnection of the relay units must be possible in accordance with the track layout, without the need to design modified circuits, wiring tables, et cetera, for each station. Moreover a system of this kind must be so constructed that the conflicting routes arising naturally from the layout are detected by the system, so that it is also unnecessary to make locking tables. To expedite production and make spare units more-readily available at the factory, a minimum variety of relay sets is desirable.

The advantages of the geographic system over the earlier electrical interlocking system with individual wiring are summarized as follows.

2.1.1 *Reduction of Planning*

Locking tables and circuit planning for individual stations are no longer necessary, eliminating many possible sources of error. All that is necessary is to set up a relay-set connection plan that follows the track layout.

2.1.2 *Economy in Production*

It was necessary in the earlier interlocking system for a switching engineer to be able to read the wiring of the circuits. Otherwise wiring lists were needed by means of which the circuits could be wired in a routine manner. Since the data for relay units of the geographic system only need be worked out once, they can be prepared economically so that the wiring can be carried out by semiskilled personnel. It is now also possible to use test equipment such as automatic routiners instead of the time-consuming testing by bell or lamp formerly necessary.

2.1.3 *Economy in Installation*

Instead of tailor-made on-site wiring between relay racks by skilled personnel, it is now possible for all interset wiring to be done on geographic cables, which are equipped in the factory with plugs and sockets for simple insertion into the racks at the site.

2.1.4 *Simple Testing*

Previously, engineers tested the entire system (typically by bell) at the site. However, since the relay units and the geographic cables are tested in the factory, there is no need for re-testing at the site. Now it is merely necessary to prove out the interlocking system functionally. To ensure that the geographic cables are not damaged at the time of installation, they can be tested by an automatic routiner after insertion but before being placed in service.

2.1.5 *Repair of Breakdowns*

Formerly when there were breakdowns, it was often necessary to disrupt operation while repairing circuits, whereas now we simply replace plug-in relay units.

2.1.6 *Simplicity of System Changes*

To revise the geographic system, it is only necessary to change the relay-set connecting

plan. The prepared geographic cables are inserted after the old cables have been removed and the operational testing completed. With the earlier interlocking system, it was first necessary for the new circuit to be designed and identified in color to distinguish it from the preceding arrangement. The necessary wiring changes were then carried out in sequence at the site during operating lulls. The greatest care was needed here, because after the modification it was essential to restore proper signaling conditions. It was particularly dangerous if any relay connections that were of a temporary nature or no longer necessary were inadvertently left in place. Safety interlocks might be bridged by these connections. This is impossible with the geographic system, since new geographic cables cannot be applied until the old cables have been removed, and there is no interference with the wiring in the relay sets.

2.2 SUPPLEMENTS TO THE GEOGRAPHIC CIRCUITS

As explained, when designing a system with factory-made relay units, it is desirable to build the circuits with geographic arrangement. It is true that, at first, arranging the relay elements in accordance with the layout does not solve the three following problems.

- (A) Route setting by entrance-exit operation.
- (B) Flank protection.
- (C) Signal-aspect selection by exit conditions.

Circuit solutions have been found for these three problems and will now be described in detail.

2.2.1 Route Setting

If a route is set by control push buttons arranged on the entrance side and exit side, there is no automatic direct connection between these control devices. This must be created by an individual circuit, for example by interconnecting the control relays assigned to the routes, but this is just what the geographic system is

intended to avoid. To solve the problem geographic circuits have been developed known as route search circuits [8].

Figure 4 shows the simplest form of route search circuit for the layout of Figure 1. The circuit is divided into sections assigned to the points, signals, entrances, and exits. These sections are framed by dashed lines and those representing points and signals contain a pair of rectangles representing normal N and reverse R route search relays.

There are two relay sets ($11N$ and $13N$) for the signals, five relay sets ($W1a$, $W1b$, $W2$, $W3a$, and $W3b$) for the points, and three exit sets ($12X$, $14X$, and $16X$). The entrance buttons in the control panel actuate contacts $11K$ and $13K$ via corresponding relays in these sets, while the exit buttons energize contacts $12K$, $14K$, and $16K$. Each point has two relays, designated by N and R , and each of these relays has two contacts, for example $1R$ and $2R$. Contacts $1N$ and $1R$ close and extend the circuit, while contacts $2N$ and $2R$ open the circuit on the unwanted side of the point.

Suppose a route is set from signal 13 to track 14 (Figure 1). Contacts $13K$ and $14K$ (Figure 4) are closed by the entrance and exit buttons. Point $1a$ faces $13K$, so that the circuit is extended in both directions to contacts $2N$ and $2R$. The circuit via contact $2N$ leads to relay R of point $1b$ and the circuit via $2R$ leads to relay N of point 2. Both are actuated, whereby the connection to $11N$ is cut off by contact $2R$ of $W1b$ and the branch is cut off by contact $2N$ of $W2$. Contact $1R$ of $W1b$ switches through to point $3a$ and then onward to contacts $2N$ and $2R$. The circuit via contact $2N$ of $W3a$ connects to relay R of $W3b$ and the circuit via $2R$ of $W3a$ leads to contact $14K$ of exit set $14X$. Contact $1R$ of $W3b$ leads to contact $12K$ of exit set $12X$.

From point $W2$, contact $1N$ connects to contact $16K$. Since only contact $14K$ is closed (by the push button), the circuits from $W3b$ and from $W2$ do not pass through contacts $12K$ and $16K$, respectively. Only the circuit coming

Geographic Railroad Interlocked Routing

from *W3a* passes through contact *14K* to relay *N* of *W3a*; this disconnects relay *R* of *W3b* via contact *2N* of *W3a*. Contact *1N* of *W3a* switches to point *W1b*. Here, since contact *2R* is open, only the relay *R* of point *W1a* can be connected via the closed contact *2N*. Contact *2R* of *W1a* interrupts the circuit to relay *N* of *W2*, so that the lower direction of the geographic circuit leading to contact *16K* is also cut off. In relay set *W1a* contact *1R* connects to relay *NK*, assigned to the entrance side, in relay set *13N*.

It is therefore possible to direct all the points to the correct position by closing an entrance contact and an exit contact. When the search finds a point trailing, the route can be deter-

mined without ambiguity, although it is necessary to search through the geographic circuits twice, once in each direction. This is done automatically by the circuit arrangement described in Figure 4.

This circuit not only has the advantage that a clearly defined channel is formed between entrance side and exit side, but also that this channel is locked with respect to all the conflicting current paths by cutoff contacts *2N* and *2R*. Using this method, therefore, it is no longer possible after setting one route to set a second conflicting route. The energized relay *NK* confirms that the route search is completed and therefore that the connection of points along the whole route has been carried out.

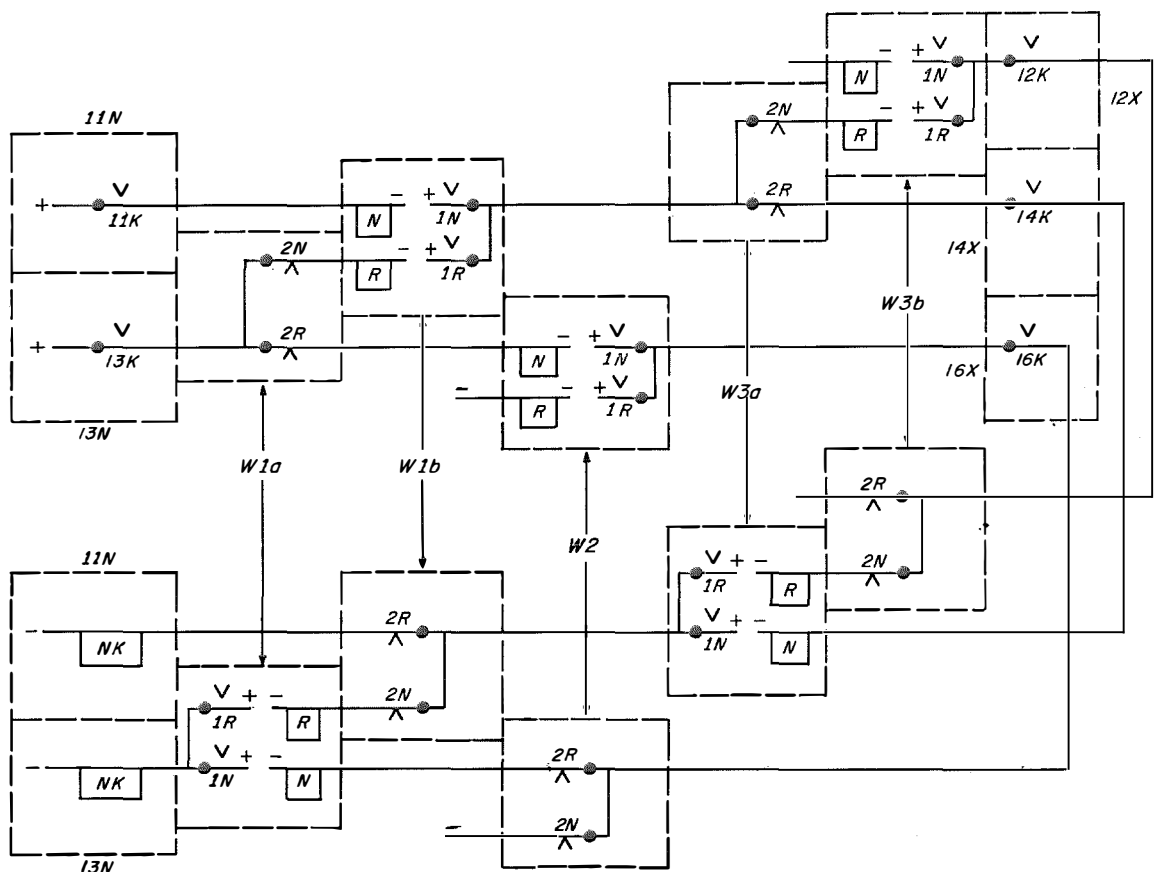

Figure 4—Route search circuits.

2.2.2 Flank Protection

The route that has been set is locked in such a way that no conflicting route can be set. In addition, the flank protection points are set to the position that deflects from the route. In the geographic system these flank protection points are also included in geographic form.

In the area of points 1a, 1b, and 2 (Figure 1), the route search circuit (Figure 4) is shown again in the upper part of Figure 5. The circuit marked in heavy lines was set after the operation of push buttons 13K and 14K.

The circuits for the flank protection search are shown in the lower part of Figure 5. These circuits ensure that flank protection point W2 is operated (heavy lines) to the reverse position. Since relay R has responded in point W1a, contact 3R is closed. This leads to point W2, where the flank protection search relay FR is operated. This causes point W2 to switch to the reverse position. Similarly, contact 3R is closed in the relay set of point W1b. This initiates a search for the flank protection (not shown) in the direction to the left of contact 3R. By means of this flank protection search, the points can be set for flank protection and then send back the flank protection detection in the same way to the point relay set from which the flank protection search originated.

2.2.3 Signal Aspect Selection

It was found that the exit of the route is not identified at the entrance in the geographic circuit. For example, it may happen that a movement for which the points are in the normal position must receive a signal aspect for full speed, but a route for which the points are in the reverse position must receive a signal aspect for reduced speed. With this arrangement therefore, selection of the signal aspect depends on the position of the points along the route. Since there are points that can be crossed in either normal or reverse position at high speed, the arrangement must be such that

three possibilities can be set by the relay unit, namely: full speed in both positions or reduced speed in one or both positions of the point [10].

Figure 6 shows one possible solution for this problem in geographic form. For simplicity, only one point is connected in the signal circuit. The signal circuit at the entrance side is shown on the left, the circuit for the exit side on the right, and the circuit for the point in the middle. It is assumed here that a signal aspect appears only when two relays are energized

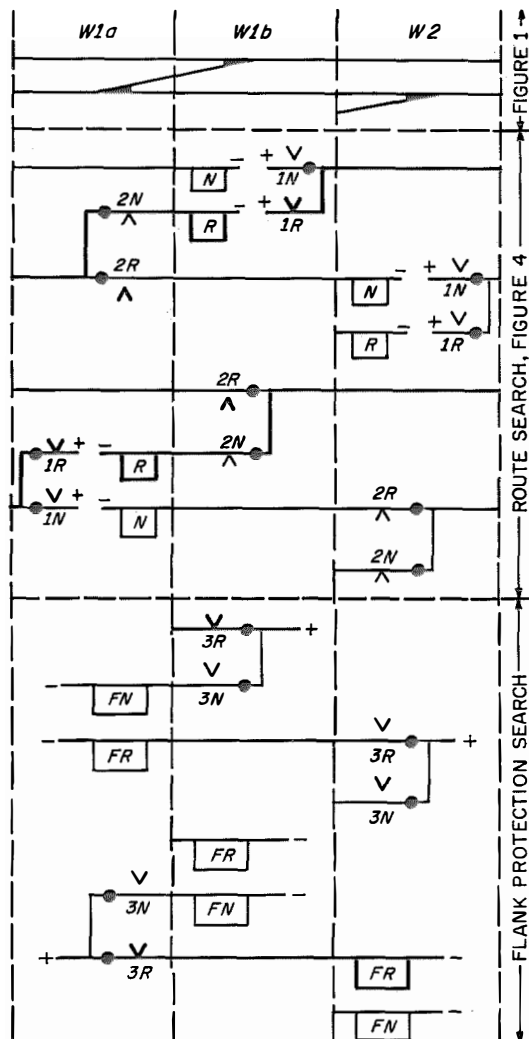

Figure 5—Flank protection search circuits.

Geographic Railroad Interlocked Routing

together. One of these is always the signal control relay *SC*, while the other is either *DR* (indicating full speed) or *HR* (indicating reduced speed). These signal circuits not only have to prove whether the route is free (*TR*), but also that the points are correctly set, that they are locked, and that there is flank protection if necessary. These combined conditions are controlled by contacts *NUK* for the normal position and *RUK* for the reverse position. Thus the signal circuits contain the detection contacts of all points and the contacts of all track circuits of the route, the track relays *TR* being energized when the track is clear. The signal process is initiated by contact *11K* at the entrance side.

The sequence of operations for the circuit shown in Figure 6 is traced in Figure 7. By closing contact *11K*, a circuit is completed via

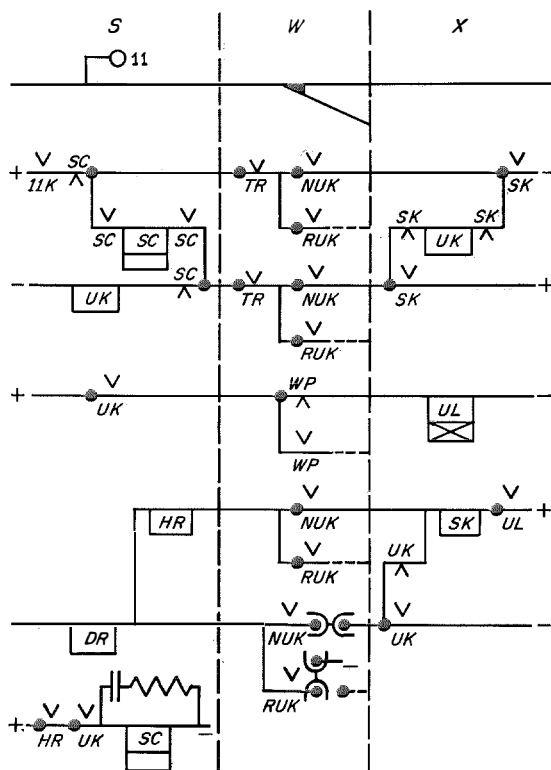

Figure 6—Control of signal aspect by associated point.

contacts *TR* and *NUK* (previously closed) of the point and relay *UK* at the exit side, to relay *UK* on the entrance side. Contacts *UK* on the entrance side are then closed. One of them connects interlocked relay *UL* at the exit side via point position contact *WP*. Since contacts *UL* and *UK* have changed settings on the exit side, current passes through relays *SK* and *HR*. One *HR* contact connects via contact *UK* a winding of relay *SC*, which is shunted by a capacitor and a resistor for slow release. Make-and-break contacts *SK* and *SC* in the top circuit change settings, whereby relays *UK* on the entrance and exit sides release. In the bottom circuit, relay *SK* is now connected in series with relay *DR*, and relay *HR* is short-circuited so that it releases. Since relays *SC* and *DR* are energized, the signal is set to clear without any speed restriction.

If the signal, depending on the position of the point, is to be set at clear with speed restriction, then instead of the through bridge there is in the point a connection with return line, as shown alongside the lowest contact *RUK* in Figure 6. Then only *HR* and *SC* would be connected, *DR* being applied on both sides to

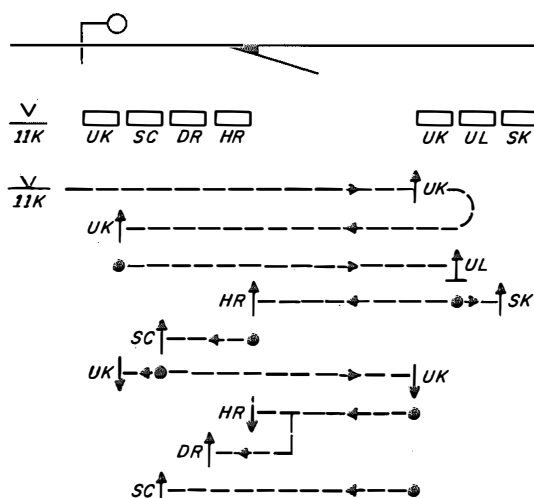

Figure 7—Typical sequence of operations for circuits in Figure 6.

return line. These reversible bridges are obtained by means of program plugs.

It is also frequently necessary to make the signal aspect depend not on the position of the point but on the aspect of the following signal, as in the British system for example. In this case there are four possible signal aspects, namely, green, yellow/yellow, yellow, and movement to occupied track. If the exit signal displays either green or yellow/yellow, then the entrance signal may display green. If the aspect of the exit signal is yellow, then the entrance signal may show yellow/yellow. If the exit signal is red, then the entrance signal may show yellow. A subsidiary signal aspect is produced for the movement to occupied track. Accordingly the entrance signal has four aspect control relays, designated in Figure 8 by *DR* (green), *HHR* (yellow/yellow), *HR* (yellow) and *COR* (call-on aspect, white). Selection of the signal aspects can be effected very simply, for example by choice of direct or alternating voltage. Relay *DR* is responsive to alternating current via capacitor, transformer, and full-wave rectifier circuit; relay *HHR* responds to direct current. If the exit signal is green or yellow/yellow, alternating current is sent through the line (*NUK* having been closed). The clear condition of the tracks and points, and also the correct position and locking of the points, are detected and relay *DR* is operated. If, on the other hand, the exit signal shows yellow, direct current is sent through the line and relay *HHR* is energized. Similarly, when the exit signal is red, relay *HR* is energized by alternating current, and when the track is occupied, relay *COR* is energized by direct current.

3. Construction of Geographic System

Assume that the geographic system is to be constructed in a geographic circuit arrangement (although it is possible to achieve the same results in other ways, if necessary). This study is restricted to the electromechanical

relay technique, because the electronic interlocking technique is still experimental [11].

3.1 CONNECTIONS

The relay sets are interconnected by geographic cables in accordance with the location of the parts they control, such as points and signals. To be able to install these cables easily and quickly and also to be able to modify the system as quickly as possible, the cables are terminated with soldered plug strips. The relay sets are in racks and the plug strips in the relay sets are inserted in the socket strips in the rack.

Figure 9 is the relay-set connection plan, which is designed for the track system of Figure 1. The geographic connections pass through all the relay sets. Only the track relay of each point can be connected with its point relay set by a direct cable, because the point relay set

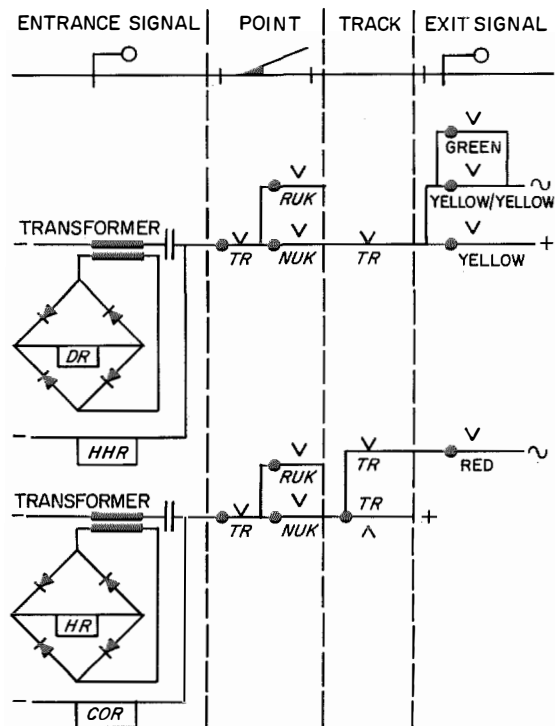

Figure 8—Control of entrance-signal aspects by aspect of signal ahead.

Geographic Railroad Interlocked Routing

contains a repeating relay for the track relay. This repeating relay is necessary because this insulated section of the points is used not only to prove the route clear, but also to prevent switching the points during occupation of the corresponding protected section. The insulated sections assigned to the points therefore have a twofold purpose and their relays require more contacts.

It is clear from Figure 9 that the control system is composed of the geographic cables and some direct cables. Direct cables will always be provided when there is an exclusive connection with a particular relay set. All relay units that contain any route conditions must be switched into the geographic system, and all those containing no route conditions are connected by direct cables.

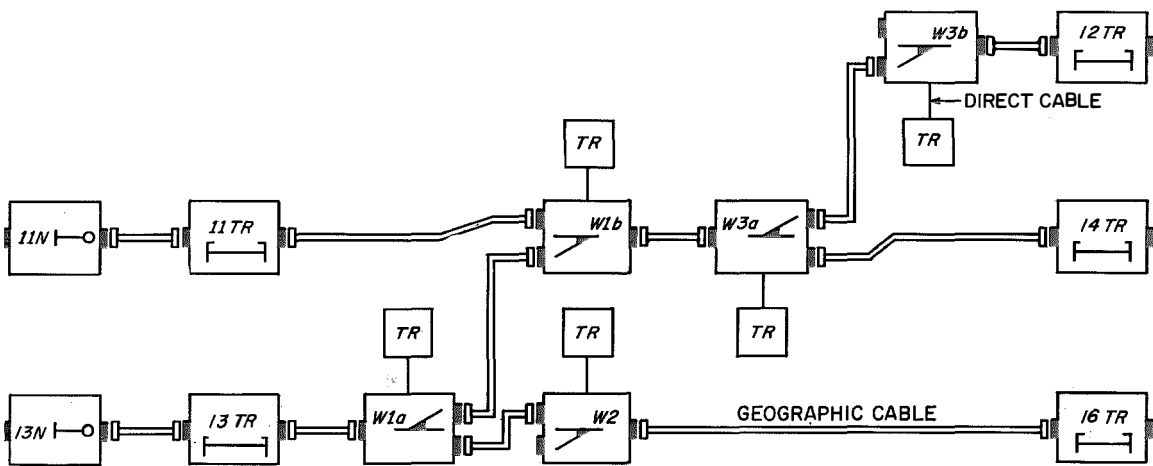

Figure 9—Relay-set connection plan.

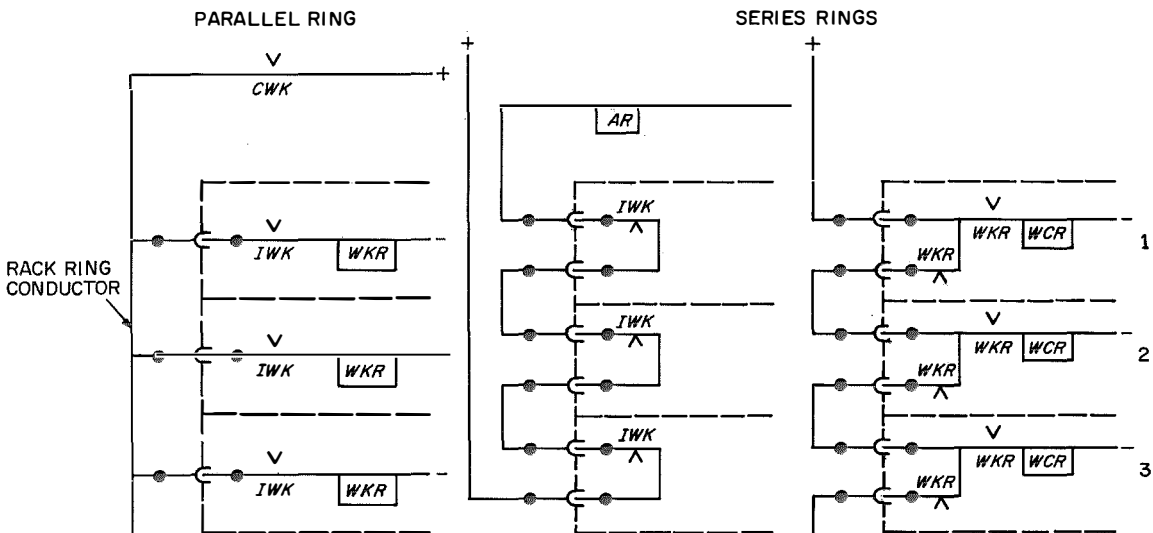

Figure 10—Ring conductors.

The circuit requires ring conductors in addition to the geographic connections. Ring conductors establish connections to all relay sets, or all relay sets of one type, from a central position, for example, a common relay test set. Figure 10 shows various types of ring conductors. The parallel ring is shown on the left as an example of individual point control, which is effected by joint control of common point push button *CWK* and individual point push buttons *IWK*. The latter energize relays *IWK* in the point relay set, the contacts of which are shown in the figure. If the common point push button is operated, voltage is applied to all the point relay sets, and it is only through operation of a push button *IWK* that relay *WKR* is energized, which effects the point control.

In addition to parallel rings, which are also needed for many other purposes, series rings are used. The center of Figure 10 shows a series ring circuit that indicates whether all the push buttons are in the rest position. This is necessary to detect a push button that is sticking through some mechanical fault. Alarm relay *AR* is connected in the ring via a back contact of each point push-button relay of the individual point relay sets. If on release the push button sticks and does not return *IWK* to its closed position, the failure of *AR* to be re-energized after a certain time has elapsed will cause an alarm to sound.

Another type of series ring circuit is shown on the right of Figure 10. It is intended to prevent switching a large number of points simultaneously. Since actuating the entrance and exit push buttons of a route having many points will cause a large number of point machines to start simultaneously, the power supply of the interlocking system would be subjected to an extraordinary peak load. To avoid this, it is necessary to actuate the point machines in sequence at intervals of about a half second, so that the high peak current of one point machine ceases before the next point machine starts. Each of the three control relays *WCR* is energized through its associated contact *WKR*, comprising one relay set.

Assume that all three relay sets shown have to be connected for one route. During the connection of relay set 1, sets 2 and 3 are cut off until contact *WKR* of the first point is restored to its normal position. The restoration of this contact to normal can be delayed as required, whereby the following point machines operate after a corresponding time lag. When *WKR* of the first point changes over, relay *WCR* of the second point is energized et cetera.

Ring circuits are useful whenever relay sets outside the interlocking route under consideration have to be energized, as when manually restoring a clear signal, when reversing a point on a clear track, when isolation is faulty, and after a trailing run-through.

In addition to geographic and ring connections, wiring connections to the control panel and the outdoor cables are necessary. These connections can be regarded as inputs from or outputs to the relay system. Walter Schmitz [12] describes the over-all wiring of geographic systems. Figure 11 shows wiring to the back of a relay rack. Eight plug strips can be seen on each relay set. The geographic cables are connected to the upper left-hand strip and the two upper right-hand strips. The lower left-hand strip contains the terminals to the panel and the outdoor cables; the strip above it contains the ring wiring connections, which are inserted at the factory as permanent rack wiring.

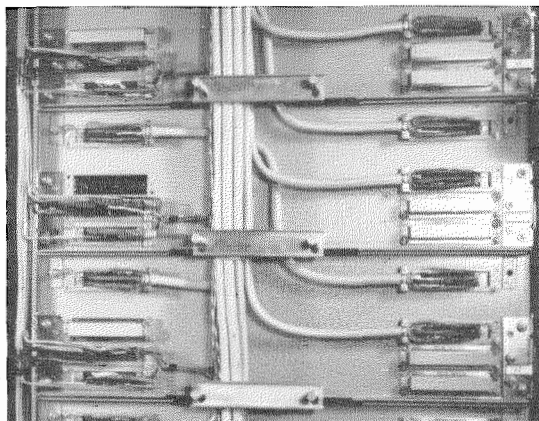

Figure 11—Rear of a relay rack.

Geographic Railroad Interlocked Routing

3.2 SEPARATION OF GEOGRAPHIC AND CONTROL PARTS

The relay sets for geographic systems are assigned to individual control functions. They contain the entire geographic part (connected via the geographic cables) and also a control part, used, for example, to set a point or a signal according to the information supplied by the geographic part. By accommodating the geographic and control parts in different relay sets, different kinds of control parts could be connected optionally to the same system. For example, merely by exchanging the control parts, it would be possible to change from direct-current point machines to 3-phase-current point machines while retaining the entire geographic equipment. However, a system of this kind is less attractive for a railroad administration than for industry, which had to construct a bewildering variety of equipment for domestic and export use, such as: electric point machines, pneumatic point machines, color

searchlight signals or color individual spotlight signals, et cetera.

In contrast to Figure 9, which shows the connection plan with combined geographic and control parts, Figure 12 shows the plan with separate geographic and control parts. The increased number of relay sets and direct cables required is evident in Figure 12, which increases cost. Not only are two relay boxes needed, with additional plug-in connections and cables, but it is also necessary that the relays for the two functions be separated from each other. A number of repeating relays are also required. If both geographic and control parts are in one relay set, contacts of one relay can be used for both purposes.

A rough estimate shows that when the two functions are separated, extra costs are incurred of the order of 20 to 25 percent of the cost of the relay equipment. Separation is undesirable even from the point of view

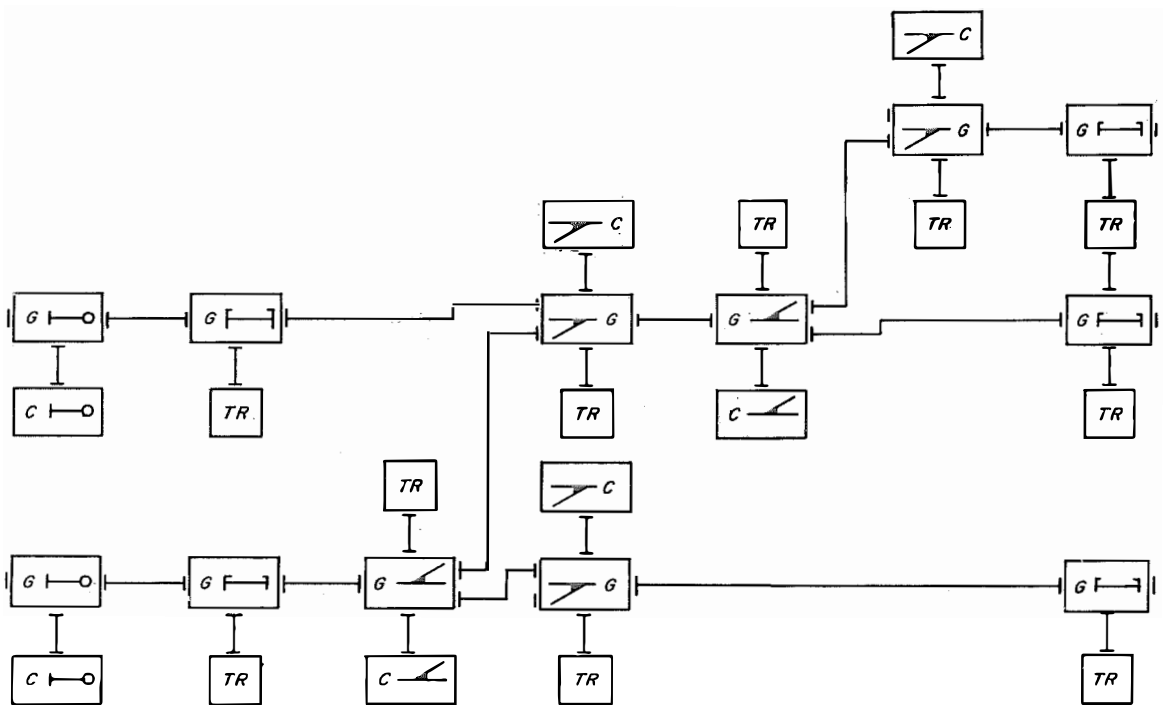

Figure 12—Connection plan with separate geographic and control relay sets.

of safety and efficient service, not only because the additional plug-in connections represent sources of breakdowns, but because faults can also arise in the direct connections between geographic and control sets. As protection from such faults will be required, there will be the additional expense of safety measures. Also, from the standpoint of storing spare relay sets for a single system, there is no advantage in separation, since the number of different relay sets is increased.

For the foregoing reasons, therefore, the combination of geographic and control parts in one relay set is recommended.

3.3 COMBINING OF POINTS IN ONE RELAY SET

It is customary in the geographic technique to assign one relay set to each point. A system of this kind is shown in the upper part of Figure 13 for a small railroad station. The 7 point sets, 6 signal sets, and 2 track sets for the departure track are shown. Usually 2 point sets are arranged one above the other and are connected by a geographic cable. This connection corresponds to the route via the two points of the

crossover. Even in a route over the straight (normal) position of a point, the adjacent point will be used for flank protection.

It might be advisable to arrange the whole crossover in one relay set as shown in the lower part of Figure 13. Such a combination of points would have the advantage that no control parts are needed to provide flank protection for routes on the through tracks and, since both points are always commonly controlled, only a single geographic part would be needed for the points. By eliminating these functions, so-much space is saved in one point set that the additional control parts for the second geographic part can be accommodated in the same point set without increasing its size. In Figure 13 full flank protection by points is obtained without special expense for relays by arranging the point connection in one relay set.

Such assemblies of control parts are possible for all combinations in which points can always be commonly controlled. Examples are: a crossover with intermediate crossing, wherein one relay set replaces three relay sets of the

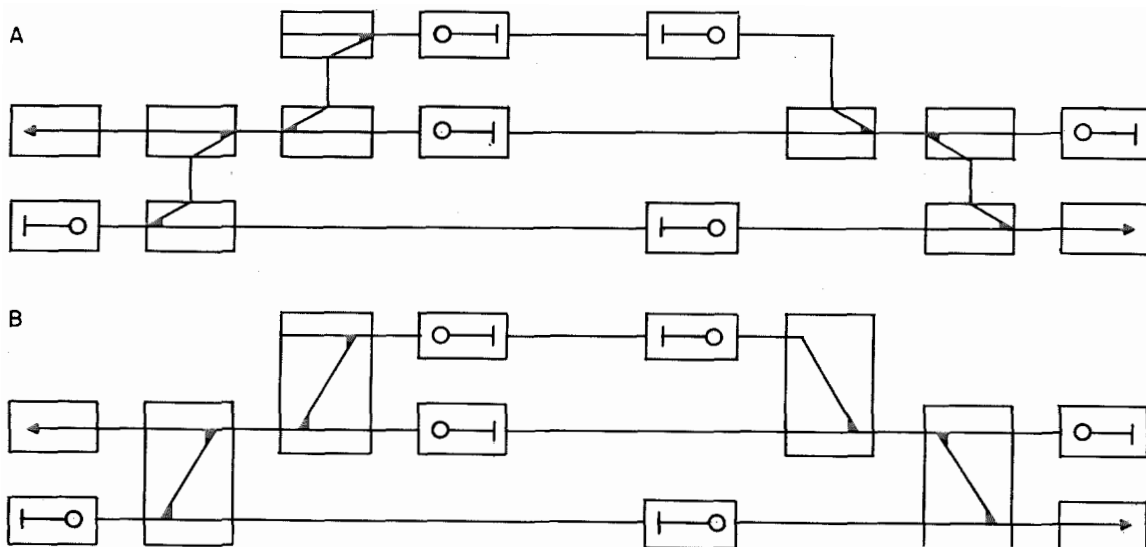

Figure 13—A illustrates a small railroad station using single point sets and B the same network using crossover sets.

Geographic Railroad Interlocked Routing

previous system; a point with derailer; and a single slip point, within which one point might often be controlled unnecessarily when a movement over the crossing is reversed. For economy it is also worth trying to assemble in one set points that have to be separately controlled, such as the double slip, the scissors crossing, and two individual points.

3.4 RELAY-SET CONSTRUCTION

The relay sets can be equipped with any combination of relays and other accessories such as transformers and rectifiers. The geographic system used two sizes of relay sets, having capacities of 27 and 45 relays. Figure 14 shows a front and back view of the larger point relay set.

The sets are wired in the factory and provided with connector strips, the mates of which are fastened into the relay rack. Some relay racks are shown in Figure 15. The sets have been removed from the rack on the right so that the connector strips can be seen. This is shown more clearly in Figure 16. To restrict the variety of relay sets, program plugs provide a connection facility for the relay-set circuits. Although there are very-different types of signals and they require interlocking, such as between distant and main signals, a single main-signal set was provided that contained all the

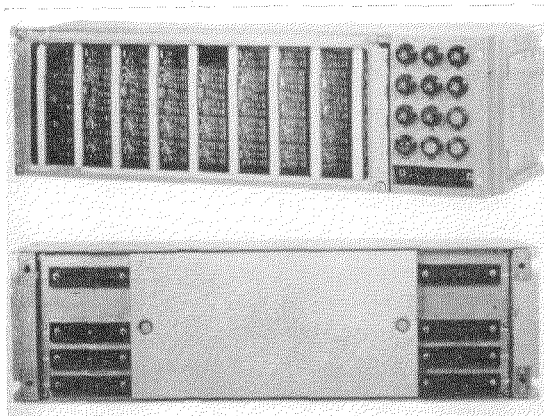

Figure 14—Point relay set.

variants, so that the switching for a particular case is effected by the program plugs permanently fastened to the rack. This ensures that the program plugs, selected as required, impose the same operating program on any given relay set.

This limit to the variety of relay sets obviously means costlier circuits than in single-purpose relay sets, since the relay sets that combine functions must contain the most-extensive programs. One must weigh carefully whether it is more economical to provide two or more types than to make a single type at an increased cost.

3.5 GEOGRAPHIC CIRCUITS

3.5.1 Route Search

The route search establishes the connection between the commonly controlled entrance and exit buttons for a certain route. There is no safety problem and measures do not have to be

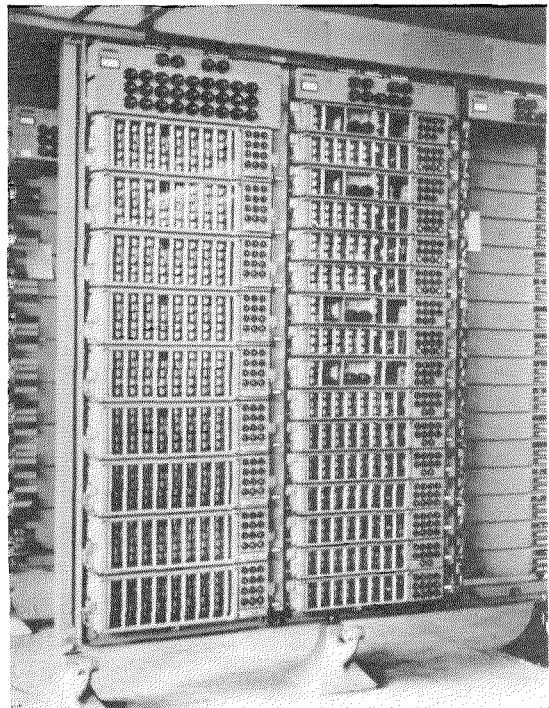

Figure 15—Relay racks.

taken against switching faults. To avoid unnecessary switching, it is advisable to interrupt the route search circuits of a point if it is not available for the route because it is manually locked or occupied. Therefore a few additions are necessary to the circuit arrangement of Figure 4, and in practice a third route search relay is provided, assigned to each facing point. When the crossovers are accommodated in a single relay set, only 4 route search relays are required compared with 6 when individual point sets are used, so that there is a saving here.

If the route search is switched through, then the point control order can be given to the associated points via another geographic circuit. It is not advisable for the point control to be effected directly by the route search relay, because points might be reversed before it has been confirmed that the whole route is also

available. Of course, the control circuit of the route search already prevents conflicting movements in a route that has been set. When the route search is finished, the only certainty is that a route to be set is permitted and is possible. This control circuit also needs no safety measures, if—as is necessary for other reasons—the control circuit is protected from circuit faults. To protect the power supply from excessive peak currents of the point machines, it is advisable to connect the points to be controlled one after the other with a time lag.

3.5.2 Flank Protection

Substantial investment is required for flank protection as, over the geographic connection, it must be searched for, set, locked, reported back to the associated route point, and again released from there. It is frequently extremely

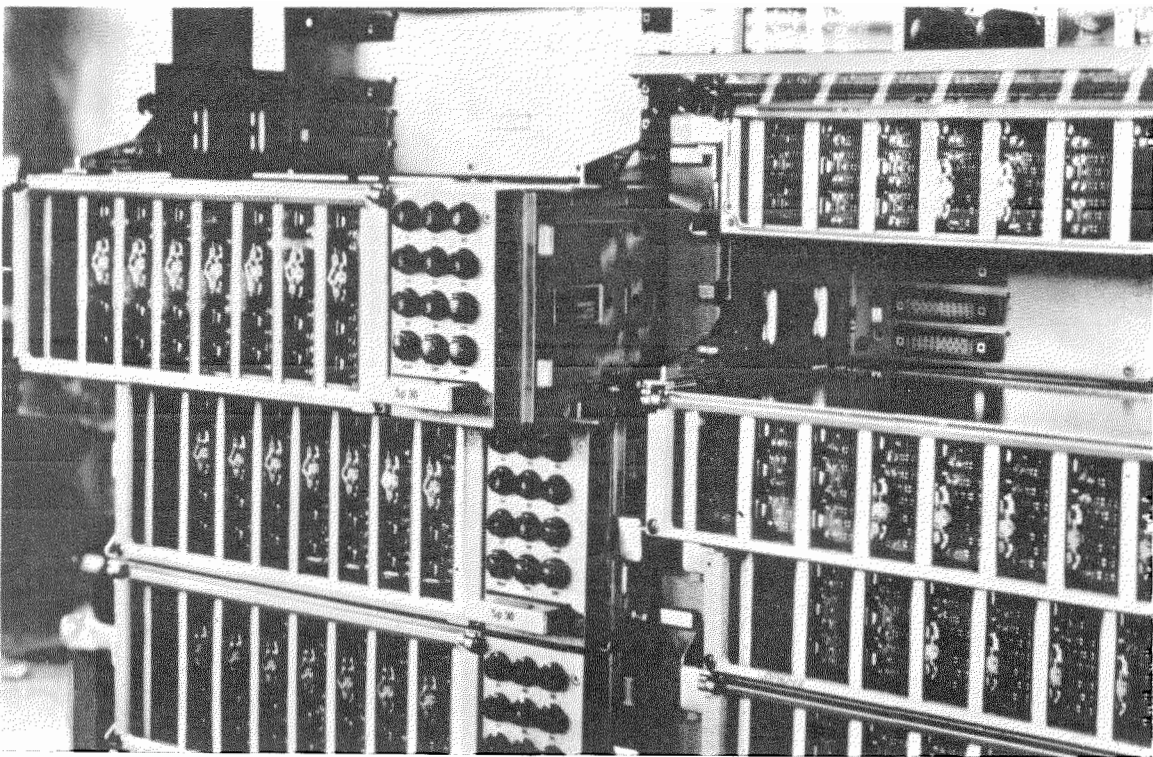

Figure 16—Enlarged view of relay racks. Note the two sizes of relay sets mounted in the racks.

Geographic Railroad Interlocked Routing

difficult to accomplish this, as all interrelations must be considered.

Flank protection is largely eliminated by the proposed combination of points in one unit, because both points always will be set together (Figure 13B). This is also the case in large interlocking systems, through careful selection of the combinations of points in one unit. Figure 17 shows the track layout of one side of a station and Figure 18 a suitable geographic connection plan for the relay sets needed to control operations over the track layout. It will be seen that when the slip points are separated and each recombined with the adjacent point, almost the whole layout can be realized in terms of crossover points. Except for the two individual points 2c/d and 4, two or more point connections are combined in one relay set. Point combination 5a/b and 7b contains a crossing with six geographic cables. Point combination 7a and 9 also requires six geographic cables, because this combination is interrupted by point 7b. Three relay sets control points 10 and 12, 11 and 13, and 15 and 17, and one relay set controls point 24 and a derailer.

Although in this more-complicated track layout the major portion of the flank protection is al-

ready accomplished by combining the points, there are still some routes for which flank protection by points is incomplete. For example, for the route over crossover 6 and 8, point 7a should be set and locked in the right-hand position. Insofar as there are no flank protection points, the corresponding shunt signals are used as flank protection and then locked in the stop position. As these signals can be controlled only via the geographic circuits, and as conflicting routes cannot be set, these signals cannot be cleared if they are needed as flank protection. Since it is already necessary to use the shunt signals largely for flank protection, and since most of the flank protection by point is already provided when crossover relay sets are used, the missing required flank protection by points should also be substituted for by signal flank protection.

It still may be necessary to confirm that the flank protection signal indicates danger. This is provided for, since extinction of a light signal triggers alarm bells. If this is not considered sufficient, it is possible to make the clear position of the signals depend on a common red proving of all signals, in which each signal in the clear position bridges its own red-proving contact.

Recently, clear proving of the flank protection space has sometimes been required. The extent

Figure 17—Track layout of one side of a station.

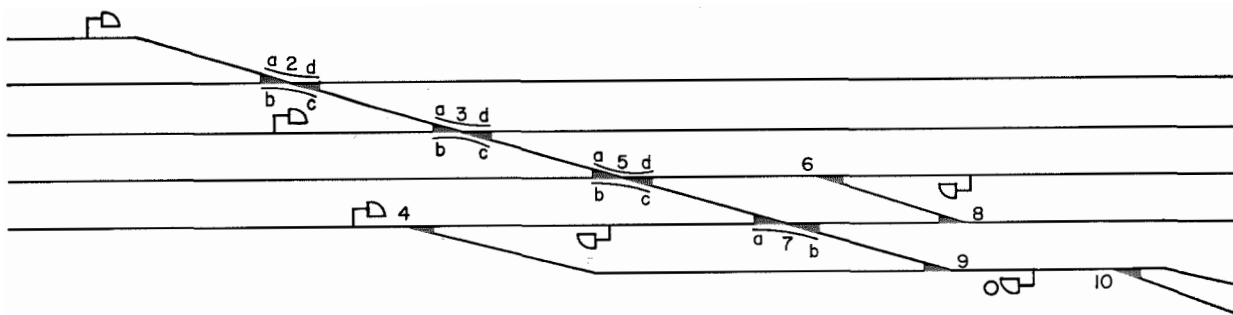

that this is justified and how it can be technically achieved without great expense are outside the scope of this article.

The next task is to check in the geographic circuits that the points of the route are cor-

rectly set, and only then is it advisable to lock the points. If the locking were effected right after operation, individual points might be locked without confirmation that all the points can be set. In principle, interlocked relays or

Figure 18—Geographic relay-set connection plan for track layout of Figure 17.

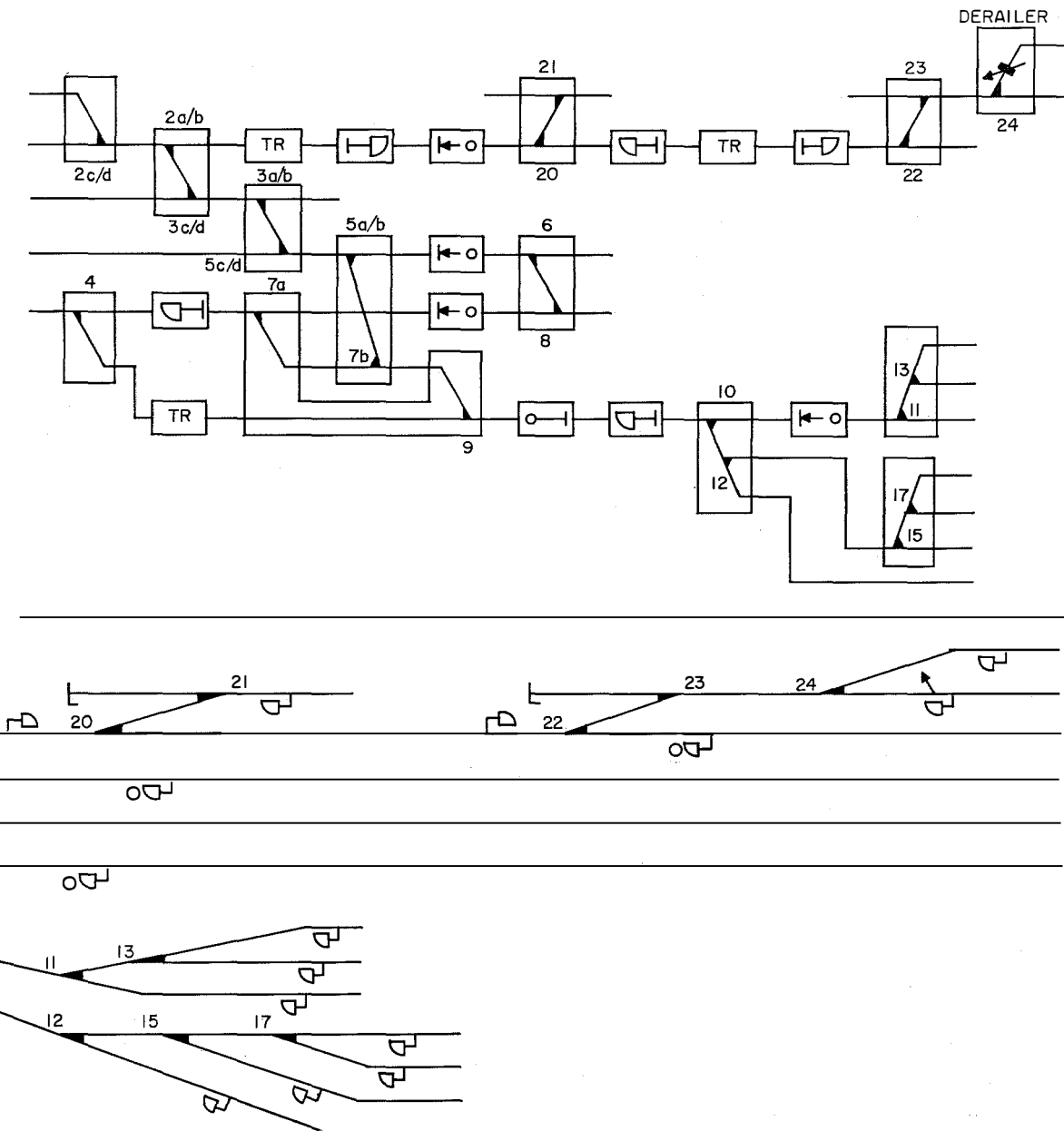

Geographic Railroad Interlocked Routing

relays that operate similarly to them should be used for the locking. The use of normally energized standard relays, still quite common, is not recommended for this purpose. This locking circuit also needs no special signaling safety, since the locking is detected in the signal control circuit.

3.5.3 Clear Signal Control

As stated earlier, a distinction can be made in clear signal control between two functions: dependence of the clear aspect on the route itself (Figure 6), and dependence of the clear aspect on the position of the preceding signal (Figure 8). Since the geographic system must be capable of both tasks, it is advisable to switch the circuit of the higher signal aspect (*DR*, Figure 8) to the lower aspect (*HR*, Figure 8) by means of program plugs in the point relay set.

Since it is necessary to prove all the dependencies by means of the signal circuit (point position and locking, track clear, and flank protection), this is the most-important circuit in the geographic system from the point of view of signaling technique. It must be protected from faults as much as possible. For this reason clear control should always be effected by at least two relays, each controlled by a separate circuit.

3.5.4 Route Release

The effectiveness of the interlocking system increases as the time required for parts of the route to be released decreases, that is, unlocked and made available for other train movements after the train has run over them. The minimum number of parts is one switch point. Therefore in geographic systems the points should be released individually after the train has passed. Only if two or more points have a common track circuit is it necessary to release them together. Since the train is endangered if a point is prematurely released, there must be a high degree of security against the effects

of errors. From the standpoint of safety, therefore, it would not be sufficient to release the locked point by dropping and subsequent pickup of the track relay of this point, as is still commonly done. The following method seems ideal and also matches the geographic technique. Occupation of the home track circuit and the two adjacent track circuits is proved and the locked point is released only when the home track circuit becomes clear.

Another frequent problem is control of speed and route indicators. This can be solved by multiple control from the exit side (similar to Figure 8).

4. References

1. Robert Helmert and Wilhelm Schmitz, "Tricon, ein neues Gleisbildstellwerk", Jubiläumsbuch "75 Jahre Lorenz 1880-1955", pages 194-202.
2. Wilhelm Schmitz, "Tricon", *Der Eisenbahn-Ingenieur*, volume 6, number 9; 1955.
3. Walter Schmitz, "Grundgedanken des Gleisbildstellwerkes SpDr", *Signal und Draht*, volume 48, pages 35-43; 1956.
4. Wolfgang Sasse, "Schaltungsaufbau des SpDrS-Stellwerkes (Bauform Siemens)", *Signal und Draht*, volume 48, pages 43-48; 1956.
5. Werner Kirmse, "Schaltungsaufbau und Bauteile des SpDrL-Stellwerke", *Signal und Draht*, volume 48, pages 51-59; 1956.
6. Wilhelm Schmitz, "Tricon, an Electric-Diagram Interlock System for Railroad Switching," *Electrical Communication*, volume 35, number 1, pages 47-56; 1958.
7. Wilhelm Schmitz, "Die Schaltung des SpDrL 30", *Signal und Draht*, volume 51, pages 137-144, 163-167; 1959.
8. Wilhelm Schmitz, Standard Elektrik Lorenz, Electrical Interlocking System with Route Setting by Chain Connection of Route Relays, German Patent 940 990; 22 May 1953.

9. Walter Schmitz, Siemens and Halske, Circuit Arrangement for Interlocking Systems with Electrical Locking, Particularly Track Diagram Interlocking Systems, German Patent 975 281; 10 April 1954.

10. Robert Helmert, Standard Elektrik Lorenz, Circuit for Dependency Circuits in Interlocking Systems, German Patent 939 936; 13 December 1953.

11. Walter Schmitz, Siemens and Halske, Device for Electric Interlocking Systems, Particularly Geographic Systems, German Patent 1 030 383; 26 June 1956.

12. Walter Schmitz, "Das Spurplanstellwerk SpDrS 60", *Signal und Draht*, volume 54, pages 17-39; 1962.

13. "Electronic Signaling Installation at Henley-on-Thames," *Railway Gazette*, volume 116, number 3, pages 74-77, 80; 1962.

5. Appendix























The graphic symbols and abbreviations used in this paper are defined in Sections 5.1 and 5.2. Abbreviations within a rectangle indicate the

operating coil of a relay, the contacts for which will be identified by the same abbreviations. If there are more than one pair of contacts, the individual pairs will be numbered.

5.1 GRAPHIC SYMBOLS (See below)

5.2 ABBREVIATIONS

<i>AR</i>	Alarm.
<i>C</i>	Control.
<i>COR</i>	Call-on-speed aspect (white).
<i>CWK</i>	Common point push button.
<i>DR</i>	Full-speed aspect (green, 3 sections clear).
<i>FN</i>	Flank protection search for normal point position.
<i>FR</i>	Flank protection search for reverse point position.
<i>G</i>	Geographic.
<i>HHR</i>	Moderate-speed aspect (yellow/yellow, 2 sections clear).
<i>HR</i>	Low-speed aspect (yellow, 1 section clear).
<i>IWK</i>	Individual point push button.
<i>K</i>	Entrance or exit.
<i>N</i>	Normal route search.

 Signal.	 Relay. The asterisk is replaced by letters indicating function of relay.	 Plug contact.
 Insulated rail joint.	 Relay, two windings.	 Track relay set for departure track.
 Pair of switch points.	 Relay, interlocked.	 Main signal relay set.
 Push button.	 Program plug.	 Shunt signal relay set.
 Front contact open, relay not energized.	 Relay contacts actuated.	 Overlap relay set.
 Front contact closed, relay energized.	 Relay contacts released.	 Shunt signal.
 Back contact open, relay energized.	 Relay contacts interlocked.	 Main and call-on signal.
 Back contact closed, relay not energized.		 Track section.

Geographic Railroad Interlocked Routing

<i>NK</i>	Entrance route search.	<i>UL</i>	Route locking.
<i>NUK</i>	Normal route detection.	<i>WCR</i>	Point control.
<i>NWK</i>	Normal point detection.	<i>WKR</i>	Point push button relay.
<i>R</i>	Reverse route search.	<i>WP</i>	Point position.
<i>RUK</i>	Reverse route detection.	<i>W1a, W1b, W2,</i>	
<i>RWK</i>	Reverse point detection.	<i>W3a, W3b</i>	Point relay sets.
<i>SC</i>	Signal control.	<i>11N, 13N</i>	Entrance relay sets.
<i>SK</i>	Signal detection.	<i>11/12SC</i>	Signal control relay from tracks 11 to 12.
<i>TR</i>	Track relay contact.		
<i>UK</i>	Route detection.	<i>12X, 14X, 16X</i>	Exit relay sets.

Wilhelm Schmitz was born on 4 April 1902 in Honnef am Rhine, Germany. He received an engineering degree in 1926 from the Technische Hochschule in Aachen, and a doctorate in engineering in 1932 from the Technische Hochschule in Berlin-Charlottenburg. In 1939 Dr. Schmitz was appointed a university lecturer.

In 1927 he joined Siemens and Halske, where he worked on the design of railroad switching systems.

He joined Standard Elektrik Lorenz in 1949, and is now head of the railroad signaling development department.

Dr. Schmitz is the recipient of numerous patents.

High-Power Reflex Klystrons for Millimetre Wavelengths

T. M. JACKSON
A. D. BRISBANE
E. A. ASH

Standard Telecommunication Laboratories Limited; Harlow, Essex, England

1. Introduction

The past few years have seen substantial advances in the realization of generators for the millimetre band. It is now possible to purchase sources for frequencies up to 300 gigahertz. Nevertheless, unlike the situation at centimetric wavelengths, cost and reliability factors have thus far hindered the applications of these devices.

The maximum attainable power at 5 millimetres is substantially less than that at 5 centimetres. This is of course a direct result of the fact that constants of materials, such as cathode-emission density and thermal and electrical conductivity, do not "scale" with physical dimensions [1]. If one attempts to scale down a centimetric tube directly, construction difficulties are likely to arise from the small size of the parts, which leads to low yields and poor reliability. By reducing demands in a certain direction, however, one can realize tubes that, within the limits of their electrical performance, have a life and reliability entirely comparable with typical centimetric tubes. The constructional effort involved need not greatly exceed that required in the manufacture of lower-frequency tubes.

For many applications, including pumps for parametric amplifiers and masers, microwave spectroscopy, and pulse-code-modulation communication, the millimetric source needs very little mechanical tuning. The design of a reflex klystron can be greatly simplified if internal tuning is avoided from the start. We have accordingly designed a series of tubes in which an attempt has been made to fully exploit this basic advantage.

2. Design Considerations

One of the basic design decisions was to rely on accuracy built into the component parts, rather than on skill or adjustments during as-

sembly. In a number of cases this requires tolerances of the order of 2 microns. It is of interest to note to what extent the difficulty of achieving tolerances is judged in different fields. For example, in transistor technology, tolerances of 0.5 micron are not uncommon, and in optics the target might well be 0.005 micron. In our opinion, the difficulty of achieving a 2-micron tolerance is frequently exaggerated, usually because it is judged in terms of conventional engineering techniques rather than in terms of new methods appropriate to the dimensions. Some of the newer techniques adopted in constructing the tubes are noted in Section 4.

Since one of our main aims was to attain high powers, the dissipation capability of the cavity system was of prime importance. In considering how to make the thermal impedance as low as possible from the point of maximum dissipation, one immediately finds that the main limitation is the throw (see Figure 1) of an electrostatically focused beam. The design of the gun system to achieve the desired perveance and maximum distance to the minimum diameter point of the beam is briefly described in Section 2.1.

Internal tuning by means of deformable membranes was to be avoided in favour of a limited degree of mechanical tuning by coupled-cavity techniques. Although wide mechanical tuning

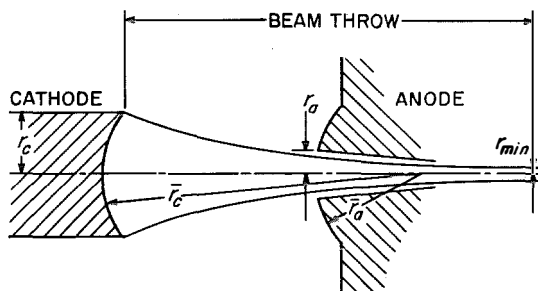

Figure 1—Beam parameters.

High-Power Reflex Klystrons

frequently is not essential, it is very desirable that tubes be capable of production with any centre frequency, over the broadest possible band, and with as few design changes as possible. The discussion in Section 4 indicates that a frequency accuracy within 0.1 per cent is obtainable, so that a tuning range of 0.3 per cent would suffice. It is a very-simple matter to obtain tuning ranges of this order with a coupled cavity. By proper design it is possible to obtain tuning ranges well in excess of 5 per cent. The design of such a tuner and a simple analytic procedure, which takes the non-linear aspects of the electron beam into account, are presented in Section 3.

An important feature of the design is the very-large frequency range obtainable (18–100 gigahertz) with only minor construction changes. The objective was a power of 1 watt at 35 gigahertz, using a beam voltage of not more than 2 kilovolts. The design procedure presented by Pierce and Shepherd [2], plus inspired guesses of cavity shunt impedances and efficiencies, suggested a beam current of 40 milliamperes. The tube, complete with external tuner, is illustrated in Figure 2.

2.1 ELECTRON-BEAM FORMATION

The gun is required to produce a 2-kilovolt, 40-milliampere beam so that the perveance

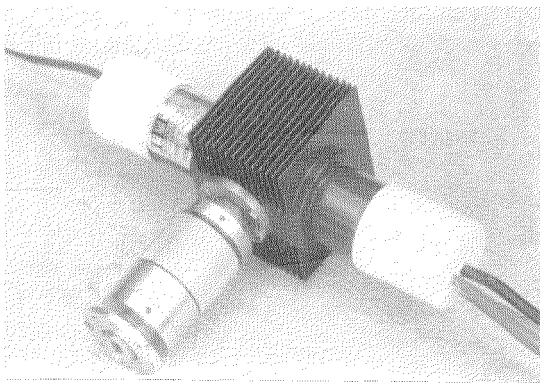

Figure 2—Millimetric reflex oscillator with external tuner.

(0.45×10^{-6}) lies well-within the design limits of Pierce type convergent guns.

To produce good interaction in the cavity, the beam at its minimum-diameter point should be as small as possible. For considerations of heat dissipation, the throw should be as large as possible. Using 0.025 centimetre (0.01 inch) for the minimum beam diameter and using a dispenser-type cathode operating at 1.6 amperes per square centimetre, a conservative figure that is consistent with life expectations of 10 000 hours, the beam area compression is then 50:1. In this high-compression regime, the effect of thermal velocities becomes increasingly important. Using the design procedure outlined by Danielson, Rosenfeld, and Saloom [3], the beam parameters in Figure 1 and Table 1 are obtained. The choice of grid shape

TABLE 1
GUN CHARACTERISTICS

Parameter	Unit of Measurement	Rating
Beam voltage	Volts	2000
Beam current	Milliamperes	40
Minimum beam diameter ($2 \times r_{\min}$)	Centimetres (inches)	0.025 (0.01)
Beam area compression ratio	—	50:1
Cathode current density	Amperes per square centimetre	1.6
Cathode temperature	Degrees Kelvin	1300
Perveance	—	0.45×10^{-6}

becomes to some extent a compromise between electrical and mechanical tolerances. A series of grid shapes were tested in an electrolytic tank to produce a design capable of being machined to close tolerances. Although, as is well known, there is only one shape of grid that will rigorously reproduce the required potential distribution along the beam edge, there are many possible shapes that approximate the required distribution with a reasonable degree of accuracy.

Several tubes were made for testing guns, and from these results the beam shape was determined. Details of the final gun can be seen in Figure 3.

2.2 CAVITY DESIGN

The shape of klystron cavities giving maximum

shunt impedance has been much explored and, in the absence of other constraints, cavities are invariably made approximately square. Heat dissipation and electron optical considerations, however, make it necessary to depart from the usual optimum cavity shape.

The design adopted has a 6·5:1 ratio of cavity height to gap spacing with a single re-entrant

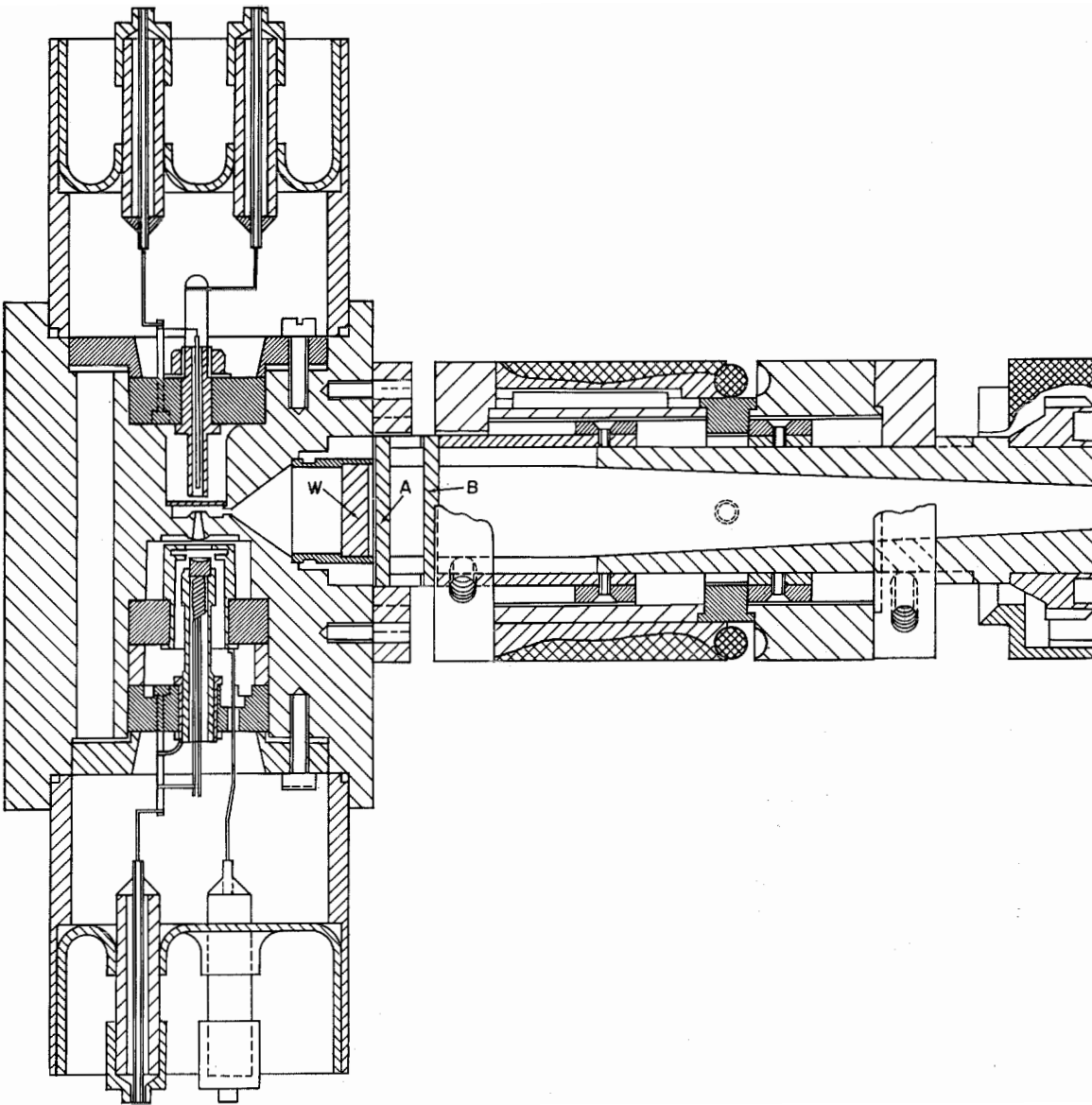

Figure 3—Reflex klystron with external tuner. *A* and *B* are dielectric slabs. *W* is a ceramic window.

High-Power Reflex Klystrons

cone. Approximate heat flow calculations show that even in the worst case, when the total beam power is dissipated at the tip of the re-entrant cone, the temperature rise does not exceed 300 degrees centigrade. In practice, of course, the power would be distributed more evenly, resulting in good frequency stability with temperature. Perturbation tests and Q measurements using this cavity ratio indicate a value of shunt impedance that is 75 per cent of the value obtainable in the ideal case [4]. Measured values of Q at 35 gigahertz are in the region of 1500, and corresponding tests on circular cylindrical cavities confirm that this closely approaches the theoretical maximum value. A transit angle of 1 radian is used, giving a gap of 120 microns at 35 gigahertz. The mean frequency sensitivity is 60 megahertz per micron.

The beam diameter (defined as containing 95 per cent of the total current) is calculated by the method given in [3], neglecting the effect of the reflected beam. The diameter of the reflected beam is in general substantially larger so that only a small fraction returns into the anode tunnel, leading to only a small effect on the electron optics of the primary beam.

To maintain the maximum interaction between beam and cavity, the diameter of the beam aperture in the cavity is made only 25 microns greater than the calculated primary beam diameter at the throat. This requires great accuracy of axial alignment to maintain high beam transmission, and is particularly important in this series of tubes where an identical electron optical system is used throughout the operating range of 18 to 100 gigahertz. The aperture diameter on the reflector side of the cavity is made slightly larger than on the gun side because the electron optics of this space are less perfect than on the gun side.

2.3 REFLECTOR DESIGN

The reflector parameters are recognized as the most-difficult design features of the reflex klystron. No suitable theory has evolved that

adequately deals with reflector design, and much of the work remains empirical.

Hence extensive experimental work on reflector shape and spacing may be necessary to optimize conditions for bunching and beam reflection.

The task can be eased by providing a multipotential reflector. The best configuration obtained experimentally is subsequently simplified into a unipotential form by electrolytic-tank methods.

It is not surprising that, in common with most other features of millimetre tubes, conditions in the reflector space become highly critical. Although tubes with a unipotential reflector can be made to oscillate without much difficulty, distinct advantages can be derived, particularly in output power, by maintaining the fine adjustment provided by a 2-potential reflector. Our work has consistently shown that the relative potentials of the inner and outer reflectors are different for each oscillating mode in any one tube.

The 2-potential reflector design that evolved has proved to be simple and effective. The outer reflector tube encloses an electrically insulated inner reflector rod.

3. External Cavity Tuner

The merits of an external cavity tuner have been considered by a number of authors [5-7]. In the present series of tubes the tuner is a detachable unit that need not be replaced with the tube. This is indicated in Figure 3. If the tuning of the external cavity is varied relative to that of the tube cavity, one of the two modes produced tends to follow the frequency of the external cavity. In practice there are two problems. The first relates to the design of the two coupling sections, one of which is between the klystron cavity and the external cavity, and the other between the external cavity and the output waveguide. The second problem relates to the actual means used to tune the external cavity.

The system analysis has been carried out in terms of the equivalent circuit indicated in Figure 4. It is possible to present such circuits in several different and largely equivalent ways. The particular choice made here has the merit that if the coupling apertures are closed to form short circuits, corresponding to $X_0 = X_1 = 0$, the resonant elements of the two now-uncoupled resonators are easily identified, and we can define uncoupled frequencies ω_0 and ω_1 respectively. We wish to calculate the resonant frequency ω_r of this combined circuit, as a function of the resonant frequency of the external cavity ω_1 relative to that of the klystron cavity ω_0 . To do this we compute the input impedance Z_{in} as seen looking into the circuit from the output side. There are in fact four resonances, but only one of these corresponds to an oscillation condition for the tube.

We are concerned with choosing X_0 and X_1 such that we tune over the largest possible range, but without sacrificing too much power output. To calculate the power output, we must take the non-linear property of the electron beam into account. We have done so very crudely, which leads, however, to usable design criteria. It is assumed that the electron beam

acts as a constant-current generator, provided that the impedance Z_b , seen looking into the circuit from the generator, is below a certain critical value Z_{crit} , and acts as a constant-voltage generator if it is above this critical value. For a particular tube it is not difficult, from simple physical considerations, to assign reasonable values to the current and constant voltage, such that the maximum output power corresponds to the known maximum output actually observed. If the working direct current can be estimated to be I and if we assume that under maximum-output conditions the radio-frequency beam current is also of the order of I , then P/I^2 is a reasonable value to choose for critical impedance Z_{crit} , where P is the maximum observed output power.

To apply this method we therefore compute the value of Z_b and then calculate the output power P at resonance, assuming a constant-current generator if $Z_b < Z_{crit}$ or a constant-voltage generator if $Z_b > Z_{crit}$. Expressions for Z_{in} , Z_b , and P are therefore readily derived. Typical computer results are shown in Figures 5 through 8, where we have expressed the frequency of the external cavity in the

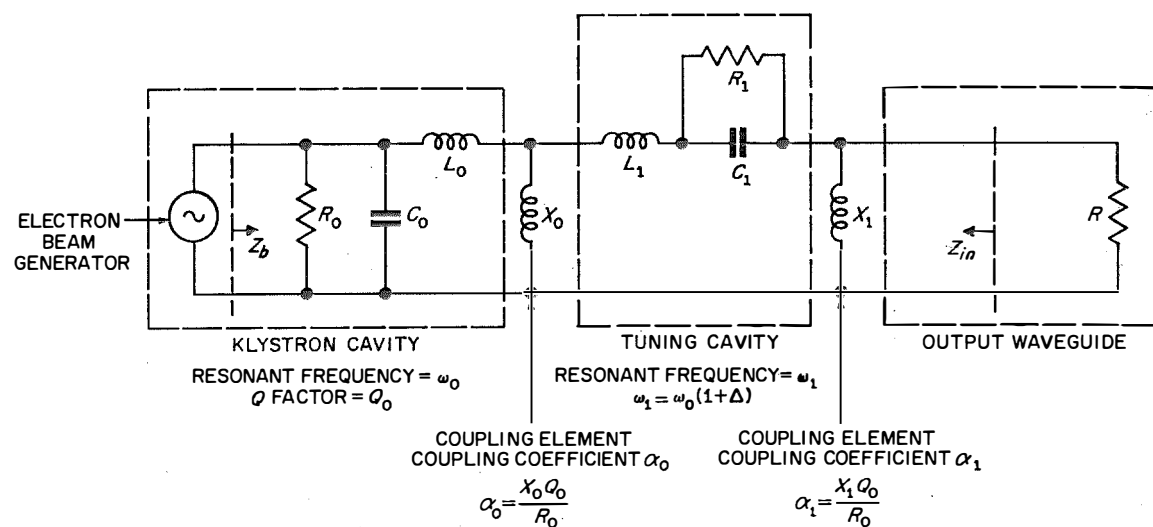

Figure 4—Equivalent circuit of the coupled cavities.

High-Power Reflex Klystrons

form $\omega_1 = \omega_0 (1 + \Delta)$, and the operating frequency of the tube and tuner combined in terms of ω_r , where $\omega_r = \omega_0 (1 + \delta)$. Under conditions of high power output, the curves suggest that tuning ranges (between the 3-decibel-down points) of 6 per cent should be attainable. It is of great interest to discover the effect of the Q of the external cavity on the performance of the tuner, the results of which are shown in Figure 8. It is seen in this instance that serious deterioration of the performance is not encountered provided that the Q of the external cavity tuner is maintained above 500. This Q refers to the unloaded value applicable to $X_0 = X_1 = 0$.

Two further results appear from these curves.

(A) The tuning range of the external cavity alone must typically cover 3 to 5 times that of the over-all resonance.

(B) A number of curves (see Figure 7) reveal a power dip in the neighbourhood of $\Delta = 0$. This dip is also usually observed in experimental results, as shown in Figure 9.

It is felt that whilst this method of analysis is very approximate, it enables us to estimate the value of the critical couplings. In practice this has greatly reduced the time needed in experiments.

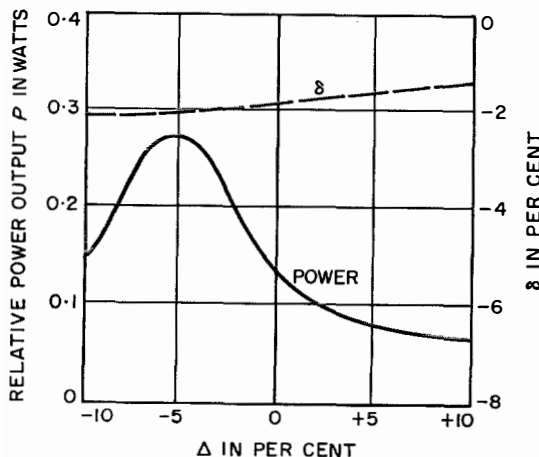

Figure 5—Theoretical tuning curves for $\alpha_0 = 0.1$ and $\alpha_1 = 0.5$.

The second problem associated with the tuner is the design of the actual tunable element. For the frequencies with which we were concerned, it was felt that a solution of the form indicated in Figure 3 would be appropriate. The tunable element in the external tuner consists of two dielectric slabs, A and B , which form the end walls of a cavity. The slabs are moved by means of lugs projecting through a slot in the circular waveguide. Typically, these slabs are a quarter-wavelength long and separated by a quarter-wavelength. By choice of the dielectric constant, it is possible to design for any desired degree of reflection and transmission. By varying the separation between the two slabs, the reflection coefficient (effectively the value of X_1) can also be adjusted. A simple mechanical arrangement allows the two slabs to be moved in unison, and by means of a clutch the same control knob moves slab B alone, which affects the tuning only slightly but alters the matching condition.

The advantage of this system is the absence of metal-to-metal contact. The best dielectrics at millimetre wavelengths are superior to metal as a reflector in that the loss per reflection can

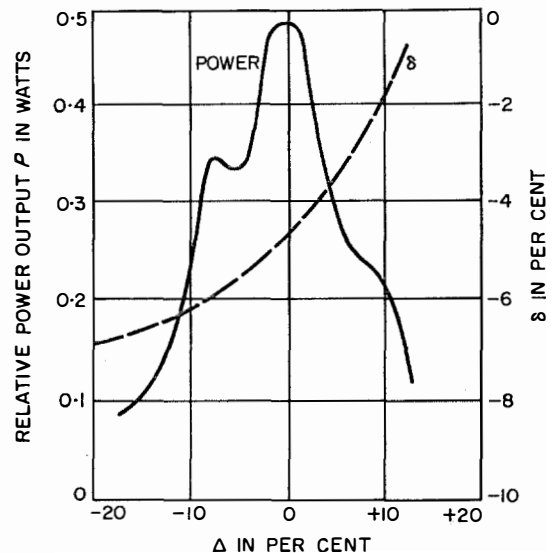

Figure 6—Theoretical tuning curves for $\alpha_0 = 0.2$ and $\alpha_1 = 0.3$.

attain a lower value. Also, the tuner cannot excite higher-order modes, and this has led to a remarkable freedom from spurious responses. The vacuum-retaining window consists of a half-wavelength-thick dielectric slab located across the circular waveguide. Finally, the very-convenient combined matching and tuning offered by this arrangement is regarded as particularly valuable for tuners at the highest frequencies.

4. Construction Techniques

In the scaling of tubes to millimetre wavelengths, the mechanical difficulties become progressively more acute. There appears to be an area, not very-well defined but in the region of 20 gigahertz, where it is desirable to depart from the more-conventional methods of tube construction in favour of new techniques. The objectives are fairly clearly defined and include the elimination of braze material from the cavity, improved mechanical alignment by single-

block body construction, and the provision of suitably stable conditions for prolonged high-temperature bakeout.

The main body of the tube is formed from a solid block of copper. The cavity and reflector locating bore are hot hobbled, producing accurate, strain-free, and temperature-stable forms reproducible to within ± 5 microns. The tapered beam aperture, cavity coupling slot, and tapered waveguide section are spark machined. The output port terminates in circular symmetry to accommodate the vacuum-retaining window. The lid of the resonant cavity is sealed in position by pressure welding [8]. Its movement during this process alters the resonant frequency of the cavity and, by continuously monitoring this, the welding process can be stopped when the cavity reaches the desired frequency. By the use of a series of hobs in conjunction with the pretuning process, it is possible to preset a cavity to any frequency to within 0.1 per cent.

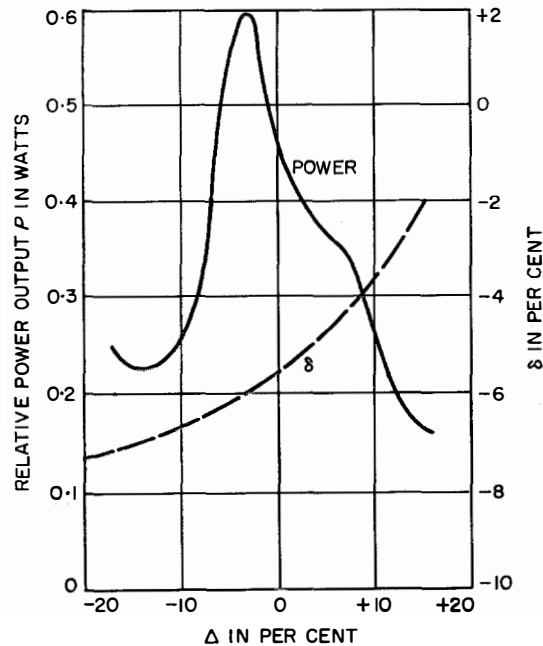

Figure 7—Theoretical tuning curves for $\alpha_0 = 0.2$ and $\alpha_1 = 0.4$.

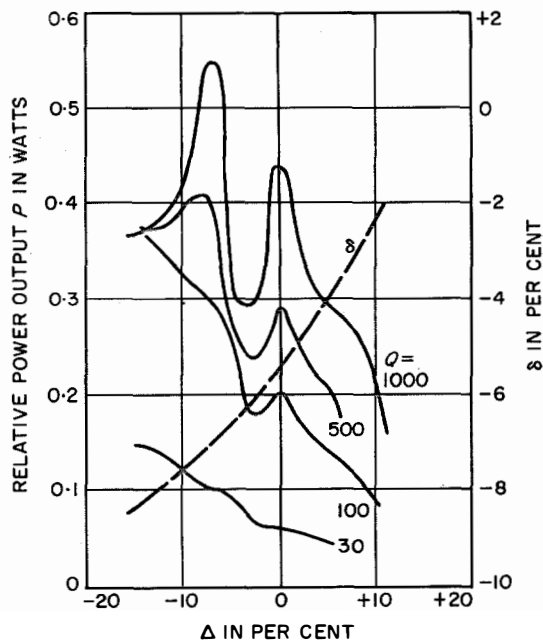

Figure 8—Theoretical tuning curves for $\alpha_0 = 0.3$ and $\alpha_1 = 0.3$. The values of Q indicated are for the external cavity.

High-Power Reflex Klystrons

The grid, cathode, and reflector parts are fitted into precision-ground ceramic insulators to form sub-assemblies, which are subsequently fitted into the locating bores provided. Dimension tolerances on most parts are maintained to within ± 5 microns and are checked by the use of air-gauging equipment capable of resolving to ± 0.5 micron. The end seals are made by argon arc welding. The lead-out connections are taken via ceramic insulator seals.

The choice of construction materials is guided by their suitability for a high-temperature processing schedule intended to meet the exacting demands of a long-life tube. At high baking temperatures the body of the tube becomes permeable to atmospheric gases and it becomes necessary to reduce the external pressure. Accordingly, the tube is surrounded by an outer vacuum chamber during bakeout. It has been established that excellent vacuum conditions are obtained by a prolonged bakeout (8 to 10 hours at 700 degrees centigrade), followed by full-power operation on the pump before seal-off.

5. Tube Characteristics and Performance

The design is applicable to the manufacture of tubes within the range of 18 to 100 gigahertz, the only adjustables over this range being the cavity, output waveguide, and window dimensions. Most of the development work has been carried out at 35 gigahertz, but tubes have been

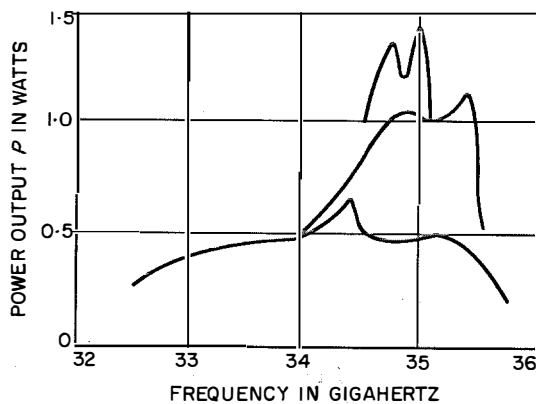

Figure 9—Typical tuning curves.

made throughout the range to establish the suitability of the design. The peak performance obtained with experimental tubes is given in Table 2. It is believed that substantial improvements are still attainable, particularly at the high-frequency end of the range. At the low-frequency end, reasonable performance can be achieved at greatly reduced resonator voltage (250 milliwatts at 1 kilovolt and 14 milliamperes).

Tuning characteristics obtained on tubes operating at 35 gigahertz are shown in Figure 9. The degree of coupling between the klystron and external tuning cavities has been adjusted for the 3 curves given, indicating the balance obtainable between power output and tuning range. The frequency stability at 35 gigahertz is better than ± 0.25 megahertz, which represents a dimensional variation in the cavity interaction gap of the order of 50 atomic layers. For the klystron with external tuner, the temperature coefficient of frequency is 1 megahertz per degree up to 60 degrees centigrade. A high order of modulation linearity has been obtained, from 0.5 to 1 per cent, expressed as the change in slope over a bandwidth of 10 megahertz. Alternatively, the measured level of harmonic distortion produced by the non-linearity gives bandwidths of the order of 10 megahertz at a second-harmonic level of -70 decibels. Typical operating conditions are given in Tables 3 and 4.

The tube output appears in circular waveguide and the required transition to normal rectangular waveguide is incorporated in the external tuner. Cooling fins are provided and, by the

Frequency in Gigahertz	Power in Watts
23	2.7
35	2.4
70	0.5
110	0.01

use of a small blower, the body is maintained a few degrees above ambient temperature. Convection cooling is adequate for all applications except those demanding the highest frequency stability.

Life testing is currently being carried out on several tubes. By November 1963, one tube had reached 4200 hours and another 1400 hours without appreciable change in characteristics. The tungsten dispenser-type cathode being used is moderately loaded at 1.6 amperes per square centimetre, whereas cathode manufacturers nowadays talk in terms of 70 000 hours of life at 2.5 amperes per square centimetre.

6. Conclusions

The design and construction of a series of high-power reflex klystron tubes covering the band from 18 to 100 gigahertz have been described. The design is aimed primarily at achieving a level of reliability and life that would make the tube suitable for large-scale systems use. The simplifications that can be made by avoiding any form of internal tuning have been fully exploited. By the use of appropriate techniques, it was found possible to obtain a piece-part accuracy that obviates the need for skill or adjustments in assembly. Results are presented for the whole frequency range; at 35 gigahertz an output of 2.5 watts was obtained, corresponding to an efficiency higher

than 3 per cent. Tuning ranges of 8 per cent have been obtained at 35 gigahertz.

7. Acknowledgments

The authors would like to express their appreciation to Mr. P. G. Eldridge and Mr. B. V. Knight for setting up much of the construction and test equipment, and for bearing the brunt of most of the measurements on the tubes. This work was carried out in cooperation with the ITT Electron Tube Division and the authors have great pleasure in acknowledging helpful discussions with several members of the staff and particularly with Mr. R. J. Blanchard.

8. References

1. J. R. Pierce, "Millimeter Waves," *Electronics*, volume 24, number 1, pages 66-69; January 1951.
2. J. R. Pierce and W. G. Shepherd, "Reflex Oscillators," *Bell System Technical Journal*, volume 26, number 3, pages 460-681; July 1947.
3. W. E. Danielson, J. L. Rosenfeld, and J. A. Saloom, "A Detailed Analysis of Beam Formation with Electron Guns of the Pierce Type," *Bell System Technical Journal*, volume 35, number 2, pages 375-420; March 1956.
4. K. Fujisawa, "General Treatment of Klystron Resonant Cavities," *IRE Transactions on Microwave Theory and Techniques*, volume MTT-6, number 4, pages 344-358; October 1958.

TABLE 3
TYPICAL OPERATING CONDITIONS

Parameter	Unit of Measurement	Rating
Cathode voltage	Volts	-2000
Grid voltage (with respect to cathode)	Volts	-50
Outer reflector voltage (with respect to cathode)	Volts	-700
Inner reflector voltage (with respect to outer reflector)	Volts	-60
Peak output power	Watts	1.5
Minimum output power over tuning range of 2 per cent	Watts	1
Centre frequency	Gigahertz	35

TABLE 4
ELECTRONIC TUNING

Reflector Mode	Peak Power in Watts	Bandwidth in Megahertz at Half-Power Points
3 $\frac{3}{4}$	2.18	82
4 $\frac{3}{4}$	0.960	220
5 $\frac{3}{4}$	0.270	550

High-Power Reflex Klystrons

5. T. Moreno, "Characteristics of Modern External Cavity Tuned Reflex Klystrons," Wescon, Los Angeles; August 1956.
6. R. G. Rockwell, "A New Klystron Amplifier Featuring a Capacitative External Tuner," *Microwave Journal*, volume 2, number 4, pages 27-32; April 1959.
7. P. E. V. Allin, "The Tuning of Coupled-Cavity Reflex Klystrons," *The Proceedings of the Institution of Electrical Engineers*, volume 105, part B, supplement number 12, pages 978-984; May 1958.
8. P. Lea-Wilson and Baker, "A Pressure Welding Technique for the Fabrication of Klystron Cavities," *SERL Technical Journal*, volume 6, page 99; 1956.

T. M. Jackson was born in Merioneth, Wales, in 1921. He joined the Royal Air Force in 1940 and was soon transferred to the Government Telecommunications Research Establishment to work on radar systems.

He joined Standard Telecommunication Laboratories in 1946, where he was initially engaged in the study of gas discharge phenomena. Since 1958, he has been concerned with power generation at millimetric wavelengths with particular attention to the development of new techniques.

Mr. Jackson is the holder of 36 patents.

A. D. Brisbane was born in Rangoon, Burma, in 1920. He was educated in London and holds the City and Guilds Final Technological Certificate in Telecommunications Engineering. From 1939 to 1945, he served with the Royal Air Force.

He joined Standard Telecommunication Laboratories in 1946 and has since been primarily

concerned with electron guns, embracing cathode research, electron optics, and ultra-high-vacuum systems.

Eric A. Ash was born in Berlin, Germany, in 1928. In 1948 he received a B.Sc. degree in electrical engineering from the Imperial College of Science, University of London, and in 1952 a Ph.D. degree for work on electron interaction effects.

From 1952 to 1954, he was research assistant and later research associate at the Electronics Research Laboratory of Stanford University, California. For one year he held a fellowship at the Nuclear Particle Laboratory, Queen Mary College, London University. In 1955, he joined Standard Telecommunication Laboratories where until October 1963, he was head of the laboratory for high-frequency electron devices.

Dr. Ash is currently at the Electrical Engineering Department of University College, London.

Quartz-Crystal Frequency Standards

K. BAULK

Standard Telephones and Cables Limited; London, England

1. Introduction

High-precision quartz-crystal oscillators have been used as frequency standards for the past four decades in standards laboratories and astronomical observatories, as well as in the more-general fields of communication and navigation.

The first quartz-controlled oscillator circuit was reported by Cady [1] in 1922, and in the following year he was able to show by an international comparison of frequency that quartz resonators were excellent frequency standards. It was soon realized that quartz oscillators could be used to control a clock mechanism. In 1927 a quartz-crystal clock was constructed by Horton and Marrison in the Bell Telephone Laboratories, which has since made many contributions to the development of piezoelectric standards of time and frequency.

In recent years Standard Telephones and Cables has also been active in this field, developing and manufacturing highly stable crystal units and frequency standards. These have been used in many applications, including navigation aids, missile tracking, frequency synthesizers and counters, mass spectrometers, communication systems, and as working time and frequency standards.

The piezoelectric effect was discovered by Pierre and Jacques Curie [2] in 1880. They found that when certain crystals were compressed in particular directions, positive and negative charges were developed on portions of their surfaces. This was termed the direct piezoelectric effect. In the year following their discovery, the Curies confirmed that a converse piezoelectric effect existed as predicted by Lippmann [3]. This phenomenon may be demonstrated by suitably placing a quartz crystal in an electric field. The crystal plate will be mechanically deformed in proportion to the strength of the field.

Forty years were to elapse before both Nicolson and Cady observed that if a crystal resonator is driven from a suitable source of alternating

voltage and if the frequency of the driving circuit approaches the mechanical resonant frequency of the crystal, the amplitude of vibration of the resonator increases considerably. Nicolson was the first to use a piezoelectric crystal to control the frequency of a vacuum-tube oscillator.

2. Crystal Characteristics

A large variety of crystals exhibit the piezoelectric effect, but crystalline quartz has several properties that make it very suitable for use as a control element in highly stable oscillators.

Quartz has exceptional physical stability, permitting resonators to be produced with parameters that are stable over long periods of time. Another important characteristic of a quartz crystal is its high Q factor, which allows it to be loosely coupled to the feedback circuit of an oscillator. A high- Q resonator requires less drive power to sustain oscillation than a low- Q resonator, and the loose coupling between crystal and feedback circuit isolates the crystal to some extent from the effects of changes in the drive circuit.

2.1 Q FACTOR

Bommel, Mason, and Warner [4] have shown that the Q of natural quartz at normal ambient temperature varies inversely with frequency. The maximum Q value attainable is limited by the internal friction of the material, and it is believed that this energy loss limits the Q of an AT -cut vibrator at 5 megahertz to 3×10^6 , and at 1 megahertz to 15×10^6 .

Mounting the vibrator must also cause some loss of energy, but resonators have been designed that minimize this loss, and Q values approaching the intrinsic Q of quartz have been achieved. It appears advantageous to use a low-frequency resonator with its inherent smaller energy loss. However, a large crystal plate is required to achieve a high Q at the lower frequencies, and the resulting crystal unit may be susceptible to mechanical disturbances.

Quartz-Crystal Frequency Standards

The properties of quartz crystals at very-low temperatures have been studied by Warner [5] and others. It was found that at the temperature of liquid helium (4.2 degrees Kelvin) Q factors in excess of 50×10^6 may be obtained. At this temperature the resonator appears to be rather sensitive to the effects of mechanical disturbances.

2.2 FREQUENCY AGEING

The term "frequency ageing" refers to the gradual change in the resonant frequency of a crystal unit throughout its life. The ageing phenomenon is a characteristic of all crystals and its degree depends on both processing technique and the design of the crystal vibrator. The frequency drift may be caused by a change in the surface loading of the element through transfer of contaminants to or from the quartz surface. It also may be caused by reorientation of the metal of the evaporated-gold-film electrodes, by changes in the crystal lattice through relaxation of stresses within the quartz and mounting, or by rearrangement of crystal-line defects within the quartz.

The frequency ageing of resonators decreases rapidly as the operating temperature is lowered, and is negligible at 4 degrees Kelvin. Even at 310 degrees Kelvin, stability of the order of 1 part in 10^{10} has been attained for periods of several months.

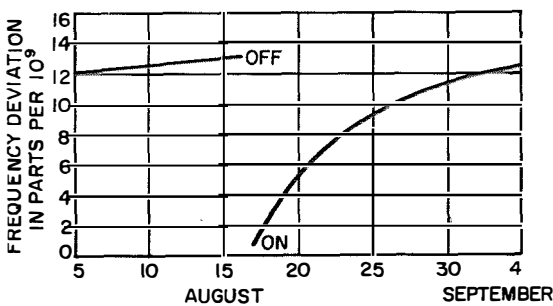

Figure 1—Effect of cooling and reheating on a 5-megahertz fifth-overtone *AT*-cut crystal unit. The oven was turned off for 7 hours.

The best ageing performance is realized only if the crystal unit is operated continuously. If the temperature of the crystal enclosure is reduced or oscillation ceases, the frequency may be low by up to several parts in 10^9 when normal conditions return. The oscillator frequency may then take several weeks to recover to the frequency it would have achieved if the disruption had not occurred.

Figure 1 shows the effect of cooling a crystal for several hours. Twenty-four hours after restoring the oven power, the frequency was low by more than one part in 10^9 , and more than 20 days elapsed before the crystal frequency returned to the level it was at before the oven was shut down. The ageing characteristic shown is typical of a rather-poor crystal unit, and other resonators of the same type have performed much better with no observable effect on the crystal ageing characteristic. Sykes, Smith, and Spencer [6] suggest that the likeliest cause of the frequency change is residual contamination within the crystal-unit enclosure. These contaminants transfer from and to the crystal plate each time oscillation stops and starts, or large temperature changes occur.

The frequency drift with time of frequency-standard crystals normally follows a natural ageing or logarithmic curve, and it is possible to extrapolate the frequency to a very-close approximation for several months in advance.

2.3 FREQUENCY DRIVE CHARACTERISTICS

The series-resonant frequency and resistance of a crystal unit depend to some extent on the amplitude of vibration, and at low drive levels the frequency change is proportional to the square of the crystal current. This frequency dependence is believed to be due to non-linearity of the elastic properties of quartz. Granato and Lücke [7] suggest that dislocations in the quartz material contribute an additional strain component to the stress field.

3. Crystal Resonators

The first quartz-crystal clock contained a 50-kilohertz resonator consisting of a rectangular X-cut bar vibrating in the direction of its length. The resonator devices and circuits that subsequently evolved are described in the following sections.

3.1 MARRISON Y-CUT RING

In the United States, Marrison [8] undertook to develop a resonator affected very little in frequency by temperature changes. A number of 100-kilohertz ring crystals ("doughnuts") were manufactured and exhibited temperature coefficients of less than 1 part in 10^6 per degree centigrade. This type of crystal was used in the Bell System frequency standard until 1937 when it was replaced by the *GT*-cut plate.

3.2 *GT*-CUT PLATE

The *GT* resonator was originated by Mason [9] in 1937. It has since been used in standards laboratories and as a control element in high-stability oscillators that supply timing pulses for radio navigation systems. The resonator is cut in such a way that a neutralizing effect occurs between two coupled modes of vibration having temperature coefficients of opposite characteristics. This results in a crystal unit with a negligible frequency change over a wide temperature range; Mason has produced resonators varying by not more than 1 part in 10^6 over a range of 100 degrees centigrade. Considerable care is required in processing to achieve this performance, and normal coefficients approach 2 parts in 10^7 per degree centigrade over a limited temperature range.

The *GT*-cut crystal has been manufactured for many years, and we produced a number of 100-kilohertz units in 1956 for use in a frequency-standard installation. The resonators had Q values around 700 000 and their initial drift rates were less than 4 parts in 10^9 per day. Within two years the ageing rate had decreased to 3 parts in 10^{10} per day, and after three years

the average drift rate was less than 1 part in 10^{10} per day. These ageing rates compare favourably with those reported by other workers. A photograph of a *GT*-cut resonator is shown in Figure 2.

It has been known for some time that small drift rates may be achieved by operating crystals at low ambient temperatures. *GT*-cut resonators maintained by the National Bureau of Standards at 4.2 degrees Kelvin have indicated ageing considerably less than 1×10^{-11} per day.

The *GT*-cut crystal was further developed by Griffin [10], who produced resonators with Q factors as high as 4×10^6 . The temperature coefficients and ageing rates of these units were similar to those obtained with our 1956 resonators.

3.3 *Y*-CUT BARS

A number of 60-kilohertz *Y*-cut resonators vibrating in an extensional mode were designed by Scheibe in Germany at the Physikalisch-

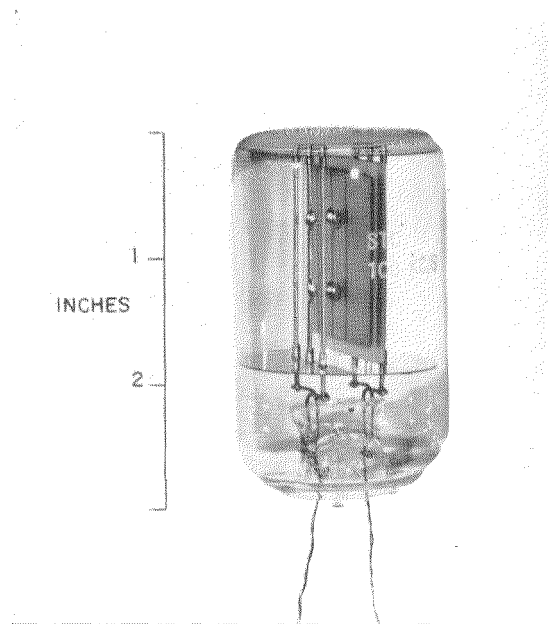

Figure 2—*GT*-cut resonator at 100 kilohertz.

Quartz-Crystal Frequency Standards

Technische Reichsanstalt, and some results obtained using these crystals in a clock installation were described in 1936 [11]. A *Y*-cut 100-kilohertz quartz bar has also been developed by Scheibe [12]. Q values of the order of 5×10^6 were obtained, and the day-to-day stability of these standards was ± 1 part in 10^{11} .

3.4 ESSEN RING

A crystal clock designed by Dye in 1936 at the National Physical Laboratory was controlled by a vibrator in the form of a 100-kilohertz quartz ring cut in the *Z* plane. The method of exciting the crystal was later modified by Essen to produce longitudinal vibrations of the third order along the circumference.

Extremely good performance has been achieved with this type of resonator in frequency-standard installations. The Q values of rings produced by the British Post Office are reported to be 2×10^6 [13], and Essen has published results obtained at several establishments over

long periods indicating drift rates between 0.25 and 1.6×10^{-10} per day.

The mounting system of the Essen ring is rather delicate and requires careful handling. The crystal unit is also expensive to manufacture. For these reasons the Essen ring has not been widely used.

3.5 *AT*-CUT RESONATORS

In 1934 a number of workers, including Lack, Willard and Fair, Koga, Bechmann, and Straubel, were investigating crystals cut at various angles from the natural crystal. One notable result of this work was the development of the *AT*-cut crystal plate, which vibrates in the thickness-shear mode. This type of plate may be excited at its fundamental resonant frequency, or at a much-higher frequency produced by excitation of the quartz plate on an odd-order mechanical overtone of some fundamental frequency. The *AT*-cut crystal, which has been produced at frequencies from below 0.5 megahertz to 250 megahertz, exhibits a frequency/temperature curve that is a combination of cubic and linear terms. By suitable choice of the cutting angle, it is possible to obtain a zero temperature coefficient at a temperature satisfactory for oven control.

The *AT*-cut plate has been used extensively in frequency-standard applications, and three types of crystal unit in particular have been developed at 1, 2.5, and 5 megahertz.

The 1-megahertz resonator vibrates in its fundamental mode and consists of a bi-convex plate with evaporated-gold electrodes on the two major surfaces. High Q values between 1 and 5×10^6 , and frequency drift rates less than 1×10^{-9} per day, have been claimed for this type of crystal.

One of the most-significant advances in recent years in quartz-crystal frequency-standard technology has been the development by Warner [14] of the plano-convex *AT*-cut fifth-overtone crystal unit. The resonators were designed to fulfill an urgent need for highly stable fre-

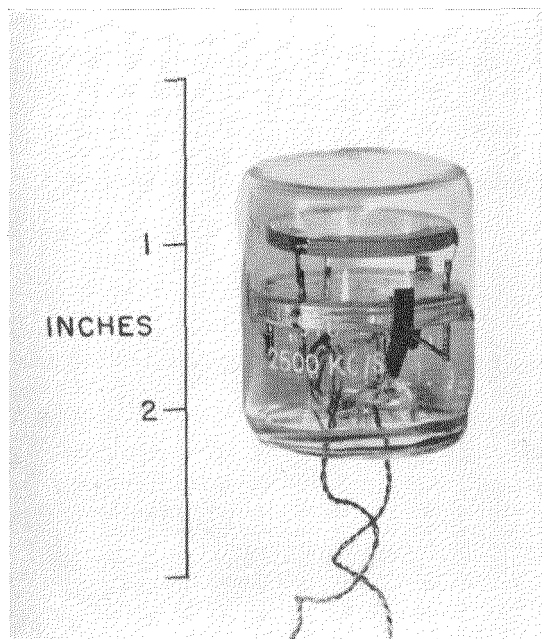

Figure 3—Fifth-overtone *AT*-cut resonator at 2.5 megahertz.

quency-standard crystals that were robust and relatively inexpensive to manufacture. A spherical contour is generated on one side of the crystal plate to restrict the mechanical vibration to the centre of the plate, effectively isolating the crystal element from the mounting wires and thus raising the resonator Q value. A photograph of a 2.5-megahertz fifth-overtone crystal is shown in Figure 3.

We have manufactured 5-megahertz crystal units of this type for several years. The Q values of these units are approximately 2.5×10^6 , and the crystals are pre-aged to drift rates of about 1×10^{-9} per day before shipment. These crystal units have remained stable to better than 3 parts in 10^8 over a period of one year.

We produced a number of 2.5-megahertz fifth-overtone crystal units in 1959. The Q factors of these resonators were between 4 and 5×10^6 , and the ageing rate reached 1×10^{-10} per day within three weeks of manufacture, subsequently decreasing to 3×10^{-10} per month. Frequency drift rates as low as 1×10^{-10} per month have been reported by other workers, but these are exceptional.

Another type of AT -cut crystal under development for high-stability applications was first reported by Bechmann [15]. The thickness-shear mode of vibration in this case is excited with an electric field parallel to the quartz plate. (The normal method of excitation is with a field perpendicular to the plate.) High Q values in excess of 10×10^6 have been claimed [16] for parallel-field-excited AT -cut vibrators, and

low ageing rates can also be achieved. However, the equivalent resistance of such crystal units is very high and complicates the design of suitable oscillators.

Performance figures of the quartz-crystal units discussed are listed in Table 1. These characteristics may be achieved only by careful manufacturing techniques and by operating the crystal unit under closely controlled conditions.

Whilst the quartz-crystal standards described in this section are still used in various parts of the world, the AT -cut fifth-overtone crystal unit is now used in most commercial applications where long-term stability, reliability, and sturdiness are of importance.

4. Temperature Control

The resonant frequency of a crystal unit is a function of temperature, and the relationship depends on the angle of cut, dimensions, and mode of vibration of the crystal. Low temperature coefficients of frequency may be obtained by suitable choice of these three items, but it is still necessary to control the operating temperature of the resonator if the highest performance is to be achieved.

The frequency excursion caused by a sudden change in crystal plate temperature may be much larger than the value expected from the frequency/temperature characteristic measured under conditions of temperature equilibrium. This frequency excursion is caused by temperature gradients within the quartz plate resulting from the thermal shock. An hour or more may

TABLE 1
QUARTZ-CRYSTAL CHARACTERISTICS

Resonator Type	Frequency in Megahertz	Q of Resonator ($\times 10^6$)	Frequency Drift per Month ($\times 10^{-9}$)
<i>GT</i> -cut	0.1	4	3
<i>Y</i> -cut bar	0.1	5	0.3
Essen ring	0.1	2	1
<i>AT</i> -cut (fifth overtone)	5	2.5	3
<i>AT</i> -cut (fifth overtone)	2.5	5	0.1

Quartz-Crystal Frequency Standards

elapse before the crystal plate recovers from the shock and the equilibrium frequency value is reached.

Various temperature-control circuits may be used to obtain a temperature stability of 0.1 degree centigrade or less, including the change-of-state oven, contact thermometer, or temperature-sensitive bridge using either on/off or proportional control.

An oven designed on the change-of-state principle was produced by Fewings [17]. In this device the melting point of a crystalline material (naphthalene) determines the oven temperature, and the latent heat of fusion of the material provides thermal ballast that reduces cycling to negligible proportions. This type of oven is capable of a differential control of ± 1 millidegree and a control ratio of 500:1.

Crystal ovens are frequently controlled by a mercury contact thermometer that is pressurized above the mercury column to avoid breaks in the column from mechanical shocks. Two ovens incorporating this method of control are shown in Figure 4. In these models the thermostat is connected to a transistor that delivers power to the oven heater. The units are robust and are suitable for operation in mobile equipments. The frequency shift produced by mechanical shocks of 40 *g* is generally much less than 1 part in 10^8 . Frequency sources of this

type can be produced with stabilities approaching 1 part in 10^8 over fairly wide temperature bands.

For the most-precise control of temperature, a bridge network is normally used. The bridge is arranged so that it is balanced at the desired operating temperature. The out-of-balance voltage produced when the temperature is below nominal is amplified and caused to supply power to the oven winding. If the oven temperature rises above nominal, a phase-sensitive detector cuts off the power.

A disadvantage of thermostat operation on the on/off principle is that temperature gradients are produced within the crystal plate that result in frequency instability. The temperature cycling may be reduced by use of a proportional control, which always supplies just-enough power to the oven to maintain it at temperature.

5. Frequency-Standard Oscillators

The design of high-precision frequency standards involves the detailed consideration of 3 main factors affecting the oscillator performance.

- (A) Close temperature control of the quartz plate is necessary.
- (B) The crystal current must be kept constant at a suitably low level.
- (C) Stable oscillator components are required.

The Meacham bridge-stabilized oscillator [18] has been used in frequency standards for many years. In this circuit the feedback path is through a Wheatstone bridge with the crystal in one arm, a tungsten lamp filament with a positive coefficient in the bridge arm conjugate to the crystal, and linear resistors in the remaining two arms. The oscillator is maintained at the frequency for which the reactance of the crystal approaches zero. The values of the resistors are so chosen that the bridge is unbalanced at low levels of applied signal in such a direction that positive feedback results and oscillations build up. As the oscillation level

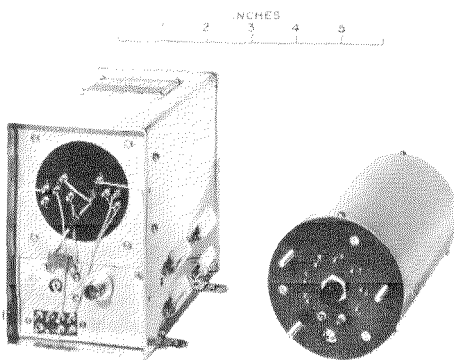

Figure 4—High-stability frequency sources.

increases, a large current flows through the tungsten lamp, increasing its resistance. This causes the feedback to decrease, thus stabilizing the amplitude of vibration of the crystal plate. Both the *GT*-cut crystal and the Essen ring have been used in the Meacham bridge oscillator for frequency-standard applications.

Another oscillator frequently used for high-stability work was developed independently by Gouriet [19] and Clapp [20], and is sometimes termed a "modified Pierce" circuit. This oscillator was used by Felch and Israel [21] in conjunction with the 5-megahertz fifth-overtone *AT*-cut crystal to produce an extremely stable frequency standard.

The frequency sources shown in Figure 4 incorporate the Felch and Israel circuit, including the 5-megahertz crystal unit. Frequency stabilities better than 1×10^{-9} have been achieved for periods of 24 hours with this type of circuit.

In recent years a number of high-precision all-transistor frequency sources have been developed with stabilities of the order of 1×10^{-10} . A modified Pierce circuit may be used and the crystal is generally housed in a proportionally controlled oven.

6. High-Stability Crystal-Oscillator Application

A frequency source based on the latest techniques has recently been developed for use in a communication system that permits 2700 speech channels to be carried over one pair of coaxial cables. A technique known as frequency-division multiplex is used for combining the 2700 conversations for transmission. For this purpose it is necessary to generate a number of basic frequencies of high stability, including 4, 12, and 124 kilohertz, which are subsequently multiplied to give a wide range of frequencies up to 12 megahertz. To avoid impairing the system performance, these basic carrier frequencies must be produced with a stability of a few parts in 10^8 per month. This stability

can most-easily be achieved by use of a crystal unit operating at a frequency considerably higher than 124 kilohertz, and an *AT*-cut resonator vibrating in its fifth mechanical overtone has been developed for this application. A frequency of 2480 kilohertz was chosen for the carrier supply oscillator, as this enables 124 kilohertz to be derived fairly easily by frequency division and also allows the latest quartz-crystal processing techniques to be used in making the crystal unit.

In this application the crystal is housed in an oven that is kept at a constant temperature by a proportional-control system. A thermistor connected into a bridge circuit senses the oven temperature and controls the amount of power supplied to the oven heater. The oscillator and temperature-control circuits use only transistors as active elements and operate from a nominal 20-volt direct-current supply. An alarm circuit is incorporated that operates if the oven temperature drifts from its normal value. The frequency source is designed to work over a wide ambient temperature range, and the circuit components are carefully selected to ensure reliability.

A high-precision quartz oscillator may also be used as a central source for a number of frequency synthesizers, each of which controls a radio equipment on shipboard and in similar installations.

7. Atomic and Molecular Standards

Quartz-crystal oscillators may be used as frequency standards when stabilities of the order of parts in 10^{10} are required for one month. To maintain a frequency with this stability for years, it must be compared with a known standard, and the oscillator must be adjusted periodically to correct for the frequency drift caused by ageing of the crystal unit and oscillator components.

In recent years a number of devices have been developed that provide a standard of frequency stable to 1×10^{-10} for years. These devices make use of the natural periodicities of atoms

Quartz-Crystal Frequency Standards

and molecules, which are constant and substantially independent of external influences. Three main types of atomic and molecular standard have been produced so far, the gas-cell device, the maser, and a passive beam device.

Gas-cell frequency standards have been under development for several years by Arditì [22, 23]. A gas-cell frequency standard consists of an oscillator with excellent short-term stability, a frequency-multiplier chain, a phase modulator, a gas-cell where the atomic transition takes place, a phase-sensitive amplifier/detector, and a feedback-loop servo that locks the oscillator to the resonant frequency of the atomic transition. The gas cell, which contains an alkali-vapour metal mixed with buffer gases at suitable pressure and temperature, is housed in a microwave cavity. A beam of light from a resonance lamp is passed through the gas cell and is focused on a photocell. The resonant cavity is excited by a phase-modulated microwave signal and, when the frequency of the resulting microwave field corresponds to the hyperfine frequency, the amount of light transmitted is reduced. Figure 5 illustrates a gas-cell frequency standard developed by Arditì.

A crystal oscillator controlled by a caesium gas cell has exhibited long-term stability of 1 part in 10^{10} . The choice of sodium, rubidium, or caesium atoms for use in the gas cell mainly depends on the requirements of the packaging specification, the temperature range of operation, and absolute accuracy. A method of improving the long-term stability and reliability of gas-cell frequency standards by a double-resonance system has recently been proposed by Arditì [24], and it is suggested that this method would produce a more-satisfactory working standard for both field and laboratory.

Passive beam devices have been produced in the United States and the United Kingdom. The resonance employed is produced by the hyperfine splitting of caesium having a frequency of approximately 9192 megahertz and is detected in an atomic-beam chamber. A caesium atomic standard constructed at the Na-

tional Physical Laboratory is stable to better than 1×10^{-10} , and this standard is made generally available by means of the radio transmissions from station *MSF* at Rugby.

Different types of masers have been produced in recent years using ammonia or hydrogen. The hydrogen maser now appears more promising for certain applications, and an accuracy of better than 10^{-13} may be possible with this device.

A great deal of work is in progress to develop atomic standards for both laboratory and mobile use. These devices require the use of high-precision quartz oscillators having stabilities better than 1×10^{-10} for short periods.

8. Conclusions

Since the introduction of the crystal oscillator, improvements in quartz-crystal design and production have resulted in quartz frequency standards with stabilities of parts in 10^{10} over long periods. The development of the *AT*-cut fifth-overtone crystal played an important part in these improvements. It permitted small portable standards to be produced with better stabilities than had been achieved previously with much-larger and more-expensive equipments.

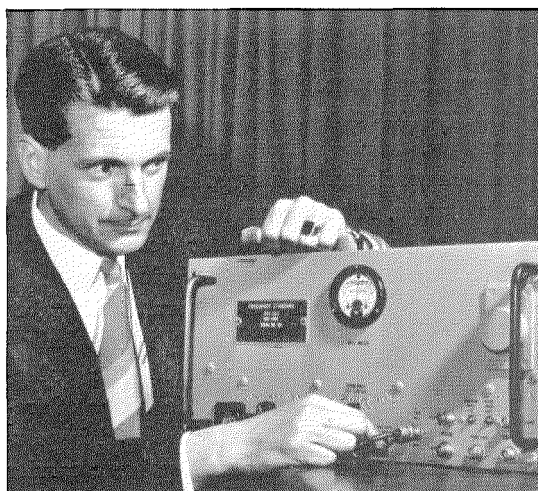

Figure 5—Gas-cell frequency standard.

It is probably true that the main improvement required of quartz-crystal oscillators is not so much in terms of better long-term stabilities, but in terms of predictable and uniform ageing rates under widely varying ambient conditions.

Atomic standards will no doubt be used increasingly as primary frequency standards in future years, but the quartz-crystal oscillator will continue to be widely used as a working standard of time and frequency in systems requiring a frequency stability of 1×10^{-9} for months.

9. Acknowledgments

The author is indebted to Mr. W. J. Young and members of his staff for their advice and assistance in the preparation of this paper.

10. References

1. W. G. Cady, "The Piezo Electric Resonator," *Proceedings of the Institute of Radio Engineers*, volume 10, number 2, pages 83-114; April 1922.
2. J. and P. Curie, "Development by Pressure of Polar-Electricity in Hemihedral Crystals with Inclined Faces," *Bulletin de la Société Mineralogique de France*, volume 3, pages 90-93; 1880.
3. G. Lippmann, "Principe de la conservation de l'électricité," *Annales Chimie Physique*, volume 24, page 145; 1881.
4. H. E. Bommel, W. P. Mason, and A. W. Warner, "Dislocations, Relaxations, and Anelasticity of Crystal Quartz," *Physical Review*, volume 102, number 1, pages 64-71; April 1956.
5. A. W. Warner, "Ultra-Precise Quartz Crystal Frequency Standards," *IRE Transactions on Instrumentation*, volume I-7, numbers 3 and 4, pages 185-188; December 1958.
6. R. A. Sykes, W. L. Smith, and W. J. Spencer, "Performance of Precision Quartz-Crystal Controlled Frequency Generators," *IRE Transactions on Instrumentation*, volume I-11, numbers 3 and 4, pages 243-247; December 1962.
7. A. Granato and K. Lücke, "Theory of Mechanical Damping Due to Dislocations," *Journal of Applied Physics*, volume 27, number 6, pages 583-593, number 7, pages 789-805; June and July 1956. Also volume 28, page 635; 1957.
8. W. A. Marrison, "A High Precision Standard of Frequency," *Proceedings of the Institute of Radio Engineers*, volume 17, number 7, pages 1103-1122; July 1929.
9. W. P. Mason, "A New Quartz-Crystal Plate, Designated the GT, Which Produces a Very Constant Frequency Over a Wide Temperature Range," *Proceedings of the I.R.E.*, volume 28, number 5, pages 220-223; May 1940.
10. J. P. Griffin, "High Stability 100-Kc Crystal Units for Frequency Standards," *Bell Laboratories Record*, volume 30, number 11, pages 433-438; November 1952.
11. A. Scheibe and U. Adelsberger, "Variations in the Length of the Astronomical Day and Time Determinations by the P.T.R. Quartz Clocks," *Physikalische Zeitschrift*, volume 37, page 185; 1936.
12. A. Scheibe, et al., "Über die Quarzgruppe der P.T.B. und Vergleichsmessungen gegenüber Atomnormalen", *Zeitschrift fuer Angewandte Physik*, volume 2, number 9, pages 352-357; September 1959.
13. H. T. Mitchell and A. K. Dobbie, "100 Kc/s Oscillator of High Precision Incorporating an Essen Type Quartz Ring," *Congrès International de Chronometrie*, Paris, France; October 1954.
14. A. W. Warner, "High-Frequency Crystal Units for Primary Frequency Standards," *Proceedings of the I.R.E.*, volume 40, number 9, pages 1030-1033; September 1952.
15. R. Bechmann, "Filter Crystals," *Proceedings of the 12th Annual Symposium on Frequency Control*, U. S. Army Signal Research and Development Laboratory, Fort Monmouth, New Jersey, pages 437-474; May 1958.

Quartz-Crystal Frequency Standards

16. R. Bechmann, "Parallel Field Excitation of Thickness Shear Modes of Quartz Plates," *Proceedings of the 14th Annual Symposium on Frequency Control*, U. S. Army Signal Research and Development Laboratory, Fort Monmouth, New Jersey, pages 68–88; June 1960.
17. D. J. Fewings, "The Change-of-State Crystal Oven," *Journal of the British Institution of Radio Engineers*, volume 21, number 2, pages 137–142; February 1961.
18. L. A. Meacham, "The Bridge-Stabilized Oscillator," *Proceedings of the Institute of Radio Engineers*, volume 26, number 10, pages 1278–1294; October 1938.
19. G. G. Gouriet, "High-Stability Oscillator," *Wireless Engineer*, volume 27, number 319, pages 105–112; April 1950.
20. J. K. Clapp, "An Inductance-Capacitance Oscillator of Unusual Frequency Stability," *Proceedings of the I.R.E.*, volume 36, number 3, pages 356–358, number 10, pages 1261–1262; March and October 1948.
21. E. P. Felch and J. O. Israel, "A Simple Circuit for Frequency Standards Employing Overtone Crystals," *Proceedings of the I.R.E.*, volume 43, number 5, pages 596–603; May 1955.
22. M. Arditi and T. R. Carver, "A Gas Cell 'Atomic Clock' Using Optical Pumping and Optical Detection," *IRE National Convention Record*, part 1, pages 3–9; 1958.
23. M. Arditi, "A Gas Cell 'Atomic Clock' as a High-Stability Frequency Standard," *IRE Transactions on Military Electronics*, volume MIL-4, number 1, pages 25–28; January 1960.
24. M. Arditi and T. R. Carver, "The Principles of the Double Resonance Method Applied to Gas Cell Frequency Standards," *Proceedings of the IEEE*, volume 51, number 1, pages 190–202; January 1963.

Kenneth Baulk was born in Bedfordshire, England, in 1927. He studied electrical engineering at Enfield Technical College. From 1945 to 1948 he served in the communications branch of the Royal Artillery.

He then joined the Post Office Research Station, London, and for six years was engaged in development of quartz crystals.

In 1954, he joined Standard Telephones and Cables, and in 1959 was placed in charge of crystal development. Since 1961, he has been responsible for the development of crystal test equipment, frequency standards, and crystal applications.

Mr. Baulk is an Associate Member of the Institution of Electrical Engineers.

Electromechanical Filters for 50 to 500 Kiloherzt

A. RUSSEN

Standard Telecommunication Laboratories Limited; Harlow, Essex, England

1. Introduction

The basic ideas underlying electromechanical filters are very old, and from time to time ingenious structures have been investigated. With the advent of new materials, however, the art has now progressed sufficiently to justify the use of these filters in communication systems.

This paper discusses practical design and construction techniques, and describes the performance of some typical filter units.

Basically, the design problem is to devise a vibrating structure to give the desired performance economically. Because mechanical vibrations have low propagation velocity compared with electromagnetic waves, the design approach is often closer to that used in an electrical filter for microwave frequencies than to a conventional lumped-circuit filter at, say, 100 kilohertz. The work therefore has two main interrelated aspects. The first is to find a suitable vibrating structure, the main criteria being freedom from spurious or unwanted modes, good resistance to shock and ambient vibrations, suitability for low-cost manufacture, and finally, convenient size and shape. The second aspect is to solve the mathematical design problems, which can be complex when performance close to the theoretical optimum is essential.

Electromechanical filters are unusual in that a number of manufacturing considerations must be resolved at the very beginning of the development. These include the method of manufacturing the resonators and couplers, their assembly into a complete structure, and the way in which tuning adjustments are to be made.

The emphasis on miniaturization in modern communication systems may favour electromechanical filters. Practical designs have been evolved that show significant size reductions over other types of filter, and it is possible that further miniaturization may be achieved

without degradation of performance. Moreover, the developed design and method of manufacture make it possible to produce small quantities of different types of filter at reasonable cost.

2. Mechanical Vibrators

The fundamental wave equations for mechanical structures are directly analogous to the well-known wave equations for electrical transmission lines [1]. To simplify the following discussions, therefore, mechanical systems will be analyzed as mechanical lines using the familiar electrical transmission-line equations. It must be understood, however, that many of the results obtained thereby are working approximations. For complete understanding, a more-detailed analysis may be necessary.

It can be shown that for an unbounded isotropic elastic solid of infinite extent, only two types of stress waves are propagated [2]. These have the following velocities.

$$C_1 = \left(\frac{\eta + 2\mu}{\rho} \right)^{1/2} \text{ for dilation waves} \quad (1)$$

$$C_2 = \left(\frac{\mu}{\rho} \right)^{1/2} \text{ for distortion waves} \quad (2)$$

where μ and η are Lami constants, and ρ is density. The Lami constants are related to Young's modulus E , rigidity modulus μ , and Poisson's ratio ν , by the following equations [2].

$$\nu = \frac{\eta}{2(\eta + \mu)}, \quad E = \frac{\mu(3\eta + 2\mu)}{\eta + \mu}.$$

When, however, a boundary surface exists, elastic surface waves are also possible. These are known as Rayleigh waves, and are propagated with a wave velocity that depends on the physical properties of the material and the frequency of vibration. Since the velocity is zero at zero frequency, this type of wave motion may be accompanied by considerable dispersion.

Furthermore, at a boundary surface when dilation or distortion waves impinge the surface at an angle inclined to the normal, there will be conversion from one type of wave motion to the other. In general, a dilation wave results in reflected distortion and dilation components. Both reflected components have different angles of incidence, but at the same time their velocities are the true velocities of the respective modes.

When conditions are such that free space is replaced by a second solid having different elastic constants from the first, the phenomena of refraction and reflection occur. In consequence, there may be four resultant stress waves, each with a different velocity and a different angle of inclination to the normal. These two phenomena, reflection and refraction, give rise to mode conversion, often introduce errors in the calculated performance, and may be responsible also for spurious or unwanted responses.

In theory, given the elastic constants of the material, the boundary conditions of the system, and assuming no body forces, the equations of motion define the degrees of freedom of the system. In practice, however, the boundary conditions of all but the simplest structures result in a set of equations that is intractable. Work has therefore been confined to the examination of comparatively simple

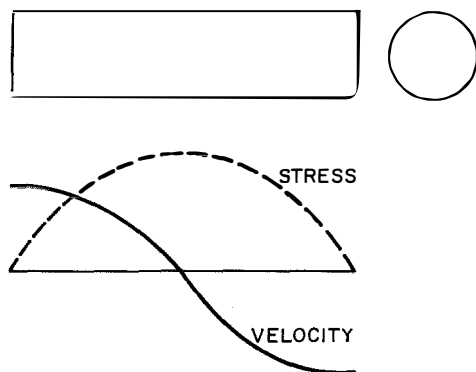

Figure 1—Standing waves of angular velocity and stress at resonance in a cylindrical resonator.

structures that vibrate in simple plane wave motion, such as long thin rods, cylinders, thin discs, flat rectangular plates, et cetera.

A simple resonator that has been studied in some detail is the long cylindrical bar. In this case, the three main vibrations are longitudinal, torsional, and lateral.

Analysis of the longitudinal mode shows that both dilation and distortion waves are present. Some dispersion is evident, hence resonant frequency depends on rod diameter. For a thin rod, the diameter of which is small compared with wavelength, the velocity is given approximately by

$$v_L = \left(\frac{E}{\rho} \right)^{1/2} \quad (3)$$

However, for a thick rod, the diameter of which is comparable to wavelength, the velocity approaches that of Rayleigh surface waves.

Simple mathematical theory of flexural waves in rods demonstrates that at low frequencies the velocity of propagation also approaches that of Rayleigh surface waves.

When plane torsional waves are considered in the fundamental mode, it can be shown that these are propagated without dispersion and their velocity is given by (2). Hence the resonant frequency of a length of line is independent of diameter and an exact determination of resonator dimensions is possible. The remainder of this discussion will be confined to torsional systems. With minor reservations, some of the results obtained and the methods of analysis may also be applied to other systems.

3. Torsional Resonators

Consider a cylindrical rod of length l and diameter $2r$. From classical theory, the total compliance C_m is given by

$$C_m = \frac{1}{\text{stiffness}} = \frac{2}{\pi \mu r^4} \quad (4)$$

and the total rotational inertia I_m by

$$I_m = \frac{\pi}{2} \rho l r^4. \quad (5)$$

Using the analogy of a mechanical to an electrical line, we may write

$$v_T = \frac{1}{(I_m C_m)^{1/2}} = \left(\frac{\mu}{\rho} \right)^{1/2} \quad (6)$$

where I_m and C_m are now values per unit length of line. Similarly, the characteristic impedance in mechanical units is given by

$$Z_{cm} = \left(\frac{I_m}{C_m} \right)^{1/2} = \frac{\pi}{2} r^4 (\mu \rho)^{1/2}. \quad (7)$$

When a rod is excited by plane torsional shear waves with the direction of propagation along its length l , the standing waves of angular velocity and stress at resonance are as shown in Figure 1. This system may be considered equivalent to a short-circuited electrical line, with angular velocity and stress corresponding to current and potential, respectively.

For most metals, $v_T \approx 3000$ metres (9840 feet) per second. Hence at 50 kilohertz, for a simple $\lambda/2$ resonator, $l \approx 3$ centimetres (1.2 inches). A 10-resonator filter, with the resonators in tandem, would therefore be inconveniently long. Fortunately, lumped-circuit techniques can be used to reduce these dimensions.

A configuration that has many useful applications is illustrated in Figure 2. Being symmetrical, it may be employed as a direct replacement for a simple $\lambda/2$ resonator.

If the lengths of the sections are much less than $\lambda/8$, the resonant frequency can be determined with fair accuracy by

$$f_0 = \frac{1}{2\pi} \frac{r_c^2}{r_i^2} \left(\frac{\mu}{l_i l_c \rho} \right)^{1/2} \quad (8)$$

where r_c is the radius of the compliance; r_i , the radius of the inertial mass; l_c , half the length of the compliance; and l_i , the length of the inertial mass. This equation neglects the effects of distributed inertia and compliance.

If the lengths are comparable to $\lambda/8$, on the other hand, (8) does not give a satisfactory result and line theory must be used. In this case the resonant frequency may be obtained from

$$\frac{r_c^4}{r_i^4} = \tan \left(\frac{\omega_0 l_c}{v_T} \right) \tan \left(\frac{\omega_0 l_i}{v_T} \right). \quad (9)$$

It should be remembered that neither (8) nor (9) is strictly accurate, since each neglects the effects of mode conversion at the impedance discontinuities.

The lumped-circuit resonator is perhaps slightly more expensive to manufacture than the simple cylinders it replaces, but the additional design freedom that results from this approach far outweighs the extra cost. From the wide range of available shapes, it should be possible to select one that satisfies the filter requirements while confining any overtones and spurious responses to a part of the frequency spectrum where they may be neglected.

4. Coupled Systems

Electromechanical filters, like their electrical counterparts, consist essentially of a system of resonators or tank circuits coupled to give a predetermined transfer impedance. An electrical ladder network can be realized in its equivalent mechanical form as a system of resonators and couplers in tandem. Although other circuit configurations may be more desirable in certain circumstances and are likewise theoretically realizable, the technology

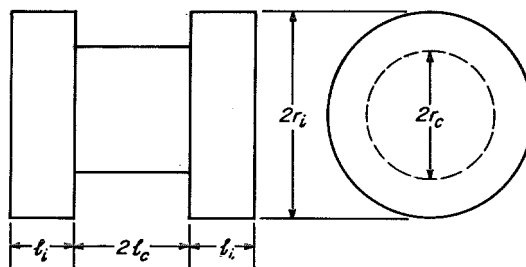

Figure 2—Mass-loaded resonator.

is not sufficiently advanced to include a study of these structures in this discussion.

A start can be made by analyzing a simple coupled pair and by showing how these results can be applied to a system consisting of many resonators in tandem.

Consider two $\lambda/2$ lines of characteristic impedance Z_{cr} joined by a $\lambda/4$ section of different characteristic impedance Z_{cn} , as illustrated in Figure 3. This system can be shown to have two degrees of freedom that occur at approximately symmetrical frequencies on both sides of a single isolated $\lambda/2$ element. To simplify the analysis, wave distortion at the junction of the lines will be neglected and advantage taken of symmetry. It will be convenient therefore to consider the impedance seen at the centre of the system.

The conditions of resonance now become $Z_{in} = \infty$ and $Z_{in} = 0$, which lead to the following equations.

$$Z_{c1} \tan\left(\frac{f}{f_0} \pi\right) + Z_{c2} \tan\left(\frac{f}{f_0} \frac{\pi}{4}\right) = 0 \quad (10)$$

$$Z_{c2} = Z_{c1} \tan\left(\frac{f}{f_0} \pi\right) \tan\left(\frac{f}{f_0} \frac{\pi}{4}\right) \quad (11)$$

where f_0 is the resonant frequency of an isolated resonator and f is the frequency variable. Putting $f = f_0 \pm \delta f$ and rearranging, the equations reduce to

$$\frac{Z_{c1}}{Z_{c2}} \tan\left(\frac{\delta f}{f_0} \pi\right) \left\{ 1 \pm \tan\left(\frac{\delta f}{f_0} \frac{\pi}{4}\right) \right\} = 1 \mp \tan\left(\frac{\delta f}{f_0} \frac{\pi}{4}\right)$$

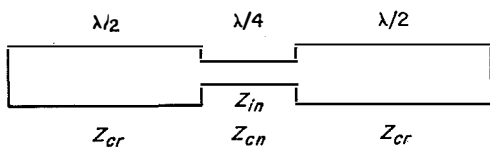

Figure 3—Two identical resonators coupled by a section having a different characteristic impedance.

which if $\tan \theta \approx \theta$ (small fractional bandwidth), may be expressed as

$$k \approx \frac{2\delta f}{f_0} \approx \frac{2}{\pi} \frac{Z_{c2}}{Z_{c1}} \left(1 - \frac{Z_{c2}}{2Z_{c1}}\right), \quad \text{when } Z_{c1} > Z_{c2} \quad (12)$$

$$k \approx \frac{2\delta f}{f_0} \approx \frac{2}{\pi} \frac{Z_{c1}}{Z_{c2}} \left(1 - \frac{Z_{c1}}{2Z_{c2}}\right), \quad \text{when } Z_{c2} > Z_{c1} \quad (13)$$

where k is the coupling coefficient between the two resonators.

When lumped-circuit or mass-loaded resonators are used, the diameter of the $\lambda/4$ coupler required to give a certain coupling coefficient may be slightly different from that obtained by solving the above equations. This problem is best resolved for a particular case by using the transmission-line equations and by considering the resonator as lumped or distributed, according to circumstances. The Smith chart is very helpful when approximate results are required quickly, especially if the system is complicated.

An equivalent electrical network for a coupled pair is shown in Figure 4. The input impedance Z_{in} is given by

$$Z_{in} = \frac{1 - \omega^2(2L_1C_1 + L_2C_2) + \omega^4L_1C_1L_2C_2}{j\omega C_1(1 - \omega^2L_2C_2)}$$

When both resonators are tuned to the same frequency, then

$$\omega_0^2 = \frac{1}{L_1C_1} = \frac{1}{L_2C_2}$$

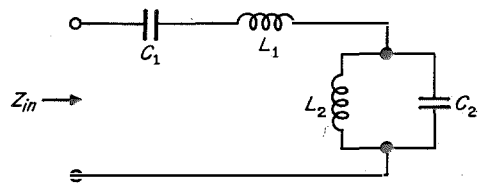

Figure 4—Equivalent electrical circuit of a mechanically coupled pair.

and assuming

$$k^2 = \frac{L_2}{L_1}$$

$$C_1 = \frac{1}{\omega_0^2 L_1}$$

the expression becomes

$$Z_{in} = \frac{1 - (\omega/\omega_0)^2(2 + k^2) + (\omega/\omega_0)^4}{j\omega C_1\{1 - (\omega/\omega_0)^2\}}$$

which has two zeros at ω_2 and ω_1 , respectively, such that

$$\frac{\omega_2 - \omega_1}{\omega_0} = k \text{ and } \omega_2\omega_1 = \omega_0^2. \quad (14)$$

The relationship $k^2 = L_2/L_1$ is very important when determining an equivalent mechanical structure and is used in the following way. Given the fifth-order network shown in Figure 5, the required values of k are

$$k_{12}^2 = \frac{L_2}{L_1}; \quad k_{23}^2 = \frac{L_2}{L_3}; \quad k_{34}^2 = \frac{L_4}{L_3}; \quad k_{45}^2 = \frac{L_4}{L_5}$$

and given the resonant frequencies with one value of impedance, the complete system is defined.

5. Transducers

Only two basic types of transducer [1] may be considered at the frequencies and bandwidths of interest, namely, piezoelectric and magnetostrictive.

Piezoelectric materials have a built-in polarization that makes them unsuitable for the generation of pure torsional vibrations. There-

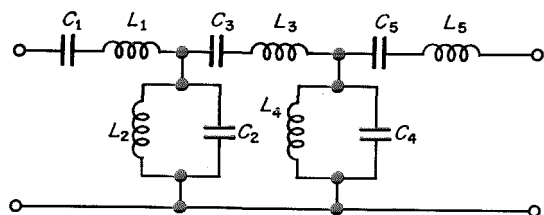

Figure 5—Electrical ladder network that is equivalent to a 5-resonator mechanical filter.

fore, when this mode is required, an arrangement is used that depends on mode conversion. One such system that has received attention is illustrated in Figure 6. The two transducers vibrate longitudinally and in push-pull so that they activate, via the longitudinal coupling wire, a torsional component in the first resonator. Any slight imbalance produces a transverse shear wave that is transmitted through the body. Many unwanted modes can be excited and may be difficult to suppress since the pick-up units can also be activated by them. This type of drive will also be somewhat sensitive to ambient vibrations.

Magnetostrictive materials can be polarized to vibrate in a torsional mode by using the Wiedemann effect. A practical arrangement for realizing this is shown in Figure 7. The transducer is made in the form of a tube, which is polarized circumferentially by passing a current through a conductor temporarily inserted in the axial hole. The longitudinal drive field is obtained from a coil as illustrated in Figure 7A. Interaction of the two fields results in a helical component and, since the strain varies along a line of flux, the torsional mode is generated.

Eddy-current losses in most metals are prohibitive between 50 and 500 kilocycles, hence nickel-zinc ferrites are favored. At remanent polarization, these have an electromechanical coupling coefficient greater than 20 per cent.

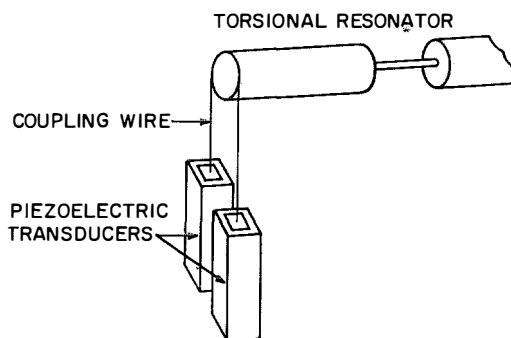

Figure 6—Longitudinal piezoelectric transducers driving a torsional filter.

The coefficient varies with applied polarizing force H as shown in Figure 7B. To achieve stability, the samples are first saturated and then subjected to a small temporary alternating field that reduces the remanent polarization as shown in Figure 7C. The samples are then assumed to be stable for values of H less than the applied stabilizing field, and for an equivalent range of temperatures, mechanical vibrations, et cetera. The final value of k_{em} resulting from this procedure can be regarded as the maximum practical working figure for the conditions imposed and is usually of the order of 10 per cent.

The input impedance seen at the terminals of a practical drive coil with polarized transducer varies with frequency as shown in Figure 8A. The equivalent networks are given in Figures 8B and 8C. From these (see Figure 4), it follows that

$$k_{em}^2 = \frac{L_m}{L_e} \approx \frac{2(f_a - f_r)}{f_r} \quad (15)$$

where k_{em} is the effective electromechanical coupling coefficient of the drive unit, f_a is the antiresonance frequency corresponding to Figure 8C, and f_r is the resonance frequency of Figure 8B.

6. Materials

Many filter specifications require a low temperature coefficient of resonant frequency.

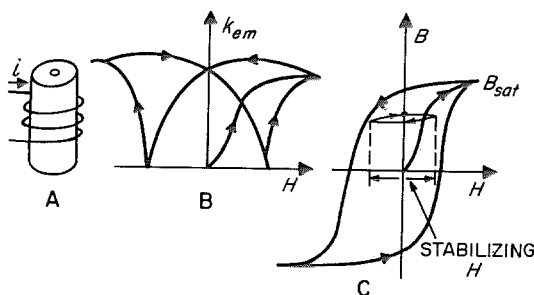

Figure 7—A shows a ferrite transducer with drive coil, B is a plot of electromechanical coupling coefficient k_{em} with polarizing force H , and C shows a B - H curve with an auxiliary loop resulting from a small temporary alternating field.

These are met by fabricating the mechanical elements from one of the nickel-iron alloys developed to have a low temperature coefficient of elasticity. Ideally, the condition for zero temperature coefficient of resonant frequency is met by adjusting the temperature coefficient of elastic modulus so that it is equal and opposite to the linear expansion coefficient. These conditions are nearly satisfied in the elinvar and *Ni-Span C* [3] alloys.

The temperature coefficient of *Ni-Span C* can be adjusted within a limited range by heat treatment, which is best performed after machining to remove residual strains. This ensures maximum stability during the working life of the filter.

After treatment, resonators have mechanical Q values in excess of 5000, with an average figure around 8000. Unfortunately, both materials are somewhat difficult to work.

7. Filter Design Techniques

With the discussed simple structure, electro-mechanical filters can be realized that are equivalent to the electrical ladder structure shown in Figure 5. These filters can be designed on any convenient basis, which may include image-parameter or insertion-loss theory, that is, Butterworth or equiripple Chebishev. The terminating impedances may be finite at each end or, alternatively, short circuit or open circuit at one end only. Thus filters may be designed to work between a range of matched loads or as coupling networks between amplifier stages. It is also possible to realize filters with attenuation poles by using the principles of mode conversion or of paralleled mechanical systems. With the attenuation poles at imaginary frequencies, the delay distortion can often be modified to give an improved transient response [4].

In all cases, the equivalent electrical design data are transformed into resonant frequencies and values of k and Q . However, if the bandwidth and pass-band shape permit, the finite

Q values of the mechanical resonators may be neglected, and only the Q values of the end circuits including terminations need be considered.

The design data for the above classes of network are summarized in the following subsections.

7.1 CONSTANT- k FILTERS

Constant- k filters [5, 6] are the most convenient to manufacture since all the inner coupling coefficients have the same value; hence coupling necks are all of equal diameter if the resonators are equal. The loss characteristics, however, are not readily calculated. The design parameters are:

f_0 = resonant frequency
 f_b = bandwidth at half-power points

$$k_{12} = \frac{f_b}{(2)^{\frac{1}{2}} f_0}$$

$$k_{23} \cdots k_{(n-2)(n-1)} = \frac{f_b}{2 f_0}$$

$$k_{(n-1)n} = \frac{f_b}{(2)^{\frac{1}{2}} f_0}$$

$$Q_1 = \frac{f_0}{f_b}$$

$$Q_2 \cdots Q_{(n-1)} = \infty$$

$$Q_n = \frac{f_0}{f_b}$$

7.1.1 Butterworth or Maximally Flat Filters [7, 8]

Power loss in decibels

$$= 10 \log_{10} \left\{ 1 + \left(\frac{f}{f_b} \right)^{2n} \right\}$$

$$k_{r(r+1)} = \frac{f_b}{f_0} \left\{ \frac{1}{4 \sin (2r-1) \theta \sin (2r+1) \theta} \right\}^{\frac{1}{2}}$$

where $\theta = \pi/2n$ radians and n = number of

resonators.

$$Q_1 = \frac{f_0}{f_b} 2 \sin \theta$$

$$Q_2 \cdots Q_{n-1} = \infty$$

$$Q_n = \frac{f_0}{f_b} 2 \sin \theta.$$

7.1.2 Chebyshev Filters

Power loss in decibels

$$= 10 \log_{10} \left[1 + \left\{ \epsilon T_n \left(\frac{f}{f_b} \right) \right\}^2 \right]$$

where f_b = bandwidth at specified ripple

ϵ = ripple factor

$$T_n(\omega) = \cosh (n \cosh^{-1} \omega).$$

$$k_{r(r+1)} = \frac{f_b}{f_0}$$

$$\times \left\{ \frac{S_n^2 + \sin^2 2r\theta}{4 \sin (2r-1)\theta \sin (2r+1)\theta} \right\}^{\frac{1}{2}}$$

where $\theta = \pi/2n$ and $S_n = \sinh \left(\frac{1}{n} \sinh \epsilon^{-1} \right)$.

$$Q_1 = \frac{f_0}{f_b} \frac{2 \sin \theta}{S_n}$$

$$Q_2 \cdots Q_{n-1} = \infty$$

$$Q_n = Q_1.$$

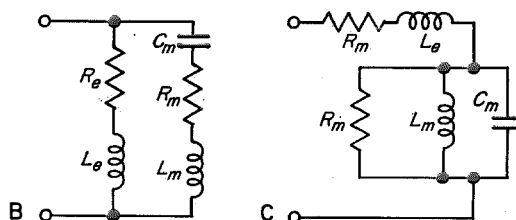
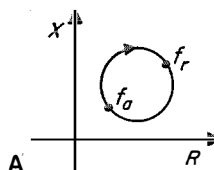

Figure 8—Input impedance of a practical drive coil with polarized transducer. *A* shows that the impedance varies with frequency, while *B* and *C* are equivalent electrical circuits.

7.1.3 *Narrow-Band and Broad-Band Considerations*

After deciding on the filter shape and evaluating the design parameters according to the above equations, the next step is to consider transducers and drive units. This can be approached in two different ways.

If k_{12} is between, say, 8 and 10 per cent, a narrow-band drive unit will be required. On the other hand, if k_{12} is less than 8 per cent, the design can be realized in either broad-band or narrow-band units.

The narrow-band unit is arranged so that the drive coil, when resonated, functions as the first resonator in the filter design, and the electromechanical coupling coefficient of the transducer is adjusted to the value k_{12} . Hence

$$L_e = \frac{Z_0 Q_1}{\omega_0}$$

for the series-tuned coil, and

$$L_e' = \frac{Z_0}{\omega_0 Q_1}$$

for the parallel-tuned coil. In each case Z_0 is the terminating impedance of the filter.

In a broad-band unit, the resonated drive coil and terminating impedance are designed as a broad-band filter section with bandwidth greater than that of the filter. The absolute value of k_{em} must therefore be greater than k_{12} , which in this case is now the coupling factor between transducer and first metal resonator. The design may be realized by using

$$Q_1 = \frac{Z_0}{\omega_0 L_m} \quad \text{and} \quad k_{em}^2 = \frac{L_m}{L_e}$$

for the series-tuned coil, and

$$Q_1 = \frac{\omega_0 L_m}{Z_0} \quad \text{and} \quad k_{em}^2 = \frac{L_e}{L_m}$$

for the parallel-tuned coil.

It follows that the narrow-band design results in a filter with 2 fewer mechanical resonators than the equivalent broad-band design. How-

ever, since the frequency stability of mechanical resonators is better than that of most electrical resonators, broad-band units are usually preferred if practicable.

7.2 TUNING OF FILTERS

Mechanical resonators can be adjusted to the correct frequency by removing material from the ends to raise the frequency and from the center to lower it. The adjacent resonators on either side are usually clamped during this procedure. Vibrations can be detected by using a small search coil that also excites the resonator. To facilitate this, the filter bodies are usually polarized before testing by passing current momentarily through them. However, it is wise to degauss the body to ensure stability after tuning. The search coil is part of a simple bridge driven by an adjustable-frequency oscillator, the amplitude of resonance being indicated with the aid of a high-gain amplifier and detector.

By exposing two coupled resonators, one having the search coil over it, two resonance peaks can be recorded. If the resonators have been adjusted correctly to f_0 , the difference between these two frequencies is a measure of coupling between them, as discussed previously. However, if the recorded coupling is higher than required, it can be adjusted by removing material from the coupler. The material must be removed evenly throughout its length or the tuning of the adjacent resonators may be affected.

It is sometimes expedient to expose more than two resonators during tuning. The number of responses is then equal to the number of resonators exposed. In this case the frequency separation between peaks, taking them in symmetrical pairs, can be obtained from the following set of equations:

1 resonator $\frac{\delta f}{f_0} = 0$

2 resonator $\left(\frac{\delta f}{f_0}\right)^2 - k_{12}^2 = 0$

$$\begin{aligned}
 &3 \text{ resonator} \quad \left(\frac{\delta f}{f_0}\right)^3 - (k_{12}^2 + k_{23}^2) = 0 \\
 &4 \text{ resonator} \quad \left(\frac{\delta f}{f_0}\right)^4 - (k_{12}^2 + k_{23}^2 + k_{34}^2) \\
 &\quad \quad \quad \times \left(\frac{\delta f}{f_0}\right) + k_{12}^2 k_{23}^2 = 0 \\
 &5 \text{ resonator} \quad \left(\frac{\delta f}{f_0}\right)^5 - (k_{12}^2 + k_{23}^2 + k_{34}^2 \\
 &\quad \quad \quad + k_{45}^2) \left(\frac{\delta f}{f_0}\right)^3 + (k_{12}^2 k_{34}^2 \\
 &\quad \quad \quad + k_{12}^2 k_{45}^2 + k_{23}^2 k_{45}^2) \\
 &\quad \quad \quad \times \left(\frac{\delta f}{f_0}\right) = 0
 \end{aligned}$$

et cetera, where δf is the frequency separation between pairs with a product equal to f_0^2 , and the k values are coupling coefficients taken in order.

7.3 PRACTICAL FILTERS

A wide range of filters have been made in the laboratory using the design principles outlined above, and representative samples are now described to illustrate the possibilities of the techniques discussed.

The insertion loss and relative delay characteristics of a filter intended for single-sideband use at a carrier frequency of 64 kilohertz are illustrated in Figure 9. This filter contains 11 mechanical resonators with coupling coefficients chosen to give a theoretical ripple of 0.1 decibel in the pass band, according to the Chebishev design equation in Section 7.1.2. Drive units were designed on a broad-band basis to match an impedance of 600 ohms at each end, and a pass-band loss of about 1 decibel was realized as shown in the figure. The over-all dimensions were approximately $14 \times 2 \times 1.8$ centimetres ($5.5 \times 0.8 \times 0.7$ inches).

The characteristics of a filter intended for telegraph use at a mid-band frequency of 100 kilohertz are shown in Figure 10. Since the

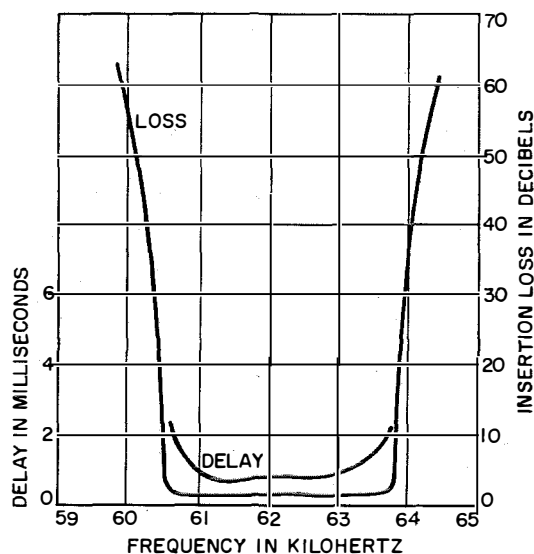

Figure 9—Insertion loss and delay of a single-sideband electromechanical filter for use at a carrier frequency of 64 kilohertz.

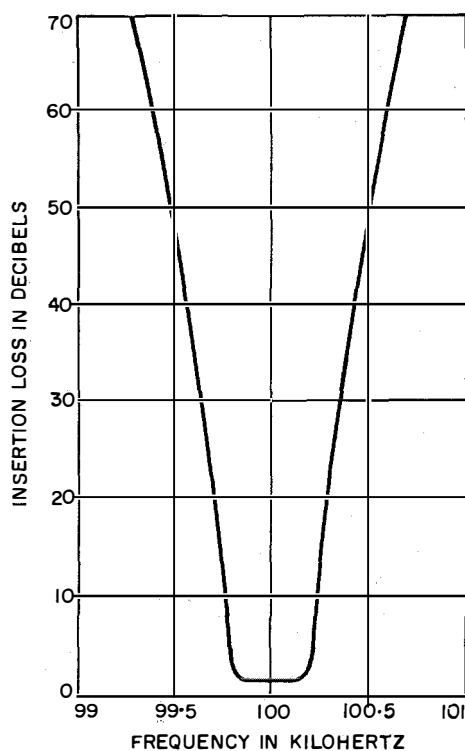

Figure 10—Insertion loss of an electromechanical telegraph filter.

transient response is important in this case, the filter was designed to have a good phase characteristic in the pass band by employing a slightly modified Butterworth-type response. It contains 7 resonators and, being a relatively narrow-band filter, has broad-band drive units. The complete unit is contained in a case with over-all dimensions of approximately $7 \times 2 \times 1.8$ centimetres ($2.8 \times 0.8 \times 0.7$ inches). It was designed to work between 75-ohm impedances and has a mid-band insertion loss of approximately 1.5 decibels.

The characteristics of a 200-kilohertz filter designed for single-sideband use with a 6-kilohertz pass band and having more than 30 decibels of carrier rejection are shown in Figure 11. The filter contains 15 mechanical resonators coupled to give Chebishev-type performance with a ripple of 0.5 decibel in the pass band. Drive units are again broad band and were designed to match terminating impedances of 1000 ohms. The mid-band insertion loss is about 1.2 decibels and the over-all dimensions $9.5 \times 2 \times 1.8$ centimetres ($3.7 \times 0.8 \times 0.7$ inches).

At higher frequencies, the dimensions of the mechanical units become rather small, and in some ways are more difficult to handle. The

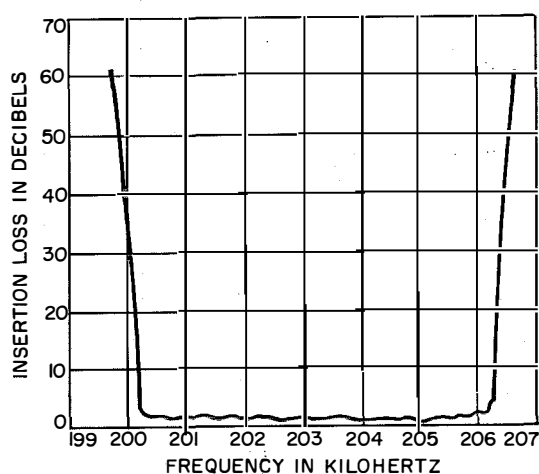

Figure 11—Insertion loss of a single-sideband electro-mechanical filter for use at a carrier frequency of 200 kilohertz.

response characteristics of a 465-kilohertz filter suitable for intermediate-frequency use are shown in Figure 12. It was designed to give a maximally flat response and contains 7 mechanical resonators. The terminating impedances were designed to be 500 ohms and 20 000 ohms, respectively. The unit is contained in a case with dimensions of $5 \times 2 \times 1.8$ centimetres ($2 \times 0.8 \times 0.7$ inches).

Figure 13 is a photograph of a typical electro-mechanical filter with drive coils and 9 mechanical resonators.

All the above filters work satisfactorily over a temperature range from 0 to 60 degrees centigrade; an even-wider range is possible with further development. They are robust and with appropriate production techniques should be inexpensive. Performance in all cases has been very close to design expectations.

8. Conclusions

Electromechanical filters can be designed and built to meet high-performance specifications. The design and production techniques are comparatively flexible, provided that suitable mechanical structures free from spurious re-

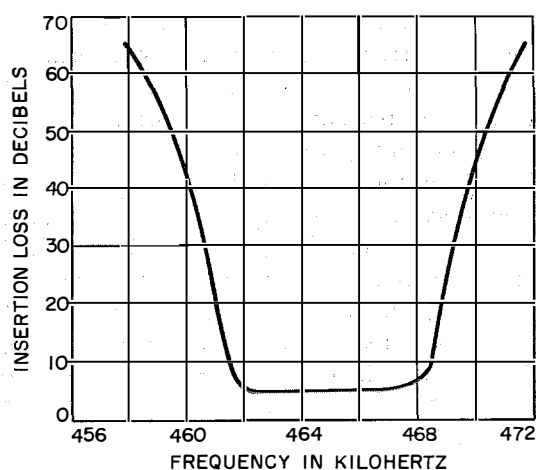

Figure 12—Insertion loss of an intermediate-frequency electro-mechanical filter at 465 kilohertz.

sponses are used. Small and robust filters can be made that compare favourably with more-conventional techniques. However, designs are restricted at present to the equivalent electrical ladder structures and sometimes use more resonators than are needed theoretically when equivalent m -derived or lattice sections are considered. This should not be regarded as a severe restriction since mechanical resonators are inexpensive.

Stability of performance with varying temperature is good enough for most applications,

being of the order of 10 parts per million per degree centigrade (average) over a range of more than 80 degrees centigrade. Even-better stability can be achieved by close control or selection of the resonator material.

9. Acknowledgment

The author wishes to thank his colleagues at Standard Telecommunication Laboratories for their help in making the sample filters described in this paper.

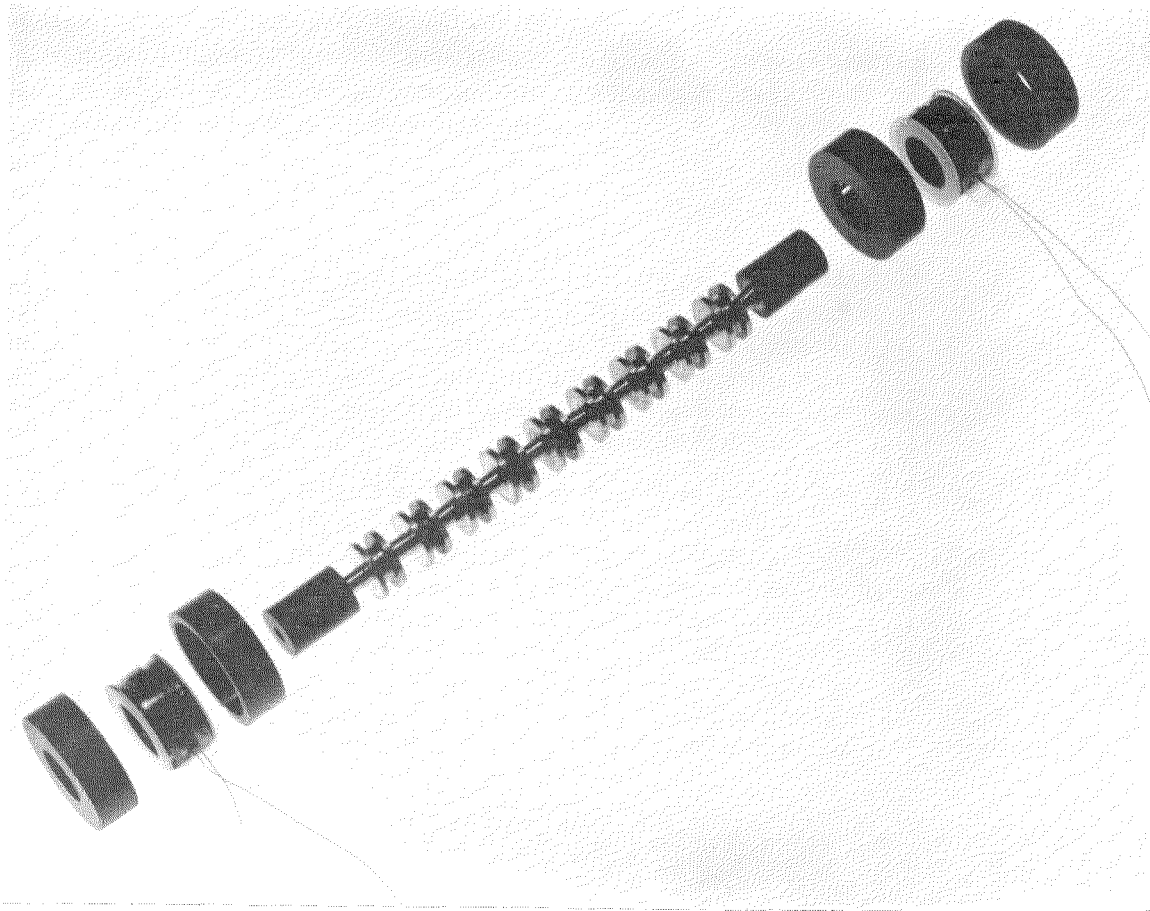

Figure 13—Typical electromechanical filter with drive coils and 9 resonators.

10. References

1. W. Mason, "Electromechanical Transducers and Wave Filters," D. Van Nostrand Company, New York: 1942.
2. H. Kolsky, "Stress Waves in Solids," Oxford University Press, London: 1953.
3. Engineering Data Bulletin, "Ni-Span C," H. A. Wilson Company, Division Engelhard Industries, Incorporated; Union, New Jersey.
4. M. Börner, "Mechanische Filter mit Dämpfungspolen," *Archiv der Elektrischen Übertragung*, volume 17, number 3, pages 103–107; 1963.
5. O. J. Zobel, "Transmission Characteristics of Electric Wave-Filters," *Bell System Technical Journal*, volume 3, number 4, pages 567–620; 1924.
6. E. Green, "Amplitude Frequency Characteristics of Ladder Networks," Marconi Wireless Telegraph Company; 1954.
7. M. Dishal, "Design of Dissipative Band-Pass Filters Producing Desired Exact Amplitude-Frequency Characteristics," *Electrical Communication*, volume 27, number 1, pages 56–81; 1950.
8. M. Dishal, "Two New Equations for the Design of Filters," *Electrical Communication*, volume 30, number 4, pages 324–337; 1953.
9. G. W. Stewart, "Acoustic Wave Filters—Bibliography," *Physical Review*, volume 20, page 528; 1922.
10. C. M. Van der Burgt, "Ferroxcube Material for Piezomagnetic Vibrators," *Philips Technical Review*, volume 18, number 10, pages 285–298; 1957.
11. M. Dishal, "Alignment and Adjustment of Synchronously Tuned Multiple-Resonant-Circuit Filters," *Electrical Communication*, volume 29, number 2, pages 154–164; 1952.

Albert Russen was born on 20 March 1920, in London, England. He joined Standard Telephones and Cables at New Southgate in 1936, where he was associated with the development and manufacture of production test gear in both the telephone and radio divisions.

In 1945, he joined the staff at Standard Telecommunication Laboratories, where he has been engaged in the development of test equipment and in problems associated with pulse code modulation and circuit theory. Mr. Russen is also responsible for the development programme covering theory and design of electromechanical filters for use in telecommunication systems.

Tandem Wire Drawing and Plastic Insulation Extruding

P. N. DELVES-BROUGHTON

Standard Telephones and Cables Limited; Newport, Monmouthshire, England

1. Introduction

During the past two decades there has been a pronounced change in wire and cable design from paper and textile insulation to plastic insulation. Switchboard and interphone cables, formerly textile-insulated and textile- or lead-sheathed, now use plasticized polyvinylchloride for both insulant and sheath.

Although paper-insulated lead-covered cables are still largely used for exchange area networks, they have been superseded in many cases by cables insulated and sheathed with polythene. Large plants have been set up by the Western Electric Company (United States) for the sole production of Alpth cables (polythene-insulated corrugated-aluminium-screened polythene-sheathed cables). The British Post Office has developed standards covering all polythene designs for local distribution cables up to 100 pairs, and they and other administrations have installed experimental polythene unit-type cables up to 2000 pairs.

Polythene shows an economic advantage over paper-insulated lead-sheathed cables for quantities up to 500 pairs. A price reduction in polythene is forecast. In addition, the lower weight factor of polythene cables allows the installation of longer lengths with fewer joints. Sheath failures admitting water that would completely disrupt paper-insulated lead-sheathed cables affect only a small number of polythene-insulated pairs and the cable is still largely operable. For this and other reasons there is a growing demand for plastic-insulated and -sheathed cables.

2. Manufacturing Methods

There have been many technical advances in recent years in the extrusion of thin-walled insulation onto wires. Conventional insulating equipment consists of a wire payoff unit, conductor preheater, extruder and cross head, cooling trough, capstan, and reeling equipment. If rotating reels or a flyoff system were

used to supply wire to the line, carefully balanced and wound reels would be needed to avoid difficulties caused by wire breaks and stretched conductors. These hazards would restrict the extrusion line speed to about 1500 feet (460 metres) per minute. In addition, reeling equipment has not advanced sufficiently to accommodate high line speeds because of problems associated with inertia, acceleration, and wire transfer between reels.

It was decided to install a wire drawing machine in tandem with an extrusion line (as this would ameliorate wire supply problems) and to design fully automatic extrusion and take-up equipment suitable for continuous operation at high wire speeds. Tandem extrusion had already been developed by the Western Electric Company but our prototype machines were designed independently.

2.1 DEVELOPMENT OF TANDEM SYSTEM

Before a tandem line could be realized, certain basic manufacturing problems had to be resolved to permit economical high-speed production of thin-walled-insulated wires. The system that evolved is described in the following paragraphs.

2.1.1 *Extruder*

To provide a high degree of concentricity of conductor and insulant, fixed centering guides are used in a 2-way extruder cross head having small capacity and balanced flow of plastic.

2.1.2 *Long-Life Core-Tube*

The core-tube, which guides the wire centrally through a die to give it a concentric covering of insulation, is subject to wear. Long-term studies gave life figures of about 1×10^6 and 2×10^6 yards (0.9×10^6 and 1.8×10^6 metres) for hardened-steel and tungsten-carbide core-tubes, respectively. These figures were inadequate for the purpose in mind. Ultimately, core-tubes fitted with

Tandem Wire Drawing and Insulation Extruding

diamond inserts assured a life in excess of 50×10^6 yards (46×10^6 metres).

2.1.3 Extrusion Die

The design of the die used for applying the insulant round the wire was critical with respect to extrusion speed and the type of material used. Taper land dies having a length-to-diameter ratio of 10:1 for polyvinylchloride and 15:1 for polythene were found to give a smooth finish at speeds up to 2500–3000 feet (750–900 metres) per minute.

2.1.4 High-Speed Take-up Equipment

When this project was being considered, no suitable equipment was available for the fully automatic high-speed reeling of small insulated wires at high extrusion speeds. Therefore it was decided to design and develop this equipment within our own organization. This was accomplished by a joint group of engineers from London and Newport. Facilities were incorporated for fully automatic wire transfer from full to empty reels at speeds up to 3000 feet (900 metres) per minute, and a mechanism was fitted for automatic reel load and discharge.

2.1.5 Electrotinning Plant

Before being introduced into the tandem line, plain copper wire is electrotinned. In the line, it is drawn to final size and annealed in one

continuous operation. This technique enhances the surface finish of the tinned wire and provides a more-uniform and thinner coating than is obtained with hot dipped wire. It also reduces the wire cost and avoids the troublesome accumulation of tin in the core-tube that occurs when hot tinned wire is processed.

3. Layout and Description

The prototype tandem line was completed in mid-1960 and provision was made to install five lines. Two were installed during 1961 and the project will be completed in 1964. Two operators are sufficient to run the 3 lines.

To prevent any possible flooding, all the tanks that supply wire-drawing liquor and cooling water were positioned outside the factory. Their drain and feed pumps are automatically controlled from a master control panel inside the factory. The cooling-water circuit can be operated as an independent unit or connected into the main factory system.

All other services are installed in ducts or overhead to give easy accessibility for maintenance.

Figure 1 is a schematic arrangement of the tandem line. The line components are described in the following sections.

3.1 CONTINUOUS WIRE SUPPLY

Plain copper wire drawn on a rod reduction machine is coiled into cylindrical packs.

Figure 1—Tandem wire drawing and extrusion line.

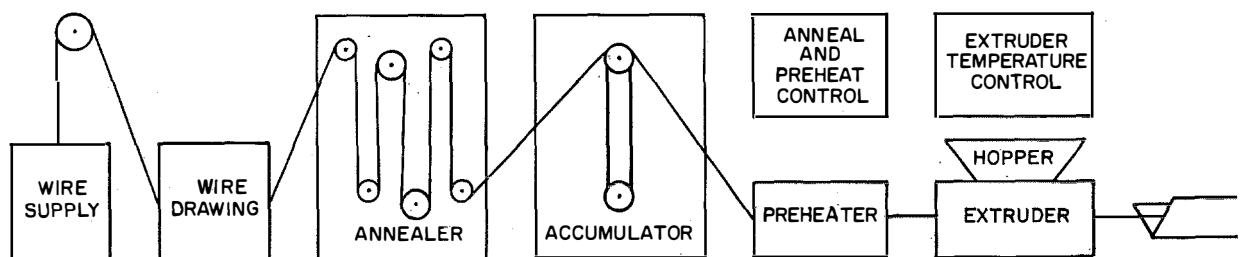

Tandem Wire Drawing and Insulation Extruding

Tinned copper wire, which is plated in the intermediate form, is coiled directly from the electroplating machine.

The packs of wire are placed under an overhead pulley frame that is fitted with a wire straightener and tensioner. The wire is paid out vertically and then guided over the pulley into the wire drawing machine. Facilities are provided for jointing the inner end of the running pack to the outer end of the stand-by pack by the Koldweld process, thereby forming a continuous supply system.

3.2 WIRE DRAWING MACHINE

The wire drawing machine was geared to suit the line drive. Replaceable hard chromium-plated draw blocks were fitted, and the final die was equipped with a steam cleaning jet to remove die lubricant from the wire. Carbon brushes were fitted to the capstan shaft to provide a return path for the annealer.

3.3 ANNEALER

The annealer was fitted with a stepless transformer having a 15-kilovolt-ampere output controlled by a saturable-core reactor. The sheaves, which are fitted with slip rings and carbon brushes to pass the heating current through the wire to be annealed, are belt driven from the wire-drawing-machine capstan. The annealer coolant is under thermostatic control. Solenoid valves adjust the blast of air used to dry the wire.

Current controls and meters for the annealer are housed in a control cabinet.

3.4 ACCUMULATOR ON INPUT SIDE

A wire accumulator and dancer control is positioned between the annealer and extruder, and has four sheaves in the top position and three sheaves in the floating position. The floating sheaves are mounted on a traveling block that slides vertically on the accumulator column, and are counterbalanced by a weighted chain passing over a sprocket at the top of the column. This sprocket is geared to a threaded shaft that causes a magnetic core to move in and out of a reactor as the floating sheaves rise and fall because of speed variations between the wire drawing machine and the extruder capstan. The reactor is used to synchronize the speed of the wire drawing machine to the capstan speed.

3.5 PREHEATER

The preheater consists of a 5-kilovolt-ampere stepless transformer controlled by a saturable-core reactor. The wire passes round four brass sheaves, current being applied to the wire via slip rings and carbon brush contacts fitted to two of the sheaves. Wire temperature is shown on an indicator that measures thermocouple current from 2 pulleys of different metals in contact with the wire.

3.6 ANNEAL AND PREHEAT CONTROL

The controls for the annealer and preheater

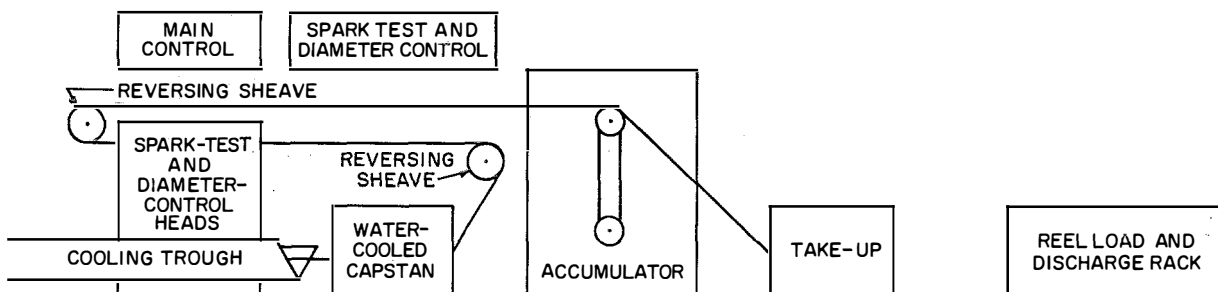

Tandem Wire Drawing and Insulation Extruding

are housed in a separate cabinet. These two units are controlled by individual variacs, which are preset in accordance with the input wire diameter and running speed.

3.7 EXTRUDER

The extruder is of robust construction. A 2.5-inch (6.4-centimetre) feed screw heats and forces the plastic into contact with the wire and operates against a thrust bearing suitable for a 3.25-inch (8.3-centimetre) feed screw. The plastic in the feed-screw cylinder and in the extruder head is heated by frictional shear from the screw, the heat balance being controlled by thermostats fitted to the cylinder wall, which is electrically heated.

Figure 2 is a simplified diagram of an extruder and Figure 3 is a photograph of the unit in the tandem line.

3.8 HOPPER

Granules of base polythene or polyvinyl-chloride compound are mixed with a colour

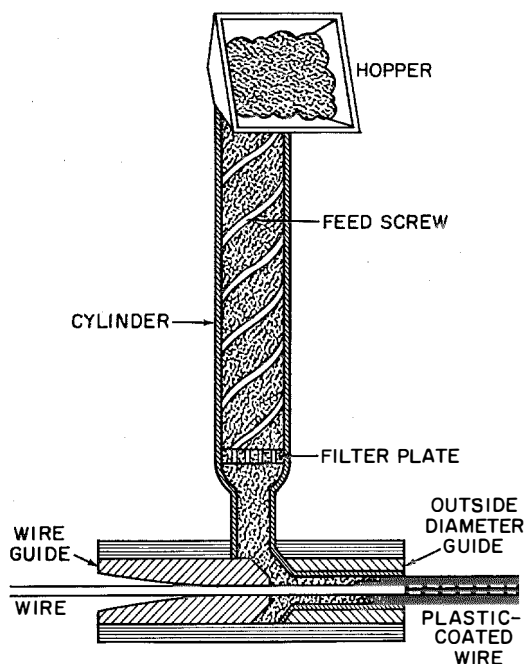

Figure 2—Principles of extruder operation.

master batch and are then conveyed pneumatically from a storage area, common to all machines, to the extruder feed hopper. When the hopper is full, back pressure on the feed line automatically switches off the supply.

3.9 EXTRUDER TEMPERATURE CONTROL

A cabinet houses four transistor-operated temperature controllers with their indicators. They control the temperature of the heating zones in the feed-screw cylinder and of the extruder head. An additional indicator records the temperature of the plastic. Selector switches are provided for automatic cooling of the extruder cylinder if required. Automatic and manual switches are provided to guard against instrument failure.

3.10 COOLING TROUGH

A 20-foot (6-metre) stainless-steel water cooling trough is provided, fitted with end weirs, catch basins, and drains. Additional weirs are located along the trough to reduce the dragout of water by the wire at high extrusion speeds.

3.11 MAIN CONTROL

The main control panel mounts all the motor and auxiliary controls. Local switches are provided to facilitate threading the tandem line. All motors are switched to automatic to start the line, and one start push button and speed control governs the speed of the complete system. On starting, all air wipers and the steam cleaners are energized. On reaching preselected line speed, the annealer and preheater are switched on automatically. Should the wire stop, slow down, or break, all auxiliary controls are de-energized. Also mounted on the panel is a double deatron counter for operating the automatic take-up stand and controls, plus a chart recorder for a micro-limit diameter controller.

Tandem Wire Drawing and Insulation Extruding

3.12 REVERSING SHEAVES

To reduce the length of the tandem line, the direction of the wire is reversed round a sheave positioned at the output of the capstan. It then goes through the spark-test and diameter-control heads to another sheave above the trough, where it is again reversed toward the accumulator on the output side.

3.13 SPARK TEST AND DIAMETER CONTROL

A direct-current 10-kilovolt spark test is applied through brush-type electrodes mounted in a box in the return wire path. A photocell light-sensing head is mounted next to the spark test electrodes. An automatic wire-diameter controller is incorporated in the line. The controls and recorder for these tests are mounted on a separate control panel.

3.14 CAPSTAN

A water-cooled aluminium capstan wheel having a diameter of 30 inches (76 centimetres), which corresponds to a circumference of 8 feet (2.5 metres), and an 8-inch (20-centimetre) diameter auxiliary guide sheave are both mounted in a cast-iron housing. They pull the insulated wire through the extrusion line and provide further cooling of the wire.

A magnetic counter incorporated in the drive to the capstan is part of the diameter-control system. A photocell and light source operate a wire-length counter.

3.15 ACCUMULATOR ON OUTPUT SIDE

This accumulator is similar in design and operation to the one on the input side, but contains 7 sheaves in the top position and 6 sheaves in the floating position. Its purpose is to control the speed of the dual-reel high-speed take-up unit.

A tachometer generator is driven by a gear train from the chain sprocket of the accumulator. Its rotation when the accumulator sheaves change position provides a voltage

that operates to stabilize the system and to provide an additional boost to the take-up motor during reel transfer. A microswitch, fitted to the magnetic-core travel mechanism, trips a main contactor and stops the entire line if the wire breaks.

3.16 TAKE-UP STAND AND REEL LOAD AND DISCHARGE RACK

The take-up stand was designed for use at speeds up to 3000 feet (900 metres) per minute. Provision is made to accommodate reels up to 16-inch (41-centimetre) flange diameter and up to 10-inch (25-centimetre) traverse. For the line described in this paper, reels of 16 × 5 inches (41 × 13 centimetres) are used, these reels subsequently being loaded into a high-speed twisting machine.

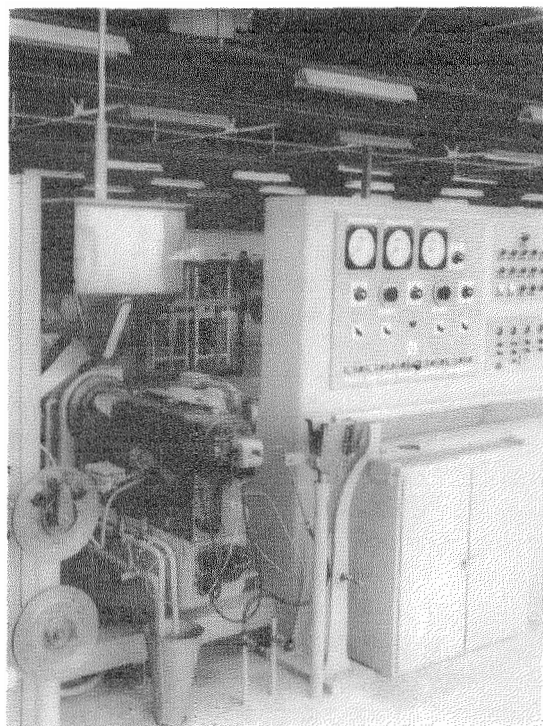

Figure 3—Extruder in the tandem line. The main control panel and cooling trough are at the right and two preheater sheaves are visible at the left.

Tandem Wire Drawing and Insulation Extruding

The following functions are hydraulically operated.

- (A) Traversing the wire between the reel flanges.
- (B) Flyover from full to empty reel.
- (C) Cutting the wire between reels.
- (D) Unclamping reels in the load/unload position.
- (E) Lowering the reel arms for the load/unload cycle.
- (F) Automatic reel load and discharge mechanism.

4. Drive System

The take-up unit consists of a 5-horse-power Emotrol drive, the motor being double ended and the drive taken through Warner magnetic clutch/brake units and toothed belts to the reel arbors. The clutch/brake units engage and disengage the appropriate reel drive in the correct sequence.

4.1 REEL TRAVERSE AND CHANGEOVER

Normal reel traversing is carried out through the medium of a variable-delivery hydraulic pump directly driven from the take-up motor. Under these conditions the rate of traverse varies with the speed of the motor, keeping the pitch of the wire constant regardless of reel speed. Traverse reversal is initiated by limit switches and solenoid-operated reversing valves. The wire guide pulley is mounted on a small auxiliary cylinder on the main traverse slide. The unit has been designed with its moving parts as light as practicable to reduce inertia.

Before reel changeover is required, a signal from a warning counter starts an auxiliary motor and hydraulic pump, and the driving clutch to the empty reel is energized.

The auxiliary hydraulic pump loads a gas/oil accumulator to a preset pressure between 1000 and 1200 pounds per square inch (70 and

84 kilogrammes per square centimetre). At a signal from a wire-length counter, a solenoid valve transfers the oil built up in the accumulator to the flyover cylinder, which transfers very quickly to the flyover guide pulley. As soon as the flyover piston reaches the end of its stroke, normal traversing resumes in the direction of the inner reel flange, and the turns of wire on the reel barrel are trapped. At this point, the wire is cut by a knife operated by a hydraulic ram, the full-reel drive clutch is disengaged and the brake applied, and the automatic reel discharge and reload cycle takes place.

The reel load and discharge mechanism is hydraulically operated by the auxiliary pump fitted to the take-up stand. It has an arm that is lowered onto a carriage while the splines fitted to the reel arbor are retracted, freeing the reel. The carriage moves sideways to a predetermined position and then tips forward, causing the full reel to run down the inclined ramp of a holding magazine.

The carriage platform then resumes the horizontal position and an empty reel is lowered from a supply ramp onto the carriage. The carriage then moves sideways and locates the reel on the retracted reel arbor. As the reel arm is raised to the running position, the splines are released and grip the reel.

4.2 MOTOR DRIVE TRANSMISSION

The capstan motor is the master control, with the motors of the wire drawing machine and extruder slaved to it. Each motor is fitted with a tachometer generator, the output voltage of which is proportional to speed. The signal voltage from the capstan motor is taken as a reference and, to make the slave motors run synchronously with this motor, their feedback voltages are compared with the reference voltage of the capstan tachometer generator. In addition, the wire-drawing-machine accumulator is fitted with a magnetic coil reactor that smooths out any variations in line speed and also compensates for any wire

stretch occurring when the conductor passes through the annealer.

The extruder runs synchronously with the capstan and is fitted with a ratio control so that the basic speed of feed screw and capstan can be adjusted to suit the required thickness of the dielectric material. Figure 4 is a simplified diagram of the extruder control. Resistors $R1$ and $R2$ control the speed of the capstan motor. The capstan tachometer generator, the output of which is proportional to the capstan speed, is used as a reference voltage for the extruder Emotrol. Therefore the extruder and capstan speeds are proportional, as are their tachometer-generator voltages.

As the reference voltage is derived from the capstan tachometer generator, the extruder speed depends on the capstan speed, adjustable resistor $R3$, and the position of switch $S2$. The reference voltage to the extruder $V_{re} = xV_{ct}$, where x is determined by the positional setting of $R3$ and V_{ct} is the capstan tachometer-generator voltage.

The extruder feedback voltage $V_{fe} = yV_{te}$, where y is the ratio of the voltage divider $R4$ and $R5$. As the extruder Emotrol functions to make the feedback voltage proportional to the reference voltage ($xV_{ct} = ykV_{te}$, where k is a constant), then

$$V_{te} = \frac{xV_{ct}}{yk}$$

The values of resistors $R4$ and $R5$ are so chosen that switch $S2$ can select values of $y = 1$ or 0.5 . The extruder Emotrol is set so that when both x and y are equal to 1, the capstan motor speed is equal to the extruder motor speed.

The drive to the take-up is completely independent of the rest of the tandem-line drive, speed control being achieved as described in Section 3.15.

Figure 5 shows the tandem line as viewed from the output side.

5. Operating Data

Raw materials must meet British Post Office specifications *CW.128*, *CW.151*, and *CW.171*. The line has been successfully operated with polythene of melt index grades 2 and 0.3 (the latter corresponding to Bakelite *PN.217*) and with plasticized polyvinylchloride to cover the wire with a thin wall of insulation. In both cases the insulant was coloured by the addition of master colour batch.

The tandem line is supplied with wire in 600-pound (272-kilogramme) payoff packs. Bare wire is obtained from an *F.13* rod machine, and an electroplating machine is used if tin coating is required.

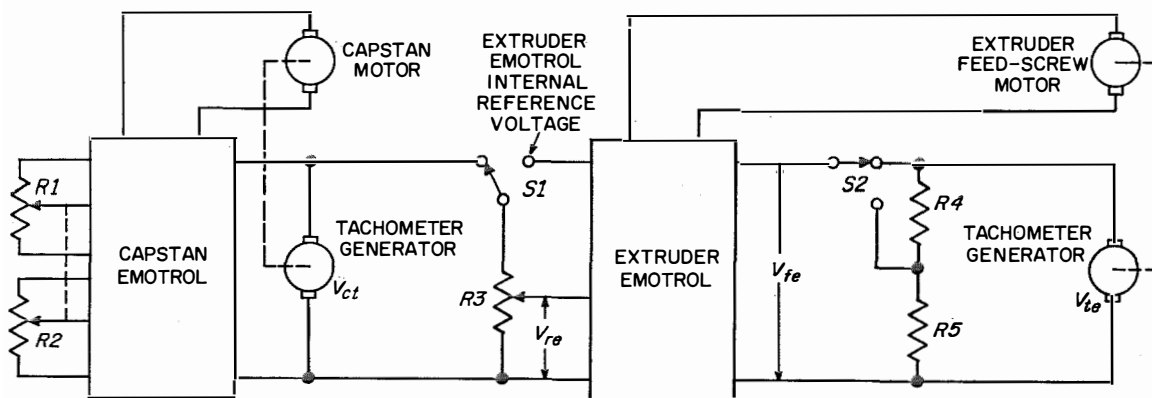

Figure 4—Method for controlling extruder plastic feed as a function of the wire speed.

Tandem Wire Drawing and Insulation Extruding

Conventional diamond dies are used in the *C.12* wire drawing machine, giving diameter reductions of approximately 4:1 over-all.

The plastic in the feed-screw cylinder is heated in part by friction with the screw and in part by electric heaters. There are three general heating zones in the cylinder. These zones are progressively hotter, and further temperature rise occurs in the extruder head. For polyvinylchloride, the cylinder temperatures are 140, 160, and 170 degrees centigrade, with a head temperature of 180 degrees. For polythene, the respective temperatures are 150, 200, 250, and 275 degrees. The screw-cooling-water exit temperatures are 40 and 45 degrees for polyvinylchloride and polythene respectively.

The filter plate at the delivery end of the feed-screw cylinder has holes that are $\frac{1}{16}$ inch (0.16 centimetre) in diameter covered by 2 wire gauzes of 70 meshes per inch (28 meshes per centimetre) and 1 gauze of 100 meshes per inch (39 meshes per centimetre).

	Polythene, Grade 0.3			Polyvinylchloride
Conductor size: Pounds per mile	4	6.5	10	6.5
Kilogrammes per kilometre	1.13	1.83	2.82	1.83
American wire gauge	26	24	22	24
Line speed: Feet per minute	2500	2500	2000	2000
Metres per minute	762	762	610	610
Screw speed: Revolutions per minute	52	68	72	50

The annealer power is set at 30 watts per pound (14 watts per kilogramme) of conductor per hour, and the coolant is maintained at 40 to 50 degrees centigrade. Operating speeds are given in Table 1.

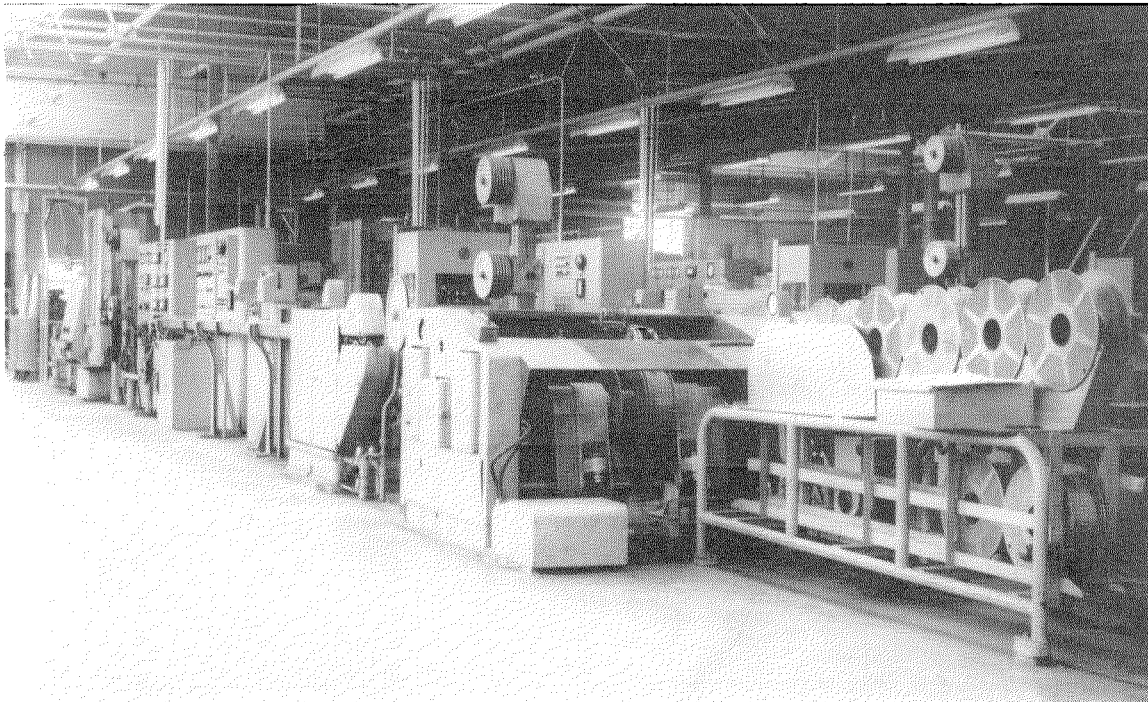

Figure 5—Tandem line viewed from output side.

6. Conclusion

One tandem line has been in operation for 36 months, two for 18 months, and two others will be completed during 1964. Two operators can run the three lines without difficulty, giving a high output at low cost.

Line speed is between 2000 and 3000 feet (600 and 900 metres) per minute, depending on wire size and insulant. The diameter control and quality of the insulated wire are very good. Faults occurred at first during reel

transfer because of the whipping action of the free ends of the cut wire, but these were overcome by reducing the line speed automatically to change reels, then accelerating to normal operating speed. This development has profoundly improved the end fault level and will ultimately allow higher line speeds.

The use of electrotinned wire has proved highly successful for polyvinylchloride-insulated wires and completely eliminates the blocking of core tubes with tin dust.

P. N. Delves-Broughton was born in Croydon, Surrey, England on 8 January 1916. In 1940, he passed the examination for Associate of the Institute of the Rubber Industry and also obtained a Diploma in Plastics Technology.

He joined Standard Telephones and Cables in 1938 and did development work on rubber, styrene, and plastic insulating materials for cables.

During the second World War, he served as a pilot with the Royal Air Force. He rejoined the company in 1947 and became head of the Newport cable factory development laboratories. Mr. Delves-Broughton is now engineer of manufacture and development for the Newport Cable Division.

Quasi-Electronic Translator in Telephone Direct Distance Dialing

TH. BURIAN
H. NORDSIECK

Standard Elektrik Lorenz AG; Stuttgart, Germany

1. General

Many engineering problems have resulted from the expansion of subscriber direct distance dialing, interest in which has assumed worldwide proportions. In addition to automatic message accounting required by the absence of an operator, and to more-rapid signaling methods in view of the increased number of switching operations, the problem of routing calls assumes special importance as it can have a decisive influence on the cost of the entire toll network. The availability of adequate and flexible routing facilities allows a system of independently operated networks to provide for alternative routes in case of overload or disturbances on the most-direct route and tends to maintain highest speech quality by reducing to the minimum the number of intertoll links in each connection.

The route of a call is determined by the digits dialed by the calling subscriber and by certain data concerning the originating station. Automatic facilities using these data and information on available circuits to determine the required routing instructions are known as

translators. As the translator to be described is for the Deutsche Bundespost, it appears advisable to outline the structure of the German toll network to see how the translator fits into that system.

2. German Toll Network

The German toll network is divided into four levels corresponding to terminal exchanges, junction centers, sectional centers, and regional centers. All regional centers are fully meshed. The other levels are of the star type with numerous tielines interconnecting the different switching centers.

The subscriber obtains access to the toll network by dialing 0. In general the individual terminal exchanges are identified for toll dialing by 4-digit codes in addition to the 0 that designates a toll call. The first digit of such a code identifies the regional center; the second, the sectional; the third, the junction; and the fourth, the terminal exchange. There may, of course, be several switching centers in the local area served by the terminal exchange. Thus closed numbering is used for the entire local area en-

Figure 1—Establishment of a connection by direct distance dialing in the German toll network.

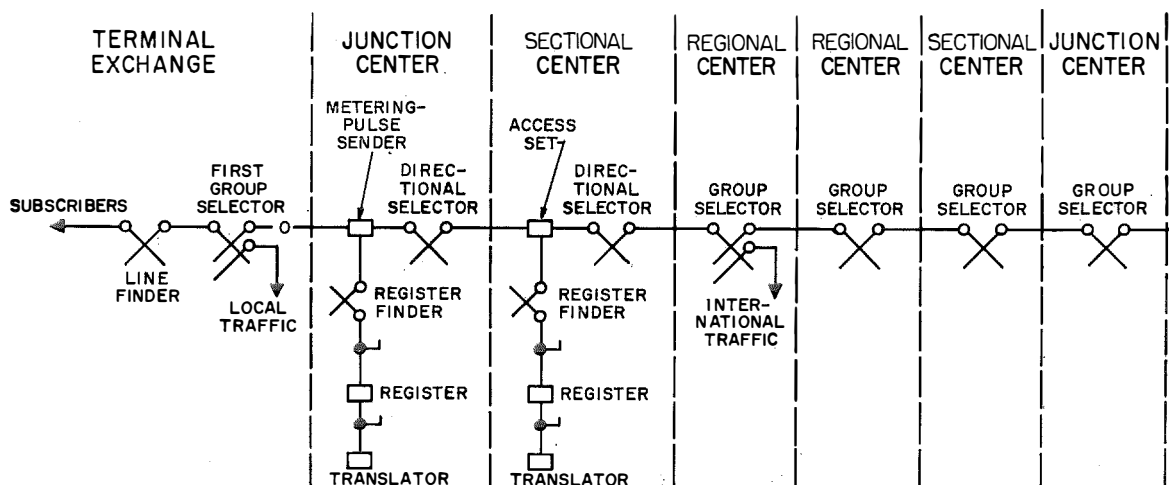

compassed by a single terminal exchange while open numbering is used in the toll network for direct distance dialing.

There are, however, some exceptions to the above-given numbering scheme and both 3- and 5-digit codes are also in use. The local areas served directly by the regional and sectional centers are designated by 3-digit codes, the final digit of which is always 1. The terminal exchange is then treated as a junction center. In lightly populated areas having a large number of small exchanges, 2-digit codes are used for the terminal exchanges, resulting in a 5-digit code.

There may also be regional centers having 2-digit codes. The German toll network now consists of 8 regional centers identified by digits 2 through 9. Any new regional centers must be given 2-digit codes, as 0 (in the second position) has been reserved for international traffic. It has been decided to reserve 12 through 19 for such additional regional centers, since 10 now designates manual positions and 11 is for special services.

Routing is determined by an evaluation of the junction-center code, which is normally of 3 digits. Translators must therefore be designed

to operate on 3 digits but include provision for later expansion to 4 digits. The junction-center code also contains an element that will indicate the rate for billing. For short distances, billing is based on the distance between the two junction centers and for longer distances between the regional centers involved. The fully automatic message-accounting system adopted works on the timed-pulse metering principle, pulses being transmitted to the calling-subscriber's meter during conversation. The pulses are arranged to be transmitted more frequently as the distance involved in the call increases. The subscriber's meter registers both local and toll charges without distinction between them. Tax indication facilities installed at the subscriber's premises permit determination of the charges. With these, a highly specialized line of automatic message-accounting devices has been developed for installation at the subscribers' premises and is particularly useful in private automatic branch exchanges.

Conversion of the toll network to direct distance dialing was started around 1954 after intensive study and some large-scale experimentation. (First distance dialing in Germany was in 1923.) At the time, register-controlled quadrangle selectors had been installed to interconnect the most-important traffic centers. Within a short time these early installations noticeably relieved the heavily loaded long-distance manual switching system. These first stages were extended in the following years with improved switching means, such as motor switches and relay crosspoint networks, and increased flexibility of routing. Figure 1 shows the present structure of the toll network.

3. Operations in Direct Distance Dialing in the German Network

On lifting the handset and hearing dial tone, the subscriber dials 0 to obtain access to a metering-pulse sender in the junction center to which his terminal exchange is connected. The metering-pulse sender is then automatically connected to a register through a register finder.

TERMINAL EXCHANGE

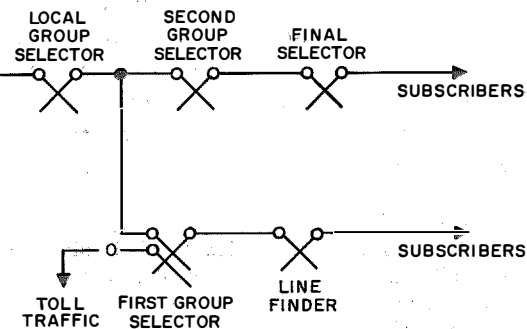

Quasi-Electronic Translator in Distance Dialing

The register stores all the following pulse trains dialed by the subscriber. When 3 digits, identifying the junction center, have been received, they are switched through to the translator for evaluation. With a holding time of only 80 milliseconds, the translator supplies zoning and routing instructions to the register, the zoning data being transferred to the metering-pulse sender to initiate connection of the appropriate meter pulse train after the beginning of the conversation. The routing instruction is sent to the marker of the next switching stage either via the register to control a motor switch or directly to operate a relay network.

After this, the call is extended from the junction center to a following center. If this is the associated sectional center, a register is seized through a connecting link and a register finder. The junction-center register then forwards the 3-digit routing instruction to the sectional-center register, which immediately interro-

gates its translator with each digit to save time. Further evaluation of zoning for accounting purposes, of course, is not needed again. The routing instruction initiates setting of the next switching stage and a proceed-to-send signal is sent to the junction center. Transmission of subsequent dial pulse trains and setting of the following switches then begins. As soon as the final selector in the destination terminal exchange has been set, an appropriate signal is returned to the junction center to release its register.

If a busy signal is encountered, the junction center releases the connection and connects busy tone to the calling subscriber. If the called subscriber answers, the final selector of the destination office transmits a signal to the metering-pulse sender in the junction center to initiate charging pulses. When the calling subscriber replaces the handset on its cradle the connection is released. If, however, the called subscriber replaces the handset first, a backward clearing signal is transmitted to initiate release of the connection from the junction center onward. To provide time for a called subscriber to interrupt a call briefly, for example to continue it from another room, this release is effected between 1 and 2 minutes after the handset has been replaced. Metering stops immediately with the release of the connection.

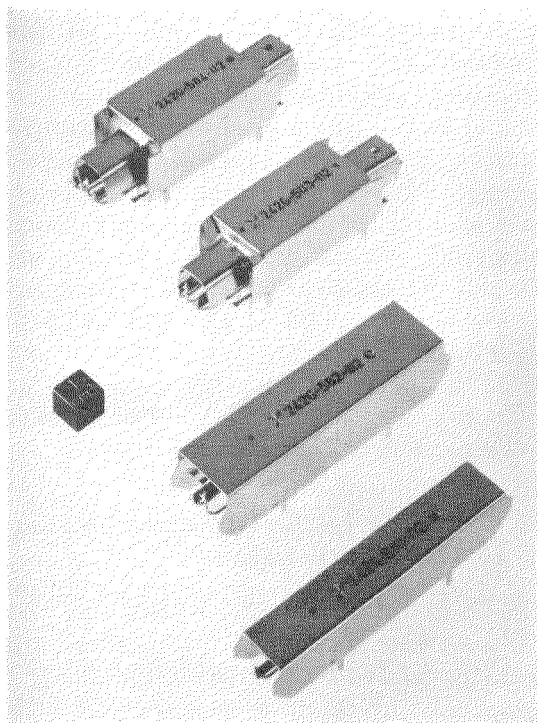

Figure 2—Herkon relays designed for mounting on printed-circuit cards.

4. Common Translators

The translators used in the German network are centralized. They are associated with several registers, being connected briefly as needed. They must, therefore, have high operating speed. For this reason earlier designs were fully electronic, employing diodes, transistors, and resistors. Although years of operation showed them to be free of errors and reliable, quasi-electronic* translators have been devel-

* Quasi-electronic, as distinguished from semi-electronic, indicates that in addition to electronic components all contacts are of the sealed reed type and have operating reliability comparable to that of high-grade electronic components.

oped around the Herkon relay for economy and compatibility. The highly reliable Herkon relay, shown in Figure 2, with its contacts sealed in an evacuated enclosure, leads to translators that are less expensive than corresponding fully electronic devices. These translators fit readily into the plant that uses relays extensively for registers, metering-pulse senders, et cetera, and operate from the same power sources.

Concerning speed, the extremely high switching speed of the fully electronic translator cannot be used in practice as it must operate in conjunction with the much-slower receiving devices in the registers. Both fully electronic and Herkon translators have identical holding times of approximately 80 milliseconds. The life of the Herkon relay, based on the number of operating cycles under full load, is fully adequate. Its life is further extended as the

contacts never close while there is a voltage difference across them or open while carrying current.

5. Operating Principles of the Herkon Translator

As indicated in Figure 3, the inputs to the translator from the register consist of one 2-wire and three 10-wire paths. The three 10-wire paths handle the digits designating the regional, sectional, and junction centers. When the regional centers require 2 digits, the 2-wire path will accommodate the additional digit as well as the special services that it now serves.

These input wires are arranged vertically on the input jumpering frame of the translator. Crossing these vertical wires are horizontal wires comprising the inputs to that number of code evaluators required for the particular

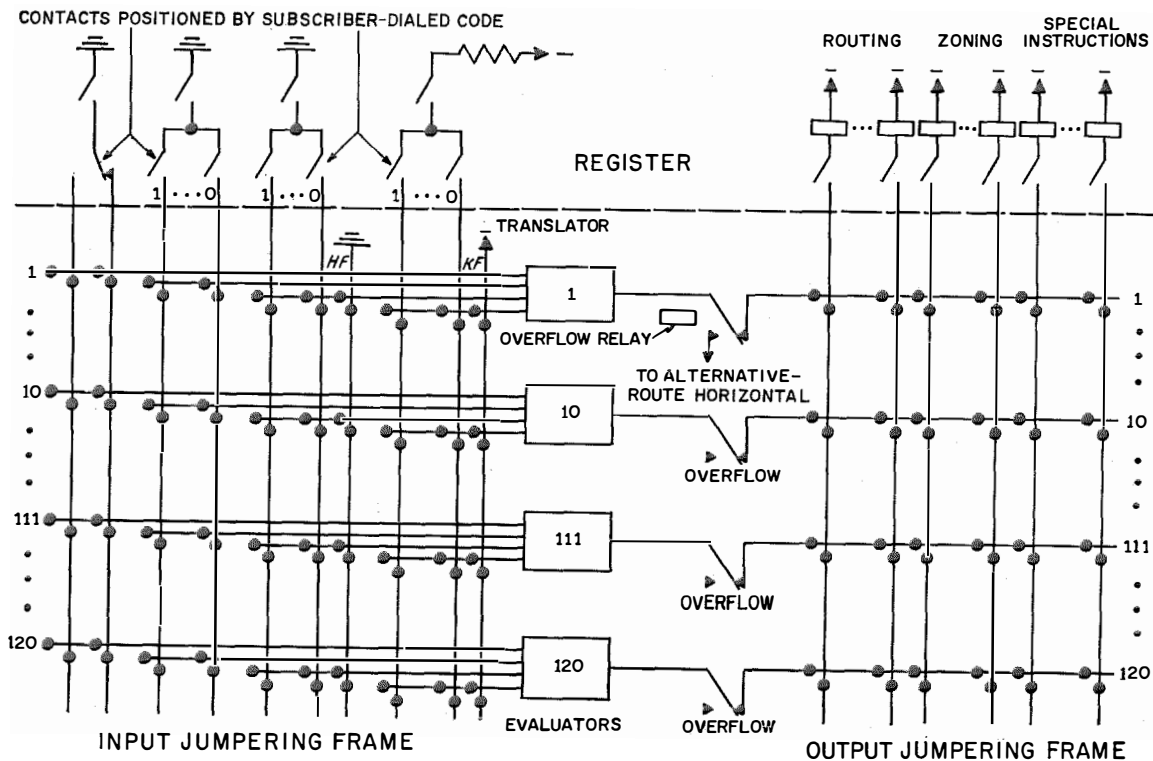

Figure 3—Circuit diagram of the Herkon translator.

Quasi-Electronic Translator in Distance Dialing

installation. Simple jumpering between vertical and horizontal wires permits each register output to be connected to the evaluator that will provide proper translation for the code dialed by the subscriber. The output from the actuated evaluator is then sent back to the register through the output jumpering frame as zoning and routing instructions.

5.1 CODE EVALUATOR

The basic circuit of the Herkon translator is shown in Figure 4. Output wire *A* is connected to ground only when the connections to all 4 input wires, *E1* through *E4*, are completed. This grounding of *A* is transferred through the output jumpering frame to relays in the register, giving the zoning and routing instructions for the toll network.

5.2 INPUT JUMPERING FRAME

In the input jumpering frame of Figure 3, the vertical input wires are connected to the appropriate horizontal wires at the crosspoints either directly or through rectifiers.

Only one code evaluator is switched through for the routing instruction and one for the zoning information. To avoid ambiguous instructions, codes leading to identical instructions are concentrated on one horizontal and connected to the same evaluator, provided this does not lead to undesirable coupling and erroneous code evaluation.

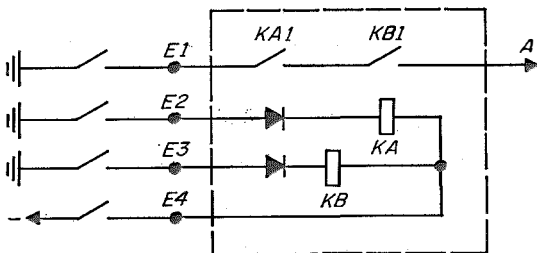

Figure 4—Basic coincidence circuit for the Herkon translator.

Two or more codes that should produce the same instructions may be combined if they differ in only one digit, for example 711, 712, and 713 differ only in the last digit. It would not be permissible to combine 711 and 723 without special precautions, however, because codes 713 and 721 would also be involved. Such combinations are permissible if all 4 codes, 711, 713, 721, and 723, are to produce the same instruction.

Frequently fewer than 3 or 4 digits are sufficient to determine the translated instructions. Therefore the sectional-center register, which serves only for routing, supplies each digit to the translator as it is received. To avoid modification of the evaluation circuit, abbreviated signaling is made possible by jumpering the unneeded (last 1 or 2) inputs for the evaluator circuit to the *HF* or *KF* verticals (Figure 3).

The translators used in the German toll network, which serves approximately 3800 terminal exchanges, require between 80 and 120 code evaluators.



Figure 5—Installation of 2 translators and their common test equipment.

5.3 OUTPUT JUMPERING FRAME

The output wires from the evaluators become the horizontal wires in the output jumpering frame. The instructions go back to the register via vertical wires with all jumpering at cross-points being through rectifiers. Instructions consist of directional information for one or two switching stages, special instructions such as for absorbing certain code digits that are no longer required, and zoning information to control the pulse trains for billing.

5.4 OVERFLOW CONTROL

An overflow facility operates when all trunks of a route are busy. It connects the output horizontal wire from the evaluation circuit calling for that route to another horizontal wire that will provide for an alternative route. This is shown in Figure 3. If an alternative route is not available or for some reason should not be provided, a busy signal is given to the register, which immediately releases.

The operating principles of this overflow control do not always prevent useless tests of lines by motor-driven selectors in a hunt for a free outlet. In some cases during the time interval between the original routing instruction from

the translator to the register and the operation of the selector, the condition of the trunk lines may change. Also, a selector may not find a free outlet in a graded group as such groups have more lines than outlets in a particular direction. This condition would not be known to the overflow control. In such cases an automatic overflow will be effected by the selectors themselves.

6. Mechanical Construction

The importance of the translator in serving many registers on a one-at-a-time basis requires high reliability and good accessibility to its elements for maintenance and repair. Figure 5 shows 2 translators with a rack of common test equipment between them. The input and output jumpering frames comprise the left portion of each translator and the code evaluators are in the boxes at the right. Jumpering may be by soldered-in wires or by plugs such as those shown in Figure 6.

Five code evaluators are mounted on a single plug-in unit, shown in Figure 7, and may be quickly replaced in case of a fault. Each circuit comprises 2 rectifiers and 2 Herkon relays, each having a single normally open contact and its operate coil.

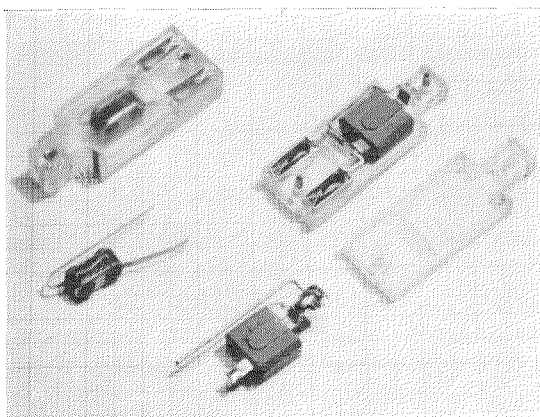

Figure 6—Jumpering plugs for use on the input and output frames.

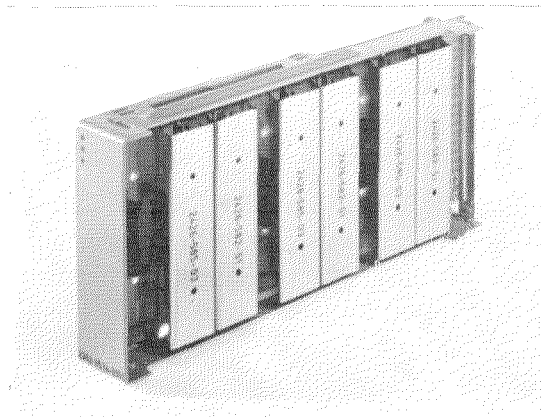

Figure 7—Plug-in unit mounting 5 code evaluators.

7. Test Facilities

If a switching center has two translators because of traffic density or for reliability of service, the test equipment may perform routine tests, for example twice per day. The same input code will be offered to both translators and their output instructions compared to detect any difference. A fault will interrupt the routine and be displayed. This automatic test occurs only when no registers require the use of a translator. If only one translator is installed, the test equipment checks the instructions for each call. Deviations are signaled immediately.

8. Application

As its mean holding time for a call is 80 milliseconds, a translator can theoretically handle 20 000 register inquiries per hour. This is ample for most switching centers. If two translators are installed for reliability, the registers are divided into 2 groups, each connected to a different translator. Connection facilities are provided to permit one translator to serve both groups of registers if necessary.

The German network uses a standard translator for all switching centers. In the junction center, the translator supplies routing, zoning, and any required special instructions. In the sectional

center, it is used exclusively for routing and special instructions. As every sectional center includes a junction center for connection of the terminal exchanges, the translator in the sectional center is used by both the sectional and junction center registers.

As all calls must clear through the translator, the destination-area codes can be counted to provide statistical data on traffic flow. Up to 10 such destination-area codes or combinations of codes may be monitored simultaneously by jumpering them on 10 horizontals with the associated evaluator outputs connected to counters. In some cases several input codes can be concentrated on a single horizontal.

The simple electrical and mechanical design of the translator permits its easy adaptation to changing requirements. A type is being developed for international subscriber dialing and must evaluate 6 calling digits and an additional call-origination signal. It must be suitable for either subscriber or operator dialing and must supply instructions for routing and for international accounting, including both country and zone. Greater use will be made of plug-in assemblies, including those for the input and output jumpering boards. These will save space and permit jumpering operations to be done unhurriedly on spare boards.

Theodor Burian was born in 1930 in Brünn, Czechoslovakia. In 1957 he graduated as a Diplom-Ingenieur from Technische Hochschule in Stuttgart.

In 1957, he joined Standard Elektrik Lorenz and is now concerned with circuit design of telephone switching especially in the field of toll dialing systems.

H. Nordsieck was born in 1927 in Bad Homburg, Germany. In 1953, he graduated as a

Diplom-Ingenieur from Technische Hochschule in Aachen.

In 1953, he joined Standard Elektrik Lorenz, where he was concerned with the development of telephone switching systems.

From 1956 to 1957, he was transferred to Standard Electric Puhelinteollisuus in Finland. On his return to Standard Elektrik Lorenz, he was assigned to the development of crossbar switching systems and is now engaged in planning of switching systems.

Mr. Nordsieck is a member of Nachrichtentechnische Gesellschaft.

World's Telephones—1963 *

More telephones were added during 1962 throughout the world than in any other year—9 200 000—representing a gain of 6.1 percent. The largest previous gain was 8 800 000, which occurred during 1959. With rapid gains, countries outside the United States are accounting for a larger share of the new telephones: 61 percent for 1962 compared with only 51 percent ten years earlier. Nevertheless, all but 14 percent of the world's telephones are

concentrated in North America and Europe. In Asia, with the third-largest number of stations but the lowest number in relation to population for any continent, Japan added more than a million telephones in 1962.

The table lends some perspective to the world gain in telephones over the past decade. It includes data for continents arranged in descending order of the ratio of telephones to population. There is some tendency for those continents with the lowest development to experience the most-rapid rates of increase in telephones.

* Abridgement from the 1963 issue of a booklet, "The World's Telephones," published yearly by the chief statistician's office of the American Telephone and Telegraph Company, New York, New York.

TABLE 1
TELEPHONES IN CONTINENTAL AREAS—1 JANUARY 1963

Area	Total			Privately Operated		Automatic	
	Number 1963	Percent of World	Per 100 Population	Number 1963	Percent of Total	Number 1963	Percent of Total
North America	87 029 400	54.7	42.2	85 967 100	98.8	84 880 200	97.5
Middle America	1 275 800	0.8	1.7	902 700	70.8	1 115 700	87.5
South America	3 732 600	2.3	2.4	1 794 500	48.1	3 233 700	86.6
Europe	49 734 800	31.2	8.2	8 634 300	17.4	42 253 600	85.0
Africa	2 155 100	1.4	0.8	27 800	1.3	1 637 200	76.0
Asia (1)	11 677 200	7.3	0.6	7 387 500	63.3	8 557 100	73.3
Oceania	3 595 100	2.3	20.9	270 400	7.5	2 882 000	80.2
World	159 200 000	100.0	5.0	104 984 300	65.9	144 559 500	90.8

(1) These data include allowances for the Asiatic parts of Turkey and the Soviet Union.

TABLE 2
YEARLY TOTAL NUMBER OF TELEPHONES IN SERVICE

Area	1962	1961	1960	1959	1958	1953
North America	83 186 400	79 830 600	76 036 400	71 799 300	68 484 000	51 430 800
Middle America	1 167 300	1 075 900	1 008 000	910 800	835 900	627 400
South America	3 475 500	3 337 600	3 145 900	2 999 600	2 845 000	2 094 800
Europe	46 377 000	43 172 700	40 340 900	37 598 100	35 218 700	24 324 000
Africa	2 081 800	2 005 300	1 904 500	1 768 600	1 663 200	1 084 300
Asia (1)	10 303 300	9 053 400	8 110 000	6 855 700	6 062 500	3 428 700
Oceania	3 408 700	3 224 500	3 054 300	2 867 900	2 690 700	1 910 000
World	150 000 000	141 700 000	133 600 000	124 800 000	117 800 000	84 900 000

(1) These data include allowances for the Asiatic parts of Turkey and the Soviet Union.

World's Telephones—1963

	Telephones per 100 Population Jan. 1, 1963	Average Annual Increase in Telephones 1953-1963	Distribution of Telephones Added 1953-1963
North America:	42.2	5.4%	47.9%
United States	43.1	5.3	43.9
Remainder	33.7	6.5	4.0
Oceania	20.9	6.5	2.3
Europe	8.2	7.4	34.2
South America	2.4	6.0	2.2
Middle America	1.7	7.4	0.9
Africa	0.8	7.1	1.4
Asia	0.6	13.0	11.1
Total	5.0	6.5	100.0

Beginning in June, the fourth and longest of the transatlantic telephone cables was laid, linking the United States directly with England. Early in 1963 a telephone cable was constructed from the State of Florida to Jamaica, and thence to the Panama Canal Zone. The British Commonwealth Pacific cable, linking Canada, Hawaii, Fiji, New Zealand, and Australia, was also opened during the year.

TABLE 3
TELEPHONES BY COUNTRIES AS OF 1 JANUARY 1963

Country or Area	Number of Telephones	Per 100 Population	Percent Automatic	Telephones by Type of Operation	
				Private	Government
NORTH AMERICA					
Canada	6 330 000	33.73	90.0	5 331 100	998 900
Greenland	0	—	—	—	—
St. Pierre and Miquelon	370	7.40	0.0	0	370
United States (1) (2)	80 699 000	43.05	98.1	80 636 000	63 000
MIDDLE AMERICA					
Bahamas	14 692	13.12	98.8	630	14 062
Barbados	11 520	4.74	100.0	11 520	0
Bermuda (3)	17 500	37.23	100.0	17 500	0
British Honduras	508	0.52	8.3	0	508
Canal Zone (3) (4)	8 472	24.21	100.0	0	8 472
Cayman Islands	32	0.36	0.0	0	32
Costa Rica	18,685	1.43	83.4	17 764	921
Cuba*	217 000	3.04	92.0	0	217 000
Dominican Republic	24 994	0.76	94.9	24 584	410
El Salvador*	20 000	0.70	50.0	0	20 000
Guadeloupe and Dependencies	4 688	1.59	0.0	0	4 688
Guatemala	19 235	0.47	91.4	0	19 235
Haiti*	4 400	0.10	86.0	0	4 400
Honduras	5 862	0.30	83.6	0	5 862
Jamaica	40 440	2.45	98.8	40 440	0
Leeward Islands:					
Antigua	1 045	1.77	0.0	0	1 045
Montserrat	220	1.69	0.0	0	220
St. Kitts	400	0.66	0.0	0	400
Total	1 665	1.25	0.0	0	1 665
Martinique	7 044	2.41	73.2	0	7 044
Mexico	613 909	1.62	83.8	612 730	1 179
Netherlands Antilles	16 077	8.08	100.0	4 019	12 058
Nicaragua	11 701	0.73	80.3	0	11 701
Panama	35 954	3.12	98.3	35 354	600
Puerto Rico	140 389	5.65	95.2	131 717	8 672
Trinidad and Tobago*	32 000	3.60	90.0	0	32 000
Turks and Caicos Islands	130	2.17	65.4	85	45
Virgin Islands (United Kingdom)	45	0.56	0.0	0	45
Virgin Islands (United States)	4 659	12.59	70.3	4 659	0

* Estimated.

- (1) Data for the State of Alaska are included. Data for the State of Hawaii are included under Oceania, rather than here under North America. Data for Alaska and Hawaii are included only for the years 1962 and 1963, after these Territories became States. Data for Alaska in 1963 are as follows: number of telephones, 49,951; per 100 population, 23.13.
- (2) The number shown as governmentally operated is estimated. More than half of such telephones are in the State of Alaska.

- (3) Data exclude telephone systems of the armed forces.
- (4) Data are as of 30 June of the year preceding that indicated.
- (5) Data are as of 31 March of the same year as that indicated.
- (6) Data for China (Mainland) are as of 1 January 1948. Those parts of the telephone system which are shown in the table as privately operated continued under such operation until 1949, when they came under government operation.
- (7) Data are as of 30 September of the year preceding that indicated.

TABLE 3—Continued
TELEPHONES BY COUNTRIES AS OF 1 JANUARY 1963

Country or Area	Number of Telephones	Per 100 Population	Percent Automatic	Telephones by Type of Operation	
				Private	Government
Windward Islands:					
Dominica	771	1.24	0.0	0	771
Grenada	1 705	1.89	100.0	1 705	0
St. Lucia	930	0.99	66.5	0	930
St. Vincent	600	0.73	0.0	0	600
Total	4 006	1.22	58.0	1 705	2 301
SOUTH AMERICA					
Argentina	1 399 565	6.48	88.4	98 515	1 301 050
Bolivia*	19 000	0.53	92.0	17 300	1 700
Brazil	1 152 115	1.51	83.0	1 091 825	60 290
British Guiana	9 159	1.51	91.2	0	9 159
Chile	220 581	2.73	81.7	219 081	1 500
Colombia*	350 000	2.34	98.0	21 000	329 000
Ecuador	37 616	0.81	96.9	0	37 616
Falkland Islands and Dependencies	430	21.50	0.0	0	430
French Guiana	1 150	3.19	0.0	0	1 150
Paraguay	12 181	0.65	92.0	0	12 181
Peru	117 415	1.00	86.1	117 415	0
Surinam	6 223	1.73	97.2	0	6 223
Uruguay	177 866	6.11	65.0	0	177 866
Venezuela	229 304	2.86	96.1	229 304	0
EUROPE					
Albania*	6 000	0.35	50.0	0	6 000
Andorra*	200	2.00	0.0	0	200
Austria	804 900	11.24	93.6	0	804 900
Belgium	1 285 357	13.91	92.6	0	1 285 357
Bulgaria*	206 700	2.57	48.0	0	206 700
Channel Islands:					
Guernsey and Dependencies	13 971	29.66	52.9	0	13 971
Jersey	19 881	31.56	63.3	0	19 881
Total	33 852	30.77	59.0	0	33 852
Czechoslovakia	1 206 711	8.68	83.7	0	1 206 711
Denmark	1 193 555	25.39	58.8	1 056 472	137 083
Finland	682 074	15.08	85.1	483 398	198 676
France	4 977 797	10.52	81.8	0	4 977 797
Germany, Democratic Republic	1 435 753	8.38	96.6	0	1 435 753
Germany, Federal Republic	7 047 031	12.37	99.8	0	7 047 031
Gibraltar (3)	3 398	12.59	100.0	0	3 398
Greece	302 843	3.58	94.2	0	302 843
Hungary	479 445	4.76	72.6	0	479 445
Iceland	45 041	23.96	72.2	0	45 041
Ireland	181 020	6.42	74.0	0	181 020
Italy	4 654 744	9.25	97.1	4 654 744	0
Liechtenstein	5 268	29.27	100.0	0	5 268
Luxemburg	62 750	19.49	99.1	0	62 750
Malta and Gozo (5)	18 047	5.49	91.0	0	18 047
Monaco	10 597	48.17	100.0	0	10 597
Netherlands	1 888 228	15.88	100.0	0	1 888 228
Norway	808 028	22.12	74.6	46 466	761 562
Poland	1 030 680	3.38	79.1	0	1 030 680
Portugal	455 063	5.09	76.1	318 069	136 994
Rumania	347 475	1.85	75.8	0	347 475
San Marino*	1 050	6.18	100.0	1 050	0
Spain	2 096 100	6.77	78.7	2 074 143	21 957
Sweden	3 053 752	40.28	93.5	0	3 053 752
Switzerland	1 875 225	32.90	100.0	0	1 875 225
Turkey	263 802	0.91	83.1	0	263 802
U.S.S.R.*	5 769 200	2.59	60.0	0	5 769 200
United Kingdom (5)	8 911 000	16.72	87.0	0	8 911 000
Yugoslavia	303 372	1.60	83.8	0	303 372
AFRICA					
Algeria	188 722	1.89	84.0	0	188 722
Angola	10 974	0.22	67.4	0	10 974
Ascension Island (3)	63	22.11	84.1	63	0
Basutoland	1 060	0.15	1.7	0	1 060
Bechuanaland	1 143	0.32	0.0	0	1 143

TABLE 3—Continued
TELEPHONES BY COUNTRIES AS OF 1 JANUARY 1963

Country or Area	Number of Telephones	Per 100 Population	Percent Automatic	Telephones by Type of Operation	
				Private	Government
Burundi	2 272	0.09	93.8	0	2 272
Cameroons	4 084	0.09	64.9	0	4 084
Cape Verde Islands	239	0.11	74.9	0	239
Central African Republic	1 919	0.12	89.1	0	1 919
Chad	2 227	0.08	86.1	0	2 227
Comoro Islands	50	0.03	0.0	0	50
Congo (Brazzaville)	6 570	0.73	90.5	0	6 570
Congo (Léopoldville)*	30 000	0.20	85.0	0	30 000
Dahomey*	2 180	0.10	79.4	0	2 180
Ethiopia	14 811	0.07	81.5	0	14 811
Gabon	2 415	0.53	92.4	0	2 415
Gambia	908	0.31	95.2	0	908
Ghana	28 514	0.40	71.1	0	28 514
Guinea*	4 200	0.13	72.0	0	4 200
Ifni	230	0.46	0.0	0	230
Ivory Coast	10 591	0.31	80.9	0	10 591
Kenya	45 873	0.49	81.8	0	45 873
Liberia*	2 600	0.20	100.0	600	2 000
Libya*	13 400	1.07	52.0	0	13 400
Malagasy	16 361	0.28	62.0	0	16 361
Mali	3 400	0.08	65.0	0	3 400
Mauritania*	350	0.04	0.0	0	350
Mauritius and Dependencies	9 973	1.45	66.6	0	9 973
Morocco	132 879	1.07	89.9	17 837	115 042
Mozambique	15 531	0.23	73.2	0	15 531
Niger	1 661	0.05	78.2	0	1 661
Nigeria	53 949	0.15	72.5	0	53 949
Portuguese Guinea	480	0.09	0.0	0	480
Réunion	7 093	1.97	0.0	0	7 093
Rhodesia and Nyasaland:					
Northern Rhodesia	27 301	1.06	95.5	0	27 301
Nyasaland	5 886	0.20	89.1	0	5 886
Southern Rhodesia	88 362	2.25	88.8	0	88 362
Total	121 549	1.28	90.3	0	121 549
Ruanda	693	0.02	0.0	0	693
Sahara, Spanish	540	2.16	0.0	0	540
St. Helena	132	2.64	0.0	0	132
São Tomé and Príncipe	432	0.66	68.3	0	432
Sénégal*	23 000	0.76	75.0	0	23 000
Seychelles and Dependencies	247	0.55	100.0	247	0
Sierra Leone*	5 100	0.20	78.0	50	5 050
Somalia*	2 100	0.10	0.0	0	2 100
Somaliland, French	1 726	2.47	100.0	0	1 726
South Africa	(5) 1 017 518	6.02	71.5	0	1 017 518
South West Africa	17 982	3.27	41.0	0	17 982
Spanish Equatorial Region	1 121	0.43	86.3	1 121	0
Spanish North Africa	7 858	5.04	100.0	7 858	0
Sudan	29 115	0.23	82.0	0	29 115
Swaziland	2 452	0.88	53.8	0	2 452
Tanganyika	17 596	0.18	73.8	0	17 596
Togo	2 477	0.16	76.2	0	2 477
Tunisia	30 223	0.70	57.3	0	30 223
Uganda	15 098	0.21	84.2	0	15 098
United Arab Republic	250 158	0.90	82.0	0	250 158
Upper Volta*	1 300	0.03	0.0	0	1 300
Zanzibar and Pemba	1 750	0.54	74.3	0	1 750
ASIA					
Aden	6 226	2.83	100.0	0	6 226
Afghanistan	8 665	0.06	58.3	0	8 665
Bahrein	4 474	2.83	100.0	4 474	0
Bhutan	0	—	—	—	—
Brunei*	900	0.99	97.0	0	900
Burma	18 816	0.08	71.7	0	18 816
Cambodia	3 527	0.06	78.7	0	3 527
Ceylon	38 618	0.37	96.2	0	38 618
China, Mainland	(6) 244 028	0.05	72.9	94 945	149 083
China, Taiwan	120 306	1.05	65.2	0	120 306

TABLE 3—Continued
TELEPHONES BY COUNTRIES AS OF 1 JANUARY 1963

Country or Area	Number of Telephones	Per 100 Population	Percent Automatic	Telephones by Type of Operation	
				Private	Government
Cyprus	22 092	3.78	99.3	0	22 092
Hong Kong	145 719	4.13	100.0	145 719	0
India (5)	602 630	0.13	62.5	3 655	598 975
Indonesia	139 613	0.14	17.4	0	139 613
Iran*	155 000	0.72	75.0	0	155 000
Iraq*	56 800	0.84	86.0	0	56 800
Israel	153 984	6.56	98.9	0	153 984
Japan (5)	7 356 007	7.72	76.3	7 356 007	0
Jordan*	24 000	1.38	70.0	0	24 000
Korea, North	n.a.	—	—	—	—
Korea, Republic of	139 327	0.53	54.2	0	139 327
Kuwait	16 826	5.16	100.0	2 019	14 807
Laos	847	0.04	53.1	0	847
Lebanon*	70 700	4.06	95.0	0	70 700
Macao	2 615	1.52	100.0	0	2 615
Malaysia, Federation of:					
Malaya	90 213	1.22	75.9	0	90 213
Sabah	4 551	0.96	99.5	0	4 551
Sarawak	5 689	0.73	78.3	0	5 689
Singapore	67 903	3.86	100.0	0	67 903
Total	168 356	1.61	86.3	0	168 356
Maldive Islands	0	—	—	—	—
Mongolia	10 525	1.03	73.3	0	10 525
Muscat and Oman	261	0.05	100.0	261	0
Nepal	1 155	0.01	97.0	0	1 155
Pakistan	94 171	0.10	72.5	0	94 171
Philippine Republic	139 659	0.46	79.8	124 079	15 580
Portuguese Timor	523	0.10	0.0	0	523
Qatar	3 564	6.36	100.0	3 564	0
Ryukyu Islands* (3)	13 700	1.52	74.0	0	13 700
Saudi Arabia (4)	25 284	0.36	35.6	0	25 284
Sikkim	0	—	—	—	—
South Arabia, Protectorate of	0	—	—	—	—
Syria	58 609	1.14	87.3	0	58 609
Thailand (7)	49 730	0.18	85.2	0	49 730
Trucial Oman	600	0.52	100.0	600	0
Viet Nam, Democratic Republic	n.a.	—	—	—	—
Viet Nam, Republic of	18 054	0.12	80.7	0	18 054
West Irian*	2 700	0.36	14.0	0	2 700
Yemen	500	0.01	0.0	0	500
OCEANIA					
Australia (4)	2 382 478	22.26	80.0	0	2 382 478
British Solomon Islands	446	0.35	9.2	0	446
Canton Island	60	15.00	100.0	0	60
Caroline Islands	750	1.39	0.0	0	750
Christmas Island (4)	103	3.22	100.0	103	0
Cocos (Keeling) Islands	63	6.30	100.0	0	63
Cook Islands	341	1.89	0.0	0	341
Fiji Islands	8 636	2.02	59.7	0	8 636
Gilbert and Ellice Islands	0	—	—	—	—
Guam	16 418	24.50	100.0	0	16 418
Mariana Islands (less Guam)	350	4.67	71.4	0	350
Marshall Islands	1 037	7.41	98.8	0	1 037
Midway Island	1 225	40.83	100.0	0	1 225
Nauru	0	—	—	—	—
New Caledonia and Dependencies	3 807	4.82	75.2	0	3 807
New Hebrides Condominium	430	0.67	100.0	0	430
New Zealand (5)	850 572	33.58	74.5	0	850 572
Niue Island	102	2.04	0.0	0	102
Norfolk Island	37	3.70	0.0	0	37
Papua and New Guinea	7 613	0.37	81.3	0	7 613
Pitcairn Island	0	—	—	—	—
Polynesia, French	1 858	2.21	0.0	0	1 858

TABLE 3—Continued
TELEPHONES BY COUNTRIES AS OF 1 JANUARY 1963

Country or Area	Number of Telephones	Per 100 Population	Percent Automatic	Telephones by Type of Operation	
				Private	Government
Samoa, American	550	2.62	100.0	0	550
Samoa, Western	1 108	0.96	0.0	0	1,108
Tokelau Islands	0	—	—	—	—
Tonga (Friendly) Islands	623	0.92	0.0	0	623
United States: Hawaii	270 322	38.34	100.0	270 322	0
Wake Island	132	10.56	100.0	0	132

TABLE 4
TELEPHONE CONVERSATIONS DURING 1962

Country or Area	Thousands of Conversations			Average Conversations per Person
	Local	Long Distance	Total	
Aden	8 076	2	8 078	36.7
Angola	20 607	389	20 996	4.3
Argentina	4 259 481	50 956	4 310 437	201.3
Australia	1 650 000	76 500	1 726 500	162.8
Bahamas, West Indies	29 675	219	29 894	269.3
Barbados, West Indies	24 000	17	24 017	100.1
Belgium	681 848	149 935	831 783	90.2
Bermuda	17 000	80	17 080	371.3
Brazil	6 238 490	104 206	6 342 696	84.3
British Guiana	8 006	750	8 756	14.6
Canada	11 164 500	244 400	11 408 900	613.4
Ceylon	92 907	5 691	98 598	9.4
Channel Islands	18 044	970	19 014	172.9
Chile	545 518	22 529	568 047	71.0
China, Taiwan	414 312	14 060	428 372	37.8
Congo (Brazzaville)	5 346	557	5 903	6.6
Costa Rica	50 348	1 201	51 549	40.4
Cyprus	22 377	2 401	24 778	42.7
Czechoslovakia	823 366	107 589	930 955	67.2
Denmark	1 239 735	290 789	1 530 524	326.9
Ethiopia	24 077	985	25 062	1.2
Fiji Islands	8 400	852	9 252	22.0
France	1 050 200	725 366	1 775 566	37.8
Germany, Democratic Republic	845 971	176 067	1 022 038	59.6
Germany, Federal Republic	3 809 533	1 372 316	5 181 849	91.3
Gibraltar	9 449	103	9 552	353.8
Greece	696 544	17 110	713 654	84.4
Guadeloupe	2 099	405	2 504	8.7
Hungary	539 938	33 288	573 226	57.0
Iceland	94 617	2 899	97 516	527.1
Ireland	150 281	16 769	167 050	59.3
Italy	6 126 423	611 973	6 738 396	134.3
Ivory Coast	8 400	495	8 895	2.6
Jamaica, West Indies	63 600	960	64 560	39.3
Korea, Republic of	1 160 422	12 333	1 172 755	44.9
Liechtenstein	1 950	1 905	3 855	226.8
Malagasy	11 300	1 911	13 211	2.3
Malaya	219 311	23 150	242 461	33.1
Martinique	4 723	19	4 742	16.5
Mexico	1 269 274	24 352	1 293 626	34.7
Morocco	113 617	9 871	123 488	10.1
Mozambique	20 880	811	21 691	3.2
Netherlands	1 175 479	555 758	1 731 237	146.8
Netherlands Antilles	33 836	27	33 863	171.0
New Caledonia	2 347	239	2 586	32.7

TABLE 4—Continued
TELEPHONE CONVERSATIONS DURING 1962

Country or Area	Thousands of Conversations			Average Conversations per Person
	Local	Long Distance	Total	
Nigeria	51 877	3 655	55 532	1.5
Norway	593 317	61 436	654 753	179.9
Papua and New Guinea	5 731	141	5 872	2.9
Peru	579 931	7 843	587 794	51.1
Philippine Republic	1 018 834	1 358	1 020 192	34.4
Portugal	418 457	52 375	470 832	52.8
Puerto Rico	254 968	5 045	260 013	105.8
Réunion	2 878	128	3 006	8.4
Sarawak	13 035	760	13 795	17.9
Singapore	198 761	1 565	200 326	115.1
South Africa (2)	1 265 680	88 459	1 354 139	81.1
South West Africa	15 335	2 272	17 607	32.3
Sweden (3)	2 827 000	395 000	3 222 000	425.0
Switzerland	731 341	684 979	1 416 320	250.2
Thailand (4)	101 367	264	101 631	3.7
Tunisia	20 198	7 306	27 504	6.4
Turkey	277 427	17 695	295 122	10.2
United Arab Republic	570 619	17 326	587 945	21.5
United Kingdom (2)	4 796 000	549 300	5 345 300	100.3
United States	100 124 000	3 771 000	103 895 000	556.6
Uruguay	434 510	7 372	441 882	152.4
Viet Nam, Republic of	23 360	364	23 724	1.6
Virgin Islands (United States)	7 494	88	7 582	210.6
Yugoslavia	452 151	34 330	486 481	25.8

(1) Data are for the year ended 30 June 1962.
(2) Data are for the year ended 31 March 1962.

(3) Data are for the year ended 30 June 1963.
(4) Data are for the year ended 30 September 1962.

United States Patents Issued to International Telephone and Telegraph System; May-July 1963.

Between 1 May 1963 and 1 July 1963, the United States Patent Office issued 25 patents to the International System. The names of the inventors, company affiliations, subjects, and patent numbers are listed below.

D. Albanese, F. Beisel, Jr., J. Kearney, and E. Norton, Jr., ITT Laboratories, Aircraft Guiding System, 3 090 957.

E. A. Ash, Standard Telecommunication Laboratories (London), Electric Wave Generators, 3 090 886.

G. W. Bain, ITT Laboratories, System for Large-Area Display of Information, 3 090 828.

D. R. Barber, Standard Telecommunication Laboratories (London), Decoding Equipment, 3 094 688.

R. Bayer, H. U. Knauer, and G. Vogel, Standard Telephon und Telegraphen (Vienna), Circuit Arrangement for an Intercom System with Alternative Operation, 3 098 122.

E. Behun, R. E. Cronkwright, J. D. Griffith, K. F. Moore, and R. E. Stalcup, ITT Laboratories, System and Method for Determining the Attitude of a Space Vehicle, 3 090 583.

W. Bezdel, Standard Telecommunication Laboratories (London), Data-Storage and Data Processing Devices, 3 090 836.

A. E. Brewster, Standard Telecommunication Laboratories (London), Pulse Coding and Decoding Arrangements, 3 094 626.

T. G. Brown, Jr., ITT Federal Laboratories, Self Checking Digital Computer System, 3 098 994.

W. G. Brown, ITT Laboratories, Noise Reducing Circuit Employing the Information on Both Leading and Trailing Edges of Received Pulses, 3 094 667.

L. A. DeRosa, ITT Federal Laboratories, Navigation System, 3 099 006.

S. H. M. Dodington, ITT Laboratories, Pulse Shaping Klystron Modulator, 3 098 980.

A. R. Fitzsimons, ITT Kellogg, Control Circuits for Money Issuing System, 3 099 274.

W. L. Harries, ITT Laboratories, Semiconductor Multiplanar Rectifying Junction Diode, 3 094 633.

S. L. Hjertstrand, Standard Radio & Telefon (Stockholm), Magnetic Crossbar Switch, 3 099 727.

C. E. Kazimir, ITT Federal Laboratories, Encircling Tool, 3 093 943.

E. Kramar and F. Steiner, Standard Elektrik Lorenz (Stuttgart), Frequency Modulated Approach Beacon, 3 094 697.

H. K. Ligotky, ITT Kellogg, Pulse Correcting Amplifiers, 3 093 753.

J. V. Martens, Bell Telephone Manufacturing (Antwerp), Combined Limiter and Two Section Bandpass Filter, 3 098 937.

A. J. Montchause and R. P. LeComte, Compagnie Général de Constructions Téléphoniques (Paris), Relay-Contact Cutting Tool, 3 099 085.

A. E. Nashman and D. Metsky, ITT Laboratories, Electronic Accelerometer, 3 090 240.

T. B. Norling, ITT Kellogg, Telephone Security System, 3 098 901.

H. Ruckert, Standard Elektrik Lorenz (Stuttgart), Detection of Stamps on Documents, 3 090 870.

H. F. Sterling, Standard Telecommunication Laboratories (London), Method and Material for Heat Treating Fusible Material, 3 090 673.

A. Sunnen, International Standard Electric, Air Traffic Display System, 3 094 698.

Frequency Modulated Approach Beacon

3 094 697

E. Kramar and F. Steiner

This is a frequency-modulated approach beacon that transmits signals on a "Doppler" principle so that the signals may be received by standard airborne receivers for very-high-frequency omnidirectional radio ranges. It uses two linear arrays, the antennas of which are energized at a carrier frequency modulated in amplitude at a given frequency, and a second frequency differing from the first carrier frequency by a lower frequency. Switches are provided successively to energize antennas of the array by the two frequencies at a switching rate equal to the given frequency, the switching operations for the respective sources being in opposite directions along the array.

Circuit Arrangement for an Intercom System with Alternative Operations

3 098 122

R. Bayer, H. U. Knauer, and G. Vogel

An intercommunication system is described having a signal amplifier and control means at

a master station, to control the communication direction between a transducer at the master station and a transducer at the remote station or stations. The master and remote stations are interconnected by two control wires and a ground or reference wire. By switching devices, the remote station can signal the master station over the reference wire and one control wire. The direction of communication is then controlled from the master station by switches at that station.

Pulse Coding and Decoding Arrangements

3 094 626

A. E. Brewster

This patent covers a magnetic trigger device consisting of a magnetic yoke of high permeability and low retentivity surrounding a plurality of closed magnetic cores of higher retentivity and preferably rectangular hysteresis characteristics. Input trigger pulses are applied to a winding common to the closed magnetic cores but independent of the yoke. Input signal pulses are applied to a magnetizing winding on a pole piece of the yoke, producing a field across the cores of variable diminishing strength, to effect a quantized coding of the input signal.

Electric Wave Generators

3 090 886

E. A. Ash

A combined backward-wave oscillator and traveling-wave tube in which the electron beams for the two tube operations are both directed in the same direction. Separate but interconnected slow-wave structures are provided to cooperate with the respective beams, the output frequency of one structure propagating in a backward mode and the other structure in a forward mode.

Principal ITT System Products

Communication Equipment and Systems

automatic telephone and telegraph central office switching systems...private telephone and telegraph exchanges—PABX and PAX, electromechanical and electronic...carrier systems: telephone, telegraph, power-line, radio multiplex...long-distance dialing and signaling equipment...automatic message accounting and ticketing equipment...switchboards: manual (local, toll), dial-assistance...test boards and desk...telephones: desk, wall, pay-station, special-environment, field sets...automatic answering and recording equipment...microwave radio systems: line-of-sight, over-the-horizon...teleprinters and facsimile equipment...broadcast transmitters: AM, FM, TV...studio equipment...point-to-point radio communication...mobile communication: air, ground, marine, portable...closed-circuit television: industrial, aircraft, nuclear radiation...slow-scan television...intercommunication, paging, and public-address systems...submarine cable systems...coaxial cable systems

Data Handling and Transmission

data storage, transmission, display...data-link systems...railway and power control and signaling systems...information-processing and document-handling systems...analog-digital converters...alarm and signaling systems...telemetry

Navigation and Radar

electronic navigation...radar: ground and airborne...simulators: aircraft, radar...antisubmarine warfare systems...distance-measuring and bearing systems: Tacan, DMET, Vortac, Loran...Instrument Landing Systems (ILS)...air-traffic-control systems...direction finders: aircraft, marine...altimeters—flight systems

Space Equipment and Systems

simulators: missile...missile fuzing, launching, guidance, tracking, recording, and control systems...missile-range control and instrumentation...electronic countermeasures...power systems: ground-support, aircraft, spacecraft, missile...ground and environmental test equipment...programmers, automatic...infrared detection and guidance equipment...global and space communication, control, and data systems...system management: worldwide, local...ground transportable satellite tracking stations.

Commercial/Industrial Equipment and Systems

inverters: static, high-power...power-supply systems...mail-handling systems...pneumatic tube systems...instruments: test, measuring...oscilloscopes: large-screen, bar-graph...vibration test equipment...pumps: centrifugal, circulating (for domestic and industrial heating)...industrial heating and cooling equipment...automatic controls, valves, instruments, and accessories...nuclear instrumentation

Components and Materials

power rectifiers: selenium, silicon...transistors...diodes: signal, zener, parametric, tunnel...semiconductor materials: germanium, silicon, gallium arsenide...picture tubes...tubes: receiving, transmitting, rectifier, thyratron, image, storage, microwave, klystron, magnetron, traveling-wave...capacitors: paper, metallized paper, electrolytic, mica, plastic film, tantalum...ferrites...magnetic cores...relays: telephone, industrial, vacuum...switches: telephone (including crossbar), industrial...magnetic counters...magnetic amplifiers and systems...resistors...varistors, thermistors, Silistor devices...quartz crystals...filters: mechanical, quartz, optical...circuits: printed, thin-film, integrated...hermetic seals...photocells, photomultipliers, infrared detectors...antennas...motors: subfractional, fractional, integral...connectors: standard, miniature, micro-miniature...speakers and turntables.

Cable and Wire Products

multiconductor telephone cable...telephone wire: bridle, distribution, drop...switchboard and terminating cable...telephone cords...submarine cable and repeaters...coaxial cable: air and solid dielectric...waveguides...aircraft cable...power cable...domestic cord sets...fuses and wiring devices...wire, general-purpose

Consumer Products

television and radio receivers...high-fidelity phonographs and equipment...tape recorders...microphones and loudspeakers...refrigerators and freezers...air conditioners...hearing aids...home intercommunication equipment...electrical housewares

International Mobile Radio Equipment
Digitrac for Handling Radar Data
Diode Modulators Having Frequency-Selective Terminations
Microwave Telephone Relay Network in Mexico
Geographic Relay System for Railroad Interlocked Routing
High-Power Reflex Klystrons for Millimetre Wavelengths
Quartz-Crystal Frequency Standards
Electromechanical Filters for 50 to 500 Kilohertz
Tandem Wire Drawing and Plastic Insulation Extruding
Quasi-Electronic Translator in Telephone Direct Distance Dialing

VOLUME 39 • NUMBER 3 • 1964